

ETSI TS 137 340 V17.3.0 (2023-01)



**Universal Mobile Telecommunications System (UMTS);
LTE;
5G;
NR;
Multi-connectivity;
Overall description;
Stage-2
(3GPP TS 37.340 version 17.3.0 Release 17)**



ReferenceRTS/TSGR-0237340vh30

Keywords5G,LTE,UMTS

ETSI

650 Route des Lucioles
F-06921 Sophia Antipolis Cedex - FRANCE

Tel.: +33 4 92 94 42 00 Fax: +33 4 93 65 47 16

Siret N° 348 623 562 00017 - APE 7112B
Association à but non lucratif enregistrée à la
Sous-Préfecture de Grasse (06) N° w061004871

Important notice

The present document can be downloaded from:

<http://www.etsi.org/standards-search>

The present document may be made available in electronic versions and/or in print. The content of any electronic and/or print versions of the present document shall not be modified without the prior written authorization of ETSI. In case of any existing or perceived difference in contents between such versions and/or in print, the prevailing version of an ETSI deliverable is the one made publicly available in PDF format at www.etsi.org/deliver.

Users of the present document should be aware that the document may be subject to revision or change of status.

Information on the current status of this and other ETSI documents is available at

<https://portal.etsi.org/TB/ETSIDeliverableStatus.aspx>

If you find errors in the present document, please send your comment to one of the following services:

<https://portal.etsi.org/People/CommitteeSupportStaff.aspx>

If you find a security vulnerability in the present document, please report it through our
Coordinated Vulnerability Disclosure Program:

<https://www.etsi.org/standards/coordinated-vulnerability-disclosure>

Notice of disclaimer & limitation of liability

The information provided in the present deliverable is directed solely to professionals who have the appropriate degree of experience to understand and interpret its content in accordance with generally accepted engineering or other professional standard and applicable regulations.

No recommendation as to products and services or vendors is made or should be implied.

No representation or warranty is made that this deliverable is technically accurate or sufficient or conforms to any law and/or governmental rule and/or regulation and further, no representation or warranty is made of merchantability or fitness for any particular purpose or against infringement of intellectual property rights.

In no event shall ETSI be held liable for loss of profits or any other incidental or consequential damages.

Any software contained in this deliverable is provided "AS IS" with no warranties, express or implied, including but not limited to, the warranties of merchantability, fitness for a particular purpose and non-infringement of intellectual property rights and ETSI shall not be held liable in any event for any damages whatsoever (including, without limitation, damages for loss of profits, business interruption, loss of information, or any other pecuniary loss) arising out of or related to the use of or inability to use the software.

Copyright Notification

No part may be reproduced or utilized in any form or by any means, electronic or mechanical, including photocopying and microfilm except as authorized by written permission of ETSI.

The content of the PDF version shall not be modified without the written authorization of ETSI.

The copyright and the foregoing restriction extend to reproduction in all media.

© ETSI 2023.
All rights reserved.

Intellectual Property Rights

Essential patents

IPRs essential or potentially essential to normative deliverables may have been declared to ETSI. The declarations pertaining to these essential IPRs, if any, are publicly available for **ETSI members and non-members**, and can be found in ETSI SR 000 314: *"Intellectual Property Rights (IPRs); Essential, or potentially Essential, IPRs notified to ETSI in respect of ETSI standards"*, which is available from the ETSI Secretariat. Latest updates are available on the ETSI Web server (<https://ipr.etsi.org/>).

Pursuant to the ETSI Directives including the ETSI IPR Policy, no investigation regarding the essentiality of IPRs, including IPR searches, has been carried out by ETSI. No guarantee can be given as to the existence of other IPRs not referenced in ETSI SR 000 314 (or the updates on the ETSI Web server) which are, or may be, or may become, essential to the present document.

Trademarks

The present document may include trademarks and/or tradenames which are asserted and/or registered by their owners. ETSI claims no ownership of these except for any which are indicated as being the property of ETSI, and conveys no right to use or reproduce any trademark and/or tradename. Mention of those trademarks in the present document does not constitute an endorsement by ETSI of products, services or organizations associated with those trademarks.

DECT™, **PLUGTESTS™**, **UMTS™** and the ETSI logo are trademarks of ETSI registered for the benefit of its Members. **3GPP™** and **LTE™** are trademarks of ETSI registered for the benefit of its Members and of the 3GPP Organizational Partners. **oneM2M™** logo is a trademark of ETSI registered for the benefit of its Members and of the oneM2M Partners. **GSM®** and the GSM logo are trademarks registered and owned by the GSM Association.

Legal Notice

This Technical Specification (TS) has been produced by ETSI 3rd Generation Partnership Project (3GPP).

The present document may refer to technical specifications or reports using their 3GPP identities. These shall be interpreted as being references to the corresponding ETSI deliverables.

The cross reference between 3GPP and ETSI identities can be found under <http://webapp.etsi.org/key/queryform.asp>.

Modal verbs terminology

In the present document "**shall**", "**shall not**", "**should**", "**should not**", "**may**", "**need not**", "**will**", "**will not**", "**can**" and "**cannot**" are to be interpreted as described in clause 3.2 of the [ETSI Drafting Rules](#) (Verbal forms for the expression of provisions).

"**must**" and "**must not**" are **NOT** allowed in ETSI deliverables except when used in direct citation.

Contents

Intellectual Property Rights	2
Legal Notice	2
Modal verbs terminology.....	2
Foreword.....	6
1 Scope	7
2 References	7
3 Definitions, symbols and abbreviations	8
3.1 Definitions	8
3.2 Abbreviations	9
4 Multi-Radio Dual Connectivity.....	10
4.1 General	10
4.1.1 Common MR-DC principles.....	10
4.1.2 MR-DC with the EPC	10
4.1.3 MR-DC with the 5GC.....	11
4.1.3.1 E-UTRA-NR Dual Connectivity	11
4.1.3.2 NR-E-UTRA Dual Connectivity	11
4.1.3.3 NR-NR Dual Connectivity	11
4.2 Radio Protocol Architecture	11
4.2.1 Control Plane	11
4.2.2 User Plane.....	12
4.3 Network interfaces	14
4.3.1 Control Plane	14
4.3.1.1 Common MR-DC principles	14
4.3.1.2 MR-DC with EPC	15
4.3.1.3 MR-DC with 5GC	15
4.3.2 User Plane.....	15
4.3.2.1 Common MR-DC principles	15
4.3.2.2 MR-DC with EPC	16
4.3.2.3 MR-DC with 5GC	16
5 Layer 1 related aspects	16
6 Layer 2 related aspects	17
6.1 MAC Sublayer.....	17
6.2 RLC Sublayer.....	17
6.3 PDCP Sublayer.....	17
6.4 SDAP Sublayer	18
6.5 BAP Sublayer	18
7 RRC related aspects.....	18
7.1 System information handling	18
7.2 Measurements.....	18
7.3 UE capability coordination.....	20
7.4 Handling of combined MN/SN RRC messages.....	21
7.5 SRB3	21
7.6 Split SRB.....	22
7.7 SCG/MCG failure handling.....	22
7.8 UE identities.....	23
7.9 Inter-node Resource Coordination	23
7.10 UE assistance information.....	23
7.11 F1-C transfer over E-UTRA.....	24
7.14 RLM/BFD relaxation	25
8 Bearer handling aspects.....	25
8.1 QoS aspects	25

8.2	Bearer type selection	27
8.3	Bearer type change	28
8.4	User data forwarding	28
9	Security related aspects	29
10	Multi-Connectivity operation related aspects.....	30
10.1	General	30
10.2	Secondary Node Addition	30
10.2.1	EN-DC	30
10.2.2	MR-DC with 5GC.....	34
10.2.3	Conditional PSCell Addition	39
10.3	Secondary Node Modification (MN/SN initiated)	39
10.3.1	EN-DC	39
10.3.2	MR-DC with 5GC.....	46
10.4	Secondary Node Release (MN/SN initiated).....	52
10.4.1	EN-DC	52
10.4.2	MR-DC with 5GC.....	54
10.5	Secondary Node Change (MN/SN initiated)	56
10.5.1	EN-DC	56
10.5.2	MR-DC with 5GC.....	63
10.6	PSCell change	70
10.7	Inter-Master Node handover with/without Secondary Node change.....	71
10.7.1	EN-DC	71
10.7.2	MR-DC with 5GC.....	73
10.8	Master Node to eNB/gNB Change	75
10.8.1	EN-DC	75
10.8.2	MR-DC with 5GC.....	77
10.9	eNB/gNB to Master Node change.....	79
10.9.1	EN-DC	79
10.9.2	MR-DC with 5GC.....	80
10.10	RRC Transfer	81
10.10.1	EN-DC	81
10.10.2	MR-DC with 5GC.....	83
10.11	Secondary RAT data volume reporting	86
10.11.1	EN-DC	86
10.11.2	MR-DC with 5GC.....	87
10.12	Activity Notification.....	88
10.12.1	EN-DC	88
10.12.2	MR-DC with 5GC.....	91
10.13	Notification Control Indication	94
10.13.1	EN-DC	94
10.13.2	MR-DC with 5GC.....	94
10.14	PDU Session Split at UPF	94
10.14.1	PDU Session Split at UPF during PDU session resource setup.....	94
10.14.2	PDU Session Split at UPF during PDU session resource modify (5GC initiated).....	95
10.14.3	PDU Session Split at UPF (RAN initiated QoS flows offloading from MN to SN)	95
10.15	F1-C Traffic Transfer	98
10.16	Support of inter-system handover involving EN-DC or MR-DC with 5GC	99
10.16.1	General.....	99
10.16.2	Inter-system handover from EPS to 5GS with the Secondary Node used as target.....	99
10.16.3	Inter-system handover from 5GS to EPS with the Source Node used as target Secondary Node	100
10.17	Inter-Master Node RRC Resume without Secondary Node change	101
10.17.1	MR-DC with 5GC.....	101
10.18	Self-optimisation for PSCell change	103
10.18.1	General.....	103
10.18.2	PSCell change failure.....	103
10.19	Conditional Handover with Secondary Node	104
10.19.1	EN-DC	104
10.19.2	MR-DC with 5GC.....	106
11	Service related aspects.....	109
11.1	Roaming and Access Restrictions	109

11.2	Support of Network Sharing	109
11.3	ARPI/SPID Handling from MN	109
12	X2/Xn Interface related aspects	109
13	Other aspects	110
13.1	Interference avoidance for in-device coexistence	110
13.2	Sidelink	110
13.3	SCG UE history information	110
Annex A (informative):	Layer 2 handling for bearer type change	111
Annex B (informative):	Supported MR-DC Handover Scenarios	113
Annex C (informative):	Change history	114
History		119

Foreword

This Technical Specification has been produced by the 3rd Generation Partnership Project (3GPP).

The contents of the present document are subject to continuing work within the TSG and may change following formal TSG approval. Should the TSG modify the contents of the present document, it will be re-released by the TSG with an identifying change of release date and an increase in version number as follows:

Version x.y.z

where:

x the first digit:

- 1 presented to TSG for information;
- 2 presented to TSG for approval;
- 3 or greater indicates TSG approved document under change control.

Y the second digit is incremented for all changes of substance, i.e. technical enhancements, corrections, updates, etc.

Z the third digit is incremented when editorial only changes have been incorporated in the document.

1 Scope

The present document provides an overview of the multi-connectivity operation using E-UTRA and NR radio access technologies. Details of the network and radio interface protocols are specified in companion specifications of the 36 and 38 series.

2 References

The following documents contain provisions which, through reference in this text, constitute provisions of the present document.

- References are either specific (identified by date of publication, edition number, version number, etc.) or non-specific.
- For a specific reference, subsequent revisions do not apply.
- For a non-specific reference, the latest version applies. In the case of a reference to a 3GPP document (including a GSM document), a non-specific reference implicitly refers to the latest version of that document *in the same Release as the present document*.

- [1] 3GPP TR 21.905: "Vocabulary for 3GPP Specifications".
- [2] 3GPP TS 36.300: "Evolved Universal Terrestrial Radio Access (E-UTRA) and Evolved Universal Terrestrial Radio Access Network (E-UTRAN); Overall description; Stage 2".
- [3] 3GPP TS 38.300: "NR; NR and NG-RAN Overall description; Stage 2".
- [4] 3GPP TS 38.331: "NR; Radio Resource Control (RRC) protocol specification".
- [5] 3GPP TS 38.423: "NG-RAN; Xn application protocol (XnAP)".
- [6] 3GPP TS 38.425: "NG-RAN; NR user plane protocol".
- [7] 3GPP TS 38.401: "NG-RAN; Architecture description".
- [8] 3GPP TS 38.133: "NG-RAN; Requirements for support of radio resource management".
- [9] 3GPP TS 36.423: "Evolved Universal Terrestrial Radio Access Network (E-UTRAN); X2 Application Protocol (X2AP)".
- [10] 3GPP TS 36.331: "Evolved Universal Terrestrial Radio Access (E-UTRA); Radio Resource Control (RRC); Protocol specification".
- [11] 3GPP TS 23.501: "System Architecture for the 5G System; Stage 2".
- [12] 3GPP TS 38.101-1: "User Equipment (UE) radio transmission and reception; Part 1: Range 1 Standalone".
- [13] 3GPP TS 38.101-2: "User Equipment (UE) radio transmission and reception; Part 2: Range 2 Standalone".
- [14] 3GPP TS 38.101-3: "User Equipment (UE) radio transmission and reception; Part 3: Range 1 and Range 2 Interworking operation with other radios".
- [15] 3GPP TS 36.323: "Evolved Universal Terrestrial Radio Access (E-UTRA); Packet Data Convergence Protocol (PDCP) specification".
- [16] 3GPP TS 38.323: "NR; Packet Data Convergence Protocol (PDCP) specification".
- [17] 3GPP TS 38.340: "Backhaul Adaptation Protocol (BAP) specification".
- [18] 3GPP TS 23.287: "Architecture enhancements for 5G System (5GS) to support Vehicle-to-Everything (V2X) services".

- [19] 3GPP TS 23.285: "Architecture enhancements for V2X services".
- [20] 3GPP TS 23.502: "Procedures for the 5G System; Stage 2".
- [21] 3GPP TS 38.213: "NR; Physical layer procedures".
- [22] 3GPP TS 24.301: "Non-Access-Stratum (NAS) protocol for Evolved Packet System (EPS); Stage 3".
- [23] 3GPP TS 38.473: "F1 application protocol (F1AP)".
- [24] 3GPP TS 23.304: "Proximity based Services (ProSe) in the 5G System (5GS)".

3 Definitions, symbols and abbreviations

3.1 Definitions

For the purposes of the present document, the terms and definitions given in TR 21.905 [1] and the following apply. A term defined in the present document takes precedence over the definition of the same term, if any, in TR 21.905 [1] and TS 36.300 [2].

Child node: IAB-DU's or IAB-donor-DU's next hop neighbour IAB-node.

Conditional PSCell Addition: a PSCell addition procedure that is executed only when PSCell addition execution condition is met.

Conditional PSCell Change: a PSCell change procedure that is executed only when PSCell change execution condition is met.

En-gNB: node providing NR user plane and control plane protocol terminations towards the UE, and acting as Secondary Node in EN-DC.

Fast MCG link recovery: in MR-DC, an RRC procedure where the UE sends an MCG Failure Information message to the MN via the SCG upon the detection of a radio link failure on the MCG.

IAB-donor: gNB that provides network access to UEs via a network of backhaul and access links.

IAB-MT: IAB-node function that terminates the Uu interface to the parent node using the procedures and behaviours specified for UEs unless stated otherwise.

IAB-node: RAN node that supports NR access links to UEs and NR backhaul links to parent nodes and child nodes. The IAB-node does not support backhauling via E-UTRA.

Master Cell Group: in MR-DC, a group of serving cells associated with the Master Node, comprising of the SpCell (PCell) and optionally one or more SCells.

Master node: in MR-DC, the radio access node that provides the control plane connection to the core network. It may be a Master eNB (in EN-DC), a Master ng-eNB (in NGEN-DC) or a Master gNB (in NR-DC and NE-DC).

MCG bearer: in MR-DC, a radio bearer with an RLC bearer (or two RLC bearers, in case of CA packet duplication in an E-UTRAN cell group, or up to four RLC bearers in case of CA packet duplication in a NR cell group) only in the MCG.

MN terminated bearer: in MR-DC, a radio bearer for which PDCP is located in the MN.

MCG SRB: in MR-DC, a direct SRB between the MN and the UE.

Multi-Radio Dual Connectivity: Dual Connectivity between E-UTRA and NR nodes, or between two NR nodes.

Ng-eNB: as defined in TS 38.300 [3].

NR sidelink communication: AS functionality enabling at least V2X Communication as defined in TS 23.287 [18] and ProSe Communication (including ProSe UE-to-Network Relay and non-Relay communication) as defined in TS 23.304 [24], between two or more nearby UEs, using NR technology but not traversing any network node.

NR sidelink discovery: AS functionality enabling ProSe non-Relay Discovery and ProSe UE-to-Network Relay discovery for Proximity based Services as defined in TS 23.304 [24] between two or more nearby UEs, using NR technology but not traversing any network node.

Parent node: IAB-MT's next hop neighbour node; the parent node can be IAB-node or IAB-donor-DU.

PCell: SpCell of a master cell group.

PSCell: SpCell of a secondary cell group.

RLC bearer: RLC and MAC logical channel configuration of a radio bearer in one cell group.

Secondary Cell Group: in MR-DC, a group of serving cells associated with the Secondary Node, comprising of the SpCell (PSCell) and optionally one or more SCells.

Secondary node: in MR-DC, the radio access node, with no control plane connection to the core network, providing additional resources to the UE. It may be an en-gNB (in EN-DC), a Secondary ng-eNB (in NE-DC) or a Secondary gNB (in NR-DC and NGEN-DC).

SCG bearer: in MR-DC, a radio bearer with an RLC bearer (or two RLC bearers, in case of CA packet duplication in an E-UTRAN cell group, or up to four RLC bearers in case of CA packet duplication in a NR cell group) only in the SCG.

SN terminated bearer: in MR-DC, a radio bearer for which PDCP is located in the SN.

SpCell: primary cell of a master or secondary cell group.

SRB3: in EN-DC, NGEN-DC and NR-DC, a direct SRB between the SN and the UE.

Split bearer: in MR-DC, a radio bearer with RLC bearers both in MCG and SCG.

Split PDU Session (or PDU Session split): a PDU Session whose QoS Flows are served by more than one SDAP entities in the NG-RAN.

Split SRB: in MR-DC, a SRB between the MN and the UE with RLC bearers both in MCG and SCG.

User plane resource configuration: in MR-DC with 5GC, encompasses radio network resources and radio access resources related to either one or more PDU sessions, one or more QoS flows, one or more DRBs, or any combination thereof.

V2X sidelink communication: AS functionality enabling V2X Communication as defined in TS 23.285 [19], between nearby UEs, using E-UTRA technology but not traversing any network node.

3.2 Abbreviations

For the purposes of the present document, the abbreviations given in TR 21.905 [1] and the following apply. An abbreviation defined in the present document takes precedence over the definition of the same abbreviation, if any, in TR 21.905 [1] and TS 36.300 [2].

BFD	Beam Failure Detection
CHO	Conditional Handover
CLI	Cross Link Interference
CPA	Conditional PSCell Addition
CPAC	Conditional PSCell Addition or Change
CPC	Conditional PSCell Change
DAPS	Dual Active Protocol Stack
DC	Intra-E-UTRA Dual Connectivity
DCP	DCI with CRC scrambled by PS-RNTI
EN-DC	E-UTRA-NR Dual Connectivity
IAB	Integrated Access and Backhaul

MCG	Master Cell Group
MN	Master Node
MR-DC	Multi-Radio Dual Connectivity
NE-DC	NR-E-UTRA Dual Connectivity
NGEN-DC	NG-RAN E-UTRA-NR Dual Connectivity
NR-DC	NR-NR Dual Connectivity
RLM	Radio Link Monitoring
SCG	Secondary Cell Group
SMTC	SS/PBCH block Measurement Timing Configuration
SN	Secondary Node
V2X	Vehicle-to-Everything

4 Multi-Radio Dual Connectivity

4.1 General

4.1.1 Common MR-DC principles

Multi-Radio Dual Connectivity (MR-DC) is a generalization of the Intra-E-UTRA Dual Connectivity (DC) described in TS 36.300 [2], where a multiple Rx/Tx capable UE may be configured to utilise resources provided by two different nodes connected via non-ideal backhaul, one providing NR access and the other one providing either E-UTRA or NR access. One node acts as the MN and the other as the SN. The MN and SN are connected via a network interface and at least the MN is connected to the core network.

The MN and/or the SN can be operated with shared spectrum channel access.

All functions specified for a UE may be used for an IAB-MT unless otherwise stated. Similar as specified for UE, the IAB-MT can access the network using either one network node or using two different nodes with EN-DC and NR-DC architectures. In EN-DC, the backhauling traffic over the E-UTRA radio interface is not supported.

NOTE 1: MR-DC is designed based on the assumption of non-ideal backhaul between the different nodes but can also be used in case of ideal backhaul.

NOTE 2: All MR-DC normative text and procedures in this version of the specification show the aggregated node case. The details about non-aggregated node for MR-DC operation are described in TS 38.401 [7].

4.1.2 MR-DC with the EPC

E-UTRAN supports MR-DC via E-UTRA-NR Dual Connectivity (EN-DC), in which a UE is connected to one eNB that acts as a MN and one en-gNB that acts as a SN. The eNB is connected to the EPC via the S1 interface and to the en-gNB via the X2 interface. The en-gNB might also be connected to the EPC via the S1-U interface and other en-gNBs via the X2-U interface.

The EN-DC architecture is illustrated in Figure 4.1.2-1 below.

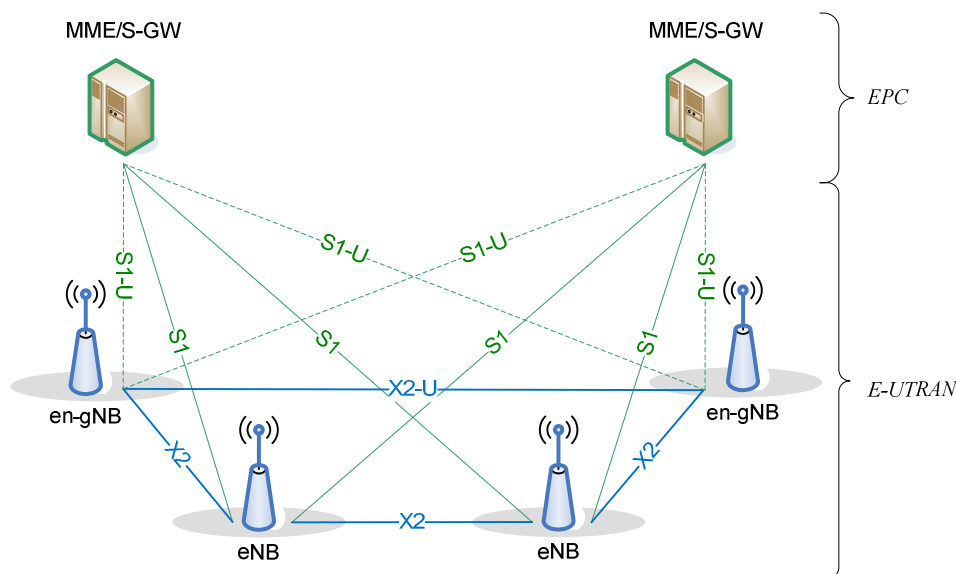

Figure 4.1.2-1: EN-DC Overall Architecture

4.1.3 MR-DC with the 5GC

4.1.3.1 E-UTRA-NR Dual Connectivity

NG-RAN supports NG-RAN E-UTRA-NR Dual Connectivity (NGEN-DC), in which a UE is connected to one ng-eNB that acts as a MN and one gNB that acts as a SN.

4.1.3.2 NR-E-UTRA Dual Connectivity

NG-RAN supports NR-E-UTRA Dual Connectivity (NE-DC), in which a UE is connected to one gNB that acts as a MN and one ng-eNB that acts as a SN.

4.1.3.3 NR-NR Dual Connectivity

NG-RAN supports NR-NR Dual Connectivity (NR-DC), in which a UE is connected to one gNB that acts as a MN and another gNB that acts as a SN. In addition, NR-DC can also be used when a UE is connected to a single gNB, acting both as a MN and as a SN, and configuring both MCG and SCG.

4.2 Radio Protocol Architecture

4.2.1 Control Plane

In MR-DC, the UE has a single RRC state, based on the MN RRC and a single C-plane connection towards the Core Network. Figure 4.2.1-1 illustrates the Control plane architecture for MR-DC. Each radio node has its own RRC entity (E-UTRA version if the node is an eNB or NR version if the node is a gNB) which can generate RRC PDUs to be sent to the UE.

RRC PDUs generated by the SN can be transported via the MN to the UE. The MN always sends the initial SN RRC configuration via MCG SRB (SRB1), but subsequent reconfigurations may be transported via MN or SN. When transporting RRC PDU from the SN, the MN does not modify the UE configuration provided by the SN.

In E-UTRA connected to EPC, at initial connection establishment SRB1 uses E-UTRA PDCP. If the UE supports EN-DC, regardless whether EN-DC is configured or not, after initial connection establishment, MCG SRBs (SRB1 and SRB2) can be configured by the network to use either E-UTRA PDCP or NR PDCP (either SRB1 and SRB2 are both configured with E-UTRA PDCP, or they are both configured with NR PDCP). Change from E-UTRA PDCP to NR PDCP (or vice-versa) is supported via a handover procedure (reconfiguration with mobility) or, for the initial change of SRB1 from E-UTRA PDCP to NR PDCP, with a reconfiguration without mobility before the initial security activation.

If the SN is a gNB (i.e. for EN-DC, NGEN-DC and NR-DC), the UE can be configured to establish a SRB with the SN (SRB3) to enable RRC PDUs for the SN to be sent directly between the UE and the SN. RRC PDUs for the SN can only be transported directly to the UE for SN RRC reconfiguration not requiring any coordination with the MN. Measurement reporting for mobility within the SN can be done directly from the UE to the SN if SRB3 is configured.

Split SRB is supported for all MR-DC options, allowing duplication of RRC PDUs generated by the MN, via the direct path and via the SN. Split SRB uses NR PDCP. This version of the specification does not support the duplication of RRC PDUs generated by the SN via the MN and SN paths.

In EN-DC, the SCG configuration is kept in the UE during suspension. During connection resumption, if the UE supports resuming with EN-DC, the UE can be configured to release, restore, or reconfigure the SCG configuration. Otherwise, the UE releases the SCG configuration (but not the radio bearer configuration) during resumption initiation.

In MR-DC with 5GC, the UE stores the PDCP/SDAP configuration and the SCG configuration when moving to RRC Inactive. During connection resumption, if the UE supports resuming with MR-DC, the UE can be configured to release, restore, or reconfigure the SCG configuration. Otherwise, it releases the SCG configuration.

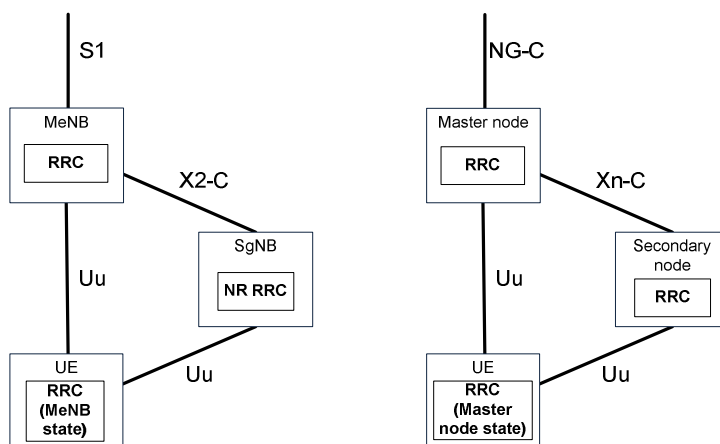

Figure 4.2.1-1: Control plane architecture for EN-DC (left) and MR-DC with 5GC (right).

4.2.2 User Plane

In MR-DC, from a UE perspective, three bearer types exist: MCG bearer, SCG bearer and split bearer. These three bearer types are depicted in Figure 4.2.2-1 for MR-DC with EPC (EN-DC) and in Figure 4.2.2-2 for MR-DC with 5GC (NGEN-DC, NE-DC and NR-DC).

In E-UTRA connected to EPC, if the UE supports EN-DC, regardless whether EN-DC is configured or not, the network can configure either E-UTRA PDCP or NR PDCP for MN terminated MCG bearers while NR PDCP is always used for all other bearers. Change from E-UTRA to NR PDCP or vice-versa can be performed via a reconfiguration procedure (with or without handover), either using release and add of the DRBs or using the full configuration option.

In MR-DC with 5GC, NR PDCP is always used for all bearer types. In NGEN-DC, E-UTRA RLC/MAC is used in the MN while NR RLC/MAC is used in the SN. In NE-DC, NR RLC/MAC is used in the MN while E-UTRA RLC/MAC is used in the SN. In NR-DC, NR RLC/MAC is used in both MN and SN.

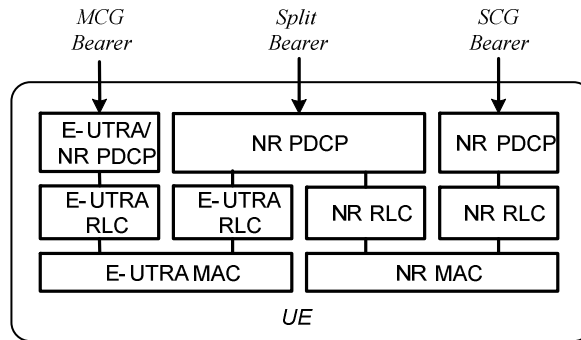

Figure 4.2.2-1: Radio Protocol Architecture for MCG, SCG and split bearers from a UE perspective in MR-DC with EPC (EN-DC)

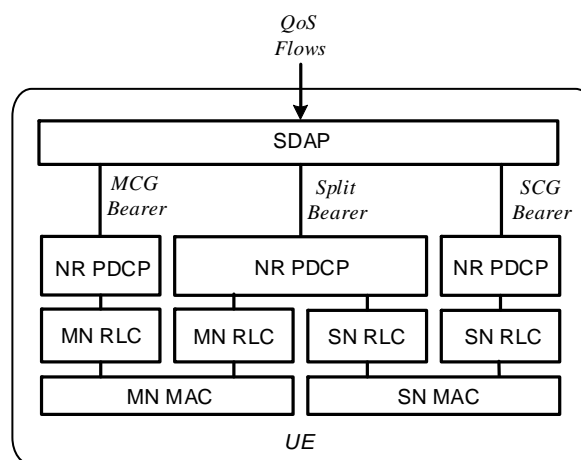

Figure 4.2.2-2: Radio Protocol Architecture for MCG, SCG and split bearers from a UE perspective in MR-DC with 5GC (NGEN-DC, NE-DC and NR-DC).

From a network perspective, each bearer (MCG, SCG and split bearer) can be terminated either in MN or in SN. Network side protocol termination options are shown in Figure 4.2.2-3 for MR-DC with EPC (EN-DC) and in Figure 4.2.2-4 for MR-DC with 5GC (NGEN-DC, NE-DC and NR-DC).

NOTE 1: Even if only SCG bearers are configured for a UE, for SRB1 and SRB2 the logical channels are always configured at least in the MCG, i.e. this is still an MR-DC configuration and a PCell always exists.

NOTE 2: If only MCG bearers are configured for a UE, i.e. there is no SCG, this is still considered an MR-DC configuration, as long as at least one of the bearers is terminated in the SN.

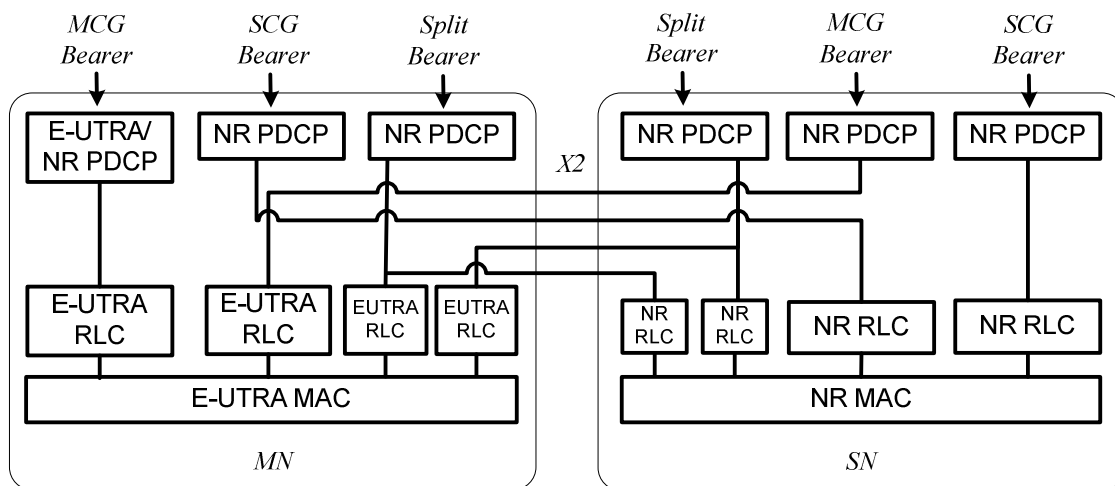

Figure 4.2.2-3: Network side protocol termination options for MCG, SCG and split bearers in MR-DC with EPC (EN-DC).

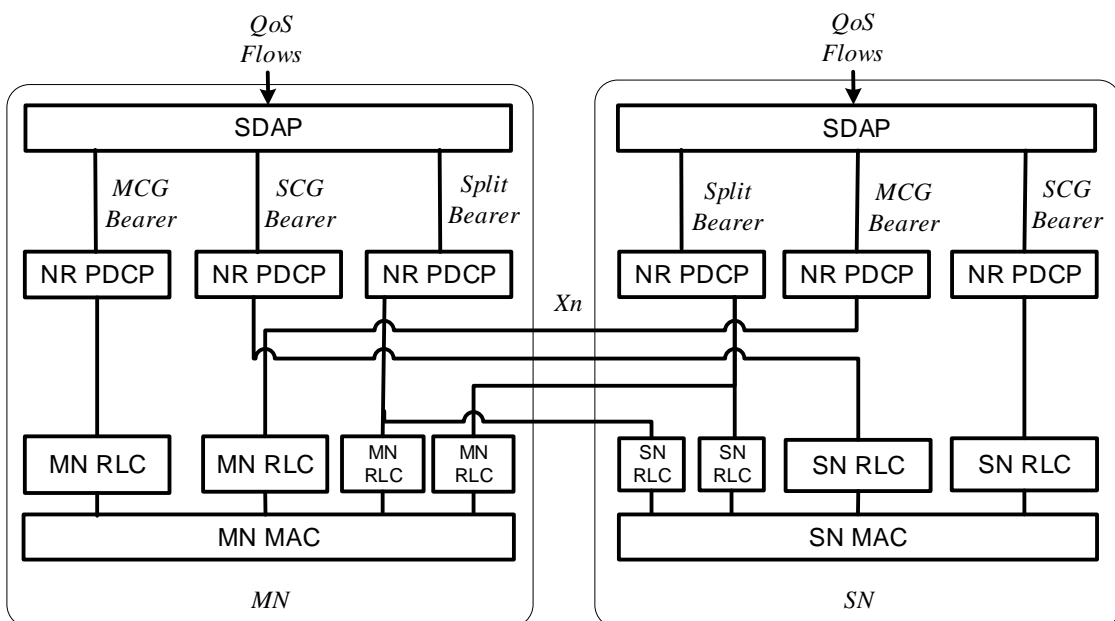

Figure 4.2.2-4: Network side protocol termination options for MCG, SCG and split bearers in MR-DC with 5GC (NGEN-DC, NE-DC and NR-DC).

4.3 Network interfaces

4.3.1 Control Plane

4.3.1.1 Common MR-DC principles

In MR-DC, there is an interface between the MN and the SN for control plane signalling and coordination. For each MR-DC UE, there is also one control plane connection between the MN and a corresponding CN entity. The MN and

the SN involved in MR-DC for a certain UE control their radio resources and are primarily responsible for allocating radio resources of their cells.

Figure 4.3.1.1-1 shows C-plane connectivity of MN and SN involved in MR-DC for a certain UE.

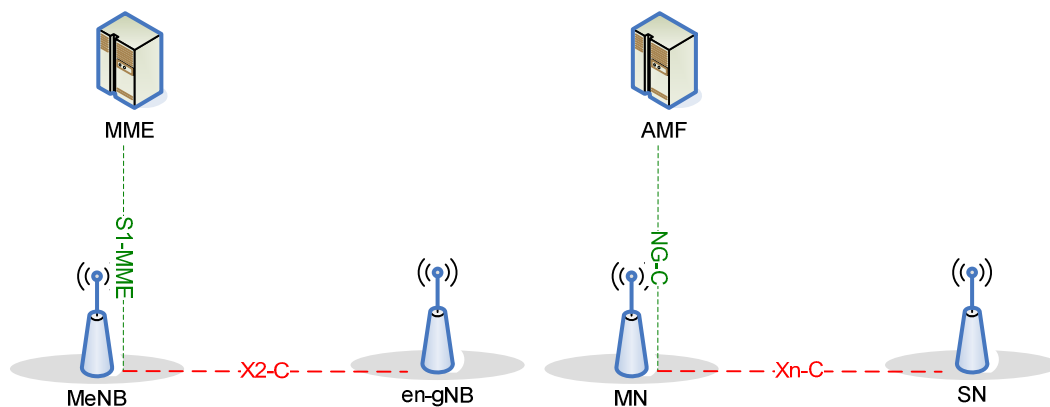

Figure 4.3.1.1-1: C-Plane connectivity for EN-DC (left) and MR-DC with 5GC (right).

4.3.1.2 MR-DC with EPC

In MR-DC with EPC (EN-DC), the involved core network entity is the MME. S1-MME is terminated in MN and the MN and the SN are interconnected via X2-C.

4.3.1.3 MR-DC with 5GC

In MR-DC with 5GC (NGEN-DC, NE-DC and NR-DC), the involved core network entity is the AMF. NG-C is terminated in the MN and the MN and the SN are interconnected via Xn-C.

4.3.2 User Plane

4.3.2.1 Common MR-DC principles

There are different U-plane connectivity options of the MN and SN involved in MR-DC for a certain UE, as shown in Figure 4.3.2.1-1. The U-plane connectivity depends on the bearer option configured:

- For *MN terminated bearers*, the user plane connection to the CN entity is terminated in the MN;
- For *SN terminated bearers*, the user plane connection to the CN entity is terminated in the SN;
- The transport of user plane data over the Uu either involves MCG or SCG radio resources or both:
 - For *MCG bearers*, only MCG radio resources are involved;
 - For *SCG bearers*, only SCG radio resources are involved;
 - For *split bearers*, both MCG and SCG radio resources are involved.
- For split bearers, *MN terminated SCG bearers* and *SN terminated MCG bearers*, PDCP data is transferred between the MN and the SN via the MN-SN user plane interface.

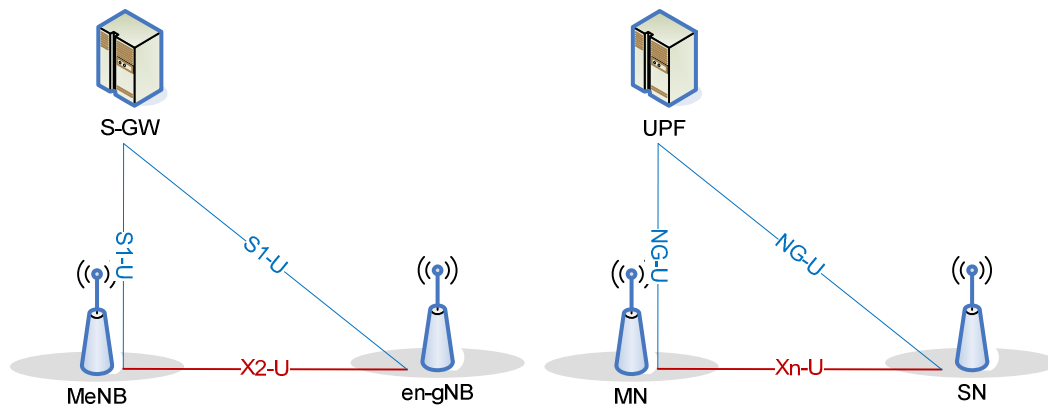

Figure 4.3.2.1-1: U-Plane connectivity for EN-DC (left) and MR-DC with 5GC (right).

4.3.2.2 MR-DC with EPC

For MR-DC with EPC (EN-DC), X2-U interface is the user plane interface between MN and SN, and S1-U is the user plane interface between the MN, the SN or both and the S-GW.

4.3.2.3 MR-DC with 5GC

For MR-DC with 5GC (NGEN-DC, NE-DC and inter-gNB NR-DC), Xn-U interface is the user plane interface between MN and SN, and NG-U is the user plane interface between the MN, the SN or both and the UPF.

5 Layer 1 related aspects

In MR-DC, two or more Component Carriers (CCs) may be aggregated over two cell groups. A UE may simultaneously receive or transmit on multiple CCs depending on its capabilities. The maximum number of configured CCs for a UE is 32 for DL and UL. Depending on UE's capabilities, up to 31 CCs can be configured for an E-UTRA cell group when the NR cell group is configured. For the NR cell group, the maximum number of configured CCs for a UE is 16 for DL and 16 for UL.

A gNB may configure the same Physical Cell ID (PCI) to more than one NR cell it serves. To avoid PCI confusion for MR-DC, NR PCIs should be allocated in a way that an NR cell is uniquely identifiable by a PCell identifier. This PCell is in the coverage area of an NR cell included in the MR-DC operation. In addition, NR PCIs should only be re-used in NR cells on the same SSB frequency sufficiently distant from each other. X2-C/Xn-C signalling supports disambiguation of NR PCIs by including the CGI of the PCell in respective X2AP/XnAP messages (e.g. SGNB ADDITION REQUEST/S-NODE ADDITION REQUEST) and by providing neighbour cell relationship via non-UE associated signaling (e.g. via the Xn Setup procedure or the NG-RAN node Configuration Update procedure).

NR-DC supports the case of no synchronization between PCell and PSCell. However, some UEs may support NR-DC only if slot-level synchronization between PCell and PSCell is ensured.

In MR-DC, power sharing can be performed within a frequency range with either semi-static or dynamic power sharing. With semi-static power sharing, the maximum UE transmission power is semi-statically split between MCG and SCG by RRC configuration. With dynamic power sharing:

- when determining the UL transmission power of an SCG transmission in (NG)EN-DC or in NR-DC, the UE takes into account transmission(s) on MCG overlapping with any part of the SCG transmission;
- when determining the UL transmission power of an MCG transmission in NE-DC, the UE takes into account transmission(s) on SCG overlapping with any part of the MCG transmission.

Details are specified in TS38.213[21].

In EN-DC, a UE configured with uplink Tx switching can have Tx dynamically switched between E-UTRA uplink carrier and NR uplink carrier for enabling 2Tx UL transmission on NR carrier.

6 Layer 2 related aspects

6.1 MAC Sublayer

In MR-DC, the UE is configured with two MAC entities: one MAC entity for the MCG and one MAC entity for the SCG. The serving cells other than the PCell can be activated/deactivated by RRC or MAC Control Element. For activation/deactivation by MAC Control Element, the serving cells of the MCG other than the PCell can only be activated/deactivated by the MAC Control Element received on MCG, and the serving cells of the SCG other than PSCell can only be activated/ deactivated by the MAC Control Element received on SCG. The MAC entity applies the bitmap for the associated cells of either MCG or SCG. When the SCG is not deactivated, the PSCell is always activated like the PCell (i.e. deactivation timer is not applied to PSCell). With the exception of PUCCH SCell, one deactivation timer is configured per SCell by RRC.

In MR-DC, semi-persistent scheduling (SPS) resources and configured grant (CG) resources can be configured on serving cells in both MCG and SCG.

In MR-DC, for 4-step RA type, contention based random access (CBRA) procedure is supported on both PCell and PSCell while contention free random access (CFRA) procedure is supported on all serving cells in both MCG and SCG. For 2-step RA type, CBRA can be supported on the PCell, if the MN is a gNB (i.e. for NE-DC and NR-DC) and on the PSCell, if the SN is a gNB (i.e. for EN-DC, NGEN-DC and NR-DC) while CFRA is only supported on the PCell, if the MN is a gNB (i.e. for NE-DC and NR-DC).

In (NG)EN-DC and NR-DC, when SCG is deactivated as described in clause 7.13, the TA timer associated with SCG continues running, the UE considers the TA is valid as long as TA timer is running. In case of SCG activation, the UE can be instructed by the network to perform random access towards PSCell even if the TA timer associated with PSCell is running and RLF and beam failure are not declared. Besides, the UE can be instructed by the network to perform SCG activation without performing random access, if the TA timer associated with PSCell is running and RLM and beam failure detection are configured but RLF or beam failure is not declared. In case of network-initiated SCG activation, both CBRA and CFRA on PSCell are supported. For CFRA, the dedicated RACH resources can be provided in the RRC message used to activate SCG.

In MR-DC, the BSR configuration, triggering and reporting are independently performed per cell group. For split bearers, the PDCP data is considered in BSR in the cell group(s) configured by RRC.

In MR-DC, separate DRX configurations are provided for MCG and SCG. A secondary DRX group can be configured in MR-DC for a cell group that includes cells in different Frequency Ranges as specified in TS 38.331 [4].

In MR-DC, PHR is independently configured per cell group. Events in one cell group can trigger power headroom reporting in both MCG and SCG. Power headroom information for one cell group is also included in a PHR transmitted in the other cell group. While the SCG is deactivated, PHR for SCG is not reported.

In MR-DC, consistent LBT failure recovery procedure as described in clause 5.6.1 in TS 38.300 [3] can be configured for both MAC entities of MCG and/or SCG when operating with shared spectrum channel access.

In MR-DC, for power saving purpose, the UE can be configured with DCP to be monitored on the PCell, if the MN is a gNB (i.e. for NE-DC and NR-DC) and/or with DCP to be monitored on the PSCell, if the SN is a gNB (i.e. for EN-DC, NGEN-DC and NR-DC).

In MR-DC, the UE may be configured with enhanced intra-UE overlapping resources prioritization on MN, if the MN is a gNB (i.e. for NE-DC and NR-DC) and on SN, if the SN is a gNB (i.e. for EN-DC, NGEN-DC and NR-DC).

6.2 RLC Sublayer

Both RLC AM and UM can be configured for MR-DC, for all bearer types (MCG, SCG and split bearers).

6.3 PDCP Sublayer

In EN-DC, CA duplication (see [3]) can be applied in the MN and in the SN, but MCG bearer CA duplication can be configured only in combination with E-UTRAN PDCP and MCG bearer CA duplication can be configured only if DC duplication is not configured for any split bearer.

In NGEN-DC, CA duplication can only be configured for SCG bearer. In NE-DC, CA duplication can only be configured for MCG bearer. In NR-DC, CA duplication can be configured for both MCG and SCG bearers, and can be configured together with DC duplication.

In MR-DC, RoHC and EHC (as described in TS 36.323 [15] and TS 38.323 [16]) can be configured for all the bearer types. In MR-DC with 5GC, UDC (as described in TS 38.323 [16]) can be configured for all the bearer types.

6.4 SDAP Sublayer

In MR-DC with 5GC, the network may host up to two SDAP protocol entities for each individual PDU session, one for MN and another one for SN (see clause 8.1). The UE is configured with one SDAP protocol entity per PDU session.

6.5 BAP Sublayer

In EN-DC and NR-DC, IAB-node and IAB-donor-DU can be configured with BAP sublayer for backhaul traffic (as described in TS 38.300 [3] and TS 38.340 [17]). In EN-DC, the BAP sublayer routes the backhaul traffic via only the NR interface. In NR-DC, the BAP sublayer can route the backhaul traffic via the two NR interfaces to the same IAB-donor.

7 RRC related aspects

7.1 System information handling

In MR-DC, the SN is not required to broadcast system information other than for radio frame timing and SFN. System information for initial configuration is provided to the UE by dedicated RRC signalling via the MN. The UE acquires, at least, radio frame timing and SFN of SCG from the PSS/SSS and MIB (if the SN is an eNB) / NR-PSS/SSS and PBCH (if the SN is a gNB) of the PSCell. In EN-DC, SN may broadcast system information to allow only IAB-MT to access the SN.

NOTE: The option that the SN does not broadcast system information other than radio frame timing and SFN relies on proper OAM configuration.

Additionally, upon change of the relevant system information of a configured SCell, the network releases and subsequently adds the concerned SCell (with updated system information), via one or more *RRC reconfiguration* messages sent on SRB1 or SRB3, if configured.

7.2 Measurements

If the measurement is configured to the UE in preparation for the Secondary Node Addition procedure described in clause 10.2, the Master node should configure the measurement to the UE.

In case of the intra-secondary node mobility described in clause 10.3, the SN should configure the measurement to the UE in coordination with the MN, if required.

The Secondary Node Change procedure described in clause 10.5 can be triggered by both the MN (only for inter-frequency secondary node change) and the SN. For secondary node changes triggered by the SN, the RRM measurement configuration is maintained by the SN which also processes the measurement reporting, without providing the measurement results to the MN.

Measurements can be configured independently by the MN and by the SN (intra-RAT measurements on serving and non-serving frequencies). The MN indicates the maximum number of frequency layers and measurement identities of intra-frequency and inter-frequency measurement that can be used in the SN to ensure that UE capabilities are not exceeded. In MR-DC, to assist MN to identify the measurement type, the SN indicates to the MN the list of SCG serving frequencies. In NR-DC, to assist SN to identify the measurement type, the MN indicates also to SN the list of MCG serving frequencies. The SN can also request the MN for new maximum values of the number of measurement identities that it can configure, and it is up to the MN whether to accommodate the SN request, based on the capability coordination principles as described in 7.3. If the SN receives from the MN a new value for the maximum number of

measurement identities, is SN responsibility to ensure that its configured measurement identities to comply with the new limit.

If MN and SN both configure measurements on the same carrier frequency then the configurations need to be consistent (if the network wants to ensure these are considered as a single measurement layer). Each node (MN and SN) can configure independently a threshold for the SpCell quality. In (NG)EN-DC scenario, when the PCell quality is above the threshold configured by the MN, the UE is still required to perform inter-RAT measurements configured by the MN on the SN RAT (while it's not required to perform intra-RAT measurements); when the PCell quality is above the threshold configured by the SN, the UE is not required to perform measurements configured by the SN. In NR-DC or NE-DC scenario, when the PCell quality is above the threshold configured by the MN, the UE is not required to perform measurements configured by the MN; when the PCell quality is above the threshold configured by the SN, the UE is not required to perform measurements configured by the SN.

NOTE: The SN cannot renegotiate the number of frequency layers allocated by the MN in this version of the protocol.

In MR-DC, both the MN and the SN can configure CGI reporting. The MN can configure CGI reporting for intra-RAT and inter-RAT cells but the SN can only configure CGI reporting of intra-RAT cells. At any point in time, the UE can be configured with at most one CGI reporting configuration. For CGI reporting coordination, the SN sends the CGI measurement request and the embedded CGI reporting configuration to the MN. Optionally, the SN sends the unknown cell information to the MN. If there is no ongoing CGI reporting measurement on UE side, the MN forwards the SN CGI measurement configuration to UE. Otherwise the MN rejects the request by sending X2/Xn reject message. In case the SN indicates the unknown cell information, and the CGI information of the requested cell is already available in the MN, the MN can also reject the request, and sends the CGI information of the requested cell to the SN. The SN cannot configure the CGI measurement using the SRB3.

Both MN-configured and SN-configured RRM measurements are supported while the SCG is deactivated. The PCell measurement cycle when in deactivated SCG state is configured by RRC.

When SRB3 is not configured or the SCG is deactivated, reports for measurements configured by the SN are sent on SRB1. When SRB3 is configured and SCG transmission of radio bearers is not suspended and the SCG is not deactivated, reports for measurements configured by the SN are sent on SRB3.

Measurement results related to the target SN can be provided by MN to target SN at MN initiated SN change procedure. Measurement results of target SN can be forwarded from source SN to target SN via MN at SN initiated SN change procedure. Measurement results related to the target SN can be provided by source MN to target MN at Inter-MN handover with/without SN change procedure.

Measurement results according to measurement configuration from the MN are encoded according to SN RRC when they are provided by MN to SN in *SgNB Addition Request* message / *SN Addition Request* message. During SN initiated SN change procedure, measurement results according to measurement configuration from SN are encoded according to SN RRC when they are provided by MN to SN in *SgNB Addition Request* message / *SN Addition Request* message.

Per-UE or per-FR measurement gaps can be configured, depending on UE capability to support independent FR measurement and network preference. Per-UE gap applies to both FR1 (E-UTRA, UTRA-FDD and NR) and FR2 (NR) frequencies. For per-FR gap, two independent gap patterns (i.e. FR1 gap and FR2 gap) are configured for FR1 and FR2 respectively. The UE may also be configured with a per-UE gap sharing configuration (applying to per-UE gap) or with two separate gap sharing configurations (applying to FR1 and FR2 measurement gaps respectively) [8].

A measurement gap configuration is always provided:

- In EN-DC, NGEN-DC and NE-DC, for UEs configured with E-UTRA inter-frequency measurements as described in table 9.1.2-2 in TS 38.133 [8];
- In EN-DC and NGEN-DC, for UEs configured with UTRAN and GERAN measurements as described in table 9.1.2-2 in TS 38.133 [8];
- In NR-DC, for UEs configured with E-UTRAN measurements as described in table 9.1.2-3 in TS 38.133 [8];
- In NR-DC, NE-DC, for UEs configured with UTRAN measurements as described in table 9.4.6.3-1 and 9.4.6.3-2 in TS 38.133 [8];
- In MR-DC, for UEs that support either per-UE or per-FR gaps, when the conditions to measure SSB based inter-frequency measurement or SSB based intra-frequency measurement as described in clause 9.2.4 in TS 38.300 [3] are met;

If per-UE gap is used, the MN decides the gap pattern and the related gap sharing configuration. If per-FR gap is used, in EN-DC and NGEN-DC, the MN decides the FR1 gap pattern and the related gap sharing configuration for FR1, while the SN decides the FR2 gap pattern and the related gap sharing configuration for FR2; in NE-DC and NR-DC, the MN decides both the FR1 and FR2 gap patterns and the related gap sharing configurations.

In EN-DC and NGEN-DC, the measurement gap configuration from the MN to the UE indicates if the configuration from the MN is a per-UE gap or an FR1 gap configuration. The MN also indicates the configured per-UE or FR1 measurement gap pattern and the gap purpose (per-UE or per-FR1) to the SN. Measurement gap configuration assistance information can be exchanged between the MN and the SN. For the case of per-UE gap, the SN indicates to the MN the list of SN configured frequencies in FR1 and FR2 measured by the UE. For the per-FR gap case, the SN indicates to the MN the list of SN configured frequencies in FR1 measured by the UE and the MN indicates to the SN the list of MN configured frequencies in FR2 measured by the UE.

In NE-DC, the MN indicates the configured per-UE or FR1 measurement gap pattern to the SN. The SN can provide a gap request to the MN, without indicating any list of frequencies.

In NR-DC, the MN indicates the configured per-UE, FR1 or FR2 measurement gap pattern and the gap purpose to the SN. The SN can indicate to the MN the list of SN configured frequencies in FR1 and FR2 measured by the UE.

In (NG)EN-DC and NR-DC, SMTC can be used for PSCell addition/PSCell change to assist the UE in finding the SSB in the target PSCell. In case the SMTC of the target PSCell is provided by both MN and SN it is up to UE implementation which one to use.

CLI measurements can be configured for NR cells in all MR-DC options. In EN-DC and NGEN-DC, only the SN can configure CLI measurements. In NE-DC, only the MN can configure CLI measurements. In NR-DC, both the MN and the SN can configure CLI measurements, and the MN informs the SN about the maximum number of CLI measurement resources that can be configured by the SN to ensure that the total number of CLI measurement resources does not exceed the UE capabilities.

7.3 UE capability coordination

In (NG)EN-DC and NE-DC, the capabilities of a UE supporting MR-DC are carried by different capability containers. Some MR-DC related capabilities are in the MR-DC container e.g. MR-DC band combinations, while other MR-DC related capabilities are contained in the E-UTRA and NR capability containers e.g. feature sets as described in TS 38.300 [3]. The MR-DC capabilities in the MR-DC container need to be visible to both MN and SN, while the capabilities in the E-UTRA and NR containers only need to be visible to the node of the concerned RAT.

In NR-DC, all NR-DC related capabilities are in the NR capability container and are visible to both MN and SN.

When retrieving MR-DC related capabilities, the MN shall provide an MR-DC filter that affects the MR-DC related capabilities in MR-DC, E-UTRA and NR capability containers. When using different *UE capability enquiry* messages to retrieve the different containers, the MN shall employ the same MR-DC filter in all enquiry messages. In the E-UTRA RRC UE capability enquiry, the MR-DC filter is also used for retrieval of NR capabilities i.e. there is in fact one MR-DC/NR filter (while there is a separate filter for E-UTRA capabilities). Furthermore, the MN stores the retrieved capabilities and the corresponding filter, used to retrieve those capabilities, in the core network for later use.

For the UE capabilities requiring coordination between E-UTRA and NR (i.e. band combinations, feature sets and the maximum power for FR1 the UE can use in SCG) or between NR MN and NR SN (i.e. band combinations, feature sets and the maximum power for FR1 and FR2), it is up to the MN to decide on how to resolve the dependency between MN and SN configurations. The MN then provides the resulting UE capabilities usable for SCG configuration to the SN, including the list of allowed MR-DC band combinations and feature sets, and the SN indicates the selected band combination and feature set to the MN. When subsequently reconfiguring the SCG, the SN should inform the MN whenever the band combination and/or feature set it selected for the SCG changes (i.e. even if the selection concerns a band combination and feature set that is allowed). As part of an SN initiated SN modification, the SN may also indicate the desired UE capabilities usable for SCG configuration (e.g. a band combination and a feature set) outside those allowed by the MN (i.e. it may re-negotiate the UE capabilities for SCG configuration), and it is up to the MN to make the final decision whether to accept or reject the request. If the MN accepts the request, the MN may provide the resulting UE capabilities e.g. by indicating the allowed band combinations and feature sets. If MN accepts but does not provide resulting UE capabilities, SN assumes the UE capabilities usable for SCG configuration are updated in accordance with the modification it requested. Otherwise, the MN rejects the request by sending X2/Xn refuse message.

In EN-DC and MR-DC with 5GC, the MN may provide the UE radio capability ID to the SN. For EN-DC, the SN may retrieve the UE Radio Capability information associated to a UE radio capability ID from the MN. For MR-DC with 5GC, the SN may retrieve the UE radio capability information associated to a UE radio capability ID from the 5GC.

7.4 Handling of combined MN/SN RRC messages

When both MCG and SCG reconfiguration is required due to the need for coordination with the MN, the *SN RRC reconfiguration* message is encapsulated in an MN RRC message that also carries the corresponding MCG reconfiguration that ensures that the combined configuration can be jointly processed by the UE. If the MN terminates a bearer using NR PDCP, the NR PDCP configuration is generated by the MN itself. If the SN terminates the bearer, the SN generates the NR PDCP configuration and sends it to the MN as a separate container.

The UE uses a joint success/failure procedure for messages in an encapsulating MN RRC message. A failure of the MN RRC messages, including one encapsulated SN RRC message with or without any MCG reconfiguration fields, triggers a re-establishment procedure. Each *SN RRC reconfiguration* message should have its own RRC response message even when the SN RRC message is encapsulated in an MN RRC message. The SN RRC response message is forwarded over X2/Xn to the SN. If a *SN RRC reconfiguration* message is contained in a MN RRC message, the UE sends a MN RRC response message that encapsulates the SN RRC response message.

NOTE: If the MN RRC message does not encapsulate an *SN RRC reconfiguration* message (i.e. an SCG configuration) but only information elements generated by the SN (e.g. the PDCP configuration for an SN terminated bearer), the UE will not send an SN RRC response message.

7.5 SRB3

SRB3 is supported in EN-DC, NGEN-DC and NR-DC, but not in NE-DC.

The decision to establish SRB3 is taken by the SN, which provides the SRB3 configuration using an SN RRC message. SRB3 establishment and release can be done at Secondary Node Addition and Secondary Node Change. SRB3 reconfiguration can be done at Secondary Node Modification procedure.

SRB3 may be used to send *SN RRC Reconfiguration*, *SN RRC Reconfiguration Complete*, *SN Measurement Report*, *MN Failure Information* (i.e., in case of failure for an SCG RLC bearer), *SN UE Assistance Information* message and *SN IABOtherInformation*, only in procedures where the MN is not involved. *SN RRC Reconfiguration Complete* messages are mapped to the same SRB as the message initiating the procedure. *SN Measurement Report* messages are mapped to SRB3, if configured, regardless of whether the configuration is received directly from the SN or via the MN. No MN RRC messages are mapped to SRB3.

If split SRB1 is not configured, SRB3 may be used by the UE to transmit to the MN an encapsulated *MCG Failure Information* message in the *ULInformationTransferMRDC* message and receive in response an encapsulated *RRC reconfiguration* message, *MobilityFromNRCommand* message, *MobilityFromEUTRACommand* message or *RRC release* message in the *DLInformationTransferMRDC* message.

SRB3 is modelled as one of the SRBs defined in TS 38.331 [4] and uses the NR-DCCH logical channel type. RRC PDUs on SRB3 are ciphered and integrity protected using NR PDCP, with security keys derived from S-K_{gNB}. The SN selects ciphering and integrity protection algorithms for the SRB3 and provides them to the MN within the SCG Configuration for transmission to the UE.

NOTE: A NR SCG RRC message sent via E-UTRA MCG SRB is protected by E-UTRA MCG SRB security (NR security is not used in this case).

SRB3 is of higher scheduling priority than all DRBs. The default scheduling priorities of split SRB1 and SRB3 are the same.

There is no requirement on the UE to perform any reordering of RRC messages between SRB1 and SRB3.

When SCG is released, SRB3 is released.

7.6 Split SRB

Split SRB is supported for both SRB1 and SRB2 (split SRB is not supported for SRB0 and SRB3) in all MR-DC cases. RRC PDUs on split SRB are ciphered and integrity protected using NR PDCP.

Split SRB can be configured by the MN in Secondary Node Addition and/or Modification procedure, with SN configuration part provided by the SN. A UE can be configured with both split SRB and SRB3 simultaneously. SRB3 and the SCG leg of split SRB can be independently configured.

For the split SRB, the selection of transmission path in downlink depends on network implementation. For uplink, the UE is configured via MN RRC signalling whether to use MCG path or duplicate the transmission on both MCG and SCG.

7.7 SCG/MCG failure handling

RLF is declared separately for the MCG and for the SCG.

If radio link failure is detected for MCG, fast MCG link recovery is configured and the SCG is not deactivated, the UE triggers fast MCG link recovery. Otherwise, the UE initiates the RRC connection re-establishment procedure. During the execution of PSCell addition or PSCell change, if radio link failure is detected for MCG, the UE initiates the RRC connection re-establishment procedure.

During fast MCG link recovery, the UE suspends MCG transmissions for all radio bearers, except SRB0, and, if any, BH RLC channels and reports the failure with *MCGFailureInformation* message to the MN via the SCG, using the SCG leg of split SRB1 or SRB3.

The UE includes in the *MCGFailureInformation* message the measurement results available according to current measurement configuration of both the MN and the SN. Once the fast MCG link recovery is triggered, the UE maintains the current measurement configurations from both the MN and the SN, and continues measurements based on configuration from the MN and the SN, if possible. The UE initiates the RRC connection re-establishment procedure if it does not receive an *RRCConnectionReconfiguration* message, *RRCReconfiguration* message, *MobilityFromNRCommand* message, *MobilityFromEUTRACommand* message, *RRCConnectionRelease* message or *RRCRelease* message within a certain time after fast MCG link recovery was initiated.

Upon reception of the *MCGFailureInformation* message, the MN can send *RRCConnectionReconfiguration* message, *RRCReconfiguration* message, *MobilityFromNRCommand* message, *MobilityFromEUTRACommand* message, *RRCConnectionRelease* message or *RRCRelease* message to the UE, using the SCG leg of split SRB1 or SRB3. Upon receiving an *RRCConnectionReconfiguration* message, *RRCReconfiguration* message, *MobilityFromNRCommand* message or *MobilityFromEUTRACommand* message, the UE resumes MCG transmissions for all radio bearers. Upon receiving an *RRCConnectionRelease* message or *RRCRelease* message, the UE releases all the radio bearers and configurations.

NOTE 1: It is up to network implementation to guarantee that the RRC-related messages are delivered to the UE by the SN before the release of its control plane resources.

The following SCG failure cases are supported:

- SCG RLF;
- SCG beam failure while the SCG is deactivated;
- SN addition/change failure;
- For EN-DC, NGEN-DC and NR-DC, SCG configuration failure or CPC configuration failure (only for messages on SRB3);
- For EN-DC, NGEN-DC and NR-DC, SCG RRC integrity check failure (on SRB3);
- For EN-DC, NGEN-DC and NR-DC, consistent UL LBT failure on PSCell;
- For IAB-MT, reception of a BH RLF indication from SCG;
- CPA/CPC execution failure.

Upon SCG failure, if MCG transmissions of radio bearers are not suspended, the UE suspends SCG transmissions for all radio bearers and, if any, BH RLC channels, if the SCG failure is not triggered by SCG beam failure, and reports the *SCGFailureInformation* to the MN, instead of triggering re-establishment. If SCG failure is detected while MCG transmissions for all radio bearers are suspended, the UE initiates the RRC connection re-establishment procedure.

SCG/MCG failure handling by UE also applies to IAB MT.

In all SCG failure cases, the UE maintains the current measurement configurations from both the MN and the SN and the UE continues measurements based on configuration from the MN and the SN if possible. The SN measurements configured to be routed via the MN will continue to be reported after the SCG failure.

NOTE 2: UE may not continue measurements based on configuration from the SN after SCG failure in certain cases (e.g. UE cannot maintain the timing of PSCell).

The UE includes in the *SCGFailureInformation* message the measurement results available according to current measurement configuration of both the MN and the SN. The MN handles the *SCGFailureInformation* message and may decide to keep, change, or release the SN/SCG. In all the cases, the measurement results according to the SN configuration and the SCG failure type may be forwarded to the old SN and/or to the new SN.

In case of CPA/CPC, upon transmission of the *SCGFailureInformation* message to the MN, the UE stops evaluating the CPA/CPC execution condition. The UE is not required to continue measurements for candidate PSCell(s) for execution condition upon transmission of the *SCGFailureInformation* message to the MN.

7.8 UE identities

In MR-DC, two C-RNTIs are independently allocated to the UE: one for MCG, and one for SCG.

7.9 Inter-node Resource Coordination

For MR-DC operations, MN and SN may coordinate their UL and DL radio resources in semi-static manner via UE associated signalling. The MN may coordinate its sidelink radio resources with the SN using the same UE associated signalling.

In EN-DC, CSI-RS based SgNB change between neighbour en-gNBs is supported by enabling that neighbour en-gNBs can exchange their own CSI-RS configurations and on/off status via the MeNB.

In NGEN-DC and NR-DC, CSI-RS based SN change between neighbour gNBs is supported by enabling that neighbour gNBs can exchange their own CSI-RS configurations and on/off status via the MN.

7.10 UE assistance information

In MR-DC, the UE can be configured to report MCG specific UE assistance information if the MN is a gNB and/or SCG specific UE assistance information if the SN is a gNB, if it prefers an adjustment on the connected mode DRX parameters, the maximum aggregated bandwidth, the maximum number of secondary component carriers, the maximum number of MIMO layers, whether the UE prefers the SCG to be deactivated, the minimum scheduling offset for cross-slot scheduling cycle length, and/or whether the UE is applying RLM/BFD measurements relaxation for power saving. In these cases, it is up to the network whether to accommodate the preference or how to use the relaxation status indications. SCG specific UE assistance information for power saving can be configured by the network via SRB1 or SRB3. SCG specific UE assistance information for power saving is directly transmitted to the SN via SRB3, if SRB3 is configured and the SCG is activated, otherwise UE transmits SCG specific UE assistance information for power saving in a transparent container to the MN. When network simultaneously configures the UE to perform radio link monitoring on the SCG and beam failure detection on the SCG while the SCG is deactivated, UE assistance information for the relaxation state report of RLM/BFD measurements for SCG is reported over MCG. UE can implicitly indicate a preference for NR SCG release by indicating zero number of carriers and zero aggregated maximum bandwidth in both FR1 and FR2.

7.11 F1-C transfer over E-UTRA

In EN-DC, the F1-AP message encapsulated in SCTP/IP or F1-C related (SCTP/)IP packet can be transferred between IAB-donor and IAB-node via E-UTRA, if configured by IAB-donor, as specified in TS 38.331 [4]. When both E-UTRA and NR are configured to transfer the F1-AP message encapsulated in SCTP/IP or F1-C related (SCTP/)IP packet, it is up to the IAB implementation when to select the E-UTRA. SRB2 is used for transporting the F1-AP message encapsulated in SCTP/IP or F1-C related (SCTP/)IP packet between IAB-MT and MN [10], and the F1-AP message encapsulated in SCTP/IP or F1-C related (SCTP/)IP packet is transferred as a container via X2-AP between MN and SN, see TS 36.423 [9].

7.12 F1-C transfer in NR-DC

In NR-DC, the F1-AP message encapsulated in SCTP/IP or F1-C related (SCTP/)IP packet can be transferred via BAP sublayer or via SRB between the IAB-node and F1-terminating IAB-donor (as specified in TS 38.401 [7]), as specified in TS 38.331 [4]. When both MCG and SCG are configured to transfer the F1-AP message encapsulated in SCTP/IP or F1-C related (SCTP/)IP packet, it is up to the IAB-node implementation for path selection. Two scenarios are supported, as shown in Figure 7.12-1.

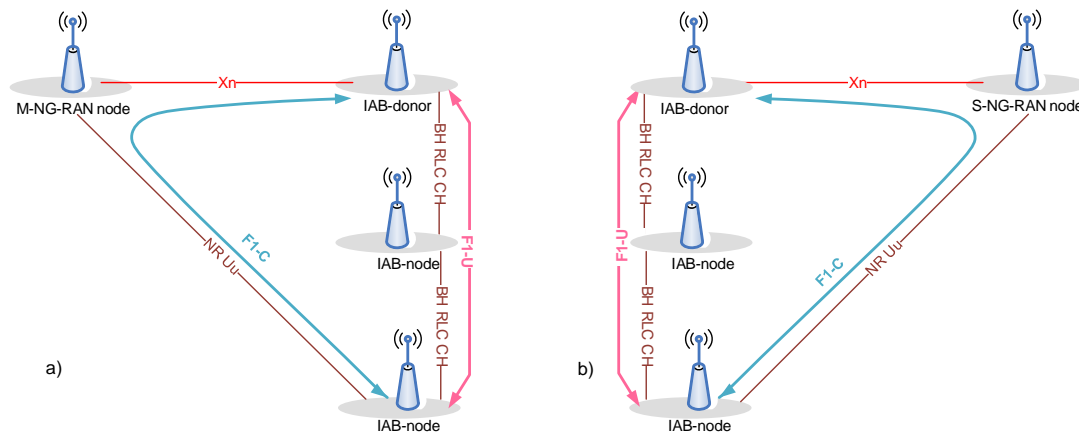

Figure 7.12-1: F1-C transfer in NR-DC; a) Scenario 1; b) Scenario 2

Scenario 1: IAB-node exchanges F1-AP message encapsulated in SCTP/IP or F1-C related (SCTP/)IP packet with the SN (F1-terminating IAB-donor as specified in TS 38.401 [7]) using NR access link via MN (non-F1-terminating IAB-donor), and exchanges F1-U traffic using backhaul link(s) with SN. SRB2 is used for transporting the F1-AP message encapsulated in SCTP/IP or F1-C related (SCTP/)IP packet between IAB-MT and MN (see TS 38.331 [4]), and the F1-AP message encapsulated in SCTP/IP or F1-C related (SCTP/)IP packet is transferred in a container via XnAP between MN and SN, see TS 38.423 [5].

Scenario 2: IAB-node exchanges F1-AP message encapsulated in SCTP/IP or F1-C related (SCTP/)IP packet with the MN (F1-terminating IAB-donor) using NR access link via SN (non-F1-terminating IAB-donor), and exchanges F1-U traffic using backhaul link(s) with MN. Split SRB2 is used for transporting the F1-AP message encapsulated in SCTP/IP or F1-C related (SCTP/)IP packet between IAB-MT and SN (see TS 38.331 [4]), and the F1-AP message encapsulated in SCTP/IP or F1-C related (SCTP/)IP packet is transferred in a container via XnAP between SN and MN, see TS 38.423 [5].

The F1-AP message encapsulated in SCTP/IP or the F1-C related (SCTP/)IP packet can be transferred either over BAP sublayer or over SRB, but the two mechanisms cannot be supported simultaneously on the same parent link. The F1-AP message encapsulated in SCTP/IP or the F1-C related (SCTP/)IP packet is transferred over BAP sublayer, if the BH RLC channel used for transferring the F1-C traffic is configured on the cell group indicated for F1-C traffic transfer according to TS 38.331 [4].

7.13 Activation and Deactivation of SCG

To enable reasonable UE battery consumption while having fast usage of SCG when (NG)EN-DC or NR-DC is configured, an activation/deactivation mechanism of SCG is supported. While the SCG is deactivated, there is no

transmission via SCG RLC bearers. Only the NR SCG can be deactivated, and all SCG SCell(s) are in deactivated state while the SCG is deactivated.

Upon SCG deactivation and while the SCG is deactivated, the network ensures that there is no uplink control PDU transmission to the deactivated SCG (e.g. the network releases statusReportRequired from PDCP entities of SCG bearers if configured, the network does not perform QoS flow remapping from a DRB associated to the deactivated SCG to another DRB). The network ensures the SCG is activated while PDCP duplication is activated for SCG RLC entities associated with a PDCP entity.

NOTE: Upon SCG (de)activation, it is up to the network to ensure there is no pending SDUs or PDUs in SCG RLC entity (e.g. instructs the UE to perform PDCP data recovery and RLC re-establishment/release, if needed).

While the SCG is deactivated, the UE will not transmit PUSCH, SRS and CSI report on SCG, and the UE is not required to monitor PDCCH or receive DL-SCH on SCG. If configured by the network, the UE performs radio link monitoring on the SCG and beam failure detection on the SCG while SCG is deactivated. In case of SCG activation without performing random access, the network can indicate TCI states to UE for PDCCH/PDSCH reception on PSCell, if not provided, the UE uses the previously activated TCI states.

The MN can configure the SCG as activated or deactivated upon e.g. PSCell addition, PSCell change, RRC Resume or handover. In case the SCG is configured as deactivated, the UE does not perform random access towards the PSCell. The network can trigger SCG RRC reconfiguration (e.g. PSCell change, configuration update) when deactivating the SCG and while the SCG is in deactivated state.

SCG activation can be requested by the MN, by the SN and by the UE. SCG deactivation can be requested by the MN and by the SN. For UL data arrival on SCG bearer(s) while the SCG is deactivated, the UE indicates to the MN that it has UL data to transmit over SCG bearer. During handover procedure, the target MN can indicate the SCG state in the RRC reconfiguration message sent to the UE by the source MN.

Network can configure whether the UE is allowed to indicate a preference for SCG deactivation to the MN.

7.14 RLM/BFD relaxation

For RLM and BFD relaxation, network may configure low mobility criterion in the NR PCell for the case of NE-DC/NR-DC, and in the NR PSCell for the case of EN-DC and NGEN-DC. MN informs SN when low mobility criterion has been configured in the NR PCell for NR-DC.

For RLM relaxation, network may configure good serving cell criterion in the NR PCell for the case of NE-DC/NR-DC, and in the NR PSCell for the case of EN-DC, NGEN-DC and NR-DC.

For BFD relaxation, network may configure good serving cell criterion in the NR PCell and/or SCell(s) for the case of NE-DC/NR-DC, and in the NR PSCell and/or SCell(s) for the case of EN-DC, NGEN-DC and NR-DC.

For RLM/BFD relaxation, network may simultaneously configure the UE to perform radio link monitoring on the SCG and beam failure detection on the SCG while SCG is deactivated. In such case, UE initiates UE assistance information for the relaxation state report of RLM/BFD measurements for SCG.

For RLM/BFD relaxation, network may simultaneously configure the UE not to perform radio link monitoring on the SCG and beam failure detection on the SCG while SCG is deactivated. In such case, UE assistance information for the relaxation state report of RLM/BFD measurements for SCG will not be initiated.

8 Bearer handling aspects

8.1 QoS aspects

In EN-DC, the E-UTRAN QoS framework defined in TS 36.300 [2] applies:

- An S1-U bearer is established between the EPC and the SN for SN terminated bearers;

- An X2-U bearer is established between the MN and the SN for split bearers, MN terminated SCG bearers and SN terminated MCG bearers;
- MN terminated and SN terminated bearers may have either MCG or SCG radio resources or both, MCG and SCG radio resources, established;

In MR-DC with 5GC:

- The NG-RAN QoS framework defined in TS 38.300 [3] applies;
- QoS flows belonging to the same PDU session may be mapped to different bearer types (see clause 4.2.2) and as a result there may be two different SDAP entities for the same PDU session: one at the MN and another one at the SN, in which case the MN decides which QoS flows are assigned to the SDAP entity in the SN. If the SN decides that its SDAP entity cannot host a given QoS flow any longer, the SN informs the MN and the MN cannot reject the request. If the MN decides that its SDAP entity can host a given QoS flow which has already been relocated to SN, the MN informs the SN;
- The MN or SN node that hosts the SDAP entity for a given QoS flow decides how to map the QoS flow to DRBs;
- If the SDAP entity for a given QoS flow is hosted by the MN and the MN decides that SCG resources are to be configured it provides to the SN
 - DRB QoS flow level QoS parameters, which the SN may reject, and
 - QoS flow to DRB mapping information and the respective per QoS flow information;
- If the SDAP entity for a given QoS flow is hosted by the SN and the SN configures MCG resources, based on offered MCG resource information from the MN, the SN provides to the MN
 - DRB QoS flow level QoS parameters, which the MN may reject, and
 - QoS flow to DRB mapping information and the respective per QoS flow information.
- If the SDAP entity for a given QoS flow is hosted by the SN, the MN provides sufficient QoS related information to enable the SN to configure appropriate SCG resources and to request the configuration of appropriate MCG resources. The MN may offer MCG resources to the SN and may indicate for GBR QoS flows the amount offered to the SN on a per QoS flow level. Otherwise, the SN can only use SCG resources for the concerned QoS flow. The SN may request the MN to release QoS flows from the SDAP entity hosted by the SN that the MN cannot reject. The MN may also offer MCG resources per PDU Session for all DRBs to which non-GBR QoS flows contained in the PDU Session are mapped.
- MN decides the DL PDU session AMBR and UL PDU session AMBR limits to be assigned to the SN, and indicates these to the SN:
 - The PDCP entity at the SN applies the received DL PDU session AMBR limit to the set of all bearers for which the SN hosts PDCP for the UE;
 - The MAC entity at the SN applies the received UL PDU session AMBR limit to the scheduled uplink radio traffic at the SN for the UE.
- The MN can decide to reallocate one or more QoS flows from the MN to the SN. In such case, the SN decides which DRBs the offloaded QoS flows are mapped to. It is possible to avoid/ minimise loss and ensure in-order delivery when reallocating all QoS flows mapped to a given DRB in the MN by keeping the QoS flows mapped to the same DRB in the SN. To achieve this, the SN should behave similar to what is specified for the target NG-RAN node upon handover, see TS 38.300 clause 9.2.3.2.2 [3]. The corresponding behaviour applies when QoS flows are re-allocated from the SN to the MN.
- The MN decides the DL UE Slice MBR and UL UE Slice MBR limits to be assigned to the SN, and indicates these to the SN:
 - The PDCP entity at the SN applies the received DL UE Slice MBR limit to the set of all bearers for which the SN hosts PDCP for the concerned Slice, as defined in TS 23.501 [11];
 - The MAC entity at the SN applies the received UL UE Slice MBR limit to the scheduled uplink radio traffic at the SN for the concerned Slice, as defined in TS 23.501 [11].

In all MR-DC cases:

- The MN decides the DL UE AMBR and UL UE AMBR limits to be assigned to the SN, and indicates these to the SN:
- The PDCP entity at the SN applies the received DL UE AMBR limit to the set of all bearers for which the SN hosts PDCP for the UE;
- The MAC entity at the SN applies the received UL UE AMBR limit to the scheduled uplink radio traffic at the SN for the UE.

To support PDU sessions mapped to different bearer types, MR-DC with 5GC provides the possibility for the MN to request the 5GC:

- For some PDU sessions of a UE: Direct the User Plane traffic of the whole PDU session either to the MN or to the SN. In that case, there is a single NG-U tunnel termination at the NG-RAN for such PDU session.
- The MN may request to change this assignment during the life time of the PDU session.
- For some other PDU sessions of a UE: Direct the User Plane traffic of a subset of the QoS flows of the PDU session to the SN (respectively MN) while the rest of the QoS flows of the PDU session is directed to the MN (respectively SN). In that case, there are two NG-U tunnel terminations at the NG-RAN for such PDU session.
- The MN may request to change this assignment during the life time of the PDU session.

To support notification control indication for GBR QoS flows along the QoS framework specified in 38.300 [3] for MR-DC with 5GC, SN and MN may mutually indicate whenever QoS requirements for GBR QoS flows cannot be fulfilled anymore or can be fulfilled again. When indicating that GBR QoS flows cannot be fulfilled anymore, SN or MN may additionally indicate the reference to the QoS Parameter Set which it can currently fulfil.

8.2 Bearer type selection

In EN-DC, for each radio bearer the MN decides the location of the PDCP entity and in which cell group(s) radio resources are to be configured. Once an SN terminated split bearer is established, e.g. by means of the Secondary Node Addition procedure or MN initiated Secondary Node Modification procedure, the SN may remove SCG resources for the respective E-RAB, as long as the QoS for the respective E-RAB is guaranteed. In case an SN terminated bearer is released or reconfigured to an MN terminated bearer, only the MN generates the corresponding configuration and the SN does not generate the release configuration.

In MR-DC with 5GC, the following principles apply:

- The MN decides per PDU session the location of the SDAP entity, i.e. whether it shall be hosted by the MN or the SN or by both (split PDU session);
- If the MN decides to host an SDAP entity it may decide some of the related QoS flows to be realized as MCG bearer, some as SCG bearer, and others to be realized as split bearer;
- If the MN decides that an SDAP entity shall be hosted in the SN, some of the related QoS flows may be realized as SCG bearer, some as MCG bearer, while others may be realized as split bearer. In this case, the SN decides how to realise the QoS flow, but if the MN does not offer MCG resources, the SN can only realize the QoS flow as SCG bearer. The SN may remove or add SCG resources for the respective QoS flows, as long as the QoS for the respective QoS flow is guaranteed
- If the MN decides that an SDAP entity shall be hosted in the SN, coordination of DRB IDs between the MN and the SN is needed to ensure unique allocation of DRBs for a UE. The SN is responsible to assign the DRB IDs for the DRBs it terminates, based on the DRB IDs indicated by the MN.
- For each PDU session, including split PDU sessions, at most one default DRB may be configured (see [3]). The MN decides whether the SN is allowed to setup the default DRB or not;
- In case an SN terminated bearer is released or reconfigured to an MN terminated bearer, the MN generates the corresponding configuration and the SN does not generate the release configuration. The only exceptional case where SN generates the release configuration is for the DRB release due to QoS flow to DRB remapping within SN.

8.3 Bearer type change

In MR-DC, all the possible bearer type change options are supported:

- MCG bearer to/from split bearer;
- MCG bearer to/from SCG bearer;
- SCG bearer to/from split bearer.

Bearer termination point change is supported for all bearer types, and can be performed with or without bearer type change:

- MN terminated bearer to/from SN terminated bearer.

For MR-DC:

- when the security key is changed for a bearer due to a termination point change, the associated PDCP and RLC entities are re-established, while MAC behavior might depend on the solution selected by the network, e.g. MAC reset, change of LCID, etc. (see Annex A);
- for MCG bearer, split bearer and SCG bearer, during MN security key change the MCG/SCG PDCP and RLC are re-established and MCG/SCG MAC is reset;
- if a bearer type change happens together with MN security key change then for MCG bearer, split bearer and SCG bearer, the MCG/SCG PDCP and RLC are re-established and MCG/SCG MAC is reset;
- if a bearer type change happens through SN change procedure, then SN terminated PDCP and SCG RLC are re-established and SCG MAC is reset. MCG RLC/MAC behavior depends on the solution selected by the network, see Annex A;
- one step (direct) bearer type change between MN terminated bearer types without using the handover procedure is supported;
- one step (direct) bearer type change between SN terminated bearer types without using the handover or SN change procedure is supported;
- one step (direct) bearer type change from/to MN terminated bearer to/from SN terminated bearer without using the handover procedure is supported;
- PDCP SN length change for an AM DRB or RLC mode change for DRB is performed using a release and add of the DRBs (in a single message) or full configuration;
- One step (direct) bearer type change with PDCP version change (only applicable for EN-DC) is supported.

For MR-DC with 5GC:

- in a bearer termination point change of a DRB from a source NG-RAN node to a target NG-RAN node, for each DRB for which the source NG-RAN node provides QoS flow to DRB mapping information to the target NG-RAN node, the source NG-RAN node also offers the indicated DRB ID for usage at the target NG-RAN node. The target NG-RAN node informs the source NG-RAN node if it accepts the DRB offloading and takes the DRB ID into use.

NOTE 1: In this clause the term "handover" refers to an E-UTRA handover or to an NR synchronous reconfiguration not necessarily implying a P(S)Cell change with or without security key change.

NOTE 2: L2 handling for bearer type change in MR-DC is also summarized in Annex A (the table does not consider the cases that PDCP SN length is changed and avoiding reuse of COUNT).

8.4 User data forwarding

Upon EN-DC specific activities, user data forwarding may be performed for E-RABs for which the bearer type change from/to MN terminated bearer to/from SN terminated bearer is performed. The behaviour of the node from which data

is forwarded is the same as specified for the "source eNB" for handover, the behaviour of the node to which data is forwarded is the same as specified for the "target eNB" for handover.

For MR-DC with 5GC, user data forwarding may be performed between NG-RAN nodes whenever the logical node hosting the PDCP entity changes. The behaviour of the node from which data is forwarded is the same as specified for the "source NG-RAN node" for handover, the behaviour of the node to which data is forwarded is the same as specified for the "target NG-RAN node" for handover.

For SN change involving full configuration, the source SN behaviour is the same as the description as specified in intra-system data forwarding in TS 36.300 [2] for the source eNB or TS 38.300 [3] for the source NG-RAN node, respectively. In case that a DRB DL forwarding tunnel was established, the target SN may identify the PDCP SDUs for which delivery was attempted by the source SN, by the presence of the PDCP SN in the forwarded GTP-U packet and may discard them.

For mobility scenarios which involve more than two RAN nodes, either direct or indirect data forwarding may be applied. Two transport layer addresses of different versions may be provided to enable that the source RAN node can select either IPv4 or IPv6.

Direct data forwarding from source SN to target NG-RAN node and from source NG-RAN node to target SN for mobility scenario is supported. Direct data forwarding from source SN to target SN for SN change scenario is also supported.

Direct data forwarding for inter-system handover is specified in TS 38.300 [3]. If a gNB and an en-gNB are involved in direct data forwarding and realised within the same network entity, inter-system handover to and from EN-DC allows direct data forwarding being performed in a node-internal way, in which case the source RAN node provides a UE context reference to the target side as described in clause 10.16. If the gNB and en-gNB are not realised within the same network entity, direct data forwarding for inter-system handover to and from en-gNB/gNB could be supported if there is direct connectivity between the two nodes.

For MR-DC with 5GC, offloading of QoS flows within one PDU session may be performed between NG-RAN nodes. The handling of End Marker packets in case of NG-RAN initiated PDU session split is described in clause 10.14.3 and 10.14.4.

9 Security related aspects

MR-DC can only be configured after security activation in the MN.

In EN-DC and NGEN-DC, for bearers terminated in the MN the network configures the UE with K_{eNB} ; for bearers terminated in the SN the network configures the UE with $S-K_{gNB}$. In NE-DC, for bearers terminated in the MN the network configures the UE with K_{gNB} ; for bearers terminated in the SN the network configures the UE with $S-K_{eNB}$. In NR-DC, for bearers terminated in the MN the network configures the UE with K_{gNB} ; for bearers terminated in the SN the network configures the UE with $S-K_{gNB}$.

In NE-DC and NR-DC, a PCell change without K_{gNB} change does not require a $S-K_{eNB}$ change (NE-DC case) or a $S-K_{gNB}$ change (NR-DC case).

In EN-DC, NGEN-DC and NR-DC, for a PSCell change that does not require a K_{eNB} change (i.e. no simultaneous PCell handover in EN-DC and NGEN-DC) or a K_{gNB} change (in NR-DC), $S-K_{gNB}$ key refresh is not required if the PDCP termination point of the SN is not changed. In NE-DC, a PSCell change always requires a $S-K_{eNB}$ change.

In EN-DC, the UE supports the NR security algorithms corresponding to the E-UTRA security algorithms signalled at NAS level and the UE NR AS Security capability is not signalled to the MN over RRC. Mapping from E-UTRA security algorithms to the corresponding NR security algorithms, where necessary, is performed at the MN. The MN sends the complete UE security capabilities including all security capability bits previously received (after mapping, where necessary) to the SN.

An EN-DC capable UE supporting user plane integrity protection when connected to E-UTRA/EPC (see TS 24.301 [22]) shall support integrity protection for all DRBs (MN and SN terminated) at any data rate, up to and including the highest data rate supported by the UE for both UL and DL. MN and/or SN terminated DRBs can have UP integrity protection activation either on or off, on a per radio bearer basis.

For MR-DC with 5GC, UP integrity protection can be configured on a per radio bearer basis. All DRBs which belong to the same PDU session always have the same UP integrity protection activation, i.e., either on or off:

- For NR-DC: MN and/or SN terminated DRBs of a PDU session can have UP integrity protection activation either on or off. A UE configured to operate in NR-DC shall support integrity protection for all DRBs (MN and SN terminated) at any data rate, up to and including the highest data rate supported by the UE for both UL and DL (see TS 38.300 [3]).
- For NE-DC: MN terminated DRBs of a PDU session can have UP integrity protection activation on; however, in this case, the MN will not at any point offload any DRB of such PDU session to the SN. A UE configured to operate in NE-DC shall support integrity protection for all MN terminated DRBs at any data rate, up to and including the highest data rate supported by the UE's radio access capabilities for both UL and DL (see TS 38.300 [3]). SN terminated DRBs of a PDU session always have UP integrity protection activation off.
- For NGEN-DC: Both MN terminated and SN terminated DRBs of a PDU session always have UP integrity protection activation off.

In MR-DC with 5GC, the MN sends the complete UE security capabilities to the SN including all NR and E-UTRA security capability bits previously received by the MN from the Core Network or from another NG-RAN node as specified in TS 38.300 [3].

In (NG)EN-DC and NR-DC, if the SCG is deactivated as described in clause 7.13, whether to perform security key update upon SCG activation is up to network implementation.

10 Multi-Connectivity operation related aspects

10.1 General

Similar procedures as defined under clause 10.1.2.8 (Dual Connectivity operation) in TS 36.300 [2] apply for MR-DC.

Similar CHO principles as defined in TS 36.300 [2] and TS 38.300 [3] apply for the Conditional PSCell Change and Conditional PSCell Addition in MR-DC.

Conditional PSCell Change and conditional PSCell addition are not supported for the MR-DC options NE-DC and NGEN-DC.

Configuration of a deactivated SCG in a conditional configuration, configuration of CPC while the SCG is deactivated and SCG deactivation while CPC is configured are not supported.

In MR-DC, CHO is supported in Master Node to eNB/gNB Change procedure and Conditional Handover with Secondary Node procedure.

10.2 Secondary Node Addition

10.2.1 EN-DC

The Secondary Node Addition procedure is initiated by the MN and is used to establish a UE context at the SN to provide resources from the SN to the UE. For bearers requiring SCG radio resources, this procedure is used to add at least the first cell of the SCG. This procedure can also be used to configure an SN terminated MCG bearer (where no SCG configuration is needed). In case of CPA, the Conditional Secondary Node Addition procedure can be used for CPA configuration and CPA execution.

Secondary Node Addition

Figure 10.2.1-1 shows the Secondary Node Addition procedure.

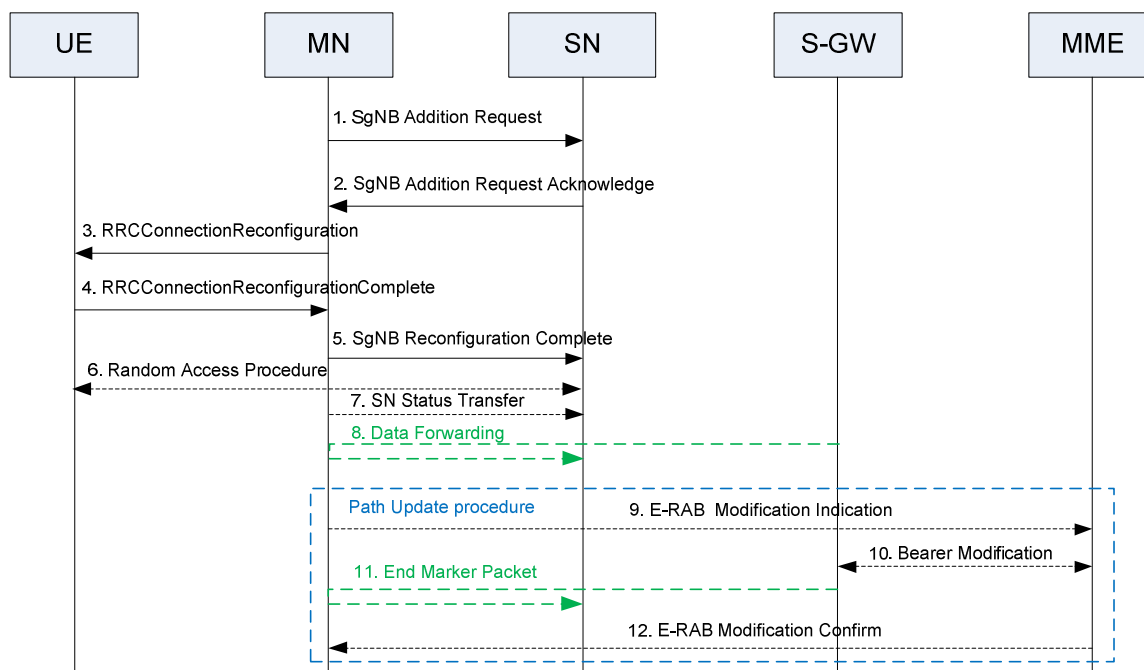

Figure 10.2.1-1: Secondary Node Addition procedure

1. The MN decides to request the SN to allocate resources for a specific E-RAB, indicating E-RAB characteristics (E-RAB parameters, TNL address information corresponding to bearer type). In addition, for bearers requiring SCG radio resources, MN indicates the requested SCG configuration information, including the entire UE capabilities and the UE capability coordination result. In this case, the MN also provides the latest measurement results for SN to choose and configure the SCG cell(s). The MN may request the SN to allocate radio resources for split SRB operation. The MN always provides all the needed security information to the SN (even if no SN terminated bearers are setup) to enable SRB3 to be setup based on SN decision. In case of bearer options that require X2-U resources between the MN and the SN, the MN provides X2-U TNL address information for the respective E-RAB, X2-U DL TNL address information for SN terminated bearers, X2-U UL TNL address information for MN terminated bearers. In case of SN terminated split bearers the MN provides the maximum QoS level that it can support. The MN may request the SCG to be activated or deactivated. The SN may reject the addition request.

NOTE 1: For split bearers, MCG and SCG resources may be requested of such an amount, that the QoS for the respective E-RAB is guaranteed by the exact sum of resources provided by the MCG and the SCG together, or even more. For MN terminated split bearers, the MN's decision is reflected in step 1 by the E-RAB parameters signalled to the SN, which may differ from E-RAB parameters received over S1.

NOTE 2: For a specific E-RAB, the MN may request the direct establishment of an SCG or a split bearer, i.e., without first having to establish an MCG bearer. It is also allowed that all E-RABs can be configured as SN terminated bearers, i.e. there is no E-RAB established as an MN terminated bearer.

2. If the RRM entity in the SN is able to admit the resource request, it allocates respective radio resources and, dependent on the bearer option, respective transport network resources. For bearers requiring SCG radio resources, the SN triggers Random Access so that synchronisation of the SN radio resource configuration can be performed. The SN decides the PSCell and other SCG SCells and provides the new SCG radio resource configuration to the MN in a *NR RRC configuration* message contained in the *SgNB Addition Request Acknowledge* message. In case of bearer options that require X2-U resources between the MN and the SN, the SN provides X2-U TNL address information for the respective E-RAB, X2-U UL TNL address information for SN terminated bearers, X2-U DL TNL address information for MN terminated bearers. For SN terminated bearers, the SN provides the S1-U DL TNL address information for the respective E-RAB and security algorithm. If SCG radio resources have been requested, the SCG radio resource configuration is provided. If the MN requested the SCG to be deactivated, the SN may keep the SCG activated. If the MN requests the SCG to be activated, the SN shall keep the SCG activated.

NOTE 3: For the SN terminated split bearer option, the SN may either decide to request resources from the MN of such an amount, that the QoS for the respective E-RAB is guaranteed by the exact sum of resources provided by the MN and the SN together, or even more. The SNs decision is reflected in step 2 by the E-RAB parameters signalled to the MN, which may differ from E-RAB parameters received in step 1. The QoS level requested from the MN shall not exceed the level that the MN offered when setting up the split bearer in step 1.

NOTE 4: In case of MN terminated bearers, transmission of user plane data may take place after step 2.

NOTE 5: In case of SN terminated bearers, data forwarding and the SN Status Transfer may take place after step 2.

3. The MN sends to the UE the *RRCConnectionReconfiguration* message including the NR RRC configuration message, without modifying it. Within the MN *RRCConnectionReconfiguration* message, the MN can indicate the SCG is deactivated.
4. The UE applies the new configuration and replies to MN with *RRCConnectionReconfigurationComplete* message, including a NR RRC response message, if needed. In case the UE is unable to comply with (part of) the configuration included in the *RRCConnectionReconfiguration* message, it performs the reconfiguration failure procedure.
5. The MN informs the SN that the UE has completed the reconfiguration procedure successfully via *SgNB ReconfigurationComplete* message, including the encoded NR RRC response message, if received from the UE.
6. If configured with bearers requiring SCG radio resources and the SCG is not deactivated, the UE performs synchronisation towards the PSCell of the SN. The order the UE sends the *RRCConnectionReconfigurationComplete* message and performs the Random Access procedure towards the SCG is not defined. The successful RA procedure towards the SCG is not required for a successful completion of the RRC Connection Reconfiguration procedure.
7. If PDCP termination point is changed to the SN for bearers using RLC AM, and when RRC full configuration is not used, the MN sends the *SN Status Transfer* message.
8. For SN terminated bearers moved from the MN, dependent on the bearer characteristics of the respective E-RAB, the MN may take actions to minimise service interruption due to activation of EN-DC (Data forwarding).
- 9-12. If applicable, the update of the UP path towards the EPC is performed.

Conditional Secondary Node Addition

Figure 10.2.1-2 shows the Conditional Secondary Node Addition procedure.

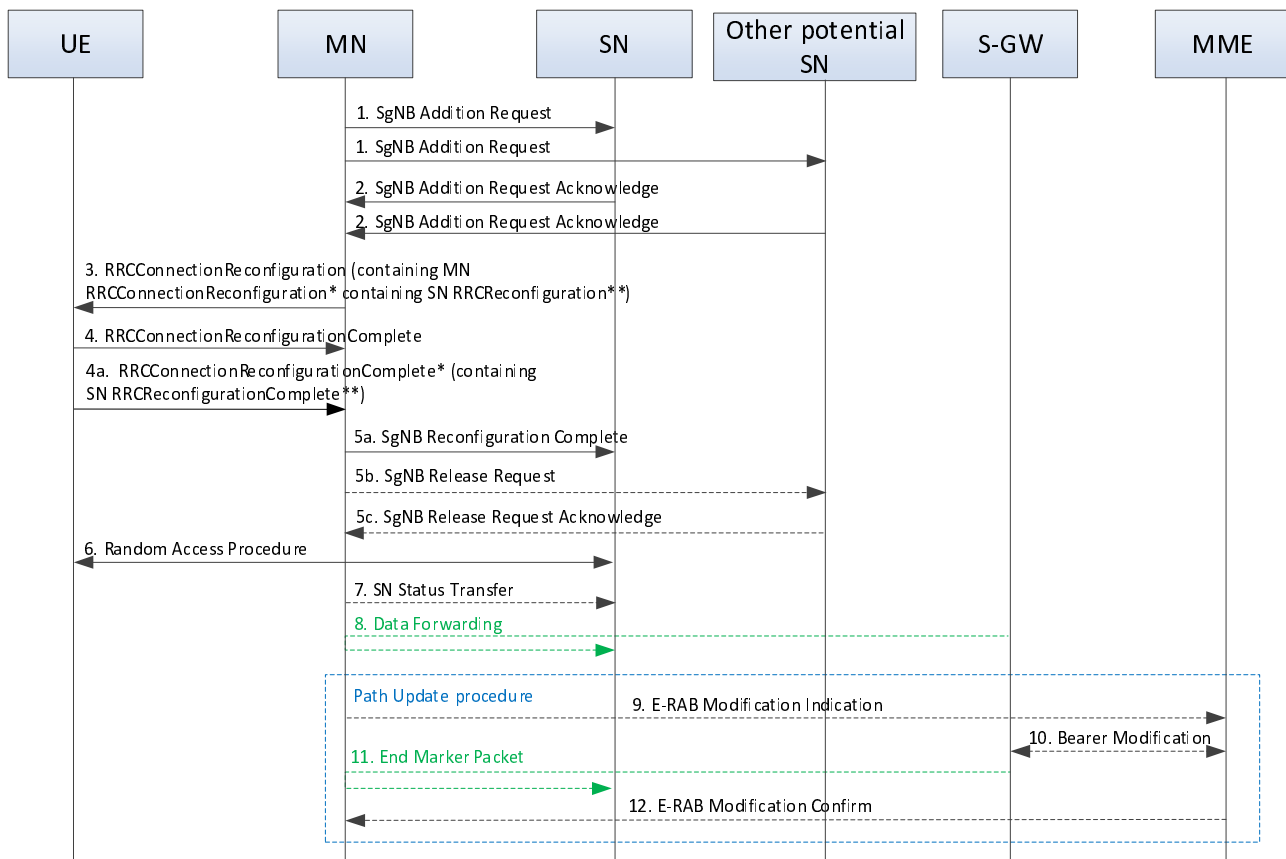

Figure 10.2.1-2: Conditional Secondary Node Addition procedure

1. The MN decides to configure CPA for the UE and requests the candidate SN(s) to allocate resources for a specific E-RAB, indicating E-RAB characteristics (E-RAB parameters, TNL address information corresponding to bearer type), indicating that the request is for CPAC and providing the upper limit for the number of PSCells that can be prepared by the candidate SN. In addition, for the bearers requiring SCG radio resources, the MN indicates the requested SCG configuration information, including the entire UE capabilities and the UE capability coordination result. In this case, the MN also provides the candidate cells recommended by MN via the latest measurement results for the candidate SN to choose from and configure the SCG cell(s). The MN may request the candidate SN to allocate radio resources for split SRB operation. The MN always provides all the needed security information to the candidate SN (even if no SN terminated bearers are setup) to enable SRB3 to be setup based on SN decision. In case of bearer options that require X2-U resources between the MN and the candidate SN, the MN provides X2-U TNL address information for the respective E-RAB, X2-U DL TNL address information for SN terminated bearers, X2-U UL TNL address information for MN terminated bearers. In case of SN terminated split bearers the MN provides the maximum QoS level that it can support. The candidate SN may reject the addition request.

NOTE 6: For split bearers, MCG and SCG resources may be requested of such an amount, that the QoS for the respective E-RAB is guaranteed by the exact sum of resources provided by the MCG and the SCG together, or even more. For MN terminated split bearers, the MN decision is reflected in step 1 by the E-RAB parameters signalled to the candidate SN, which may differ from E-RAB parameters received over S1.

NOTE 7: For a specific E-RAB, the MN may request the direct establishment of an SCG or a split bearer, i.e., without first having to establish an MCG bearer. It is also allowed that all E-RABs can be configured as SN terminated bearers, i.e. there is no E-RAB established as an MN terminated bearer.

2. If the RRM entity in the candidate SN is able to admit the resource request, it allocates respective radio resources and, dependent on the bearer option, respective transport network resources, and provides the prepared PSCell ID(s) to the MN. For bearers requiring SCG radio resources, the candidate SN configures Random Access so that synchronisation of the SN radio resource configuration can be performed at the CPA execution. From the list of cells indicated within the measurement results provided by the MN, the candidate SN decides the list of PSCell(s) to prepare (considering the maximum number indicated by the MN) and, for each prepared PSCell, the candidate SN decides SCG SCells and provides the corresponding SCG radio resource configuration to the MN

in an NR *RRCReconfiguration*** message contained in the *SgNB Addition Request Acknowledge* message. The candidate SN can either accept or reject each of the candidate cells listed within the measurement results indicated by the MN, i.e. it cannot configure any alternative candidates. In case of bearer options that require X2-U resources between the MN and the candidate SN, the candidate SN provides X2-U TNL address information for the respective E-RAB, X2-U UL TNL address information for SN terminated bearers, X2-U DL TNL address information for MN terminated bearers. For SN terminated bearers, the candidate SN provides the S1-U DL TNL address information for the respective E-RAB and security algorithm. If SCG radio resources have been requested, the SCG radio resource configuration is provided.

NOTE 8: For the SN terminated split bearer option, the candidate SN may either decide to request resources from the MN of such an amount, that the QoS for the respective E-RAB is guaranteed by the exact sum of resources provided by the MN and the candidate SN together, or even more. The candidate SN decision is reflected in step 2 by the E-RAB parameters signalled to the MN, which may differ from E-RAB parameters received in step 1. The QoS level requested from the MN shall not exceed the level that the MN offered when setting up the split bearer in step 1.

NOTE 9: In case of SN terminated bearers, early data forwarding may take place after step 2. For the early data forwarding of SN terminated bearers, the MN forwards the PDCP SDU to the candidate SN and also sends the *Early Status Transfer* message. For the early transmission of MN terminated split/SCG bearers, the MN forwards the PDCP PDU to the candidate SN.

3. The MN sends to the UE an *RRCCConnectionReconfiguration* message including the CPA configuration, i.e. a list of *RRCCConnectionReconfiguration** messages and associated execution conditions. Each *RRCCConnectionReconfiguration** message contains the SCG configuration in the *RRCReconfiguration*** message received from the candidate SN in step 2 and possibly an MCG configuration. Besides, the *RRCCConnectionReconfiguration* message can also include an updated MCG configuration, e.g., to configure the required conditional measurements.
4. The UE applies the *RRCCConnectionReconfiguration* message received in step 3, stores the CPA configuration and replies to the MN with an *RRCCConnectionReconfigurationComplete* message. In case the UE is unable to comply with (part of) the configuration included in the *RRCCConnectionReconfiguration* message, it performs the reconfiguration failure procedure.
- 4a. The UE starts evaluating the execution conditions. If the execution condition of one candidate PSCell is satisfied, the UE applies *RRCCConnectionReconfiguration** message corresponding to the selected candidate PSCell, and sends an *RRCCConnectionReconfigurationComplete** message, including an NR *RRCReconfigurationComplete*** message for the selected candidate PSCell, and information enabling the MN to identify the SN of the selected candidate PSCell.
- 5a-5c. The MN informs the SN of the selected candidate PSCell that the UE has completed the reconfiguration procedure successfully via *SgNB Reconfiguration Complete* message, including the *RRCReconfigurationComplete*** message. The MN sends the *SgNB Release Request* message(s) to cancel CPA in the other candidate SN(s), if configured. The other candidate SN(s) acknowledges the release request.
6. The UE performs synchronisation towards the PSCell indicated in the *RRCCConnectionReconfiguration** message applied in step 4a. The order the UE sends the *RRCCConnectionReconfigurationComplete** message and performs the Random Access procedure towards the SCG is not defined. The successful RA procedure towards the SCG is not required for a successful completion of the RRC Connection Reconfiguration procedure.
7. If PDCP termination point is changed to the SN for bearers using RLC AM, and when RRC full configuration is not used, the MN sends the *SN Status Transfer* message.
8. For SN terminated bearers moved from the MN, dependent on the bearer characteristics of the respective E-RAB, the MN may take actions to minimise service interruption due to activation of EN-DC (Data forwarding).
- 9-12. If applicable, the update of the UP path towards the EPC is performed.

10.2.2 MR-DC with 5GC

The Secondary Node (SN) Addition procedure is initiated by the MN and is used to establish a UE context at the SN in order to provide resources from the SN to the UE. For bearers requiring SCG radio resources, this procedure is used to add at least the initial SCG serving cell of the SCG. This procedure can also be used to configure an SN terminated

MCG bearer (where no SCG configuration is needed). In case of CPA, the Conditional Secondary Node Addition procedure can be used for CPA configuration and CPA execution.

Secondary Node Addition

Figure 10.2.2-1 shows the SN Addition procedure.

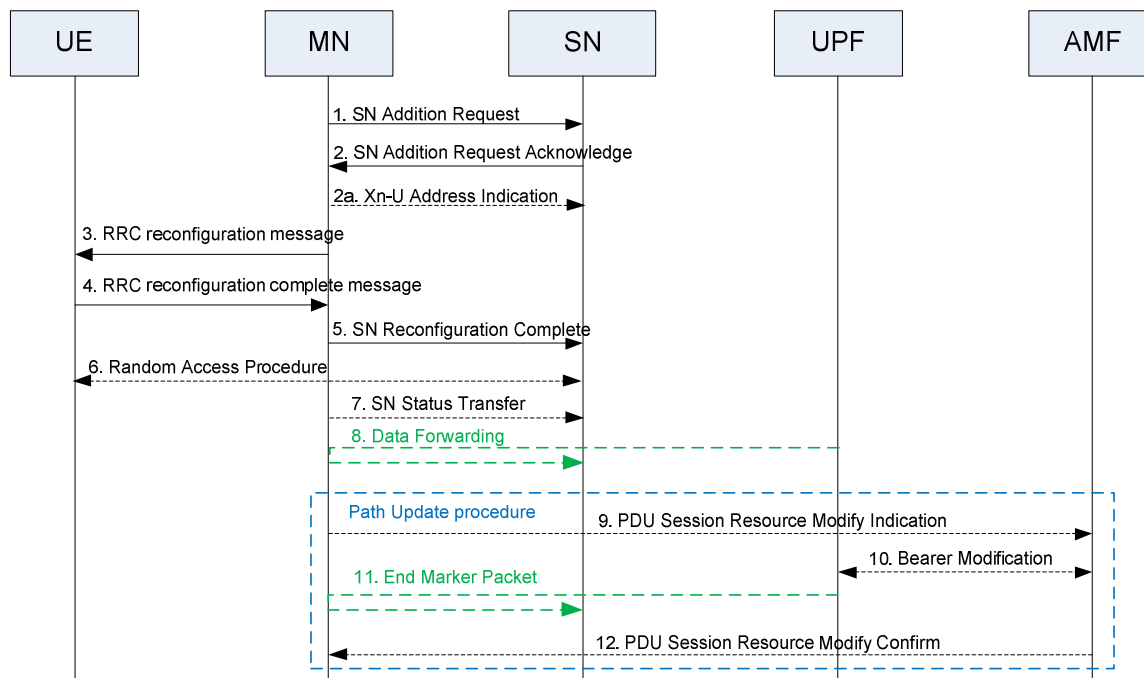

Figure 10.2.2-1: SN Addition procedure

1. The MN decides to request the target SN to allocate resources for one or more specific PDU Sessions/QoS Flows, indicating QoS Flows characteristics (QoS Flow Level QoS parameters, PDU session level TNL address information, and PDU session level Network Slice info). In addition, for bearers requiring SCG radio resources, MN indicates the requested SCG configuration information, including the entire UE capabilities and the UE capability coordination result. In this case, the MN also provides the latest measurement results for SN to choose and configure the SCG cell(s). The MN may request the SN to allocate radio resources for split SRB operation. In NGEN-DC and NR-DC, the MN always provides all the needed security information to the SN (even if no SN terminated bearers are setup) to enable SRB3 to be setup based on SN decision. The MN may request the SCG to be activated or deactivated.

For MN terminated bearer options that require Xn-U resources between the MN and the SN, the MN provides Xn-U UL TNL address information. For SN terminated bearers, the MN provides a list of available DRB IDs. The S-NG-RAN node shall store this information and use it when establishing SN terminated bearers. The SN may reject the request.

For SN terminated bearer options that require Xn-U resources between the MN and the SN, the MN provides in step 1 a list of QoS flows per PDU Sessions for which SCG resources are requested to be setup upon which the SN decides how to map QoS flows to DRB.

- NOTE 1: For split bearers, MCG and SCG resources may be requested of such an amount, that the QoS for the respective QoS Flow is guaranteed by the exact sum of resources provided by the MCG and the SCG together, or even more. For MN terminated split bearers, the MN decision is reflected in step 1 by the QoS Flow parameters signalled to the SN, which may differ from QoS Flow parameters received over NG.
- NOTE 2: For a specific QoS flow, the MN may request the direct establishment of SCG and/or split bearers, i.e. without first having to establish MCG bearers. It is also allowed that all QoS flows can be mapped to SN terminated bearers, i.e. there is no QoS flow mapped to an MN terminated bearer.
2. If the RRM entity in the SN is able to admit the resource request, it allocates respective radio resources and, dependent on the bearer type options, respective transport network resources. For bearers requiring SCG radio

resources the SN triggers UE Random Access so that synchronisation of the SN radio resource configuration can be performed. The SN decides for the PSCell and other SCG SCells and provides the new SCG radio resource configuration to the MN within an SN RRC configuration message contained in the *SN Addition Request Acknowledge* message. If the MN requested the SCG to be deactivated, the SN may keep the SCG activated. If the MN requests the SCG to be activated, the SN shall keep the SCG activated. In case of bearer options that require Xn-U resources between the MN and the SN, the SN provides Xn-U TNL address information for the respective DRB, Xn-U UL TNL address information for SN terminated bearers, Xn-U DL TNL address information for MN terminated bearers. For SN terminated bearers, the SN provides the NG-U DL TNL address information for the respective PDU Session and security algorithm. If SCG radio resources have been requested, the SCG radio resource configuration is provided.

NOTE 3: In case of MN terminated bearers, transmission of user plane data may take place after step 2.

NOTE 4: In case of SN terminated bearers, data forwarding and the SN Status Transfer may take place after step 2.

NOTE 5: For MN terminated bearers for which PDCP duplication with CA is configured in NR SCG side, the MN allocates up to 4 separate Xn-U bearers and the SN provides a logical channel ID for primary or split secondary path to the MN.

For SN terminated bearers for which PDCP duplication with CA is configured in NR MCG side, the SN allocates up to 4 separate Xn-U bearers and the MN provides a logical channel ID for primary or split secondary path to the SN via an additional MN-initiated SN modification procedure.

- 2a. For SN terminated bearers using MCG resources, the MN provides Xn-U DL TNL address information in the *Xn-U Address Indication* message.
3. The MN sends the MN RRC reconfiguration message to the UE including the SN RRC configuration message, without modifying it. Within the MN RRC reconfiguration message, the MN can indicate the SCG is deactivated.
4. The UE applies the new configuration and replies to MN with MN RRC reconfiguration complete message, including an SN RRC response message for SN, if needed. In case the UE is unable to comply with (part of) the configuration included in the MN RRC reconfiguration message, it performs the reconfiguration failure procedure.
5. The MN informs the SN that the UE has completed the reconfiguration procedure successfully via *SN Reconfiguration Complete* message, including the SN RRC response message, if received from the UE.
6. If configured with bearers requiring SCG radio resources and the SCG is not deactivated, the UE performs synchronisation towards the PSCell configured by the SN. The order the UE sends the MN RRC reconfiguration complete message and performs the Random Access procedure towards the SCG is not defined. The successful RA procedure towards the SCG is not required for a successful completion of the RRC Connection Reconfiguration procedure.
7. If PDCP termination point is changed to the SN for bearers using RLC AM, and when RRC full configuration is not used, the MN sends the *SN Status Transfer* message.
8. For SN terminated bearers or QoS flows moved from the MN, dependent on the characteristics of the respective bearer or QoS flow, the MN may take actions to minimise service interruption due to activation of MR-DC (Data forwarding).
- 9-12. If applicable, the update of the UP path towards the 5GC is performed via a PDU Session Path Update procedure.

Conditional Secondary Node Addition

Figure 10.2.2-2 shows the Conditional SN Addition procedure.

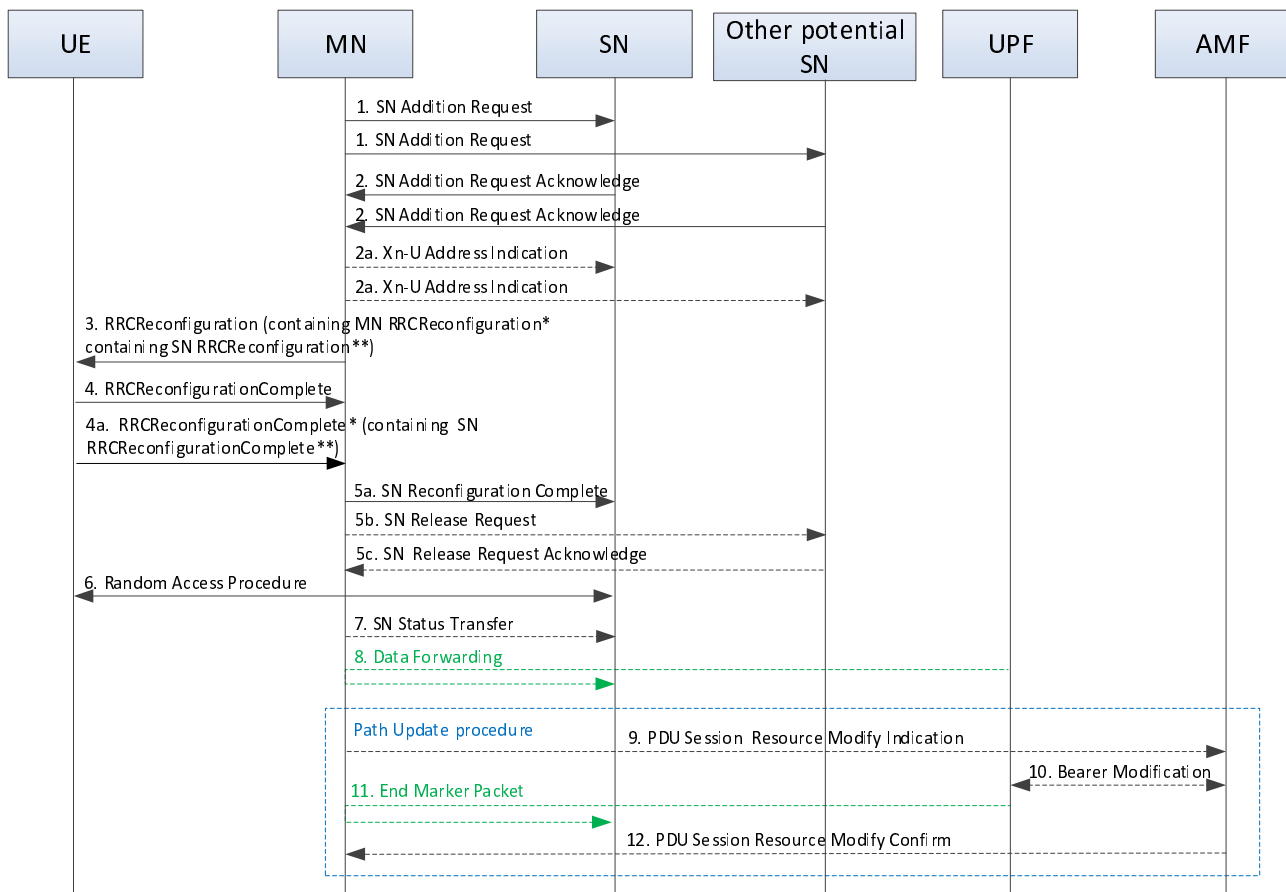

Figure 10.2.2-2: Conditional Secondary Node Addition procedure

1. The MN decides to configure CPA for the UE. The MN requests the candidate SN(s) to allocate resources for one or more specific PDU Sessions/QoS Flows, indicating QoS Flows characteristics (QoS Flow Level QoS parameters, PDU session level TNL address information, and PDU session level Network Slice info), indicating that the request is for CPA and providing the upper limit for the number of PSCells that can be prepared by the candidate SN. In addition, for bearers requiring SCG radio resources, the MN indicates the requested SCG configuration information, including the entire UE capabilities and the UE capability coordination result. In this case, the MN also provides the candidate cells recommended by MN via the latest measurement results for the candidate SN to choose and configure the SCG cell(s). The MN may request the candidate SN to allocate radio resources for split SRB operation. In NR-DC, the MN always provides all the needed security information to the candidate SN (even if no SN terminated bearers are setup) to enable SRB3 to be setup based on SN decision.

For MN terminated bearer options that require Xn-U resources between the MN and the candidate SN, the MN provides Xn-U UL TNL address information. For SN terminated bearers, the MN provides a list of available DRB IDs. The candidate SN shall store this information and use it when establishing SN terminated bearers. The candidate SN may reject the addition request.

For SN terminated bearer options that require Xn-U resources between the MN and the candidate SN, the MN provides in step 1 a list of QoS flows per PDU Sessions for which SCG resources are requested to be setup upon which the candidate SN decides how to map QoS flows to DRB.

NOTE 6: For split bearers, MCG and SCG resources may be requested of such an amount, that the QoS for the respective QoS Flow is guaranteed by the exact sum of resources provided by the MCG and the SCG together, or even more. For MN terminated split bearers, the MN decision is reflected in step 1 by the QoS Flow parameters signalled to the candidate SN, which may differ from QoS Flow parameters received over NG.

NOTE 7: For a specific QoS flow, the MN may request the direct establishment of SCG and/or split bearers, i.e. without first having to establish MCG bearers. It is also allowed that all QoS flows can be mapped to SN terminated bearers, i.e. there is no QoS flow mapped to an MN terminated bearer.

2. If the RRM entity in the candidate SN is able to admit the resource request, it allocates respective radio resources and, dependent on the bearer type options, respective transport network resources, and provides the prepared PSCell ID(s) to the MN. For bearers requiring SCG radio resources the candidate SN configures Random Access so that synchronisation of the SN radio resource configuration can be performed at the CPA execution. From the list of cells indicated within the measurement results provided by the MN, the candidate SN decides the list of PSCell(s) to prepare (considering the maximum number indicated by the MN) and, for each prepared PSCell, the candidate SN decides other SCG SCells and provides the new corresponding SCG radio resource configuration to the MN in an *NR RRCReconfiguration*** message, contained in the *SN Addition Request Acknowledge* message. The candidate SN can either accept or reject each of the candidate cells listed within the measurement results indicated by the MN, i.e. it cannot configure any alternative candidates. In case of bearer options that require Xn-U resources between the MN and the candidate SN, the candidate SN provides Xn-U TNL address information for the respective DRB, Xn-U UL TNL address information for SN terminated bearers, Xn-U DL TNL address information for MN terminated bearers. For SN terminated bearers, the candidate SN provides the NG-U DL TNL address information for the respective PDU Session and security algorithm. If SCG radio resources have been requested, the SCG radio resource configuration is provided.

NOTE 8: For MN terminated bearers for which PDCP duplication with CA is configured in NR SCG side, the MN allocates up to 4 separate Xn-U bearers and the candidate SN provides a logical channel ID for primary or split secondary path to the MN.

For SN terminated bearers for which PDCP duplication with CA is configured in NR MCG side, the candidate SN allocates up to 4 separate Xn-U bearers and the MN provides a logical channel ID for primary or split secondary path to the candidate SN via an additional MN-initiated SN modification procedure.

NOTE 9: In case of SN terminated bearers, early data forwarding may take place after step 2. For the early data forwarding of SN terminated bearers, the MN forwards the PDCP SDU to the candidate SN. For the early transmission of MN terminated split/SCG bearers, the MN forwards the PDCP PDU to the candidate SN.

- 2a. For SN terminated bearers using MCG resources, the MN provides Xn-U DL TNL address information in the *Xn-U Address Indication* message. In case of early data forwarding in CPA, the MN sends the *Early Status Transfer* message to the candidate SN.
3. The MN sends to the UE an *RRCReconfiguration* message including the CPA configuration, i.e. a list of *RRCReconfiguration** messages and associated execution conditions. Each *RRCReconfiguration** message contains the SCG configuration in the *RRCReconfiguration*** received from the candidate SN in step 2 and possibly an MCG configuration. Besides, the *RRCReconfiguration* message can also include an updated MCG configuration, e.g. to configure the required conditional measurements.
4. The UE applies the *RRCReconfiguration* message received in step 3, stores the CPA configuration and replies to the MN with an *RRCReconfigurationComplete* message. In case the UE is unable to comply with (part of) the configuration included in the *RRCReconfiguration* message, it performs the reconfiguration failure procedure.
- 4a. The UE starts evaluating the execution conditions. If the execution condition of one candidate PSCell is satisfied, the UE applies *RRCReconfiguration** message corresponding to the selected candidate PSCell, and sends an MN *RRCReconfigurationComplete** message, including an *RRCReconfigurationComplete*** message for the selected candidate PSCell, and information enabling the MN to identify the SN of the selected candidate PSCell.
- 5a-5c. The MN informs the SN of the selected candidate PSCell that the UE has completed the reconfiguration procedure successfully via *SN Reconfiguration Complete* message, including the *RRCReconfigurationComplete*** message. The MN sends the *SN Release Request* message(s) to cancel CPA in the other candidate SN(s), if configured. The other candidate SN(s) acknowledges the release request.
6. The UE performs synchronisation towards the PSCell indicated in the *RRCReconfiguration** message applied in step 4a. The order the UE sends the MN *RRCReconfigurationComplete** message and performs the Random Access procedure towards the SCG is not defined. The successful RA procedure towards the SCG is not required for a successful completion of the RRC Connection Reconfiguration procedure.
7. If PDCP termination point is changed to the SN for bearers using RLC AM, and when RRC full configuration is not used, the MN sends the *SN Status Transfer* message.

8. For SN terminated bearers or QoS flows moved from the MN, dependent on the characteristics of the respective bearer or QoS flow, the MN may take actions to minimise service interruption due to activation of MR-DC (Data forwarding).
- 9-12. If applicable, the update of the UP path towards the 5GC is performed via a PDU Session Path Update procedure.

10.2.3 Conditional PSCell Addition

A Conditional PSCell Addition (CPA) is defined as a PSCell addition that is executed by the UE when execution condition(s) is met. The UE starts evaluating the execution condition(s) upon receiving the CPA configuration, and stops evaluating the execution condition(s) once PSCell addition or PCell change is triggered.

The following principles apply to CPA:

- The CPA configuration contains the configuration of CPA candidate PSCell(s), execution condition(s) and may contain the MCG configuration, to be applied when CPA execution is triggered.
- An execution condition may consist of one or two trigger condition(s) (see *CondEvent*, as defined in TS 38.331 [4] or TS 36.331 [10]). Only a single RS type and at most two different trigger quantities (e.g. RSRP and RSRQ, RSRP and SINR, etc.) can be used for the evaluation of CPA execution condition of a single candidate PSCell.
- Before any CPA execution condition is satisfied, upon reception of PSCell addition command or PCell change command, the UE executes the PSCell addition procedure as described in clause 10.2.1 or 10.2.2, or the PCell change procedure as described in clause 9.2.3.2 in TS 38.300 [3] or clause 10.1.2.1 in TS 36.300 [2], regardless of any previously received CPA configuration. Upon the successful completion of PSCell addition procedure or PCell change procedure, the UE releases the stored CPA configuration.
- While executing CPA, the UE is not required to continue evaluating the execution condition of other candidate PSCell(s) or PCell(s).
- Once the CPA procedure is executed successfully, the UE releases all stored conditional reconfigurations (i.e. for CPA and for CHO, as specified in TS 38.300 [3] or TS 36.300 [2]).

CPA configuration in HO command, in PSCell addition command, or within any conditional reconfiguration (i.e., CPA, CPC or CHO configuration) is not supported.

10.3 Secondary Node Modification (MN/SN initiated)

10.3.1 EN-DC

The Secondary Node Modification procedure may be initiated either by the MN or by the SN and be used to modify, establish or release bearer contexts, to transfer bearer contexts to and from the SN or to modify other properties of the UE context within the same SN. It may also be used to transfer an NR RRC message from the SN to the UE via the MN and the response from the UE via MN to the SN (e.g. when SRB3 is not used). In case of CPA or inter-SN CPC, this procedure is used to modify CPA or inter-SN CPC configuration within the same candidate SN. In case of CPA or inter-SN CPC, this procedure may also be triggered by the candidate SN to add some prepared PSCells from the suggested list or cancel part of the prepared PSCells. This procedure may be initiated by the MN or SN to request the SN or MN to deactivate or activate the SCG.

The Secondary Node modification procedure does not necessarily need to involve signalling towards the UE.

MN initiated SN Modification

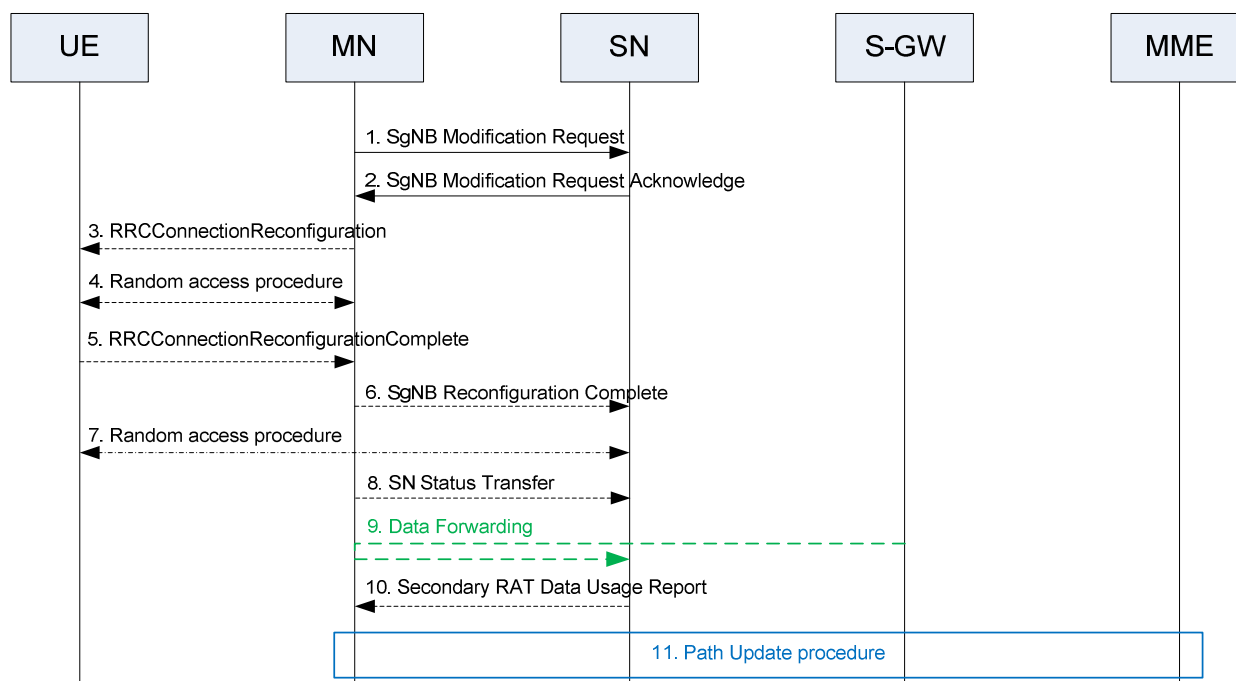

Figure 10.3.1-1: SN Modification procedure - MN initiated

The MN uses the procedure to initiate configuration changes of the SCG within the same SN, e.g. the addition, modification or release of SCG bearer(s) and the SCG RLC bearer of split bearer(s), as well as configuration changes for SN terminated MCG bearers. Bearer termination point change is realized by adding the new bearer configuration and releasing the old bearer configuration within a single MN initiated SN Modification procedure for the respective E-RAB. The MN uses this procedure to perform handover within the same MN while keeping the SN. The MN also uses the procedure to query the current SCG configuration, e.g. when delta configuration is applied in an MN initiated SN change. The MN also uses the procedure to provide the S-RLF related information to the SN. The MN also uses this procedure to activate or deactivate the SCG. The MN may not use the procedure to initiate the addition, modification or release of SCG SCells. The SN may reject the request, except if it concerns the release of SN terminated bearer(s) or the SCG RLC bearer of MN terminated bearer(s), or if it is used to perform handover within the same MN while keeping the SN. Figure 10.3.1-1 shows an example signalling flow for an MN initiated SN Modification procedure.

1. The MN sends the *SgNB Modification Request* message, which may contain bearer context related or other UE context related information, data forwarding address information (if applicable) and the requested SCG configuration information, including the UE capability coordination result to be used as basis for the reconfiguration by the SN. The MN may request the SCG to be activated or deactivated. In case a security key update in the SN is required, a new *SgNB Security Key* is included. In case of SCG RLC re-establishment for E-RABs configured with an MN terminated bearer with an SCG RLC bearer for which no bearer type change is performed, the MN provides a new UL GTP tunnel endpoint to the SN. The SN shall continue sending UL PDCP PDUs to the MN with the previous UL GTP tunnel endpoint until it re-establishes the RLC and use the new UL GTP tunnel endpoint after re-establishment. In case of PDCP re-establishment for E-RABs configured with an SN terminated bearer with an MCG RLC bearer for which no bearer type change is performed, the MN provides a new DL GTP tunnel endpoint to the SN. The SN shall continue sending DL PDCP PDUs to the MN with the previous DL GTP tunnel endpoint until it performs PDCP re-establishment and use the new DL GTP tunnel endpoint starting with the PDCP re-establishment.
2. The SN responds with the *SgNB Modification Request Acknowledge* message, which may contain SCG radio resource configuration information within a NR RRC configuration message and data forwarding address information (if applicable). If the MN requested the SCG to be activated or deactivated, the SN indicates whether the SCG is activated or deactivated. In case of a security key update (with or without PSCell change), for E-RABs configured with the MN terminated bearer option that require X2-U resources between the MN and the SN, for which no bearer type change is performed, the SN provides a new DL GTP tunnel endpoint to the MN. The MN shall continue sending DL PDCP PDUs to the SN with the previous DL GTP tunnel endpoint until it performs PDCP re-establishment or PDCP data recovery, and use the new DL GTP tunnel endpoint starting with the PDCP re-establishment or data recovery. In case of a security key update (with or without PSCell change), for E-RABs configured with the SN terminated bearer option that require X2-U resources between the MN and the SN, for which no bearer type change is performed, the SN provides a new UL GTP tunnel endpoint to the

MN. The MN shall continue sending UL PDCP PDUs to the SN with the previous UL GTP tunnel endpoint until it re-establishes the RLC and use the new UL GTP tunnel endpoint after re-establishment.

NOTE 00: In case SN includes the indication of full RRC configuration in *SgNB Modification Request Acknowledge* message to MN e.g. comprehension failure upon intra-CU inter-DU change, MN performs release and add of the NR SCG part of the configuration but does not release SN terminated radio bearers towards the UE.

- 3-5. The MN initiates the RRC connection reconfiguration procedure, including the NR RRC configuration message. The UE applies the new configuration, synchronizes to the MN (if instructed, in case of intra-MN handover) and replies with *RRCConnectionReconfigurationComplete*, including a NR RRC response message, if needed. In case the UE is unable to comply with (part of) the configuration included in the *RRCConnectionReconfiguration* message, it performs the reconfiguration failure procedure.
6. Upon successful completion of the reconfiguration, the success of the procedure is indicated in the *SgNB Reconfiguration Complete* message.
7. If instructed, the UE performs synchronisation towards the PSCell of the SN as described in SgNB addition procedure. Otherwise, the UE may perform UL transmission after having applied the new configuration.
8. If PDCP termination point is changed for bearers using RLC AM, and when RRC full configuration is not used, the SN Status Transfer takes place between the MN and the SN (Figure 10.3.1-1 depicts the case where a bearer context is transferred from the MN to the SN).

NOTE 0: The SN may not be aware that a SN terminated bearer requested to be released is reconfigured to a MN terminated bearer. The SN Status for the released SN terminated bearers with RLC AM may also be transferred to the MN.

9. If applicable, data forwarding between MN and the SN takes place (Figure 10.3.1-1 depicts the case where a bearer context is transferred from the MN to the SN).
10. The SN sends the *Secondary RAT Data Usage Report* message to the MN and includes the data volumes delivered to and received from the UE over the NR radio for the E-RABs to be released and for the E-RABs for which the S1 UL GTP Tunnel endpoint was requested to be modified.

NOTE 1: The order the SN sends the *Secondary RAT Data Usage Report* message and performs data forwarding with MN is not defined. The SN may send the report when the transmission of the related bearer is stopped.

11. If applicable, a path update is performed.

SN initiated SN Modification with MN involvement

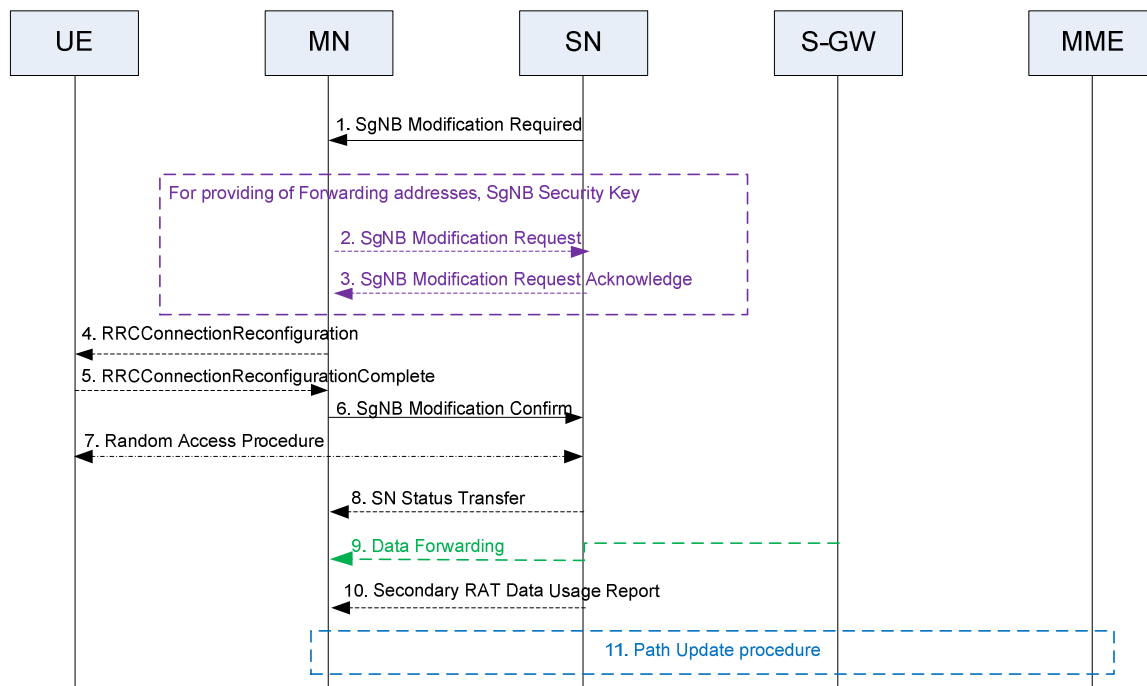

Figure 10.3.1-2: SN Modification procedure - SN initiated with MN involvement

The SN uses the procedure to perform configuration changes of the SCG within the same SN, e.g. to trigger the release of SCG bearer(s) and the SCG RLC bearer of split bearer(s) (upon which the MN may release the bearer or maintain current bearer type or reconfigure it to an MCG bearer, either MN terminated or SN terminated), to trigger the release of SCG resources (e.g., release SCG lower layer resources but keep SN), and to trigger PSCell change (e.g. when a new security key is required or when the MN needs to perform PDCP data recovery). The MN cannot reject the release request of SCG bearer and the SCG RLC bearer of a split bearer and the release request of SCG resources. The SN also uses this procedure to activate or deactivate the SCG. The MN shall either accept modification of all of the requested SCG bearer(s) and the SCG RLC bearer of split bearer(s) and the request of activation or deactivation of the SCG, or fail the procedure. Figure 10.3.1-2 shows an example signalling flow for an SN initiated SgNB Modification procedure, with MN involvement.

1. The SN sends the *SgNB Modification Required* message including a NR RRC configuration message, which may contain bearer context related, other UE context related information and the new SCG radio resource configuration. The SN may request the SCG to be activated or deactivated. For bearer release or modification, a corresponding E-RAB list is included in the *SgNB Modification Required* message. In case of change of security key, the *PDCP Change Indication* indicates that a $S-K_{\text{SgNB}}$ update is required. In case the MN needs to perform PDCP data recovery, the *PDCP Change Indication* indicates that PDCP data recovery is required. In case SN decides to trigger SCG release, the E-RABs to be modified list includes all the E-RABs of the UE with SCG resource indicated as not present for each E-RAB.

The SN can decide whether the change of security key is required.

NOTE 1a: In case SN includes the indication of full RRC configuration in *SgNB Modification Required* message to MN e.g. comprehension failure upon intra-CU inter-DU change, MN performs release and add of the NR SCG part of the configuration but does not release SN terminated radio bearers towards the UE.

NOTE 1b: In case that either CHO or any conditional reconfiguration is prepared, and if a prepared SN initiated intra-SN CPC procedure or reconfiguration with sync of the SCG using SRB3 is executed, the SN shall notify to the MN via the *SgNB Modification Required* message. The *SgNB Modification Required* message may include the SCG configuration that has been applied in the UE. The MN considers that a conditional reconfiguration, if any configured in the UE, has been released due to the execution of the (conditional) SCG reconfiguration.

- 2/3. The MN initiated SN Modification procedure may be triggered by the *SN Modification Required* message (e.g. to provide information such as data forwarding addresses, new SN security key, measurement gap, etc...)

NOTE 2: If only SN security key is provided in step 2, the MN does not need to wait for the reception of step 3 to initiate the RRC connection reconfiguration procedure.

4. The MN sends the *RRCCConnectionReconfiguration* message including a NR RRC configuration message to the UE including the new SCG radio resource configuration.
5. The UE applies the new configuration and sends the *RRCCConnectionReconfigurationComplete* message, including an encoded NR RRC response message, if needed. In case the UE is unable to comply with (part of) the configuration included in the *RRCCConnectionReconfiguration* message, it performs the reconfiguration failure procedure.
6. Upon successful completion of the reconfiguration, the success of the procedure is indicated in the *SgNB Modification Confirm* message containing the encoded NR RRC response message, if received from the UE.
7. If instructed, the UE performs synchronisation towards the PSCell of the SN as described in SN addition procedure. Otherwise, the UE may perform UL transmission after having applied the new configuration.
8. If PDCP termination point is changed for bearers using RLC AM, and when RRC full configuration is not used, the SN Status Transfer takes place between the MN and the SN (Figure 10.3.1-2 depicts the case where a bearer context is transferred from the SN to the MN).

NOTE 2a: The SN may not be aware that a SN terminated bearer requesting to release is reconfigured to a MN terminated bearer. The SN Status for the released SN terminated bearers with RLC AM may also be transferred to the MN.

9. If applicable, data forwarding between MN and the SN takes place (Figure 10.3.1-2 depicts the case where a bearer context is transferred from the SN to the MN).
10. The SN sends the *Secondary RAT Data Usage Report* message to the MN and includes the data volumes delivered to and received from the UE over the NR radio for the E-RABs to be released.

NOTE 3: The order the SN sends the *Secondary RAT Data Usage Report* message and performs data forwarding with MN is not defined. The SN may send the report when the transmission of the related bearer is stopped.

11. If applicable, a path update is performed.

SN initiated SN Modification without MN involvement

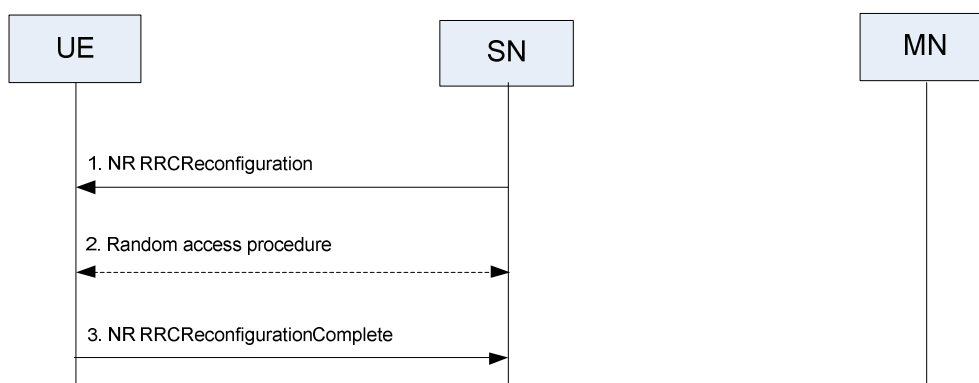

Figure 10.3.1-3: SN modification - SN initiated without MN involvement

The SN initiated modification without MN involved procedure is used to modify the configuration within SN in case no coordination with MN is required, including the addition/modification/release of SCG SCell and PSCell change (e.g. when the security key does not need to be changed and the MN does not need to be involved in PDCP recovery). The SN may initiate the procedure to configure or modify CPC configuration within the same SN. Figure 10.3.1-3 shows an example signalling flow for SN initiated SN modification procedure, without MN involvement. The SN can decide whether the Random Access procedure is required.

1. The SN sends the *RRCReconfiguration* message to the UE through SRB3. The UE applies the new configuration. In case the UE is unable to comply with (part of) the configuration included in the *RRCReconfiguration* message, it performs the reconfiguration failure procedure.
2. If instructed, the UE performs synchronisation towards the PSCell of the SN.
3. The UE replies with the *RRCReconfigurationComplete* message.

SN initiated Conditional SN Modification without MN involvement (SRB3 is used)

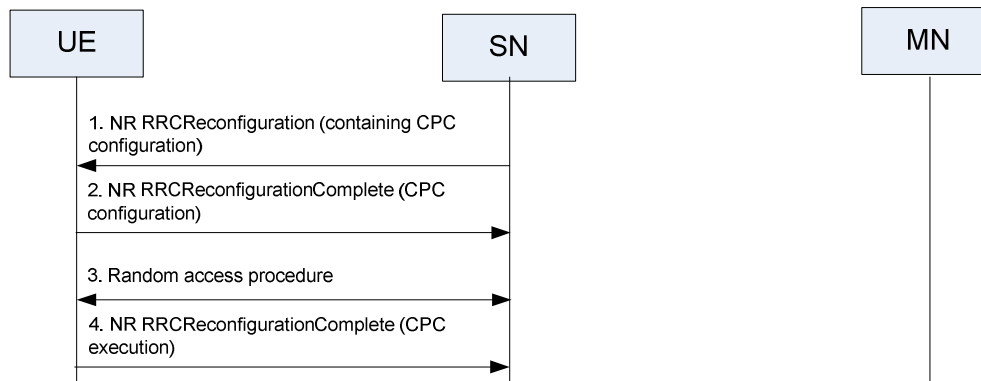

Figure 10.3.1-3a: SN Modification - SN-initiated without MN involvement and SRB3 is used to configure CPC.

The SN initiates the procedure when it needs to transfer an NR RRC message to the UE and SRB3 is used to configure CPC.

1. The SN sends the *RRCReconfiguration* message including CPC configuration to the UE through SRB3.
2. The UE applies the new configuration. In case the UE is unable to comply with (part of) the configuration included in the *RRCReconfiguration* message, it performs the reconfiguration failure procedure. The UE starts evaluating the CPC execution conditions for the candidate PSCell(s). The UE maintains connection with the source PSCell and replies with the *RRCReconfigurationComplete* message to the SN via SRB3.
3. If at least one CPC candidate PSCell satisfies the corresponding CPC execution condition, the UE detaches from the source PSCell, applies the stored configuration corresponding to the selected candidate PSCell and synchronises to the candidate PSCell.
4. The UE completes the CPC execution procedure by sending an *RRCReconfigurationComplete* message to the new PSCell.

Transfer of an NR RRC message to/from the UE (when SRB3 is not used)

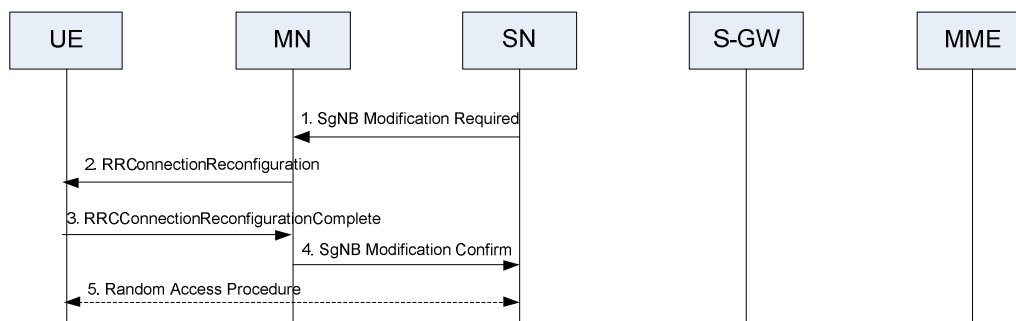

Figure 10.3.1-4: Transfer of an NR RRC message to/from the UE

The SN initiates the procedure when it needs to transfer an NR RRC message to the UE and SRB3 is not used.

1. The SN initiates the procedure by sending the *SgNB Modification Required* to the MN.
2. The MN forwards the NR RRC message to the UE in the *RRCConnectionReconfiguration* message.

3. The UE applies the new configuration and replies with the *RRCConnectionReconfigurationComplete* message. In case the UE is unable to comply with (part of) the configuration included in the NR RRC message, it performs the reconfiguration failure procedure.
4. The MN forwards the NR RRC response message, if received from the UE, to the SN in the *SgNB Modification Confirm* message.
5. If instructed, the UE performs synchronisation towards the PSCell of the SN as described in SgNB Addition procedure. Otherwise the UE may perform UL transmission after having applied the new configuration.

SN initiated Conditional SN Modification without MN involvement (SRB3 is not used)

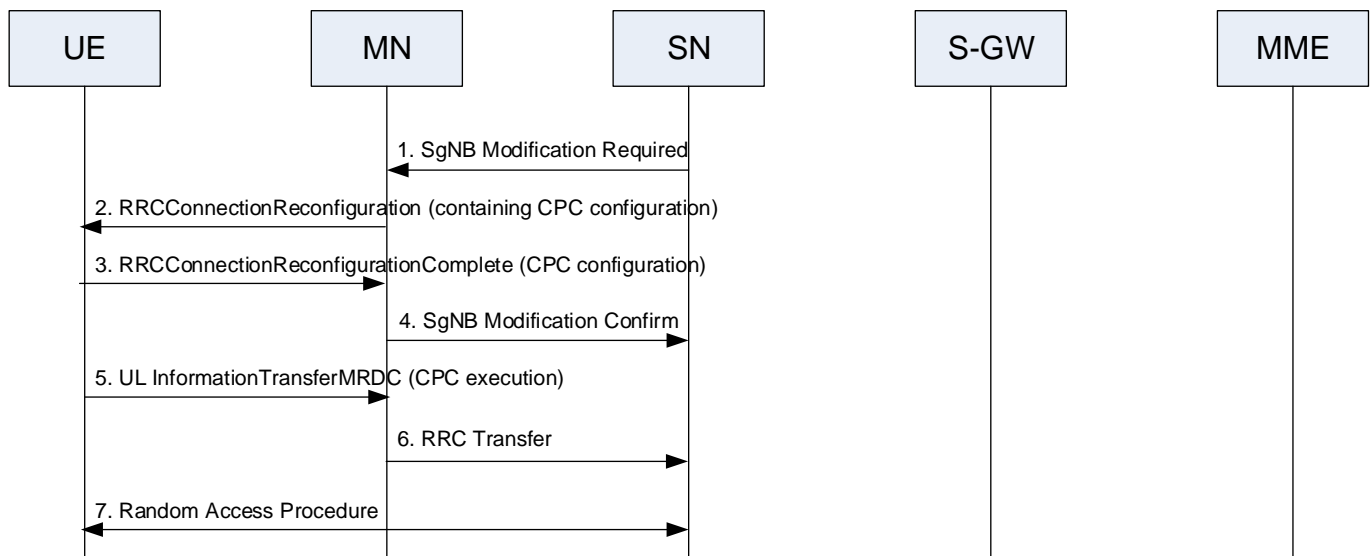

Figure 10.3.1-5: SN Modification - SN-initiated without MN involvement and SRB3 is not used to configure CPC

The SN initiates the procedure when it needs to transfer an NR RRC message to the UE and SRB3 is not used to configure CPC.

1. The SN initiates the procedure by sending the *SgNB Modification Required* to the MN including the SN RRC reconfiguration message with CPC configuration.
2. The MN forwards the SN RRC reconfiguration message to the UE including it in the *RRCConnectionReconfiguration* message.
3. The UE replies with the *RRCConnectionReconfigurationComplete* message by including the SN RRC reconfiguration complete message. In case the UE is unable to comply with (part of) the configuration included in the SN RRC reconfiguration message, it performs the reconfiguration failure procedure. The UE maintains connection with source PSCell after receiving CPC configuration, and starts evaluating the CPC execution conditions for the candidate PSCell(s).
4. The MN forwards the SN RRC response message, if received from the UE, to the SN by including it in the *SgNB Modification Confirm* message.
5. If at least one CPC candidate PSCell satisfies the corresponding CPC execution condition, the UE completes the CPC execution procedure by an *ULInformationTransferMRDC* message to the MN which includes an embedded *RRCReconfigurationComplete* message to the selected target PSCell.
6. The *RRCReconfigurationComplete* message is forwarded to the SN embedded in *RRC Transfer* message.
7. The UE detaches from the source PSCell, applies the stored corresponding configuration and synchronises to the selected candidate PSCell.

10.3.2 MR-DC with 5GC

The SN Modification procedure may be initiated either by the MN or by the SN and be used to modify the current user plane resource configuration (e.g. related to PDU session, QoS flow or DRB) or to modify other properties of the UE context within the same SN. It may also be used to transfer an RRC message from the SN to the UE via the MN and the response from the UE via MN to the SN (e.g. when SRB3 is not used). In NGEN-DC and NR-DC, the RRC message is an NR message (i.e., *RRCReconfiguration*) whereas in NE-DC it is an E-UTRA message (i.e., *RRCConnectionReconfiguration*). In case of CPA or inter-SN CPC, this procedure is used to modify CPA or inter-SN CPC configuration within the same candidate SN. In case of CPA or inter-SN CPC, this procedure may also be triggered by the candidate SN to add some prepared PSCells from the suggested list or cancel part of the prepared PSCells. This procedure may be initiated by the MN or SN to request the SN or MN to activate or deactivate the SCG.

The SN modification procedure does not necessarily need to involve signalling towards the UE.

MN initiated SN Modification

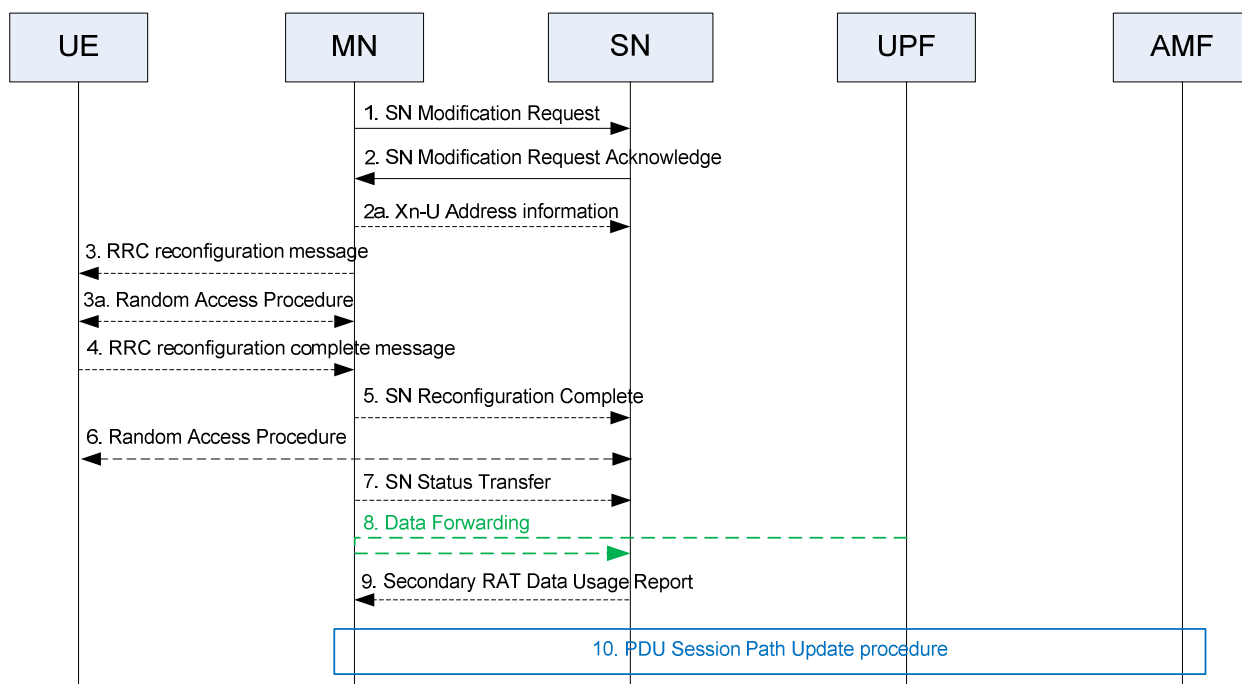

Figure 10.3.2-1: SN Modification procedure - MN initiated

The MN uses the procedure to initiate configuration changes of the SCG within the same SN, including addition, modification or release of the user plane resource configuration. The MN uses this procedure to perform handover within the same MN while keeping the SN, when the SN needs to be involved (i.e. in NGEN-DC). The MN also uses the procedure to query the current SCG configuration, e.g. when delta configuration is applied in an MN initiated SN change. The MN also uses the procedure to provide the S-RLF related information to the SN or to provide additional available DRB IDs to be used for SN terminated bearers. The MN also uses this procedure to activate or deactivate the SCG. The MN may not use the procedure to initiate the addition, modification or release of SCG SCells. The SN may reject the request, except if it concerns the release of the user plane resource configuration, or if it is used to perform handover within the same MN while keeping the SN. Figure 10.3.2-1 shows an example signalling flow for an MN initiated SN Modification procedure.

1. The MN sends the *SN Modification Request* message, which may contain user plane resource configuration related or other UE context related information, PDU session level Network Slice info and the requested SCG configuration information, including the UE capabilities coordination result to be used as basis for the reconfiguration by the SN. In case a security key update in the SN is required, a new *SN Security Key* is included. In case the PDCP data recovery in the SN is required, the *PDCP Change Indication* is included which indicates that PDCP data recovery is required in SN.
2. The SN responds with the *SN Modification Request Acknowledge* message, which may contain new SCG radio configuration information within an SN RRC reconfiguration message, and data forwarding address information

(if applicable). If the MN requested the SCG to be activated or deactivated, the SN indicates whether the SCG is activated or deactivated.

NOTE 1: For MN terminated bearers to be setup for which PDCP duplication with CA is configured in NR SCG side, the MN allocates up to 4 separate Xn-U bearers and the SN provides a logical channel ID for primary or split secondary path to the MN.

For SN terminated bearers to be setup for which PDCP duplication with CA is configured in NR MCG side, the SN allocates up to 4 separate Xn-U bearers and the MN provides a logical channel ID for primary or split secondary path to the SN via an additional MN-initiated SN modification procedure.

- 2a. When applicable, the MN provides data forwarding address information to the SN. For SN terminated bearers using MCG resources, the MN provides Xn-U DL TNL address information in the *Xn-U Address Indication* message.
- 3/4. The MN initiates the RRC reconfiguration procedure, including an SN RRC reconfiguration message. The UE applies the new configuration, synchronizes to the MN (if instructed, in case of intra-MN handover) and replies with MN RRC reconfiguration complete message, including an SN RRC response message, if needed. In case the UE is unable to comply with (part of) the configuration included in the MN RRC reconfiguration message, it performs the reconfiguration failure procedure.
5. Upon successful completion of the reconfiguration, the success of the procedure is indicated in the *SN Reconfiguration Complete* message.
6. If instructed, the UE performs synchronisation towards the PSCell of the SN as described in SN addition procedure. Otherwise, the UE may perform UL transmission after having applied the new configuration.
7. If PDCP termination point is changed for bearers using RLC AM, and when RRC full configuration is not used, the SN Status Transfer takes place between the MN and the SN (Figure 10.3.2-1 depicts the case where a bearer context is transferred from the MN to the SN).
8. If applicable, data forwarding between MN and the SN takes place (Figure 10.3.2-1 depicts the case where a user plane resource configuration related context is transferred from the MN to the SN).
9. The SN sends the *Secondary RAT Data Usage Report* message to the MN and includes the data volumes delivered to and received from the UE as described in clause 10.11.2.

NOTE 2: The order the SN sends the *Secondary RAT Data Usage Report* message and performs data forwarding with MN is not defined. The SN may send the report when the transmission of the related QoS flow is stopped.

10. If applicable, a PDU Session path update procedure is performed.

SN initiated SN Modification with MN involvement

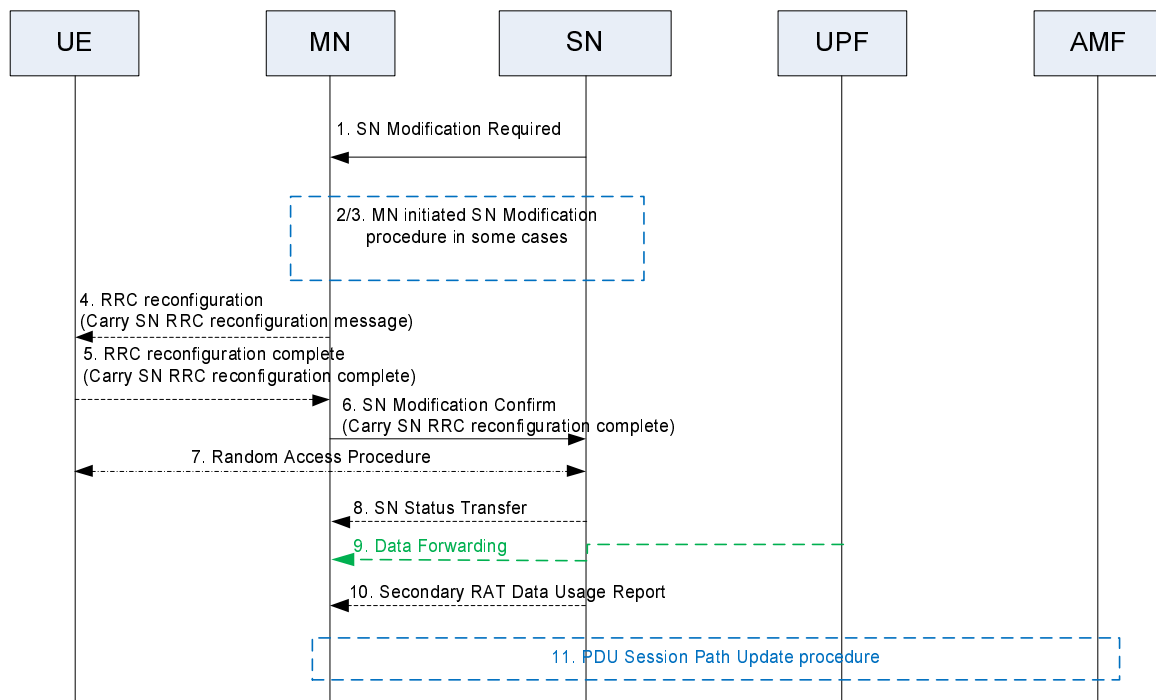

Figure 10.3.2-2: SN Modification procedure - SN initiated with MN involvement

The SN uses the procedure to perform configuration changes of the SCG within the same SN, e.g. to trigger the modification/release of the user plane resource configuration, to trigger the release of SCG resources (e.g., release SCG lower layer resources but keep SN), and to trigger PSCell changes (e.g. when a new security key is required or when the MN needs to perform PDCP data recovery). The MN cannot reject the release request of PDU session/QoS flows and the release request of SCG resources. The SN also uses the procedure to request the MN to provide more DRB IDs to be used for SN terminated bearers or to return DRB IDs used for SN terminated bearers that are not needed any longer. The SN also uses this procedure to activate or deactivate the SCG. Figure 10.3.2-2 shows an example signalling flow for SN initiated SN Modification procedure.

1. The SN sends the *SN Modification Required* message including an SN RRC reconfiguration message, which may contain user plane resource configuration related context, other UE context related information and the new radio resource configuration of SCG. The SN may request the SCG to be activated or deactivated. In case of change of security key, the *PDCP Change Indication* indicates that an SN security key update is required. In case the MN needs to perform PDCP data recovery, the *PDCP Change Indication* indicates that PDCP data recovery is required.

The SN can decide whether the change of security key is required.

NOTE 3a: In case that either CHO or any conditional reconfiguration is prepared, and if a prepared SN initiated intra-SN CPC procedure or reconfiguration with sync of the SCG using SRB3 is executed, the SN shall notify to the MN via the *SN Modification Required* message. The *SN Modification Required* message may include the SCG configuration that has been applied in the UE. The MN considers that a conditional reconfiguration, if any configured in the UE, has been released due to the execution of the (conditional) SCG reconfiguration.

- 2/3. The MN initiated SN Modification procedure may be triggered by *SN Modification Required* message, e.g. when an SN security key change needs to be applied.

NOTE 3: For SN terminated bearers to be setup for which PDCP duplication with CA is configured in NR MCG side, the SN allocates up to 4 separate Xn-U bearers and the MN provides a logical channel ID for primary or split secondary path to the SN via the nested MN-initiated SN modification procedure.

4. The MN sends the MN RRC reconfiguration message to the UE including the SN RRC reconfiguration message with the new SCG radio resource configuration.
5. The UE applies the new configuration and sends the MN RRC reconfiguration complete message, including an SN RRC response message, if needed. In case the UE is unable to comply with (part of) the configuration included in the MN RRC reconfiguration message, it performs the reconfiguration failure procedure.

6. Upon successful completion of the reconfiguration, the success of the procedure is indicated in the *SN Modification Confirm* message including the SN RRC response message, if received from the UE.
7. If instructed, the UE performs synchronisation towards the PSCell configured by the SN as described in SN Addition procedure. Otherwise, the UE may perform UL transmission directly after having applied the new configuration.
8. If PDCP termination point is changed for bearers using RLC AM, and when RRC full configuration is not used, the SN Status Transfer takes place between the MN and the SN (Figure 10.3.2-2 depicts the case where a bearer context is transferred from the SN to the MN).
9. If applicable, data forwarding between MN and the SN takes place (Figure 10.3.2-2 depicts the case where a user plane resource configuration related context is transferred from the SN to the MN).
10. The SN sends the *Secondary RAT Data Usage Report* message to the MN and includes the data volumes delivered to and received from the UE as described in clause 10.11.2.

NOTE 4: The order the SN sends the *Secondary RAT Data Usage Report* message and performs data forwarding with MN is not defined. The SN may send the report when the transmission of the related QoS flow is stopped.

11. If applicable, a PDU Session path update procedure is performed.

SN initiated SN Modification without MN involvement

This procedure is not supported for NE-DC.

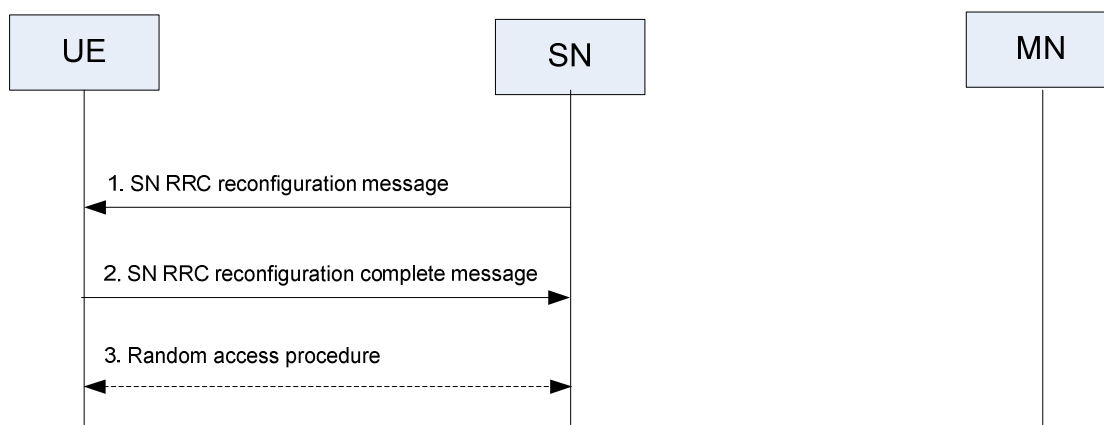

Figure 10.3.2-3: SN Modification – SN initiated without MN involvement

The SN initiated SN modification procedure without MN involvement is used to modify the configuration within SN in case no coordination with MN is required, including the addition/modification/release of SCG SCell and PSCell change (e.g. when the security key does not need to be changed and the MN does not need to be involved in PDCP recovery). The SN may initiate the procedure to configure or modify CPC configuration within the same SN. Figure 10.3.2-3 shows an example signalling flow for SN initiated SN modification procedure without MN involvement. The SN can decide whether the Random Access procedure is required.

1. The SN sends the SN RRC reconfiguration message to the UE through SRB3.
2. The UE applies the new configuration and replies with the SN RRC reconfiguration complete message. In case the UE is unable to comply with (part of) the configuration included in the SN RRC reconfiguration message, it performs the reconfiguration failure procedure.
3. If instructed, the UE performs synchronisation towards the PSCell of the SN as described in SN Addition procedure. Otherwise the UE may perform UL transmission after having applied the new configuration.

SN initiated Conditional SN Modification without MN involvement (SRB3 is used)

This procedure is not supported for NE-DC and NGEN-DC.

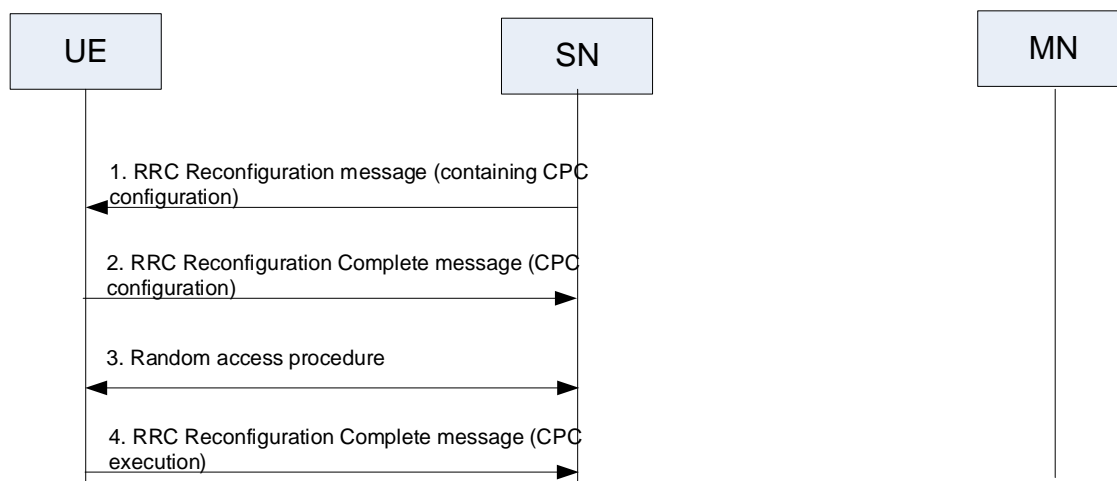

Figure 10.3.2-3a: SN Modification – SN-initiated without MN involvement and SRB3 is used to configure CPC.

The SN initiates the procedure when it needs to transfer an NR RRC message to the UE and SRB3 is used to configure CPC.

1. The SN sends the SN RRC reconfiguration including CPC configuration to the UE through SRB3.
2. The UE applies the new configuration. In case the UE is unable to comply with (part of) the configuration included in the SN RRC reconfiguration message, it performs the reconfiguration failure procedure. The UE starts evaluating the CPC execution conditions for the candidate PSCell(s). The UE maintains connection with the source PSCell and replies with the *RRCReconfigurationComplete* message to the SN via SRB3.
3. If at least one CPC candidate PSCell satisfies the corresponding CPC execution condition, the UE detaches from the source PSCell, applies the stored configuration corresponding to the selected candidate PSCell and synchronises to the candidate PSCell.
4. The UE completes the CPC execution procedure by sending an *RRCReconfigurationComplete* message to the new PSCell.

Transfer of an NR RRC message to/from the UE (when SRB3 is not used)

This procedure is supported for all the MR-DC options.

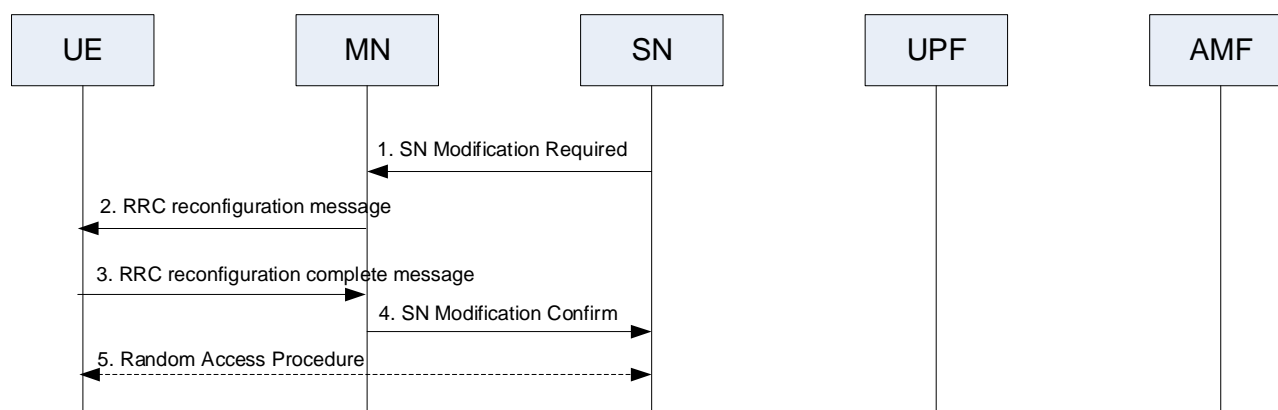

Figure 10.3.2-4: Transfer of an NR RRC message to/from the UE

The SN initiates the procedure when it needs to transfer an NR RRC message to the UE and SRB3 is not used.

1. The SN initiates the procedure by sending the *SN Modification Required* to the MN including the SN RRC reconfiguration message.
2. The MN forwards the SN RRC reconfiguration message to the UE including it in the RRC reconfiguration message.

3. The UE applies the new configuration and replies with the RRC reconfiguration complete message by including the SN RRC reconfiguration complete message. In case the UE is unable to comply with (part of) the configuration included in the SN RRC reconfiguration message, it performs the reconfiguration failure procedure.
4. The MN forwards the SN RRC response message, if received from the UE, to the SN by including it in the *SN Modification Confirm* message.
5. If instructed, the UE performs synchronisation towards the PSCell of the SN as described in SN Addition procedure. Otherwise the UE may perform UL transmission after having applied the new configuration.

SN initiated Conditional SN Modification without MN involvement (SRB3 is not used)

This procedure is not supported for NE-DC and NGEN-DC.

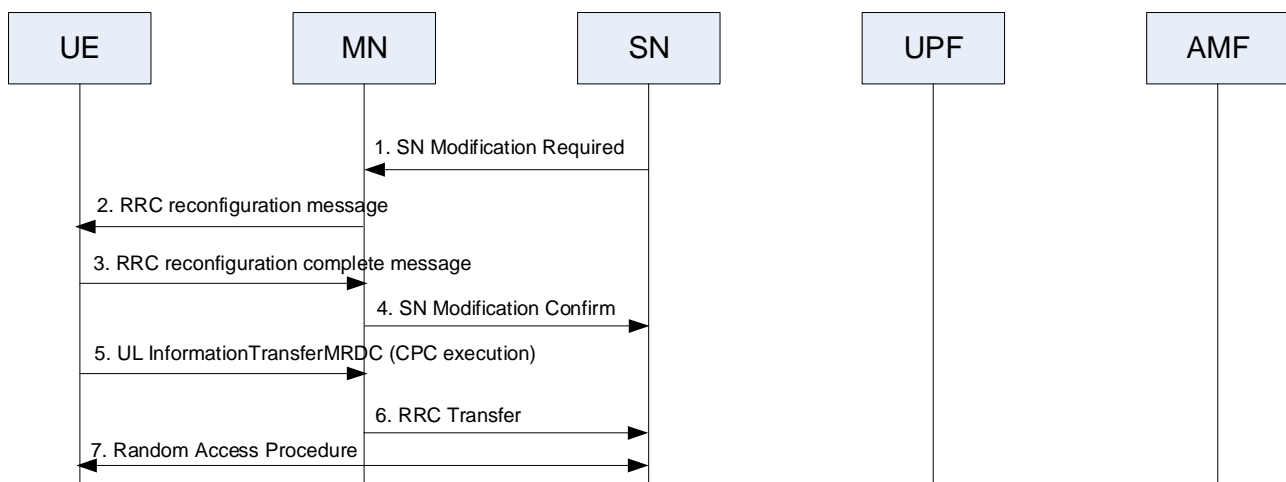

Figure 10.3.2-5: SN Modification – SN-initiated without MN involvement and SRB3 is not used to configure CPC

The SN initiates the procedure when it needs to transfer an NR RRC message to the UE and SRB3 is not used to configure CPC.

1. The SN initiates the procedure by sending the *SN Modification Required* to the MN including the SN RRC reconfiguration message with CPC configuration.
2. The MN forwards the SN RRC reconfiguration message to the UE including it in the *RRCReconfiguration* message.
3. The UE replies with the *RRCReconfigurationComplete* message by including the SN RRC reconfiguration complete message. In case the UE is unable to comply with (part of) the configuration included in the SN RRC reconfiguration message, it performs the reconfiguration failure procedure. The UE maintains connection with source PSCell after receiving CPC configuration, and starts evaluating the CPC execution conditions for the candidate PSCell(s).
4. The MN forwards the SN RRC response message, if received from the UE, to the SN by including it in the *SN Modification Confirm* message.
5. If at least one CPC candidate PSCell satisfies the corresponding CPC execution condition, the UE completes the CPC execution procedure by an *ULInformationTransferMRDC* message to the MN which includes an embedded *RRCReconfigurationComplete* message to the selected target PSCell.
6. The *RRCReconfigurationComplete* message is forwarded to the SN embedded in *RRC Transfer* message.
7. The UE detaches from the source PSCell, applies the stored corresponding configuration and synchronises to the selected candidate PSCell.

10.4 Secondary Node Release (MN/SN initiated)

10.4.1 EN-DC

The Secondary Node Release procedure may be initiated either by the MN or by the SN and is used to initiate the release of the UE context at the SN. The recipient node of this request can reject it, e.g., if a SN change procedure is triggered by the SN.

In case of CPA or CPC, this procedure may be initiated either by the MN or the candidate SN, and it is used to cancel all the prepared PSCells at the candidate SN and initiate the release of related UE context at the candidate SN.

It does not necessarily need to involve signalling towards the UE, e.g., in case of the RRC connection re-establishment due to Radio Link Failure in MN.

MN initiated SN Release

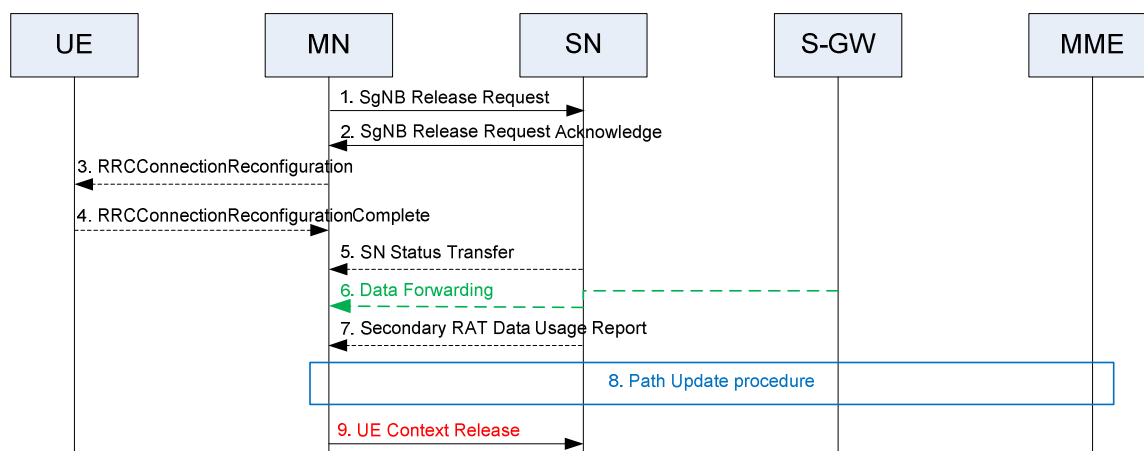

Figure 10.4.1-1: SN Release procedure – MN initiated

Figure 10.4.1-1 shows an example signalling flow for the MN initiated Secondary Node Release procedure when SN Release is confirmed by SN.

1. The MN initiates the procedure by sending the *SgNB Release Request* message. If applicable, the MN provides data forwarding addresses to the SN.
2. The SN confirms SN Release by sending the *SgNB Release Request Acknowledge* message. If appropriate, the SN may reject SN Release, e.g. if the SN change procedure is triggered by the SN.

NOTE 0: If CPA or CPC is configured, upon reception of the *SgNB Release Request Acknowledge* message the MN cancels all CPAC with the target candidate SN(s).

- 3/4. If required, the MN indicates in the *RRCConnectionReconfiguration* message towards the UE that the UE shall release the entire SCG configuration. In case the UE is unable to comply with (part of) the configuration included in the *RRCConnectionReconfiguration* message, it performs the reconfiguration failure procedure.

NOTE 1: If data forwarding is applied, timely coordination between steps 1 and 2 may minimize gaps in service provision, this is however regarded to be an implementation matter.

5. For bearers using RLC AM, the SN sends the *SN Status Transfer* message.

6. Data forwarding from the SN to the MN may start.

7. The SN sends the *Secondary RAT Data Usage Report* message to the MN and includes the data volumes delivered to and received from the UE over the NR radio for the related E-RABs.

NOTE 2: If data forwarding is applied, the order the SN sends the *Secondary RAT Data Usage Report* message and starts data forwarding with MN is not defined i.e., step 7 can take place before step 6. The SN does not need to wait for the end of data forwarding to send the *Secondary RAT Data Usage Report* message.

8. If applicable, the path update procedure is initiated.
9. Upon reception of the *UE Context Release* message, the SN releases radio and C-plane related resources associated to the UE context. Any ongoing data forwarding may continue.

SN initiated SN Release

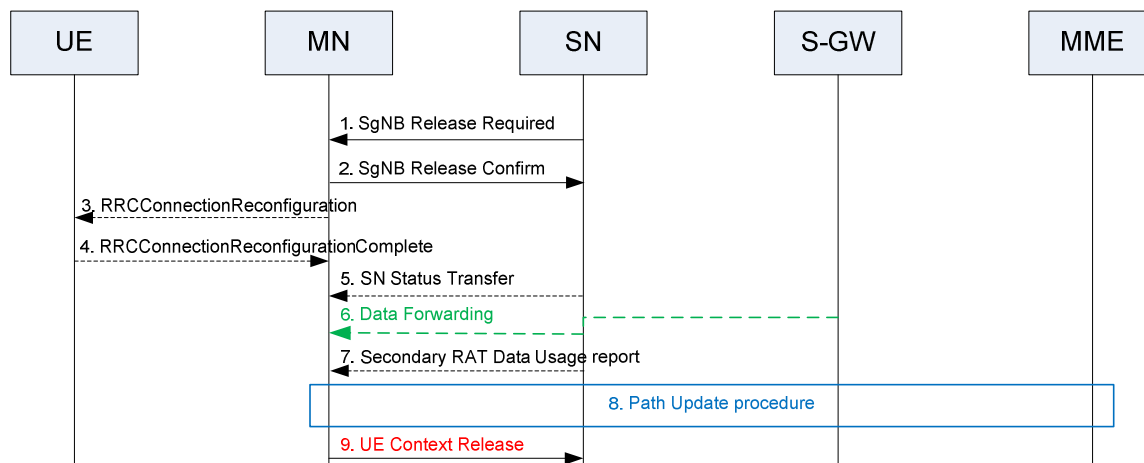

Figure 10.4.1-2: SN Release procedure – SN initiated

Figure 10.4.1-2 shows an example signalling flow for the SN initiated Secondary Node Release procedure.

1. The SN initiates the procedure by sending the *SgNB Release Required* message which may contain inter-node message to support delta configuration.
2. If applicable, the MN provides data forwarding addresses to the SN in the *SgNB Release Confirm* message. The SN may start data forwarding and stop providing user data to the UE as early as it receives the *SgNB Release Confirm* message.

NOTE 2a: If CPA or CPC is configured, upon reception of the *SgNB Release Required* message the MN cancels all CPAC with the target candidate SN(s).

- 3/4. If required, the MN indicates in the *RRCConnectionReconfiguration* message towards the UE that the UE shall release the entire SCG configuration. In case the UE is unable to comply with (part of) the configuration included in the *RRCConnectionReconfiguration* message, it performs the reconfiguration failure procedure.

NOTE 3: If data forwarding is applied, timely coordination between steps 2 and 3 may minimize gaps in service provision. This is however regarded to be an implementation matter.

5. For bearers using RLC AM, the SN sends the *SN Status Transfer* message.
6. Data forwarding from the SN to the MN may start.
7. The SN sends the *Secondary RAT Data Usage Report* message to the MN and includes the data volumes delivered to and received from the UE over the NR radio for the related E-RABs.

NOTE 4: If data forwarding is applied, the order the SN sends the *Secondary RAT Data Usage Report* message and starts data forwarding with MN is not defined i.e., step 7 can take place before step 6. The SN does not need to wait for the end of data forwarding to send the *Secondary RAT Data Usage Report* message.

8. If applicable, the path update procedure is initiated.
9. Upon reception of the *UE Context Release* message, the SN releases radio and C-plane related resources associated to the UE context. Any ongoing data forwarding may continue.

10.4.2 MR-DC with 5GC

The SN Release procedure may be initiated either by the MN or by the SN and is used to initiate the release of the UE context and relevant resources at the SN. The recipient node of this request can reject it, e.g., if an SN change procedure is triggered by the SN.

In case of CPA or CPC, this procedure may be initiated either by the MN or the candidate SN, and it is used to cancel all the prepared PSCells at the candidate SN and initiate the release of related UE context at the candidate SN.

MN initiated SN Release

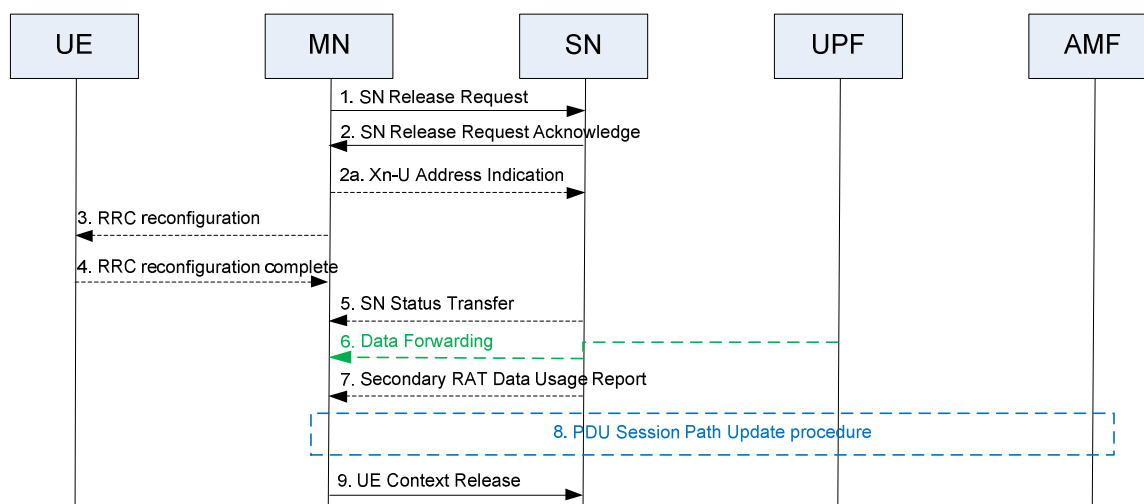

Figure 10.4.2-1: SN release procedure - MN initiated

Figure 10.4.2-1 shows an example signalling flow for the MN initiated SN Release procedure.

1. The MN initiates the procedure by sending the *SN Release Request* message.
2. The SN confirms SN Release by sending the *SN Release Request Acknowledge* message. If appropriate, the SN may reject SN Release, e.g., if the SN change procedure is triggered by the SN.

NOTE 00: If CPA or CPC is configured, upon reception of the *SN Release Request Acknowledge* message the MN cancels all CPAC with the target candidate SN(s).

- 2a. When applicable, the MN provides forwarding address information to the SN.

NOTE 0: The MN may send the *Xn-U Address Indication* message to provide forwarding address information before step 2.

- 3/4. If required, the MN indicates in the MN RRC reconfiguration message towards the UE that the UE shall release the entire SCG configuration. In case the UE is unable to comply with (part of) the configuration included in the MN RRC reconfiguration message, it performs the reconfiguration failure procedure.

NOTE 1: If data forwarding is applied, timely coordination between steps 1 and 2 may minimize gaps in service provision, this is however regarded to be an implementation matter.

5. If PDCP termination point is changed to the MN for bearers using RLC AM, the SN sends the *SN Status Transfer* message.
6. Data forwarding from the SN to the MN may start.
7. The SN sends the *Secondary RAT Data Usage Report* message to the MN and includes the data volumes delivered to and received from the UE as described in clause 10.11.2.

NOTE 1a: If data forwarding is applied, the order the SN sends the *Secondary RAT Data Usage Report* message and starts data forwarding with MN is not defined i.e., step 7 can take place before step 6. The SN does not need to wait for the end of data forwarding to send the *Secondary RAT Data Usage Report* message.

8. If applicable, the PDU Session path update procedure is initiated.
9. Upon reception of the *UE Context Release* message, the SN releases radio and C-plane related resources associated to the UE context. Any ongoing data forwarding may continue.

SN initiated SN Release

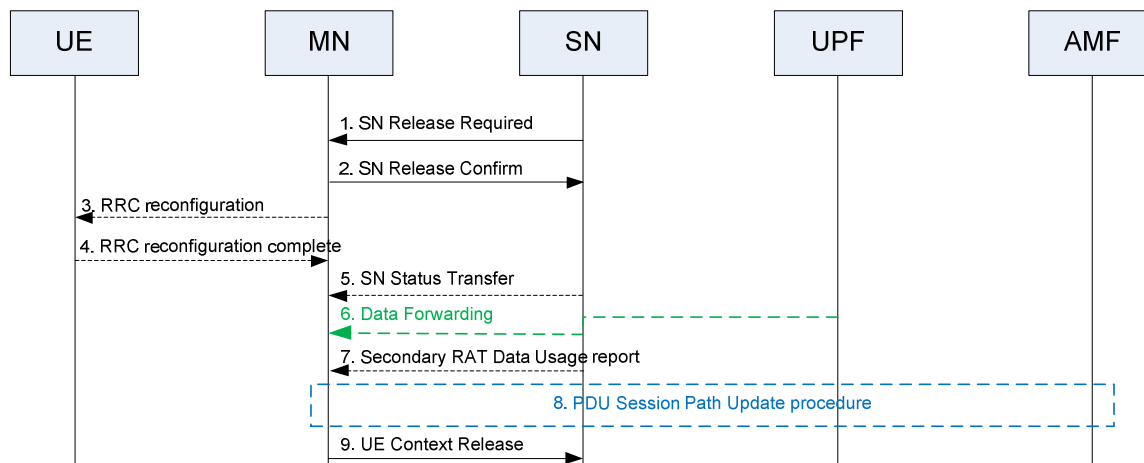

Figure 10.4.2-2: SN release procedure - SN initiated

Figure 10.4.2-2 shows an example signalling flow for the SN initiated SN Release procedure.

1. The SN initiates the procedure by sending the *SN Release Required* message which may contain inter-node message to support delta configuration.
2. If data forwarding is requested, the MN provides data forwarding addresses to the SN in the *SN Release Confirm* message. The SN may start data forwarding and stop providing user data to the UE as early as it receives the *SN Release Confirm* message.

NOTE 1b: If CPA or CPC is configured, upon reception of the *SN Release Required* message the MN cancels all CPAC with the target candidate SN(s).

- 3/4. If required, the MN indicates in the MN RRC reconfiguration message towards the UE that the UE shall release the entire SCG configuration. In case the UE is unable to comply with (part of) the configuration included in the MN RRC reconfiguration message, it performs the reconfiguration failure procedure.

NOTE 2: If data forwarding is applied, timely coordination between steps 2 and 3 may minimize gaps in service provision. This is however regarded to be an implementation matter.

5. If PDCP termination point is changed to the MN for bearers using RLC AM, the SN sends the *SN Status Transfer* message.
6. Data forwarding from the SN to the MN may start.
7. The SN sends the *Secondary RAT Data Usage Report* message to the MN and includes the data volumes delivered to and received from the UE as described in clause 10.11.2.

NOTE 3: If data forwarding is applied, the order the SN sends the *Secondary RAT Data Usage Report* message and starts data forwarding with MN is not defined i.e., step 7 can take place before step 6. The SN does not need to wait for the end of data forwarding to send the *Secondary RAT Data Usage Report* message.

8. If applicable, the PDU Session path update procedure is initiated.
9. Upon reception of the *UE Context Release* message, the SN releases radio and C-plane related resources associated to the UE context. Any ongoing data forwarding may continue.

10.5 Secondary Node Change (MN/SN initiated)

10.5.1 EN-DC

The Secondary Node Change procedure is initiated either by MN or SN and used to transfer a UE context from a source SN to a target SN and to change the SCG configuration in UE from one SN to another. In case of CPC, the Conditional Secondary Node Change procedure initiated either by the MN or SN is also used for CPC configuration and CPC execution.

NOTE 1: Inter-RAT SN change procedure with single RRC reconfiguration is not supported in this version of the protocol (i.e. no transition from EN-DC to DC).

The Secondary Node Change procedure always involves signalling over MCG SRB towards the UE.

MN initiated SN Change

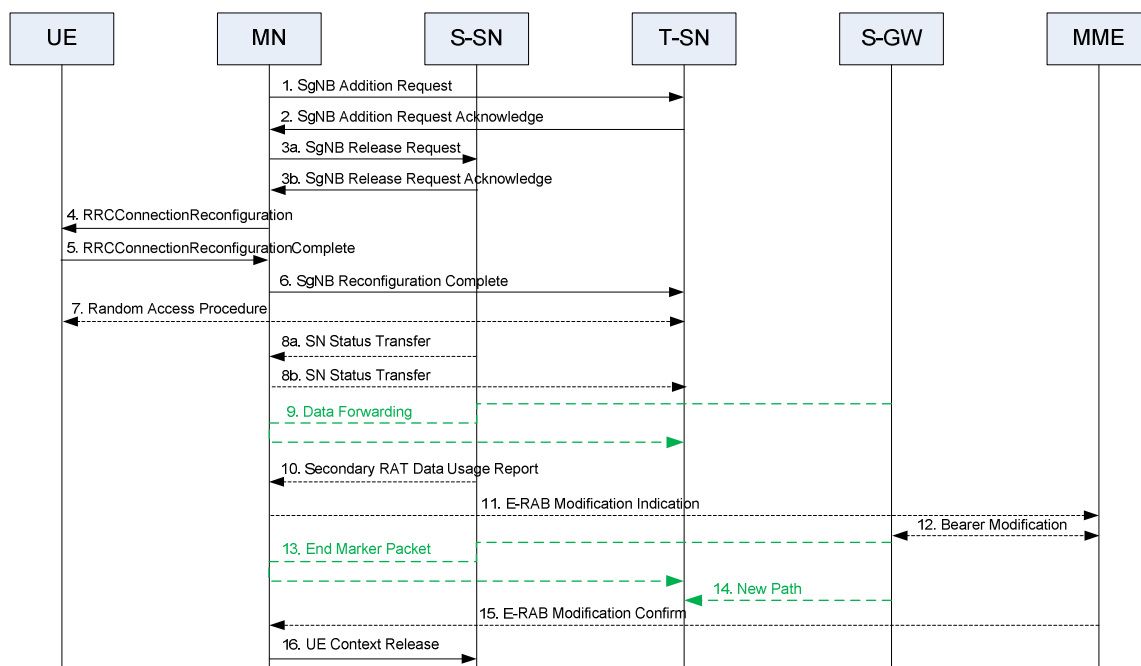

Figure 10.5.1-1: SN Change – MN initiated

Figure 10.5.1-1 shows an example signalling flow for the MN initiated Secondary Node Change:

- 1/2. The MN initiates the SN change by requesting the target SN to allocate resources for the UE by means of the SgNB Addition procedure. The MN may include measurement results related to the target SN. If forwarding is needed, the target SN provides forwarding addresses to the MN. The target SN includes the indication of the full or delta RRC configuration.

NOTE 2: The MN may trigger the MN-initiated SN Modification procedure (to the source SN) to retrieve the current SCG configuration before step 1.

NOTE 2a: In case the target SN includes the indication of the full RRC configuration, the MN performs release of the SN terminated radio bearer configuration and release and add of the NR SCG configuration part towards the UE.

3. If the allocation of target SN resources was successful, the MN initiates the release of the source SN resources including a Cause indicating SCG mobility. The Source SN may reject the release. If data forwarding is needed the MN provides data forwarding addresses to the source SN. If direct data forwarding is used for SN terminated bearers, the MN provides data forwarding addresses as received from the target SN to source SN. Reception of the *SgNB Release Request* message triggers the source SN to stop providing user data to the UE and, if applicable, to start data forwarding.

- 4/5. The MN triggers the UE to apply the new configuration. The MN indicates to the UE the new configuration in the *RRCConnectionReconfiguration* message including the NR RRC configuration message generated by the target SN. The UE applies the new configuration and sends the *RRCConnectionReconfigurationComplete* message, including the encoded NR RRC response message for the target SN, if needed. In case the UE is unable to comply with (part of) the configuration included in the *RRCConnectionReconfiguration* message, it performs the reconfiguration failure procedure.
6. If the RRC connection reconfiguration procedure was successful, the MN informs the target SN via *SgNBReconfigurationComplete* message with the encoded NR RRC response message for the target SN, if received from the UE.
7. If configured with bearers requiring SCG radio resources, the UE synchronizes to the target SN.
8. For SN terminated bearers using RLC AM, the source SN sends the *SN Status Transfer* message, which the MN sends then to the target SN, if needed.
9. If applicable, data forwarding from the source SN takes place. It may be initiated as early as the source SN receives the *SgNB Release Request* message from the MN.
10. The source SN sends the *Secondary RAT Data Usage Report* message to the MN and includes the data volumes delivered to and received from the UE over the NR radio for the related E-RABs.
- NOTE 3: The order the SN sends the *Secondary RAT Data Usage Report* message and performs data forwarding with MN is not defined. The SN may send the report when the transmission of the related bearer is stopped.
- 11-15. If applicable, a path update is triggered by the MN.
16. Upon reception of the *UE Context Release* message, the source SN releases radio and C-plane related resources associated to the UE context. Any ongoing data forwarding may continue.

SN initiated SN Change

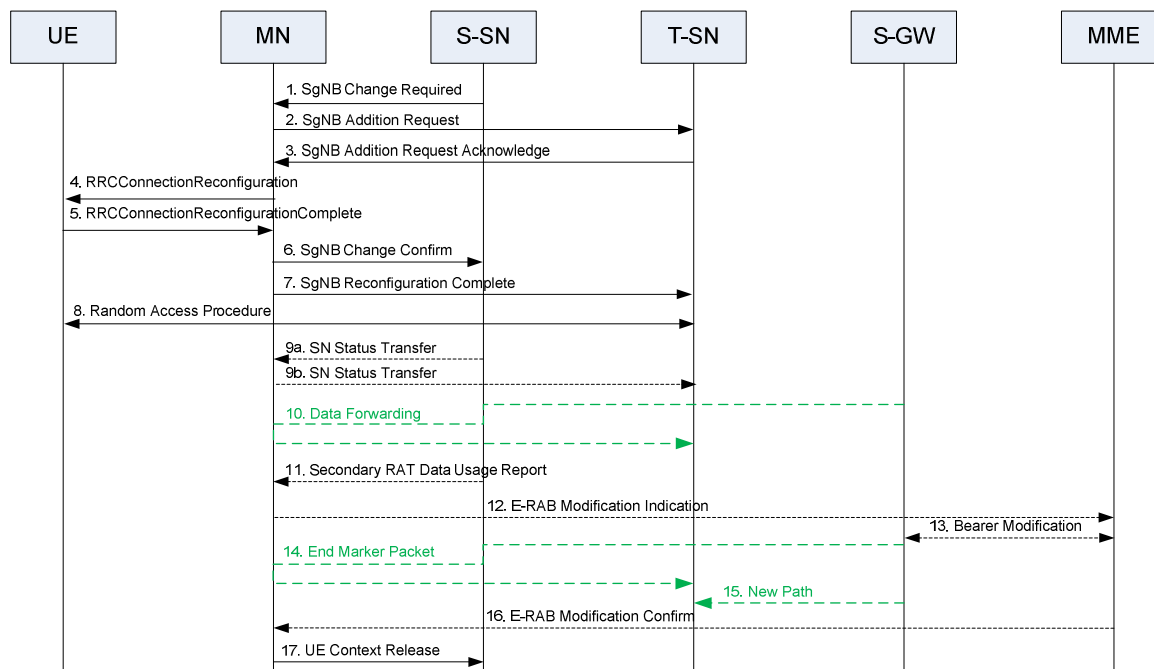

Figure 10.5.1-2: SN Change – SN initiated

Figure 10.5.1-2 shows an example signalling flow for the Secondary Node Change initiated by the SN:

1. The source SN initiates the SN change procedure by sending *SgNB Change Required* message which contains target SN ID information and may include the SCG configuration (to support delta configuration) and measurement results related to the target SN.

- 2/3. The MN requests the target SN to allocate resources for the UE by means of the SgNB Addition procedure, including the measurement results related to the target SN received from the source SN. If forwarding is needed, the target SN provides forwarding addresses to the MN. The target SN includes the indication of the full or delta RRC configuration.

NOTE 3a: In case the target SN includes the indication of the full RRC configuration, the MN performs release of the SN terminated radio bearer configuration and release and add of the NR SCG configuration part towards the UE.

- 4/5. The MN triggers the UE to apply the new configuration. The MN indicates the new configuration to the UE in the *RRConnectionReconfiguration* message including the NR RRC configuration message generated by the target SN. The UE applies the new configuration and sends the *RRConnectionReconfigurationComplete* message, including the encoded NR RRC response message for the target SN, if needed. In case the UE is unable to comply with (part of) the configuration included in the *RRConnectionReconfiguration* message, it performs the reconfiguration failure procedure.
6. If the allocation of target SN resources was successful, the MN confirms the release of the source SN resources. If data forwarding is needed the MN provides data forwarding addresses to the source SN. If direct data forwarding is used for SN terminated bearers, the MN provides data forwarding addresses as received from the target SN to source SN. Reception of the *SgNB Change Confirm* message triggers the source SN to stop providing user data to the UE and, if applicable, to start data forwarding.
7. If the RRC connection reconfiguration procedure was successful, the MN informs the target SN via *SgNB Reconfiguration Complete* message with the encoded NR RRC response message for the target SN, if received from the UE.
8. The UE synchronizes to the target SN.
9. For SN terminated bearers using RLC AM, the source SN sends the *SN Status Transfer* message, which the MN sends then to the target SN, if needed.
10. If applicable, data forwarding from the source SN takes place. It may be initiated as early as the source SN receives the *SgNB Change Confirm* message from the MN.
11. The source SN sends the *Secondary RAT Data Usage Report* message to the MN and includes the data volumes delivered to and received from the UE over the NR radio for the related E-RABs.
- NOTE 4: The order the source SN sends the *Secondary RAT Data Usage Report* message and performs data forwarding with MN/target SN is not defined. The SgNB may send the report when the transmission of the related bearer is stopped.
- 12-16. If applicable, a path update is triggered by the MN.
17. Upon reception of the *UE Context Release* message, the source SN releases radio and C-plane related resources associated to the UE context. Any ongoing data forwarding may continue.

MN initiated conditional SN Change

The MN initiated conditional inter-SN change procedure is used for CPC configuration and CPC execution.

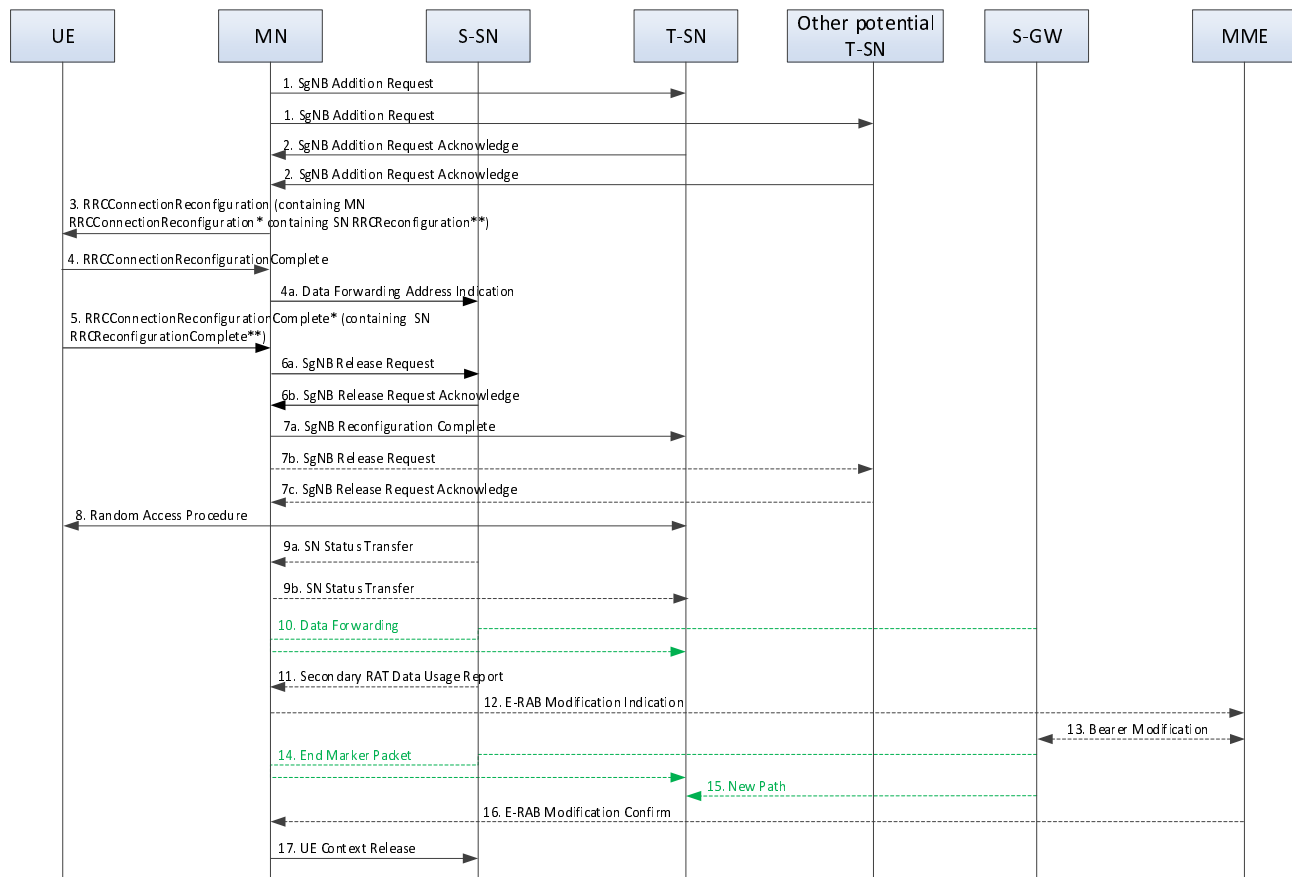

Figure 10.5.1-3: Conditional SN Change – MN initiated

Figure 10.5.1-3 shows an example signalling flow for the MN initiated Conditional Secondary Node Change:

- 1/2. The MN initiates the conditional SN change by requesting the candidate SN(s) to allocate resources for the UE by means of the SgNB Addition procedure, indicating that the request is for CPAC. The MN also provides the candidate cells recommended by MN via the latest measurement results for the candidate SN(s) to choose and configure the SCG cell(s), and provides the upper limit for the number of PSCells that can be prepared by the candidate SN. From the measurement results indicated by the MN, the candidate SN decides the list of PSCell(s) to prepare (considering the maximum number indicated by the MN) and, for each prepared PSCell, the candidate SN decides other SCG SCells and provides the new corresponding SCG radio resource configuration to the MN in an NR *RRCReconfiguration*** message contained in the *SgNB Addition Request Acknowledge* message with the prepared PSCell ID(s). If forwarding is needed, the candidate SN provides forwarding addresses to the MN. The candidate SN includes the indication of the full or delta RRC configuration. The candidate SN can either accept or reject each of the candidate cells listed within the measurement results indicated by the MN, i.e. it cannot configure any alternative candidates.

NOTE 5: The MN may trigger the MN-initiated SN Modification procedure (to the source SN) to retrieve the current SCG configuration before step 1.

NOTE 5a: In case the candidate SN includes the indication of the full RRC configuration, the MN performs release of the SN terminated radio bearer configuration and release and add of the NR SCG configuration part towards the UE in the conditional configuration.

3. The MN sends to the UE an *RRCConnectionReconfiguration* message including the CPC configuration, i.e. a list of *RRCConnectionReconfiguration** messages and associated execution conditions, in which each *RRCConnectionReconfiguration** message contains the SCG configuration in the *RRCReconfiguration*** message received from the candidate SN in step 2 and possibly an MCG configuration. Besides, the *RRCConnectionReconfiguration* message can also include an updated MCG configuration, e.g., to configure the required conditional measurements.
4. The UE applies the *RRCConnectionReconfiguration* message received in step 3, stores the CPC configuration and replies to the MN with an *RRCConnectionReconfigurationComplete* message. In case the UE is unable to

comply with (part of) the configuration included in the *RRConnectionReconfiguration* message, it performs the reconfiguration failure procedure.

- 4a. Upon receiving the *RRConnectionReconfigurationComplete* message from the UE, the MN triggers the Data Forwarding Address Indication procedure to the source SN to inform that the CPC has been configured, the source SN, if applicable, together with the Early Status Transfer procedure, starts early data forwarding. The PDCP SDU forwarding may take place during early data forwarding.

NOTE 5b: Separate Data Forwarding Address Indication procedures may be invoked to provide different forwarding addresses of the prepared candidate target SNs. In this case, it is up to the MN and the source SN implementations to make sure that the EARLY STATUS TRANSFER message(s) from the source SN, if any, is forwarded to the right target destination. The Data Forwarding Address Indication procedure may further be invoked to indicate to the source SN to stop already initiated early data forwarding for some SN-terminated bearers if they are no longer subject to data forwarding due to the modification or cancellation of the prepared conditional SN change procedures.

5. The UE starts evaluating the execution conditions. If the execution condition of one candidate PSCell is satisfied, the UE applies *RRConnectionReconfiguration** message corresponding to the selected candidate PSCell, and sends an *RRConnectionReconfigurationComplete** message, including an NR *RRReconfigurationComplete*** message for the selected candidate PSCell, and information enabling the MN to identify the SN of the selected candidate PSCell.
- 6a-6b. The MN triggers the MeNB initiated SgNB Release procedure to inform the source SN to stop providing user data to the UE, and, if applicable, the address of the SN of the selected candidate PSCell to start data forwarding.
- 7a-7c. If the RRC connection reconfiguration procedure was successful, the MN informs the SN of the selected candidate PSCell via *SgNB Reconfiguration Complete* message, including the SN *RRReconfigurationComplete*** message. The MN sends the *SgNB Release Request* message(s) to cancel CPC in the other candidate SN(s), if configured. The other candidate SN(s) acknowledges the release request.
8. The UE synchronizes to the PSCell indicated in the *RRConnectionReconfiguration** message applied in step 5.
- 9a-9b. For SN terminated bearers using RLC AM, the source SN sends the *SN Status Transfer* message, which the MN sends to the SN of the selected candidate PSCell, if needed.
10. If applicable, data forwarding from the source SN takes place. It may be initiated as early as the source SN receives the early data forwarding address in step 4a.
11. The source SN sends the *Secondary RAT Data Usage Report* message to the MN and includes the data volumes delivered to and received from the UE over the NR radio for the related E-RABs.
- NOTE 6: The order the SN sends the *Secondary RAT Data Usage Report* message and performs data forwarding with MN is not defined. The SN may send the report when the transmission of the related bearer is stopped.
- 12-16. If applicable, a path update is triggered by the MN.
17. Upon reception of the *UE Context Release* message, the source SN releases radio and C-plane related resources associated to the UE context. Any ongoing data forwarding may continue.

SN initiated conditional SN Change

The SN initiated conditional SN change procedure is used for CPC configuration and CPC execution.

The SN initiated conditional SN change procedure may also be initiated by the source SN, to modify the existing SN-initiated CPC configuration, or to trigger the release of the candidate SN by cancellation of all the prepared PSCells at the candidate SN and releasing the CPC related UE context at the candidate SN.

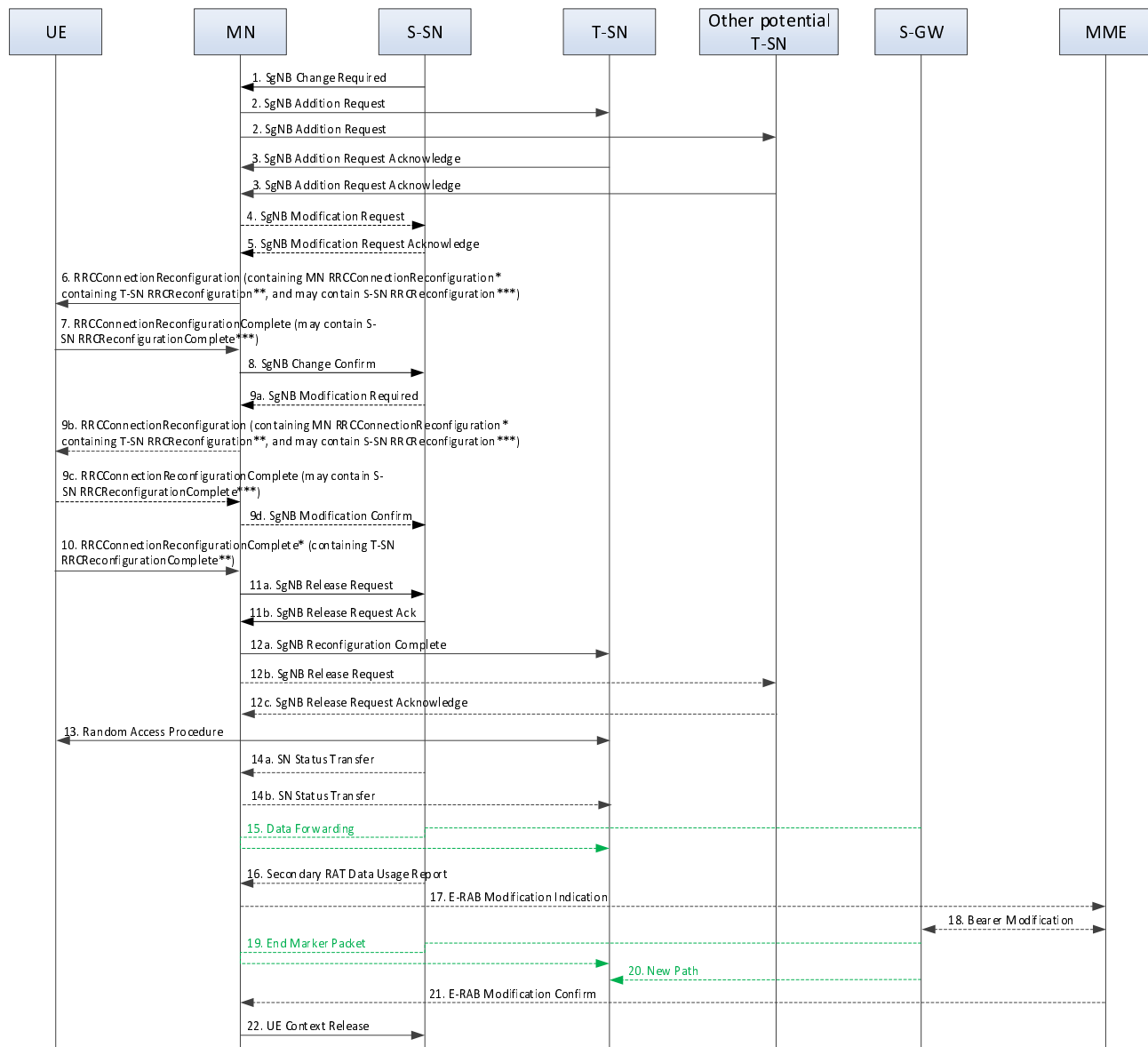

Figure 10.5.1-4: Conditional SN Change – SN initiated

Figure 10.5.1-4 shows an example signalling flow for the Conditional Secondary Node Change initiated by the SN:

1. The source SN initiates the conditional SN change procedure by sending *SgNB Change Required* message which contains a CPC initiation indication. The message also contains candidate SN ID(s) information and may include the SCG configuration (to support delta configuration), and contains the measurement results related to the candidate SN(s). The message also includes a list of proposed PSCell candidates recommended by the source SN, including execution conditions, the upper limit for the number of PSCells that can be prepared by each candidate SN, and may also include the SCG measurement configurations for CPC (e.g. measurement ID(s) to be used for CPC).
- 2/3. The MN requests each candidate SN to allocate resources for the UE by means of the SgNB Addition procedure(s), indicating the request is for CPAC, and the measurements results related to the candidate SN and indicating a list of proposed PSCell candidates received from the source SN, but not including execution conditions. Within the list of PSCells suggested by the source SN, the candidate SN decides the list of PSCell(s) to prepare (considering the maximum number indicated by the MN) and, for each prepared PSCell, the candidate SN decides SCG SCells and provides the new corresponding SCG radio resource configuration to the MN in an *NR RRCReconfiguration*** message contained in the *SgNB Addition Request Acknowledge* message. If data forwarding is needed, the candidate SN provides data forwarding addresses to the MN. The candidate SN includes the indication of full or delta RRC configuration, and the list of prepared PSCell IDs to the MN. The candidate SN can either accept or reject each of the candidate cells suggested by the source SN, i.e. it cannot configure any alternative candidates.

NOTE 6a: In case the candidate SN includes the indication of the full RRC configuration, the MN performs release of the SN terminated radio bearer configuration and release and add of the NR SCG configuration part towards the UE in the conditional configuration.

- 4/5. The MN may indicate the candidate PSCells accepted by each candidate SN to the source SN via *SgNB Modification Request* message before it configures the UE e.g., when not all candidate PSCells were accepted by the candidate SN(s). If the MN does not send such indication, step 4 and 5 are skipped. If requested, the source SN sends an *SgNB Modification Request Acknowledge* message and if needed, provides an updated measurement configurations and/or the execution conditions for CPC to the MN.
6. The MN sends to the UE an *RRCCConnectionReconfiguration* message including the CPC configuration, i.e. a list of *RRCCConnectionReconfiguration** messages and associated execution conditions, in which each *RRCCConnectionReconfiguration** message contains the SCG configuration in the *RRCCReconfiguration*** message received from the candidate SN in step 3 and possibly an MCG configuration. Besides, the *RRCCConnectionReconfiguration* message can also include an updated MCG configuration, as well as the NR *RRCCReconfiguration**** message generated by the source SN, e.g., to configure the required conditional measurements.
7. The UE applies the *RRCCConnectionReconfiguration* message received in step 6, stores the CPC configuration and replies to the MN with an *RRCCConnectionReconfigurationComplete* message, which can include an NR *RRCCReconfigurationComplete**** message. In case the UE is unable to comply with (part of) the configuration included in the *RRCCConnectionReconfiguration* message, it performs the reconfiguration failure procedure.
8. If an NR RRC response message is included, the MN informs the source SN with the NR *RRCCReconfigurationComplete**** message via *SgNB Change Confirm* message. If step 4 and 5 are skipped, the MN will indicate the candidate PSCells accepted by each candidate SN to the source SN in the *SgNB Change Confirm* message.

The MN sends the *SgNB Change Confirm* message towards the source SN to indicate that CPC is prepared, and in such case the source SN continues providing user data to the UE. If early data forwarding is applied, the MN informs the source SN the data forwarding addresses as received from the candidate SN(s), the source SN, if applicable, together with the Early Status Transfer procedure, starts early data forwarding. The PDCP SDU forwarding may take place during early data forwarding. In case multiple candidate SNs are prepared, the MN includes a list of Target SgNB ID and list of data forwarding addresses to the source SN.

NOTE 6b: The Data Forwarding Address Indication procedure may further be invoked to indicate to the source SN to stop already initiated early data forwarding for some PDCP SDUs if they are no longer subject to data forwarding due to the modification or cancellation of the prepared conditional PSCell change.

- 9a-9d. The source SN may send the *SgNB Modification Required* message to trigger an update of CPC execution condition and/or corresponding SCG measurement configuration for CPC. In such case in step 9b, the MN reconfigures the UE and in step 9c the UE responds with *RRCCConnectionReconfigurationComplete*, similarly as in steps 6 and 7.
10. The UE starts evaluating the execution conditions. If the execution condition of one candidate PSCell is satisfied, the UE applies the *RRCCConnectionReconfiguration** message corresponding to the selected candidate PSCell, and sends an *RRCCConnectionReconfigurationComplete** message, including the NR *RRCCReconfigurationComplete*** message for the selected candidate PSCell, and information enabling the MN to identify the SN of the selected candidate PSCell.
- 11a-11b. The MN triggers the MeNB initiated SgNB Release procedure to inform source SN to stop providing user data to the UE, and provide the address of the SN of the selected candidate PSCell and if applicable, start late data forwarding.
- 12a-12c. If the RRC connection reconfiguration procedure was successful, the MN informs the SN of the selected candidate PSCell via *SgNB Reconfiguration Complete* message, including the SN *RRCCReconfigurationComplete*** message. The MN sends the *SgNB Release Request* message(s) to cancel CPC in the other candidate SN(s), if configured. The other candidate SN(s) acknowledges the release request.
13. The UE synchronizes to the PSCell indicated in the *RRCCConnectionReconfiguration** message applied in step 10.
- 14a-14b. For SN terminated bearers using RLC AM, the source SN sends the *SN Status Transfer* message, which the MN sends then to the SN of the selected candidate PSCell, if needed.

15. If applicable, data forwarding from the source SN takes place. It may be initiated as early as the source SN receives the early data forwarding message from the MN.

16. The source SN sends the *Secondary RAT Data Usage Report* message to the MN and includes the data volumes delivered to and received from the UE over the NR radio for the related E-RABs.

NOTE 7: The order the source SN sends the *Secondary RAT Data Usage Report* message and performs data forwarding with MN/target SN is not defined. The SgNB may send the report when the transmission of the related bearer is stopped.

17-21. If applicable, a path update is triggered by the MN.

22. Upon reception of the *UE Context Release* message, the source SN releases radio and C-plane related resources associated to the UE context. Any ongoing data forwarding may continue.

10.5.2 MR-DC with 5GC

MN initiated SN Change

The MN initiated SN change procedure is used to transfer a UE context from the source SN to a target SN and to change the SCG configuration in UE from one SN to another.

The Secondary Node Change procedure always involves signalling over MCG SRB towards the UE.

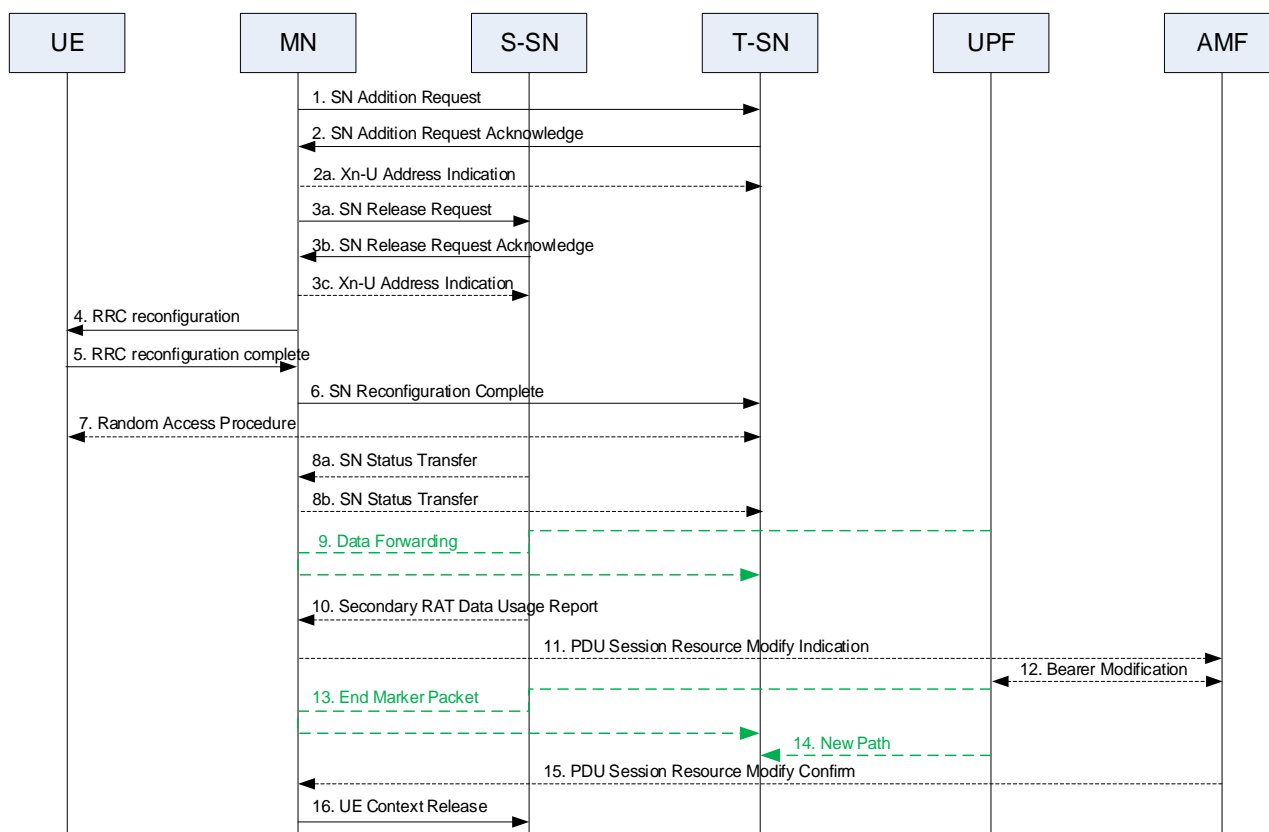

Figure 10.5.2-1: SN change procedure - MN initiated

Figure 10.5.2-1 shows an example signalling flow for the SN Change initiated by the MN:

1/2. The MN initiates the SN change by requesting the target SN to allocate resources for the UE by means of the SN Addition procedure. The MN may include measurement results related to the target SN. If data forwarding is needed, the target SN provides data forwarding addresses to the MN. The target SN includes the indication of the full or delta RRC configuration.

NOTE 1: The MN may trigger the MN-initiated SN Modification procedure (to the source SN) to retrieve the current SCG configuration and to allow provision of data forwarding related information before step 1.

- 2a. For SN terminated bearers using MCG resources, the MN provides Xn-U DL TNL address information in the *Xn-U Address Indication* message.
 3. If the allocation of target SN resources was successful, the MN initiates the release of the source SN resources including a Cause indicating SCG mobility. The Source SN may reject the release. If data forwarding is needed the MN provides data forwarding addresses to the source SN. If direct data forwarding is used for SN terminated bearers, the MN provides data forwarding addresses as received from the target SN to source SN. Reception of the *SN Release Request* message triggers the source SN to stop providing user data to the UE.
 - 4/5. The MN triggers the UE to apply the new configuration. The MN indicates the new configuration to the UE in the MN RRC reconfiguration message including the target SN RRC reconfiguration message. The UE applies the new configuration and sends the MN RRC reconfiguration complete message, including the SN RRC response message for the target SN, if needed. In case the UE is unable to comply with (part of) the configuration included in the MN RRC reconfiguration message, it performs the reconfiguration failure procedure.
 6. If the RRC connection reconfiguration procedure was successful, the MN informs the target SN via *SN Reconfiguration Complete* message with the included SN RRC response message for the target SN, if received from the UE.
 7. If configured with bearers requiring SCG radio resources the UE synchronizes to the target SN.
 8. If PDCP termination point is changed for bearers using RLC AM, the source SN sends the *SN Status Transfer* message, which the MN sends then to the target SN, if needed.
 9. If applicable, data forwarding from the source SN takes place. It may be initiated as early as the source SN receives the *SN Release Request* message from the MN.
 10. The source SN sends the *Secondary RAT Data Usage Report* message to the MN and includes the data volumes delivered to and received from the UE as described in clause 10.11.2.
- NOTE 2: The order the SN sends the *Secondary RAT Data Usage Report* message and performs data forwarding with MN is not defined. The SN may send the report when the transmission of the related QoS flow is stopped.
- 11-15. If applicable, a PDU Session path update procedure is triggered by the MN.
16. Upon reception of the *UE Context Release* message, the source SN releases radio and C-plane related resources associated to the UE context. Any ongoing data forwarding may continue

SN initiated SN Change

The SN initiated SN change procedure is used to transfer a UE context from the source SN to a target SN and to change the SCG configuration in UE from one SN to another.

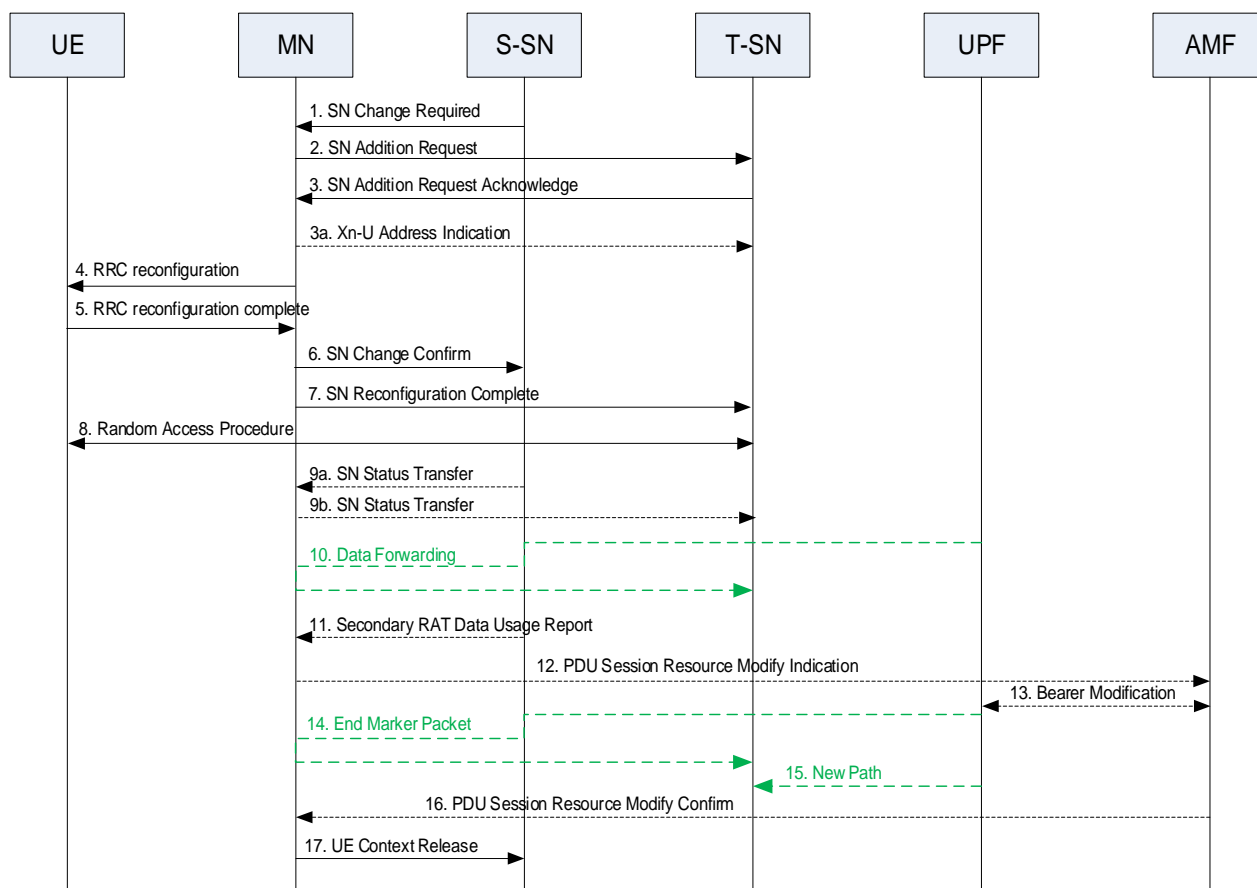

Figure 10.5.2-2: SN change procedure - SN initiated

Figure 10.5.2-2 shows an example signalling flow for the SN Change initiated by the SN:

1. The source SN initiates the SN change procedure by sending the *SN Change Required* message, which contains a candidate target node ID and may include the SCG configuration (to support delta configuration) and measurement results related to the target SN.
- 2/3. The MN requests the target SN to allocate resources for the UE by means of the SN Addition procedure, including the measurement results related to the target SN received from the source SN. If data forwarding is needed, the target SN provides data forwarding addresses to the MN. The target SN includes the indication of the full or delta RRC configuration.
- 3a. For SN terminated bearers using MCG resources, the MN provides Xn-U DL TNL address information in the *Xn-U Address Indication* message.
- 4/5. The MN triggers the UE to apply the new configuration. The MN indicates the new configuration to the UE in the MN RRC reconfiguration message including the SN RRC reconfiguration message generated by the target SN. The UE applies the new configuration and sends the MN RRC reconfiguration complete message, including the SN RRC response message for the target SN, if needed. In case the UE is unable to comply with (part of) the configuration included in the MN RRC reconfiguration message, it performs the reconfiguration failure procedure.
6. If the allocation of target SN resources was successful, the MN confirms the change of the source SN. If data forwarding is needed the MN provides data forwarding addresses to the source SN. If direct data forwarding is used for SN terminated bearers, the MN provides data forwarding addresses as received from the target SN to source SN. Reception of the *SN Change Confirm* message triggers the source SN to stop providing user data to the UE and, if applicable, to start data forwarding.
7. If the RRC connection reconfiguration procedure was successful, the MN informs the target SN via *SN Reconfiguration Complete* message with the included SN RRC response message for the target SN, if received from the UE.

8. The UE synchronizes to the target SN.
 9. If PDCP termination point is changed for bearers using RLC AM, the source SN sends the *SN Status Transfer* message, which the MN sends then to the target SN, if needed.
 10. If applicable, data forwarding from the source SN takes place. It may be initiated as early as the source SN receives the *SN Change Confirm* message from the MN.
 11. The source SN sends the *Secondary RAT Data Usage Report* message to the MN and includes the data volumes delivered to and received from the UE as described in clause 10.11.2.
- NOTE 3: The order the SN sends the *Secondary RAT Data Usage Report* message and performs data forwarding with MN/target SN is not defined. The SN may send the report when the transmission of the related QoS flow is stopped.
- 12-16. If applicable, a PDU Session path update procedure is triggered by the MN.
 17. Upon reception of the *UE Context Release* message, the source SN releases radio and C-plane related resources associated to the UE context. Any ongoing data forwarding may continue.

MN initiated conditional SN Change

The Conditional Secondary Node Change procedure is initiated by the MN for CPC configuration and CPC execution.

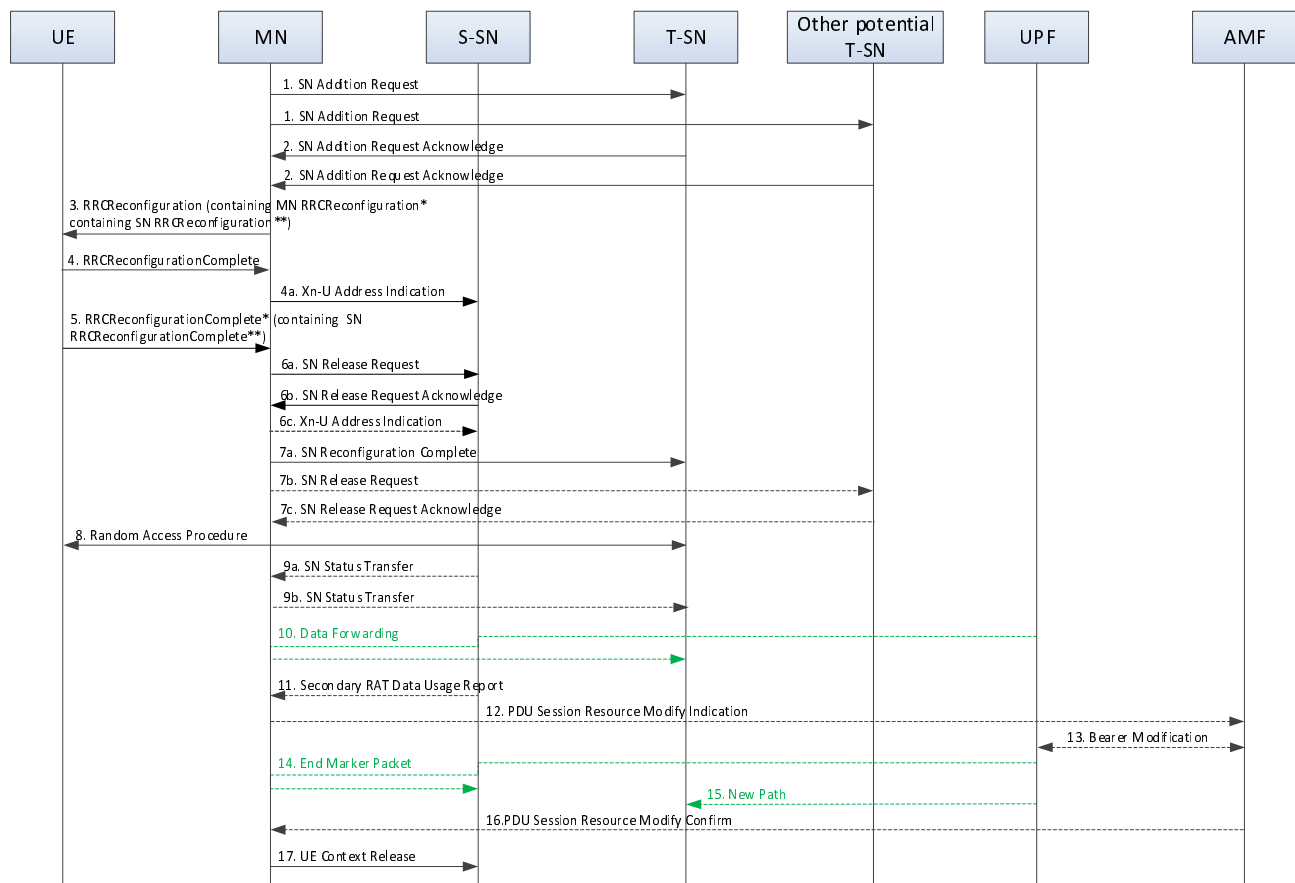

Figure 10.5.2-3: Conditional SN change procedure - MN initiated

Figure 10.5.2-3 shows an example signalling flow for the conditional SN Change initiated by the MN:

- 1/2. The MN initiates the conditional SN change by requesting the candidate SN(s) to allocate resources for the UE by means of the SN Addition procedure, indicating that the request is for CPAC. The MN also provides the candidate cells recommended by MN via the latest measurement results for the candidate SN(s) to choose and configure the SCG cell(s), provides the upper limit for the number of PSCells that can be prepared by the candidate SN. Within the list of cells as indicated within the measurement results indicated by the MN, the candidate SN decides the list of PSCell(s) to prepare (considering the maximum number indicated by the MN)

and, for each prepared PSCell, the candidate SN decides other SCG SCells and provides the new corresponding SCG radio resource configuration to the MN in an NR *RRCReconfiguration*** message contained in the *SN Addition Request Acknowledge* message with the prepared PSCell ID(s). If data forwarding is needed, the candidate SN provides data forwarding addresses to the MN. The candidate SN includes the indication of the full or delta RRC configuration. The candidate SN can either accept or reject each of the candidate cells listed within the measurement results indicated by the MN, i.e. it cannot configure any alternative candidates.

NOTE 4: The MN may trigger the MN-initiated SN Modification procedure (to the source SN) to retrieve the current SCG configuration and to allow provision of data forwarding related information before step 1.

3. The MN sends to the UE an *RRCReconfiguration* message including the CPC configuration, i.e. a list of *RRCReconfiguration** messages and associated execution conditions, in which each *RRCReconfiguration** message contains the SCG configuration in the *RRCReconfiguration*** message received from the candidate SN in step 2 and possibly an MCG configuration. Besides, the *RRCReconfiguration* message can also include an updated MCG configuration, e.g., to configure the required conditional measurements.
4. The UE applies the *RRCReconfiguration* message received in step 3, stores the CPC configuration and replies to the MN with an *RRCReconfigurationComplete* message. In case the UE is unable to comply with (part of) the configuration included in the *RRCReconfiguration* message, it performs the reconfiguration failure procedure.
- 4a. Upon receiving the MN *RRCReconfigurationComplete* message from the UE, the MN informs the source SN that the CPC has been configured via Xn-U Address Indication procedure, the source SN, if applicable, together with the Early Status Transfer procedure, starts early data forwarding. The PDCP SDU forwarding may take place during early data forwarding.

NOTE 4a: Separate Xn-U Address Indication procedures may be invoked to provide different forwarding addresses of the prepared candidate target SNs. In this case, it is up to the MN and the source SN implementations to make sure that the EARLY STATUS TRANSFER message(s) from the source SN, if any, is forwarded to the right target destination. The Xn-U Address Indication procedure may further be invoked to indicate to the source SN to stop already initiated early data forwarding for some SN-terminated bearers if they are no longer subject to data forwarding due to the modification or cancellation of the prepared conditional SN change procedures.

5. The UE starts evaluating the execution conditions. If the execution condition of one candidate PSCell is satisfied, the UE applies *RRCReconfiguration** message corresponding to the selected candidate PSCell, and sends an MN *RRCReconfigurationComplete** message, including an NR *RRCReconfigurationComplete*** message for the selected candidate PSCell, and information enabling the MN to identify the SN of the selected candidate PSCell.
- 6a-6c. The MN triggers the MN initiated SN Release procedure to inform the source SN to stop providing user data to the UE, and if applicable, triggers the Xn-U Address Indication procedure to inform the source SN the address of the SN of the selected candidate PSCell, to start late data forwarding.
- 7a-7c. If the RRC connection reconfiguration procedure was successful, the MN informs the SN of the selected candidate PSCell via *SN Reconfiguration Complete* message, including the SN *RRCReconfigurationComplete*** message. The MN sends the *SN Release Request* message(s) to cancel CPC in the other candidate SN(s), if configured. The other candidate SN(s) acknowledges the release request.
8. The UE synchronizes to the PSCell indicated in the *RRCReconfiguration** message applied in step 5.
- 9a-9b. If PDCP termination point is changed for bearers using RLC AM, the source SN sends the message, which the MN sends then to the SN of the selected candidate PSCell, if needed.
10. If applicable, data forwarding from the source SN takes place. It may be initiated as early as the source SN receives the early data forwarding address in step 4a.
11. The source SN sends the *Secondary RAT Data Usage Report* message to the MN and includes the data volumes delivered to and received from the UE as described in clause 10.11.2.

NOTE 5: The order the SN sends the *Secondary RAT Data Usage Report* message and performs data forwarding with MN is not defined. The SN may send the report when the transmission of the related QoS flow is stopped.

- 12-16. If applicable, a PDU Session path update procedure is triggered by the MN.

17. Upon reception of the *UE Context Release* message, the source SN releases radio and C-plane related resources associated to the UE context. Any ongoing data forwarding may continue.

SN initiated conditional SN Change

The SN initiated conditional SN change procedure is used for CPC configuration and CPC execution.

The SN initiated conditional SN change procedure may also be initiated by the source SN, to modify the existing CPC configuration, or to trigger the release of the candidate SN by cancellation of all the prepared PSCells at the candidate SN and releasing the CPC related UE context at the candidate SN.

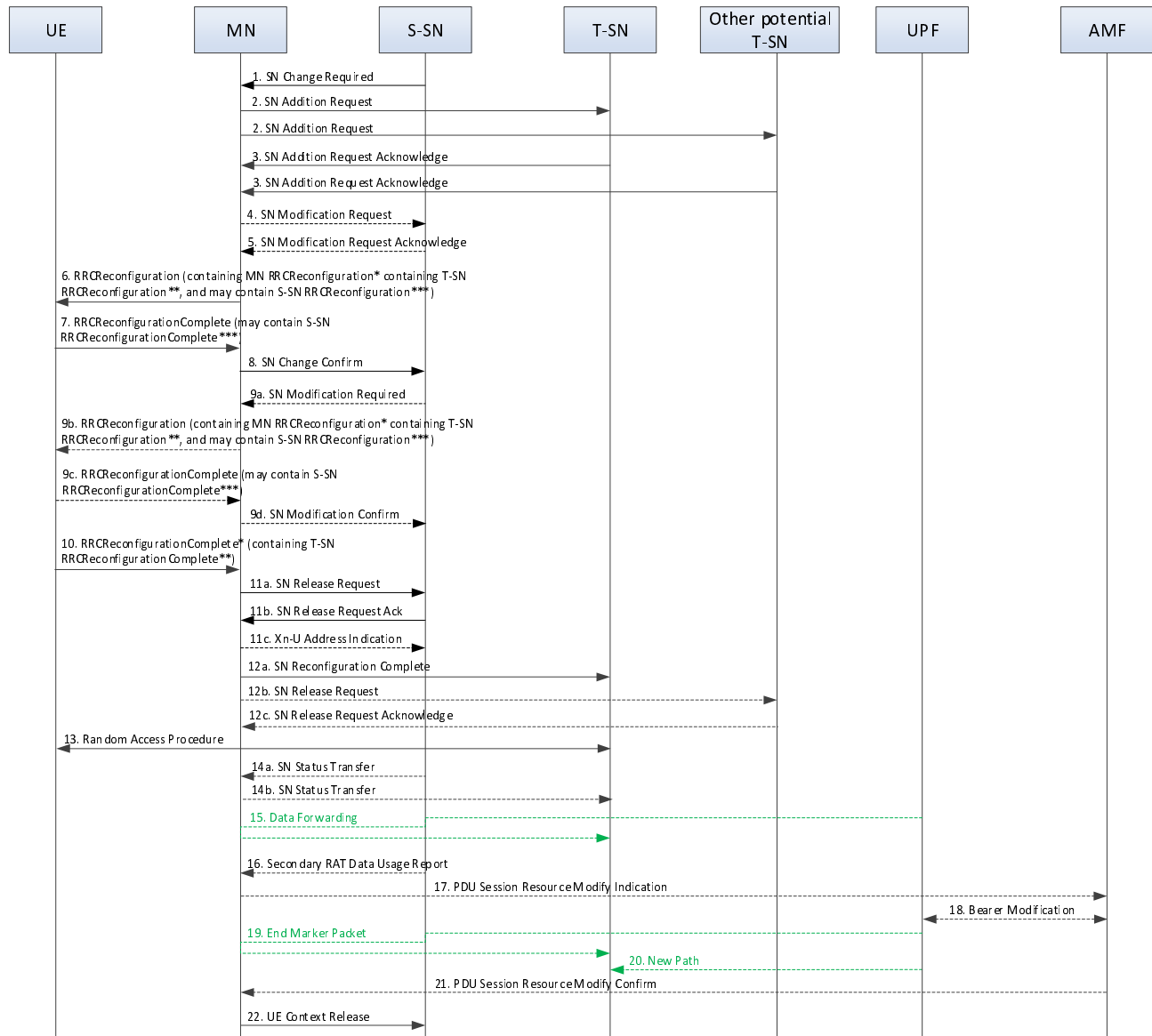

Figure 10.5.2-4: Conditional SN change procedure - SN initiated

Figure 10.5.2-4 shows an example signalling flow for the conditional SN Change initiated by the SN:

1. The source SN initiates the conditional SN change procedure by sending the *SN Change Required* message, which contains a CPC initiation indication. The message also contains candidate node ID(s) and may include the SCG configuration (to support delta configuration), and contains the measurements results which may include cells that are not CPC candidates. The message also includes a list of proposed PSCell candidates recommended by the source SN, including execution conditions, the upper limit for the number of PSCells that can be prepared by each candidate SN, and may also include the SCG measurement configurations for CPC (e.g. measurement ID(s) to be used for CPC).

- 2/3. The MN requests each candidate SN(s) to allocate resources for the UE by means of the SN Addition procedure(s), indicating the request is for CPAC, and the measurements results which may include cells that are not CPC candidates received from the source SN to the candidate SN, and indicating a list of proposed PSCell candidates received from the source SN, but not including execution conditions. Within the list of PSCells suggested by the source SN, the candidate SN decides the list of PSCell(s) to prepare (considering the maximum number indicated by the MN) and, for each prepared PSCell, the candidate SN decides SCG SCells and provides the new corresponding SCG radio resource configuration to the MN in an NR *RRCReconfiguration*** message contained in the *SgNB Addition Request Acknowledge* message. If data forwarding is needed, the candidate SN provides data forwarding addresses to the MN. The candidate SN includes the indication of full or delta RRC configuration, and the list of prepared PSCell IDs to the MN. The candidate SN can either accept or reject each of the candidate cells suggested by the source SN, i.e., it cannot configure any alternative candidates.
- 4/5. The MN may indicate the candidate PSCells accepted by each candidate SN to the source SN via *SN Modification Request* message before it configures the UE, e.g., when not all candidate PSCells were accepted by the candidate SN(s). If the MN does not send such indication, step 4 and 5 are skipped. If requested, the source SN sends an *SN Modification Request Acknowledge* message and if needed, provides an updated measurement configurations and/or the execution conditions to the MN.
6. The MN sends to the UE an *RRCReconfiguration* message including the CPC configuration, i.e. a list of *RRCReconfiguration** messages and associated execution conditions, in which each *RRCReconfiguration** message contains the SCG configuration in the *RRCReconfiguration*** message received from the candidate SN in step 3 and possibly an MCG configuration. Besides, the *RRCReconfiguration* message can also include an updated MCG configuration, as well as the NR *RRCReconfiguration**** message generated by the source SN, e.g., to configure the required conditional measurements.
7. The UE applies the *RRCReconfiguration* message received in step 6, stores the CPC configuration and replies to the MN with an *RRCReconfigurationComplete* message, which can include an NR *RRCReconfigurationComplete**** message. In case the UE is unable to comply with (part of) the configuration included in the *RRCReconfiguration* message, it performs the reconfiguration failure procedure.
8. If an SN RRC response message is included, the MN informs the source SN with the SN *RRCReconfigurationComplete**** message via *SN Change Confirm* message. If step 4 and 5 are skipped, the MN will indicate the candidate PSCells accepted by each candidate SN to the source SN in the *SN Change Confirm* message.

The MN sends the *SN Change Confirm* message towards the source SN to indicate that CPC is prepared, and in such case the source SN continues providing user data to the UE. If early data forwarding is applied, the MN informs the source SN the data forwarding addresses as received from the candidate SN(s), the source SN, if applicable, together with the Early Status Transfer procedure, starts early data forwarding. The PDCP SDU forwarding may take place during early data forwarding. In case multiple candidate SNs are prepared, the MN includes a list of Target SN ID and list of data forwarding addresses to the source SN.

NOTE 5a: The Xn-U Address Indication procedure may further be invoked to indicate to the source SN to stop already initiated early data forwarding for some PDCP SDUs if they are no longer subject to data forwarding due to the modification or cancellation of the prepared conditional PSCell change.

- 9a-9d. The source SN may send the *SN Modification Required* message to trigger an update of CPC execution condition and/or corresponding SCG measurement configuration for CPC. In such case in step 9b, the MN reconfigures the UE and in step 9c the UE responds with *RRCReconfigurationComplete*, similarly as in steps 6 and 7.
10. The UE starts evaluating the execution conditions. If the execution condition of one candidate PSCell is satisfied, the UE applies *RRCReconfiguration** message corresponding to the selected candidate PSCell, and sends an *RRCReconfigurationComplete** message, including an *RRCReconfigurationComplete*** message for the selected candidate PSCell, and information enabling the MN to identify the SN of the selected candidate PSCell.
- 11a-11c. The MN triggers the MN initiated SN Release procedure to inform the source SN to stop providing user data to the UE, and triggers the Xn-U Address Indication procedure to inform the source SN the address of the SN of the selected candidate PSCell and if applicable, starts late data forwarding.
- 12a-12c. If the RRC connection reconfiguration procedure was successful, the MN informs the SN of the selected candidate PSCell via *SN Reconfiguration Complete* message, including the SN *RRCReconfigurationComplete***

message. The MN sends the *SN Release Request* message(s) to cancel CPC in the other candidate SN(s), if configured. The other candidate SN(s) acknowledges the release request.

13. The UE synchronizes to the PSCell indicated in the *RRCReconfiguration** message applied in step 10.

14. If PDCP termination point is changed for bearers using RLC AM, the source SN sends the *SN Status Transfer* message, which the MN sends then to the SN of the selected candidate PSCell, if needed.

15. If applicable, data forwarding from the source SN takes place. It may be initiated as early as the source SN receives the data forwarding address related information from the MN.

16. The source SN sends the *Secondary RAT Data Usage Report* message to the MN and includes the data volumes delivered to and received from the UE as described in clause 10.11.2.

NOTE 6: The order the SN sends the *Secondary RAT Data Usage Report* message and performs data forwarding with MN/target SN is not defined. The SN may send the report when the transmission of the related QoS flow is stopped.

17-21. If applicable, a PDU Session path update procedure is triggered by the MN.

22. Upon reception of the *UE Context Release* message, the source SN releases radio and C-plane related resources associated to the UE context. Any ongoing data forwarding may continue.

10.6 PSCell change

In MR-DC, a PSCell change does not always require a security key change.

If a security key change is required, this is performed through a synchronous SCG reconfiguration procedure towards the UE involving random access on PSCell and a security key change, during which the MAC entity configured for SCG is reset and RLC configured for SCG is re-established regardless of the bearer type(s) established on SCG. For SN terminated bearers, PDCP is re-established. In all MR-DC options, to perform this procedure within the same SN, the SN Modification procedure as described in clause 10.3 is used, setting the *PDCP Change Indication* to indicate that a $S\text{-}K_{\text{gNB}}$ (for EN-DC, NGEN-DC and NR-DC) or $S\text{-}K_{\text{eNB}}$ (for NE-DC) update is required when the procedure is initiated by the SN or including the *SgNB Security Key / SN Security Key* when the procedure is initiated by the MN. In all MR-DC options, to perform a PSCell change between different SN nodes, the SN Change procedure as described in clause 10.5 is used.

If a security key change is not required (only possible in EN-DC, NGEN-DC and NR-DC), this is performed through a synchronous SCG reconfiguration procedure without security key change towards the UE involving random access on PSCell, during which the MAC entity configured for SCG is reset and RLC configured for SCG is re-established regardless of the bearer type(s) established on SCG. For DRBs using RLC AM mode PDCP data recovery applies, and for DRBs using RLC UM no action is performed in PDCP. For SRB3 PDCP may discard all stored SDUs and PDUs. Unless MN terminated SCG or split bearers are configured, this does not require MN involvement. In this case, if location information was requested for the UE, the SN informs the MN about the PSCell change (as part of location information) using the SN initiated SN modification procedure independently from the reconfiguration of the UE. In case of MN terminated SCG or split bearers, the SN initiated SN Modification procedure as described in clause 10.3 is used, setting the *PDCP Change Indication* to indicate that a PDCP data recovery is required. If the MN subscribes to PSCell changes to retrieve the SCG UE history information, the SN informs the MN about the SCG UE history information using the SN initiated SN modification procedure when the SCG UE history information changes.

A Conditional PSCell Change (CPC) is defined as a PSCell change that is executed by the UE when execution condition(s) is met. The UE starts evaluating the execution condition(s) upon receiving the CPC configuration, and stops evaluating the execution condition(s) once PSCell change or PCell change is triggered. Intra-SN CPC without MN involvement, inter-SN CPC initiated either by MN or SN are supported.

The following principles apply to CPC:

- The CPC configuration contains the configuration of CPC candidate PSCell(s) and execution condition(s) and may contain the MCG configuration for inter-SN CPC, to be applied when CPC execution is triggered.
- An execution condition may consist of one or two trigger condition(s) (see *CondEvent*, as defined in TS 38.331 [4] or TS 36.331 [10]). Only single RS type and at most two different trigger quantities (e.g. RSRP and RSRQ, RSRP and SINR, etc.) can be used for the evaluation of CPC execution condition of a single candidate PSCell.

- Before any CPC execution condition is satisfied, upon reception of PSCell change command or PCell change command, the UE executes the PSCell change procedure as described in clause 10.3 and 10.5 or the PCell change procedure as described in clause 9.2.3.2 in TS 38.300[3] or clause 10.1.2.1 in TS 36.300 [2], regardless of any previously received CPC configuration. Upon the successful completion of PSCell change procedure or PCell change procedure, the UE releases all stored CPC configurations.
- While executing CPC, the UE is not required to continue evaluating the execution condition of other candidate PSCell(s) or PCell(s).
- Once the CPC procedure is executed successfully, the UE releases all stored conditional reconfigurations (i.e. for CPC and for CHO, as specified in TS 38.300 [3] or TS 36.300 [2]).
- Upon the release of SCG, the UE releases the stored CPC configurations.
- MN can inform SN of the maximum number of conditional reconfigurations the SN is allowed to configure for SN initiated CPC including both intra-SN and inter-SN CPC.

CPC configuration in HO command, in PSCell addition/change command or within any conditional reconfiguration (i.e. CPA, CPC or CHO configuration) is not supported.

10.7 Inter-Master Node handover with/without Secondary Node change

10.7.1 EN-DC

Inter-Master Node handover with/without MN initiated Secondary Node change is used to transfer context data from a source MN to a target MN while the context at the SN is kept or moved to another SN. During an Inter-Master Node handover, the target MN decides whether to keep or change the SN (or release the SN, as described in clause 10.8).

NOTE 1: Void.

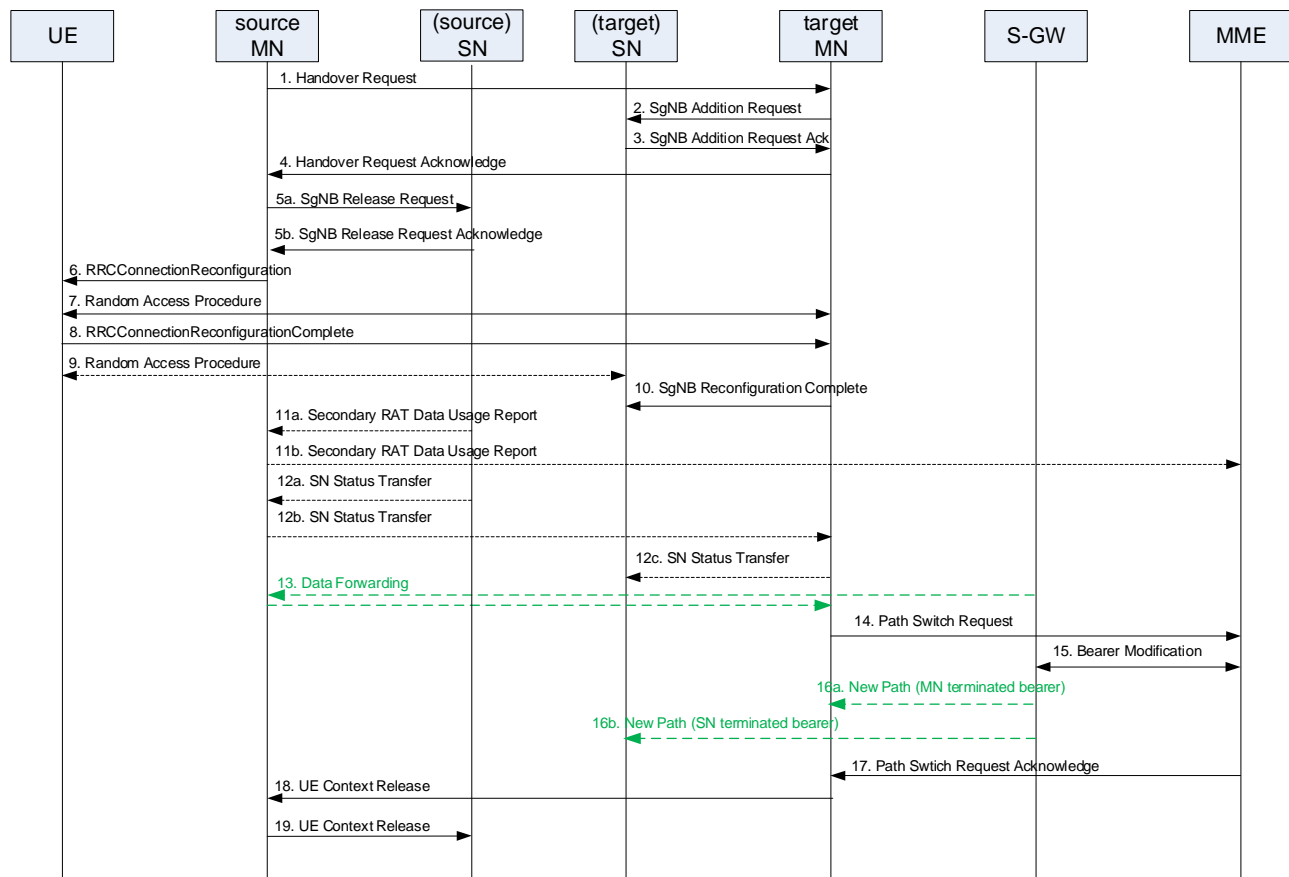

Figure 10.7.1-1: Inter-MN handover with/without MN initiated SN change

Figure 10.7.1-1 shows an example signaling flow for inter-Master Node handover with or without MN initiated Secondary Node change:

NOTE 2: For an inter-Master Node handover without Secondary Node change, the source SN and the target SN shown in Figure 10.7.1-1 are the same node.

1. The source MN starts the handover procedure by initiating the X2 Handover Preparation procedure including both MCG and SCG configuration. The source MN includes the (source) SN UE X2AP ID, SN ID and the UE context in the (source) SN in the *Handover Request* message.

NOTE 3: The source MN may trigger the MN-initiated SN Modification procedure (to the source SN) to retrieve the current SCG configuration before step 1.

2. If the target MN decides to keep the UE context in SN, the target MN sends *SgNB Addition Request* to the SN including the SN UE X2AP ID as a reference to the UE context in the SN that was established by the source MN. If the target MN decides to change the SN allowing delta configuration, the target MN sends the *SgNB Addition Request* to the target SN including the UE context in the source SN that was established by the source MN. Otherwise, the target MN may send the *SgNB Addition Request* to the target SN including neither the SN UE X2AP ID nor the UE context in the source SN that was established by the source MN.

3. The (target) SN replies with *SgNB Addition Request Acknowledge*. The (target) SN may include the indication of the full or delta RRC configuration.

NOTE 3a: In case the target SN includes the indication of the full RRC configuration, the MN performs release of the SN terminated radio bearer configuration and release and add of the NR SCG configuration part towards the UE.

NOTE 3b: Void.

4. The target MN includes within the *Handover Request Acknowledge* message a transparent container to be sent to the UE as an RRC message to perform the handover, and may also provide forwarding addresses to the source

MN. The target MN indicates to the source MN that the UE context in the SN is kept if the target MN and the SN decided to keep the UE context in the SN in step 2 and step 3.

5. The source MN sends *SgNB Release Request* to the (source) SN including a Cause indicating MCG mobility. The (source) SN acknowledges the release request. The source MN indicates to the (source) SN that the UE context in SN is kept, if it receives the indication from the target MN. If the indication as the UE context kept in SN is included, the SN keeps the UE context.

6. The source MN triggers the UE to apply the new configuration.

7/8. The UE synchronizes to the target MN and replies with *RRCConnectionReconfigurationComplete* message.

9. If configured with bearers requiring SCG radio resources, the UE synchronizes to the (target) SN.

NOTE 3b1: The order the UE performs Random Access towards the MN (step 7) and performs the Random Access procedure towards the SN (step 9) is not defined.

10. If the RRC connection reconfiguration procedure was successful, the target MN informs the (target) SN via *SgNB Reconfiguration Complete* message.

- 11a. The SN sends the *Secondary RAT Data Usage Report* message to the source MN and includes the data volumes delivered to and received from the UE over the NR radio for the related E-RABs.

NOTE 4: The order the source SN sends the *Secondary RAT Data Usage Report* message and performs data forwarding with MN/target SN is not defined. The SgNB may send the report when the transmission of the related bearer is stopped.

- 11b. The source MN sends the *Secondary RAT Report* message to MME to provide information on the used NR resource.

12. For bearers using RLC AM, the source MN sends the *SN Status Transfer* message, including, if needed, SN Status received from the source SN to the target MN. The target forwards the SN Status to the target SN, if needed.

13. If applicable, data forwarding takes place from the source side. If the SN is kept, data forwarding may be omitted for SN-terminated bearers kept in the SN.

- 14-17. The target MN initiates the S1 Path Switch procedure.

NOTE 5: If new UL TEIDs of the S-GW are included, the target MN performs the MN initiated SN Modification procedure to provide them to the SN.

18. The target MN initiates the UE Context Release procedure towards the source MN.

19. Upon reception of the *UE Context Release* message, the (source) SN releases C-plane related resources associated to the UE context towards the source MN. Any ongoing data forwarding may continue. The SN shall not release the UE context associated with the target MN if the UE context kept indication was included in the *SgNB Release Request* message in step 5.

10.7.2 MR-DC with 5GC

Inter-MN handover with/without MN initiated SN change is used to transfer UE context data from a source MN to a target MN while the UE context at the SN is kept or moved to another SN. During an Inter-Master Node handover, the target MN decides whether to keep or change the SN (or release the SN, as described in clause 10.8). Only intra-RAT Inter-Master node handover with/without SN change is supported (e.g. no transition from NGEN-DC to NR-DC).

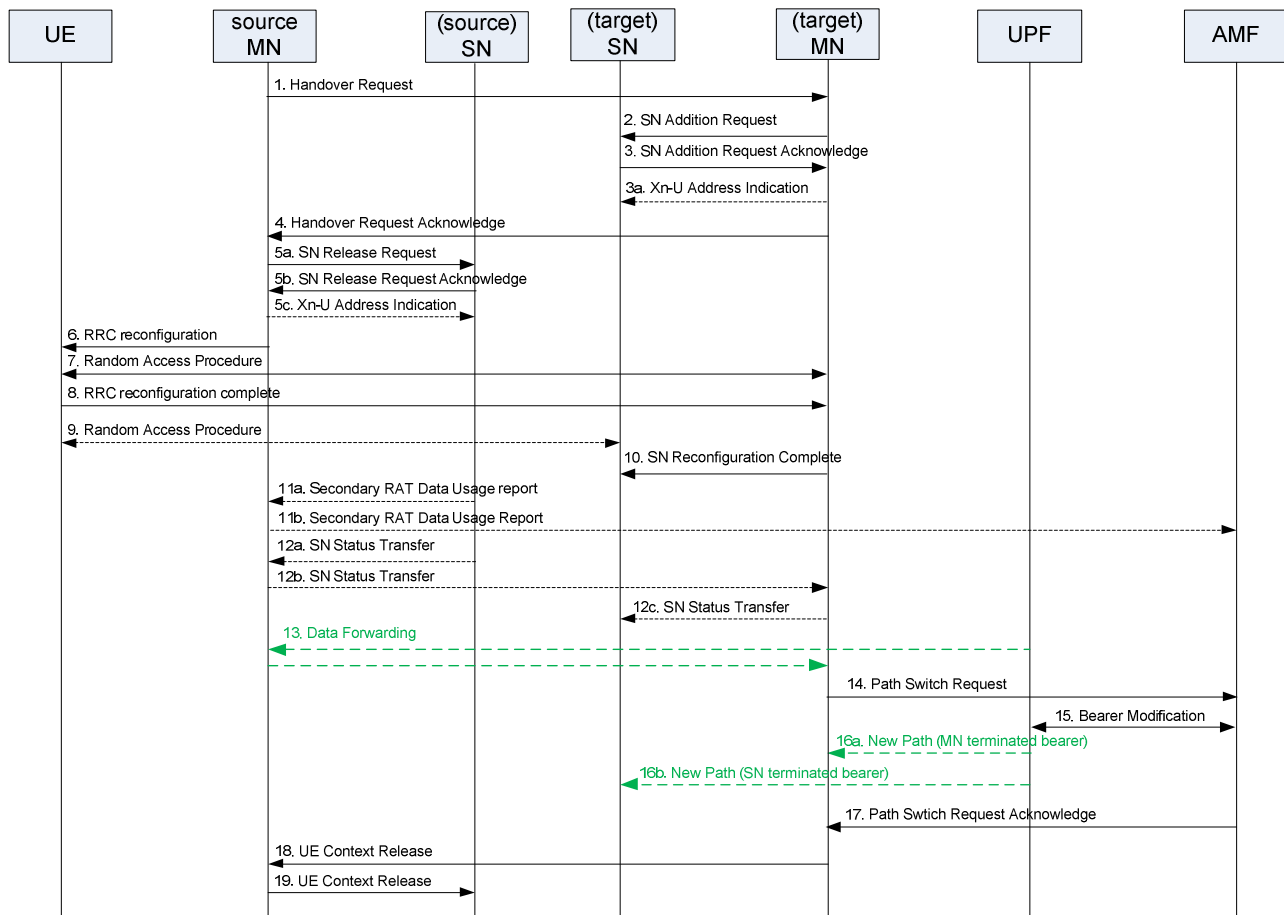

Figure 10.7.2-1: Inter-MN handover with/without MN initiated SN change procedure

Figure 10.7.2-1 shows an example signalling flow for inter-MN handover with or without MN initiated SN change:

NOTE 1: For an Inter-Master Node handover without Secondary Node change, the source SN and the target SN shown in Figure 10.7.2-1 are the same node.

1. The source MN starts the handover procedure by initiating the Xn Handover Preparation procedure including both MCG and SCG configuration. The source MN includes the source SN UE XnAP ID, SN ID and the UE context in the source SN in the *Handover Request* message.

NOTE 2: The source MN may trigger the MN-initiated SN Modification procedure (to the source SN) to retrieve the current SCG configuration and to allow provision of data forwarding related information before step 1.

2. If the target MN decides to keep the UE context in source SN, the target MN sends *SN Addition Request* to the SN including the SN UE XnAP ID as a reference to the UE context in the SN that was established by the source MN. If the target MN decides to change the SN allowing delta configuration, the target MN sends the *SN Addition Request* to the target SN including the UE context in the source SN that was established by the source MN. Otherwise, the target MN may send the *SN Addition Request* to the target SN including neither the SN UE XnAP ID nor the UE context in the source SN that was established by the source MN.

3. The (target) SN replies with *SN Addition Request Acknowledge*. The (target) SN may include the indication of the full or delta RRC configuration.

NOTE 2a0: Void.

- 3a. For SN terminated bearers using MCG resources, the target MN provides Xn-U DL TNL address information in the *Xn-U Address Indication* message.

4. The target MN includes within the *Handover Request Acknowledge* message the MN RRC reconfiguration message to be sent to the UE in order to perform the handover, and may also provide forwarding addresses to the

source MN. If PDU session split is performed in the target side during handover procedure, more than one data forwarding addresses corresponding to each node are included in the *Handover Request Acknowledge* message. The target MN indicates to the source MN that the UE context in the SN is kept if the target MN and the SN decided to keep the UE context in the SN in step 2 and step 3.

5a/5b. The source MN sends *SN Release Request* message to the (source) SN including a Cause indicating MCG mobility. The (source) SN acknowledges the release request. The source MN indicates to the (source) SN that the UE context in SN is kept, if it receives the indication from the target MN. If the indication as the UE context kept in SN is included, the SN keeps the UE context.

5c. The source MN sends XN-U Address Indication message to the (source) SN to transfer data forwarding information. More than one data forwarding addresses may be provided if the PDU session is split in the target side.

6. The source MN triggers the UE to perform handover and apply the new configuration.

7/8. The UE synchronizes to the target MN and replies with MN RRC reconfiguration *complete* message.

9. If configured with bearers requiring SCG radio resources, the UE synchronizes to the (target) SN.

NOTE 2a1: The order the UE performs Random Access towards the MN (step 7) and performs the Random Access procedure towards the SN (step 9) is not defined.

10. If the RRC connection reconfiguration procedure was successful, the target MN informs the (target) SN via *SN Reconfiguration Complete* message.

11a. The source SN sends the *Secondary RAT Data Usage Report* message to the source MN and includes the data volumes delivered to and received from the UE over the NR/E-UTRA radio as described in clause 10.11.2.

NOTE 2a2: The order the source SN sends the *Secondary RAT Data Usage Report* message and performs data forwarding with MN/target SN is not defined. The SN may send the report when the transmission of the related QoS is stopped.

11b. The source MN sends the *Secondary RAT Report* message to AMF to provide information on the used NR/E-UTRA resource.

12. For bearers using RLC AM, the source MN sends the *SN Status Transfer* message to the target MN, including, if needed, SN Status received from the source SN. The target forwards the SN Status to the target SN, if needed.

13. If applicable, data forwarding takes place from the source side. If the SN is kept, data forwarding may be omitted for SN terminated bearers or QoS flows kept in the SN.

14-17. The target MN initiates the Path Switch procedure. If the target MN includes multiple DL TEIDs for one PDU session in the *Path Switch Request* message, multiple UL TEID of the UPF for the PDU session should be included in the *Path Switch Ack* message in case there is TEID update in UPF.

NOTE 3: If new UL TEIDs of the UPF for SN are included, the target MN performs MN initiated SN Modification procedure to provide them to the SN.

18. The target MN initiates the UE Context Release procedure towards the source MN.

19. Upon reception of the *UE Context Release* message from source MN, the (source) SN releases C-plane related resources associated to the UE context towards the source MN. Any ongoing data forwarding may continue. The SN shall not release the UE context associated with the target MN if the UE context kept indication was included in the *SN Release Request* message in step 5.

10.8 Master Node to eNB/gNB Change

10.8.1 EN-DC

The Master Node to eNB Change procedure is used to transfer context data from a source MN/SN to a target eNB.

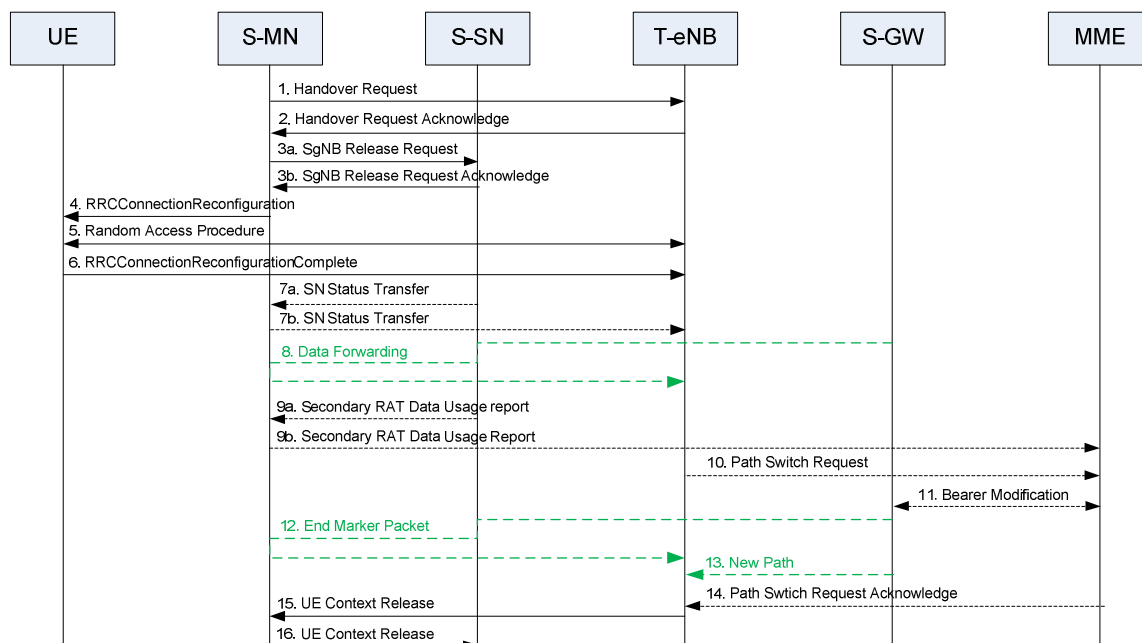

Figure 10.8.1-1: Master Node to eNB Change procedure

Figure 10.8.1-1 shows an example signalling flow for the Master Node to eNB Change procedure:

1. The source MN starts the MN to eNB Change procedure by initiating the X2 Handover Preparation procedure, including both MCG and SCG configuration.

NOTE 1: The source MN may trigger the MN-initiated SN Modification procedure (to the source SN) to retrieve the current SCG configuration before step 1.

2. The target eNB includes the field in HO command which releases SCG configuration, and may also provide forwarding addresses to the source MN.
3. If the allocation of target eNB resources was successful, the MN initiates the release of the source SN resources towards the source SN including a Cause indicating MCG mobility. The SN acknowledges the release request. If data forwarding is needed, the MN provides data forwarding addresses to the source SN. Reception of the *SgNB Release Request* message triggers the source SN to stop providing user data to the UE and, if applicable, to start data forwarding.

NOTE 1a: In case the handover is a conditional handover, step 3a and step 3b are performed after the source MN receives an indication that the UE has successfully accessed one of the potential target eNB(s) as described in step 11a in Figure 10.1.2.1a-1 in TS 36.300 [2], i.e., after step 6 in Figure 10.8.1-1.

NOTE 1b: In case the handover is a conditional handover, the Data Forwarding Address Indication procedure is executed right after step 2. This Data Forwarding Address Indication procedure notifies conditional handover to the source SN, for which it may decide to perform, if applicable, early data forwarding for SN-terminated bearers, together with the sending of an *EARLY STATUS TRANSFER* message to the source MN. Separate Data Forwarding Address Indication procedures may be invoked to provide different forwarding addresses of the prepared conditional handovers. In this case, it is up to the source MN and SN implementations to make sure that the *EARLY STATUS TRANSFER* message(s) from the source SN, if any, is forwarded to the right target destination. The Data Forwarding Address Indication procedure may further be invoked to indicate to the source SN to stop already initiated early data forwarding for some SN-terminated bearers if they are no longer subject to data forwarding due to the modification or cancellation of the prepared conditional handovers. If applicable, the normal data forwarding and *SN STATUS TRANSFER* message would follow from the source SN once it receives the *SgNB Release Request* message of the step 3a that is performed after step 6.

4. The MN triggers the UE to apply the new configuration. Upon receiving the new configuration, the UE releases the entire SCG configuration.
- 5/6. The UE synchronizes to the target eNB.

7. For SN terminated bearers using RLC AM, the SN sends the *SN Status Transfer* message, which the source MN sends then to the target eNB.

8. If applicable, data forwarding takes place from the source side.

9a. The source SN sends the *Secondary RAT Data Usage Report* message to the source MN and includes the data volumes delivered to and received from the UE over the NR radio for the related E-RABs.

NOTE 2: The order the SN sends the *Secondary RAT Data Usage Report* message and performs data forwarding with MN is not defined. The SN may send the report when the transmission of the related bearer is stopped.

9b. The source MN sends the *Secondary RAT Report* message to MME to provide information on the used NR resource.

10-14. The target eNB initiates the S1 Path Switch procedure.

15. The target eNB initiates the UE Context Release procedure towards the source MN.

16. Upon reception of the *UE Context Release* message, the SN releases radio and C-plane related resources associated to the UE context. Any ongoing data forwarding may continue.

NOTE 3: Inter-system HO from E-UTRA with EN-DC configuration to NR or to E-UTRA connected to 5GC is also supported.

10.8.2 MR-DC with 5GC

The MN to ng-eNB/gNB Change procedure is used to transfer UE context data from a source MN/SN to a target ng-eNB/gNB. Both the cases where the source MN and the target node belong to the same RAT (i.e. they are both ng-eNBs or both gNBs) and the cases where the source MN and the target node belong to different RATs are supported.

NOTE 0: Inter-system HO from ng-eNB/gNB MN to eNB is also supported.

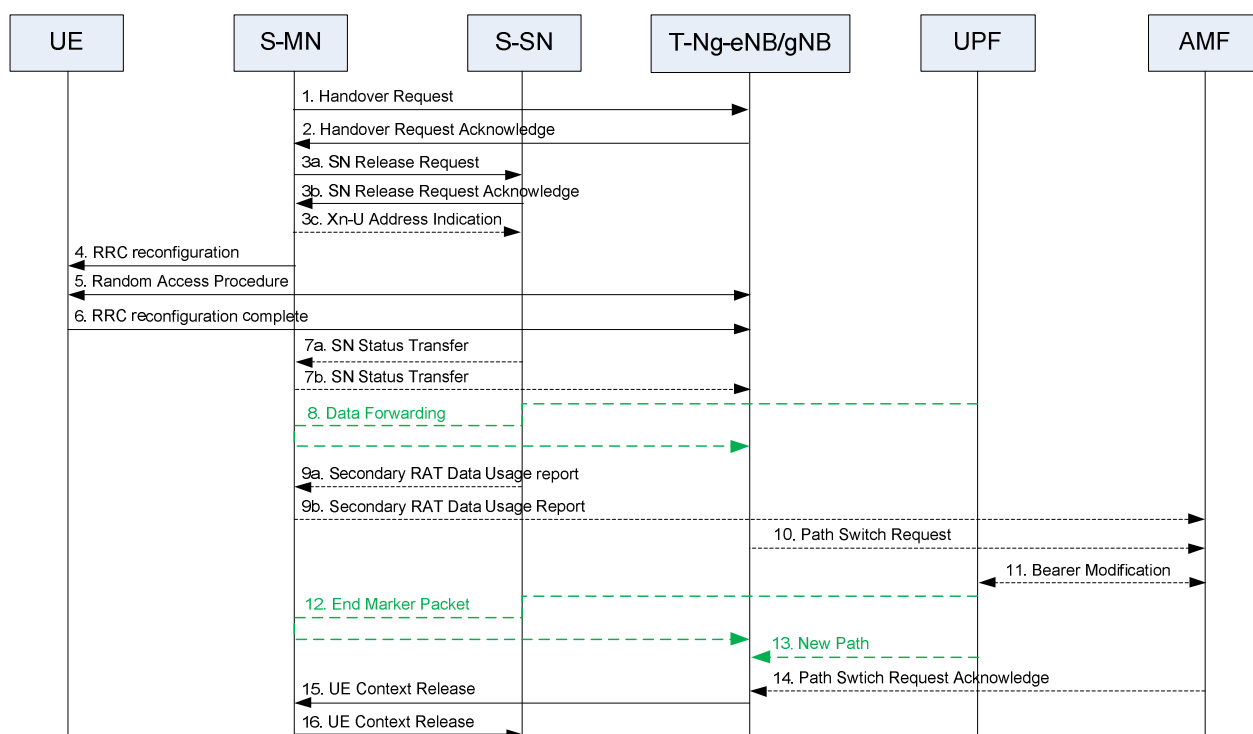

Figure 10.8.2-1: MN to ng-eNB/gNB Change procedure

Figure 10.8.2-1 shows an example signalling flow for the MN to ng-eNB/gNB Change procedure:

1. The source MN starts the MN to ng-eNB/gNB Change procedure by initiating the Xn Handover Preparation procedure, including both MCG and SCG configuration.

NOTE 1: The source MN may trigger the MN-initiated SN Modification procedure (to the source SN) to retrieve the current SCG configuration and to allow provision of data forwarding related information before step 1.

2. The target ng-eNB/gNB includes the field in HO command which releases the SCG configuration, and may also provide forwarding addresses to the source MN.
3. If the resource allocation of target ng-eNB/gNB was successful, the MN initiates the release of the source SN resources towards the source SN including a Cause indicating MCG mobility. The SN acknowledges the release request. If data forwarding is needed, the MN provides data forwarding addresses to the source SN. Reception of the *SN Release Request* message triggers the source SN to stop providing user data to the UE and, if applicable, to start data forwarding.

NOTE 1a: In case the handover is a conditional handover, step 3a and step 3b are performed after the source MN receives an indication that the UE has successfully accessed one of the potential target gNB(s) as described in step 8a in Figure 9.2.3.4.2-1 in TS 38.300 [3], i.e., after step 6 in Figure 10.8.2-1.

NOTE 1b: In case the handover is a conditional handover, the step 3c is executed right after step 2. The *Xn-U Address Indication* message notifies conditional handover to the source SN, for which it may decide to perform, if applicable, early data forwarding for SN-terminated bearers, together with the sending of an *EARLY STATUS TRANSFER* message to the source MN. Separate Xn-U Address Indication procedures may be invoked to provide different forwarding addresses of the prepared conditional handovers. In this case, it is up to the source MN and SN implementations to make sure that the *EARLY STATUS TRANSFER* message(s) from the source SN, if any, is forwarded to the right target destination. The Xn-U Address Indication procedure may further be invoked to indicate to the source SN to stop already initiated early data forwarding for some SN-terminated bearers if they are no longer subject to data forwarding due to the modification or cancellation of the prepared conditional handovers. If applicable, the normal data forwarding and *SN STATUS TRANSFER* message would follow from the source SN once it receives the *SN Release Request* message of the step 3a that is performed after step 6. In case the step 3c Xn-U Address Indication procedure corresponding to the conditional handover that the UE successfully accessed was rejected by the source SN, the source MN re-sends it after the step 3b that is performed after step 6.

4. The MN triggers the UE to perform HO and apply the new configuration. Upon receiving the new configuration, the UE releases the entire SCG configuration.

5/6. The UE synchronizes to the target ng-eNB/gNB.

7. If PDCP termination point is changed for bearers using RLC AM, the SN sends the *SN Status Transfer* message, which the source MN sends then to the target ng-eNB/gNB.

8. If applicable, data forwarding takes place from the source side.

- 9a. The source SN sends the *Secondary RAT Data Usage Report* message to the source MN and includes the data volumes delivered to and received from the UE as described in clause 10.11.2.

NOTE 2: The order the SN sends the *Secondary RAT Data Usage Report* message and performs data forwarding with MN is not defined. The SN may send the report when the transmission of the related QoS flow is stopped.

- 9b. The source MN sends the *Secondary RAT Report* message to AMF to provide information on the used NR/E-UTRA resource.

10-14. The target ng-eNB/gNB initiates the Path Switch procedure.

15. The target ng-eNB/gNB initiates the UE Context Release procedure towards the source MN.

16. Upon reception of the *UE Context Release* message from the MN, the source SN releases radio and C-plane related resources associated to the UE context. Any ongoing data forwarding may continue.

10.9 eNB/gNB to Master Node change

10.9.1 EN-DC

The eNB to Master Node change procedure is used to transfer context data from a source eNB to a target MN that adds an SN during the handover.

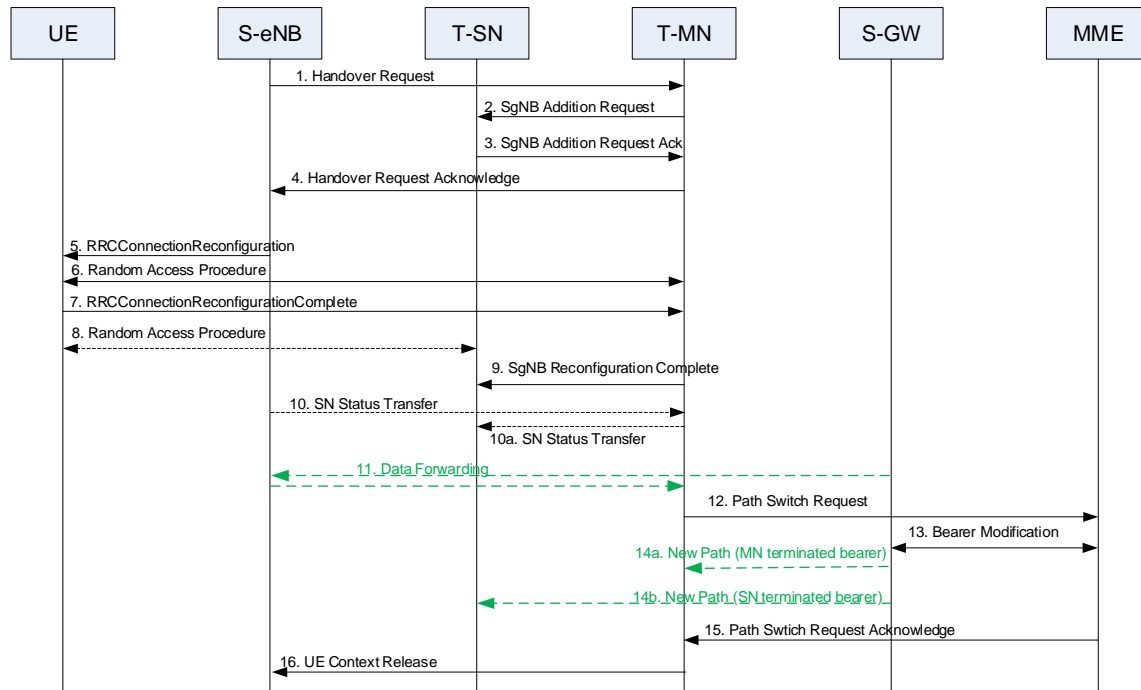

Figure 10.9.1-1: eNB to Master Node change

Figure 10.9.1-1 shows an example signaling flow for eNB to Master Node change:

1. The source eNB starts the handover procedure by initiating the X2 Handover Preparation procedure.
2. The target MN sends *SgNB Addition Request* to the target SN.
3. The target SN replies with *SgNB Addition Request Acknowledge*. If data forwarding is needed, the target SN provides forwarding addresses to the target MN.

NOTE 0: Void.

4. The target MN includes within the *Handover Request Acknowledge* message a transparent container to be sent to the UE as an E-UTRA RRC message, including a NR RRC configuration message which also includes the SCG configuration, to perform the handover, and may also provide forwarding addresses to the source eNB.

5. The source eNB triggers the UE to apply the new configuration.

- 6/7. The UE synchronizes to the target MN and replies with *RRCConnectionReconfigurationComplete* message.

8. If configured with bearers requiring SCG radio resources, the UE synchronizes to the target SN.

NOTE 0: The order the UE performs Random Access towards the target MN (step 6) and performs the Random Access procedure towards the target SN (step 8) is not defined.

9. If the RRC connection reconfiguration procedure was successful, the target MN informs the target SN.

10. For bearers using RLC AM, the source eNB sends the *SN Status Transfer* message, which the target MN forwards then to the target SN, if needed.

11. Data forwarding from the source eNB takes place.

12-15. The target MN initiates the S1 Path Switch procedure.

NOTE 1: If new UL TEIDs of the S-GW are included, the target MN performs MN initiated SN Modification procedure to provide them to the target SN.

16. The target MN initiates the *UE Context Release* procedure towards the source eNB.

NOTE 2: Void.

NOTE 3: Void.

10.9.2 MR-DC with 5GC

The ng-eNB/gNB to MN change procedure is used to transfer UE context data from a source ng-eNB/gNB to a target MN that adds an SN during the handover. Only the cases where the source node and the target MN belong to the same RAT (i.e. they are both ng-eNBs or both gNBs) are supported.

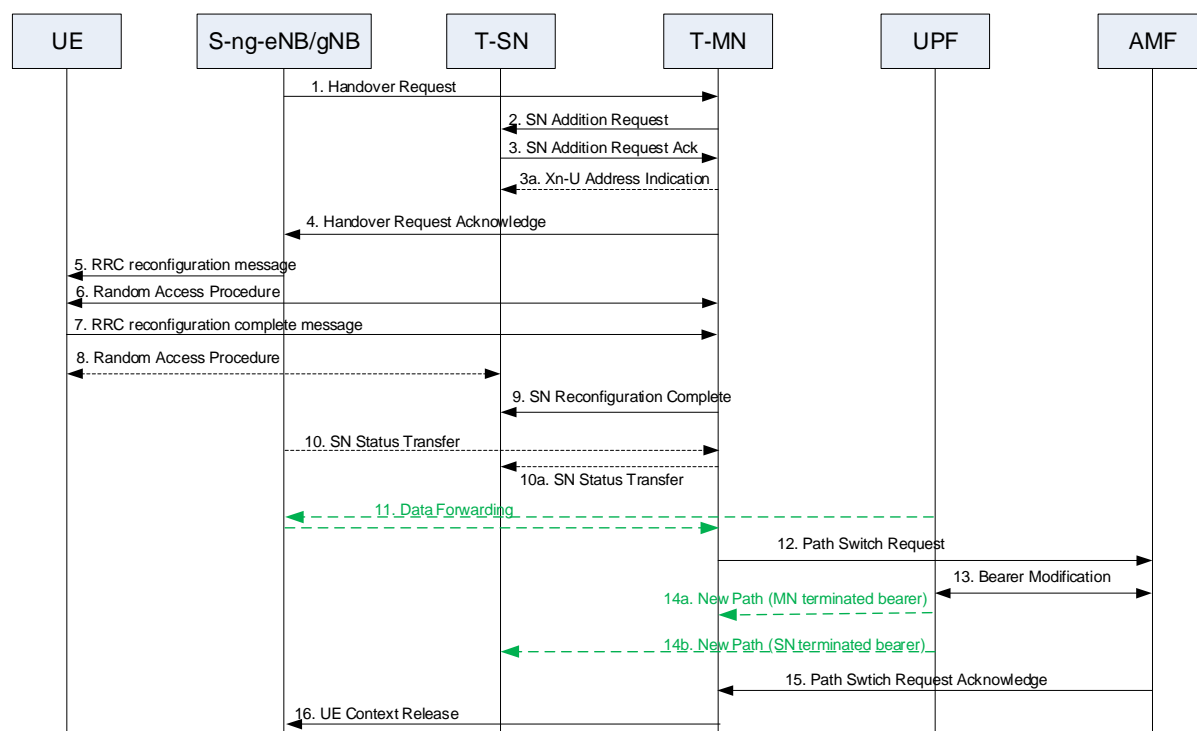

Figure 10.9.2-1: ng-eNB/gNB to MN change procedure

Figure 10.9.2-1 shows an example signalling flow for ng-eNB/gNB to MN change:

1. The source ng-eNB/gNB starts the handover procedure by initiating the Xn Handover Preparation procedure.
2. The target MN sends *SN Addition Request* to the target SN.
3. The target SN replies with *SN Addition Request Acknowledge*. If data forwarding is needed, the target SN provides forwarding addresses to the target MN.

NOTE 0: Void.

- 3a. For SN terminated bearers using MCG resources, the target MN provides Xn-U DL TNL address information in the *Xn-U Address Indication* message.
4. The target MN includes within the *Handover Request Acknowledge* message the SN RRC reconfiguration message to be sent to the UE that includes the SCG configuration to perform the handover, and may also provide forwarding addresses to the source ng-eNB/gNB.
5. The source ng-eNB/gNB triggers the UE to perform handover and apply the new configuration.

6/7. The UE synchronizes to the target MN and replies with MN RRC reconfiguration complete message including the SN RRC reconfiguration complete message.

8. If configured with bearers requiring SCG radio resources, the UE synchronizes to the target SN.

NOTE 1: The order the UE performs Random Access towards the target MN (step 6) and performs the Random Access procedure towards the target SN (step 8) is not defined.

9. If the RRC connection reconfiguration procedure was successful, the target MN informs the target SN via *SN Reconfiguration Complete* message.

10. For bearers using RLC AM, the source ng-eNB/gNB sends the *SN Status Transfer* message, which the target MN forwards then to the target SN, if needed.

11. Data forwarding from the source ng-eNB/gNB takes place.

12-15. The target MN initiates the PDU Session Path Switch procedure.

NOTE 2: If new UL TEIDs of the UPF are included, the target MN performs MN initiated SN Modification procedure to provide them to the target SN.

16. The target MN initiates the *UE Context Release* procedure towards the source ng-eNB/gNB.

10.10 RRC Transfer

10.10.1 EN-DC

The RRC Transfer procedure is used to deliver an RRC message, encapsulated in a PDCP PDU between the MN and the SN (and vice versa) so that it may be forwarded to/from the UE using split SRB. The RRC transfer procedure is also used for:

- providing an NR measurement report, NR failure information, NR UE assistance information or intra-SN CPC execution completion from the UE to the SN via the MN. If UE is IAB-MT, providing NR IAB other information from the IAB-MT to the SN via the MN;
- providing MCG failure information from the UE to the MN via the SN and an RRC reconfiguration, or release, or an inter-RAT handover command from the MN to the UE via the SN.

Additional details of the RRC transfer procedure are defined in TS 36.423 [9].

Split SRB:

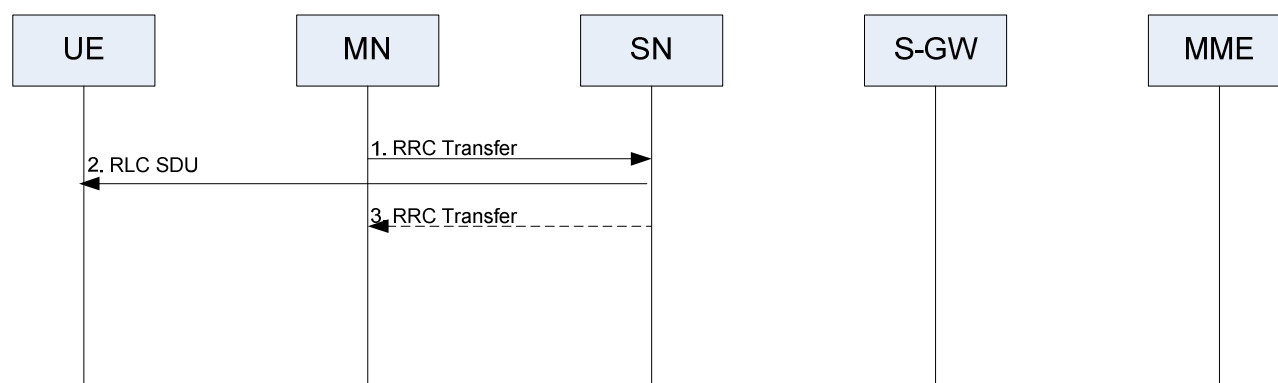

Figure 10.10.1-1: RRC Transfer procedure for the split SRB (DL operation)

Figure 10.10.1-1 shows an example signaling flow for the DL RRC Transfer in case of the split SRB:

1. The MN, when it decides to use the split SRBs, starts the procedure by initiating the RRC Transfer procedure. The MN encapsulates the RRC message in a PDCP-C PDU and ciphers with own keys.

NOTE: The usage of the split SRBs shall be indicated in the Secondary Node Addition procedure or Modification procedure.

2. The SN forwards the RRC message to the UE.
3. The SN may send PDCCP delivery acknowledgement of the RRC message forwarded in step 2.

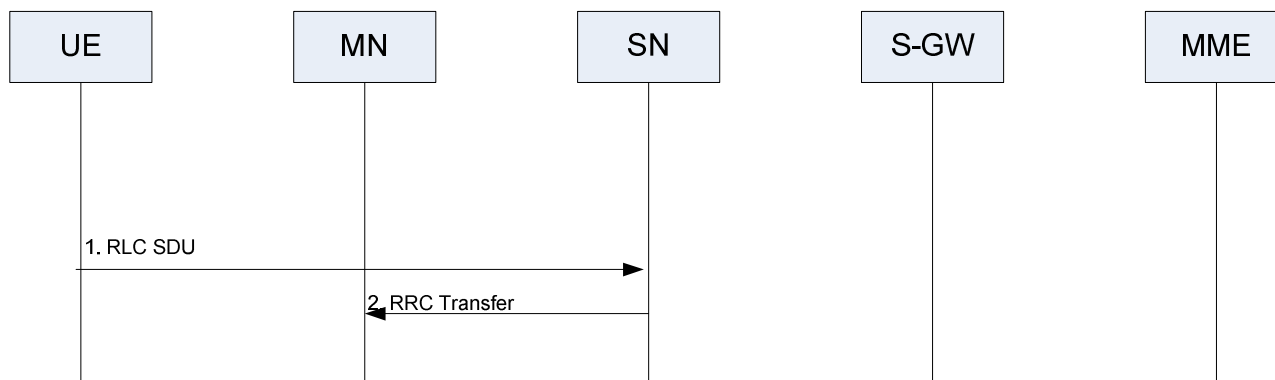

Figure 10.10.1-2: RRC Transfer procedure for the split SRB (UL operation)

Figure 10.10.1-2 shows an example signaling flow for the UL RRC Transfer in case of the split SRB:

1. When the UE provides response to the RRC message, it sends it to the SN.
2. The SN initiates the RRC Transfer procedure, in which it transfers the received PDCCP-C PDU with encapsulated RRC message.

NR measurement report, NR failure information, NR UE assistance information, NR IAB other information or intra-SN CPC execution completion:

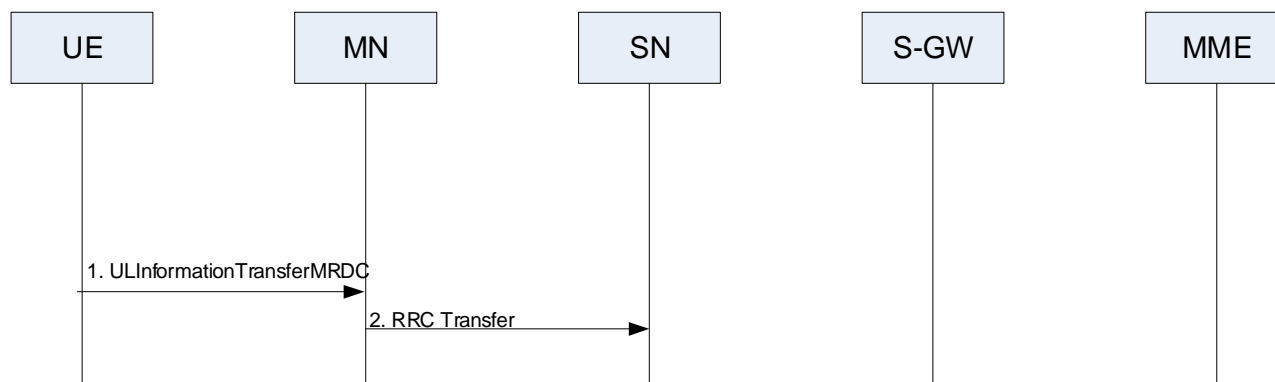

Figure 10.10.1-3: RRC Transfer procedure for NR measurement report, NR failure information, NR UE assistance information, NR IAB other information or intra-SN CPC execution completion

Figure 10.10.1-3 shows an example signaling flow for RRC Transfer in case of the forwarding of the NR measurement report, NR failure information, NR IAB other information from the UE, NR UE assistance information or intra-SN CPC execution completion:

1. When the UE sends a measurement report, NR failure information, NR UE assistance information, NR IAB other information or intra-SN CPC execution completion, it sends it to the MN in a container within *ULInformationTransferMRDC* message as specified in TS 36.331 [10].
2. The MN initiates the RRC Transfer procedure, in which it transfers the received NR measurement report, NR failure information, NR UE assistance information, NR IAB other information or intra-SN CPC execution completion as an octet string.

MCG failure information and RRC Reconfiguration / RRC Release / inter-RAT handover command over SRB3:

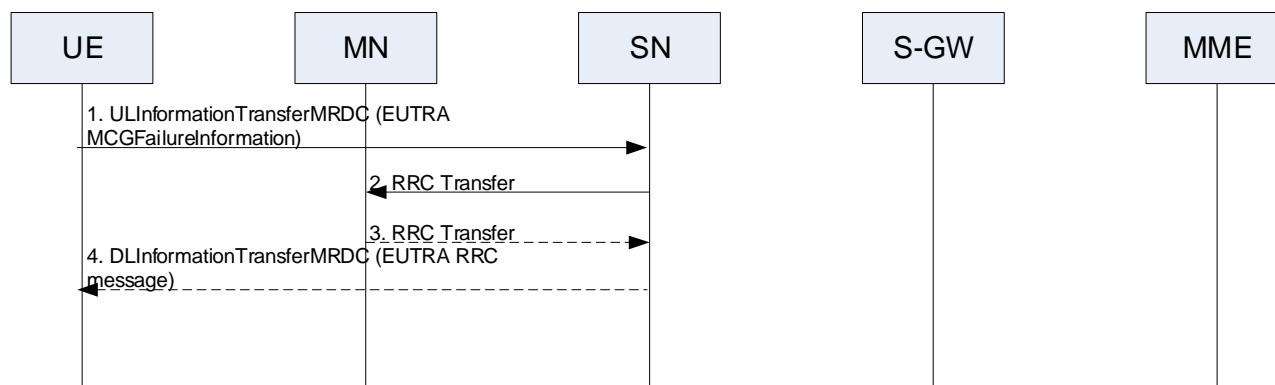

Figure 10.10.1-4: RRC Transfer procedure for MCG failure information

Figure 10.10.1-4 shows an example signaling flow for RRC Transfer in case of the forwarding of the MCG failure information from the UE:

1. When the UE sends EUTRA *MCGFailureInformation* message over SRB3, it sends it to the SN in a container within *ULInformationTransferMRDC* message as specified in TS 38.331 [4].
2. The SN initiates the RRC Transfer procedure, in which it transfers the received EUTRA *MCGFailureInformation* message as an octet string.
3. The MN initiates the RRC Transfer procedure, in which it transfers the EUTRA *RRCCConnectionReconfiguration* message, or EUTRA *RRCCConnectionRelease* message, or *MobilityFromEUTRACommand* message as an octet string.
4. The SN sends the received EUTRA RRC message to the UE over SRB3 in a container within *DLInformationTransferMRDC*, message as specified in TS 38.331 [4].

10.10.2 MR-DC with 5GC

The RRC Transfer procedure is used to deliver an RRC message, encapsulated in a PDCP PDU between the MN and the SN (and vice versa) so that it may be forwarded to/from the UE using split SRB. The RRC transfer procedure is also used for:

- providing a SN measurement report, failure information report, SN UE assistance information or intra-SN CPC execution completion from the UE to the SN. If UE is IAB-MT, providing NR IAB other information from the IAB-MT to the SN when the IAB-donor is the SN;
- providing MCG failure information from the UE to the MN via the SN and an RRC reconfiguration, or release, or an inter-RAT handover command from the MN to the UE via the SN;
- providing F1-C traffic from an IAB-node to the MN via the SN, or F1-C traffic from the MN to an IAB-node via the SN.

Additional details of the RRC transfer procedure are defined in TS 38.423 [5].

Split SRB:

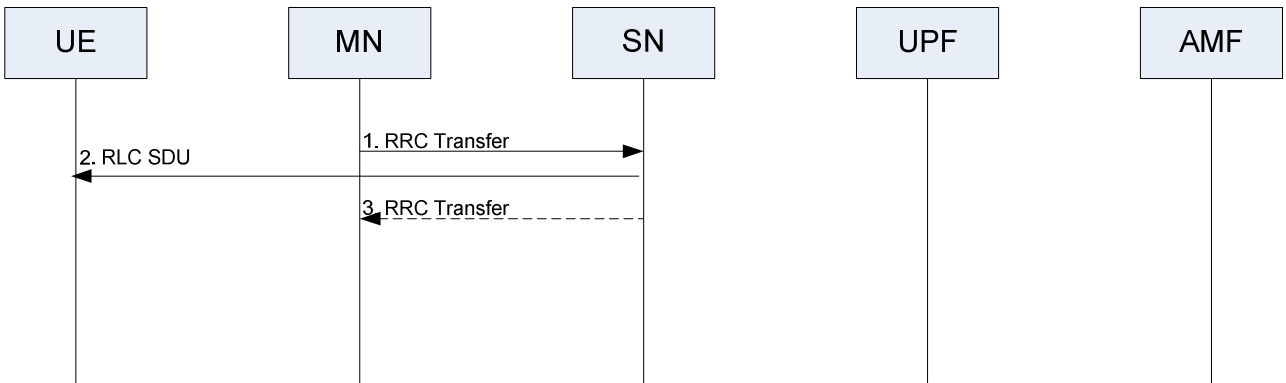

Figure 10.10.2-1: RRC Transfer procedure for split SRB (DL operation)

Figure 10.10.2-1 shows an example signaling flow for DL RRC Transfer in case of the split SRB:

1. The MN, when it decides to use the split SRBs, starts the procedure by initiating the RRC Transfer procedure. The MN encapsulates the RRC message in a PDCP PDU and ciphers with own keys.

NOTE: The usage of the split SRBs shall be indicated in the Secondary Node Addition procedure or Modification procedure.

2. The SN forwards the RRC message to the UE.
3. The SN may send PDCP delivery acknowledgement of the RRC message forwarded in step 2.

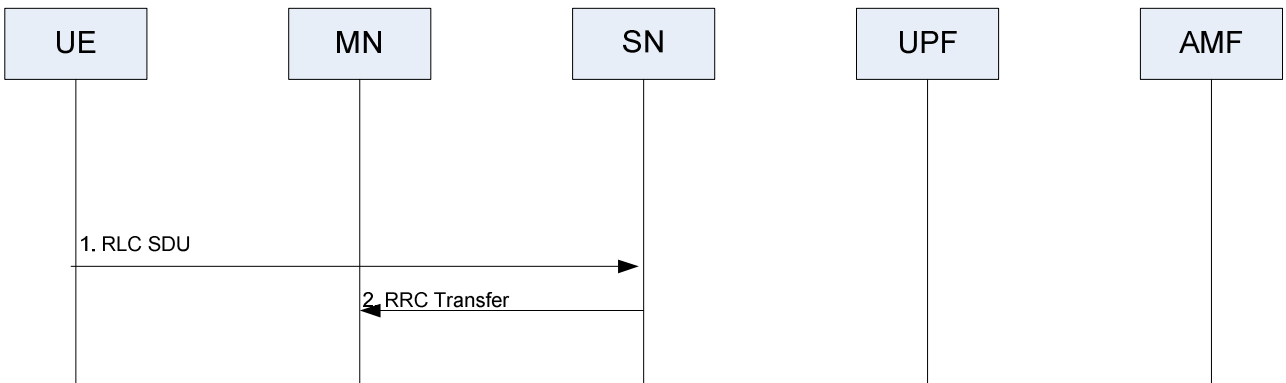

Figure 10.10.2-2: RRC Transfer procedure for split SRB (UL operation)

Figure 10.10.2-2 shows an example signaling flow for UL RRC Transfer in case of the split SRB:

1. When the UE provides response to the RRC message, it sends it to the SN.
2. The SN initiates the RRC Transfer procedure, in which it transfers the received PDCP PDU with encapsulated RRC message.

SN measurement report, failure information report, SN UE assistance information, intra-SN CPC execution completion or IAB other information:

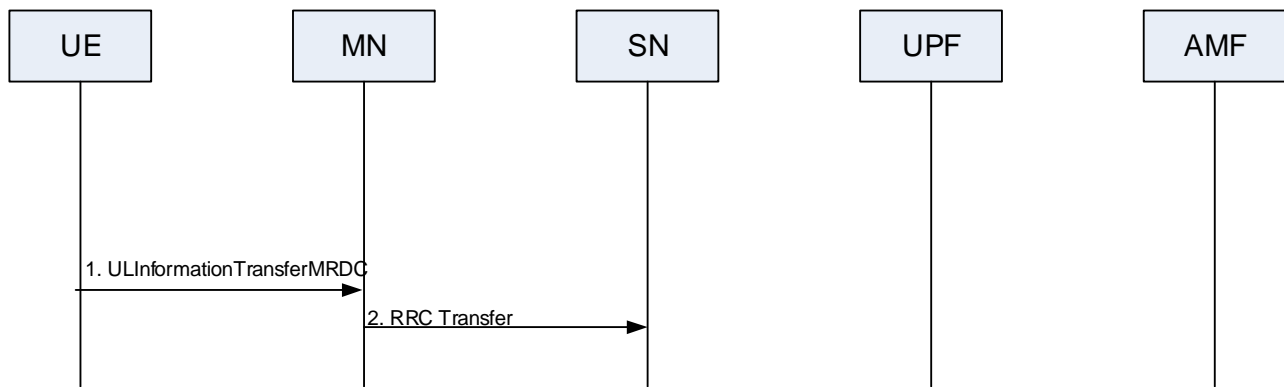

Figure 10.10.2-3: RRC Transfer procedure for SN measurement report, failure information report, SN UE assistance information, intra-SN CPC execution completion or IAB other information

Figure 10.10.2-3 shows an example signaling flow for RRC Transfer in case of the forwarding of the SN measurement report, failure information report, SN UE assistance information, intra-SN CPC execution completion or IAB other information from the UE:

1. When the UE sends an SN measurement report, failure information report, SN UE assistance information, intra-SN CPC execution completion or IAB other information it sends it to the MN in a container called *ULInformationTransferMRDC* message as specified in TS 38.331 [4].
2. The MN initiates the RRC Transfer procedure, in which it transfers the received SN measurement report, failure information, SN UE assistance information, intra-SN CPC execution completion or IAB other information as an octet string.

MCG failure information and RRC Reconfiguration / RRC Release / inter-RAT handover command over SRB3:

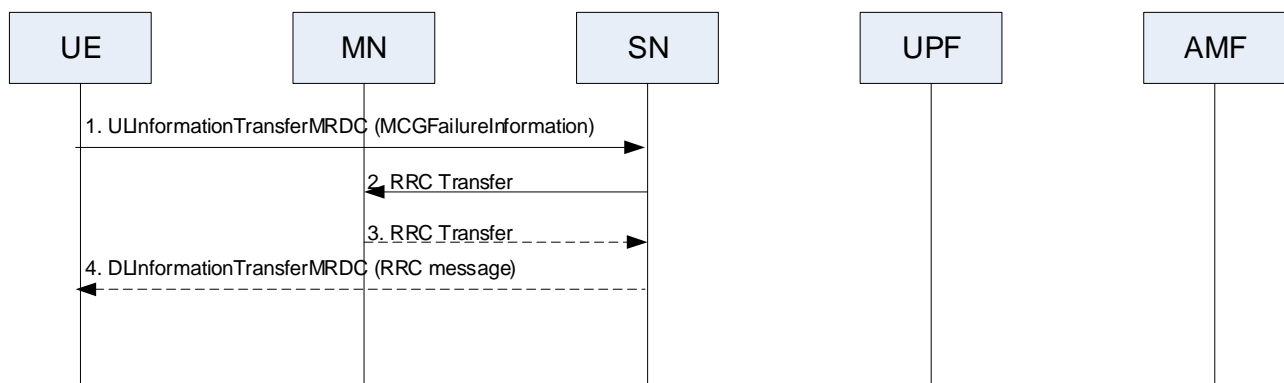

Figure 10.10.2-4: RRC Transfer procedure for MCG failure information

Figure 10.10.2-4 shows an example signaling flow for RRC Transfer in case of the forwarding of the MCG failure information from the UE:

1. When the UE sends *MCGFailureInformation* message over SRB3, it sends it to the SN in a container called *ULInformationTransferMRDC* message as specified in TS 38.331 [4].
2. The SN initiates the RRC Transfer procedure, in which it transfers the received *MCGFailureInformation* message as an octet string.
3. The MN initiates the RRC Transfer procedure, in which it transfers the *RRCCONNECTIONReconfiguration* message, or *RRCCONNECTIONReconfiguration* message, or *RRCCONNECTIONRelease* message, or *RRCCONNECTIONRelease* message, or *MOBILITYFromNRCommand* message, or *MOBILITYFromEUTRACommand* message as an octet string.
4. The SN sends the received RRC message to the UE in a container called *DLInformationTransferMRDC* message, as specified in TS 38.331 [4].

F1-C traffic transfer:

Figure 10.10.2-5: Scenario 2: F1-C Traffic Transfer procedure between IAB-MT and MN (F1-terminating node) in NR-DC

1. The IAB-MT sends a F1-AP message encapsulated in SCTP/IP or F1-C related (SCTP/)IP packet to the SN (non-F1-terminating IAB-donor) via split SRB2 in a container within *ULInformationTransfer* message encapsulated in a PDCP PDU as specified in TS 38.331 [4].
2. The SN initiates the RRC Transfer procedure, in which it transfers the received PDCP PDU (*ULInformationTransfer* message) including F1-AP message.
3. When the MN (F1-terminating IAB-donor) sends a F1-AP message encapsulated in SCTP/IP or F1-C related (SCTP/)IP packet, it starts the procedure by initiating the RRC Transfer procedure, if split SRB2 is determined to be used and usage of SCG path is determined. The MN sends the F1-AP message to the SN in a container within *DLInformationTransfer* message encapsulated in a PDCP PDU specified in TS 38.331 [4].
4. The SN forwards the encapsulated *DLInformationTransfer* message in a PDCP PDU as specified in TS 38.331 [4] to IAB-MT.

10.11 Secondary RAT data volume reporting

10.11.1 EN-DC

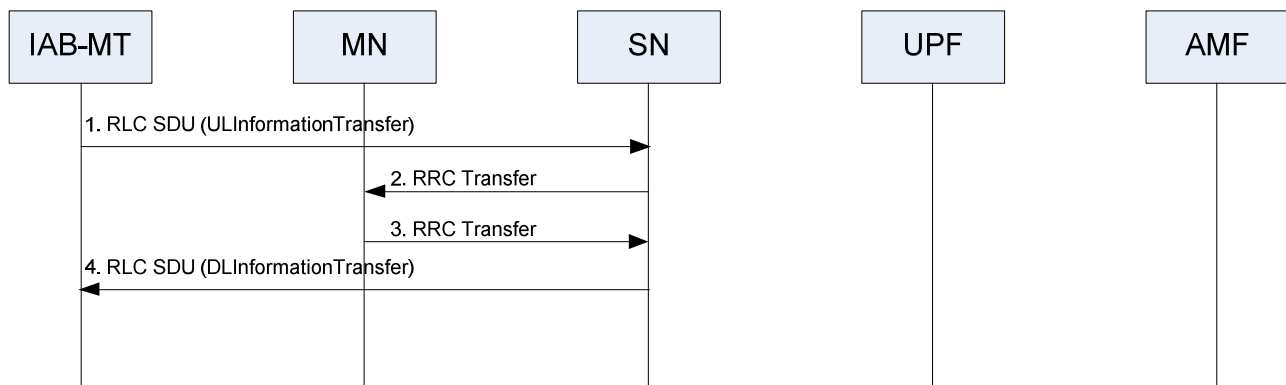
The secondary RAT data volume reporting function is used to report the data volume of secondary RAT to CN. In EN-DC, if configured, the MN reports the uplink and downlink data volumes of used NR resources to the EPC on a per EPS bearer basis as specified in TS 36.300 [2]. Periodic reporting is performed by periodically sending the *Secondary RAT Data Usage Report* messages to the MME.

The data volume is counted by the node hosting PDCP. Downlink data volume is counted in bytes of PDCP SDUs successfully delivered to the UE over NR (for RLC AM) or transmitted to the UE over NR (for RLC UM). Uplink data volume is counted in bytes of PDCP SDUs received by the node hosting PDCP over NR. Forwarded packets shall not be counted when PDCP entity is relocated. When PDCP duplication is activated, packets shall be counted only once.

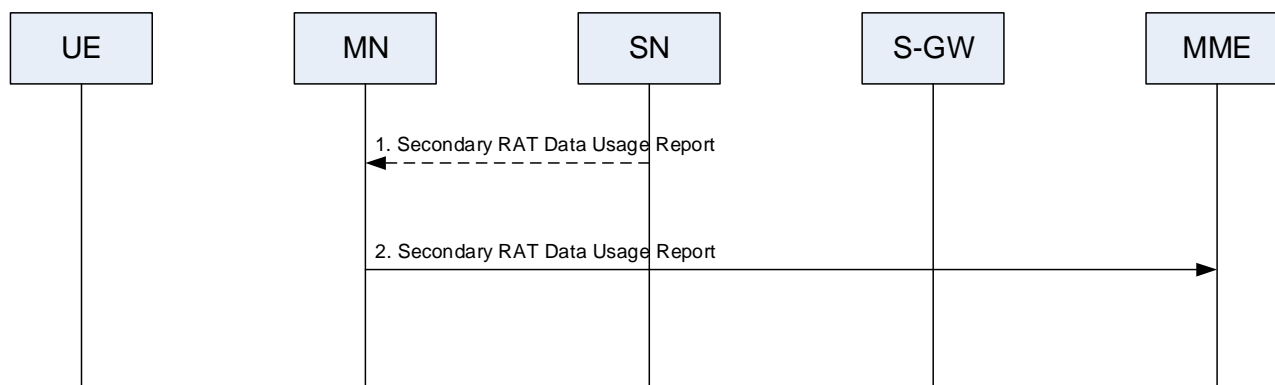

Figure 10.11.1-1: Secondary RAT data volume periodic reporting - EN-DC

Figure 10.11.1-1 shows an example signalling flow for secondary RAT data volume periodic reporting:

1. If the periodic reporting is configured, then the SN periodically sends the *Secondary RAT Data Usage Report* message to the MN and includes the data volumes of used NR radio resources for the related SN-terminated E-RABs.
2. The MN sends the *Secondary RAT Data Usage Report* message to MME to provide information on the used NR resource.

NOTE: The *Secondary RAT Data Usage Report* message sent by the MN may also include secondary RAT report information of MN-terminated bearers.

10.11.2 MR-DC with 5GC

The secondary RAT data volume reporting function is used to report the data volume of secondary RAT to the 5GC. In MR-DC with 5GC, if configured, the MN reports the uplink and downlink data volumes of used secondary RAT resources to the 5GC as specified in TS 23.501 [11]. Configuration for reporting of secondary RAT data volume may happen separately for NR and E-UTRA. Secondary RAT data volume reporting indicates the secondary RAT type. For each PDU session, it contains data volumes consumed for the whole PDU Session, or for selected QoS flow, or both. Periodic reporting is performed by periodically sending the *Secondary RAT Data Usage Report* messages to the 5GC.

The data volume is counted by the node hosting PDCP. Downlink data volume is counted in bytes of SDAP SDUs successfully delivered to the UE (for RLC AM) or transmitted to the UE (for RLC UM). Uplink data volume is counted in bytes of SDAP SDUs received by the node hosting PDCP. Forwarded packets shall not be counted when PDCP entity is relocated. When PDCP duplication is activated, packets shall be counted only once.

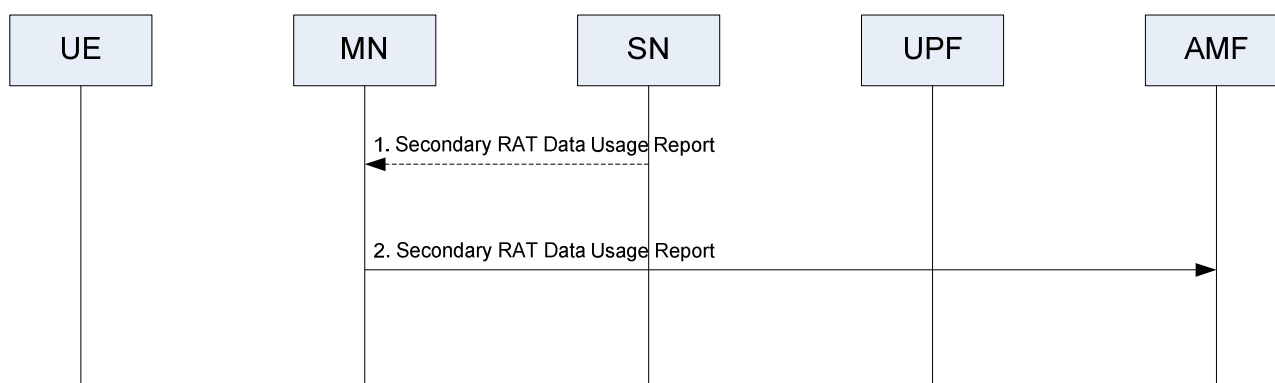

Figure 10.11.2-1: Secondary RAT data volume periodic reporting - MR-DC with 5GC

Figure 10.11.2-1 shows an example signalling flow for secondary RAT data volume periodic reporting:

1. For SN terminated bearers, the SN sends the *Secondary RAT Data Usage Report* message to the MN and includes the data volumes of used secondary RAT resources for PDU Sessions or selected QoS flows or both

mapped to SN-terminated bearers. If periodic reporting is configured, then the SN periodically sends the *Secondary RAT Data Usage Report* message to the MN and includes the data volumes of used radio resources.

2. The MN sends the *Secondary RAT Data Usage Report* message to the 5GC to provide information on the used radio resources.

NOTE: The *Secondary RAT Data Usage Report* message sent by the MN may also include secondary RAT data volumes of used secondary RAT resources for MN terminated bearers.

10.12 Activity Notification

10.12.1 EN-DC

The Activity Notification function is used to report user plane activity within SN resources. It can either report inactivity or resumption of activity after inactivity was reported. In EN-DC the Activity Reporting is provided from the SN only. The MN may take further actions.

EN-DC Activity Notification

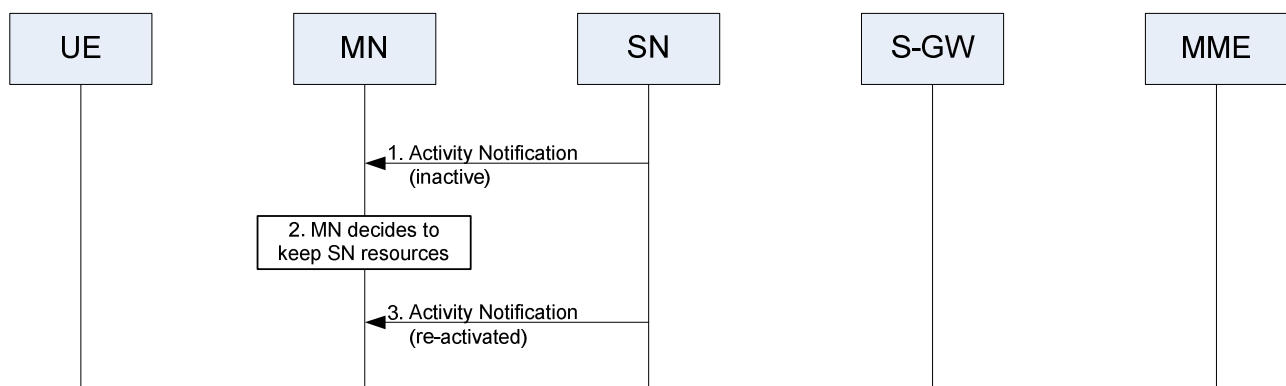

Figure 10.12.1-1: Support of Activity Notification in EN-DC

Support of Activity Notification in EN-DC is used to keep the MN informed about user traffic activity in resources owned by the SN. The MN may take appropriate action upon receiving such notification.

1. The SN informs the MN about user data inactivity of resources owned by the SN.
2. The MN decides to keep SN resources.
3. After a while the SN reports resumption of user plane activity.

EN-DC with suspended RRC connection – SCG configuration released in SN

The Activity Notification function may be used to enable EN-DC with suspended RRC connected operation. The MN node may decide, after inactivity is reported from the SN and also MN resources show no activity, to send the UE to suspended RRC connection. Resumption to RRC_CONNECTED may take place after activity is reported from the SN for SN terminated bearers.

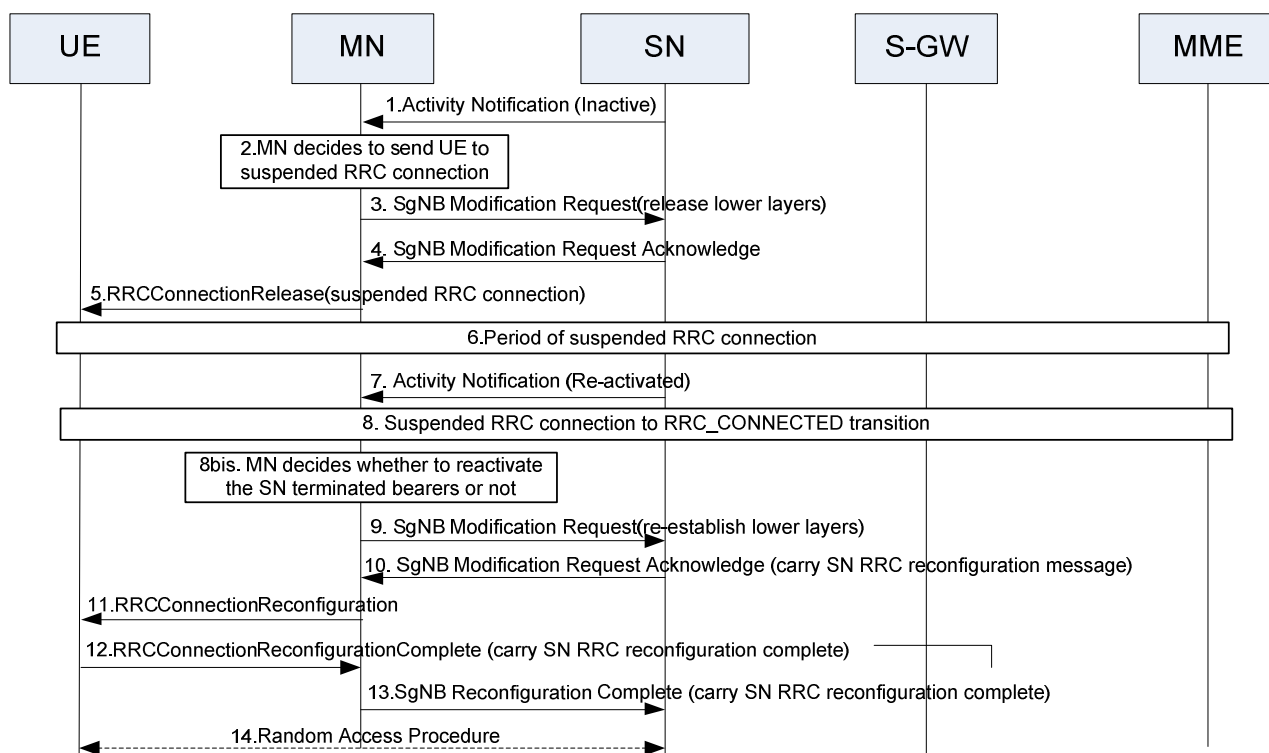

Figure 10.12.1-2: Support of Activity Notification in EN-DC with suspended RRC connection – SCG configuration released in SN

Figure 10.12.1-2 shows how Activity Notification function interacts with E-UTRAN functions for suspended RRC connection and SgNB Modification procedures in order to keep the higher layer EN-DC E-UTRAN resources established for UEs in suspended RRC connection, including S1 and X2 interface C-plane, U-plane and bearer contexts established while lower layer MCG and SCG resources are released. E-UTRAN memorises the cell group configuration for MCG in order to apply delta signalling at resume, as specified in TS 36.331 [4]. After the UE has transited successfully back to RRC_CONNECTED, lower layer SCG resources are established afterwards by means of RRC Connection Reconfiguration.

1. The SN notifies the MN about user data inactivity for SN terminated bearers.
2. The MN decides to send the UE to suspended RRC connection.
- 3/4. The MN triggers the MN initiated SgNB Modification procedure, requesting the SN to release lower layers.
5. The UE is sent to suspended RRC connection.
- 6-8. After a period of suspended RRC connection, upon activity notification from the SN, the UE returns to RRC_CONNECTED.
- 8bis. MN decides whether to reactivate the SN terminated bearers. If (e.g. due to UE mobility), MN decides not to reactivate the SN terminated bearers, it initiates the MN initiated SN release procedure and the procedure ends.
- 9/10. The MN triggers the MN initiated SgNB Modification procedure to re-establish lower layers. The SN provides configuration data within an SN RRC configuration message.
- 11-14. The RRC Connection Reconfiguration procedure commences.

EN-DC with suspended RRC connection - SCG configuration suspended in SN

The Activity Notification function may be used to enable EN-DC with suspended RRC connection operation. The MN node may decide, after inactivity is reported from the SN and also MN resources show no activity, to send the UE to suspended RRC connection, while keeping the SCG configuration. Resumption to RRC_CONNECTED may take place after activity is reported from the SN for SN terminated bearers.

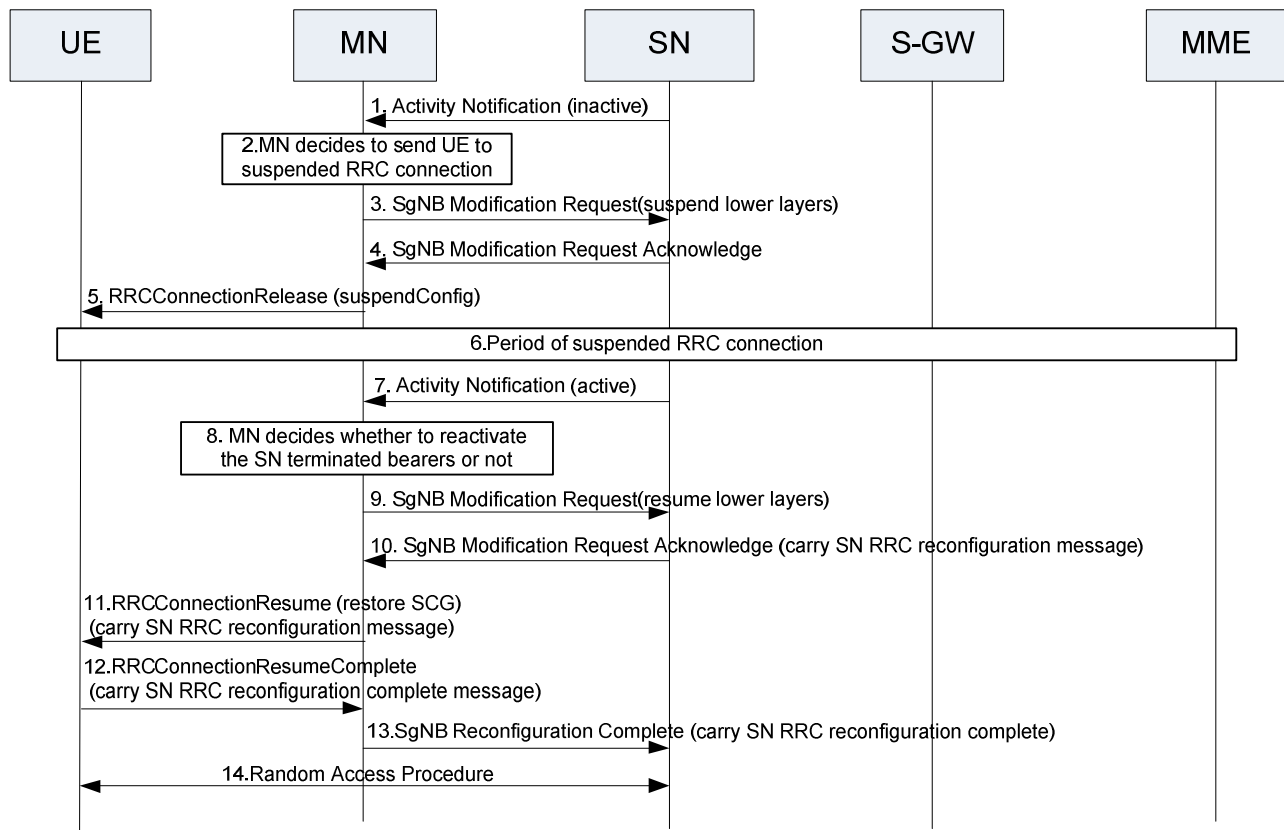

Figure 10.12.1-3: Support of Activity Notification in EN-DC with suspended RRC connection - SCG configuration suspended in SN

Figure 10.12.1-3 shows how Activity Notification function interacts with functions for suspended RRC connection and SgNB Modification procedures in order to keep the full EN-DC resources established for UEs in suspended RRC connection. When the UE transits successfully back to RRC_CONNECTED, lower layer MCG and SCG configurations are restored or reconfigured by means of RRC Connection Resume.

1. The SN notifies the MN about user data inactivity for SN terminated bearers.
2. The MN decides to send the UE to suspended RRC connection.
- 3/4. The MN triggers the MN initiated SN Modification procedure, requesting the SN to suspend lower layers.
5. The UE is sent to suspended RRC connection.
- 6-7. After a period of suspended RRC connection, the MN receives activity notification from the SN.
8. The MN decides whether to reactivate the SN terminated bearers. If (e.g. due to UE mobility), the MN decides not to reactivate the SN terminated bearers, it initiates the MN initiated SN release procedure, rather than the MN initiated SN modification procedure in steps 9/10. If the MN decides to return the UE to RRC_CONNECTED, the network triggered state transition from suspended RRC connection to RRC_CONNECTED commences.
- 9/10. The MN triggers the MN initiated SN Modification procedure to resume the SCG lower layers. If the SCG configuration needs to be updated, the SN provides the configuration data within an SN RRC configuration message.
- 11/12. The UE is instructed to resume both the MCG and the SCG. If the SCG configuration is to be updated, the new configuration is provided in the *RRCConnectionResume* message.
13. The MN informs the SN that the UE has completed the reconfiguration procedure successfully, via the *SgNB Reconfiguration Complete* message, including the SN RRC response message, if received from the UE.
14. The UE performs synchronisation towards the PSCell of the SN.

10.12.2 MR-DC with 5GC

The Activity Notification function is used to report user plane activity within SN resources or to report a RAN Paging Failure event to the SN. It can either report inactivity or resumption of activity after inactivity was reported. In MR-DC with 5GC the Activity Reporting is provided from the SN only. The MN may take further actions. RAN Paging Failure Reporting is provided from the MN only.

MR-DC with 5GC Activity Notification

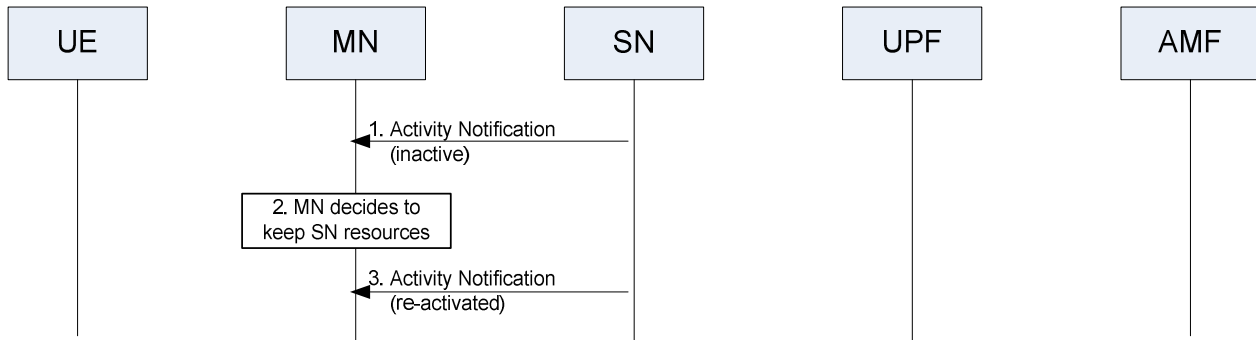

Figure 10.12.2-1: Support of Activity Notification in MR-DC with 5GC

1. The SN notifies the MN about user data inactivity.
2. The MN decides further actions that impact SN resources (e.g. send UE to RRC_INACTIVE, bearer reconfiguration). In the case shown, MN takes no action.
3. The SN notifies the MN that the (UE or PDU Session or QoS flow) is no longer inactive.

MR-DC with 5GC with RRC_INACTIVE – SCG configuration released in SN

The Activity Notification function may be used to enable MR-DC with 5GC with RRC_INACTIVE operation. The MN node may decide, after inactivity is reported from the SN and also MN resources show no activity, to send the UE to RRC_INACTIVE. Resumption to RRC_CONNECTED may take place after activity is reported from the SN for SN terminated bearers.

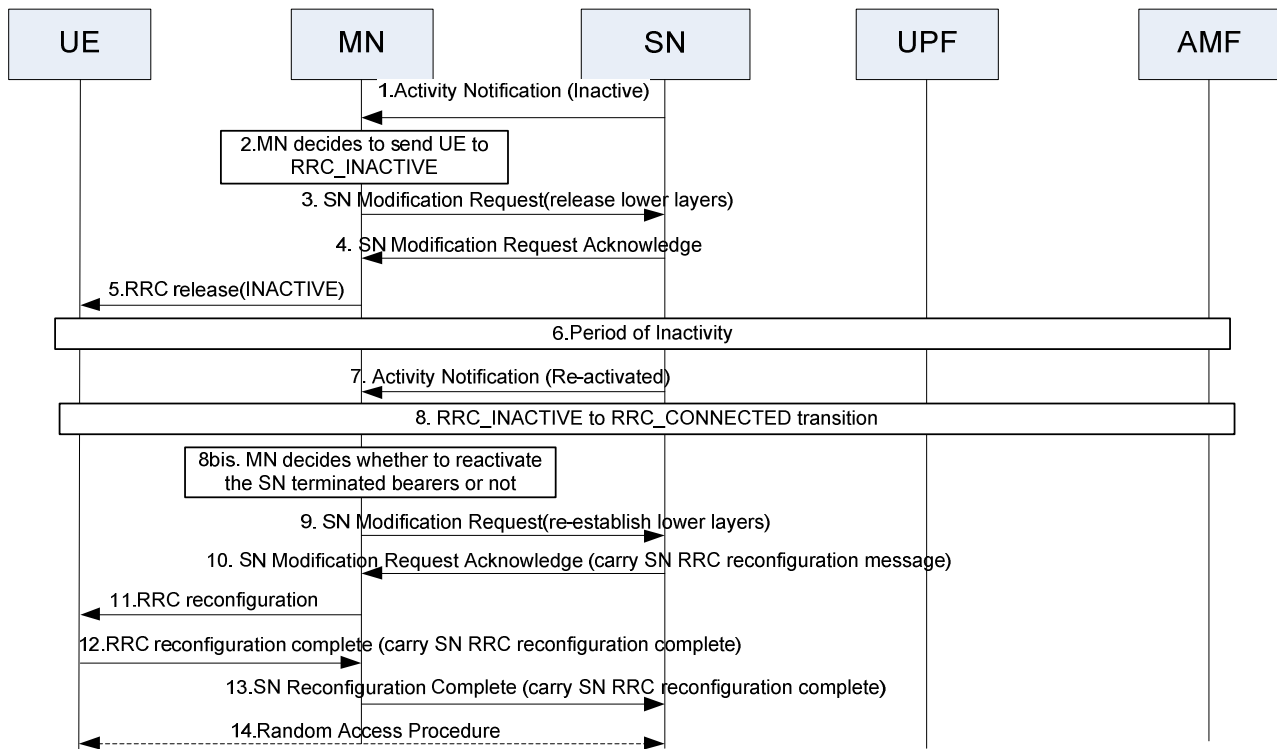

Figure 10.12.2-2: Support of Activity Notification in MR-DC with 5GC with RRC_Inactive – SCG configuration released in SN

Figure 10.12.2-2 shows how Activity Notification function interacts with NG-RAN functions for RRC_INACTIVE and SN Modification procedures in order to keep the higher layer MR-DC NG-RAN resources established for UEs in RRC_INACTIVE, including NG and Xn interface C-plane, U-plane and bearer contexts established while lower layer MCG and SCG resources are released. NG-RAN memorises the cell group configuration for MCG in order to apply delta signalling at resume, as specified in TS 38.331 [4]. After the UE has transited successfully back to RRC_CONNECTED, lower layer SCG resources are established afterwards by means of RRC Connection Reconfiguration.

1. The SN notifies the MN about user data inactivity for SN terminated bearers.
2. The MN decides to send the UE to RRC_INACTIVE.
- 3/4. The MN triggers the MN initiated SN Modification procedure, requesting the SN to release lower layers.
5. The UE is sent to RRC_INACTIVE.
- 6-8. After a period of inactivity, upon activity notification from the SN, the UE returns to RRC_CONNECTED.
- 8bis. MN decides whether to reactivate the SN terminated bearers. If (e.g. due to UE mobility), MN decides not to reactivate the SN terminated bearers, it initiates the MN initiated SN release procedure and the procedure ends.
- 9/10. The MN triggers the MN initiated SN Modification procedure to re-establish lower layers. The SN provides configuration data within an SN RRC reconfiguration message.
- 11-14. The RRC Connection Reconfiguration procedure commences.

MR-DC with 5GC with RRC_INACTIVE - SCG configuration suspended in SN

The Activity Notification function may be used to enable MR-DC with 5GC with RRC_INACTIVE operation. The MN node may decide, after inactivity is reported from the SN and also MN resources show no activity, to send the UE to RRC_INACTIVE, while keeping the SCG configuration. Resumption to RRC_CONNECTED may take place after activity is reported from the SN for SN terminated bearers.

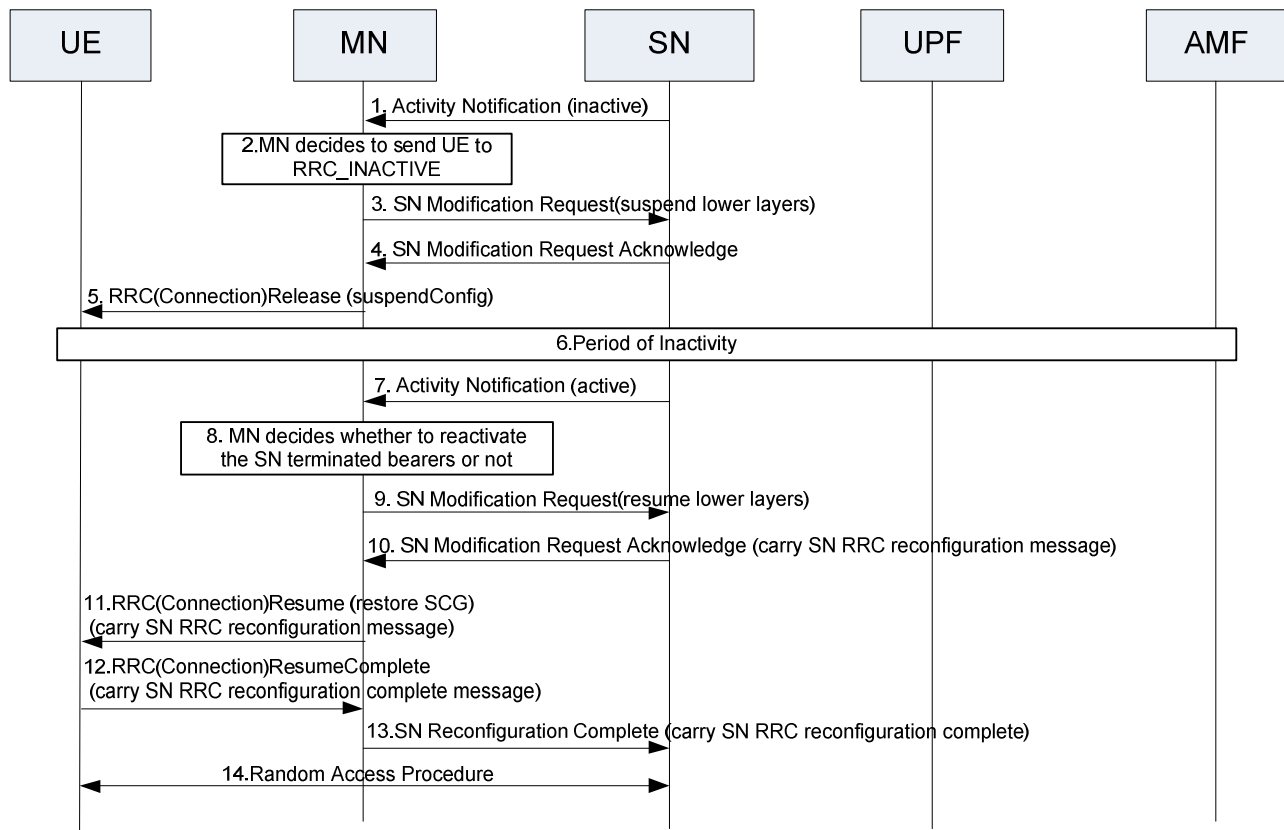

Figure 10.12.2-3: Support of Activity Notification in MR-DC with 5GC with RRC_Inactive - SCG configuration suspended in SN

Figure 10.12.2-3 shows how Activity Notification function interacts with NG-RAN functions for RRC_INACTIVE and SN Modification procedures in order to keep the full MR-DC NG-RAN resources established for UEs in RRC_INACTIVE. When the UE transits successfully back to RRC_CONNECTED, lower layer MCG and SCG configurations are restored or reconfigured by means of RRC (Connection) Resume.

1. The SN notifies the MN about user data inactivity for SN terminated bearers.
2. The MN decides to send the UE to RRC_INACTIVE.
- 3/4. The MN triggers the MN initiated SN Modification procedure, requesting the SN to suspend lower layers.
5. The UE is sent to RRC_INACTIVE.
- 6-7. After a period of inactivity, the MN receives activity notification from the SN.
8. The MN decides whether to reactivate the SN terminated bearers. If (e.g. due to UE mobility), the MN decides not to reactivate the SN terminated bearers, it initiates the MN initiated SN release procedure, rather than the MN initiated SN modification procedure in steps 9/10. If the MN decides to return the UE to RRC_CONNECTED, the network triggered state transition from RRC_INACTIVE to RRC_CONNECTED commences as described in clause 9.2.2.4.2 in TS 38.300 [3].
- 9/10. The MN triggers the MN initiated SN Modification procedure to resume the SCG lower layers. If the SCG configuration needs to be updated, the SN provides the configuration data within an SN RRC reconfiguration message.
- 11/12. The UE is instructed to resume both the MCG and the SCG. If the SCG configuration is to be updated, the new configuration is provided in the RRC(Connection)Resume message.
13. The MN informs the SN that the UE has completed the reconfiguration procedure successfully, via the *SN Reconfiguration Complete* message, including the SN RRC response message, if received from the UE.
14. The UE performs synchronisation towards the PSCell of the SN.

10.13 Notification Control Indication

10.13.1 EN-DC

Notification Control Indication procedure is not supported in EN-DC.

10.13.2 MR-DC with 5GC

The Notification Control Indication procedure may be initiated either by the MN or by the SN and is used to indicate that GFBR for one or several QoS flows cannot be fulfilled any more or can be fulfilled again by the reporting node.

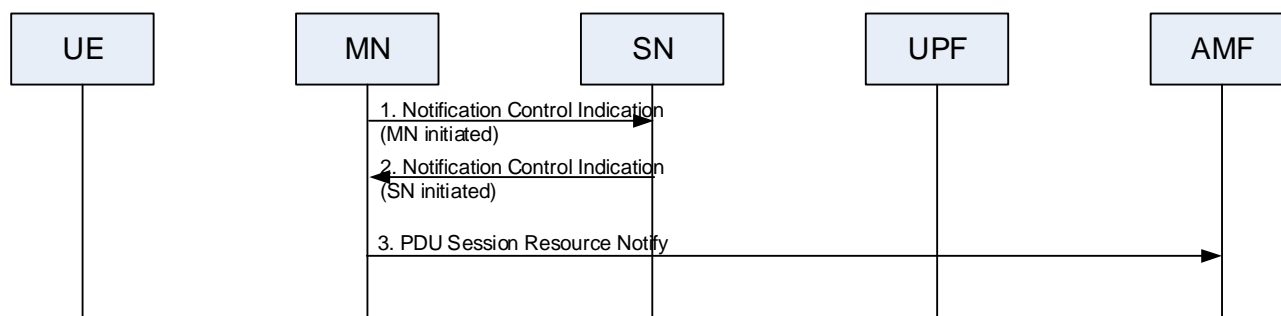

Figure 10.13.2-1: Notification Control Indication procedure

Figure 10.13.2-1 shows an example signalling flow for the Notification Control Indication procedure.

1. The MN may, for an SN terminated bearer, indicate, that the GFBR requested from the MN cannot be fulfilled anymore.
In case the SN terminated bearer is configured as a split bearer, the SN may decide to increase the share provided by the SN or it may decide to notify the MN that resources requested for the SN terminated bearer cannot fulfill the GFBR any more.
2. Continuing the example message flow from step 1, the SN informs the MN that the GFBR for an SN terminated bearer cannot be fulfilled any more.
3. The MN decides to inform the 5GC that NG-RAN cannot fulfill the GFBR for a GBR QoS flow any more.

10.14 PDU Session Split at UPF

10.14.1 PDU Session Split at UPF during PDU session resource setup

When a new PDU session needs to be established, the 5GC may provide two UL TEID addresses during PDU Session Resource Setup in order to allow for PDU session split. The MN may perform the SN Addition or the MN-initiated SN Modification procedure. If the MN decides to split the PDU session, the MN provides two DL TEID addresses and also the QoS flows associated with each tunnel.

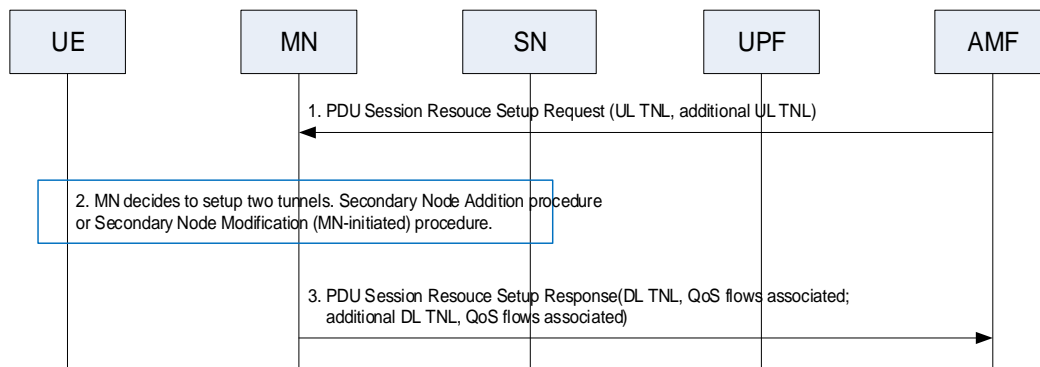

Figure 10.14.1-1: PDU Session Split at UPF during PDU session resource setup

1. The 5GC provides two UL TEID addresses during PDU Session Resource Setup, to be applied as the first UL tunnel on the NG-U interface and the additional NG-U tunnel in case the MN decides to split the PDU session.
2. The MN decides to setup two tunnels. The MN uses the SN Addition procedure (as described in 10.2.2) or the MN-initiated SN Modification procedure (as described in 10.3.2) up to step 6.
3. The MN provides a DL TEID address to be applied as the first and an additional DL tunnel address on the NG-U interface. The MN also provides which QoS flows are associated with which tunnel.

10.14.2 PDU Session Split at UPF during PDU session resource modify (5GC initiated)

The 5GC may provide an additional UL TEID address during PDU Session Resource Modify in order to allow the MN to split the PDU session. The MN may perform the SN Addition or the MN-initiated SN Modification procedure. If the MN decides to split the PDU session, the MN provides a DL TEID address to be applied as the additional DL tunnel address and the QoS flows associated with that tunnel.

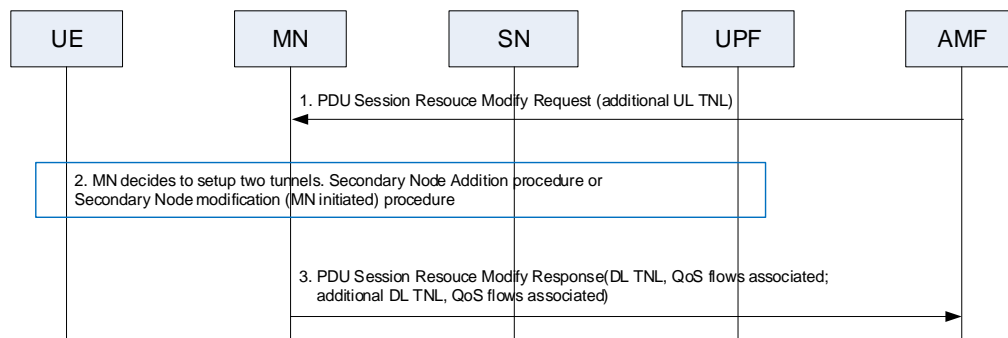

Figure 10.14.2-1: PDU Session Split at UPF during PDU session resource modify

1. The 5GC provides an additional UL TEID address during PDU Session Resource Modify, to be applied as the additional NG-U tunnel in case the MN decides to split the PDU session.
2. The MN decides to setup two tunnels. If the new tunnel is to be setup at the SN, the MN uses the SN Addition procedure (as described in 10.2.2) or the MN-initiated SN Modification procedure (as described in 10.3.2) up to step 6, or up to step 8 if a QoS flow is moved to the SN and data forwarding applies.
3. The MN provides a DL TEID address to be applied as the additional DL tunnel address on the NG-U interface and the QoS flows associated with that tunnel.

10.14.3 PDU Session Split at UPF (RAN initiated QoS flows offloading from MN to SN)

When some QoS flows are offloaded from the MN to the SN, the MN may decide to split the PDU session served by the MN into more than one NG-U tunnels. The MN sends the *SN Addition/Modification Request* message including UPF UL TEID address used at the MN. Later on, if the MN receives a new UL TEID in the *PDU Session Resource Modify Confirm* message, the MN may provide the new UL TEID to the SN.

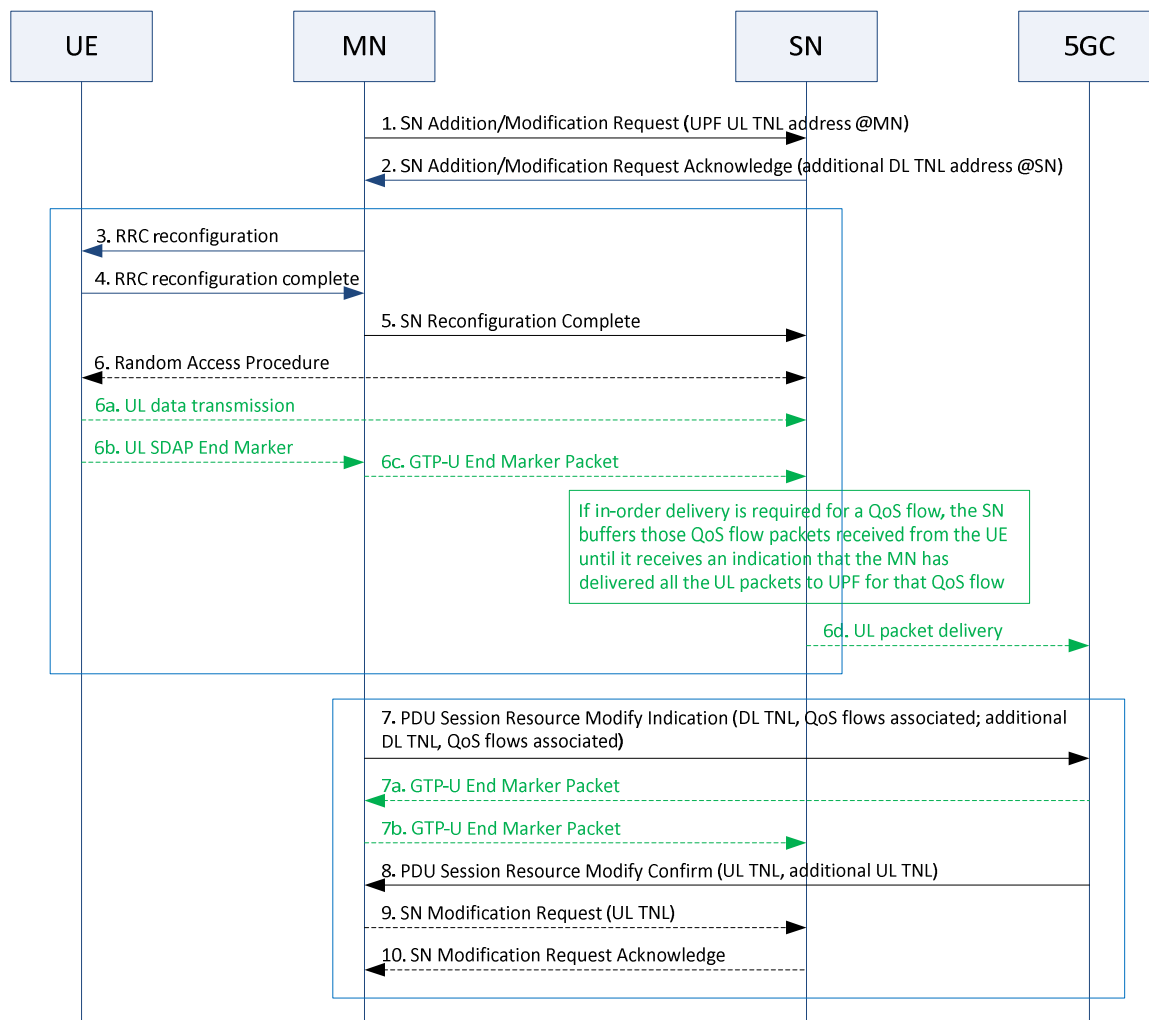

Figure 10.14.3-1: PDU Session Split at UPF during RAN initiated PDU session resource modify (QoS flows offloading from MN to SN)

- 1-2. If the MN decides to split a PDU session, it uses the SN Addition procedure or the MN-initiated SN Modification procedure, including current UPF UL NG-U tunnel used at the MN. If in-order delivery is required for some QoS flows, an UL forwarding tunnel may be set up for the PDU session at this stage.

NOTE 1: In case the MN offloads some QoS flows to the SN within a PDU session already split between the MN and the SN, the MN initiated SN Modification procedure is used.

- 3-6d. If in-order delivery is required, the SN buffers the first packets received from the UE for a certain QoS flow until it receives an GTP-U end marker packet over the UL forwarding tunnel indicating that the MN has delivered all UL packets from the source side to UPF for that QoS flow. Then the SN starts delivering UL packets to UPF for that QoS flow using the UPF UL TEID address used at the MN received at step 1.

- 7-8. The MN uses the *PDU Session Resource Modify Indication* message to inform 5GC that the PDU session is split into two tunnels and indicate which QoS flows are associated with which DL tunnel. The 5GC triggers the sending of DL End Marker packets without QFI tag at step 7a and confirms with the *PDU Session Resource Modify Confirm* message and allocates corresponding uplink tunnels.

After receiving the End Marker packet(s) from UPF at step 7a, the MN determines that the End Marker packets only work on the offloaded QoS flows, and may stop delivering and discard DL packets of the offloaded QoS flows, and the MN shall continue transmitting DL packets for the not offloaded QoS flows, if any.

7a./7b. After receiving the DL end marker from 5GC at step 7a, the MN may generate at step 7b DL End Marker packets without QFI tag towards the SN.

9-10. If the MN receives a new UL TEID in the *PDU Session Resource Modify Confirm* message for itself, the MN will use it to deliver UL packets to UPF. If the MN receives a new UL TEID for the SN, then the MN-initiated SN Modification procedure (i.e., step 9 and step 10) is used to provide the new UL TEID to the SN and then the SN switches to use the new UL TEID to deliver UL packets.

10.14.4 PDU Session Split at UPF (RAN initiates QoS flows offloading from SN to MN)

When some QoS flows are offloaded from the SN to the MN, the MN may decide to split the PDU session served by the SN into more than one NG-U tunnels. If the MN requests to offload, the MN sends the *SN Modification Request* message to the SN. In case the SN requests to offload, the SN sends the *SN Modification Required* message to the MN.

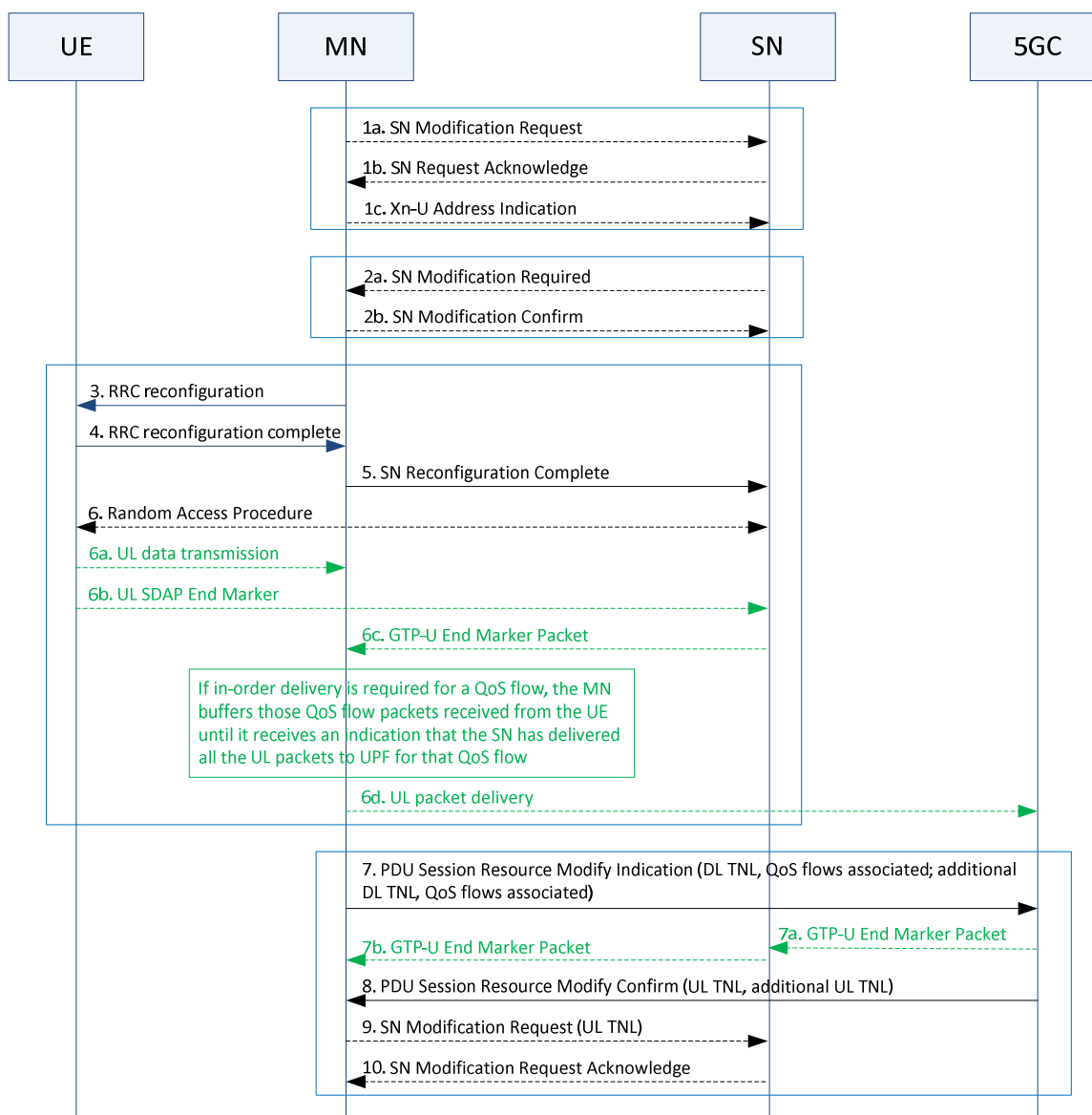

Figure 10.14.4-1: PDU Session Split at UPF during RAN initiated PDU session resource modify (QoS flows offloading from SN to MN)

1a-1c. When the MN requests to offload some QoS flows from the SN to the MN for a PDU session, it sends the *SN Modification Request* message. If in-order delivery is required for some of the QoS flows, an UL forwarding tunnel may be setup for the PDU session at this stage and the MN provides the UL forwarding tunnel address information in the *Xn-U Address Indication* message.

2a-2b. When the SN requests to offload some QoS flows to the MN for a PDU session, the SN sends the *SN Modification Required* message. If in-order delivery is required for some of the QoS flows, an UL forwarding tunnel may be setup for the PDU session at this stage and the MN provides the UL forwarding tunnel address information in the *SN Modification Confirm* message.

3-6d. If in-order delivery is required, the MN buffers the first packets received from the UE for a certain QoS flow until it receives a GTP-U end marker packet over the UL forwarding tunnel indicating that the SN has delivered all UL packets from the source side to UPF for that QoS flow.

7-8. The MN uses the *PDU Session Resource Modify Indication* message to inform 5GC that the PDU session is split into two tunnels and indicate which QoS flows are associated with which DL tunnel. The 5GC triggers the sending of DL End Marker packets without QFI tag at step 7a and confirms with the *PDU Session Resource Modify Confirm* message and allocates corresponding uplink tunnels.

After receiving the End Marker packet(s) from UPF at step 7a, the SN determines that the End Marker packets only work on the offloaded QoS flows, and may stop delivering and discard DL packets of the offloaded QoS flows, and the SN shall continue transmitting DL packets for the not offloaded QoS flows, if any.

7a./7b. After receiving the DL end marker from 5GC at step 7a, the SN may generate at step 7b DL End Marker packets without QFI tag towards the MN.

9-10. If the MN receives a new UL TEID in the *PDU Session Resource Modify Confirm* message for itself, the MN will use it to deliver UL packets to UPF. If the MN receives a new UL TEID for the SN, then the MN-initiated SN Modification procedure (i.e., the step 9 and step 10) is used to provide the new UL TEID to the SN and then the SN switches to use the new UL TEID to deliver UL packets.

10.15 F1-C Traffic Transfer

In EN-DC/NR-DC, the F1-C Traffic Transfer message is sent by the MN to the SN or by the SN to MN to transfer the F1-C traffic to and from an IAB-node.

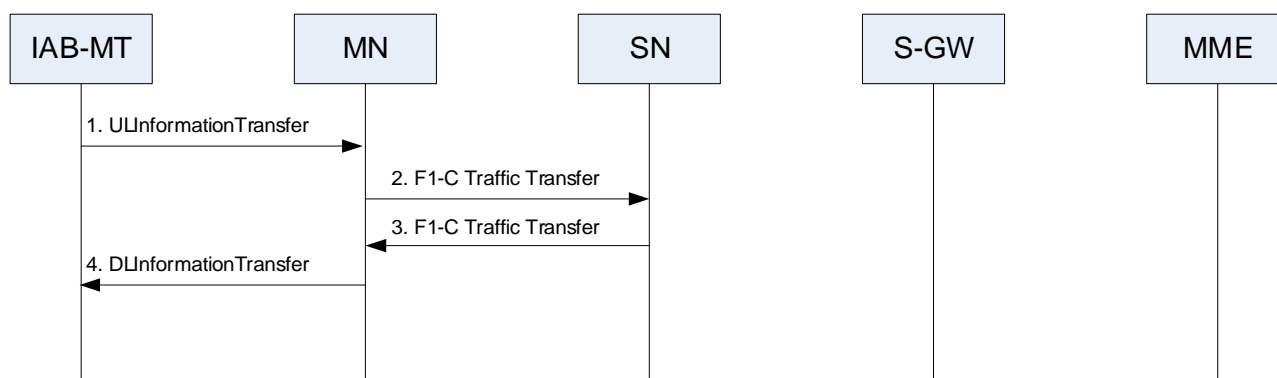

Figure 10.15-1: F1-C transfer procedure in EN-DC

1. When the IAB-MT sends a F1-AP message encapsulated in SCTP/IP or F1-C related (SCTP/IP) packet, it sends it to the MN in a container within *ULInformationTransfer* message as specified in TS 36.331 [10].
2. The MN initiates the F1-C Traffic Transfer procedure, in which it transfers the received F1-AP message encapsulated in (SCTP/IP) or F1-C related (SCTP/IP) packet as an octet string.
3. When the SN sends a F1-AP message encapsulated in SCTP/IP or F1-C related (SCTP/IP) packet, it sends it to the MN as an octet string through the F1-C Traffic Transfer procedure.
4. The MN sends the received F1-AP message encapsulated in SCTP/IP or F1-C related (SCTP/IP) packet to the IAB-MT in a container within *DLInformationTransfer* message as specified in TS 36.331 [10].

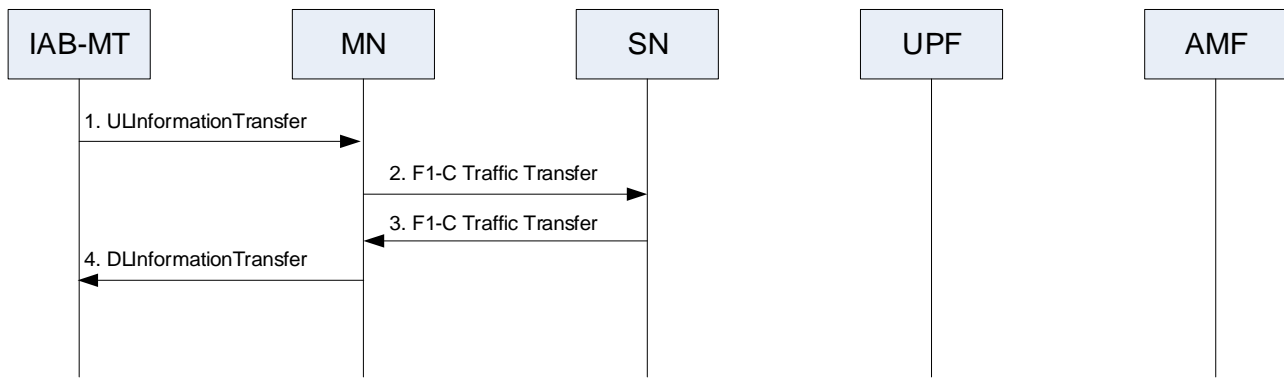

Figure 10.15-2: Scenario 1: F1-C transfer between IAB-MT and SN (F1-terminating node) in NR-DC

1. The IAB-MT sends a F1-AP message encapsulated in SCTP/IP or F1-C related (SCTP/IP) packet to the MN (non-F1-terminating node) via SRB2 in a container within *ULInformationTransfer* message as specified in TS 38.331 [4].
2. The MN initiates the F1-C Traffic Transfer procedure, in which it transfers the received F1-AP message encapsulated in (SCTP/IP) or F1-C related (SCTP/IP) packet as an octet string.
3. The SN (F1-terminating node) sends a F1-AP message encapsulated in SCTP/IP or F1-C related (SCTP/IP) packet to the MN as an octet string through the F1-C Traffic Transfer procedure.
4. The MN sends the received F1-AP message encapsulated in SCTP/IP or F1-C related (SCTP/IP) packet to the IAB-MT via SRB2 in a container within *DLInformationTransfer* message as specified in TS 38.331 [4].

10.16 Support of inter-system handover involving EN-DC or MR-DC with 5GC

10.16.1 General

Inter-system handover is specified in TS 23.501 [11] and TS 23.502 [20]. Data forwarding for inter-system handover is specified in TS 38.300 [3] and clause 8.4.

Inter-system Inter-Master node handover with/without SN change is not supported in this version of the protocol (e.g. no transition from EN-DC to NGEN-DC or NR-DC).

Inter-system HO from NR to E-UTRA with EN-DC configuration is supported in this version of the specification. N26 based inter-system HO will be executed between source RAN and gNB.

Inter-system HO from E-UTRA connected to 5GC to E-UTRA with EN-DC configuration is not supported. Inter-system HO from E-UTRA with EPC to MR-DC with 5GC is not supported.

Inter-system handover with source gNB and the target en-gNB or the source en-gNB and the target gNB being realised within the same network entity is supported in this version of the specification as described in clause 10.16.2 and clause 10.16.3.

10.16.2 Inter-system handover from EPS to 5GS with the Secondary Node used as target

Inter-system handover from EPS to 5GS with the Secondary Node used as target refers to a deployment scenario where the source en-gNB and the target gNB are realised within the same network entity.

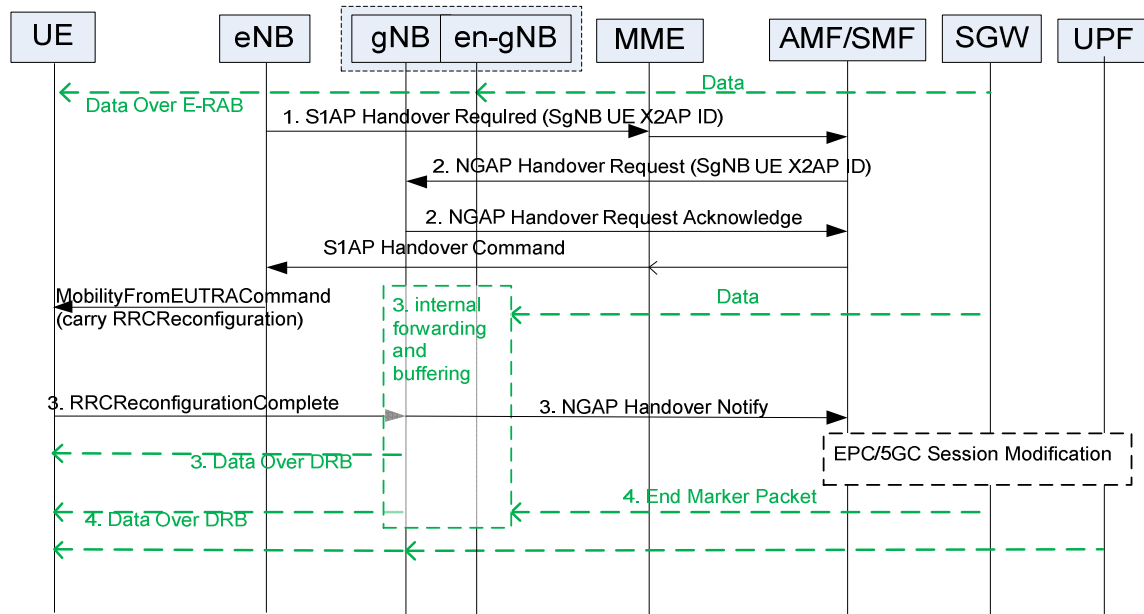

Figure 10.16.2-1: Inter-system handover from EPS to 5GS with the Secondary Node used as target

- Step 1: The (source) eNB, performing EN-DC with the (source) en-gNB triggers handover preparation including the SgNB UE X2AP ID within the Source NG-RAN to Target NG-RAN Transparent Container.
- Step 2: The target gNB infers from the received SgNB UE X2AP ID in the *Handover Request* message that direct data forwarding can be performed in a node-internal way.
- Step 3: DL UP data is forwarded in a node-internal way for the SN terminated bearers.
- Step 4: After the end marker has arrived from the SGW, the (target) gNB processes UP data from the UPF.

10.16.3 Inter-system handover from 5GS to EPS with the Source Node used as target Secondary Node

Inter-system handover from 5GS to EPS with the Source Node used as target Secondary Node refers to a deployment scenario where the source gNB and the target en-gNB are realised within the same network entity.

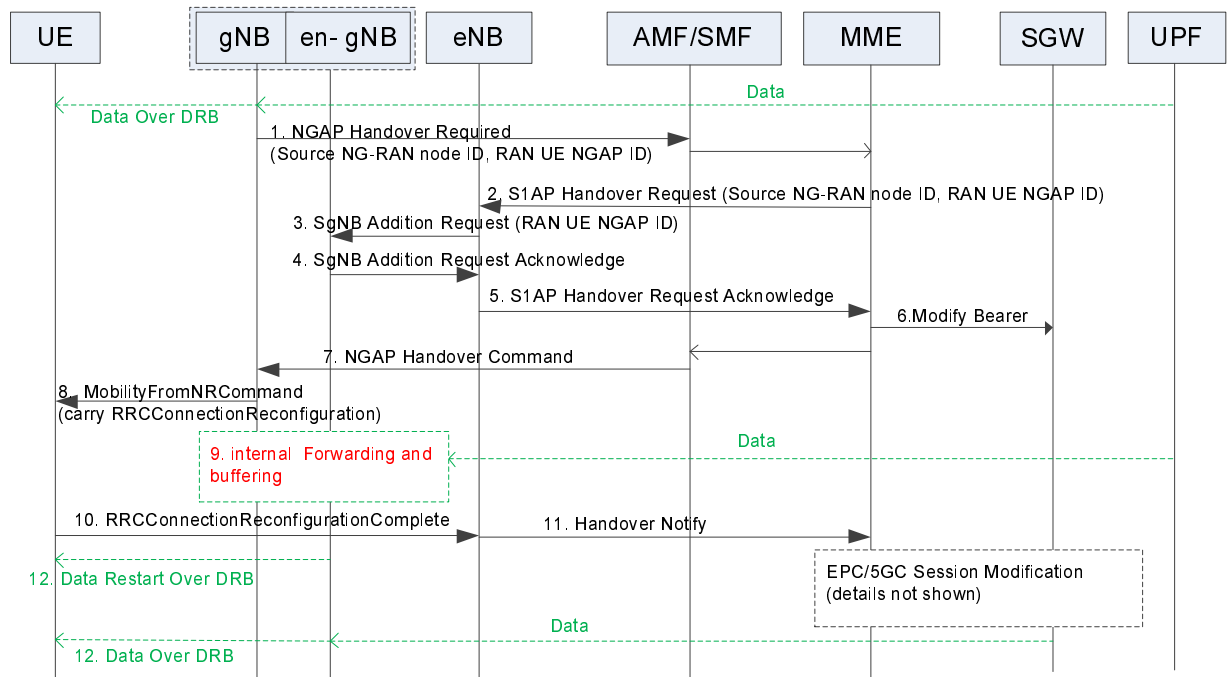

Figure 10.16.3-1: Inter-system handover from 5GS to EPS with the Source Node used as target Secondary Node

1. The (source) gNB triggers handover preparation phase including in the Source eNB to Target eNB Transparent Container the Source NG-RAN node ID and the RAN UE NGAP ID.
2. The target eNB receives the Source NG-RAN node ID and the RAN UE NGAP ID in the Source eNB to Target eNB Transparent Container.
- 3.-4. The X2AP SgNB Addition procedure is performed towards the (target) en-gNB indicated in the Source NG-RAN node ID received in step 2. The eNB includes the RAN UE NGAP ID received in step 2 in the X2 SgNB Addition Request message.
- 5.-8. Handover proceeds.
9. DL UP data is forwarded in a node-internal way for the SN terminated bearers.

10.17 Inter-Master Node RRC Resume without Secondary Node change

10.17.1 MR-DC with 5GC

Inter-MN RRC Resume without MN initiated SN change is used to transfer UE context data from a source MN to a target MN while the UE context at the SN is kept. During the procedure, the target MN may decide not to keep the SN.

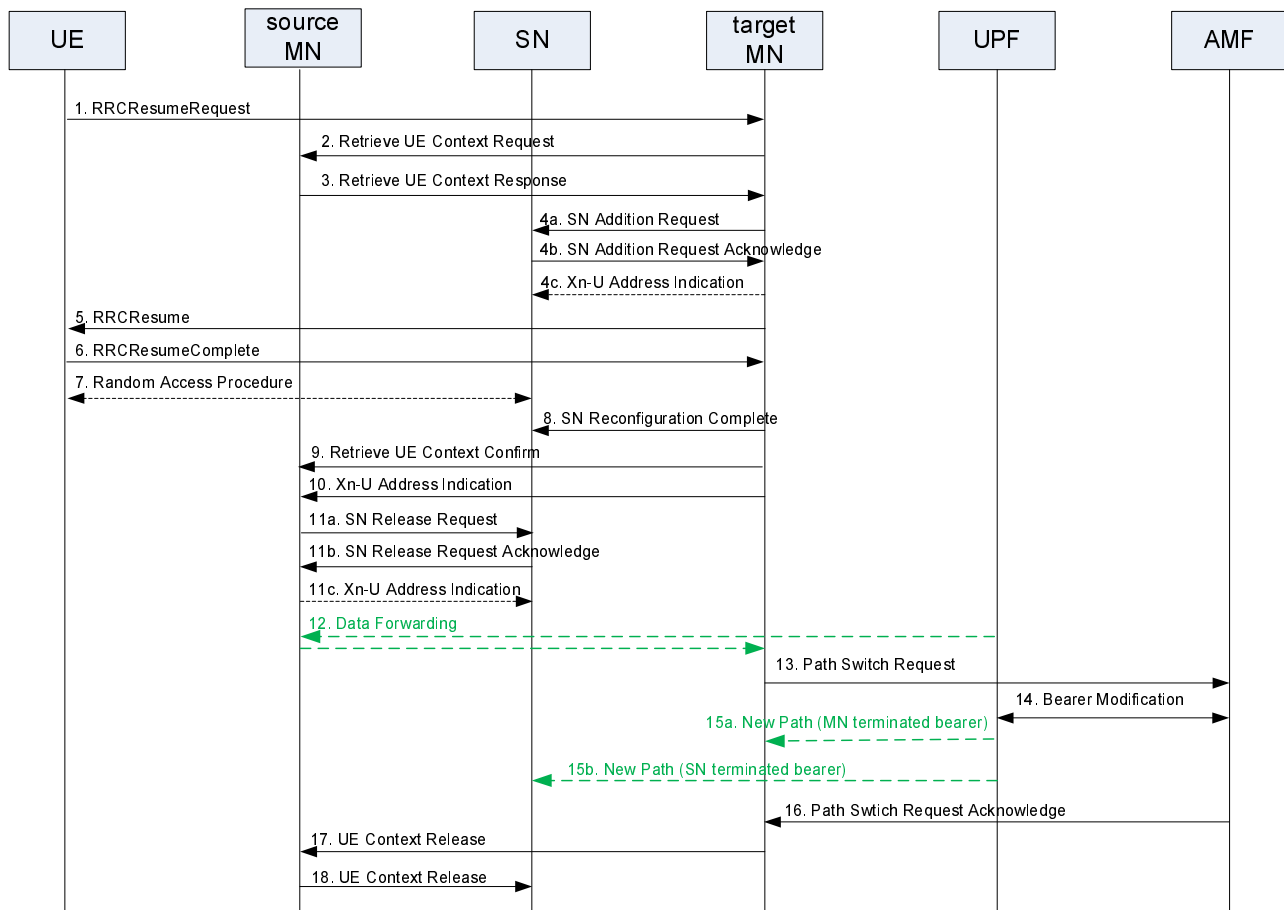

Figure 10.17.1-1: Inter-MN RRC Resume without MN initiated SN change procedure

Figure 10.17.1-1 shows an example signalling flow for inter-MN RRC Resume without MN initiated SN change:

1. The UE resumes from RRC_INACTIVE, providing the I-RNTI, allocated by the source MN, i.e., the last serving NG-RAN node.
2. The target MN, if able to resolve the NG-RAN node identity contained in the I-RNTI, requests the source MN to provide UE Context by initiating the Xn Retrieve UE Context procedure.
3. If the verification is successful, the source MN provides UE context data. The source MN includes the SN UE XnAP ID, SN ID and the UE context in the SN in the *Retrieve UE Context Response* message.

NOTE 1: The source MN may trigger the MN-initiated SN Modification procedure (to the SN) to retrieve the current SCG configuration and to allow provision of data forwarding related information before step 3.4a. If the target MN decides to keep the SN, the target MN sends *SN Addition Request* to the SN including the SN UE XnAP ID as a reference to the UE context in the SN that was established by the source MN.

4b. The SN replies with *SN Addition Request Acknowledge* message.

4c. For SN terminated bearers using MCG resources, the target MN provides Xn-U DL TNL address information in the *Xn-U Address Indication* message.

5/6. The target MN and UE complete the resumption of the RRC connection.

7. If configured with bearers requiring SCG radio resources, the UE synchronizes to the SN.

NOTE 2: The order the UE sends the *RRCResumeComplete* message towards the target MN (step 6) and performs the Random Access procedure towards the SN (step 7) is not defined.

8. If the RRC connection reconfiguration procedure was successful, the target MN informs the SN via *SN Reconfiguration Complete* message.

9. If the RRC connection reconfiguration procedure was successful, the target MN initiates the Xn Retrieve UE Context Confirm procedure and indicates to the source MN whether the UE context in the SN is kept or not.
 10. The Xn-U Address Indication procedure may be invoked by the target MN to provide forwarding address information if loss of DL user data buffered in the source side needs to be avoided.
 - 11a/11b. The source MN sends *SN Release Request* message to the SN including a Cause indicating MCG mobility. The SN acknowledges the release request. The source MN indicates to the SN that the UE context in the SN is kept, if it receives the indication from the target MN. If the indication as the UE context kept in the SN is included, the SN keeps the UE context.
 - 11c. If received in step 10, the source MN sends the *Xn-U Address Indication* message to the SN to transfer data forwarding information. More than one data forwarding addresses may be provided if the PDU session is split in the target side.
 12. If applicable, data forwarding takes place from the source side. If the SN is kept, data forwarding may be omitted for SN terminated bearers or QoS flows kept in the SN.
 - 13-16. The target MN initiates the Path Switch procedure. If the target MN includes multiple DL TEIDs for one PDU session in the *Path Switch Request* message, multiple UL TEID of the UPF for the PDU session should be included in the *Path Switch Ack* message in case there is TEID update in UPF.
- NOTE 3: If new UL TEIDs of the UPF for SN terminated bearers are included, the target MN performs MN initiated SN Modification procedure to provide them to the SN.
17. The target MN initiates the UE Context Release procedure towards the source MN.
 18. Upon reception of the *UE Context Release* message from source MN, the SN releases C-plane related resources associated to the UE context towards the source MN. Any ongoing data forwarding may continue. The SN shall not release the UE context associated with the target MN if the UE context kept indication was included in the *SN Release Request* message in step 11.

10.18 Self-optimisation for PSCell change

10.18.1 General

For analysis of PSCell change failure, the UE makes the SCG Failure Information available to the MN.

MN performs initial analysis to identify the node that caused the failure. The MN may use the SCG Failure Information Report procedure to verify whether intra-SN PSCell change has been triggered in the last serving SN and stores the SCG Failure Information for the time needed to receive possible response from the last serving SN. If the failure is caused by a source SN, the MN forwards then the SCG Failure Information to the source SN. The node responsible for the last PSCell change (the source SN, the last serving SN or the MN) performs the final root cause analysis.

10.18.2 PSCell change failure

One of the functions of self-optimization for PSCell change is to detect PSCell change failures that occur due to Too late PSCell change or Too early PSCell change, or Triggering PSCell change to wrong PSCell. These problems are defined as follows:

- Too late PSCell change: an SCG failure occurs after the UE has stayed for a long period of time in the PSCell; a suitable different PSCell is found based on the measurements reported from the UE.
- Too early PSCell change: an SCG failure occurs shortly after a successful PSCell change from a source PSCell to a target PSCell or a PSCell change failure occurs during the PSCell change procedure; source PSCell is still the suitable PSCell based on the measurements reported from the UE.
- Triggering PSCell change to wrong PSCell: an SCG failure occurs shortly after a successful PSCell change from a source PSCell to a target PSCell or a PSCell change failure occurs during the PSCell change procedure; a suitable PSCell different with source PSCell or target PSCell is found based on the measurements reported from the UE.

In the definition above, the "successful PSCell change" refers to the UE state, namely the successful completion of the RA procedure.

10.19 Conditional Handover with Secondary Node

10.19.1 EN-DC

The Conditional Handover with Secondary Node procedure is used for configuration and execution of CHO with SN. This procedure includes the cases where the SN is kept, changed or added. If the SN is kept, the UE context at the SN is kept. If the SN is changed, the UE context at the source SN is moved to the target SN.

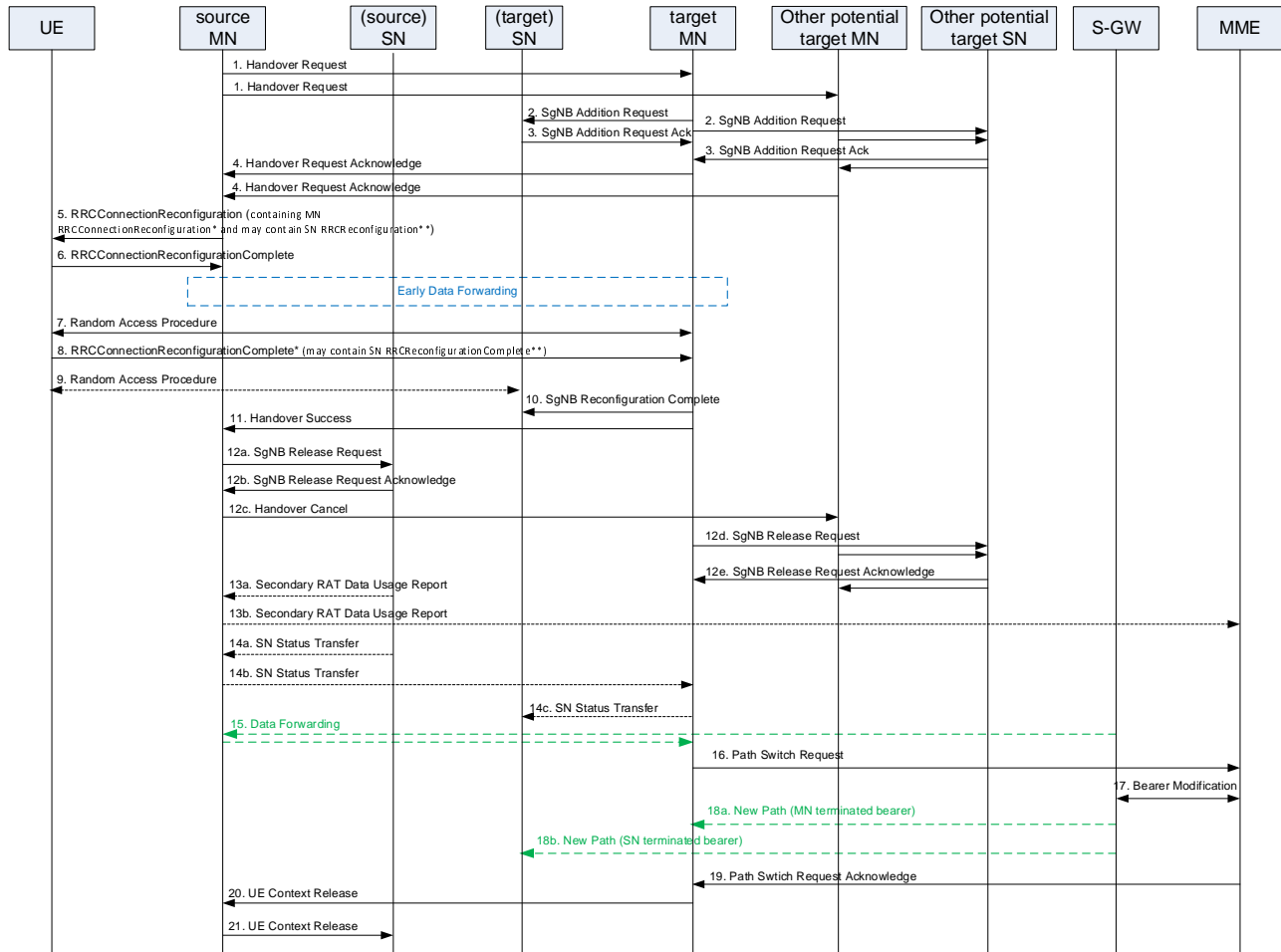

Figure 10.19.1-1: Conditional Handover with Secondary Node procedure

Figure 10.19.1-1 shows an example signaling flow for Conditional Handover with Secondary Node.

NOTE 1: For a CHO without SN change, the source SN and the target SN shown in Figure 10.19.1-1 are the same node.

NOTE 2: For a CHO with SN addition, the source SN and steps involved with the source SN in Figure 10.19.1-1 are ignored.

1. The source MN starts the conditional handover procedure by initiating the X2 Handover Preparation procedure including MCG configuration and, if the UE is configured with an SCG, SCG configuration. The source MN may include the (source) SN UE X2AP ID, SN ID, the UE context in the (source) SN and the Conditional Handover Information Request IE in the *Handover Request* message.

NOTE 3: In case of the CHO with/without SN change, the source MN may trigger the MN-initiated SN Modification procedure (to the source SN) to retrieve the current SCG configuration, if configured, before step 1.

2. If the candidate MN decides to keep the UE context in the SN, the candidate MN sends the *SgNB Addition Request* message to the SN including the SN UE X2AP ID as a reference to the UE context in the SN that was established by the source MN. If the candidate MN decides to change the SN allowing delta configuration, the candidate MN sends the *SgNB Addition Request* message to the candidate SN including the UE context in the source SN that was established by the source MN. Otherwise, the candidate MN may send the *SgNB Addition Request* message to the candidate SN including neither the SN UE X2AP ID nor the UE context in the source SN that was established by the source MN. Within the *SgNB Addition Request* message, the candidate MN also includes the CHO related information, i.e., CHO Information SN Addition IE.
3. The (candidate) SN replies with the *SN Addition Request Acknowledge* message. The (candidate) SN may include the indication of full or delta RRC configuration.

NOTE 4: In CHO with SCG configuration, it is up to the candidate MN implementation to make sure that the CG-Config provided from the (candidate) SN can be used in all CHO preparations.

4. The candidate MN includes within the *Handover Request Acknowledge* message a transparent container to be sent to the UE as an RRC message to perform the conditional handover, and may also provide forwarding addresses to the source MN. The candidate MN indicates to the source MN that the UE context in the SN is kept if the candidate MN and the SN decided to keep the UE context in the SN in step 2 and step 3.
5. The source MN sends an *RRCCConnectionReconfiguration* message to the UE, including the CHO configuration, i.e. a list of *RRCCConnectionReconfiguration** messages and associated execution conditions, in which each *RRCCConnectionReconfiguration** message contains an MCG configuration and possibly an SCG configuration in the *RRCCReconfiguration*** message received from the candidate SN in step 3.
6. The UE applies the *RRCCConnectionReconfiguration* message received in step 5, stores the CHO configuration and replies to the MN with an *RRCCConnectionReconfigurationComplete* message.

Editor's Note: FFS. It's up to RAN3 decision when to perform early data forwarding for SN-terminated bearers.

- 7/8. The UE maintains connection with the source MN and, if the UE is configured with a PSCell, with the source PSCell, after receiving CHO configuration, and starts evaluating the CHO execution condition for the candidate cell(s). If at least one CHO candidate cell satisfies the corresponding CHO execution condition, the UE detaches from the source MN, applies the stored corresponding configuration for that selected candidate cell, synchronises to that candidate cell and completes the RRC handover procedure by sending *RRCCConnectionReconfigurationComplete** message to the target MN. The UE releases stored CHO configurations after successful completion of RRC handover procedure.

NOTE 5: In case the target SN includes the indication of full RRC configuration, the MN performs release of the SN terminated radio bearer configuration and release and add of the NR SCG configuration part towards the UE.

9. If configured with bearers requiring SCG radio resources, the UE synchronizes to the (target) SN.

NOTE 6: The order the UE performs Random Access towards the MN (step 7) and performs the Random Access procedure towards the (target) SN (step 9) is not defined.

10. If the RRC connection reconfiguration procedure was successful, the target MN informs the (target) SN via *SgNB Reconfiguration Complete* message.
11. The target MN sends the *Handover Success* message to the source MN to inform that the UE has successfully accessed the target cell.
- 12a/b. The source MN sends *SgNB Release Request* message to the (source) SN including a Cause indicating MCG mobility and, if applicable, data forwarding information. The (source) SN acknowledges the release request. The source MN indicates to the (source) SN that the UE context in SN is kept, if it receives the indication from the target MN.
- 12c. The source MN sends the *Handover Cancel* message toward the other signalling connections or other candidate MNs, if any, to cancel CHO for the UE.

12d/e. The target MN or/and other candidate MN(s) sends the *SgNB Release Request* message(s) to other candidate SN(s), if configured. The other candidate SN(s) acknowledges the release request.

13a. The (source) SN sends the *Secondary RAT Data Usage Report* message to the source MN and includes the data volumes delivered to and received from the UE over the NR radio for the related E-RABs.

NOTE 7: The order the source SN sends the *Secondary RAT Data Usage Report* message and performs data forwarding with MN/target SN is not defined. The SgNB may send the report when the transmission of the related bearer is stopped.

13b. The source MN sends the *Secondary RAT Data Usage Report* message to MME to provide information on the used NR resource.

14. For bearers using RLC AM, the source MN sends the *SN Status Transfer* message, including, if needed, SN Status received from the source SN to the target MN. The target MN forwards the SN Status to the target SN, if needed.

15. If applicable, data forwarding takes place from the source side. If the SN is kept, data forwarding may be omitted for SN-terminated bearers kept in the SN.

16-19. The target MN initiates the S1 Path Switch procedure.

NOTE 8: If new UL TEIDs of the S-GW are included, the target MN performs the MN initiated SN Modification procedure to provide them to the SN.

20. The target MN initiates the UE Context Release procedure towards the source MN.

21. Upon reception of the *UE Context Release* message, the (source) SN releases C-plane related resources associated to the UE context towards the source MN. Any ongoing data forwarding may continue. The SN shall not release the UE context associated with the target MN if the UE context kept indication was included in the *SgNB Release Request* message in step 12a.

10.19.2 MR-DC with 5GC

The Conditional Handover with Secondary Node procedure is used for configuration and execution of CHO with SN. This procedure includes the cases where the SN is kept, changed or added. If the SN is kept, the UE context at the SN is kept. If the SN is changed, the UE context at the source SN is moved to the target SN.

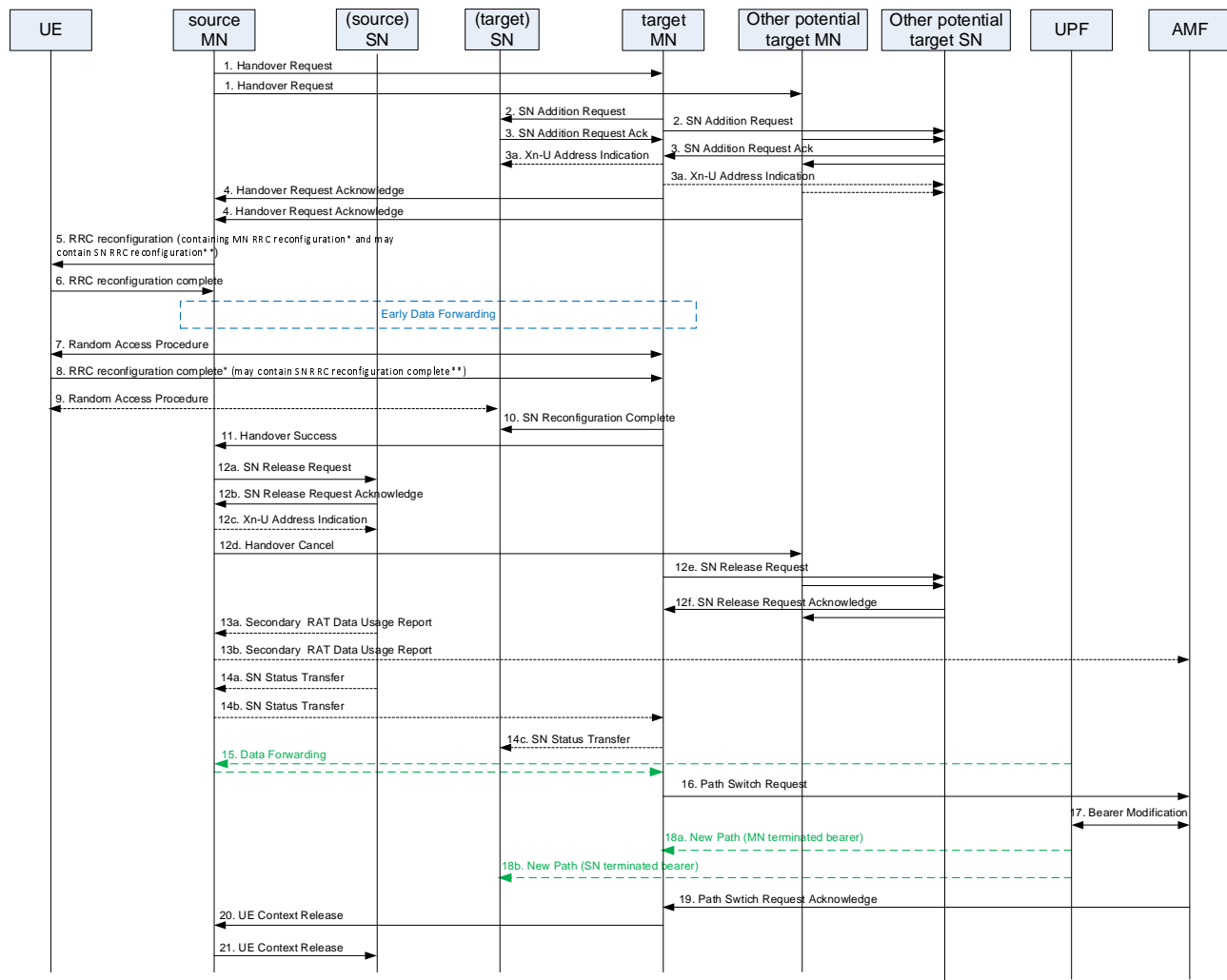

Figure 10.19.2-1: Conditional Handover with Secondary Node procedure

Figure 10.19.2-1 shows an example signaling flow for Conditional Handover with Secondary Node.

NOTE 1: For a CHO without SN change, the source SN and the target SN shown in Figure 10.19.2-1 are the same node.

NOTE 2: For a CHO with SN addition, the source SN and steps involved with the source SN in Figure 10.19.2-1 are ignored.

1. The source MN starts the conditional handover procedure by initiating the Xn Handover Preparation procedure including MCG configuration and, if the UE is configured with an SCG, SCG configuration. The source MN includes the (source) SN UE XnAP ID, SN ID, the UE context in the (source) SN and the Conditional Handover Information Request IE in the *Handover Request* message.

NOTE 3: In case of the CHO with/without SN change, the source MN may trigger the MN-initiated SN Modification procedure (to the source SN) to retrieve the current SCG configuration, if configured, before step 1.

2. If the candidate MN decides to keep the UE context in the SN, the candidate MN sends the *SN Addition Request* message to the SN including the SN UE XnAP ID as a reference to the UE context in the SN that was established by the source MN. If the candidate MN decides to change the SN allowing delta configuration, the candidate MN sends the *SN Addition Request* message to the candidate SN including the UE context in the source SN that was established by the source MN. Otherwise, the candidate MN may send the *SN Addition Request* message to the candidate SN including neither the SN UE XnAP ID nor the UE context in the source SN that was established by the source MN. Within the *SN Addition Request* message, the candidate MN also includes the CHO related information, i.e., CHO Information SN Addition IE.

3. The (candidate) SN replies with the *SN Addition Request Acknowledge* message. The (candidate) SN may include the indication of the full or delta RRC configuration.

NOTE 4: In CHO with SCG configuration, it is up to the candidate MN implementation to make sure that the CG-Config provided from the (candidate) SN can be used in all CHO preparations.

- 3a. For the SN terminated bearers using MCG resources, the candidate MN provides Xn-U DL TNL address information in the *Xn-U Address Indication* message.
4. The candidate MN includes within the *Handover Request Acknowledge* message the MN RRC reconfiguration message to be sent to the UE in order to perform the conditional handover, and may also provide forwarding addresses to the source MN. If PDU session split is performed in the target side during handover procedure, more than one data forwarding addresses corresponding to each node are included in the *Handover Request Acknowledge* message. The candidate MN indicates to the source MN that the UE context in the SN is kept if the candidate MN and the SN decided to keep the UE context in the SN in step 2 and step 3.
5. The source MN sends an RRC reconfiguration message to the UE, including the CHO configuration, i.e. a list of RRC reconfiguration* messages and associated execution conditions, in which each RRC reconfiguration* message contains an MCG configuration and possibly an SCG configuration in the RRC reconfiguration** message received from the candidate SN in step 3.
6. The UE applies the RRC reconfiguration message received in step 5, stores the CHO configuration and replies to the MN with an RRC reconfiguration complete message.

Editor's Note: FFS. It's up to RAN3 decision when to perform early data forwarding for SN-terminated bearers.

- 7/8. The UE maintains connection with the source MN and, if the UE is configured with a PSCell, with the source PSCell, after receiving CHO configuration, and starts evaluating the CHO execution condition for the candidate cell(s). If at least one CHO candidate cell satisfies the corresponding CHO execution condition, the UE detaches from the source MN, applies the stored corresponding configuration for that selected candidate cell, synchronises to that candidate cell and completes the RRC handover procedure by sending RRC reconfiguration complete* message to the target MN. The UE releases stored CHO configurations after successful completion of RRC handover procedure.

NOTE 5: In case the target SN includes the indication of the full RRC configuration, the MN performs release of the SN terminated radio bearer configuration and release and add of the NR SCG configuration part towards the UE.

9. If configured with bearers requiring SCG radio resources, the UE synchronizes to the (target) SN.

NOTE 6: The order the UE performs Random Access towards the MN (step 7) and performs the Random Access procedure towards the (target) SN (step 9) is not defined.

10. If the RRC connection reconfiguration procedure was successful, the target MN informs the (target) SN via *SN Reconfiguration Complete* message.
11. The target MN sends the *Handover Success* message to the source MN to inform that the UE has successfully accessed the target cell.
- 12a/b. The source MN sends *SN Release Request* message to the (source) SN including a Cause indicating MCG mobility. The (source) SN acknowledges the release request. The source MN indicates to the (source) SN that the UE context in SN is kept, if it receives the indication from the target MN.
- 12c. The source MN sends *XN-U Address Indication* message to the (source) SN to transfer data forwarding information. More than one data forwarding addresses may be provided if the PDU session is split in the target side.
- 12d. The source MN sends the *Handover Cancel* message toward the other signalling connections or other candidate MNs, if any, to cancel CHO for the UE.
- 12e/f. The target MN or/and other candidate MN(s) sends the *SN Release Request* message(s) to other candidate SN(s), if configured. The other candidate SN(s) acknowledges the release request.
- 13a. The (source) SN sends the *Secondary RAT Data Usage Report* message to the source MN and includes the data volumes delivered to and received from the UE over the NR/E-UTRA radio as described in clause 10.11.2.

NOTE 7: The order the source SN sends the *Secondary RAT Data Usage Report* message and performs data forwarding with MN/target SN is not defined. The SN may send the report when the transmission of the related QoS is stopped.

13b. The source MN sends the *Secondary RAT Data Usage Report* message to AMF to provide information on the used NR/E-UTRA resource.

14. For bearers using RLC AM, the source MN sends the *SN Status Transfer* message to the target MN, including, if needed, SN Status received from the source SN. The target MN forwards the SN Status to the target SN, if needed.

15. If applicable, data forwarding takes place from the source side. If the SN is kept, data forwarding may be omitted for the SN terminated bearers or QoS flows kept in the SN.

16-19. The target MN initiates the Path Switch procedure. If the target MN includes multiple DL TEIDs for one PDU session in the *Path Switch Request* message, multiple UL TEID of the UPF for the PDU session should be included in the *Path Switch Ack* message in case there is TEID update in UPF.

NOTE 8: If new UL TEIDs of the UPF for SN are included, the target MN performs MN initiated SN Modification procedure to provide them to the SN.

20. The target MN initiates the UE Context Release procedure towards the source MN.

21. Upon reception of the *UE Context Release* message from source MN, the (source) SN releases C-plane related resources associated to the UE context towards the source MN. Any ongoing data forwarding may continue. The SN shall not release the UE context associated with the target MN if the UE context kept indication was included in the *SN Release Request* message in step 12a.

11 Service related aspects

11.1 Roaming and Access Restrictions

The principles for conveying roaming and access restriction info for EN-DC are described in TS 36.300 [2].

For MR-DC with 5GC, SCG (re)selection at the SN is based on roaming and access restriction information in SN. If roaming and access restriction information is not available at the SN, the SN shall consider that there is no restriction for SCG (re)selection. Therefore, MN needs to convey the up-to-date roaming and access restriction information to SN via XnAP messages.

11.2 Support of Network Sharing

E-UTRAN and NG-RAN aspects of network sharing are specified in TS 36.300 [2] and TS 38.300 [3].

11.3 ARPI/SPID Handling from MN

Usage of the Subscriber Profile ID for RAT/Frequency Priority (SPID) and the Additional RRM Policy Index (ARPI) in E-UTRAN is specified in TS 36.300 [2] and applies to EN-DC. Therefore, the MN needs to convey the up-to-date ARPI/SPID information to the SN via X2AP messages.

12 X2/Xn Interface related aspects

Stage 2 specification for X2-C procedures for EN-DC is contained in TS 36.300 [2].

Xn-C procedures for MR-DC with 5GC are specified in TS 38.423 [5].

X2-U procedures for EN-DC and Xn-U procedures for MR-DC with 5GC are specified in TS 38.425 [6].

13 Other aspects

13.1 Interference avoidance for in-device coexistence

In-Device Coexistence (IDC) solution as described in TS 36.300 [2] is extended to address EN-DC operation. Only FDM solution, where the list of NR carriers suffering from IDC problems is signalled in IDC indication, is supported in this version of the specifications. The requirement on RRM/RLM/CSI measurements in different phases of IDC interference defined in TS 36.300 [2] is applicable except that for NR serving cell, the requirements in TS 38.133 [8] and TS 38.101-1 [12], TS 38.101-2 [13], TS 38.101-3 [14] apply.

13.2 Sidelink

NR Sidelink Communication, V2X Sidelink Communication and NR Sidelink Discovery cannot be configured in MR-DC in this release.

13.3 SCG UE history information

The MN stores and correlates the UE History Information from MN and SN(s) as long as the UE stays in MR-DC, forwards UE History Information and optional UE History Information from the UE to its connected SNs. The resulting information is then used by SN for dual-connectivity operation. The SN is in charge of collecting SCG UE history information and providing the collected information to the MN.

If the UE stays in a PSCell for a duration exceeding the maximum value of the Time Stay parameter, the SN may store the PSCell information with consecutive entries using the same PSCell identity. The total stay time in this PSCell is the sum of stay time for all consecutive PSCell with the same identity.

The SN shall provide the collected SCG UE history information, if available, to the MN in the following procedures:

- the SN Release, and SN initiated SN Change procedures
- the MN initiated SN Modification procedure if requested by the MN in this procedure
- the SN initiated SN modification procedure upon PSCell change if subscribed in the SN Addition procedure

When the target NG-RAN node receives the SCG UHI from the source NG-RAN node via Handover Request message for CHO, the target NG-RAN node updates the time UE stayed in cell of the latest PSCell entry (i.e. the source PSCell) when the UE successfully accesses to a candidate cell of the target NG-RAN node. The updated value of the time UE stayed in the source PSCell is equal to the value received from the source NG-RAN node during the Handover Preparation plus the time from receiving Handover Request message from the source NG-RAN node to receiving RRC Reconfiguration Complete message from the UE.

Annex A (informative): Layer 2 handling for bearer type change

This clause provides for information an overview on L2 handling for bearer type change in MR-DC, with and without a security key change due to a change of the termination point.

Table A-1: L2 handling for bearer type change with and without a security key change due to a change of the termination point.

Bearer type change from row to col	MCG		Split		SCG	
	no change of termination point (no key change)	change of termination point (key change)	no change of termination point (no key change)	change of termination point (key change)	no change of termination point (no key change)	change of termination point (key change)
MCG	N/A	PDCP: Re-establish MCG RLC: See Note 1 MCG MAC: See Note 1 SCG RLC: No action SCG MAC: No action	PDCP: Reconfigure MCG RLC: No action MCG MAC: No action SCG RLC: Establish SCG MAC: Reconfigure	PDCP: Re-establish MCG RLC: See Note 1 MCG MAC: See Note 1 SCG RLC: Establish SCG MAC: Reconfigure	PDCP: Recovery MCG RLC: See Note 3 MCG MAC: Reconfigure SCG RLC: Establish SCG MAC: Reconfigure	PDCP: Re-establish MCG RLC: See Note 3 MCG MAC: Reconfigure SCG RLC: Establish SCG MAC: Reconfigure
Split	PDCP: Recovery MCG RLC: No action MCG MAC: No action SCG RLC: See Note 4 SCG MAC: Reconfigure	PDCP: Re-establish MCG RLC: See Note 1 MCG MAC: See Note 1 SCG RLC: See Note 4 SCG MAC: Reconfigure	N/A	PDCP: Re-establish MCG RLC: See Note 1 MCG MAC: See Note 1 SCG RLC: See Note 1 SCG MAC: See Note 1	PDCP: Recovery MCG RLC: See Note 3 MCG MAC: Reconfigure SCG RLC: No action SCG MAC: No action	PDCP: Re-establish MCG RLC: See Note 3 MCG MAC: Reconfigure SCG RLC: See Note 1 SCG MAC: See Note 1
SCG	PDCP: Recovery MCG RLC: Establish MCG MAC: Reconfigure SCG RLC: See Note 4 SCG MAC: Reconfigure	PDCP: Re-establish MCG RLC: Establish MCG MAC: Reconfigure SCG RLC: See Note 4 SCG MAC: Reconfigure	PDCP: Reconfigure MCG RLC: Establish MCG MAC: Reconfigure SCG RLC: No action SCG MAC: No action	PDCP: Re-establish MCG RLC: Establish MCG MAC: Reconfigure SCG RLC: See Note 1 SCG MAC: See Note 1	N/A	PDCP: Re-establish MCG RLC: No action MCG MAC: No action SCG RLC: See Note 1 SCG MAC: See Note 1

NOTE 1: For EN-DC and NGEN-DC MCG, NE-DC SCG: the MAC/RLC behaviour depends on the solution selected by the network. It can be PCell handover (for EN-DC and NGEN-DC) or PSCell change (for NE-DC), which triggers MAC reset and RLC re-establishment. Alternatively, the logical channel identity can be changed, either via RLC bearer release and add for the same DRB (including RLC re-establishment), or via reconfiguration of the RLC bearer with RLC-re-establishment.

For EN-DC and NGEN-DC SCG, NE-DC MCG, NR-DC MCG and SCG: the MAC/RLC behaviour depends on the solution selected by the network. It can be reconfiguration with sync, with MAC reset and RLC re-establishment. Alternatively, the logical channel identity can be changed via RLC bearer release and add.

NOTE 2: Void

NOTE 3: For EN-DC and NGEN-DC: Re-establishment and release. For NE-DC and NR-DC: Release.

NOTE 4: For NE-DC: Re-establishment and release. For EN-DC, NGEN-DC and NR-DC: Release.

Annex B (informative): Supported MR-DC Handover Scenarios

Table B-1 summarizes the supported handover scenarios involving MR-DC configurations.

Table B-1: Supported MR-DC handover scenarios.

To (column) HO from (row)	E-UTRA with EPC	E-UTRA with 5GC	NR	GERAN or UTRAN	EN-DC	NGEN-DC	NE-DC	NR-DC
E-UTRA with EPC	YES	YES	YES	YES	YES	NO	NO	NO
E-UTRA with 5GC	YES	YES	YES	NO	NO	YES	NO	NO
NR	YES	YES	YES	NOTE 1	YES	NO	YES	YES
GERAN or UTRAN	YES	NO	NO	YES	NO	NO	NO	NO
EN-DC	YES	YES	YES	YES	YES	NO	NO	NO
NGEN-DC	YES	YES	YES	NO	NO	YES	NO	NO
NE-DC	YES	YES	YES	NOTE 1	NO	NO	YES	NO
NR-DC	YES	YES	YES	NOTE 1	NO	NO	NO	YES

NOTE 1: Only SRVCC handover of IMS voice bearer to UTRAN is supported.

NOTE 2: All handover scenarios according to Table B-1 that have a DC option in the column "from" are supported during fast MCG failure recovery.

NOTE 3: Only intra-RAT conditional handover is supported except for E-UTRA with 5GC scenario.

NOTE 4: DAPS handover is only supported from E-UTRA with EPC to E-UTRA with EPC and from NR to NR.

Annex C (informative): Change history

Change history							
Date	Meeting	Tdoc	CR	Rev	Cat	Subject/Comment	New version
2017.04	RAN2#9 7bis	R2-1703828	-	-	-	Draft Skeleton	0.0.1
2017.04	RAN2#9 7bis	R2-1703923	-	-	-	Endorsed Skeleton	0.0.2
2017.05	RAN2#9 8	R2-1704898	-	-	-	Initial version, including: Agreements from TR38.912 Agreements from RAN2#97bis on: - System information handling - Measurements - UE capability coordination - Handling of combined MN/SN RRC messages - SCG SRB - MCG split SRB - SN/MN Failure handling - QoS aspects - Bearer type configuration - Security aspects	0.1.0
2017.06	RAN2 NR AdHoc2	R2-1706418	-	-	-	Agreements from RAN3#96 on: - Network interfaces - Initial EN-DC operation related aspects - UP related aspects Agreements from RAN2#98 on: - Measurement coordination - UE capability coordination - SCG SRB Further RAN2 agreements on EN-DC operation related aspects	0.1.1
2017.06	RAN2 NR AdHoc2	R2-1707467	-	-	-	Endorsed version at RAN2 NR AH2, also including: Initial description of procedures for MR-DC with 5GC Correction to SN initiated SN change procedure for EN-DC	0.2.0
2017.08	RAN2#9 9	R2-1708080	-	-	-	Agreements from RAN3 NR AH2 on: - Data forwarding for SCG split bearer - Path Update procedure Agreements from RAN2 NR AH2 on: - Bearer type harmonization / bearer type change - UE capability coordination - SRB3 (SCG SRB) - MCG Split SRB - SN failure handling - Security handling - SN Addition procedure - MN initiated SN Modification/Release procedures Miscellaneous corrections	0.2.1
2017.08	RAN2#9 9	R2-1709831	-	-	-	Endorsed version at RAN2#99	0.3.0
2017.08	RAN2#9 9	R2-1709939	-	-	-	Agreements from RAN2#99 on: - Bearer type harmonization / bearer type change - SN failure handling - Measurement result exchange - Security aspects - Embedded RRC transport - Other MR-DC procedures related aspects RAN3 endorsed TPs on miscellaneous corrections to MR-DC procedures (in R3-173187, R3-173380, R3-173381, R3-173384, R3-173386, R3-173388 and R3-173390),	0.4.0
2017.09	RAN#77	RP-171872	-	-	-	Provided for information to RAN	1.0.0
2017.09	RAN#77	RP-172036	-	-	-	Correction of some auto-formatting issues	1.0.1
2017.09	RAN2#9 9bis	R2-1711526	-	-	-	Alignment to the agreed terminology for the different nodes: - introduction of the en-gNB term - replacement of MeNB and SgNB with MN and SN Clarification on UE capabilities coordination Clarification in Figure 4.2.2-2 that there is one SDAP entity per cell group	1.0.2
2017.10	RAN2#9 9bis	R2-1711937	-	-	-	Endorsed version at RAN2#99bis	1.1.0
2017.10	RAN2#9	R2-1712072	-	-	-	Agreements from RAN2#99bis on:	1.1.1

	9bis					<ul style="list-style-type: none"> - Bearer type harmonization / bearer type change - SCG change and Pscell change - MN/SN measurement coordination - UE capabilities coordination - MR-DC procedures related aspects - Security aspects Agreed Text Proposals in: <ul style="list-style-type: none"> - R2-1711929 TP on SN modification without MN involvement - R2-1711942 TP on inter-MN HO with SN change Agreements from RAN3#97bis in R3-174254, collecting changes from: <ul style="list-style-type: none"> - R3-174214 Text Proposal for QoS Handling in 5GC DC - R3-174132 Completion of the RRC tunnelling in MR-DC - R3-174136 Stage 2 TP on bearer type change without MAC reset - R3-174221 TP for Supporting MN Initiate SN Change - R3-174194 UE-AMBR enforcement - R3-174234 Secondary RAT data volume reporting - R3-174160 MN and SN role for QoS flow to DRB mapping - R3-174101 Clean-up of 37.340 RAN3 Related Part 	
2017.11	RAN2#100	R2-1712301	-	-	-	Clean version	1.2.0
2017.11	RAN2#100	R2-1712302	-	-	-	MR-DC related agreements moved from TS 38.300: <ul style="list-style-type: none"> - on two C-RNTIs independently allocated at the UE - on RLF declared separately for the MCG and for the SCG - on roaming and access restrictions for MR-DC with 5GC - on SPS and BSR configuration, triggering and reporting Addition of a note on support of ideal backhaul. Clarification on use of SRB3. Clarification on security key handling. Editorial corrections in various Figures Removal of FFSs for MR-DC with 5GC (moved to a separate list)	1.2.1
2017.12	RAN2#100	R2-1714080	-	-	-	Agreed Text Proposals in: <ul style="list-style-type: none"> - R2-1713141 TP on 37.340 - R2-1713838 Bearer type change with PDPC version change - R2-1714176 PSCell change clarification and SCG Change removal - R2-1714183 Stage 2 TP to update bearer type description - R2-1714237 Clarification for the MR-DC QoS framework - R3-174308 Cleanup of reference/definitions for 37.340 - R3-174565 TP for SCG Change related to Bearer Type Change - R3-174661 TP for querying SCGconfig for MN to eNB/gNB Change - R3-174763 TP for a unified 5G User Plane protocol - R3-174876 Further Clean-up of TS37.340 RAN3 Related Part - R3-174913 Clarifications on Inter-MN handover with SN change - R3-174916 Clarification on the interface between gNB for Option 3 - R3-174917 Tunnel ID switching in case of reconfiguration - R3-174921 Introducing bearer harmonization – RAN3 parts - R3-174923 On security related IE in MN initiated SN modification - R3-174928 TP on UE-AMBR for EN-DC - R3-174930 Stage 2 for secondary RAT data volume reporting - R3-175009 Removing data forwarding from corresponding node - R3-175048 Stage 2 TP for bearer type change - R3-174975 Race conditions in case of SN release Other miscellaneous agreements from RAN2#100 	1.2.2
2017.12	RAN2#100	R2-1714251	-	-	-	RAN2 agreed version	1.3.0
2017.12	RP-78	RP-172464	-	-	-	Provided for approval to RAN	2.0.0
2017/12	RP-78					Upgraded to Rel-15	15.0.0
2018/03	RP-79	RP-180440	0004	1	F	Miscellaneous corrections	15.1.0
	RP-79	RP-180440	0008	1	F	Baseline CR for TS 37.340 (RAN3 part) covering agreements of RAN3 #NR adhoc 1801 and RAN3 #99	15.1.0
2018/06	RP-80	RP-181214	0012	2	F	Further miscellaneous corrections	15.2.0
	RP-80	RP-181214	0014	1	F	CR on EN-DC bearer type changes in TS 37.340	15.2.0
	RP-80	RP-181214	0015	1	F	CR on EN-DC reconfiguration procedure via SRB3 in TS 37.340	15.2.0
	RP-80	RP-181214	0017	-	F	Radio Protocol Architecture figure clarification with SDAP	15.2.0
	RP-80	RP-181215	0018	1	F	Stage 2 CR on combined bearer type and termination point change	15.2.0
	RP-80	RP-181215	0021	1	F	Correction to TS 37.340 on PDPC version for SRB	15.2.0
	RP-80	RP-181215	0024	1	F	L2 handling for bearer type change when PDPC SN length changed	15.2.0
	RP-80	RP-181215	0025	1	F	Correction on SN configured NR measurements after SCG failure	15.2.0
	RP-80	RP-181215	0026	1	F	Clarification of the usage of SN Status Transfer	15.2.0
	RP-80	RP-181215	0027	-	F	Addition of the full config indicator in SN Change	15.2.0
	RP-80	RP-181216	0028	2	F	Coordination of Inactivity for EN-DC	15.2.0
	RP-80	RP-181216	0029	-	F	CR on maintaining the bearer type on wrap-around for TS37.340	15.2.0
	RP-80	RP-181216	0030	2	F	Enabling re-use of NR PCIs in cells served by the same SN in EN-DC	15.2.0
2018/09	RP-81	RP-181939	0037	2	F	Clarification on number of CC for NR CA	15.3.0
	RP-81	RP-181942	0039	2	F	CR for 37.340 for CA duplication of LTE bearer	15.3.0
	RP-81	RP-181942	0042	-	F	Capturing the agreement related to Count wrap around handling for	15.3.0

						split bearer type	
	RP-81	RP-181941	0043	1	F	Miscellaneous clarifications	15.3.0
	RP-81	RP-181941	0044	1	F	Inclusion of measurement gap related agreements	15.3.0
	RP-81	RP-181942	0046	2	F	Small correction about bear type change	15.3.0
	RP-81	RP-181942	0047	3	F	CR to 37.340 on the Layer 2 handling for bearer type change	15.3.0
	RP-81	RP-181939	0048	-	F	CR on the support of RLC mode reconfiguration	15.3.0
	RP-81	RP-181939	0051	-	F	Corrections on 37.340 for bearer type change support	15.3.0
	RP-81	RP-181941	0054	1	F	NR Corrections (37.340 Baseline CR covering RAN3-101 agreements)	15.3.0
2018/12	RP-82	RP-182650	0067	1	F	Split SRB UL configuration	15.4.0
	RP-82	RP-182656	0071	1	F	Miscellaneous clarifications	15.4.0
	RP-82	RP-182669	0073	4	B	Agreements for MR-DC	15.4.0
	RP-82	RP-182651	0079	-	F	Correction for SN terminated MCG bearer	15.4.0
	RP-82	RP-182667	0082	3	F	Updates to UE capability coordination for MR-DC	15.4.0
	RP-82	RP-182664	0084	2	F	Corrections on RRC transfer procedure in EN-DC	15.4.0
	RP-82	RP-182666	0085	3	F	Correction of SN Initiated SN Modification procedure for Measurement Gap	15.4.0
	RP-82	RP-182660	0086	1	F	Stage 2 CR on Measurement gap configuration scenarios	15.4.0
	RP-82	RP-182669	0092	1	B	Baseline CR for TS37.340	15.4.0
2019/03	RP-83	RP-190543	0090	3	F	Corrections for MR-DC procedures	15.5.0
	RP-83	RP-190543	0096	2	F	QoS flow offloading for MR-DC	15.5.0
	RP-83	RP-190540	0098	1	F	Introduction of IDC mechanism for EN-DC operation	15.5.0
	RP-83	RP-190543	0104	1	F	Correction on UP integrity protection in late drop	15.5.0
	RP-83	RP-190543	0106	1	F	Corrections to SN Modification Request in MR-DC	15.5.0
	RP-83	RP-190553	0107	-	F	PSCell information for LI purposes	15.5.0
	RP-83	RP-190544	0108	-	F	Correction of EN DC data volume reporting and relocation	15.5.0
	RP-83	RP-190544	0110	-	F	Data volume reporting for MR-DC with 5GC	15.5.0
	RP-83	RP-190544	0111	-	F	Correction of RAN triggered PDU session split	15.5.0
	RP-83	RP-190544	0112	-	F	Correction of PDU session split at handover	15.5.0
	RP-83	RP-190544	0113	-	F	TEID change in case of key change	15.5.0
	RP-83	RP-190545	0114	1	F	Support of PDU session split during inter-MN handover for MR-DC with 5GC	15.5.0
2019/06	RP-84	RP-191375	0116	1	F	MN-SN coordination for ANR in MR-DC	15.6.0
	RP-84	RP-191378	0118	3	F	CR on 37.340 for s-Measure in NR-DC and NE-DC	15.6.0
	RP-84	RP-191374	0120	-	F	Clarification on RLC bearer release and add	15.6.0
	RP-84	RP-191374	0122	-	F	Activation/deactivation of SCells in MR-DC	15.6.0
	RP-84	RP-191374	0123	-	F	Corrections on MN and SN inter-node resource coordination	15.6.0
	RP-84	RP-191376	0124	1	F	Measurement gap coordination in MR-DC	15.6.0
	RP-84	RP-191379	0125	2	F	Inter-RAT HO support	15.6.0
	RP-84	RP-191376	0126	1	F	Editorial clean-up	15.6.0
	RP-84	RP-191379	0133	-	F	Various Clean-ups for TS37.340	15.6.0
	RP-84	RP-191380	0134	-	F	Correction of RAN triggered PDU session split	15.6.0
	RP-84	RP-191381	0135	1	F	Allow MN to retrieve forwarding proposal from the source SN	15.6.0
	RP-84	RP-191380	0136	-	F	RAN paging failure handling in SN	15.6.0
	RP-84	RP-191380	0137	-	F	Rapporteur Clean-ups of Secondary RAT Data Volume Report	15.6.0
	RP-84	RP-191380	0138	-	F	Correction of the references to the GTP tunnel endpoint information	15.6.0
	RP-84	RP-191380	0139	-	F	In-order delivery when QoS flows offloaded from SN	15.6.0
	RP-84	RP-191380	0140	-	F	RAN sharing with multiple Cell ID broadcast	15.6.0
2019/09	RP-85	RP-192191	0141	1	F	PDCCP configuration generation	15.7.0
	RP-85	RP-192190	0142	1	F	Clarification on selectedBandCombination	15.7.0
	RP-85	RP-192194	0143	3	F	Clarification about PSCell change between different SN nodes	15.7.0
	RP-85	RP-192193	0144	2	F	Clarification of handover terminology	15.7.0
	RP-85	RP-192191	0145	1	F	Default DRB handling	15.7.0
	RP-85	RP-192192	0148	1	F	Capability report and coordination in NR-DC	15.7.0
	RP-85	RP-192191	0151	1	F	LTE to NR-DC Inter-RAT HO support	15.7.0
	RP-85	RP-192190	0153	-	F	Correction of E-RAB Modification Indication	15.7.0
	RP-85	RP-192191	0154	1	F	TS37.340 Rapporteur Cleanups	15.7.0
2019/12	RP-86	RP-192934	0155	2	F	PDCCP version in EN-DC	15.8.0
	RP-86	RP-192936	0157	3	F	SMTC setting for NR PSCell change in MR-DC	15.8.0
	RP-86	RP-192937	0158	3	F	PDCCP configuration generation (email discussion of 107#25)	15.8.0
	RP-86	RP-192936	0159	3	F	Correction on sending Failure Information via SRB3	15.8.0
	RP-86	RP-192938	0160	2	F	Clarification of NR-DC synchronization	15.8.0
	RP-86	RP-192938	0163	2	F	Clarification on security key change and bearer termination point change	15.8.0
	RP-86	RP-192936	0168	1	F	Clarification regarding QoS handling in MRDC with 5G CN	15.8.0
	RP-86	RP-192936	0169	1	F	Missing RACH aspect for DC	15.8.0
	RP-86	RP-192937	0170	-	F	IP version on X2-U	15.8.0
	RP-86	RP-192937	0171	-	F	Correction to MR-DC with 5GC with RRC_INACTIVE	15.8.0
	RP-86	RP-192938	0172	-	F	Correction of SN Status Transfer during HO with DC	15.8.0
	RP-86	RP-192938	0174	1	F	DRB ID co-ordination between MN and SN	15.8.0
	RP-86	RP-192938	0175	-	F	Correcting misbehaviors and clean-ups on 37.340 related to PDU session split	15.8.0
	RP-86	RP-192938	0177	-	F	Stage2 Clarifications for RRC_Inactive with MR-DC@5GC	15.8.0

	RP-86	RP-192938	0178	-	F	Correction of NG connection in MR DC	15.8.0
	RP-86	RP-192938	0179	-	F	Correcting misbehaviors and clean-ups on 37.340 related to data forwarding and SN status transfer	15.8.0
	RP-86	RP-192945	0173	1	B	Stage2 Introduction of ARPI&SPID for EN-DC	16.0.0
	RP-86	RP-192943	0176	1	B	Resuming SCG in RRC Resume	16.0.0
	RP-86	RP-192943	0180	1	F	Clarification on the offered non-GBR resources	16.0.0
2020/03	RP-87	RP-200350	0165	3	B	Introduction of SRVCC from 5G to 3G	16.1.0
	RP-87	RP-200340	0182	1	B	Introduction of cross link interference management	16.1.0
	RP-87	RP-200341	0183	2	B	Introduction of NR-U to 37.340	16.1.0
	RP-87	RP-200344	0184	2	B	CR for supporting UE Power Saving in TS 37.340	16.1.0
	RP-87	RP-200357	0185	-	B	Stage 2 CR for Inter-RAT HO between NR to EN-DC in Rel-16	16.1.0
	RP-87	RP-200349	0186	2	B	Correction of TS 37.340 on the support of MR-DC for IAB	16.1.0
	RP-87	RP-200346	0187	-	B	Introduction of 5G V2X with NR Sidelink	16.1.0
	RP-87	RP-200348	0188	-	B	Introduction of CA/DC enhancements to 37.340	16.1.0
2020/07	RP-88	RP-201174	0189	4	F	SRB3 for reporting UAI for power saving	16.2.0
	RP-88	RP-201179	0192	3	F	Miscellaneous correction to 37.340 for IAB	16.2.0
	RP-88	RP-201160	0194	2	A	Correction on MN-SN measurements coordination in INM	16.2.0
	RP-88	RP-201181	0195	3	B	Introduction of IIOT features to TS 37.340	16.2.0
	RP-88	RP-201166	0198	2	F	Clarification on PDCP version change	16.2.0
	RP-88	RP-201162	0205	1	A	Corrections to MAC description	16.2.0
	RP-88	RP-201191	0208	1	F	Correction on MN-SN measurements coordination in INM	16.2.0
	RP-88	RP-201178	0209	-	F	DCCA corrections	16.2.0
	RP-88	RP-201177	0210	-	B	Introduction of Conditional PSCell Change for intra-SN without MN involvement	16.2.0
	RP-88	RP-201178	0211	-	B	Support of inter-RAT handover in response to MCGFailureInformation	16.2.0
	RP-88	RP-201177	0212	1	B	TS37.340 Stage2 Introduction of Rel-16 Mobility Enhancement in MR-DC	16.2.0
	RP-88	RP-201180	0213	-	B	Supporting of RACS for EN-DC and MR-DC	16.2.0
	RP-88	RP-201212	0214	-	C	Introduction of Inter-gNB CSI-RS Based Mobility	16.2.0
	RP-88	RP-201296	0216	1	A	Support of SN not broadcasting system information	16.2.0
2020/09	RP-89	RP-201930	0218	-	F	Minor Correction for CPC Configuration Related Procedure	16.3.0
	RP-89	RP-201932	0222	1	F	Mandatory support of full rate user plane integrity protection in MR-DC	16.3.0
	RP-89	RP-201930	0223	1	F	Correction of signalling flow for CPC	16.3.0
	RP-89	RP-201924	0225	1	F	Miscellaneous correction for TS 37.340 for IAB	16.3.0
	RP-89	RP-201922	0227	-	F	Miscellaneous corrections for DCCA	16.3.0
	RP-89	RP-201933	0228	-	F	Inter-system direct forwarding with shared en-gNB/gNB	16.3.0
	RP-89	RP-201938	0230	1	F	Further correction for CA-based PDCP duplication for Industrial IoT	16.3.0
	RP-89	RP-201931	0231	1	F	Introducing UE Radio Capability Mapping procedure for EN-DC	16.3.0
2020-12	RP-90	RP-202774	0220	2	F	Corrections to CPC with and without SRB3 involved	16.4.0
	RP-90	RP-202790	0233	1	A	UE Capabilities description	16.4.0
	RP-90	RP-202772	0234	-	F	CR to 37.340 on SRB3 description	16.4.0
	RP-90	RP-202770	0235	1	B	CR for 37.340 on power control for NR_DC	16.4.0
	RP-90	RP-202774	0236	1	F	Miscellaneous corrections for Mobility Enhancements	16.4.0
	RP-90	RP-202777	0238	-	F	Clarification for secondary DRX	16.4.0
	RP-90	RP-202777	0239	-	F	Full rate UP IP correction	16.4.0
	RP-90	RP-202790	0241	1	A	End marker handling in case of MR-DC NG-RAN initiated QoS Flow offloading	16.4.0
	RP-90	RP-202769	0242	-	F	Corrections on AQP for notification control	16.4.0
2021-03	RP-91	RP-210701	0244	-	A	Correction on the PDCP Change Indication for 37.340	16.5.0
	RP-91	RP-210689	0245	1	F	CR on co-configuration of sidelink and MR-DC	16.5.0
	RP-91	RP-210690	0246	1	F	CR on support of NR-DC within the same gNB-DU	16.5.0
	RP-91	RP-210703	0248	1	F	Corrections on UL power sharing	16.5.0
	RP-91	RP-210702	0249	1	A	Correction on user plane handling for full configuration in SN Change	16.5.0
	RP-91	RP-210698	0251	-	F	Non-support of CHO/CPC with LTE/5GC	16.5.0
	RP-91	RP-210701	0254	-	A	Correction of DL End Markers and QoS Flow Mobility	16.5.0
2021-06	RP-92	RP-211483	0256	1	A	CR on MN and SN configuration restriction coordination	16.6.0
	RP-92	RP-211471	0257	2	F	CR on SCG suspend in EN-DC	16.6.0
	RP-92	RP-211472	0258	1	F	Clarification on IP packet type in DedicatedInfoF1c	16.6.0
	RP-92	RP-211471	0261	3	F	Miscellaneous corrections on DCCA, 2-step RACH, IIOT	16.6.0
	RP-92	RP-211473	0262	2	F	Miscellaneous corrections to 37.340 on mobility enhancement	16.6.0
	RP-92	RP-211482	0264	1	A	CR on SCG release in EN-DC	16.6.0
	RP-92	RP-211485	0272	-	A	Correction on PSCell change without security key change and data forwarding upon SN change with full configuration	16.6.0
	RP-92	RP-211486	0274	-	A	Clarification on RRC full config for PSCell change	16.6.0
	RP-92	RP-211473	0275	-	F	37.340 correction for CHO early data forwarding in MN to eNB/gNB Change scenario	16.6.0
	RP-92	RP-211480	0276	-	F	Addition of sidelink MR-DC resource coordination	16.6.0
	RP-92	RP-211484	0278	-	A	No partial success in the SN initiated SN Modification procedure for EN-DC	16.6.0
	RP-92	RP-211484	0280	-	A	R16CR37.340 for SCG release	16.6.0
2021-09	RP-93	RP-212438	0266	2	A	Clarification on RACH procedure for HO with PSCell	16.7.0
	RP-93	RP-212438	0285	-	A	Clean-up on Xn-U Address Indication procedure	16.7.0

2021-12	RP-94	RP-213341	0288	-	F	Corrections on SCG/MCG failure handling	16.8.0
	RP-94	RP-213341	0291	-	A	Clarification for SgNB trigger SCG release in Rel-16 in TS 37.340	16.8.0
	RP-94	RP-213341	0292	-	F	Correction on SN-initiated SN Release	16.8.0
2022-03	RP-95	RP-220472	0300	1	A	Clarification on inter-MN handover without SN change	16.9.0
	RP-95	RP-220835	0303	1	F	CR on data forwarding between EN-DC/MR-DC and SA handover	16.9.0
2022-03	RP-95	RP-220495	0294	1	B	Introducing support of UP IP for EPC connected architectures using NR PDC	17.0.0
	RP-95	RP-220486	0296	1	B	Introduction of CP-UP separation support in NR eIAB	17.0.0
	RP-95	RP-220489	0298	-	B	Introduction of the support for UDC in NR	17.0.0
	RP-95	RP-220510	0301	-	B	Inter-MN RRC Resume without SN change [InterMNRResume]	17.0.0
	RP-95	RP-220510	0302	1	C	On UE security capability to address SA3 request [UE_Sec_Caps]	17.0.0
	RP-95	RP-220510	0304	-	F	Support of CHO with SCG configuration[CHOWithDCkept]	17.0.0
	RP-95	RP-220490	0306	-	B	Enhancement of RAN Slicing	17.0.0
	RP-95	RP-220839	0308	-	B	Addition of SON features enhancement	17.0.0
	RP-95	RP-220485	0309	-	B	Introduction of further multi-RAT dual-connectivity enhancements	17.0.0
2022-06	RP-96	RP-221728	0310	3	F	Corrections on TS 37.340 for DCCA enhancement	17.1.0
	RP-96	RP-221718	0313	2	F	Miscellaneous Corrections to 37.340	17.1.0
	RP-96	RP-221712	0324	1	A	Correction for SCell activation	17.1.0
	RP-96	RP-221714	0326	2	F	Rapporteur Clean-up	17.1.0
	RP-96	RP-221713	0328	1	A	Support of 1Tx-2Tx UL Tx switching for EN-DC	17.1.0
	RP-96	RP-221736	0329	-	C	Support of CHO with SCG configuration - 37340 [CHOWithDCkept]	17.1.0
	RP-96	RP-221733	0330	-	F	Correction on MRO for SN Change Failure	17.1.0
	RP-96	RP-221728	0331	2	F	Stage-2 aspects for CPAC	17.1.0
	RP-96	RP-221733	0332	-	F	Corrections to UE History Information in MR-DC	17.1.0
	RP-96	RP-221727	0333	1	F	Introduction of UE power saving enhancements In 37.340	17.1.0
2022-09	RP-97	RP-222522	0340	2	F	Corrections for DCCA enhancement	17.2.0
	RP-97	RP-222521	0342	1	A	Rapporteur Clean-up	17.2.0
	RP-97	RP-222523	0343	1	F	Miscellaneous Corrections to 37.340	17.2.0
	RP-97	RP-222522	0346	-	F	Clarification on direct data forwarding for MN initiated CPC to TS37340	17.2.0
	RP-97	RP-222522	0347	-	F	Coordination of CHO and intra-SN SCG reconfiguration	17.2.0
2022-12	RP-98	RP-223414	0350	4	F	Corrections for DCCA enhancement	17.3.0
	RP-98	RP-223412	0351	1	F	Correction on Sidelink based U2N Relay	17.3.0
	RP-98	RP-223413	0353	1	F	Miscellaneous corrections on TS 37.340 for ePowSav	17.3.0
	RP-98	RP-223410	0356	-	F	Failure handling for SCG MRO	17.3.0
	RP-98	RP-223410	0357	-	F	Correction for TS 37.340 on UHI in MR-DC	17.3.0
	RP-98	RP-223409	0358	1	F	Interaction between CPC Cancel and SN Release	17.3.0
	RP-98	RP-223409	0359	-	F	Clarification on direct data forwarding for SN initiated CPC to TS37.340	17.3.0

History

Document history		
V17.0.0	May 2022	Publication
V17.1.0	August 2022	Publication
V17.2.0	October 2022	Publication
V17.3.0	January 2023	Publication