

ETSI TS 137 355 V16.6.0 (2021-10)



**LTE;
5G;
LTE Positioning Protocol (LPP)
(3GPP TS 37.355 version 16.6.0 Release 16)**



Reference

RTS/TSGR-0237355vg60

Keywords

5G,LTE

ETSI

650 Route des Lucioles
F-06921 Sophia Antipolis Cedex - FRANCE

Tel.: +33 4 92 94 42 00 Fax: +33 4 93 65 47 16

Siret N° 348 623 562 00017 - NAF 742 C
Association à but non lucratif enregistrée à la
Sous-Préfecture de Grasse (06) N° 7803/88

Important notice

The present document can be downloaded from:

<http://www.etsi.org/standards-search>

The present document may be made available in electronic versions and/or in print. The content of any electronic and/or print versions of the present document shall not be modified without the prior written authorization of ETSI. In case of any existing or perceived difference in contents between such versions and/or in print, the prevailing version of an ETSI deliverable is the one made publicly available in PDF format at www.etsi.org/deliver.

Users of the present document should be aware that the document may be subject to revision or change of status.

Information on the current status of this and other ETSI documents is available at

<https://portal.etsi.org/TB/ETSIDeliverableStatus.aspx>

If you find errors in the present document, please send your comment to one of the following services:

<https://portal.etsi.org/People/CommitteeSupportStaff.aspx>

Copyright Notification

No part may be reproduced or utilized in any form or by any means, electronic or mechanical, including photocopying and microfilm except as authorized by written permission of ETSI.

The content of the PDF version shall not be modified without the written authorization of ETSI.

The copyright and the foregoing restriction extend to reproduction in all media.

© ETSI 2021.

All rights reserved.

DECT™, **PLUGTESTS™**, **UMTS™** and the ETSI logo are trademarks of ETSI registered for the benefit of its Members.

3GPP™ and **LTE™** are trademarks of ETSI registered for the benefit of its Members and of the 3GPP Organizational Partners.

oneM2M™ logo is a trademark of ETSI registered for the benefit of its Members and of the oneM2M Partners.

GSM® and the GSM logo are trademarks registered and owned by the GSM Association.

Intellectual Property Rights

Essential patents

IPRs essential or potentially essential to normative deliverables may have been declared to ETSI. The information pertaining to these essential IPRs, if any, is publicly available for **ETSI members and non-members**, and can be found in ETSI SR 000 314: "*Intellectual Property Rights (IPRs); Essential, or potentially Essential, IPRs notified to ETSI in respect of ETSI standards*", which is available from the ETSI Secretariat. Latest updates are available on the ETSI Web server (<https://ipr.etsi.org/>).

Pursuant to the ETSI IPR Policy, no investigation, including IPR searches, has been carried out by ETSI. No guarantee can be given as to the existence of other IPRs not referenced in ETSI SR 000 314 (or the updates on the ETSI Web server) which are, or may be, or may become, essential to the present document.

Trademarks

The present document may include trademarks and/or tradenames which are asserted and/or registered by their owners. ETSI claims no ownership of these except for any which are indicated as being the property of ETSI, and conveys no right to use or reproduce any trademark and/or tradename. Mention of those trademarks in the present document does not constitute an endorsement by ETSI of products, services or organizations associated with those trademarks.

Legal Notice

This Technical Specification (TS) has been produced by ETSI 3rd Generation Partnership Project (3GPP).

The present document may refer to technical specifications or reports using their 3GPP identities. These shall be interpreted as being references to the corresponding ETSI deliverables.

The cross reference between 3GPP and ETSI identities can be found under <http://webapp.etsi.org/key/queryform.asp>.

Modal verbs terminology

In the present document "**shall**", "**shall not**", "**should**", "**should not**", "**may**", "**need not**", "**will**", "**will not**", "**can**" and "**cannot**" are to be interpreted as described in clause 3.2 of the [ETSI Drafting Rules](#) (Verbal forms for the expression of provisions).

"**must**" and "**must not**" are **NOT** allowed in ETSI deliverables except when used in direct citation.

Contents

Intellectual Property Rights	2
Legal Notice	2
Modal verbs terminology.....	2
Foreword.....	12
1 Scope	13
2 References	13
3 Definitions and Abbreviations.....	15
3.1 Definitions	15
3.2 Abbreviations	15
4 Functionality of Protocol.....	18
4.1 General	18
4.1.1 LPP Configuration	18
4.1.2 LPP Sessions and Transactions.....	18
4.1.3 LPP Position Methods	19
4.1.4 LPP Messages	19
4.2 Common LPP Session Procedure	19
4.3 LPP Transport	20
4.3.1 Transport Layer Requirements	20
4.3.2 LPP Duplicate Detection	20
4.3.3 LPP Acknowledgement	21
4.3.3.1 General	21
4.3.3.2 Procedure related to Acknowledgement.....	21
4.3.4 LPP Retransmission.....	22
4.3.4.1 General	22
4.3.4.2 Procedure related to Retransmission.....	22
4.3.5 LPP Message Segmentation.....	23
5 LPP Procedures	24
5.1 Procedures related to capability transfer	24
5.1.1 Capability Transfer procedure	24
5.1.2 Capability Indication procedure.....	24
5.1.3 Reception of LPP Request Capabilities	25
5.1.4 Transmission of LPP Provide Capabilities	25
5.2 Procedures related to Assistance Data Transfer	25
5.2.1 Assistance Data Transfer procedure	25
5.2.1a Periodic Assistance Data Transfer procedure	26
5.2.1b Periodic Assistance Data Transfer with Update procedure.....	28
5.2.2 Assistance Data Delivery procedure	28
5.2.2a Periodic Assistance Data Delivery procedure.....	29
5.2.3 Transmission of LPP Request Assistance Data	31
5.2.4 Reception of LPP Provide Assistance Data	31
5.3 Procedures related to Location Information Transfer.....	31
5.3.1 Location Information Transfer procedure.....	31
5.3.2 Location Information Delivery procedure	32
5.3.3 Reception of Request Location Information.....	32
5.3.4 Transmission of Provide Location Information	33
5.4 Error Handling Procedures	33
5.4.1 General.....	33
5.4.2 Procedures related to Error Indication	33
5.4.3 LPP Error Detection.....	33
5.4.4 Reception of an LPP Error Message	34
5.5 Abort Procedure	35
5.5.1 General.....	35
5.5.2 Procedures related to Abort	35

5.5.3	Reception of an LPP Abort Message	35
6	Information Element Abstract Syntax Definition.....	35
6.1	General	35
6.2	LPP PDU Structure	36
–	<i>LPP-PDU-Definitions</i>	36
–	<i>LPP-Message</i>	36
–	<i>LPP-MessageBody</i>	37
–	<i>LPP-TransactionID</i>	37
6.3	Message Body IEs	38
–	<i>RequestCapabilities</i>	38
–	<i>ProvideCapabilities</i>	38
–	<i>RequestAssistanceData</i>	39
–	<i>ProvideAssistanceData</i>	39
–	<i>RequestLocationInformation</i>	40
–	<i>ProvideLocationInformation</i>	41
–	<i>Abort</i>	41
–	<i>Error</i>	42
6.4	Common IEs.....	42
6.4.1	Common Lower-Level IEs	42
–	<i>AccessTypes</i>	42
–	<i>ARFCN-ValueEUTRA</i>	43
–	<i>ARFCN-ValueNR</i>	43
–	<i>ARFCN-ValueUTRA</i>	43
–	<i>CarrierFreq-NB</i>	43
–	<i>CellGlobalIdEUTRA-AndUTRA</i>	44
–	<i>CellGlobalIdGERAN</i>	44
–	<i>ECGI</i>	45
–	<i>Ellipsoid-Point</i>	45
–	<i>Ellipsoid-PointWithUncertaintyCircle</i>	45
–	<i>EllipsoidPointWithUncertaintyEllipse</i>	45
–	<i>EllipsoidPointWithAltitude</i>	46
–	<i>EllipsoidPointWithAltitudeAndUncertaintyEllipsoid</i>	46
–	<i>EllipsoidArc</i>	46
–	<i>EPDU-Sequence</i>	46
–	<i>FreqBandIndicatorNR</i>	47
–	<i>HighAccuracyEllipsoidPointWithUncertaintyEllipse</i>	47
–	<i>HighAccuracyEllipsoidPointWithAltitudeAndUncertaintyEllipsoid</i>	48
–	<i>HorizontalVelocity</i>	48
–	<i>HorizontalWithVerticalVelocity</i>	48
–	<i>HorizontalVelocityWithUncertainty</i>	48
–	<i>HorizontalWithVerticalVelocityAndUncertainty</i>	49
–	<i>LocationCoordinateTypes</i>	49
–	<i>NCGI</i>	49
–	<i>NR-PhysCellId</i>	49
–	<i>PeriodicAssistanceDataControlParameters</i>	50
–	<i>Polygon</i>	50
–	<i>PositioningModes</i>	50
–	<i>SegmentationInfo</i>	51
–	<i>VelocityTypes</i>	51
6.4.2	Common Positioning	51
–	<i>CommonIEsRequestCapabilities</i>	51
–	<i>CommonIEsProvideCapabilities</i>	52
–	<i>CommonIEsRequestAssistanceData</i>	52
–	<i>CommonIEsProvideAssistanceData</i>	53
–	<i>CommonIEsRequestLocationInformation</i>	53
–	<i>CommonIEsProvideLocationInformation</i>	57
–	<i>CommonIEsAbort</i>	59
–	<i>CommonIEsError</i>	60
6.4.3	Common NR Positioning Information Elements	60
–	<i>DL-PRS-ID-Info</i>	60
–	<i>NR-AdditionalPathList</i>	61

–	<i>NR-DL-PRS-AssistanceData</i>	61
–	<i>NR-DL-PRS-BeamInfo</i>	64
–	<i>NR-DL-PRS-Info</i>	66
–	<i>NR-DL-PRS-ProcessingCapability</i>	69
–	<i>NR-DL-PRS-QCL-ProcessingCapability</i>	70
–	<i>NR-DL-PRS-ResourceID</i>	71
–	<i>NR-DL-PRS-ResourcesCapability</i>	71
–	<i>NR-DL-PRS-ResourceSetID</i>	72
–	<i>NR-PositionCalculationAssistance</i>	72
–	<i>NR-RTD-Info</i>	73
–	<i>NR-SelectedDL-PRS-IndexList</i>	74
–	<i>NR-SSB-Config</i>	75
–	<i>NR-TimeStamp</i>	76
–	<i>NR-TimingQuality</i>	76
–	<i>NR-TRP-LocationInfo</i>	77
–	<i>NR-UL-SRS-Capability</i>	78
–	<i>ReferencePoint</i>	81
–	<i>RelativeLocation</i>	81
6.5	Positioning Method IEs	83
6.5.1	OTDOA Positioning	83
6.5.1.1	OTDOA Assistance Data	83
–	<i>OTDOA-ProvideAssistanceData</i>	83
6.5.1.2	OTDOA Assistance Data Elements	83
–	<i>OTDOA-ReferenceCellInfo</i>	83
–	<i>PRS-Info</i>	85
–	<i>TDD-Config</i>	87
–	<i>OTDOA-NeighbourCellInfoList</i>	87
–	<i>OTDOA-ReferenceCellInfoNB</i>	90
–	<i>PRS-Info-NB</i>	92
–	<i>OTDOA-NeighbourCellInfoListNB</i>	95
6.5.1.3	OTDOA Assistance Data Request	98
–	<i>OTDOA-RequestAssistanceData</i>	98
6.5.1.4	OTDOA Location Information	98
–	<i>OTDOA-ProvideLocationInformation</i>	98
6.5.1.5	OTDOA Location Information Elements	99
–	<i>OTDOA-SignalMeasurementInformation</i>	99
–	<i>OTDOA-SignalMeasurementInformation-NB</i>	102
–	<i>OTDOA-MeasQuality</i>	104
–	<i>AdditionalPath</i>	105
6.5.1.6	OTDOA Location Information Request	105
–	<i>OTDOA-RequestLocationInformation</i>	105
6.5.1.7	OTDOA Capability Information	106
–	<i>OTDOA-ProvideCapabilities</i>	106
6.5.1.8	OTDOA Capability Information Request	108
–	<i>OTDOA-RequestCapabilities</i>	108
6.5.1.9	OTDOA Error Elements	108
–	<i>OTDOA-Error</i>	108
–	<i>OTDOA-LocationServerErrorCauses</i>	108
–	<i>OTDOA-TargetDeviceErrorCauses</i>	109
6.5.2	A-GNSS Positioning	109
6.5.2.1	GNSS Assistance Data	109
–	<i>A-GNSS-ProvideAssistanceData</i>	109
–	<i>GNSS-CommonAssistData</i>	109
–	<i>GNSS-GenericAssistData</i>	110
–	<i>GNSS-PeriodicAssistData</i>	111
6.5.2.2	GNSS Assistance Data Elements	111
–	<i>GNSS-ReferenceTime</i>	111
–	<i>GNSS-SystemTime</i>	113
–	<i>GPS-TOW-Assist</i>	113
–	<i>NetworkTime</i>	114
–	<i>GNSS-ReferenceLocation</i>	117
–	<i>GNSS-IonosphericModel</i>	117

-	<i>KlobucharModelParameter</i>	117
-	<i>KlobucharModel2Parameter</i>	118
-	<i>NeQuickModelParameter</i>	119
-	<i>GNSS-EarthOrientationParameters</i>	119
-	<i>GNSS-RTK-ReferenceStationInfo</i>	120
-	<i>GNSS-RTK-CommonObservationInfo</i>	122
-	<i>GNSS-RTK-AuxiliaryStationData</i>	123
-	<i>GNSS-SSR-CorrectionPoints</i>	125
-	<i>GNSS-TimeModelList</i>	126
-	<i>GNSS-DifferentialCorrections</i>	127
-	<i>GNSS-NavigationModel</i>	130
-	<i>StandardClockModelList</i>	132
-	<i>NAV-ClockModel</i>	133
-	<i>CNAV-ClockModel</i>	133
-	<i>GLONASS-ClockModel</i>	134
-	<i>SBAS-ClockModel</i>	135
-	<i>BDS-ClockModel</i>	135
-	<i>BDS-ClockModel2</i>	136
-	<i>NavIC-ClockModel</i>	136
-	<i>NavModelKeplerianSet</i>	137
-	<i>NavModelNAV-KeplerianSet</i>	138
-	<i>NavModelCNAV-KeplerianSet</i>	140
-	<i>NavModel-GLONASS-ECEF</i>	141
-	<i>NavModel-SBAS-ECEF</i>	142
-	<i>NavModel-BDS-KeplerianSet</i>	143
-	<i>NavModel-BDS-KeplerianSet2</i>	144
-	<i>NavModel-NavIC-KeplerianSet</i>	147
-	<i>GNSS-RealTimeIntegrity</i>	148
-	<i>GNSS-DataBitAssistance</i>	148
-	<i>GNSS-AcquisitionAssistance</i>	149
-	<i>GNSS-Almanac</i>	153
-	<i>AlmanacKeplerianSet</i>	154
-	<i>AlmanacNAV-KeplerianSet</i>	154
-	<i>AlmanacReducedKeplerianSet</i>	155
-	<i>AlmanacMidiAlmanacSet</i>	156
-	<i>AlmanacGLONASS-AlmanacSet</i>	157
-	<i>AlmanacECEF-SBAS-AlmanacSet</i>	158
-	<i>AlmanacBDS-AlmanacSet</i>	159
-	<i>AlmanacNavIC-AlmanacSet</i>	160
-	<i>GNSS-UTC-Model</i>	161
-	<i>UTC-ModelSet1</i>	161
-	<i>UTC-ModelSet2</i>	162
-	<i>UTC-ModelSet3</i>	163
-	<i>UTC-ModelSet4</i>	163
-	<i>UTC-ModelSet5</i>	164
-	<i>GNSS-AuxiliaryInformation</i>	165
-	<i>BDS-DifferentialCorrections</i>	166
-	<i>BDS-GridModelParameter</i>	167
-	<i>GNSS-RTK-Observations</i>	167
-	<i>GLO-RTK-BiasInformation</i>	170
-	<i>GNSS-RTK-MAC-CorrectionDifferences</i>	171
-	<i>GNSS-RTK-Residuals</i>	173
-	<i>GNSS-RTK-FKP-Gradients</i>	174
-	<i>GNSS-SSR-OrbitCorrections</i>	176
-	<i>GNSS-SSR-ClockCorrections</i>	178
-	<i>GNSS-SSR-CodeBias</i>	179
-	<i>GNSS-SSR-URA</i>	180
-	<i>GNSS-SSR-PhaseBias</i>	181
-	<i>GNSS-SSR-STECCorrection</i>	182
-	<i>GNSS-SSR-GriddedCorrection</i>	185
-	<i>NavIC-DifferentialCorrections</i>	187
-	<i>NavIC-GridModelParameter</i>	189

6.5.2.3	GNSS Assistance Data Request	190
–	<i>A-GNSS-RequestAssistanceData</i>	190
–	<i>GNSS-CommonAssistDataReq</i>	191
–	<i>GNSS-GenericAssistDataReq</i>	192
–	<i>GNSS-PeriodicAssistDataReq</i>	193
6.5.2.4	GNSS Assistance Data Request Elements	194
–	<i>GNSS-ReferenceTimeReq</i>	194
–	<i>GNSS-ReferenceLocationReq</i>	195
–	<i>GNSS-IonosphericModelReq</i>	195
–	<i>GNSS-EarthOrientationParametersReq</i>	196
–	<i>GNSS-RTK-ReferenceStationInfoReq</i>	196
–	<i>GNSS-RTK-AuxiliaryStationDataReq</i>	196
–	<i>GNSS-SSR-CorrectionPointsReq</i>	197
–	<i>GNSS-TimeModelListReq</i>	197
–	<i>GNSS-DifferentialCorrectionsReq</i>	197
–	<i>GNSS-NavigationModelReq</i>	198
–	<i>GNSS-RealTimeIntegrityReq</i>	199
–	<i>GNSS-DataBitAssistanceReq</i>	200
–	<i>GNSS-AcquisitionAssistanceReq</i>	200
–	<i>GNSS-AlmanacReq</i>	201
–	<i>GNSS-UTC-ModelReq</i>	201
–	<i>GNSS-AuxiliaryInformationReq</i>	202
–	<i>BDS-DifferentialCorrectionsReq</i>	202
–	<i>BDS-GridModelReq</i>	202
–	<i>GNSS-RTK-ObservationsReq</i>	202
–	<i>GLO-RTK-BiasInformationReq</i>	203
–	<i>GNSS-RTK-MAC-CorrectionDifferencesReq</i>	203
–	<i>GNSS-RTK-ResidualsReq</i>	204
–	<i>GNSS-RTK-FKP-GradientsReq</i>	204
–	<i>GNSS-SSR-OrbitCorrectionsReq</i>	205
–	<i>GNSS-SSR-ClockCorrectionsReq</i>	205
–	<i>GNSS-SSR-CodeBiasReq</i>	205
–	<i>GNSS-SSR-URA-Req</i>	206
–	<i>GNSS-SSR-PhaseBiasReq</i>	206
–	<i>GNSS-SSR-STECCorrectionReq</i>	206
–	<i>GNSS-SSR-GriddedCorrectionReq</i>	206
–	<i>NavIC-DifferentialCorrectionsReq</i>	207
–	<i>NavIC-GridModelReq</i>	207
6.5.2.5	GNSS Location Information	207
–	<i>A-GNSS-ProvideLocationInformation</i>	207
6.5.2.6	GNSS Location Information Elements	207
–	<i>GNSS-SignalMeasurementInformation</i>	207
–	<i>MeasurementReferenceTime</i>	208
–	<i>GNSS-MeasurementList</i>	210
–	<i>GNSS-LocationInformation</i>	214
6.5.2.7	GNSS Location Information Request	215
–	<i>A-GNSS-RequestLocationInformation</i>	215
6.5.2.8	GNSS Location Information Request Elements	215
–	<i>GNSS-PositioningInstructions</i>	215
6.5.2.9	GNSS Capability Information	216
–	<i>A-GNSS-ProvideCapabilities</i>	216
6.5.2.10	GNSS Capability Information Elements	218
–	<i>GNSS-CommonAssistanceDataSupport</i>	218
–	<i>GNSS-ReferenceTimeSupport</i>	219
–	<i>GNSS-ReferenceLocationSupport</i>	219
–	<i>GNSS-IonosphericModelSupport</i>	219
–	<i>GNSS-EarthOrientationParametersSupport</i>	220
–	<i>GNSS-RTK-ReferenceStationInfoSupport</i>	220
–	<i>GNSS-RTK-AuxiliaryStationDataSupport</i>	220
–	<i>GNSS-GenericAssistanceDataSupport</i>	220
–	<i>GNSS-TimeModelListSupport</i>	222
–	<i>GNSS-DifferentialCorrectionSupport</i>	222

–	<i>GNSS-NavigationModelSupport</i>	223
–	<i>GNSS-RealTimeIntegritySupport</i>	223
–	<i>GNSS-DataBitAssistanceSupport</i>	223
–	<i>GNSS-AcquisitionAssistanceSupport</i>	224
–	<i>GNSS-AlmanacSupport</i>	224
–	<i>GNSS-UTC-ModelSupport</i>	224
–	<i>GNSS-AuxiliaryInformationSupport</i>	225
–	<i>BDS-DifferentialCorrectionsSupport</i>	225
–	<i>BDS-GridModelSupport</i>	225
–	<i>GNSS-RTK-ObservationsSupport</i>	225
–	<i>GLO-RTK-BiasInformationSupport</i>	226
–	<i>GNSS-RTK-MAC-CorrectionDifferencesSupport</i>	226
–	<i>GNSS-RTK-ResidualsSupport</i>	226
–	<i>GNSS-RTK-FKP-GradientsSupport</i>	226
–	<i>GNSS-SSR-OrbitCorrectionsSupport</i>	227
–	<i>GNSS-SSR-ClockCorrectionsSupport</i>	227
–	<i>GNSS-SSR-URA-Support</i>	227
–	<i>GNSS-SSR-STECCorrectionSupport</i>	228
–	<i>GNSS-SSR-GriddedCorrectionSupport</i>	228
–	<i>NavIC-DifferentialCorrectionsSupport</i>	228
–	<i>NavIC-GridModelSupport</i>	228
6.5.2.11	GNSS Capability Information Request	228
–	<i>A-GNSS-RequestCapabilities</i>	228
6.5.2.12	GNSS Error Elements	229
–	<i>A-GNSS-Error</i>	229
–	<i>GNSS-LocationServerErrorCauses</i>	229
–	<i>GNSS-TargetDeviceErrorCauses</i>	230
6.5.2.13	Common GNSS Information Elements	230
–	<i>GNSS-FrequencyID</i>	230
–	<i>GNSS-ID</i>	231
–	<i>GNSS-ID-Bitmap</i>	231
–	<i>GNSS-Link-CombinationsList</i>	232
–	<i>GNSS-NavListInfo</i>	232
–	<i>GNSS-NetworkID</i>	232
–	<i>GNSS-PeriodicControlParam</i>	232
–	<i>GNSS-ReferenceStationID</i>	233
–	<i>GNSS-SignalID</i>	233
–	<i>GNSS-SignalIDs</i>	235
–	<i>GNSS-SubNetworkID</i>	236
–	<i>SBAS-ID</i>	237
–	<i>SBAS-IDs</i>	237
–	<i>SV-ID</i>	237
6.5.3	Enhanced Cell ID Positioning	238
6.5.3.1	E-CID Location Information	238
–	<i>ECID-ProvideLocationInformation</i>	238
6.5.3.2	E-CID Location Information Elements	238
–	<i>ECID-SignalMeasurementInformation</i>	238
6.5.3.3	E-CID Location Information Request	240
–	<i>ECID-RequestLocationInformation</i>	240
6.5.3.4	E-CID Capability Information	240
–	<i>ECID-ProvideCapabilities</i>	240
6.5.3.5	E-CID Capability Information Request	241
–	<i>ECID-RequestCapabilities</i>	241
6.5.3.6	E-CID Error Elements	241
–	<i>ECID-Error</i>	241
–	<i>ECID-LocationServerErrorCauses</i>	241
–	<i>ECID-TargetDeviceErrorCauses</i>	242
6.5.4	Terrestrial Beacon System Positioning	242
6.5.4.1	TBS Location Information	242
–	<i>TBS-ProvideLocationInformation</i>	242
6.5.4.2	TBS Location Information Elements	243
–	<i>TBS-MeasurementInformation</i>	243

–	<i>MBS-BeaconMeasList</i>	243
6.5.4.3	TBS Location Information Request	244
–	<i>TBS-RequestLocationInformation</i>	244
6.5.4.4	TBS Capability Information	244
–	<i>TBS-ProvideCapabilities</i>	244
–	<i>MBS-AssistanceDataSupportList</i>	245
6.5.4.5	TBS Capability Information Request	245
–	<i>TBS-RequestCapabilities</i>	245
6.5.4.6	TBS Error Elements	246
–	<i>TBS-Error</i>	246
–	<i>TBS-LocationServerErrorCauses</i>	246
–	<i>TBS-TargetDeviceErrorCauses</i>	246
6.5.4.7	TBS Assistance Data	247
–	<i>TBS-ProvideAssistanceData</i>	247
6.5.4.8	TBS Assistance Data Elements	247
–	<i>TBS-AssistanceDataList</i>	247
–	<i>MBS-AlmanacAssistance</i>	247
–	<i>MBS-AcquisitionAssistance</i>	248
6.5.4.9	TBS Assistance Data Request	248
–	<i>TBS-RequestAssistanceData</i>	248
6.5.5	Sensor based Positioning	248
6.5.5.0	Introduction	248
6.5.5.1	Sensor Location Information	249
–	<i>Sensor-ProvideLocationInformation</i>	249
6.5.5.2	Sensor Location Information Elements	249
–	<i>Sensor-MeasurementInformation</i>	249
–	<i>Sensor-MotionInformation</i>	250
6.5.5.3	Sensor Location Information Request	251
–	<i>Sensor-RequestLocationInformation</i>	251
6.5.5.4	Sensor Capability Information	252
–	<i>Sensor-ProvideCapabilities</i>	252
6.5.5.5	Sensor Capability Information Request	253
–	<i>Sensor-RequestCapabilities</i>	253
6.5.5.6	Sensor Error Elements	253
–	<i>Sensor-Error</i>	253
–	<i>Sensor-LocationServerErrorCauses</i>	253
–	<i>Sensor-TargetDeviceErrorCauses</i>	253
6.5.5.7	Sensor Assistance Data	254
–	<i>Sensor-ProvideAssistanceData</i>	254
6.5.5.8	Sensor Assistance Data Elements	254
–	<i>Sensor-AssistanceDataList</i>	254
6.5.5.9	Sensor Assistance Data Request	255
–	<i>Sensor-RequestAssistanceData</i>	255
6.5.6	WLAN-based Positioning	255
6.5.6.1	WLAN Location Information	256
–	<i>WLAN-ProvideLocationInformation</i>	256
6.5.6.2	WLAN Location Information Elements	256
–	<i>WLAN-MeasurementInformation</i>	256
6.5.6.3	WLAN Location Information Request	257
–	<i>WLAN-RequestLocationInformation</i>	257
6.5.6.4	WLAN Capability Information	258
–	<i>WLAN-ProvideCapabilities</i>	258
6.5.6.5	WLAN Capability Information Request	258
–	<i>WLAN-RequestCapabilities</i>	258
6.5.6.6	WLAN Error Elements	259
–	<i>WLAN-Error</i>	259
–	<i>WLAN-LocationServerErrorCauses</i>	259
–	<i>WLAN-TargetDeviceErrorCauses</i>	259
6.5.7	Bluetooth-based Positioning	263
6.5.7.1	Bluetooth Location Information	263
–	<i>BT-ProvideLocationInformation</i>	263
6.5.7.2	Bluetooth Location Information Elements	263

–	<i>BT-MeasurementInformation</i>	263
6.5.7.3	Bluetooth Location Information Request	264
–	<i>BT-RequestLocationInformation</i>	264
6.5.7.4	Bluetooth Capability Information	264
–	<i>BT-ProvideCapabilities</i>	264
6.5.7.5	Bluetooth Capability Information Request	265
–	<i>BT-RequestCapabilities</i>	265
6.5.7.6	BT Error Elements	265
–	<i>BT-Error</i>	265
–	<i>BT-LocationServerErrorCauses</i>	265
–	<i>BT-TargetDeviceErrorCauses</i>	266
6.5.8	NR UL Positioning	266
6.5.8.1	NR UL Capability Information	266
–	<i>NR-UL-ProvideCapabilities</i>	266
6.5.8.2	NR UL Capability Information Request	266
–	<i>NR-UL-RequestCapabilities</i>	266
6.5.9	NR E-CID Positioning	266
6.5.9.1	NR E-CID Location Information	267
–	<i>NR-ECID-ProvideLocationInformation</i>	267
6.5.9.2	NR E-CID Location Information Elements	267
–	<i>NR-ECID-SignalMeasurementInformation</i>	267
6.5.9.3	NR E-CID Location Information Request	268
–	<i>NR-ECID-RequestLocationInformation</i>	268
6.5.9.4	NR E-CID Capability Information	268
–	<i>NR-ECID-ProvideCapabilities</i>	268
6.5.9.5	NR E-CID Capability Information Request	269
–	<i>NR-ECID-RequestCapabilities</i>	269
6.5.9.6	NR E-CID Error Elements	269
–	<i>NR-ECID-Error</i>	269
–	<i>NR-ECID-LocationServerErrorCauses</i>	269
–	<i>NR-ECID-TargetDeviceErrorCauses</i>	270
6.5.10	NR DL-TDOA Positioning	270
6.5.10.1	NR DL-TDOA Assistance Data	270
–	<i>NR-DL-TDOA-ProvideAssistanceData</i>	270
6.5.10.2	NR DL-TDOA Assistance Data Request	271
–	<i>NR-DL-TDOA-RequestAssistanceData</i>	271
6.5.10.3	NR DL-TDOA Location Information	271
–	<i>NR-DL-TDOA-ProvideLocationInformation</i>	271
6.5.10.4	NR DL-TDOA Location Information Elements	272
–	<i>NR-DL-TDOA-SignalMeasurementInformation</i>	272
–	<i>NR-DL-TDOA-LocationInformation</i>	273
6.5.10.5	NR DL-TDOA Location Information Request	274
–	<i>NR-DL-TDOA-RequestLocationInformation</i>	274
6.5.10.6	NR DL-TDOA Capability Information	274
–	<i>NR-DL-TDOA-ProvideCapabilities</i>	274
–	<i>NR-DL-TDOA-MeasurementCapability</i>	275
6.5.10.7	NR DL-TDOA Capability Information Request	275
–	<i>NR-DL-TDOA-RequestCapabilities</i>	275
6.5.10.8	NR DL-TDOA Error Elements	275
–	<i>NR-DL-TDOA-Error</i>	275
–	<i>NR-DL-TDOA-LocationServerErrorCauses</i>	276
–	<i>NR-DL-TDOA-TargetDeviceErrorCauses</i>	276
6.5.11	NR DL-AoD Positioning	276
6.5.11.1	NR DL-AoD Assistance Data	276
–	<i>NR-DL-AoD-ProvideAssistanceData</i>	276
6.5.11.2	NR DL-AoD Assistance Data Request	277
–	<i>NR-DL-AoD-RequestAssistanceData</i>	277
6.5.11.3	NR DL-AoD Location Information	277
–	<i>NR-DL-AoD-ProvideLocationInformation</i>	277
6.5.11.4	NR DL-AoD Location Information Elements	278
–	<i>NR-DL-AoD-SignalMeasurementInformation</i>	278
–	<i>NR-DL-AoD-LocationInformation</i>	279

6.5.11.5	NR DL-AoD Location Information Request.....	279
–	<i>NR-DL-AoD-RequestLocationInformation</i>	279
6.5.11.6	NR DL-AoD Capability Information	280
–	<i>NR-DL-AoD-ProvideCapabilities</i>	280
–	<i>NR-DL-AoD-MeasurementCapability</i>	280
6.5.11.7	NR DL-AoD Capability Information Request	281
–	<i>NR-DL-AoD-RequestCapabilities</i>	281
6.5.11.8	NR DL-AoD Error Elements.....	281
–	<i>NR-DL-AoD-Error</i>	281
–	<i>NR-DL-AoD-LocationServerErrorCauses</i>	281
–	<i>NR-DL-AoD-TargetDeviceErrorCauses</i>	282
6.5.12	NR Multi-RTT Positioning.....	282
6.5.12.1	NR Multi-RTT Assistance Data.....	282
–	<i>NR-Multi-RTT-ProvideAssistanceData</i>	282
6.5.12.2	NR Multi-RTT Assistance Data Request	283
–	<i>NR-Multi-RTT-RequestAssistanceData</i>	283
6.5.12.3	NR Multi-RTT Location Information	283
–	<i>NR-Multi-RTT-ProvideLocationInformation</i>	283
6.5.12.4	NR Multi-RTT Location Information Elements.....	283
–	<i>NR-Multi-RTT-SignalMeasurementInformation</i>	283
6.5.12.5	NR Multi-RTT Location Information Request.....	285
–	<i>NR-Multi-RTT-RequestLocationInformation</i>	285
6.5.12.6	NR Multi-RTT Capability Information.....	286
–	<i>NR-Multi-RTT-ProvideCapabilities</i>	286
–	<i>NR-Multi-RTT-MeasurementCapability</i>	286
6.5.12.7	NR Multi-RTT Capability Information Request	287
–	<i>NR-Multi-RTT-RequestCapabilities</i>	287
6.5.12.8	NR Multi-RTT Error Elements	287
–	<i>NR-Multi-RTT-Error</i>	287
–	<i>NR-Multi-RTT-LocationServerErrorCauses</i>	287
–	<i>NR-Multi-RTT-TargetDeviceErrorCauses</i>	288
6.6	Multiplicity and type constraint values	288
–	<i>Multiplicity and type constraint definitions</i>	288
–	<i>End of LPP-PDU-Definitions</i>	288
7	Broadcast of assistance data	289
7.1	General	289
7.2	Mapping of <i>posSibType</i> to assistance data element.....	289
7.3	Procedures related to broadcast information elements	290
7.4	Broadcast information elements	292
7.4.1	Basic production	292
–	<i>LPP-Broadcast-Definitions</i>	292
7.4.2	Element definitions	292
–	<i>AssistanceDataSIBelement</i>	292
–	<i>OTDOA-UE-Assisted</i>	293
–	<i>NR-UEB-TRP-LocationData</i>	294
–	<i>NR-UEB-TRP-RTD-Info</i>	294
–	<i>End of LPP-Broadcast-Definitions</i>	294
7.5	Broadcast ciphering (informative).....	294
Annex A (informative):	Change History	297
History		300

Foreword

This Technical Specification has been produced by the 3rd Generation Partnership Project (3GPP).

The contents of the present document are subject to continuing work within the TSG and may change following formal TSG approval. Should the TSG modify the contents of the present document, it will be re-released by the TSG with an identifying change of release date and an increase in version number as follows:

Version x.y.z

where:

- x the first digit:
 - 1 presented to TSG for information;
 - 2 presented to TSG for approval;
 - 3 or greater indicates TSG approved document under change control.
- y the second digit is incremented for all changes of substance, i.e. technical enhancements, corrections, updates, etc.
- z the third digit is incremented when editorial only changes have been incorporated in the document.

1 Scope

The present document contains the definition of the LTE Positioning Protocol (LPP) for the radio access technologies E-UTRA/LTE and NR.

2 References

The following documents contain provisions which, through reference in this text, constitute provisions of the present document.

- References are either specific (identified by date of publication, edition number, version number, etc.) or non specific.
- For a specific reference, subsequent revisions do not apply.
- For a non-specific reference, the latest version applies. In the case of a reference to a 3GPP document (including a GSM document), a non-specific reference implicitly refers to the latest version of that document *in the same Release as the present document*.

- [1] 3GPP TR 21.905: "Vocabulary for 3GPP Specifications".
- [2] 3GPP TS 36.305: "Stage 2 functional specification of User Equipment (UE) positioning in E-UTRAN".
- [3] 3GPP TS 23.271: "Functional stage 2 description of Location Services (LCS)".
- [4] IS-GPS-200, Revision D, Navstar GPS Space Segment/Navigation User Interfaces, March 7th, 2006.
- [5] IS-GPS-705, Navstar GPS Space Segment/User Segment L5 Interfaces, September 22, 2005.
- [6] IS-GPS-800, Navstar GPS Space Segment/User Segment L1C Interfaces, September 4, 2008.
- [7] IS-QZSS, Quasi Zenith Satellite System Navigation Service Interface Specifications for QZSS, Ver.1.1, July 31, 2009.
- [8] Galileo OS Signal in Space ICD (OS SIS ICD), Issue 1.2, February 2014, European Union.
- [9] Global Navigation Satellite System GLONASS Interface Control Document, Version 5.1, 2008.
- [10] Specification for the Wide Area Augmentation System (WAAS), US Department of Transportation, Federal Aviation Administration, DTFA01-96-C-00025, 2001.
- [11] RTCM-SC104, RTCM Recommended Standards for Differential GNSS Service (v.2.3), August 20, 2001.
- [12] 3GPP TS 36.331: "Evolved Universal Terrestrial Radio Access (E-UTRA); Radio Resource Control (RRC); Protocol specification".
- [13] 3GPP TS 25.331: "Radio Resource Control (RRC); Protocol Specification".
- [14] 3GPP TS 44.031: "Location Services (LCS); Mobile Station (MS) - Serving Mobile Location Centre (SMLC) Radio Resource LCS Protocol (RRLP)".
- [15] 3GPP TS 23.032: "Universal Geographical Area Description (GAD)".
- [16] 3GPP TS 36.211: "Evolved Universal Terrestrial Radio Access (E-UTRA); Physical Channels and Modulation".
- [17] 3GPP TS 36.214: "Evolved Universal Terrestrial Radio Access (E-UTRA); Physical layer – Measurements".

- [18] 3GPP TS 36.133: "Evolved Universal Terrestrial Radio Access (E-UTRA); Requirements for support of radio resource management".
- [19] 3GPP TS 23.003: "Numbering, addressing and identification".
- [20] OMA-TS-LPPe-V1_0, LPP Extensions Specification, Open Mobile Alliance.
- [21] 3GPP TS 36.101: "Evolved Universal Terrestrial Radio Access (E-UTRA); User Equipment (UE) radio transmission and reception".
- [22] ITU-T Recommendation X.691 (07/2002) "Information technology - ASN.1 encoding rules: Specification of Packed Encoding Rules (PER)" (Same as the ISO/IEC International Standard 8825-2).
- [23] BDS-SIS-ICD-B1I-3.0: "BeiDou Navigation Satellite System Signal In Space Interface Control Document Open Service Signal B1I (Version 3.0)", February, 2019.
- [24] ATIS-0500027: "Recommendations for Establishing Wide Scale Indoor Location Performance", May 2015.
- [25] Bluetooth Special Interest Group: "Bluetooth Core Specification v4.2", December 2014.
- [26] IEEE 802.11, Part 11: "Wireless LAN Medium Access Control (MAC) and Physical Layer (PHY) Specifications".
- [27] IETF RFC 6225, "Dynamic Host Configuration Protocol Options for Coordinate-Based Location Configuration Information", July 2011.
- [28] 3GPP TS 36.213: "Evolved Universal Terrestrial Radio Access (E-UTRA); Physical layer procedures".
- [29] "Earth Gravitational Model 96 (EGM96)", National Geospatial-Intelligence Agency, NASA.
- [30] RTCM Standard 10403.3: "Differential GNSS (Global Navigation Satellite Systems) Services" – Version 3, October 7, 2016.
- [31] IGS ANTEX: "The Antenna Exchanged Format" – version 1.4, September 15, 2010.
- [32] Federal Information Processing Standards Publication 197, "Specification for the ADVANCED ENCRYPTION STANDARD (AES)", November 26, 2001.
- [33] NIST Special Publication 800-38A, "Recommendation for Block Cipher Modes of Operation Methods and Techniques", 2001.
- [34] 3GPP TS 38.101-2: "NR; User Equipment (UE) radio transmission and reception; Part 2: Range 2 Standalone".
- [35] 3GPP TS 38.331: "NR; Radio Resource Control (RRC); Protocol specification".
- [36] 3GPP TS 38.215: "NR; Physical layer measurements".
- [37] 3GPP TS 38.101-1: "NR; User Equipment (UE) radio transmission and reception; Part 1: Range 1 Standalone".
- [38] IRNSS Signal-In-Space (SPS) Interface Control Document (ICD) for standard positioning service version 1.1, Aug 2017.
- [39] BDS-SIS-ICD-B1C-1.0: "BeiDou Navigation Satellite System Signal In Space Interface Control Document Open Service Signal B1C (Version 1.0)", December, 2017.
- [40] 3GPP TS 38.305: "NG Radio Access Network (NG-RAN); Stage 2 functional specification of User Equipment (UE) positioning in NG-RAN".
- [41] 3GPP TS 38.211: "3rd Generation Partnership Project; Technical Specification Group Radio Access Network; NR; Physical channels and modulation".
- [42] 3GPP TS 23.273: "5G System (5GS) Location Services (LCS); Stage 2".

- [43] IS-QZSS-L6-001, Quasi-Zenith Satellite System Interface Specification – Centimetre Level Augmentation Service, Cabinet Office, November 5, 2018.
- [44] 3GPP TR 38.901: "Technical Specification Group Radio Access Network; Study on channel model for frequencies from 0.5 to 100 GHz".
- [45] 3GPP TS 38.214: "NR; Physical layer procedures for data".
- [46] 3GPP TS 38.133: "NR; Requirements for support of radio resource management".
- [47] 3GPP TS 38.300: "NR; NR and NG-RAN Overall Description; Stage 2".
- [48] 3GPP TS 38.213: "NR; Physical layer procedures for control".

3 Definitions and Abbreviations

3.1 Definitions

For the purposes of the present document, the terms and definitions given in TR 21.905 [1], TS 36.305 [2], TS 23.271 [3], 38.305 [40] and TS 23.273 [42] apply. Other definitions are provided below.

Anchor carrier: In NB-IoT, a carrier where the UE assumes that NPSS/NSSS/NPBCH/SIB-NB for FDD or NPSS/NSSS/NPBCH for TDD are transmitted.

Location Server: a physical or logical entity (e.g., E-SMLC, SUPL SLP, or LMF) that manages positioning for a target device by obtaining measurements and other location information from one or more positioning units and providing assistance data to positioning units to help determine this. A Location Server may also compute or verify the final location estimate.

NB-IoT: NB-IoT allows access to network services via E-UTRA with a channel bandwidth limited to 200 kHz.

Observed Time Difference Of Arrival (OTDOA): The time interval that is observed by a target device between the reception of downlink signals from two different TPs. If a signal from TP 1 is received at the moment t_1 , and a signal from TP 2 is received at the moment t_2 , the OTDOA is $t_2 - t_1$.

PRS-only TP: A TP which only transmits PRS signals or DL-PRS for PRS-based TBS positioning and is not associated with a cell.

Reference Source: a physical entity or part of a physical entity that provides signals (e.g., RF, acoustic, infra-red) that can be measured (e.g., by a Target Device) in order to obtain the location of a Target Device.

Relative Time Difference (RTD): The relative time difference between a TRP i and a TRP j , is defined as $t_j - t_i$, where t_i and t_j are defined as the time when TRP i and j transmit the start of one subframe respectively.

Target Device: the device that is being positioned (e.g., UE or SUPL SET).

Transmission Point (TP): A set of geographically co-located transmit antennas (e.g. antenna array (with one or more antenna elements)) for one cell, part of one cell or one PRS-only TP. Transmission Points can include base station (eNodeB) antennas, remote radio heads, a remote antenna of a base station, an antenna of a PRS-only TP, etc. One cell can be formed by one or multiple transmission points. For a homogeneous deployment, each transmission point may correspond to one cell.

Transmission-Reception Point (TRP): A set of geographically co-located antennas (e.g. antenna array (with one or more antenna elements)) supporting TP and/or RP functionality.

3.2 Abbreviations

For the purposes of the present document, the following abbreviations apply.

ADR	Accumulated Delta-Range
A-GNSS	Assisted-GNSS

AP	Access Point
ARFCN	Absolute Radio Frequency Channel Number
ARP	Antenna Reference Point
BDS	BeiDou Navigation Satellite System
BIPM	Bureau International des Poids et Mesures (International Bureau of Weights and Measures)
BSSID	Basic Service Set Identifier
BTS	Base Transceiver Station (GERAN)
CID	Cell-ID (positioning method)
CNAV	Civil Navigation
CRS	Cell-specific Reference Signals
DL-AoD	Downlink Angle-of-Departure
DL-TDOA	Downlink Time Difference Of Arrival
ECEF	Earth-Centered, Earth-Fixed
ECGI	Evolved Cell Global Identifier
ECI	Earth-Centered-Inertial
E-CID	Enhanced Cell-ID (positioning method)
EGNOS	European Geostationary Navigation Overlay Service
E-SMLC	Enhanced Serving Mobile Location Centre
E-UTRA	Evolved Universal Terrestrial Radio Access
E-UTRAN	Evolved Universal Terrestrial Radio Access Network
EOP	Earth Orientation Parameters
EPDU	External Protocol Data Unit
FDMA	Frequency Division Multiple Access
FEC	Forward Error Correction
FKP	(German) Flächen-Korrektur-Parameter (area correction parameter)
FTA	Fine Time Assistance
GAGAN	GPS Aided Geo Augmented Navigation
GLONASS	GLObal'naya NAVigatsionnaya Sputnikovaya Sistema (Engl.: Global Navigation Satellite System)
GNSS	Global Navigation Satellite System
GPS	Global Positioning System
HA GNSS	High-Accuracy GNSS (RTK, PPP)
ICD	Interface Control Document
IGS	International GNSS Service
IOD	Issue of Data
IRNSS	Indian Regional Navigation Satellite System
IS	Interface Specification
LLA	Latitude Longitude Altitude
LMF	Location Management Function
LPP	LTE Positioning Protocol
LPPa	LTE Positioning Protocol Annex
LSB	Least Significant Bit
MAC	Master Auxiliary Concept
MBS	Metropolitan Beacon System
MO-LR	Mobile Originated Location Request
MSAS	Multi-functional Satellite Augmentation System
MSB	Most Significant Bit
msd	mean solar day
MT-LR	Mobile Terminated Location Request
Multi-RTT	Multiple-Round Trip Time
NAV	Navigation
NavIC	NAVigation with Indian Constellation
NB-IoT	NarrowBand Internet of Things
NCGI	NR Cell Global Identifier
NICT	National Institute of Information and Communications Technology
NI-LR	Network Induced Location Request
NPRS	Narrowband Positioning Reference Signals
NR	NR Radio Access
NRSRP	Narrowband Reference Signal Received Power
NRSRQ	Narrowband Reference Signal Received Quality
NTSC	National Time Service Center of Chinese Academy of Sciences
OSR	Observation Space Representation
OTDOA	Observed Time Difference Of Arrival

PBCH	Physical Broadcast Channel
PDU	Protocol Data Unit
PPP	Precise Point Positioning
PRB	Physical Resource Block
PRC	Pseudo-Range Correction
PRS	Positioning Reference Signals
posSIB	Positioning System Information Block
PZ-90	Parametry Zemli 1990 Goda – Parameters of the Earth Year 1990
QZS	Quasi Zenith Satellite
QZSS	Quasi-Zenith Satellite System
QZST	Quasi-Zenith System Time
RF	Radio Frequency
RP	Reception Point
RRC	Range-Rate Correction
	Radio Resource Control
RSRP	Reference Signal Received Power
RSRQ	Reference Signal Received Quality
RSTD	Reference Signal Time Difference
RTK	Real-Time Kinematic
RTT	Round Trip Time
RU	Russia
SBAS	Space Based Augmentation System
SET	SUPL Enabled Terminal
SFN	System Frame Number
SLP	SUPL Location Platform
SRS	Sounding Reference Signal
SS	Synchronization Signal
SSB	Synchronization Signal Block, SS/PBCH Block
SSID	Service Set Identifier
SSR	State Space Representation
STEC	Slant TEC
SUPL	Secure User Plane Location
SV	Space Vehicle
TB	Terrestrial Beacon
TBS	Terrestrial Beacon System
TEC	Total Electron Content
TECU	TEC Units
TLM	Telemetry
TOA	Time Of Arrival
TOD	Time Of Day
TOW	Time Of Week
TP	Transmission Point
TRP	Transmission-Reception Point
UDRE	User Differential Range Error
ULP	User Plane Location Protocol
URA	User Range Accuracy
USNO	US Naval Observatory
UT1	Universal Time No.1
UTC	Coordinated Universal Time
WAAS	Wide Area Augmentation System
WGS-84	World Geodetic System 1984
WLAN	Wireless Local Area Network

4 Functionality of Protocol

4.1 General

4.1.1 LPP Configuration

LPP is used point-to-point between a location server (E-SMLC, LMF or SLP) and a target device (UE or SET) in order to position the target device using position-related measurements obtained by one or more reference sources. Figure 4.1.1-1 shows the configuration as applied to the control- and user-plane location solutions for E-UTRAN and NG-RAN (as defined in TS 36.305 [2], TS 38.305 [40], TS 23.273 [42] and TS 23.271 [3]).

NB-IoT is a non-backward compatible variant of E-UTRAN supporting a reduced set of functionalities. In this specification, procedures and messages specified for the UE equally apply to the UE in NB-IoT.

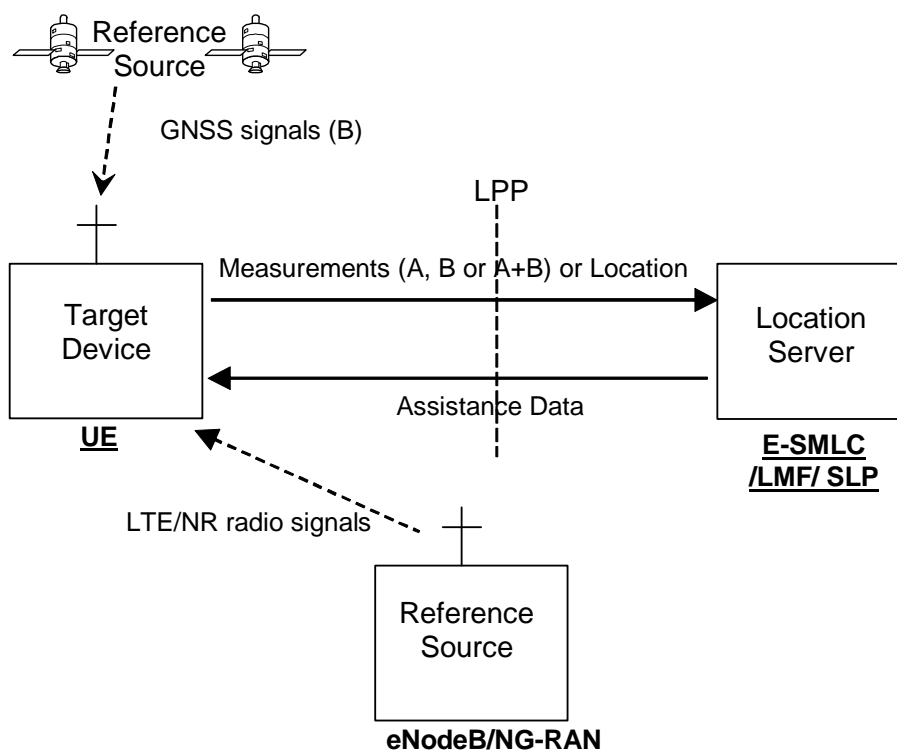

Figure 4.1.1-1: LPP Configuration for Control- and User-Plane Positioning in E-UTRAN or NG-RAN

4.1.2 LPP Sessions and Transactions

An LPP session is used between a Location Server and the target device in order to obtain location related measurements or a location estimate or to transfer assistance data. A single LPP session is used to support a single location request (e.g., for a single MT-LR, MO-LR or NI-LR). Multiple LPP sessions can be used between the same endpoints to support multiple different location requests (as required by TS 23.271 [3]). Each LPP session comprises one or more LPP transactions, with each LPP transaction performing a single operation (capability exchange, assistance data transfer, or location information transfer). In E-UTRAN and NG-RAN, the LPP transactions are realized as LPP procedures. The instigator of an LPP session will always instigate the first LPP transaction, but subsequent transactions may be instigated by either end. LPP transactions within a session may occur serially or in parallel. LPP transactions are indicated at the LPP protocol level with a transaction ID in order to associate messages with one another (e.g., request and response).

Messages within a transaction are linked by a common transaction identifier.

4.1.3 LPP Position Methods

Internal LPP positioning methods and associated signalling content are defined in this specification.

This version of the specification defines OTDOA (based on LTE signals), A-GNSS, E-CID (based on LTE signals), Sensor, TBS, WLAN, Bluetooth, NR E-CID, NR DL-TDOA, NR DL-AoD and NR Multi-RTT positioning methods.

4.1.4 LPP Messages

Each LPP transaction involves the exchange of one or more LPP messages between the location server and the target device. The general format of an LPP message consists of a set of common fields followed by a body. The body (which may be empty) contains information specific to a particular message type. Each message type contains information specific to one or more positioning methods and/or information common to all positioning methods.

The common fields are as follows:

Field	Role
Transaction ID	Identify messages belonging to the same transaction
Transaction End Flag	Indicate when a transaction (e.g. one with periodic responses) has ended
Sequence Number	Enable detection of a duplicate LPP message at a receiver
Acknowledgement	Enable an acknowledgement to be requested and/or returned for any LPP message

NOTE: Use of the Transaction ID and Transaction End fields conform to the procedures in clause 5 and are independent of the means used to transport LPP messages (e.g., whether using a NAS MO-LR Request, NAS Generic Transport or user-plane solution).

The following message types are defined:

- Request Capabilities;
- Provide Capabilities;
- Request Assistance Data;
- Provide Assistance Data;
- Request Location Information;
- Provide Location Information;
- Abort;
- Error.

4.2 Common LPP Session Procedure

The purpose of this procedure is to support an LPP session comprising a sequence of LPP transactions. The procedure is described in Figure 4.2-1.

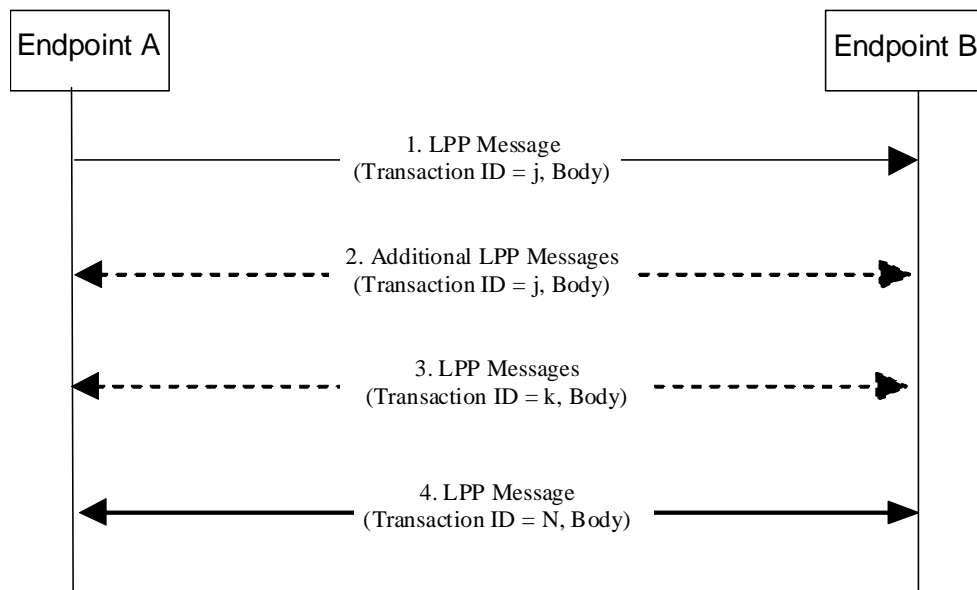

Figure 4.2-1 LPP Session Procedure

1. Endpoint A, which may be either the target or the server, initiates an LPP session by sending an LPP message for an initial LPP transaction j to the other endpoint B (which has an opposite role to A).
2. Endpoints A and B may exchange further messages to continue the transaction started in step 1.
3. Either endpoint may instigate further transactions by sending additional LPP messages.
4. A session is terminated by a final transaction N in which LPP messages will be exchanged between the two endpoints.

Within each transaction, all constituent messages shall contain the same transaction identifier. The last message sent in each transaction shall have the IE *endTransaction* set to TRUE. Transactions that occur in parallel shall use different transaction IDs; transaction IDs for completed transactions may be reused at any time after the final message of the previous transaction with the same ID is known to have been received.

4.3 LPP Transport

4.3.1 Transport Layer Requirements

LPP requires reliable, in-sequence delivery of LPP messages from the underlying transport layers. This clause describes the transport capabilities that are available within LPP. A UE implementing LPP for the control-plane solution shall support LPP reliable transport (including all three of duplicate detection, acknowledgement, and retransmission).

LPP reliable transport functionality is not used in the user-plane solution.

The following requirements in clauses 4.3.2, 4.3.3, and 4.3.4 for LPP reliable transport apply only when the capability is supported.

4.3.2 LPP Duplicate Detection

A sender shall include a sequence number in all LPP messages sent for a particular location session. The sequence number shall be distinct for different LPP messages sent in the same direction in the same location session (e.g., may start at zero in the first LPP message and increase monotonically in each succeeding LPP message). Sequence numbers used in the uplink and downlink are independent (e.g., can be the same).

A receiver shall record the most recent received sequence number for each location session. If a message is received carrying the same sequence number as that last received for the associated location session, it shall be discarded. Otherwise (i.e., if the sequence number is different or if no sequence number was previously received or if no sequence number is included), the message shall be processed.

Sending and receiving sequence numbers shall be deleted in a server when the associated location session is terminated and shall be deleted in a target device when there has been no activity for a particular location session for 10 minutes.

NOTE: For LPP control-plane use, a target device can be aware of a location session from information provided at the NAS level for downlink transport of an LPP message.

4.3.3 LPP Acknowledgement

4.3.3.1 General

Each LPP message may carry an acknowledgement request and/or an acknowledgement indicator. A LPP message including an acknowledgement request (i.e., that include the IE *ackRequested* set to TRUE) shall also include a sequence number. Upon reception of an LPP message which includes the IE *ackRequested* set to TRUE, a receiver returns an LPP message with an acknowledgement response (i.e., that includes the *ackIndicator* IE set to the same sequence number of the message being acknowledged). An acknowledgement response may contain no LPP message body (in which case only the sequence number being acknowledged is significant); alternatively, the acknowledgement may be sent in an LPP message along with an LPP message body. An acknowledgement is returned for each received LPP message that requested an acknowledgement including any duplicate(s). Once a sender receives an acknowledgement for an LPP message, and provided any included sequence number is matching, it is permitted to send the next LPP message. No message reordering is needed at the receiver since this stop-and-wait method of sending ensures that messages normally arrive in the correct order.

When an LPP message is transported via a NAS MO-LR request, the message does not request an acknowledgement.

4.3.3.2 Procedure related to Acknowledgement

Figure 4.3.3.2-1 shows the procedure related to acknowledgement.

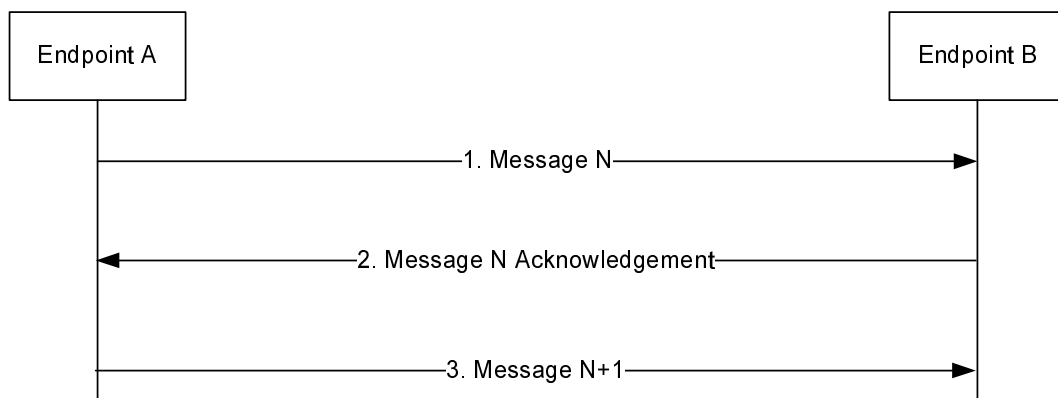

Figure 4.3.3.2-1: LPP Acknowledgement procedure

1. Endpoint A sends an LPP message *N* to Endpoint B which includes the IE *ackRequested* set to TRUE and a sequence number.
2. If LPP message *N* is received and Endpoint B is able to decode the *ackRequested* value and sequence number, Endpoint B shall return an acknowledgement for message *N*. The acknowledgement shall contain the IE *ackIndicator* set to the same sequence number as that in message *N*.
3. When the acknowledgement for LPP message *N* is received and provided the included *ackIndicator* IE matches the sequence number sent in message *N*, Endpoint A sends the next LPP message *N+1* to Endpoint B when this message is available.

4.3.4 LPP Retransmission

4.3.4.1 General

This capability builds on the acknowledgement and duplicate detection capabilities. When an LPP message which requires acknowledgement is sent and not acknowledged, it is resent by the sender following a timeout period up to three times. If still unacknowledged after that, the sender aborts all LPP activity for the associated session. The timeout period is determined by the sender implementation but shall not be less than a minimum value of 250 ms.

In addition, for NB-IoT the timeout period may be determined by the sender implementation based on e.g., the coverage level of the UE.

4.3.4.2 Procedure related to Retransmission

Figure 4.3.4.2-1 shows the procedure related to retransmission when combined with acknowledgement and duplicate detection.

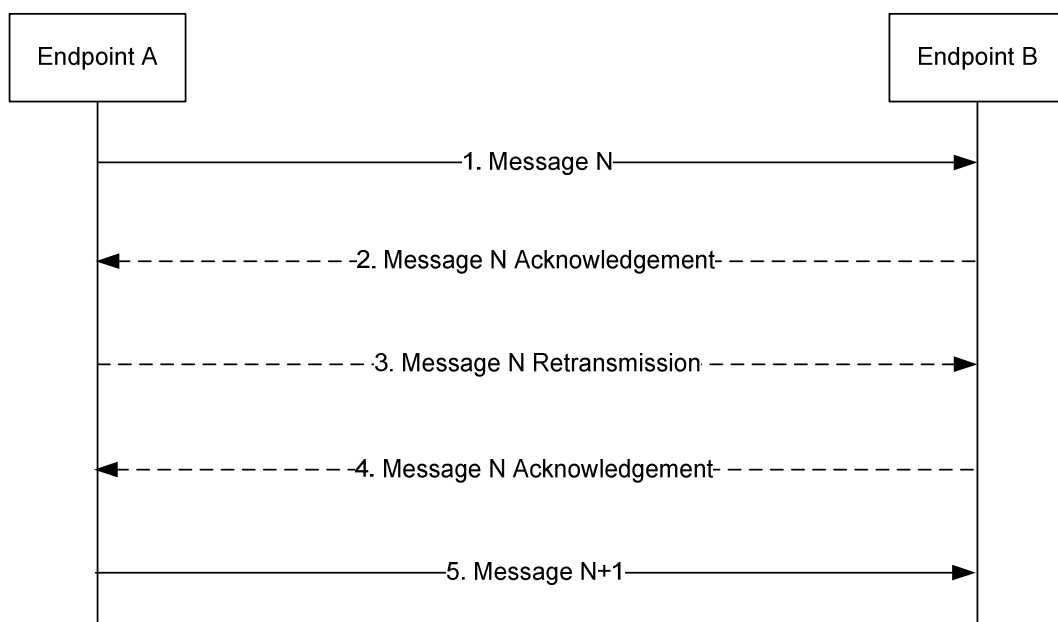

Figure 4.3.4.2-1: LPP Retransmission procedure

1. Endpoint A sends an LPP message N to Endpoint B for a particular location session and includes a request for acknowledgement along with a sequence number.
2. If LPP message N is received and Endpoint B is able to decode the *ackRequested* value and sequence number (regardless of whether the message body can be correctly decoded), Endpoint B shall return an acknowledgement for message N . If the acknowledgement is received by Endpoint A (such that the acknowledged message can be identified and sequence numbers are matching), Endpoint A skips steps 3 and 4.
3. If the acknowledgement in step 2 is not received after a timeout period, Endpoint A shall retransmit LPP message N and shall include the same sequence number as in step 1.
4. If LPP message N in step 3 is received and Endpoint B is able to decode the *ackRequested* value and sequence number (regardless of whether the message body can be correctly decoded and whether or not the message is considered a duplicate), Endpoint B shall return an acknowledgement. Steps 3 may be repeated one or more times if the acknowledgement in step 4 is not received after a timeout period by Endpoint A. If the acknowledgement in step 4 is still not received after sending three retransmissions, Endpoint A shall abort all procedures and activity associated with LPP support for the particular location session.
5. Once an acknowledgement in step 2 or step 4 is received, Endpoint A sends the next LPP message $N+1$ for the location session to Endpoint B when this message is available.

4.3.5 LPP Message Segmentation

An LPP message body may be sent in several shorter LPP messages instead of one long LPP message to deliver a large amount of information (e.g., in case the LPP message size exceeds the maximum message size supported by lower layers). When a sender employs LPP message segmentation, the sender shall include the IE *SegmentationInfo* in each LPP message segment. The sender shall indicate in all but the final message segment that more messages are on the way.

When a receiver receives an LPP message indicating that more messages are on the way, the receiver may store the LPP message. If the receiver receives a subsequent LPP message for the same session and transaction ID, the receiver shall assume that the new LPP message continues the segmentation of the earlier message and may store the new message if the new message indicates that more messages are on the way. If the new message indicates that no more messages are on the way, the receiver shall assume that message segmentation is complete and shall process the new message and any stored message segments for the same session and transaction ID.

The reliable transport rules specified in clause 4.3.2, 4.3.3, and 4.3.4 apply to each individual LPP message segment, independently of the value of the IE *SegmentationInfo*.

The rules for setting the common fields of the LPP message specified in clause 4.1.4 (Transaction ID, Transaction End Flag, Sequence Number, Acknowledgment) apply to each individual LPP message segment, independently of the value of the IE *SegmentationInfo*.

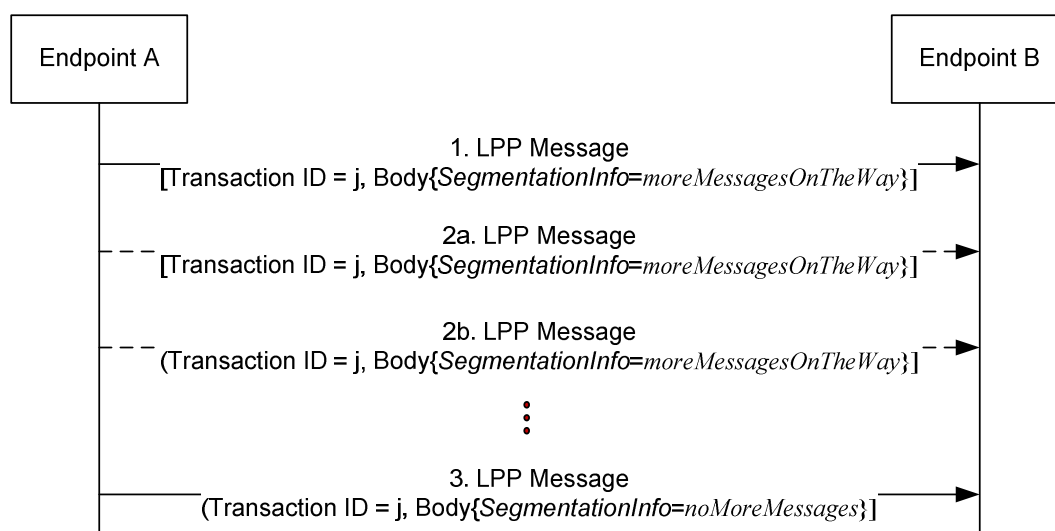

Figure 4.3.5-1: LPP Message Segmentation procedure

1. Endpoint A sends an LPP message to Endpoint B for a particular location session and includes the IE *SegmentationInfo* set to *moreMessagesOnTheWay* to indicate that this is one of many LPP message segments used to deliver the entire LPP message body.
2. Endpoint A may send one or more additional LPP messages to Endpoint B with the IE *SegmentationInfo* set to *moreMessagesOnTheWay* to continue delivering the segmented LPP message.
3. Endpoint A sends the final LPP message segment to Endpoint B and includes the IE *SegmentationInfo* set to *noMoreMessages* to indicate that this is the final LPP message segment. Endpoint B assumes that the complete LPP message body has been received.

5 LPP Procedures

5.1 Procedures related to capability transfer

The purpose of the procedures that are grouped together in this clause is to enable the transfer of capabilities from the target device to the server. Capabilities in this context refer to positioning and protocol capabilities related to LPP and the positioning methods supported by LPP.

These procedures instantiate the Capability Transfer transaction from TS 36.305 [2] and TS 38.305 [40].

5.1.1 Capability Transfer procedure

The Capability Transfer procedure is shown in Figure 5.1.1-1.

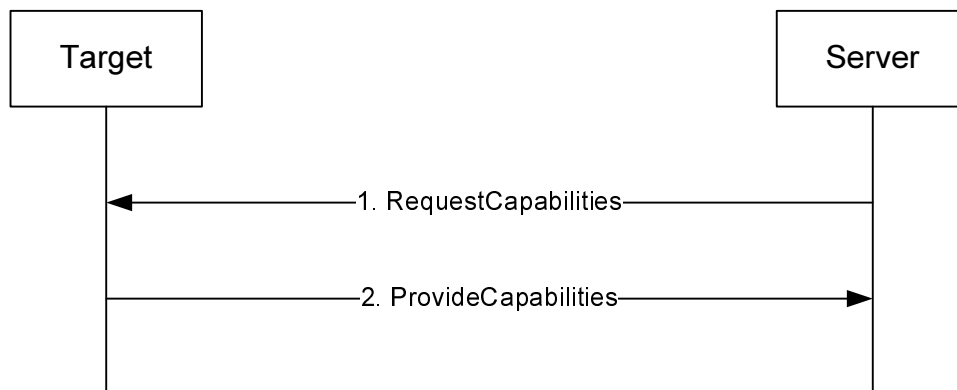

Figure 5.1.1-1: LPP Capability Transfer procedure

1. The server sends a *RequestCapabilities* message to the target. The server may indicate the types of capability needed.
2. The target responds with a *ProvideCapabilities* message to the server. The capabilities shall correspond to any capability types specified in step 1. This message shall include the *endTransaction* IE set to TRUE.

5.1.2 Capability Indication procedure

The Capability Indication procedure allows the target to provide unsolicited capabilities to the server and is shown in Figure 5.1.2-1.

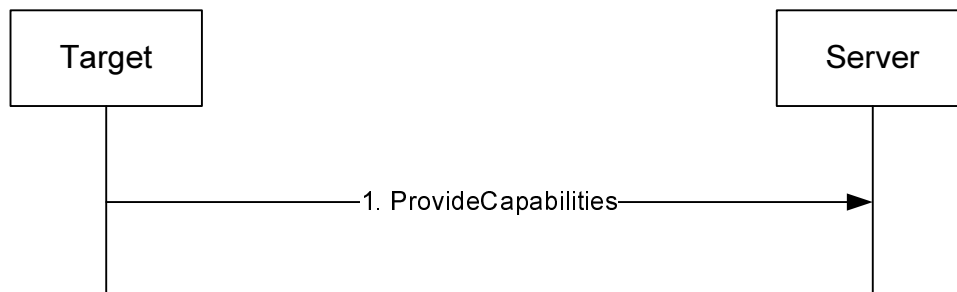

Figure 5.1.2-1: LPP Capability Indication procedure

1. The target sends a *ProvideCapabilities* message to the server. This message shall include the *endTransaction* IE set to TRUE.

5.1.3 Reception of LPP Request Capabilities

Upon receiving a *RequestCapabilities* message, the target device shall generate a *ProvideCapabilities* message as a response.

The target device shall:

- 1> for each positioning method for which a request for capabilities is included in the message:
 - 2> if the target device supports this positioning method:
 - 3> include the capabilities of the device for that supported positioning method in the response message;
- 1> set the IE *LPP-TransactionID* in the response message to the same value as the IE *LPP-TransactionID* in the received message;
- 1> deliver the response message to lower layers for transmission.

5.1.4 Transmission of LPP Provide Capabilities

When triggered to transmit a *ProvideCapabilities* message, the target device shall:

- 1> for each positioning method whose capabilities are to be indicated:
 - 2> set the corresponding IE to include the device's capabilities;
 - 2> if OTDOA capabilities are to be indicated:
 - 3> include the IE *supportedBandListEUTRA*;
- 1> deliver the response to lower layers for transmission.

5.2 Procedures related to Assistance Data Transfer

The purpose of the procedures in this clause is to enable the target to request assistance data from the server to assist in positioning, and to enable the server to transfer assistance data to the target in the absence of a request.

These procedures instantiate the Assistance Data Transfer transaction from TS 36.305 [2] and TS 38.305 [40].

5.2.1 Assistance Data Transfer procedure

The Assistance Data Transfer procedure is shown in Figure 5.2.1-1.

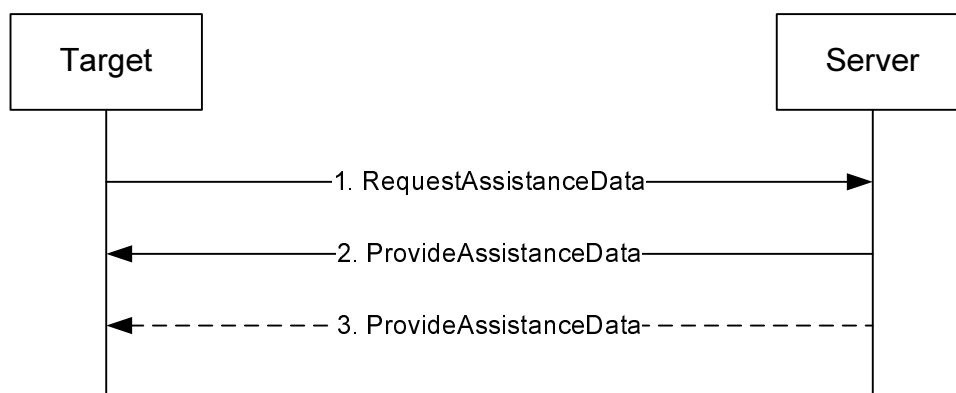

Figure 5.2.1-1: LPP Assistance data transfer procedure

1. The target sends a *RequestAssistanceData* message to the server.
2. The server responds with a *ProvideAssistanceData* message to the target containing assistance data. The transferred assistance data should match or be a subset of the assistance data requested in step 1. The server may

also provide any not requested information that it considers useful to the target. If step 3 does not occur, this message shall set the *endTransaction* IE to TRUE.

- The server may transmit one or more additional *ProvideAssistanceData* messages to the target containing further assistance data. The transferred assistance data should match or be a subset of the assistance data requested in step 1. The server may also provide any not requested information that it considers useful to the target. The last message shall include the *endTransaction* IE set to TRUE.

5.2.1a Periodic Assistance Data Transfer procedure

The Periodic Assistance Data Transfer procedure is shown in Figure 5.2.1a-1. This procedure enables a target to request a server to send assistance data periodically.

NOTE 1: In this version of the specification, periodic assistance data transfer is supported for HA GNSS (e.g., RTK) positioning only.

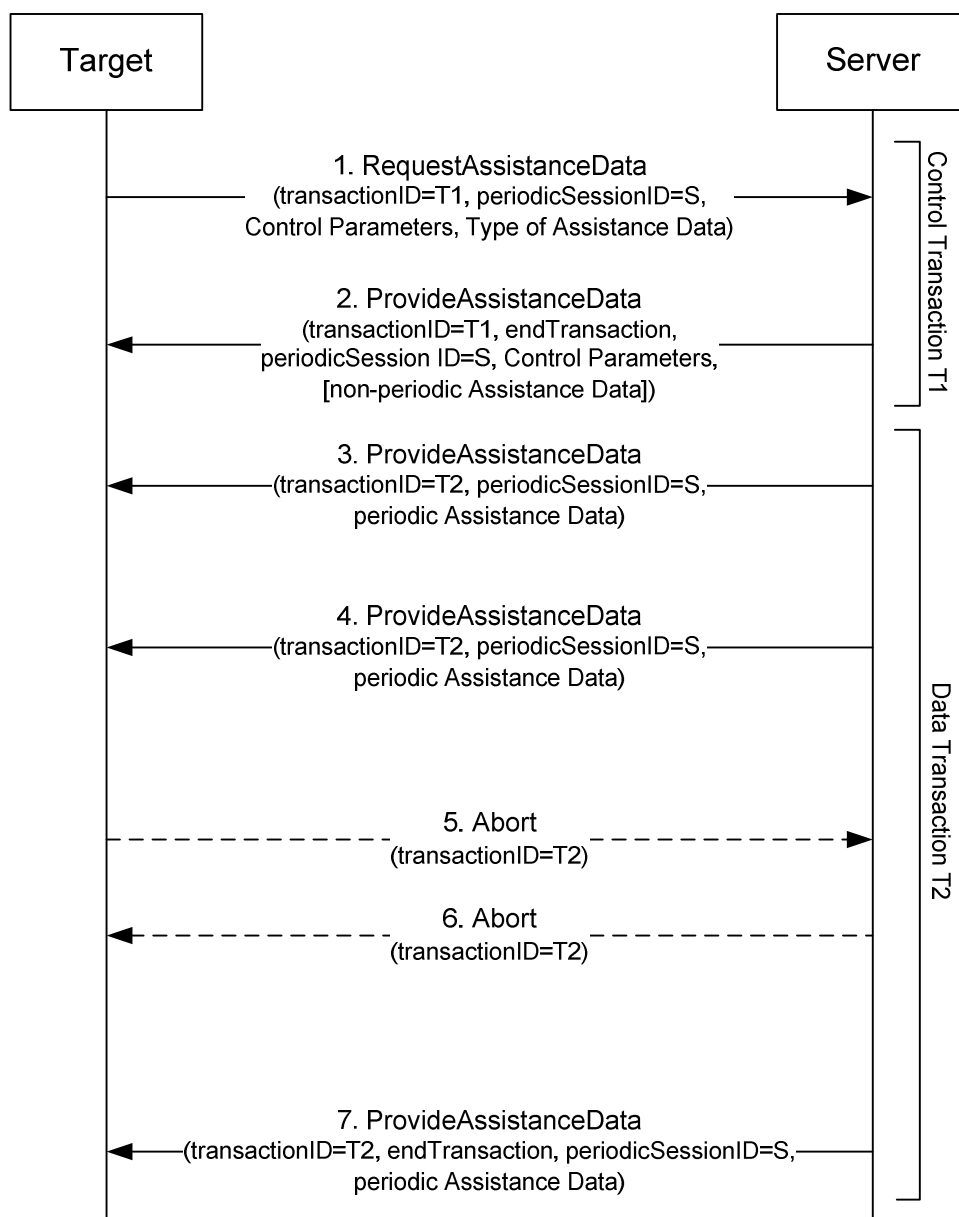

Figure 5.2.1a-1: LPP Periodic Assistance data transfer procedure

1. The target sends a *RequestAssistanceData* message to the server using some available *transactionID* T1. The message contains a *periodicSessionID* S (different to any other *periodicSessionID* currently in use between the target and server) in the IE *CommonIEsRequestAssistanceData*. The message also includes a positioning method specific assistance data request element (e.g., IE *A-GNSS-RequestAssistanceData*) identifying the type of assistance data being requested together with desired periodicity conditions for sending it and a duration for ending the assistance data transfer (e.g., in IE *GNSS-PeriodicAssistDataReq*).
2. The server responds with a *ProvideAssistanceData* message to the target. The message uses the *transactionID* T1 in step 1 and indicates the end of this transaction. The message contains the *periodicSessionID* S in IE *CommonIEsProvideAssistanceData*. If the request can be supported, the message contains the control parameters in the positioning method specific assistance data (e.g., IE *A-GNSS-ProvideAssistanceData*) which may confirm or redefine the type of assistance data or periodicity parameters requested at step 1 (e.g., in IE *GNSS-PeriodicAssistData*). If the target requested non-periodic assistance data in addition to the periodic assistance data in step 1, the *ProvideAssistanceData* message may also include the non-periodic assistance data in this step 2 (but not any periodic assistance data).
If the request cannot be supported (fully or partly), an error reason is provided in the positioning method specific IE (e.g., IE *A-GNSS-Error*). If the request cannot even partly be supported remaining steps are then not performed.

NOTE 2: The target device infers from an absence of the *periodicSessionID* that the location server does not support periodic assistance data delivery. In that case, the target device does not expect the Data Transaction (Steps 3-7).

3. When the first periodic message is available, the server sends an unsolicited *ProvideAssistanceData* message to the target containing the *periodicSessionID* S and the periodic assistance data confirmed in step 2. The message uses some available *transactionID* T2 that may be different to T1.

NOTE 3: The positioning method specific control parameters (e.g., IE *GNSS-PeriodicAssistData*) are not included in the data transaction.

4. The server may continue to send further *ProvideAssistanceData* messages to the target containing the periodic assistance data confirmed or redefined in step 2 when each additional periodicity condition occurs.

NOTE 4: The target device expects a *ProvideAssistanceData* messages at the in Step 2 confirmed interval(s). If some or all of the assistance data is not available at each periodic interval, an error indication is provided in the positioning method specific IE (e.g., IE *A-GNSS-Error*).

5. If the target requires the session to end, the target sends an *Abort* message to the server for transaction T2 that may optionally include an *abortCause*. Remaining steps are then omitted.
6. If the server requires the session to end, the server sends an *Abort* message to the target for transaction T2 that may optionally include an *abortCause*. Remaining steps are then omitted.
7. When the duration or other conditions for ending the periodic assistance data transfer occur, the last *ProvideAssistanceData* message transferred indicates the end of transaction T2.

5.2.1b Periodic Assistance Data Transfer with Update procedure

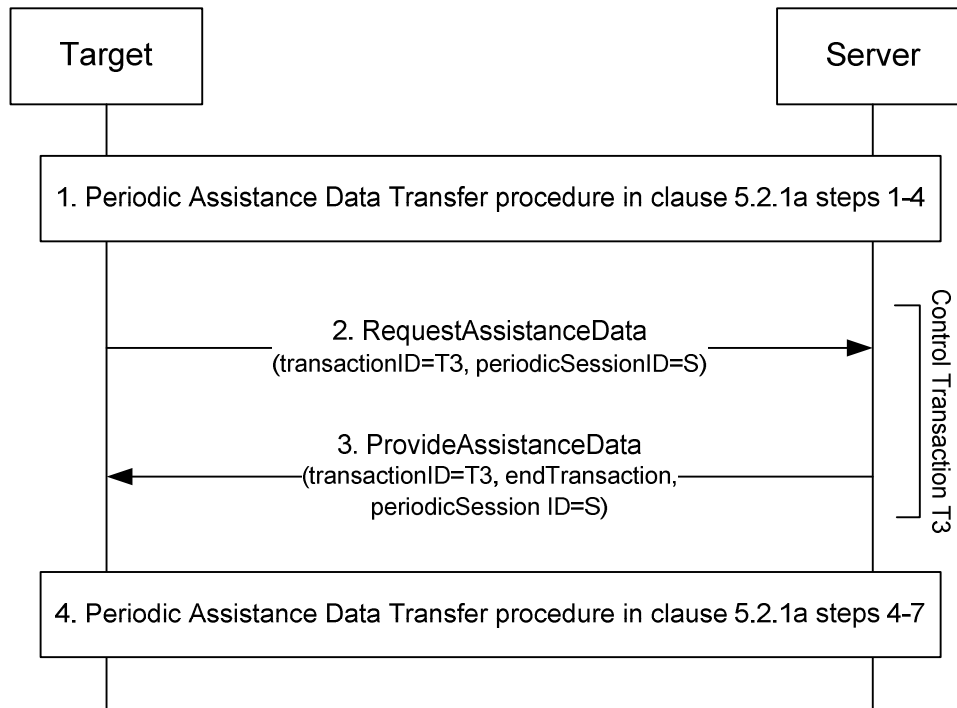

Figure 5.2.1b-1: LPP Periodic Assistance data transfer with update procedure

1. Steps 1-2 and optionally steps 3-4 are performed for the Periodic Assistance Data Transfer procedure in clause 5.2.1a with the following exceptions:
 - The *RequestAssistanceData* message in step 1 indicates the update capabilities of the target device.
 - The *ProvideAssistanceData* message in step 2 indicates the update capabilities of the target device which are supported by the server.
2. If the target device changes its primary cell and if the update capabilities of the target device supported by the server in step 1 include update of a primary cell ID, the target device sends a *RequestAssistanceData* message to the server using some available *transactionID* T3, which is different from T2 (previously used in step 2). The message contains the *periodicSessionID* S (previously used in step 1) and the new primary cell ID in the IE *CommonIEsRequestAssistanceData*.
3. The server responds with a *ProvideAssistanceData* message to the target. The message uses the *transactionID* T3 in step 2 and indicates the end of this transaction. The message contains the *periodicSessionID* S in IE *CommonIEsProvideAssistanceData*. Steps 2-3 are repeated each time the target device changes its primary cell.
4. Steps 4-7 are performed for the Periodic Assistance Data Transfer procedure in clause 5.2.1a.

5.2.2 Assistance Data Delivery procedure

The Assistance Data Delivery procedure allows the server to provide unsolicited assistance data to the target and is shown in Figure 5.2.2-1.

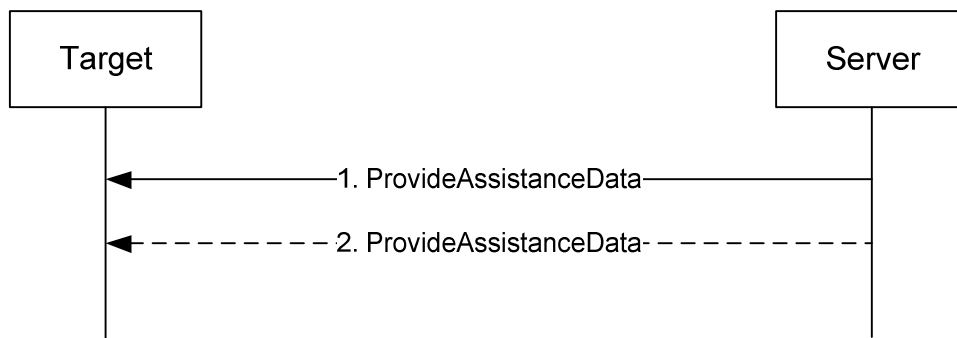

Figure 5.2.2-1: LPP Assistance data transfer procedure

1. The server sends a *ProvideAssistanceData* message to the target containing assistance data. If step 2 does not occur, this message shall set the *endTransaction* IE to TRUE.
2. The server may transmit one or more additional *ProvideAssistanceData* messages to the target containing additional assistance data. The last message shall include the *endTransaction* IE set to TRUE.

5.2.2a Periodic Assistance Data Delivery procedure

The Periodic Assistance Data Delivery procedure allows the server to provide unsolicited periodic assistance data to the target and is shown in Figure 5.2.2a-1.

NOTE 1: In this version of the specification, periodic assistance data delivery is supported for HA GNSS (e.g., RTK) positioning only.

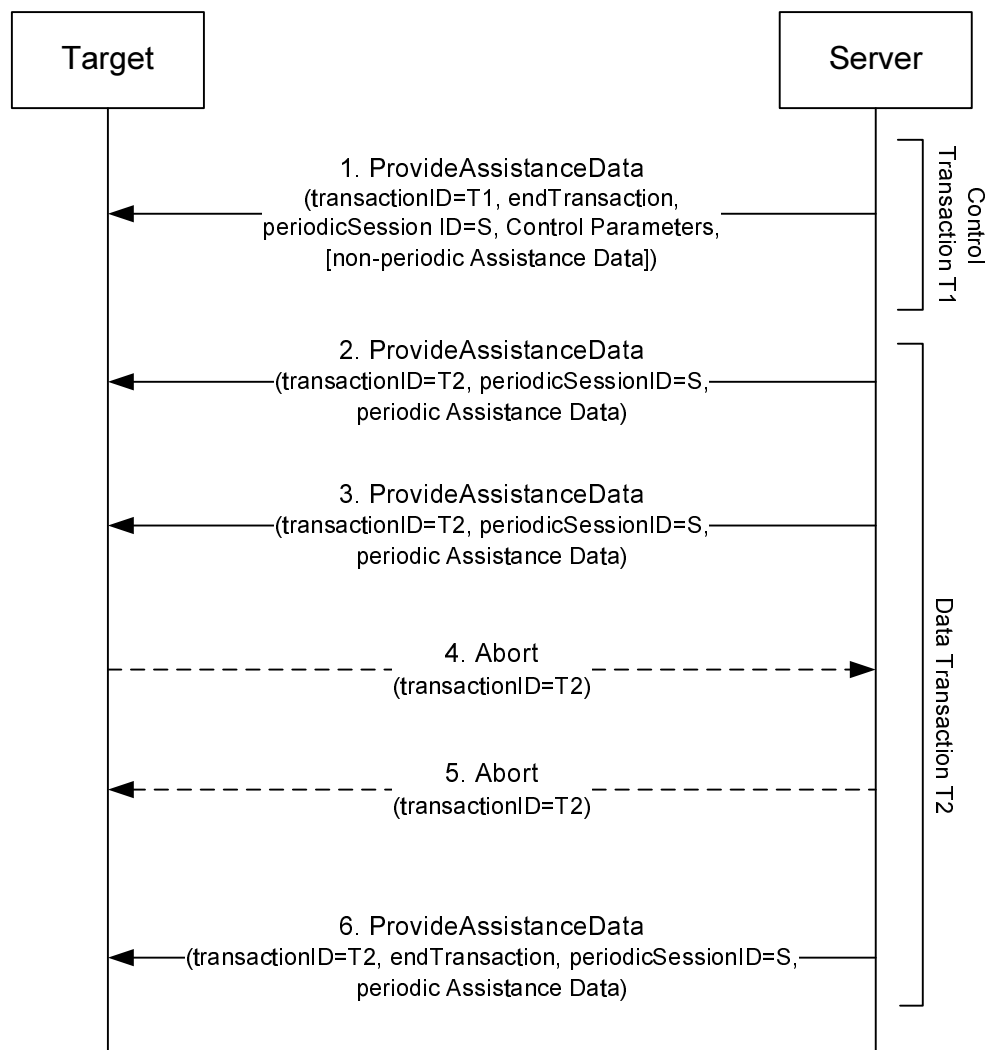

Figure 5.2.2a-1: LPP Periodic Assistance data delivery procedure

1. The server sends a *ProvideAssistanceData* message to the target using some available *transactionID* T1 and indicates the end of this transaction. The message contains a *periodicSessionID* S (different to any other *periodicSessionID* currently in use between the server and target) in the IE *CommonIEsProvideAssistanceData*. The message includes positioning method specific assistance data control parameters (e.g., in IE *A-GNSS-ProvideAssistanceData*) identifying the type of periodic assistance data being delivered together with periodicity conditions for sending it and a duration for ending the assistance data delivery (e.g., in IE *GNSS-PeriodicAssistData*). The *ProvideAssistanceData* message may also include non-periodic assistance data (but not any periodic assistance data).
2. When the first periodic message is available, the server sends an unsolicited *ProvideAssistanceData* message to the target containing the *periodicSessionID* S and the periodic assistance data announced in step 1. The message uses some available *transactionID* T2 that may be different to T1.

NOTE 2: The positioning method specific control parameters (e.g., IE *GNSS-PeriodicAssistData*) are not included in the data transaction.

3. The server may continue to send further *ProvideAssistanceData* messages to the target containing the periodic assistance data announced in step 2 when each additional periodicity condition occurs.

NOTE3: The target device expects a *ProvideAssistanceData* messages at the in Step 2 announced interval(s). If some or all of the assistance data is not available at each periodic interval, an error indication is provided in the positioning method specific IE (e.g., IE *A-GNSS-Error*).

4. If the target requires the session to end, the target sends an *Abort* message to the server for transaction T2 that may optionally include an *abortCause*. Remaining steps are then omitted.
5. If the server requires the session to end, the server sends an *Abort* message to the target for transaction T2 that may optionally include an *abortCause*. Remaining steps are then omitted.
6. When the duration or other conditions for ending the periodic assistance data transfer occur, the last *ProvideAssistanceData* message transferred indicates the end of transaction T2.

5.2.3 Transmission of LPP Request Assistance Data

When triggered to transmit a *RequestAssistanceData* message, the target device shall:

- 1> set the IEs for the positioning-method-specific request for assistance data to request the data indicated by upper layers.

5.2.4 Reception of LPP Provide Assistance Data

Upon receiving a *ProvideAssistanceData* message, the target device shall:

- 1> for each positioning method contained in the message:
 - 2> deliver the related assistance data to upper layers.

5.3 Procedures related to Location Information Transfer

The purpose of the procedures in this clause is to enable the server to request location measurement data and/or a location estimate from the target, and to enable the target to transfer location measurement data and/or a location estimate to a server in the absence of a request.

These procedures instantiate the Location Information Transfer transaction in TS 36.305 [2] and TS 38.305 [40].

NOTE: The service layer (e.g. NAS or OMA SUPL ULP) would be used to transfer information associated with a location request from a target to a server (MO-LR).

5.3.1 Location Information Transfer procedure

The Location Information Transfer procedure is shown in Figure 5.3.1-1.

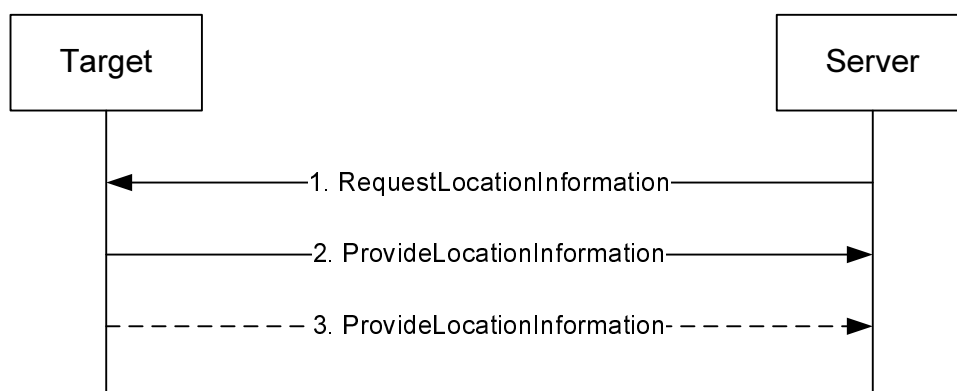

Figure 5.3.1-1: LPP Location Information transfer procedure

1. The server sends a *RequestLocationInformation* message to the target to request location information, indicating the type of location information needed and potentially the associated QoS.

2. The target sends a *ProvideLocationInformation* message to the server to transfer location information. The location information transferred should match or be a subset of the location information requested in step 1 unless the server explicitly allows additional location information. If step 3 does not occur, this message shall set the *endTransaction* IE to TRUE.
3. If requested in step 1, the target sends additional *ProvideLocationInformation* messages to the server to transfer location information. The location information transferred should match or be a subset of the location information requested in step 1 unless the server explicitly allows additional location information. The last message shall include the *endTransaction* IE set to TRUE.

5.3.2 Location Information Delivery procedure

The Location Information Delivery allows the target to provide unsolicited location information to the server. The procedure is shown in Figure 5.3.2-1.

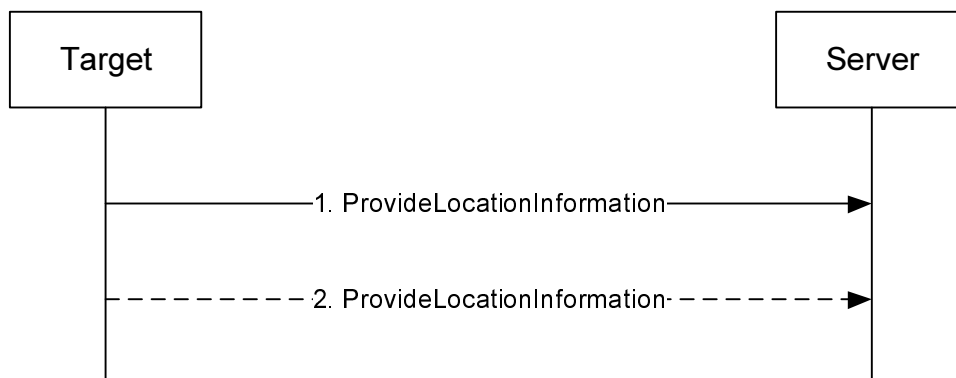

Figure 5.3.2-1: LPP Location Information Delivery procedure

1. The target sends a *ProvideLocationInformation* message to the server to transfer location information. If step 2 does not occur, this message shall set the *endTransaction* IE to TRUE.
2. The target may send one or more additional *ProvideLocationInformation* messages to the server containing additional location information data. The last message shall include the *endTransaction* IE set to TRUE.

5.3.3 Reception of Request Location Information

Upon receiving a *RequestLocationInformation* message, the target device shall:

- 1> if the requested information is compatible with the target device capabilities and configuration:
 - 2> include the requested information in a *ProvideLocationInformation* message;
 - 2> set the IE *LPP-TransactionID* in the response to the same value as the IE *LPP-TransactionID* in the received message;
 - 2> deliver the *ProvideLocationInformation* message to lower layers for transmission.
- 1> otherwise:
 - 2> if one or more positioning methods are included that the target device does not support:
 - 3> continue to process the message as if it contained only information for the supported positioning methods;
 - 3> handle the signaling content of the unsupported positioning methods by LPP error detection as in 5.4.3.

5.3.4 Transmission of Provide Location Information

When triggered to transmit *ProvideLocationInformation* message, the target device shall:

- 1> for each positioning method contained in the message:
 - 2> set the corresponding IE to include the available location information;
- 1> deliver the response to lower layers for transmission.

5.4 Error Handling Procedures

5.4.1 General

This clause describes how a receiving entity (target device or location server) behaves in cases when it receives erroneous or unexpected data or detects that certain data are missing.

5.4.2 Procedures related to Error Indication

Figure 5.4.2-1 shows the Error indication procedure.

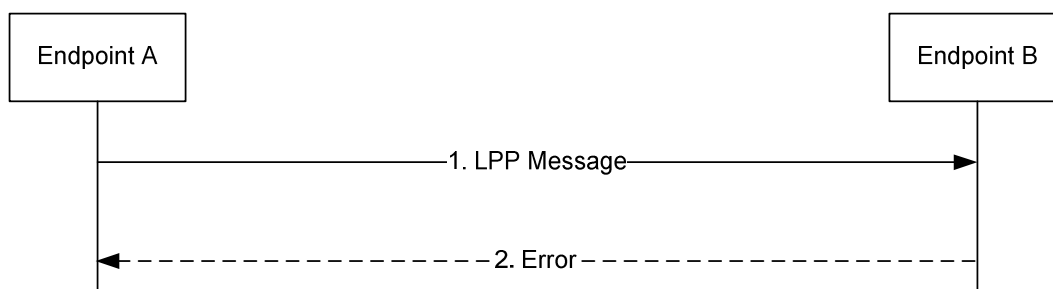

Figure 5.4.2-1: LPP Error Indication procedure

1. Endpoint A sends an LPP message to Endpoint B.
2. Endpoint B determines that the LPP message in step 1 contains an error. Endpoint B returns an *Error* message to Endpoint A indicating the error or errors and discards the message in step 1. If Endpoint B is able to determine that the erroneous LPP message in step 1 is an LPP Error or Abort Message, Endpoint B discards the message in step 1 without returning an *Error* message to Endpoint A.

5.4.3 LPP Error Detection

Upon receiving any LPP message, the receiving entity shall attempt to decode the message and verify the presence of any errors and:

- 1> if decoding errors are encountered:
 - 2> if the receiver can not determine that the received message is an LPP *Error* or *Abort* message:
 - 3> return an LPP *Error* message to the sender and include the received *LPP-TransactionID*, if this was decoded, and type of error;
 - 3> if the receiver can determine the session and the *LPP-TransactionID* and the received message includes the IE *SegmentationInfo* and the receiver has previously stored message segments for this session and *LPP-TransactionID*:
 - 4> discard all stored LPP message segments for this session and *LPP-TransactionID*;
 - 3> discard the received message and stop the error detection procedure;

- 1> if the message is a duplicate of a previously received message:
 - 2> discard the message and stop the error detection procedure;
- 1> if the *LPP-TransactionID* matches the *LPP-TransactionID* for a procedure that is still ongoing for the same session and the message type is invalid for the current state of the procedure:
 - 2> abort the ongoing procedure;
 - 2> return an LPP *Error* message to the sender and include the received transaction ID and type of error;
 - 2> if the message includes the IE *SegmentationInfo* and the receiver has previously stored message segments for this session and *LPP-TransactionID*:
 - 3> discard all stored LPP message segments for this session and *LPP-TransactionID*;
 - 2> discard the message and stop the error detection procedure;
- 1> if the message includes the IE *SegmentationInfo*:
 - 2> if the receiver has previously stored LPP message segments for this session and *LPP-TransactionID*:
 - 3> if the received message type is different to the stored message type:
 - 4> return an LPP *Error* message to the sender and include the received transaction ID and type of error;
 - 4> discard the message and all stored LPP message segments for this session and *LPP-TransactionID* and stop the error detection procedure;
 - 2> if the IE *SegmentationInfo* has the value *moreMessagesOnTheWay*:
 - 3> store the received message;
 - NOTE: As an implementation option, the receiver of an LPP Provide Assistance Data or LPP Provide Location Information message may process the received message segment instead of storing the message.
 - 2> if the IE *SegmentationInfo* has the value *noMoreMessages*:
 - 3> continue error detection for the received message and any stored LPP message segments for this session and *LPP-TransactionID*;
 - 1> if the message type is an LPP *RequestCapabilities* and some of the requested information is not supported:
 - 2> return any information that can be provided in a normal response.
 - 1> if the message type is an LPP *RequestAssistanceData* or *RequestLocationInformation* and some or all of the requested information is not supported:
 - 2> return any information that can be provided in a normal response, which includes indications on other information that is not supported.

5.4.4 Reception of an LPP Error Message

Upon receiving an *Error* message, a device shall:

- 1> abort any ongoing procedure associated with the *LPP-TransactionID* if included in the received message.

The device may:

- 1> restart the aborted procedure taking into consideration the returned error information.

5.5 Abort Procedure

5.5.1 General

The purpose of the abort procedure is to allow the target device or location server to abort an ongoing procedure due to some unexpected event (e.g., cancellation of a location request by an LCS client). It can also be used to stop an ongoing procedure (e.g., periodic location reporting from the target device).

5.5.2 Procedures related to Abort

Figure 5.5.2-1 shows the Abort procedure.

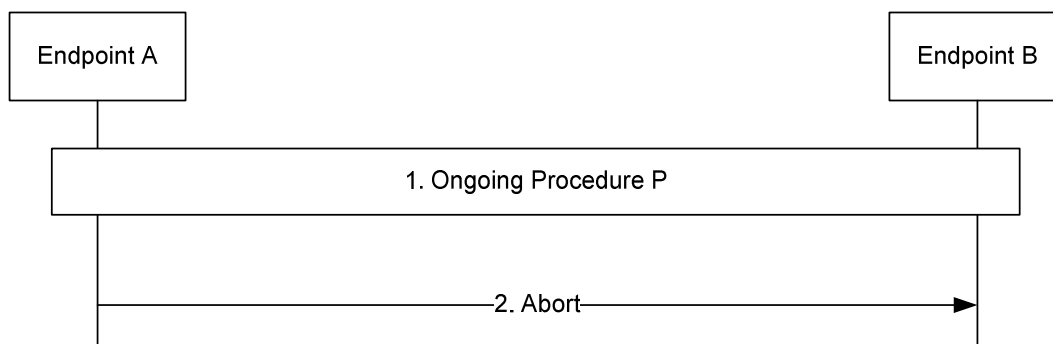

Figure 5.5.2-1: LPP Abort procedure

1. A procedure P is ongoing between endpoints A and B.
2. Endpoint A determines that the procedure must be aborted and sends an *Abort* message to Endpoint B carrying the transaction ID for procedure P. Endpoint B aborts procedure P.

5.5.3 Reception of an LPP Abort Message

Upon receiving an *Abort* message, a device shall:

- 1> abort any ongoing procedure associated with the transaction ID indicated in the message.

6 Information Element Abstract Syntax Definition

6.1 General

The contents of each LPP message is specified in clause 6.2 using ASN.1 to specify the message syntax and using tables when needed to provide further detailed information about the fields specified in the message syntax.

The ASN.1 in this clause uses the same format and coding conventions as described in Annex A of TS 36.331 [12].

Transfer syntax for LPP messages is derived from their ASN.1 definitions by use of Basic Packed Encoding Rules (BASIC-PER), Unaligned Variant, as specified in ITU-T Rec. X.691 [22]. The encoded LPP message always contains a multiple of 8 bits.

Transfer syntax for LPP IEs is derived from their ASN.1 definitions by use of Basic Packed Encoding Rules (BASIC-PER), Unaligned Variant, as specified in ITU-T Rec. X.691 [22]. The encoded LPP IE always contains a multiple of 8 bits. This applies when a single LPP IE is encoded as the basic production, i.e. for other purposes than encoding the LPP IE within an LPP message.

The need for fields to be present in a message or an abstract type, i.e., the ASN.1 fields that are specified as OPTIONAL in the abstract notation (ASN.1), is specified by means of comment text tags attached to the OPTIONAL

statement in the abstract syntax. The meaning of each tag is specified in table 6.1-1. The use of these tags in the uplink (target to server) direction does not impose any requirements on the server.

Table 6.1-1: Meaning of abbreviations used to specify the need for fields to be present

Abbreviation	Meaning
Cond <i>conditionTag</i>	<i>Conditionally present</i> A field for which the need is specified by means of conditions. For each <i>conditionTag</i> , the need is specified in a tabular form following the ASN.1 segment. In case, according to the conditions, a field is not present, the target takes no action and where applicable shall continue to use the existing value (and/or the associated functionality) unless explicitly stated otherwise in the description of the field itself.
Need OP	<i>Optionally present</i> A field that is optional to signal. For downlink messages, the target is not required to take any special action on absence of the field beyond what is specified in the procedural text or the field description table following the ASN.1 segment. The target behaviour on absence should be captured either in the procedural text or in the field description.
Need ON	<i>Optionally present, No action</i> A field that is optional to signal. If the message is received by the target, and in case the field is absent, the target takes no action and where applicable shall continue to use the existing value (and/or the associated functionality).
Need OR	<i>Optionally present, Release</i> A field that is optional to signal. If the message is received by the target, and in case the field is absent, the target shall discontinue/ stop using/ delete any existing value (and/ or the associated functionality).

When specifying information elements which are to be represented by BIT STRINGS, if not otherwise specifically stated in the field description of the concerned IE or elsewhere, the following principle applies with regards to the ordering of bits:

- The first bit (leftmost bit) contains the most significant bit (MSB);
- the last bit (rightmost bit) contains the least significant bit (LSB).

6.2 LPP PDU Structure

– *LPP-PDU-Definitions*

This ASN.1 segment is the start of the LPP PDU definitions.

```
-- ASN1START
LPP-PDU-Definitions {
itu-t (0) identified-organization (4) etsi (0) mobileDomain (0)
eps-Access (21) modules (3) lpp (7) version1 (1) lpp-PDU-Definitions (1) }
DEFINITIONS AUTOMATIC TAGS ::=
BEGIN
-- ASN1STOP
```

– *LPP-Message*

The *LPP-Message* provides the complete set of information for an invocation or response pertaining to an LPP transaction.

```
-- ASN1START
LPP-Message ::= SEQUENCE {
  transactionID      LPP-TransactionID  OPTIONAL,  -- Need ON
  endTransaction    BOOLEAN,
  sequenceNumber    SequenceNumber     OPTIONAL,  -- Need ON
  acknowledgement   Acknowledgement    OPTIONAL,  -- Need ON
  lpp-MessageBody   LPP-MessageBody    OPTIONAL  -- Need ON
```

```

}
SequenceNumber ::= INTEGER (0..255)
Acknowledgement ::= SEQUENCE {
    ackRequested    BOOLEAN,
    ackIndicator    SequenceNumber    OPTIONAL
}
-- ASN1STOP

```

LPP-Message field descriptions

transactionID	This field is omitted if an <i>lpp-MessageBody</i> is not present (i.e. in an LPP message sent only to acknowledge a previously received message) or if it is not available to the transmitting entity (e.g., in an <i>LPP-Error</i> message triggered by a message that could not be parsed). If present, this field shall be ignored at a receiver in an LPP message for which the <i>lpp-MessageBody</i> is not present.
endTransaction	This field indicates whether an LPP message is the last message carrying an <i>lpp-MessageBody</i> in a transaction (TRUE) or not last (FALSE). When LPP message segmentation is used, only the final LPP message segment may indicate the end of the transaction.
sequenceNumber	This field may be included when LPP operates over the control plane and an <i>lpp-MessageBody</i> is included but shall be omitted otherwise.
acknowledgement	This field is included in an LPP acknowledgement and in any LPP message requesting an acknowledgement when LPP operates over the control plane and is omitted otherwise.
ackRequested	This field indicates whether an LPP acknowledgement is requested (TRUE) or not (FALSE). A value of TRUE may only be included when an <i>lpp-MessageBody</i> is included.
ackIndicator	This field indicates the sequence number of the message being acknowledged.
lpp-MessageBody	This field may be omitted in the case the message is sent only to acknowledge a previously received message.

– *LPP-MessageBody*

The *LPP-MessageBody* identifies the type of an LPP message and contains all LPP information specifically associated with that type.

```

-- ASN1START
LPP-MessageBody ::= CHOICE {
    c1 CHOICE {
        requestCapabilities    RequestCapabilities,
        provideCapabilities    ProvideCapabilities,
        requestAssistanceData  RequestAssistanceData,
        provideAssistanceData  ProvideAssistanceData,
        requestLocationInformation RequestLocationInformation,
        provideLocationInformation ProvideLocationInformation,
        abort                  Abort,
        error                  Error,
        spare7 NULL, spare6 NULL, spare5 NULL, spare4 NULL,
        spare3 NULL, spare2 NULL, spare1 NULL, spare0 NULL
    },
    messageClassExtension SEQUENCE {}
}
-- ASN1STOP

```

– *LPP-TransactionID*

The *LPP-TransactionID* identifies a particular LPP transaction and the initiator of the transaction.

```

-- ASN1START
LPP-TransactionID ::= SEQUENCE {
    initiator Initiator,

```

```

    transactionNumber      TransactionNumber,
    ...
}

Initiator ::= ENUMERATED {
    locationServer,
    targetDevice,
    ...
}

TransactionNumber ::= INTEGER (0..255)

-- ASN1STOP

```

6.3 Message Body IEs

– *RequestCapabilities*

The *RequestCapabilities* message body in a LPP message is used by the location server to request the target device capability information for LPP and the supported individual positioning methods.

```

-- ASN1START

RequestCapabilities ::= SEQUENCE {
    criticalExtensions      CHOICE {
        c1                  CHOICE {
            requestCapabilities-r9      RequestCapabilities-r9-IEs,
            spare3 NULL, spare2 NULL, spare1 NULL
        },
        criticalExtensionsFuture      SEQUENCE {}
    }
}

RequestCapabilities-r9-IEs ::= SEQUENCE {
    commonIEsRequestCapabilities      CommonIEsRequestCapabilities      OPTIONAL, -- Need ON
    a-gnss-RequestCapabilities        A-GNSS-RequestCapabilities        OPTIONAL, -- Need ON
    otdoa-RequestCapabilities          OTDOA-RequestCapabilities          OPTIONAL, -- Need ON
    ecid-RequestCapabilities           ECID-RequestCapabilities           OPTIONAL, -- Need ON
    epdu-RequestCapabilities           EPDU-Sequence                       OPTIONAL, -- Need ON
    ...,
    [[ sensor-RequestCapabilities-r13  Sensor-RequestCapabilities-r13    OPTIONAL, -- Need ON
       tbs-RequestCapabilities-r13     TBS-RequestCapabilities-r13     OPTIONAL, -- Need ON
       wlan-RequestCapabilities-r13    WLAN-RequestCapabilities-r13    OPTIONAL, -- Need ON
       bt-RequestCapabilities-r13      BT-RequestCapabilities-r13      OPTIONAL, -- Need ON
    ]],
    [[ nr-ECID-RequestCapabilities-r16  NR-ECID-RequestCapabilities-r16    OPTIONAL, -- Need ON
       nr-Multi-RTT-RequestCapabilities-r16
                                           NR-Multi-RTT-RequestCapabilities-r16
                                           OPTIONAL, -- Need ON
       nr-DL-AoD-RequestCapabilities-r16
                                           NR-DL-AoD-RequestCapabilities-r16  OPTIONAL, -- Need ON
       nr-DL-TDOA-RequestCapabilities-r16
                                           NR-DL-TDOA-RequestCapabilities-r16  OPTIONAL, -- Need ON
       nr-UL-RequestCapabilities-r16    NR-UL-RequestCapabilities-r16     OPTIONAL, -- Need ON
    ]]
}

-- ASN1STOP

```

– *ProvideCapabilities*

The *ProvideCapabilities* message body in a LPP message indicates the LPP capabilities of the target device to the location server.

```

-- ASN1START

ProvideCapabilities ::= SEQUENCE {
    criticalExtensions      CHOICE {
        c1                  CHOICE {
            provideCapabilities-r9      ProvideCapabilities-r9-IEs,

```

```

        spare3 NULL, spare2 NULL, spare1 NULL
    },
    criticalExtensionsFuture    SEQUENCE {}
}
}
ProvideCapabilities-r9-IEs ::= SEQUENCE {
    commonIEsProvideCapabilities    CommonIEsProvideCapabilities    OPTIONAL,
    a-gnss-ProvideCapabilities      A-GNSS-ProvideCapabilities      OPTIONAL,
    otdoa-ProvideCapabilities        OTDOA-ProvideCapabilities        OPTIONAL,
    ecid-ProvideCapabilities          ECID-ProvideCapabilities          OPTIONAL,
    epdu-ProvideCapabilities          EPDU-Sequence                    OPTIONAL,
    . . .
    [[ sensor-ProvideCapabilities-r13  Sensor-ProvideCapabilities-r13    OPTIONAL,
        tbs-ProvideCapabilities-r13     TBS-ProvideCapabilities-r13      OPTIONAL,
        wlan-ProvideCapabilities-r13    WLAN-ProvideCapabilities-r13     OPTIONAL,
        bt-ProvideCapabilities-r13      BT-ProvideCapabilities-r13       OPTIONAL
    ]],
    [[ nr-ECID-ProvideCapabilities-r16  NR-ECID-ProvideCapabilities-r16   OPTIONAL,
        nr-Multi-RTT-ProvideCapabilities-r16
                                                NR-Multi-RTT-ProvideCapabilities-r16   OPTIONAL,
        nr-DL-AoD-ProvideCapabilities-r16
                                                NR-DL-AoD-ProvideCapabilities-r16     OPTIONAL,
        nr-DL-TDOA-ProvideCapabilities-r16
                                                NR-DL-TDOA-ProvideCapabilities-r16   OPTIONAL,
        nr-UL-ProvideCapabilities-r16   NR-UL-ProvideCapabilities-r16     OPTIONAL
    ]]
}
-- ASN1STOP

```

– RequestAssistanceData

The *RequestAssistanceData* message body in a LPP message is used by the target device to request assistance data from the location server.

```

-- ASN1START
RequestAssistanceData ::= SEQUENCE {
    criticalExtensions    CHOICE {
        cl                CHOICE {
            requestAssistanceData-r9    RequestAssistanceData-r9-IEs,
            spare3 NULL, spare2 NULL, spare1 NULL
        },
        criticalExtensionsFuture    SEQUENCE {}
    }
}
RequestAssistanceData-r9-IEs ::= SEQUENCE {
    commonIEsRequestAssistanceData    CommonIEsRequestAssistanceData    OPTIONAL,
    a-gnss-RequestAssistanceData      A-GNSS-RequestAssistanceData      OPTIONAL,
    otdoa-RequestAssistanceData        OTDOA-RequestAssistanceData        OPTIONAL,
    epdu-RequestAssistanceData          EPDU-Sequence                      OPTIONAL,
    . . .
    [[ sensor-RequestAssistanceData-r14  Sensor-RequestAssistanceData-r14    OPTIONAL,
        tbs-RequestAssistanceData-r14     TBS-RequestAssistanceData-r14      OPTIONAL,
        wlan-RequestAssistanceData-r14    WLAN-RequestAssistanceData-r14     OPTIONAL
    ]],
    [[ nr-Multi-RTT-RequestAssistanceData-r16  NR-Multi-RTT-RequestAssistanceData-r16  OPTIONAL,
        nr-DL-AoD-RequestAssistanceData-r16    NR-DL-AoD-RequestAssistanceData-r16    OPTIONAL,
        nr-DL-TDOA-RequestAssistanceData-r16    NR-DL-TDOA-RequestAssistanceData-r16    OPTIONAL
    ]]
}
-- ASN1STOP

```

– ProvideAssistanceData

The *ProvideAssistanceData* message body in a LPP message is used by the location server to provide assistance data to the target device either in response to a request from the target device or in an unsolicited manner.

```

-- ASN1START
ProvideAssistanceData ::= SEQUENCE {
    criticalExtensions CHOICE {
        c1 CHOICE {
            provideAssistanceData-r9 ProvideAssistanceData-r9-IEs,
            spare3 NULL, spare2 NULL, spare1 NULL
        },
        criticalExtensionsFuture SEQUENCE {}
    }
}

ProvideAssistanceData-r9-IEs ::= SEQUENCE {
    commonIEsProvideAssistanceData CommonIEsProvideAssistanceData OPTIONAL, -- Need ON
    a-gnss-ProvideAssistanceData A-GNSS-ProvideAssistanceData OPTIONAL, -- Need ON
    otdoa-ProvideAssistanceData OTDOA-ProvideAssistanceData OPTIONAL, -- Need ON
    epdu-Provide-Assistance-Data EPDU-Sequence OPTIONAL, -- Need ON
    ...,
    [[
    sensor-ProvideAssistanceData-r14 Sensor-ProvideAssistanceData-r14 OPTIONAL, -- Need ON
    tbs-ProvideAssistanceData-r14 TBS-ProvideAssistanceData-r14 OPTIONAL, -- Need ON
    wlan-ProvideAssistanceData-r14 WLAN-ProvideAssistanceData-r14 OPTIONAL -- Need ON
    ]],
    [[
    nr-Multi-RTT-ProvideAssistanceData-r16
        NR-Multi-RTT-ProvideAssistanceData-r16
        OPTIONAL, -- Need ON

    nr-DL-AoD-ProvideAssistanceData-r16
        NR-DL-AoD-ProvideAssistanceData-r16 OPTIONAL, -- Need ON

    nr-DL-TDOA-ProvideAssistanceData-r16
        NR-DL-TDOA-ProvideAssistanceData-r16
        OPTIONAL -- Need ON
    ]]
}
-- ASN1STOP

```

– RequestLocationInformation

The *RequestLocationInformation* message body in a LPP message is used by the location server to request positioning measurements or a position estimate from the target device.

```

-- ASN1START
RequestLocationInformation ::= SEQUENCE {
    criticalExtensions CHOICE {
        c1 CHOICE {
            requestLocationInformation-r9 RequestLocationInformation-r9-IEs,
            spare3 NULL, spare2 NULL, spare1 NULL
        },
        criticalExtensionsFuture SEQUENCE {}
    }
}

RequestLocationInformation-r9-IEs ::= SEQUENCE {
    commonIEsRequestLocationInformation CommonIEsRequestLocationInformation OPTIONAL, -- Need ON
    a-gnss-RequestLocationInformation A-GNSS-RequestLocationInformation OPTIONAL, -- Need ON
    otdoa-RequestLocationInformation OTDOA-RequestLocationInformation OPTIONAL, -- Need ON
    ecid-RequestLocationInformation ECID-RequestLocationInformation OPTIONAL, -- Need ON
    epdu-RequestLocationInformation EPDU-Sequence OPTIONAL, -- Need ON
    ...,
    [[
    sensor-RequestLocationInformation-r13
        Sensor-RequestLocationInformation-r13
        OPTIONAL, -- Need ON

    tbs-RequestLocationInformation-r13 TBS-RequestLocationInformation-r13 OPTIONAL, -- Need ON
    wlan-RequestLocationInformation-r13 WLAN-RequestLocationInformation-r13 OPTIONAL, -- Need ON
    bt-RequestLocationInformation-r13 BT-RequestLocationInformation-r13 OPTIONAL -- Need ON
    ]],
    [[
    nr-ECID-RequestLocationInformation-r16
        NR-ECID-RequestLocationInformation-r16
        OPTIONAL, -- Need ON

    nr-Multi-RTT-RequestLocationInformation-r16
        NR-Multi-RTT-RequestLocationInformation-r16
        OPTIONAL, -- Need ON
    ]]
}

```

```

        nr-DL-AoD-RequestLocationInformation-r16
            NR-DL-AoD-RequestLocationInformation-r16
            OPTIONAL, -- Need ON
        nr-DL-TDOA-RequestLocationInformation-r16
            NR-DL-TDOA-RequestLocationInformation-r16
            OPTIONAL -- Need ON
    ]]
}
-- ASN1STOP

```

RequestLocationInformation field descriptions

commonIEsRequestLocationInformation

This field specifies the location information type requested by the location server and optionally other configuration information associated with the requested location information. This field should always be included in this version of the protocol.

– *ProvideLocationInformation*

The *ProvideLocationInformation* message body in a LPP message is used by the target device to provide positioning measurements or position estimates to the location server.

```

-- ASN1START
ProvideLocationInformation ::= SEQUENCE {
    criticalExtensions      CHOICE {
        cl                  CHOICE {
            provideLocationInformation-r9 ProvideLocationInformation-r9-IEs,
            spare3 NULL, spare2 NULL, spare1 NULL
        },
        criticalExtensionsFuture SEQUENCE {}
    }
}

ProvideLocationInformation-r9-IEs ::= SEQUENCE {
    commonIEsProvideLocationInformation
        CommonIEsProvideLocationInformation OPTIONAL,
    a-gnss-ProvideLocationInformation A-GNSS-ProvideLocationInformation OPTIONAL,
    otdoa-ProvideLocationInformation OTDOA-ProvideLocationInformation OPTIONAL,
    ecid-ProvideLocationInformation ECID-ProvideLocationInformation OPTIONAL,
    epdu-ProvideLocationInformation EPDU-Sequence OPTIONAL,
    ...,
    [[
    sensor-ProvideLocationInformation-r13
        Sensor-ProvideLocationInformation-r13
        OPTIONAL,
    tbs-ProvideLocationInformation-r13 TBS-ProvideLocationInformation-r13 OPTIONAL,
    wlan-ProvideLocationInformation-r13 WLAN-ProvideLocationInformation-r13 OPTIONAL,
    bt-ProvideLocationInformation-r13 BT-ProvideLocationInformation-r13 OPTIONAL
    ]],
    [[
    nr-ECID-ProvideLocationInformation-r16
        NR-ECID-ProvideLocationInformation-r16 OPTIONAL,
    nr-Multi-RTT-ProvideLocationInformation-r16
        NR-Multi-RTT-ProvideLocationInformation-r16 OPTIONAL,
    nr-DL-AoD-ProvideLocationInformation-r16
        NR-DL-AoD-ProvideLocationInformation-r16 OPTIONAL,
    nr-DL-TDOA-ProvideLocationInformation-r16
        NR-DL-TDOA-ProvideLocationInformation-r16 OPTIONAL
    ]]
}
-- ASN1STOP

```

– *Abort*

The *Abort* message body in a LPP message carries a request to abort an ongoing LPP procedure.

```

-- ASN1START
Abort ::= SEQUENCE {
    criticalExtensions      CHOICE {

```

```

        c1 CHOICE {
            abort-r9 Abort-r9-IEs,
            spare3 NULL, spare2 NULL, spare1 NULL
        },
        criticalExtensionsFuture SEQUENCE {}
    }
}

Abort-r9-IEs ::= SEQUENCE {
    commonIEsAbort CommonIEsAbort OPTIONAL, -- Need ON
    ...,
    epdu-Abort EPDU-Sequence OPTIONAL -- Need ON
}

-- ASN1STOP

```

– Error

The *Error* message body in a LPP message carries information concerning a LPP message that was received with errors.

```

-- ASN1START

Error ::= CHOICE {
    error-r9 Error-r9-IEs,
    criticalExtensionsFuture SEQUENCE {}
}

Error-r9-IEs ::= SEQUENCE {
    commonIEsError CommonIEsError OPTIONAL, -- Need ON
    ...,
    epdu-Error EPDU-Sequence OPTIONAL -- Need ON
}

-- ASN1STOP

```

6.4 Common IEs

Common IEs comprise IEs that are applicable to more than one LPP positioning method.

6.4.1 Common Lower-Level IEs

– AccessTypes

The IE *AccessTypes* is used to indicate several cellular access types using a bit map.

```

-- ASN1START

AccessTypes ::= SEQUENCE {
    accessTypes BIT STRING {
        eutra (0),
        ultra (1),
        gsm (2),
        nb-iot (3),
        nr-v1510 (4) } (SIZE (1..8)),
    ...
}

-- ASN1STOP

```

AccessTypes field descriptions

accessTypes

This field specifies the cellular access type(s). This is represented by a bit string, with a one-value at the bit position means the particular access type is addressed; a zero-value means not addressed.

– *ARFCN-ValueEUTRA*

The IEs *ARFCN-ValueEUTRA* and *ARFCN-ValueEUTRA-v9a0* are used to indicate the ARFCN of the E-UTRA carrier frequency, as defined in TS 36.331 [12].

```
-- ASN1START
ARFCN-ValueEUTRA ::= INTEGER (0..maxEARFCN)
ARFCN-ValueEUTRA-v9a0 ::= INTEGER (maxEARFCN-Plus1..maxEARFCN2)
ARFCN-ValueEUTRA-r14 ::= INTEGER (0..maxEARFCN2)
-- ASN1STOP
```

NOTE: For fields using the original value range, as defined by IE *ARFCN-ValueEUTRA* i.e. without suffix, value *maxEARFCN* indicates that the E-UTRA carrier frequency is indicated by means of an extension.

– *ARFCN-ValueNR*

The IE *ARFCN-ValueNR* is used to indicate the ARFCN applicable for a downlink, uplink or bi-directional (TDD) NR global frequency raster, as defined in TS 38.101-2 [34] and TS 38.101-1 [37].

```
-- ASN1START
ARFCN-ValueNR-r15 ::= INTEGER (0..3279165)
-- ASN1STOP
```

– *ARFCN-ValueUTRA*

The IE *ARFCN-ValueUTRA* is used to indicate the ARFCN of the UTRA carrier frequency, as defined in TS 25.331 [13].

```
-- ASN1START
ARFCN-ValueUTRA ::= INTEGER (0..16383)
-- ASN1STOP
```

– *CarrierFreq-NB*

The IE *CarrierFreq-NB* is used to provide the NB-IoT carrier frequency, as defined in TS 36.101 [21].

```
-- ASN1START
CarrierFreq-NB-r14 ::= SEQUENCE {
    carrierFreq-r14          ARFCN-ValueEUTRA-r14,
    carrierFreqOffset-r14   CarrierFreqOffsetNB-r14 OPTIONAL,
    ...
}
-- ASN1STOP
```

***CarrierFreq-NB* field descriptions**

carrierFreq

This field specifies the ARFCN applicable for the NB-IoT carrier frequency as defined in TS 36.101 [21, Table 5.7.3-1].

carrierFreqOffset

This field specifies the offset of the NB-IoT channel number to EARFCN as defined in TS 36.101 [21].

– *CarrierFreqOffsetNB*

The IE *CarrierFreqOffsetNB* is used to provide the offset of the NB-IoT channel number to EARFCN of a NB-IoT carrier.

```

-- ASN1START
CarrierFreqOffsetNB-r14 ::=      ENUMERATED {
                                v-10, v-9, v-8, v-7, v-6, v-5, v-4, v-3, v-2, v-1, v-0dot5,
                                v0, v1, v2, v3, v4, v5, v6, v7, v8, v9
                                }
-- ASN1STOP

```

<i>CarrierFreqOffsetNB</i> field descriptions

<p>CarrierFreqOffsetNB</p> <p>This field specifies the offset of the NB-IoT channel number to EARFCN as defined in TS 36.101 [21]. Value v-10 means -10, v-9 means -9, and so on.</p>
--

– *CellGlobalIdEUTRA-AndUTRA*

The IE *CellGlobalIdEUTRA-AndUTRA* specifies the global Cell Identifier for E-UTRA or UTRA, the globally unique identity of a cell in E-UTRA or UTRA.

```

-- ASN1START
CellGlobalIdEUTRA-AndUTRA ::= SEQUENCE {
    plmn-Identity      SEQUENCE {
                        mcc      SEQUENCE (SIZE (3)) OF INTEGER (0..9),
                        mnc      SEQUENCE (SIZE (2..3)) OF INTEGER (0..9)
                        },
    cellIdentity       CHOICE {
        eutra          BIT STRING (SIZE (28)),
        utra           BIT STRING (SIZE (32))
    },
    ...
}
-- ASN1STOP

```

<i>CellGlobalIdEUTRA-AndUTRA</i> field descriptions

<p>plmn-Identity</p> <p>This field identifies the PLMN of the cell as defined in TS 36.331 [12].</p>
<p>cellIdentity</p> <p>This field defines the identity of the cell within the context of the PLMN as defined in TS 36.331 [12] and TS 25.331 [13]. The size of the bit string allows for the 32-bit extended UTRAN cell ID; in the case the cell ID is shorter, the first bits of the string are set to 0.</p>

– *CellGlobalIdGERAN*

The IE *CellGlobalIdGERAN* specifies the global Cell Identifier for GERAN, the globally unique identity of a cell in GERAN.

```

-- ASN1START
CellGlobalIdGERAN ::= SEQUENCE {
    plmn-Identity      SEQUENCE {
                        mcc      SEQUENCE (SIZE (3)) OF INTEGER (0..9),
                        mnc      SEQUENCE (SIZE (2..3)) OF INTEGER (0..9)
                        },
    locationAreaCode   BIT STRING (SIZE (16)),
    cellIdentity       BIT STRING (SIZE (16)),
    ...
}
-- ASN1STOP

```

CellGlobalIdGERAN field descriptions
<i>plmn-Identity</i> This field identifies the PLMN of the cell.
<i>locationAreaCode</i> This field is a fixed length code identifying the location area within a PLMN.
<i>cellIdentity</i> This field specifies the cell Identifier which is unique within the context of the GERAN location area.

– *ECGI*

The IE *ECGI* specifies the Evolved Cell Global Identifier (ECGI), the globally unique identity of a cell in E-UTRA (TS 36.331 [12]).

NOTE: The IE *ECGI* is also used for NB-IoT access.

```
-- ASN1START
ECGI ::= SEQUENCE {
    mcc          SEQUENCE (SIZE (3)) OF INTEGER (0..9),
    mnc          SEQUENCE (SIZE (2..3)) OF INTEGER (0..9),
    cellidentity BIT STRING (SIZE (28))
}
-- ASN1STOP
```

– *Ellipsoid-Point*

The IE *Ellipsoid-Point* is used to describe a geographic shape as defined in TS 23.032 [15].

```
-- ASN1START
Ellipsoid-Point ::= SEQUENCE {
    latitudeSign      ENUMERATED {north, south},
    degreesLatitude   INTEGER (0..8388607),          -- 23 bit field
    degreesLongitude  INTEGER (-8388608..8388607)   -- 24 bit field
}
-- ASN1STOP
```

– *Ellipsoid-PointWithUncertaintyCircle*

The IE *Ellipsoid-PointWithUncertaintyCircle* is used to describe a geographic shape as defined in TS 23.032 [15].

```
-- ASN1START
Ellipsoid-PointWithUncertaintyCircle ::= SEQUENCE {
    latitudeSign      ENUMERATED {north, south},
    degreesLatitude   INTEGER (0..8388607),          -- 23 bit field
    degreesLongitude  INTEGER (-8388608..8388607),   -- 24 bit field
    uncertainty       INTEGER (0..127)
}
-- ASN1STOP
```

– *EllipsoidPointWithUncertaintyEllipse*

The IE *EllipsoidPointWithUncertaintyEllipse* is used to describe a geographic shape as defined in TS 23.032 [15].

```
-- ASN1START
EllipsoidPointWithUncertaintyEllipse ::= SEQUENCE {
    latitudeSign      ENUMERATED {north, south},
    degreesLatitude   INTEGER (0..8388607),          -- 23 bit field
    degreesLongitude  INTEGER (-8388608..8388607),   -- 24 bit field
    uncertaintySemiMajor  INTEGER (0..127),
    uncertaintySemiMinor  INTEGER (0..127),
}
-- ASN1STOP
```

```

orientationMajorAxis    INTEGER (0..179),
confidence               INTEGER (0..100)
}
-- ASN1STOP

```

– *EllipsoidPointWithAltitude*

The IE *EllipsoidPointWithAltitude* is used to describe a geographic shape as defined in TS 23.032 [15].

```

-- ASN1START
EllipsoidPointWithAltitude ::= SEQUENCE {
    latitudeSign          ENUMERATED {north, south},
    degreesLatitude       INTEGER (0..8388607),           -- 23 bit field
    degreesLongitude      INTEGER (-8388608..8388607),    -- 24 bit field
    altitudeDirection     ENUMERATED {height, depth},
    altitude              INTEGER (0..32767)              -- 15 bit field
}
-- ASN1STOP

```

– *EllipsoidPointWithAltitudeAndUncertaintyEllipsoid*

The IE *EllipsoidPointWithAltitudeAndUncertaintyEllipsoid* is used to describe a geographic shape as defined in TS 23.032 [15].

```

-- ASN1START
EllipsoidPointWithAltitudeAndUncertaintyEllipsoid ::= SEQUENCE {
    latitudeSign          ENUMERATED {north, south},
    degreesLatitude       INTEGER (0..8388607),           -- 23 bit field
    degreesLongitude      INTEGER (-8388608..8388607),    -- 24 bit field
    altitudeDirection     ENUMERATED {height, depth},
    altitude              INTEGER (0..32767),             -- 15 bit field
    uncertaintySemiMajor   INTEGER (0..127),
    uncertaintySemiMinor  INTEGER (0..127),
    orientationMajorAxis  INTEGER (0..179),
    uncertaintyAltitude   INTEGER (0..127),
    confidence            INTEGER (0..100)
}
-- ASN1STOP

```

– *EllipsoidArc*

The IE *EllipsoidArc* is used to describe a geographic shape as defined in TS 23.032 [15].

```

-- ASN1START
EllipsoidArc ::= SEQUENCE {
    latitudeSign          ENUMERATED {north, south},
    degreesLatitude       INTEGER (0..8388607),           -- 23 bit field
    degreesLongitude      INTEGER (-8388608..8388607),    -- 24 bit field
    innerRadius           INTEGER (0..65535),             -- 16 bit field,
    uncertaintyRadius     INTEGER (0..127),
    offsetAngle           INTEGER (0..179),
    includedAngle         INTEGER (0..179),
    confidence            INTEGER (0..100)
}
-- ASN1STOP

```

– *EPDU-Sequence*

The *EPDU-Sequence* contains IEs that are defined externally to LPP by other organizations.

```

-- ASN1START
EPDU-Sequence ::= SEQUENCE (SIZE (1..maxEPDU)) OF EPDU
maxEPDU INTEGER ::= 16
EPDU ::= SEQUENCE {
    ePDU-Identifier      EPDU-Identifier,
    ePDU-Body           EPDU-Body
}
EPDU-Identifier ::= SEQUENCE {
    ePDU-ID             EPDU-ID,
    ePDU-Name          EPDU-Name      OPTIONAL,
    ...
}
EPDU-ID ::= INTEGER (1..256)
EPDU-Name ::= VisibleString (SIZE (1..32))
EPDU-Body ::= OCTET STRING
-- ASN1STOP

```

EPDU-Sequence field descriptions

EPDU-ID

This field provides a unique integer ID for the externally defined positioning method. Its value is assigned to the external entity that defines the EPDU. See table External PDU Identifier Definition for a list of external PDU identifiers defined in this version of the specification.

EPDU-Name

This field provides an optional character encoding which can be used to provide a quasi-unique name for an external PDU – e.g., by containing the name of the defining organization and/or the name of the associated public or proprietary standard for the EPDU.

EPDU-Body

The content and encoding of this field are defined externally to LPP.

External PDU Identifier Definition

EPDU-ID	EPDU Defining entity	Method name	Reference
1	OMA LOC	OMA LPP extensions (LPPe)	OMA-TS-LPPe-V1_0 [20]

– ***FreqBandIndicatorNR***

The IE *FreqBandIndicatorNR* specifies the NR band indicator (TS 38.331 [35]).

```

-- ASN1START
FreqBandIndicatorNR-r16 ::= INTEGER (1..1024)
-- ASN1STOP

```

– ***HighAccuracyEllipsoidPointWithUncertaintyEllipse***

The IE *HighAccuracyEllipsoidPointWithUncertaintyEllipse* is used to describe a geographic shape as defined in TS 23.032 [15].

```

-- ASN1START
HighAccuracyEllipsoidPointWithUncertaintyEllipse-r15 ::= SEQUENCE {
    degreesLatitude-r15      INTEGER(-2147483648..2147483647),
    degreesLongitude-r15     INTEGER(-2147483648..2147483647),
    uncertaintySemiMajor-r15 INTEGER (0..255),
    uncertaintySemiMinor-r15 INTEGER (0..255),
    orientationMajorAxis-r15 INTEGER (0..179),
    confidence-r15           INTEGER (0..100)
}
-- ASN1STOP

```



```

}
-- ASN1STOP

```

– *HighAccuracyEllipsoidPointWithAltitudeAndUncertaintyEllipsoid*

The IE *HighAccuracyEllipsoidPointWithAltitudeAndUncertaintyEllipsoid* is used to describe a geographic shape as defined in TS 23.032 [15].

```

-- ASN1START
HighAccuracyEllipsoidPointWithAltitudeAndUncertaintyEllipsoid-r15 ::= SEQUENCE {
    degreesLatitude-r15          INTEGER(-2147483648..2147483647),
    degreesLongitude-r15         INTEGER(-2147483648..2147483647),
    altitude-r15                 INTEGER(-64000..1280000),
    uncertaintySemiMajor-r15     INTEGER (0..255),
    uncertaintySemiMinor-r15     INTEGER (0..255),
    orientationMajorAxis-r15     INTEGER (0..179),
    horizontalConfidence-r15     INTEGER (0..100),
    uncertaintyAltitude-r15      INTEGER (0..255),
    verticalConfidence-r15       INTEGER (0..100)
}
-- ASN1STOP

```

– *HorizontalVelocity*

The IE *HorizontalVelocity* is used to describe a velocity shape as defined in TS 23.032 [15].

```

-- ASN1START
HorizontalVelocity ::= SEQUENCE {
    bearing          INTEGER(0..359),
    horizontalSpeed  INTEGER(0..2047)
}
-- ASN1STOP

```

– *HorizontalWithVerticalVelocity*

The IE *HorizontalWithVerticalVelocity* is used to describe a velocity shape as defined in TS 23.032 [15].

```

-- ASN1START
HorizontalWithVerticalVelocity ::= SEQUENCE {
    bearing          INTEGER(0..359),
    horizontalSpeed  INTEGER(0..2047),
    verticalDirection ENUMERATED{upward, downward},
    verticalSpeed    INTEGER(0..255)
}
-- ASN1STOP

```

– *HorizontalVelocityWithUncertainty*

The IE *HorizontalVelocityWithUncertainty* is used to describe a velocity shape as defined in TS 23.032 [15].

```

-- ASN1START
HorizontalVelocityWithUncertainty ::= SEQUENCE {
    bearing          INTEGER(0..359),
    horizontalSpeed  INTEGER(0..2047),
    uncertaintySpeed  INTEGER(0..255)
}
-- ASN1STOP

```

– *HorizontalWithVerticalVelocityAndUncertainty*

The IE *HorizontalWithVerticalVelocityAndUncertainty* is used to describe a velocity shape as defined in TS 23.032 [15].

```
-- ASN1START
HorizontalWithVerticalVelocityAndUncertainty ::= SEQUENCE {
    bearing                INTEGER(0..359),
    horizontalSpeed        INTEGER(0..2047),
    verticalDirection      ENUMERATED{upward, downward},
    verticalSpeed          INTEGER(0..255),
    horizontalUncertaintySpeed  INTEGER(0..255),
    verticalUncertaintySpeed  INTEGER(0..255)
}
-- ASN1STOP
```

– *LocationCoordinateTypes*

The IE *LocationCoordinateTypes* defines a list of possible geographic shapes as defined in TS 23.032 [15].

```
-- ASN1START
LocationCoordinateTypes ::= SEQUENCE {
    ellipsoidPoint                BOOLEAN,
    ellipsoidPointWithUncertaintyCircle  BOOLEAN,
    ellipsoidPointWithUncertaintyEllipse  BOOLEAN,
    polygon                       BOOLEAN,
    ellipsoidPointWithAltitude      BOOLEAN,
    ellipsoidPointWithAltitudeAndUncertaintyEllipsoid  BOOLEAN,
    ellipsoidArc                   BOOLEAN,
    ...
    [[
        highAccuracyEllipsoidPointWithUncertaintyEllipse-r15
                                                    BOOLEAN    OPTIONAL, -- Need ON
        highAccuracyEllipsoidPointWithAltitudeAndUncertaintyEllipsoid-r15
                                                    BOOLEAN    OPTIONAL  -- Need ON
    ]]
}
-- ASN1STOP
```

– *NCGI*

The IE *NCGI* specifies the NR Cell Global Identifier (NCGI) which is used to identify NR cells globally (TS 38.331 [35]).

```
-- ASN1START
NCGI-r15 ::= SEQUENCE {
    mcc-r15          SEQUENCE (SIZE (3)) OF INTEGER (0..9),
    mnc-r15          SEQUENCE (SIZE (2..3)) OF INTEGER (0..9),
    nr-cellidentity-r15  BIT STRING (SIZE (36))
}
-- ASN1STOP
```

– *NR-PhysCellId*

The IE *NR-PhysCellId* specifies the NR physical cell identifier (TS 38.331 [35]).

```
-- ASN1START
NR-PhysCellID-r16 ::= INTEGER (0..1007)
-- ASN1STOP
```

– *PeriodicAssistanceDataControlParameters*

The IE *PeriodicAssistanceDataControlParameters* is used in a periodic assistance data delivery procedure as described in clauses 5.2.1a and 5.2.2a.

```
-- ASN1START
PeriodicAssistanceDataControlParameters-r15 ::= SEQUENCE {
    periodicSessionID-r15          PeriodicSessionID-r15,
    ...
    [[
        updateCapabilities-r15     UpdateCapabilities-r15     OPTIONAL    -- Need ON
    ]]
}

PeriodicSessionID-r15 ::= SEQUENCE {
    periodicSessionInitiator-r15   ENUMERATED { locationServer, targetDevice, ... },
    periodicSessionNumber-r15     INTEGER (0..255),
    ...
}

UpdateCapabilities-r15 ::= BIT STRING {primaryCellID-r15     (0)} (SIZE(1..8))
-- ASN1STOP
```

***PeriodicAssistanceDataControlParameters* field descriptions**

periodicSessionID

This field identifies a particular periodic assistance data delivery session and the initiator of the session.

updateCapabilities

This field identifies the capabilities of the sending entity to support an update of periodic assistance data. A bit value set to one indicates a capability is supported and a bit value set to zero indicates a capability is not supported.

– *Polygon*

The IE *Polygon* is used to describe a geographic shape as defined in TS 23.032 [15].

```
-- ASN1START
Polygon ::= SEQUENCE (SIZE (3..15)) OF PolygonPoints

PolygonPoints ::= SEQUENCE {
    latitudeSign          ENUMERATED {north, south},
    degreesLatitude      INTEGER (0..8388607),          -- 23 bit field
    degreesLongitude     INTEGER (-8388608..8388607)    -- 24 bit field
}
-- ASN1STOP
```

– *PositioningModes*

The IE *PositioningModes* is used to indicate several positioning modes using a bit map.

```
-- ASN1START
PositioningModes ::= SEQUENCE {
    posModes             BIT STRING {
        standalone (0),
        ue-based (1),
        ue-assisted (2)
    } (SIZE (1..8)),
    ...
}
-- ASN1STOP
```

***PositioningModes* field descriptions**

posModes

This field specifies the positioning mode(s). This is represented by a bit string, with a one-value at the bit position means the particular positioning mode is addressed; a zero-value means not addressed.

– *SegmentationInfo*

The IE *SegmentationInfo* is used by a sender to indicate that LPP message segmentation is used, as specified in clause 4.3.5.

```
-- ASN1START
SegmentationInfo-r14 ::= ENUMERATED { noMoreMessages, moreMessagesOnTheWay }
-- ASN1STOP
```

SegmentationInfo field descriptions

SegmentationInfo

noMoreMessages indicates that this is the only or last LPP message segment used to deliver the entire message body.

moreMessagesOnTheWay indicates that this is one of multiple LPP message segments used to deliver the entire message body.

– *VelocityTypes*

The IE *VelocityTypes* defines a list of possible velocity shapes as defined in TS 23.032 [15].

```
-- ASN1START
VelocityTypes ::= SEQUENCE {
    horizontalVelocity                BOOLEAN,
    horizontalWithVerticalVelocity    BOOLEAN,
    horizontalVelocityWithUncertainty  BOOLEAN,
    horizontalWithVerticalVelocityAndUncertainty  BOOLEAN,
    ...
}
-- ASN1STOP
```

6.4.2 Common Positioning

– *CommonIEsRequestCapabilities*

The *CommonIEsRequestCapabilities* carries common IEs for a Request Capabilities LPP message Type.

```
-- ASN1START
CommonIEsRequestCapabilities ::= SEQUENCE {
    ...,
    [[
        lpp-message-segmentation-req-r14    BIT STRING {
            serverToTarget    (0),
            targetToServer    (1) }    OPTIONAL -- Need ON
    ]]
}
-- ASN1STOP
```

CommonIEsRequestCapabilities field descriptions

lpp-message-segmentation-req

This field, if present, indicates that the target device is requested to provide its LPP message segmentation capabilities.

If bit 0 is set to value 1, it indicates that the server is able to send segmented LPP messages to the target device; if bit 0 is set to value 0 it indicates that the server is not able to send segmented LPP messages to the target device.

If bit 1 is set to value 1, it indicates that the server is able to receive segmented LPP messages from the target device; if bit 1 is set to value 0 it indicates that the server is not able to receive segmented LPP messages from the target device.

CommonIEsProvideCapabilities

The *CommonIEsProvideCapabilities* carries common IEs for a Provide Capabilities LPP message Type.

```
-- ASN1START
CommonIEsProvideCapabilities ::= SEQUENCE {
    ...,
    [[
        segmentationInfo-r14          SegmentationInfo-r14          OPTIONAL,  -- Cond Segmentation
        lpp-message-segmentation-r14  BIT STRING { serverToTarget (0),
                                                targetToServer (1) }  OPTIONAL
    ]]
}
-- ASN1STOP
```

Conditional presence	Explanation
<i>Segmentation</i>	This field is optionally present, need OP, if <i>lpp-message-segmentation-req</i> has been received from the location server with bit 1 (<i>targetToServer</i>) set to value 1. The field shall be omitted if <i>lpp-message-segmentation-req</i> has not been received in this location session, or has been received with bit 1 (<i>targetToServer</i>) set to value 0.

CommonIEsProvideCapabilities field descriptions

segmentationInfo

This field indicates whether this *ProvideCapabilities* message is one of many segments, as specified in clause 4.3.5.

lpp-message-segmentation

This field, if present, indicates the target device's LPP message segmentation capabilities.

If bit 0 is set to value 1, it indicates that the target device supports receiving segmented LPP messages; if bit 0 is set to value 0 it indicates that the target device does not support receiving segmented LPP messages.

If bit 1 is set to value 1, it indicates that the target device supports sending segmented LPP messages; if bit 1 is set to value 0 it indicates that the target device does not support sending segmented LPP messages.

CommonIEsRequestAssistanceData

The *CommonIEsRequestAssistanceData* carries common IEs for a Request Assistance Data LPP message Type.

```
-- ASN1START
CommonIEsRequestAssistanceData ::= SEQUENCE {
    primaryCellID          ECGI          OPTIONAL,  -- Cond EUTRA
    ...,
    [[
        segmentationInfo-r14          SegmentationInfo-r14          OPTIONAL  -- Cond Segmentation
    ]],
    [[
        periodicAssistanceDataReq-r15
        PeriodicAssistanceDataControlParameters-r15
        primaryCellID-r15          NCGI-r15          OPTIONAL  -- Cond PerADreq
    ]],
    primaryCellID-r15          NCGI-r15          OPTIONAL  -- Cond NR
}
-- ASN1STOP
```

Conditional presence	Explanation
<i>EUTRA</i>	The field is mandatory present for E-UTRA or NB-IoT access. The field shall be omitted for non-EUTRA and non-NB-IoT user plane support.
<i>Segmentation</i>	This field is optionally present, need OP, if <i>lpp-message-segmentation-req</i> has been received from the location server with bit 1 (<i>targetToServer</i>) set to value 1. The field shall be omitted if <i>lpp-message-segmentation-req</i> has not been received in this location session, or has been received with bit 1 (<i>targetToServer</i>) set to value 0.
<i>PerADreq</i>	The field is mandatory present if the target device requests periodic assistance data delivery. Otherwise it is not present.
<i>NR</i>	The field is mandatory present for NR access. The field shall be omitted for non-NR user plane support.

CommonIEsRequestAssistanceData field descriptions	
primaryCellID	This parameter identifies the current primary cell for the target device.
segmentationInfo	This field indicates whether this <i>RequestAssistanceData</i> message is one of many segments, as specified in clause 4.3.5.
periodicAssistanceDataReq	This field indicates a request for periodic assistance data delivery, as specified in clause 5.2.1a.

– CommonIEsProvideAssistanceData

The *CommonIEsProvideAssistanceData* carries common IEs for a Provide Assistance Data LPP message Type.

```
-- ASN1START
CommonIEsProvideAssistanceData ::= SEQUENCE {
    . . .
    [[
        segmentationInfo-r14      SegmentationInfo-r14      OPTIONAL    -- Need ON
    ]],
    [[
        periodicAssistanceData-r15  PeriodicAssistanceDataControlParameters-r15
                                     OPTIONAL              -- Cond PerAD
    ]]
}
-- ASN1STOP
```

Conditional presence	Explanation
<i>PerAD</i>	The field is mandatory present in a periodic assistance data delivery session. Otherwise it is not present.

CommonIEsRequestAssistanceData field descriptions	
segmentationInfo	This field indicates whether this <i>ProvideAssistanceData</i> message is one of many segments, as specified in clause 4.3.5.
periodicAssistanceData	This field indicates a periodic assistance data delivery, as specified in clauses 5.2.1a and 5.2.2a.

– CommonIEsRequestLocationInformation

The *CommonIEsRequestLocationInformation* carries common IEs for a Request Location Information LPP message Type.

```
-- ASN1START
CommonIEsRequestLocationInformation ::= SEQUENCE {
    locationInformationType      LocationInformationType,
    triggeredReporting           TriggeredReportingCriteria OPTIONAL,  -- Cond ECID
    periodicalReporting          PeriodicalReportingCriteria OPTIONAL,  -- Need ON
    additionalInformation        AdditionalInformation      OPTIONAL,  -- Need ON
    qos                         QoS                      OPTIONAL,  -- Need ON
    environment                  Environment             OPTIONAL,  -- Need ON
    locationCoordinateTypes      LocationCoordinateTypes OPTIONAL,  -- Need ON
    velocityTypes                VelocityTypes        OPTIONAL,  -- Need ON
    . . .
    [[
        messageSizeLimitNB-r14  MessageSizeLimitNB-r14  OPTIONAL    -- Need ON
    ]],
    [[
        segmentationInfo-r14    SegmentationInfo-r14      OPTIONAL    -- Need ON
    ]]
}

LocationInformationType ::= ENUMERATED {
    locationEstimateRequired,
    locationMeasurementsRequired,

```

```

    locationEstimatePreferred,
    locationMeasurementsPreferred,
    ...
}

PeriodicalReportingCriteria ::= SEQUENCE {
    reportingAmount      ENUMERATED {
        ra1, ra2, ra4, ra8, ra16, ra32,
        ra64, ra-Infinity
    } DEFAULT ra-Infinity,
    reportingInterval    ENUMERATED {
        noPeriodicalReporting, ri0-25,
        ri0-5, ri1, ri2, ri4, ri8, ri16, ri32, ri64
    }
}

TriggeredReportingCriteria ::= SEQUENCE {
    cellChange          BOOLEAN,
    reportingDuration    ReportingDuration,
    ...
}

ReportingDuration ::= INTEGER (0..255)

AdditionalInformation ::= ENUMERATED {
    onlyReturnInformationRequested,
    mayReturnAdditionalInformation,
    ...
}

QoS ::= SEQUENCE {
    horizontalAccuracy      HorizontalAccuracy      OPTIONAL,  -- Need ON
    verticalCoordinateRequest  BOOLEAN,
    verticalAccuracy        VerticalAccuracy        OPTIONAL,  -- Need ON
    responseTime            ResponseTime            OPTIONAL,  -- Need ON
    velocityRequest         BOOLEAN,
    ...,
    [[ responseTimeNB-r14    ResponseTimeNB-r14    OPTIONAL  -- Need ON
    ]],
    [[ horizontalAccuracyExt-r15  HorizontalAccuracyExt-r15    OPTIONAL,  -- Need ON
    verticalAccuracyExt-r15      VerticalAccuracyExt-r15      OPTIONAL  -- Need ON
    ]],
}

HorizontalAccuracy ::= SEQUENCE {
    accuracy      INTEGER(0..127),
    confidence    INTEGER(0..100),
    ...
}

VerticalAccuracy ::= SEQUENCE {
    accuracy      INTEGER(0..127),
    confidence    INTEGER(0..100),
    ...
}

HorizontalAccuracyExt-r15 ::= SEQUENCE {
    accuracyExt-r15    INTEGER(0..255),
    confidence-r15     INTEGER(0..100),
    ...
}

VerticalAccuracyExt-r15 ::= SEQUENCE {
    accuracyExt-r15    INTEGER(0..255),
    confidence-r15     INTEGER(0..100),
    ...
}

ResponseTime ::= SEQUENCE {
    time            INTEGER (1..128),
    ...,
    [[ responseTimeEarlyFix-r12    INTEGER (1..128)        OPTIONAL  -- Need ON
    ]],
    [[ unit-r15                    ENUMERATED { ten-seconds, ... } OPTIONAL  -- Need ON
    ]],
}

ResponseTimeNB-r14 ::= SEQUENCE {

```

```

timeNB-r14                INTEGER (1..512),
responseTimeEarlyFixNB-r14  INTEGER (1..512)          OPTIONAL,      -- Need ON
...
[[ 'unitNB-r15            ENUMERATED { ten-seconds, ... } OPTIONAL      -- Need ON
]]
}

Environment ::= ENUMERATED {
    badArea,
    notBadArea,
    mixedArea,
    ...
}

MessageSizeLimitNB-r14 ::= SEQUENCE {
    measurementLimit-r14  INTEGER (1..512)          OPTIONAL,      -- Need ON
    ...
}

-- ASN1STOP

```

Conditional presence	Explanation
ECID	The field is optionally present, need ON, if E-CID or NR E-CID is requested. Otherwise it is not present.

CommonEsRequestLocationInformation field descriptions

locationInformationType

This IE indicates whether the server requires a location estimate or measurements. For '*locationEstimateRequired*', the target device shall return a location estimate if possible, or indicate a location error if not possible. For '*locationMeasurementsRequired*', the target device shall return measurements if possible, or indicate a location error if not possible. For '*locationEstimatePreferred*', the target device shall return a location estimate if possible, but may also or instead return measurements for any requested position methods for which a location estimate is not possible. For '*locationMeasurementsPreferred*', the target device shall return location measurements if possible, but may also or instead return a location estimate for any requested position methods for which return of location measurements is not possible.

triggeredReporting

This IE indicates that triggered reporting is requested and comprises the following subfields:

- **cellChange**: If this field is set to TRUE, the target device provides requested location information each time the primary cell has changed.
- **reportingDuration**: Maximum duration of triggered reporting in seconds. A value of zero is interpreted to mean an unlimited (i.e. "infinite") duration. The target device should continue triggered reporting for the *reportingDuration* or until an LPP *Abort* or LPP *Error* message is received.

The *triggeredReporting* field should not be included by the location server and shall be ignored by the target device if the *periodicalReporting* IE or *responseTime* IE or *responseTimeNB* IE is included in *CommonEsRequestLocationInformation*.

periodicalReporting

This IE indicates that periodic reporting is requested and comprises the following subfields:

- **reportingAmount** indicates the number of periodic location information reports requested. Enumerated values correspond to 1, 2, 4, 8, 16, 32, 64, or infinite/indefinite number of reports. If the *reportingAmount* is '*infinite/indefinite*', the target device should continue periodic reporting until an LPP *Abort* message is received. The value '*ra1*' shall not be used by a sender.
- **reportingInterval** indicates the interval between location information reports and the response time requirement for the first location information report. Enumerated values ri0-25, ri0-5, ri1, ri2, ri4, ri8, ri16, ri32, ri64 correspond to reporting intervals of 1, 2, 4, 8, 10, 16, 20, 32, and 64 seconds, respectively. Measurement reports containing no measurements or no location estimate are required when a *reportingInterval* expires before a target device is able to obtain new measurements or obtain a new location estimate. The value '*noPeriodicalReporting*' shall not be used by a sender.

additionalInformation

This IE indicates whether a target device is allowed to return additional information to that requested. If this IE indicates '*onlyReturnInformationRequested*' then the target device shall not return any additional information to that requested by the server. If this IE indicates '*mayReturnAdditionalInformation*' then the target device may return additional information to that requested by the server. If a location estimate is returned, any additional information is restricted to that associated with a location estimate (e.g. might include velocity if velocity was not requested but cannot include measurements). If measurements are returned, any additional information is restricted to additional measurements (e.g. might include E-CID measurements if A-GNSS measurements were requested but not E-CID measurements).

qos

CommonEsRequestLocationInformation field descriptions

This IE indicates the quality of service and comprises a number of sub-fields. In the case of measurements, some of the sub-fields apply to the location estimate that could be obtained by the server from the measurements provided by the target device assuming that the measurements are the only sources of error. Fields are as follows:

- **horizontalAccuracy** indicates the maximum horizontal error in the location estimate at an indicated confidence level. The 'accuracy' corresponds to the encoded uncertainty as defined in TS 23.032 [15] and 'confidence' corresponds to confidence as defined in TS 23.032 [15].
- **verticalCoordinateRequest** indicates whether a vertical coordinate is required (TRUE) or not (FALSE)
- **verticalAccuracy** indicates the maximum vertical error in the location estimate at an indicated confidence level and is only applicable when a vertical coordinate is requested. The 'accuracy' corresponds to the encoded uncertainty altitude as defined in TS 23.032 [15] and 'confidence' corresponds to confidence as defined in TS 23.032 [15].
- **responseTime**
 - **time** indicates the maximum response time as measured between receipt of the *RequestLocationInformation* and transmission of a *ProvideLocationInformation*. If the *unit* field is absent, this is given as an integer number of seconds between 1 and 128. If the *unit* field is present, the maximum response time is given in units of 10-seconds, between 10 and 1280 seconds. If the *periodicalReporting* IE is included in *CommonEsRequestLocationInformation*, this field should not be included by the location server and shall be ignored by the target device (if included).
 - **responseTimeEarlyFix** indicates the maximum response time as measured between receipt of the *RequestLocationInformation* and transmission of a *ProvideLocationInformation* containing early location measurements or an early location estimate. If the *unit* field is absent, this is given as an integer number of seconds between 1 and 128. If the *unit* field is present, the maximum response time is given in units of 10-seconds, between 10 and 1280 seconds. When this IE is included, a target should send a *ProvideLocationInformation* (or more than one *ProvideLocationInformation* if location information will not fit into a single message) containing early location information according to the *responseTimeEarlyFix* IE and a subsequent *ProvideLocationInformation* (or more than one *ProvideLocationInformation* if location information will not fit into a single message) containing final location information according to the *time* IE. A target shall omit sending a *ProvideLocationInformation* if the early location information is not available at the expiration of the time value in the *responseTimeEarlyFix* IE. A server should set the *responseTimeEarlyFix* IE to a value less than that for the *time* IE. A target shall ignore the *responseTimeEarlyFix* IE if its value is not less than that for the *time* IE.
 - **unit** indicates the unit of the *time* and *responseTimeEarlyFix* fields. Enumerated value 'ten-seconds' corresponds to a resolution of 10 seconds. If this field is absent, the unit/resolution is 1 second.
- **velocityRequest** indicates whether velocity (or measurements related to velocity) is requested (TRUE) or not (FALSE).
- **responseTimeNB**

If the *periodicalReporting* IE or *responseTime* IE is included in *CommonEsRequestLocationInformation*, this field should not be included by the location server and shall be ignored by the target device (if included).

 - **timeNB** indicates the maximum response time as measured between receipt of the *RequestLocationInformation* and transmission of a *ProvideLocationInformation*. If the *unit* field is absent, this is given as an integer number of seconds between 1 and 512. If the *unit* field is present, the maximum response time is given in units of 10-seconds, between 10 and 5120 seconds.
 - **responseTimeEarlyFixNB** indicates the maximum response time as measured between receipt of the *RequestLocationInformation* and transmission of a *ProvideLocationInformation* containing early location measurements or an early location estimate. If the *unit* field is absent, this is given as an integer number of seconds between 1 and 512. If the *unit* field is present, the maximum response time is given in units of 10-seconds, between 10 and 5120 seconds. When this IE is included, a target should send a *ProvideLocationInformation* (or more than one *ProvideLocationInformation* if location information will not fit into a single message) containing early location information according to the *responseTimeEarlyFixNB* IE and a subsequent *ProvideLocationInformation* (or more than one *ProvideLocationInformation* if location information will not fit into a single message) containing final location information according to the *timeNB* IE. A target shall omit sending a *ProvideLocationInformation* if the early location information is not available at the expiration of the time value in the *responseTimeEarlyFixNB* IE. A server should set the *responseTimeEarlyFixNB* IE to a value less than that for the *timeNB* IE. A target shall ignore the *responseTimeEarlyFixNB* IE if its value is not less than that for the *timeNB* IE.
 - **unitNB** indicates the unit of the *timeNB* and *responseTimeEarlyFixNB* fields. Enumerated value 'ten-second' corresponds to a resolution of 10 seconds. If this field is absent, the unit/resolution is 1 second.
- **horizontalAccuracyExt** indicates the maximum horizontal error in the location estimate at an indicated confidence level. The 'accuracyExt' corresponds to the encoded high accuracy uncertainty as defined in TS 23.032 [15] and 'confidence' corresponds to confidence as defined in TS 23.032 [15]. This field should not be included by the location server and shall be ignored by the target device if the *horizontalAccuracy* field is included in QoS.
- **verticalAccuracyExt** indicates the maximum vertical error in the location estimate at an indicated confidence level and is only applicable when a vertical coordinate is requested. The 'accuracyExt' corresponds to the encoded high accuracy uncertainty as defined in TS 23.032 [15] and 'confidence' corresponds to confidence as

CommonIEsRequestLocationInformation field descriptions
<p>defined in TS 23.032 [15]. This field should not be included by the location server and shall be ignored by the target device if the <i>verticalAccuracy</i> field is included in QoS.</p> <p>All QoS requirements shall be obtained by the target device to the degree possible but it is permitted to return a response that does not fulfill all QoS requirements if some were not attainable. The single exception is <i>time</i> and <i>timeNB</i> which shall always be fulfilled – even if that means not fulfilling other QoS requirements.</p> <p>A target device supporting NB-IoT access shall support the <i>responseTimeNB</i> IE.</p> <p>A target device supporting HA GNSS shall support the <i>HorizontalAccuracyExt</i>, <i>VerticalAccuracyEx</i>, and <i>unit</i> fields.</p> <p>A target device supporting NB-IoT access and HA GNSS shall support the <i>unitNB</i> field.</p>
<p>environment</p> <p>This field provides the target device with information about expected multipath and non line of sight (NLOS) in the current area. The following values are defined:</p> <ul style="list-style-type: none"> - <i>badArea</i>: possibly heavy multipath and NLOS conditions (e.g. bad urban or urban). - <i>notBadArea</i>: no or light multipath and usually LOS conditions (e.g. suburban or rural). - <i>mixedArea</i>: environment that is mixed or not defined. <p>If this field is absent, a default value of 'mixedArea' applies.</p>
<p>locationCoordinateTypes</p> <p>This field provides a list of the types of location estimate that the target device may return when a location estimate is obtained by the target.</p>
<p>velocityTypes</p> <p>This fields provides a list of the types of velocity estimate that the target device may return when a velocity estimate is obtained by the target.</p>
<p>messageSizeLimitNB</p> <p>This field provides an octet limit on the amount of location information a target device can return.</p> <ul style="list-style-type: none"> - measurementLimit indicates the maximum amount of location information the target device should return in response to the <i>RequestLocationInformation</i> message received from the location server. <p>The limit applies to the overall size of the LPP message at LPP level (LPP Provide Location Information), and is specified in steps of 100 octets. The message size limit is then given by the value provided in <i>measurementLimit</i> times 100 octets.</p>
<p>segmentationInfo</p> <p>This field indicates whether this <i>RequestLocationInformation</i> message is one of many segments, as specified in clause 4.3.5</p>

CommonIEsProvideLocationInformation

The *CommonIEsProvideLocationInformation* carries common IEs for a Provide Location Information LPP message Type.

```

-- ASN1START
CommonIEsProvideLocationInformation ::= SEQUENCE {
    locationEstimate          LocationCoordinates    OPTIONAL,
    velocityEstimate          Velocity                OPTIONAL,
    locationError              LocationError          OPTIONAL,
    ...,
    [[ earlyFixReport-r12     EarlyFixReport-r12    OPTIONAL
    ]],
    [[ locationSource-r13     LocationSource-r13    OPTIONAL,
    locationTimestamp-r13    UTCTime                OPTIONAL
    ]],
    [[ segmentationInfo-r14   SegmentationInfo-r14  OPTIONAL          -- Cond Segmentation
    ]]
}

LocationCoordinates ::= CHOICE {
    ellipsoidPoint                Ellipsoid-Point,
    ellipsoidPointWithUncertaintyCircle  Ellipsoid-PointWithUncertaintyCircle,
    ellipsoidPointWithUncertaintyEllipse  EllipsoidPointWithUncertaintyEllipse,
    polygon                        Polygon,
    ellipsoidPointWithAltitude      EllipsoidPointWithAltitude,
    ellipsoidPointWithAltitudeAndUncertaintyEllipsoid  EllipsoidPointWithAltitudeAndUncertaintyEllipsoid,
    ellipsoidArc                    EllipsoidArc,
    ...,
    highAccuracyEllipsoidPointWithUncertaintyEllipse-v1510
                                HighAccuracyEllipsoidPointWithUncertaintyEllipse-r15,
    highAccuracyEllipsoidPointWithAltitudeAndUncertaintyEllipsoid-v1510
                                HighAccuracyEllipsoidPointWithAltitudeAndUncertaintyEllipsoid-r15
}

```

```
Velocity ::= CHOICE {
    horizontalVelocity                HorizontalVelocity,
    horizontalWithVerticalVelocity    HorizontalWithVerticalVelocity,
    horizontalVelocityWithUncertainty HorizontalVelocityWithUncertainty,
    horizontalWithVerticalVelocityAndUncertainty HorizontalWithVerticalVelocityAndUncertainty,
    ...
}

LocationError ::= SEQUENCE {
    locationFailureCause LocationFailureCause,
    ...
}

LocationFailureCause ::= ENUMERATED {
    undefined,
    requestedMethodNotSupported,
    positionMethodFailure,
    periodicLocationMeasurementsNotAvailable,
    ...
}

EarlyFixReport-r12 ::= ENUMERATED {
    noMoreMessages,
    moreMessagesOnTheWay
}

LocationSource-r13 ::= BIT STRING { a-gnss          (0),
                                     wlan            (1),
                                     bt              (2),
                                     tbs            (3),
                                     sensor          (4),
                                     ha-gnss-v1510  (5),
                                     motion-sensor-v1550 (6),
                                     dl-tdoa-r16    (7),
                                     dl-aod-r16     (8) } (SIZE(1..16))

-- ASN1STOP
```

Conditional presence	Explanation
<i>Segmentation</i>	This field is optionally present, need OP, if <i>lpp-message-segmentation-req</i> has been received from the location server with bit 1 (<i>targetToServer</i>) set to value 1. The field shall be omitted if <i>lpp-message-segmentation-req</i> has not been received in this location session, or has been received with bit 1 (<i>targetToServer</i>) set to value 0.

CommonIEsProvideLocationInformation field descriptions
<p>locationEstimate This field provides a location estimate using one of the geographic shapes defined in TS 23.032 [15]. Coding of the values of the various fields internal to each geographic shape follow the rules in TS 23.032 [15]. The conditions for including this field are defined for the <i>locationInformationType</i> field in a Request Location Information message.</p>
<p>velocityEstimate This field provides a velocity estimate using one of the velocity shapes defined in TS 23.032 [15]. Coding of the values of the various fields internal to each velocity shape follow the rules in TS 23.032 [15].</p>
<p>locationError This field shall be included if and only if a location estimate and measurements are not included in the LPP PDU. The field includes information concerning the reason for the lack of location information. The <i>LocationFailureCause</i> 'periodicLocationMeasurementsNotAvailable' shall be used by the target device if periodic location reporting was requested, but no measurements or location estimate are available when <i>the reportingInterval</i> expired.</p>
<p>earlyFixReport This field shall be included if and only if the <i>ProvideLocationInformation</i> message contains early location measurements or an early location estimate. The target device shall set the values of this field as follows:</p> <ul style="list-style-type: none"> - <i>noMoreMessages</i>: This is the only or last <i>ProvideLocationInformation</i> message used to deliver the entire set of early location information. - <i>moreMessagesOnTheWay</i>: This is one of multiple <i>ProvideLocationInformation</i> messages used to deliver the entire set of early location information (if early location information will not fit into a single message). <p>If this field is included, the IE <i>SegmentationInfo</i> shall not be included.</p>
<p>locationSource This field provides the source positioning technology for the location estimate. NOTE 1: In this version of the specification, the entry 'tbs' is used only for TBS positioning based on MBS signals. NOTE 2: The entry 'sensor' is used only for positioning technology that uses barometric pressure sensor. The entry 'motion-sensor' is used for positioning technology that uses sensor(s) to detect displacement and movement, e.g. accelerometers, gyros, magnetometers.</p>
<p>locationTimestamp This field provides the UTC time when the location estimate is valid and should take the form of <i>YYMMDDhhmmssZ</i>.</p>
<p>segmentationInfo This field indicates whether this <i>ProvideLocationInformation</i> message is one of many segments, as specified in clause 4.3.5</p>

– CommonIEsAbort

The *CommonIEsAbort* carries common IEs for an Abort LPP message Type.

```
-- ASN1START
CommonIEsAbort ::= SEQUENCE {
  abortCause          ENUMERATED {
    undefined,
    stopPeriodicReporting,
    targetDeviceAbort,
    networkAbort,
    . . . ,
    stopPeriodicAssistanceDataDelivery-v1510
  }
}
-- ASN1STOP
```

CommonIEsAbort field descriptions**abortCause**

This IE defines the request to abort an ongoing procedure. The abort cause '*stopPeriodicReporting*' should be used by the location server to stop any ongoing location reporting configured as *periodicalReporting* or *triggeredReporting* in the *CommonIEsRequestLocationInformation*.

The abort cause '*stopPeriodicAssistanceDataDelivery*' should be used by the location server or target device to stop any ongoing periodic assistance data delivery, as specified in clauses 5.2.1a and 5.2.2a.

CommonIEsError

The *CommonIEsError* carries common IEs for an Error LPP message Type.

```
-- ASN1START
CommonIEsError ::= SEQUENCE {
    errorCause      ENUMERATED {
        undefined,
        lppMessageHeaderError,
        lppMessageBodyError,
        epduError,
        incorrectDataValue,
        . . . ,
        lppSegmentationError-v1450
    }
}
-- ASN1STOP
```

CommonIEsError field descriptions**errorCause**

This IE defines the cause for an error. '*lppMessageHeaderError*', '*lppMessageBodyError*' and '*epduError*' is used if a receiver is able to detect a coding error in the LPP header (i.e., in the common fields), LPP message body or in an EPDU, respectively. '*lppSegmentationError*' is used if a receiver detects an error in LPP message segmentation.

6.4.3 Common NR Positioning Information Elements**DL-PRS-ID-Info**

The IE *DL-PRS-ID-Info* provides the IDs of the reference TRPs' DL-PRS Resources.

```
-- ASN1START
DL-PRS-ID-Info-r16 ::= SEQUENCE {
    dl-PRS-ID-r16          INTEGER (0..255),
    nr-DL-PRS-ResourceID-List-r16 SEQUENCE (SIZE (1..nrMaxResourceIDs-r16)) OF
                                                NR-DL-PRS-ResourceID-r16
                                                OPTIONAL, -- Need ON
    nr-DL-PRS-ResourceSetID-r16 NR-DL-PRS-ResourceSetID-r16
                                                OPTIONAL -- Need ON
}
-- ASN1STOP
```

DL-PRS-ID-Info field descriptions**nr-DL-PRS-ResourceID-List**

This field provides a list of DL-PRS Resource IDs under the same DL-PRS Resource Set.

– *NR-AdditionalPathList*

The IE *NR-AdditionalPathList* is used by the target device to provide information about additional paths in association to the TOA measurements associated to NR positioning in the form of a relative time difference and a quality value. The additional path *nr-relativeTimeDifference* is the detected path timing relative to the detected path timing used for the TOA value, and each additional path can be associated with a quality value *nr-path-Quality*.

```
-- ASN1START
NR-AdditionalPathList-r16 ::= SEQUENCE (SIZE(1..2)) OF NR-AdditionalPath-r16
NR-AdditionalPath-r16 ::= SEQUENCE {
    nr-RelativeTimeDifference-r16 CHOICE {
        k0-r16 INTEGER(0..16351),
        k1-r16 INTEGER(0..8176),
        k2-r16 INTEGER(0..4088),
        k3-r16 INTEGER(0..2044),
        k4-r16 INTEGER(0..1022),
        k5-r16 INTEGER(0..511),
        ...
    },
    nr-PathQuality-r16 NR-TimingQuality-r16 OPTIONAL,
    ...
}
-- ASN1STOP
```

***NR-AdditionalPathList* field descriptions**

nr-RelativeTimeDifference

This field specifies the additional detected path timing relative to the detected path timing of the reference resource. The mapping of reported values and measured quantity value is defined in TS 38.133 [46] clause 10.1.23.3.3 and 10.1.25.3.3. A positive value indicates that the particular path is later in time than the detected path of the reference; a negative value indicates that the particular path is earlier in time than the detected path of the reference.

nr-PathQuality

This field specifies the target device's best estimate of the quality of the detected timing of the additional path.

– *NR-DL-PRS-AssistanceData*

The IE *NR-DL-PRS-AssistanceData* is used by the location server to provide DL-PRS assistance data.

NOTE 1: The location server should include at least one TRP for which the SFN can be obtained by the target device, e.g. the serving TRP.

NOTE 2: The *nr-DL-PRS-ReferenceInfo* defines the "assistance data reference" TRP whose DL-PRS configuration is included in *nr-DL-PRS-AssistanceDataList*. The *nr-DL-PRS-SFN0-Offset's* and *nr-DL-PRS-expectedRSTD's* in *nr-DL-PRS-AssistanceDataList* are provided relative to the "assistance data reference" TRP.

NOTE 3: The network signals a value of zero for the *nr-DL-PRS-SFN0-Offset*, *nr-DL-PRS-expectedRSTD*, and *nr-DL-PRS-expectedRSTD-uncertainty* of the "assistance data reference" TRP in *nr-DL-PRS-AssistanceDataList*.

NOTE 4: For NR DL-TDOA positioning (see clause 6.5.10) the *nr-DL-PRS-ReferenceInfo* defines also the requested "RSTD reference".

For DL-PRS processing, the LPP layer may inform lower layers to start performing DL-PRS measurements and provide to lower layers the information about the location of DL-PRS, e.g. DL-PRS-PointA, DL-PRS Positioning occasion information.

```
-- ASN1START
NR-DL-PRS-AssistanceData-r16 ::= SEQUENCE {
    nr-DL-PRS-ReferenceInfo-r16 DL-PRS-ID-Info-r16,
    nr-DL-PRS-AssistanceDataList-r16 SEQUENCE (SIZE (1..nrMaxFreqLayers-r16)) OF
        NR-DL-PRS-AssistanceDataPerFreq-r16,
    nr-SSB-Config-r16 SEQUENCE (SIZE (1..nrMaxTRPs-r16)) OF
        NR-SSB-Config-r16 OPTIONAL, -- Need ON
    ...
}
```

```

}
NR-DL-PRS-AssistanceDataPerFreq-r16 ::= SEQUENCE {
    nr-DL-PRS-PositioningFrequencyLayer-r16
        NR-DL-PRS-PositioningFrequencyLayer-r16,
    nr-DL-PRS-AssistanceDataPerFreq-r16 SEQUENCE (SIZE (1..nrMaxTRPsPerFreq-r16)) OF
        NR-DL-PRS-AssistanceDataPerTRP-r16,
    ...
}

NR-DL-PRS-AssistanceDataPerTRP-r16 ::= SEQUENCE {
    dl-PRS-ID-r16 INTEGER (0..255),
    nr-PhysCellID-r16 NR-PhysCellID-r16 OPTIONAL, -- Need ON
    nr-CellGlobalID-r16 NCGI-r15 OPTIONAL, -- Need ON
    nr-ARFCN-r16 ARFCN-ValueNR-r15 OPTIONAL, -- Need ON
    nr-DL-PRS-SFN0-Offset-r16 NR-DL-PRS-SFN0-Offset-r16,
    nr-DL-PRS-ExpectedRSTD-r16 INTEGER (-3841..3841),
    nr-DL-PRS-ExpectedRSTD-Uncertainty-r16
        INTEGER (0..246),
    nr-DL-PRS-Info-r16 NR-DL-PRS-Info-r16,
    ...
    [[
        prs-OnlyTP-r16 ENUMERATED { true } OPTIONAL -- Need ON
    ]]
}

NR-DL-PRS-PositioningFrequencyLayer-r16 ::= SEQUENCE {
    dl-PRS-SubcarrierSpacing-r16 ENUMERATED {kHz15, kHz30, kHz60, kHz120, ...},
    dl-PRS-ResourceBandwidth-r16 INTEGER (1..63),
    dl-PRS-StartPRB-r16 INTEGER (0..2176),
    dl-PRS-PointA-r16 ARFCN-ValueNR-r15,
    dl-PRS-CombSizeN-r16 ENUMERATED {n2, n4, n6, n12, ...},
    dl-PRS-CyclicPrefix-r16 ENUMERATED {normal, extended, ...},
    ...
}

NR-DL-PRS-SFN0-Offset-r16 ::= SEQUENCE {
    sfn-Offset-r16 INTEGER (0..1023),
    integerSubframeOffset-r16 INTEGER (0..9),
    ...
}

-- ASN1STOP

```

NR-DL-PRS-AssistanceData field descriptions

nr-DL-PRS-ReferenceInfo	This field specifies the IDs of the assistance data reference TRP.
nr-DL-PRS-AssistanceDataList	This field specifies the DL-PRS resources for each frequency layer.
nr-SSB-Config	This field specifies the SSB configuration of the TRPs.
nr-DL-PRS-PositioningFrequencyLayer	This field specifies the Positioning Frequency Layer for the <i>nr-DL-PRS-AssistanceDataPerFreq</i> field.
nr-DL-PRS-AssistanceDataPerFreq	This field specifies the DL-PRS Resources for the TRPs within the Positioning Frequency Layer.
dl-PRS-ID	This field is used along with a DL-PRS Resource Set ID and a DL-PRS Resource ID to uniquely identify a DL-PRS Resource, and is associated with a single TRP.
nr-PhysCellID	This field specifies the physical cell identity of the TRP. When the field <i>prs-OnlyTP</i> is included, this field is not included.
nr-CellGlobalID	This field specifies the NCGI, the globally unique identity of a cell in NR, as defined in TS 38.331 [35]. When the field <i>prs-OnlyTP</i> is included, this field is not included.
nr-ARFCN	This field specifies the NR-ARFCN of the TRP's CD-SSB (as defined in TS 38.300 [47]) corresponding to <i>nr-PhysCellID</i> . When the field <i>prs-OnlyTP</i> is included, this field is not included.

NR-DL-PRS-AssistanceData field descriptions
<p>nr-DL-PRS-SFN0-Offset</p> <p>This field specifies the time offset of the SFN#0 slot#0 for the given TRP with respect to SFN#0 slot#0 of the assistance data reference TRP and comprises the following subfields:</p> <ul style="list-style-type: none"> - sfn-Offset specifies the SFN offset at the TRP antenna location between the assistance data reference TRP and this neighbour TRP. The offset corresponds to the number of full radio frames counted from the beginning of a radio frame #0 of the assistance data reference TRP to the beginning of the closest subsequent radio frame #0 of this neighbour TRP. - integerSubframeOffset specifies the frame boundary offset at the TRP antenna location between the assistance data reference TRP and this neighbour TRP counted in full subframes. The offset is counted from the beginning of a subframe #0 of the assistance data reference TRP to the beginning of the closest subsequent subframe #0 of this neighbour TRP, rounded down to multiples of subframes.
<p>nr-DL-PRS-ExpectedRSTD</p> <p>This field indicates the RSTD value that the target device is expected to measure between this TRP and the assistance data reference TRP. The <i>nr-DL-PRS-ExpectedRSTD</i> field takes into account the expected propagation time difference as well as transmit time difference of PRS positioning occasions between the two TRPs. The resolution is $4 \times T_s$, with $T_s = 1 / (15000 \times 2048)$ seconds.</p>
<p>nr-DL-PRS-ExpectedRSTD-Uncertainty</p> <p>This field indicates the uncertainty in <i>nr-DL-PRS-ExpectedRSTD</i> value. The uncertainty is related to the location server's a-priori estimate of the target device location. The <i>nr-DL-PRS-ExpectedRSTD</i> and <i>nr-DL-PRS-ExpectedRSTD-Uncertainty</i> together define the search window for the target device. The resolution R is</p> <ul style="list-style-type: none"> - T_s if all PRS resources are in frequency range 2, - $4 \times T_s$ otherwise, <p>with $T_s = 1 / (15000 \times 2048)$ seconds. The target device may assume that the beginning of the subframe for the PRS of this TRP is received within the search window of size</p> <ul style="list-style-type: none"> - $[-nr-DL-PRS-ExpectedRSTD-Uncertainty \times R ; nr-DL-PRS-ExpectedRSTD-Uncertainty \times R]$ centred at $T_{REF} + 1$ millisecond $\times N + nr-DL-PRS-ExpectedRSTD \times 4 \times T_s$, <p>where T_{REF} is the reception time of the beginning of the subframe for the PRS of the assistance data reference TRP at the target device antenna connector, and N can be calculated based on</p> <ul style="list-style-type: none"> - <i>nr-DL-PRS-SFN0-Offset</i> - <i>dl-PRS-Periodicity-and-ResourceSetSlotOffset</i> - <i>dl-PRS-ResourceSlotOffset</i>.
<p>nr-DL-PRS-Info</p> <p>This field specifies the PRS configuration of the TRP.</p>
<p>dl-PRS-SubcarrierSpacing</p> <p>This field specifies the subcarrier spacing of the DL-PRS Resource. 15, 30, 60 kHz for FR1; 60, 120 kHz for FR2. All DL-PRS Resources and DL-PRS Resource Sets in the same Positioning Frequency layer have the same value of <i>dl-PRS-SubcarrierSpacing</i>.</p>
<p>dl-PRS-ResourceBandwidth</p> <p>This field specifies the number of PRBs allocated for the DL-PRS Resource (allocated DL-PRS bandwidth) in multiples of 4 PRBs. All DL-PRS Resources of the DL-PRS Resource Set have the same bandwidth. All DL-PRS Resource Sets belonging to the same Positioning Frequency Layer have the same value of DL-PRS Bandwidth and Start PRB. Integer value 1 corresponds to 24 PRBs, value 2 corresponds to 28 PRBs, value 3 corresponds to 32 PRBs and so on.</p>
<p>dl-PRS-StartPRB</p> <p>This field specifies the start PRB index defined as offset with respect to reference DL-PRS Point A for the Positioning Frequency Layer. All DL-PRS Resources Sets belonging to the same Positioning Frequency Layer have the same value of <i>dl-PRS-StartPRB</i>.</p>
<p>dl-PRS-PointA</p> <p>This field specifies the absolute frequency of the reference resource block for the DL-PRS. Its lowest subcarrier is also known as DL-PRS Point A. A single DL-PRS Point A for DL-PRS Resource allocation is provided per Positioning Frequency Layer. All DL-PRS Resources belonging to the same DL-PRS Resource Set have the same DL-PRS Point A.</p>
<p>dl-PRS-CombSizeN</p> <p>This field specifies the Resource Element spacing in each symbol of the DL-PRS Resource. All DL-PRS Resource Sets belonging to the same Positioning Frequency Layer have the same value of comb size N.</p>
<p>dl-PRS-CyclicPrefix</p> <p>This field specifies the Cyclic Prefix length of the DL-PRS Resource. All DL-PRS Resources Sets belonging to the same Positioning Frequency Layer have the same value of <i>dl-PRS-CyclicPrefix</i>.</p>

NR-DL-PRS-AssistanceData field descriptions**prs-OnlyTP**

This field, if present, indicates that the *NR-DL-PRS-AssistanceData* is provided for a PRS-only TP. Whether the field is present or absent should be the same for all the *NR-DL-PRS-AssistanceData* of all the PRS transmitted under the same TP.

The target device shall not assume that any other signals or physical channels are present for the TRP other than DL-PRS.

NR-DL-PRS-BeamInfo

The IE *NR-DL-PRS-BeamInfo* is used by the location server to provide spatial direction information of the DL-PRS Resources.

```
-- ASN1START
NR-DL-PRS-BeamInfo-r16 ::= SEQUENCE (SIZE (1..nrMaxFreqLayers-r16)) OF
    NR-DL-PRS-BeamInfoPerFreqLayer-r16
NR-DL-PRS-BeamInfoPerFreqLayer-r16 ::= SEQUENCE (SIZE (1..nrMaxTRPsPerFreq-r16)) OF
    NR-DL-PRS-BeamInfoPerTRP-r16
NR-DL-PRS-BeamInfoPerTRP-r16 ::= SEQUENCE {
    dl-PRS-ID-r16                INTEGER (0..255),
    nr-PhysCellID-r16           NR-PhysCellID-r16        OPTIONAL, -- Need ON
    nr-CellGlobalID-r16        NCGI-r15                 OPTIONAL, -- Need ON
    nr-ARFCN-r16               ARFCN-ValueNR-r15         OPTIONAL, -- Need ON
    associated-DL-PRS-ID-r16    INTEGER (0..255)         OPTIONAL, -- Need OP
    lcs-GCS-TranslationParameter-r16
        LCS-GCS-TranslationParameter-r16
        OPTIONAL, -- Need OP
    dl-PRS-BeamInfoSet-r16      DL-PRS-BeamInfoSet-r16   OPTIONAL, -- Need OP
    ...
}
DL-PRS-BeamInfoSet-r16 ::= SEQUENCE (SIZE(1..nrMaxSetsPerTrpPerFreqLayer-r16)) OF
    DL-PRS-BeamInfoResourceSet-r16
DL-PRS-BeamInfoResourceSet-r16 ::= SEQUENCE (SIZE(1..nrMaxResourcesPerSet-r16)) OF
    DL-PRS-BeamInfoElement-r16
DL-PRS-BeamInfoElement-r16 ::= SEQUENCE {
    dl-PRS-Azimuth-r16          INTEGER (0..359),
    dl-PRS-Azimuth-fine-r16     INTEGER (0..9)          OPTIONAL, -- Need ON
    dl-PRS-Elevation-r16        INTEGER (0..180)         OPTIONAL, -- Need ON
    dl-PRS-Elevation-fine-r16   INTEGER (0..9)          OPTIONAL, -- Need ON
    ...
}
LCS-GCS-TranslationParameter-r16 ::= SEQUENCE {
    alpha-r16                   INTEGER (0..359),
    alpha-fine-r16              INTEGER (0..9)          OPTIONAL, -- Cond AzElFine
    beta-r16                    INTEGER (0..359),
    beta-fine-r16               INTEGER (0..9)          OPTIONAL, -- Cond AzElFine
    gamma-r16                   INTEGER (0..359),
    gamma-fine-r16              INTEGER (0..9)          OPTIONAL, -- Cond AzElFine
    ...
}
-- ASN1STOP
```

Conditional presence	Explanation
<i>AzElFine</i>	The field is mandatory present if <i>dl-PRS-Azimuth-fine</i> or <i>dl-PRS-Elevation-fine</i> are present; otherwise it is not present.

NR-DL-PRS-Beam-Info field descriptions
<p>dl-PRS-ID This field is used along with a DL-PRS Resource Set ID and a DL-PRS Resources ID to uniquely identify a DL-PRS Resource. This ID can be associated with multiple DL-PRS Resource Sets associated with a single TRP. Each TRP should only be associated with one such ID.</p>
<p>nr-PhysCellID This field specifies the physical cell identity of the associated TRP, as defined in TS 38.331 [35].</p>
<p>nr-CellGlobalID This field specifies the NCGI, the globally unique identity of a cell in NR, of the associated TRP, as defined in TS 38.331 [35]. The server should include this field if it considers that it is needed to resolve ambiguity in the TRP indicated by <i>nr-PhysCellID</i>.</p>
<p>nr-ARFCN This field specifies the NR-ARFCN of the TRP's CD-SSB (as defined in TS 38.300 [47]) corresponding to <i>nr-PhysCellID</i>.</p>
<p>associated-DL-PRS-ID This field specifies the <i>dl-PRS-ID</i> of the associated TRP from which the beam information and parameters for LCS to GCS translation are adopted. If the field is omitted, the beam information is provided via the <i>dl-prs-BeamInfoSet</i> field and the LCS to GCS translation parameter is provided via the <i>lcs-GCS-TranslationParameter</i>. If the field is present, the fields <i>lcs-GCS-TranslationParameter</i> and <i>dl-PRS-BeamInfoSet</i> shall be absent.</p>
<p>lcs-GCS-TranslationParameter This field provides the angles α (bearing angle), β (downtilt angle) and γ (slant angle) for the translation of a Local Coordinate System (LCS) to a Global Coordinate System (GCS) as defined in TR 38.901 [44]. If this field and the field associated-DL-PRS-ID are absent, the <i>dl-PRS-Azimuth</i> and <i>dl-PRS-Elevation</i> are provided in a GCS.</p>
<p>dl-PRS-BeamInfoSet This field provides the DL-PRS beam information for each DL-PRS Resource of the DL-PRS Resource Set associated with this TRP.</p>
<p>dl-PRS-Azimuth This field specifies the azimuth angle of the boresight direction in which the DL-PRS Resources associated with this DL-PRS Resource ID in the DL-PRS Resource Set are transmitted. For a Global Coordinate System (GCS), the azimuth angle is measured counter-clockwise from geographical North. For a Local Coordinate System (LCS), the azimuth angle is measured measured counter-clockwise from the x-axis of the LCS. Scale factor 1 degree; range 0 to 359 degrees.</p>
<p>dl-PRS-Azimuth-fine This field provides finer granularity for the <i>dl-PRS-Azimuth</i>. The total azimuth angle of the boresight direction is given by <i>dl-PRS-Azimuth</i> + <i>dl-PRS-Azimuth-fine</i>. Scale factor 0.1 degrees; range 0 to 0.9 degrees.</p>
<p>dl-PRS-Elevation This field specifies the elevation angle of the boresight direction in which the DL-PRS Resources associated with this DL-PRS Resource ID in the DL-PRS Resource Set are transmitted. For a Global Coordinate System (GCS), the elevation angle is measured relative to zenith and positive to the horizontal direction (elevation 0 deg. points to zenith, 90 deg to the horizon). For a Local Coordinate System (LCS), the elevation angle is measured relative to the z-axis of the LCS (elevation 0 deg. points to the z-axis, 90 deg to the x-y plane). Scale factor 1 degree; range 0 to 180 degrees.</p>
<p>dl-PRS-Elevation-fine This field provides finer granularity for the <i>dl-PRS-Elevation</i>. The total elevation angle of the boresight direction is given by <i>dl-PRS-Elevation</i> + <i>dl-PRS-Elevation-fine</i>. Scale factor 0.1 degrees; range 0 to 0.9 degrees.</p>
<p>alpha This field specifies the bearing angle α for the translation of the LCS to a GCS as defined in TR 38.901 [44]. Scale factor 1 degree; range 0 to 359 degrees.</p>
<p>alpha-fine This field provides finer granularity for the <i>alpha</i>. The total bearing angle α is given by <i>alpha</i> + <i>alpha-fine</i>. Scale factor 0.1 degrees; range 0 to 0.9 degrees.</p>
<p>beta This field specifies the downtilt angle β for the translation of the LCS to a GCS as defined in TR 38.901 [44]. Scale factor 1 degree; range 0 to 359 degrees.</p>
<p>beta-fine This field provides finer granularity for the <i>beta</i>. The total downtilt angle β is given by <i>beta</i> + <i>beta-fine</i>. Scale factor 0.1 degrees; range 0 to 0.9 degrees.</p>
<p>gamma This field specifies the slant angle γ for the translation of the LCS to a GCS as defined in TR 38.901 [44]. Scale factor 1 degree; range 0 to 359 degrees.</p>

gamma-fine

This field provides finer granularity for the *gamma*.

The total slant angle γ is given by *gamma* + *gamma-fine*.

Scale factor 0.1 degrees; range 0 to 0.9 degrees.

– NR-DL-PRS-Info

The IE *NR-DL-PRS-Info* defines downlink PRS configuration.

```

-- ASN1START
NR-DL-PRS-Info-r16 ::= SEQUENCE {
    nr-DL-PRS-ResourceSetList-r16      SEQUENCE (SIZE (1..nrMaxSetsPerTrpPerFreqLayer-r16)) OF
                                        NR-DL-PRS-ResourceSet-r16,
    ...
}

NR-DL-PRS-ResourceSet-r16 ::= SEQUENCE {
    nr-DL-PRS-ResourceSetID-r16        NR-DL-PRS-ResourceSetID-r16,
    dl-PRS-Periodicity-and-ResourceSetSlotOffset-r16
                                        NR-DL-PRS-Periodicity-and-ResourceSetSlotOffset-r16,
    dl-PRS-ResourceRepetitionFactor-r16 ENUMERATED {n2, n4, n6, n8, n16, n32, ...}
                                        OPTIONAL,      -- Need OP
    dl-PRS-ResourceTimeGap-r16         ENUMERATED {s1, s2, s4, s8, s16, s32, ...}
                                        OPTIONAL,      -- Cond Rep
    dl-PRS-NumSymbols-r16              ENUMERATED {n2, n4, n6, n12, ...},
    dl-PRS-MutingOption1-r16           DL-PRS-MutingOption1-r16      OPTIONAL,      -- Need OP
    dl-PRS-MutingOption2-r16           DL-PRS-MutingOption2-r16      OPTIONAL,      -- Need OP
    dl-PRS-ResourcePower-r16           INTEGER (-60..50),
    dl-PRS-ResourceList-r16            SEQUENCE (SIZE (1..nrMaxResourcesPerSet-r16)) OF
                                        NR-DL-PRS-Resource-r16,
    ...
}

DL-PRS-MutingOption1-r16 ::= SEQUENCE {
    dl-prs-MutingBitRepetitionFactor-r16
                                        ENUMERATED { n1, n2, n4, n8, ... } OPTIONAL,      -- Need OP
    nr-option1-muting-r16              NR-MutingPattern-r16,
    ...
}

DL-PRS-MutingOption2-r16 ::= SEQUENCE {
    nr-option2-muting-r16              NR-MutingPattern-r16,
    ...
}

NR-MutingPattern-r16 ::= CHOICE {
    po2-r16                            BIT STRING (SIZE(2)),
    po4-r16                            BIT STRING (SIZE(4)),
    po6-r16                            BIT STRING (SIZE(6)),
    po8-r16                            BIT STRING (SIZE(8)),
    po16-r16                           BIT STRING (SIZE(16)),
    po32-r16                           BIT STRING (SIZE(32)),
    ...
}

NR-DL-PRS-Resource-r16 ::= SEQUENCE {
    nr-DL-PRS-ResourceID-r16           NR-DL-PRS-ResourceID-r16,
    dl-PRS-SequenceID-r16              INTEGER (0.. 4095),
    dl-PRS-CombSizeN-AndReOffset-r16   CHOICE {
        n2-r16                          INTEGER (0..1),
        n4-r16                          INTEGER (0..3),
        n6-r16                          INTEGER (0..5),
        n12-r16                         INTEGER (0..11),
        ...
    },
    dl-PRS-ResourceSlotOffset-r16      INTEGER (0..nrMaxResourceOffsetValue-l-r16),
    dl-PRS-ResourceSymbolOffset-r16   INTEGER (0..12),
    dl-PRS-QCL-Info-r16               DL-PRS-QCL-Info-r16      OPTIONAL,      --Need ON
    ...
}

DL-PRS-QCL-Info-r16 ::= CHOICE {
    ssb-r16                            SEQUENCE {
        pci-r16                          NR-PhysCellID-r16,

```

```

        ssb-Index-r16                INTEGER (0..63),
        rs-Type-r16                  ENUMERATED {typeC, typeD, typeC-plus-typeD}
    },
    dl-PRS-r16                        SEQUENCE {
        qcl-DL-PRS-ResourceID-r16    NR-DL-PRS-ResourceID-r16,
        qcl-DL-PRS-ResourceSetID-r16 NR-DL-PRS-ResourceSetID-r16
    }
}

NR-DL-PRS-Periodicity-and-ResourceSetSlotOffset-r16 ::= CHOICE {
    scs15-r16        CHOICE {
        n4-r16            INTEGER (0..3),
        n5-r16            INTEGER (0..4),
        n8-r16            INTEGER (0..7),
        n10-r16           INTEGER (0..9),
        n16-r16           INTEGER (0..15),
        n20-r16           INTEGER (0..19),
        n32-r16           INTEGER (0..31),
        n40-r16           INTEGER (0..39),
        n64-r16           INTEGER (0..63),
        n80-r16           INTEGER (0..79),
        n160-r16          INTEGER (0..159),
        n320-r16          INTEGER (0..319),
        n640-r16          INTEGER (0..639),
        n1280-r16         INTEGER (0..1279),
        n2560-r16         INTEGER (0..2559),
        n5120-r16         INTEGER (0..5119),
        n10240-r16        INTEGER (0..10239),
        ...
    },
    scs30-r16        CHOICE {
        n8-r16            INTEGER (0..7),
        n10-r16           INTEGER (0..9),
        n16-r16           INTEGER (0..15),
        n20-r16           INTEGER (0..19),
        n32-r16           INTEGER (0..31),
        n40-r16           INTEGER (0..39),
        n64-r16           INTEGER (0..63),
        n80-r16           INTEGER (0..79),
        n128-r16          INTEGER (0..127),
        n160-r16          INTEGER (0..159),
        n320-r16          INTEGER (0..319),
        n640-r16          INTEGER (0..639),
        n1280-r16         INTEGER (0..1279),
        n2560-r16         INTEGER (0..2559),
        n5120-r16         INTEGER (0..5119),
        n10240-r16        INTEGER (0..10239),
        n20480-r16        INTEGER (0..20479),
        ...
    },
    scs60-r16        CHOICE {
        n16-r16           INTEGER (0..15),
        n20-r16           INTEGER (0..19),
        n32-r16           INTEGER (0..31),
        n40-r16           INTEGER (0..39),
        n64-r16           INTEGER (0..63),
        n80-r16           INTEGER (0..79),
        n128-r16          INTEGER (0..127),
        n160-r16          INTEGER (0..159),
        n256-r16          INTEGER (0..255),
        n320-r16          INTEGER (0..319),
        n640-r16          INTEGER (0..639),
        n1280-r16         INTEGER (0..1279),
        n2560-r16         INTEGER (0..2559),
        n5120-r16         INTEGER (0..5119),
        n10240-r16        INTEGER (0..10239),
        n20480-r16        INTEGER (0..20479),
        n40960-r16        INTEGER (0..40959),
        ...
    },
    scs120-r16        CHOICE {
        n32-r16           INTEGER (0..31),
        n40-r16           INTEGER (0..39),
        n64-r16           INTEGER (0..63),
        n80-r16           INTEGER (0..79),
        n128-r16          INTEGER (0..127),
        n160-r16          INTEGER (0..159),
        n256-r16          INTEGER (0..255),

```

```

n320-r16          INTEGER (0..319),
n512-r16          INTEGER (0..511),
n640-r16          INTEGER (0..639),
n1280-r16         INTEGER (0..1279),
n2560-r16         INTEGER (0..2559),
n5120-r16         INTEGER (0..5119),
n10240-r16        INTEGER (0..10239),
n20480-r16        INTEGER (0..20479),
n40960-r16        INTEGER (0..40959),
n81920-r16        INTEGER (0..81919),
...
},
...
}
-- ASN1STOP

```

Conditional presence	Explanation
<i>Rep</i>	The field is mandatory present, if <i>dl-PRS-ResourceRepetitionFactor</i> is present. Otherwise it is not present.

NR-DL-PRS-Info field descriptions	
<i>nr-DL-PRS-ResourceSetID</i>	This field specifies the DL-PRS Resource Set ID, which is used to identify the DL-PRS Resource Set of the TRP across all the frequency layers.
<i>dl-PRS-Periodicity-and-ResourceSetSlotOffset</i>	This field specifies the periodicity of DL-PRS allocation in slots configured per DL-PRS Resource Set and the slot offset with respect to SFN #0 slot #0 for a TRP where the DL-PRS Resource Set is configured (i.e. slot where the first DL-PRS Resource of DL-PRS Resource Set occurs).
<i>dl-PRS-ResourceRepetitionFactor</i>	This field specifies how many times each DL-PRS Resource is repeated for a single instance of the DL-PRS Resource Set. It is applied to all resources of the DL-PRS Resource Set. Enumerated values <i>n2, n4, n6, n8, n16, n32</i> correspond to 2, 4, 6, 8, 16, 32 resource repetitions, respectively. If this field is absent, the value for <i>dl-PRS-ResourceRepetitionFactor</i> is 1 (i.e., no resource repetition).
<i>dl-PRS-ResourceTimeGap</i>	This field specifies the offset in units of slots between two repeated instances of a DL-PRS Resource corresponding to the same DL-PRS Resource ID within a single instance of the DL-PRS Resource Set. The time duration spanned by one DL-PRS Resource Set containing repeated DL-PRS Resources should not exceed DL-PRS-Periodicity.
<i>dl-PRS-NumSymbols</i>	This field specifies the number of symbols per DL-PRS Resource within a slot.
<i>dl-PRS-MutingOption1</i>	This field specifies the DL-PRS muting configuration of the TRP for the Option-1 muting, as specified in TS 38.214 [45], and comprises the following sub-fields: <ul style="list-style-type: none"> - <i>dl-prs-MutingBitRepetitionFactor</i> indicates the number of consecutive instances of the DL-PRS Resource Set corresponding to a single bit of the <i>nr-option1-muting</i> bit map. Enumerated values <i>n1, n2, n4, n8</i> correspond to 1, 2, 4, 8 consecutive instances, respectively. If this sub-field is absent, the value for <i>dl-prs-MutingBitRepetitionFactor</i> is <i>n1</i>. - <i>nr-option1-muting</i> defines a bitmap of the time locations where the DL-PRS Resource is transmitted (value '1') or not (value '0') for a DL-PRS Resource Set, as specified in TS 38.214 [45]. If this field is absent, Option-1 muting is not in use for the TRP.
<i>dl-PRS-MutingOption2</i>	This field specifies the DL-PRS muting configuration of the TRP for the Option-2 muting, as specified in TS 38.214 [45], and comprises the following sub-fields: <ul style="list-style-type: none"> - <i>nr-option2-muting</i> defines a bitmap of the time locations where the DL-PRS Resource is transmitted (value '1') or not (value '0'). Each bit of the bitmap corresponds to a single repetition of the DL-PRS Resource within an instance of a DL-PRS Resource Set, as specified in TS 38.214 [45]. The size of this bitmap should be the same as the value for <i>dl-PRS-ResourceRepetitionFactor</i>. If this field is absent, Option-2 muting is not in use for the TRP.
<i>dl-PRS-ResourcePower</i>	This field specifies the average EPRE of the resources elements that carry the PRS in dBm that is used for PRS transmission. The UE assumes constant EPRE is used for all REs of a given DL-PRS resource.
<i>dl-PRS-SequenceId</i>	This field specifies the sequence Id used to initialize c_{init} value used in pseudo random generator TS 38.211 [41], clause 5.2.1 for generation of DL-PRS sequence for transmission on a given DL-PRS Resource.

dl-PRS-CombSizeN-AndReOffset

This field specifies the Resource Element spacing in each symbol of the DL-PRS Resource and the Resource Element (RE) offset in the frequency domain for the first symbol in a DL-PRS Resource. All DL-PRS Resource Sets belonging to the same Positioning Frequency Layer have the same value of comb size. The relative RE offsets of following symbols are defined relative to the RE Offset in the frequency domain of the first symbol in the DL-PRS Resource according to TS 38.211 [41]. The comb size configuration should be aligned with the comb size configuration for the frequency layer.

dl-PRS-ResourceSlotOffset

This field specifies the starting slot of the DL-PRS Resource with respect to the corresponding DL-PRS-Resource Set Slot Offset.

dl-PRS-ResourceSymbolOffset

This field specifies the starting symbol of the DL-PRS Resource within a slot determined by *dl-PRS-ResourceSlotOffset*.

dl-PRS-QCL-Info

This field specifies the QCL indication with other DL reference signals for serving and neighbouring cells and comprises the following subfields:

- **ssb** indicates the SSB information for QCL source and comprises the following sub-fields:
 - **pci** specifies the physical cell ID of the cell with the SSB that is configured as the source reference signal for the DL-PRS. The UE obtains the SSB configuration for the SSB configured as source reference signal for the DL-PRS by indexing to the field *nr-SSB-Config* with this physical cell identity.
 - **ssb-Index** indicates the index for the SSB configured as the source reference signal for the DL-PRS.
 - **rs-Type** indicates the QCL type.
- **dl-PRS** indicates the PRS information for QCL source reference signal and comprises the followings sub-fields:
 - **qcl-DL-PRS-ResourceID** specifies DL-PRS Resource ID of the DL-PRS resource used as the source reference signal.
 - **qcl-DL-PRS-ResourceSetID** indicates the DL-PRS Resource Set ID of the DL-PRS Resource Set used as the source reference signal.

NR-DL-PRS-ProcessingCapability

The IE *NR-DL-PRS-ProcessingCapability* defines the common DL-PRS Processing capability. In the case of capabilities for multiple NR positioning methods are provided, the IE *NR-DL-PRS-ProcessingCapability* applies across the NR positioning methods and the target device shall indicate the same values for the capabilities in IEs *NR-DL-TDOA-ProvideCapabilities*, *NR-DL-AoD-ProvideCapabilities*, and *NR-Multi-RTT-ProvideCapabilities*.

The *PRS-ProcessingCapabilityPerBand* is defined for a single positioning frequency layer on a certain band (i.e., a target device supporting multiple positioning frequency layers is expected to process one frequency layer at a time).

```
-- ASN1START
NR-DL-PRS-ProcessingCapability-r16 ::= SEQUENCE {
    prs-ProcessingCapabilityBandList-r16    SEQUENCE (SIZE (1..nrMaxBands-r16)) OF
                                           PRS-ProcessingCapabilityPerBand-r16,
    maxSupportedFreqLayers-r16            INTEGER (1..4),
    simulLTE-NR-PRS-r16                   ENUMERATED { supported } OPTIONAL,
    ...
}

PRS-ProcessingCapabilityPerBand-r16 ::= SEQUENCE {
    freqBandIndicatorNR-r16               FreqBandIndicatorNR-r16,
    supportedBandwidthPRS-r16             CHOICE {
        fr1                               ENUMERATED { mhz5, mhz10, mhz20, mhz40,
                                                       mhz50, mhz80, mhz100 },
        fr2                               ENUMERATED { mhz50, mhz100, mhz200, mhz400 },
        ...
    },
    dl-PRS-BufferType-r16                 ENUMERATED { type1, type2, ... },
    durationOfPRS-Processing-r16          SEQUENCE {
        durationOfPRS-ProcessingSymbols-r16 ENUMERATED { nDot125, nDot25, nDot5, n1,
                                                       n2, n4, n6, n8, n12, n16, n20, n25,
                                                       n30, n32, n35, n40, n45, n50 },
        durationOfPRS-ProcessingSymbolsInEveryTms-r16
                                           ENUMERATED { n8, n16, n20, n30, n40, n80,
                                                       n160, n320, n640, n1280 },
        ...
    },
    maxNumOfDL-PRS-ResProcessedPerSlot-r16 SEQUENCE {
        scs15-r16                         ENUMERATED { n1, n2, n4, n8, n16, n24, n32,
                                                       n48, n64 } OPTIONAL,
        scs30-r16                         ENUMERATED { n1, n2, n4, n8, n16, n24, n32,

```

```

        scs60-r16          ENUMERATED {n48, n64}          OPTIONAL,
        scs120-r16       ENUMERATED {n1, n2, n4, n8, n16, n24, n32,
        ..                n48, n64}          OPTIONAL,
        ..                ..                ..                ..
    },
    ..
}
-- ASN1STOP

```

NR-DL-PRS-ProcessingCapability field descriptions

maxSupportedFreqLayers

Indicates the maximum number of positioning frequency layers supported by UE.

supportedBandwidthPRS

Indicates the maximum number of DL-PRS bandwidth in MHz, which is supported and reported by UE.

dl-PRS-BufferType

Indicates DL-PRS buffering capability. Value *type1* indicates sub-slot/symbol level buffering and value *type2* indicates slot level buffering.

durationOfPRS-Processing

Indicates the duration *N* of DL-PRS symbols in units of ms a UE can process every *T* ms assuming maximum DL-PRS bandwidth provided in *supportedBandwidthPRS* and comprises the following subfields:

- **durationOfPRS-ProcessingSymbols**: This field specifies the values for *N*. Enumerated values indicate 0.125, 0.25, 0.5, 1, 2, 4, 8, 12, 16, 20, 25, 30, 35, 40, 45, 50 ms.
- **durationOfPRS-ProcessingSymbolsInEveryTms**: This field specifies the values for *T*. Enumerated values indicate 8, 16, 20, 30, 40, 80, 160, 320, 640, 1280 ms.

See NOTE.

maxNumOfDL-PRS-ResProcessedPerSlot

Indicates the maximum number of DL-PRS resources that UE can process in a slot. SCS: 15 kHz, 30 kHz, 60 kHz are applicable for FR1 bands. SCS: 60 kHz, 120 kHz are applicable for FR2 bands.

simULTE-NR-PRS

Indicates whether the UE supports parallel processing of LTE PRS and NR PRS.

NOTE: When the target device provides the *durationOfPRS-Processing* capability (*N*, *T*) for any $P(\geq T)$ time window defined in TS 38.214 [45] clause 5.1.6.5, the target device should be capable of processing all DL-PRS resources within *P*, if

- $N \geq K$ where *K* is defined in the TS 38.214 [45] clause 5.1.6.5, and
- the number of DL-PRS Resources in each slot does not exceed the *maxNumOfDL-PRS-ResProcessedPerSlot*, and
- the configured measurement gap and a maximum ratio of measurement gap length (MGL) / measurement gap repetition period (MGRP) is as specified in TS 38.133 [46].

– **NR-DL-PRS-QCL-ProcessingCapability**

The IE *NR-DL-PRS-QCL-ProcessingCapability* defines the common UE DL-PRS QCL Processing capability. The UE can include this IE only if the UE supports *NR-DL-PRS-ProcessingCapability*. Otherwise, the UE does not include this IE.

In the case of capabilities for multiple NR positioning methods are provided, the IE *NR-DL-PRS-QCL-ProcessingCapability* applies across the NR positioning methods and the target device shall indicate the same values for the capabilities in IEs *NR-DL-TDOA-ProvideCapabilities*, *NR-DL-AoD-ProvideCapabilities*, and *NR-Multi-RTT-ProvideCapabilities*.

```

-- ASN1START
NR-DL-PRS-QCL-ProcessingCapability-r16 ::= SEQUENCE {
    dl-PRS-QCL-ProcessingCapabilityBandList-r16  SEQUENCE (SIZE (1..nrMaxBands-r16)) OF
    ..                DL-PRS-QCL-ProcessingCapabilityPerBand-r16,
    ..
}
DL-PRS-QCL-ProcessingCapabilityPerBand-r16 ::= SEQUENCE {
    freqBandIndicatorNR-r16          FreqBandIndicatorNR-r16,
    ssb-FromNeighCellAsQCL-r16     ENUMERATED { supported} OPTIONAL,
}
-- ASN1STOP

```

```

    prs-FromServNeighCellAsQCL-r16          ENUMERATED { supported } OPTIONAL,
    ...
}
-- ASN1STOP

```

NR-DL-PRS-QCL-ProcessingCapability field descriptions

ssbFromNeighCellAsQCL

Indicates the support of SSB from neighbour cell as QCL source of a DL-PRS. UE supporting this feature also support reusing SSB measurement from RRM for receiving PRS.

Note: It refers to Type-C for FR1 and Type-C & Type-D support for FR2.

prs-FromServNeighCellAsQCL

Indicates the support of DL-PRS from serving/neighbour cell as QCL source of a DL-PRS.

Note: It refers to Type-D support for FR2.

– NR-DL-PRS-ResourceID

The IE *NR-DL-PRS-ResourceID* defines the identity of a DL-PRS Resource of a DL-PRS Resource Set of a TRP.

```

-- ASN1START
NR-DL-PRS-ResourceID-r16 ::= INTEGER (0..nrMaxNumDL-PRS-ResourcesPerSet-1-r16)
-- ASN1STOP

```

– NR-DL-PRS-ResourcesCapability

The IE *NR-DL-PRS-ResourcesCapability* defines the DL-PRS resources capability for each positioning method. The UE can include this IE only if the UE supports *NR-DL-PRS-ProcessingCapability*. Otherwise, the UE does not include this IE.

```

-- ASN1START
NR-DL-PRS-ResourcesCapability-r16 ::= SEQUENCE {
    maxNrOfDL-PRS-ResourceSetPerTrpPerFrequencyLayer-r16
        INTEGER (1..2),
    maxNrOfTRP-AcrossFreqs-r16
        ENUMERATED { n4, n6, n12, n16, n32,
                    n64, n128, n256, ... },
    maxNrOfPosLayer-r16
        INTEGER (1..4),
    dl-PRS-ResourcesCapabilityBandList-r16
        SEQUENCE (SIZE (1..nrMaxBands-r16)) OF
            DL-PRS-ResourcesCapabilityPerBand-r16,
    dl-PRS-ResourcesBandCombinationList-r16
        DL-PRS-ResourcesBandCombinationList-r16,
    ...
}

DL-PRS-ResourcesCapabilityPerBand-r16 ::= SEQUENCE {
    freqBandIndicatorNR-r16
        FreqBandIndicatorNR-r16,
    maxNrOfDL-PRS-ResourcesPerResourceSet-r16
        ENUMERATED { n1, n2, n4, n8, n16, n32, n64, ... },
    maxNrOfDL-PRS-ResourcesPerPositioningFrequencyLayer-r16
        ENUMERATED { n6, n24, n32, n64, n96, n128,
                    n256, n512, n1024, ... },
    ...
}

DL-PRS-ResourcesBandCombinationList-r16 ::= SEQUENCE (SIZE (1..maxBandComb-r16)) OF
    DL-PRS-ResourcesBandCombination-r16

DL-PRS-ResourcesBandCombination-r16 ::= SEQUENCE {
    bandList-r16
        SEQUENCE (SIZE (1..maxSimultaneousBands-r16)) OF
            FreqBandIndicatorNR-r16,
    maxNrOfDL-PRS-ResourcesAcrossAllFL-TRP-ResourceSet-r16
        CHOICE {
            fr1-Only-r16
                ENUMERATED {n6, n24, n64, n128, n192,
                            n256, n512, n1024, n2048},
            fr2-Only-r16
                ENUMERATED {n24, n64, n96, n128, n192,
                            n256, n512, n1024, n2048},
            fr1-FR2Mix-r16
                SEQUENCE {
                    fr1-r16
                        ENUMERATED {n6, n24, n64, n96, n128,
                                    n192, n256, n512, n1024, n2048},
                    fr2-r16
                        ENUMERATED {n24, n64, n96, n128, n192,

```



```

n256, n512, n1024, n2048},
    },
    ...
  },
  ...
}
-- ASN1STOP

```

NR-DL-PRS-ResourcesCapability field descriptions

maxNrOfDL-PRS-ResourceSetPerTrpPerFrequencyLayer

Indicates the maximum number of DL-PRS Resource Sets per TRP per frequency layer supported by UE.

maxNrOfTRP-AcrossFreqs

Indicates the maximum number of TRPs across all positioning frequency layers.

maxNrOfPosLayer

Indicates the maximum number of supported positioning layer.

dl-PRS-ResourcesBandCombinationList

Provides the capabilities of DL-PRS Resources for the indicated band combination in *bandList*. This field is provided for all band combinations for which the target device supports DL-PRS.

maxNrOfDL-PRS-ResourcesPerResourceSet

Indicates the maximum number of DL-PRS Resources per DL-PRS Resource Set. Value 16, 32, 64 are only applicable to FR2 bands. Value 1 is not applicable for DL-AoD.

maxNrOfDL-PRS-ResourcesPerPositioningFrequencylayer

Indicates the maximum number of DL-PRS resources per TRP across all frequency layers. Value 6 is only applicable to FR1 bands.

maxNrOfDL-PRS-ResourcesAcrossAllFL-TRP-ResourceSet

Indicates the maximum number of DL-PRS Resources supported by UE across all frequency layers, TRPs and DL-PRS Resource Sets.

fr1-Only: This is applicable for FR1 only band combinations;

fr2-Only: This is applicable for FR2 only band combinations;

fr1-FR2Mix: This is applicable for band combinations containing FR1 and FR2 bands. fr1 means for FR1 in FR1/FR2 mixed operation, and fr2 means for FR2 in FR1/FR2 mixed operation.

– NR-DL-PRS-ResourceSetID

The IE *NR-DL-PRS-ResourceSetID* defines the identity of a DL-PRS Resource Set of a TRP.

```

-- ASN1START
NR-DL-PRS-ResourceSetID-r16 ::= INTEGER (0..nrMaxNumDL-PRS-ResourceSetsPerTRP-1-r16)
-- ASN1STOP

```

– NR-PositionCalculationAssistance

The IE *NR-PositionCalculationAssistance* is used by the location server to provide assistance data to enable UE-based downlink positioning.

```

-- ASN1START
NR-PositionCalculationAssistance-r16 ::= SEQUENCE {
  nr-TRP-LocationInfo-r16      NR-TRP-LocationInfo-r16      OPTIONAL, -- Need ON
  nr-DL-PRS-BeamInfo-r16      NR-DL-PRS-BeamInfo-r16      OPTIONAL, -- Need ON
  nr-RTD-Info-r16             NR-RTD-Info-r16             OPTIONAL, -- Need ON
  ...
}
-- ASN1STOP

```

NR-PositionCalculationAssistance field descriptions
nr-TRP-LocationInfo This field provides the location coordinates of the antenna reference points of the TRPs.
nr-DL-PRS-BeamInfo This field provides the spatial directions of DL-PRS Resources for TRPs.
nr-RTD-Info This field provides the time synchronization information between the reference TRP and neighbour TRPs.

– NR-RTD-Info

The IE *NR-RTD-Info* is used by the location server to provide time synchronization information between a reference TRP and a list of neighbour TRPs.

```

-- ASN1START
NR-RTD-Info-r16 ::= SEQUENCE {
    referenceTRP-RTD-Info-r16      ReferenceTRP-RTD-Info-r16,
    rtd-InfoList-r16              RTD-InfoList-r16,
    ...
}

ReferenceTRP-RTD-Info-r16 ::= SEQUENCE {
    dl-PRS-ID-Ref-r16              INTEGER (0..255),
    nr-PhysCellID-Ref-r16          NR-PhysCellID-r16          OPTIONAL,    -- Need ON
    nr-CellGlobalID-Ref-r16        NCGI-r15                  OPTIONAL,    -- Need ON
    nr-ARFCN-Ref-r16               ARFCN-ValueNR-r15          OPTIONAL,    -- Need ON
    refTime-r16                    CHOICE {
        systemFrameNumber-r16      BIT STRING (SIZE (10)),
        utc-r16                     UTCTime,
        ...
    },
    rtd-RefQuality-r16             NR-TimingQuality-r16      OPTIONAL,    -- Need ON
    ...
}

RTD-InfoList-r16 ::= SEQUENCE (SIZE (1..nrMaxFreqLayers-r16)) OF RTD-InfoListPerFreqLayer-r16
RTD-InfoListPerFreqLayer-r16 ::= SEQUENCE (SIZE(1..nrMaxTRPsPerFreq-r16)) OF RTD-InfoElement-r16
RTD-InfoElement-r16 ::= SEQUENCE {
    dl-PRS-ID-r16                  INTEGER (0..255),
    nr-PhysCellID-r16              NR-PhysCellID-r16          OPTIONAL,    -- Need ON
    nr-CellGlobalID-r16            NCGI-r15                  OPTIONAL,    -- Need ON
    nr-ARFCN-r16                   ARFCN-ValueNR-r15          OPTIONAL,    -- Need ON
    subframeOffset-r16             INTEGER (0..1966079),
    rtd-Quality-r16                NR-TimingQuality-r16,
    ...
}
-- ASN1STOP

```

NR-RTD-Info field descriptions
<p>referenceTRP-RTD-Info This field defines the reference TRP for the RTD and comprises the following sub-fields:</p> <ul style="list-style-type: none"> - dl-PRS-ID-Ref: This field is used along with a DL-PRS Resource Set ID and a DL-PRS Resources ID to uniquely identify a DL-PRS Resource, and is associated to the reference TRP. - nr-PhysCellId-Ref: This field specifies the physical cell identity of the reference TRP. - nr-CellGlobalId-Ref: This field specifies the NCGI, the globally unique identity of a cell in NR, of the reference TRP. - nr-ARFCN-Ref: This field specifies the NR-ARFCN of the TRP's CD-SSB (as defined in TS 38.300 [47]) corresponding to <i>nr-PhysCellID</i>. - refTime: This field specifies the reference time at which the <i>rtd-InfoList</i> is valid. The <i>systemFrameNumber</i> choice refers to the SFN of the reference TRP. - rtd-RefQuality: This field specifies the quality of the timing of reference TRP, used to determine the RTD values provided in <i>rtd-InfoList</i>.
<p>dl-PRS-ID This field is used along with a DL-PRS Resource Set ID and a DL-PRS Resources ID to uniquely identify a DL-PRS Resource. This ID can be associated with multiple DL-PRS Resource Sets associated with a single TRP for which the <i>RTD-InfoElement</i> is applicable.</p>
<p>nr-PhysCellID This field specifies the physical cell identity of the associated TRP for which the <i>RTD-InfoElement</i> is applicable, as defined in TS 38.331 [35].</p>
<p>nr-CellGlobalID This field specifies the NCGI, the globally unique identity of a cell in NR, of the associated TRP for which the <i>RTD-InfoElement</i> is applicable, as defined in TS 38.331 [35]. The server should include this field if it considers that it is needed to resolve ambiguity in the TRP indicated by <i>nr-PhysCellID</i>.</p>
<p>nr-ARFCN This field specifies the NR-ARFCN of the TRP's CD-SSB (as defined in TS 38.300 [47]) corresponding to <i>nr-PhysCellID</i> for which the <i>RTD-InfoElement</i> is applicable.</p>
<p>subframeOffset This field specifies the subframe boundary offset at the TRP antenna location between the reference TRP and this neighbour TRP in time units $T_c = 1/(\Delta f_{\max} \cdot N_f)$ where $\Delta f_{\max} = 480 \cdot 10^3$ Hz and $N_f = 4096$ (TS 38.211 [41]). The offset is counted from the beginning of a subframe #0 of the reference TRP to the beginning of the closest subsequent subframe of this neighbour TRP. Scale factor 1 T_c.</p>
<p>rtd-Quality This field specifies the quality of the RTD.</p>

– NR-SelectedDL-PRS-IndexList

The IE *NR-SelectedDL-PRS-IndexList* is used by the location server to provide the selected DL-PRS Resource of *nr-DL-PRS-AssistanceDataList* to the target device.

In the case of assistance data for multiple NR positioning methods are provided, the IE *NR-DL-PRS-AssistanceData* shall be present in only one of *NR-Multi-RTT-ProvideAssistanceData*, *NR-DL-AoD-ProvideAssistanceData*, or *NR-DL-TDOA-ProvideAssistanceData*.

```
-- ASN1START
NR-SelectedDL-PRS-IndexList-r16 ::= SEQUENCE (SIZE (1..nrMaxFreqLayers-r16)) OF
    NR-SelectedDL-PRS-PerFreq-r16

NR-SelectedDL-PRS-PerFreq-r16 ::= SEQUENCE {
    nr-SelectedDL-PRS-FrequencyLayerIndex-r16    INTEGER (0..nrMaxFreqLayers-1-r16),
    nr-SelectedDL-PRS-IndexListPerFreq-r16      SEQUENCE (SIZE (1..nrMaxTRPsPerFreq-r16)) OF
                                                NR-SelectedDL-PRS-IndexPerTRP-r16
                                                OPTIONAL,    --Need OP
    ...
}

NR-SelectedDL-PRS-IndexPerTRP-r16 ::= SEQUENCE {
    nr-SelectedTRP-Index-r16                    INTEGER (0..nrMaxTRPsPerFreq-1-r16),
    dl-SelectedPRS-ResourceSetIndexList-r16     SEQUENCE (SIZE (1..nrMaxSetsPerTrpPerFreqLayer-r16))
                                                OF DL-SelectedPRS-ResourceSetIndex-r16
                                                OPTIONAL,    --Need OP
    ...
}

DL-SelectedPRS-ResourceSetIndex-r16 ::= SEQUENCE {
```

```

nr-DL-SelectedPRS-ResourceSetIndex-r16      INTEGER (0..nrMaxSetsPerTrpPerFreqLayer-1-r16),
dl-SelectedPRS-ResourceIndexList-r16       SEQUENCE (SIZE (1..nrMaxResourcePerSet-r16)) OF
                                             DL-SelectedPRS-ResourceIndex-r16
}
                                             OPTIONAL --Need OP
DL-SelectedPRS-ResourceIndex-r16 ::= SEQUENCE {
  nr-DL-SelectedPRS-ResourceIdIndex-r16     INTEGER (0..nrMaxNumDL-PRS-ResourcesPerSet-1-r16),
  ...
}
-- ASN1STOP

```

NR-SelectedDL-PRS-IndexList field descriptions

nr-SelectedDL-PRS-FrequencyLayerIndex

This field indicates the frequency layer provided in IE *NR-DL-PRS-AssistanceData*. Value 0 corresponds to the first frequency layer provided in *nr-DL-PRS-AssistanceDataList* in IE *NR-DL-PRS-AssistanceData*, value 1 to the second frequency layer in *nr-DL-PRS-AssistanceDataList*, and so on.

nr-SelectedDL-PRS-IndexListPerFreq

This field provides the list of addressed TRPs of the selected frequency layer. If this field is absent, all DL-PRS Resources of all TRPs of the indicated frequency layer are addressed.

nr-SelectedTRP-Index

This field indicates the addressed TRP of the selected frequency layer. Value 0 corresponds to the first entry in *nr-DL-PRS-AssistanceDataPerFreq* provided in IE *NR-DL-PRS-AssistanceData*, value 1 corresponds to the second entry in *nr-DL-PRS-AssistanceDataPerFreq*, and so on.

dl-SelectedPRS-ResourceSetIndexList

This field provides the list of addressed DL-PRS Resource Sets of the selected TRPs of the selected frequency layer. If this field is absent, all DL-PRS Resource Sets and Resources of the indicated TRP are addressed.

nr-DL-SelectedPRS-ResourceSetIndex

This field indicates the addressed DL-PRS Resource Set of the selected TRP of the selected frequency layer. Value 0 corresponds to the first entry in *nr-DL-PRS-ResourceSetList* in IE *NR-DL-PRS-Info* provided in IE *NR-DL-PRS-AssistanceData*. Value 1 corresponds to the second entry in the *nr-DL-PRS-ResourceSetList* in IE *NR-DL-PRS-Info*.

dl-SelectedPRS-ResourceIndexList

This field provides the list of addressed DL-PRS Resources of the selected DL-PRS Resource Set of the selected TRP of the selected frequency layer. If this field is absent, all DL-PRS Resources of the indicated DL-PRS Resource Set are addressed.

nr-dl-SelectedPRS-ResourceIdIndex

This field indicates the addressed DL-PRS Resource of the selected DL-PRS Resource Set of the TRP of the selected frequency layer. Value 0 corresponds to the first entry in *dl-PRS-ResourceList* in IE *NR-DL-PRS-Info* provided in IE *NR-DL-PRS-AssistanceData*. Value 1 corresponds to the second entry in the *dl-PRS-ResourceList* in IE *NR-DL-PRS-Info*, and so on.

NR-SSB-Config

The IE *NR-SSB-Config* defines SSB configuration.

```

-- ASN1START
NR-SSB-Config-r16 ::= SEQUENCE {
  nr-PhysCellID-r16          NR-PhysCellID-r16,
  nr-ARFCN-r16              ARFCN-ValueNR-r15,
  ss-PBCH-BlockPower-r16    INTEGER (-60..50),
  halfFrameIndex-r16        INTEGER (0..1),
  ssb-periodicity-r16       ENUMERATED { ms5, ms10, ms20, ms40, ms80, ms160, ... },
  ssb-PositionsInBurst-r16   CHOICE {
    shortBitmap-r16          BIT STRING (SIZE (4)),
    mediumBitmap-r16         BIT STRING (SIZE (8)),
    longBitmap-r16           BIT STRING (SIZE (64))
  }
  OPTIONAL, --Need OR
  ssb-SubcarrierSpacing-r16  ENUMERATED {kHz15, kHz30, kHz60, kHz120, kHz240, ...},
  sfn-SSB-Offset-r16        INTEGER (0..15),
  ...
}
-- ASN1STOP

```

NR-SSB-Config field descriptions	
nr-ARFCN	This field specifies the ARFCN of the first RE of SSB's RB#10.
ss-PBCH-BlockPower	Average EPRE of the resources elements that carry secondary synchronization signals in dBm that the NW used for SSB transmission, see TS 38.213 [48], clause 7.
halfFrameIndex	Indicates the 5 msec offset of the SSB within a 10 msec system frame.
ssb-periodicity	The SSB periodicity in ms for the rate matching purpose.
ssb-PositionsInBurst	Indicates the time domain positions of the transmitted SS-blocks in a half frame with SS/PBCH blocks as defined in TS 38.213 [48], clause 4.1. The first/leftmost bit corresponds to SS/PBCH block index 0, the second bit corresponds to SS/PBCH block index 1, and so on. Value 0 in the bitmap indicates that the corresponding SS/PBCH block is not transmitted while value 1 indicates that the corresponding SS/PBCH block is transmitted.
ssb-SubcarrierSpacing	Subcarrier spacing of SSB. Only the values 15 kHz or 30 kHz (FR1), and 120 kHz or 240 kHz (FR2) are applicable.
sfn-SSB-Offset	Indicates the 10 msec system frame offset of the SSB within the SSB periodicity. Value 0 indicates that the SSB is transmitted in the first system frame; 1 indicates that the SSB is transmitted in the second system frame and so on. This field shall be configured according to the field <i>ssb-Periodicity</i> and the indicated system frame shall not exceed the configured SSB periodicity.

– NR-TimeStamp

The IE *NR-TimeStamp* defines the UE measurement associated time stamp.

```

-- ASN1START
NR-TimeStamp-r16 ::= SEQUENCE {
    dl-PRS-ID-r16          INTEGER (0..255),
    nr-PhysCellID-r16     NR-PhysCellID-r16          OPTIONAL, -- Need ON
    nr-CellGlobalID-r16   NCGI-r15                  OPTIONAL, -- Need ON
    nr-ARFCN-r16          ARFCN-ValueNR-r15         OPTIONAL, -- Need ON
    nr-SFN-r16            INTEGER (0..1023),
    nr-Slot-r16           CHOICE {
        scs15-r16          INTEGER (0..9),
        scs30-r16          INTEGER (0..19),
        scs60-r16          INTEGER (0..39),
        scs120-r16         INTEGER (0..79)
    },
    ...
}
-- ASN1STOP

```

NR-TimeStamp field descriptions	
dl-PRS-ID	This field specifies the DL-PRS ID of the TRP for which the <i>nr-SFN</i> is applicable.
nr-PhysCellID	This field specifies the physical cell identity of the associated TRP, as defined in TS 38.331 [35].
nr-CellGlobalID	This field specifies the NCGI, the globally unique identity of a cell in NR, of the associated TRP, as defined in TS 38.331 [35].
nr-ARFCN	This field specifies the ARFCN of the TRP's CD-SSB (as defined in TS 38.300 [47]) corresponding to <i>nr-PhysCellID</i> associated with the <i>dl-PRS-ID</i> .
nr-SFN	This field specifies the NR system frame number for the time stamp.
nr-Slot	This field specifies the NR slot number within the NR system frame number indicated by <i>nr-SFN</i> for the time stamp.

– NR-TimingQuality

The IE *NR-TimingQuality* defines the quality of a timing value (e.g., of a TOA measurement).

```

-- ASN1START
NR-TimingQuality-r16 ::= SEQUENCE {
    timingQualityValue-r16      INTEGER (0..31),
    timingQualityResolution-r16 ENUMERATED {mdot1, m1, m10, m30, ...},
    ...
}
-- ASN1STOP

```

NR-TimingQuality field descriptions

timingQualityValue

This field provides an estimate of uncertainty of the timing value for which the IE *NR-TimingQuality* is provided in units of metres.

timingQualityResolution

This field provides the resolution used in the *timingQualityValue* field. Enumerated values *mdot1*, *m1*, *m10*, *m30* correspond to 0.1, 1, 10, 30 metres, respectively.

-- **NR-TRP-LocationInfo**

The IE *NR-TRP-LocationInfo* is used by the location server to provide the coordinates of the antenna reference points for a set of TRPs. For each TRP, the ARP location can be provided for each associated PRS Resource ID per PRS Resource Set.

```

-- ASN1START
NR-TRP-LocationInfo-r16 ::= SEQUENCE (SIZE (1..nrMaxFreqLayers-r16)) OF
    NR-TRP-LocationInfoPerFreqLayer-r16

NR-TRP-LocationInfoPerFreqLayer-r16 ::= SEQUENCE {
    referencePoint-r16      ReferencePoint-r16      OPTIONAL,    -- Cond NotSameAsPrev
    trp-LocationInfoList-r16 SEQUENCE (SIZE (1..nrMaxTRPsPerFreq-r16)) OF
        TRP-LocationInfoElement-r16,
    ...
}

TRP-LocationInfoElement-r16 ::= SEQUENCE {
    dl-PRS-ID-r16           INTEGER (0..255),
    nr-PhysCellID-r16      NR-PhysCellID-r16      OPTIONAL,    -- Need ON
    nr-CellGlobalID-r16    NCGI-r15               OPTIONAL,    -- Need ON
    nr-ARFCN-r16           ARFCN-ValueNR-r15      OPTIONAL,    -- Need ON
    associated-DL-PRS-ID-r16 INTEGER (0..255)      OPTIONAL,    -- Need OP
    trp-Location-r16       RelativeLocation-r16    OPTIONAL,    -- Need OP
    trp-DL-PRS-ResourceSets-r16 SEQUENCE (SIZE(1..nrMaxSetsPerTrpPerFreqLayer-r16)) OF
        DL-PRS-ResourceSets-TRP-Element-r16 OPTIONAL,    -- Need OP
    ...
}

DL-PRS-ResourceSets-TRP-Element-r16 ::= SEQUENCE {
    dl-PRS-ResourceSetARP-r16 RelativeLocation-r16    OPTIONAL,    -- Need OP
    dl-PRS-Resource-ARP-List-r16 SEQUENCE (SIZE(1..nrMaxResourcesPerSet-r16)) OF
        DL-PRS-Resource-ARP-Element-r16 OPTIONAL,    -- Need OP
    ...
}

DL-PRS-Resource-ARP-Element-r16 ::= SEQUENCE {
    dl-PRS-Resource-ARP-location-r16 RelativeLocation-r16    OPTIONAL,    -- Need OP
    ...
}
-- ASN1STOP

```

Conditional presence	Explanation
<i>NotSameAsPrev</i>	The field is mandatory present in the first entry of the <i>NR-TRP-LocationInfoPerFreqLayer</i> list; otherwise it is optionally present, need OP.

NR-TRP-LocationInfo field descriptions
<p>referencePoint This field specifies the reference point used to define the TRP location in the <i>trp-LocationInfoList</i>. If this field is absent, the reference point is the same as in the previous entry of the <i>NR-TRP-LocationInfoPerFreqLayer</i> list.</p>
<p>trp-LocationInfoList This field provides the antenna reference point locations of the DL-PRS Resources for the TRPs and comprises the following sub-fields:</p> <ul style="list-style-type: none"> - dl-PRS-ID: This field is used along with a DL-PRS Resource Set ID and a DL-PRS Resources ID to uniquely identify a DL-PRS Resource, and is associated to a single TRP. - nr-PhysCellID: This field specifies the physical cell identity of the associated TRP. - nr-CellGlobalID: This field specifies the NCGI, the globally unique identity of a cell in NR, of the associated TRP. - nr-ARFCN: This field specifies the NR-ARFCN of the TRP's CD-SSB (as defined in TS 38.300 [47]) corresponding to <i>nr-PhysCellID</i>. - associated-DL-PRS-ID: This field, if present, specifies the <i>dl-PRS-ID</i> of the associated TRP from which the <i>trp-location</i> information is adopted. If the field is present, the field <i>trp-Location</i> shall be absent. - trp-Location: This field provides the location of the TRP relative to the <i>referencePoint</i> location. If this field is absent the TRP location coincides with the <i>referencePoint</i> location, unless the field <i>associated-dl-PRS-ID</i> is present, in which case the <i>trp-Location</i> is adopted from the associated TRP indicated by <i>associated-dl-PRS-ID</i>. - trp-DL-PRS-ResourceSets: This field provides the antenna reference point location(s) of the DL-PRS Resource Set(s) associated with this TRP. If this field is absent, the antenna reference point location(s) of the DL-PRS Resource Set(s) coincides with the <i>trp-Location</i> location. This field comprises the following sub-fields: <ul style="list-style-type: none"> - dl-PRS-ResourceSetARP: This field provides the antenna reference point location of the DL-PRS Resource Set relative to the <i>trp-Location</i> location. If this field is absent, the antenna reference point location of this DL-PRS Resource Set coincides with the <i>trp-Location</i> location. - dl-PRS-Resource-ARP-List: This field provides the antenna reference point location(s) of the DL-PRS Resource(s) associated with this Resource Set of the TRP. If this field is absent, the antenna reference point location(s) of the DL-PRS Resources coincides with the <i>dl-PRS-ResourceSetARP</i> location. This field comprises the following sub-fields: <ul style="list-style-type: none"> - dl-PRS-Resource-ARP-location: This field provides the antenna reference point location of the DL-PRS Resource associated with the DL-PRS Resource Set of the TRP relative to the <i>dl-PRS-ResourceSetARP</i> location. If this field is absent, the antenna reference point location of this DL-PRS Resource coincides with the <i>dl-PRS-ResourceSetARP</i> location.

NR-UL-SRS-Capability

The IE *NR-UL-SRS-Capability* defines the UE uplink SRS capability.

```

-- ASN1START
NR-UL-SRS-Capability-r16 ::= SEQUENCE {
    srs-CapabilityBandList-r16          SEQUENCE (SIZE (1..nrMaxBands-r16)) OF
                                         SRS-CapabilityPerBand-r16,
    srs-PosResourceConfigCA-BandList-r16 SEQUENCE (SIZE (1..nrMaxConfiguredBands-r16)) OF
                                         SRS-PosResourcesPerBand-r16          OPTIONAL,
    maxNumberSRS-PosPathLossEstimateAllServingCells-r16
                                         ENUMERATED {n1, n4, n8, n16}          OPTIONAL,
    maxNumberSRS-PosSpatialRelationsAllServingCells-r16
                                         ENUMERATED {n0, n1, n2, n4, n8, n16}  OPTIONAL,
    ...
}

SRS-CapabilityPerBand-r16 ::= SEQUENCE {
    freqBandIndicatorNR-r16             FreqBandIndicatorNR-r16,
    olpc-SRS-Pos-r16                    OLPC-SRS-Pos-r16                    OPTIONAL,
    spatialRelationsSRS-Pos-r16         SpatialRelationsSRS-Pos-r16         OPTIONAL,
    ...
}

OLPC-SRS-Pos-r16 ::= SEQUENCE {
    olpc-SRS-PosBasedOnPRS-Serving-r16  ENUMERATED {supported}            OPTIONAL,
    olpc-SRS-PosBasedOnSSB-Neigh-r16    ENUMERATED {supported}            OPTIONAL,
    olpc-SRS-PosBasedOnPRS-Neigh-r16    ENUMERATED {supported}            OPTIONAL,
    maxNumberPathLossEstimatePerServing-r16
                                         ENUMERATED {n1, n4, n8, n16}          OPTIONAL,
    ...
}

SpatialRelationsSRS-Pos-r16 ::= SEQUENCE {
    spatialRelation-SRS-PosBasedOnSSB-Serving-r16
                                         ENUMERATED {supported}            OPTIONAL,
    spatialRelation-SRS-PosBasedOnCSI-RS-Serving-r16
                                         ENUMERATED {supported}            OPTIONAL,
    spatialRelation-SRS-PosBasedOnPRS-Serving-r16
                                         ENUMERATED {supported}            OPTIONAL,
}

```

```

    spatialRelation-SRS-PosBasedOnSRS-r16          ENUMERATED {supported}          OPTIONAL,
    spatialRelation-SRS-PosBasedOnSSB-Neigh-r16    ENUMERATED {supported}          OPTIONAL,
    spatialRelation-SRS-PosBasedOnPRS-Neigh-r16    ENUMERATED {supported}          OPTIONAL,
    ...
}

SRS-PosResourcesPerBand-r16 ::= SEQUENCE {
    freqBandIndicatorNR-r16          FreqBandIndicatorNR-r16,
    maxNumberSRS-PosResourceSetsPerBWP-r16    ENUMERATED {n1, n2, n4, n8, n12, n16},
    maxNumberSRS-PosResourcesPerBWP-r16        ENUMERATED {n1, n2, n4, n8, n16, n32, n64},
    maxNumberPeriodicSRS-PosResourcesPerBWP-r16    ENUMERATED {n1, n2, n4, n8, n16, n32, n64},
    maxNumberAP-SRS-PosResourcesPerBWP-r16        ENUMERATED {n1, n2, n4, n8, n16, n32, n64}
                                                OPTIONAL,
    maxNumberSP-SRS-PosResourcesPerBWP-r16        ENUMERATED {n1, n2, n4, n8, n16, n32, n64}
                                                OPTIONAL,
    ...
}
-- ASN1STOP

```

NR-UL-SRS-Capability field descriptions
<p>maxNumberSRS-PosPathLossEstimateAllServingCells Indicates the maximum number of pathloss estimates that the UE can simultaneously maintain for all the SRS resource sets for positioning across all cells in addition to the up to four pathloss estimates that the UE maintains per serving cell for the PUSCH/PUCCH/SRS transmissions. The UE shall include this field if the UE supports any of <i>olpc-SRS-PosBasedOnPRS-Serving</i>, <i>olpc-SRS-PosBasedOnSSB-Neigh</i> and <i>olpc-SRS-PosBasedOnPRS-Neigh</i>. Otherwise, the UE does not include this field.</p>
<p>maxNumberSRS-PosSpatialRelationsAllServingCells indicates the maximum number of maintained spatial relations for all the SRS resource sets for positioning across all serving cells in addition to the spatial relations maintained spatial relations per serving cell for the PUSCH/PUCCH/SRS transmissions. It is only applied for FR2. The UE can include this field only if the UE supports any of <i>spatialRelation-SRS-PosBasedOnSSB-Serving</i>, <i>spatialRelation-SRS-PosBasedOnCSI-RS-Serving</i>, <i>spatialRelation-SRS-PosBasedOnPRS-Serving</i>, <i>spatialRelation-SRS-PosBasedOnSSB-Neigh</i> or <i>spatialRelation-SRS-PosBasedOnPRS-Neigh</i>. Otherwise, the UE does not include this field.</p>
<p>olpc-SRS-Pos Indicates whether the UE supports open-loop power control for SRS for positioning. The capability signalling comprises the following parameters.</p> <ul style="list-style-type: none"> - olpc-SRS-PosBasedOnPRS-Serving indicates whether the UE supports OLPC for SRS for positioning based on PRS from the serving cell in the same band. The UE can include this field only if the UE supports <i>NR-DL-PRS-ProcessingCapability</i> and <i>srs-PosResources</i> TS38.331 [35]. Otherwise, the UE does not include this field. - olpc-SRS-PosBasedOnSSB-Neigh indicates whether the UE supports OLPC for SRS for positioning based on SSB from the neighbouring cell in the same band. The UE can include this field only if the UE supports <i>srs-PosResources</i> TS 38.331 [35]. Otherwise, the UE does not include this field. - olpc-SRS-PosBasedOnPRS-Neigh indicates whether the UE supports OLPC for SRS for positioning based on PRS from the neighbouring cell in the same band. The UE can include this field only if the UE supports <i>olpc-SRS-PosBasedOnPRS-Serving</i>. Otherwise, the UE does not include this field. - maxNumberPathLossEstimatePerServing indicates the maximum number of pathloss estimates that the UE can simultaneously maintain for all the SRS resource sets for positioning per serving cell in addition to the up to four pathloss estimates that the UE maintains per serving cell for the PUSCH/PUCCH/SRS transmissions. The UE shall include this field if the UE supports any of <i>olpc-SRS-PosBasedOnPRS-Serving</i>, <i>olpc-SRS-PosBasedOnSSB-Neigh</i> and <i>olpc-SRS-PosBasedOnPRS-Neigh</i>. Otherwise, the UE does not include this field.
<p>spatialRelationsSRS-Pos Indicates whether the UE supports spatial relations for SRS for positioning. It is only applicable for FR2. The capability signalling comprises the following parameters.</p> <ul style="list-style-type: none"> - spatialRelation-SRS-PosBasedOnSSB-Serving indicates whether the UE supports spatial relation for SRS for positioning based on SSB from the serving cell in the same band. The UE can include this field only if the UE supports <i>srs-PosResources</i> TS 38.331 [35]. Otherwise, the UE does not include this field. - spatialRelation-SRS-PosBasedOnCSI-RS-Serving indicates whether the UE supports spatial relation for SRS for positioning based on CSI-RS from the serving cell in the same band. The UE can include this field only if the UE supports <i>spatialRelation-SRS-PosBasedOnSSB-Serving</i>. Otherwise, the UE does not include this field. - spatialRelation-SRS-PosBasedOnPRS-Serving indicates whether the UE supports spatial relation for SRS for positioning based on PRS from the serving cell in the same band. The UE can include this field only if the UE supports any of DL-PRS Resources for DL-AoD, DL-PRS Resources for DL-TDOA or DL-PRS Resources for Multi-RTT, or <i>srs-PosResources</i> TS 38.331 [35]. Otherwise, the UE does not include this field. - spatialRelation-SRS-PosBasedOnSRS indicates whether the UE supports spatial relation for SRS for positioning based on SRS in the same band. The UE can include this field only if the UE supports <i>srs-PosResources</i> TS 38.331 [35]. Otherwise, the UE does not include this field. - spatialRelation-SRS-PosBasedOnSSB-Neigh indicates whether the UE supports spatial relation for SRS for positioning based on SSB from the neighbouring cell in the same band. The UE can include this field only if the UE supports <i>spatialRelation-SRS-PosBasedOnSSB-Serving</i>. Otherwise, the UE does not include this field. - spatialRelation-SRS-PosBasedOnPRS-Neigh indicates whether the UE supports spatial relation for SRS for positioning based on PRS from the neighbouring cell in the same band. The UE can include this field only if the UE supports <i>spatialRelation-SRS-PosBasedOnPRS-Serving</i>. Otherwise, the UE does not include this field.

NR-UL-SRS-Capability field descriptions**srs-PosResourceConfigCA-BandList**

This field indicates the number of SRS for positioning resources supported by the target device. The target device includes this field for each band for the current configured CA band combination. The capability signalling comprises the following parameters.

- **freqBandIndicatorNR** indicates the current configured NR band of the target device.
- **maxNumberSRS-PosResourceSetsPerBWP** indicates the maximum number of SRS Resource Sets for positioning supported by the target device per BWP. Enumerated values *n1, n2, n4, n8, n12, n16* correspond to 1, 2, 4, 8, 12, 16 SRS Resource Sets for positioning, respectively.
- **maxNumberSRS-PosResourcesPerBWP** indicates the maximum number of periodic, semi-persistent, and aperiodic SRS Resources for positioning supported by the target device per BWP. Enumerated values *n1, n2, n4, n8, n16, n32, n64* correspond to 1, 2, 4, 8, 16, 32, 64 SRS Resources for positioning, respectively.
- **maxNumberPeriodicSRS-PosResourcesPerBWP** indicates the maximum number of periodic SRS Resources for positioning supported by the target device per BWP. Enumerated values *n1, n2, n4, n8, n16, n32, n64* correspond to 1, 2, 4, 8, 16, 32, 64 periodic SRS Resources for positioning, respectively.
- **maxNumberAP-SRS-PosResourcesPerBWP** indicates the maximum number of aperiodic SRS Resources for positioning supported by the target device per BWP. Enumerated values *n1, n2, n4, n8, n16, n32, n64* correspond to 1, 2, 4, 8, 16, 32, 64 aperiodic SRS Resources for positioning, respectively.
- **maxNumberSP-SRS-PosResourcesPerBWP** indicates the maximum number of semi-persistent SRS Resources for positioning supported by the target device per BWP. Enumerated values *n1, n2, n4, n8, n16, n32, n64* correspond to 1, 2, 4, 8, 16, 32, 64 semi-persistent SRS Resources for positioning, respectively.

ReferencePoint

The IE *ReferencePoint* provides a well-defined location relative to which other locations may be defined.

```
-- ASN1START
ReferencePoint-r16 ::= SEQUENCE {
    referencePointGeographicLocation-r16    CHOICE {
        location3D-r16                      EllipsoidPointWithAltitudeAndUncertaintyEllipsoid,
        ha-location3D-r16                    HighAccuracyEllipsoidPointWithAltitudeAndUncertaintyEllipsoid-r15,
        ...
    },
    ...
}
-- ASN1STOP
```

ReferencePoint field descriptions**referencePointGeographicLocation**

This field provides the geodetic location of the reference point.

RelativeLocation

The IE *RelativeLocation* provides a location relative to some known reference location.

```
-- ASN1START
RelativeLocation-r16 ::= SEQUENCE {
    milli-arc-second-units-r16    ENUMERATED { mas0-03, mas0-3, mas3, mas30, ... },
    height-units-r16              ENUMERATED { mm, cm, m, ... },
    delta-latitude-r16            Delta-Latitude-r16,
    delta-longitude-r16          Delta-Longitude-r16,
    delta-height-r16              Delta-Height-r16,
    locationUNC-r16               LocationUncertainty-r16                OPTIONAL,    -- Need OP
    ...
}

Delta-Latitude-r16 ::= SEQUENCE {
    delta-Latitude-r16            INTEGER (-1024..1023),
    coarse-delta-Latitude-r16    INTEGER (0..4095)                OPTIONAL,    -- Need OP
    ...
}

Delta-Longitude-r16 ::= SEQUENCE {
    delta-Longitude-r16          INTEGER (-1024..1023),
    coarse-delta-Longitude-r16  INTEGER (0..4095)                OPTIONAL,    -- Need OP
}
```

```

}
...
Delta-Height-r16 ::= SEQUENCE {
    delta-Height-r16                INTEGER (-1024..1023),
    coarse-delta-Height-r16         INTEGER (0..4095)        OPTIONAL,        -- Need OP
    ...
}

LocationUncertainty-r16 ::= SEQUENCE {
    horizontalUncertainty-r16       INTEGER (0..255),
    horizontalConfidence-r16        INTEGER (0..100),
    verticalUncertainty-r16         INTEGER (0..255),
    verticalConfidence-r16          INTEGER (0..100)
}

-- ASN1STOP

```

RelativeLocation field descriptions

milli-arc-second-units

This field provides the units and scale factor for the *delta-latitude* and *delta-longitude* fields. Enumerated values *mas0-03*, *mas0-3*, *mas3*, and *mas30*, correspond to 0.03, 0.3, 3, and 30 milliarcseconds, respectively.

height-units

This field provides the units and scale factor for the *delta-height* field. Enumerated values *mm*, *cm*, and *m* correspond to 10^{-3} metre, 10^{-2} metre, and 1 metres, respectively.

delta-latitude

This field specifies the delta value in latitude of the desired location, defined as "desired location" minus "reference point location" and comprises the following sub-fields:

- **delta-Latitude** specifies the delta value in latitude in the unit provided in *milli-arc-second-units* field.
- **coarse-delta-Latitude** specifies the delta value in latitude in 1024 times the size of the unit provided in *milli-arc-second-units* field and with the same sign as in the *delta-Latitude* field. If this field is absent, the value for *coarse-delta-Latitude* is zero.

I.e., the full *delta-latitude* is given by:

$(\text{delta-Latitude} \times \text{milli-arc-second-units}) \pm (\text{coarse-delta-Latitude} \times 1024 \times \text{milli-arc-second-units})$ [milli-arc-seconds]

delta-longitude

This field specifies the delta value in longitude of the desired location, defined as "desired location" minus "reference point location" and comprises the following sub-fields:

- **delta-Longitude** specifies the delta value in longitude in the unit provided in *milli-arc-second-units* field.
- **coarse-delta-Longitude** specifies the delta value in longitude in 1024 times the size of the unit provided in *milli-arc-second-units* field and with the same sign as in the *delta-Longitude* field. If this field is absent, the value for *coarse-delta-Longitude* is zero.

I.e., the full *delta-longitude* is given by:

$(\text{delta-Longitude} \times \text{milli-arc-second-units}) \pm (\text{coarse-delta-Longitude} \times 1024 \times \text{milli-arc-second-units})$ [milli-arc-seconds]

delta-height

This field specifies the delta value in ellipsoidal height of the desired location, defined as "desired location" minus "reference point location" and comprises the following sub-fields:

- **delta-Height** specifies the delta value in ellipsoidal height in the unit provided in *height-units* field.
- **coarse-delta-Height** specifies the delta value in ellipsoidal height in 1024 times the size of the unit provided in *height-units* field and with the same sign as in the *delta-Height* field. If this field is absent, the value for *coarse-delta-Height* is zero.

I.e., the full *delta-height* is given by:

$(\text{delta-Height} \times \text{height-units}) \pm (\text{coarse-delta-Height} \times 1024 \times \text{height-units})$ [metres]

locationUNC

This field specifies the uncertainty of the location coordinates and comprises the following sub-fields:

- **horizontalUncertainty** indicates the horizontal uncertainty of the ARP latitude/longitude. The '*horizontalUncertainty*' corresponds to the encoded high accuracy uncertainty as defined in TS 23.032 [15] and '*horizontalConfidence*' corresponds to confidence as defined in TS 23.032 [15].
- **verticalUncertainty** indicates the vertical uncertainty of the ARP altitude. The '*verticalUncertainty*' corresponds to the encoded high accuracy uncertainty as defined in TS 23.032 [15] and '*verticalConfidence*' corresponds to confidence as defined in TS 23.032 [15].

If this field is absent, the uncertainty is the same as for the associated reference point location.

6.5 Positioning Method IEs

6.5.1 OTDOA Positioning

This clause defines the information elements for downlink OTDOA positioning, which includes TBS positioning based on PRS signals (TS 36.305 [2]).

6.5.1.1 OTDOA Assistance Data

– *OTDOA-ProvideAssistanceData*

The IE *OTDOA-ProvideAssistanceData* is used by the location server to provide assistance data to enable UE-assisted downlink OTDOA. It may also be used to provide OTDOA positioning specific error reason.

Throughout clause 6.5.1, "assistance data reference cell" refers to the cell defined by the IE *OTDOA-ReferenceCellInfo* and "NB-IoT assistance data reference cell" refers to the cell defined by the IE *OTDOA-ReferenceCellInfoNB* (see clause 6.5.1.2). "RSTD reference cell" applies only in clause 6.5.1.5.

If both IEs, *OTDOA-ReferenceCellInfo* and *OTDOA-ReferenceCellInfoNB* are included in *OTDOA-ProvideAssistanceData*, the assistance data reference cell and NB-IoT assistance data reference cell correspond to the same cell, and the target device may assume that PRS and NPRS antenna ports are quasi co-located, as defined in TS 36.211 [16].

Throughout clause 6.5.1, the term "cell" refers to "transmission point (TP)", unless distinguished in the field description.

NOTE 1: The location server should include at least one cell for which the SFN can be obtained by the target device, e.g. the serving cell, in the assistance data, either as the assistance data reference cell or in the neighbour cell list. Otherwise the target device will be unable to perform the OTDOA measurement and the positioning operation will fail.

NOTE 2: Due to support of cells containing multiple TPs and PRS-only TPs not associated with cells, the term "cell" as used in clause 6.5.1 may not always correspond to a cell for the E-UTRAN.

NOTE 3: For NB-IoT access, due to support of NPRS on multiple carriers, the term "cell" as used in clause 6.5.1 refers to the anchor carrier, unless otherwise stated.

```
-- ASN1START
OTDOA-ProvideAssistanceData ::= SEQUENCE {
    otdoa-ReferenceCellInfo      OTDOA-ReferenceCellInfo      OPTIONAL, -- Need ON
    otdoa-NeighbourCellInfo     OTDOA-NeighbourCellInfoList  OPTIONAL, -- Need ON
    otdoa-Error                 OTDOA-Error                OPTIONAL, -- Need ON
    ...,
    [
        otdoa-ReferenceCellInfoNB-r14  OTDOA-ReferenceCellInfoNB-r14  OPTIONAL, -- Need ON
        otdoa-NeighbourCellInfoNB-r14  OTDOA-NeighbourCellInfoListNB-r14  OPTIONAL, -- Need ON
    ]
}
-- ASN1STOP
```

6.5.1.2 OTDOA Assistance Data Elements

– *OTDOA-ReferenceCellInfo*

The IE *OTDOA-ReferenceCellInfo* is used by the location server to provide assistance data reference cell information for OTDOA assistance data. The slot number offsets and expected RSTDs in *OTDOA-NeighbourCellInfoList* are provided relative to the cell defined by this IE. If *earfcnRef* of this assistance data reference cell is different from that of the serving cell, the LPP layer shall inform lower layers to start performing inter-frequency RSTD measurements with this cell and provide to lower layers the information about this assistance data reference cell, e.g. EARFCN and PRS positioning occasion information.

NOTE: The location server should always include the PRS configuration of the assistance data reference and neighbour cells. Otherwise the UE may not meet the accuracy requirements as defined in TS 36.133 [18].

```
-- ASN1START
OTDOA-ReferenceCellInfo ::= SEQUENCE {
  physCellId          INTEGER (0..503),
  cellGlobalId       ECGI                               OPTIONAL,      -- Need ON
  earfcnRef           ARFCN-ValueEUTRA                 OPTIONAL,      -- Cond NotSameAsServ0
  antennaPortConfig  ENUMERATED {ports1-or-2, ports4, ... }
                                                            OPTIONAL,      -- Cond NotSameAsServ1
  cpLength            ENUMERATED { normal, extended, ... },
  prsInfo             PRS-Info                          OPTIONAL,      -- Cond PRS
  ...,
  [[ earfcnRef-v9a0   ARFCN-ValueEUTRA-v9a0           OPTIONAL      -- Cond NotSameAsServ2
  ]],
  [[ tpId-r14         INTEGER (0..4095)                OPTIONAL,      -- Need ON
   cpLengthCRS-r14   ENUMERATED { normal, extended, ... }
                                                            OPTIONAL,      -- Cond CRS
   sameMBSFNconfigRef-r14 BOOLEAN                    OPTIONAL,      -- Need ON
   dlBandwidth-r14   ENUMERATED {n6, n15, n25, n50, n75, n100}
                                                            OPTIONAL,      -- Cond NotSameAsServ3
   addPRSconfigRef-r14 SEQUENCE (SIZE (1..maxAddPRSconfig-r14)) OF PRS-Info
                                                                OPTIONAL      -- Need ON
  ]],
  [[
  [[
   nr-LTE-SFN-Offset-r15 INTEGER (0..1023)              OPTIONAL      -- Cond NR
  ]],
  [[
   tdd-config-v1520      TDD-Config-v1520             OPTIONAL,      -- Need ON
   nr-LTE-fineTiming-Offset-r15 INTEGER (0..19)         OPTIONAL      -- Cond FineOffset
  ]]]
}

maxAddPRSconfig-r14      INTEGER ::= 2

-- ASN1STOP
```

Conditional presence	Explanation
<i>NotSameAsServ0</i>	This field is absent if <i>earfcnRef-v9a0</i> is present. Otherwise, the field is mandatory present if the EARFCN of the OTDOA assistance data reference cell is not the same as the EARFCN of the target devices' current primary cell.
<i>NotSameAsServ1</i>	The field is mandatory present if the antenna port configuration of the OTDOA assistance data reference cell is not the same as the antenna port configuration of the target devices' current primary cell.
<i>NotSameAsServ2</i>	The field is absent if <i>earfcnRef</i> is present. Otherwise, the field is mandatory present if the EARFCN of the OTDOA assistance data reference cell is not the same as the EARFCN of the target devices' current primary cell.
<i>PRS</i>	The field is mandatory present if positioning reference signals are available in the assistance data reference cell (TS 36.211 [16]); otherwise it is not present.
<i>CRS</i>	The field is optionally present, need ON, if <i>prsInfo</i> is present. Otherwise it is not present.
<i>NotSameAsServ3</i>	The field is mandatory present if the downlink bandwidth configuration of the assistance data reference cell is not the same as the downlink bandwidth configuration of the target devices' current primary cell and if PRS frequency hopping is used in the assistance data reference cell (TS 36.211 [16]); otherwise it is not present.
<i>NR</i>	The field is optionally present, need ON, if the target device is served by an NR cell; otherwise it is not present.
<i>FineOffset</i>	The field is optionally present, need ON, if <i>nr-LTE-SFN-Offset</i> is present. Otherwise it is not present.

OTDOA-ReferenceCellInfo field descriptions	
physCellId	This field specifies the physical cell identity of the assistance data reference cell, as defined in TS 36.331 [12].
cellGlobalId	This field specifies the ECGI, the globally unique identity of a cell in E-UTRA, of the assistance data reference cell, as defined in TS 36.331 [12]. The server should include this field if it considers that it is needed to resolve ambiguity in the cell indicated by <i>physCellId</i> .
earfcnRef	This field specifies the EARFCN of the assistance data reference cell.

OTDOA-ReferenceCellInfo field descriptions	
antennaPortConfig	This field specifies whether 1 (or 2) antenna port(s) or 4 antenna ports for cell specific reference signals (CRS) are used in the assistance data reference cell.
cpLength	This field specifies the cyclic prefix length of the assistance data reference cell PRS if the <i>prsInfo</i> field is present, otherwise this field specifies the cyclic prefix length of the assistance data reference cell CRS.
prsInfo	This field specifies the first PRS configuration of the assistance data reference cell.
tpld	This field specifies an identity of the transmission point. This field together with the <i>physCellId</i> and/or <i>prsID</i> may be used to identify the transmission point in the case the same physical cell ID is shared by multiple transmission points.
cpLengthCRS	This field specifies the cyclic prefix length of the assistance data reference cell CRS. If this field is present, the target device may assume the CRS and PRS antenna ports of the assistance data reference cell are quasi co-located (as defined in TS 36.211 [16]).
sameMBSFNconfigRef	This field indicates whether the MBSFN subframe configuration of the assistance data reference cell is the same as the current primary cell of the target device. TRUE means the same, and FALSE means not the same.
dlBandwidth	This field specifies the downlink bandwidth configuration of the assistance data reference cell, N_{RB} in downlink, see TS 36.101 [21, table 5.6-1]. Enumerated value <i>n6</i> corresponds to 6 resource blocks, <i>n15</i> to 15 resource blocks and so on.
addPRSconfigRef	This field specifies the additional (second and possibly third) PRS configuration(s) of the assistance data reference cell.
nr-LTE-SFN-Offset	This field specifies the SFN offset between the serving NR cell and the LTE assistance data reference cell. The offset corresponds to the number of full radio frames counted from the beginning of a radio frame #0 of the NR serving cell to the beginning of the closest subsequent radio frame #0 of the assistance data reference cell.
tdd-config	This field specifies the TDD specific physical channel configuration of the assistance data reference cell. The field should be present if the assistance data reference cell is a TDD cell and if the TDD UL/DL configuration of the assistance data reference cell is not the same as the target devices' current primary cell or if the target devices' current primary cell is a FDD cell.
nr-LTE-fineTiming-Offset	This field specifies the frame boundary offset between the NR serving cell and the LTE assistance data reference cell in units of 0.5 ms. The offset is counted from the beginning of a subframe #0 of the NR serving cell to the beginning of the closest subsequent subframe #0 of the LTE assistance data reference cell, rounded down to multiples of 0.5 ms. Value 0 corresponds to 0 ms, value 1 corresponds to 0.5 ms, 2 to 1 ms and so on.

– PRS-Info

The IE *PRS-Info* provides the information related to the configuration of PRS in a cell.

```

-- ASN1START
PRS-Info ::= SEQUENCE {
    prs-Bandwidth          ENUMERATED { n6, n15, n25, n50, n75, n100, ... },
    prs-ConfigurationIndex INTEGER (0..4095),
    numDL-Frames          ENUMERATED {sf-1, sf-2, sf-4, sf-6, ..., sf-add-v1420},
    ...,
    prs-MutingInfo-r9     CHOICE {
        po2-r9            BIT STRING (SIZE(2)),
        po4-r9            BIT STRING (SIZE(4)),
        po8-r9            BIT STRING (SIZE(8)),
        po16-r9           BIT STRING (SIZE(16)),
        ...,
        po32-v1420        BIT STRING (SIZE(32)),
        po64-v1420        BIT STRING (SIZE(64)),
        po128-v1420       BIT STRING (SIZE(128)),
        po256-v1420       BIT STRING (SIZE(256)),
        po512-v1420       BIT STRING (SIZE(512)),
        po1024-v1420      BIT STRING (SIZE(1024))
    }
    [,
    prsID-r14              INTEGER (0..4095) OPTIONAL, -- Need OP
    add-numDL-Frames-r14  INTEGER (1..160) OPTIONAL, -- Need ON
    prsOccGroupLen-r14    ENUMERATED {g2, g4, g8, g16, g32, g64, g128,...} OPTIONAL, -- Cond sf-add
    prsHoppingInfo-r14    CHOICE {

```

– TDD-Config

The IE *TDD-Config* is used to specify the TDD specific physical channel configuration.

```
-- ASN1START
TDD-Config-v1520 ::= SEQUENCE {
    subframeAssignment-v1520      ENUMERATED { sa0, sa1, sa2, sa3, sa4, sa5, sa6 },
    ...
}
-- ASN1STOP
```

TDD-Config field descriptions

subframeAssignment

This field specifies the TDD UL/DL subframe configuration where *sa0* points to Configuration 0, *sa1* to Configuration 1 etc. as specified in TS 36.211 [16], table 4.2-2. The target device assumes the same value for all assistance data cells residing on same frequency band.

– OTDOA-NeighbourCellInfoList

The IE *OTDOA-NeighbourCellInfoList* is used by the location server to provide neighbour cell information for OTDOA assistance data. If the target device is not capable of supporting additional neighbour cells (as indicated by the absence of the IE *additionalNeighbourCellInfoList* in *OTDOA-ProvideCapabilities*), the set of cells in the *OTDOA-NeighbourCellInfoList* is grouped per frequency layer and in the decreasing order of priority for measurement to be performed by the target device, with the first cell in the list being the highest priority for measurement and with the same *earfcn* not appearing in more than one instance of *OTDOA-NeighbourFreqInfo*.

If the target device is capable of supporting additional neighbour cells (as indicated by the presence of the IE *additionalNeighbourCellInfoList* in *OTDOA-ProvideCapabilities*), the list may contain all cells (up to 3x24 cells) belonging to the same frequency layer or cells from different frequency layers with the first cell in the list still being the highest priority for measurement.

The prioritization of the cells in the list is left to server implementation. The target device should provide the available measurements in the same order as provided by the server.

If inter-frequency neighbour cells are included in *OTDOA-NeighbourCellInfoList*, where an inter-frequency is a E-UTRA frequency which is different from the E-UTRA serving cell frequency, the LPP layer shall inform lower layers to start performing inter-frequency RSTD measurements for these neighbour cells and also provide to lower layers the information about these neighbour cells, e.g. EARFCN and PRS positioning occasion information.

```
-- ASN1START
OTDOA-NeighbourCellInfoList ::= SEQUENCE (SIZE (1..maxFreqLayers)) OF OTDOA-NeighbourFreqInfo
OTDOA-NeighbourFreqInfo ::= SEQUENCE (SIZE (1..24)) OF OTDOA-NeighbourCellInfoElement
OTDOA-NeighbourCellInfoElement ::= SEQUENCE {
    physCellId                INTEGER (0..503),
    cellGlobalId              ECGI
    earfcn                    ARFCN-ValueEUTRA OPTIONAL, -- Need ON
    cpLength                  ENUMERATED {normal, extended, ...}
    prsInfo                   PRS-Info OPTIONAL, -- Cond NotSameAsRef1
    antennaPortConfig         ENUMERATED {ports-1-or-2, ports-4, ...}
    slotNumberOffset          INTEGER (0..19) OPTIONAL, -- Cond NotsameAsRef3
    prs-SubframeOffset        INTEGER (0..1279) OPTIONAL, -- Cond NotSameAsRef4
    expectedRSTD              INTEGER (0..16383),
    expectedRSTD-Uncertainty  INTEGER (0..1023),
    ...
    [[ earfcn-v9a0            ARFCN-ValueEUTRA-v9a0 OPTIONAL -- Cond NotSameAsRef5
    ]],
    [[ tpId-r14              INTEGER (0..4095) OPTIONAL, -- Need ON
    prs-only-tp-r14          ENUMERATED { true } OPTIONAL, -- Cond TBS
    cpLengthCRS-r14          ENUMERATED { normal, extended, ... }
    ]],
    ...
}
-- ASN1STOP
```



```

sameMBSFNconfigNeighbour-r14    BOOLEAN                OPTIONAL,        -- Need ON
dlBandwidth-r14                 ENUMERATED {n6, n15, n25, n50, n75, n100}
addPRSconfigNeighbour-r14       SEQUENCE (SIZE (1..maxAddPRSconfig-r14)) OF
                                Add-PRSconfigNeighbourElement-r14
                                OPTIONAL                -- Need ON
]],
[[
tdd-config-v1520                TDD-Config-v1520    OPTIONAL        -- Need ON
]]
}

Add-PRSconfigNeighbourElement-r14 ::= SEQUENCE {
add-prsInfo-r14                 PRS-Info            OPTIONAL,        -- Cond NotSameAsRef7
...
}

maxFreqLayers    INTEGER ::= 3

-- ASN1STOP

```

Conditional presence	Explanation
<i>NotsameAsRef0</i>	The field is absent if <i>earfcn-v9a0</i> is present. If <i>earfcn-v9a0</i> is not present, the field is mandatory present if the EARFCN is not the same as for the assistance data reference cell; otherwise it is not present.
<i>NotsameAsRef1</i>	The field is mandatory present if the cyclic prefix length is not the same as for the assistance data reference cell; otherwise it is not present.
<i>NotsameAsRef2</i>	The field is mandatory present if the first PRS configuration is not the same as for the assistance data reference cell; otherwise it is not present.
<i>NotsameAsRef3</i>	The field is mandatory present if the antenna port configuration is not the same as for the assistance data reference cell; otherwise it is not present.
<i>NotsameAsRef4</i>	The field is mandatory present if the slot timing is not the same as for the assistance data reference cell; otherwise it is not present.
<i>NotSameAsRef5</i>	The field is absent if <i>earfcn</i> is present. If <i>earfcn</i> is not present, the field is mandatory present if the EARFCN is not the same as for the assistance data reference cell; otherwise it is not present.
<i>InterFreq</i>	The field is optionally present, need OP, if the EARFCN is not the same as for the assistance data reference cell; otherwise it is not present.
<i>TBS</i>	The field is mandatory present if the <i>OTDOA-NeighbourCellInfoElement</i> is provided for a PRS-only TP; otherwise it is not present.
<i>CRS</i>	The field is optionally present, need ON, if <i>prsInfo</i> is present. Otherwise it is not present.
<i>NotSameAsRef6</i>	The field is mandatory present if PRS frequency hopping is used on this neighbour cell (TS 36.211 [16]) and if the downlink bandwidth configuration is not the same as for the assistance data reference cell; otherwise it is not present.
<i>NotSameAsRef7</i>	The field is mandatory present if any instance of the additional PRS configurations of <i>addPRSconfigNeighbour</i> is not the same as the corresponding instance of the additional PRS configuration of the <i>addPRSconfigRef</i> for the assistance data reference cell; otherwise it is not present.

OTDOA-NeighbourCellInfoList field descriptions

<i>physCellId</i>	This field specifies the physical cell identity of the neighbour cell, as defined in TS 36.331 [12].
<i>cellGlobalId</i>	This field specifies the ECGI, the globally unique identity of a cell in E-UTRA, of the neighbour cell, as defined in TS 36.331 [12]. The server should provide this field if it considers that it is needed to resolve any ambiguity in the cell identified by <i>physCellId</i> .
<i>earfcn</i>	This field specifies the EARFCN of the neighbour cell.
<i>cpLength</i>	This field specifies the cyclic prefix length of the neighbour cell PRS if PRS are present in this neighbour cell, otherwise this field specifies the cyclic prefix length of CRS in this neighbour cell.

OTDOA-NeighbourCellInfoList field descriptions
<p>prslInfo This field specifies the first PRS configuration of the neighbour cell. When the EARFCN of the neighbour cell is the same as for the assistance data reference cell, the target device may assume that each PRS positioning occasion in the neighbour cell at least partially overlaps with a PRS positioning occasion in the assistance data reference cell where the maximum offset between the transmitted PRS positioning occasions may be assumed to not exceed half a subframe. When the EARFCN of the neighbour cell is the same as for the assistance data reference cell, the target may assume that this cell has the same PRS periodicity (T_{PRS}) as the assistance data reference cell.</p>
<p>antennaPortConfig This field specifies whether 1 (or 2) antenna port(s) or 4 antenna ports for cell specific reference signals are used.</p>
<p>slotNumberOffset This field specifies the slot number offset at the transmitter between this cell and the assistance data reference cell. The <i>slotNumberOffset</i> together with the current slot number of the assistance data reference cell may be used to calculate the current slot number of this cell which may further be used to generate the CRS sequence by the target device. The offset corresponds to the number of full slots counted from the beginning of a radio frame of the assistance data reference cell to the beginning of the closest subsequent radio frame of this cell. If this field is absent, the slot timing is the same as for the assistance data reference cell.</p>
<p>prs-SubframeOffset This field specifies the offset between the first PRS subframe of the first PRS occasion group of the first PRS configuration in the assistance data reference cell on the reference carrier frequency layer and the first PRS subframe in the closest subsequent PRS occasion group of the PRS configuration with the longest PRS occasion group periodicity (NOTE 1) of this cell on the other carrier frequency layer. The value is given in number of full sub-frames. If the EARFCN is not the same as for the assistance data reference cell and the field is not present but PRS are available on this cell, the receiver shall consider the PRS subframe offset for this cell to be 0.</p>
<p>expectedRSTD If PRS is transmitted: This field indicates the RSTD value that the target device is expected to measure between this cell and the assistance data reference cell. The <i>expectedRSTD</i> field takes into account the expected propagation time difference as well as transmit time difference of PRS positioning occasions between the two cells. The RSTD value can be negative and is calculated as (<i>expectedRSTD</i>-8192). The resolution is $3 \times T_s$, with $T_s = 1/(15000 \times 2048)$ seconds. If PRS is not transmitted: This field indicates the RSTD value that the target device is expected to measure between this cell and the assistance data reference cell. The <i>expectedRSTD</i> field takes into account the expected propagation time difference as well as transmit time difference between the two cells. The RSTD value can be negative and is calculated as (<i>expectedRSTD</i>-8192). The resolution is $3 T_s$, with $T_s = 1/(15000 \times 2048)$ seconds.</p>
<p>expectedRSTD-Uncertainty If PRS is transmitted: This field indicates the uncertainty in <i>expectedRSTD</i> value. The uncertainty is related to the location server's a-priori estimation of the target device location. The <i>expectedRSTD</i> and <i>expectedRSTD-Uncertainty</i> together define the search window for the target device. The scale factor of the <i>expectedRSTD-Uncertainty</i> field is $3 \times T_s$, with $T_s = 1/(15000 \times 2048)$ seconds. The target device may assume that the beginning of the PRS occasion group of the PRS configuration with the longest PRS occasion group periodicity (NOTE) of the neighbour cell is received within the search window of size $[- \text{expectedRSTD-Uncertainty} \times 3 \times T_s, \text{expectedRSTD-Uncertainty} \times 3 \times T_s]$ centred at $T_{REF} + 1 \text{ millisecond} \times N + (\text{expectedRSTD} - 8192) \times 3 \times T_s$, where T_{REF} is the reception time of the beginning of the first PRS occasion group of the first PRS configuration of the assistance data reference cell at the target device antenna connector, $N = 0$ when the EARFCN of the neighbour cell is equal to that of the assistance data reference cell, and $N = \text{prs-SubframeOffset}$ otherwise. If PRS is not transmitted: This field indicates the uncertainty in <i>expectedRSTD</i> value. The uncertainty is related to the location server's a-priori estimation of the target device location. The <i>expectedRSTD</i> and <i>expectedRSTD-Uncertainty</i> together define the search window for the target device. The scale factor of the <i>expectedRSTD-Uncertainty</i> field is $3 \times T_s$, with $T_s = 1/(15000 \times 2048)$ seconds. If T_x is the reception time of the beginning of the subframe X of the assistance data reference cell at the target device antenna connector, the target device may assume that the beginning of the closest subframe of this neighbour cell to subframe X is received within the search window of size $[- \text{expectedRSTD-Uncertainty} \times 3 \times T_s, \text{expectedRSTD-Uncertainty} \times 3 \times T_s]$ centred at $T_x + (\text{expectedRSTD} - 8192) \times 3 \times T_s$,</p>

OTDOA-NeighbourCellInfoList field descriptions	
<i>tpld</i>	This field specifies an identity of the transmission point. This field together with the <i>physCellId</i> and/or <i>prsID</i> may be used to identify the transmission point in the case the same physical cell ID is shared by multiple transmission points.
<i>prs-only-tp</i>	This field, if present, indicates that the <i>OTDOA-NeighbourCellInfoElement</i> is provided for a PRS-only TP. For the purpose of RSTD measurements from a PRS-only TP, the target device shall not assume any other signals or physical channels are present other than PRS (TS 36.213 [28]). For the purpose of RSTD measurements from a PRS-only TP, the target device shall use the <i>physCellId</i> only for PRS generation, and only if no PRS-ID is provided for this TP.
<i>cpLengthCRS</i>	This field specifies the cyclic prefix length of this assistance data neighbour cell CRS. If this field is present, the target device may assume the CRS and PRS antenna ports of this assistance data neighbour cell are quasi co-located (as defined in TS 36.211 [16]).
<i>sameMBSFNconfigNeighbour</i>	This field indicates whether the MBSFN subframe configuration of the neighbour cell is the same as the current primary cell of the target device. TRUE means the same, and FALSE means not the same.
<i>dlBandwidth</i>	This field specifies the downlink bandwidth configuration of the neighbour cell, N_{RB} in downlink, see TS 36.101 [21, table 5.6-1]. Enumerated value <i>n6</i> corresponds to 6 resource blocks, <i>n15</i> to 15 resource blocks and so on.
<i>addPRSconfigNeighbour</i>	This field specifies the additional (second and possibly third) PRS configuration(s) of the neighbour cell. When the EARFCN of the neighbour cell is the same as for the assistance data reference cell, the target device may assume that each PRS positioning occasion in each instance of <i>addPRSconfigNeighbour</i> in the neighbour cell at least partially overlaps with a PRS positioning occasion of the same instance of <i>addPRSconfigRef</i> in the assistance data reference cell where the maximum offset between the transmitted PRS positioning occasions may be assumed to not exceed half a subframe. When the EARFCN of the neighbour cell is the same as for the assistance data reference cell, the target may assume that each instance of <i>addPRSconfigNeighbour</i> of this cell has the same PRS periodicity (T_{PRS}) as the corresponding instance of <i>addPRSconfigRef</i> of the assistance data reference cell.
<i>tdd-config</i>	This field specifies the TDD specific physical channel configuration of the neighbour cell <i>earfcn</i> . The field should be present if this neighbour cell is a TDD cell and if the TDD UL/DL configuration for assistance data cells on this <i>earfcn</i> has not been provided in any other instance of <i>OTDOA-NeighbourCellInfoElement</i> or in IE <i>OTDOA-ReferenceCellInfo</i> , and is not the same as the target device's current primary cell when this is a TDD cell. NOTE 2.

NOTE 1: If this cell has more than one PRS configuration with equal longest PRS occasion group periodicity (i.e., PRS occasion group length times T_{PRS}), the first such configuration is referenced. In order to avoid ambiguity for frequency hopping, a PRS occasion group should contain at least 2 PRS occasions with hopping between 2 narrowbands and at least 4 PRS occasions with hopping between 4 narrowbands.

NOTE 2: The target device assumes the same TDD UL/DL configuration for all TDD cells residing on same frequency band specified by *earfcn*. Therefore, the location server should include the field *tdd-config* only once for assistance data cells with the same *earfcn* in IE *OTDOA-ProvideAssistanceData*. The location server does not need to include the field *tdd-config* for any assistance data cell in IE *OTDOA-ProvideAssistanceData* with the same *earfcn* or the same TDD UL/DL configuration as the target devices' current primary cell if this is a TDD cell.

– OTDOA-ReferenceCellInfoNB

The IE *OTDOA-ReferenceCellInfoNB* is used by the location server to provide NB-IoT assistance data reference cell information for OTDOA assistance data.

```
-- ASN1START
OTDOA-ReferenceCellInfoNB-r14 ::= SEQUENCE {
    physCellIdNB-r14          INTEGER (0..503)          OPTIONAL,  -- Cond NoPRS-AD1
    cellGlobalIdNB-r14       ECGI                      OPTIONAL,  -- Cond NoPRS-AD2
    carrierFreqRef-r14       CarrierFreq-NB-r14        OPTIONAL,  -- Cond NotSameAsServ1
    earfcn-r14               ARFCN-ValueEUTRA-r14      OPTIONAL,  -- Cond Inband
    eutra-NumCRS-Ports-r14   ENUMERATED {ports1-or-2, ports4}
                                OPTIONAL,  -- Cond NoPRS-AD3
    otdoa-SIB1-NB-repetitions-r14  ENUMERATED { r4, r8, r16 }  OPTIONAL,  -- Cond NotSameAsServ2
    nprsInfo-r14             PRS-Info-NB-r14           OPTIONAL,  -- Cond NPRS-Type1
    ...
}
```

```

[[
  nprsInfo-Type2-v1470          PRS-Info-NB-r14          OPTIONAL  -- Cond NPRS-Type2
]],
[[  tdd-config-r15             TDD-Config-v1520         OPTIONAL  -- Need ON
]]
}
-- ASN1STOP

```

Conditional presence	Explanation
<i>NoPRS-AD1</i>	This field is mandatory present if the <i>OTDOA-ReferenceCellInfo</i> IE is not included in <i>OTDOA-ProvideAssistanceData</i> , or if the <i>OTDOA-ReferenceCellInfo</i> IE is included in <i>OTDOA-ProvideAssistanceData</i> and the narrowband physical layer cell identity is not the same as the physical cell identity provided in <i>OTDOA-ReferenceCellInfo</i> IE. Otherwise it is not present.
<i>NoPRS-AD2</i>	This field is optionally present, need ON, if the <i>OTDOA-ReferenceCellInfo</i> IE is not included in <i>OTDOA-ProvideAssistanceData</i> , or if the <i>OTDOA-ReferenceCellInfo</i> IE is included in <i>OTDOA-ProvideAssistanceData</i> and the global cell identity is not the same as provided in <i>OTDOA-ReferenceCellInfo</i> IE.
<i>NotSameAsServ1</i>	This field is mandatory present if the carrier frequency of the NB-IoT assistance data reference cell is not the same as the carrier frequency of the target devices' current serving NB-IoT cell. Otherwise it is not present.
<i>Inband</i>	This field is mandatory present, if the NPRS is configured within the LTE spectrum allocation (inband deployment). Otherwise it is not present.
<i>NoPRS-AD3</i>	This field is mandatory present if the <i>OTDOA-ReferenceCellInfo</i> IE is not included in <i>OTDOA-ProvideAssistanceData</i> and if the NB-IoT assistance data reference cell is deployed within the LTE spectrum allocation (inband deployment). Otherwise it is not present.
<i>NotSameAsServ2</i>	This field is mandatory present, if NPRS configuration Part B only is configured on the NB-IoT assistance data reference cell, and if the repetition number of SIB1-NB of the NB-IoT assistance data reference cell is not the same as the repetition number of SIB1-NB of the target devices' current serving NB-IoT cell. Otherwise it is not present.
<i>NPRS-Type1</i>	The field is mandatory present if Type 1 narrowband positioning reference signals are available in the assistance data reference cell (TS 36.211 [16]); otherwise it is not present.
<i>NPRS-Type2</i>	The field is mandatory present if Type 2 narrowband positioning reference signals are available in the assistance data reference cell (TS 36.211 [16]); otherwise it is not present.

OTDOA-ReferenceCellInfoNB field descriptions
<p>physCellIdNB This field specifies the narrowband physical layer cell identity of the NB-IoT assistance data reference cell, as defined in TS 36.331 [12]. If this field is absent and if the <i>OTDOA-ReferenceCellInfo</i> IE is included in <i>OTDOA-ProvideAssistanceData</i> the narrowband physical layer cell identity is the same as the <i>physCellId</i> provided in <i>OTDOA-ReferenceCellInfo</i> IE.</p>
<p>cellGlobalIdNB This field specifies the global cell identity of the NB-IoT assistance data reference cell, as defined in TS 36.331 [12]. If this field is absent and if the <i>OTDOA-ReferenceCellInfo</i> IE with <i>cellGlobalId</i> is included in <i>OTDOA-ProvideAssistanceData</i>, the global cell identity is the same as provided in <i>OTDOA-ReferenceCellInfo</i> IE.</p>
<p>carrierFreqRef This field specifies the carrier frequency of the NB-IoT assistance data reference cell.</p>
<p>earfcn This field specifies the EARFCN of the E-UTRAN frequency, in which the NB-IoT cell is deployed.</p>
<p>utra-NumCRS-Ports This field specifies whether 1 (or 2) antenna port(s) or 4 antenna ports for cell specific reference signals (CRS) are used in the NB-IoT assistance data reference cell. If this field is absent and if the <i>OTDOA-ReferenceCellInfo</i> IE is included in <i>OTDOA-ProvideAssistanceData</i>, the number of CRS antenna ports is the same as provided in <i>OTDOA-ReferenceCellInfo</i> IE.</p>
<p>otdoa-SIB1-NB-repetitions This field specifies the repetition number of SIB1-NB of the NB-IoT assistance data reference cell. Enumerated values r4 correspond to 4 repetitions, r8 to 8 repetitions, and r16 to 16 repetitions. Note, when NPRS configuration Part B only is configured on the NB-IoT assistance data reference cell (i.e., anchor carrier), <i>nprs-NumSF</i> does also count/include subframes containing NPSS, NSSS, NPBCH, or SIB1-NB, but the UE can assume that no NPRS are transmitted in these subframes (TS 36.211 [16]).</p>

OTDOA-ReferenceCellInfoNB field descriptions
<p>nprsInfo This field specifies the Type 1 NPRS (TS 36.211 [16]) configuration of the NB-IoT assistance data reference cell.</p> <p>When the target device receives this field with <i>operationModelInfoNPRS</i> set to value 'standalone', the target device shall assume no NPRS are transmitted on that NB-IoT carrier.</p>
<p>nprsInfo-Type2 This field specifies the Type 2 NPRS (TS 36.211 [16]) configuration of the NB-IoT assistance data reference cell.</p>
<p>tdd-config Indicates the TDD specific physical channel configuration of the NB-IoT assistance data reference cell operating in TDD mode. This field should be present if the DL/UL subframe configuration of the NB-IoT assistance data reference cell is not the same as the DL/UL subframe configuration of the current serving NB-IoT cell of the target device, or if the current serving NB-IoT cell of the target device operates in FDD mode.</p>

– PRS-Info-NB

The IE *PRS-Info-NB* provides the information related to the configuration of NPRS in a cell. If *PRS-Info-NB* includes configurations for multiple NPRS carrier frequencies, the target device may assume the antenna ports for the NPRS carrier are quasi co-located, as defined in TS 36.211 [16].

```

-- ASN1START
PRS-Info-NB-r14 ::= SEQUENCE (SIZE (1..maxCarrier-r14)) OF NPRS-Info-r14
NPRS-Info-r14 ::= SEQUENCE {
  operationModeInfoNPRS-r14  ENUMERATED { inband, standalone },
  nprs-carrier-r14           CarrierFreq-NB-r14  OPTIONAL, -- Cond Standalone/Guardband
  nprsSequenceInfo-r14     INTEGER (0..174)    OPTIONAL, -- Cond Inband
  nprsID-r14                INTEGER (0..4095)  OPTIONAL, -- Cond NPRS-ID
  partA-r14                 SEQUENCE {
    nprsBitmap-r14         CHOICE {
      subframePattern10-r14  BIT STRING (SIZE (10)),
      subframePattern40-r14  BIT STRING (SIZE (40))
    },
    nprs-MutingInfoA-r14   CHOICE {
      po2-r14               BIT STRING (SIZE(2)),
      po4-r14               BIT STRING (SIZE(4)),
      po8-r14               BIT STRING (SIZE(8)),
      po16-r14              BIT STRING (SIZE(16)),
      ...
    }
  }
}
partB-r14                 SEQUENCE {
  nprs-Period-r14          ENUMERATED { ms160, ms320, ms640, ms1280, ... , ms2560-v1510},
  nprs-startSF-r14        ENUMERATED { zero, one-eighth, two-eighths, three-eighths,
    four-eighths, five-eighths, six-eighths,
    seven-eighths, ...},
  nprs-NumSF-r14          ENUMERATED { sf10, sf20, sf40, sf80, sf160, sf320,
    sf640, sf1280, ... , sf2560-v1510},
  nprs-MutingInfoB-r14   CHOICE {
    po2-r14                BIT STRING (SIZE(2)),
    po4-r14                BIT STRING (SIZE(4)),
    po8-r14                BIT STRING (SIZE(8)),
    po16-r14               BIT STRING (SIZE(16)),
    ...
  }
}
[[ sibi-SF-TDD-r15        ENUMERATED {sf0, sf4, sf0and5}    OPTIONAL -- Cond SIB1-TDD
]]
}
...
[[
partA-TDD-r15            SEQUENCE {
  nprsBitmap-r15        CHOICE {
    subframePattern10-TDD-r15  BIT STRING (SIZE (8)),
    subframePattern40-TDD-r15  BIT STRING (SIZE (32)),
    ...
  },
  nprs-MutingInfoA-r15   CHOICE {
    po2-r15               BIT STRING (SIZE(2)),
    po4-r15               BIT STRING (SIZE(4)),
    po8-r15               BIT STRING (SIZE(8)),
}

```

```

        pol16-r15          BIT STRING (SIZE(16)),
        ...
    }
    ...
}
]]
}

maxCarrier-r14  INTEGER ::= 5

-- ASN1STOP
    
```

Conditional presence	Explanation
<i>Standalone/Guardband</i>	This field is mandatory present, if the NPRS is configured in standalone or guardband operation mode. Otherwise it is not present.
<i>Inband</i>	This field is mandatory present, if the NPRS is configured within the LTE spectrum allocation (inband deployment) and the LTE carrier frequency is not provided in the assistance data. Otherwise it is not present.
<i>NPRS-ID</i>	The field is mandatory present, if the NPRS is generated based on the NPRS-ID (TS 36.211 [16]), different from the PCI. Otherwise the field is not present.
<i>MutingA</i>	The field is mandatory present, if muting is used for the NPRS Part A or Part A TDD configuration. Otherwise the field is not present.
<i>PartA</i>	The field is mandatory present, if NPRS is configured based on a bitmap of subframes which are not NB-IoT DL subframes (i.e., invalid DL subframes) (Part A configuration). Otherwise the field is not present. This field is not applicable for NB-IoT operating in TDD mode.
<i>MutingB</i>	The field is mandatory present, if muting is used for the NPRS Part B configuration. Otherwise the field is not present.
<i>PartB</i>	The field is mandatory present, if NPRS is configured based on a NPRS period, a NPRS subframe offset, and a number of consecutive NPRS downlink subframes per positioning occasion (Part B configuration). Otherwise the field is not present. If NPRS configuration Part A and Part B are both configured, then a subframe contains NPRS if both configurations indicate that it contains NPRS.
<i>PartA-TDD</i>	The field is mandatory present, if NPRS is configured for NB-IoT operating in TDD mode and if NPRS is configured based on a bitmap of subframes which are not NB-IoT DL subframes (i.e., invalid DL subframes) (Part A TDD configuration). Otherwise the field is not present.
<i>SIB1-TDD</i>	The field is mandatory present, if NPRS is configured for NB-IoT operating in TDD mode and if SIB1-NB is transmitted on this carrier frequency. Otherwise the field is not present.

PRs-Info-NB field descriptions
<p>operationModeInfoNPRS This field specifies the operation mode of the NPRS carrier. The value 'standalone' indicates standalone or guardband operation mode.</p>
<p>nprs-carrier This field specifies the NB-IoT carrier frequency for the NPRS.</p>
<p>nprsSequenceInfo This field specifies the index of the PRB containing the NPRS as defined in the table <i>nprsSequenceInfo</i> to E-UTRA PRB index relation below.</p>
<p>nprsID This field specifies the NPRS-ID as defined in TS 36.211 [16].</p>
<p>sib1-SF-TDD This field indicates the subframe(s) used to transmit SIB1-NB. Values <i>sf0</i> and <i>sf4</i> correspond with subframe #0 and #4 respectively. Value <i>sf0and5</i> corresponds with subframes #0 and #5.</p>
<p>subframePattern10, subframePattern40 This field specifies the NPRS subframe Part A configuration over 10 ms or 40 ms. Subframes not containing NPRS are indicated with value '0' in the bitmap; subframes containing NPRS are indicated with value '1' in the bitmap. The first/leftmost bit corresponds to the subframe #0 of the radio frame satisfying SFN mod x = 0, where x is the size of the bit string divided by 10.</p>

PRS-Info-NB field descriptions	
nprs-MutingInfoA	<p>This field specifies the NPRS muting configuration of the NB-IoT carrier Part A configuration. The NPRS muting configuration is defined by a periodic NPRS muting sequence with periodicity T_{REP} where T_{REP}, counted in the number of NPRS positioning occasions, can be 2, 4, 8, or 16 which is also the length of the selected bit string that represents this NPRS muting sequence. If a bit in the NPRS muting sequence is set to '0', then the NPRS is muted in the corresponding NPRS positioning occasion. A NPRS positioning occasion for Part A comprises one radio frame (i.e., 10 subframes). The first/leftmost bit of the NPRS muting sequence corresponds to the first NPRS positioning occasion that starts after the beginning of the NB-IoT assistance data reference cell SFN=0. The sequence is valid for all subframes after the target device has received the <i>nprs-MutingInfoA</i>.</p> <p>When the SFN of the NB-IoT assistance data reference cell is not known to the target device and <i>nprs-MutingInfoA</i> is provided for a cell in the <i>OTDOA-NeighbourCellInfoListNB</i> IE, the target device may assume no NPRS is transmitted by that cell.</p>
nprs-Period	<p>This field specifies the NPRS occasion period T_{NPRS} (TS 36.211 [16]). Enumerated values correspond to 160 ms, 320 ms, 640 ms, 1280 ms, and 2560 ms. The value <i>ms2560</i> is only applicable to TDD mode.</p>
nprs-startSF	<p>This field specifies the subframe offset α_{NPRS} (TS 36.211 [16]). Enumerated values correspond to α of 0, 1/8, 2/8, 3/8, 4/8, 5/8, 6/8, or 7/8.</p>
nprs-NumSF	<p>This field specifies the number of consecutive downlink subframes N_{NPRS} in one NPRS positioning occasion (TS 36.211 [16]). Enumerated values correspond to 10, 20, 40, 80, 160, 320, 640, 1280, and 2560 subframes. The values <i>sf10</i> and <i>sf20</i> are only applicable to FDD mode. The value <i>sf2560</i> is only applicable to TDD mode.</p> <p>When the target device receives a <i>nprs-NumSF</i> which exceeds the <i>nprs-Period</i> (i.e., $N_{NPRS} > T_{NPRS}$), the target device may assume no NPRS is transmitted by that cell.</p>
nprs-MutingInfoB	<p>This field specifies the NPRS muting configuration of the NB-IoT carrier Part B configuration. The NPRS muting configuration is defined by a periodic NPRS muting sequence with periodicity T_{REP} where T_{REP}, counted in the number of NPRS positioning occasions, can be 2, 4, 8, or 16 which is also the length of the selected bit string that represents this NPRS muting sequence. If a bit in the NPRS muting sequence is set to '0', then the NPRS is muted in the corresponding NPRS positioning occasion. A NPRS positioning occasion for Part B comprises N_{NPRS} consecutive downlink positioning subframes, where N_{NPRS} is given by the <i>nprs-NumSF</i> field. The first/leftmost bit of the NPRS muting sequence corresponds to the first NPRS positioning occasion that starts after the beginning of the NB-IoT assistance data reference cell SFN=0. The sequence is valid for all subframes after the target device has received the <i>nprs-MutingInfoB</i>.</p> <p>When the SFN of the NB-IoT assistance data reference cell is not known to the UE and <i>nprs-MutingInfoB</i> is provided for a cell in the <i>OTDOA-NeighbourCellInfoListNB</i> IE, the target device may assume no NPRS is transmitted by that cell.</p> <p>When the UE receives a T_{REP}-bit muting pattern together with a NPRS periodicity T_{NPRS} for the same carrier which exceeds 10240 subframes (i.e., $T_{REP} \times T_{NPRS} > 10240$ subframes), the target device shall assume an n-bit muting pattern based on the first n bits, where $n = 10240/T_{NPRS}$.</p>
subframePattern10-TDD, subframePattern40-TDD	<p>This field specifies the NPRS subframe Part A configuration for TDD over 10 ms or 40 ms. The UE shall assume that subframe number 1 and 2 are not used for NPRS. The MSB of the NPRS bitmap corresponds to subframe 0, the second MSB corresponds to subframe 3, the third MSB corresponds to subframe 4 and so on, as also shown in Figure NPRS bitmap to subframe number mapping below.</p>

nprsSequenceInfo to E-UTRA PRB index relation

nprsSequenceInfo	E-UTRA PRB index n'_{PRB} for odd number of N_{RB}^{DL} [16]	nprsSequenceInfo	E-UTRA PRB index n'_{PRB} for even number of N_{RB}^{DL} [16]
0 - 74	-37, -36, ..., 37	75 - 174	-50, -49, ..., 49

NOTE: Based on the above relation, in inband deployment, the carrier frequency of the NPRS carrier (f_{NB-IoT}) can be calculated as follows:

$$f_{NB-IoT} = \begin{cases} f_{EUTRA} + 7.5 + 180 \cdot n'_{PRB} & \text{if } nprsSequenceInfo \leq 74 \text{ and } n'_{PRB} > 0 \\ f_{EUTRA} - 7.5 + 180 \cdot n'_{PRB} & \text{if } nprsSequenceInfo \leq 74 \text{ and } n'_{PRB} < 0 \\ f_{EUTRA} + 180 \cdot n'_{PRB} & \text{if } nprsSequenceInfo \leq 74 \text{ and } n'_{PRB} = 0 \\ f_{EUTRA} + 97.5 + 180 \cdot n'_{PRB} & \text{if } nprsSequenceInfo \geq 75 \text{ and } n'_{PRB} \geq 0 \\ f_{EUTRA} - 97.5 + 180 \cdot (n'_{PRB} + 1) & \text{if } nprsSequenceInfo \geq 75 \text{ and } n'_{PRB} < 0 \end{cases}$$

where f_{EUTRA} is derived from $earfcn$ according to TS 36.101 [21, 5.7.3].

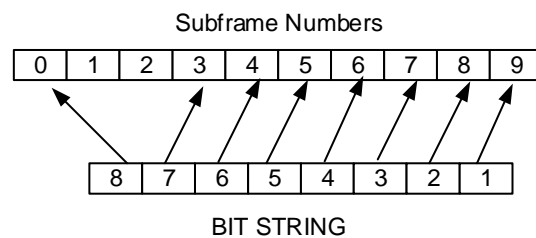

Figure 6.5.1.2-1: NPRS bitmap to subframe number mapping

– OTDOA-NeighbourCellInfoListNB

The IE *OTDOA-NeighbourCellInfoListNB* is used by the location server to provide NB-IoT neighbour cell information for OTDOA assistance data.

```
-- ASN1START
OTDOA-NeighbourCellInfoListNB-r14 ::= SEQUENCE (SIZE (1..maxCells-r14)) OF
    OTDOA-NeighbourCellInfoNB-r14

OTDOA-NeighbourCellInfoNB-r14 ::= SEQUENCE {
    physCellIdNB-r14          INTEGER (0..503)          OPTIONAL,      -- Cond NoPRS-AD1
    cellGlobalIdNB-r14       ECGI                      OPTIONAL,      -- Cond NoPRS-AD2
    carrierFreq-r14          CarrierFreq-NB-r14        OPTIONAL,      -- Cond NotSameAsRef1
    earfcn-r14               ARFCN-ValueEUTRA-r14      OPTIONAL,      -- Cond Inband
    eutra-NumCRS-Ports-r14   ENUMERATED {ports-1-or-2, ports-4, ...} OPTIONAL,      -- Cond NotsameAsRef2
    otdoa-SIB1-NB-repetitions-r14
        ENUMERATED { r4, r8, r16 }                    OPTIONAL,      -- Cond NotSameAsRef3
    nprsInfo-r14              PRS-Info-NB-r14          OPTIONAL,      -- Cond NotsameAsRef4
    nprs-slotNumberOffset-r14 INTEGER (0..19)          OPTIONAL,      -- Cond NotsameAsRef5
    nprs-SFN-Offset-r14      INTEGER (0..63)          OPTIONAL,      -- Cond NotsameAsRef6
    nprs-SubframeOffset-r14  INTEGER (0..1279)        OPTIONAL,      -- Need OP
    expectedRSTD-r14         INTEGER (0..16383)        OPTIONAL,      -- Cond NoPRS-AD3
    expectedRSTD-Uncertainty-r14
        INTEGER (0..1023)                              OPTIONAL,      -- Cond NoPRS-AD3
    prsNeighbourCellIndex-r14
        INTEGER (1..72)                                OPTIONAL,      -- Cond PRS-AD
    ...,
    [[
    nprsInfo-Type2-v1470      PRS-Info-NB-r14          OPTIONAL      -- Cond NotSameAsRef4
    ]],
    [[ tdd-config-r15         TDD-Config-v1520         OPTIONAL      -- Need ON
    ]]
}

maxCells-r14    INTEGER ::= 72
-- ASN1STOP
```

Conditional presence	Explanation
<i>NoPRS-AD1</i>	This field is mandatory present if the <i>OTDOA-NeighbourCellInfoList</i> IE is not included in <i>OTDOA-ProvideAssistanceData</i> , or if the <i>OTDOA-NeighbourCellInfoList</i> IE is included in <i>OTDOA-ProvideAssistanceData</i> and the narrowband physical layer cell identity of this cell is not the same as the physical cell identity of the corresponding cell (as indicated by <i>prsNeighbourCellIndex</i>) in <i>OTDOA-NeighbourCellInfoList</i> IE.
<i>NoPRS-AD2</i>	This field is optionally present, need ON, if the <i>OTDOA-NeighbourCellInfoList</i> IE is not included in <i>OTDOA-ProvideAssistanceData</i> , or if the <i>OTDOA-NeighbourCellInfoList</i> IE is included in <i>OTDOA-ProvideAssistanceData</i> and the global cell identity of this cell is not the same as for the corresponding cell (as indicated by <i>prsNeighbourCellIndex</i>) in <i>OTDOA-NeighbourCellInfoList</i> IE.
<i>Inband</i>	This field is mandatory present, if the NPRS is configured within the LTE spectrum allocation (inband deployment). Otherwise it is not present.
<i>NotSameAsRef1</i>	The field is mandatory present if the carrier frequency is not the same as for the NB-IoT assistance data reference cell; otherwise it is not present.
<i>NotSameAsRef2</i>	The field is mandatory present if this cell is deployed within the LTE spectrum allocation (inband deployment) and if the number of E-UTRA CRS antenna ports is not the same as for the NB-IoT assistance data reference cell; otherwise it is not present.
<i>NotSameAsRef3</i>	This field is mandatory present if NPRS configuration Part B only is configured on this neighbour cell, and if the repetition number of SIB1-NB of this neighbor cell is not the same as the repetition number of SIB1-NB of the NB-IoT assistance data reference cell. Otherwise it is not present.
<i>NotSameAsRef4</i>	The field is mandatory present, if the NPRS configuration is not the same as for the NB-IoT assistance data reference cell; otherwise it is not present.
<i>NotSameAsRef5</i>	The field is mandatory present if the slot timing is not the same as for the NB-IoT assistance data reference cell; otherwise it is not present.
<i>NotSameAsRef6</i>	The field is mandatory present if the frame timing is not the same as for the NB-IoT assistance data reference cell; otherwise it is not present.
<i>NoPRS-AD3</i>	This field is mandatory present if the <i>OTDOA-NeighbourCellInfoList</i> IE is not included in <i>OTDOA-ProvideAssistanceData</i> , or if the <i>OTDOA-NeighbourCellInfoList</i> IE is included in <i>OTDOA-ProvideAssistanceData</i> and <i>prsNeighbourCellIndex</i> is absent for this cell.
<i>PRS-AD</i>	This field is optionally present, need OP, if the <i>OTDOA-NeighbourCellInfoList</i> IE is included in <i>OTDOA-ProvideAssistanceData</i> ; otherwise it is not present.

OTDOA-NeighbourCellInfoListNB field descriptions
<p>physCellIdNB This field specifies the narrowband physical cell identity of the NB-IoT neighbour cell, as defined in TS 36.331 [12]. If this field is absent and if the <i>OTDOA-NeighbourCellInfoList</i> IE is included in <i>OTDOA-ProvideAssistanceData</i> the narrowband physical layer cell identity is the same as the <i>physCellId</i> provided for the corresponding cell (as indicated by <i>prsNeighbourCellIndex</i>) in <i>OTDOA-NeighbourCellInfoList</i> IE.</p>
<p>cellGlobalIdNB This field specifies the global cell ID of the NB-IoT neighbour cell, as defined in TS 36.331 [12]. If this field is absent and if the <i>OTDOA-NeighbourCellInfoList</i> IE with <i>cellGlobalId</i> is included in <i>OTDOA-ProvideAssistanceData</i>, the global cell identity of the NB-IoT neighbour cell is the same as provided for the corresponding cell (as indicated by <i>prsNeighbourCellIndex</i>) in <i>OTDOA-NeighbourCellInfoList</i> IE.</p>
<p>carrierFreq This field specifies the carrier frequency of the NB-IoT neighbour cell.</p>
<p>earfcn This field specifies the EARFCN of the E-UTRAN frequency, in which the NB-IoT cell is deployed.</p>
<p>eutra-NumCRS-Ports This field specifies whether 1 (or 2) antenna port(s) or 4 antenna ports for cell specific reference signals are used.</p>
<p>otdoa-SIB1-NB-repetitions This field specifies the repetition number of SIB1-NB of the neighbour cell. Enumerated values r4 correspond to 4 repetitions, r8 to 8 repetitions, and r16 to 16 repetitions. Note, when NPRS configuration Part B only is configured on this NB-IoT neighbour cell (i.e., anchor carrier), <i>nprs-NumSF</i> does also count/include subframes containing NPSS, NSSS, NPBCH, or SIB1-NB, but the UE can assume that no NPRS are transmitted in these subframes (TS 36.211 [16]).</p>

OTDOA-NeighbourCellInfoListNB field descriptions
<p>nprsInfo This field specifies the Type 1 NPRS (TS 36.211 [16]) configuration of the NB-IoT neighbour cell.</p> <p>When the carrier frequency of the NB-IoT neighbour cell is the same as for the NB-IoT assistance data reference cell, the target device may assume that each NPRS positioning occasion for each NPRS carrier frequency in the neighbour cell at least partially overlaps with a NPRS positioning occasion for each NPRS carrier frequency in the NB-IoT assistance data reference cell where the maximum offset between the transmitted NPRS positioning occasions may be assumed to not exceed half a subframe.</p> <p>When the carrier frequency of the neighbour cell is the same as for the NB-IoT assistance data reference cell, and NPRS configuration Part B is configured, the target may assume that this cell has the same NPRS periodicity (T_{NPRS}) as the assistance data reference cell for each NPRS carrier frequency.</p> <p>When the target device receives this field with <i>operationModelInfoNPRS</i> set to value 'standalone', the target device shall assume no NPRS are transmitted on that NB-IoT carrier.</p>
<p>nprs-slotNumberOffset This field specifies the slot number offset at the transmitter between this cell and the NB-IoT assistance data reference cell. The offset corresponds to the number of full slots counted from the beginning of a radio frame of the NB-IoT assistance data reference cell to the beginning of the closest subsequent radio frame of this cell. If this field is absent, the slot timing is the same as for the NB-IoT assistance data reference cell.</p>
<p>nprs-SFN-Offset This field specifies the SFN offset (modulo 64) at the transmitter between this cell and the NB-IoT assistance data reference cell. The offset corresponds to the number of full radio frames counted from the beginning of a radio frame #0 of the NB-IoT assistance data reference cell to the beginning of the closest subsequent radio frame #0 of this cell. The UE may use this field together with the <i>nprs-slotNumberOffset</i> and <i>otdoa-SIB1-NB-repetitions</i> to determine the SIB1-NB subframes of this neighbour cell.</p>
<p>nprs-SubframeOffset This field specifies the offset between the first NPRS subframe in the NB-IoT assistance data reference cell (NOTE 1) and the first NPRS subframe in the closest subsequent NPRS positioning occasion of the NPRS carrier with the longest NPRS periodicity of this cell (NOTE 2). The value is given in number of full sub-frames. If this field is not present, the receiver shall consider the NPRS subframe offset to be 0.</p>
<p>expectedRSTD This field indicates the RSTD value that the target device is expected to measure between this cell and the NB-IoT assistance data reference cell. The <i>expectedRSTD</i> field takes into account the expected propagation time difference as well as transmit time difference of NPRS positioning occasions between the two cells. The RSTD value can be negative and is calculated as (<i>expectedRSTD</i>-8192). The resolution is $3 \times T_s$, with $T_s = 1/(15000 \times 2048)$ seconds. If this field is absent and if the <i>OTDOA-NeighbourCellInfoList</i> IE is included in <i>OTDOA-ProvideAssistanceData</i>, the expected RSTD is the same as provided in <i>OTDOA-NeighbourCellInfoList</i> IE for the corresponding cell (as indicated by <i>prsNeighbourCellIndex</i>).</p>
<p>expectedRSTD-Uncertainty This field indicates the uncertainty in <i>expectedRSTD</i> value. The uncertainty is related to the location server's a-priori estimation of the target device location. The <i>expectedRSTD</i> and <i>expectedRSTD-Uncertainty</i> together define the search window for the target device.</p> <p>The scale factor of the <i>expectedRSTD-Uncertainty</i> field is $3 \times T_s$, with $T_s = 1/(15000 \times 2048)$ seconds.</p> <p>If this field is absent and if the <i>OTDOA-NeighbourCellInfoList</i> IE is included in <i>OTDOA-ProvideAssistanceData</i>, the expected RSTD uncertainty is the same as provided in <i>OTDOA-NeighbourCellInfoList</i> IE for the corresponding cell (as indicated by <i>prsNeighbourCellIndex</i>).</p> <p>The target device may assume that the beginning of the NPRS positioning occasion of the NPRS carrier with the longest NPRS periodicity of the neighbour cell (NOTE 2) is received within the search window of size $[-\text{expectedRSTD-Uncertainty} \times 3 \times T_s, \text{expectedRSTD-Uncertainty} \times 3 \times T_s]$ centred at $T_{\text{REF}} + 1 \text{ millisecond} \times N + (\text{expectedRSTD} - 8192) \times 3 \times T_s$, where T_{REF} is the reception time of the beginning of the NPRS positioning occasion of the NB-IoT assistance data reference cell (NOTE 1) at the target device antenna connector, and $N = \text{nprs-SubframeOffset}$.</p>

OTDOA-NeighbourCellInfoListNB field descriptions
<p>prsNeighbourCellIndex This field contains an index of the entry in IE <i>OTDOA-NeighbourCellInfoList</i>. Value 1 corresponds to the first cell in <i>OTDOA-NeighbourCellInfoList</i>, value 2 to the second, and so on. If this field is absent, and if the <i>OTDOA-NeighbourCellInfoList</i> IE is included in <i>OTDOA-ProvideAssistanceData</i>, it means there is no corresponding cell in <i>OTDOA-NeighbourCellInfoList</i> IE for this cell. The target device may assume the antenna ports of the PRS of the cell indicated by <i>prsNeighbourCellIndex</i> and the NPRS of this cell are quasi co-located, as defined in TS 36.211 [16].</p>
<p>nprsInfo-Type2 This field specifies the Type 2 NPRS (TS 36.211 [16]) configuration of the NB-IoT neighbour cell.</p>
<p>tdd-config Indicates the TDD specific physical channel configuration of the NB-IoT assistance data neighbour cell operating in TDD mode. This field should be present if the DL/UL subframe configuration of the NB-IoT assistance data neighbour cell is not the same as for the NB-IoT assistance data reference cell, or if the current serving NB-IoT cell of the target device operates in FDD mode.</p>

NOTE 1: If the NB-IoT assistance data reference cell (i.e., anchor carrier) has no NPRS configured, the first NPRS carrier in *PRS-Info-NB* is referenced.

NOTE 2: "Cell" in this context may not necessarily be the anchor carrier. If this "cell" has more than one NPRS carrier with equal longest periodicity, the first such NPRS carrier in *PRS-Info-NB* is referenced. The length of a NPRS positioning occasion for Part A in this context is the length of the *nprsBitmap* bit string.

6.5.1.3 OTDOA Assistance Data Request

– *OTDOA-RequestAssistanceData*

The IE *OTDOA-RequestAssistanceData* is used by the target device to request assistance data from a location server.

```
-- ASN1START
OTDOA-RequestAssistanceData ::= SEQUENCE {
    physCellId          INTEGER (0..503),
    ...,
    [[
        adType-r14      BIT STRING { prs (0), nprs (1) } (SIZE (1..8))      OPTIONAL
    ]],
    [[
        nrPhysCellId-r15  INTEGER (0..1007)                                OPTIONAL
    ]]
}
-- ASN1STOP
```

OTDOA-RequestAssistanceData field descriptions
<p>physCellId This field specifies the E-UTRA physical cell identity of the current primary cell of the target device.</p>
<p>adType This field specifies the assistance data requested. This is represented by a bit string, with a one-value at the bit position means the particular assistance data is requested; a zero-value means not requested. Bit 0 indicates that PRS assistance data are requested, bit 1 indicates that NPRS assistance data are requested.</p>
<p>nrPhysCellId This field specifies the NR physical cell identity of the current primary cell of the target device. If this field is present, the target device sets the <i>physCellId</i> to an arbitrary value which shall be ignored by the location server.</p>

6.5.1.4 OTDOA Location Information

– *OTDOA-ProvideLocationInformation*

The IE *OTDOA-ProvideLocationInformation* is used by the target device to provide OTDOA location measurements to the location server. It may also be used to provide OTDOA positioning specific error reason.

```
-- ASN1START
```

```

OTDOA-ProvideLocationInformation ::= SEQUENCE {
    otdoaSignalMeasurementInformation  OTDOA-SignalMeasurementInformation  OPTIONAL,
    otdoa-Error                        OTDOA-Error                        OPTIONAL,
    . . . ,
    [[
        otdoaSignalMeasurementInformation-NB-r14  OTDOA-SignalMeasurementInformation-NB-r14
                                                    OPTIONAL
    ]]
}
-- ASN1STOP

```

6.5.1.5 OTDOA Location Information Elements

– *OTDOA-SignalMeasurementInformation*

The IE *OTDOA-SignalMeasurementInformation* is used by the target device to provide RSTD measurements to the location server. The RSTD measurements are provided for a neighbour cell and the RSTD reference cell, both of which are provided in the IE *OTDOA-ProvideAssistanceData*. The RSTD reference cell may or may not be the same as the assistance data reference cell provided in *OTDOA-ReferenceCellInfo* or *OTDOA-ReferenceCellInfoNB*. If the target device stops reporting inter-frequency RSTD measurements, where the inter-frequency RSTD measurement is an OTDOA RSTD measurement with at least one cell on a frequency different from the serving cell frequency, the LPP layer shall inform lower layers that inter-frequency RSTD measurements are stopped.

NOTE 1: If there are more than 24 *NeighbourMeasurementElement* to be sent, the target device may send them in multiple *ProvideLocationInformation* messages, as described under clause 5.3.

NOTE 2: If NPRS/PRS antenna ports are quasi co-located, the target device provides a single RSTD measurement for the quasi co-located antenna ports of NPRS/PRS.

```

-- ASN1START
OTDOA-SignalMeasurementInformation ::= SEQUENCE {
    systemFrameNumber  BIT STRING (SIZE (10)),
    physCellIdRef      INTEGER (0..503),
    cellGlobalIdRef    ECGI                OPTIONAL,
    earfcnRef          ARFCN-ValueEUTRA    OPTIONAL,        -- Cond NotSameAsRef0
    referenceQuality    OTDOA-MeasQuality  OPTIONAL,
    neighbourMeasurementList  NeighbourMeasurementList,
    . . . ,
    [[ earfcnRef-v9a0    ARFCN-ValueEUTRA-v9a0  OPTIONAL        -- Cond NotSameAsRef1
    ]],
    [[ tpIdRef-r14      INTEGER (0..4095)        OPTIONAL,        -- Cond ProvidedByServer0
       prsIdRef-r14     INTEGER (0..4095)        OPTIONAL,        -- Cond ProvidedByServer1
       additionalPathsRef-r14
                               AdditionalPathList-r14  OPTIONAL,
       nprsIdRef-r14    INTEGER (0..4095)        OPTIONAL,        -- Cond ProvidedByServer2
       carrierFreqOffsetNB-Ref-r14
                               CarrierFreqOffsetNB-r14  OPTIONAL,    -- Cond NB-IoT
       hyperSFN-r14    BIT STRING (SIZE (10))  OPTIONAL        -- Cond H-SFN
    ]],
    [[
    [[
        motionTimeSource-r15      MotionTimeSource-r15      OPTIONAL
    ]]]
}

NeighbourMeasurementList ::= SEQUENCE (SIZE(1..24)) OF NeighbourMeasurementElement

NeighbourMeasurementElement ::= SEQUENCE {
    physCellIdNeighbour  INTEGER (0..503),
    cellGlobalIdNeighbour  ECGI                OPTIONAL,
    earfcnNeighbour      ARFCN-ValueEUTRA    OPTIONAL,        -- Cond NotSameAsRef2
    rstd                 INTEGER (0..12711),
    rstd-Quality         OTDOA-MeasQuality,
    . . . ,
    [[ earfcnNeighbour-v9a0  ARFCN-ValueEUTRA-v9a0  OPTIONAL        -- Cond NotSameAsRef3
    ]],
    [[ tpIdNeighbour-r14    INTEGER (0..4095)        OPTIONAL,        -- Cond ProvidedByServer0
       prsIdNeighbour-r14  INTEGER (0..4095)        OPTIONAL,        -- Cond ProvidedByServer1
       delta-rstd-r14      INTEGER (0..5)          OPTIONAL,
       additionalPathsNeighbour-r14
                               AdditionalPathList-r14  OPTIONAL,

```

```

        nprsIdNeighbour-r14 INTEGER (0..4095)          OPTIONAL,          -- Cond ProvidedByServer2
        carrierFreqOffsetNB-Neighbour-r14
            CarrierFreqOffsetNB-r14 OPTIONAL          -- Cond NB-IoT
    ]],
    [[
        delta-SFN-r15          INTEGER (-8192..8191)  OPTIONAL
    ]]
}

AdditionalPathList-r14 ::= SEQUENCE (SIZE(1..maxPaths-r14)) OF AdditionalPath-r14

maxPaths-r14    INTEGER ::= 2

MotionTimeSource-r15 ::= SEQUENCE {
    timeSource-r15          ENUMERATED {servingCell, referenceCell, gnss, mixed,
                                        other, none, ...}
}

-- ASN1STOP

```

Conditional presence	Explanation
<i>NotSameAsRef0</i>	The field is absent if the corresponding <i>earfcnRef-v9a0</i> is present. Otherwise, the target device shall include this field if the EARFCN of the RSTD reference cell is not the same as the EARFCN of the assistance data reference cell provided in the OTDOA assistance data.
<i>NotSameAsRef1</i>	The field is absent if the corresponding <i>earfcnRef</i> is present. Otherwise, the target device shall include this field if the EARFCN of the RSTD reference cell is not the same as the EARFCN of the assistance data reference cell provided in the OTDOA assistance data.
<i>NotSameAsRef2</i>	The field is absent if the corresponding <i>earfcnNeighbour-v9a0</i> is present. Otherwise, the target device shall include this field if the EARFCN of this neighbour cell is not the same as the <i>earfcnRef</i> for the RSTD reference cell.
<i>NotSameAsRef3</i>	The field is absent if the corresponding <i>earfcnNeighbour</i> is present. Otherwise, the target device shall include this field if the EARFCN of this neighbour cell is not the same as the <i>earfcnRef</i> for the RSTD reference cell.
<i>ProvidedByServer0</i>	The target device shall include this field if a <i>tpld</i> for this transmission point is included in the <i>OTDOA-ProvideAssistanceData</i> . Otherwise the field is absent.
<i>ProvidedByServer1</i>	The target device shall include this field if a <i>prsid</i> for this transmission point is included in the <i>OTDOA-ProvideAssistanceData</i> . Otherwise the field is absent.
<i>ProvidedByServer2</i>	The target device shall include this field if an <i>nprsid</i> for this cell is included in the <i>OTDOA-ProvideAssistanceData</i> and if this cell is a NB-IoT only cell (without associated LTE PRS cell). Otherwise the field is absent.
<i>NB-IoT</i>	The target device shall include this field if the cell is a NB-IoT only cell (without associated LTE PRS cell). Otherwise the field is absent.
<i>H-SFN</i>	The target device shall include this field if it was able to determine a hyper SFN of the RSTD reference cell.

OTDOA-SignalMeasurementInformation field descriptions
<p>systemFrameNumber</p> <p>If the <i>deltaSFN</i> and <i>motionTimeSource</i> fields are not present, this field specifies the SFN of the RSTD reference cell containing the starting subframe of the PRS or NPRS positioning occasion if PRS or NPRS are available on the RSTD reference cell, or subframe of the CRS for RSTD measurements if PRS and NPRS are not available on the RSTD reference cell during which the most recent neighbour cell RSTD measurement was performed. In the case of more than a single PRS configuration on the RSTD reference cell, the first PRS configuration is referenced.</p> <p>If the <i>deltaSFN</i> and <i>motionTimeSource</i> fields are present, this field specifies the SFN of the RSTD reference cell when the TOA measurement for the RSTD reference cell has been made.</p>
<p>physCellIdRef</p> <p>This field specifies the physical cell identity of the RSTD reference cell.</p>
<p>cellGlobalIdRef</p> <p>This field specifies the ECGI, the globally unique identity of a cell in E-UTRA, of the RSTD reference cell. The target shall provide this IE if it knows the ECGI of the RSTD reference cell.</p>
<p>earfcnRef</p> <p>This field specifies the EARFCN of the RSTD reference cell.</p>

OTDOA-SignalMeasurementInformation field descriptions	
referenceQuality	This field specifies the target device's best estimate of the quality of the TOA measurement from the RSTD reference cell, $T_{\text{SubframeRxRef}}$, where $T_{\text{SubframeRxRef}}$ is the time of arrival of the signal from the RSTD reference cell. When <i>deltaSFN</i> and <i>motionTimeSource</i> are both included, the target device shall not include measurement errors caused by motion of the target device in <i>referenceQuality</i> (e.g. the target device may assume the target device was stationary during OTDOA measurements).
neighbourMeasurementList	This list contains the measured RSTD values for neighbour cells together with the RSTD reference cell, along with quality for each measurement.
tpldRef	This field specifies the transmission point ID of the RSTD reference cell.
prslidRef	This field specifies the PRS-ID of the first PRS configuration of the RSTD reference cell.
additionalPathsRef	This field specifies one or more additional detected path timing values for the RSTD reference cell, relative to the path timing used for determining the <i>rstd</i> value. If this field was requested but is not included, it means the UE did not detect any additional path timing values.
nprslidRef	This field specifies the NPRS-ID of the RSTD reference cell.
carrierFreqOffsetNB-Ref	This field specifies the offset of the NB-IoT channel number to EARFCN given by <i>earfcnRef</i> as defined in TS 36.101 [21].
hyperSFN	This field specifies the hyper SFN as defined in TS 36.331 [12] of the RSTD reference cell for the <i>systemFrameNumber</i> .
motionTimeSource	This field provides reference information concerning the movement of the target device and comprises the following subfields: <ul style="list-style-type: none"> - timeSource specifies the external time source to which UE time was locked during the OTDOA measurements. Enumerated value "mixed" indicates that UE time was locked to more than one external time source during OTDOA measurements (e.g. is applicable to a change in serving cell when the serving cell was used as a time source). The value "other" indicates some other external time source. The value "none" indicates that UE time was not locked to an external time source. If this field is present, the target device shall also provide the IE <i>Sensor-MotionInformation</i> in IE <i>Sensor-ProvideLocationInformation</i> .
physCellIdNeighbour	This field specifies the physical cell identity of the neighbour cell for which the RSTDs are provided.
cellGlobalIdNeighbour	This field specifies the ECGLI, the globally unique identity of a cell in E-UTRA, of the neighbour cell for which the RSTDs are provided. The target device shall provide this IE if it was able to determine the ECGLI of the neighbour cell at the time of measurement.
earfcnNeighbour	This field specifies the EARFCN of the neighbour cell used for the RSTD measurements.
rstd	This field specifies the relative timing difference between this neighbour cell and the RSTD reference cell, as defined in TS 36.214 [17]. Mapping of the measured quantity is defined as in TS 36.133 [18] clause 9.1.10.3.
rstd-Quality	This field specifies the target device's best estimate of the quality of the measured <i>rstd</i> . When <i>deltaSFN</i> and <i>motionTimeSource</i> both included, the target device shall not include measurement errors caused by motion of the target device in <i>rstd-Quality</i> (e.g. the target device may assume the target device was stationary during OTDOA measurements).
tpldNeighbour	This field specifies the transmission point ID for the neighbour cell for which the RSTDs are provided.
prslidNeighbour	This field specifies the PRS-ID of the first PRS configuration of the neighbour cell for which the RSTDs are provided.
delta-rstd	This field specifies the higher-resolution RSTD Δ_{RSTD} as defined in TS 36.133 [18] clause 9.1.10.4. Mapping of the measured quantity is defined as in TS 36.133 [18] clause 9.1.10.4.

OTDOA-SignalMeasurementInformation field descriptions
<p>additionalPathsNeighbour This field specifies one or more additional detected path timing values for the neighbour cell, relative to the path timing used for determining the <i>rstd</i> value. If this field was requested but is not included, it means the UE did not detect any additional path timing values.</p>
<p>nprsdNeighbour This field specifies the NPRS-ID of the neighbour cell for which the RSTDs are provided.</p>
<p>carrierFreqOffsetNB-Neighbour This field specifies the offset of the NB-IoT channel number to EARFCN given by <i>earfcnNeighbour</i> as defined in TS 36.101 [21].</p>
<p>delta-SFN This field provides information concerning the movement of the target device: Together with <i>systemFrameNumber</i> specifies the <i>measurementSFN</i> of the RSTD reference cell when the TOA measurement for this neighbour cell has been made for determining the <i>rstd</i>. The <i>measurementSFN</i> is given by <i>systemFrameNumber</i> + <i>delta-SFN</i>. (The actual SFN is the <i>measurementSFN</i> modulo 1024.). The <i>measurementSFN</i> is used in IE <i>Sensor-MotionInformation</i> to provide movement information corresponding to the TOA measurement time. If this field is present, the target device shall also provide the IE <i>Sensor-MotionInformation</i> in IE <i>Sensor-ProvideLocationInformation</i>.</p>

OTDOA-SignalMeasurementInformation-NB

The IE *OTDOA-SignalMeasurementInformation-NB* is used by the target device to provide RSTD measurements to the location server. The RSTD measurements are provided for a neighbour cell and the RSTD reference cell, both of which are provided in the IE *OTDOA-ProvideAssistanceData*. The RSTD reference cell may or may not be the same as the assistance data reference cell provided in *OTDOA-ReferenceCellInfo* or *OTDOA-ReferenceCellInfoNB*. If the target device stops reporting inter-frequency RSTD measurements, where the inter-frequency RSTD measurement is an OTDOA RSTD measurement with at least one cell on a frequency different from the serving cell frequency, the LPP layer shall inform lower layers that inter-frequency RSTD measurements are stopped.

NOTE 1: If there are more than 24 *NeighbourMeasurementElement-NB* to be sent, the target device may send them in multiple *ProvideLocationInformation* messages, as described under clause 5.3.

NOTE 2: If NPRS/PRS antenna ports are quasi co-located, the target device provides a single RSTD measurement for the quasi co-located antenna ports of NPRS/PRS.

```
-- ASN1START

OTDOA-SignalMeasurementInformation-NB-r14 ::= SEQUENCE {
    systemFrameNumber-r14          BIT STRING (SIZE (10)),
    physCellIdRef-r14              INTEGER (0..503),
    cellGlobalIdRef-r14           ECGI                      OPTIONAL,
    earfcnRef-r14                 ARFCN-ValueEUTRA-r14       OPTIONAL,    -- Cond NotSameAsRef0
    referenceQuality-r14          OTDOA-MeasQuality          OPTIONAL,
    neighbourMeasurementList-r14  NeighbourMeasurementList-NB-r14,
    tpIdRef-r14                   INTEGER (0..4095)           OPTIONAL,    -- Cond ProvidedByServer0
    prsIdRef-r14                  INTEGER (0..4095)           OPTIONAL,    -- Cond ProvidedByServer1
    additionalPathsRef-r14        AdditionalPathList-r14  OPTIONAL,
    nprsdRef-r14                  INTEGER (0..4095)           OPTIONAL,    -- Cond ProvidedByServer2
    carrierFreqOffsetNB-Ref-r14   CarrierFreqOffsetNB-r14 OPTIONAL,    -- Cond NB-IoT
    hyperSFN-r14                  BIT STRING (SIZE (10))     OPTIONAL,    -- Cond H-SFN
    ...
}

NeighbourMeasurementList-NB-r14 ::= SEQUENCE (SIZE(1..24)) OF NeighbourMeasurementElement-NB-r14

NeighbourMeasurementElement-NB-r14 ::= SEQUENCE {
    physCellIdNeighbour-r14       INTEGER (0..503),
    cellGlobalIdNeighbour-r14     ECGI                      OPTIONAL,
    earfcnNeighbour-r14           ARFCN-ValueEUTRA-r14       OPTIONAL,    -- Cond NotSameAsRef2
    rstd-r14                      INTEGER (0..12711),
    rstd-Quality-r14              OTDOA-MeasQuality,
    tpIdNeighbour-r14            INTEGER (0..4095)           OPTIONAL,    -- Cond ProvidedByServer0
    prsIdNeighbour-r14           INTEGER (0..4095)           OPTIONAL,    -- Cond ProvidedByServer1
    delta-rstd-r14               INTEGER (0..5)              OPTIONAL,
    additionalPathsNeighbour-r14  AdditionalPathList-r14  OPTIONAL,
    nprsdNeighbour-r14           INTEGER (0..4095)           OPTIONAL,    -- Cond ProvidedByServer2
    carrierFreqOffsetNB-Neighbour-r14 CarrierFreqOffsetNB-r14 OPTIONAL,    -- Cond NB-IoT

```

```

}
...
-- ASN1STOP

```

Conditional presence	Explanation
<i>NotSameAsRef0</i>	The target device shall include this field if the EARFCN of the RSTD reference cell is not the same as the EARFCN of the assistance data reference cell provided in the OTDOA assistance data.
<i>NotSameAsRef2</i>	The target device shall include this field if the EARFCN of this neighbour cell is not the same as the <i>earfcnRef</i> for the RSTD reference cell.
<i>ProvidedByServer0</i>	The target device shall include this field if a <i>tpld</i> for this transmission point is included in the <i>OTDOA-ProvideAssistanceData</i> . Otherwise the field is absent.
<i>ProvidedByServer1</i>	The target device shall include this field if a <i>prsid</i> for this transmission point is included in the <i>OTDOA-ProvideAssistanceData</i> . Otherwise the field is absent.
<i>ProvidedByServer2</i>	The target device shall include this field if an <i>nprsid</i> for this cell is included in the <i>OTDOA-ProvideAssistanceData</i> and if this cell is a NB-IoT only cell (without associated LTE PRS cell). Otherwise the field is absent.
<i>NB-IoT</i>	The target device shall include this field if the cell is a NB-IoT only cell (without associated LTE PRS cell). Otherwise the field is absent.
<i>H-SFN</i>	The target device shall include this field if it was able to determine a hyper SFN of the RSTD reference cell.

OTDOA-SignalMeasurementInformation-NB field descriptions	
<i>systemFrameNumber</i>	This field specifies the SFN of the RSTD reference cell containing the starting subframe of the PRS or NPRS positioning occasion if PRS or NPRS are available on the RSTD reference cell, or subframe of the CRS for RSTD measurements if PRS and NPRS are not available on the RSTD reference cell during which the most recent neighbour cell RSTD measurement was performed. In the case of more than a single PRS configuration on the RSTD reference cell, the first PRS configuration is referenced.
<i>physCellIdRef</i>	This field specifies the physical cell identity of the RSTD reference cell.
<i>cellGlobalIdRef</i>	This field specifies the ECGL, the globally unique identity of a cell in E-UTRA, of the RSTD reference cell. The target shall provide this IE if it knows the ECGL of the RSTD reference cell.
<i>earfcnRef</i>	This field specifies the EARFCN of the RSTD reference cell.
<i>referenceQuality</i>	This field specifies the target device's best estimate of the quality of the TOA measurement from the RSTD reference cell, $T_{\text{SubframeRxRef}}$, where $T_{\text{SubframeRxRef}}$ is the time of arrival of the signal from the RSTD reference cell.
<i>neighbourMeasurementList</i>	This list contains the measured RSTD values for neighbour cells together with the RSTD reference cell, along with quality for each measurement.
<i>tpldRef</i>	This field specifies the transmission point ID of the RSTD reference cell.
<i>prsidRef</i>	This field specifies the PRS-ID of the first PRS configuration of the RSTD reference cell.
<i>additionalPathsRef</i>	This field specifies one or more additional detected path timing values for the RSTD reference cell, relative to the path timing used for determining the <i>rstd</i> value. If this field was requested but is not included, it means the UE did not detect any additional path timing values.
<i>nprsidRef</i>	This field specifies the NPRS-ID of the RSTD reference cell.
<i>carrierFreqOffsetNB-Ref</i>	This field specifies the offset of the NB-IoT channel number to EARFCN given by <i>earfcnRef</i> as defined in TS 36.101 [21].
<i>hyperSFN</i>	This field specifies the hyper SFN as defined in TS 36.331 [12] of the RSTD reference cell for the <i>systemFrameNumber</i> .
<i>physCellIdNeighbour</i>	This field specifies the physical cell identity of the neighbour cell for which the RSTDs are provided.
<i>cellGlobalIdNeighbour</i>	This field specifies the ECGL, the globally unique identity of a cell in E-UTRA, of the neighbour cell for which the RSTDs are provided. The target device shall provide this IE if it was able to determine the ECGL of the neighbour cell at the time of measurement.

OTDOA-SignalMeasurementInformation-NB field descriptions	
earfcnNeighbour	This field specifies the EARFCN of the neighbour cell used for the RSTD measurements.
rstd	This field specifies the relative timing difference between this neighbour cell and the RSTD reference cell, as defined in TS 36.214 [17]. Mapping of the measured quantity is defined as in TS 36.133 [18] clause 9.1.10.3.
rstd-Quality	This field specifies the target device's best estimate of the quality of the measured <i>rstd</i> .
tpldNeighbour	This field specifies the transmission point ID for the neighbour cell for which the RSTDs are provided.
prslidNeighbour	This field specifies the PRS-ID of the first PRS configuration of the neighbour cell for which the RSTDs are provided.
delta-rstd	This field specifies the higher-resolution RSTD Δ_{RSTD} as defined in TS 36.133 [18] clause 9.1.10.4. Mapping of the measured quantity is defined as in TS 36.133 [18] clause 9.1.10.4.
additionalPathsNeighbour	This field specifies one or more additional detected path timing values for the neighbour cell, relative to the path timing used for determining the <i>rstd</i> value. If this field was requested but is not included, it means the UE did not detect any additional path timing values.
nprslidNeighbour	This field specifies the NPRS-ID of the neighbour cell for which the RSTDs are provided.
carrierFreqOffsetNB-Neighbour	This field specifies the offset of the NB-IoT channel number to EARFCN given by <i>earfcnNeighbour</i> as defined in TS 36.101 [21].

OTDOA-MeasQuality

```

-- ASN1START
OTDOA-MeasQuality ::= SEQUENCE {
    error-Resolution      BIT STRING (SIZE (2)),
    error-Value          BIT STRING (SIZE (5)),
    error-NumSamples     BIT STRING (SIZE (3))          OPTIONAL,
    ...
}
-- ASN1STOP

```

OTDOA-MeasQuality field descriptions	
error-Resolution	This field specifies the resolution R used in <i>error-Value</i> field. The encoding on two bits is as follows: '00' 5 metres '01' 10 metres '10' 20 metres '11' 30 metres
error-Value	This field specifies the target device's best estimate of the uncertainty of the OTDOA (or TOA) measurement. The encoding on five bits is as follows: '00000' 0 to (R*1-1) metres '00001' R*1 to (R*2-1) metres '00010' R*2 to (R*3-1) metres ... '11111' R*31 metres or more; where R is the resolution defined by <i>error-Resolution</i> field. E.g., R=20 m corresponds to 0-19 m, 20-39 m,...,620+ m.

OTDOA-MeasQuality field descriptions**error-NumSamples**

If the *error-Value* field provides the sample uncertainty of the OTDOA (or TOA) measurement, this field specifies how many measurements have been used by the target device to determine this (i.e., sample size). Following 3 bit encoding is used:

'000'	Not the baseline metric
'001'	5-9
'010'	10-14
'011'	15-24
'100'	25-34
'101'	35-44
'110'	45-54
'111'	55 or more.

In the case of the value '000', the *error-Value* field contains the target device's best estimate of the uncertainty of the OTDOA (or TOA) measurement not based on the baseline metric. E.g., other measurements such as signal-to-noise-ratio or signal strength can be utilized to estimate the *error-Value*.

If this field is absent, the value of this field is '000'.

AdditionalPath

The IE *AdditionalPath* is used by the target device to provide information about additional paths associated with the RSTD measurements in the form of a relative time difference and a quality value. The additional path *relativeTimeDifference* is the detected path timing relative to the detected path timing used for the *rstd* value (TS 36.214 [17]), and each additional path can be associated with a quality value *path-Quality*.

```
-- ASN1START
AdditionalPath-r14 ::= SEQUENCE {
    relativeTimeDifference-r14  INTEGER (-256..255),
    path-Quality-r14           OTDOA-MeasQuality           OPTIONAL,
    ...
}
-- ASN1STOP
```

AdditionalPath field descriptions**relativeTimeDifference**

This field specifies the additional detected path timing relative to the detected path timing used for the *rstd* value in units of 0.5 Ts, with $T_s=1/(15000*2048)$ seconds. A positive value indicates that the particular path is later in time than the detected path used for RSTD; a negative value indicates that the particular path is earlier in time than the detected path used for RSTD.

path-Quality

This field specifies the target device's best estimate of the quality of the detected timing of the additional path.

6.5.1.6 OTDOA Location Information Request**OTDOA-RequestLocationInformation**

The IE *OTDOA-RequestLocationInformation* is used by the location server to request OTDOA location measurements from a target device. Details of the required measurements (e.g. details of assistance data reference cell and neighbour cells) are conveyed in the *OTDOA-ProvideAssistanceData* IE in a separate Provide Assistance Data message.

```
-- ASN1START
OTDOA-RequestLocationInformation ::= SEQUENCE {
    assistanceAvailability  BOOLEAN,
    ...
    [[
        multipathRSTD-r14   ENUMERATED { requested }   OPTIONAL,   -- Need ON
        maxNoOfRSTDmeas-r14 INTEGER (1..32)           OPTIONAL
    ]],
    [[
        motionMeasurements-r15 ENUMERATED { requested }   OPTIONAL   -- Need ON
    ]]
}
-- ASN1STOP
```

```
-- ASN1STOP
```

OTDOA-RequestLocationInformation field descriptions
<p>assistanceAvailability This field indicates whether the target device may request additional OTDOA assistance data from the server. TRUE means allowed and FALSE means not allowed.</p>
<p>multipathRSTD This field, if present, indicates that the target device is requested to report additional detected path timing information per RSTD reference and neighbour cell.</p>
<p>maxNoOfRSTDmeas This field, if present, indicates the maximum number of <i>NeighbourMeasurementElement</i> fields (i.e., RSTD measurements) the target device can provide in <i>OTDOA-SignalMeasurementInformation</i>.</p>
<p>motionMeasurements This field, if present, indicates that the target device is requested to report the motion measurements (<i>deltaSFN</i> and <i>motionTimeSource</i>) in <i>OTDOA-SignalMeasurementInformation</i> as well as the IE <i>Sensor-MotionInformation</i> in IE <i>Sensor-ProvideLocationInformation</i>.</p>

6.5.1.7 OTDOA Capability Information

– OTDOA-ProvideCapabilities

The IE *OTDOA-ProvideCapabilities* is used by the target device to indicate its capability to support OTDOA and to provide its OTDOA positioning capabilities to the location server.

```
-- ASN1START
OTDOA-ProvideCapabilities ::= SEQUENCE {
    otdoa-Mode          BIT STRING { ue-assisted          (0),
                                     ue-assisted-NB-r14    (1),
                                     ue-assisted-NB-TDD-r15 (2) } (SIZE (1..8)),
    ...,
    supportedBandListEUTRA          SEQUENCE (SIZE (1..maxBands)) OF SupportedBandEUTRA          OPTIONAL,
    supportedBandListEUTRA-v9a0    SEQUENCE (SIZE (1..maxBands)) OF SupportedBandEUTRA-v9a0
    interFreqRSTDmeasurement-r10   ENUMERATED { supported } OPTIONAL,
    additionalNeighbourCellInfoList-r10  ENUMERATED { supported } OPTIONAL,
    prs-id-r14                      ENUMERATED { supported } OPTIONAL,
    tp-separation-via-muting-r14     ENUMERATED { supported } OPTIONAL,
    additional-prs-config-r14       ENUMERATED { supported } OPTIONAL,
    prs-based-tbs-r14              ENUMERATED { supported } OPTIONAL,
    additionalPathsReport-r14      ENUMERATED { supported } OPTIONAL,
    densePrsConfig-r14            ENUMERATED { supported } OPTIONAL,
    maxSupportedPrsBandwidth-r14   ENUMERATED { n6, n15, n25, n50, n75, n100, ... } OPTIONAL,
    prsOccGroup-r14               ENUMERATED { supported } OPTIONAL,
    prsFrequencyHopping-r14       ENUMERATED { supported } OPTIONAL,
    maxSupportedPrsConfigs-r14     ENUMERATED { c2, c3 } OPTIONAL,
    periodicalReporting-r14       ENUMERATED { supported } OPTIONAL,
    multiPrbNprs-r14             ENUMERATED { supported } OPTIONAL,
    idleStateForMeasurements-r14   ENUMERATED { required } OPTIONAL,
    numberOfRXantennas-r14        ENUMERATED { rx1, ... } OPTIONAL,
    motionMeasurements-r15        ENUMERATED { supported } OPTIONAL,
    interRAT-RSTDmeasurement-r15   ENUMERATED { supported } OPTIONAL
}

maxBands INTEGER ::= 64

SupportedBandEUTRA ::= SEQUENCE {
    bandEUTRA          INTEGER (1..maxFBI)
}

SupportedBandEUTRA-v9a0 ::= SEQUENCE {
    bandEUTRA-v9a0    INTEGER (maxFBI-Plus1..maxFBI2)    OPTIONAL
}

maxFBI          INTEGER ::= 64 -- Maximum value of frequency band indicator
maxFBI-Plus1   INTEGER ::= 65 -- lowest value extended FBI range
maxFBI2        INTEGER ::= 256 -- highest value extended FBI range

-- ASN1STOP
```

OTDOA-ProvideCapabilities field descriptions
<p>otdoa-Mode This field specifies the OTDOA mode(s) supported by the target device. This is represented by a bit string, with a one value at the bit position means the particular OTDOA mode is supported; a zero value means not supported. A zero-value in all bit positions in the bit string means OTDOA positioning method is not supported by the target device.</p> <p>ue-assisted: Bit 0 indicates that the target device supports UE-assisted OTDOA and LTE PRS. ue-assisted-NB: Bit 1 indicates that the target device supports UE-assisted OTDOA and NB-IoT NPRS. ue-assisted-NB-TDD: Bit 2 indicates that the target device supports UE-assisted OTDOA and NB-IoT NPRS for TDD.</p>
<p>SupportedBandEUTRA This field specifies the frequency bands for which the target device supports RSTD measurements. One entry corresponding to each supported E-UTRA band as defined in TS 36.101 [21]. In the case the target device includes <i>bandEUTRA-v9a0</i>, the target device shall set the corresponding entry of <i>bandEUTRA</i> (i.e. without suffix) to <i>maxFBI</i>.</p>
<p>interFreqRSTDmeasurement This field, if present, indicates that the target device supports inter-frequency RSTD measurements within and between the frequency bands indicated in <i>SupportedBandEUTRA</i>.</p>
<p>additionalNeighbourCellInfoList This field, if present, indicates that the target device supports up to 3x24 <i>OTDOA-NeighbourCellInfoElement</i> in <i>OTDOA-NeighbourCellInfoList</i> in <i>OTDOA-ProvideAssistanceData</i> without any restriction for the <i>earfcn</i> in each <i>OTDOA-NeighbourCellInfoElement</i> as specified in clause 6.5.1.2.</p>
<p>prs-id This field, if present, indicates that the target device supports PRS generation based on the PRS-ID as specified in TS 36.211 [16] and support for TP-ID in <i>OTDOA-ReferenceCellInfo</i> and <i>OTDOA-NeighbourCellInfoList</i>.</p>
<p>tp-separation-via-muting This field, if present, indicates that the target device supports RSTD measurements for cells which have associated transmission points (e.g., Remote Radio Heads) within the cell coverage and where these associated transmission points have the same physical cell identity as the associated cell, and where these transmission points are identified via a different muting pattern. The field also indicates support for TP-ID in <i>OTDOA-ReferenceCellInfo</i> and <i>OTDOA-NeighbourCellInfoList</i>.</p>
<p>additional-prs-config This field, if present, indicates that the target device supports additional PRS configurations. The additional PRS configuration in <i>PRS-Info</i> IE comprise:</p> <ul style="list-style-type: none"> - support for <i>prs-ConfigurationIndex</i> > 2399; - support for N_{PRS} values in addition to 1, 2, 4 and 6 (<i>add-numDL-Frames</i> in <i>PRS-Info</i>); - support for muting bit string lengths > 16 bits.
<p>prs-based-tbs This field, if present, indicates that the target device supports RSTD measurements for PRS-only TPs.</p>
<p>additionalPathsReport This field, if present, indicates that the target device supports reporting of timing information for additional detected paths for RSTD reference and each neighbour cell.</p>
<p>densePrsConfig This field, if present, indicates that the target device supports a subset of the additional PRS configurations associated with capability <i>additional-prs-config</i> which comprises:</p> <ul style="list-style-type: none"> - support for <i>prs-ConfigurationIndex</i> > 2404; - support for N_{PRS} values of 10, 20, 40, 80 and 160 (in addition to 1, 2, 4 and 6). <p>In the case <i>additional-prs-config</i> is present, this field is not present.</p>
<p>maxSupportedPrsBandwidth This field, if present, indicates the maximum PRS bandwidth supported by the target device. Enumerated value n6 corresponds to 6 resource blocks, n15 to 15 resource blocks and so on. If this field is not present, the target device is assumed to support the PRS bandwidth associated with the target device type, which for LTE devices including Cat-M1/M2 is 100 resource blocks and for NB-IoT devices is 1 resource block.</p>
<p>prsOccGroup This field, if present, indicates that the target device supports PRS occasion groups, which implies that each bit of a configured muting pattern applies per PRS occasion group.</p>
<p>prsFrequencyHopping This field, if present, indicates that the target device supports PRS occasion frequency hopping, as specified in TS 36.211 [16].</p>
<p>maxSupportedPrsConfigs This field, if present, indicates that the target device supports multiple PRS configurations per cell. Enumerated value c2 indicates support for up to 2 configurations; c3 indicates support for up to 3 configurations.</p>
<p>periodicalReporting This field, if present, indicates that the target device supports <i>periodicalReporting</i> of RSTD measurements. If this field is absent, the location server may assume that the target device does not support <i>periodicalReporting</i> in <i>CommonEsRequestLocationInformation</i>.</p>
<p>multiPrbNprs This field, if present, indicates that the target device supports NPRS configuration in more than one resource block (i.e., <i>maxCarrier</i> in <i>PRS-Info-NB</i> greater 1).</p>
<p>idleStateForMeasurements This field, if present, indicates that the target device requires idle state to perform RSTD measurements.</p>

OTDOA-ProvideCapabilities field descriptions
<p>numberOfRXantennas This field is not applicable to NB-IoT devices. This field, if present, indicates the number of UE downlink receive antennas for RSTD measurements (see TS 36.133 [18]). Enumerated value rx1 indicates a single antenna receiver. If this field is absent, the target device is assumed to support two RX antennas for RSTD measurements.</p>
<p>motionMeasurements This field, if present, indicates that the target device supports reporting of motion measurements (<i>deltaSFN</i> and <i>motionTimeSource</i>) in <i>OTDOA-SignalMeasurementInformation</i>. The presence of this field implies presence of <i>sensor-MotionInformationSup</i> in IE <i>Sensor-ProvideCapabilities</i>.</p>
<p>interRAT-RSTDmeasurement This field, if present, indicates that the target device supports inter-RAT RSTD measurements (TS 38.215 [36]); i.e., E-UTRA RSTD measurements when the target device is served by an NR cell.</p>

6.5.1.8 OTDOA Capability Information Request

– *OTDOA-RequestCapabilities*

The IE *OTDOA-RequestCapabilities* is used by the location server to request the capability of the target device to support OTDOA and to request OTDOA positioning capabilities from a target device.

```
-- ASN1START
OTDOA-RequestCapabilities ::= SEQUENCE {
    ...
}
-- ASN1STOP
```

6.5.1.9 OTDOA Error Elements

– *OTDOA-Error*

The IE *OTDOA-Error* is used by the location server or target device to provide OTDOA error reasons to the target device or location server, respectively.

```
-- ASN1START
OTDOA-Error ::= CHOICE {
    locationServerErrorCauses      OTDOA-LocationServerErrorCauses,
    targetDeviceErrorCauses       OTDOA-TargetDeviceErrorCauses,
    ...
}
-- ASN1STOP
```

– *OTDOA-LocationServerErrorCauses*

The IE *OTDOA-LocationServerErrorCauses* is used by the location server to provide OTDOA error reasons to the target device.

```
-- ASN1START
OTDOA-LocationServerErrorCauses ::= SEQUENCE {
    cause      ENUMERATED { undefined,
                           assistanceDataNotSupportedByServer,
                           assistanceDataSupportedButCurrentlyNotAvailableByServer,
                           ...
                           },
    ...
}
-- ASN1STOP
```

– OTDOA-TargetDeviceErrorCauses

The IE *OTDOA-TargetDeviceErrorCauses* is used by the target device to provide OTDOA error reasons to the location server.

```
-- ASN1START
OTDOA-TargetDeviceErrorCauses ::= SEQUENCE {
  cause      ENUMERATED {      undefined,
                               assistance-data-missing,
                               unableToMeasureReferenceCell,
                               unableToMeasureAnyNeighbourCell,
                               attemptedButUnableToMeasureSomeNeighbourCells,
                               ...
                               },
  ...
}
-- ASN1STOP
```

6.5.2 A-GNSS Positioning

6.5.2.1 GNSS Assistance Data

– A-GNSS-ProvideAssistanceData

The IE *A-GNSS-ProvideAssistanceData* is used by the location server to provide assistance data to enable UE-based and UE-assisted A-GNSS. It may also be used to provide GNSS positioning specific error reasons.

```
-- ASN1START
A-GNSS-ProvideAssistanceData ::= SEQUENCE {
  gnss-CommonAssistData      GNSS-CommonAssistData      OPTIONAL,  -- Need ON
  gnss-GenericAssistData     GNSS-GenericAssistData     OPTIONAL,  -- Need ON
  gnss-Error                  A-GNSS-Error                OPTIONAL,  -- Need ON
  ...
  [[
    gnss-PeriodicAssistData-r15 GNSS-PeriodicAssistData-r15  OPTIONAL  -- Cond CtrTrans
  ]]
}
-- ASN1STOP
```

Conditional presence	Explanation
<i>CtrTrans</i>	The field is mandatory present in the control transaction of a periodic assistance data delivery session as described in clauses 5.2.1a and 5.2.2a. Otherwise it is not present.

– GNSS-CommonAssistData

The IE *GNSS-CommonAssistData* is used by the location server to provide assistance data which can be used for any GNSS.

```
-- ASN1START
GNSS-CommonAssistData ::= SEQUENCE {
  gnss-ReferenceTime      GNSS-ReferenceTime      OPTIONAL,  -- Need ON
  gnss-ReferenceLocation  GNSS-ReferenceLocation  OPTIONAL,  -- Need ON
  gnss-IonosphericModel   GNSS-IonosphericModel   OPTIONAL,  -- Need ON
  gnss-EarthOrientationParameters GNSS-EarthOrientationParameters  OPTIONAL,  -- Need ON
  ...
  [[
    gnss-RTK-ReferenceStationInfo-r15
      GNSS-RTK-ReferenceStationInfo-r15  OPTIONAL,  -- Need ON
    gnss-RTK-CommonObservationInfo-r15
      GNSS-RTK-CommonObservationInfo-r15  OPTIONAL,  -- Cond RTK
    gnss-RTK-AuxiliaryStationData-r15
      GNSS-RTK-AuxiliaryStationData-r15  OPTIONAL  -- Need ON
  ]]
}
```

```

    ]],
    [[
        gnss-SSR-CorrectionPoints-r16
                                GNSS-SSR-CorrectionPoints-r16    OPTIONAL    -- Need ON
    ]]
}
-- ASN1STOP

```

Conditional presence	Explanation
RTK	The field is mandatory present if the IE <i>GNSS-RTK-Observations</i> is included in IE <i>GNSS-GenericAssistData</i> ; otherwise it is not present.

– GNSS-GenericAssistData

The IE *GNSS-GenericAssistData* is used by the location server to provide assistance data for a specific GNSS. The specific GNSS for which the provided assistance data are applicable is indicated by the IE *GNSS-ID* and (if applicable) by the IE *SBAS-ID*. Assistance for up to 16 GNSSs can be provided.

```

-- ASN1START
GNSS-GenericAssistData ::= SEQUENCE (SIZE (1..16)) OF GNSS-GenericAssistDataElement
GNSS-GenericAssistDataElement ::= SEQUENCE {
    gnss-ID                GNSS-ID,
    sbas-ID                SBAS-ID                OPTIONAL,    -- Cond GNSS-ID-SBAS
    gnss-TimeModels        GNSS-TimeModelList     OPTIONAL,    -- Need ON
    gnss-DifferentialCorrections GNSS-DifferentialCorrections OPTIONAL,    -- Need ON
    gnss-NavigationModel   GNSS-NavigationModel   OPTIONAL,    -- Need ON
    gnss-RealTimeIntegrity GNSS-RealTimeIntegrity   OPTIONAL,    -- Need ON
    gnss-DataBitAssistance GNSS-DataBitAssistance   OPTIONAL,    -- Need ON
    gnss-AcquisitionAssistance GNSS-AcquisitionAssistance OPTIONAL,    -- Need ON
    gnss-Almanac           GNSS-Almanac           OPTIONAL,    -- Need ON
    gnss-UTC-Model        GNSS-UTC-Model        OPTIONAL,    -- Need ON
    gnss-AuxiliaryInformation GNSS-AuxiliaryInformation OPTIONAL,    -- Need ON
    ...,
    [[
        bds-DifferentialCorrections-r12
                                BDS-DifferentialCorrections-r12  OPTIONAL,    -- Cond GNSS-ID-BDS
        bds-GridModel-r12       BDS-GridModelParameter-r12       OPTIONAL,    -- Cond GNSS-ID-BDS
    ]],
    [[
        gnss-RTK-Observations-r15 GNSS-RTK-Observations-r15    OPTIONAL,    -- Need ON
        glo-RTK-BiasInformation-r15 GLO-RTK-BiasInformation-r15    OPTIONAL,    -- Cond GNSS-ID-GLO
        gnss-RTK-MAC-CorrectionDifferences-r15
                                GNSS-RTK-MAC-CorrectionDifferences-r15
                                OPTIONAL,    -- Need ON
        gnss-RTK-Residuals-r15    GNSS-RTK-Residuals-r15    OPTIONAL,    -- Need ON
        gnss-RTK-FKP-Gradients-r15 GNSS-RTK-FKP-Gradients-r15    OPTIONAL,    -- Need ON
        gnss-SSR-OrbitCorrections-r15
                                GNSS-SSR-OrbitCorrections-r15    OPTIONAL,    -- Need ON
        gnss-SSR-ClockCorrections-r15
                                GNSS-SSR-ClockCorrections-r15    OPTIONAL,    -- Need ON
        gnss-SSR-CodeBias-r15     GNSS-SSR-CodeBias-r15     OPTIONAL,    -- Need ON
    ]],
    [[
        gnss-SSR-URA-r16         GNSS-SSR-URA-r16         OPTIONAL,    -- Need ON
        gnss-SSR-PhaseBias-r16    GNSS-SSR-PhaseBias-r16    OPTIONAL,    -- Need ON
        gnss-SSR-STEC-Correction-r16
                                GNSS-SSR-STEC-Correction-r16
                                OPTIONAL,    -- Need ON
        gnss-SSR-GriddedCorrection-r16
                                GNSS-SSR-GriddedCorrection-r16
                                OPTIONAL,    -- Need ON
        navic-DifferentialCorrections-r16
                                NavIC-DifferentialCorrections-r16
                                OPTIONAL,    -- Cond GNSS-ID-NavIC
        navic-GridModel-r16       NavIC-GridModelParameter-r16
                                OPTIONAL,    -- Cond GNSS-ID-NavIC
    ]]
}
-- ASN1STOP

```

Conditional presence	Explanation
<i>GNSS-ID-SBAS</i>	The field is mandatory present if the <i>GNSS-ID = sbas</i> ; otherwise it is not present.
<i>GNSS-ID-BDS</i>	The field may be present if the <i>GNSS-ID = bds</i> ; otherwise it is not present.
<i>GNSS-ID-GLO</i>	The field is optionally present, need ON, if the <i>GNSS ID = glonass</i> ; otherwise it is not present.
<i>GNSS-ID-NAVIC</i>	The field is optionally present, need ON, if the <i>GNSS-ID = navic</i> ; otherwise it is not present

– *GNSS-PeriodicAssistData*

The IE *GNSS-PeriodicAssistData* is used by the location server to provide control parameters for a periodic assistance data delivery session (e.g., interval and duration) to the target device.

NOTE: Omission of a particular assistance data type field in IE *GNSS-PeriodicAssistData* means that the location server does not provide this assistance data type in a data transaction of a periodic assistance data delivery session, as described in clauses 5.2.1a and 5.2.2a. Inclusion of no assistance data type fields in IE *GNSS-PeriodicAssistData* means that a periodic assistance data delivery session is terminated.

```
-- ASN1START
GNSS-PeriodicAssistData-r15 ::= SEQUENCE {
  gnss-RTK-PeriodicObservations-r15      GNSS-PeriodicControlParam-r15  OPTIONAL,  -- Need ON
  glo-RTK-PeriodicBiasInformation-r15    GNSS-PeriodicControlParam-r15  OPTIONAL,  -- Need ON
  gnss-RTK-MAC-PeriodicCorrectionDifferences-r15
                                          GNSS-PeriodicControlParam-r15  OPTIONAL,  -- Need ON
  gnss-RTK-PeriodicResiduals-r15        GNSS-PeriodicControlParam-r15  OPTIONAL,  -- Need ON
  gnss-RTK-FKP-PeriodicGradients-r15    GNSS-PeriodicControlParam-r15  OPTIONAL,  -- Need ON
  gnss-SSR-PeriodicOrbitCorrections-r15
                                          GNSS-PeriodicControlParam-r15  OPTIONAL,  -- Need ON
  gnss-SSR-PeriodicClockCorrections-r15
                                          GNSS-PeriodicControlParam-r15  OPTIONAL,  -- Need ON
  gnss-SSR-PeriodicCodeBias-r15         GNSS-PeriodicControlParam-r15  OPTIONAL,  -- Need ON
  . . .
  [
    gnss-SSR-PeriodicCURA-r16             GNSS-PeriodicControlParam-r15  OPTIONAL,  -- Need ON
    gnss-SSR-PeriodicPhaseBias-r16       GNSS-PeriodicControlParam-r15  OPTIONAL,  -- Need ON
    gnss-SSR-PeriodicSTEC-Correction-r16 GNSS-PeriodicControlParam-r15  OPTIONAL,  -- Need ON
    gnss-SSR-PeriodicGriddedCorrection-r16 GNSS-PeriodicControlParam-r15  OPTIONAL,  -- Need ON
  ]
}
-- ASN1STOP
```

6.5.2.2 GNSS Assistance Data Elements

– *GNSS-ReferenceTime*

The IE *GNSS-ReferenceTime* is used by the location server to provide the GNSS specific system time with uncertainty and the relationship between GNSS system time and network air-interface timing of the eNodeB/NodeB/BTS transmission in the reference cell.

If the IE *networkTime* is present, the IEs *gnss-SystemTime* and *networkTime* provide a valid relationship between GNSS system time and air-interface network time, as seen at the approximate location of the target device, i.e. the propagation delay from the gNB/ng-eNB/eNodeB/NodeB/BTS to the target device shall be compensated for by the location server. Depending on implementation, the relation between GNSS system time and air-interface network time may have varying accuracy. The uncertainty of this timing relation is provided in the IE *referenceTimeUnc*. If the propagation delay from the eNodeB/NodeB/BTS to the target device is not accurately known, the location server shall use the best available approximation of the propagation delay and take the corresponding delay uncertainty into account in the calculation of the IE *referenceTimeUnc*.

If the IE *networkTime* is not present, the IE *gnssSystemTime* is an estimate of current GNSS system time at time of reception of the IE *GNSS-ReferenceTime* by the target device. The location server should achieve an accuracy of +/- 3 seconds for this estimate including allowing for the transmission delay between the location server and the target device. Note that the target device should further compensate *gnss-SystemTime* for the time between the reception of *GNSS-ReferenceTime* and the time when the *gnss-SystemTime* is used.

The location server shall provide a value for the *gnss-TimeID* only for GNSSs supported by the target device.

The IE *GNSS-ReferenceTimeForOneCell* can be provided multiple times (up to 16) to provide fine time assistance for several (neighbour) cells.

```

-- ASN1START
GNSS-ReferenceTime ::= SEQUENCE {
    gnss-SystemTime      GNSS-SystemTime,
    referenceTimeUnc     INTEGER (0..127)           OPTIONAL, -- Cond noFTA
    gnss-ReferenceTimeForCells SEQUENCE (SIZE (1..16)) OF
        GNSS-ReferenceTimeForOneCell  OPTIONAL, -- Need ON
    ...
}

GNSS-ReferenceTimeForOneCell ::= SEQUENCE {
    networkTime      NetworkTime,
    referenceTimeUnc INTEGER (0..127),
    bsAlign          ENUMERATED {true}  OPTIONAL,
    ...
}
-- ASN1STOP
    
```

Conditional presence	Explanation
<i>noFTA</i>	The field may be present if <i>gnss-ReferenceTimeForCells</i> is absent; otherwise it is not present.

GNSS-ReferenceTime field descriptions	
<i>gnss-SystemTime</i>	This field provides the specific GNSS system time.
<i>networkTime</i>	This field specifies the cellular network time at the epoch corresponding to <i>gnss-SystemTime</i> .
<i>referenceTimeUnc</i>	<p>This field provides the accuracy of the relation between <i>gnssSystemTime</i> and <i>networkTime</i> time if IE <i>networkTime</i> is provided. When IE <i>networkTime</i> is not provided, this field can be included to provide the accuracy of the provided <i>gnssSystemTime</i>.</p> <p>If GNSS TOD is the given GNSS time, then the true GNSS time, corresponding to the provided network time as observed at the target device location, lies in the interval [GNSS TOD - <i>referenceTimeUnc</i>, GNSS TOD + <i>referenceTimeUnc</i>].</p> <p>The uncertainty <i>r</i>, expressed in microseconds, is mapped to a number <i>K</i>, with the following formula:</p> $r = C * ((1+x)^K - 1)$ <p>with C = 0.5 and x = 0.14. To encode any higher value of uncertainty than that corresponding in the above formula to K=127, the same value, K=127, shall also be used. The uncertainty is then coded on 7 bits, as the binary encoding of K. Example values for the <i>referenceTimeUnc</i> Format: see table K to uncertainty relation below.</p>
<i>bsAlign</i>	<p>This flag, if present, indicates that the transmission timings of all cells sharing, depending on the RAT, the same carrier frequency and Tracking Area/Location Area/Routing Area as the cell indicated, are frame aligned. This information allows the target device to derive the GNSS - cellular time relation for any of these cells based on the timing relation information provided in <i>GNSS-ReferenceTime</i>. The flag should be set consistently in all these cells. This flag does not guarantee SFN alignment.</p>

K to uncertainty relation

Value of K	Value of uncertainty
0	0 nanoseconds
1	70 nanoseconds
2	149.8 nanoseconds
-	-
50	349.62 microseconds
-	-
127	≥ 8.43 seconds

– GNSS-SystemTime

```

-- ASN1START
GNSS-SystemTime ::= SEQUENCE {
    gnss-TimeID          GNSS-ID,
    gnss-DayNumber       INTEGER (0..32767),
    gnss-TimeOfDay       INTEGER (0..86399),
    gnss-TimeOfDayFrac-msec  INTEGER (0..999)          OPTIONAL, -- Need ON
    notificationOfLeapSecond BIT STRING (SIZE(2))  OPTIONAL, -- Cond gnss-TimeID-glonass
    gps-TOW-Assist       GPS-TOW-Assist             OPTIONAL, -- Cond gnss-TimeID-gps
    ...
}
-- ASN1STOP

```

Conditional presence	Explanation
<i>gnss-TimeID-glonass</i>	The field may be present if <i>gnss-TimeID</i> =`glonass`; otherwise it is not present.
<i>gnss-TimeID-gps</i>	The field may be present if <i>gnss-TimeID</i> =`gps`; otherwise it is not present.

GNSS-SystemTime field descriptions
<p><i>gnss-TimeID</i> This field specifies the GNSS for which the <i>GNSS-SystemTime</i> is provided.</p>
<p><i>gnss-DayNumber</i> This field specifies the sequential number of days (with day count starting at 0) from the origin of the GNSS System Time as follows: GPS, QZSS, SBAS – Days from January 6th 1980 00:00:00 UTC (USNO); Galileo – Days from Galileo System Time (GST) start epoch, defined as 13 seconds before midnight between 21st August and 22nd August 1999; i.e., GST was equal to 13 seconds at August 22nd 1999 00:00:00 UTC; GLONASS – Days from December 31st 1995 21:00:00 UTC (SU), which is local UTC Moscow January 1st 1996 00:00:00, defined as UTC(SU) + 3 hours in [9]; BDS – Days from January 1st 2006 00:00:00 UTC (NTSC). NavIC – Days from NavIC System Time start epoch, defined as 13 seconds before midnight between 21st August and 22nd August 1999; i.e., NavIC System Time was equal to 00:00:00 at August 21st, 1999 23:55:47 UTC (BIPM).</p>
<p><i>gnss-TimeOfDay</i> This field specifies the integer number of seconds from the GNSS day change.</p>
<p><i>gnss-TimeOfDayFrac-msec</i> This field specifies the fractional part of the <i>gnssTimeOfDay</i> field in 1-milli-seconds resolution. The total GNSS TOD is <i>gnss-TimeOfDay</i> + <i>gnssTimeOfDayFrac-msec</i>.</p>
<p><i>notificationOfLeapSecond</i> This field specifies the notification of forthcoming leap second correction, as defined by parameter KP in [9, Table 4.7].</p>
<p><i>gps-TOW-Assist</i> This field contains several fields in the Telemetry (TLM) Word and Handover Word (HOW) that are currently being broadcast by the respective GPS satellites. Combining this information with GPS TOW enables the target device to know the entire 1.2-second (60-bit) pattern of TLM and HOW that is transmitted at the start of each six-second NAV subframe by the particular GPS satellite.</p>

– GPS-TOW-Assist

```

-- ASN1START
GPS-TOW-Assist ::= SEQUENCE (SIZE(1..64)) OF GPS-TOW-AssistElement
GPS-TOW-AssistElement ::= SEQUENCE {
    satelliteID          INTEGER (1..64),
    tlmWord              INTEGER (0..16383),
    antiSpoof            INTEGER (0..1),
    alert                INTEGER (0..1),
    tlmRsvdBits          INTEGER (0..3),
    ...
}
-- ASN1STOP

```

GPS-TOW-Assist field descriptions	
satelliteID	This field identifies the satellite for which the <i>GPS-TOW-Assist</i> is applicable. This field is identical to the GPS PRN Signal No. defined in [4].
tImWord	This field contains a 14-bit value representing the Telemetry Message (TLM) being broadcast by the GPS satellite identified by the particular <i>satelliteID</i> , with the MSB occurring first in the satellite transmission, as defined in [4].
antiSpoof	This field contains the Anti-Spoof flag that is being broadcast by the GPS satellite identified by <i>satelliteID</i> , as defined in [4].
alert	This field contains the Alert flag that is being broadcast by the GPS satellite identified by <i>satelliteID</i> , as defined in [4].
tImRsvdBits	This field contains the two reserved bits in the TLM Word being broadcast by the GPS satellite identified by <i>satelliteID</i> , with the MSB occurring first in the satellite transmission, as defined in [4].

NetworkTime

```

-- ASN1START
NetworkTime ::= SEQUENCE {
    secondsFromFrameStructureStart    INTEGER(0..12533),
    fractionalSecondsFromFrameStructureStart    INTEGER(0..3999999),
    frameDrift                        INTEGER (-64..63)    OPTIONAL,    -- Cond GNSSsynch
    cellID                            CHOICE {
        eUTRA                          SEQUENCE {
            physCellId                  INTEGER (0..503),
            cellGlobalIdEUTRA          CellGlobalIdEUTRA-AndUTRA    OPTIONAL,    -- Need ON
            earfcn                      ARFCN-ValueEUTRA,
            ...,
            [[ earfcn-v9a0              ARFCN-ValueEUTRA-v9a0    OPTIONAL    -- Cond EARFCN-max
            ]],
        },
        uTRA                            SEQUENCE {
            mode                        CHOICE {
                fdd                      SEQUENCE {
                    primary-CPICH-Info    INTEGER (0..511),
                    ...,
                },
                tdd                      SEQUENCE {
                    cellParameters        INTEGER (0..127),
                    ...,
                }
            },
            cellGlobalIdUTRA            CellGlobalIdEUTRA-AndUTRA    OPTIONAL,    -- Need ON
            uarfcn                      ARFCN-ValueUTRA,
            ...,
        },
        gSM                             SEQUENCE {
            bcchCarrier                 INTEGER (0..1023),
            bsic                        INTEGER (0..63),
            cellGlobalIdGERAN           CellGlobalIdGERAN            OPTIONAL,    -- Need ON
            ...,
        },
        ...,
        nBiot-r14                       SEQUENCE {
            nbPhysCellId-r14            INTEGER (0..503),
            nbCellGlobalId-r14          ECGI                        OPTIONAL,    -- Need ON
            nbCarrierFreq-r14           CarrierFreq-NB-r14,
            ...,
        },
        nr-r15                          SEQUENCE {
            nrPhysCellId-r15            INTEGER (0..1007),
            nrCellGlobalID-r15          NCGI-r15                    OPTIONAL,    -- Need ON
            nrARFCN-r15                 ARFCN-ValueNR-r15,
            ...,
        }
    },
    ...
}
-- ASN1STOP

```

Conditional presence	Explanation
<i>EARFCN-max</i>	The field is mandatory present if the corresponding <i>earfcn</i> (i.e. without suffix) is set to <i>maxEARFCN</i> . Otherwise the field is not present.
<i>GNSSsynch</i>	The field is present and set to 0 if <i>NetworkTime</i> is synchronized to <i>gnss-SystemTime</i> ; otherwise the field is optionally present, need OR.

NetworkTime field descriptions
<p><i>secondsFromFrameStructureStart</i> This field specifies the number of seconds from the beginning of the longest frame structure in the corresponding air interface. In the case of E-UTRA, the SFN cycle length is 10.24 seconds. In the case of UTRA, the SFN cycle length is 40.96 seconds. In the case of GSM, the hyperframe length is 12533.76 seconds. In the case of NB-IoT, the Hyper-SFN cycle lengths is 10485.76 seconds. In the case of NR, the SFN cycle length is 10.24 seconds.</p>
<p><i>fractionalSecondsFromFrameStructureStart</i> This field specifies the fractional part of the <i>secondsFromFrameStructureStart</i> in 250 ns resolution. The total time since the particular frame structure start is <i>secondsFromFrameStructureStart</i> + <i>fractionalSecondsFromFrameStructureStart</i></p>
<p><i>frameDrift</i> This field specifies the drift rate of the GNSS-network time relation with scale factor 2^{-30} seconds/second, in the range from $-5.9605e-8$ to $+5.8673e-8$ sec/sec.</p>
<p><i>cellID</i> This field specifies the cell for which the GNSS-network time relation is provided.</p>
<p><i>physCellId</i> This field specifies the physical cell identity of the reference cell (E-UTRA), as defined in TS 36.331 [12], for which the GNSS network time relation is provided.</p>
<p><i>cellGlobalIdEUTRA</i> This field specifies the Evolved Cell Global Identifier (ECGI), the globally unique identity of a cell in E-UTRA, of the reference cell for the GNSS-network time relation, as defined in TS 36.331 [12].</p>
<p><i>earfcn</i> This field specifies E-ARFCN of the reference cell for the GNSS-network time relation (E-UTRA). In the case the server includes <i>earfcn-v9a0</i>, the server shall set the corresponding <i>earfcn</i> (i.e. without suffix) to <i>maxEARFCN</i>.</p>
<p><i>primary-CPICH-Info</i> This field specifies the physical cell identity of the reference cell (UTRA) for the GNSS-network time relation, as defined in TS 25.331 [13].</p>
<p><i>cellParameters</i> This field specifies the physical cell identity of the reference cell (UTRA) for the GNSS-network time relation, as defined in TS 25.331 [13].</p>
<p><i>cellGlobalIdUTRA</i> The field specifies the global UTRAN Cell Identifier, the globally unique identity of a cell in UTRA, of the reference cell for the GNSS-network time relation, as defined in TS 25.331 [13].</p>
<p><i>uarfcn</i> This field specifies ARFCN of the reference cell for the GNSS-network time relation (UTRA).</p>
<p><i>bcchCarrier</i> This field specifies the absolute GSM RF channel number of the BCCH of the reference base station (GERAN) for the GNSS-network time relation, as defined in TS 44.031 [14].</p>
<p><i>bsic</i> This field specifies the Base Station Identity Code of the reference base station (GERAN) for the GNSS-network time relation, as defined in TS 44.031 [14].</p>
<p><i>cellGlobalIdGERAN</i> This field specifies the Cell Global Identification (CGI), the globally unique identity of a cell in GERAN, of the reference base station for the GNSS-network time relation.</p>
<p><i>nbPhysCellId</i> This field specifies the narrowband physical layer cell identity of the NB-IoT reference cell, as defined in TS 36.331 [12], for which the GNSS network time relation is provided.</p>
<p><i>nbCellGlobalId</i> This field specifies the global cell identifier of the NB-IoT reference cell for which the GNSS-network time relation is provided, as defined in TS 36.331 [12].</p>
<p><i>nbCarrierFreq</i> This field specifies the carrier frequency of the NB-IoT reference cell for which the GNSS-network time relation is provided.</p>
<p><i>nrPhysCellId</i> This field specifies the physical cell identity of the reference cell (NR), as defined in TS 38.331 [35], for which the GNSS network time relation is provided.</p>
<p><i>nrCellGlobalID</i> This field specifies the NR Cell Global Identifier (NCGI) of the reference cell (NR) for the GNSS-network time relation, as defined in TS 38.331 [35].</p>
<p><i>nrARFCN</i> This field specifies NR-ARFCN of the reference cell (NR) for the GNSS-network time relation.</p>

– GNSS-ReferenceLocation

The IE *GNSS-ReferenceLocation* is used by the location server to provide the target device with a-priori knowledge of its location in order to improve GNSS receiver performance. The IE *GNSS-ReferenceLocation* is provided in WGS-84 reference system.

```
-- ASN1START
GNSS-ReferenceLocation ::= SEQUENCE {
    threeDlocation      EllipsoidPointWithAltitudeAndUncertaintyEllipsoid,
    ...
}
-- ASN1STOP
```

– GNSS-IonosphericModel

The IE *GNSS-IonosphericModel* is used by the location server to provide parameters to model the propagation delay of the GNSS signals through the ionosphere. Proper use of these fields allows a single-frequency GNSS receiver to remove parts of the ionospheric delay from the pseudorange measurements. Three Ionospheric Models are supported: The Klobuchar model as defined in [4], the NeQuick model as defined in [8], and the klobucharModel2 as defined in [39].

```
-- ASN1START
GNSS-IonosphericModel ::= SEQUENCE {
    klobucharModel      KlobucharModelParameter      OPTIONAL,  -- Need ON
    neQuickModel        NeQuickModelParameter        OPTIONAL,  -- Need ON
    ...
    [[ klobucharModel2-r16  KlobucharModel2Parameter-r16  OPTIONAL  -- Need ON
    ]]
}
-- ASN1STOP
```

– KlobucharModelParameter

```
-- ASN1START
KlobucharModelParameter ::= SEQUENCE {
    dataID              BIT STRING (SIZE (2)),
    alfa0               INTEGER (-128..127),
    alfa1               INTEGER (-128..127),
    alfa2               INTEGER (-128..127),
    alfa3               INTEGER (-128..127),
    beta0               INTEGER (-128..127),
    beta1               INTEGER (-128..127),
    beta2               INTEGER (-128..127),
    beta3               INTEGER (-128..127),
    ...
}
-- ASN1STOP
```

***KlobucharModelParameter* field descriptions**

dataID

When *dataID* has the value '11' it indicates that the parameters have been generated by QZSS, and the parameters have been specialized and are applicable within the area defined in [7]. When *dataID* has the value '01' it indicates that the parameters have been generated by BDS B1I, and UE shall use these parameters according to the description given in 5.2.4.7 in [23]. When the *dataID* has the value '10', it indicates that the parameters have been generated by NavIC, and UE shall use these parameters according to the description given in [38]. When *dataID* has the value '00' it indicates the parameters are applicable worldwide [4], [7].

alpha0

This field specifies the α_0 parameter of the Klobuchar model, as specified in [4], [23], [38].
Scale factor 2^{-30} seconds.

<i>KlobucharModelParamater</i> field descriptions
<p><i>alpha1</i> This field specifies the α_1 parameter of the Klobuchar model, as specified in [4], [23], [38]. Scale factor 2^{27} seconds/semi-circle.</p>
<p><i>alpha2</i> This field specifies the α_2 parameter of the Klobuchar model, as specified in [4], [23], [38]. Scale factor 2^{24} seconds/semi-circle².</p>
<p><i>alpha3</i> This field specifies the α_3 parameter of the Klobuchar model, as specified in [4], [23], [38]. Scale factor 2^{24} seconds/semi-circle³.</p>
<p><i>beta0</i> This field specifies the β_0 parameter of the Klobuchar model, as specified in [4], [23], [38]. Scale factor 2^{11} seconds.</p>
<p><i>beta1</i> This field specifies the β_1 parameter of the Klobuchar model, as specified in [4], [23], [38]. Scale factor 2^{14} seconds/semi-circle.</p>
<p><i>beta2</i> This field specifies the β_2 parameter of the Klobuchar model, as specified in [4], [23], [38]. Scale factor 2^{16} seconds/semi-circle².</p>
<p><i>beta3</i> This field specifies the β_3 parameter of the Klobuchar model, as specified in [4], [23], [38]. Scale factor 2^{16} seconds/semi-circle³.</p>

KlobucharModel2Parameter

```

-- ASN1START
KlobucharModel2Parameter-r16 ::= SEQUENCE {
    alfa1-r16          INTEGER (0..1023),
    alfa2-r16          INTEGER (-128..127),
    alfa3-r16          INTEGER (0..255),
    alfa4-r16          INTEGER (0..255),
    alfa5-r16          INTEGER (0..255),
    alfa6-r16          INTEGER (-128..127),
    alfa7-r16          INTEGER (-128..127),
    alfa8-r16          INTEGER (-128..127),
    alfa9-r16          INTEGER (-128..127),
    ...
}
-- ASN1STOP

```

<i>KlobucharModel2Parameter</i> field descriptions
<p><i>alfa1</i> This field specifies the α_1 parameter of the Klobuchar model, as specified in 7.8.1 in [39]. Scale factor 2^{-3} TECU.</p>
<p><i>alfa2</i> This field specifies the α_2 parameter of the Klobuchar model, as specified in 7.8.1 in [39]. Scale factor 2^{-3} TECU.</p>
<p><i>alfa3</i> This field specifies the α_3 parameter of the Klobuchar model, as specified in 7.8.1 in [39]. Scale factor 2^{-3} TECU.</p>
<p><i>alfa4</i> This field specifies the α_4 parameter of the Klobuchar model, as specified in 7.8.1 in [39]. Scale factor 2^{-3} TECU.</p>
<p><i>alfa5</i> This field specifies the α_5 parameter of the Klobuchar model, as specified in 7.8.1 in [39]. Scale factor -2^{-3} TECU.</p>
<p><i>alfa6</i> This field specifies the α_6 parameter of the Klobuchar model, as specified in 7.8.1 in [39]. Scale factor 2^{-3} TECU.</p>
<p><i>alfa7</i> This field specifies the α_7 parameter of the Klobuchar model, as specified in 7.8.1 in [39]. Scale factor 2^{-3} TECU.</p>

KlobucharModel2Parameter field descriptions
<p>alfa8 This field specifies the α_8 parameter of the Klobuchar model, as specified in 7.8.1 in [39]. Scale factor 2^{-3} TECU.</p>
<p>alfa9 This field specifies the α_9 parameter of the Klobuchar model, as specified in 7.8.1 in [39]. Scale factor 2^{-3} TECU.</p>

– NeQuickModelParameter

```
-- ASN1START
NeQuickModelParameter ::= SEQUENCE {
    ai0          INTEGER (0..2047),
    ai1          INTEGER (-1024..1023),
    ai2          INTEGER (-8192..8191),
    ionoStormFlag1  INTEGER (0..1)      OPTIONAL,  -- Need OP
    ionoStormFlag2  INTEGER (0..1)      OPTIONAL,  -- Need OP
    ionoStormFlag3  INTEGER (0..1)      OPTIONAL,  -- Need OP
    ionoStormFlag4  INTEGER (0..1)      OPTIONAL,  -- Need OP
    ionoStormFlag5  INTEGER (0..1)      OPTIONAL,  -- Need OP
    ...
}
-- ASN1STOP
```

NeQuickModelParameter field descriptions
<p>ai0 Effective Ionisation Level 1st order parameter. Scale factor 2^{-2} Solar Flux Units (SFUs), [8] clause 5.1.6.</p>
<p>ai1 Effective Ionisation Level 2nd order parameter. Scale factor 2^{-8} Solar Flux Units/degree, [8] clause 5.1.6.</p>
<p>ai2 Effective Ionisation Level 3rd order parameter. Scale factor 2^{-15} Solar Flux Units/degree², [8] clause 5.1.6.</p>
<p>ionoStormFlag1, ionoStormFlag2, ionoStormFlag3, ionoStormFlag4, ionoStormFlag5 These fields specify the ionosphere disturbance flags (1,...,5) for five different regions as described in [8], clause 5.1.6. If the ionosphere disturbance flag for a region is not present the target device shall treat the ionosphere disturbance condition as unknown.</p>

– GNSS-EarthOrientationParameters

The IE *GNSS-EarthOrientationParameters* is used by the location server to provide parameters to construct the ECEF and ECI coordinate transformation as defined in [4]. The IE *GNSS-EarthOrientationParameters* indicates the relationship between the Earth's rotational axis and WGS-84 reference system.

```
-- ASN1START
GNSS-EarthOrientationParameters ::= SEQUENCE {
    teop          INTEGER (0..65535),
    pmX           INTEGER (-1048576..1048575),
    pmXdot        INTEGER (-16384..16383),
    pmY           INTEGER (-1048576..1048575),
    pmYdot        INTEGER (-16384..16383),
    deltaUT1      INTEGER (-1073741824..1073741823),
    deltaUT1dot   INTEGER (-262144..262143),
    ...
}
-- ASN1STOP
```

GNSS-EarthOrientationParameters field descriptions
<p>teop This field specifies the EOP data reference time in seconds, as specified in [4], [39]. Scale factor 2^4 seconds.</p>

GNSS-EarthOrientationParameters field descriptions	
pmX	This field specifies the X-axis polar motion value at reference time in arc-seconds, as specified in [4], [39]. Scale factor 2 ⁻²⁰ arc-seconds.
pmXdots	This field specifies the X-axis polar motion drift at reference time in arc-seconds/day, as specified in [4], [39]. Scale factor 2 ⁻²¹ arc-seconds/day.
pmY	This field specifies the Y-axis polar motion value at reference time in arc-seconds, as specified in [4], [39]. Scale factor 2 ⁻²⁰ arc-seconds.
pmYdots	This field specifies the Y-axis polar motion drift at reference time in arc-seconds/day, as specified in [4], [39]. Scale factor 2 ⁻²¹ arc-seconds/day.
deltaUT1	This field specifies the UT1-UTC difference at reference time in seconds, as specified in [4], [39]. Scale factor 2 ⁻²⁴ seconds.
deltaUT1dots	This field specifies the Rate of UT1-UTC difference at reference time in seconds/day, as specified in [4], [39]. Scale factor 2 ⁻²⁵ seconds/day.

– GNSS-RTK-ReferenceStationInfo

The IE *GNSS-RTK-ReferenceStationInfo* is used by the location server to provide the Earth-centered, Earth-fixed (ECEF) coordinates of the antenna reference point (ARP) of the stationary reference station for which the *GNSS-RTK-Observations* assistance data are provided together with reference station antenna description.

The parameters provided in IE *GNSS-RTK-ReferenceStationInfo* are used as specified for message type 1006, 1033 and 1032 in [30].

```
-- ASN1START
GNSS-RTK-ReferenceStationInfo-r15 ::= SEQUENCE {
    referenceStationID-r15          GNSS-ReferenceStationID-r15,
    referenceStationIndicator-r15   ENUMERATED {physical, non-physical},
    antenna-reference-point-ECEF-X-r15  INTEGER (-137438953472..137438953471),
    antenna-reference-point-ECEF-Y-r15  INTEGER (-137438953472..137438953471),
    antenna-reference-point-ECEF-Z-r15  INTEGER (-137438953472..137438953471),
    antennaHeight-r15               INTEGER (0..65535)                OPTIONAL, -- Need ON
    antennaDescription-r15           AntennaDescription-r15          OPTIONAL, -- Need ON
    antenna-reference-point-unc-r15    AntennaReferencePointUnc-r15  OPTIONAL, -- Need ON
    physical-reference-station-info-r15 PhysicalReferenceStationInfo-r15  OPTIONAL, -- Cond NP
    ...
    [[
    equalIntegerAmbiguityLevel-r16     EqualIntegerAmbiguityLevel-r16  OPTIONAL -- Need ON
    ]]
}

AntennaDescription-r15 ::= SEQUENCE {
    antennaDescriptor-r15            VisibleString (SIZE (1..256)),
    antennaSetUpID-r15               ENUMERATED { non-zero }          OPTIONAL, -- Need OP
    ...
}

AntennaReferencePointUnc-r15 ::= SEQUENCE {
    uncertainty-X-r15                INTEGER (0..255),
    confidence-X-r15                  INTEGER (0..100),
    uncertainty-Y-r15                INTEGER (0..255),
    confidence-Y-r15                  INTEGER (0..100),
    uncertainty-Z-r15                INTEGER (0..255),
    confidence-Z-r15                  INTEGER (0..100),
    ...
}

PhysicalReferenceStationInfo-r15 ::= SEQUENCE {
    physicalReferenceStationID-r15    GNSS-ReferenceStationID-r15,
    physical-ARP-ECEF-X-r15           INTEGER (-137438953472..137438953471),
    physical-ARP-ECEF-Y-r15           INTEGER (-137438953472..137438953471),
    physical-ARP-ECEF-Z-r15           INTEGER (-137438953472..137438953471),
    physical-ARP-unc-r15              AntennaReferencePointUnc-r15  OPTIONAL, -- Need ON
    ...
}
```

```
EqualIntegerAmbiguityLevel-r16 ::= CHOICE {  
    allReferenceStations-r16      NULL,  
    referenceStationList-r16      ReferenceStationList-r16  
}  
  
ReferenceStationList-r16 ::= SEQUENCE (SIZE(1..16)) OF GNSS-ReferenceStationID-r15  
  
-- ASN1STOP
```

Conditional presence	Explanation
NP	The field is optionally present, need ON, if the <i>referenceStationIndicator</i> has the value ' <i>non-physical</i> '; otherwise it is not present.

GNSS-RTK-ReferenceStationInfo field descriptions	
referenceStationID	The Reference Station ID is determined by the RTK service provider.
referenceStationIndicator	This field specifies type of reference station. Enumerated value <i>physical</i> indicates a real, physical reference station; value <i>non-physical</i> indicates a non-physical or computed reference station.
antenna-reference-point-ECEF-X	This field specifies the antenna reference point X-coordinate in the World Geodetic System 1984 (WGS 84) datum. Scale factor 0.0001 m; range $\pm 13,743,895.3471$ m.
antenna-reference-point-ECEF-Y	This field specifies the antenna reference point Y-coordinate in the World Geodetic System 1984 (WGS 84) datum. Scale factor 0.0001 m; range $\pm 13,743,895.3471$ m.
antenna-reference-point-ECEF-Z	This field specifies the antenna reference point Z-coordinate in the World Geodetic System 1984 (WGS 84) datum. Scale factor 0.0001 m; range $\pm 13,743,895.3471$ m.
antennaHeight	This field specifies the height of the Antenna Reference Point above the marker used in the survey campaign. Scale factor 0.0001 m; range 0–6.5535 m.
antennaDescriptor	This field provides an ASCII descriptor of the reference station antenna using IGS naming convention [31]. The descriptor can be used to look up model specific phase centre corrections of that antenna.
antennaSetUpID	This field, if present, indicates that the standard IGS Model is not valid ($\neq 0$ [30]). If this field is absent the standard IGS Model is valid ('0 = Use standard IGS Model' [30]).
antenna-reference-point-unc	This field specifies the uncertainty of the ARP coordinates. <i>uncertainty-X</i> , <i>uncertainty-Y</i> , and <i>uncertainty-Z</i> correspond to the encoded high accuracy uncertainty of the X, Y, and Z-coordinate, respectively, as defined in TS 23.032 [15]. <i>confidence-X</i> , <i>confidence-Y</i> , and <i>confidence-Z</i> corresponds to confidence as defined in TS 23.032 [15].
physical-reference-station-info	This field provides the earth-centred, earth-fixed (ECEF) coordinates of the antenna reference point (ARP) for the real (or "physical") reference station used. This field may be used in the case of the non-physical reference station approach to allow the target device to refer baseline vectors to a physical reference rather than to a non-physical reference without any connection to a physical point.
physicalReferenceStationID	This field specifies the station ID of a real reference station, when the <i>referenceStationIndicator</i> has the value ' <i>non-physical</i> '.
physical-ARP-ECEF-X	This field specifies the antenna reference point X-coordinate in the World Geodetic System 1984 (WGS 84) datum. Scale factor 0.0001 m; range $\pm 13,743,895.3471$ m.
physical-ARP-ECEF-Y	This field specifies the antenna reference point Y-coordinate in the World Geodetic System 1984 (WGS 84) datum. Scale factor 0.0001 m; range $\pm 13,743,895.3471$ m.
physical-ARP-ECEF-Z	This field specifies the antenna reference point Z-coordinate in the World Geodetic System 1984 (WGS 84) datum. Scale factor 0.0001 m; range $\pm 13,743,895.3471$ m.
physical-ARP-unc	This field specifies the uncertainty of the ARP coordinates.
equalIntegerAmbiguityLevel	This field specifies the integer ambiguity level of this reference station in relation to other reference stations. Either, the presence or absence of <i>allReferenceStations</i> indicates whether the integer ambiguity level may be assumed to be aligned between all reference stations or not (interpreted as no alignment is facilitated from the location server), or <i>referenceStationList</i> provides a list of reference stations for which the integer ambiguity level may be assumed to be the same.

– GNSS-RTK-CommonObservationInfo

The IE *GNSS-RTK-CommonObservationInfo* is used by the location server to provide common information applicable to the IE *GNSS-RTK-Observations*.

The parameters provided in IE *GNSS-RTK-CommonObservationInfo* are used as specified for message type 1071-1127 in [30].

```
-- ASN1START
GNSS-RTK-CommonObservationInfo-r15 ::= SEQUENCE {
    referenceStationID-r15          GNSS-ReferenceStationID-r15,
```

```

clockSteeringIndicator-r15      INTEGER (0..3),
externalClockIndicator-r15     INTEGER (0..3),
smoothingIndicator-r15        BIT STRING (SIZE(1)),
smoothingInterval-r15         BIT STRING (SIZE(3)),
...
}
-- ASN1STOP

```

GNSS-RTK-CommonObservationInfo field descriptions	
referenceStationID	This field specifies the Station ID for which the <i>GNSS-RTK-Observations</i> are provided.
clockSteeringIndicator	This field provides the clock steering indicator. The interpretation of the value is as follows: 0 clock steering is not applied In this case, the receiver clock must be kept in the range of ±1 ms (approximately ±300 km) 1 clock steering has been applied In this case, the receiver clock must be kept in the range of ±1 microsecond (approximately ±300 metres). 2 unknown clock steering status 3 reserved
externalClockIndicator	This field provides the external clock indicator. The interpretation of the value is as follows: 0 internal clock is used 1 external clock is used, clock status is "locked" 2 external clock is used, clock status is "not locked", which may indicate external clock failure and that the transmitted data may not be reliable. 3 unknown clock is used
smoothingIndicator	This field provides the GNSS Divergence-free Smoothing Indicator. The interpretation of the value is as follows: 1 Divergence-free smoothing is used 0 Other type of smoothing is used
smoothingInterval	The GNSS Smoothing Interval is the integration period over which the pseudorange code phase measurements are averaged using carrier phase information. Divergence-free smoothing may be continuous over the entire period for which the satellite is visible. A value of zero indicates no smoothing is used. See table " <i>smoothingInterval</i> value to Smoothing Interval relation" below.

smoothingInterval value to Smoothing Interval relation

smoothingInterval value	Smoothing Interval
000 (0)	No smoothing
001 (1)	< 30 s
010 (2)	30-60 s
011 (3)	1-2 min
100 (4)	2-4 min
101 (5)	4-8 min
110 (6)	>8 min
111 (7)	Unlimited smoothing interval

GNSS-RTK-AuxiliaryStationData

The IE *GNSS-RTK-AuxiliaryStationData* is used by the location server to provide the coordinates of the antenna reference point (ARP) of Auxiliary Reference Stations, relative to the coordinates provided in IE *GNSS-RTK-ReferenceStationInfo*. The reference station provided in IE *GNSS-RTK-ReferenceStationInfo* is the Master Reference Station. Therefore, one Master Reference Station with its associated Auxiliary Stations is used in a single Provide Assistance Data message.

The parameters provided in IE *GNSS-RTK-AuxiliaryStationData* are used as specified for message type 1014 in [30].

```

-- ASN1START
GNSS-RTK-AuxiliaryStationData-r15 ::= SEQUENCE {
    networkID-r15          GNSS-NetworkID-r15,
    subNetworkID-r15      GNSS-SubNetworkID-r15
}
-- Need ON

```

```

    master-referenceStationID-r15    GNSS-ReferenceStationID-r15,
    auxiliaryStationList-r15        AuxiliaryStationList-r15,
    ...
}

AuxiliaryStationList-r15 ::= SEQUENCE (SIZE (1..32)) OF AuxiliaryStationElement-r15

AuxiliaryStationElement-r15 ::= SEQUENCE {
    aux-referenceStationID-r15      GNSS-ReferenceStationID-r15,
    aux-master-delta-latitude-r15   INTEGER (-524288..524287),
    aux-master-delta-longitude-r15 INTEGER (-1048576..1048575),
    aux-master-delta-height-r15    INTEGER (-4194304..4194303),
    aux-ARP-unc-r15                Aux-ARP-Unc-r15                OPTIONAL,    -- Need ON
    ...
}

Aux-ARP-Unc-r15 ::= SEQUENCE {
    horizontalUncertainty-r15      INTEGER (0..255),
    horizontalConfidence-r15      INTEGER (0..100),
    verticalUncertainty-r15       INTEGER (0..255)                OPTIONAL,    -- Need ON
    verticalConfidence-r15       INTEGER (0..100)                OPTIONAL,    -- Need ON
    ...
}

-- ASN1STOP

```

GNSS-RTK-AuxiliaryStationData field descriptions

networkID

This field defines the network and the source of the particular set of reference stations and their observation information. The RTK service provider should ensure that the *networkID* is unique in the region serviced. The *networkID* indicates an area and its reference stations where the service providers will provide a homogenous solution with levelled integer ambiguities between its reference stations. In general, the area indicated by *networkID* will comprise one subnetwork with a unique *subNetworkID*.

subNetworkID

This field identifies the subnetwork of a network identified by *networkID*. In general the area indicated by *networkID* will consist of one subnetwork. The *subNetworkID* indicates the actual solution number of integer ambiguity level. If one network has only one subnetwork, this indicates that an ambiguity level throughout the whole network is established.

master-referenceStationID

This field identifies the Master Reference Station.

aux-referenceStationID

This field identifies the Auxiliary Reference Station.

aux-master-delta-latitude

This field provides the delta value in latitude of Antenna Reference Point of "Auxiliary Reference Station minus Master Reference Station" in geographical coordinates based on GRS80 ellipsoid parameters for the same ECEF system as used in IE *GNSS-RTK-ReferenceStationInfo*.

Scale factor 25×10^{-6} degrees; range ± 13.1071 degrees.

aux-master-delta-longitude

This field provides the delta value in longitude of Antenna Reference Point of "Auxiliary Reference Station minus Master Reference Station" in geographical coordinates based on GRS80 ellipsoid parameters for the same ECEF system as used in IE *GNSS-RTK-ReferenceStationInfo*.

Scale factor 25×10^{-6} degrees; range ± 26.2142 degrees.

aux-master-delta-height

This field provides the delta value in ellipsoidal height of Antenna Reference Point of "Auxiliary Reference Station minus Master Reference Station" in geographical coordinates based on GRS80 ellipsoid parameters for the same ECEF system as used in IE *GNSS-RTK-ReferenceStationInfo*.

Scale factor 1 millimetre; range ± 4194.303 m.

aux-ARP-unc

This field specifies the uncertainty of the auxiliary station ARP coordinates and comprise the following fields:

- **horizontalUncertainty** indicates the horizontal uncertainty of the ARP latitude/longitude. The '*horizontalUncertainty*' corresponds to the encoded high accuracy uncertainty as defined in TS 23.032 [15] and '*horizontalConfidence*' corresponds to confidence as defined in TS 23.032 [15].
- **verticalUncertainty** indicates the vertical uncertainty of the ARP altitude. The '*verticalUncertainty*' corresponds to the encoded high accuracy uncertainty as defined in TS 23.032 [15] and '*verticalConfidence*' corresponds to confidence as defined in TS 23.032 [15].

– GNSS-SSR-CorrectionPoints

The IE *GNSS-SSR-CorrectionPoints* is used by the location server to provide a list of correction point coordinates or an array of correction points ("grid") for which the *GNSS-SSR-GriddedCorrection* are valid.

```

-- ASN1START
GNSS-SSR-CorrectionPoints-r16 ::= SEQUENCE {
    correctionPointSetID-r16      INTEGER (0..16383),
    correctionPoints-r16         CHOICE {
        listOfCorrectionPoints-r16  GNSS-SSR-ListOfCorrectionPoints-r16,
        arrayOfCorrectionPoints-r16  GNSS-SSR-ArrayOfCorrectionPoints-r16
    },
    ...
}

GNSS-SSR-ListOfCorrectionPoints-r16 ::= SEQUENCE {
    referencePointLatitude-r16     INTEGER (-16384..16383),
    referencePointLongitude-r16    INTEGER (-32768..32767),
    relativeLocationsList-r16      SEQUENCE (SIZE (0..63)) OF RelativeLocationElement-r16,
    ...
}

RelativeLocationElement-r16 ::= SEQUENCE {
    deltaLatitude-r16             INTEGER (-512..511),
    deltaLongitude-r16            INTEGER (-1024..1023),
    ...
}

GNSS-SSR-ArrayOfCorrectionPoints-r16 ::= SEQUENCE {
    referencePointLatitude-r16     INTEGER (-16384..16383),
    referencePointLongitude-r16    INTEGER (-32768..32767),
    numberOfStepsLatitude-r16     INTEGER (0..63),
    numberOfStepsLongitude-r16    INTEGER (0..63),
    stepOfLatitude-r16            INTEGER (1..511),
    stepOfLongitude-r16           INTEGER (1..1023),
    bitmaskOfGrids-r16           BIT STRING (SIZE (64))
    ...
}
-- ASN1STOP

```

GNSS-SSR-CorrectionPoints field descriptions

correctionPointSetID

This field provides the ID of the Atmospheric Correction Point set. It is a regionally unique arbitrary number that is used by the UE to ensure that the atmospheric corrections are being applied to the correct set of points.

referencePointLatitude

This field specifies the latitude for the reference point, expressed in the range of -90° , $+90^\circ$, coded as a number between -2^{14} and $2^{14}-1$, coded in 2's complement binary on 15 bits. The relation between the latitude X in the range $[-90^\circ, 90^\circ]$ and the coded number N is:

$$N = \left\lfloor \frac{X}{90^\circ} 2^{14} \right\rfloor$$

where $\lfloor x \rfloor$ denotes the greatest integer less than or equal to x (floor operator).

For the *listOfCorrectionPoints*, the reference point defines the 1st correction point location.

For the *arrayOfCorrectionPoints*, the reference point defines the northwest corner of the correction point array.

referencePointLongitude

This field specifies the longitude for the reference point, expressed in the range -180° , $+180^\circ$, coded as a number between -2^{15} and $2^{15}-1$, coded in 2's complement binary on 16 bits. The relation between the longitude X in the range $[-180^\circ, 180^\circ)$ and the coded number N is:

$$N = \left\lfloor \frac{X}{180^\circ} 2^{15} \right\rfloor$$

For the *listOfCorrectionPoints*, the reference point defines the 1st correction point location.

For the *arrayOfCorrectionPoints*, the reference point defines the northwest corner of the correction point array.

GNSS-SSR-CorrectionPoints field descriptions
<p>relativeLocationsList This field specifies the 2nd, 3rd, ..., 64th correction point location.</p>
<p>deltaLatitude This field specifies the delta value in latitude of this correction point location relative to the previous point on the list or the reference point in the case of the first additional point, defined as "correction point location" minus "previous correction point location" in units of 0.01 degrees.</p>
<p>deltaLongitude This field specifies the delta value in longitude of this correction point location relative to the previous point on the list or the reference point in the case of the first additional point, defined as "correction point location" minus "previous correction point location" in units of 0.01 degrees.</p>
<p>numberOfStepsLatitude, numberOfStepsLongitude These fields specify the number of steps for latitude and longitude direction respectively.</p>
<p>stepOfLatitude, stepOfLongitude These fields specify the spacing of the correction points for latitude and longitude respectively. The unit and scale factor is 0.01 degrees.</p>
<p>bitmaskOfGrids This field specifies the availability of correction data at the correction points in the array. If a specific bit is enabled (set to '1'), the correction is available. Only the first <i>numberOfStepsLatitude</i> × <i>numberOfStepsLongitude</i> bits are used, the remainder are set to '0'. Starting with the northwest corner of the array (top left on a north oriented map) the correction points are enumerated with row precedence – first row west to east, second row west to east, until last row west to east – ending with the southeast corner of the array. If the field is omitted all correction points are used and none omitted.</p>

– GNSS-TimeModelList

The IE *GNSS-TimeModelList* is used by the location server to provide the GNSS-GNSS system time offset between the GNSS system time indicated by IE *GNSS-ID* in IE *GNSS-GenericAssistDataElement* to the GNSS system time indicated by IE *gnss-TO-ID*. Several *GNSS-TimeModelElement* IEs can be included with different *gnss-TO-ID* fields. The location server should provide a *GNSS-TimeModelList* for the same *GNSS-ID* as the *gnss-TimeID* in IE *GNSS-SystemTime* in *GNSS-ReferenceTime* assistance. If the location server does not provide a *GNSS-TimeModelList* for the same *GNSS-ID* as the *gnss-TimeID* in IE *GNSS-SystemTime* in *GNSS-ReferenceTime* assistance the target device assumes *tA1* and *tA2* are equal to zero.

```
-- ASN1START
GNSS-TimeModelList ::= SEQUENCE (SIZE (1..15)) OF GNSS-TimeModelElement
GNSS-TimeModelElement ::= SEQUENCE {
    gnss-TimeModelRefTime    INTEGER (0..65535),
    tA0                      INTEGER (-67108864..67108863),
    tA1                      INTEGER (-4096..4095)                OPTIONAL, -- Need ON
    tA2                      INTEGER (-64..63)                    OPTIONAL, -- Need ON
    gnss-TO-ID               INTEGER (1..15),
    weekNumber               INTEGER (0..8191)                    OPTIONAL, -- Need ON
    deltaT                   INTEGER (-128..127)                 OPTIONAL, -- Need ON
    ...
}
-- ASN1STOP
```

GNSS-TimeModelElement field descriptions
<p>gnss-TimeModelRefTime This field specifies the reference time of week for <i>GNSS-TimeModelElement</i> and it is given in GNSS specific system time. Scale factor 2⁴ seconds.</p>
<p>tA0 This field specifies the bias coefficient of the <i>GNSS-TimeModelElement</i>. Scale factor 2⁻³⁵ seconds.</p>
<p>tA1 This field specifies the drift coefficient of the <i>GNSS-TimeModelElement</i>. Scale factor of 2⁻⁵¹ seconds/second.</p>
<p>tA2 This field specifies the drift rate correction coefficient of the <i>GNSS-TimeModelElement</i>. Scale factor of 2⁻⁶⁸ seconds/second².</p>

GNSS-TimeModelElement field descriptions
<p>gnss-TO-ID This field specifies the GNSS system time of the GNSS for which the <i>GNSS-TimeModelElement</i> is applicable. <i>GNSS-TimeModelElement</i> contains parameters to convert GNSS system time from the system indicated by <i>GNSS-ID</i> to GNSS system time indicated by <i>gnss-TO-ID</i>. The conversion is defined in [4,5,6]. See table of <i>gnss-TO-ID</i> to Indication relation below. NOTE.</p>
<p>weekNumber This field specifies the reference week of the <i>GNSS-TimeModelElement</i> given in GNSS specific system time. The location server should include this field, if <i>tA1</i> or <i>tA2</i> is included. Scale factor 1 week.</p>
<p>deltaT This field specifies the integer number of seconds of the GNSS-GNSS time offset provided in the <i>GNSS-TimeModelElement</i>. Scale factor 1 second.</p>

gnss-TO-ID to Indication relation

Value of <i>gnss-TO-ID</i>	Indication
1	GPS
2	Galileo
3	QZSS
4	GLONASS
5	BDS
6	NavIC
7-15	reserved

NOTE: The time relationship between the system time indicated by *GNSS-ID* and system time indicated by *gnss-TO-ID* is given by the following equation:

$$t_{\text{GNSS}} = t_{\text{E}} - (A_{0\text{GGTO}} + A_{1\text{GGTO}} (t_{\text{E}} - t_{\text{GGTO}} + 604800 (WN - WN_{\text{GGTO}})) + A_{2\text{GGTO}} (t_{\text{E}} - t_{\text{GGTO}} + 604800 (WN - WN_{\text{GGTO}}))^2)$$

where

t_{GNSS} is the system time of week for the GNSS indicated by *gnss-TO-ID*.
 t_{E} is the system time of week for the GNSS indicated by *GNSS-ID*.
 WN is the week number of the GNSS system time indicated by *GNSS-ID* corresponding to the t_{E} .
 t_{GGTO} is the system time of week for the time model data in the GNSS time indicated by *GNSS-ID* and given by the *gnss-TimeModelRefTime* field.
 WN_{GGTO} is the week number for the time model data in the GNSS time indicated by *GNSS-ID* corresponding to the t_{GGTO} and given by the *weekNumber* field.
 $A_{0\text{GGTO}}$ is given by the *tA0* field.
 $A_{1\text{GGTO}}$ is given by the *tA1* field.
 $A_{2\text{GGTO}}$ is given by the *tA2* field.

If the *tA1* and *tA2* are not included in the *GNSS-TimeModelElement*, the target device assumes $A_{1\text{GGTO}}$ and $A_{2\text{GGTO}}$ are equal to zero.

The GNSS system times in the IE *GNSS-TimeModelList* and used in the equation above are all given in Time of Week (TOW) and Week Number (WN) in the indicated GNSS specific system time. For conversion between TOW/WN and Day Number/Time of Day (*gnss-DayNumber/gnss-TimeOfDay*) a GNSS week consists of 7 days since the origin of the particular GNSS System time (with the week number count starting at 0), and a day consists of 86400 seconds.

GNSS-DifferentialCorrections

The IE *GNSS-DifferentialCorrections* is used by the location server to provide differential GNSS corrections to the target device for a specific GNSS. Differential corrections can be provided for up to 3 signals per GNSS.

```
-- ASN1START
```

```
GNSS-DifferentialCorrections ::= SEQUENCE {
```



```

    dgnss-RefTime      INTEGER (0..3599),
    dgnss-SgnTypeList  DGNSS-SgnTypeList,
    ...
}

DGNSS-SgnTypeList ::= SEQUENCE (SIZE (1..3)) OF DGNSS-SgnTypeElement

DGNSS-SgnTypeElement ::= SEQUENCE {
    gnss-SignalID      GNSS-SignalID,
    gnss-StatusHealth  INTEGER (0..7),
    dgnss-SatList      DGNSS-SatList,
    ...
}

DGNSS-SatList ::= SEQUENCE (SIZE (1..64)) OF DGNSS-CorrectionsElement

DGNSS-CorrectionsElement ::= SEQUENCE {
    svID               SV-ID,
    iod                BIT STRING (SIZE(11)),
    udre               INTEGER (0..3),
    pseudoRangeCor     INTEGER (-2047..2047),
    rangeRateCor       INTEGER (-127..127),
    udreGrowthRate     INTEGER (0..7)          OPTIONAL, -- Need ON
    udreValidityTime   INTEGER (0..7)          OPTIONAL, -- Need ON
    ...
}

-- ASN1STOP

```

GNSS-DifferentialCorrections field descriptions

dgnss-RefTime

This field specifies the time for which the DGNSS corrections are valid, modulo 1 hour. *dgnss-RefTime* is given in GNSS specific system time.
Scale factor 1-second.

dgnss-SgnTypeList

This list includes differential correction data for different GNSS signal types, identified by *GNSS-SignalID*.

gnss-StatusHealth

This field specifies the status of the differential corrections. The values of this field and their respective meanings are defined as in table *gnss-StatusHealth* Value to Indication relation below.

The first six values in this field indicate valid differential corrections. When using the values described below, the "UDRE Scale Factor" value is applied to the UDRE values contained in the element. The purpose is to indicate an estimate in the amount of error in the corrections.

The value "110" indicates that the source of the differential corrections (e.g., reference station or external DGNSS network) is currently not being monitored. The value "111" indicates that the corrections provided by the source are invalid, as judged by the source.

dgnss-SatList

This list includes differential correction data for different GNSS satellites, identified by *SV-ID*.

iod

This field specifies the Issue of Data field which contains the identity for the *GNSS-NavigationModel*.

udre

This field provides an estimate of the uncertainty (1- σ) in the corrections for the particular satellite. The value in this field shall be multiplied by the UDRE Scale Factor in the *gnss-StatusHealth* field to determine the final UDRE estimate for the particular satellite. The meanings of the values for this field are shown in the table *udre* Value to Indication relation below.

pseudoRangeCor

This field specifies the correction to the pseudorange for the particular satellite at *dgnss-RefTime*, t_0 . The value of this field is given in metres and the scale factor is 0.32 metres in the range of ± 655.04 metres. The method of calculating this field is described in [11].

If the location server has received a request for GNSS assistance data from a target device which included a request for the GNSS Navigation Model and DGNSS, the location server shall determine, for each satellite, if the navigation model stored by the target device is still suitable for use with DGNSS corrections and if so and if DGNSS corrections are supported the location server should send DGNSS corrections without including the GNSS Navigation Model. The *iod* value sent for a satellite shall always be the IOD value that corresponds to the navigation model for which the pseudo-range corrections are applicable.

The target device shall only use the *pseudoRangeCor* value when the IOD value received matches its available navigation model.

Pseudo-range corrections are provided with respect to GNSS specific geodetic datum (e.g., PZ-90.02 if *GNSS-ID* indicates GLONASS).

Scale factor 0.32 metres.

GNSS-DifferentialCorrections field descriptions**rangeRateCor**

This field specifies the rate-of-change of the pseudorange correction for the particular satellite, using the satellite ephemeris and clock corrections identified by the *iod* field. The value of this field is given in metres per second and the resolution is 0.032 metres/second in the range of ± 4.064 metres/second. For some time $t_1 > t_0$, the corrections for *iod* are estimated by

$$\text{PRC}(t_1, \text{IOD}) = \text{PRC}(t_0, \text{IOD}) + \text{RRC}(t_0, \text{IOD}) \cdot (t_1 - t_0),$$

and the target device uses this to correct the pseudorange it measures at t_1 , $\text{PR}_m(t_1, \text{IOD})$, by

$$\text{PR}(t_1, \text{IOD}) = \text{PR}_m(t_1, \text{IOD}) + \text{PRC}(t_1, \text{IOD}).$$

The location server shall always send the RRC value that corresponds to the PRC value that it sends. The target device shall only use the RRC value when the *iod* value received matches its available navigation model.

Scale factor 0.032 metres/second.

udreGrowthRate

This field provides an estimate of the growth rate of uncertainty ($1-\sigma$) in the corrections for the particular satellite identified by *SV-ID*. The estimated UDRE at time value specified in the *udreValidityTime* t_1 is calculated as follows:

$$\text{UDRE}(t_0+t_1) = \text{UDRE}(t_0) \times \text{udreGrowthRate},$$

where t_0 is the DGNSS Reference Time *dgnss-RefTime* for which the corrections are valid, t_1 is the *udreValidityTime* field, $\text{UDRE}(t_0)$ is the value of the *udre* field, and *udreGrowthRate* field is the factor as shown in the table Value of *udreGrowthRate* to Indication relation below.

udreValidityTime

This field specifies the time when the *udreGrowthRate* field applies and is included if *udreGrowthRate* is included. The meaning of the values for this field is as shown in the table Value of *udreValidityTime* to Indication relation below.

gnss-StatusHealth Value to Indication relation

gnss-StatusHealth Value	Indication
000	UDRE Scale Factor = 1.0
001	UDRE Scale Factor = 0.75
010	UDRE Scale Factor = 0.5
011	UDRE Scale Factor = 0.3
100	UDRE Scale Factor = 0.2
101	UDRE Scale Factor = 0.1
110	Reference Station Transmission Not Monitored
111	Data is invalid - disregard

udre Value to Indication relation

udre Value	Indication
00	UDRE \leq 1.0 m
01	1.0 m < UDRE \leq 4.0 m
10	4.0 m < UDRE \leq 8.0 m
11	8.0 m < UDRE

Value of udreGrowthRate to Indication relation

Value of udreGrowthRate	Indication
000	1.5
001	2
010	4
011	6
100	8
101	10
110	12
111	16

Value of udreValidityTime to Indication relation

Value of udreValidityTime	Indication [seconds]
000	20

001	40
010	80
011	160
100	320
101	640
110	1280
111	2560

– GNSS-*NavigationModel*

The IE *GNSS-NavigationModel* is used by the location server to provide precise navigation data to the GNSS capable target device. In response to a request from a target device for GNSS Assistance Data, the location server shall determine whether to send the navigation model for a particular satellite to a target device based upon factors like the T-Toe limit specified by the target device and any request from the target device for DGNSS (see also *GNSS-DifferentialCorrections*). GNSS Orbit Model can be given in Keplerian parameters or as state vector in Earth-Centered Earth-Fixed coordinates, dependent on the *GNSS-ID* and the target device capabilities. The meaning of these parameters is defined in relevant ICDs of the particular GNSS and GNSS specific interpretations apply. For example, GPS and QZSS use the same model parameters but some parameters have a different interpretation [7].

```
-- ASN1START

GNSS-NavigationModel ::= SEQUENCE {
    nonBroadcastIndFlag      INTEGER (0..1),
    gnss-SatelliteList      GNSS-NavModelSatelliteList,
    ...
}

GNSS-NavModelSatelliteList ::= SEQUENCE (SIZE(1..64)) OF GNSS-NavModelSatelliteElement

GNSS-NavModelSatelliteElement ::= SEQUENCE {
    svID                    SV-ID,
    svHealth                BIT STRING (SIZE(8)),
    iod                    BIT STRING (SIZE(11)),
    gnss-ClockModel         GNSS-ClockModel,
    gnss-OrbitModel         GNSS-OrbitModel,
    ...
    [[ svHealthExt-v1240 BIT STRING (SIZE(4))          OPTIONAL          -- Need ON
    ]]
}

GNSS-ClockModel ::= CHOICE {
    standardClockModelList StandardClockModelList,          -- Model-1
    nav-ClockModel         NAV-ClockModel,                  -- Model-2
    cnav-ClockModel        CNAV-ClockModel,                 -- Model-3
    glonass-ClockModel     GLONASS-ClockModel,              -- Model-4
    sbas-ClockModel        SBAS-ClockModel,                 -- Model-5
    ...,
    bds-ClockModel-r12     BDS-ClockModel-r12,              -- Model-6
    bds-ClockModel2-r16    BDS-ClockModel2-r16,             -- Model-7
    navic-ClockModel-r16   NavIC-ClockModel-r16             -- Model-8
}

GNSS-OrbitModel ::= CHOICE {
    keplerianSet           NavModelKeplerianSet,             -- Model-1
    nav-KeplerianSet       NavModelNAV-KeplerianSet,        -- Model-2
    cnav-KeplerianSet      NavModelCNAV-KeplerianSet,       -- Model-3
    glonass-ECEF           NavModel-GLONASS-ECEF,           -- Model-4
    sbas-ECEF              NavModel-SBAS-ECEF,              -- Model-5
    ...,
    bds-KeplerianSet-r12   NavModel-BDS-KeplerianSet-r12,   -- Model-6
    bds-KeplerianSet2-r16  NavModel-BDS-KeplerianSet2-r16, -- Model-7
    navic-KeplerianSet-r16 NavModel-NavIC-KeplerianSet-r16 -- Model-8
}

-- ASN1STOP
```

GNSS-<i>NavigationModel</i> field descriptions	
<i>nonBroadcastIndFlag</i>	This field indicates if the <i>GNSS-NavigationModel</i> elements are not derived from satellite broadcast data or are given in a format not native to the GNSS. A value of 0 means the <i>GNSS-NavigationModel</i> data elements correspond to GNSS satellite broadcast data; a value of 1 means the <i>GNSS-NavigationModel</i> data elements are not derived from satellite broadcast.
<i>gnss-SatelliteList</i>	This list provides ephemeris and clock corrections for GNSS satellites indicated by <i>SV-ID</i> .
<i>svHealth</i>	This field specifies the satellite's current health. The health values are GNSS system specific. The interpretation of <i>svHealth</i> depends on the <i>GNSS-ID</i> and is as shown in table GNSS to <i>svHealth</i> Bit String(8) relation below.
<i>iod</i>	This field specifies the Issue of Data and contains the identity for GNSS Navigation Model. In the case of broadcasted GPS NAV ephemeris, the <i>iod</i> contains the IODC as described in [4]. In the case of broadcasted Modernized GPS ephemeris, the <i>iod</i> contains the 11-bit parameter t_{oe} as defined in [4, Table 30-I] [6, Table 3.5-1]. In the case of broadcasted SBAS ephemeris, the <i>iod</i> contains the 8 bits Issue of Data as defined in [10] Message Type 9. In the case of broadcasted QZSS QZS-L1 ephemeris, the <i>iod</i> contains the IODC as described in [7]. In the case of broadcasted QZSS QZS-L1C/L2C/L5 ephemeris, the <i>iod</i> contains the 11-bit parameter t_{oe} as defined in [7]. In the case of broadcasted GLONASS ephemeris, the <i>iod</i> contains the parameter t_b as defined in [9]. In the case of broadcasted Galileo ephemeris, the <i>iod</i> contains the IOD index as described in [8]. In the case of broadcasted BDS B1I ephemeris, the <i>iod</i> contains 11 MSB bits of the t_{oe} as defined in [23]. In the case of broadcasted BDS B1C ephemeris, the <i>iod</i> contains the IODC as described in [39]. In the case of broadcasted NavIC ephemeris, the <i>iod</i> contains 11 MSB bits of the t_{oe} as defined in [38]. The interpretation of <i>iod</i> depends on the <i>GNSS-ID</i> and is as shown in table GNSS to <i>iod</i> Bit String(11) relation below.
<i>svHealthExt</i>	This field specifies the satellite's additional current health. The health values are GNSS system specific. The interpretation of <i>svHealthExt</i> depends on the <i>GNSS-ID</i> and is as shown in table GNSS to <i>svHealthExt</i> Bit String(4) relation below.

GNSS to *svHealth* Bit String(8) relation

GNSS	<i>svHealth</i> Bit String(8)							
	Bit 1 (MSB)	Bit 2	Bit 3	Bit 4	Bit 5	Bit 6	Bit 7	Bit 8 (LSB)
GPS L1/CA ⁽¹⁾	SV Health [4]						'0' (reserved)	'0' (reserved)
Modernized GPS ⁽²⁾	L1C Health [6]	L1 Health [4,5]	L2 Health [4,5]	L5 Health [4,5]	'0' (reserved)	'0' (reserved)	'0' (reserved)	'0' (reserved)
SBAS ⁽³⁾	Ranging On (0), Off(1) [10]	Corrections On(0), Off(1) [10]	Integrity On(0), Off(1) [10]	'0' (reserved)	'0' (reserved)	'0' (reserved)	'0' (reserved)	'0' (reserved)
QZSS ⁽⁴⁾ QZS-L1	SV Health [7]						'0' (reserved)	'0' (reserved)
QZSS ⁽⁵⁾ QZS-L1C/L2C/L5	L1C Health [7]	L1 Health [7]	L2 Health [7]	L5 Health [7]	'0' (reserved)	'0' (reserved)	'0' (reserved)	'0' (reserved)
GLONASS	B_n (MSB) [9, page 30]	F_r [9, Table 4.4]				'0' (reserved)	'0' (reserved)	'0' (reserved)
Galileo [8, clause 5.1.9.3]	E5a Data Validity Status	E5b Data Validity Status	E1-B Data Validity Status	E5a Signal Health Status		'0' (reserved)	'0' (reserved)	'0' (reserved)
BDS B1I ⁽⁶⁾ [23]	B1I Health (SatH1) [23]	'0' (reserved)	'0' (reserved)	'0' (reserved)	'0' (reserved)	'0' (reserved)	'0' (reserved)	'0' (reserved)
BDS B1C ⁽⁷⁾ [39]	Sat Clock Health [39]	B1C Health [39]	'0' (reserved)	'0' (reserved)	'0' (reserved)	'0' (reserved)	'0' (reserved)	'0' (reserved)
NavIC	L5 health	'0' (reserved)	'0' (reserved)	'0' (reserved)	'0' (reserved)	'0' (reserved)	'0' (reserved)	'0' (reserved)
Note 1:	If <i>GNSS-ID</i> indicates 'gps', and GNSS Orbit Model-2 is included, this interpretation of <i>svHealth</i> applies.							
Note 2:	If <i>GNSS-ID</i> indicates 'gps', and GNSS Orbit Model-3 is included, this interpretation of <i>svHealth</i> applies. If a certain signal is not supported on the satellite indicated by <i>SV-ID</i> , the corresponding health bit shall be set to '1' (i.e., signal can not be used).							
Note 3:	<i>svHealth</i> , in the case that <i>GNSS-ID</i> indicates 'sbas', includes the 5 LSBs of the Health included in GEO Almanac Message Parameters (Type 17) [10].							
Note 4:	If <i>GNSS-ID</i> indicates 'qzss', and GNSS Orbit Model-2 is included, this interpretation of <i>svHealth</i> applies.							
Note 5:	If <i>GNSS-ID</i> indicates 'qzss', and GNSS Orbit Model-3 is included, this interpretation of <i>svHealth</i> applies.							
Note 6:	If <i>GNSS-ID</i> indicates 'bds', and GNSS Orbit Model-6 is included, this interpretation of <i>svHealth</i> applies.							
Note 7:	If <i>GNSS-ID</i> indicates 'bds', and GNSS Orbit Model-7 is included, this interpretation of <i>svHealth</i> applies.							

GNSS to iod Bit String(11) relation

GNSS	iod Bit String(11)										
	Bit 1 (MSB)	Bit 2	Bit 3	Bit 4	Bit 5	Bit 6	Bit 7	Bit 8	Bit 9	Bit 10	Bit 11 (LSB)
GPS L1/CA	'0'	Issue of Data, Clock [4]									
Modernized GPS	t_{oe} (seconds, scale factor 300, range 0 – 604500) [4,5,6]										
SBAS	'0'	'0'	'0'	Issue of Data ([10], Message Type 9)							
QZSS QZS-L1	'0'	Issue of Data, Clock [7]									
QZSS QZS-L1C/L2C/L5	t_{oe} (seconds, scale factor 300, range 0 – 604500) [7]										
GLONASS	'0'	'0'	'0'	'0'	t_b (minutes, scale factor 15) [9]						
Galileo	'0'	IODnav [8]									
BDS B1I	11 MSB bits of t_{oe} (seconds, scale factor 512, range 0 – 604672) [23]										
BDS B1C	'0'	Issue of Data, Clock [39]									
NavIC	11 MSB bits of t_{oe} (seconds, scale factor 512) [38]										

GNSS to svHealthExt Bit String(4) relation

GNSS	svHealthExt Bit String(4)			
	Bit 1 (MSB)	Bit 2	Bit 3	Bit 4 (LSB)
Galileo [8, clause 5.1.9.3]	E5b Signal Health Status		E1-B Signal Health Status	

StandardClockModelList

```

-- ASN1START
StandardClockModelList ::= SEQUENCE (SIZE(1..2)) OF StandardClockModelElement
StandardClockModelElement ::= SEQUENCE {
    stanClockToc          INTEGER (0..16383),
    stanClockAF2         INTEGER (-32..31),
    stanClockAF1         INTEGER (-1048576..1048575),
    stanClockAF0         INTEGER (-1073741824..1073741823),
    stanClockTgd         INTEGER (-512..511) OPTIONAL, -- Need ON
    sisa                 INTEGER (0..255),
    stanModelID          INTEGER (0..1) OPTIONAL, -- Need ON
    ...
}
-- ASN1STOP
    
```

StandardClockModelList field descriptions
<p>standardClockModelList <i>gnss-ClockModel</i> Model-1 contains one or two clock model elements. If included, clock Model-1 shall be included once or twice depending on the target device capability. If the target device is supporting multiple Galileo signals, the location server shall include both F/Nav and I/Nav clock models in <i>gnss-ClockModel</i> if the location server assumes the target device to perform location information calculation using multiple signals.</p>
<p>stanClockToc Parameter t_{oc} defined in [8]. Scale factor 60 seconds.</p>
<p>stanClockAF2 Parameter af_2 defined in [8]. Scale factor 2^{-59} seconds/second².</p>
<p>stanClockAF1 Parameter af_1 defined in [8]. Scale factor 2^{-46} seconds/second.</p>
<p>stanClockAF0 Parameter af_0 defined in [8]. Scale factor 2^{-34} seconds.</p>

StandardClockModelList field descriptions
<p>stanClockTgd Parameter T_{GD}, Broadcast Group Delay (BGD), defined in [8]. Scale factor 2^{-32} seconds. This field is required if the target device supports only single frequency Galileo signal.</p>
<p>sisa Signal-In-Space Accuracy (SISA), defined in [8] clause 5.1.11.</p>
<p>stanModelID This field specifies the identity of the clock model according to the table Value of <i>stanModelID</i> to Identity relation below. This field is required if the location server includes both F/Nav and I/Nav Galileo clock models in <i>gnss-ClockModel</i>.</p>

Value of *stanModelID* to Identity relation

Value of <i>stanModelID</i>	Identity
0	I/Nav (E1,E5b)
1	F/Nav (E1,E5a)

NAV-ClockModel

```
-- ASN1START
NAV-ClockModel ::= SEQUENCE {
    navToc          INTEGER (0..37799),
    navaf2          INTEGER (-128..127),
    navaf1          INTEGER (-32768..32767),
    navaf0          INTEGER (-2097152..2097151),
    navTgd          INTEGER (-128..127),
    ...
}
-- ASN1STOP
```

NAV-ClockModel field descriptions
<p>navToc Parameter t_{oc}, time of clock (seconds) [4,7]. Scale factor 2^4 seconds.</p>
<p>navaf2 Parameter a_2, clock correction polynomial coefficient (sec/sec²) [4,7]. Scale factor 2^{-55} seconds/second².</p>
<p>navaf1 Parameter a_1, clock correction polynomial coefficient (sec/sec) [4,7]. Scale factor 2^{-43} seconds/second.</p>
<p>navaf0 Parameter a_0, clock correction polynomial coefficient (seconds) [4,7]. Scale factor 2^{-31} seconds.</p>
<p>navTgd Parameter T_{GD}, group delay (seconds) [4,7]. Scale factor 2^{-31} seconds.</p>

CNAV-ClockModel

```
-- ASN1START
CNAV-ClockModel ::= SEQUENCE {
    cnavToc          INTEGER (0..2015),
    cnavTop          INTEGER (0..2015),
    cnavURA0        INTEGER (-16..15),
    cnavURA1        INTEGER (0..7),
    cnavURA2        INTEGER (0..7),
    cnavAf2          INTEGER (-512..511),
    cnavAf1          INTEGER (-524288..524287),
    cnavAf0          INTEGER (-33554432..33554431),
    cnavTgd          INTEGER (-4096..4095),

```

```

cnavISCL1cp    INTEGER (-4096..4095)    OPTIONAL, -- Need ON
cnavISCL1cd    INTEGER (-4096..4095)    OPTIONAL, -- Need ON
cnavISCL1ca    INTEGER (-4096..4095)    OPTIONAL, -- Need ON
cnavISCL2c    INTEGER (-4096..4095)    OPTIONAL, -- Need ON
cnavISCL5i5    INTEGER (-4096..4095)    OPTIONAL, -- Need ON
cnavISCL5q5    INTEGER (-4096..4095)    OPTIONAL, -- Need ON
...
}
-- ASN1STOP

```

CNAV-ClockModel field descriptions

<p>cnavToc Parameter t_{oc}, clock data reference time of week (seconds) [4,5,6,7]. Scale factor 300 seconds.</p>
<p>cnavTop Parameter t_{op}, clock data predict time of week (seconds) [4,5,6,7]. Scale factor 300 seconds</p>
<p>cnavURA0 Parameter URA_{oc} Index, SV clock accuracy index (dimensionless) [4,5,6,7].</p>
<p>cnavURA1 Parameter URA_{oc1} Index, SV clock accuracy change index (dimensionless) [4,5,6,7].</p>
<p>cnavURA2 Parameter URA_{oc2} Index, SV clock accuracy change rate index (dimensionless) [4,5,6,7].</p>
<p>cnavAf2 Parameter a_{f2-n}, SV clock drift rate correction coefficient (sec/sec²) [4,5,6,7]. Scale factor 2⁻⁶⁰ seconds/second².</p>
<p>cnavAf1 Parameter a_{f1-n}, SV clock drift correction coefficient (sec/sec) [4,5,6,7]. Scale factor 2⁻⁴⁸ seconds/second.</p>
<p>cnavAf0 Parameter a_{f0-n}, SV clock bias correction coefficient (seconds) [4,5,6,7]. Scale factor 2⁻³⁵ seconds.</p>
<p>cnavTgd Parameter T_{GD}, Group delay correction (seconds) [4,5,6,7]. Scale factor 2⁻³⁵ seconds.</p>
<p>cnavISCL1cp Parameter $ISCL_{1CP}$, inter signal group delay correction (seconds) [6,7]. Scale factor 2⁻³⁵ seconds. The location server should include this field if the target device is GPS capable and supports the L1_c signal.</p>
<p>cnavISCL1cd Parameter $ISCL_{1CD}$, inter signal group delay correction (seconds) [6,7]. Scale factor 2⁻³⁵ seconds. The location server should include this field if the target device is GPS capable and supports the L1_c signal.</p>
<p>cnavISCL1ca Parameter $ISCL_{1C/A}$, inter signal group delay correction (seconds) [4,5,7]. Scale factor 2⁻³⁵ seconds. The location server should include this field if the target device is GPS capable and supports the L1_{CA} signal.</p>
<p>cnavISCL2c Parameter $ISCL_{2C}$, inter signal group delay correction (seconds) [4,5,7]. Scale factor 2⁻³⁵ seconds. The location server should include this field if the target device is GPS capable and supports the L2_c signal.</p>
<p>cnavISCL5i5 Parameter $ISCL_{5i5}$, inter signal group delay correction (seconds) [5,7]. Scale factor 2⁻³⁵ seconds. The location server should include this field if the target device is GPS capable and supports the L5 signal.</p>
<p>cnavISCL5q5 Parameter $ISCL_{5q5}$, inter signal group delay correction (seconds) [5,7]. Scale factor 2⁻³⁵ seconds. The location server should include this field if the target device is GPS capable and supports the L5 signal.</p>

GLONASS-ClockModel

```

-- ASN1START
GLONASS-ClockModel ::= SEQUENCE {
    gLoTau    INTEGER (-2097152..2097151),

```

```

    gloGamma      INTEGER (-1024..1023),
    gloDeltaTau   INTEGER (-16..15)           OPTIONAL,    -- Need ON
    ...
}
-- ASN1STOP

```

GLONASS-ClockModel field descriptions

gloTau

Parameter $\tau_n(t_b)$, satellite clock offset (seconds) [9].
Scale factor 2^{-30} seconds.

gloGamma

Parameter $\gamma_n(t_b)$, relative frequency offset from nominal value (dimensionless) [9].
Scale factor 2^{-40} .

gloDeltaTau

Parameter $\Delta\tau_n$, time difference between transmission in G2 and G1 (seconds) [9].
Scale factor 2^{-30} seconds.

The location server should include this parameter if the target device is dual frequency GLONASS receiver capable.

– ***SBAS-ClockModel***

```

-- ASN1START
SBAS-ClockModel ::= SEQUENCE {
    sbasTo          INTEGER (0..5399),
    sbasAgfo        INTEGER (-2048..2047),
    sbasAgf1        INTEGER (-128..127),
    ...
}
-- ASN1STOP

```

SBAS-ClockModel field descriptions

sbasTo

Parameter t_0 [10].
Scale factor 16 seconds.

sbasAgfo

Parameter a_{Gfo} [10].
Scale factor 2^{-31} seconds.

sbasAgf1

Parameter a_{Gf1} [10].
Scale factor 2^{-40} seconds/second.

– ***BDS-ClockModel***

The IE *BDS-ClockModel* is used for BDS B1I defined in [23].

```

-- ASN1START
BDS-ClockModel-r12 ::= SEQUENCE {
    bdsAODC-r12     INTEGER (0..31),
    bdsToc-r12      INTEGER (0..131071),
    bdsA0-r12       INTEGER (-8388608..8388607),
    bdsA1-r12       INTEGER (-2097152..2097151),
    bdsA2-r12       INTEGER (-1024..1023),
    bdsTgd1-r12     INTEGER (-512..511),
    ...
}
-- ASN1STOP

```

BDS-ClockModel field descriptions
<p>bdsAODC Parameter Age of Data, Clock (AODC), see [23], Table 5-6.</p>
<p>bdsToc Parameter T_{oc}, Time of clock (seconds) [23]. Scale factor 2^3 seconds.</p>
<p>bdsA0 Parameter a_0, Clock correction polynomial coefficient (seconds) [23]. Scale factor 2^{-33} seconds.</p>
<p>bdsA1 Parameter a_1, Clock correction polynomial coefficient (sec/sec) [23]. Scale factor 2^{-50} sec/sec.</p>
<p>bdsA2 Parameter a_2, Clock correction polynomial coefficient (sec/sec²) [23]. Scale factor 2^{-66} sec/sec².</p>
<p>bdsTgd1 Parameter Equipment group delay differential T_{GD1} [23]. Scale factor is 0.1 nanosecond.</p>

– *BDS-ClockModel2*

The IE *BDS-ClockModel2* is used for BDS B1C defined in [39].

```
-- ASN1START
BDS-ClockModel2-r16 ::= SEQUENCE {
    bdsToc-r16      INTEGER (0..2047),
    bdsA0-r16      INTEGER (-16777216..16777215),
    bdsA1-r16      INTEGER (-2097152..2097151),
    bdsA2-r16      INTEGER (-1024..1023),
    bdsTgdB1Cp-r16 INTEGER (-2048..2047),
    bdsIscB1Cd-r16 INTEGER (-2048..2047),
    ...
}
-- ASN1STOP
```

BDS-ClockModel2 field descriptions
<p>bdsToc Parameter T_{oc}, Clock correction parameters reference time (seconds), see [39], 7.5.1. Scale factor 300 seconds.</p>
<p>bdsA0 Parameter a_0, Satellite clock time bias correction coefficient (seconds), see [39], 7.5.1. Scale factor 2^{-34} seconds.</p>
<p>bdsA1 Parameter a_1, Satellite clock time drift correction coefficient (sec/sec), see [39], 7.5.1. Scale factor 2^{-50} sec/sec.</p>
<p>bdsA2 Parameter a_2, Satellite clock time drift rate correction coefficient (sec/sec²), see [39], 7.5.1. Scale factor 2^{-66} sec/sec².</p>
<p>bdsTgdB1Cp Parameter T_{GDB1Cp} Group delay differential of the B1C pilot component (seconds), see [39], 7.6.1. Scale factor is 2^{-34} seconds.</p>
<p>bdsIscB1Cd Parameter ISC_{B1Cd} Group delay differential between the B1C data and pilot components (seconds), see [39], 7.6.1. Scale factor is 2^{-34} seconds.</p>

– *NavIC-ClockModel*

```
-- ASN1START
NavIC-ClockModel-r16 ::= SEQUENCE {
    navic-Toc-r16      INTEGER (0..65535),
    navic-af2-r16      INTEGER (-128..127),
    navic-af1-r16      INTEGER (-32768..32767),
    navic-af0-r16      INTEGER (-2097152..2097151),
    navic-Tgd-r16      INTEGER (-128..127),
}
```

```

...
}
-- ASN1STOP

```

NavIC-ClockModel field descriptions
<p>navic-Toc Parameter t_{oc}, time of clock (seconds) [38], Table-11. Scale factor 2^4 seconds.</p>
<p>navic-af2 Parameter a_2, clock correction polynomial coefficient (sec/sec²) [38]. Scale factor 2^{55} seconds/second².</p>
<p>navic-af1 Parameter a_1, clock correction polynomial coefficient (sec/sec) [38]. Scale factor 2^{43} seconds/second.</p>
<p>navic-af0 Parameter a_0, clock correction polynomial coefficient (seconds) [38]. Scale factor 2^{31} seconds.</p>
<p>navic-Tgd Parameter T_{GD}, group delay (seconds) [38]. Scale factor 2^{31} seconds.</p>

NavModelKeplerianSet

```

-- ASN1START
NavModelKeplerianSet ::= SEQUENCE {
    keplerToe      INTEGER (0 .. 16383),
    keplerW        INTEGER (-2147483648 .. 2147483647),
    keplerDeltaN   INTEGER (-32768 .. 32767),
    keplerM0       INTEGER (-2147483648 .. 2147483647),
    keplerOmegaDot INTEGER (-8388608 .. 8388607),
    keplerE        INTEGER (0 .. 4294967295),
    keplerIDot     INTEGER (-8192 .. 8191),
    keplerAPowerHalf INTEGER (0 .. 4294967295),
    keplerI0       INTEGER (-2147483648 .. 2147483647),
    keplerOmega0   INTEGER (-2147483648 .. 2147483647),
    keplerCrS      INTEGER (-32768 .. 32767),
    keplerCis      INTEGER (-32768 .. 32767),
    keplerCus      INTEGER (-32768 .. 32767),
    keplerCrc      INTEGER (-32768 .. 32767),
    keplerCic      INTEGER (-32768 .. 32767),
    keplerCuc      INTEGER (-32768 .. 32767),
    ...
}
-- ASN1STOP

```

NavModelKeplerianSet field descriptions
<p>keplerToe Parameter t_{oe}, time-of-ephemeris in seconds [8]. Scale factor 60 seconds.</p>
<p>keplerW Parameter ω, argument of perigee (semi-circles) [8]. Scale factor 2^{31} semi-circles.</p>
<p>keplerDeltaN Parameter Δn, mean motion difference from computed value (semi-circles/sec) [8]. Scale factor 2^{43} semi-circles/second.</p>
<p>keplerM0 Parameter M_0, mean anomaly at reference time (semi-circles) [8]. Scale factor 2^{31} semi-circles.</p>
<p>keplerOmegaDot Parameter Ω_{dot}, rate of change of right ascension (semi-circles/sec) [8]. Scale factor 2^{43} semi-circles/second.</p>

NavModelKeplerianSet field descriptions
<p>keplerE Parameter e, eccentricity [8]. Scale factor 2⁻³³.</p>
<p>KeplerIDot Parameter Idot, rate of change of inclination angle (semi-circles/sec) [8]. Scale factor 2⁻⁴³ semi-circles/second.</p>
<p>keplerAPowerHalf Parameter sqrtA, square root of semi-major Axis in (metres)^½ [8]. Scale factor 2⁻¹⁹ metres^½.</p>
<p>keplerI0 Parameter i₀, inclination angle at reference time (semi-circles) [8]. Scale factor 2⁻³¹ semi-circles.</p>
<p>keplerOmega0 Parameter OMEGA₀, longitude of ascending node of orbit plane at weekly epoch (semi-circles) [8]. Scale factor 2⁻³¹ semi-circles.</p>
<p>keplerCrs Parameter C_{rs}, amplitude of the sine harmonic correction term to the orbit radius (metres) [8]. Scale factor 2⁻⁵ metres.</p>
<p>keplerCis Parameter C_{is}, amplitude of the sine harmonic correction term to the angle of inclination (radians) [8]. Scale factor 2⁻²⁹ radians.</p>
<p>keplerCus Parameter C_{us}, amplitude of the sine harmonic correction term to the argument of latitude (radians) [8]. Scale factor 2⁻²⁹ radians.</p>
<p>keplerCrc Parameter C_{rc}, amplitude of the cosine harmonic correction term to the orbit radius (metres) [8]. Scale factor 2⁻⁵ metres.</p>
<p>keplerCic Parameter C_{ic}, amplitude of the cosine harmonic correction term to the angle of inclination (radians) [8]. Scale factor 2⁻²⁹ radians.</p>
<p>keplerCuc Parameter C_{uc}, amplitude of the cosine harmonic correction term to the argument of latitude (radians) [8]. Scale factor 2⁻²⁹ radians.</p>

NavModelNAV-KeplerianSet

```

-- ASN1START
NavModelNAV-KeplerianSet ::= SEQUENCE {
    navURA          INTEGER (0..15),
    navFitFlag       INTEGER (0..1),
    navToe           INTEGER (0..37799),
    navOmega         INTEGER (-2147483648..2147483647),
    navDeltaN        INTEGER (-32768..32767),
    navM0            INTEGER (-2147483648..2147483647),
    navOmegaADot     INTEGER (-8388608..8388607),
    navE             INTEGER (0..4294967295),
    navIDot          INTEGER (-8192..8191),
    navAPowerHalf    INTEGER (0..4294967295),
    navI0            INTEGER (-2147483648..2147483647),
    navOmegaA0       INTEGER (-2147483648..2147483647),
    navCrs           INTEGER (-32768..32767),
    navCis           INTEGER (-32768..32767),
    navCus           INTEGER (-32768..32767),
    navCrc           INTEGER (-32768..32767),
    navCic           INTEGER (-32768..32767),
    navCuc           INTEGER (-32768..32767),
    addNAVparam      SEQUENCE {
        ephemerCodeOnL2  INTEGER (0..3),
        ephemerL2Pflag   INTEGER (0..1),
        ephemerSF1Rsvd   SEQUENCE {
            reserved1    INTEGER (0..8388607),    -- 23-bit field
            reserved2    INTEGER (0..16777215),   -- 24-bit field
            reserved3    INTEGER (0..16777215),   -- 24-bit field
            reserved4    INTEGER (0..65535)      -- 16-bit field
        },
        ephemerAODA      INTEGER (0..31)
    },
    OPTIONAL, -- Need ON
}

```

```

}
...
-- ASN1STOP

```

NavModelNAV-KeplerianSet field descriptions
<p>navURA Parameter URA Index, SV accuracy (dimensionless) [4,7].</p>
<p>navFitFlag Parameter Fit Interval Flag, fit interval indication (dimensionless) [4,7]</p>
<p>navToe Parameter t_{oe}, time of ephemeris (seconds) [4,7]. Scale factor 2^4 seconds.</p>
<p>navOmega Parameter ω, argument of perigee (semi-circles) [4,7]. Scale factor 2^{31} semi-circles.</p>
<p>navDeltaN Parameter Δn, mean motion difference from computed value (semi-circles/sec) [4,7]. Scale factor 2^{43} semi-circles/second.</p>
<p>navM0 Parameter M_0, mean anomaly at reference time (semi-circles) [4,7]. Scale factor 2^{31} semi-circles.</p>
<p>navOmegaADot Parameter $\dot{\Omega}$, rate of right ascension (semi-circles/sec) [4,7]. Scale factor 2^{43} semi-circles/second.</p>
<p>navE Parameter e, eccentricity (dimensionless) [4,7]. Scale factor 2^{33}.</p>
<p>navIDot Parameter \dot{I}, rate of inclination angle (semi-circles/sec) [4,7]. Scale factor 2^{43} semi-circles/second.</p>
<p>navAPowerHalf Parameter \sqrt{A}, square root of semi-major axis (metres²) [4,7]. Scale factor 2^{19} metres^{1/2}.</p>
<p>navI0 Parameter i_0, inclination angle at reference time (semi-circles) [4,7]. Scale factor 2^{31} semi-circles.</p>
<p>navOmegaA0 Parameter Ω_0, longitude of ascending node of orbit plane at weekly epoch (semi-circles) [4,7]. Scale factor 2^{31} semi-circles.</p>
<p>navCrs Parameter C_{rs}, amplitude of sine harmonic correction term to the orbit radius (metres) [4,7]. Scale factor 2^5 metres.</p>
<p>navCis Parameter C_{is}, amplitude of sine harmonic correction term to the angle of inclination (radians) [4,7]. Scale factor 2^{29} radians.</p>
<p>navCus Parameter C_{us}, amplitude of sine harmonic correction term to the argument of latitude (radians) [4,7]. Scale factor 2^{29} radians.</p>
<p>navCrc Parameter C_{rc}, amplitude of cosine harmonic correction term to the orbit radius (metres) [4,7]. Scale factor 2^5 metres.</p>
<p>navCic Parameter C_{ic}, amplitude of cosine harmonic correction term to the angle of inclination (radians) [4,7]. Scale factor 2^{29} radians.</p>
<p>navCuc Parameter C_{uc}, amplitude of cosine harmonic correction term to the argument of latitude (radians) [4,7]. Scale factor 2^{29} radians.</p>
<p>addNAVparam These fields include data and reserved bits in the GPS NAV message [4,14]. These additional navigation parameters, if provided by the location server, allow the target device to perform data wipe-off similar to what is done by the target device with the <i>GNSS-DataBitAssistance</i>.</p>

NavModelCNAV-KeplerianSet

```

-- ASN1START
NavModelCNAV-KeplerianSet ::= SEQUENCE {
    cnavTop                INTEGER (0..2015),
    cnavURAIindex         INTEGER (-16..15),
    cnavDeltaA            INTEGER (-33554432..33554431),
    cnavAdot              INTEGER (-16777216..16777215),
    cnavDeltaNo           INTEGER (-65536..65535),
    cnavDeltaNoDot        INTEGER (-4194304..4194303),
    cnavMo                INTEGER (-4294967296..4294967295),
    cnavE                 INTEGER (0..8589934591),
    cnavOmega             INTEGER (-4294967296..4294967295),
    cnavOMEGA0            INTEGER (-4294967296..4294967295),
    cnavDeltaOmegaDot     INTEGER (-65536..65535),
    cnavIo                INTEGER (-4294967296..4294967295),
    cnavIoDot             INTEGER (-16384..16383),
    cnavCis               INTEGER (-32768..32767),
    cnavCic               INTEGER (-32768..32767),
    cnavCrs               INTEGER (-8388608..8388607),
    cnavCrc               INTEGER (-8388608..8388607),
    cnavCus               INTEGER (-1048576..1048575),
    cnavCuc               INTEGER (-1048576..1048575),
    ...
}
-- ASN1STOP

```

NavModelCNAV-KeplerianSet field descriptions

<p><i>cnavTop</i> Parameter t_{op}, data predict time of week (seconds) [4,5,6,7]. Scale factor 300 seconds.</p>
<p><i>cnavURAIindex</i> Parameter URA_{oe} Index, SV accuracy (dimensionless) [4,5,6,7].</p>
<p><i>cnavDeltaA</i> Parameter ΔA, semi-major axis difference at reference time (metres) [4,5,6,7]. Scale factor 2^{-9} metres.</p>
<p><i>cnavAdot</i> Parameter \dot{A}, change rate in semi-major axis (metres/second) [4,5,6,7]. Scale factor 2^{-21} metres/second.</p>
<p><i>cnavDeltaNo</i> Parameter Δn_0, mean motion difference from computed value at reference time (semi-circles/sec) [4,5,6,7]. Scale factor 2^{-44} semi-circles/second.</p>
<p><i>cnavDeltaNoDot</i> Parameter $\Delta \dot{n}_0$, rate of mean motion difference from computed value (semi-circles/sec²) [4,5,6,7]. Scale factor 2^{-57} semi-circles/second².</p>
<p><i>cnavMo</i> Parameter M_{0-n}, mean anomaly at reference time (semi-circles) [4,5,6,7]. Scale factor 2^{-32} semi-circles.</p>
<p><i>cnavE</i> Parameter e_n, eccentricity (dimensionless) [4,5,6,7]. Scale factor 2^{-34}.</p>
<p><i>cnavOmega</i> Parameter ω_n, argument of perigee (semi-circles) [4,5,6,7]. Scale factor 2^{-32} semi-circles.</p>
<p><i>cnavOMEGA0</i> Parameter Ω_{0-n}, reference right ascension angle (semi-circles) [4,5,6,7]. Scale factor 2^{-32} semi-circles.</p>
<p><i>cnavDeltaOmegaDot</i> Parameter $\Delta \dot{\Omega}$, rate of right ascension difference (semi-circles/sec) [4,5,6,7]. Scale factor 2^{-44} semi-circles/second.</p>
<p><i>cnavIo</i> Parameter i_{0-n}, inclination angle at reference time (semi-circles) [4,5,6,7]. Scale factor 2^{-32} semi-circles.</p>
<p><i>cnavIoDot</i> Parameter $i_{0-n-DOT}$, rate of inclination angle (semi-circles/sec) [4,5,6,7]. Scale factor 2^{-44} semi-circles/second.</p>

<i>NavModelCNAV-KeplerianSet</i> field descriptions
<p><i>cnavCis</i> Parameter C_{is-n}, amplitude of sine harmonic correction term to the angle of inclination (radians) [4,5,6,7]. Scale factor 2^{-30} radians.</p>
<p><i>cnavCic</i> Parameter C_{ic-n}, amplitude of cosine harmonic correction term to the angle of inclination (radians) [4,5,6,7]. Scale factor 2^{-30} radians.</p>
<p><i>cnavCrs</i> Parameter C_{rs-n}, amplitude of sine harmonic correction term to the orbit radius (metres) [4,5,6,7]. Scale factor 2^{-8} metres.</p>
<p><i>cnavCrc</i> Parameter C_{rc-n}, amplitude of cosine harmonic correction term to the orbit radius (metres) [4,5,6,7]. Scale factor 2^{-8} metres.</p>
<p><i>cnavCus</i> Parameter C_{us-n}, amplitude of the sine harmonic correction term to the argument of latitude (radians) [4,5,6,7]. Scale factor 2^{-30} radians.</p>
<p><i>cnavCuc</i> Parameter C_{uc-n}, amplitude of cosine harmonic correction term to the argument of latitude (radians) [4,5,6,7]. Scale factor 2^{-30} radians.</p>

– *NavModel-GLONASS-ECEF*

```

-- ASN1START
NavModel-GLONASS-ECEF ::= SEQUENCE {
    gloEn          INTEGER (0..31),
    gloP1         BIT STRING (SIZE(2)),
    gloP2         BOOLEAN,
    gloM          INTEGER (0..3),
    gloX          INTEGER (-67108864..67108863),
    gloXdot       INTEGER (-8388608..8388607),
    gloXdotdot    INTEGER (-16..15),
    gloY          INTEGER (-67108864..67108863),
    gloYdot       INTEGER (-8388608..8388607),
    gloYdotdot    INTEGER (-16..15),
    gloZ          INTEGER (-67108864..67108863),
    gloZdot       INTEGER (-8388608..8388607),
    gloZdotdot    INTEGER (-16..15),
    ...
}
-- ASN1STOP

```

<i>NavModel-GLONASS-ECEF</i> field descriptions
<p><i>gloEn</i> Parameter E_n, age of data (days) [9]. Scale factor 1 days.</p>
<p><i>gloP1</i> Parameter P1, time interval between two adjacent values of t_b (minutes) [9].</p>
<p><i>gloP2</i> Parameter P2, change of t_b flag (dimensionless) [9].</p>
<p><i>gloM</i> Parameter M, type of satellite (dimensionless) [9].</p>
<p><i>gloX</i> Parameter $x_n(t_b)$, x-coordinate of satellite at time t_b (kilometres) [9]. Scale factor 2^{-11} kilometres.</p>
<p><i>gloXdot</i> Parameter $\dot{x}_n(t_b)$, x-coordinate of satellite velocity at time t_b (kilometres/second) [9]. Scale factor 2^{-20} kilometres/second.</p>
<p><i>gloXdotdot</i> Parameter $\ddot{x}_n(t_b)$, x-coordinate of satellite acceleration at time t_b (kilometres/second²) [9]. Scale factor 2^{-30} kilometres/second².</p>

NavModel-GLONASS-ECEF field descriptions
<p>gloY Parameter $y_n(t_b)$, y-coordinate of satellite at time t_b (kilometres) [9]. Scale factor 2^{-11} kilometres.</p>
<p>gloYdot Parameter $\dot{y}_n(t_b)$, y-coordinate of satellite velocity at time t_b (kilometres/second) [9]. Scale factor 2^{-20} kilometres/second.</p>
<p>gloYdotdot Parameter $\ddot{y}_n(t_b)$, y-coordinate of satellite acceleration at time t_b (kilometres/second²) [9]. Scale factor 2^{-30} kilometres/second².</p>
<p>gloZ Parameter $z_n(t_b)$, z-coordinate of satellite at time t_b (kilometres) [9]. Scale factor 2^{-11} kilometres.</p>
<p>gloZdot Parameter $\dot{z}_n(t_b)$, z-coordinate of satellite velocity at time t_b (kilometres/second) [9]. Scale factor 2^{-20} kilometres/second.</p>
<p>gloZdotdot Parameter $\ddot{z}_n(t_b)$, z-coordinate of satellite acceleration at time t_b (kilometres/second²) [9]. Scale factor 2^{-30} kilometres/second².</p>

– **NavModel-SBAS-ECEF**

```

-- ASN1START
NavModel-SBAS-ECEF ::= SEQUENCE {
    sbasTo          INTEGER (0..5399)                OPTIONAL,  -- Cond ClockModel
    sbasAccuracy    BIT STRING (SIZE(4)),
    sbasXg          INTEGER (-536870912..536870911),
    sbasYg          INTEGER (-536870912..536870911),
    sbasZg          INTEGER (-16777216..16777215),
    sbasXgDot       INTEGER (-65536..65535),
    sbasYgDot       INTEGER (-65536..65535),
    sbasZgDot       INTEGER (-131072..131071),
    sbasXgDotDot    INTEGER (-512..511),
    sbasYgDotDot    INTEGER (-512..511),
    sbasZgDotDot    INTEGER (-512..511),
    ...
}
-- ASN1STOP
    
```

Conditional presence	Explanation
<i>ClockModel</i>	This field is mandatory present if <i>gnss-ClockModel</i> Model-5 is not included; otherwise it is not present.

NavModel-SBAS-ECEF field descriptions
<p>sbasTo Parameter t_0, time of applicability (seconds) [10]. Scale factor 16 seconds.</p>
<p>sbasAccuracy Parameter Accuracy, (dimensionless) [10].</p>
<p>sbasXg Parameter X_G, (metres) [10]. Scale factor 0.08 metres.</p>
<p>sbasYg Parameter Y_G, (metres) [10]. Scale factor 0.08 metres.</p>
<p>sbasZg Parameter Z_G, (metres) [10]. Scale factor 0.4 metres.</p>

<i>NavModel-SBAS-ECEF</i> field descriptions
<p><i>sbasXgDot</i> Parameter X_G, Rate-of-Change, (metres/second) [10]. Scale factor 0.000625 metres/second.</p>
<p><i>sbasYgDot</i> Parameter Y_G, Rate-of-Change, (metres/second) [10]. Scale factor 0.000625 metres/second.</p>
<p><i>sbasZgDot</i> Parameter Z_G, Rate-of-Change, (metres/second) [10]. Scale factor 0.004 metres/second.</p>
<p><i>sbasXgDotDot</i> Parameter X_G, Acceleration, (metres/second²) [10]. Scale factor 0.0000125 metres/second².</p>
<p><i>sbasYgDotDot</i> Parameter Y_G, Acceleration, (metres/second²) [10]. Scale factor 0.0000125 metres/second².</p>
<p><i>sbasZgDotDot</i> Parameter Z_G Acceleration, (metres/second²) [10]. Scale factor 0.0000625 metres/second².</p>

– *NavModel-BDS-KeplerianSet*

The IE *NavModel-BDS-KeplerianSet* is used for BDS B1I defined in [23].

```
-- ASN1START
NavModel-BDS-KeplerianSet-r12 ::= SEQUENCE {
    bdsAODE-r12          INTEGER (0..31),
    bdsURAI-r12         INTEGER (0..15),
    bdsToe-r12          INTEGER (0..131071),
    bdsAPowerHalf-r12   INTEGER (0..4294967295),
    bdsE-r12            INTEGER (0..4294967295),
    bdsW-r12            INTEGER (-2147483648..2147483647),
    bdsDeltaN-r12       INTEGER (-32768..32767),
    bdsM0-r12           INTEGER (-2147483648..2147483647),
    bdsOmega0-r12       INTEGER (-2147483648..2147483647),
    bdsOmegaDot-r12     INTEGER (-8388608..8388607),
    bdsI0-r12           INTEGER (-2147483648..2147483647),
    bdsIDot-r12         INTEGER (-8192..8191),
    bdsCuc-r12          INTEGER (-131072..131071),
    bdsCus-r12          INTEGER (-131072..131071),
    bdsCrc-r12          INTEGER (-131072..131071),
    bdsCrs-r12          INTEGER (-131072..131071),
    bdsCic-r12          INTEGER (-131072..131071),
    bdsCis-r12          INTEGER (-131072..131071),
    ...
}
-- ASN1STOP
```

NavModel-BDS-KeplerianSet field descriptions
bdsAODE Parameter Age of Data, Ephemeris (AODE), see [23], Table 5-8.
bdsURAI Parameter URA Index, URA is used to describe the signal-in-space accuracy in metres as defined in [23].
bdsToe Parameter t_{oe} , Ephemeris reference time (seconds) [23]. Scale factor 2^3 seconds.
bdsAPowerHalf Parameter $A^{1/2}$, Square root of semi-major axis (metres ²) [23]. Scale factor 2^{-19} metres ² .
bdsE Parameter e, Eccentricity, dimensionless [23]. Scale factor 2^{-33} .
bdsW Parameter ω , Argument of perigee (semi-circles) [23]. Scale factor 2^{-31} semi-circles.
bdsDeltaN Parameter Δn , Mean motion difference from computed value (semi-circles/sec) [23]. Scale factor 2^{-43} semi-circles/second.
bdsM0 Parameter M_0 , Mean anomaly at reference time (semi-circles) [23]. Scale factor 2^{-31} semi-circles.
bdsOmega0 Parameter Ω_0 , Longitude of ascending node of orbital of plane computed according to reference time (semi-circles) [23]. Scale factor 2^{-31} semi-circles.
bdsOmegaDot Parameter $\dot{\Omega}$, Rate of right ascension (semi-circles/sec) [23]. Scale factor 2^{-43} semi-circles/second.
bdsI0 Parameter i_0 , Inclination angle at reference time (semi-circles) [23]. Scale factor 2^{-31} semi-circles.
bdsIDot Parameter \dot{i} , Rate of inclination angle (semi-circles/sec) [23]. Scale factor 2^{-43} semi-circles/second.
bdsCuc Parameter C_{uc} , Amplitude of cosine harmonic correction term to the argument of latitude (radians) [23]. Scale factor 2^{-31} radians.
bdsCus Parameter C_{us} , Amplitude of sine harmonic correction term to the argument of latitude (radians) [23]. Scale factor 2^{-31} radians.
bdsCrc Parameter C_{rc} , Amplitude of cosine harmonic correction term to the orbit radius (metres) [23]. Scale factor 2^{-6} metres.
bdsCrs Parameter C_{rs} , Amplitude of sine harmonic correction term to the orbit radius (metres) [23]. Scale factor 2^{-6} metres.
bdsCic Parameter C_{ic} , Amplitude of cosine harmonic correction term to the angle of inclination (radians) [23]. Scale factor 2^{-31} radians.
bdsCis Parameter C_{is} , Amplitude of sine harmonic correction term to the angle of inclination (radians) [23]. Scale factor 2^{-31} radians.

– NavModel-BDS-KeplerianSet2

The IE *NavModel-BDS-KeplerianSet2* is used for BDS B1C defined in [39].

```
-- ASN1START
NavModel-BDS-KeplerianSet2-r16 ::= SEQUENCE {
    bdsIODE-r16          INTEGER (0..255),
    bdsToe-r16          INTEGER (0..2047),
    bdsDeltaA-r16       INTEGER (-33554432..33554431),
```

```
bdsAdot-r16          INTEGER (-16777216..16777216),
bdsDeltaN0-r16      INTEGER (-65536..65535),
bdsDeltaN0dot-r16   INTEGER (-4194304..4194303),
bdsM0-r16           INTEGER (-4294967296..4294967295),
bdsE-r16            INTEGER (0..8589934591),
bdsOmega-r16        INTEGER (-4294967296..4294967295),
bdsOmega0-r16       INTEGER (-4294967296..4294967295),
bdsI0-r16           INTEGER (-4294967296..4294967295),
bdsOmegaDot-r16     INTEGER (-262144..262143),
bdsI0Dot-r16        INTEGER (-16384..16383),
bdsCuc-r16          INTEGER (-1048576..1048575),
bdsCus-r16          INTEGER (-1048576..1048575),
bdsCrc-r16          INTEGER (-8388608..8388607),
bdsCrs-r16          INTEGER (-8388608..8388607),
bdsCic-r16          INTEGER (-32768..32767),
bdsCis-r16          INTEGER (-32768..32767),
...
}
-- ASN1STOP
```

<i>NavModel-BDS-KeplerianSet2</i> field descriptions
<p><i>bdsIODE</i> Parameter, Issue Of Data, Ephemeris (IODE), see [39], 7.4.1.</p>
<p><i>bdsToe</i> Parameter t_{oe}, Ephemeris reference time (seconds), defined in [39], 7.7.1. Scale factor 300 seconds.</p>
<p><i>bdsDeltaA</i> Parameter ΔA, Semi-major axis difference at reference time (metre), defined in [39], 7.7.1. Scale factor 2^{-9} metres.</p>
<p><i>bdsAdot</i> Parameter \dot{A}, Change rate in semi-major axis (metre/second), defined in [39], 7.7.1 Scale factor 2^{21} metre/second. The value 16777216 is not signalled.</p>
<p><i>bdsDeltaN0</i> Parameter Δn_0, Mean motion difference from computed value at reference time (semi-circles /sec), defined in [39], 7.7.1 Scale factor 2^{44} semi-circles /second.</p>
<p><i>bdsDeltaN0dot</i> Parameter Δn_{0dot}, Rate of mean motion difference from computed value at reference time (semi-circles /sec²), defined in [39], 7.7.1 Scale factor 2^{57} semi-circles /second².</p>
<p><i>bdsM0</i> Parameter M_0, Mean anomaly at reference time (semi-circles) [39]. Scale factor 2^{-32} semi-circles.</p>
<p><i>bdsE</i> Parameter e, Eccentricity [39]. Scale factor 2^{-34}.</p>
<p><i>bdsOmega</i> Parameter ω, Argument of perigee (semi-circles) [39]. Scale factor 2^{-32} semi-circles.</p>
<p><i>bdsOmega0</i> Parameter Ω_0, Longitude of ascending node of orbital plane at weekly epoch (semi-circles) [39]. Scale factor 2^{-32} semi-circles.</p>
<p><i>bdsI0</i> Parameter i_0, Inclination angle at reference time (semi-circles) [39] Scale factor 2^{-32} semi-circles.</p>
<p><i>bdsOmegaDot</i> Parameter $\dot{\Omega}$, Rate of right ascension (semi-circles/sec) [39]. Scale factor 2^{44} semi-circles/second.</p>
<p><i>bdsI0Dot</i> Parameter i_{0dot}, Rate of inclination angle (semi-circles/sec) [39]. Scale factor 2^{44} semi-circles/second.</p>
<p><i>bdsCuc</i> Parameter C_{uc}, Amplitude of cosine harmonic correction to the argument of latitude (radians) [39]. Scale factor 2^{-30} radians.</p>
<p><i>bdsCus</i> Parameter C_{us}, Amplitude of sine harmonic correction to the argument of latitude (radians) [39]. Scale factor 2^{-30} radians.</p>
<p><i>bdsCrc</i> Parameter C_{rc}, Amplitude of cosine harmonic correction term to the orbit radius (metres) [39]. Scale factor 2^{-8} metres.</p>
<p><i>bdsCrs</i> Parameter C_{rs}, Amplitude of sine harmonic correction term to the orbit radius (metres) [39]. Scale factor 2^{-8} metres.</p>
<p><i>bdsCic</i> Parameter C_{ic}, Amplitude of cosine harmonic correction term to the angle of inclination (radians) [39]. Scale factor 2^{-30} radians.</p>
<p><i>bdsCis</i> Parameter C_{is}, Amplitude of sine harmonic correction term to the angle of inclination (radians) [39]. Scale factor 2^{-30} radians.</p>

NavModel-NavIC-KeplerianSet

```

-- ASN1START
NavModel-NavIC-KeplerianSet-r16 ::= SEQUENCE {
    navic-Toe-r16          INTEGER (0..65536),
    navic-URAI-r16        INTEGER (0..15),
    navic-W-r16           INTEGER (-2147483648..2147483647),
    navic-DeltaN-r16      INTEGER (-2097152..2097151),
    navic-M0-r16          INTEGER (-2147483648..2147483647),
    navic-OmegaDot-r16    INTEGER (-2147483648..2147483647),
    navic-E-r16           INTEGER (0..4294967295),
    navic-IDot-r16        INTEGER (-8192..8191),
    navic-APowerHalf-r16  INTEGER (0..4294967295),
    navic-I0-r16          INTEGER (-2147483648..2147483647),
    navic-Omega0-r16      INTEGER (-2147483648..2147483647),
    navic-Crs-r16         INTEGER (-32768..32767),
    navic-Cis-r16         INTEGER (-32768..32767),
    navic-Cus-r16         INTEGER (-32768..32767),
    navic-Crc-r16         INTEGER (-32768..32767),
    navic-Cic-r16         INTEGER (-32768..32767),
    navic-Cuc-r16         INTEGER (-32768..32767),
    ...
}
-- ASN1STOP

```

NavModel-NavIC-KeplerianSet field descriptions

<p>navic-Toe Parameter t_{oe}, time-of-ephemeris in seconds [38]. Scale factor 2^4 seconds.</p>
<p>navic-URAI Parameter User Range Accuracy Index (in metres). This is a one-sigma estimate of the user range errors in the navigation data for the transmitting satellite as described under clause 6.2.1.4 in [38]</p>
<p>navic-W Parameter ω, argument of perigee (semi-circles) [38]. Scale factor 2^{31} semi-circles.</p>
<p>navic-DeltaN Parameter Δn, mean motion difference from computed value (semi-circles/sec) [38] Scale factor 2^{41} semi-circles/second</p>
<p>navic-M0 Parameter M_0, mean anomaly at reference time (semi-circles) [38] Scale factor 2^{31} semi-circles.</p>
<p>navic-OmegaDot Parameter OMEGADot, rate of change of right ascension (semi-circles/sec) [38] Scale factor 2^{41} semi-circles/second</p>
<p>navic-E Parameter e, eccentricity [38] Scale factor 2^{33}.</p>
<p>navic-IDot Parameter I_{dot}, rate of change of inclination angle (semi-circles/sec) [38] Scale factor 2^{43} semi-circles/second.</p>
<p>navic-APowerHalf Parameter \sqrt{a}, square root of semi-major Axis in (metres)^{1/2} [38] Scale factor 2^{19} metres^{1/2}.</p>
<p>navic-I0 Parameter i_0, inclination angle at reference time (semi-circles) [38] Scale factor 2^{31} semi-circles.</p>
<p>navic-Omega0 Parameter OMEGA0, longitude of ascending node of orbit plane at weekly epoch (semi-circles) [38] Scale factor 2^{31} semi-circles.</p>
<p>navic-Crs Parameter C_{rs}, amplitude of the sine harmonic correction term to the orbit radius (metres) [38] Scale factor 2^4 metres</p>
<p>navic-Cis Parameter C_{is}, amplitude of the sine harmonic correction term to the angle of inclination (radians) [38] Scale factor 2^{28} radians</p>

<i>NavModel-NavIC-KeplerianSet</i> field descriptions
<p>navic-Cus Parameter C_{US}, amplitude of the sine harmonic correction term to the argument of latitude (radians) [38] Scale factor 2^{28} radians</p>
<p>navic-Crc Parameter C_{RC}, amplitude of the cosine harmonic correction term to the orbit radius (metres) [38] Scale factor 2^4 metres</p>
<p>navic-Cic Parameter C_{IC}, amplitude of the cosine harmonic correction term to the angle of inclination (radians) [38] Scale factor 2^{28} radians</p>
<p>navic-Cuc Parameter C_{UC}, amplitude of the cosine harmonic correction term to the argument of latitude (radians) [38] Scale factor 2^{28} radians</p>

– *GNSS-RealTimeIntegrity*

The IE *GNSS-RealTimeIntegrity* is used by the location server to provide parameters that describe the real-time status of the GNSS constellations. *GNSS-RealTimeIntegrity* data communicates the health of the GNSS signals to the mobile in real-time.

The location server shall always transmit the *GNSS-RealTimeIntegrity* with the current list of unhealthy signals (i.e., not only for signals/SVs currently visible at the reference location), for any GNSS positioning attempt and whenever GNSS assistance data are sent. If the number of bad signals is zero, then the *GNSS-RealTimeIntegrity* IE shall be omitted.

```
-- ASN1START
GNSS-RealTimeIntegrity ::= SEQUENCE {
    gnss-BadSignalList  GNSS-BadSignalList,
    ...
}
GNSS-BadSignalList ::= SEQUENCE (SIZE(1..64)) OF BadSignalElement
BadSignalElement ::= SEQUENCE {
    badSVID             SV-ID,
    badSignalID         GNSS-SignalIDs  OPTIONAL,  -- Need OP
    ...
}
-- ASN1STOP
```

<i>GNSS-RealTimeIntegrity</i> field descriptions
<p>gnss-BadSignalList This field specifies a list of satellites with bad signal or signals.</p>
<p>badSVID This field specifies the GNSS <i>SV-ID</i> of the satellite with bad signal or signals.</p>
<p>badSignalID This field identifies the bad signal or signals of a satellite. This is represented by a bit string in <i>GNSS-SignalIDs</i>, with a one-value at a bit position means the particular GNSS signal type of the SV is unhealthy; a zero-value means healthy. Absence of this field means that all signals on the specific SV are bad.</p>

– *GNSS-DataBitAssistance*

The IE *GNSS-DataBitAssistance* is used by the location server to provide data bit assistance data for specific satellite signals for data wipe-off. The data bits included in the assistance data depends on the GNSS and its signal.

```
-- ASN1START
GNSS-DataBitAssistance ::= SEQUENCE {
    gnss-TOD             INTEGER (0..3599),
    gnss-TODfrac         INTEGER (0..999)  OPTIONAL,  -- Need ON
    gnss-DataBitsSatList GNSS-DataBitsSatList,
    ...
}
GNSS-DataBitsSatList ::= SEQUENCE (SIZE(1..64)) OF GNSS-DataBitsSatElement
```

```

GNSS-DataBitsSatElement ::= SEQUENCE {
    svID                SV-ID,
    gnss-DataBitsSgnList  GNSS-DataBitsSgnList,
    ...
}

GNSS-DataBitsSgnList ::= SEQUENCE (SIZE(1..8)) OF GNSS-DataBitsSgnElement

GNSS-DataBitsSgnElement ::= SEQUENCE {
    gnss-SignalType     GNSS-SignalID,
    gnss-DataBits       BIT STRING (SIZE (1..1024)),
    ...
}

-- ASN1STOP

```

GNSS-DataBitAssistance field descriptions

gnss-TOD

This field specifies the reference time of the first bit of the data in *GNSS-DataBitAssistance* in integer seconds in GNSS specific system time, modulo 1 hour.
Scale factor 1 second.

gnss-TODfrac

This field specifies the fractional part of the *gnss-TOD* in 1-milli-second resolution.
Scale factor 1 millisecond. The total GNSS TOD is *gnss-TOD* + *gnss-TODfrac*.

gnss-DataBitsSatList

This list specifies the data bits for a particular GNSS satellite *SV-ID* and signal *GNSS-SignalID*.

svID

This field specifies the GNSS *SV-ID* of the satellite for which the *GNSS-DataBitAssistance* is given.

gnss-SignalType

This field identifies the GNSS signal type of the *GNSS-DataBitAssistance*.

gnss-DataBits

Data bits are contained in GNSS system and data type specific format.

In the case of GPS L1 C/A, it contains the NAV data modulation bits as defined in [4].

In the case of Modernized GPS L1C, it contains the encoded and interleaved modulation symbols as defined in [6] clause 3.2.3.1. In the case of Modernized GPS L2C, it contains either the NAV data modulation bits, the FEC encoded NAV data modulation symbols, or the FEC encoded CNAV data modulation symbols, dependent on the current signal configuration of this satellite as defined in [4, Table 3-III]. In the case of Modernized GPS L5, it contains the FEC encoded CNAV data modulation symbols as defined in [5].

In the case of SBAS, it contains the FEC encoded data modulation symbols as defined in [10].

In the case of QZSS QZS-L1, it contains the NAV data modulation bits as defined in [7] clause 5.2. In the case of QZSS QZS-L1C, it contains the encoded and interleaved modulation symbols as defined in [7] clause 5.3. In the case of QZSS QZS-L2C, it contains the encoded modulation symbols as defined in [7] clause 5.5. In the case of QZSS QZS-L5, it contains the encoded modulation symbols as defined in [7] clause 5.6.

In the case of GLONASS, it contains the 100 sps differentially Manchester encoded modulation symbols as defined in [9] clause 3.3.2.2.

In the case of Galileo, it contains the FEC encoded and interleaved modulation symbols. The logical levels 1 and 0 correspond to signal levels -1 and +1, respectively.

In the case of BDS B1I, it contains the encoded and interleaved modulation symbols as defined in [23], clause 5.1.3. In the case of BDS B1C, it contains the encoded and interleaved modulation symbols as defined in [39], clause 6.2.2. In the case of NavIC, it contains the FEC encoded and interleaved Navigation symbols as defined in [38].

GNSS-AcquisitionAssistance

The IE *GNSS-AcquisitionAssistance* is used by the location server to provide parameters that enable fast acquisition of the GNSS signals. Essentially, these parameters describe the range and derivatives from respective satellites to the reference location at the reference time *GNSS-SystemTime* provided in IE *GNSS-ReferenceTime*.

Whenever *GNSS-AcquisitionAssistance* is provided by the location server, the IE *GNSS-ReferenceTime* shall be provided as well. E.g., even if the target device request for assistance data includes only a request for *GNSS-AcquisitionAssistance*, the location server shall also provide the corresponding IE *GNSS-ReferenceTime*.

Figure 6.5.2.2-1 illustrates the relation between some of the fields, using GPS TOW as exemplary reference.

```

-- ASN1START
GNSS-AcquisitionAssistance ::= SEQUENCE {
    gnss-SignalID          GNSS-SignalID,
    gnss-AcquisitionAssistList  GNSS-AcquisitionAssistList,
    ...,
    confidence-r10          INTEGER (0..100)    OPTIONAL    -- Need ON
}

GNSS-AcquisitionAssistList ::= SEQUENCE (SIZE(1..64)) OF GNSS-AcquisitionAssistElement

GNSS-AcquisitionAssistElement ::= SEQUENCE {
    svID                   SV-ID,
    doppler0                INTEGER (-2048..2047),
    doppler1                INTEGER (0..63),
    dopplerUncertainty      INTEGER (0..4),
    codePhase               INTEGER (0..1022),
    intCodePhase            INTEGER (0..127),
    codePhaseSearchWindow  INTEGER (0..31),
    azimuth                 INTEGER (0..511),
    elevation               INTEGER (0..127),
    ...,
    codePhase1023           BOOLEAN          OPTIONAL,    -- Need OP
    dopplerUncertaintyExt-r10  ENUMERATED {    d60,
                                                d80,
                                                d100,
                                                d120,
                                                noInformation, ... }    OPTIONAL    -- Need ON
}
-- ASN1STOP

```

GNSS-AcquisitionAssistance field descriptions

gnss-SignalID

This field specifies the GNSS signal for which the acquisition assistance are provided.

gnss-AcquisitionAssistList

These fields provide a list of acquisition assistance data for each GNSS satellite.

confidence

This field specifies the confidence level of the reference location area or volume used to calculate the acquisition assistance parameters (search windows). A high percentage value (e.g., 98% or more) indicates to the target device that the provided search windows are reliable. The location server should include this field to indicate the confidence level of the provided information.

svID

This field specifies the GNSS SV-ID of the satellite for which the *GNSS-AcquisitionAssistance* is given.

doppler0

This field specifies the Doppler (0th order term) value. A positive value in Doppler defines the increase in satellite signal frequency due to velocity towards the target device. A negative value in Doppler defines the decrease in satellite signal frequency due to velocity away from the target device. Doppler is given in unit of m/s by multiplying the Doppler value in Hz by the nominal wavelength of the assisted signal.

Scale factor 0.5 m/s in the range from -1024 m/s to +1023.5 m/s.

doppler1

This field specifies the Doppler (1st order term) value. A positive value defines the rate of increase in satellite signal frequency due to acceleration towards the target device. A negative value defines the rate of decrease in satellite signal frequency due to acceleration away from the target device.

Scale factor 1/210 m/s² in the range from -0.2 m/s² to +0.1 m/s².

Actual value of Doppler (1st order term) is calculated as $(-42 + \text{doppler1}) * 1/210 \text{ m/s}^2$, with *doppler1* in the range of 0...63.

dopplerUncertainty

This field specifies the Doppler uncertainty value. It is defined such that the Doppler experienced by a stationary target device is in the range [Doppler-Doppler Uncertainty] to [Doppler+Doppler Uncertainty]. Doppler Uncertainty is given in unit of m/s by multiplying the Doppler Uncertainty value in Hz by the nominal wavelength of the assisted signal.

Defined values: 2.5 m/s, 5 m/s, 10 m/s, 20 m/s, 40 m/s as encoded by an integer *n* in the range 0-4 according to:

$$2^{-n}(40) \text{ m/s}; n = 0 - 4.$$

If the *dopplerUncertaintyExt* field is present, the target device that supports the *dopplerUncertaintyExt* shall ignore this field.

GNSS-AcquisitionAssistance field descriptions	
codePhase	This field together with the <i>codePhase1023</i> field specifies the code phase, in units of milli-seconds, in the range from 0 to 1 millisecond scaled by the nominal chipping rate of the GNSS signal, where increasing values of the field signify increasing predicted signal code phases, as seen by a receiver at the reference location at the reference time. The reference location would typically be an <i>a priori</i> estimate of the target device location. Scale factor 2^{-10} ms in the range from 0 to $(1-2^{-10})$ ms. Note: The value $(1-2^{-10})$ ms is encoded using the <i>codePhase1023</i> IE.
intCodePhase	This field contains integer code phase (expressed modulo 128 ms). The satellite integer milli-seconds code phase currently being transmitted at the reference time, as seen by a receiver at the reference location is calculated as reference time (expressed in milli-seconds) minus (<i>intCodePhase</i> + ($n \times 128$ ms)), as shown in Figure 6.5.2.2-1, with $n = \dots, -2, -1, 0, 1, 2, \dots$ Scale factor 1 ms in the range from 0 to 127 ms.
codePhaseSearchWindow	This field contains the code phase search window. The code phase search window accounts for the uncertainty in the estimated target device location but not any uncertainty in reference time. It is defined such that the expected code phase is in the range [Code Phase–Code Phase Search Window] to [Code Phase+Code Phase Search Window] given in units of milli-seconds. Range 0-31, mapping according to the table <i>codePhaseSearchWindow</i> Value to Code Phase Search Window [ms] relation shown below.
azimuth	This field specifies the azimuth angle. An angle of x degrees means the satellite azimuth a is in the range ($x \leq a < x+0.703125$) degrees. Scale factor 0.703125 degrees.
elevation	This field specifies the elevation angle. An angle of y degrees means the satellite elevation e is in the range ($y \leq e < y+0.703125$) degrees. Scale factor 0.703125 degrees.
codePhase1023	This field if set to TRUE indicates that the code phase has the value $1023 \times 2^{-10} = (1-2^{-10})$ ms. This field may only be set to TRUE if the value provided in the <i>codePhase</i> IE is 1022. If this field is set to FALSE, the code phase is the value provided in the <i>codePhase</i> IE in the range from 0 to $(1 - 2 \times 2^{-10})$ ms. If this field is not present and the <i>codePhase</i> IE has the value 1022, the target device may assume that the code phase is between $(1 - 2 \times 2^{-10})$ and $(1 - 2^{-10})$ ms.
dopplerUncertaintyExt	If this field is present, the target device that supports this field shall ignore the <i>dopplerUncertainty</i> field. The location server should include this field only if supported by the target device. This field specifies the Doppler uncertainty value. It is defined such that the Doppler experienced by a stationary target device is in the range [Doppler–Doppler Uncertainty] to [Doppler+Doppler Uncertainty]. Doppler Uncertainty is given in unit of m/s by multiplying the Doppler Uncertainty value in Hz by the nominal wavelength of the assisted signal. Enumerated values define 60 m/s, 80 m/s, 100 m/s, 120 m/s, and "No Information".

codePhaseSearchWindow Value to Code Phase Search Window [ms] relation

codePhaseSearchWindow Value	Code Phase Search Window [ms]
'00000'	No information
'00001'	0,002
'00010'	0,004
'00011'	0,008
'00100'	0,012
'00101'	0,016
'00110'	0,024
'00111'	0,032
'01000'	0,048
'01001'	0,064
'01010'	0,096
'01011'	0,128
'01100'	0,164
'01101'	0,200
'01110'	0,250
'01111'	0,300
'10000'	0,360
'10001'	0,420

'10010'	0,480
'10011'	0,540
'10100'	0,600
'10101'	0,660
'10110'	0,720
'10111'	0,780
'11000'	0,850
'11001'	1,000
'11010'	1,150
'11011'	1,300
'11100'	1,450
'11101'	1,600
'11110'	1,800
'11111'	2,000

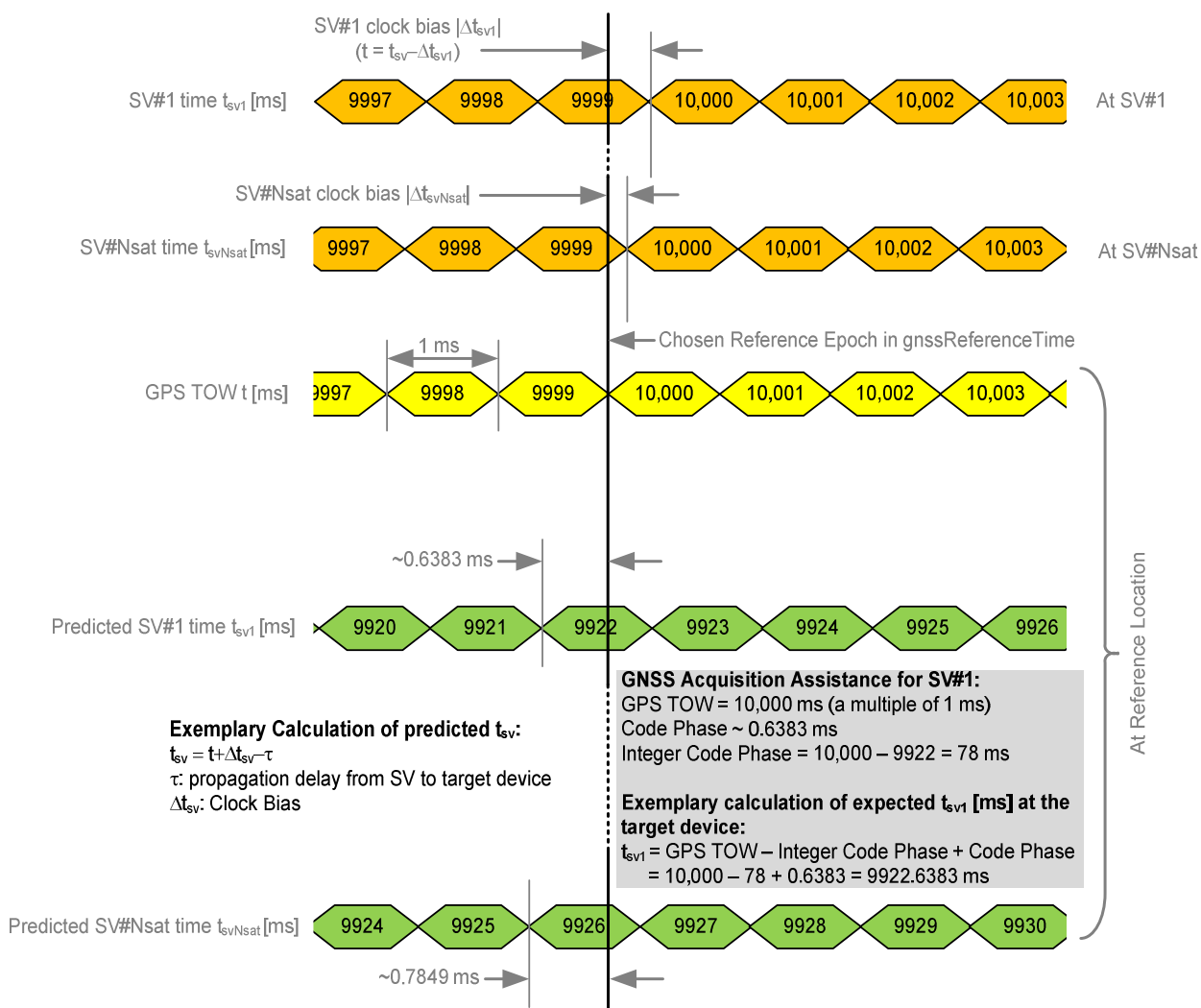

Figure 6.5.2.2-1: Exemplary calculation of some GNSS Acquisition Assistance fields.

– GNSS-Almanac

The IE *GNSS-Almanac* is used by the location server to provide the coarse, long-term model of the satellite positions and clocks. The meaning of these parameters is defined in relevant ICDs of the particular GNSS and GNSS specific interpretations apply. For example, GPS and QZSS use the same model parameters but some parameters have a different interpretation [7]. *GNSS-Almanac* is useful for receiver tasks that require coarse accuracy, such as determining satellite visibility. The model is valid for up to a few weeks, typically. Since it is a long-term model, the field should be provided for all satellites available in the GNSS constellation (i.e., not only for SVs visible at the reference location and including SVs flagged as unhealthy in almanac). The *completeAlmanacProvided* field indicates whether or not the location server provided almanacs for the complete GNSS constellation.

```
-- ASN1START
GNSS-Almanac ::= SEQUENCE {
    weekNumber          INTEGER (0..255)    OPTIONAL,  -- Need ON
    toa                 INTEGER (0..255)    OPTIONAL,  -- Need ON
    ioda               INTEGER (0..3)      OPTIONAL,  -- Need ON
    completeAlmanacProvided  BOOLEAN,
    gnss-AlmanacList    GNSS-AlmanacList,
    ...,
    [[ toa-ext-v1240      INTEGER (256..1023)  OPTIONAL,  -- Need ON
      ioda-ext-v1240     INTEGER (4..15)       OPTIONAL  -- Need ON
    ]],
    [[
      weekNumber-ext-r16  INTEGER (256..8191)   OPTIONAL,  -- Need ON
      toa-ext2-r16        INTEGER (256..65535)  OPTIONAL  -- Need ON
    ]]
}

GNSS-AlmanacList ::= SEQUENCE (SIZE(1..64)) OF GNSS-AlmanacElement

GNSS-AlmanacElement ::= CHOICE {
    keplerianAlmanacSet      AlmanacKeplerianSet,      -- Model-1
    keplerianNAV-Almanac     AlmanacNAV-KeplerianSet,  -- Model-2
    keplerianReducedAlmanac  AlmanacReducedKeplerianSet, -- Model-3
    keplerianMidiAlmanac     AlmanacMidiAlmanacSet,    -- Model-4
    keplerianGLONASS         AlmanacGLONASS-AlmanacSet, -- Model-5
    ecef-SBAS-Almanac        AlmanacECEF-SBAS-AlmanacSet, -- Model-6
    ...,
    keplerianBDS-Almanac-r12  AlmanacBDS-AlmanacSet-r12, -- Model-7
    keplerianNavIC-Almanac-r16  AlmanacNavIC-AlmanacSet-r16 -- Model-8
}

-- ASN1STOP
```

GNSS-Almanac field descriptions

weekNumber, weekNumber-ext

This field specifies the almanac reference week number in GNSS specific system time to which the almanac reference time *toa* is referenced, modulo 256 weeks. Either *weekNumber* or *weekNumber-ext* is required for non-GLONASS GNSSs.

In the case of Galileo, the almanac reference week number WN_a natively contains only the 2 LSB's [8], clause 5.1.10].

In the case of BDS B1C, the almanac reference week number is defined in [39], 7.9.1.

In the case of NavIC, the almanac reference week number is defined in [38].

toa, toa-ext, toa-ext2

In the cases that *GNSS-ID* does not indicate Galileo or NavIC, this field specifies the almanac reference time given in GNSS specific system time, in units of seconds with a scale factor of 2^{12} . *toa* is required for non-GLONASS GNSSs when the *toa-ext2* is not present.

In the case that *GNSS-ID* indicates Galileo, this field specifies the almanac reference time given in GNSS specific system time, in units of seconds with a scale factor of 600 seconds. Either *toa* or *toa-ext* is required for Galileo GNSS. In the case that *GNSS-ID* indicates NavIC, this field specifies the almanac reference time given in GNSS specific system time, in units of seconds with a scale factor of 16 seconds [38]. Either *toa* or *toa-ext2* is required for NavIC GNSS.

ioda, ioda-ext

This field specifies the issue of data. Either *ioda* or *ioda-ext* is required for Galileo GNSS.

completeAlmanacProvided

If set to TRUE, the *gnss-AlmanacList* contains almanacs for the complete GNSS constellation indicated by *GNSS-ID*.

gnss-AlmanacList

This list contains the almanac model for each GNSS satellite in the GNSS constellation.

– AlmanacKeplerianSet

```

-- ASN1START
AlmanacKeplerianSet ::= SEQUENCE {
    svID                SV-ID,
    kepAlmanacE         INTEGER (0..2047),
    kepAlmanacDeltaI   INTEGER (-1024..1023),
    kepAlmanacOmegaDot INTEGER (-1024..1023),
    kepSV-StatusINAV   BIT STRING (SIZE (4)),
    kepSV-StatusFNAV   BIT STRING (SIZE (2))           OPTIONAL,  -- Need ON
    kepAlmanacPowerHalf INTEGER (-4096..4095),
    kepAlmanacOmega0   INTEGER (-32768..32767),
    kepAlmanacW         INTEGER (-32768..32767),
    kepAlmanacM0        INTEGER (-32768..32767),
    kepAlmanacAF0       INTEGER (-32768..32767),
    kepAlmanacAF1       INTEGER (-4096..4095),
    ...
}
-- ASN1STOP

```

AlmanacKeplerianSet field descriptions

svID	This field identifies the satellite for which the GNSS Almanac Model is given.
kepAlmanacE	Parameter e, eccentricity, dimensionless [8]. Scale factor 2^{-16} .
kepAlmanacDeltaI	Parameter δ_i , inclination at reference time relative to $i_0=56^\circ$; semi-circles [8]. Scale factor 2^{-14} semi-circles.
kepAlmanacOmegaDot	Parameter $\dot{\Omega}$, rate of change of right ascension (semi-circles/sec) [8]. Scale factor 2^{-33} semi-circles/seconds.
kepSV-StatusINAV	This field contains the I/NAV signal health status [8], clause 5.1.10 , E5b _{HS} and E1-B _{HS} , where E5b _{HS} occupies the 2 MSBs in <i>kepSV-StatusINAV</i> , and E1-B _{HS} the two LSBs.
kepSV-StatusFNAV	This field contains the F/NAV signal health status [8], clause 5.1.10 ,E5a _{HS} . If the target device is supporting multiple Galileo signals, the location server shall include this field.
kepAlmanacAPowerHalf	Parameter $\Delta(a^{1/2})$, difference with respect to the square root of the nominal semi-major axis, (metres) ^{1/2} [8]. Scale factor 2^{-9} metres ^{1/2} .
kepAlmanacOmega0	Parameter OMEGA ₀ , longitude of ascending node of orbital plane at weekly epoch (semi-circles) [8]. Scale factor 2^{-15} semi-circles.
kepAlmanacW	Parameter ω , argument of perigee (semi-circles) [8]. Scale factor 2^{-15} semi-circles.
kepAlmanacM0	Parameter M ₀ , mean anomaly at reference time (semi-circles) [8]. Scale factor 2^{-15} semi-circles.
kepAlmanacAF0	Parameter af ₀ , satellite clock correction bias, seconds [8]. Scale factor 2^{-19} seconds.
kepAlmanacAF1	Parameter af ₁ , satellite clock correction linear, sec/sec [8]. Scale factor 2^{-38} seconds/second.

– AlmanacNAV-KeplerianSet

```

-- ASN1START
AlmanacNAV-KeplerianSet ::= SEQUENCE {
    svID                SV-ID,
    navAlmE             INTEGER (0..65535),
    navAlmDeltaI        INTEGER (-32768..32767),

```

```

navAlmOMEGADOT      INTEGER (-32768..32767),
navAlmSVHealth      INTEGER (0..255),
navAlmSqrtA         INTEGER (0..16777215),
navAlmOMEGAo        INTEGER (-8388608..8388607),
navAlmOmega         INTEGER (-8388608..8388607),
navAlmMo            INTEGER (-8388608..8388607),
navAlmaf0           INTEGER (-1024..1023),
navAlmaf1           INTEGER (-1024..1023),
...
}
-- ASN1STOP

```

AlmanacNAV-KeplerianSet field descriptions

svID

This field identifies the satellite for which the GNSS Almanac Model is given.

navAlmE

Parameter e , eccentricity, dimensionless [4,7].
Scale factor 2^{-21} .

navAlmDeltai

Parameter δ_i , correction to inclination, semi-circles [4,7].
Scale factor 2^{-19} semi-circles.

navAlmOMEGADOT

Parameter $\dot{\Omega}$, rate of right ascension, semi-circles/sec [4,7].
Scale factor 2^{-38} semi-circles/second.

navAlmSVHealth

Parameter SV Health, satellite health [4,7].

navAlmSqrtA

Parameter \sqrt{A} , square root of the semi-major axis, metres² [4,7]
Scale factor 2^{-11} metres².

navAlmOMEGAo

Parameter Ω_0 , longitude of ascending node of orbit plane at weekly epoch, semi-circles [4,7].
Scale factor 2^{-23} semi-circles.

navAlmOmega

Parameter ω , argument of perigee semi-circles [4,7].
Scale factor 2^{-23} semi-circles.

navAlmMo

Parameter M_0 , mean anomaly at reference time semi-circles [4,7].
Scale factor 2^{-23} semi-circles.

navAlmaf0

Parameter a_{i0} , apparent satellite clock correction seconds [4,7].
Scale factor 2^{-20} seconds.

navAlmaf1

Parameter a_{i1} , apparent satellite clock correction sec/sec [4,7].
Scale factor 2^{-38} semi-circles seconds/second.

AlmanacReducedKeplerianSet

```

-- ASN1START
AlmanacReducedKeplerianSet ::= SEQUENCE {
    svID          SV-ID,
    redAlmDeltaA  INTEGER (-128..127),
    redAlmOmega0  INTEGER (-64..63),
    redAlmPhi0    INTEGER (-64..63),
    redAlmL1Health  BOOLEAN,
    redAlmL2Health  BOOLEAN,
    redAlmL5Health  BOOLEAN,
    ...
}
-- ASN1STOP

```

<i>AlmanacReducedKeplerianSet</i> field descriptions
svID This field identifies the satellite for which the GNSS Almanac Model is given.
redAlmDeltaA Parameter δ_A , metres [4], [5], [6], [7], [39]. Scale factor 2^{+9} metres.
redAlmOmega0 Parameter Ω_0 , semi-circles [4], [5], [6], [7], [39]. Scale factor 2^{-6} semi-circles.
redAlmPhi0 Parameter Φ_0 , semi-circles [4], [5], [6], [7], [39]. Scale factor 2^{-6} semi-circles.
redAlmL1Health Parameter L1 Health, dimensionless [4], [5], [6], [7]. If <i>GNSS-ID</i> = BDS, this field indicates the Satellite clock health state (the 8th bit) defined in table 7-14 [39] for BDS B1C.
redAlmL2Health Parameter L2 Health, dimensionless [4], [5], [6], [7]. If <i>GNSS-ID</i> = BDS, this field indicates the B1C signal health state (the 7th bit) defined in table 7-14 [39] for BDS B1C.
redAlmL5Health Parameter L5 Health, dimensionless [4], [5], [6], [7].

– *AlmanacMidiAlmanacSet*

```

-- ASN1START
AlmanacMidiAlmanacSet ::= SEQUENCE {
    svID                SV-ID,
    midiAlmE            INTEGER (0..2047),
    midiAlmDeltaI       INTEGER (-1024..1023),
    midiAlmOmegaDot     INTEGER (-1024..1023),
    midiAlmSqrtA        INTEGER (0..131071),
    midiAlmOmega0       INTEGER (-32768..32767),
    midiAlmOmega        INTEGER (-32768..32767),
    midiAlmMo           INTEGER (-32768..32767),
    midiAlmaf0          INTEGER (-1024..1023),
    midiAlmaf1          INTEGER (-512..511),
    midiAlmL1Health     BOOLEAN,
    midiAlmL2Health     BOOLEAN,
    midiAlmL5Health     BOOLEAN,
    ...
}
-- ASN1STOP

```

AlmanacMidiAlmanacSet field descriptions
<p>svID This field identifies the satellite for which the GNSS Almanac Model is given.</p>
<p>midiAlmE Parameter e, dimensionless [4], [5], [6], [7], [39]. Scale factor 2^{-16}.</p>
<p>midiAlmDeltaI Parameter δ_i, semi-circles [4], [5], [6], [7], [39]. Scale factor 2^{-14} semi-circles.</p>
<p>midiAlmOmegaDot Parameter $\dot{\Omega}$, semi-circles/sec [4], [5], [6], [7], [39]. Scale factor 2^{-33} semi-circles/second.</p>
<p>midiAlmSqrtA Parameter \sqrt{A}, metres^{1/2} [4], [5], [6], [7], [39]. Scale factor 2^{-4} metres^{1/2}.</p>
<p>midiAlmOmega0 Parameter Ω_0, semi-circles [4], [5], [6], [7], [39]. Scale factor 2^{-15} semi-circles.</p>
<p>midiAlmOmega Parameter ω, semi-circles [4], [5], [6], [7], [39]. Scale factor 2^{-15} semi-circles.</p>
<p>midiAlmMo Parameter M_0, semi-circles [4], [5], [6], [7], [39]. Scale factor 2^{-15} semi-circles.</p>
<p>midiAlmaf0 Parameter a_{f0}, seconds [4], [5], [6], [7], [39]. Scale factor 2^{-20} seconds.</p>
<p>midiAlmaf1 Parameter a_{f1}, sec/sec [4], [5], [6], [7], [39]. Scale factor 2^{-37} seconds/second.</p>
<p>midiAlmL1Health Parameter L1 Health, dimensionless [4], [5], [6], [7]. If <i>GNSS-ID</i> = BDS, this field indicates the satellite clock health state (the 8th bit) defined in table 7-14 [39] for BDS B1C.</p>
<p>midiAlmL2Health Parameter L2 Health, dimensionless [4], [5], [6], [7]. If <i>GNSS-ID</i> = BDS, this field indicates the B1C signal health state (the 7th bit) defined in table 7-14 [39] for BDS B1C.</p>
<p>midiAlmL5Health Parameter L5 Health, dimensionless [4], [5], [6], [7].</p>

AlmanacGLONASS-AlmanacSet

```

-- ASN1START
AlmanacGLONASS-AlmanacSet ::= SEQUENCE {
    gloAlm-NA          INTEGER (1..1461),
    gloAlmNA          INTEGER (1..24),
    gloAlmHA          INTEGER (0..31),
    gloAlmLambdaA     INTEGER (-1048576..1048575),
    gloAlmtLambdaA    INTEGER (0..2097151),
    gloAlmDeltaIa     INTEGER (-131072..131071),
    gloAlmDeltaTA     INTEGER (-2097152..2097151),
    gloAlmDeltaTdotA  INTEGER (-64..63),
    gloAlmEpsilonA    INTEGER (0..32767),
    gloAlmOmegaA      INTEGER (-32768..32767),
    gloAlmTauA        INTEGER (-512..511),
    gloAlmCA          INTEGER (0..1),
    gloAlmMA          BIT STRING (SIZE(2))
    ...
}
-- ASN1STOP

```

<i>AlmanacGLONASS-AlmanacSet</i> field descriptions
<i>gloAlmNA</i> Parameter N^A , days [9]. Scale factor 1 days.
<i>gloAlmna</i> Parameter n^A , dimensionless [9].
<i>gloAlmHA</i> Parameter H_n^A , dimensionless [9].
<i>gloAlmLambdaA</i> Parameter λ_n^A , semi-circles [9]. Scale factor 2^{20} semi-circles.
<i>gloAlmtlambdaA</i> Parameter $t_{\lambda_n^A}$, seconds [9]. Scale factor 2^{-5} seconds.
<i>gloAlmDeltala</i> Parameter Δi_n^A , semi-circles [9]. Scale factor 2^{20} semi-circles.
<i>gloAlmDeltaTA</i> Parameter ΔT_n^A , sec/orbit period [9]. Scale factor 2^{-9} seconds/orbit period.
<i>gloAlmDeltaTdotA</i> Parameter $\Delta T_DOT_n^A$, sec/orbit period ² [9]. Scale factor 2^{-14} seconds/orbit period ² .
<i>gloAlmEpsilonA</i> Parameter ϵ_n^A , dimensionless [9]. Scale factor 2^{20} .
<i>gloAlmOmegaA</i> Parameter ω_n^A , semi-circles [9]. Scale factor 2^{15} semi-circles.
<i>gloAlmTauA</i> Parameter τ_n^A , seconds [9]. Scale factor 2^{-18} seconds.
<i>gloAlmCA</i> Parameter C_n^A , dimensionless [9].
<i>gloAlmMA</i> Parameter M_n^A , dimensionless [9]. This parameter is present if its value is nonzero; otherwise it is not present.

AlmanacECEF-SBAS-AlmanacSet

```

-- ASN1START
AlmanacECEF-SBAS-AlmanacSet ::= SEQUENCE {
    sbasAlmDataID      INTEGER (0..3),
    svID               SV-ID,
    sbasAlmHealth      BIT STRING (SIZE(8)),
    sbasAlmXg          INTEGER (-16384..16383),
    sbasAlmYg          INTEGER (-16384..16383),
    sbasAlmZg          INTEGER (-256..255),
    sbasAlmXgdot       INTEGER (-4..3),
    sbasAlmYgdot       INTEGER (-4..3),
    sbasAlmZgdot       INTEGER (-8..7),
    sbasAlmTo          INTEGER (0..2047),
    ...
}
-- ASN1STOP

```

<i>AlmanacECEF-SBAS-AlmanacSet</i> field descriptions
<i>sbasAlmDataID</i> Parameter Data ID, dimensionless [10].
<i>svID</i> This field identifies the satellite for which the GNSS Almanac Model is given.
<i>sbasAlmHealth</i> Parameter Health, dimensionless [10].
<i>sbasAlmXg</i> Parameter X _G , metres [10]. Scale factor 2600 metres.
<i>sbasAlmYg</i> Parameter Y _G , metres [10]. Scale factor 2600 metres.
<i>sbasAlmZg</i> Parameter Z _G , metres [10]. Scale factor 26000 metres.
<i>sbasAlmXgdot</i> Parameter X _G Rat-of-Change, metres/second [10]. Scale factor 10 metres/second.
<i>sbasAlmYgDot</i> Parameter Y _G Rate-of-Change, metres/second [10]. Scale factor 10 metres/second.
<i>sbasAlmZgDot</i> Parameter Z _G Rate-of-Change, metres/second [10]. Scale factor 40.96 metres/second.
<i>sbasAlmTo</i> Parameter t ₀ , seconds [10]. Scale factor 64 metres/second.

AlmanacBDS-AlmanacSet

```

-- ASN1START
AlmanacBDS-AlmanacSet-r12 ::= SEQUENCE {
    svID                SV-ID,
    bdsAlmToa-r12      INTEGER (0..255)                OPTIONAL,    -- Cond NotSameForAllSV
    bdsAlmSqrtA-r12    INTEGER (0..16777215),
    bdsAlmE-r12        INTEGER (0..131071),
    bdsAlmW-r12        INTEGER (-8388608..8388607),
    bdsAlmM0-r12       INTEGER (-8388608..8388607),
    bdsAlmOmega0-r12   INTEGER (-8388608..8388607),
    bdsAlmOmegaDot-r12 INTEGER (-65536..65535),
    bdsAlmDeltaI-r12   INTEGER (-32768..32767),
    bdsAlmA0-r12       INTEGER (-1024..1023),
    bdsAlmA1-r12       INTEGER (-1024..1023),
    bdsSvHealth-r12    BIT STRING (SIZE(9))        OPTIONAL,    -- Cond SV-ID
    ...
}
-- ASN1STOP
    
```

Conditional presence	Explanation
<i>NotSameForAllSV</i>	This field may be present if the t _{0a} is not the same for all SVs; otherwise it is not present and the t _{0a} is provided in <i>GNSS-Almanac</i> .
<i>SV-ID</i>	This field is mandatory present if <i>SV-ID</i> is between 0 and 63; otherwise it is not present.

AlmanacBDS-AlmanacSet field descriptions
svID This field identifies the satellite for which the GNSS Almanac Model is given.
bdsAlmToa Parameter t_{oa} , Almanac reference time (seconds) [23] Scale factor 2^{12} seconds.
bdsAlmSqrtA Parameter $A^{1/2}$, Square root of semi-major axis (metres ^{1/2}) [23] Scale factor 2^{11} metres ^{1/2} .
bdsAlmE Parameter e , Eccentricity, dimensionless [23] Scale factor 2^{21} .
bdsAlmW Parameter ω , Argument of Perigee (semi-circles) [23] Scale factor 2^{23} semi-circles.
bdsAlmM0 Parameter M_0 , Mean anomaly at reference time (semi-circles) [23] Scale factor 2^{23} semi-circles.
bdsAlmOmega0 Parameter Ω_0 , Longitude of ascending node of orbital plane computed according to reference time (semi-circles) [23] Scale factor 2^{23} semi-circles.
bdsAlmOmegaDot Parameter $\dot{\Omega}$, Rate of right ascension (semi-circles/second) [23] Scale factor 2^{38} semi-circles/second.
bdsAlmDeltaI Parameter δ_i , Correction of orbit reference inclination at reference time (semi-circles) [23] Scale factor 2^{19} semi-circles.
bdsAlmA0 Parameter a_0 , Satellite clock bias (seconds) [23] Scale factor 2^{20} seconds.
bdsAlmA1 Parameter a_1 , Satellite clock rate (sec/sec) [23] Scale factor 2^{38} seconds/seconds.
bdsSvHealth This field indicates satellites health information as defined in [23] Table 5-16. The left most bit is the MSB.

AlmanacNavIC-AlmanacSet

```

-- ASN1START
AlmanacNavIC-AlmanacSet-r16 ::= SEQUENCE {
    svID-r16                SV-ID,
    navic-AlmToa-r16        INTEGER (0..65535)           OPTIONAL,  -- Cond NotSameForAllSV
    navic-AlmE-r16          INTEGER (0..65535),
    navic-AlmOMEGADOT-r16  INTEGER (-32768..32767),
    navic-AlmSqrtA-r16     INTEGER (0..16777215),
    navic-AlmOMEGAO-r16    INTEGER (-8388608..8388607),
    navic-AlmOmega-r16     INTEGER (-8388608..8388607),
    navic-AlmMo-r16        INTEGER (-8388608..8388607),
    navic-Almaf0-r16       INTEGER (-1024..1023),
    navic-Almaf1-r16       INTEGER (-1024..1023),
    ...
}
-- ASN1STOP

```

Conditional presence	Explanation
<i>NotSameForAllSV</i>	This field is optionally present, need ON, if the t_{oa} is not the same for all SVs; otherwise it is not present and the t_{oa} is provided in <i>GNSS-Almanac</i> .

AlmanacNavIC-AlmanacSet field descriptions	
svID	This field identifies the satellite for which the Almanac model is given
navic-AlmToa	This field provides the time of almanac set Scale factor 16 seconds.
navic-AlmE	Parameter e, eccentricity, dimensionless Scale factor 2^{21} .
navic-AlmOMEGADOT	Parameter $\dot{\Omega}$, rate of right ascension, semi-circles/sec Scale factor 2^{38} semi-circles/second
navic-AlmSqrta	Parameter \sqrt{A} , square root of the semi-major axis, metres ^{1/2} Scale factor 2^{11} metres ^{1/2} .
navic-AlmOMEGAo	Parameter Ω_0 , longitude of ascending node of orbit plane at weekly epoch, semi-circles Scale factor 2^{23} semi-circles.
navic-AlmOmega	Parameter ω , argument of perigee semi-circles Scale factor 2^{23} semi-circles.
navic-AlmMo	Parameter M_0 , mean anomaly at reference time semi-circles Scale factor 2^{23} semi-circles.
navic-Almaf0	Parameter a_0 , apparent satellite clock correction seconds Scale factor 2^{20} seconds.
navic-Almaf1	Parameter a_1 , apparent satellite clock correction sec/sec Scale factor 2^{38} semi-circles seconds/second.

– GNSS-UTC-Model

The IE *GNSS-UTC-Model* is used by the location server to provide several sets of parameters needed to relate GNSS system time to Universal Time Coordinate (UTC), as defined in [4], [5], [6], [7], [8], [9], [10], [23], [38], [39].

The UTC time standard, UTC(k), is GNSS specific. E.g., if *GNSS-ID* indicates GPS, *GNSS-UTC-Model* contains a set of parameters needed to relate GPS system time to UTC(USNO); if *GNSS-ID* indicates QZSS, *GNSS-UTC-Model* contains a set of parameters needed to relate QZST to UTC(NICT); if *GNSS-ID* indicates GLONASS, *GNSS-UTC-Model* contains a set of parameters needed to relate GLONASS system time to UTC(RU); if *GNSS-ID* indicates SBAS, *GNSS-UTC-Model* contains a set of parameters needed to relate SBAS network time for the SBAS indicated by *SBAS-ID* to the UTC standard defined by the UTC Standard ID; if *GNSS-ID* indicates BDS, *GNSS-UTC-Model* contains a set of parameters needed to relate BDS system time to UTC (NTSC), where *UTC-ModelSet2* is used for BDS B1C, and *UTC-ModelSet5* is used for BDS B1I; if the *GNSS-ID* indicates NavIC, the *GNSS-UTC-Model* contains a set of parameters needed to relate NavIC system time to the UTC (BIPM).

```
-- ASN1START
GNSS-UTC-Model ::= CHOICE {
    utcModel1      UTC-ModelSet1,          -- Model-1
    utcModel2      UTC-ModelSet2,          -- Model-2
    utcModel3      UTC-ModelSet3,          -- Model-3
    utcModel4      UTC-ModelSet4,          -- Model-4
    . . .
    utcModel5-r12  UTC-ModelSet5-r12      -- Model-5
}
-- ASN1STOP
```

– UTC-ModelSet1

```
-- ASN1START
UTC-ModelSet1 ::= SEQUENCE {
```

```

gnss-Utc-A1      INTEGER (-8388608..8388607),
gnss-Utc-A0      INTEGER (-2147483648..2147483647),
gnss-Utc-Tot     INTEGER (0..255),
gnss-Utc-WNt     INTEGER (0..255),
gnss-Utc-DeltaTls  INTEGER (-128..127),
gnss-Utc-WNlsf   INTEGER (0..255),
gnss-Utc-DN      INTEGER (-128..127),
gnss-Utc-DeltaTlsf  INTEGER (-128..127),
...
}
-- ASN1STOP

```

UTC-ModelSet1 field descriptions

gnss-Utc-A1

Parameter A_1 , scale factor 2^{-50} seconds/second [4,7,8].

gnss-Utc-A0

Parameter A_0 , scale factor 2^{-30} seconds [4,7,8].

gnss-Utc-Tot

Parameter t_{ot} , scale factor 2^{12} seconds [4,7,8].

gnss-Utc-WNt

Parameter WN_t , scale factor 1 week [4,7,8].

gnss-Utc-DeltaTls

Parameter Δ_{tLS} , scale factor 1 second [4,7,8].

gnss-Utc-WNlsf

Parameter WN_{LSF} , scale factor 1 week [4,7,8].

gnss-Utc-DN

Parameter DN, scale factor 1 day [4,7,8].

gnss-Utc-DeltaTlsf

Parameter Δ_{tLSF} , scale factor 1 second [4,7,8].

UTC-ModelSet2

```

-- ASN1START
UTC-ModelSet2 ::= SEQUENCE {
    utcA0      INTEGER (-32768..32767),
    utcA1      INTEGER (-4096..4095),
    utcA2      INTEGER (-64..63),
    utcDeltaTls  INTEGER (-128..127),
    utcTot      INTEGER (0..65535),
    utcWNt      INTEGER (0..8191),
    utcWNlsf    INTEGER (0..255),
    utcDN       BIT STRING (SIZE(4)),
    utcDeltaTlsf  INTEGER (-128..127),
    ...
    [ [
        utcWNlsf-ext-r16    INTEGER (256..8191) OPTIONAL    -- Need ON
    ] ]
}
-- ASN1STOP

```

UTC-ModelSet2 field descriptions

utcA0

Parameter A_{0-n} , bias coefficient of GNSS time scale relative to UTC time scale (seconds) [4], [5], [6], [7], [38], [39].
Scale factor 2^{-35} seconds.

utcA1

Parameter A_{1-n} , drift coefficient of GNSS time scale relative to UTC time scale (sec/sec) [4], [5], [6], [7], [38], [39].
Scale factor 2^{-51} seconds/second.

utcA2

Parameter A_{2-n} , drift rate correction coefficient of GNSS time scale relative to UTC time scale (sec/sec²) [4], [5], [6], [7], [38], [39].
Scale factor 2^{-68} seconds/second².

utcDeltaTls

Parameter Δ_{tLS} , current or past leap second count (seconds) [4], [5], [6], [7], [38], [39].
Scale factor 1 second.

UTC-ModelSet2 field descriptions
<p>utcTot Parameter t_{ot}, time data reference time of week (seconds) [4], [5], [6], [7], [38], [39]. Scale factor 2^4 seconds.</p>
<p>utcWNot Parameter $W_{N_{ot}}$, time data reference week number (weeks) [4], [5], [6], [7], [38], [39]. Scale factor 1 week.</p>
<p>utcWNlsf, utcWNlsf-ext Parameter $W_{N_{lsf}}$, leap second reference week number (weeks) [4], [5], [6], [7], [38], [39]. If the field <i>utcWNlsf-ext</i> is present, the field <i>utcWNlsf</i> shall be ignored by the receiver. Scale factor 1 week.</p>
<p>utcDN Parameter DN, leap second reference day number (days) [4], [5], [6], [7], [38], [39]. Scale factor 1 day.</p>
<p>utcDeltaTlsf Parameter Δt_{lsf}, current or future leap second count (seconds) [4], [5], [6], [7], [38], [39]. Scale factor 1 second.</p>

UTC-ModelSet3

```

-- ASN1START
UTC-ModelSet3 ::= SEQUENCE {
    nA                INTEGER (1..1461),
    tauC              INTEGER (-2147483648..2147483647),
    b1                INTEGER (-1024..1023)                OPTIONAL, -- Cond GLONASS-M
    b2                INTEGER (-512..511)                  OPTIONAL, -- Cond GLONASS-M
    kp                BIT STRING (SIZE(2))                OPTIONAL, -- Cond GLONASS-M
    ...
}
-- ASN1STOP

```

Conditional presence	Explanation
GLONASS-M	The field is mandatory present if GLONASS-M satellites are present in the current GLONASS constellation; otherwise it is not present.

UTC-ModelSet3 field descriptions
<p>nA Parameter N^A, calendar day number within four-year period beginning since the leap year (days) [9]. Scale factor 1 day.</p>
<p>tauC Parameter τ_c, GLONASS time scale correction to UTC(SU) (seconds) [9]. Scale factor 2^{-31} seconds.</p>
<p>b1 Parameter B1, coefficient to determine $\Delta UT1$ (seconds) [9]. Scale factor 2^{-10} seconds.</p>
<p>b2 Parameter B2, coefficient to determine $\Delta UT1$ (seconds/msd) [9]. Scale factor 2^{-16} seconds/msd.</p>
<p>kp Parameter KP, notification of expected leap second correction (dimensionless) [9].</p>

UTC-ModelSet4

```

-- ASN1START
UTC-ModelSet4 ::= SEQUENCE {
    utcAlwnt          INTEGER (-8388608..8388607),
    utcA0wnt          INTEGER (-2147483648..2147483647),
    utcTot            INTEGER (0..255),
    utcWNt            INTEGER (0..255),
    utcDeltaTls       INTEGER (-128..127),
    utcWNlsf          INTEGER (0..255),
    utcDN             INTEGER (-128..127),

```

```

utcDeltaTlsf      INTEGER (-128..127),
utcStandardID    INTEGER (0..7),
...
}
-- ASN1STOP

```

UTC-ModelSet4 field descriptions
<p>utcA1wnt Parameter A_{1WNT}, sec/sec ([10], Message Type 12). Scale factor 2^{50} seconds/second.</p>
<p>utcA0wnt Parameter A_{0WNT}, seconds ([10], Message Type 12). Scale factor 2^{30} seconds.</p>
<p>utcTot Parameter t_{ot}, seconds ([10], Message Type 12). Scale factor 2^{12} seconds.</p>
<p>utcWNt Parameter WN_t, weeks ([10], Message Type 12). Scale factor 1 week.</p>
<p>utcDeltaTls Parameter Δ_{tLS}, seconds ([10], Message Type 12). Scale factor 1 second.</p>
<p>utcWNlsf Parameter WN_{LSF}, weeks ([10], Message Type 12). Scale factor 1 week.</p>
<p>utcDN Parameter DN, days ([10], Message Type 12). Scale factor 1 day.</p>
<p>utcDeltaTlsf Parameter Δ_{tLSF}, seconds ([10], Message Type 12). Scale factor 1 second.</p>
<p>utcStandardID If GNSS-ID indicates 'sbas', this field indicates the UTC standard used for the SBAS network time indicated by SBAS-ID to UTC relation as defined in the table Value of UTC Standard ID to UTC Standard relation shown below ([10], Message Type 12).</p>

Value of UTC Standard ID to UTC Standard relation

Value of UTC Standard ID	UTC Standard
0	UTC as operated by the Communications Research Laboratory (CRL), Tokyo, Japan
1	UTC as operated by the National Institute of Standards and Technology (NIST)
2	UTC as operated by the U. S. Naval Observatory (USNO)
3	UTC as operated by the International Bureau of Weights and Measures (BIPM)
4-7	Reserved for future definition

UTC-ModelSet5

```

-- ASN1START
UTC-ModelSet5-r12 ::= SEQUENCE {
  utcA0-r12      INTEGER (-2147483648..2147483647),
  utcA1-r12      INTEGER (-8388608..8388607),
  utcDeltaTls-r12  INTEGER (-128..127),
  utcWNlsf-r12   INTEGER (0..255),
  utcDN-r12      INTEGER (0..255),
  utcDeltaTlsf-r12  INTEGER (-128..127),
  ...
}
-- ASN1STOP

```

UTC-ModelSet5 field descriptions
<p>utcA0 Parameter A_{0UTC}, BDS clock bias relative to UTC, seconds [23]. Scale factor 2^{-30} seconds.</p>
<p>utcA1 Parameter A_{1UTC}, BDS clock rate relative to UTC, sec/sec [23]. Scale factor 2^{-50} sec/sec.</p>
<p>utcDeltaTls Parameter Δ_{tLS}, delta time due to leap seconds before the new leap second effective, seconds [23]. Scale factor 1 second.</p>
<p>utcWNlSF Parameter WN_{LSF}, week number of the new leap second, weeks [23]. Scale factor 1 week.</p>
<p>utcDN Parameter DN, day number of week of the new leap second, days [23]. Scale factor 1 day.</p>
<p>utcDeltaTlSF Parameter Δ_{tLSF}, delta time due to leap seconds after the new leap second effective, seconds [23]. Scale factor 1 second.</p>

– GNSS-AuxiliaryInformation

The IE *GNSS-AuxiliaryInformation* is used by the location server to provide additional information dependent on the *GNSS-ID*. If *GNSS-AuxiliaryInformation* is provided together with other satellite dependent GNSS assistance data (i.e., any of *GNSS-DifferentialCorrections*, *GNSS-NavigationModel*, *GNSS-DataBitAssistance*, or *GNSS-AcquisitionAssistance* IEs), the *GNSS-AuxiliaryInformation* should be provided for the same satellites and in the same LPP message as the other satellite dependent GNSS assistance data.

```
-- ASN1START

GNSS-AuxiliaryInformation ::= CHOICE {
    gnss-ID-GPS          GNSS-ID-GPS,
    gnss-ID-GLONASS     GNSS-ID-GLONASS,
    ...,
    [[ gnss-ID-BDS-r16   GNSS-ID-BDS-r16
    ]]
}

GNSS-ID-GPS ::= SEQUENCE (SIZE(1..64)) OF GNSS-ID-GPS-SatElement

GNSS-ID-GPS-SatElement ::= SEQUENCE {
    svID                SV-ID,
    signalsAvailable    GNSS-SignalIDs,
    ...
}

GNSS-ID-GLONASS ::= SEQUENCE (SIZE(1..64)) OF GNSS-ID-GLONASS-SatElement

GNSS-ID-GLONASS-SatElement ::= SEQUENCE {
    svID                SV-ID,
    signalsAvailable    GNSS-SignalIDs,
    channelNumber       INTEGER (-7..13)          OPTIONAL,      -- Cond FDMA
    ...
}

GNSS-ID-BDS-r16 ::= SEQUENCE (SIZE(1..64)) OF GNSS-ID-BDS-SatElement-r16

GNSS-ID-BDS-SatElement-r16 ::= SEQUENCE {
    svID-r16            SV-ID,
    satType-r16         INTEGER (0..3),
    ...
}

-- ASN1STOP
```

Conditional presence	Explanation
<i>FDMA</i>	The field is mandatory present if the GLONASS SV indicated by <i>svID</i> broadcasts FDMA signals; otherwise it is not present.

GNSS-AuxiliaryInformation field descriptions	
gnss-ID-GPS	This choice may only be present if <i>GNSS-ID</i> indicates GPS.
gnss-ID-GLONASS	This choice may only be present if <i>GNSS-ID</i> indicates GLONASS.
gnss-ID-BDS	This choice may only be present if <i>GNSS-ID</i> indicates BDS.
svID	This field specifies the GNSS SV for which the <i>GNSS-AuxiliaryInformation</i> is given.
signalsAvailable	This field indicates the ranging signals supported by the satellite indicated by <i>svID</i> . This field is given as a bit string as defined in <i>GNSS-SignalIDs</i> for a particular GNSS. If a bit is set to '1' it indicates that the satellite identified by <i>svID</i> transmits ranging signals according to the signal correspondence in <i>GNSS-SignalIDs</i> . If a bit is set to '0' it indicates that the corresponding signal is not supported on the satellite identified by <i>svID</i> .
channelNumber	This field indicates the GLONASS carrier frequency number of the satellite identified by <i>svID</i> , as defined in [9].
satType	This field identifies the BDS B1C Satellite orbit type, defined in [39]. 1 indicates the GEO satellite, 2 indicates the IGSO satellite, 3 indicates the MEO satellite, and 0 is reserved.

– *BDS-DifferentialCorrections*

The IE *BDS-DifferentialCorrections* is used by the location server to provide differential corrections to the target device for BDS B1I.

```
-- ASN1START
BDS-DifferentialCorrections-r12 ::= SEQUENCE {
    dbds-RefTime-r12          INTEGER (0..3599),
    bds-SgnTypeList-r12      BDS-SgnTypeList-r12,
    ...
}

BDS-SgnTypeList-r12 ::= SEQUENCE (SIZE (1..3)) OF BDS-SgnTypeElement-r12

BDS-SgnTypeElement-r12 ::= SEQUENCE {
    gnss-SignalID            GNSS-SignalID          OPTIONAL,    -- Need ON
    dbds-CorrectionList-r12 DBDS-CorrectionList-r12,
    ...
}

DBDS-CorrectionList-r12 ::= SEQUENCE (SIZE (1..64)) OF DBDS-CorrectionElement-r12

DBDS-CorrectionElement-r12 ::= SEQUENCE {
    svID                    SV-ID,
    bds-UDREI-r12          INTEGER (0..15),
    bds-RURAI-r12          INTEGER (0..15),
    bds-ECC-DeltaT-r12     INTEGER (-4096..4095),
    ...
}
-- ASN1STOP
```

BDS-DifferentialCorrections field descriptions
<p><i>dbds-RefTime</i> This field <i>specifies</i> the time for which the differential corrections are valid, modulo 1 hour. <i>dbds-RefTime</i> is given in BDS system time. Scale factor 1-second.</p>
<p><i>bds-UDREI</i> This field indicates user differential range error information by user differential range error index (UDREI) as defined in [23], clause 5.3.3.8.2.</p>
<p><i>bds-RURAI</i> This field indicates Regional User Range Accuracy (RURA) information by Regional User Range Accuracy Index (UDREI) as defined in [23], clause 5.3.3.7.</p>
<p><i>bds-ECC-DeltaT</i> This field indicates the BDS differential correction information which is expressed in equivalent clock correction (Δt). Add the value of Δt to the observed pseudo-range to correct the effect caused by the satellite clock offset and ephemeris error. Value -4096 means the Δt is not available. The scale factor is 0.1 metre.</p>

– **BDS-GridModelParameter**

The IE *BDS-GridModelParameter* is used by the location server to provide Ionospheric Grid Information to the target device for BDS BII.

```
-- ASN1START
BDS-GridModelParameter-r12 ::= SEQUENCE {
    bds-RefTime-r12          INTEGER (0..3599),
    gridIonList-r12         GridIonList-r12,
    ...
}
GridIonList-r12 ::= SEQUENCE (SIZE (1..320)) OF GridIonElement-r12
GridIonElement-r12 ::= SEQUENCE {
    igp-ID-r12              INTEGER (1..320),
    dt-r12                  INTEGER (0..511),
    givei-r12               INTEGER (0..15),
    ...
}
-- ASN1STOP
```

BDS-GridModelParameter field descriptions
<p><i>bds-RefTime</i> This field specifies the time for which the grid model parameters are valid, modulo 1 hour. <i>bds-RefTime</i> is given in BDS system time. Scale factor 1-second.</p>
<p><i>gridIonList</i> This list provides ionospheric grid point information for each grid point. Up to 16 instances are used in this version of the specification. The values 17 to 320 are reserved for future use.</p>
<p><i>igp-ID</i> This field indicates the ionospheric grid point (IGP) number as defined in [23], clause 5.3.3.9.</p>
<p><i>dt</i> This field indicates d_T as defined in [23], clause 5.3.3.9.1, i.e. the vertical delay at the corresponding IGP indicated by <i>igp-ID</i>. The scale factor is 0.125 metre.</p>
<p><i>givei</i> This field indicates the Grid Ionospheric Vertical Error Index (GIVEI) which is used to describe the delay correction accuracy at ionospheric grid point indicated by <i>igp-ID</i>, the mapping between GIVEI and GIVE is defined in [23], clause 5.3.3.9.2.</p>

– **GNSS-RTK-Observations**

The IE *GNSS-RTK-Observations* is used by the location server to provide GNSS reference station observables (pseudorange, phaserange, phaserange-rate (Doppler), and carrier-to-noise ratio) of the GNSS signals. Essentially, these

parameters describe the range and derivatives from respective satellites to the reference station location provided in IE *GNSS-RTK-ReferenceStationInfo*.

The parameters provided in IE *GNSS-RTK-Observations* are used as specified for message type 1071-1127 in [30].

```
-- ASN1START

GNSS-RTK-Observations-r15 ::= SEQUENCE {
    epochTime-r15                GNSS-SystemTime,
    gnss-ObservationList-r15     GNSS-ObservationList-r15,
    ...
}

GNSS-ObservationList-r15 ::= SEQUENCE (SIZE(1..64)) OF GNSS-RTK-SatelliteDataElement-r15

GNSS-RTK-SatelliteDataElement-r15 ::= SEQUENCE{
    svID-r15                     SV-ID,
    integer-ms-r15               INTEGER (0..254)                OPTIONAL,    -- Need ON
    rough-range-r15              INTEGER (0..1023),
    rough-phase-range-rate-r15   INTEGER (-8192..8191)           OPTIONAL,    -- Need ON
    gnss-rtk-SatelliteSignalDataList-r15  GNSS-RTK-SatelliteSignalDataList-r15,
    ...
}

GNSS-RTK-SatelliteSignalDataList-r15 ::= SEQUENCE (SIZE(1..24)) OF
                                         GNSS-RTK-SatelliteSignalDataElement-r15

GNSS-RTK-SatelliteSignalDataElement-r15 ::= SEQUENCE {
    gnss-SignalID-r15           GNSS-SignalID,
    fine-PseudoRange-r15        INTEGER (-524288..524287),
    fine-PhaseRange-r15         INTEGER (-8388608..8388607),
    lockTimeIndicator-r15       INTEGER (0..1023),
    halfCycleAmbiguityIndicator-r15  BIT STRING (SIZE (1)),
    carrier-to-noise-ratio-r15   INTEGER (0..1023)                OPTIONAL,    -- Need ON
    fine-PhaseRangeRate-r15     INTEGER (-16384..16383)           OPTIONAL,    -- Need ON
    ...
}

-- ASN1STOP
```

GNSS-RTK-Observations field descriptions

epochTime

This field specifies the epoch time of the observations. The *gnss-TimeID* in *GNSS SystemTime* shall be the same as the *GNSS-ID* in IE *GNSS-GenericAssistDataElement*.

GNSS-RTK-Observations field descriptions	
svID	This field specifies the GNSS SV-ID of the satellite for which the GNSS Observations are provided.
integer-ms	This field contains the integer number of milliseconds in the satellite rough range. Rough range can be used to restore complete observables for a given satellite. Scale factor 1 milli-second in the range from 0 to 254 milli-seconds.
rough-range	This field contains the sub-milliseconds in the satellite rough range (modulo 1 millisecond). Scale factor 2^{-10} milli-seconds in the range from 0 to $(1-2^{-10})$ milli-seconds.
rough-phase-range-rate	This field contains the GNSS satellite rough phaserange rate. Scale factor 1 m/s. Range ± 8191 m/s.
gnss-SignalID	This field specifies the GNSS signal for which the GNSS observations are provided.
fine-PseudoRange	This field contains the GNSS signal fine pseudorange. Full pseudorange corresponding to the given signal is the sum of this field and the fields <i>integer-ms</i> and <i>rough-range</i> . NOTE 1. Scale factor 2^{-29} milli-seconds. Range $\pm(2^{-10}-2^{-29})$ milli-seconds.
fine-PhaseRange	This field contains the GNSS signal fine phaserange. Being added to fields <i>integer-ms</i> and <i>rough-range</i> allows getting the full phaserange observable corresponding to given signal. NOTE 2. Scale factor 2^{-31} milli-seconds. Range $\pm(2^{-8}-2^{-31})$ milli-seconds.
lockTimeIndicator	This field provides a measure of the amount of time during which the receiver has maintained continuous lock on that satellite signal. If a cycle slip occurs during the previous measurement cycle, the lock time indicator shall be reset to zero. The mapping of lock-time parameters as defined in [30] is according to the table <i>lockTimeIndicator</i> value to lock-time parameters relation shown below.
halfCycleAmbiguityIndicator	Value 0 indicates no half-cycle ambiguity. Value 1 indicates half-cycle ambiguity. When providing phaserange with unresolved polarity encoding this bit shall be set to 1. A target device that is not capable of handling half-cycle ambiguities shall skip such phaserange observables. If polarity resolution forced phaserange to be corrected by half-a-cycle, then the <i>lockTimeIndicator</i> must be reset to zero, indicating that despite continuous tracking the final phaserange experienced non-continuity.
carrier-to-noise-ratio	This field provides the GNSS signal carrier-to-noise-ratio in dB-Hz. Scale factor 2^{-4} dB-Hz in the range from 0.0625 to 63.9375 dB-Hz.
fine-PhaseRangeRate	This field contains the GNSS signal fine Phase Range Rate. Full phaserange rate is the sum of this field and the <i>rough-phase-range-rate</i> field. NOTE 3. Scale factor 0.0001 m/s. Range ± 1.6383 m/s.

NOTE 1: Complete Pseudorange for each signal (i) of given satellite can be restored as follows:

$$\text{Pseudorange}(i) = c/1000 \times (\text{integer-ms} + \text{rough_range}/1024 + 2^{-29} \times \text{fine_Pseudorange}(i)), \text{ metre.}$$

NOTE 2: Complete Phaserange for each signal (i) of given satellite can be restored as follows:

$$\text{Phaserange}(i) = c/1000 \times (\text{integer-ms} + \text{rough_range}/1024 + 2^{-31} \times \text{fine_Phaserange}(i)), \text{ metre.}$$

NOTE 3: Complete PhaseRangeRate for each signal (i) of given satellite can be restored as follows:

$$\text{PhaseRangeRate}(i) = \text{rough-phase-range-rate} + 0.0001 * \text{fine-PhaseRangeRate} (i), \text{ metre/second.}$$

NOTE 4: The speed of light c is 299,792,458 metres per second.

lockTimeIndicator value to lock-time parameters relation

lockTimeIndicator value (i)	Supplementary coefficient (k) [30]	Minimum Lock Time (ms) [30]	Range of Indicated Lock Times (t) (ms) [30]
0 – 63	1	i	$0 \leq t < 64$
64 – 95	2	$2 \times i - 64$	$64 \leq t < 128$
96 – 127	4	$4 \times i - 256$	$128 \leq t < 256$
128 – 159	8	$8 \times i - 768$	$256 \leq t < 512$
160 – 191	16	$16 \times i - 2048$	$512 \leq t < 1024$
192 – 223	32	$32 \times i - 5120$	$1024 \leq t < 2048$
224 – 255	64	$64 \times i - 12288$	$2048 \leq t < 4096$
256 – 287	128	$128 \times i - 28672$	$4096 \leq t < 8192$
288 – 319	256	$256 \times i - 65536$	$8192 \leq t < 16384$
320 – 351	512	$512 \times i - 147456$	$16384 \leq t < 32768$
352 – 383	1024	$1024 \times i - 327680$	$32768 \leq t < 65536$
384 – 415	2048	$2048 \times i - 720896$	$65536 \leq t < 131072$
416 – 447	4096	$4096 \times i - 1572864$	$131072 \leq t < 262144$
448 – 479	8192	$8192 \times i - 3407872$	$262144 \leq t < 524288$
480 – 511	16384	$16384 \times i - 7340032$	$524288 \leq t < 1048576$
512 – 543	32768	$32768 \times i - 15728640$	$1048576 \leq t < 2097152$
544 – 575	65536	$65536 \times i - 33554432$	$2097152 \leq t < 4194304$
576 – 607	131072	$131072 \times i - 71303168$	$4194304 \leq t < 8388608$
608 – 639	262144	$262144 \times i - 150994944$	$8388608 \leq t < 16777216$
640 – 671	524288	$524288 \times i - 318767104$	$16777216 \leq t < 33554432$
672 – 703	1048576	$1048576 \times i - 671088640$	$33554432 \leq t < 67108864$
704	2097152	$2097152 \times i - 1409286144$	$67108864 \leq t$
705 – 1023		Reserved	

GLO-RTK-BiasInformation

The IE *GLO-RTK-BiasInformation* is used by the location server to provide the so-called "GLONASS Code-Phase bias values" (CPB) for up to all FDMA GLONASS observations.

If IE *GNSS-RTK-Observations* for *gnss-ID = glonass* are provided, but IE *GLO-RTK-BiasInformation* is not provided, the target device assumes that the CPB information has been applied to the GLONASS observation data a priori.

The parameters provided in IE *GLO-RTK-BiasInformation* are used as specified for message type 1230 in [30].

```
-- ASN1START
GLO-RTK-BiasInformation-r15 ::= SEQUENCE{
  referenceStationID-r15      GNSS-ReferenceStationID-r15,
  cpbIndicator-r15           BIT STRING (SIZE(1)),
  l1-ca-cpBias-r15          INTEGER (-32768..32767)          OPTIONAL,      -- Need ON
  l1-p-cpBias-r15          INTEGER (-32768..32767)          OPTIONAL,      -- Need ON
  l2-ca-cpBias-r15          INTEGER (-32768..32767)          OPTIONAL,      -- Need ON
  l2-p-cpBias-r15          INTEGER (-32768..32767)          OPTIONAL,      -- Need ON
  ...
}
-- ASN1STOP
```

GLO-RTK-BiasInformation field descriptions**referenceStationID**

This field specifies the Station ID for which the *GLO-RTK-BiasInformation* is provided.

cpbIndicator

This field specifies the GLONASS Code-Phase Bias Indicator. The interpretation of the value is as follows:

0 – The GLONASS Pseudorange and Phasorange observations in IE *GNSS-RTK-Observations* are not aligned to the same measurement epoch.

1 – The GLONASS Pseudorange and Phasorange observations in IE *GNSS-RTK-Observations* are aligned to the same measurement epoch.

GLO-RTK-BiasInformation field descriptions
<p>I1-ca-cpBias</p> <p>This field specifies the GLONASS L1 C/A Code-Phase Bias, which represents the offset between the L1 C/A Pseudorange and L1 Phasorange measurement epochs in metres.</p> <p>If <i>cpbIndicator</i> is set to 0, the measurement epoch of the GLONASS L1 Phasorange measurements may be aligned using:</p> <p style="padding-left: 2em;">Aligned GLONASS L1 Phasorange = Full GLONASS L1 Phasorange + GLONASS L1 C/A Code-Phase Bias.</p> <p>If <i>cpbIndicator</i> is set to 1, the measurement epoch of the GLONASS L1 Phasorange measurements may be unaligned using:</p> <p style="padding-left: 2em;">Unaligned GLONASS L1 Phasorange = Full GLONASS L1 Phasorange – GLONASS L1 C/A Code-Phase Bias.</p> <p>Scale factor 0.02 m. Range ± 655.34 m.</p>
<p>I1-p-cpBias</p> <p>This field specifies the GLONASS L1 P Code-Phase Bias, which represents the offset between the L1 P Pseudorange and L1 Phasorange measurement epochs in metres.</p> <p>If <i>cpbIndicator</i> is set to 0, the measurement epoch of the GLONASS L1 Phasorange measurements may be aligned using:</p> <p style="padding-left: 2em;">Aligned GLONASS L1 Phasorange = Full GLONASS L1 Phasorange + GLONASS L1 P Code-Phase Bias.</p> <p>If <i>cpbIndicator</i> is set to 1, the measurement epoch of the GLONASS L1 Phasorange measurements may be unaligned using:</p> <p style="padding-left: 2em;">Unaligned GLONASS L1 Phasorange = Full GLONASS L1 Phasorange – GLONASS L1 P Code-Phase Bias.</p> <p>Scale factor 0.02 m. Range ± 655.34 m.</p>
<p>I2-ca-cpBias</p> <p>This field specifies the GLONASS L2 C/A Code-Phase Bias, which represents the offset between the L2 C/A Pseudorange and L2 Phasorange measurement epochs in metres.</p> <p>If <i>cpbIndicator</i> is set to 0, the measurement epoch of the GLONASS L2 Phasorange measurements may be aligned using:</p> <p style="padding-left: 2em;">Aligned GLONASS L2 Phasorange = Full GLONASS L2 Phasorange + GLONASS L2 C/A Code-Phase Bias.</p> <p>If <i>cpbIndicator</i> is set to 1, the measurement epoch of the GLONASS L2 Phasorange measurements may be unaligned using:</p> <p style="padding-left: 2em;">Unaligned GLONASS L2 Phasorange = Full GLONASS L2 Phasorange – GLONASS L2 C/A Code-Phase Bias.</p> <p>Scale factor 0.02 m. Range ± 655.34 m.</p>
<p>I2-p-cpBias</p> <p>This field specifies the GLONASS L2 P Code-Phase Bias, which represents the offset between the L2 P Pseudorange and L2 Phasorange measurement epochs in metres.</p> <p>If <i>cpbIndicator</i> is set to 0, the measurement epoch of the GLONASS L2 Phasorange measurements may be aligned using:</p> <p style="padding-left: 2em;">Aligned GLONASS L2 Phasorange = Full GLONASS L2 Phasorange + GLONASS L2 P Code-Phase Bias.</p> <p>If <i>cpbIndicator</i> is set to 1, the measurement epoch of the GLONASS L2 Phasorange measurements may be unaligned using:</p> <p style="padding-left: 2em;">Unaligned GLONASS L2 Phasorange = Full GLONASS L2 Phasorange – GLONASS L2 P Code-Phase Bias.</p> <p>Scale factor 0.02 m. Range ± 655.34 m.</p>

– GNSS-RTK-MAC-CorrectionDifferences

The IE *GNSS-RTK-MAC-CorrectionDifferences* is used by the location server to provide dispersive (ionospheric) and non-dispersive (geometric) correction difference components for up to 32 pairs of Auxiliary and Master Reference Stations. The Master Reference Station coordinates are provided in IE *GNSS-RTK-ReferenceStationInfo* and the Auxiliary Station coordinates are provided in IE *GNSS-RTK-AuxiliaryStationData*.

The parameters provided in IE *GNSS-RTK-MAC-CorrectionDifferences* are used as specified for message type 1017 and 1039 in [30] and apply to all GNSSs.

```

-- ASN1START
GNSS-RTK-MAC-CorrectionDifferences-r15 ::= SEQUENCE {
    networkID-r15                GNSS-NetworkID-r15,
    subNetworkID-r15            GNSS-SubNetworkID-r15,
    master-ReferenceStationID-r15 GNSS-ReferenceStationID-r15,
    l1-r15                      GNSS-FrequencyID-r15,
    l2-r15                      GNSS-FrequencyID-r15,
    rtkCorrectionDifferencesList-r15 RTK-CorrectionDifferencesList-r15,
    ...
}
RTK-CorrectionDifferencesList-r15 ::= SEQUENCE (SIZE (1..32)) OF
    RTK-CorrectionDifferencesElement-r15
RTK-CorrectionDifferencesElement-r15 ::= SEQUENCE {

```

```

epochTime-r15                GNSS-SystemTime ,
auxiliary-referenceStationID-r15 GNSS-ReferenceStationID-r15,
geometric-ionospheric-corrections-differences-r15
                                Geometric-Ionospheric-Corrections-Differences-r15,
...
}

Geometric-Ionospheric-Corrections-Differences-r15 ::= SEQUENCE (SIZE(1..64)) OF
    Geometric-Ionospheric-Corrections-Differences-Element-r15

Geometric-Ionospheric-Corrections-Differences-Element-r15 ::= SEQUENCE {
    svID-r15                    SV-ID,
    ambiguityStatusFlag-r15     INTEGER (0..3),
    non-synch-count-r15        INTEGER (0..7),
    geometricCarrierPhaseCorrectionDifference-r15
                                INTEGER (-65536..65535),
    iod-r15                     BIT STRING (SIZE(11)),
    ionosphericCarrierPhaseCorrectionDifference-r15
                                INTEGER (-65536..65535),
    ...
}

-- ASN1STOP

```

GNSS-RTK-MAC-CorrectionDifferences field descriptions	
networkID	This field provides the network ID.
subNetworkID	This field identifies the subnetwork of a network identified by <i>networkID</i> .
master-ReferenceStationID	This field specifies the station ID of the Master Reference Station.
I1, I2	These fields specify the dual-frequency combination of L1 and L2 link/frequencies for which the <i>rtkCorrectionDifferencesList</i> is provided. If the fields are absent, the default interpretation in table 'L1/L2 default interpretation' applies.
rtkCorrectionDifferencesList	This field provides the correction differences for Auxiliary-Master Reference Station pairs.
epochTime	This field specifies the epoch time of observations used to derive the correction differences. The <i>gnss-TimeID</i> in <i>GNSS-SystemTime</i> shall be the same as the <i>GNSS-ID</i> in IE <i>GNSS-GenericAssistDataElement</i> .
auxiliary-referenceStationID	This field specifies the station ID of the Auxiliary Reference Station.
svID	This field specifies the satellite for which the data is provided.
ambiguityStatusFlag	This field provides the ambiguity status. 'L1' below corresponds to the link indicated by the <i>I1</i> field; 'L2' below corresponds to the link indicated by the <i>I2</i> field. <ul style="list-style-type: none"> 0 - Reserved for future use (artificial observations) 1 - Correct Integer Ambiguity Level for L1 and L2 2 - Correct Integer Ambiguity Level for L1-L2 widelane 3 - Uncertain Integer Ambiguity Level. Only a likely guess is used.
non-synch-count	This field provides the count of unrecoverable cycle slips. Whenever an unrecoverable cycle slip occurs this count shall be increased. The counter shall not be increased more than once per minute. Data for satellites with cycle slips more frequent than once per minute should not be provided.
geometricCarrierPhaseCorrectionDifference	This field provides the Geometric Carrier Phase Correction Difference (GCPCD), which is the Correction Difference for the geometric part (troposphere and orbits) calculated based on integer leveled L1 and L2 correction differences (L1CD and L2CD). $GCPCD = \frac{f_1^2}{f_1^2 - f_2^2} L1CD - \frac{f_2^2}{f_1^2 - f_2^2} L2CD$ L1CD, L2CD, and ICPCD are presented in metres. 'L1' below corresponds to the link indicated by the <i>I1</i> field; 'L2' below corresponds to the link indicated by the <i>I2</i> field. Scale factor 0.5 millimetre; range ± 32.767 metres.
iod	This field specifies the IOD value of the broadcast ephemeris used for calculation of Correction Differences (see IE <i>GNSS-NavigationModel</i>).

GNSS-RTK-MAC-CorrectionDifferences field descriptions**ionosphericCarrierPhaseCorrectionDifference**

This field provides the Ionospheric Carrier Phase Correction Difference (ICPCD), which is the Correction Difference for the ionospheric part calculated based on integer leveled L1 and L2 correction differences (L1CD and L2CD).

$$ICPCD = \frac{f_2^2}{f_2^2 - f_1^2} L1CD - \frac{f_1^2}{f_2^2 - f_1^2} L2CD$$

L1CD, L2CD, and ICPCD are presented in metres. 'L1' below corresponds to the link indicated by the *l1* field; 'L2' below corresponds to the link indicated by the *l2* field.

Scale factor 0.5 millimetre; range ± 32.767 metres.

L1/L2 default interpretation

GNSS	<i>l1</i>	<i>l2</i>
GPS	L1	L2
SBAS	L1	L5
QZSS	L1	L2
Galileo	E1	E5a
GLONASS	G1	G2
BDS	B1	B2

GNSS-RTK-Residuals

The IE *GNSS-RTK-Residuals* is used by the location server to provide Network RTK correction residual error information.

If the interpolation of the corrections for the target device location is performed at the location server, resulting in a non-physical reference station, the *GNSS-RTK-Residuals* are referenced to the non-physical reference station.

If the interpolation of the corrections is performed by the target device (e.g., using *GNSS-RTK-MAC-CorrectionDifferences*), the *GNSS-RTK-Residuals* are referenced to the closest master or auxiliary station to the target device.

The parameters provided in IE *GNSS-RTK-Residuals* are used as specified for message type 1030 and 1031 in [30] and apply to all GNSSs.

```
-- ASN1START
GNSS-RTK-Residuals-r15 ::= SEQUENCE {
    epochTime-r15          GNSS-SystemTime,
    referenceStationID-r15 GNSS-ReferenceStationID-r15,
    n-Refs-r15             INTEGER (0..127),
    l1-r15                 GNSS-FrequencyID-r15           OPTIONAL, -- Need OP
    l2-r15                 GNSS-FrequencyID-r15           OPTIONAL, -- Need OP
    rtk-residuals-list-r15 RTK-Residuals-List-r15,
    ...
}
RTK-Residuals-List-r15 ::= SEQUENCE (SIZE(1..64)) OF RTK-Residuals-Element-r15
RTK-Residuals-Element-r15 ::= SEQUENCE {
    svID-r15          SV-ID,
    s-oc-r15          INTEGER (0..255),
    s-od-r15          INTEGER (0..511),
    s-oh-r15          INTEGER (0..63),
    s-lc-r15          INTEGER (0..1023),
    s-ld-r15          INTEGER (0..1023),
    ...
}
-- ASN1STOP
```

GNSS-RTK-Residuals field descriptions	
epochTime	This field specifies the epoch time of the Network RTK Residual Error data. The <i>gnss-TimeID</i> in <i>GNSS-SystemTime</i> shall be the same as the <i>GNSS-ID</i> in IE <i>GNSS-GenericAssistDataElement</i> .
referenceStationID	This field specifies the Reference Station ID. The Reference Station may be a physical or non-physical station.
n-Refs	This field specifies the number of reference stations used to derive the residual statistics (1 to 127; 127 indicates 127 or more stations). The number of reference stations should never be zero. If zero is encountered the target device should ignore the message.
l1, l2	These fields specify the dual-frequency combination of L1 and L2 link/frequencies for which the <i>rtk residuals-list</i> is provided. If the fields are absent, the default interpretation in table 'L1/L2 default interpretation' in IE <i>GNSS-RTK-MAC-CorrectionDifferences</i> applies.
svID	This field specifies the satellite for which the data is provided.
s-oc	This field specifies the constant term of standard deviation (1 sigma) for non-dispersive interpolation residuals, <i>s_{oc}</i> . Scale factor 0.5 millimetre; range 0–127 millimetre. NOTE 1.
s-od	This field specifies the distance dependent term of standard deviation (1 sigma) for nondispersive interpolation residuals, <i>s_{od}</i> . Scale factor 0.01 ppm; range 0–5.11 ppm. NOTE 1.
s-oh	This field specifies the height dependent term of standard deviation (1 sigma) for nondispersive interpolation residuals, <i>s_{oh}</i> . Scale factor 0.1 ppm; range 0–5.1 ppm. NOTE 1.
s-lc	This field specifies the constant term of standard deviation (1 sigma) for dispersive interpolation residuals (as affecting L1 frequency), <i>s_{lc}</i> . 'L1' corresponds to the link indicated by the <i>l1</i> field. Scale factor 0.5 millimetre; range 0–511 millimetre
s-lid	This field specifies the distance dependent term of standard deviation (1 sigma) for dispersive interpolation residuals (as affecting L1 frequency), <i>s_{ld}</i> . 'L1' corresponds to the link indicated by the <i>l1</i> field. NOTE 2.

NOTE 1: The complete standard deviation for the expected non-dispersive interpolation residual is computed from *s-oc*, *s-od* and *s-oh* using the formula:

$$s_o = \sqrt{s_{oc}^2 + s_{od}^2 \cdot d_{Ref}^2 + s_{oh}^2 \cdot dh_{Ref}^2} \quad [\text{mm}]$$

where d_{Ref} is the distance of the target device from the nearest physical reference station in [km] and $|dh_{Ref}|$ is the absolute value of the height difference between the nearest physical reference station and the target device in [km].

NOTE 2: The complete standard deviation for the expected dispersive interpolation residual is computed from *s-lc* and *s-lid* using the formula:

$$s_l(L1) = \sqrt{s_{lc}^2 + s_{ld}^2 \cdot d_{Ref}^2} \quad [\text{mm}]$$

where d_{Ref} is the distance of the target device from the nearest physical reference station in [km].

The standard deviation for the L2 frequency is calculated using the formula:

$$s_l(L2) = s_l(L1) \cdot \frac{\lambda_2^2}{\lambda_1^2} \quad [\text{mm}] \quad \text{'L2' corresponds to the link indicated by the } l2 \text{ field; } \lambda_1=c/f_1, \lambda_2=c/f_2 \text{ are the}$$

nominal wavelengths of the links indicated by the *l1*, *l2* fields, respectively.

– GNSS-RTK-FKP-Gradients

The IE *GNSS-RTK-FKP-Gradients* is used by the location server to provide the FKP Network RTK gradients of distance-dependent errors like ionosphere, troposphere and orbits. The target device may use the gradients to compute the influence of the distance dependent errors for its own position.

The parameters provided in IE *GNSS-RTK-FKP-Gradients* are used as specified for message type 1034 and 1035 in [30] and apply to all GNSSs.

```
-- ASN1START
```

```
GNSS-RTK-FKP-Gradients-r15 ::= SEQUENCE {
```

```

referenceStationID-r15          GNSS-ReferenceStationID-r15,
epochTime-r15                  GNSS-SystemTime,
l1-r15                         GNSS-FrequencyID-r15          OPTIONAL,  -- Need OP
l2-r15                         GNSS-FrequencyID-r15          OPTIONAL,  -- Need OP
fkp-gradients-list-r15        FKP-Gradients-List-r15,
...
}

FKP-Gradients-List-r15 ::= SEQUENCE (SIZE(1..64)) OF FKP-Gradients-Element-r15

FKP-Gradients-Element-r15 ::= SEQUENCE {
    svID-r15                    SV-ID,
    iod-r15                     BIT STRING (SIZE(11)),
    north-geometric-gradient-r15 INTEGER (-2048..2047),
    east-geometric-gradient-r15  INTEGER (-2048..2047),
    north-ionospheric-gradient-r15 INTEGER (-8192..8191),
    east-ionospheric-gradient-r15 INTEGER (-8192..8191),
    ...
}
-- ASN1STOP

```

GNSS-RTK-FKP-Gradients field descriptions

referenceStationID	This field specifies the Reference Station ID. The Reference Station may be a physical or non-physical station.
epochTime	This field specifies the epoch time of the FKP data. The <i>gnss-TimeID</i> in <i>GNSS-SystemTime</i> shall be the same as the <i>GNSS-ID</i> in IE <i>GNSS-GenericAssistDataElement</i> .
l1, l2	These fields specify the dual-frequency combination of L1 and L2 link/frequencies for which the <i>fkp-gradients-list</i> is provided. If the fields are absent, the default interpretation in table 'L1/L2 default interpretation' in IE <i>GNSS-RTK-MAC-CorrectionDifferences</i> applies. NOTE.
svID	This field specifies the satellite for which the data is provided.
iod	This field specifies the IOD value of the broadcast ephemeris used for calculation of FKP data (see IE <i>GNSS-NavigationModel</i>).
north-geometric-gradient	This field specifies the gradient (FKP) of the geometric (non-dispersive) error components in South-North direction in parts per million of the south-north distance to the reference station. Scale factor 0.01 ppm; range ± 20.47 ppm.
east-geometric-gradient	This field specifies the gradient (FKP) of the geometric (non-dispersive) error components in West-East direction in parts per million of the west-east distance to the reference station. Scale factor 0.01 ppm; range ± 20.47 ppm.
north-ionospheric-gradient	This field specifies the gradient (FKP) of the ionospheric (dispersive) error component in South-North direction. Scale factor 0.01 ppm; range ± 81.91 ppm.
east-ionospheric-gradient	This field specifies the gradient (FKP) of the ionospheric (dispersive) error component in West-East direction. Scale factor 0.01 ppm; range ± 81.91 ppm.

NOTE: As described in [30], the distance dependent error for the geometric part $\delta\rho_0$ and ionospheric part $\delta\rho_I$ is computed from the gradients provided in *FKP-Gradients-Element*. The distance dependent error for a carrier phase measurements Φ on a signal with frequency f can be computed by:

$$\delta\rho_{\phi,f} = \delta\rho_0 + \left(\frac{f_1}{f}\right)^2 \delta\rho_I$$

where f_1, f is the link/frequency indicated by the *l1, l2* fields, respectively.

– GNSS-SSR-OrbitCorrections

The IE *GNSS-SSR-OrbitCorrections* is used by the location server to provide radial, along-track and cross-track orbit corrections. The target device may use the parameters to compute a satellite position correction to be combined with the satellite position calculated from broadcast ephemeris.

The parameters provided in IE *GNSS-SSR-OrbitCorrections* are used as specified for SSR Clock Messages (e.g., message type 1057 and 1063) in [30] and apply to all GNSSs.

```
-- ASN1START

GNSS-SSR-OrbitCorrections-r15 ::= SEQUENCE {
    epochTime-r15                GNSS-SystemTime,
    ssrUpdateInterval-r15        INTEGER (0..15),
    satelliteReferenceDatum-r15  ENUMERATED { itrf, regional, ... },
    iod-ssr-r15                  INTEGER (0..15),
    ssr-OrbitCorrectionList-r15  SSR-OrbitCorrectionList-r15,
    ...
}

SSR-OrbitCorrectionList-r15 ::= SEQUENCE (SIZE(1..64)) OF SSR-OrbitCorrectionSatelliteElement-r15

SSR-OrbitCorrectionSatelliteElement-r15 ::= SEQUENCE {
    svID-r15                      SV-ID,
    iod-r15                        BIT STRING (SIZE(11)),
    delta-radial-r15               INTEGER (-2097152..2097151),
    delta-AlongTrack-r15           INTEGER (-524288..524287),
    delta-CrossTrack-r15          INTEGER (-524288..524287),
    dot-delta-radial-r15           INTEGER (-1048576..1048575)    OPTIONAL, -- Need ON
    dot-delta-AlongTrack-r15      INTEGER (-262144..262143)      OPTIONAL, -- Need ON
    dot-delta-CrossTrack-r15     INTEGER (-262144..262143)      OPTIONAL, -- Need ON
    ...
}

-- ASN1STOP
```

GNSS-SSR-OrbitCorrections field descriptions	
epochTime	This field specifies the epoch time of the orbit corrections. The <i>gnss-TimeID</i> in <i>GNSS-SystemTime</i> shall be the same as the <i>GNSS-ID</i> in IE <i>GNSS-GenericAssistDataElement</i> .
ssrUpdateInterval	This field specifies the SSR Update Interval. The SSR Update Intervals for all SSR parameters start at time 00:00:00 of the GPS time scale. A change of the SSR Update Interval during the transmission of SSR data should ensure consistent data for a target device. See table Value of <i>ssrUpdateInterval</i> to SSR Update Interval relation below. NOTE 1.
satelliteReferenceDatum	This field specifies the satellite reference datum for the orbit corrections.
iod-ssr	This field specifies the Issue of Data number for the SSR data. A change of <i>iod-ssr</i> is used to indicate a change in the SSR generating configuration.
svID	This field specifies the satellite for which the orbit corrections are provided.
iod	This field specifies the IOD value of the broadcast ephemeris for which the orbit corrections are valid (see IE <i>GNSS-NavigationModel</i>). NOTE 2.
delta-radial	This field specifies the radial orbit correction for broadcast ephemeris. NOTE 3. Scale factor 0.1 mm; range ± 209.7151 m.
delta-AlongTrack	This field specifies the along-track orbit correction for broadcast ephemeris. NOTE 3. Scale factor 0.4 mm; range ± 209.7148 m.
delta-CrossTrack	This field specifies the cross-track orbit correction for broadcast ephemeris. NOTE 3. Scale factor 0.4 mm; range ± 209.7148 m.
dot-delta-radial	This field specifies the velocity of radial orbit correction for broadcast ephemeris. NOTE 3. Scale factor 0.001 mm/s; range ± 1.048575 m/s.
dot-delta-AlongTrack	This field specifies the velocity of along-track orbit correction for broadcast ephemeris. NOTE 3. Scale factor 0.004 mm/s; range ± 1.048572 m/s.
dot-delta-CrossTrack	This field specifies the velocity of cross-track orbit correction for broadcast ephemeris. NOTE 3. Scale factor 0.004 mm/s; range ± 1.048572 m/s.

NOTE 1: The update intervals are aligned to the GPS time scale for all GNSSs in order to allow synchronous operation for multiple GNSS services. This means that the update intervals may not be aligned to the beginning of the day for another GNSS. Due to the leap seconds, this is generally the case for GLONASS.

NOTE 2: In the cases that *gnss-ID* indicates 'gps' or 'qzss', the *iod* refers to the NAV broadcast ephemeris (GPS L1 C/A or QZSS QZS-L1, respectively, in table GNSS to iod Bit String(11) relation in IE *GNSS-NavigationModel*).

NOTE 3: The reference time t_0 is $epochTime + \frac{1}{2} \times ssrUpdateInterval$. The reference time t_0 for *ssrUpdateInterval* '0' is *epochTime*.

Value of *ssrUpdateInterval* to SSR Update Interval relation

Value of <i>ssrUpdateInterval</i>	SSR Update Interval
0	1 second
1	2 seconds
2	5 seconds
3	10 seconds
4	15 seconds
5	30 seconds
6	60 seconds
7	120 seconds
8	240 seconds
9	300 seconds
10	600 seconds
11	900 seconds
12	1800 seconds
13	3600 seconds
14	7200 seconds
15	10800 seconds

— *GNSS-SSR-ClockCorrections*

The IE *GNSS-SSR-ClockCorrections* is used by the location server to provide clock correction parameters. The target device may use the parameters to compute a clock correction to be applied to the broadcast satellite clock parameters, identified by *iod* of corresponding *GNSS-SSR-OrbitCorrections*.

The parameters provided in IE *GNSS-SSR-ClockCorrections* are used as specified for SSR Clock Messages (e.g., message type 1058 and 1064) in [30] and apply to all GNSSs.

```
-- ASN1START

GNSS-SSR-ClockCorrections-r15 ::= SEQUENCE {
    epochTime-r15                GNSS-SystemTime,
    ssrUpdateInterval-r15        INTEGER (0..15),
    iod-ssr-r15                   INTEGER (0..15),
    ssr-ClockCorrectionList-r15   SSR-ClockCorrectionList-r15,
    ...
}

SSR-ClockCorrectionList-r15 ::= SEQUENCE (SIZE(1..64)) OF SSR-ClockCorrectionSatelliteElement-r15

SSR-ClockCorrectionSatelliteElement-r15 ::= SEQUENCE {
    svID-r15                      SV-ID,
    delta-Clock-C0-r15             INTEGER (-2097152..2097151),
    delta-Clock-C1-r15             INTEGER (-1048576..1048575)           OPTIONAL, -- Need ON
    delta-Clock-C2-r15             INTEGER (-67108864..67108863)       OPTIONAL, -- Need ON
    ...
}

-- ASN1STOP
```

GNSS-SSR-ClockCorrections field descriptions	
epochTime	This field specifies the epoch time of the clock corrections. The gnsstimeID in <i>GNSS-SystemTime</i> shall be the same as the <i>GNSS-ID</i> in IE <i>GNSS-GenericAssistDataElement</i> .
ssrUpdateInterval	This field specifies the SSR Update Interval. The SSR Update Intervals for all SSR parameters start at time 00:00:00 of the GPS time scale. A change of the SSR Update Interval during the transmission of SSR data should ensure consistent data for a target device. See table Value of <i>ssrUpdateInterval</i> to SSR Update Interval relation in IE <i>GNSS-SSR-OrbitCorrections</i> .
iod-ssr	This field specifies the Issue of Data number for the SSR data. A change of iod-ssr is used to indicate a change in the SSR generating configuration.
svID	This field specifies the satellite for which the clock corrections are provided.
delta-Clock-C0	This field specifies the C ₀ polynomial coefficient for correction of broadcast satellite clock. NOTE 1. Scale factor 0.1 mm; range ±209.7151 m.
delta-Clock-C1	This field specifies the C ₁ polynomial coefficient for correction of broadcast satellite clock. NOTE 1. Scale factor 0.001 mm/s; range ±1.048575 m/s.
delta-Clock-C2	This field specifies the C ₂ polynomial coefficient for correction of broadcast satellite clock. NOTE 1. Scale factor 0.00002 mm/s ² ; range ±1.34217726 m/s ² .

NOTE 1: The reference time t_0 is $epochTime + \frac{1}{2} \times ssrUpdateInterval$. The reference time t_0 for *ssrUpdateInterval* '0' is *epochTime*.

– GNSS-SSR-CodeBias

The IE *GNSS-SSR-CodeBias* is used by the location server to provide GNSS signal code bias. The target device may add the code bias to the pseudo-range measurement of the corresponding code signal to get corrected pseudo-ranges.

NOTE: Any code biases transmitted in the broadcast messages (e.g., the GPS group delay differential T_{GD} [4] (*NAV-ClockModel*)) are not applied at all by the target device.

The parameters provided in IE *GNSS-SSR-CodeBias* are used as specified for SSR Code Bias Messages (e.g., message type 1059 and 1065) in [30] and apply to all GNSSs.

```
-- ASN1START
GNSS-SSR-CodeBias-r15 ::= SEQUENCE {
    epochTime-r15                GNSS-SystemTime,
    ssrUpdateInterval-r15        INTEGER (0..15),
    iod-ssr-r15                  INTEGER (0..15),
    ssr-CodeBiasSatList-r15      SSR-CodeBiasSatList-r15,
    ...
}

SSR-CodeBiasSatList-r15 ::= SEQUENCE (SIZE(1..64)) OF SSR-CodeBiasSatElement-r15

SSR-CodeBiasSatElement-r15 ::= SEQUENCE {
    svID-r15                     SV-ID,
    ssr-CodeBiasSignalList-r15   SSR-CodeBiasSignalList-r15,
    ...
}

SSR-CodeBiasSignalList-r15 ::= SEQUENCE (SIZE(1..16)) OF SSR-CodeBiasSignalElement-r15

SSR-CodeBiasSignalElement-r15 ::= SEQUENCE {
    signal-and-tracking-mode-ID-r15  GNSS-SignalID,
    codeBias-r15                     INTEGER (-8192..8191),
    ...
}
-- ASN1STOP
```

GNSS-SSR-CodeBias field descriptions	
epochTime	This field specifies the epoch time of the code bias data. The <i>gnss-TimeID</i> in <i>GNSS-SystemTime</i> shall be the same as the <i>GNSS-ID</i> in IE <i>GNSS-GenericAssistDataElement</i> .
ssrUpdateInterval	This field specifies the SSR Update Interval. The SSR Update Intervals for all SSR parameters start at time 00:00:00 of the GPS time scale. A change of the SSR Update Interval during the transmission of SSR data should ensure consistent data for a target device. See table Value of <i>ssrUpdateInterval</i> to SSR Update Interval relation in IE <i>GNSS-SSR-OrbitCorrections</i> .
iod-ssr	This field specifies the Issue of Data number for the SSR data. A change of <i>iod-ssr</i> is used to indicate a change in the SSR generating configuration.
svID	This field specifies the GNSS satellite for which the code biases are provided.
signal-and-tracking-mode-ID	This field specifies the GNSS signal for which the code biases are provided.
codeBias	This field provides the code bias for the GNSS signal indicated by <i>signal-and-tracking-mode-ID</i> . Scale factor 0.01 m; range ± 81.91 m.

— GNSS-SSR-URA

The IE *GNSS-SSR-URA* is used by the location server to provide quality information for the provided SSR assistance data.

The parameters provided in IE *GNSS-SSR-URA* are used as specified for the SSR URA Messages (e.g., message type 1061 and 1067) in [30] and apply to all GNSSs.

```
-- ASN1START
GNSS-SSR-URA-r16 ::= SEQUENCE {
    epochTime-r16                GNSS-SystemTime,
    ssrUpdateInterval-r16        INTEGER (0..15),
    iod-ssr-r16                  INTEGER (0..15),
    ssr-URA-SatList-r16         SSR-URA-SatList-r16,
    ...
}

SSR-URA-SatList-r16 ::= SEQUENCE (SIZE(1..64)) OF SSR-URA-SatElement-r16

SSR-URA-SatElement-r16 ::= SEQUENCE {
    svID-r16                     SV-ID,
    ssr-URA-r16                 BIT STRING (SIZE (6)),
    ...
}
-- ASN1STOP
```

GNSS-SSR-URA field descriptions	
epochTime	This field specifies the epoch time of the SSR User Range Accuracy (URA). The <i>gnss-TimeID</i> in <i>GNSS-SystemTime</i> shall be the same as the <i>GNSS-ID</i> in IE <i>GNSS-GenericAssistDataElement</i> .
ssrUpdateInterval	This field specifies the SSR Update Interval. The SSR Update Intervals for all SSR parameters start at time 00:00:00 of the GPS time scale. A change of the SSR Update Interval during the transmission of SSR data should ensure consistent data for a target device. See table Value of <i>ssrUpdateInterval</i> to SSR Update Interval relation in IE <i>GNSS-SSR-OrbitCorrections</i> .
iod-ssr	This field specifies the Issue of Data number for the SSR data. A change of <i>iod-ssr</i> is used to indicate a change in the SSR generating configuration.
svID	This field specifies the GNSS satellite for which the SSR URA is provided.
ssr-URA	This field specifies the User Range Accuracy (URA) (1-sigma) for the range correction provided in the SSR assistance data. The URA is represented by a combination of CLASS and VALUE. The 3 MSB define the CLASS with a range of 0-7 and the 3 LSB define the VALUE with a range of 0-7. The URA is computed by: <div style="text-align: center;"> $SSR\ URA\ [mm] \leq 3^{CLASS} \left(1 + \frac{VALUE}{4} - 1 \right) \quad [mm]$ </div> See Table 'Relationship between SSR troposphere quality and URA indicator and physical quantity' in <i>GNSS-SSR-GriddedCorrection</i> .

– GNSS-SSR-PhaseBias

The IE *GNSS-SSR-PhaseBias* is used by the location server to provide GNSS signal phase bias. The target device may add the phase bias to the phase-range measurement of the corresponding phase signal to get corrected phase-ranges.

The parameters provided in IE *GNSS-SSR-PhaseBias* are used as specified for Compact SSR GNSS Satellite Phase Bias Messages (e.g., message type 4073,5) in [43] and apply to all GNSSs.

```
-- ASN1START
GNSS-SSR-PhaseBias-r16 ::= SEQUENCE {
    epochTime-r16           GNSS-SystemTime,
    ssrUpdateInterval-r16  INTEGER (0..15),
    iod-ssr-r16            INTEGER (0..15),
    ssr-PhaseBiasSatList-r16  SSR-PhaseBiasSatList-r16,
    ...
}

SSR-PhaseBiasSatList-r16 ::= SEQUENCE (SIZE(1..64)) OF SSR-PhaseBiasSatElement-r16

SSR-PhaseBiasSatElement-r16 ::= SEQUENCE {
    svID-r16                SV-ID,
    ssr-PhaseBiasSignalList-r16  SSR-PhaseBiasSignalList-r16,
    ...
}

SSR-PhaseBiasSignalList-r16 ::= SEQUENCE (SIZE(1..16)) OF SSR-PhaseBiasSignalElement-r16

SSR-PhaseBiasSignalElement-r16 ::= SEQUENCE {
    signal-and-tracking-mode-ID-r16  GNSS-SignalID,
    phaseBias-r16                    INTEGER (-16384..16383),
    phaseDiscontinuityIndicator-r16  INTEGER (0..3),
    phaseBiasIntegerIndicator-r16    INTEGER (0..3)                OPTIONAL, -- Need OP
    ...
}
-- ASN1STOP
```

GNSS-SSR-PhaseBias field descriptions	
epochTime	This field specifies the epoch time of the phase bias data. The <i>gnss-TimeID</i> in <i>GNSS-SystemTime</i> shall be the same as the <i>GNSS-ID</i> in IE <i>GNSS-GenericAssistDataElement</i> .
ssrUpdateInterval	This field specifies the SSR Update Interval. The SSR Update Intervals for all SSR parameters start at time 00:00:00 of the GPS time scale. A change of the SSR Update Interval during the transmission of SSR data should ensure consistent data for a target device. See table Value of <i>ssrUpdateInterval</i> to SSR Update Interval relation in IE <i>GNSS-SSR-OrbitCorrections</i> .
iod-ssr	This field specifies the Issue of Data number for the SSR data. A change of <i>iod-ssr</i> is used to indicate a change in the SSR generating configuration.
svID	This field specifies the GNSS satellite for which the phase biases are provided.
signal-and-tracking-mode-ID	This field specifies the GNSS signal for which the phase biases are provided.
phaseBias	This field provides the phase bias for the GNSS signal indicated by <i>signal-and-tracking-mode-ID</i> . Scale factor 0.001 m; range ± 16.383 m.
phaseDiscontinuityIndicator	This field provides the phase discontinuity counter for the GNSS signal indicated by <i>signal-and-tracking-mode-ID</i> . This counter is increased for every discontinuity in phase (roll-over from 3 to 0).
phaseBiasIntegerIndicator	This field informs whether the phase bias is Undifferenced Integer (Value 0), Widelane Integer (Value 1) or Non-Integer (Value 2): Value 0: The Undifferenced Integer Phase Bias supports PPP-RTK fixed, widelane or float mode. Value 1: The Widelane Integer Phase Bias indicates that after application of the Phase Bias value, this signal can be differenced with any other signal from the same satellite that also has Widelane Integer Phase Bias indicated to form a new combined carrier phase measurement of integer quality, supporting PPP-RTK widelane fixed mode. Value 2: The Non-Integer Phase Bias supports PPP-RTK float mode. Value 3: Reserved. If the <i>phaseBiasIntegerIndicator</i> field is not present then it is interpreted as having Value 0 (Undifferenced Integer).

– GNSS-SSR-STECCorrection

The IE *GNSS-SSR-STECCorrection* is used by the location server to provide ionosphere slant delay correction. The ionosphere slant delay (STECCorrection) consists of the polynomial part provided in *GNSS-SSR-STECCorrection* and the residual part provided in *GNSS-SSR-GriddedCorrection*.

The parameters provided in IE *GNSS-SSR-STECCorrection* are used as specified for Compact SSR STECCorrection Messages (e.g., message type 4073,8) in [43] and apply to all GNSSs.

```
-- ASN1START
GNSS-SSR-STECCorrection-r16 ::= SEQUENCE {
    epochTime-r16                GNSS-SystemTime,
    ssrUpdateInterval-r16        INTEGER (0..15),
    iod-ssr-r16                  INTEGER (0..15),
    correctionPointSetID-r16     INTEGER (0..16383),
    stec-SatList-r16             STECCorrection-SatList-r16,
    ...
}

STECCorrection-SatList-r16 ::= SEQUENCE (SIZE(1..64)) OF STECCorrection-SatElement-r16

STECCorrection-SatElement-r16 ::= SEQUENCE {
    svID-r16                     SV-ID,
    stecQualityIndicator-r16     BIT STRING (SIZE(6)),
    stec-C00-r16                 INTEGER (-8192..8191),
    stec-C01-r16                 INTEGER (-2048..2047)                OPTIONAL, -- Need ON
    stec-C10-r16                 INTEGER (-2048..2047)                OPTIONAL, -- Need ON
    stec-C11-r16                 INTEGER (-512..511)                  OPTIONAL, -- Need ON
    ...
}
-- ASN1STOP
```

GNSS-SSR-STECCorrection field descriptions
<p>epochTime This field specifies the epoch time of the STEC correction data. The <i>gnss-TimeID</i> in <i>GNSS-SystemTime</i> shall be the same as the <i>GNSS-ID</i> in IE <i>GNSS-GenericAssistDataElement</i>.</p>
<p>ssrUpdateInterval This field specifies the SSR Update Interval. The SSR Update Intervals for all SSR parameters start at time 00:00:00 of the GPS time scale. A change of the SSR Update Interval during the transmission of SSR data should ensure consistent data for a target device. See table Value of <i>ssrUpdateInterval</i> to SSR Update Interval relation in IE <i>GNSS-SSR-OrbitCorrections</i>.</p>
<p>correctionPointSetID This field provides the ID of the <i>GNSS-SSR-CorrectionPoints</i> set. The reference point used for the STEC calculations (see NOTE below) is the reference point provided in IE <i>GNSS-SSR-CorrectionPoints</i> with the same <i>correctionPointSetID</i>.</p>
<p>iod-ssr This field specifies the Issue of Data number for the SSR data. A change of <i>iod-ssr</i> is used to indicate a change in the SSR generating configuration.</p>
<p>svID This field specifies the GNSS satellite for which the STEC corrections are provided.</p>
<p>stecQualityIndicator This field specifies SSR STEC quality indicator. The STEC quality indicator is represented by a combination of CLASS and VALUE. The 3 MSB define the CLASS with a range of 0-7 and the 3 LSB define the VALUE with a range of 0-7. See Table 'Relationship between SSR STEC quality indicator and physical quantity' below.</p>
<p>stec-C00 This field provides the polynomial coefficient C_{00} used to define the STEC. as defined in [43]. NOTE Scale factor 0.05 TECU; range ± 409.55 TECU.</p>
<p>stec-C01 This field provides the polynomial coefficient C_{01} used to define the STEC as defined in [43]. NOTE Scale factor 0.02 TECU/deg; range ± 40.94 TECU/deg.</p>
<p>stec-C10 This field provides the polynomial coefficient C_{10} used to define the STEC as defined in [43]. NOTE Scale factor 0.02 TECU/deg; range ± 40.94 TECU/deg.</p>
<p>stec-C11 This field provides the polynomial coefficient C_{11} used to define the STEC as defined in [43]. NOTE Scale factor 0.02 TECU/deg²; range ± 10.22 TECU/deg².</p>

NOTE: The polynomial coefficients C_{00} , C_{01} , C_{10} , C_{11} are used to define the STEC as follows:

(1) If only C_{00} is included in *STEC-SatElement*:

$$\delta I_{ai} = C_{00}.$$

(2) If only C_{00} , C_{01} and C_{10} are included in *STEC-SatElement*:

$$\delta I_{ai} = C_{00} + C_{01}(\phi - \phi_0) + C_{10}(\lambda - \lambda_0).$$

(3) If all of C_{00} , C_{01} , C_{10} and C_{11} are included in *STEC-SatElement*:

$$\delta I_{ai} = C_{00} + C_{01}(\phi - \phi_0) + C_{10}(\lambda - \lambda_0) + C_{11}(\phi - \phi_0)(\lambda - \lambda_0).$$

Other combinations of C_{00} , C_{01} , C_{10} , C_{11} than (1)-(3) above are undefined in this version of the specification.

The equations above depend on the latitude ϕ and longitude λ of an evaluated point and latitude ϕ_0 and longitude λ_0 of the reference point which is defined in IE *GNSS-SSR-CorrectionPoints* (*referencePointLatitude* and *referencePointLongitude*).

Relationship between SSR STEC quality indicator and physical quantity

CLASS	VALUE	Index	SSR STEC Quality Indicator Q [TECU]
7	7	63	33.6664 < Q
7	6	62	30.2992 < Q ≤ 33.6664
7	5	61	26.9319 < Q ≤ 30.2992
7	4	60	23.5647 < Q ≤ 26.9319
7	3	59	20.1974 < Q ≤ 23.5647
7	2	58	16.8301 < Q ≤ 20.1974
7	1	57	13.4629 < Q ≤ 16.8301
7	0	56	12.3405 < Q ≤ 13.4629
6	7	55	11.2180 < Q ≤ 12.3405
6	6	54	10.0956 < Q ≤ 11.2180
6	5	53	8.9732 < Q ≤ 10.0956
6	4	52	7.8508 < Q ≤ 8.9732
6	3	51	6.7284 < Q ≤ 7.8508
6	2	50	5.6059 < Q ≤ 6.7284
6	1	49	4.4835 < Q ≤ 5.6059
6	0	48	4.1094 < Q ≤ 4.4835
5	7	47	3.7352 < Q ≤ 4.1094
5	6	46	3.3611 < Q ≤ 3.7352
5	5	45	2.9870 < Q ≤ 3.3611
5	4	44	2.6128 < Q ≤ 2.9870
5	3	43	2.2387 < Q ≤ 2.6128
5	2	42	1.8645 < Q ≤ 2.2387
5	1	41	1.4904 < Q ≤ 1.8645
5	0	40	1.3657 < Q ≤ 1.4904
4	7	39	1.2410 < Q ≤ 1.3657
4	6	38	1.1163 < Q ≤ 1.2410
4	5	37	0.9915 < Q ≤ 1.1163
4	4	36	0.8668 < Q ≤ 0.9915
4	3	35	0.7421 < Q ≤ 0.8668
4	2	34	0.6174 < Q ≤ 0.7421
4	1	33	0.4927 < Q ≤ 0.6174
4	0	32	0.4511 < Q ≤ 0.4927
3	7	31	0.4096 < Q ≤ 0.4511
3	6	30	0.3680 < Q ≤ 0.4096
3	5	29	0.3264 < Q ≤ 0.3680
3	4	28	0.2848 < Q ≤ 0.3264
3	3	27	0.2433 < Q ≤ 0.2848
3	2	26	0.2017 < Q ≤ 0.2433
3	1	25	0.1601 < Q ≤ 0.2017
3	0	24	0.1463 < Q ≤ 0.1601
2	7	23	0.1324 < Q ≤ 0.1463
2	6	22	0.1186 < Q ≤ 0.1324
2	5	21	0.1047 < Q ≤ 0.1186
2	4	20	0.0908 < Q ≤ 0.1047
2	3	19	0.0770 < Q ≤ 0.0908
2	2	18	0.0631 < Q ≤ 0.0770
2	1	17	0.0493 < Q ≤ 0.0631
2	0	16	0.0447 < Q ≤ 0.0493
1	7	15	0.0400 < Q ≤ 0.0447
1	6	14	0.0354 < Q ≤ 0.0400
1	5	13	0.0308 < Q ≤ 0.0354
1	4	12	0.0262 < Q ≤ 0.0308
1	3	11	0.0216 < Q ≤ 0.0262
1	2	10	0.0169 < Q ≤ 0.0216
1	1	9	0.0123 < Q ≤ 0.0169
1	0	8	0.0108 < Q ≤ 0.0123
0	7	7	0.0092 < Q ≤ 0.0108
0	6	6	0.0077 < Q ≤ 0.0092
0	5	5	0.0062 < Q ≤ 0.0077
0	4	4	0.0046 < Q ≤ 0.0062
0	3	3	0.0031 < Q ≤ 0.0046

0	2	2	$0.0015 < Q \leq 0.0031$
0	1	1	$Q \leq 0.0015$
0	0	0	undefined/unknown

– GNSS-SSR-GriddedCorrection

The IE *GNSS-SSR-GriddedCorrection* is used by the location server to provide troposphere delay correction, together with the residual part of the STEC corrections.

The parameters provided in IE *GNSS-SSR-GriddedCorrection* are used as specified for Compact SSR Gridded Correction Message (e.g., message type 4073,9) in [43] and apply to all GNSSs.

```
-- ASN1START

GNSS-SSR-GriddedCorrection-r16 ::= SEQUENCE {
    epochTime-r16                GNSS-SystemTime,
    ssrUpdateInterval-r16        INTEGER (0..15),
    iod-ssr-r16                   INTEGER (0..15),
    troposphericDelayQualityIndicator-r16  BIT STRING (SIZE(6))          OPTIONAL, -- Cond Tropo
    correctionPointSetID-r16      INTEGER (0..16383),
    gridList-r16                  GridList-r16,
    ...
}

GridList-r16 ::= SEQUENCE (SIZE(1..64)) OF GridElement-r16

GridElement-r16 ::= SEQUENCE {
    troposphericDelayCorrection-r16  TroposphericDelayCorrection-r16  OPTIONAL, -- Need ON
    stecResidualSatList-r16          STECResidualSatList-r16        OPTIONAL, -- Need ON
    ...
}

TroposphericDelayCorrection-r16 ::= SEQUENCE {
    tropoHydroStaticVerticalDelay-r16  INTEGER (-256..255),
    tropoWetVerticalDelay-r16          INTEGER (-128..127),
    ...
}

STECResidualSatList-r16 ::= SEQUENCE (SIZE(1..64)) OF STECResidualSatElement-r16

STECResidualSatElement-r16 ::= SEQUENCE {
    svID-r16                        SV-ID,
    stecResidualCorrection-r16      CHOICE {
        b7-r16                       INTEGER (-64..63),
        b16-r16                       INTEGER (-32768..32767)
    },
    ...
}

-- ASN1STOP
```

Conditional presence	Explanation
<i>Tropo</i>	The field is mandatory present if <i>troposphericDelayCorrection</i> is included in <i>gridList</i> . Otherwise it is not present.

GNSS-SSR-GriddedCorrection field descriptions	
epochTime	This field specifies the epoch time of the gridded correction data. The <i>gnss-TimeID</i> in <i>GNSS-SystemTime</i> shall be the same as the <i>GNSS-ID</i> in IE <i>GNSS-GenericAssistDataElement</i> .
ssrUpdateInterval	This field specifies the SSR Update Interval. The SSR Update Intervals for all SSR parameters start at time 00:00:00 of the GPS time scale. A change of the SSR Update Interval during the transmission of SSR data should ensure consistent data for a target device. See table Value of <i>ssrUpdateInterval</i> to SSR Update Interval relation in IE <i>GNSS-SSR-OrbitCorrections</i> .
iod-ssr	This field specifies the Issue of Data number for the SSR data. A change of <i>iod-ssr</i> is used to indicate a change in the SSR generating configuration.
troposphericDelayQualityIndicator	This field specifies the quality indicator of the tropospheric delay. The troposphere quality indicator is represented by a combination of CLASS and VALUE. The 3 MSB define the CLASS with a range of 0-7 and the 3 LSB define the VALUE with a range of 0-7. The troposphere quality indicator is computed by: $\text{SSR Troposphere Quality [mm]} \leq 3^{\text{CLASS}} \left(1 + \frac{\text{VALUE}}{4} \right) - 1 \text{ [mm]}$ See Table 'Relationship between SSR troposphere quality and URA indicator and physical quantity' below.
correctionPointSetID	This field provides the ID of the <i>GNSS-SSR-CorrectionPoints</i> set. The <i>GNSS-SSR-GriddedCorrection</i> are valid for the correction points provided in IE <i>GNSS-SSR-CorrectionPoints</i> with the same <i>correctionPointSetID</i> .
gridList	This field provides the troposphere delay correction together with the residual part of the STEC corrections for up to 64 correction points defined in IE <i>GNSS-SSR-CorrectionPoints</i> . If the IE <i>GNSS-SSR-CorrectionPoints</i> , which belongs to the <i>correctionPointSetID</i> , includes the <i>listOfCorrectionPoints</i> , the <i>gridList</i> includes the same number of entries, and listed in the same order, as in the <i>listOfCorrectionPoints</i> . If the IE <i>GNSS-SSR-CorrectionPoints</i> , which belongs to this <i>correctionPointSetID</i> , includes the <i>arrayOfCorrectionPoints</i> the <i>gridList</i> includes the same number of entries, and listed in the same order, as defined by the enabled bits in the <i>bitmaskOfGrids</i> .
tropoHydroStaticVerticalDelay	This field specifies the variation in the hydro static troposphere vertical delay relative to nominal value. The target device should add the constant nominal value of 2.3 m to calculate the tropospheric hydro-static vertical delay. Scale factor 0.004 m; range ± 1.02 m.
tropoWetVerticalDelay	This field specifies the variation in the wet troposphere vertical delay relative to nominal value. The target device should add the constant value of 0.252 m to calculate the tropospheric wet (non hydro-static) vertical delay. Scale factor 0.004 m; range ± 0.508 m.
svID	This field specifies the GNSS satellite for which the STEC residual corrections are provided.
stecResidualCorrection	This field specifies the STEC residual correction. Scale factor 0.04 TECU; range ± 2.52 TECU (b7) or ± 1310.68 TECU (b16).

Relationship between SSR troposphere quality and URA indicator and physical quantity

CLASS	VALUE	Index	SSR troposphere quality indicator and SSR URA Q [mm]
7	7	63	5466.50 < Q
7	6	62	4919.75 < Q ≤ 5466.50
7	5	61	4373.75 < Q ≤ 4919.75
7	4	60	3826.25 < Q ≤ 4373.00
7	3	59	3279.50 < Q ≤ 3826.25
7	2	58	2732.75 < Q ≤ 3279.50
7	1	57	2186.00 < Q ≤ 2732.75
7	0	56	2003.75 < Q ≤ 2186.00
6	7	55	1821.50 < Q ≤ 2003.75
6	6	54	1639.25 < Q ≤ 1821.50
6	5	53	1457.00 < Q ≤ 1639.25
6	4	52	1274.75 < Q ≤ 1457.00
6	3	51	1092.50 < Q ≤ 1274.75
6	2	50	910.25 < Q ≤ 1092.50
6	1	49	728.00 < Q ≤ 910.25
6	0	48	667.25 < Q ≤ 728.00

5	7	47	606.50	< Q ≤	667.25
5	6	46	545.75	< Q ≤	606.50
5	5	45	485.00	< Q ≤	545.75
5	4	44	424.25	< Q ≤	485.00
5	3	43	363.50	< Q ≤	425.25
5	2	42	302.75	< Q ≤	363.50
5	1	41	242.00	< Q ≤	302.75
5	0	40	221.75	< Q ≤	242.00
4	7	39	201.50	< Q ≤	221.75
4	6	38	181.25	< Q ≤	201.50
4	5	37	161.00	< Q ≤	181.25
4	4	36	140.75	< Q ≤	161.00
4	3	35	120.50	< Q ≤	140.75
4	2	34	100.25	< Q ≤	120.50
4	1	33	80.00	< Q ≤	100.25
4	0	32	73.25	< Q ≤	80.00
3	7	31	66.50	< Q ≤	73.25
3	6	30	59.75	< Q ≤	66.50
3	5	29	53.00	< Q ≤	59.75
3	4	28	46.25	< Q ≤	53.00
3	3	27	39.50	< Q ≤	46.25
3	2	26	32.75	< Q ≤	39.50
3	1	25	26.00	< Q ≤	32.75
3	0	24	23.75	< Q ≤	26.00
2	7	23	21.50	< Q ≤	23.75
2	6	22	19.25	< Q ≤	21.50
2	5	21	17.00	< Q ≤	19.25
2	4	20	14.75	< Q ≤	17.00
2	3	19	12.50	< Q ≤	14.75
2	2	18	10.25	< Q ≤	12.50
2	1	17	8.00	< Q ≤	10.25
2	0	16	7.25	< Q ≤	8.00
1	7	15	6.50	< Q ≤	7.25
1	6	14	5.75	< Q ≤	6.50
1	5	13	5.00	< Q ≤	5.75
1	4	12	4.25	< Q ≤	5.00
1	3	11	3.50	< Q ≤	4.25
1	2	10	2.75	< Q ≤	3.50
1	1	9	2.00	< Q ≤	2.75
1	0	8	1.75	< Q ≤	2.00
0	7	7	1.50	< Q ≤	1.75
0	6	6	1.25	< Q ≤	1.50
0	5	5	1.00	< Q ≤	1.25
0	4	4	0.75	< Q ≤	1.00
0	3	3	0.50	< Q ≤	0.75
0	2	2	0.25	< Q ≤	0.50
0	1	1		Q ≤	0.25
0	0	0			undefined/unknown

– NavIC-DifferentialCorrections

The IE *NavIC-DifferentialCorrections* parameters provide users with sets of correction terms that apply to the clock and ephemeris data transmitted by other satellites in the AutoNav mode as defined in [38] under clause 6.2.6.

```
-- ASN1START
NavIC-DifferentialCorrections-r16 ::= SEQUENCE {
    navic-RefTOWC-r16          INTEGER (0..50400),
    navic-CorrectionListAutoNav-r16 NavIC-CorrectionListAutoNav-r16,
    ...
}
NavIC-CorrectionListAutoNav-r16 ::= SEQUENCE (SIZE (1..64)) OF NavIC-CorrectionElementAutoNav-r16
NavIC-CorrectionElementAutoNav-r16 ::= SEQUENCE {
    svID                      SV-ID,
```

```
    navic-Tod-r16             INTEGER (0..65535),
    navic-iodec-r16          INTEGER (0..255),
    navic-UDRAI-r16          INTEGER (-16..15),
    navic-UDRArateI-r16      INTEGER (-16..15),
    navic-EDC-r16            NavIC-EDC-r16,
    navic-CDC-r16            NavIC-CDC-r16,
    ...
}

NavIC-EDC-r16 ::= SEQUENCE {
    navic-AlphaEDC-r16       INTEGER (-8192..8191),
    navic-BetaEDC-r16        INTEGER (-8192..8191),
    navic-GammaEDC-r16       INTEGER (-16384..16383),
    navic-AoIcorrection-r16  INTEGER (-2048..2047),
    navic-AoRAcorrection-r16 INTEGER (-2048..2047),
    navic-SemiMajorcorrection-r16 INTEGER (-2048..2047),
    ...
}

NavIC-CDC-r16 ::= SEQUENCE {
    navic-ClockBiasCorrection-r16 INTEGER (-4096..4095),
    navic-ClockDriftCorrection-r16 INTEGER (-128..127),
    ...
}

-- ASN1STOP
```

NavIC-DifferentialCorrections field descriptions
<p>navic-RefTOWC The transmission timing of the navigation message provided through the Time of Week Count (TOWC) corresponding to the given set of grid ionospheric parameters. It indicates the number of 12 second counts represented in 17 bits. The TOW count value ranges from 1 to 50400 to cover one entire week. The Time of Week (TOW) in seconds is obtained by multiplying TOWC with 12 as defined in [38], clause 5.7.</p>
<p>navic-Tod This field indicates the NavIC Time of Differential Correction in seconds. Scale factor 16 seconds</p>
<p>navic-iodec This field indicates Issue of Data Ephemeris and Clock which provides the user with a convenient means of detecting any change in the ephemeris and clock parameters as described under clause 6.2.1.3 in [38]</p>
<p>navic-UDRAI This field indicates the index for the User Differential Range Accuracy (in metres) value which enables users to estimate the accuracy obtained after differential corrections are applied as described under clause 6.2.6 in [38]</p>
<p>navic-UDRARatel This field indicates the index for the change rate of User Differential Range Accuracy (metres/second) value which enables users to estimate the accuracy obtained after differential corrections are applied as described under clause 6.2.6 in [38]</p>
<p>navic-AlphaEDC This field indicates the Alpha correction to Ephemeris parameter ($\Delta\alpha$), which is one of the six keplerian elements defining the ephemeris differential corrections (EDC) for NavIC as defined under clause 6.1.3.5 in [38]. Scale factor 2^{-34}</p>
<p>navic-BetaEDC This field indicates Beta correction to Ephemeris parameter ($\Delta\beta$), which is one of the six keplerian elements defining the ephemeris differential corrections (EDC) for NavIC as defined under clause 6.1.3.5 in [38]. Scale factor 2^{-34}</p>
<p>navic-GammaEDC This field indicates the Gamma correction to Ephemeris parameter ($\Delta\gamma$), which is one of the six keplerian elements defining the ephemeris differential corrections (EDC) for NavIC as defined under clause 6.1.3.5 in [38]. Scale factor 2^{-32} semi-circles.</p>
<p>navic-Aolcorrection This field indicates the Angle of inclination correction (Δi), which is one of the six keplerian elements defining the ephemeris differential corrections (EDC) for NavIC as defined under clause 6.1.3.5 in [38]. Scale factor 2^{-32} semi-circles.</p>
<p>navic-AoRAcorrection This field indicates the Angle of right ascension correction ($\Delta\Omega$), which is one of the six keplerian elements defining the ephemeris differential corrections (EDC) for NavIC as defined under clause 6.1.3.5 in [38]. Scale factor 2^{-32} semi-circles.</p>
<p>navic-SemiMajorcorrection This field indicates the Semi-major correction (ΔA), which is one of the six keplerian elements defining the ephemeris differential corrections (EDC) for NavIC as defined under clause 6.1.3.5 in [38]. Scale factor 2^{-9} metres.</p>
<p>navic-ClockBiasCorrection This field indicates correction to the satellite clock bias coefficient (δaf_0), which is one of the two Satellite clock differential corrections (CDC) containing corrections to the NavIC satellite clock polynomial coefficients as defined under clause 6.1.3.5 in [38]. Scale factor 2^{-35} seconds.</p>
<p>navic-ClockDriftCorrection This field indicates correction to the satellite clock drift coefficient (δaf_1), which is one of the two Satellite clock differential corrections (CDC) containing corrections to the NavIC satellite clock polynomial coefficients as defined under clause 6.1.3.5 in [38]. Scale factor 2^{-51} sec / sec.</p>

NavIC-GridModelParameter

```

-- ASN1START
NavIC-GridModelParameter-r16 ::= SEQUENCE {
    navic-RefTOWC-r16    INTEGER (0..50400),
    regionMasked-r16    INTEGER (0..1023),
    regionIgpList-r16   RegionIgpList-r16,
    ...
}
RegionIgpList-r16 ::= SEQUENCE (SIZE (1..16)) OF RegionIgpElement-r16
RegionIgpElement-r16 ::= SEQUENCE {

```

```

regionID-r16    INTEGER (0..15),
givei1-r16     INTEGER (0..15),
givd1-r16      INTEGER (0..511),
givei2-r16     INTEGER (0..15),
givd2-r16      INTEGER (0..511),
givei3-r16     INTEGER (0..15),
givd3-r16      INTEGER (0..511),
givei4-r16     INTEGER (0..15),
givd4-r16      INTEGER (0..511),
givei5-r16     INTEGER (0..15),
givd5-r16      INTEGER (0..511),
givei6-r16     INTEGER (0..15),
givd6-r16      INTEGER (0..511),
givei7-r16     INTEGER (0..15),
givd7-r16      INTEGER (0..511),
givei8-r16     INTEGER (0..15),
givd8-r16      INTEGER (0..511),
givei9-r16     INTEGER (0..15),
givd9-r16      INTEGER (0..511),
givei10-r16    INTEGER (0..15),
givd10-r16     INTEGER (0..511),
givei11-r16    INTEGER (0..15),
givd11-r16     INTEGER (0..511),
givei12-r16    INTEGER (0..15),
givd12-r16     INTEGER (0..511),
givei13-r16    INTEGER (0..15),
givd13-r16     INTEGER (0..511),
givei14-r16    INTEGER (0..15),
givd14-r16     INTEGER (0..511),
givei15-r16    INTEGER (0..15),
givd15-r16     INTEGER (0..511),
...
}
-- ASN1STOP

```

NavIC-GridModelParameter field descriptions

navic-RefTOWC

The transmission timing of the navigation message provided through the Time of Week Count (TOWC) corresponding to the given set of grid ionospheric parameters. It indicates the number of 12 second counts represented in 17 bits. The TOW count value ranges from 1 to 50400 to cover one entire week. The Time of Week (TOW) in seconds is obtained by multiplying TOWC with 12 as defined in [38], clause 5.7.

regionMasked

Total 90 Ionospheric Grid Points (IGP) are defined in [38] clause 6.2.3 table 25. 15 IGP points are grouped into a single region. The region masked indicates the total number of regions for which the corrections are provided. For the current service area of the IRNSS, regions masked are 6.

regionIgpList

This list provides the set of IGPs corresponding to each region. Up to 6 instances (0 to 5) are used in this version of the specification. The values 6 to 15 are reserved for future use.

regionID

regionID along with index of the IGPS point corresponding gives the location of IGPS point as defined in [38], table 25, clause 6.2.3.

givei1, givei2, .. , givei15

This field indicates the Grid Ionospheric Vertical Error Index (GIVEI) which is used to describe the delay correction accuracy at ionospheric grid point indicated by the *igp-ID*, the mapping between GIVEI and GIVE is defined in [38], clause 6.2.2 and table 27.

givd1, givd2, ... , givd15

This field indicates the Grid Ionospheric Vertical Delay (GIVD) as defined in [38], clause 5.3.3.8.1, i.e. the vertical delay at the corresponding Ionospheric Grid points (IGPs) indicated by *igp-ID*. The scale factor is 0.125 metre.

6.5.2.3 GNSS Assistance Data Request

– A-GNSS-RequestAssistanceData

The IE *A-GNSS-RequestAssistanceData* is used by the target device to request GNSS assistance data from a location server.

```
-- ASN1START
```

```

A-GNSS-RequestAssistanceData ::= SEQUENCE {
  gnss-CommonAssistDataReq      GNSS-CommonAssistDataReq      OPTIONAL, -- Cond CommonADReq
  gnss-GenericAssistDataReq     GNSS-GenericAssistDataReq     OPTIONAL, -- Cond GenADReq
  ...
  [[
    gnss-PeriodicAssistDataReq-r15
                                GNSS-PeriodicAssistDataReq-r15 OPTIONAL -- Cond PerADReq
  ]]
}
-- ASN1STOP

```

Conditional presence	Explanation
<i>CommonADReq</i>	The field is mandatory present if the target device requests <i>GNSS-CommonAssistData</i> ; otherwise it is not present.
<i>GenADReq</i>	This field is mandatory present if the target device requests <i>GNSS-GenericAssistData</i> for one or more specific GNSS; otherwise it is not present.
<i>PerADReq</i>	This field is mandatory present if the target device requests periodic GNSS assistance data delivery. This field may only be included if any of the fields are included in IE <i>GNSS-GenericAssistDataReq</i> : <ul style="list-style-type: none"> - <i>GNSS-RTK-ObservationsReq</i>, - <i>GLO-RTK-BiasInformationReq</i>, - <i>GNSS-RTK-MAC-CorrectionDifferencesReq</i>, - <i>GNSS-RTK-ResidualsReq</i>, - <i>GNSS-RTK-FKP-GradientsReq</i>, - <i>GNSS-SSR-OrbitCorrectionsReq</i>, - <i>GNSS-SSR-ClockCorrectionsReq</i>, - <i>GNSS-SSR-CodeBiasReq</i>, - <i>GNSS-SSR-URA-Req</i>, - <i>GNSS-SSR-PhaseBiasReq</i>, - <i>GNSS-SSR-STECCorrectionReq</i>, or - <i>GNSS-SSR-GriddedCorrectionReq</i>.

– GNSS-CommonAssistDataReq

The IE *GNSS-CommonAssistDataReq* is used by the target device to request assistance data that are applicable to any GNSS from a location server.

```

-- ASN1START
GNSS-CommonAssistDataReq ::= SEQUENCE {
  gnss-ReferenceTimeReq      GNSS-ReferenceTimeReq
                              OPTIONAL, -- Cond RefTimeReq
  gnss-ReferenceLocationReq  GNSS-ReferenceLocationReq
                              OPTIONAL, -- Cond RefLocReq
  gnss-IonosphericModelReq   GNSS-IonosphericModelReq
                              OPTIONAL, -- Cond IonoModReq
  gnss-EarthOrientationParametersReq
                              GNSS-EarthOrientationParametersReq
                              OPTIONAL, -- Cond EOPReq
  ...
  [[
    gnss-RTK-ReferenceStationInfoReq-r15
                                GNSS-RTK-ReferenceStationInfoReq-r15
                                OPTIONAL, -- Cond ARPReq
    gnss-RTK-AuxiliaryStationDataReq-r15
                                GNSS-RTK-AuxiliaryStationDataReq-r15
                                OPTIONAL -- Cond AuxARPReq
  ]],
  [[
    gnss-SSR-CorrectionPointsReq-r16
                                GNSS-SSR-CorrectionPointsReq-r16
                                OPTIONAL -- Cond PointsReq
  ]]
}
-- ASN1STOP

```

Conditional presence	Explanation
<i>RefTimeReq</i>	The field is mandatory present if the target device requests <i>GNSS-ReferenceTime</i> ; otherwise it is not present.
<i>RefLocReq</i>	This field is mandatory present if the target device requests <i>GNSS-ReferenceLocation</i> ; otherwise it is not present.
<i>IonoModReq</i>	This field is mandatory present if the target device requests <i>GNSS-IonosphericModel</i> ; otherwise it is not present.
<i>EOPReq</i>	This field is mandatory present if the target device requests <i>GNSS-EarthOrientationParameters</i> ; otherwise it is not present.
<i>ARPRReq</i>	This field is mandatory present if the target device requests <i>GNSS-RTK-ReferenceStationInfo</i> ; otherwise it is not present.
<i>AuxARPRReq</i>	This field is mandatory present if the target device requests <i>GNSS-RTK-AuxiliaryStationData</i> ; otherwise it is not present.
<i>PointsReq</i>	This field is mandatory present if the target device requests <i>GNSS-SSR-CorrectionPoints</i> ; otherwise it is not present.

– GNSS-GenericAssistDataReq

The IE *GNSS-GenericAssistDataReq* is used by the target device to request assistance data from a location server for one or more specific GNSSs. The specific GNSS for which the assistance data are requested is indicated by the IE *GNSS-ID* and (if applicable) by the IE *SBAS-ID*. Assistance for up to 16 GNSSs can be requested.

```
-- ASN1START
GNSS-GenericAssistDataReq ::= SEQUENCE (SIZE (1..16)) OF GNSS-GenericAssistDataReqElement
GNSS-GenericAssistDataReqElement ::= SEQUENCE {
  gnss-ID          GNSS-ID,
  sbas-ID          SBAS-ID                               OPTIONAL, -- Cond GNSS-ID-SBAS
  gnss-TimeModelsReq  GNSS-TimeModelListReq           OPTIONAL, -- Cond TimeModReq
  gnss-DifferentialCorrectionsReq GNSS-DifferentialCorrectionsReq OPTIONAL, -- Cond DGNSS-Req
  gnss-NavModelReq    GNSS-NavModelReq                OPTIONAL, -- Cond NavModReq
  gnss-RTIntegrityReq GNSS-RealTimeIntegrityReq       OPTIONAL, -- Cond RTIReq
  gnss-DataBitAssistanceReq GNSS-DataBitAssistanceReq   OPTIONAL, -- Cond DataBitsReq
  gnss-AcquisitionAssistanceReq GNSS-AcquisitionAssistanceReq   OPTIONAL, -- Cond AcquAssistReq
  gnss-AlmanacReq     GNSS-AlmanacReq                 OPTIONAL, -- Cond AlmanacReq
  gnss-UTCModelReq    GNSS-UTC-ModelReq              OPTIONAL, -- Cond UTCModReq
  gnss-AuxiliaryInformationReq GNSS-AuxiliaryInformationReq   OPTIONAL, -- Cond AuxInfoReq
  ...
  [[
    bds-DifferentialCorrectionsReq-r12 BDS-DifferentialCorrectionsReq-r12
                                         OPTIONAL, -- Cond DBDS-Req
    bds-GridModelReq-r12 BDS-GridModelReq-r12
                                         OPTIONAL, -- Cond BDS-GridModReq
  ]],
  [[
    gnss-RTK-ObservationsReq-r15 GNSS-RTK-ObservationsReq-r15   OPTIONAL, -- Cond RTK-OSR-Req
    glo-RTK-BiasInformationReq-r15 GLO-RTK-BiasInformationReq-r15 OPTIONAL, -- Cond GLO-CPB-Req
    gnss-RTK-MAC-CorrectionDifferencesReq-r15 GNSS-RTK-MAC-CorrectionDifferencesReq-r15
                                         OPTIONAL, -- Cond MAC-Req
    gnss-RTK-ResidualsReq-r15 GNSS-RTK-ResidualsReq-r15        OPTIONAL, -- Cond Res-Req
    gnss-RTK-FKP-GradientsReq-r15 GNSS-RTK-FKP-GradientsReq-r15 OPTIONAL, -- Cond FKP-Req
    gnss-SSR-OrbitCorrectionsReq-r15 GNSS-SSR-OrbitCorrectionsReq-r15
                                         OPTIONAL, -- Cond OC-Req
    gnss-SSR-ClockCorrectionsReq-r15 GNSS-SSR-ClockCorrectionsReq-r15
                                         OPTIONAL, -- Cond CC-Req
    gnss-SSR-CodeBiasReq-r15 GNSS-SSR-CodeBiasReq-r15          OPTIONAL, -- Cond CB-Req
  ]],
  [[
    gnss-SSR-URA-Req-r16 GNSS-SSR-URA-Req-r16                OPTIONAL, -- Cond URA-Req
    gnss-SSR-PhaseBiasReq-r16 GNSS-SSR-PhaseBiasReq-r16        OPTIONAL, -- Cond PB-Req
    gnss-SSR-STEC-CorrectionReq-r16 GNSS-SSR-STEC-CorrectionReq-r16
                                         OPTIONAL, -- Cond STEC-Req
    gnss-SSR-GriddedCorrectionReq-r16 GNSS-SSR-GriddedCorrectionReq-r16
                                         OPTIONAL, -- Cond Grid-Req
    navic-DifferentialCorrectionsReq-r16
  ]]
```

```

    NavIC-DifferentialCorrectionsReq-r16
    navic-GridModelReq-r16 NavIC-GridModelReq-r16 OPTIONAL, -- Cond DNavIC-Req
  ]] NavIC-GridModReq OPTIONAL -- Cond NavIC-GridModReq
}
-- ASN1STOP

```

Conditional presence	Explanation
<i>GNSS-ID-SBAS</i>	The field is mandatory present if the <i>GNSS-ID</i> = <i>sbas</i> ; otherwise it is not present.
<i>TimeModReq</i>	The field is mandatory present if the target device requests <i>GNSS-TimeModelList</i> ; otherwise it is not present.
<i>DGNSS-Req</i>	The field is mandatory present if the target device requests <i>GNSS-DifferentialCorrections</i> ; otherwise it is not present.
<i>NavModReq</i>	The field is mandatory present if the target device requests <i>GNSS-NavigationModel</i> ; otherwise it is not present.
<i>RTIReq</i>	The field is mandatory present if the target device requests <i>GNSS-RealTimeIntegrity</i> ; otherwise it is not present.
<i>DataBitsReq</i>	The field is mandatory present if the target device requests <i>GNSS-DataBitAssistance</i> ; otherwise it is not present.
<i>AcquAssistReq</i>	The field is mandatory present if the target device requests <i>GNSS-AcquisitionAssistance</i> ; otherwise it is not present.
<i>AlmanacReq</i>	The field is mandatory present if the target device requests <i>GNSS-Almanac</i> ; otherwise it is not present.
<i>UTCModReq</i>	The field is mandatory present if the target device requests <i>GNSS-UTCModel</i> ; otherwise it is not present.
<i>AuxInfoReq</i>	The field is mandatory present if the target device requests <i>GNSS-AuxiliaryInformation</i> ; otherwise it is not present.
<i>DBDS-Req</i>	The field is mandatory present if the target device requests <i>BDS-DifferentialCorrections</i> ; otherwise it is not present. This field may only be present if <i>gnss-ID</i> indicates 'bds'.
<i>BDS-GridModReq</i>	The field is mandatory present if the target device requests <i>BDS-GridModel</i> ; otherwise it is not present. This field may only be present if <i>gnss-ID</i> indicates 'bds'.
<i>RTK-OSR-Req</i>	The field is mandatory present if the target device requests <i>GNSS-RTK-Observations</i> ; otherwise it is not present.
<i>GLO-CPB-Req</i>	The field is mandatory present if the target device requests <i>GLO-RTK-BiasInformation</i> ; otherwise it is not present.
<i>MAC-Req</i>	The field is mandatory present if the target device requests <i>GNSS-RTK-MAC-CorrectionDifferences</i> ; otherwise it is not present.
<i>Res-Req</i>	The field is mandatory present if the target device requests <i>GNSS-RTK-Residuals</i> ; otherwise it is not present.
<i>FKP-Req</i>	The field is mandatory present if the target device requests <i>GNSS-RTK-FKP-Gradients</i> ; otherwise it is not present.
<i>OC-Req</i>	The field is mandatory present if the target device requests <i>GNSS-SSR-OrbitCorrections</i> ; otherwise it is not present.
<i>CC-Req</i>	The field is mandatory present if the target device requests <i>GNSS-SSR-ClockCorrections</i> ; otherwise it is not present.
<i>CB-Req</i>	The field is mandatory present if the target device requests <i>GNSS-SSR-CodeBias</i> ; otherwise it is not present.
<i>URA-Req</i>	The field is mandatory present if the target device requests <i>GNSS-SSR-URA</i> ; otherwise it is not present.
<i>PB-Req</i>	The field is mandatory present if the target device requests <i>GNSS-SSR-PhaseBias</i> ; otherwise it is not present.
<i>STEC-Req</i>	The field is mandatory present if the target device requests <i>GNSS-SSR-STEC-Correction</i> ; otherwise it is not present.
<i>Grid-Req</i>	The field is mandatory present if the target device requests <i>GNSS-SSR-GriddedCorrection</i> ; otherwise it is not present.
<i>DNavIC-Req</i>	The field is mandatory present if the target device requests <i>NavIC-DifferentialCorrections</i> ; otherwise it is not present. This field may only be present if the <i>gnss-ID</i> indicates 'navic'.
<i>NavIC-GridModReq</i>	The field is mandatory present if the target device requests <i>NavIC-GridModel</i> ; otherwise it is not present. This field may only be present if the <i>gnss-ID</i> indicates 'navic'.

– *GNSS-PeriodicAssistDataReq*

The IE *GNSS-PeriodicAssistDataReq* is used by the target device to request periodic assistance data delivery from a location server.

```

-- ASN1START
GNSS-PeriodicAssistDataReq-r15 ::= SEQUENCE {
  gnss-RTK-PeriodicObservationsReq-r15  GNSS-PeriodicControlParam-r15  OPTIONAL, -- Cond pOSR
  glo-RTK-PeriodicBiasInformationReq-r15  GNSS-PeriodicControlParam-r15  OPTIONAL, -- Cond pCPB
  gnss-RTK-MAC-PeriodicCorrectionDifferencesReq-r15
  GNSS-PeriodicControlParam-r15  OPTIONAL, -- Cond pMAC
  gnss-RTK-PeriodicResidualsReq-r15      GNSS-PeriodicControlParam-r15  OPTIONAL, -- Cond pRes
  gnss-RTK-FKP-PeriodicGradientsReq-r15  GNSS-PeriodicControlParam-r15  OPTIONAL, -- Cond pFKP
  gnss-SSR-PeriodicOrbitCorrectionsReq-r15
  GNSS-PeriodicControlParam-r15  OPTIONAL, -- Cond pOC
  gnss-SSR-PeriodicClockCorrectionsReq-r15
  GNSS-PeriodicControlParam-r15  OPTIONAL, -- Cond pCC
  gnss-SSR-PeriodicCodeBiasReq-r15      GNSS-PeriodicControlParam-r15  OPTIONAL, -- Cond pCB
  ...
  [[
  gnss-SSR-PeriodicURA-Req-r16          GNSS-PeriodicControlParam-r15  OPTIONAL, -- Cond pURA
  gnss-SSR-PeriodicPhaseBiasReq-r16     GNSS-PeriodicControlParam-r15  OPTIONAL, -- Cond pPB
  gnss-SSR-PeriodicSTEC-CorrectionReq-r16 GNSS-PeriodicControlParam-r15  OPTIONAL, -- Cond pSTEC
  gnss-SSR-PeriodicGriddedCorrectionReq-r16
  GNSS-PeriodicControlParam-r15  OPTIONAL -- Cond pGrid
  ]]
}
-- ASN1STOP

```

Conditional presence	Explanation
<i>pOSR</i>	The field is mandatory present if the target device requests periodic <i>GNSS-RTK-Observations</i> ; otherwise it is not present.
<i>pCPB</i>	The field is mandatory present if the target device requests periodic <i>GLO-RTK-BiasInformation</i> ; otherwise it is not present.
<i>pMAC</i>	The field is mandatory present if the target device requests periodic <i>GNSS-RTK-MAC-CorrectionDifferences</i> ; otherwise it is not present.
<i>pRes</i>	The field is mandatory present if the target device requests periodic <i>GNSS-RTK-Residuals</i> ; otherwise it is not present.
<i>pFKP</i>	The field is mandatory present if the target device requests periodic <i>GNSS-RTK-FKP-Gradients</i> ; otherwise it is not present.
<i>pOC</i>	The field is mandatory present if the target device requests periodic <i>GNSS-SSR-OrbitCorrections</i> ; otherwise it is not present.
<i>pCC</i>	The field is mandatory present if the target device requests periodic <i>GNSS-SSR-ClockCorrections</i> ; otherwise it is not present.
<i>pCB</i>	The field is mandatory present if the target device requests periodic <i>GNSS-SSR-CodeBias</i> ; otherwise it is not present.
<i>pURA</i>	The field is mandatory present if the target device requests periodic <i>GNSS-SSR-URA</i> ; otherwise it is not present.
<i>pPB</i>	The field is mandatory present if the target device requests periodic <i>GNSS-SSR-PhaseBias</i> ; otherwise it is not present.
<i>pSTEC</i>	The field is mandatory present if the target device requests periodic <i>GNSS-SSR-STEC-Correction</i> ; otherwise it is not present.
<i>pGrid</i>	The field is mandatory present if the target device requests periodic <i>GNSS-SSR-GriddedCorrection</i> ; otherwise it is not present.

6.5.2.4 GNSS Assistance Data Request Elements

– *GNSS-ReferenceTimeReq*

The IE *GNSS-ReferenceTimeReq* is used by the target device to request the *GNSS-ReferenceTime* assistance from the location server.

```

-- ASN1START
GNSS-ReferenceTimeReq ::= SEQUENCE {
  gnss-TimeReqPrefList  SEQUENCE (SIZE (1..8)) OF GNSS-ID,
  gps-TOW-assistReq     BOOLEAN
  notOfLeapSecReq      BOOLEAN
  ...
}
-- ASN1STOP

```

Conditional presence	Explanation
<i>gps</i>	The field is mandatory present if <i>gnss-TimeReqPrefList</i> includes a <i>GNSS-ID= 'gps'</i> ; otherwise it is not present.
<i>glonass</i>	The field is mandatory present if <i>gnss-TimeReqPrefList</i> includes a <i>GNSS-ID= 'glonass'</i> ; otherwise it is not present.

GNSS-ReferenceTimeReq field descriptions
<p><i>gnss-TimeReqPrefList</i> This field is used by the target device to request the system time for a specific GNSS, specified by GNSS-ID in the order of preference. The first <i>GNSS-ID</i> in the list is the most preferred GNSS for reference time, the second <i>GNSS-ID</i> is the second most preferred, etc.</p>
<p><i>gps-TOW-assistReq</i> This field is used by the target device to request the <i>gps-TOW-Assist</i> field in <i>GNSS-SystemTime</i>. TRUE means requested.</p>
<p><i>notOfLeapSecReq</i> This field is used by the target device to request the <i>notificationOfLeapSecond</i> field in <i>GNSS-SystemTime</i>. TRUE means requested.</p>

– *GNSS-ReferenceLocationReq*

The IE *GNSS-ReferenceLocationReq* is used by the target device to request the *GNSS-ReferenceLocation* assistance from the location server.

```
-- ASN1START
GNSS-ReferenceLocationReq ::= SEQUENCE {
    ...
}
-- ASN1STOP
```

– *GNSS-IonosphericModelReq*

The IE *GNSS-IonosphericModelReq* is used by the target device to request the *GNSS-IonosphericModel* assistance from the location server.

```
-- ASN1START
GNSS-IonosphericModelReq ::= SEQUENCE {
    klobucharModelReq BIT STRING (SIZE(2)) OPTIONAL, -- Cond klobuchar
    neQuickModelReq NULL OPTIONAL, -- Cond nequick
    ...,
    [[ klobucharModel2Req-r16 NULL OPTIONAL -- Cond klobuchar2
    ]]
}
-- ASN1STOP
```

Conditional presence	Explanation
<i>klobuchar</i>	The field is mandatory present if the target device requests <i>klobucharModel</i> ; otherwise it is not present. The BIT STRING defines the <i>dataID</i> requested, defined in IE <i>KlobucharModelParameter</i> .
<i>nequick</i>	The field is mandatory present if the target device requests <i>neQuickModel</i> ; otherwise it is not present.
<i>klobuchar2</i>	The field is mandatory present if the target device requests <i>klobucharModel2</i> ; otherwise it is not present.

– GNSS-EarthOrientationParametersReq

The IE *GNSS-EarthOrientationParametersReq* is used by the target device to request the *GNSS-EarthOrientationParameters* assistance from the location server.

```
-- ASN1START
GNSS-EarthOrientationParametersReq ::= SEQUENCE {
    ...
}
-- ASN1STOP
```

– GNSS-RTK-ReferenceStationInfoReq

The IE *GNSS-RTK-ReferenceStationInfoReq* is used by the target device to request the *GNSS-RTK-ReferenceStationInfo* assistance from the location server.

```
-- ASN1START
GNSS-RTK-ReferenceStationInfoReq-r15 ::= SEQUENCE {
    antennaDescriptionReq-r15          BOOLEAN,
    antennaHeightReq-r15              BOOLEAN,
    physicalReferenceStationReq-r15    BOOLEAN,
    stationID-r15                     GNSS-ReferenceStationID-r15    OPTIONAL,
    ...
}
-- ASN1STOP
```

GNSS-RTK-ReferenceStationInfoReq field descriptions

antennaDescriptionReq

This field specifies whether or not the location server is requested to include the field *AntennaDescription* in the *GNSS-RTK-ReferenceStationInfo* IE. TRUE means requested.

antennaHeightReq

This field specifies whether or not the location server is requested to include the field *antennaHeight* in the *GNSS-RTK-ReferenceStationInfo* IE. TRUE means requested.

physicalReferenceStationReq

This field specifies whether or not the location server is requested to include the field *physical-reference-station-info* in the *GNSS-RTK-ReferenceStationInfo* IE. TRUE means requested.

stationID

This field specifies the Station ID for which the *GNSS-RTK-ReferenceStationInfo* is requested.

– GNSS-RTK-AuxiliaryStationDataReq

The IE *GNSS-RTK-AuxiliaryStationDataReq* is used by the target device to request the *GNSS-RTK-AuxiliaryStationData* assistance from the location server.

```
-- ASN1START
GNSS-RTK-AuxiliaryStationDataReq-r15 ::= SEQUENCE {
    master-referenceStationID-r15      GNSS-ReferenceStationID-r15    OPTIONAL,
    ...
}
-- ASN1STOP
```

GNSS-RTK-AuxiliaryStationDataReq field descriptions

master-referenceStationID

This field specifies the Master Reference Station ID for which the Auxiliary Stations are requested.

– GNSS-SSR-CorrectionPointsReq

The IE *GNSS-SSR-CorrectionPointsReq* is used by the target device to request the *GNSS-SSR-CorrectionPoints* assistance from the location server.

```
-- ASN1START
GNSS-SSR-CorrectionPointsReq-r16 ::= SEQUENCE {
    correctionPointSetID-Req-r16      INTEGER (0..16383)      OPTIONAL,
    ...
}
-- ASN1STOP
```

GNSS-SSR-CorrectionPointsReq field descriptions

correctionPointSetID-Req

This field specifies the ID of the Atmospheric Correction Point set for which the *GNSS-SSR-CorrectionPoints* are requested.

– GNSS-TimeModelListReq

The IE *GNSS-TimeModelListReq* is used by the target device to request the *GNSS-TimeModelElement* assistance from the location server.

```
-- ASN1START
GNSS-TimeModelListReq ::= SEQUENCE (SIZE(1..15)) OF GNSS-TimeModelElementReq
GNSS-TimeModelElementReq ::= SEQUENCE {
    gnss-TO-IDsReq      INTEGER (1..15),
    deltaTreq           BOOLEAN,
    ...
}
-- ASN1STOP
```

GNSS-TimeModelElementReq field descriptions

gnss-TO-IDsReq

This field specifies the requested *gnss-TO-ID*. The meaning and encoding is the same as the *gnss-TO-ID* field in the *GNSS-TimeModelElement* IE.

deltaTreq

This field specifies whether or not the location server is requested to include the *deltaT* field in the *GNSS-TimeModelElement* IE. TRUE means requested.

– GNSS-DifferentialCorrectionsReq

The IE *GNSS-DifferentialCorrectionsReq* is used by the target device to request the *GNSS-DifferentialCorrections* assistance from the location server.

```
-- ASN1START
GNSS-DifferentialCorrectionsReq ::= SEQUENCE {
    dgnss-SignalsReq      GNSS-SignalIDs,
    dgnss-ValidityTimeReq  BOOLEAN,
    ...
}
-- ASN1STOP
```

GNSS-DifferentialCorrectionsReq field descriptions

dgnss-SignalsReq

This field specifies the GNSS Signal(s) for which the *GNSS-DifferentialCorrections* are requested. A one-value at a bit position means DGNSS corrections for the specific signal are requested; a zero-value means not requested. The target device shall set a maximum of three bits to value 'one'.

GNSS-DifferentialCorrectionsReq field descriptions
<p><i>dgnss-ValidityTimeReq</i> This field specifies whether the <i>udreGrowthRate</i> and <i>udreValidityTime</i> in <i>GNSS-DifferentialCorrections</i> are requested or not. TRUE means requested.</p>

– ***GNSS-NavigationModelReq***

The IE *GNSS-NavigationModelReq* is used by the target device to request the *GNSS-NavigationModel* assistance from the location server.

```

-- ASN1START

GNSS-NavigationModelReq ::= CHOICE {
    storedNavList      StoredNavListInfo,
    reqNavList         ReqNavListInfo,
    ...
}

StoredNavListInfo ::= SEQUENCE {
    gnss-WeekOrDay     INTEGER (0..4095),
    gnss-Toe           INTEGER (0..255),
    t-toeLimit         INTEGER (0..15),
    satListRelatedDataList SatListRelatedDataList OPTIONAL,
    ...
}

SatListRelatedDataList ::= SEQUENCE (SIZE (1..64)) OF SatListRelatedDataElement

SatListRelatedDataElement ::= SEQUENCE {
    svID               SV-ID,
    iod                BIT STRING (SIZE(11)),
    clockModelID       INTEGER (1..8)           OPTIONAL,
    orbitModelID       INTEGER (1..8)           OPTIONAL,
    ...
}

ReqNavListInfo ::= SEQUENCE {
    svReqList          BIT STRING (SIZE (64)),
    clockModelID-PrefList SEQUENCE (SIZE (1..8)) OF INTEGER (1..8)           OPTIONAL,
    orbitModelID-PrefList SEQUENCE (SIZE (1..8)) OF INTEGER (1..8)           OPTIONAL,
    addNavparamReq     BOOLEAN                 OPTIONAL, -- Cond orbitModelID-2
    ...
}

-- ASN1STOP
    
```

Conditional presence	Explanation
<i>orbitModelID-2</i>	The field is mandatory present if <i>orbitModelID-PrefList</i> is absent or includes a Model-ID = '2'; otherwise it is not present.

GNSS-NavigationModelReq field descriptions
<p><i>storedNavList</i> This list provides information to the location server about which <i>GNSS-NavigationModel</i> data the target device has currently stored for the particular GNSS indicated by <i>GNSS-ID</i>.</p>
<p><i>reqNavList</i> This list provides information to the location server which <i>GNSS-NavigationModel</i> data are requested by the target device.</p>
<p><i>gnss-WeekOrDay</i> If <i>GNSS-ID</i> does not indicate 'glonass', this field defines the GNSS Week number of the assistance currently held by the target device. If <i>GNSS-ID</i> is set to 'glonass', this field defines the calendar number of day within the four-year interval starting from 1st of January in a leap year, as defined by the parameter N_T in [9] of the assistance currently held by the target device.</p>

GNSS-<i>NavigationModelReq</i> field descriptions
<p><i>gnss-Toe</i> If <i>GNSS-ID</i> does not indicate 'glonass', this field defines the GNSS time of ephemeris in hours of the latest ephemeris set contained by the target device. If <i>GNSS-ID</i> is set to 'glonass', this field defines the time of ephemeris in units of 15 minutes of the latest ephemeris set contained by the target device (range 0 to 95 representing time values between 0 and 1425 minutes). In this case, values 96 to 255 shall not be used by the sender.</p>
<p><i>t-toeLimit</i> If <i>GNSS-ID</i> does not indicate 'glonass', this IE defines the ephemeris age tolerance of the target device in units of hours. If <i>GNSS-ID</i> is set to 'glonass', this IE defines the ephemeris age tolerance of the target device in units of 30 minutes.</p>
<p><i>satListRelatedDataList</i> This list defines the clock and orbit models currently held by the target device for each SV. This field is not included if the target device does not have any stored clock and orbit models for any SV.</p>
<p><i>svID</i> This field identifies the particular GNSS satellite.</p>
<p><i>iod</i> This field identifies the issue of data currently held by the target device.</p>
<p><i>clockModelID, orbitModelID</i> These fields define the clock and orbit model number currently held by the target device. If these fields are absent, the default interpretation of the table <i>GNSS-ID</i> to <i>clockModelID</i> & <i>orbitModelID</i> relation below applies.</p>
<p><i>svReqList</i> This field defines the SV for which the navigation model assistance is requested. Each bit position in this BIT STRING represents a <i>SV-ID</i>. Bit 0 represents <i>SV-ID</i>=0 and bit 63 represents <i>SV-ID</i>=63. A one-value at a bit position means the navigation model data for the corresponding <i>SV-ID</i> is requested, a zero-value means not requested.</p>
<p><i>clockModelIDPrefList, orbitModelID-PrefList</i> These fields define the Model-IDs of the clock and orbit models that the target device wishes to obtain in the order of preference. The first Model-ID in the list is the most preferred model, the second Model-ID the second most preferred, etc. If these fields are absent, the default interpretation of the table <i>GNSS-ID</i> to <i>clockModelID-PrefList</i> & <i>orbitModelIDPrefList</i> relation below applies.</p>
<p><i>addNavparamReq</i> This field specifies whether the location server is requested to include the <i>addNAVparam</i> fields in <i>GNSS-<i>NavigationModel</i></i> IE (<i>NavModel-NAVKeplerianSet</i> field) or not. TRUE means requested.</p>

GNSS-ID to *clockModelID* & *orbitModelID* relation

<i>GNSS-ID</i>	<i>clockModelID</i>	<i>orbitModelID</i>
gps	2	2
sbas	5	5
qzss	2	2
galileo	1	1
glonass	4	4
bds	6	6
navic	8	8

GNSS-ID to *clockModelID-PrefList* & *orbitModelID-PrefList* relation

<i>GNSS-ID</i>	<i>clockModelID-PrefList</i>	<i>orbitModelID-PrefList</i>
gps	Model-2	Model-2
sbas	Model-5	Model-5
qzss	Model-2	Model-2
galileo	Model-1	Model-1
glonass	Model-4	Model-4
bds	Model-6	Model-6
navic	Model-8	Model-8

– *GNSS-RealTimeIntegrityReq*

The IE *GNSS-RealTimeIntegrityReq* is used by the target device to request the *GNSS-RealTimeIntegrity* assistance from the location server.

-- ASN1START

```

GNSS-RealTimeIntegrityReq ::= SEQUENCE {
    ...
}
-- ASN1STOP

```

– *GNSS-DataBitAssistanceReq*

The IE *GNSS-DataBitAssistanceReq* is used by the target device to request the *GNSS-DataBitAssistance* assistance from the location server.

```

-- ASN1START
GNSS-DataBitAssistanceReq ::= SEQUENCE {
    gnss-TOD-Req          INTEGER (0..3599),
    gnss-TOD-FracReq     INTEGER (0..999)          OPTIONAL,
    dataBitInterval      INTEGER (0..15),
    gnss-SignalType      GNSS-SignalIDs,
    gnss-DataBitsReq     GNSS-DataBitsReqSatList OPTIONAL,
    ...
}

GNSS-DataBitsReqSatList ::= SEQUENCE (SIZE(1..64)) OF GNSS-DataBitsReqSatElement

GNSS-DataBitsReqSatElement ::= SEQUENCE {
    svID                  SV-ID,
    ...
}
-- ASN1STOP

```

GNSS-DataBitAssistanceReq field descriptions

gnss-TOD-Req

This field specifies the reference time for the first data bit requested in GNSS specific system time, modulo 1 hour. Scale factor 1 second.

gnss-TOD-FracReq

This field specifies the fractional part of *gnss-TOD-Req* in 1-milli-second resolution. Scale factor 1 millisecond.

dataBitInterval

This field specifies the time length for which the Data Bit Assistance is requested. The *GNSS-DataBitAssistance* shall be relative to the time interval (*gnss-TOD-Req*, *gnss-TOD-Req* + *dataBitInterval*).

The *dataBitInterval* *r*, expressed in seconds, is mapped to a binary number K with the following formula:

$$r = 0.1 \times 2^K$$

Value K=15 means that the time interval is not specified.

gnss-SignalType

This field specifies the GNSS Signal(s) for which the *GNSS-DataBitAssistance* are requested. A one-value at a bit position means *GNSS-DataBitAssistance* for the specific signal is requested; a zero-value means not requested.

gnss-DataBitsReq

This list contains the SV-IDs for which the *GNSS-DataBitAssistance* is requested.

– *GNSS-AcquisitionAssistanceReq*

The IE *GNSS-AcquisitionAssistanceReq* is used by the target device to request the *GNSS-AcquisitionAssistance* assistance from the location server.

```

-- ASN1START
GNSS-AcquisitionAssistanceReq ::= SEQUENCE {
    gnss-SignalID-Req    GNSS-SignalID,
    ...
}
-- ASN1STOP

```

GNSS-AcquisitionAssistanceReq field descriptions**gnss-SignalID-Req**

This field specifies the GNSS signal type for which *GNSSAcquisitionAssistance* is requested.

– GNSS-AlmanacReq

The IE *GNSS-AlmanacReq* is used by the target device to request the *GNSS-Almanac* assistance from the location server.

```
-- ASN1START
GNSS-AlmanacReq ::= SEQUENCE {
    modelID          INTEGER(1..8)    OPTIONAL,
    ...
}
-- ASN1STOP
```

GNSS-AlmanacReq field descriptions**modelID**

This field specifies the Almanac Model ID requested. If this field is absent, the default interpretation as in the table GNSS-ID to modelID relation below applies.

GNSS-ID to modelID relation

<i>GNSS-ID</i>	<i>modelID</i>
gps	2
sbas	6
qzss	2
galileo	1
glonass	5
bds	7
navic	8

– GNSS-UTC-ModelReq

The IE *GNSS-UTC-ModelReq* is used by the target device to request the *GNSS-UTC-Model* assistance from the location server.

```
-- ASN1START
GNSS-UTC-ModelReq ::= SEQUENCE {
    modelID          INTEGER(1..8)    OPTIONAL,
    ...
}
-- ASN1STOP
```

GNSS-UTC-ModelReq field descriptions**modelID**

This field specifies the *GNSS-UTCModel* set requested. If this field is absent, the default interpretation as in the table GNSS-ID to modelID relation below applies.

GNSS-ID to modelID relation

<i>GNSS-ID</i>	<i>modelID</i>
gps	1
sbas	4
qzss	1
galileo	1
glonass	3
bds	5
navic	2

– ***GNSS-AuxiliaryInformationReq***

The IE *GNSS-AuxiliaryInformationReq* is used by the target device to request the *GNSS-AuxiliaryInformation* assistance from the location server.

```
-- ASN1START
GNSS-AuxiliaryInformationReq ::= SEQUENCE {
    ...
}
-- ASN1STOP
```

– ***BDS-DifferentialCorrectionsReq***

The IE *BDS-DifferentialCorrectionsReq* is used by the target device to request the *BDS-DifferentialCorrections* assistance from the location server.

```
-- ASN1START
BDS-DifferentialCorrectionsReq-r12 ::= SEQUENCE {
    dgnss-SignalsReq          GNSS-SignalIDs,
    ...
}
-- ASN1STOP
```

***BDS-DifferentialCorrectionsReq* field descriptions**

dgnss-SignalsReq

This field specifies the BDS Signal(s) for which the *BDS-DifferentialCorrections* are requested. A one-value at a bit position means BDS differential corrections for the specific signal are requested; a zero-value means not requested. The target device shall set a maximum of three bits to value 'one'. This only applies for the B1I signal.

– ***BDS-GridModelReq***

The IE *BDS-GridModelReq* is used by the target device to request the *BDS-GridModel* assistance from the location server.

```
-- ASN1START
BDS-GridModelReq-r12 ::= SEQUENCE {
    ...
}
-- ASN1STOP
```

– ***GNSS-RTK-ObservationsReq***

The IE *GNSS-RTK-ObservationsReq* is used by the target device to request the *GNSS-RTK-Observations* assistance from the location server.

```

-- ASN1START
GNSS-RTK-ObservationsReq-r15 ::= SEQUENCE {
    gnss-RTK-SignalsReq-r15          GNSS-SignalIDs,
    gnss-RTK-Integer-ms-Req-r15     BOOLEAN,
    gnss-RTK-PhaseRangeRateReq-r15  BOOLEAN,
    gnss-RTK-CNR-Req-r15            BOOLEAN,
    stationID-r15                   GNSS-ReferenceStationID-r15  OPTIONAL,
    ...
}
-- ASN1STOP

```

GNSS-RTK-ObservationsReq field descriptions

gnss-RTK-SignalsReq

This field specifies the GNSS Signal(s) for which the *GNSS-RTK-Observations* are requested. A one-value at a bit position means RTK observations for the specific signal are requested; a zero-value means not requested.

gnss-RTK-Integer-ms-Req

This field specifies whether the integer-ms is requested or not. TRUE means requested.

gnss-RTK-PhaseRangeRateReq

This field specifies whether the *rough-phase-range-rate* and *fine-PhaseRangeRate* are requested or not. TRUE means requested.

gnss-RTK-CNR-Req

This field specifies whether the *carrier-to-noise-ratio* is requested or not. TRUE means requested.

stationID

This field specifies the Station ID for which the *GNSS-RTK-Observations* are requested.

— *GLO-RTK-BiasInformationReq*

The IE *GLO-RTK-BiasInformationReq* is used by the target device to request the *GLO-RTK-BiasInformation* assistance from the location server.

```

-- ASN1START
GLO-RTK-BiasInformationReq-r15 ::= SEQUENCE {
    stationID-r15                   GNSS-ReferenceStationID-r15  OPTIONAL,
    ...
}
-- ASN1STOP

```

GLO-RTK-BiasInformationReq field descriptions

stationID

This field specifies the Station ID for which the *GLO-RTK-BiasInformation* is requested.

— *GNSS-RTK-MAC-CorrectionDifferencesReq*

The IE *GNSS-RTK-MAC-CorrectionDifferencesReq* is used by the target device to request the *GNSS-RTK-MAC-CorrectionDifferences* assistance from the location server.

```

-- ASN1START
GNSS-RTK-MAC-CorrectionDifferencesReq-r15 ::= SEQUENCE {
    master-ReferenceStationID-r15   GNSS-ReferenceStationID-r15  OPTIONAL,
    aux-ReferenceStationList-r15     AUX-ReferenceStationList-r15  OPTIONAL,
    linkCombinations-PrefList-r15   GNSS-Link-CombinationsList-r15  OPTIONAL,
    ...
}
AUX-ReferenceStationList-r15 ::= SEQUENCE (SIZE (1..32)) OF AUX-ReferenceStationID-Element-r15
AUX-ReferenceStationID-Element-r15 ::= SEQUENCE {
    aux-stationID-r15               GNSS-ReferenceStationID-r15,
    ...
}
-- ASN1STOP

```

GNSS-RTK-MAC-CorrectionDifferencesReq field descriptions
<p>master-ReferenceStationID, aux-ReferenceStationList These fields specify the Master and Auxiliary Reference Station IDs for which the <i>GNSS-RTK-MAC-CorrectionDifferences</i> are requested.</p>
<p>linkCombinations-PrefList This field specifies the dual-frequency combination of L1 and L2 link/frequencies for which the target device wishes to obtain the <i>GNSS-RTK-MAC-CorrectionDifferences</i> in the order of preference. The first <i>GNSS-Link-Combinations</i> in <i>GNSS-Link-CombinationsList</i> is the most preferred combination, the second <i>GNSS-Link-Combinations</i> in <i>GNSS-Link-CombinationsList</i> is the second most preferred, etc.</p>

– GNSS-RTK-ResidualsReq

The IE *GNSS-RTK-ResidualsReq* is used by the target device to request the *GNSS-RTK-Residuals* assistance from the location server.

```
-- ASN1START
GNSS-RTK-ResidualsReq-r15 ::= SEQUENCE {
    stationID-r15                GNSS-ReferenceStationID-r15    OPTIONAL,
    linkCombinations-PrefList-r15  GNSS-Link-CombinationsList-r15  OPTIONAL,
    ...
}
-- ASN1STOP
```

GNSS-RTK-ResidualsReq field descriptions
<p>stationID This field specifies the Station ID for which the <i>GNSS-RTK-Residuals</i> are requested.</p>
<p>linkCombinations-PrefList This field specifies the dual-frequency combination of L1 and L2 link/frequencies for which the target device wishes to obtain the <i>GNSS-RTK-Residuals</i> in the order of preference. The first <i>GNSS-Link-Combinations</i> in <i>GNSS-Link-CombinationsList</i> is the most preferred combination, the second <i>GNSS-Link-Combinations</i> in <i>GNSS-Link-CombinationsList</i> is the second most preferred, etc.</p>

– GNSS-RTK-FKP-GradientsReq

The IE *GNSS-RTK-FKP-GradientsReq* is used by the target device to request the *GNSS-RTK-FKP-Gradients* assistance from the location server.

```
-- ASN1START
GNSS-RTK-FKP-GradientsReq-r15 ::= SEQUENCE {
    stationID-r15                GNSS-ReferenceStationID-r15    OPTIONAL,
    linkCombinations-PrefList-r15  GNSS-Link-CombinationsList-r15  OPTIONAL,
    ...
}
-- ASN1STOP
```

GNSS-RTK-FKP-GradientsReq field descriptions
<p>stationID This field specifies the Station ID for which the <i>GNSS-RTK-FKP-Gradients</i> are requested.</p>
<p>linkCombinations-PrefList This field specifies the dual-frequency combination of L1 and L2 link/frequencies for which the target device wishes to obtain the <i>GNSS-RTK-FKP-Gradients</i> in the order of preference. The first <i>GNSS-Link-Combinations</i> in <i>GNSS-Link-CombinationsList</i> is the most preferred combination, the second <i>GNSS-Link-Combinations</i> in <i>GNSS-Link-CombinationsList</i> is the second most preferred, etc.</p>

– GNSS-SSR-OrbitCorrectionsReq

The IE *GNSS-SSR-OrbitCorrectionsReq* is used by the target device to request the *GNSS-SSR-OrbitCorrections* assistance from the location server.

```
-- ASN1START
GNSS-SSR-OrbitCorrectionsReq-r15 ::= SEQUENCE {
    storedNavList-r15                GNSS-NavListInfo-r15                OPTIONAL,
    ...
}
-- ASN1STOP
```

GNSS-SSR-OrbitCorrectionsReq field descriptions

storedNavList

This list provides information to the location server about which NAV data the target device has currently stored for the particular GNSS indicated by *GNSS-ID*.

– GNSS-SSR-ClockCorrectionsReq

The IE *GNSS-SSR-ClockCorrectionsReq* is used by the target device to request the *GNSS-SSR-ClockCorrections* assistance from the location server.

```
-- ASN1START
GNSS-SSR-ClockCorrectionsReq-r15 ::= SEQUENCE {
    storedNavList-r15                GNSS-NavListInfo-r15                OPTIONAL,
    ...
}
-- ASN1STOP
```

GNSS-SSR-ClockCorrectionsReq field descriptions

storedNavList

This list provides information to the location server about which NAV data the target device has currently stored for the particular GNSS indicated by *GNSS-ID*.

– GNSS-SSR-CodeBiasReq

The IE *GNSS-SSR-CodeBiasReq* is used by the target device to request the *GNSS-SSR-CodeBias* assistance from the location server.

```
-- ASN1START
GNSS-SSR-CodeBiasReq-r15 ::= SEQUENCE {
    signal-and-tracking-mode-ID-Map-r15  GNSS-SignalIDs,
    storedNavList-r15                GNSS-NavListInfo-r15                OPTIONAL,
    ...
}
-- ASN1STOP
```

GNSS-SSR-CodeBiasReq field descriptions

signal-and-tracking-mode-ID-Map

This field specifies the GNSS signal(s) for which the *GNSS-SSR-CodeBias* is requested.

storedNavList

This list provides information to the location server about which NAV data the target device has currently stored for the particular GNSS indicated by *GNSS-ID*.

– GNSS-SSR-URA-Req

The IE *GNSS-SSR-URA-Req* is used by the target device to request the *GNSS-SSR-URA* assistance from the location server.

```
-- ASN1START
GNSS-SSR-URA-Req-r16 ::= SEQUENCE {
    ...
}
-- ASN1STOP
```

– GNSS-SSR-PhaseBiasReq

The IE *GNSS-SSR-PhaseBiasReq* is used by the target device to request the *GNSS-SSR-PhaseBias* assistance from the location server.

```
-- ASN1START
GNSS-SSR-PhaseBiasReq-r16 ::= SEQUENCE {
    signal-and-tracking-mode-ID-Map-r16      GNSS-SignalIDs,
    storedNavList-r16                       GNSS-NavListInfo-r15          OPTIONAL,
    ...
}
-- ASN1STOP
```

GNSS-SSR-PhaseBiasReq field descriptions

signal-and-tracking-mode-ID-Map

This field specifies the GNSS signal(s) for which the *GNSS-SSR-PhaseBias* is requested.

storedNavList

This list provides information to the location server about which NAV data the target device has currently stored for the particular GNSS indicated by *GNSS-ID*.

– GNSS-SSR-STECCorrectionReq

The IE *GNSS-SSR-STECCorrectionReq* is used by the target device to request the *GNSS-SSR-STECCorrection* assistance from the location server.

```
-- ASN1START
GNSS-SSR-STECCorrectionReq-r16 ::= SEQUENCE {
    ...
}
-- ASN1STOP
```

– GNSS-SSR-GriddedCorrectionReq

The IE *GNSS-SSR-GriddedCorrectionReq* is used by the target device to request the *GNSS-SSR-GriddedCorrection* assistance from the location server.

```
-- ASN1START
GNSS-SSR-GriddedCorrectionReq-r16 ::= SEQUENCE {
    ...
}
-- ASN1STOP
```

– *NavIC-DifferentialCorrectionsReq*

The IE *NavIC-DifferentialCorrectionsReq* is used by the target device to request the *NavIC-DifferentialCorrections* assistance from the location server.

```
-- ASN1START
NavIC-DifferentialCorrectionsReq-r16 ::= SEQUENCE {
    dgnss-SignalsReq-r16          GNSS-SignalIDs,
    ...
}
-- ASN1STOP
```

***NavIC-DifferentialCorrectionsReq* field descriptions**

dgnss-SignalsReq

This field specifies the NavIC Signal(s) for which the *NavIC-DifferentialCorrections* are requested. A one-value at a bit position means the NavIC differential corrections for the specific signal are requested; a zero-value means not requested. The target device shall set a maximum of three bits to value 'one'.

– *NavIC-GridModelReq*

The IE *NavIC-GridModelReq* is used by the target device to request the *NavIC-GridModel* assistance from the location server.

```
-- ASN1START
NavIC-GridModelReq-r16 ::= SEQUENCE {
    ...
}
-- ASN1STOP
```

6.5.2.5 GNSS Location Information

– *A-GNSS-ProvideLocationInformation*

The IE *A-GNSS-ProvideLocationInformation* is used by the target device to provide location measurements (e.g., pseudo-ranges, location estimate, velocity) to the location server, together with time information. It may also be used to provide GNSS positioning specific error reason.

```
-- ASN1START
A-GNSS-ProvideLocationInformation ::= SEQUENCE {
    gnss-SignalMeasurementInformation  GNSS-SignalMeasurementInformation  OPTIONAL,
    gnss-LocationInformation           GNSS-LocationInformation           OPTIONAL,
    gnss-Error                         A-GNSS-Error                     OPTIONAL,
    ...
}
-- ASN1STOP
```

6.5.2.6 GNSS Location Information Elements

– *GNSS-SignalMeasurementInformation*

The IE *GNSS-SignalMeasurementInformation* is used by the target device to provide GNSS signal measurement information to the location server and GNSS-network time association if requested by the location server. This information includes the measurements of code phase, Doppler, C/N_0 and optionally accumulated carrier phase, also called accumulated deltarange (ADR), which enable the UE-assisted GNSS method where position is computed in the location server. Figure 6.5.2.6-1 illustrates the relation between some of the fields.

```
-- ASN1START
```



```

GNSS-SignalMeasurementInformation ::= SEQUENCE {
    measurementReferenceTime      MeasurementReferenceTime,
    gnss-MeasurementList          GNSS-MeasurementList,
    ...
}
-- ASN1STOP

```

GNSS-SignalMeasurementInformation field descriptions

measurementReferenceTime

This field specifies the GNSS system time for which the information provided in *gnss-MeasurementList* is valid. It may also include network time, if requested by the location server and supported by the target device.

gnss-MeasurementList

This field provides GNSS signal measurement information for up to 16 GNSSs.

– *MeasurementReferenceTime*

The IE *MeasurementReferenceTime* is used to specify the time when the measurements provided in *A-GNSS-ProvideLocationInformation* are valid. It may also include GNSS-network time association, in which case reported measurements shall be valid for the cellular frame boundary defined in the network time association.

```

-- ASN1START
MeasurementReferenceTime ::= SEQUENCE {
    gnss-TOD-msec      INTEGER (0..3599999),
    gnss-TOD-frac     INTEGER (0..3999)          OPTIONAL,
    gnss-TOD-unc      INTEGER (0..127)          OPTIONAL,
    gnss-TimeID       GNSS-ID,
    networkTime       CHOICE {
        eUTRA         SEQUENCE {
            physCellId      INTEGER (0..503),
            cellGlobalId    CellGlobalIdEUTRA-AndUTRA          OPTIONAL,
            systemFrameNumber BIT STRING (SIZE (10)),
            ...
        },
        uTRA           SEQUENCE {
            mode            CHOICE {
                fdd         SEQUENCE {
                    primary-CPICH-Info INTEGER (0..511),
                    ...
                },
                tdd         SEQUENCE {
                    cellParameters    INTEGER (0..127),
                    ...
                }
            },
            cellGlobalId    CellGlobalIdEUTRA-AndUTRA          OPTIONAL,
            referenceSystemFrameNumber
                INTEGER (0..4095),
            ...
        },
        gSM             SEQUENCE {
            bcchCarrier     INTEGER (0..1023),
            bsic            INTEGER (0..63),
            cellGlobalId    CellGlobalIdGERAN                  OPTIONAL,
            referenceFrame  SEQUENCE {
                referenceFN    INTEGER (0..65535),
                referenceFNMSB INTEGER (0..63)                OPTIONAL,
                ...
            },
            deltaGNSS-TOD   INTEGER (0 .. 127)          OPTIONAL,
            ...
        },
        ...
    },
    ...
    nbIoT-r14           SEQUENCE {
        nbPhysCellId-r14    INTEGER (0..503),
        nbCellGlobalId-r14  ECGI                          OPTIONAL,
        sfn-r14             BIT STRING (SIZE (10)),
        hyperSFN-r14       BIT STRING (SIZE (10))          OPTIONAL,
        ...
    },
}
-- ASN1STOP

```

```

nr-r15 SEQUENCE {
  nrPhysCellId-r15 INTEGER (0..1007),
  nrCellGlobalID-r15 NCGI-r15 OPTIONAL,
  nr-sfn-r15 BIT STRING (SIZE (10)),
  ...
}
OPTIONAL,
...
}
-- ASN1STOP

```

MeasurementReferenceTime field descriptions

gnss-TOD-msec

This field specifies the GNSS TOD for which the measurements and/or location estimate are valid. The 22 bits of GNSS TOD are the least significant bits. The most significant bits shall be derived by the location server to unambiguously derive the GNSS TOD.

The value for GNSS TOD is derived from the GNSS specific system time indicated in *gnss-TimeID* rounded down to the nearest millisecond unit.

Scale factor 1 millisecond.

gnss-TOD-frac

This field specifies the fractional part of the GNSS TOD in 250 ns resolution. The total GNSS TOD is given by *gnss-TOD-msec* + *gnss-TOD-frac*.

Scale factor 250 nanoseconds.

gnss-TOD-unc

This field provides the accuracy of the relation GNSS-network time when GNSS-network time association is provided. When GNSS-network time association is not provided, this element can be included to provide the accuracy of the reported *gnss-TOD-msec*.

If GNSS TOD is the given GNSS time, then the true GNSS time, corresponding to the provided network time if applicable, as observed at the target device location, lies in the interval [GNSS TOD – *gnss-TOD-unc*, GNSS TOD + *gnss-TOD-unc*].

The uncertainty *r*, expressed in microseconds, is mapped to a number K, with the following formula:

$$r = C * ((1+x)^K - 1)$$

with $C = 0.5$ and $x = 0.14$. To encode any higher value of uncertainty than that corresponding in the above formula to $K=127$, the same value, $K=127$, shall also be used. The uncertainty is then coded on 7 bits, as the binary encoding of K. Examples of *gnss-TOD-unc* value are as in the table Value of K to Value of uncertainty relation below.

This field shall be included if the target device provides GNSS-network time relationship.

gnss-TimeID

This field specifies the GNSS system time for which the *gnss-TOD-msec* (and *gnss-TOD-frac* if applicable) is provided.

networkTime

These fields specify the network time event which the GNSS TOD time stamps.

This field shall be included if the target device provides GNSS-network time relationship.

physCellId

This field identifies the reference cell (E-UTRA), as defined in TS 36.331 [12], that is used for the GNSS-network time relation.

cellGlobalId

This field specifies the globally unique cell identifier (Evolved Cell Global Identifier (ECGI) in E-UTRA, global UTRAN Cell Identifier in UTRA, or Cell Global Identification (CGI) in GERAN) of the reference cell, as defined in TS 36.331 [12] for E-UTRA and in TS 25.331 [13] for UTRA, for which the GNSS network time relation is provided.

systemFrameNumber

This field specifies the system frame number in E-UTRA which the GNSS time time stamps, as defined in TS 36.331 [12].

mode

This field identifies the reference cell for the GNSS-network time relation, as defined in TS 25.331 [13].

referenceSystemFrameNumber

This field specifies the system frame number in UTRA, as defined in TS 25.331 [13], which is used for time stamping.

bcchCarrier, bsic

This field identifies the reference cell for the GNSS-network time relation in GERAN, as defined in TS 44.031 [14].

MeasurementReferenceTime field descriptions
<p>referenceFN, referenceFNMSB</p> <p>These fields specify the frame number in GERAN which the GNSS time time stamps, as defined in TS 44.031 [14]. The time of the reference frame boundary is as observed by the target device, i.e. without Timing Advance compensation. The <i>referenceFNMSB</i> field indicates the most significant bits of the frame number of the reference BTS corresponding to the <i>GNSS-MeasurementList</i>. Starting from the complete GSM frame number denoted FN, the target device calculates Reference FN MSB as</p> $\text{Reference FN MSB} = \text{floor}(\text{FN}/42432)$ <p>The complete GSM frame number FN can then be reconstructed in the location server by combining the fields <i>referenceFN</i> with <i>referenceFNMSB</i> in the following way</p> $\text{FN} = \text{referenceFNMSB} * 42432 + \text{referenceFN}$
<p>deltaGNSS-TOD</p> <p>This field specifies the difference in milliseconds between <i>gnss-TOD-msec</i> reported and the milli-second part of the SV time <i>tsv_1</i> of the first SV in the list reported from the target device, as defined in TS 44.031 [14]. The <i>deltaGNSS-TOD</i> is defined as</p> $\text{deltaGNSS-TOD} = \text{gnss-TOD-msec} - \text{fix}(\text{tsv}_1)$ <p>where <i>fix()</i> denotes rounding to the nearest integer towards zero.</p>
<p>nbPhysCellId</p> <p>This field identifies the reference cell, as defined in TS 36.331 [12] that is used for the GNSS-network time relation.</p>
<p>nbCellGlobalId</p> <p>This field specifies the global cell identifier of the NB-IoT reference cell, as defined in TS 36.331 [12], for which the GNSS network time relation is provided.</p>
<p>sfn</p> <p>This field specifies the system frame number in NB-IoT which the GNSS time time stamps, as defined in TS 36.331 [12].</p>
<p>hyperSFN</p> <p>This field specifies the hyper-SFN in NB-IoT which the GNSS time time stamps, as defined in TS 36.331 [12].</p>
<p>nrPhysCellId</p> <p>This field identifies the reference cell (NR), as defined in TS 38.331 [35], that is used for the GNSS-network time relation.</p>
<p>nrCellGlobalId</p> <p>This field specifies the NR Cell Global Identifier (NCGI) of the reference cell, as defined in TS 38.331 [35], for which the GNSS network time relation is provided.</p>
<p>nr-sfn</p> <p>This field specifies the system frame number in NR which the GNSS time time stamps, as defined in TS 38.331 [35].</p>

Value of K to Value of uncertainty relation

Value of K	Value of uncertainty
0	0 microseconds
1	0.07 microseconds
2	0.1498 microseconds
-	-
50	349.62 microseconds
-	-
127	≥ 8430000 microseconds

– GNSS-MeasurementList

The IE *GNSS-MeasurementList* is used by the target device to provide measurements of code phase, Doppler, C/N_0 and optionally accumulated carrier phase, also called accumulated deltarange (ADR).

```
-- ASN1START
GNSS-MeasurementList ::= SEQUENCE (SIZE(1..16)) OF GNSS-MeasurementForOneGNSS
GNSS-MeasurementForOneGNSS ::= SEQUENCE {
    gnss-ID                GNSS-ID,
    gnss-SgnMeasList       GNSS-SgnMeasList,
    ...
}
GNSS-SgnMeasList ::= SEQUENCE (SIZE(1..8)) OF GNSS-SgnMeasElement
GNSS-SgnMeasElement ::= SEQUENCE {
    gnss-SignalID          GNSS-SignalID,
```

```

    gnss-CodePhaseAmbiguity INTEGER (0..127)          OPTIONAL,
    gnss-SatMeasList       GNSS-SatMeasList,
    ...
}

GNSS-SatMeasList ::= SEQUENCE (SIZE(1..64)) OF GNSS-SatMeasElement

GNSS-SatMeasElement ::= SEQUENCE {
    svID                SV-ID,
    cNo                 INTEGER (0..63),
    mpathDet            ENUMERATED {notMeasured (0), low (1), medium (2), high (3), ...},
    carrierQualityInd  INTEGER (0..3)                OPTIONAL,
    codePhase           INTEGER (0..2097151),
    integerCodePhase   INTEGER (0..127)              OPTIONAL,
    codePhaseRMSError  INTEGER (0..63),
    doppler             INTEGER (-32768..32767)      OPTIONAL,
    adr                INTEGER (0..33554431)         OPTIONAL,
    ...
    [[
        adrMSB-r15      INTEGER (0..15)              OPTIONAL,
        adrSign-r15     ENUMERATED {positive, negative} OPTIONAL,
        adrRMSerror-r15 INTEGER (0..127)              OPTIONAL,
        delta-codePhase-r15 INTEGER (0..7)            OPTIONAL
    ]]
}

-- ASN1STOP

```

GNSS-MeasurementList field descriptions

gnss-ID

This field identifies the GNSS constellation on which the GNSS signal measurements were measured. Measurement information for up to 16 GNSSs can be included.

gnss-SgnMeasList

This list provides GNSS signal measurement information for up to 8 GNSS signal types per GNSS.

gnss-SignalID

This field identifies the signal on which GNSS signal measurement parameters were measured.

gnss-CodePhaseAmbiguity

This field provides the ambiguity of the code phase measurement. It is given in units of milli-seconds in the range between 0 and 127 milli-seconds.

The total code phase for a satellite k (Satk) is given modulo this *gnss-CodePhaseAmbiguity* and is reconstructed with:
 $Code_Phase_Tot(Satk) = codePhase(Satk) + integerCodePhase(Satk) + n * gnss-CodePhaseAmbiguity$, $n = 0, 1, 2, \dots$
 If there is no code phase ambiguity, the *gnss-CodePhaseAmbiguity* shall be set to 0.

The field is optional. If *gnss-CodePhaseAmbiguity* is absent, the default value is 1 milli-second.

gnss-SatMeasList

This list provides GNSS signal measurement information for up to 64 GNSS satellites.

svID

This field identifies the satellite on which the GNSS signal measurements were measured.

cNo

This field provides an estimate of the carrier-to-noise ratio of the received signal from the particular satellite. The target device shall set this field to the value of the satellite C/N_0 , as referenced to the antenna connector, in units of 1 dB-Hz, in the range from 0 to 63 dB-Hz.

Scale factor 1 dB-Hz.

mpathDet

This field contains the multipath indicator value, defined in the table Value of *mpathDet* to Multipath Indication relation below.

GNSS-MeasurementList field descriptions	
carrierQualityInd	<p>If the fields <i>adrMSB</i>, <i>adrSign</i>, <i>adrRMSError</i>, and <i>delta-codePhase</i> are not present: This field indicates the quality of a carrier phase measurement. The LSB indicates the data polarity, that is, if the data from a specific satellite is received inverted, this is indicated by setting the LSB value to '1'. In the case the data is not inverted, the LSB is set to '0'. The MSB indicates if accumulation of the carrier phase has been continuous, that is, without cycle slips since the previous measurement report. If the carrier phase accumulation has been continuous, the MSB value is set to '1X'. Otherwise, the MSB is set to '0X'.</p> <p>This field is optional but shall be included if the <i>adr</i> field is included. See table Bit to Polarity Indication relation below. If any of the fields <i>adrMSB</i>, <i>adrSign</i>, <i>adrRMSError</i>, or <i>delta-codePhase</i> are present: This field indicates the quality of a carrier phase measurement. The LSB indicates the half-cycle ambiguity, that is, if there are no half-cycle ambiguities present in the ADR measurement report the LSB is set to '0'. In the case there are half-cycle ambiguities present in the ADR measurement report the LSB is set to '1'. When reporting ADR with unresolved polarity encoding the target device shall set this bit to 1.</p> <p>The MSB indicates if accumulation of the carrier phase has been continuous, that is, without cycle slips since the previous measurement report. If the carrier phase accumulation has been continuous (no cycle slips), the MSB value is set to '1X'. Otherwise, the MSB is set to '0X'. If polarity resolution forced the ADR measurement to be corrected by half-a-cycle, then the MSB must be set to '0', indicating that despite continuous tracking the reported ADR experienced non-continuity. See table Bit to Ambiguity Indication relation below. The target device shall include this field if the <i>adr</i> field is included.</p>
codePhase	<p>This field contains the whole and fractional value of the code-phase measurement made by the target device for the particular satellite signal at the time of measurement in the units of ms. GNSS specific code phase measurements (e.g. chips) are converted into unit of ms by dividing the measurements by the nominal values of the measured signal chipping rate. Scale factor 2^{-21} milli-seconds, in the range from 0 to $(1-2^{-21})$ milli-seconds.</p>
integerCodePhase	<p>This field indicates the integer milli-second part of the code phase that is expressed modulo the <i>gnss-CodePhaseAmbiguity</i>. The value of the ambiguity is given in the <i>gnss-CodePhaseAmbiguity</i> field. The <i>integerCodePhase</i> is optional. If <i>integerCodePhase</i> is absent, the default value is 0 milli-second. Scale factor 1 milli-second, in the range from 0 to 127 milli-seconds.</p>
codePhaseRMSError	<p>This field contains the pseudorange RMS error value. This parameter is specified according to a floating-point representation shown in the table below.</p>
doppler	<p>This field contains the Doppler measured by the target device for the particular satellite signal. This information can be used to compute the 3-D velocity of the target device. Doppler measurements are converted into unit of m/s by multiplying the Doppler measurement in Hz by the nominal wavelength of the measured signal. Scale factor 0.04 metre/second. This field is optional, but shall be included, if the <i>velocityRequest</i> in <i>CommonIEsRequestLocationInformation</i> is set to TRUE.</p>
adr	<p>This field contains the absolute value of the ADR measurement measured by the target device for the particular satellite signal. This information can be used to compute the 3-D velocity or high-accuracy position of the target device. ADR measurements are converted into units of metre by multiplying the ADR measurement by the nominal wavelength of the measured signal. Scale factor 2^{-10} metres, in the range from 0 to 32767.5 metres. This field is optional, but shall be included, if the <i>adrMeasReq</i> in <i>GNSS-PositioningInstructions</i> is set to TRUE and if ADR measurements are supported by the target device (i.e., <i>adr-Support</i> is set to TRUE in <i>A-GNSS-ProvideCapabilities</i>).</p>
adrMSB	<p>This field contains the 4-MSBs of the ADR measurement in the case the ADR measurement is outside the range of the field <i>adr</i> alone. Scale factor 32768 metres. If present, the full ADR measurement is constructed as $adrMSB \times 32768 + adr \times 2^{-10}$ metres, representing measurements in the range from 0 to 524287.9990234375 metres. This field is optional, but shall be included, if the capability <i>adrEnhancementsSupport</i> is set to TRUE and the ADR measurement is outside the range of the <i>adr</i> field.</p>
adrSign	<p>This field indicates the sign of the ADR measurement.</p>
adrRMSError	<p>This field contains the ADR root mean squared error value. Scale factor 2^{-10} metres.</p>
delta-codePhase	<p>This field specifies the higher resolution of the <i>codePhase</i> measurement. Scale factor 2^{-24} milli-seconds. The full code phase measurement is constructed as $codePhase \times 2^{-21} + delta-codePhase \times 2^{-24}$ milli-seconds, in the range from 0 to $(1-2^{-24})$ milli-seconds.</p>

Value of *mpathDet* to Multipath Indication relation

Value of	Multipath Indication
----------	----------------------

<i>mpathDet</i>	
00	Not measured
01	Low, MP error < 5m
10	Medium, 5m < MP error < 43m
11	High, MP error > 43m

Bit to Polarity Indication relation

Value	Polarity Indication
0	Data Direct, carrier phase not continuous
1	Data Inverted, carrier phase not continuous
2	Data Direct, carrier phase continuous
3	Data Inverted, carrier phase continuous

Bit to Ambiguity Indication relation

Value	Value MSB, LSB	Polarity Indication
0	00	carrier phase not continuous, no half-cycle ambiguity
1	01	carrier phase not continuous, half-cycle ambiguity
2	10	carrier phase continuous, no half-cycle ambiguity
3	11	carrier phase continuous, half-cycle ambiguity

floating-point representation

Index	Mantissa	Exponent	Floating-Point value, x_i	Pseudorange value, P
0	000	000	0.5	$P < 0.5$
1	001	000	0.5625	$0.5 \leq P < 0.5625$
l	x	y	$0.5 * (1 + x/8) * 2^y$	$x_{i-1} \leq P < x_i$
62	110	111	112	$104 \leq P < 112$
63	111	111	--	$112 \leq P$

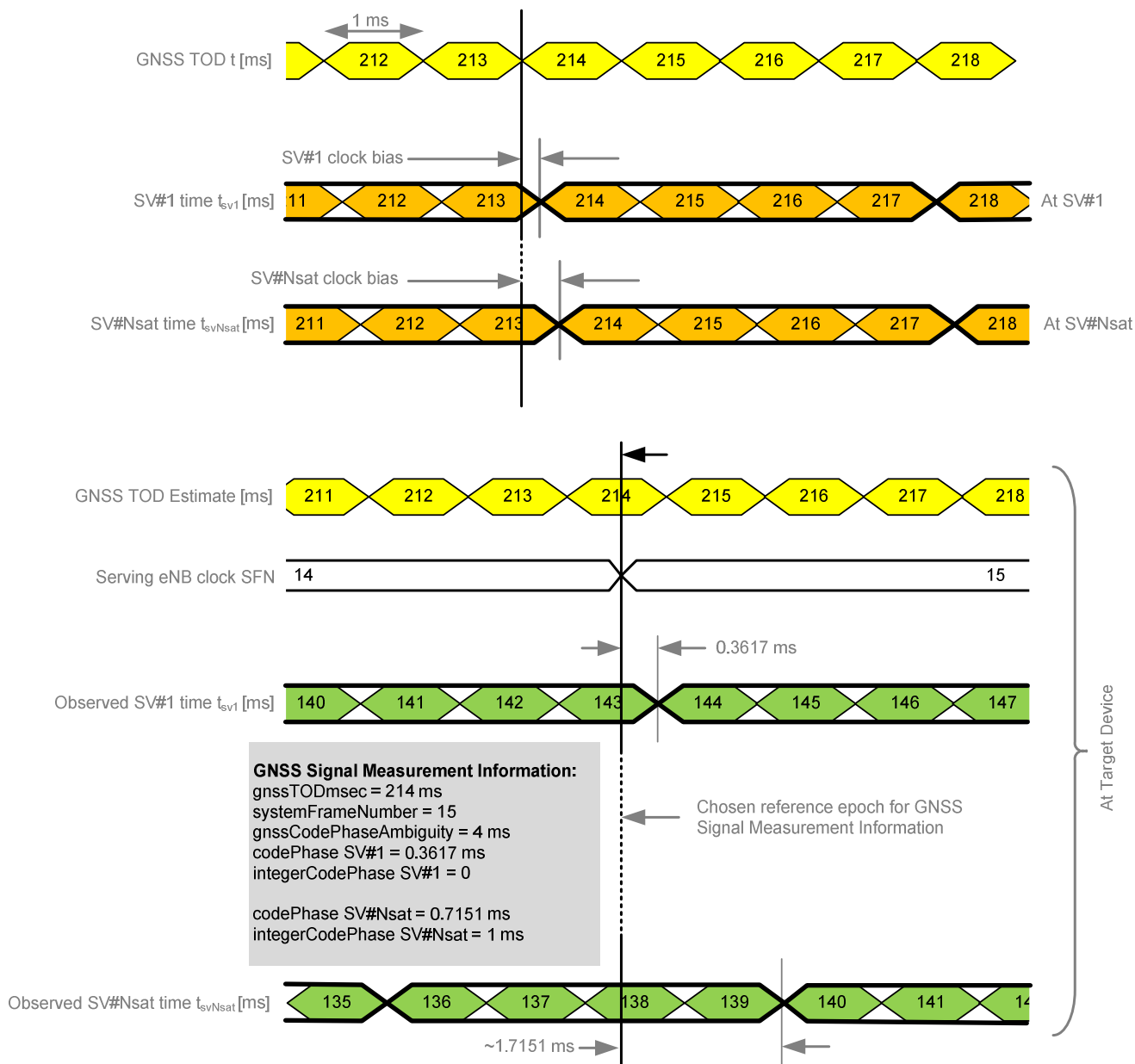

Figure 6.5.2.6-1: Exemplary calculation of some GNSS Signal Measurement Information fields.

GNSS-LocationInformation

The IE *GNSS-LocationInformation* is included by the target device when location and optionally velocity information derived using GNSS or hybrid GNSS and other measurements is provided to the location server.

```

-- ASN1START
GNSS-LocationInformation ::= SEQUENCE {
    measurementReferenceTime      MeasurementReferenceTime,
    agnss-List                    GNSS-ID-Bitmap,
    ...
}
-- ASN1STOP
    
```

GNSS-LocationInformation field descriptions
<p>measurementReferenceTime This field specifies the GNSS system time for which the location estimate and optionally velocity are valid. It may also include GNSS-network time relationship, if requested by the location server and supported by the target device.</p>
<p>agnss-List This field provides a list of satellite systems used by the target device to calculate the location estimate and velocity estimate, if included. This is represented by a bit string in <i>GNSS-ID-Bitmap</i>, with a one-value at the bit position means the particular method has been used; a zero-value means not used.</p>

6.5.2.7 GNSS Location Information Request

– *A-GNSS-RequestLocationInformation*

The IE *A-GNSS-RequestLocationInformation* is used by the location server to request location information from the target device using GNSS.

```
-- ASN1START
A-GNSS-RequestLocationInformation ::= SEQUENCE {
    gnss-PositioningInstructions    GNSS-PositioningInstructions,
    ...
}
-- ASN1STOP
```

6.5.2.8 GNSS Location Information Request Elements

– *GNSS-PositioningInstructions*

The IE *GNSS-PositioningInstructions* is used to provide GNSS measurement instructions.

```
-- ASN1START
GNSS-PositioningInstructions ::= SEQUENCE {
    gnss-Methods                GNSS-ID-Bitmap,
    fineTimeAssistanceMeasReq   BOOLEAN,
    adrMeasReq                  BOOLEAN,
    multiFreqMeasReq           BOOLEAN,
    assistanceAvailability       BOOLEAN,
    ...
    [[
        ha-GNSS-Req-r15          ENUMERATED { true }    OPTIONAL    -- Cond UEB
    ]]
}
-- ASN1STOP
```

Conditional presence	Explanation
<i>UEB</i>	The field is optionally present, need OP, if the <i>locationInformationType</i> is set to <i>locationEstimateRequired</i> , <i>locationEstimatePreferred</i> , or <i>locationMeasurementsPreferred</i> ; otherwise it is not present.

GNSS-PositioningInstructions field descriptions
<p>gnssMethods This field indicates the satellite systems allowed by the location server. This is represented by a bit string in <i>GNSS-ID-Bitmap</i>, with a one-value at the bit position means the particular GNSS is allowed; a zero-value means not allowed. The target device shall not request assistance data or report or obtain measurements for systems that are not indicated in this bit map. At least one of the bits in this bit map shall be set to value one.</p>
<p>fineTimeAssistanceMeasReq This field indicates whether the target device is requested to report GNSS-network time association. TRUE means requested.</p>
<p>adrMeasReq This field indicates whether the target device is requested to include ADR measurements in <i>GNSS-MeasurementList</i> IE or not. TRUE means requested.</p>

GNSS-PositioningInstructions field descriptions
<p>multiFreqMeasReq This field indicates whether the target device is requested to report measurements on multiple supported GNSS signal types in <i>GNSS-MeasurementList</i> IE or not. TRUE means requested.</p>
<p>assistanceAvailability This field indicates whether the target device may request additional GNSS assistance data from the server. TRUE means allowed and FALSE means not allowed.</p>
<p>ha-GNSS-Req This field, if present, indicates that any location estimate provided by the target device should be obtained using high accuracy RTK/PPP methods.</p>

6.5.2.9 GNSS Capability Information

– A-GNSS-ProvideCapabilities

The IE *A-GNSS-Provide-Capabilities* is used by the target device to indicate its capability to support A-GNSS and to provide its A-GNSS location capabilities (e.g., GNSSs and assistance data supported) to the location server.

```

-- ASN1START
A-GNSS-ProvideCapabilities ::= SEQUENCE {
    gnss-SupportList          GNSS-SupportList          OPTIONAL,
    assistanceDataSupportList AssistanceDataSupportList OPTIONAL,
    locationCoordinateTypes   LocationCoordinateTypes  OPTIONAL,
    velocityTypes             VelocityTypes            OPTIONAL,
    ...,
    [[ periodicalReportingNotSupported-r14
        PositioningModes          OPTIONAL,
        idleStateForMeasurements-r14
        ENUMERATED { required }   OPTIONAL
    ]],
    [[ periodicAssistanceData-r15
        BIT STRING { solicited (0),
                    unsolicited (1) } (SIZE (1..8))  OPTIONAL
    ]]
}

GNSS-SupportList ::= SEQUENCE (SIZE(1..16)) OF GNSS-SupportElement

GNSS-SupportElement ::= SEQUENCE {
    gnss-ID          GNSS-ID,
    sbas-IDs         SBAS-IDs          OPTIONAL,  -- Cond GNSS-ID-SBAS
    agnss-Modes     PositioningModes,
    gnss-Signals    GNSS-SignalIDs,
    fta-MeasSupport SEQUENCE {
        cellTime    AccessTypes,
        mode        PositioningModes,
        ...
    } OPTIONAL,  -- Cond fta
    adr-Support     BOOLEAN,
    velocityMeasurementSupport
    BOOLEAN,
    ...,
    [[
        adrEnhancementsSupport-r15 ENUMERATED { true }  OPTIONAL,
        ha-gnss-Modes-r15          PositioningModes  OPTIONAL
    ]]
}

AssistanceDataSupportList ::= SEQUENCE {
    gnss-CommonAssistanceDataSupport GNSS-CommonAssistanceDataSupport,
    gnss-GenericAssistanceDataSupport GNSS-GenericAssistanceDataSupport,
    ...
}

-- ASN1STOP

```

Conditional presence	Explanation
<i>GNSS-ID-SBAS</i>	The field is mandatory present if the <i>GNSS-ID</i> = <i>sbas</i> ; otherwise it is not present.
<i>fta</i>	The field is mandatory present if the target device supports the reporting of fine time assistance measurements; otherwise it is not present.

A-GNSS-ProvideCapabilities field descriptions	
<i>gnss-SupportList</i>	This field specifies the list of GNSS supported by the target device and the target device capabilities associated with each of the supported GNSS. This field shall be present if the <i>gnss-SupportListReq</i> in the A-GNSS - <i>RequestCapabilities</i> IE is set to TRUE and if the target device supports the A-GNSS positioning method. If the IE <i>A-GNSS-Provide-Capabilities</i> is provided unsolicited, this field shall be included if the target device supports the assisted GNSS positioning method.
<i>gnss-ID</i>	This field specifies the GNSS supported by the target device for which the capabilities in <i>GNSS-SupportElement</i> are provided.
<i>sbas-IDs</i>	This field specifies the SBAS(s) supported by the target device. This is represented by a bit string, with a one-value at the bit position means the particular SBAS is supported; a zero-value means not supported.
<i>agnss-Modes</i>	This field specifies the GNSS mode(s) supported by the target device for the GNSS indicated by <i>gnss-ID</i> . This is represented by a bit string, with a one-value at the bit position means the particular GNSS mode is supported; a zero-value means not supported.
<i>gnss-Signals</i>	This field specifies the GNSS signal(s) supported by the target device for the GNSS indicated by <i>gnss-ID</i> . This is represented by a bit string, with a one-value at the bit position means the particular GNSS signal type is supported; a zero-value means not supported.
<i>fta-MeasSupport</i>	This field specifies that the target device is capable of performing fine time assistance measurements (i.e., GNSS-cellular time association reporting). The <i>cellTime</i> field specifies for which cellular network(s) this capability is supported. This is represented by a bit string, with a one-value at the bit position means FTA measurements for the specific cellular network time is supported; a zero-value means not supported. The <i>mode</i> field specifies for which GNSS mode(s) FTA measurements are supported by the target device. This is represented by a bit string, with a one-value at the bit position means FTA measurements for the GNSS mode is supported; a zero-value means not supported.
<i>adr-Support</i>	This field specifies whether the target device supports ADR measurement reporting. TRUE means supported.
<i>velocityMeasurementSupport</i>	This field specifies whether the target device supports measurement reporting related to velocity. TRUE means supported.
<i>assistanceDataSupportList</i>	This list defines the assistance data and assistance data choices supported by the target device. This field shall be present if the <i>assistanceDataSupportListReq</i> in the A-GNSS- <i>RequestCapabilities</i> IE is set to TRUE and if the target device supports GNSS assistance data. If the IE <i>A-GNSS-Provide-Capabilities</i> is provided unsolicited, this field shall be included if the target device supports any GNSS assistance data.

A-GNSS-ProvideCapabilities field descriptions
<p>locationCoordinateTypes This parameter identifies the geographical location coordinate types that a target device supports for GNSS. TRUE indicates that a location coordinate type is supported and FALSE that it is not. This field shall be present if the <i>locationVelocityTypesReq</i> in the A-GNSS-RequestCapabilities IE is set to TRUE and if the target device supports UE-based or standalone GNSS positioning method. If the IE A-GNSS-Provide-Capabilities is provided unsolicited, this field shall be included if the target device supports UE-based or standalone GNSS positioning method.</p>
<p>velocityTypes This parameter identifies the velocity types that a target device supports for GNSS. TRUE indicates that a velocity type is supported and FALSE that it is not. FALSE for all velocity types indicates that velocity reporting is not supported. This field shall be present if the <i>locationVelocityTypesReq</i> in the A-GNSS-RequestCapabilities IE is set to TRUE and if the target device supports UE-based or standalone GNSS positioning method. If the IE A-GNSS-Provide-Capabilities is provided unsolicited, this field shall be included if the target device supports UE-based or standalone GNSS positioning method.</p>
<p>periodicalReportingNotSupported This field, if present, specifies the positioning modes for which the target device does not support <i>periodicalReporting</i>. This is represented by a bit string, with a one-value at the bit position means <i>periodicalReporting</i> for the positioning mode is not supported; a zero-value means supported. If this field is absent, the location server may assume that the target device supports <i>periodicalReporting</i> in <i>CommonIEsRequestLocationInformation</i> for each supported positioning mode.</p>
<p>idleStateForMeasurements This field, if present, indicates that the target device requires idle state to perform GNSS measurements.</p>
<p>periodicAssistanceData This field identifies the periodic assistance data delivery procedures supported by the target device. This is represented by a bit string, with a one value at the bit position means the periodic assistance data delivery procedure is supported; a zero value means not supported. Bit 0 (solicited) represents the procedure according to clause 5.2.1a; bit (1) (unsolicited) represents the procedure according to clause 5.2.2a.</p>
<p>adrEnhancementsSupport This field, if present, indicates that the target device supports the fields <i>adrMSB</i>, <i>adrSign</i>, <i>adrRMSerror</i>, and <i>delta-codePhase</i> in IE <i>GNSS-MeasurementList</i>. This field may only be present if <i>adr-Support</i> is set to TRUE, and shall be absent if <i>adr-Support</i> is set to FALSE.</p>
<p>ha-gnss-Modes This field specifies the High-Accuracy GNSS mode(s) supported by the target device for the GNSS indicated by <i>gnss-ID</i>. This is represented by a bit string, with a one-value at the bit position means the particular GNSS mode is supported; a zero-value means not supported.</p>

6.5.2.10 GNSS Capability Information Elements

– GNSS-CommonAssistanceDataSupport

The IE *GNSS-CommonAssistanceDataSupport* is used by the target device to provide information on supported GNSS common assistance data types to the location server.

```

-- ASN1START
GNSS-CommonAssistanceDataSupport ::= SEQUENCE {
    gnss-ReferenceTimeSupport          GNSS-ReferenceTimeSupport
                                       OPTIONAL, -- Cond RefTimeSup
    gnss-ReferenceLocationSupport      GNSS-ReferenceLocationSupport
                                       OPTIONAL, -- Cond RefLocSup
    gnss-IonosphericModelSupport       GNSS-IonosphericModelSupport
                                       OPTIONAL, -- Cond IonoModSup
    gnss-EarthOrientationParametersSupport GNSS-EarthOrientationParametersSupport
                                       OPTIONAL, -- Cond EOPSup
    ...
    [
        gnss-RTK-ReferenceStationInfoSupport-r15
                                       GNSS-RTK-ReferenceStationInfoSupport-r15
                                       OPTIONAL, -- Cond ARPSup
        gnss-RTK-AuxiliaryStationDataSupport-r15
                                       GNSS-RTK-AuxiliaryStationDataSupport-r15
                                       OPTIONAL -- Cond AuxARPSup
    ]
}
-- ASN1STOP

```

Conditional presence	Explanation
<i>RefTimeSup</i>	The field is mandatory present if the target device supports <i>GNSS-ReferenceTime</i> ; otherwise it is not present.
<i>RefLocSup</i>	This field is mandatory present if the target device supports <i>GNSS-ReferenceLocation</i> ; otherwise it is not present.
<i>IonoModSup</i>	This field is mandatory present if the target device supports <i>GNSS-IonosphericModel</i> ; otherwise it is not present.
<i>EOPSup</i>	This field is mandatory present if the target device supports <i>GNSS-EarthOrientationParameters</i> ; otherwise it is not present.
<i>ARPSup</i>	This field is mandatory present if the target device supports <i>GNSS-RTK-ReferenceStationInfo</i> ; otherwise it is not present.
<i>AuxARPSup</i>	This field is mandatory present if the target device supports <i>GNSS-RTK-AuxiliaryStationData</i> ; otherwise it is not present.

– *GNSS-ReferenceTimeSupport*

```
-- ASN1START
GNSS-ReferenceTimeSupport ::= SEQUENCE {
    gnss-SystemTime    GNSS-ID-Bitmap,
    fta-Support        AccessTypes          OPTIONAL, -- Cond fta
    ...
}
-- ASN1STOP
```

Conditional presence	Explanation
<i>fta</i>	The field is mandatory present if the target device supports fine time assistance in <i>GNSSReferenceTime</i> IE; otherwise it is not present.

***GNSS-ReferenceTimeSupport* field descriptions**

gnss-SystemTime

This field specifies the GNSS system time(s) supported by the target device. This is represented by a bit string in *GNSS-ID-Bitmap*, with a one-value at the bit position means the particular GNSS system time is supported; a zero-value means not supported.

fta-Support

This field specifies that the target device supports fine time assistance (i.e., GNSS-cellular time association) in *GNSS-ReferenceTime* IE. This is represented by a bit string in *AccessTypes*, with a one-value at the bit position means FTA for the specific cellular network time is supported; a zero-value means not supported.

– *GNSS-ReferenceLocationSupport*

```
-- ASN1START
GNSS-ReferenceLocationSupport ::= SEQUENCE {
    ...
}
-- ASN1STOP
```

– *GNSS-IonosphericModelSupport*

```
-- ASN1START
GNSS-IonosphericModelSupport ::= SEQUENCE {
    ionoModel        BIT STRING {
        klobuchar    (0),
        neQuick      (1),
        klobuchar2-r16 (2) } (SIZE (1..8)),
    ...
}
-- ASN1STOP
```

GNSS-IonosphericModelSupport field descriptions***ionoModel***

This field specifies the ionospheric model(s) supported by the target device. This is represented by a bit string, with a one-value at the bit position means the particular ionospheric model is supported; a zero-value means not supported.

GNSS-EarthOrientationParametersSupport

```
-- ASN1START
GNSS-EarthOrientationParametersSupport ::= SEQUENCE {
    ...
}
-- ASN1STOP
```

GNSS-RTK-ReferenceStationInfoSupport

```
-- ASN1START
GNSS-RTK-ReferenceStationInfoSupport-r15 ::= SEQUENCE {
    ...
}
-- ASN1STOP
```

GNSS-RTK-AuxiliaryStationDataSupport

```
-- ASN1START
GNSS-RTK-AuxiliaryStationDataSupport-r15 ::= SEQUENCE {
    ...
}
-- ASN1STOP
```

GNSS-GenericAssistanceDataSupport

The IE *GNSS-GenericAssistanceDataSupport* is used by the target device to provide information on supported GNSS generic assistance data types to the location server for each supported GNSS.

```
-- ASN1START
GNSS-GenericAssistanceDataSupport ::=
    SEQUENCE (SIZE (1..16)) OF GNSS-GenericAssistDataSupportElement
GNSS-GenericAssistDataSupportElement ::= SEQUENCE {
    gnss-ID                GNSS-ID,
    sbas-ID                SBAS-ID                                OPTIONAL, -- Cond GNSS-ID-SBAS
    gnss-TimeModelsSupport GNSS-TimeModelListSupport
    gnss-DifferentialCorrectionsSupport GNSS-DifferentialCorrectionsSupport
    gnss-NavigationModelSupport GNSS-NavigationModelSupport
    gnss-RealTimeIntegritySupport GNSS-RealTimeIntegritySupport
    gnss-DataBitAssistanceSupport GNSS-DataBitAssistanceSupport
    gnss-AcquisitionAssistanceSupport GNSS-AcquisitionAssistanceSupport
    gnss-AlmanacSupport    GNSS-AlmanacSupport
    gnss-UTC-ModelSupport  GNSS-UTC-ModelSupport
    gnss-AuxiliaryInformationSupport GNSS-AuxiliaryInformationSupport
    ...
    OPTIONAL, -- Cond TimeModSup
    OPTIONAL, -- Cond DGNSS-Sup
    OPTIONAL, -- Cond NavModSup
    OPTIONAL, -- Cond RTISup
    OPTIONAL, -- Cond DataBitsSup
    OPTIONAL, -- Cond AcquAssistSup
    OPTIONAL, -- Cond AlmanacSup
    OPTIONAL, -- Cond UTCModSup
    OPTIONAL, -- Cond AuxInfoSup
    ...
}
```

```

[[
  bds-DifferentialCorrectionsSupport-r12
      BDS-DifferentialCorrectionsSupport-r12
      OPTIONAL, -- Cond DBDS-Sup
  bds-GridModelSupport-r12
      BDS-GridModelSupport-r12
      OPTIONAL -- Cond BDS-GridModSup
]],
[[
  gnss-RTK-ObservationsSupport-r15
      GNSS-RTK-ObservationsSupport-r15
      OPTIONAL, -- Cond RTK-OSR-Sup
  glo-RTK-BiasInformationSupport-r15
      GLO-RTK-BiasInformationSupport-r15
      OPTIONAL, -- Cond GLO-CPB-Sup
  gnss-RTK-MAC-CorrectionDifferencesSupport-r15
      GNSS-RTK-MAC-CorrectionDifferencesSupport-r15
      OPTIONAL, -- Cond MAC-Sup
  gnss-RTK-ResidualsSupport-r15
      GNSS-RTK-ResidualsSupport-r15
      OPTIONAL, -- Cond Res-Sup
  gnss-RTK-FKP-GradientsSupport-r15
      GNSS-RTK-FKP-GradientsSupport-r15
      OPTIONAL, -- Cond FKP-Sup
  gnss-SSR-OrbitCorrectionsSupport-r15
      GNSS-SSR-OrbitCorrectionsSupport-r15
      OPTIONAL, -- Cond OC-Sup
  gnss-SSR-ClockCorrectionsSupport-r15
      GNSS-SSR-ClockCorrectionsSupport-r15
      OPTIONAL, -- Cond CC-Sup
  gnss-SSR-CodeBiasSupport-r15
      GNSS-SSR-CodeBiasSupport-r15
      OPTIONAL -- Cond CB-Sup
]],
[[
  gnss-SSR-URA-Support-r16
      GNSS-SSR-URA-Support-r16
      OPTIONAL, -- Cond URA-Sup
  gnss-SSR-PhaseBiasSupport-r16
      GNSS-SSR-PhaseBiasSupport-r16
      OPTIONAL, -- Cond PB-Sup
  gnss-SSR-STECCorrectionSupport-r16
      GNSS-SSR-STECCorrectionSupport-r16
      OPTIONAL, -- Cond STEC-Sup
  gnss-SSR-GriddedCorrectionSupport-r16
      GNSS-SSR-GriddedCorrectionSupport-r16
      OPTIONAL, -- Cond Grid-Sup
  navic-DifferentialCorrectionsSupport-r16
      NavIC-DifferentialCorrectionsSupport-r16
      OPTIONAL, -- Cond DNavIC-Sup
  navic-GridModelSupport-r16
      NavIC-GridModelSupport-r16
      OPTIONAL -- Cond NavIC-GridModSup
]]
}
-- ASN1STOP

```

Conditional presence	Explanation
<i>GNSS-ID-SBAS</i>	The field is mandatory present if the <i>GNSS-ID</i> = <i>sbas</i> ; otherwise it is not present.
<i>TimeModSup</i>	The field is mandatory present if the target device supports <i>GNSS-TimeModelList</i> ; otherwise it is not present.
<i>DGNSS-Sup</i>	The field is mandatory present if the target device supports <i>GNSS-DifferentialCorrections</i> ; otherwise it is not present.
<i>NavModSup</i>	The field is mandatory present if the target device supports <i>GNSS-NavigationModel</i> ; otherwise it is not present.
<i>RTISup</i>	The field is mandatory present if the target device supports <i>GNSS-RealTimeIntegrity</i> ; otherwise it is not present.
<i>DataBitsSup</i>	The field is mandatory present if the target device supports <i>GNSS-DataBitAssistance</i> ; otherwise it is not present.
<i>AcquAssistSup</i>	The field is mandatory present if the target device supports <i>GNSS-AcquisitionAssistance</i> ; otherwise it is not present.
<i>AlmanacSup</i>	The field is mandatory present if the target device supports <i>GNSS-Almanac</i> ; otherwise it is not present.
<i>UTCModSup</i>	The field is mandatory present if the target device supports <i>GNSS-UTC-Model</i> ; otherwise it is not present.
<i>AuxInfoSup</i>	The field is mandatory present if the target device supports <i>GNSS-AuxiliaryInformation</i> ; otherwise it is not present.
<i>DBDS-Sup</i>	The field is mandatory present if the target device supports <i>BDS-DifferentialCorrections</i> ; otherwise it is not present. This field may only be present if <i>gnss-ID</i> indicates 'bds'.

Conditional presence	Explanation
<i>BDS-GridModSup</i>	The field is mandatory present if the target device supports <i>BDS-GridModel</i> ; otherwise it is not present. This field may only be present if <i>gnss-ID</i> indicates 'bds'.
<i>RTK-OSR-Sup</i>	The field is mandatory present if the target device supports <i>GNSS-RTK-Observations</i> ; otherwise it is not present. Note, support for <i>GNSS-RTK-Observations</i> implies support for <i>GNSS-RTK-CommonObservationInfo</i> as well.
<i>GLO-CPB-Sup</i>	The field is mandatory present if the target device supports <i>GLO-RTK-BiasInformation</i> ; otherwise it is not present. This field may only be present if <i>gnss-ID</i> indicates 'glonass'.
<i>MAC-Sup</i>	The field is mandatory present if the target device supports <i>GNSS-RTK-MAC-CorrectionDifferences</i> ; otherwise it is not present.
<i>Res-Sup</i>	The field is mandatory present if the target device supports <i>GNSS-RTK-Residuals</i> ; otherwise it is not present.
<i>FKP-Sup</i>	The field is mandatory present if the target device supports <i>GNSS-RTK-FKP-Gradients</i> ; otherwise it is not present.
<i>OC-Sup</i>	The field is mandatory present if the target device supports <i>GNSS-SSR-OrbitCorrections</i> ; otherwise it is not present.
<i>CC-Sup</i>	The field is mandatory present if the target device supports <i>GNSS-SSR-ClockCorrections</i> ; otherwise it is not present.
<i>CB-Sup</i>	The field is mandatory present if the target device supports <i>GNSS-SSR-CodeBias</i> ; otherwise it is not present.
<i>URA-Sup</i>	The field is mandatory present if the target device supports <i>GNSS-SSR-URA</i> ; otherwise it is not present.
<i>PB-Sup</i>	The field is mandatory present if the target device supports <i>GNSS-SSR-PhaseBias</i> ; otherwise it is not present.
<i>STEC-Sup</i>	The field is mandatory present if the target device supports <i>GNSS-SSR-STEC-Correction</i> ; otherwise it is not present.
<i>Grid-Sup</i>	The field is mandatory present if the target device supports <i>GNSS-SSR-GriddedCorrection</i> ; otherwise it is not present. Note, support for <i>GNSS-SSR-GriddedCorrection</i> implies support for <i>GNSS-SSR-CorrectionPoints</i> as well.
<i>DNavIC-Sup</i>	The field is mandatory present if the target device supports <i>NavIC-DifferentialCorrections</i> ; otherwise it is not present. This field may only be present if the <i>gnss-ID</i> indicates 'navic'.
<i>NavIC-GridModSup</i>	The field is mandatory present if the target device supports <i>NavIC-GridModel</i> ; otherwise it is not present. This field may only be present if the <i>gnss-ID</i> indicates 'navic'.

– *GNSS-TimeModelListSupport*

```
-- ASN1START
GNSS-TimeModelListSupport ::= SEQUENCE {
    ...
}
-- ASN1STOP
```

– *GNSS-DifferentialCorrectionSupport*

```
-- ASN1START
GNSS-DifferentialCorrectionsSupport ::= SEQUENCE {
    gnssSignalIDs          GNSS-SignalIDs,
    dgnss-ValidityTimeSup  BOOLEAN,
    ...
}
-- ASN1STOP
```

***GNSS-DifferentialCorrectionsSupport* field descriptions**

gnssSignalIDs

This field specifies the GNSS signal types for which differential corrections are supported by the target device. This is represented by a bit string in *GNSS-SignalIDs*, with a one-value at the bit position means differential corrections for the particular GNSS signal type is supported; a zero-value means not supported.

dgnss-ValidityTimeSup

This field specifies if the target device supports estimation of UDRE based on growth rate and validity time for differential corrections. TRUE means supported.

– GNSS-*NavigationModelSupport*

```

-- ASN1START
GNSS-NavigationModelSupport ::= SEQUENCE {
  clockModel      BIT STRING {
    model-1      (0),
    model-2      (1),
    model-3      (2),
    model-4      (3),
    model-5      (4),
    model-6      (5),
    model-7-r16 (6),
    model-8-r16 (7) } (SIZE (1..8))    OPTIONAL,
  orbitModel     BIT STRING {
    model-1      (0),
    model-2      (1),
    model-3      (2),
    model-4      (3),
    model-5      (4),
    model-6      (5),
    model-7-r16 (6),
    model-8-r16 (7) } (SIZE (1..8))    OPTIONAL,
  ...
}
-- ASN1STOP

```

GNSS-*NavigationModelSupport* field descriptions

clockModel

This field specifies the *gnss-ClockModel* choice(s) in *GNSS-NavigationModel* IE supported by the target device for the GNSS indicated by *GNSS-ID*. This is represented by a bit string, with a one-value at the bit position means the particular clock model is supported; a zero-value means not supported.

If the target device supports GPS and *GNSS-NavigationModel* assistance, it shall support *clockModel* Model-2.

If the target device supports SBAS and *GNSS-NavigationModel* assistance, it shall support *clockModel* Model-5.

If the target device supports QZSS and *GNSS-NavigationModel* assistance, it shall support *clockModel* Model-2.

If the target device supports Galileo and *GNSS-NavigationModel* assistance, it shall support *clockModel* Model-1.

If the target device supports GLONASS and *GNSS-NavigationModel* assistance, it shall support *clockModel* Model-4.

If the target device supports BDS and *GNSS-NavigationModel* assistance, it shall support *clockModel* Model-6.

If the target device supports NavIC and *GNSS-NavigationModel* assistance, it shall support *clockModel* Model-8.

If this field is absent, the target device supports the mandatory (native) *clockModel* choice only as listed above for the GNSS indicated by *GNSS-ID*.

orbitModel

This field specifies the *gnss-OrbitModel* choice(s) in *GNSS-NavigationModel* IE supported by the target device for the GNSS indicated by *GNSS-ID*. This is represented by a bit string, with a one-value at the bit position means the particular orbit model is supported; a zero-value means not supported.

If the target device supports GPS and *GNSS-NavigationModel* assistance, it shall support *orbitModel* Model-2.

If the target device supports SBAS and *GNSS-NavigationModel* assistance, it shall support *orbitModel* Model-5.

If the target device supports QZSS and *GNSS-NavigationModel* assistance, it shall support *orbitModel* Model-2.

If the target device supports Galileo and *GNSS-NavigationModel* assistance, it shall support *orbitModel* Model-1.

If the target device supports GLONASS and *GNSS-NavigationModel* assistance, it shall support *orbitModel* Model-4.

If the target device supports BDS and *GNSS-NavigationModel* assistance, it shall support *orbitModel* Model-6.

If the target device supports NavIC and *GNSS-NavigationModel* assistance, it shall support *orbitModel* Model-8.

If this field is absent, the target device supports the mandatory (native) *orbitModel* choice only as listed above for the GNSS indicated by *GNSS-ID*.

– GNSS-*RealTimeIntegritySupport*

```

-- ASN1START
GNSS-RealTimeIntegritySupport ::= SEQUENCE {
  ...
}
-- ASN1STOP

```

– GNSS-*DataBitAssistanceSupport*

```

-- ASN1START

```



```

GNSS-DataBitAssistanceSupport ::= SEQUENCE {
    ...
}
-- ASN1STOP

```

– GNSS-AcquisitionAssistanceSupport

```

-- ASN1START
GNSS-AcquisitionAssistanceSupport ::= SEQUENCE {
    ...
    confidenceSupport-r10          ENUMERATED { true }      OPTIONAL,
    dopplerUncertaintyExtSupport-r10  ENUMERATED { true }  OPTIONAL
}
-- ASN1STOP

```

GNSS-AcquisitionAssistanceSupport field descriptions

confidenceSupport

If this field is present, the target device supports the *confidence* field in *GNSS-AcquisitionAssistance*.

dopplerUncertaintyExtSupport

If this field is present, the target device supports the *dopplerUncertaintyExt* field in *GNSS-AcquisitionAssistance*.

– GNSS-AlmanacSupport

```

-- ASN1START
GNSS-AlmanacSupport ::= SEQUENCE {
    almanacModel          BIT STRING {
        model-1          (0),
        model-2          (1),
        model-3          (2),
        model-4          (3),
        model-5          (4),
        model-6          (5),
        model-7          (6) } (SIZE (1..8))      OPTIONAL,
    ...
}
-- ASN1STOP

```

GNSS-AlmanacSupport field descriptions

almanacModel

This field specifies the *almanacModel* choice(s) in *GNSS-Almanac* IE supported by the target device for the GNSS indicated by *GNSS-ID*. This is represented by a bit string, with a one-value at the bit position means the particular almanac model is supported; a zero-value means not supported.

If the target device supports GPS and *GNSS-Almanac* assistance, it shall support Model-2.

If the target device supports SBAS and *GNSS-Almanac* assistance, it shall support Model-6.

If the target device supports QZSS and *GNSS-Almanac* assistance, it shall support Model-2.

If the target device supports Galileo and *GNSS-Almanac* assistance, it shall support Model-1.

If the target device supports GLONASS and *GNSS-Almanac* assistance, it shall support Model-5.

If the target device supports BDS and *GNSS-Almanac* assistance, it shall support Model-7.

If this field is absent, the target device supports the mandatory (native) *almanacModel* choice only as listed above for the GNSS indicated by *GNSS-ID*.

– GNSS-UTC-ModelSupport

```

-- ASN1START
GNSS-UTC-ModelSupport ::= SEQUENCE {
    utc-Model          BIT STRING {
        model-1          (0),
        model-2          (1),
        model-3          (2),
        model-4          (3),
        model-5          (4) } (SIZE (1..8))      OPTIONAL,
    ...
}

```

```
}
-- ASN1STOP
```

GNSS-UTC-ModelSupport field descriptions

utc-Model

This field specifies the *GNSS-UTC-Model* choice(s) in *GNSS-UTC-Model* IE supported by the target device for the GNSS indicated by *GNSS-ID*. This is represented by a bit string, with a one-value at the bit position means the particular UTC model is supported; a zero-value means not supported.

If the target device supports GPS and *GNSS-UTC-Model* assistance, it shall support Model-1.

If the target device supports SBAS and *GNSS-UTC-Model* assistance, it shall support Model-4.

If the target device supports QZSS and *GNSS-UTC-Model* assistance, it shall support Model-1.

If the target device supports Galileo and *GNSS-UTC-Model* assistance, it shall support Model-1.

If the target device supports GLONASS and *GNSS-UTC-Model* assistance, it shall support Model-3.

If the target device supports BDS and *GNSS-UTC-Model* assistance, it shall support Model-5.

If this field is absent, the target device supports the mandatory (native) *utc-Model* choice only as listed above for the GNSS indicated by *GNSS-ID*.

GNSS-AuxiliaryInformationSupport

```
-- ASN1START
GNSS-AuxiliaryInformationSupport ::= SEQUENCE {
    ...
}
-- ASN1STOP
```

BDS-DifferentialCorrectionsSupport

```
-- ASN1START
BDS-DifferentialCorrectionsSupport-r12 ::= SEQUENCE {
    gnssSignalIDs          GNSS-SignalIDs,
    ...
}
-- ASN1STOP
```

BDS-DifferentialCorrectionsSupport field descriptions

gnssSignalIDs

This field specifies the BDS signal types for which differential corrections are supported by the target device. This is represented by a bit string in *GNSS-SignalIDs*, with a one-value at the bit position means differential corrections for the particular BDS signal type is supported; a zero-value means not supported.

BDS-GridModelSupport

```
-- ASN1START
BDS-GridModelSupport-r12 ::= SEQUENCE {
    ...
}
-- ASN1STOP
```

GNSS-RTK-ObservationsSupport

```
-- ASN1START
GNSS-RTK-ObservationsSupport-r15 ::= SEQUENCE {
    gnssSignalIDs-r15      GNSS-SignalIDs,
    ...
}
-- ASN1STOP
```

```
-- ASN1STOP
```

GNSS-RTK-ObservationsSupport field descriptions
--

gnssSignalIDs

This field specifies the GNSS signal types for which *GNSS-RTK-Observations* are supported by the target device. This is represented by a bit string in *GNSS-SignalIDs*, with a one-value at the bit position means *GNSS-RTK-Observations* for the particular GNSS signal type is supported; a zero-value means not supported.

– **GLO-RTK-BiasInformationSupport**

```
-- ASN1START
```

```
GLO-RTK-BiasInformationSupport-r15 ::= SEQUENCE {
    ...
}
```

```
-- ASN1STOP
```

– **GNSS-RTK-MAC-CorrectionDifferencesSupport**

```
-- ASN1START
```

```
GNSS-RTK-MAC-CorrectionDifferencesSupport-r15 ::= SEQUENCE {
    link-combinations-support-r15      GNSS-Link-CombinationsList-r15,
    ...
}
```

```
-- ASN1STOP
```

GNSS-RTK-MAC-CorrectionDifferencesSupport field descriptions

link-combinations-support

This field specifies the GNSS link/frequency combinations for which *GNSS-RTK-MAC-CorrectionDifferences* are supported by the target device for the GNSS indicated by *GNSS-ID*.

– **GNSS-RTK-ResidualsSupport**

```
-- ASN1START
```

```
GNSS-RTK-ResidualsSupport-r15 ::= SEQUENCE {
    link-combinations-support-r15      GNSS-Link-CombinationsList-r15,
    ...
}
```

```
-- ASN1STOP
```

GNSS-RTK-ResidualsSupport field descriptions

link-combinations-support

This field specifies the GNSS link/frequency combinations for which *GNSS-RTK-Residuals* are supported by the target device for the GNSS indicated by *GNSS-ID*.

– **GNSS-RTK-FKP-GradientsSupport**

```
-- ASN1START
```

```
GNSS-RTK-FKP-GradientsSupport-r15 ::= SEQUENCE {
    link-combinations-support-r15      GNSS-Link-CombinationsList-r15,
    ...
}
```

```
-- ASN1STOP
```

GNSS-RTK-FKP-GradientsSupport field descriptions***link-combinations-support***

This field specifies the GNSS link/frequency combinations for which *GNSS-RTK-FKP-Gradients* are supported by the target device for the GNSS indicated by *GNSS-ID*.

GNSS-SSR-OrbitCorrectionsSupport

```
-- ASN1START
GNSS-SSR-OrbitCorrectionsSupport-r15 ::= SEQUENCE {
    ...
}
-- ASN1STOP
```

GNSS-SSR-ClockCorrectionsSupport

```
-- ASN1START
GNSS-SSR-ClockCorrectionsSupport-r15 ::= SEQUENCE {
    ...
}
-- ASN1STOP
```

GNSS-SSR-CodeBiasSupport

```
-- ASN1START
GNSS-SSR-CodeBiasSupport-r15 ::= SEQUENCE {
    signal-and-tracking-mode-ID-Sup-r15    GNSS-SignalIDs,
    ...
}
-- ASN1STOP
```

GNSS-SSR-CodeBiasSupport field descriptions***signal-and-tracking-mode-ID-Sup***

This field specifies the GNSS signal(s) for which the *GNSS-SSR-CodeBias* is supported by the target device.

GNSS-SSR-URA-Support

```
-- ASN1START
GNSS-SSR-URA-Support-r16 ::= SEQUENCE {
    ...
}
-- ASN1STOP
```

GNSS-SSR-PhaseBiasSupport

```
-- ASN1START
GNSS-SSR-PhaseBiasSupport-r16 ::= SEQUENCE {
    signal-and-tracking-mode-ID-Sup-r16    GNSS-SignalIDs,
    ...
}
-- ASN1STOP
```

GNSS-SSR-PhaseBiasSupport field descriptions**signal-and-tracking-mode-ID-Sup**

This field specifies the GNSS signal(s) for which the *GNSS-SSR-PhaseBias* is supported by the target device.

– **GNSS-SSR-STECCorrectionSupport**

```
-- ASN1START
GNSS-SSR-STECCorrectionSupport-r16 ::= SEQUENCE {
    ...
}
-- ASN1STOP
```

– **GNSS-SSR-GriddedCorrectionSupport**

```
-- ASN1START
GNSS-SSR-GriddedCorrectionSupport-r16 ::= SEQUENCE {
    ...
}
-- ASN1STOP
```

– **NavIC-DifferentialCorrectionsSupport**

```
-- ASN1START
NavIC-DifferentialCorrectionsSupport-r16 ::= SEQUENCE {
    gnssSignalIDs-r16          GNSS-SignalIDs,
    ...
}
-- ASN1STOP
```

NavIC-DifferentialCorrectionsSupport field descriptions**gnssSignalIDs**

This field specifies the NavIC signal types for which differential corrections are supported by the target device. This is represented by a bit string in *GNSS-SignalIDs*, with a one-value at the bit position means differential corrections for the particular NavIC signal type is supported; a zero-value means not supported.

– **NavIC-GridModelSupport**

```
-- ASN1START
NavIC-GridModelSupport-r16 ::= SEQUENCE {
    ...
}
-- ASN1STOP
```

6.5.2.11 GNSS Capability Information Request

– **A-GNSS-RequestCapabilities**

The IE *A-GNSS-Request-Capabilities* is used by the location server to request A-GNSS location capabilities (e.g., GNSSs and assistance data supported) from the target device.

```
-- ASN1START
A-GNSS-RequestCapabilities ::= SEQUENCE {
    gnss-SupportListReq          BOOLEAN,
```

```

assistanceDataSupportListReq    BOOLEAN,
locationVelocityTypesReq        BOOLEAN,
...
}
-- ASN1STOP

```

A-GNSS-RequestCapabilities field descriptions

gnss-SupportListReq

This field specifies whether the target device is requested to include the *gnss-SupportList* field in the *A-GNSS-ProvideCapabilities* IE or not. TRUE means requested.

assistanceDataSupportListReq

This field specifies whether the target device is requested to include the *assistanceDataSupportList* field in the *A-GNSS-ProvideCapabilities* IE or not. TRUE means requested.

locationVelocityTypesReq

This field specifies whether the target device is requested to include the *locationCoordinateTypes* field and *velocityTypes* field in the *A-GNSS-ProvideCapabilities* IE or not. TRUE means requested.

6.5.2.12 GNSS Error Elements

– *A-GNSS-Error*

The IE *A-GNSS-Error* is used by the location server or target device to provide GNSS error reasons.

```

-- ASN1START
A-GNSS-Error ::= CHOICE {
    locationServerErrorCauses    GNSS-LocationServerErrorCauses,
    targetDeviceErrorCauses      GNSS-TargetDeviceErrorCauses,
    ...
}
-- ASN1STOP

```

– *GNSS-LocationServerErrorCauses*

The IE *GNSS-LocationServerErrorCauses* is used by the location server to provide GNSS error reasons to the target device.

```

-- ASN1START
GNSS-LocationServerErrorCauses ::= SEQUENCE {
    cause    ENUMERATED {
        undefined,
        undeliveredAssistanceDataIsNotSupportedByServer,
        undeliveredAssistanceDataIsSupportedButCurrentlyNotAvailableByServer,
        undeliveredAssistanceDataIsPartlyNotSupportedAndPartlyNotAvailableByServer,
        ...,
        unconfirmedPeriodicAssistanceDataIsNotSupported-v1510,
        unconfirmedPeriodicAssistanceDataIsSupportedButCurrentlyNotAvailable-v1510,
        unconfirmedPeriodicAssistanceDataIsPartlyNotSupportedAndPartlyNotAvailable-v1510,
        undeliveredPeriodicAssistanceDataIsCurrentlyNotAvailable-v1510
    },
    ...
}
-- ASN1STOP

```

GNSS-LocationServerErrorCauses field descriptions**cause**

This field provides a GNSS specific error cause. The cause values '*unconfirmedPeriodicAssistanceDataIsNotSupported*', '*unconfirmedPeriodicAssistanceDataIsSupportedButCurrentlyNotAvailable*' and '*unconfirmedPeriodicAssistanceDataIsPartlyNotSupportedAndPartlyNotAvailable*' may only be included in the control transaction of a periodic assistance data transfer procedure, as described in clause 5.2.1a. The cause value '*undeliveredPeriodicAssistanceDataIsCurrentlyNotAvailable*' may only be included in the data transaction of a periodic assistance data transfer procedure when periodic assistance data are not available when the periodicity condition occurs, as described in clauses 5.2.1a and 5.2.2a.

GNSS-TargetDeviceErrorCauses

The IE *GNSS-TargetDeviceErrorCauses* is used by the target device to provide GNSS error reasons to the location server.

```
-- ASN1START
GNSS-TargetDeviceErrorCauses ::= SEQUENCE {
  cause          ENUMERATED { undefined,
                             thereWereNotEnoughSatellitesReceived,
                             assistanceDataMissing,
                             notAllRequestedMeasurementsPossible,
                             ...
                           },
  fineTimeAssistanceMeasurementsNotPossible    NULL          OPTIONAL,
  adrMeasurementsNotPossible                   NULL          OPTIONAL,
  multiFrequencyMeasurementsNotPossible       NULL          OPTIONAL,
  ...
}
-- ASN1STOP
```

GNSS-TargetDeviceErrorCauses field descriptions**cause**

This field provides a GNSS specific error cause. If the cause value is '*notAllRequestedMeasurementsPossible*', the target device was not able to provide all requested GNSS measurements (but may be able to report a location estimate or location measurements). In this case, the target device should include any of the '*fineTimeAssistanceMeasurementsNotPossible*', '*adrMeasurementsNotPossible*', or '*multiFrequencyMeasurementsNotPossible*' fields, as applicable.

6.5.2.13 Common GNSS Information Elements**GNSS-FrequencyID**

The IE *GNSS-FrequencyID* is used to indicate a specific GNSS link/frequency. The interpretation of *GNSS-FrequencyID* depends on the *GNSS-ID*.

```
-- ASN1START
GNSS-FrequencyID-r15 ::= SEQUENCE {
  gnss-FrequencyID-r15    INTEGER (0 .. 7),
  ...
}
-- ASN1STOP
```

GNSS-FrequencyID field descriptions**gnss-FrequencyID**

This field specifies a particular GNSS link/frequency. The interpretation of *gnss-FrequencyID* depends on the *GNSS-ID* and is as shown in the table Value & Explanation relation below.

Value & Explanation relation

System	Value	Explanation	
		Link	Centre Frequency [MHz]
GPS	0	L1	1575.42
	1	L2	1227.60
	2	L5	1176.45
	3-7	reserved	
SBAS	0	L1	1575.42
	1	L5	1176.45
	2-7	reserved	
QZSS	0	L1	1575.42
	1	L2	1227.60
	2	L5	1176.45
	3-7	reserved	
GLONASS k = -7..13	0	G1	1602+kx0.5625
	1	G2	1246+kx0.4375
	2	G3	1202.025
	3-7	reserved	
Galileo	0	E1	1575.420
	1	E6	1278.750
	2	E5a	1176.450
	3	E5b	1207.140
	4	E5	1191.795
	5-7	reserved	
BDS	0	B1I	1561.098
	1	B1C	1575.420
	2	B2	1207.140
	3	B3	1268.520
	4-7	reserved	
NavIC	0	L5	1176.450
	1-7	reserved	

– GNSS-ID

The IE *GNSS-ID* is used to indicate a specific GNSS.

```
-- ASN1START
GNSS-ID ::= SEQUENCE {
    gnss-id      ENUMERATED{ gps, sbas, qzss, galileo, glonass, ..., bds, navic-v1610 },
    ...
}
-- ASN1STOP
```

– GNSS-ID-Bitmap

The IE *GNSS-ID-Bitmap* is used to indicate several GNSSs using a bit map.

```
-- ASN1START
GNSS-ID-Bitmap ::= SEQUENCE {
    gnss-ids      BIT STRING {
        gps      (0),
        sbas     (1),
        qzss     (2),
        galileo  (3),
        glonass  (4),
        bds      (5),
        navic-v1610 (6) } (SIZE (1..16)),
    ...
}
-- ASN1STOP
```

GNSS-ID-Bitmap field descriptions***gnss-ids***

This field specifies the GNSS(s). This is represented by a bit string, with a one-value at the bit position means the particular GNSS is addressed; a zero-value means not addressed.

– ***GNSS-Link-CombinationsList***

```
-- ASN1START
GNSS-Link-CombinationsList-r15 ::= SEQUENCE (SIZE(1..8)) OF GNSS-Link-Combinations-r15
GNSS-Link-Combinations-r15 ::= SEQUENCE {
    l1-r15      GNSS-FrequencyID-r15,
    l2-r15      GNSS-FrequencyID-r15,
    ...
}
-- ASN1STOP
```

– ***GNSS-NavListInfo***

```
-- ASN1START
GNSS-NavListInfo-r15 ::= SEQUENCE (SIZE (1..64)) OF SatListElement-r15
SatListElement-r15 ::= SEQUENCE {
    svID-r15      SV-ID,
    iod-r15       BIT STRING (SIZE(11)),
    ...
}
-- ASN1STOP
```

– ***GNSS-NetworkID***

The IE *GNSS-NetworkID* defines the reference network and the source of the particular set of reference stations and their observation information. This IE is used for MAC Network RTK as described in [30].

```
-- ASN1START
GNSS-NetworkID-r15 ::= SEQUENCE {
    networkID-r15      INTEGER (0..255),
    ...
}
-- ASN1STOP
```

– ***GNSS-PeriodicControlParam***

The IE *GNSS-PeriodicControlParam* is used to specify control parameters for a periodic assistance data delivery.

```
-- ASN1START
GNSS-PeriodicControlParam-r15 ::= SEQUENCE {
    deliveryAmount-r15      INTEGER (1..32),
    deliveryInterval-r15    INTEGER (1..64),
    ...
}
-- ASN1STOP
```

GNSS-PeriodicControlParam field descriptions
<p>deliveryAmount This field specifies the number of periodic assistance data deliveries. Integer values $N=1\dots31$ correspond to an amount of 2^N. Integer value $N=32$ indicates an 'infinite/indefinite' amount, which means that the assistance data delivery should continue until a LPP <i>Abort</i> message is received.</p>
<p>deliveryInterval This field specifies the interval between assistance data deliveries in seconds.</p>

– **GNSS-ReferenceStationID**

The IE *GNSS-ReferenceStationID* is used to identify a specific GNSS Reference Station.

```

-- ASN1START
GNSS-ReferenceStationID-r15 ::= SEQUENCE {
    referenceStationID-r15      INTEGER (0..65535),
    providerName-r15           VisibleString (SIZE (1..32))      OPTIONAL, -- Need ON
    ...
}
-- ASN1STOP
    
```

GNSS-ReferenceStationID field descriptions
<p>referenceStationID This field provides the reference station identity.</p>
<p>providerName This field is associated with a GNSS correction data provider to ensure that the <i>referenceStationID</i>'s are unique from a target device perspective.</p>

– **GNSS-SignalID**

The IE *GNSS-SignalID* is used to indicate a specific GNSS signal type. The interpretation of *GNSS-SignalID* depends on the *GNSS-ID*.

```

-- ASN1START
GNSS-SignalID ::= SEQUENCE {
    gnss-SignalID      INTEGER (0 .. 7),
    ...
    [[
        gnss-SignalID-Ext-r15  INTEGER (8..23)      OPTIONAL      -- Need ON
    ]]
}
-- ASN1STOP
    
```

GNSS-SignalID field descriptions
<p>gnss-SignalID, gnss-SignalID-Ext This field specifies a particular GNSS signal. The interpretation of <i>gnss-SignalID</i> and <i>gnss-SignalID-Ext</i> depends on the <i>GNSS-ID</i> and is as shown in the table System to Value & Explanation relation below. If the field <i>gnss-SignalID-Ext</i> is present, the <i>gnss-SignalID</i> should be set to value 7 and shall be ignored by the receiver.</p>

System to Value & Explanation relation

System	Value	Explanation
GPS	0	GPS L1 C/A
	1	GPS L1C
	2	GPS L2C
	3	GPS L5
	4	GPS L1 P
	5	GPS L1 Z-tracking
	6	GPS L2 C/A

	7	GPS L2 P
	8	GPS L2 Z-tracking
	9	GPS L2 L2C(M)
	10	GPS L2 L2C(L)
	11	GPS L2 L2C(M+L)
	12	GPS L5 I
	13	GPS L5 Q
	14	GPS L5 I+Q
	15	GPS L1 L1C(D)
	16	GPS L1 L1C(P)
	17	GPS L1 L1C(D+P)
	18-23	Reserved
SBAS	0	L1 C/A
	1	L5 I
	2	L5 Q
	3	L5 I+Q
	4-7	Reserved
QZSS	0	QZS-L1 C/A
	1	QZS-L1C
	2	QZS-L2C
	3	QZS-L5
	4	QZS-LEX S
	5	QZS-LEX L
	6	QZS-LEX S+L
	7	QZS-L2 L2C(M)
	8	QZS-L2 L2C(L)
	9	QZS-L2 L2C(M+L)
	10	QZS-L5 I
	11	QZS-L5 Q
	12	QZS-L5 I+Q
	13	QZS L1 L1C(D)
	14	QZS L1 L1C(P)
	15	QZS L1 L1C(D+P)
	16-23	Reserved

GLONASS	0	GLONASS G1 C/A
	1	GLONASS G2 C/A
	2	GLONASS G3
	3	GLONASS G1 P
	4	GLONASS G2 P
	5	GLONASS G1a(D)
	6	GLONASS G1a(P)
	7	GLONASS G1a (D+P)
	8	GLONASS G2a(I)
	9	GLONASS G2a(P)
	10	GLONASS G2a(I+P)
	11	GLONASS G3 I
	12	GLONASS G3 Q
	13	GLONASS G3 I+Q
14-23	Reserved	
Galileo	0	Galileo E1
	1	Galileo E5A
	2	Galileo E5B
	3	Galileo E6
	4	Galileo E5A + E5B
	5	Galileo E1 C No data
	6	Galileo E1 A
	7	Galileo E1 B I/NAV OS/CS/SoL
	8	Galileo E1 B+C
	9	Galileo E1 A+B+C
	10	Galileo E6 C
	11	Galileo E6 A
	12	Galileo E6 B
	13	Galileo E6 B+C
	14	Galileo E6 A+B+C
	15	Galileo E5B I
	16	Galileo E5B Q
	17	Galileo E5B I+Q
	18	Galileo E5(A+B) I
	19	Galileo E5(A+B) Q
	20	Galileo E5(A+B) I+Q
	21	Galileo E5A I
	22	Galileo E5A Q
23	Galileo E5A I+Q	
BDS	0	B1 I
	1	B1 Q
	2	B1 I+Q
	3	B3 I
	4	B3 Q
	5	B3 I+Q
	6	B2 I
	7	B2 Q
	8	B2 I+Q
	9	B1C(D)
	10	B1C(P)
	11	B1C(D+P)
12-23	Reserved	
NavIC	0	NavIC L5 SPS
	1-23	Reserved

– GNSS-SignalIDs

The IE *GNSSSignal-IDs* is used to indicate several GNSS signals using a bit map. The interpretation of *GNSSSignal-IDs* depends on the *GNSS-ID*.

```
-- ASN1START
```

```
GNSS-SignalIDs ::= SEQUENCE {
```

```

gnss-SignalIDs      BIT STRING (SIZE(8)),
...
[[
  gnss-SignalIDs-Ext-r15 BIT STRING (SIZE(16))          OPTIONAL  -- Need ON
]]
}
-- ASN1STOP

```

GNSS-SignalIDs field descriptions

gnss-SignalIDs, gnss-SignalIDs-Ext

This field specifies one or several GNSS signals using a bit map. A one-value at the bit position means the particular signal is addressed; a zero-value at the particular bit position means the signal is not addressed. The interpretation of the bit map in *gnssSignalIDs* and *gnss-SignalIDs-Ext* depends on the *GNSS-ID* and is shown in the table below. Unfilled table entries indicate no assignment and shall be set to zero.

Interpretation of the bit map in *gnssSignalIDs*

GNSS	Bit 1 (MSB)	Bit 2	Bit 3	Bit 4	Bit 5	Bit 6	Bit 7	Bit 8 (LSB)
GPS	L1 C/A	L1C	L2C	L5	L1P	L1 Z	L2 C/A	L2 P
SBAS	L1 C/A	L5 I	L5 Q	L5 I+Q				
QZSS	QZS-L1 C/A	QZS-L1C	QZS-L2C	QZS-L5	LEX S	LEX L	LEX S+L	L2C(M)
GLONASS	G1 C/A	G2 C/A	G3	G1 P	G2 P	G1a(D)	G1a(P)	G1a(D+P)
Galileo	E1	E5a	E5b	E6	E5a+E5b	E1 C No Data	E1 A	E1 B I/NAV OS/CS/SoL
BDS	B1 I	B1 Q	B1 I+Q	B3 I	B3 Q	B3 I+Q	B2 I	B2 Q
NavIC	L5 SPS							

Interpretation of the bit map in *gnssSignalIDs-Ext*

GNSS	Bit 1 (MSB)	Bit 2	Bit 3	Bit 4	Bit 5	Bit 6	Bit 7	Bit 8
GPS	L2 Z	L2C(M)	L2C(L)	L2C(M+L)	L5 I	L5 Q	L5 I+Q	L1C(D)
SBAS								
QZSS	L2C(L)	L2C(M+L)	L5 I	L5 Q	L5 I+Q	L1C(D)	L1C(P)	L1C(D+P)
GLONASS	G2a(I)	G2a(P)	G2a(I+P)	G3 I	G3 Q	G3(I+Q)		
Galileo	E1 B+C	E1 A+B+C	E6C	E6A	E6B	E6 B+C	E6 A+B+C	E5B I
BDS	B2 I+Q	B1C(D)	B1C(P)	B1C(D+P)				
NavIC								

GNSS	Bit 9	Bit 10	Bit 11	Bit 12	Bit 13	Bit 14	Bit 15	Bit 16 (LSB)
GPS	L1C(P)	L1C(D+P)						
SBAS								
QZSS								
GLONASS								
Galileo	E5B Q	E5B I+Q	E5(A+B) I	E5(A+B) Q	E5(A+B) I+Q	E5A I	E5A Q	E5A I+Q
BDS								
NavIC								

– GNSS-SubNetworkID

The IE *GNSS-SubNetworkID* defines the subnetwork of a network identified by *GNSS-NetworkID*. This IE is used for MAC Network RTK as described in [30].

```

-- ASN1START
GNSS-SubNetworkID-r15 ::= SEQUENCE {

```

```

    subNetworkID-r15                INTEGER (0..15),
    ...
}
-- ASN1STOP

```

– SBAS-ID

The IE *SBAS-ID* is used to indicate a specific SBAS.

```

-- ASN1START
SBAS-ID ::= SEQUENCE {
    sbas-id          ENUMERATED { waas, egnos, msas, gagan, ...},
    ...
}
-- ASN1STOP

```

– SBAS-IDs

The IE *SBAS-IDs* is used to indicate several SBASs using a bit map.

```

-- ASN1START
SBAS-IDs ::= SEQUENCE {
    sbas-IDs          BIT STRING {
        waas          (0),
        egnos         (1),
        msas          (2),
        gagan         (3) } (SIZE (1..8)),
    ...
}
-- ASN1STOP

```

SBAS-IDs field descriptions

sbas-IDs

This field specifies one or several SBAS(s) using a bit map. A one-value at the bit position means the particular SBAS is addressed; a zero-value at the particular bit position means the SBAS is not addressed.

– SV-ID

The IE *SV-ID* is used to indicate a specific GNSS satellite. The interpretation of *SV-ID* depends on the *GNSS-ID*.

```

-- ASN1START
SV-ID ::= SEQUENCE {
    satellite-id      INTEGER(0..63),
    ...
}
-- ASN1STOP

```

SV-ID field descriptions

satellite-id

This field specifies a particular satellite within a specific GNSS. The interpretation of *satellite-id* depends on the *GNSS-ID* see the table below.

Interpretation of *satellite-id*

System	Value of <i>satellite-id</i>	Interpretation of <i>satellite-id</i>
GPS	'0' – '62' '63'	Satellite PRN Signal No. 1 to 63 Reserved
SBAS	'0' – '38' '39' – '63'	Satellite PRN Signal No. 120 to 158 Reserved
QZSS	'0' – '9' '10' – '63'	Satellite PRN Signal No. 193 to 202 Reserved
GLONASS	'0' – '23' '24' – '63'	Slot Number 1 to 24 Reserved
Galileo	'0' – '35' '36' – '63'	Code No. 1 to 36 Reserved
BDS	'0' – '62' '63'	Satellite ranging code number No.1 to 63 Reserved
NavIC	'0' – '13' '14'–'63'	Satellite PRN Signal No. 1 to 14 Reserved

6.5.3 Enhanced Cell ID Positioning

6.5.3.1 E-CID Location Information

– *ECID-ProvideLocationInformation*

The IE *ECID-ProvideLocationInformation* is used by the target device to provide E-CID location measurements to the location server. It may also be used to provide E-CID positioning specific error reason.

```
-- ASN1START
ECID-ProvideLocationInformation ::= SEQUENCE {
    ecid-SignalMeasurementInformation    ECID-SignalMeasurementInformation    OPTIONAL,
    ecid-Error                           ECID-Error                           OPTIONAL,
    ...
}
-- ASN1STOP
```

6.5.3.2 E-CID Location Information Elements

– *ECID-SignalMeasurementInformation*

The IE *ECID-SignalMeasurementInformation* is used by the target device to provide various UE-measurements to the location server.

```
-- ASN1START
ECID-SignalMeasurementInformation ::= SEQUENCE {
    primaryCellMeasuredResults    MeasuredResultsElement    OPTIONAL,
    measuredResultsList           MeasuredResultsList,
    ...
}
MeasuredResultsList ::= SEQUENCE (SIZE(1..32)) OF MeasuredResultsElement
MeasuredResultsElement ::= SEQUENCE {
    physCellId                INTEGER (0..503),
    cellGlobalId              CellGlobalIdEUTRA-AndUTRA    OPTIONAL,
    arfcnEUTRA                ARFCN-ValueEUTRA,
    systemFrameNumber         BIT STRING (SIZE (10))    OPTIONAL,
    rsrp-Result               INTEGER (0..97)    OPTIONAL,
    rsrq-Result               INTEGER (0..34)    OPTIONAL,
    ue-RxTxTimeDiff          INTEGER (0..4095)    OPTIONAL,
    ...
    [[ arfcnEUTRA-v9a0        ARFCN-ValueEUTRA-v9a0    OPTIONAL    -- Cond EARFCN-max
    ]],
}
```

```

[[ nrsrp-Result-r14          INTEGER (0..113)          OPTIONAL,
   nrsrq-Result-r14         INTEGER (0..74)           OPTIONAL,
   carrierFreqOffsetNB-r14  CarrierFreqOffsetNB-r14 OPTIONAL,
   hyperSFN-r14             BIT STRING (SIZE (10))          OPTIONAL
]],
[[
   rsrp-Result-v1470        INTEGER (-17..-1)              OPTIONAL,
   rsrq-Result-v1470        INTEGER (-30..46)              OPTIONAL
]]
}
-- ASN1STOP

```

Conditional presence	Explanation
<i>EARFCN-max</i>	The field is mandatory present if the corresponding <i>arfcnEUTRA</i> (i.e. without suffix) is set to <i>maxEARFCN</i> . Otherwise the field is not present.
<i>NB-IoT</i>	The field is mandatory present if the measured cell is a NB-IoT cell. Otherwise it is not present.

ECID-SignalMeasurementInformation field descriptions
<p>primaryCellMeasuredResults This field contains measurements for the primary cell (if the primary cell is a E-UTRA or NB-IoT cell), when the target device reports measurements for both primary cell (E-UTRA or NB-IoT) and neighbour cells. This field shall be omitted when the target device reports measurements for the primary cell (E-UTRA or NB-IoT) only, in which case the measurements for the primary cell (E-UTRA or NB-IoT) is reported in the <i>measuredResultsList</i>. This field shall be omitted when the primary cell is not a E-UTRA or NB-IoT cell.</p>
<p>measuredResultsList This list contains the E-CID measurements for up to 32 E-UTRA or NB-IoT cells.</p>
<p>physCellId This field specifies the physical cell identity of the measured cell.</p>
<p>cellGlobalId This field specifies cell global ID of the measured cell. The target device shall provide this field if it was able to determine the ECGI of the measured cell at the time of measurement.</p>
<p>arfcnEUTRA This field specifies the ARFCN of the measured E-UTRA carrier frequency, as defined in TS 36.331 [12]. In the case the target device includes <i>arfcnEUTRA-v9a0</i>, the target device shall set the corresponding <i>arfcnEUTRA</i> (i.e. without suffix) to <i>maxEARFCN</i>.</p>
<p>systemFrameNumber This field specifies the system frame number of the measured cell during which the measurements have been performed. The target device shall include this field if it was able to determine the SFN of the cell at the time of measurement.</p>
<p>rsrp-Result This field specifies the reference signal received power (RSRP) measurement, as defined in TS 36.331 [12], TS 36.214 [17]. In the case the target device includes <i>rsrp-Result-v1470</i>, the target device shall set the corresponding <i>rsrp-Result</i> (i.e. without suffix) to value 0.</p>
<p>rsrq-Result This field specifies the reference signal received quality (RSRQ) measurement, as defined in TS 36.331 [12], TS 36.214 [17]. In the case the target device includes <i>rsrq-Result-v1470</i>, the target device shall set the corresponding <i>rsrq-Result</i> (i.e. without suffix) to value 0 or 34.</p>
<p>ue-RxTxTimeDiff This field specifies the UE Rx-Tx time difference measurement, as defined in TS 36.214 [17]. It is provided only for measurements on the UE's primary cell. Measurement report mapping is according to TS 36.133 [18].</p>
<p>nrsrp-Result This field specifies the narrowband reference signal received power (NRSRP) measurement, as defined in TS 36.214 [17]. Measurement report mapping is according to TS 36.133 [18].</p>
<p>nrsrq-Result This field specifies the narrowband reference signal received quality (NRSRQ) measurement, as defined in TS 36.214 [17]. Measurement report mapping to the value defined in TS 36.133 [18]. Values 0..29 map to values NRSRQ_-30..NRSRQ_-1. Values 30..62 map to NRSRQ_01..NRSRQ_33. Values 63..74 map to NRSRQ_35..NRSRQ_46. The UE does not report NRSRQ_00 nor NRSRQ_34.</p>
<p>carrierFreqOffsetNB This field specifies the offset of the NB-IoT channel number to ARFCN given by <i>arfcnEUTRA</i> as defined in TS 36.101 [21].</p>

ECID-SignalMeasurementInformation field descriptions**hyperSFN**

This field specifies the hyper-SFN of the measured cell during which the measurements have been performed. The target device shall include this field if it was able to determine the hyper-SFN of the cell at the time of measurement.

6.5.3.3 E-CID Location Information Request

– **ECID-RequestLocationInformation**

The IE *ECID-RequestLocationInformation* is used by the location server to request E-CID location measurements from a target device.

```
-- ASN1START
ECID-RequestLocationInformation ::= SEQUENCE {
    requestedMeasurements BIT STRING {
        rsrpReq      (0),
        rsrqReq      (1),
        ueRxTxReq    (2),
        nrsrpReq-r14 (3),
        nrsrqReq-r14 (4)} (SIZE(1..8)),
    ...
}
-- ASN1STOP
```

ECID-RequestLocationInformation field descriptions**requestedMeasurements**

This field specifies the E-CID measurements requested. This is represented by a bit string, with a one-value at the bit position means the particular measurement is requested; a zero-value means not requested.

6.5.3.4 E-CID Capability Information

– **ECID-ProvideCapabilities**

The IE *ECID-ProvideCapabilities* is used by the target device to indicate its capability to support E-CID and to provide its E-CID location capabilities to the location server.

```
-- ASN1START
ECID-ProvideCapabilities ::= SEQUENCE {
    ecid-MeasSupported BIT STRING {
        rsrpSup      (0),
        rsrqSup      (1),
        ueRxTxSup    (2),
        nrsrpSup-r14 (3),
        nrsrqSup-r14 (4)} (SIZE(1..8)),
    ...
    [[ ueRxTxSupTDD-r13 ENUMERATED { true } OPTIONAL ]],
    [[ periodicalReporting-r14 ENUMERATED { supported } OPTIONAL,
        triggeredReporting-r14 ENUMERATED { supported } OPTIONAL,
        idleStateForMeasurements-r14 ENUMERATED { required } OPTIONAL ]],
}
-- ASN1STOP
```

<i>ECID-Provide-Capabilities</i> field descriptions
<p><i>ecid-MeasSupported</i> This field specifies the E-CID measurements supported by the target device. This is represented by a bit string, with a one-value at the bit position means the particular measurement is supported; a zero-value means not supported. A zero-value in all bit positions in the bit string means only the basic Cell ID positioning method is supported by the target device. If the UE Rx-Tx time difference measurement is supported by the target device (i.e., <i>ueRxTxSup</i> field is set to one), it means that the UE supports the UE Rx-Tx time difference measurement reporting via both LPP signaling and RRC signalling. If a target device doesn't support LPP, the E-SMLC may assume the target device can not report the UE Rx-Tx time difference measurement results via RRC signalling.</p>
<p><i>ueRxTxSupTDD</i> This field, if present, indicates that any UE Rx-Tx time difference measurement reporting for TDD from the target device includes the <i>N_{TAoffset}</i> according to TS 36.211 [16], TS 36.214 [17] and uses the UE Rx-Tx time difference measurement report mapping for TDD as specified in TS 36.133 [18]. This field may only be included if the <i>ueRxTxSup</i> field in <i>ecid-MeasSupported</i> is set to value one.</p>
<p><i>periodicalReporting</i> This field, if present, indicates that the target device supports <i>periodicalReporting</i> of E-CID measurements. If this field is absent, the location server may assume that the target device does not support <i>periodicalReporting</i> in <i>CommonEsRequestLocationInformation</i>.</p>
<p><i>triggeredReporting</i> This field, if present, indicates that the target device supports <i>triggeredReporting</i> for the <i>cellChange</i> event. If this field is absent, the location server may assume that the target device does not support <i>triggeredReporting</i> in <i>CommonEsRequestLocationInformation</i>.</p>
<p><i>idleStateForMeasurements</i> This field, if present, indicates that the target device requires idle state to perform E-CID measurements.</p>

6.5.3.5 E-CID Capability Information Request

– *ECID-RequestCapabilities*

The IE *ECID-RequestCapabilities* is used by the location server to request E-CID positioning capabilities from a target device.

```
-- ASN1START
ECID-RequestCapabilities ::= SEQUENCE {
    ...
}
-- ASN1STOP
```

6.5.3.6 E-CID Error Elements

– *ECID-Error*

The IE *ECID-Error* is used by the location server or target device to provide E-CID error reasons to the target device or location server, respectively.

```
-- ASN1START
ECID-Error ::= CHOICE {
    locationServerErrorCauses      ECID-LocationServerErrorCauses,
    targetDeviceErrorCauses       ECID-TargetDeviceErrorCauses,
    ...
}
-- ASN1STOP
```

– *ECID-LocationServerErrorCauses*

The IE *ECID-LocationServerErrorCauses* is used by the location server to provide E-CID error reasons to the target device.

```

-- ASN1START
ECID-LocationServerErrorCauses ::= SEQUENCE {
    cause          ENUMERATED {   undefined,
                                  ...
                                },
    ...
}
-- ASN1STOP

```

– *ECID-TargetDeviceErrorCauses*

The IE *ECID-TargetDeviceErrorCauses* is used by the target device to provide E-CID error reasons to the location server.

```

-- ASN1START
ECID-TargetDeviceErrorCauses ::= SEQUENCE {
    cause          ENUMERATED {   undefined,
                                  requestedMeasurementNotAvailable,
                                  notAllRequestedMeasurementsPossible,
                                  ...
                                },
    rsrpMeasurementNotPossible          NULL          OPTIONAL,
    rsrqMeasurementNotPossible          NULL          OPTIONAL,
    ueRxTxMeasurementNotPossible        NULL          OPTIONAL,
    ...
    [
    nrsrpMeasurementNotPossible-r14     NULL          OPTIONAL,
    nrsrqMeasurementNotPossible-r14     NULL          OPTIONAL
    ]
}
-- ASN1STOP

```

***ECID-TargetDeviceErrorCauses* field descriptions**

cause

This field provides a E-CID specific error cause. If the cause value is 'notAllRequestedMeasurementsPossible', the target device was not able to provide all requested E-CID measurements (but may be able to provide some measurements). In this case, the target device should include any of the *rsrpMeasurementNotPossible*, *rsrqMeasurementNotPossible*, *ueRxTxMeasurementNotPossible*, *nrsrpMeasurementNotPossible*, or *nrsrqMeasurementNotPossible* fields, as applicable.

6.5.4 Terrestrial Beacon System Positioning

6.5.4.1 TBS Location Information

– *TBS-ProvideLocationInformation*

The IE *TBS-ProvideLocationInformation* is used by the target device to provide TBS location measurements to the location server. It may also be used to provide TBS positioning specific error reason.

```

-- ASN1START
TBS-ProvideLocationInformation-r13 ::= SEQUENCE {
    tbs-MeasurementInformation-r13      TBS-MeasurementInformation-r13    OPTIONAL,
    tbs-Error-r13                       TBS-Error-r13                    OPTIONAL,
    ...
}
-- ASN1STOP

```

6.5.4.2 TBS Location Information Elements

– *TBS-MeasurementInformation*

The IE *TBS-MeasurementInformation* is used by the target device to provide TBS location measurements to the location server.

```
-- ASN1START
TBS-MeasurementInformation-r13 ::= SEQUENCE {
    measurementReferenceTime-r13    UTCTime                OPTIONAL,
    mbs-SgnMeasList-r13            MBS-BeaconMeasList-r13  OPTIONAL, -- Cond MBS
    ...
}
-- ASN1STOP
```

Conditional presence	Explanation
<i>MBS</i>	The field is mandatory present if the <i>TBS-MeasurementInformation</i> is provided for an MBS system; otherwise it is not present.

TBS-MeasurementInformation field descriptions

measurementReferenceTime

This field provides the UTC time when the TBS measurements are performed and should take the form of *YYMMDDhhmmssZ*.

mbs-SgnMeasList

This field provides the MBS measurements for up to 64 MBS beacons.

– *MBS-BeaconMeasList*

The IE *MBS-BeaconMeasList* is used by the target device to provide MBS location measurements to the location server, as defined in the MBS ICD [24].

```
-- ASN1START
MBS-BeaconMeasList-r13 ::= SEQUENCE (SIZE(1..64)) OF MBS-BeaconMeasElement-r13
MBS-BeaconMeasElement-r13 ::= SEQUENCE {
    transmitterID-r13            INTEGER (0..32767),
    codePhase-r13                INTEGER (0..2097151),
    codePhaseRMSError-r13       INTEGER (0..63),
    ...
    [[ rssi-r14                   INTEGER (-130..-30)    OPTIONAL
    ]]
}
-- ASN1STOP
```

MBS-BeaconMeasList field descriptions

transmitterID

This field contains the MBS transmitter identifier.

codePhase

This field contains the value of the code-phase measurement made by the target device for the particular beacon signal at the time of measurement in the units of ms. MBS specific code phase measurements (e.g. chips) are converted into unit of ms by dividing the measurements by the nominal values of the measured signal chipping rate. Scale factor 2^{-21} milli-seconds, in the range from 0 to $(1 \cdot 2^{-21})$ milli-seconds.

codePhaseRMSError

This field contains the pseudorange RMS error value. This parameter is specified according to a floating-point representation shown in the table below.

MBS-BeaconMeasList field descriptions**rssI**

This field provides an estimate of the received signal strength from the MBS beacon as referenced to the UE antenna connector.

If the estimated received signal strength for the MBS beacon is less than -130 dBm, the UE shall report an RSSI value of -130. If the estimated received signal strength for the MBS beacon is greater than -30 dBm, the UE shall report an RSSI value of -30.

Scale factor 1 dBm.

floating-point representation

Index	Mantissa	Exponent	Floating-Point value, x_i	Pseudorange value, P [m]
0	000	000	0.5	$P < 0.5$
1	001	000	0.5625	$0.5 \leq P < 0.5625$
i	x	y	$0.5 * (1 + x/8) * 2^y$	$x_{i-1} \leq P < x_i$
62	110	111	112	$104 \leq P < 112$
63	111	111	--	$112 \leq P$

6.5.4.3 TBS Location Information Request**– TBS-RequestLocationInformation**

The IE *TBS-RequestLocationInformation* is used by the location server to request location information for TBS-based methods from the target device.

```
-- ASN1START
TBS-RequestLocationInformation-r13 ::= SEQUENCE {
    mbsSgnMeasListReq-r13          BOOLEAN,
    . . .
    [ [ mbsAssistanceAvailability-r14  BOOLEAN                                OPTIONAL, -- Need ON
        mbsRequestedMeasurements-r14  BIT STRING {
            rssi          (0) } (SIZE(1..8))  OPTIONAL -- Need ON
        ] ]
}
-- ASN1STOP
```

TBS-RequestLocationInformation field descriptions**mbsSgnMeasListReq**

This field indicates whether the target device is requested to report MBS measurements in *TBS-MeasurementInformation* IE or not. TRUE means requested.

mbsAssistanceAvailability

This field indicates whether the target device may request additional MBS assistance data from the server. TRUE means allowed and FALSE means not allowed.

mbsRequestedMeasurements

This field indicates the additional MBS measurements requested and may only be included if *mbsSgnMeasListReq* is set to TRUE. This field is represented by a bit string, with a one-value at the bit position means the particular measurement is requested; a zero-value means not requested. The following measurement requests can be included.

rssI: Beacon signal strength at the target

6.5.4.4 TBS Capability Information**– TBS-ProvideCapabilities**

The IE *TBS-ProvideCapabilities* is used by the target device to indicate its capability to support TBS and to provide its TBS location capabilities to the location server.

```

-- ASN1START
TBS-ProvideCapabilities-r13 ::= SEQUENCE {
    tbs-Modes-r13          BIT STRING {   standalone      (0),
                                          ue-assisted      (1),
                                          ue-based        (2)} (SIZE (1..8)),
    ...,
    [ [ mbs-AssistanceDataSupportList-r14  MBS-AssistanceDataSupportList-r14  OPTIONAL,
        periodicalReportingSupported-r14  PositioningModes                    OPTIONAL,
        mbs-ConfigSupport-r14            BIT STRING {   tb1      (0),
                                                         tb2      (1),
                                                         tb3      (2),
                                                         tb4      (3)} (SIZE (1..8))          OPTIONAL,
        mbs-IdleStateForMeasurements-r14  ENUMERATED { required }             OPTIONAL
      ] ]
}
-- ASN1STOP

```

TBS-ProvideCapabilities field descriptions

tbs-Modes

This field specifies the TBS mode(s) supported by the target device. This is represented by a bit string, with a one-value at the bit position means the particular TBS mode is supported; a zero-value means not supported.

mbs-AssistanceDataSupportList

This list defines the MBS assistance data supported by the target device. This field shall be present if the target device supports MBS assistance data.

periodicalReportingSupported

This field, if present, specifies the positioning modes for which the target device supports *periodicalReporting*. This is represented by a bit string, with a one-value at the bit position means *periodicalReporting* for the positioning mode is supported; a zero-value means not supported. If this field is absent, the location server may assume that the target device does not support *periodicalReporting* in *CommonIEsRequestLocationInformation*.

mbs-ConfigSupport

This field specifies the MBS configurations supported by the target device. This field shall be present if the target device supports MBS [24].

mbs-IdleStateForMeasurements

This field, if present, indicates that the target device requires idle state to perform MBS measurements.

- ***MBS-AssistanceDataSupportList***

The IE *MBS-AssistanceDataSupportList* is used by the target device to indicate its capability to support MBS Assistance Data and to provide its capabilities to the location server.

```

-- ASN1START
MBS-AssistanceDataSupportList-r14 ::= SEQUENCE {
    mbs-AcquisitionAssistanceDataSupport-r14  BOOLEAN,
    mbs-AlmanacAssistanceDataSupport-r14     BOOLEAN,
    ...
}
-- ASN1STOP

```

MBS-AssistanceDataSupportList field descriptions

mbs-AcquisitionAssistanceDataSupport

This field specifies whether the target device supports MBS Acquisition Assistance Data. TRUE means supported.

mbs-AlmanacAssistanceDataSupport

This field specifies whether the target device supports MBS Almanac Assistance Data. TRUE means supported.

6.5.4.5 TBS Capability Information Request

- ***TBS-RequestCapabilities***

The IE *TBS-RequestCapabilities* is used by the location server to request TBS positioning capabilities from a target device.

```
-- ASN1START
TBS-RequestCapabilities-r13 ::= SEQUENCE {
    ...
}
-- ASN1STOP
```

6.5.4.6 TBS Error Elements

– *TBS-Error*

The IE *TBS-Error* is used by the location server or target device to provide TBS error reasons to the target device or location server, respectively.

```
-- ASN1START
TBS-Error-r13 ::= CHOICE {
    locationServerErrorCauses-r13      TBS-LocationServerErrorCauses-r13,
    targetDeviceErrorCauses-r13       TBS-TargetDeviceErrorCauses-r13,
    ...
}
-- ASN1STOP
```

– *TBS-LocationServerErrorCauses*

The IE *TBS-LocationServerErrorCauses* is used by the location server to provide error reasons for TBS positioning to the target device.

```
-- ASN1START
TBS-LocationServerErrorCauses-r13 ::= SEQUENCE {
    cause-r13      ENUMERATED { undefined,
    ...,
    assistanceDataNotSupportedByServer-v1420,
    assistanceDataSupportedButCurrentlyNotAvailableByServer-v1420
    },
    ...
}
-- ASN1STOP
```

– *TBS-TargetDeviceErrorCauses*

The IE *TBS-TargetDeviceErrorCauses* is used by the target device to provide error reasons for TBS positioning to the location server.

```
-- ASN1START
TBS-TargetDeviceErrorCauses-r13 ::= SEQUENCE {
    cause-r13      ENUMERATED { undefined,
    thereWereNotEnoughMBSBeaconsReceived,
    ...,
    assistanceDataMissing-v1420
    },
    ...
}
-- ASN1STOP
```

TBS-TargetDeviceErrorCauses field descriptions

cause

This field provides a TBS specific error cause.

6.5.4.7 TBS Assistance Data

– *TBS-ProvideAssistanceData*

The IE *TBS-ProvideAssistanceData* is used by the location server to provide assistance data to assist in position estimation at the UE (e.g. for UE-based mode) and/or to expedite the acquisition of TBS signals. It may also be used to provide TBS positioning specific error reasons.

```
-- ASN1START
TBS-ProvideAssistanceData-r14 ::= SEQUENCE {
    tbs-AssistanceDataList-r14  TBS-AssistanceDataList-r14  OPTIONAL,  -- Need ON
    tbs-Error-r14                TBS-Error-r13              OPTIONAL,  -- Need ON
    ...
}
-- ASN1STOP
```

6.5.4.8 TBS Assistance Data Elements

– *TBS-AssistanceDataList*

The IE *TBS-AssistanceDataList* is used by the location server to provide the TBS specific assistance data to the UE.

```
-- ASN1START
TBS-AssistanceDataList-r14 ::= SEQUENCE {
    mbs-AssistanceDataList-r14  MBS-AssistanceDataList-r14  OPTIONAL,  -- Need ON
    ...
}
MBS-AssistanceDataList-r14 ::= SEQUENCE (SIZE (1..maxMBS-r14)) OF MBS-AssistanceDataElement-r14
MBS-AssistanceDataElement-r14 ::= SEQUENCE {
    mbs-AlmanacAssistance-r14    MBS-AlmanacAssistance-r14    OPTIONAL,  -- Need ON
    mbs-AcquisitionAssistance-r14 MBS-AcquisitionAssistance-r14  OPTIONAL,  -- Need ON
    ...
}
-- ASN1STOP
```

– *MBS-AlmanacAssistance*

The IE *MBS-AlmanacAssistance* is used by the location server to provide LLA of MBS transmitters to enable position estimation at the UE.

```
-- ASN1START
MBS-AlmanacAssistance-r14 ::= SEQUENCE {
    transmitterID-r14            INTEGER (0..32767),
    transmitterLatitude-r14      BIT STRING (SIZE (26)),
    transmitterLongitude-r14     BIT STRING (SIZE (27)),
    transmitterAltitude-r14      BIT STRING (SIZE (15)),
    timeCorrection-r14           INTEGER (0..25)  OPTIONAL,  -- Need ON
    ...
}
-- ASN1STOP
```

***MBS-AlmanacAssistance* field descriptions**

transmitterID

This field specifies the MBS transmitter ID [24].

transmitterLatitude

This field specifies latitude of the MBS transmitter, degrees. Scale factor $4/2^{20}$ decimal degrees, added to -90° . Valid range -90° to 90° [24].

MBS-AlmanacAssistance field descriptions
<p>transmitterLongitude This field specifies longitude of the MBS transmitter, degrees. Scale factor $4/2^{20}$ decimal degrees, added to -180°. Valid range -180° to 180° [24].</p>
<p>transmitterAltitude This field specifies altitude of the MBS transmitter, metres. Scale factor 0.29 metres, added to -500 metres. Valid range -500 to 9002.43 metres [24].</p>
<p>timeCorrection This field contains the residual timing error for a particular beacon, in units of nano-seconds, in the range from 0 to 25. This field is used for UE-based mode only, by subtracting from the <i>codePhase</i> measurement made by the target device [24].</p>

– MBS-AcquisitionAssistance

The IE *MBS-AcquisitionAssistance* is used by the location server to provide parameters that support acquisition of the MBS signals [24].

```
-- ASN1START
MBS-AcquisitionAssistance-r14 ::= SEQUENCE {
    transmitterID-r14          INTEGER (0..32767)           OPTIONAL, -- Need ON
    mbsConfiguration-r14      ENUMERATED {tb1, tb2, tb3, tb4, ...} OPTIONAL, -- Need ON
    pnCodeIndex-r14          INTEGER (1..128)           OPTIONAL, -- Need ON
    freq-r14                  INTEGER (919750000..927250000) OPTIONAL, -- Need ON
    ...
}
-- ASN1STOP
```

MBS-AcquisitionAssistance field descriptions
<p>transmitterID This field contains the MBS transmitter identifier [24].</p>
<p>mbsConfiguration This field specifies MBS configuration as defined in the MBS ICD [24].</p>
<p>pnCodeIndex This field specifies the index of the MBS PN code [24].</p>
<p>freq This field specifies the MBS signal centre frequency in units of Hz [24].</p>

6.5.4.9 TBS Assistance Data Request

– TBS-RequestAssistanceData

The IE *TBS-RequestAssistanceData* is used by the target device to request TBS assistance data from a location server.

```
-- ASN1START
TBS-RequestAssistanceData-r14 ::= SEQUENCE {
    mbs-AlmanacAssistanceDataReq-r14    BOOLEAN,
    mbs-AcquisitionAssistanceDataReq-r14  BOOLEAN,
    ...
}
-- ASN1STOP
```

6.5.5 Sensor based Positioning

6.5.5.0 Introduction

This clause defines support for sensor-based positioning. The supported sensor methods are "Barometric pressure sensor" and "Motion sensor" as described in TS 36.305, clauses 8.6 and 8.10 respectively [2].

6.5.5.1 Sensor Location Information

– *Sensor-ProvideLocationInformation*

The IE *Sensor-ProvideLocationInformation* is used by the target device to provide location information for sensor-based methods to the location server. It may also be used to provide sensor specific error reason.

```
-- ASN1START
Sensor-ProvideLocationInformation-r13 ::= SEQUENCE {
    sensor-MeasurementInformation-r13    Sensor-MeasurementInformation-r13    OPTIONAL,
    sensor-Error-r13                    Sensor-Error-r13                    OPTIONAL,
    . . . ,
    [[
    sensor-MotionInformation-r15         Sensor-MotionInformation-r15         OPTIONAL
    ]]
}
-- ASN1STOP
```

6.5.5.2 Sensor Location Information Elements

– *Sensor-MeasurementInformation*

The IE *Sensor-MeasurementInformation* is used by the target device to provide UE sensor measurements to the location server.

```
-- ASN1START
Sensor-MeasurementInformation-r13 ::= SEQUENCE {
    measurementReferenceTime-r13        UTCTime                        OPTIONAL,
    uncompensatedBarometricPressure-r13 INTEGER (30000..115000)          OPTIONAL, -- Cond Barometer
    . . . ,
    [[
    uncertainty-r14                     SEQUENCE {
        range-r14                       INTEGER (0..1000),
        confidence-r14                  INTEGER (1..100)
    }
    ]],
    [[ adjustment-r16                   INTEGER (-5000..5000)          OPTIONAL
    ]]
}
-- ASN1STOP
```

Conditional presence	Explanation
<i>Barometer</i>	The field is mandatory present if the <i>Sensor-MeasurementInformation</i> is provided for barometric pressure; otherwise it is not present.

<i>Sensor-MeasurementInformation</i> field descriptions	
<i>measurementReferenceTime</i>	This field provides the UTC time when the sensor measurements are performed and should take the form of <i>YYMMDDhhmmssZ</i> .
<i>uncompensatedBarometricPressure</i>	This field provides the uncompensated barometric pressure as measured by the UE sensor, in units of Pa.
<i>uncertainty</i>	This field provides the expected range for the pressure measurement in units of Pa and the confidence as a percentage that the true pressure lies in a range of (measurement – range) to (measurement + range).
<i>adjustment</i>	This field provides any adjustment available in the UE, in units of Pa, to allow the production of a compensated atmospheric pressure measurement where compensated atmospheric pressure = <i>uncompensatedBarometricPressure</i> + <i>adjustment</i>

– *Sensor-MotionInformation*

The IE *Sensor-MotionInformation* is used by the target device to provide UE movement information to the location server. The movement information comprises an ordered series of points. This information may be obtained by the target device using one or more motion sensors.

```

-- ASN1START
Sensor-MotionInformation-r15 ::= SEQUENCE {
    refTime-r15           DisplacementTimeStamp-r15,
    displacementInfoList-r15  DisplacementInfoList-r15,
    ...
}

DisplacementInfoList-r15 ::= SEQUENCE (SIZE (1..128)) OF DisplacementInfoListElement-r15

DisplacementInfoListElement-r15 ::= SEQUENCE {
    deltaTimeStamp-r15    DeltaTime-r15,
    displacement-r15      Displacement-r15           OPTIONAL,
    ...
}

DisplacementTimeStamp-r15 ::= CHOICE {
    utcTime-r15           UTC-Time-r15,
    gnsstime-r15          MeasurementReferenceTime,
    systemFrameNumber-r15 SFN-r15,
    measurementSFN-r15    INTEGER(-8192..9214),
    ...
}

DeltaTime-r15 ::= CHOICE {
    deltaTimeSec-r15      INTEGER (1..16384),
    deltaTimeSFN-r15     INTEGER (1..4096),
    ...
}

SFN-r15 ::= SEQUENCE {
    sfn-r15               BIT STRING (SIZE (10)),
    hyperSFN-r15         BIT STRING (SIZE (10))   OPTIONAL,
    ...
}

Displacement-r15 ::= SEQUENCE {
    bearing-r15           INTEGER (0..3599),
    bearingUncConfidence-r15  INTEGER (0..100)           OPTIONAL,
    bearingRef-r15       ENUMERATED { geographicNorth, magneticNorth, local },
    horizontalDistance-r15  INTEGER (0..8191),
    horizontalDistanceUnc-r15  INTEGER (0..255)           OPTIONAL,
    horizontalUncConfidence-r15  INTEGER (0..100)           OPTIONAL,
    verticalDirection-r15  ENUMERATED{upward, downward}   OPTIONAL,
    verticalDistance-r15   INTEGER(0..8191)               OPTIONAL,
    verticalDistanceUnc-r15  INTEGER (0..255)           OPTIONAL,
    verticalUncConfidence-r15  INTEGER (0..100)           OPTIONAL,
    ...
}

UTC-Time-r15 ::= SEQUENCE {
    utcTime-r15          UTCTime,
    utcTime-ms-r15      INTEGER (0..999),
    ...
}
-- ASN1STOP

```

Sensor-MotionInformation field descriptions
<p>refTime This field provides the reference time t_0 associated with the starting position of the first displacement in the displacement list.</p>
<p>displacementInfoList This field provides an ordered series of direction and distance travelled by the target device and comprises the following subfields:</p> <ul style="list-style-type: none"> - deltaTimeStamp specifies the time between t_{n-1} and t_n, where n corresponds to the order of entry in the <i>DisplacementInfoList</i> ($n=0$ corresponds to the time provided in <i>refTime</i>). - displacement provides the direction and distance travelled between time t_{n-1} and t_n.
<p>utcTime This field provides the time stamp of the <i>refTime</i> in UTC time and comprises the following subfields:</p> <ul style="list-style-type: none"> - <i>utcTime</i> in the form of YYMMDDhhmmssZ. - <i>utcTime-ms</i> specifies the fractional part of the UTC time in ms resolution.
<p>gnssTime This field provides the time stamp of the <i>refTime</i> in GNSS time.</p>
<p>systemFrameNumber This field provides the time stamp of the <i>refTime</i> in serving cell SFN time.</p>
<p>measurementSFN This field provides the time stamp of the <i>refTime</i> in form of the measurement SFN as defined in <i>deltaSFN</i> in IE <i>OTDOA-SignalMeasurementInformation</i>. This field may be included when OTDOA measurements are included.</p>
<p>deltaTimeSec This field provides the time between t_{n-1} and t_n in units of milliseconds.</p>
<p>deltaTimeSFN This field provides the time between t_{n-1} and t_n in units of system frame numbers.</p>
<p>bearing This field specifies the direction (heading) of the horizontal displacement measured clockwise from <i>bearingRef</i>. Scale factor 0.1 degree.</p>
<p>bearingRef This field specifies the reference direction for the <i>bearing</i>. Enumerated value 'geographicNorth' indicates that the <i>bearing</i> is measured clockwise from the Geographic North; 'magneticNorth' indicates that the <i>bearing</i> is measured clockwise from the Magnetic North; 'local' indicates that the <i>bearing</i> is measured clockwise from an arbitrary (undefined) reference direction.</p>
<p>horizontalDistance This field specifies the horizontal distance travelled between time t_{n-1} and t_n. Scale factor 1 cm.</p>
<p>horizontalDistanceUnc, horizontalUncConfidence This field specifies the horizontal uncertainty of the displacement (corresponding to t_n). <i>horizontalDistanceUnc</i> corresponds to the encoded high accuracy uncertainty as defined in TS 23.032 [15]. <i>horizontalUncConfidence</i> corresponds to confidence as defined in TS 23.032 [15].</p>
<p>verticalDistance This field specifies the vertical distance travelled between time t_{n-1} and t_n. Scale factor 1 cm.</p>
<p>verticalDistanceUnc, verticalUncConfidence This field specifies the vertical uncertainty of the displacement (corresponding to t_n). <i>verticalDistanceUnc</i> corresponds to the encoded high accuracy uncertainty as defined in TS 23.032 [15]. <i>verticalUncConfidence</i> corresponds to confidence as defined in TS 23.032 [15].</p>

6.5.5.3 Sensor Location Information Request

– *Sensor-RequestLocationInformation*

The IE *Sensor-RequestLocationInformation* is used by the location server to request location information for sensor-based methods from a target device.

```
-- ASN1START
Sensor-RequestLocationInformation-r13 ::= SEQUENCE {
    uncompensatedBarometricPressureReq-r13    BOOLEAN,
    . . . ,
    [[ assistanceAvailability-r14                BOOLEAN    OPTIONAL    -- Need ON
    ]],
    [[ sensor-MotionInformationReq-r15          BOOLEAN    OPTIONAL    -- Need ON
    ]],
    [[ adjustmentReq-r16                       BOOLEAN    OPTIONAL    -- Need ON
    ]],
}
```

```
-- ASN1STOP
```

Sensor-RequestLocationInformation field descriptions
<p>uncompensatedBarometricPressureReq This field indicates whether the target device is requested to report Barometric pressure measurements in <i>Sensor-MeasurementInformation</i> IE or not. TRUE means requested.</p>
<p>assistanceAvailability This field indicates whether the target device may request additional Sensor assistance data from the server. TRUE means allowed and FALSE means not allowed.</p>
<p>sensor-MotionInformationReq This field indicates whether the target device is requested to report movement information in IE <i>Sensor-MotionInformation</i> or not. TRUE means requested.</p>
<p>adjustmentReq This field indicates whether the target device is requested to report <i>adjustment</i> in IE <i>Sensor-MeasurementInformation</i> or not. TRUE means requested.</p>

6.5.5.4 Sensor Capability Information

– *Sensor-ProvideCapabilities*

The IE *Sensor-ProvideCapabilities* is used by the target device to provide capabilities for sensor-based methods from to the location server.

```
-- ASN1START
Sensor-ProvideCapabilities-r13 ::= SEQUENCE {
    sensor-Modes-r13          BIT STRING {      standalone (0),
                                                ue-assisted (1),
                                                ue-based   (2)} (SIZE (1..8)),
    . . . ,
    [[ sensor-AssistanceDataSupportList-r14  Sensor-AssistanceDataSupportList-r14  OPTIONAL,
       periodicalReportingSupported-r14     PositioningModes                    OPTIONAL,
       idleStateForMeasurements-r14        ENUMERATED { required }             OPTIONAL
    ]],
    [[ sensor-MotionInformationSup-r15       ENUMERATED { true }                 OPTIONAL
    ]],
    [[ adjustmentSupported-r16              ENUMERATED { true }                 OPTIONAL
    ]]
}

Sensor-AssistanceDataSupportList-r14 ::= SEQUENCE {
    . . . ,
    [[ validityPeriodSupported-v1520        ENUMERATED { true }                 OPTIONAL,
       validityAreaSupported-v1520         ENUMERATED { true }                 OPTIONAL
    ]]
}
-- ASN1STOP
```

Sensor-ProvideCapabilities field descriptions
<p>sensor-Modes This field specifies the sensor mode(s) supported by the target device. This is represented by a bit string, with a one-value at the bit position means the particular sensor mode is supported; a zero-value means not supported.</p>
<p>sensor-AssistanceDataSupportList This field specifies a list of sensor assistance data supported by the target device. This field shall be present if the target device supports assistance data for Barometric pressure sensor.</p>
<p>validityPeriodSupported This field, if present, indicates that the target device supports <i>period</i> i.e. pressure validity period and pressure rate as part of the <i>Sensor-AssistanceDataList</i>.</p>
<p>validityAreaSupported This field, if present, indicates that the target device supports <i>area</i> i.e. pressure validity area and North/East pressure gradient as part of the <i>Sensor-AssistanceDataList</i>.</p>
<p>periodicalReportingSupported This field, if present, specifies the positioning modes for which the target device supports <i>periodicalReporting</i>. This is represented by a bit string, with a one-value at the bit position means <i>periodicalReporting</i> for the positioning mode is supported; a zero-value means not supported. If this field is absent, the location server may assume that the target device does not support <i>periodicalReporting</i> in <i>CommonEsRequestLocationInformation</i>.</p>

<i>Sensor-ProvideCapabilities</i> field descriptions
<i>idleStateForMeasurements</i> This field, if present, indicates that the target device requires idle state to perform sensor measurements.
<i>sensor-MotionInformationSup</i> This field, if present, indicates that the target device supports displacement reporting in IE <i>Sensor-MotionInformation</i> .
<i>adjustmentSupported</i> This field, if present, indicates that the target device supports the <i>adjustment</i> IE in <i>Sensor-MeasurementInformation</i> .

6.5.5.5 Sensor Capability Information Request

– *Sensor-RequestCapabilities*

The IE *Sensor-RequestCapabilities* is used by the location server to request capabilities for sensor-based methods from the target device.

```
-- ASN1START
Sensor-RequestCapabilities-r13 ::= SEQUENCE {
    ...
}
-- ASN1STOP
```

6.5.5.6 Sensor Error Elements

– *Sensor-Error*

The IE *Sensor-Error* is used by the location server or target device to provide Sensor Error Reasons to the target device or location server, respectively.

```
-- ASN1START
Sensor-Error-r13 ::= CHOICE {
    locationServerErrorCauses-r13      Sensor-LocationServerErrorCauses-r13,
    targetDeviceErrorCauses-r13       Sensor-TargetDeviceErrorCauses-r13,
    ...
}
-- ASN1STOP
```

– *Sensor-LocationServerErrorCauses*

The IE *Sensor-LocationServerErrorCauses* is used by the location server to provide error reasons for Sensor positioning to the target device.

```
-- ASN1START
Sensor-LocationServerErrorCauses-r13 ::= SEQUENCE {
    cause-r13      ENUMERATED { undefined,
    ...,
    assistanceDataNotSupportedByServer-v1420,
    assistanceDataSupportedButCurrentlyNotAvailableByServer-v1420
    },
    ...
}
-- ASN1STOP
```

– *Sensor-TargetDeviceErrorCauses*

The IE *Sensor-TargetDeviceErrorCauses* is used by the target device to provide error reasons for Sensor positioning to the location server.

```

-- ASN1START
Sensor-TargetDeviceErrorCauses-r13 ::= SEQUENCE {
  cause-r13          ENUMERATED { undefined,
    ...,
    assistanceDataMissing-v1420
  },
  ...
}
-- ASN1STOP

```

6.5.5.7 Sensor Assistance Data

– *Sensor-ProvideAssistanceData*

The IE *Sensor-ProvideAssistanceData* is used by the location server to provide assistance data to assist in altitude computation at the UE (e.g. for UE-based mode). It may also be used to provide Sensor positioning specific error reasons.

```

-- ASN1START
Sensor-ProvideAssistanceData-r14 ::= SEQUENCE {
  sensor-AssistanceDataList-r14  Sensor-AssistanceDataList-r14  OPTIONAL,  -- Need ON
  sensor-Error-r14                Sensor-Error-r13                OPTIONAL,  -- Need ON
  ...
}
-- ASN1STOP

```

6.5.5.8 Sensor Assistance Data Elements

– *Sensor-AssistanceDataList*

The IE *Sensor-AssistanceDataList* is used by the location server to provide the Sensor specific assistance data to the UE.

```

-- ASN1START
Sensor-AssistanceDataList-r14 ::= SEQUENCE {
  refPressure-r14      INTEGER (-20000..10000),
  refPosition-r14     EllipsoidPointWithAltitudeAndUncertaintyEllipsoid  OPTIONAL,  -- Need ON
  refTemperature-r14  INTEGER (-64..63)  OPTIONAL,  -- Need ON
  ...,
  [[
  period-v1520        SEQUENCE {
    pressureValidityPeriod-v1520  PressureValidityPeriod-v1520,
    referencePressureRate-v1520   INTEGER (-128..127)  OPTIONAL,  -- Need ON
    ...
  }  OPTIONAL,  -- Need ON
  area-v1520          SEQUENCE {
    pressureValidityArea-v1520    PressureValidityArea-v1520,
    gN-pressure-v1520            INTEGER (-1024..1023)  OPTIONAL,  -- Need ON
    gE-pressure-v1520            INTEGER (-1024..1023)  OPTIONAL,  -- Need ON
    ...
  }  OPTIONAL,  -- Need ON
  ]]
}

PressureValidityArea-v1520 ::= SEQUENCE {
  centerPoint-v1520      Ellipsoid-Point,
  validityAreaWidth-v1520  INTEGER (1..128),
  validityAreaHeight-v1520  INTEGER (1..128),
  ...
}

PressureValidityPeriod-v1520 ::= SEQUENCE {
  beginTime-v1520        GNSS-SystemTime,
  beginTimeAlt-v1520     INTEGER (0..2881)  OPTIONAL,  -- Need ON
  duration-v1520         INTEGER (1..2881),

```

```

}
...
-- ASN1STOP

```

Sensor-AssistanceDataList field descriptions
<p>refPressure This field specifies the atmospheric pressure (Pa) nominal at sea level, EGM96 [29] to the target. The scale factor is 1 Pa. The value is added to the nominal pressure of 101325 Pa.</p>
<p>refPosition This field specifies the reference position at which the pressure measurement is made, as an ellipsoid point with altitude and uncertainty ellipsoid.</p>
<p>refTemperature Local temperature measurement at the reference where the pressure measurement is made. The scale factor 1K. The value is added to 273K.</p>
<p>period This field specifies the pressure validity period and reference pressure rate.</p>
<p>pressureValidityPeriod</p> <ul style="list-style-type: none"> - beginTime: this field specifies the start time of the pressure validity period in <i>GNSS System Time</i>. - beginTimeAlt: this field specifies an alternative start time. It may be used by the target device if <i>GNSS-System Time</i> is not available. The alternative start time is relative to the time the message was received. The scale factor is 15 min. The range is from 0 minutes to 43215 minutes = 30 days. - duration: this field specifies the duration of the validity period after the begin time. The scale factor is 15 minutes. The range is from 15 minutes to 43215 minutes = 30 days.
<p>referencePressureRate This field specifies the rate of change of pressure. When this field is included, the reference pressure applies only at the start of the pressure validity period. The scale factor is 10Pa/hour.</p>
<p>area This field specifies the area within which the provided atmospheric reference pressure is valid and any spatial drift.</p>
<p>pressureValidityArea</p> <ul style="list-style-type: none"> - centerPoint: this field specifies the coordinates of the centre of the rectangular validity area. - validityAreaWidth: this field specifies the width of the rectangular validity area. Width is measured from the centre along the latitude and is measured as the total width of the rectangle. The scale factor is 1km. The range is from 1km to 128km. - validityAreaHeight: this fields specifies the height of the rectangular validity area. Height is measured from the centre along the longitude and is measured as the total height of the rectangle. The scale factor is 1km. The range is from 1km to 128km. <p>If this field is present, <i>refPosition</i> should not be provided by the location server and if provided, shall be ignored by the target device.</p>
<p>gN-pressure This field specifies the northward gradient of the reference pressure calculated from the centre of the <i>pressureValidityArea</i>. The scale factor is 1 Pa/km. If this field is not provided, the gradient is assumed to be zero.</p>
<p>gE-pressure This field specifies the eastward gradient of the reference pressure calculated from the centre of the <i>pressureValidityArea</i>. The scale factor is 1 Pa/km. If this field is not provided, the gradient is assumed to be zero.</p>

6.5.5.9 Sensor Assistance Data Request

– *Sensor-RequestAssistanceData*

The IE *Sensor-RequestAssistanceData* is used by the target device to request Sensor assistance data from a location server.

```

-- ASN1START
Sensor-RequestAssistanceData-r14 ::= SEQUENCE {
    ...
}
-- ASN1STOP

```

6.5.6 WLAN-based Positioning

This clause defines support for positioning using measurements related to WLAN access points.

6.5.6.1 WLAN Location Information

– *WLAN-ProvideLocationInformation*

The IE *WLAN-ProvideLocationInformation* is used by the target device to provide measurements for one or more WLANs to the location server. It may also be used to provide WLAN positioning specific error reason.

```
-- ASN1START
WLAN-ProvideLocationInformation-r13 ::= SEQUENCE {
    wlan-MeasurementInformation-r13    WLAN-MeasurementInformation-r13    OPTIONAL,
    wlan-Error-r13                    WLAN-Error-r13                    OPTIONAL,
    ...
}
-- ASN1STOP
```

6.5.6.2 WLAN Location Information Elements

– *WLAN-MeasurementInformation*

```
-- ASN1START
WLAN-MeasurementInformation-r13 ::= SEQUENCE {
    measurementReferenceTime-r13      UTCTime                        OPTIONAL,
    wlan-MeasurementList-r13          WLAN-MeasurementList-r13     OPTIONAL,
    ...
}
WLAN-MeasurementList-r13 ::= SEQUENCE (SIZE(1..maxWLAN-AP-r13)) OF WLAN-MeasurementElement-r13
WLAN-MeasurementElement-r13 ::= SEQUENCE {
    wlan-AP-Identifier-r13            WLAN-AP-Identifier-r13,
    rssi-r13                          INTEGER (-127..128)           OPTIONAL,
    rtt-r13                            WLAN-RTT-r13                OPTIONAL,
    apChannelFrequency-r13           INTEGER (0..256)            OPTIONAL,
    servingFlag-r13                   BOOLEAN                       OPTIONAL,
    ...
}
WLAN-AP-Identifier-r13 ::= SEQUENCE {
    bssid-r13                          OCTET STRING (SIZE (6)),
    ssid-r13                            OCTET STRING (SIZE (1..32))  OPTIONAL,
    ...
}
WLAN-RTT-r13 ::= SEQUENCE {
    rttValue-r13                       INTEGER (0..16777215),
    rttUnits-r13                       ENUMERATED {
        microseconds,
        hundredsofnanoseconds,
        tensofnanoseconds,
        nanoseconds,
        tenthssofnanoseconds,
        ... },
    rttAccuracy-r13 INTEGER (0..255)           OPTIONAL,
    ...
}
-- ASN1STOP
```

WLAN-MeasurementInformation field descriptions	
measurementReferenceTime	This field provides the UTC time when the WLAN measurements are performed and should take the form of <i>YYMMDDhhmmssZ</i> .
wlan-MeasurementList	This field provides the WLAN measurements for up to 64 WLAN APs.
wlan-AP-Identifier	This field provides the BSSID and optionally the SSID of the wireless network served by the WLAN AP [26].
rssi	This field provides the AP signal strength (RSSI) of a beacon frame, probe response frame or measurement pilot frame measured at the target in dBm as defined in Table 6-7 of [26].
rtt	This field provides the measured round trip time between the target device and WLAN AP and optionally the accuracy expressed as the standard deviation of the delay. Units for each of these are 1000ns, 100ns, 10ns, 1ns, and 0.1ns.
apChannelFrequency	This field provides the AP channel number identification of the reported WLAN AP.
servingFlag	This parameter indicates whether a set of WLAN AP measurements were obtained for a serving WLAN AP (TRUE) or a non-serving WLAN AP (FALSE). A target device with multiple radio support may indicate more than one type of serving access for the same time instant.
rttValue	This field specifies the Round Trip Time (RTT) measurement between the target device and WLAN AP in units given by the field <i>rttUnits</i> .
rttUnits	This field specifies the Units for the fields <i>rttValue</i> and <i>rttAccuracy</i> . The available Units are 1000ns, 100ns, 10ns, 1ns, and 0.1ns.
rttAccuracy	This field provides the estimated accuracy of the provided <i>rttValue</i> expressed as the standard deviation in units given by the field <i>rttUnits</i> .

6.5.6.3 WLAN Location Information Request

– *WLAN-RequestLocationInformation*

The IE *WLAN-RequestLocationInformation* is used by the location server to request WLAN measurements from a target device.

```
-- ASN1START
WLAN-RequestLocationInformation-r13 ::= SEQUENCE {
    requestedMeasurements-r13 BIT STRING {
        rssi          (0),
        rtt           (1)} (SIZE(1..8)),
    ...
    [[ assistanceAvailability-r14 BOOLEAN OPTIONAL -- Need ON
    ]]
}
-- ASN1STOP
```

WLAN-RequestLocationInformation field descriptions	
requestedMeasurements	This field specifies the WLAN measurements requested. This is represented by a bit string, with a one-value at the bit position means the particular measurement is requested; a zero-value means not requested. The following measurement requests can be included. rssi: AP signal strength at the target rtt: Round Trip Time between target and AP
assistanceAvailability	This field indicates whether the target device may request additional WLAN assistance data from the server. TRUE means allowed and FALSE means not allowed.

6.5.6.4 WLAN Capability Information

– *WLAN-ProvideCapabilities*

The IE *WLAN-ProvideCapabilities* is used by the target device to provide its capabilities for WLAN positioning to the location server.

```
-- ASN1START
WLAN-ProvideCapabilities-r13 ::= SEQUENCE {
  wlan-Modes-r13          BIT STRING {  standalone      (0),
                                         ue-assisted     (1),
                                         ue-based       (2) }      (SIZE (1..8)),
  wlan-MeasSupported-r13 BIT STRING {
    rssi-r13            (0),
    rtt-r13            (1) }      (SIZE(1..8)),
  ... ,
  [[ wlan-AP-AD-Supported-r14
     BIT STRING {  ap-identifier  (0),
                  ap-location   (1) }      (SIZE (1..8))
     OPTIONAL,
     periodicalReportingSupported-r14 PositioningModes
     idleStateForMeasurements-r14   ENUMERATED {  required   }
     OPTIONAL
  ]]
}
-- ASN1STOP
```

***WLAN-ProvideCapabilities* field descriptions**

wlan-Modes

This field specifies the WLAN mode(s) supported by the target device. This is represented by a bit string, with a one value at the bit position means the WLAN mode is supported; a zero value means not supported.

wlan-MeasSupported

This field specifies the measurements supported by the target device when accessing a WLAN. This is represented by a bit string, with a one-value at the bit position means the particular measurement is supported; a zero-value means not supported. A zero-value in all bit positions in the bit string means only the basic WLAN positioning method is supported by the target device which is reporting of the WLAN identity. The following bits are assigned for the indicated measurements.

rssi: AP signal strength at the target
rtt: Round Trip Time between target and AP

wlan-AP-AD-Supported

This field specifies the WLAN AP assistance data supported by the target device. This is represented by a bit string, with a one-value at the bit position means the particular assistance data is supported; a zero-value means not supported. A zero-value in all bit positions or absence of this field means no assistance data is supported. The following bits are assigned for the indicated assistance data.

ap-identifier: WLAN AP identity information
ap-location: WLAN AP location information

periodicalReportingSupported

This field, if present, specifies the positioning modes for which the target device supports *periodicalReporting*. This is represented by a bit string, with a one value at the bit position means *periodicalReporting* for the positioning mode is supported; a zero value means not supported. If this field is absent, the location server may assume that the target device does not support *periodicalReporting* in *CommonIEsRequestLocationInformation*.

idleStateForMeasurements

This field, if present, indicates that the target device requires idle state to perform WLAN measurements.

6.5.6.5 WLAN Capability Information Request

– *WLAN-RequestCapabilities*

The IE *WLAN-RequestCapabilities* is used by the location server to request WLAN positioning capabilities information from a target device.

```

-- ASN1START
WLAN-RequestCapabilities-r13 ::= SEQUENCE {
    ...
}
-- ASN1STOP

```

6.5.6.6 WLAN Error Elements

– *WLAN-Error*

The IE *WLAN-Error* is used by the location server or target device to provide error reasons for WLAN positioning to the target device or location server, respectively.

```

-- ASN1START
WLAN-Error-r13 ::= CHOICE {
    locationServerErrorCauses-r13          WLAN-LocationServerErrorCauses-r13,
    targetDeviceErrorCauses-r13           WLAN-TargetDeviceErrorCauses-r13,
    ...
}
-- ASN1STOP

```

– *WLAN-LocationServerErrorCauses*

The IE *WLAN-LocationServerErrorCauses* is used by the location server to provide error reasons for WLAN positioning to the target device.

```

-- ASN1START
WLAN-LocationServerErrorCauses-r13 ::= SEQUENCE {
    cause-r13                               ENUMERATED {undefined,
    ...
    requestedADNotAvailable-v1420,
    notAllrequestedADAvailable-v1420
    },
    ...
    [[ apLocationDataUnavailable-r14        NULL        OPTIONAL        -- Need ON
    ]]
}
-- ASN1STOP

```

WLAN-LocationServerErrorCauses field descriptions

cause

This field provides a WLAN AP specific error cause for the server applicable to provision of assistance data. If the cause value is '*requestedADNotAvailable*', none of the requested assistance data could be provided and no further information needs to be included. If the cause value is '*notAllRequestedADAvailable*', the server was able to provide some but not all requested WLAN AP assistance data. In this case, the server should include any of the specific error indications as applicable. Note that inclusion of these fields is applicable when some of the associated information can be provided for some WLAN APs but not for all WLAN APs.

– *WLAN-TargetDeviceErrorCauses*

The IE *WLAN-TargetDeviceErrorCauses* is used by the target device to provide error reasons for WLAN positioning to the location server.

```

-- ASN1START
WLAN-TargetDeviceErrorCauses-r13 ::= SEQUENCE {
    cause-r13                               ENUMERATED {undefined,
    requestedMeasurementsNotAvailable,
    notAllrequestedMeasurementsPossible,
    ...
}

```

```

    wlan-AP-RSSI-MeasurementNotPossible-r13      },
    wlan-AP-RTT-MeasurementNotPossible-r13      NULL      OPTIONAL,
    ...                                          NULL      OPTIONAL,
}
-- ASN1STOP

```

WLAN-TargetDeviceErrorCauses field descriptions

cause

This field provides a WLAN specific error cause. If the cause value is 'notAllRequestedMeasurementsPossible', the target device was not able to provide all requested WLAN measurements (but may be able to provide some measurements). In this case, the target device should include any of the *wlan-AP-RSSI-MeasurementNotPossible*, or *wlan-AP-RTT-MeasurementNotPossible* fields, as applicable.

6.5.6.7 WLAN Assistance Data

– WLAN-ProvideAssistanceData

The IE *WLAN-ProvideAssistanceData* is used by the location server to provide assistance data to enable UE-based and UE-assisted WLAN positioning. It may also be used to provide WLAN positioning specific error reason.

```

-- ASN1START
WLAN-ProvideAssistanceData-r14 ::= SEQUENCE {
    wlan-DataSet-r14      SEQUENCE (SIZE (1..maxWLAN-Datasets-r14)) OF WLAN-DataSet-r14      OPTIONAL,      -- Need ON
    wlan-Error-r14       WLAN-Error-r13      OPTIONAL,      -- Need ON
    ...
}
-- ASN1STOP

```

WLAN-ProvideAssistanceData field descriptions

wlan-DataSet

This field provides data for sets of WLAN APs.

wlan-Error

This field provides error information and may be included when a Provide Assistance Data is sent in response to a Request Assistance Data. It is allowed to include both a *wlan-DataSet* field and a *wlan-Error* field (e.g. when only some requested WLAN assistance data is provided).

6.5.6.8 WLAN Assistance Data Elements

– WLAN-DataSet

The IE *WLAN-DataSet* is used by the location server to provide WLAN AP information for one set of WLAN APs.

```

-- ASN1START
WLAN-DataSet-r14 ::= SEQUENCE {
    wlan-AP-List-r14      SEQUENCE (SIZE (1..maxWLAN-AP-r14)) OF WLAN-AP-Data-r14,
    supportedChannels-11a-r14      SupportedChannels-11a-r14      OPTIONAL,      -- Need ON
    supportedChannels-11bg-r14     SupportedChannels-11bg-r14     OPTIONAL,      -- Need ON
    ...
}

SupportedChannels-11a-r14 ::= SEQUENCE {
    ch34-r14      BOOLEAN,
    ch36-r14      BOOLEAN,
    ch38-r14      BOOLEAN,
    ch40-r14      BOOLEAN,
    ch42-r14      BOOLEAN,
    ch44-r14      BOOLEAN,
    ch46-r14      BOOLEAN,
    ch48-r14      BOOLEAN,
    ch52-r14      BOOLEAN,
}

```

```

    ch56-r14      BOOLEAN,
    ch60-r14      BOOLEAN,
    ch64-r14      BOOLEAN,
    ch149-r14     BOOLEAN,
    ch153-r14     BOOLEAN,
    ch157-r14     BOOLEAN,
    ch161-r14     BOOLEAN
  }

SupportedChannels-11bg-r14 ::= SEQUENCE {
  ch1-r14        BOOLEAN,
  ch2-r14        BOOLEAN,
  ch3-r14        BOOLEAN,
  ch4-r14        BOOLEAN,
  ch5-r14        BOOLEAN,
  ch6-r14        BOOLEAN,
  ch7-r14        BOOLEAN,
  ch8-r14        BOOLEAN,
  ch9-r14        BOOLEAN,
  ch10-r14       BOOLEAN,
  ch11-r14       BOOLEAN,
  ch12-r14       BOOLEAN,
  ch13-r14       BOOLEAN,
  ch14-r14       BOOLEAN
}

-- ASN1STOP

```

WLAN-DataSet field descriptions

wlan-AP-List

This field provides information for WLAN APs in the data set.

supportedChannels-11a

This field defines the superset of all channels supported by all WLAN APs in the data set of type 801.11a (5GHz band).

supportedChannels-11bg

This field defines the superset of all channels supported by all WLAN APs in the data set of type 801.11b or 802.11g (2.4 GHz band).

– WLAN-AP-Data

The IE *WLAN-AP-Data* is used by the location server to provide information for one WLAN AP as part of WLAN AP assistance data.

```

-- ASN1START

WLAN-AP-Data-r14 ::= SEQUENCE {
  wlan-AP-Identifier-r14      WLAN-AP-Identifier-r13,
  wlan-AP-Location-r14        WLAN-AP-Location-r14      OPTIONAL,  -- Need ON
  ...
}

WLAN-AP-Location-r14 ::= SEQUENCE {
  locationDataLCI-r14         LocationDataLCI-r14,
  ...
}

LocationDataLCI-r14 ::= SEQUENCE {
  latitudeUncertainty-r14     BIT STRING (SIZE (6)),
  latitude-r14                BIT STRING (SIZE (34)),
  longitudeUncertainty-r14    BIT STRING (SIZE (6)),
  longitude-r14               BIT STRING (SIZE (34)),
  altitudeUncertainty-r14     BIT STRING (SIZE (6))      OPTIONAL,  -- Need ON
  altitude-r14                BIT STRING (SIZE (30))      OPTIONAL,  -- Need ON
  datum-r14                   BIT STRING (SIZE (8)),
  ...
}

-- ASN1STOP

```

WLAN-AP-Data field descriptions

wlan-AP-Location

WLAN-AP-Data field descriptions**- locationDataLCI**

This field provides the location of the WLAN AP in the form of Location Configuration Information (LCI) defined in [27] and includes the following subfields:

- latitudeUncertainty: 6-bits quantifying the amount of uncertainty in latitude. A value of 0 is reserved to indicate that the uncertainty is unknown; values greater than 34 are reserved. Its relation with the corresponding value in degrees is expressed with the following formula:

$$\text{latitudeUncertainty} = 8 - \text{ceil}(\log_2(\text{uncertainty in degrees}))$$
- latitude: A 34-bits fixed point value consisting of 9-bits of integer and 25-bits of fraction indicating the Latitude (+/- 90 degrees) of the AP.
- longitudeUncertainty: 6-bits quantifying the amount of uncertainty in longitude. A value of 0 is reserved to indicate that the uncertainty is unknown; values greater than 34 are reserved. Its relation with the corresponding value in degrees is expressed with the following formula:

$$\text{longitudeUncertainty} = 8 - \text{ceil}(\log_2(\text{uncertainty in degrees}))$$
- longitude: A 34-bits fixed point value consisting of 9-bits of integer and 25-bits of fraction indicating the Longitude (+/- 180 degrees) of the AP.
- altitudeUncertainty: 6-bits value quantifying the amount of uncertainty in the altitude value. A value of 0 is reserved to indicate that the uncertainty is unknown; values greater than 30 are reserved. Its relation with the corresponding value in metres is expressed with the following formula:

$$\text{altitudeUncertainty} = 21 - \text{ceil}(\log_2(\text{uncertainty in metres}))$$
- altitude: A 30-bit fixed point value consisting of 22-bits of integer and 8-bits of fraction indicating the altitude of the AP in metres.
- datum: 8-bits indicating the map datum used for the coordinates. Defined codes are:
 Bit 1: World Geodetic System 1984 (WGS-84)
 Bit 2: North American Datum 1983 (NAD-83) with North American Vertical Datum 1988 (NAVD-88)
 Bit 3: North American Datum 1983 (NAD-83) with Mean Lower Low Water (MLLW) vertical datum.
 Bits 4 – 8 are reserved.

6.5.6.9 WLAN Assistance Data Request**– WLAN-RequestAssistanceData**

The IE *WLAN-RequestAssistanceData* is used by the target device to request WLAN assistance data from a location server.

```
-- ASN1START
WLAN-RequestAssistanceData-r14 ::= SEQUENCE {
  requestedAD-r14          BIT STRING { ap-identifier (0),
                                         ap-location (1)} (SIZE (1..8)),
  visibleAPs-r14          SEQUENCE (SIZE (1..maxVisibleAPs-r14)) OF WLAN-AP-Identifier-r13
  OPTIONAL,
  wlan-AP-StoredData-r14 SEQUENCE (SIZE (1..maxKnownAPs-r14)) OF WLAN-AP-Identifier-r13
  OPTIONAL,
  ...
}
-- ASN1STOP
```

WLAN-RequestAssistanceData field descriptions**requestedAD**

This field specifies the WLAN AP assistance data requested. This is represented by a bit string, with a one-value at the bit position means the particular assistance data is requested; a zero-value means not requested. The following assistance data types are included:

- ap-identifier: WLAN AP identity information
- ap-location: WLAN AP location information

WLAN-RequestAssistanceData field descriptions
<p>visibleAPs This field enables a target to indicate to a server the identities of currently visible WLAN APs. This may assist a server to provide assistance data for WLAN APs nearby to the target. A target shall provide visible APs in order of received signal strength with the AP with the highest signal strength provided first.</p>
<p>wlan-AP-StoredData This field enables a target to indicate to a server the identities of WLAN APs for which the target has stored assistance data received previously from the server. This may enable the server to avoid resending data for the same APs.</p>

6.5.7 Bluetooth-based Positioning

6.5.7.1 Bluetooth Location Information

– *BT-ProvideLocationInformation*

The IE *BT-ProvideLocationInformation* is used by the target device to provide measurements for one or more Bluetooth beacons to the location server. It may also be used to provide Bluetooth positioning specific error reason.

```
-- ASN1START
BT-ProvideLocationInformation-r13 ::= SEQUENCE {
    bt-MeasurementInformation-r13    BT-MeasurementInformation-r13    OPTIONAL,
    bt-Error-r13                    BT-Error-r13                OPTIONAL,
    ...
}
-- ASN1STOP
```

6.5.7.2 Bluetooth Location Information Elements

– *BT-MeasurementInformation*

```
-- ASN1START
BT-MeasurementInformation-r13 ::= SEQUENCE {
    measurementReferenceTime-r13    UTCTime                    OPTIONAL,
    bt-MeasurementList-r13          BT-MeasurementList-r13    OPTIONAL,
    ...
}
BT-MeasurementList-r13 ::= SEQUENCE (SIZE(1..maxBT-Beacon-r13)) OF BT-MeasurementElement-r13
BT-MeasurementElement-r13 ::= SEQUENCE {
    btAddr-r13                      BIT STRING (SIZE (48)),
    rssi-r13                         INTEGER (-128..127)        OPTIONAL,
    ...
}
-- ASN1STOP
```

BT-MeasurementInformation field descriptions
<p>measurementReferenceTime This field provides the UTC time when the Bluetooth measurements are performed and should take the form of <i>YYMMDDhhmmssZ</i>.</p>
<p>bt-MeasurementList This field provides the Bluetooth measurements for up to 32 Bluetooth beacons.</p>
<p>btAddr This field specifies the Bluetooth public address of the Bluetooth beacon [25].</p>
<p>rssi This field provides the beacon received signal strength indicator (RSSI) in dBm.</p>

6.5.7.3 Bluetooth Location Information Request

– *BT-RequestLocationInformation*

The IE *BT-RequestLocationInformation* is used by the location server to request Bluetooth measurements from a target device.

```
-- ASN1START
BT-RequestLocationInformation-r13 ::= SEQUENCE {
    requestedMeasurements-r13 BIT STRING {
        rssi (0)} (SIZE(1..8)),
    ...
}
-- ASN1STOP
```

***BT-RequestLocationInformation* field descriptions**

requestedMeasurements

This field specifies the Bluetooth measurements requested. This is represented by a bit string, with a one-value at the bit position means the particular measurement is requested; a zero-value means not requested. The following measurement requests can be included.

rssi: Bluetooth beacon signal strength at the target

6.5.7.4 Bluetooth Capability Information

– *BT-ProvideCapabilities*

The IE *BT-ProvideCapabilities* is used by the target device to provide its capabilities for Bluetooth positioning to the location server.

```
-- ASN1START
BT-ProvideCapabilities-r13 ::= SEQUENCE {
    bt-Modes-r13 BIT STRING {
        standalone (0),
        ue-assisted (1)} (SIZE (1..8)),
    bt-MeasSupported-r13 BIT STRING {
        rssi-r13 (0)} (SIZE (1..8)),
    ...,
    [[
        idleStateForMeasurements-r14
            ENUMERATED { required } OPTIONAL,
        periodicalReportingSupported-r14
            PositioningModes OPTIONAL
    ]]
}
-- ASN1STOP
```

BT-ProvideCapabilities field descriptions
<p>bt-Modes This field specifies the Bluetooth mode(s) supported by the target device. This is represented by a bit string, with a one value at the bit position means the Bluetooth mode is supported; a zero value means not supported.</p>
<p>bt-MeasSupported This field specifies the Bluetooth measurements supported by the target device. This is represented by a bit string, with a one-value at the bit position means the particular measurement is supported; a zero-value means not supported. A zero-value in all bit positions in the bit string means only the basic Bluetooth positioning method is supported by the target device which is reporting of the Bluetooth beacon identity. The following bits are assigned for the indicated measurements.</p> <p style="padding-left: 40px;">rssi: Bluetooth beacon signal strength at the target device</p>
<p>idleStateForMeasurements This field, if present, indicates that the target device requires idle state to perform BT measurements.</p>
<p>periodicalReportingSupported This field, if present, specifies the positioning modes for which the target device supports <i>periodicalReporting</i>. This is represented by a bit string, with a one value at the bit position means <i>periodicalReporting</i> for the positioning mode is supported; a zero value means not supported. If this field is absent, the location server may assume that the target device does not support <i>periodicalReporting</i> in <i>CommonIEsRequestLocationInformation</i>.</p>

6.5.7.5 Bluetooth Capability Information Request

– *BT-RequestCapabilities*

The IE *BT-RequestCapabilities* is used by the location server to request Bluetooth positioning capabilities from a target device.

```
-- ASN1START
BT-RequestCapabilities-r13 ::= SEQUENCE {
    ...
}
-- ASN1STOP
```

6.5.7.6 BT Error Elements

– *BT-Error*

The IE *BT-Error* is used by the location server or target device to provide error reasons for Bluetooth positioning to the target device or location server, respectively.

```
-- ASN1START
BT-Error-r13 ::= CHOICE {
    locationServerErrorCauses-r13      BT-LocationServerErrorCauses-r13,
    targetDeviceErrorCauses-r13       BT-TargetDeviceErrorCauses-r13,
    ...
}
-- ASN1STOP
```

– *BT-LocationServerErrorCauses*

The IE *BT-LocationServerErrorCauses* is used by the location server to provide error reasons for Bluetooth positioning to the target device.

```
-- ASN1START
BT-LocationServerErrorCauses-r13 ::= SEQUENCE {
    cause-r13          ENUMERATED {undefined, ...},
    ...
}
-- ASN1STOP
```

– *BT-TargetDeviceErrorCauses*

The IE *BT-TargetDeviceErrorCauses* is used by the target device to provide error reasons for Bluetooth positioning to the location server.

```
-- ASN1START
BT-TargetDeviceErrorCauses-r13 ::= SEQUENCE {
    cause-r13          ENUMERATED {undefined,
                                   requestedMeasurementsNotAvailable,
                                   notAllRequestedMeasurementsPossible,
                                   ...
                                   },
    bt-Beacon-rssiMeasurementNotPossible-r13  NULL        OPTIONAL,
    ...
}
-- ASN1STOP
```

***BT-TargetDeviceErrorCauses* field descriptions**

cause

This field provides a Bluetooth specific error cause. If the cause value is 'notAllRequestedMeasurementsPossible', the target device was not able to provide all requested Bluetooth measurements (but may be able to provide some measurements). In this case, the target device should include *bt-Beacon-rssiMeasurementNotPossible* field.

6.5.8 NR UL Positioning

6.5.8.1 NR UL Capability Information

– *NR-UL-ProvideCapabilities*

The IE *NR-UL-ProvideCapabilities* is used by the target device to indicate its capability to support UL-PRS and to provide its UL-PRS capabilities to the location server.

```
-- ASN1START
NR-UL-ProvideCapabilities-r16 ::= SEQUENCE {
    nr-UL-SRS-Capability-r16      NR-UL-SRS-Capability-r16,
    ...
}
-- ASN1STOP
```

6.5.8.2 NR UL Capability Information Request

– *NR-UL-RequestCapabilities*

The IE *NR-UL-RequestCapabilities* is used by the location server to request the capability of the target device to support UL-PRS and to request UL-PRS capabilities from a target device.

```
-- ASN1START
NR-UL-RequestCapabilities-r16 ::= SEQUENCE {
    ...
}
-- ASN1STOP
```

6.5.9 NR E-CID Positioning

This clause defines the information elements for NR E-CID positioning (TS 38.305 [40]).

6.5.9.1 NR E-CID Location Information

– *NR-ECID-ProvideLocationInformation*

The IE *NR-ECID-ProvideLocationInformation* is used by the target device to provide NR E-CID location measurements to the location server. It may also be used to provide NR E-CID positioning specific error reason.

```
-- ASN1START
NR-ECID-ProvideLocationInformation-r16 ::= SEQUENCE {
    nr-ECID-SignalMeasurementInformation-r16    NR-ECID-SignalMeasurementInformation-r16 OPTIONAL,
    nr-ECID-Error-r16                          NR-ECID-Error-r16                          OPTIONAL,
    ...
}
-- ASN1STOP
```

6.5.9.2 NR E-CID Location Information Elements

– *NR-ECID-SignalMeasurementInformation*

The IE *NR-ECID-SignalMeasurementInformation* is used by the target device to provide NR E-CID measurements to the location server.

```
-- ASN1START
NR-ECID-SignalMeasurementInformation-r16 ::= SEQUENCE {
    nr-PrimaryCellMeasuredResults-r16    NR-MeasuredResultsElement-r16,
    nr-MeasuredResultsList-r16          NR-MeasuredResultsList-r16          OPTIONAL,
    ...
}

NR-MeasuredResultsList-r16 ::= SEQUENCE (SIZE(1..32)) OF NR-MeasuredResultsElement-r16

NR-MeasuredResultsElement-r16 ::= SEQUENCE {
    nr-PhysCellID-r16                    NR-PhysCellID-r16,
    nr-ARFCN-r16                          CHOICE {
        ssb-ARFCN-r16                    ARFCN-ValueNR-r15,
        csi-RS-pointA-r16                 ARFCN-ValueNR-r15
    },
    nr-CellGlobalID-r16                  NCGI-r15                                OPTIONAL,
    systemFrameNumber-r16                 BIT STRING (SIZE (10))                   OPTIONAL,
    resultsSSB-Cell-r16                   MeasQuantityResults-r16                   OPTIONAL,
    resultsCSI-RS-Cell-r16                 MeasQuantityResults-r16                   OPTIONAL,
    resultsSSB-Indexes-r16                 ResultsPerSSB-IndexList-r16               OPTIONAL,
    resultsCSI-RS-Indexes-r16              ResultsPerCSI-RS-IndexList-r16            OPTIONAL,
    ...
}

MeasQuantityResults-r16 ::= SEQUENCE {
    nr-RSRP-r16                           INTEGER (0..127)                           OPTIONAL,
    nr-RSRQ-r16                           INTEGER (0..127)                           OPTIONAL
}

ResultsPerSSB-IndexList-r16 ::= SEQUENCE (SIZE (1..64)) OF ResultsPerSSB-Index-r16

ResultsPerSSB-Index-r16 ::= SEQUENCE {
    ssb-Index-r16                          INTEGER (0..63),
    ssb-Results-r16                         MeasQuantityResults-r16
}

ResultsPerCSI-RS-IndexList-r16 ::= SEQUENCE (SIZE (1..64)) OF ResultsPerCSI-RS-Index-r16

ResultsPerCSI-RS-Index-r16 ::= SEQUENCE {
    csi-RS-Index-r16                       INTEGER (0..95),
    csi-RS-Results-r16                     MeasQuantityResults-r16
}
-- ASN1STOP
```

NR-ECID-SignalMeasurementInformation field descriptions	
nr-PrimaryCellMeasuredResults	This field contains the NR E-CID measurements for the primary cell.
nr-MeasuredResultsList	This field contains the NR E-CID measurements for up to 32 neighbour cells.
nr-PhysCellID	This field specifies the NR physical cell identity of the measured cell.
nr-ARFCN	This field specifies the ARFCN of the first RE of SSB's RB#10 or the point A of CSI-RS.
nr-CellGlobalID	This field specifies the NR cell global ID of the measured cell. The target device shall provide this field if it was able to determine the NCGI of the measured cell at the time of measurement.
systemFrameNumber	This field specifies the system frame number of the measured cell during which the measurements have been performed. The target device shall include this field if it was able to determine the SFN of the cell at the time of measurement.
resultsSSB-Cell	This field specifies the SS reference signal received power (SS-RSRP) and quality (SS-RSRQ) measurement aggregated at cell level, as defined in TS 38.331 [35].
resultsCSI-RS-Cell	This field specifies the CSI-RS reference signal received power (CSI-RSRP) and quality (CSI-RSRQ) measurement aggregated at cell level, as defined in TS 38.331 [35].
resultsSSB-Indexes	This field specifies the SS reference signal received power (SS-RSRP) and quality (SS-RSRQ) measurement per SSB resource, as defined in TS 38.331 [35].
resultsCSI-RS-Indexes	This field specifies the CSI-RS reference signal received power (CSI-RSRP) and quality (CSI-RSRQ) per CSI-RS resource, as defined in TS 38.331 [35].
nr-RSRP	This field specifies the integer value for RSRP measurements according to Table 10.1.6.1-1 in TS 38.133 [46].
nr-RSRQ	This field specifies the integer value for RSRQ measurements according to Table 10.1.11.1-1 in TS 38.133 [46].

6.5.9.3 NR E-CID Location Information Request

– NR-ECID-RequestLocationInformation

The IE *NR-ECID-RequestLocationInformation* is used by the location server to request NR E-CID location measurements from a target device.

```
-- ASN1START
NR-ECID-RequestLocationInformation-r16 ::= SEQUENCE {
    requestedMeasurements-r16      BIT STRING {
        ssrsrpReq          (0),
        ssrsrqReq          (1),
        csirsrpReq         (2),
        csirsrqReq         (3)} (SIZE(1..8)),
    ...
}
-- ASN1STOP
```

NR-ECID-RequestLocationInformation field descriptions	
requestedMeasurements	This field specifies the NR E-CID measurements requested. This is represented by a bit string, with a one-value at the bit position means the particular measurement is requested; a zero-value means not requested.

6.5.9.4 NR E-CID Capability Information

– NR-ECID-ProvideCapabilities

The IE *NR-ECID-ProvideCapabilities* is used by the target device to indicate its capability to support NR E-CID and to provide its NR E-CID positioning capabilities to the location server.

```

-- ASN1START
NR-ECID-ProvideCapabilities-r16 ::= SEQUENCE {
    nr-ECID-MeasSupported-r16      BIT STRING {
        ssrsrpSup      (0),
        ssrsrqSup      (1),
        csirsrpSup      (2),
        csirsrqSup      (3)} (SIZE(1..8)),
    periodicalReporting-r16      ENUMERATED { supported } OPTIONAL,
    triggeredReporting-r16      ENUMERATED { supported } OPTIONAL,
    ...
}
-- ASN1STOP

```

NR-ECID-ProvideCapabilities field descriptions

nr-ECID-MeasSupported:

Indicates the supported NR ECID measurements:

- *ssrsrpSup* indicates the UE supports SSB based cell/beam specific RSRP measurement;
- *ssrsrqSup* indicates the UE supports SSB based cell/beam specific RSRQ measurement;
- *csirsrpSup* indicates the UE supports CSI-RS based cell/beam specific RSRP measurement;
- *csirsrqSup* indicates the UE supports CSI-RS based cell/beam specific RSRQ measurement.

6.5.9.5 NR E-CID Capability Information Request

– *NR-ECID-RequestCapabilities*

The IE *NR-ECID-RequestCapabilities* is used by the location server to request the capability of the target device to support NR E-CID and to request NR E-CID positioning capabilities from a target device.

```

-- ASN1START
NR-ECID-RequestCapabilities-r16 ::= SEQUENCE {
    ...
}
-- ASN1STOP

```

6.5.9.6 NR E-CID Error Elements

– *NR-ECID-Error*

The IE *NR-ECID-Error* is used by the location server or target device to provide NR E-CID error reasons to the target device or location server, respectively.

```

-- ASN1START
NR-ECID-Error-r16 ::= CHOICE {
    locationServerErrorCauses-r16      NR-ECID-LocationServerErrorCauses-r16,
    targetDeviceErrorCauses-r16      NR-ECID-TargetDeviceErrorCauses-r16,
    ...
}
-- ASN1STOP

```

– *NR-ECID-LocationServerErrorCauses*

The IE *NR-ECID-LocationServerErrorCauses* is used by the location server to provide NR E-CID error reasons to the target device.

```

-- ASN1START
NR-ECID-LocationServerErrorCauses-r16 ::= SEQUENCE {
    cause-r16      ENUMERATED { undefined,
    ...
    },
}

```

```

}
...
-- ASN1STOP

```

– NR-ECID-TargetDeviceErrorCauses

The IE *NR-ECID-TargetDeviceErrorCauses* is used by the target device to provide NR E-CID error reasons to the location server.

```

-- ASN1START
NR-ECID-TargetDeviceErrorCauses-r16 ::= SEQUENCE {
  cause-r16          ENUMERATED { undefined,
                                requestedMeasurementNotAvailable,
                                notAllRequestedMeasurementsPossible,
                                ...
                              },
  ss-RSRPMeasurementNotPossible-r16  NULL          OPTIONAL,
  ss-RSRQMeasurementNotPossible-r16  NULL          OPTIONAL,
  csi-RSRPMeasurementNotPossible-r16  NULL          OPTIONAL,
  csi-RSRQMeasurementNotPossible-r16  NULL          OPTIONAL,
  ...
}
-- ASN1STOP

```

NR-ECID-TargetDeviceErrorCauses field descriptions

cause

This field provides a NR E-CID specific error cause. If the cause value is 'notAllRequestedMeasurementsPossible', the target device was not able to provide all requested NR E-CID measurements (but may be able to provide some measurements). In this case, the target device should include any of the *ss-RSRPMeasurementNotPossible*, *ss-RSRQMeasurementNotPossible*, *csi-RSRPMeasurementNotPossible*, or *csi-RSRQMeasurementNotPossible* fields, as applicable.

6.5.10 NR DL-TDOA Positioning

This clause defines the information elements for NR downlink TDOA positioning (TS 38.305 [40]).

6.5.10.1 NR DL-TDOA Assistance Data

– NR-DL-TDOA-ProvideAssistanceData

The IE *NR-DL-TDOA-ProvideAssistanceData* is used by the location server to provide assistance data to enable UE-assisted and UE-based NR DL-TDOA. It may also be used to provide NR DL-TDOA positioning specific error reason.

```

-- ASN1START
NR-DL-TDOA-ProvideAssistanceData-r16 ::= SEQUENCE {
  nr-DL-PRS-AssistanceData-r16          NR-DL-PRS-AssistanceData-r16          OPTIONAL,  -- Need ON
  nr-SelectedDL-PRS-IndexList-r16       NR-SelectedDL-PRS-IndexList-r16       OPTIONAL,  -- Need ON
  nr-PositionCalculationAssistance-r16  NR-PositionCalculationAssistance-r16  OPTIONAL,  -- Cond UEB
  nr-DL-TDOA-Error-r16                  NR-DL-TDOA-Error-r16                  OPTIONAL,  -- Need ON
  ...
}
-- ASN1STOP

```

Conditional presence	Explanation
UEB	The field is optionally present, need ON, for UE based NR DL-TDOA; otherwise it is not present.

NR-DL-TDOA-ProvideAssistanceData field descriptions
<p>nr-DL-PRS-AssistanceData This field specifies the assistance data reference and neighbour TRPs and provides the DL-PRS configuration for the TRPs. Note, if this field is absent but the <i>nr-SelectedDL-PRS-IndexList</i> field is present, the <i>nr-DL-PRS-AssistanceData</i> may be provided in IE <i>NR-Multi-RTT-ProvideAssistanceData</i> or <i>NR-DL-AoD-ProvideAssistanceData</i>.</p>
<p>nr-SelectedDL-PRS-IndexList This field specifies the DL-PRS Resources which are applicable for this <i>NR-DL-TDOA-ProvideAssistanceData</i> message.</p>
<p>nr-PositionCalculationAssistance This field provides position calculation assistance data for UE-based mode.</p>
<p>nr-DL-TDOA-Error This field provides DL-TDOA error reasons.</p>

6.5.10.2 NR DL-TDOA Assistance Data Request

– *NR-DL-TDOA-RequestAssistanceData*

The IE *NR-DL-TDOA-RequestAssistanceData* is used by the target device to request assistance data from a location server.

```
-- ASN1START
NR-DL-TDOA-RequestAssistanceData-r16 ::= SEQUENCE {
    nr-PhysCellID-r16          NR-PhysCellID-r16          OPTIONAL,
    nr-AdType-r16             BIT STRING { dl-prs (0),
                                         posCalc (1) } (SIZE (1..8)),
    ...
}
-- ASN1STOP
```

NR-DL-TDOA-RequestAssistanceData field descriptions
<p>nr-PhysCellID This field specifies the NR physical cell identity of the current primary cell of the target device.</p>
<p>nr-AdType This field indicates the requested assistance data. <i>dl-prs</i> means requested assistance data is <i>nr-DL-PRS-AssistanceData</i>, <i>posCalc</i> means requested assistance data is <i>nr-PositionCalculationAssistance</i> for UE based positioning.</p>

6.5.10.3 NR DL-TDOA Location Information

– *NR-DL-TDOA-ProvideLocationInformation*

The IE *NR-DL-TDOA-ProvideLocationInformation* is used by the target device to provide NR DL-TDOA location measurements to the location server. It may also be used to provide NR DL-TDOA positioning specific error reason.

```
-- ASN1START
NR-DL-TDOA-ProvideLocationInformation-r16 ::= SEQUENCE {
    nr-DL-TDOA-SignalMeasurementInformation-r16
                                         NR-DL-TDOA-SignalMeasurementInformation-r16
                                         OPTIONAL,
    nr-dl-tdoa-LocationInformation-r16    NR-DL-TDOA-LocationInformation-r16
    nr-DL-TDOA-Error-r16                 NR-DL-TDOA-Error-r16                 OPTIONAL,
    ...
}
-- ASN1STOP
```

6.5.10.4 NR DL-TDOA Location Information Elements

– *NR-DL-TDOA-SignalMeasurementInformation*

The IE *NR-DL-TDOA-SignalMeasurementInformation* is used by the target device to provide NR DL-TDOA measurements to the location server.

NOTE 1: The *dl-PRS-ReferenceInfo* defines the "RSTD reference" TRP. The *nr-RSTD's* and *nr-RSTD-ResultDiff's* in *nr-DL-TDOA-MeasList* are provided relative to the "RSTD reference" TRP.

NOTE 2: The "RSTD reference" TRP may or may not be the same as the "assistance data reference" TRP provided by *nr-DL-PRS-ReferenceInfo* in IE *NR-DL-PRS-AssistanceData*.

NOTE 3: The target device includes a value of zero for the *nr-RSTD* and *nr-RSTD-ResultDiff* of the "RSTD reference" TRP in *nr-DL-TDOA-MeasList*.

```
-- ASN1START
NR-DL-TDOA-SignalMeasurementInformation-r16 ::= SEQUENCE {
    dl-PRS-ReferenceInfo-r16      DL-PRS-ID-Info-r16,
    nr-DL-TDOA-MeasList-r16      NR-DL-TDOA-MeasList-r16,
    ...
}

NR-DL-TDOA-MeasList-r16 ::= SEQUENCE (SIZE(1..nrMaxTRPs-r16)) OF NR-DL-TDOA-MeasElement-r16

NR-DL-TDOA-MeasElement-r16 ::= SEQUENCE {
    dl-PRS-ID-r16                INTEGER (0..255),
    nr-PhysCellID-r16            NR-PhysCellID-r16                OPTIONAL,
    nr-CellGlobalID-r16          NCGI-r15                        OPTIONAL,
    nr-ARFCN-r16                 ARFCN-ValueNR-r15              OPTIONAL,
    nr-DL-PRS-ResourceID-r16      NR-DL-PRS-ResourceID-r16    OPTIONAL,
    nr-DL-PRS-ResourceSetID-r16   NR-DL-PRS-ResourceSetID-r16  OPTIONAL,
    nr-TimeStamp-r16             NR-TimeStamp-r16,
    nr-RSTD-r16                  CHOICE {
        k0-r16                    INTEGER (0..1970049),
        k1-r16                    INTEGER (0..985025),
        k2-r16                    INTEGER (0..492513),
        k3-r16                    INTEGER (0..246257),
        k4-r16                    INTEGER (0..123129),
        k5-r16                    INTEGER (0..61565),
        ...
    },
    nr-AdditionalPathList-r16     NR-AdditionalPathList-r16    OPTIONAL,
    nr-TimingQuality-r16         NR-TimingQuality-r16,
    nr-DL-PRS-RSRP-Result-r16    INTEGER (0..126)            OPTIONAL,
    nr-DL-TDOA-AdditionalMeasurements-r16
                                NR-DL-TDOA-AdditionalMeasurements-r16  OPTIONAL,
    ...
}

NR-DL-TDOA-AdditionalMeasurements-r16 ::= SEQUENCE (SIZE (1..3)) OF
                                NR-DL-TDOA-AdditionalMeasurementElement-r16

NR-DL-TDOA-AdditionalMeasurementElement-r16 ::= SEQUENCE {
    nr-DL-PRS-ResourceID-r16      NR-DL-PRS-ResourceID-r16    OPTIONAL,
    nr-DL-PRS-ResourceSetID-r16   NR-DL-PRS-ResourceSetID-r16  OPTIONAL,
    nr-TimeStamp-r16             NR-TimeStamp-r16,
    nr-RSTD-ResultDiff-r16       CHOICE {
        k0-r16                    INTEGER (0..8191),
        k1-r16                    INTEGER (0..4095),
        k2-r16                    INTEGER (0..2047),
        k3-r16                    INTEGER (0..1023),
        k4-r16                    INTEGER (0..511),
        k5-r16                    INTEGER (0..255),
        ...
    },
    nr-TimingQuality-r16         NR-TimingQuality-r16,
    nr-DL-PRS-RSRP-ResultDiff-r16 INTEGER (0..61)            OPTIONAL,
    nr-AdditionalPathList-r16     NR-AdditionalPathList-r16    OPTIONAL,
    ...
}
-- ASN1STOP
```

NR-DL-TDOA-SignalMeasurementInformation field descriptions	
dl-PRS-ID	This field is used along with a DL-PRS Resource Set ID and a DL-PRS Resources ID to uniquely identify a DL-PRS Resource. This ID can be associated with multiple DL-PRS Resource Sets associated with a single TRP. Each TRP should only be associated with one such ID.
nr-PhysCellID	This field specifies the physical cell identity of the associated TRP, as defined in TS 38.331 [35].
nr-CellGlobalID	This field specifies the NCGI, the globally unique identity of a cell in NR, of the associated TRP, as defined in TS 38.331 [35].
nr-ARFCN	This field specifies the NR-ARFCN of the TRP's CD-SSB (as defined in TS 38.300 [47]) corresponding to <i>nr-PhysCellID</i> .
nr-TimeStamp	This field specifies the time instance at which the TOA and DL PRS-RSRP (if included) measurement is performed. The <i>nr-SFN</i> and <i>nr-Slot</i> in IE <i>NR-TimeStamp</i> correspond to the TRP provided in <i>dl-PRS-ReferenceInfo</i> as specified in TS 38.214 [45]. Note, the TOA measurement refers to the TOA of this neighbour TRP or the reference TRP, as applicable, used to determine the <i>nr-RSTD</i> or <i>nr-RSTD-ResultDiff</i> .
nr-RSTD	This field specifies the relative timing difference between this neighbour TRP and the PRS reference TRP, as defined in TS 38.215 [36]. Mapping of the measured quantity is defined as in TS 38.133 [46].
nr-AdditionalPathList	This field specifies one or more additional detected path timing values for the TRP or resource, relative to the path timing used for determining the <i>nr-RSTD</i> value. If this field was requested but is not included, it means the UE did not detect any additional path timing values.
nr-TimingQuality	This field specifies the target device's best estimate of the quality of the TOA measurement. Note, the TOA measurement refers to the TOA of this neighbour TRP or the reference TRP, as applicable, used to determine the <i>nr-RSTD</i> or <i>nr-RSTD-ResultDiff</i> .
nr-DL-PRS-RSRP-Result	This field specifies the NR DL-PRS reference signal received power (DL PRS-RSRP) measurement, as defined in TS 38.215 [36]. The mapping of the quantity is defined as in TS 38.133 [46].
nr-RSTD-ResultDiff	This field provides the additional DL RSTD measurement result relative to <i>nr-RSTD</i> . The RSTD value of this measurement is obtained by adding the value of this field to the value of the <i>nr-RSTD</i> field. The mapping of the field is defined in TS 38.133 [46].
nr-DL-PRS-RSRP-ResultDiff	This field provides the additional DL-PRS RSRP measurement result relative to <i>nr-DL-PRS-RSRP-Result</i> . The DL-PRS RSRP value of this measurement is obtained by adding the value of this field to the value of the <i>nr-DL-PRS-RSRP-Result</i> field. The mapping of the field is defined in TS 38.133 [46].

– NR-DL-TDOA-LocationInformation

The IE *NR-DL-TDOA-LocationInformation* is included by the target device when location information derived using NR DL-TDOA is provided to the location server.

```

-- ASN1START
NR-DL-TDOA-LocationInformation-r16 ::= SEQUENCE {
    measurementReferenceTime-r16 CHOICE {
        systemFrameNumber-r16 NR-TimeStamp-r16,
        utc-time-r16 UTCTime,
        ...
    } OPTIONAL,
    ...
}
-- ASN1STOP

```

NR-DL-TDOA-LocationInformation field descriptions	
measurementReferenceTime	This field specifies the time for which the location estimate is valid.

6.5.10.5 NR DL-TDOA Location Information Request

– *NR-DL-TDOA-RequestLocationInformation*

The IE *NR-DL-TDOA-RequestLocationInformation* is used by the location server to request NR DL-TDOA location measurements from a target device.

```
-- ASN1START
NR-DL-TDOA-RequestLocationInformation-r16 ::= SEQUENCE {
  nr-DL-PRS-RstdMeasurementInfoRequest-r16    ENUMERATED { true }                OPTIONAL, -- Need ON
  nr-RequestedMeasurements-r16               BIT STRING { prsrsrcReq (0) } (SIZE(1..8)),
  nr-AssistanceAvailability-r16              BOOLEAN,
  nr-DL-TDOA-ReportConfig-r16               NR-DL-TDOA-ReportConfig-r16      OPTIONAL, -- Need ON
  additionalPaths-r16                       ENUMERATED { requested }          OPTIONAL, -- Need ON
  ...
}

NR-DL-TDOA-ReportConfig-r16 ::= SEQUENCE {
  maxDL-PRS-RSTD-MeasurementsPerTRPPair-r16  INTEGER (1..4)                    OPTIONAL, -- Need ON
  timingReportingGranularityFactor-r16       INTEGER (0..5)                    OPTIONAL, -- Need ON
  ...
}
-- ASN1STOP
```

NR-DL-TDOA-RequestLocationInformation field descriptions**nr-AssistanceAvailability**

This field indicates whether the target device may request additional PRS assistance data from the server. TRUE means allowed and FALSE means not allowed.

nr-RequestedMeasurements

This field specifies the NR DL-TDOA measurements requested. This is represented by a bit string, with a one-value at the bit position means the particular measurement is requested; a zero-value means not requested.

nr-DL-PRS-RstdMeasurementInfoRequest

This field indicates whether the target device is requested to report DL-PRS Resource ID(s) or DL-PRS Resource Set ID(s) used for determining the timing of each TRP in RSTD measurements.

maxDL-PRS-RSTD-MeasurementsPerTRPPair

This field specifies the maximum number of DL-PRS RSTD measurements per pair of TRPs. The maximum number is defined across all Positioning Frequency Layers.

timingReportingGranularityFactor

This field specifies the recommended reporting granularity for the DL RSTD measurements. Value (0.5) corresponds to $(k0..k5)$ used for *nr-RSTD* and *nr-RSTD-ResultDiff* in *NR-DL-TDOA-MeasElement*. The UE may select a different granularity value for *nr-RSTD* and *nr-RSTD-ResultDiff*.

additionalPaths

This field, if present, indicates that the target device is requested to provide the *nr-AdditionalPathList* in IE *NR-DL-TDOA-SignalMeasurementInformation*.

6.5.10.6 NR DL-TDOA Capability Information

– *NR-DL-TDOA-ProvideCapabilities*

The IE *NR-DL-TDOA-ProvideCapabilities* is used by the target device to indicate its capability to support NR DL-TDOA and to provide its NR DL-TDOA positioning capabilities to the location server.

```
-- ASN1START
NR-DL-TDOA-ProvideCapabilities-r16 ::= SEQUENCE {
  nr-DL-TDOA-Mode-r16                PositioningModes,
  nr-DL-TDOA-PRS-Capability-r16      NR-DL-PRS-ResourcesCapability-r16,
  nr-DL-TDOA-MeasurementCapability-r16 NR-DL-TDOA-MeasurementCapability-r16,
  nr-DL-PRS-QCL-ProcessingCapability-r16 NR-DL-PRS-QCL-ProcessingCapability-r16,
  nr-DL-PRS-ProcessingCapability-r16 NR-DL-PRS-ProcessingCapability-r16,
  additionalPathsReport-r16          ENUMERATED { supported }          OPTIONAL,
  periodicalReporting-r16            PositioningModes                    OPTIONAL,
  ...
}
-- ASN1STOP
```

NR-DL-TDOA-ProvideCapabilities field descriptions
<p>nr-DL-TDOA-Mode This field specifies the NR DL-TDOA mode(s) supported by the target device.</p>
<p>periodicalReporting This field, if present, specifies the positioning modes for which the target device supports <i>periodicalReporting</i>. This is represented by a bit string, with a one-value at the bit position means <i>periodicalReporting</i> for the positioning mode is supported; a zero-value means not supported. If this field is absent, the target device does not support <i>periodicalReporting</i> in <i>CommonEsRequestLocationInformation</i>.</p>

– NR-DL-TDOA-MeasurementCapability

The IE *NR-DL-TDOA-MeasurementCapability* defines the DL-TDOA measurement capability. The UE can include this IE only if the UE supports *NR-DL-PRS-ResourcesCapability* for DL-TDOA. Otherwise, the UE does not include this IE;

```
-- ASN1START
NR-DL-TDOA-MeasurementCapability-r16 ::= SEQUENCE {
    dl-RSTD-MeasurementPerPairOfTRP-FR1-r16      INTEGER (1..4),
    dl-RSTD-MeasurementPerPairOfTRP-FR2-r16      INTEGER (1..4),
    supportOfDL-PRS-RSRP-MeasFR1-r16            ENUMERATED { supported} OPTIONAL,
    supportOfDL-PRS-RSRP-MeasFR2-r16            ENUMERATED { supported} OPTIONAL,
    ...
}
-- ASN1STOP
```

NR-DL-TDOA-MeasurementCapability field descriptions
<p>dl-RSTD-MeasurementPerPairOfTRP-FR1 Indicates number of DL RSTD measurements per pair of TRPs on FR1.</p>
<p>dl-RSTD-MeasurementPerPairOfTRP-FR2 Indicates number of DL RSTD measurements per pair of TRPs on FR2.</p>
<p>supportOfDL-PRS-RSRP-MeasFR1 Indicates whether the UE supports DL-PRS RSRP measurement for DL-TDOA on FR1.</p>
<p>supportOfDL-PRS-RSRP-MeasFR2 Indicates whether the UE supports DL-PRS RSRP measurement for DL-TDOA on FR2.</p>

6.5.10.7 NR DL-TDOA Capability Information Request

– NR-DL-TDOA-RequestCapabilities

The IE *NR-DL-TDOA-RequestCapabilities* is used by the location server to request the capability of the target device to support NR DL-TDOA and to request NR DL-TDOA positioning capabilities from a target device.

```
-- ASN1START
NR-DL-TDOA-RequestCapabilities-r16 ::= SEQUENCE {
    ...
}
-- ASN1STOP
```

6.5.10.8 NR DL-TDOA Error Elements

– NR-DL-TDOA-Error

The IE *NR-DL-TDOA-Error* is used by the location server or target device to provide NR DL-TDOA error reasons to the target device or location server, respectively.

```
-- ASN1START
```

```

NR-DL-TDOA-Error-r16 ::= CHOICE {
  locationServerErrorCauses-r16      NR-DL-TDOA-LocationServerErrorCauses-r16,
  targetDeviceErrorCauses-r16       NR-DL-TDOA-TargetDeviceErrorCauses-r16,
  ...
}
-- ASN1STOP

```

– *NR-DL-TDOA-LocationServerErrorCauses*

The IE *NR-DL-TDOA-LocationServerErrorCauses* is used by the location server to provide NR DL-TDOA error reasons to the target device.

```

-- ASN1START
NR-DL-TDOA-LocationServerErrorCauses-r16 ::= SEQUENCE {
  cause-r16      ENUMERATED {
    undefined,
    assistanceDataNotSupportedByServer,
    assistanceDataSupportedButCurrentlyNotAvailableByServer,
    notProvidedAssistanceDataNotSupportedByServer,
    ...
  },
  ...
}
-- ASN1STOP

```

– *NR-DL-TDOA-TargetDeviceErrorCauses*

The IE *NR-DL-TDOA-TargetDeviceErrorCauses* is used by the target device to provide NR DL-TDOA error reasons to the location server.

```

-- ASN1START
NR-DL-TDOA-TargetDeviceErrorCauses-r16 ::= SEQUENCE {
  cause-r16      ENUMERATED {
    undefined,
    assistance-data-missing,
    unableToMeasureAnyTRP,
    attemptedButUnableToMeasureSomeNeighbourTRPs,
    thereWereNotEnoughSignalsReceivedForUeBasedDL-TDOA,
    locationCalculationAssistanceDataMissing,
    ...
  },
  ...
}
-- ASN1STOP

```

6.5.11 NR DL-AoD Positioning

This clause defines the information elements for NR downlink AoD positioning (TS 38.305 [40]).

6.5.11.1 NR DL-AoD Assistance Data

– *NR-DL-AoD-ProvideAssistanceData*

The IE *NR-DL-AoD-ProvideAssistanceData* is used by the location server to provide assistance data to enable UE-assisted and UE-based NR DL-AoD. It may also be used to provide NR DL-AoD positioning specific error reason.

```

-- ASN1START
NR-DL-AoD-ProvideAssistanceData-r16 ::= SEQUENCE {
  nr-DL-PRS-AssistanceData-r16      NR-DL-PRS-AssistanceData-r16      OPTIONAL, -- Need ON
  nr-SelectedDL-PRS-IndexList-r16    NR-SelectedDL-PRS-IndexList-r16  OPTIONAL, -- Need ON
  nr-PositionCalculationAssistance-r16 NR-PositionCalculationAssistance-r16
                                     OPTIONAL, -- Cond UEB
}
-- ASN1STOP

```

```

nr-DL-AoD-Error-r16          NR-DL-AoD-Error-r16          OPTIONAL,  -- Need ON
...
}
-- ASN1STOP

```

Conditional presence	Explanation
<i>UEB</i>	The field is optionally present, need ON, for UE based NR DL-AoD; otherwise it is not present.

NR-DL-AoD-ProvideAssistanceData field descriptions

nr-DL-PRS-AssistanceData

This field specifies the assistance data reference and neighbour TRPs and provides the DL-PRS configuration for the TRPs.

Note, if this field is absent but the *nr-SelectedDL-PRS-IndexList* field is present, the *nr-DL-PRS-AssistanceData* may be provided in IE *NR-Multi-RTT-ProvideAssistanceData* or *NR-DL-TDOA-ProvideAssistanceData*.

nr-SelectedDL-PRS-IndexList

This field specifies the DL-PRS Resources which are applicable for this *NR-DL-AoD-ProvideAssistanceData* message.

nr-PositionCalculationAssistance

This field provides position calculation assistance data for UE-based mode.

nr-DL-AoD-Error

This field provides DL-AoD error reasons.

6.5.11.2 NR DL-AoD Assistance Data Request

– *NR-DL-AoD-RequestAssistanceData*

The IE *NR-DL-AoD-RequestAssistanceData* is used by the target device to request assistance data from a location server.

```

-- ASN1START
NR-DL-AoD-RequestAssistanceData-r16 ::= SEQUENCE {
  nr-PhysCellID-r16          NR-PhysCellID-r16          OPTIONAL,
  nr-AdType-r16              BIT STRING { dl-prs (0),
                                         posCalc (1) } (SIZE (1..8)),
  ...
}
-- ASN1STOP

```

NR-DL-AoD-RequestAssistanceData field descriptions

nr-PhysCellID

This field specifies the NR physical cell identity of the current primary cell of the target device.

nr-AdType

This field indicates the requested assistance data. *dl-prs* means requested assistance data is *nr-DL-PRS-AssistanceData*, *posCalc* means requested assistance data is *nr-PositionCalculationAssistance* for UE based positioning.

6.5.11.3 NR DL-AoD Location Information

– *NR-DL-AoD-ProvideLocationInformation*

The IE *NR-DL-AoD-ProvideLocationInformation* is used by the target device to provide NR DL-AoD location measurements to the location server. It may also be used to provide NR DL-AoD positioning specific error reason.

```

-- ASN1START
NR-DL-AoD-ProvideLocationInformation-r16 ::= SEQUENCE {
  nr-DL-AoD-SignalMeasurementInformation-r16
  NR-DL-AoD-SignalMeasurementInformation-r16
}
-- ASN1STOP

```

```

        nr-dl-AoD-LocationInformation-r16      NR-DL-AoD-LocationInformation-r16      OPTIONAL,
        nr-DL-AoD-Error-r16                  NR-DL-AoD-Error-r16                    OPTIONAL,
        ...
    }
-- ASN1STOP

```

6.5.11.4 NR DL-AoD Location Information Elements

– *NR-DL-AoD-SignalMeasurementInformation*

The IE *NR-DL-AoD-SignalMeasurementInformation* is used by the target device to provide NR DL-AoD measurements to the location server. The measurements are provided as a list of TRPs, where the first TRP in the list is used as reference TRP.

```

-- ASN1START
NR-DL-AoD-SignalMeasurementInformation-r16 ::= SEQUENCE {
    nr-DL-AoD-MeasList-r16      NR-DL-AoD-MeasList-r16,
    ...
}
NR-DL-AoD-MeasList-r16 ::= SEQUENCE (SIZE(1..nrMaxTRPs-r16)) OF NR-DL-AoD-MeasElement-r16
NR-DL-AoD-MeasElement-r16 ::= SEQUENCE {
    dl-PRS-ID-r16                INTEGER (0..255),
    nr-PhysCellID-r16            NR-PhysCellID-r16                OPTIONAL,
    nr-CellGlobalID-r16         NCGI-r15                    OPTIONAL,
    nr-ARFCN-r16                ARFCN-ValueNR-r15                OPTIONAL,
    nr-DL-PRS-ResourceID-r16    NR-DL-PRS-ResourceID-r16    OPTIONAL,
    nr-DL-PRS-ResourceSetID-r16 NR-DL-PRS-ResourceSetID-r16 OPTIONAL,
    nr-TimeStamp-r16            NR-TimeStamp-r16,
    nr-DL-PRS-RSRP-Result-r16   INTEGER (0..126),
    nr-DL-PRS-RxBeamIndex-r16   INTEGER (1..8)                OPTIONAL,
    nr-DL-AoD-AdditionalMeasurements-r16
                                NR-DL-AoD-AdditionalMeasurements-r16 OPTIONAL,
    ...
}
NR-DL-AoD-AdditionalMeasurements-r16 ::= SEQUENCE (SIZE (1..7)) OF
                                NR-DL-AoD-AdditionalMeasurementElement-r16
NR-DL-AoD-AdditionalMeasurementElement-r16 ::= SEQUENCE {
    nr-DL-PRS-ResourceID-r16    NR-DL-PRS-ResourceID-r16    OPTIONAL,
    nr-DL-PRS-ResourceSetID-r16 NR-DL-PRS-ResourceSetID-r16 OPTIONAL,
    nr-TimeStamp-r16            NR-TimeStamp-r16,
    nr-DL-PRS-RSRP-ResultDiff-r16 INTEGER (0..30),
    nr-DL-PRS-RxBeamIndex-r16   INTEGER (1..8)                OPTIONAL,
    ...
}
-- ASN1STOP

```

NR-DL-AoD-SignalMeasurementInformation field descriptions
<p>dl-PRS-ID This field is used along with a DL-PRS Resource Set ID and a DL-PRS Resources ID to uniquely identify a DL-PRS Resource. This ID can be associated with multiple DL-PRS Resource Sets associated with a single TRP. Each TRP should only be associated with one such ID.</p>
<p>nr-PhysCellID This field specifies the physical cell identity of the associated TRP, as defined in TS 38.331 [35].</p>
<p>nr-CellGlobalID This field specifies the NCGI, the globally unique identity of a cell in NR, of the associated TRP, as defined in TS 38.331 [35].</p>
<p>nr-ARFCN This field specifies the NR-ARFCN of the TRP's CD-SSB (as defined in TS 38.300 [47]) corresponding to <i>nr-PhysCellID</i>.</p>
<p>nr-TimeStamp This field specifies the time instance at which the measurement is performed.</p>
<p>nr-DL-PRS-RSRP-Result This field specifies the NR DL-PRS reference signal received power (DL PRS-RSRP) measurement, as defined in TS 38.215 [36]. The mapping of the measured quantity is defined as in TS 38.133 [46].</p>
<p>nr-DL-PRS-RxBeamIndex This field provides an index of the target device receive beam used for DL-PRS measurements. If the value of the receive beam index for two or more DL PRS measurements is the same, it indicates that the target device receive beam for the two or more DL PRS measurements were made with the same RX beam. The field is mandatory present if at least two DL-PRS RSRP measurements from the same DL-PRS Resource Set have been made with the same RX beam by the target device; otherwise it is not present.</p>
<p>nr-DL-PRS-RSRP-ResultDiff This field provides the additional DL-PRS RSRP measurement result relative to <i>nr-DL-PRS-RSRP-Result</i>. The DL-PRS RSRP value of this measurement is obtained by adding the value of this field to the value of the <i>nr-DL-PRS-RSRP-Result</i> field. The mapping of the field is defined in TS 38.133 [46].</p>

– NR-DL-AoD-LocationInformation

The IE *NR-DL-AoD-LocationInformation* is included by the target device when location information derived using NR DL-AoD is provided to the location server.

```
-- ASN1START
NR-DL-AoD-LocationInformation-r16 ::= SEQUENCE {
    measurementReferenceTime-r16 CHOICE {
        sfn-time-r16 NR-TimeStamp-r16,
        utc-time-r16 UTCTime,
        ...
    } OPTIONAL,
    ...
}
-- ASN1STOP
```

NR-DL-AoD-LocationInformation field descriptions
<p>measurementReferenceTime This field specifies the time for which the location estimate is valid.</p>

6.5.11.5 NR DL-AoD Location Information Request

– NR-DL-AoD-RequestLocationInformation

The IE *NR-DL-AoD-RequestLocationInformation* is used by the location server to request NR DL-AoD location measurements from a target device.

```
-- ASN1START
NR-DL-AoD-RequestLocationInformation-r16 ::= SEQUENCE {
    nr-AssistanceAvailability-r16 BOOLEAN,
    nr-DL-AoD-ReportConfig-r16 NR-DL-AoD-ReportConfig-r16,
    ...
}
-- ASN1STOP
```



```

NR-DL-AoD-ReportConfig-r16 ::= SEQUENCE {
    maxDL-PRS-RSRP-MeasurementsPerTRP-r16    INTEGER (1..8)          OPTIONAL, -- Need ON
    ...
}
-- ASN1STOP

```

NR-DL-AoD-RequestLocationInformation field descriptions

nr-AssistanceAvailability

This field indicates whether the target device may request additional PRS assistance data from the server. TRUE means allowed and FALSE means not allowed.

maxDL-PRS-RSRP-MeasurementsPerTRP

This field specifies the maximum number of DL-PRS RSRP measurements on different DL-PRS Resources from the same TRP.

6.5.11.6 NR DL-AoD Capability Information

– NR-DL-AoD-ProvideCapabilities

The IE *NR-DL-AoD-ProvideCapabilities* is used by the target device to indicate its capability to support NR DL-AoD and to provide its NR DL-AoD positioning capabilities to the location server.

```

-- ASN1START
NR-DL-AoD-ProvideCapabilities-r16 ::= SEQUENCE {
    nr-DL-AoD-Mode-r16                PositioningModes,
    nr-DL-AoD-PRS-Capability-r16      NR-DL-PRS-ResourcesCapability-r16,
    nr-DL-AoD-MeasurementCapability-r16 NR-DL-AoD-MeasurementCapability-r16,
    nr-DL-PRS-QCL-ProcessingCapability-r16 NR-DL-PRS-QCL-ProcessingCapability-r16,
    nr-DL-PRS-ProcessingCapability-r16 NR-DL-PRS-ProcessingCapability-r16,
    periodicalReporting-r16           PositioningModes          OPTIONAL,
    ...
}
-- ASN1STOP

```

NR-DL-AoD-ProvideCapabilities field descriptions

nr-DL-AoD-Mode

This field specifies the NR DL-AoD mode(s) supported by the target device.

periodicalReporting

This field, if present, specifies the positioning modes for which the target device supports *periodicalReporting*. This is represented by a bit string, with a one-value at the bit position means *periodicalReporting* for the positioning mode is supported; a zero-value means not supported. If this field is absent, the target device does not support *periodicalReporting* in *CommonEsRequestLocationInformation*.

– NR-DL-AoD-MeasurementCapability

The IE *NR-DL-AoD-MeasurementCapability* defines the DL-AoD measurement capability. The UE can include this IE only if the UE supports *NR-DL-PRS-ResourcesCapability* for DL-AoD. Otherwise, the UE does not include this IE;

```

-- ASN1START
NR-DL-AoD-MeasurementCapability-r16 ::= SEQUENCE {
    maxDL-PRS-RSRP-MeasurementFR1-r16    INTEGER (1..8),
    maxDL-PRS-RSRP-MeasurementFR2-r16    INTEGER (1..8),
    dl-AoD-MeasCapabilityBandList-r16     SEQUENCE (SIZE (1..nrMaxBands-r16)) OF
                                          DL-AoD-MeasCapabilityPerBand-r16,
    ...
}

DL-AoD-MeasCapabilityPerBand-r16 ::= SEQUENCE {
    freqBandIndicatorNR-r16              FreqBandIndicatorNR-r16,
    simul-NR-DL-AoD-DL-TDOA-r16          ENUMERATED { supported} OPTIONAL,
    simul-NR-DL-AoD-Multi-RTT-r16        ENUMERATED { supported} OPTIONAL,
    ...
}

```

```
}
-- ASN1STOP
```

<i>NR-DL-AoD-MeasurementCapability</i> field descriptions
<p><i>maxDL-PRS-RSRP-MeasurementFR1</i> Indicates the maximum number of DL-PRS RSRP measurements on different PRS resources from the same TRP supported by the UE on FR1.</p>
<p><i>maxDL-PRS-RSRP-MeasurementFR2</i> Indicates the maximum number of DL-PRS RSRP measurements on different PRS resources from the same TRP supported by the UE on FR2.</p>
<p><i>simul-NR-DL-AoD-DL-TDOA</i> Indicates whether the UE supports simultaneous processing for DL-AoD and DL-TDOA measurements. The UE can include this field only if the UE supports DL-TDOA and DL-AoD. Otherwise, the UE does not include this field;</p>
<p><i>simul-NR-DL-AoD-Multi-RTT</i> Indicates whether the UE supports simultaneous processing for DL-AoD and UE Multi-RTT measurements. The UE can include this field only if the UE supports Multi-RTT and DL-AoD. Otherwise, the UE does not include this field;</p>

6.5.11.7 NR DL-AoD Capability Information Request

– *NR-DL-AoD-RequestCapabilities*

The IE *NR-DL-AoD-RequestCapabilities* is used by the location server to request the capability of the target device to support NR DL-AoD and to request NR DL-AoD positioning capabilities from a target device.

```
-- ASN1START
NR-DL-AoD-RequestCapabilities-r16 ::= SEQUENCE {
    ...
}
-- ASN1STOP
```

6.5.11.8 NR DL-AoD Error Elements

– *NR-DL-AoD-Error*

The IE *NR-DL-AoD-Error* is used by the location server or target device to provide NR DL-AoD error reasons to the target device or location server, respectively.

```
-- ASN1START
NR-DL-AoD-Error-r16 ::= CHOICE {
    locationServerErrorCauses-r16      NR-DL-AoD-LocationServerErrorCauses-r16,
    targetDeviceErrorCauses-r16       NR-DL-AoD-TargetDeviceErrorCauses-r16,
    ...
}
-- ASN1STOP
```

– *NR-DL-AoD-LocationServerErrorCauses*

The IE *NR-DL-AoD-LocationServerErrorCauses* is used by the location server to provide NR DL-AoD error reasons to the target device.

```
-- ASN1START
NR-DL-AoD-LocationServerErrorCauses-r16 ::= SEQUENCE {
    cause-r16      ENUMERATED {
        undefined,
        assistanceDataNotSupportedByServer,
        assistanceDataSupportedButCurrentlyNotAvailableByServer,
        notProvidedAssistanceDataNotSupportedByServer,
        ...
    },
}
-- ASN1STOP
```

```

}
...
-- ASN1STOP

```

– *NR-DL-AoD-TargetDeviceErrorCauses*

The IE *NR-DL-AoD-TargetDeviceErrorCauses* is used by the target device to provide NR DL-AoD error reasons to the location server.

```

-- ASN1START
NR-DL-AoD-TargetDeviceErrorCauses-r16 ::= SEQUENCE {
  cause-r16      ENUMERATED {
    undefined,
    assistance-data-missing,
    unableToMeasureAnyTRP,
    attemptedButUnableToMeasureSomeNeighbourTRPs,
    thereWereNotEnoughSignalsReceivedForUeBasedDL-AoD,
    locationCalculationAssistanceDataMissing,
    ...
  },
  ...
}
-- ASN1STOP

```

6.5.12 NR Multi-RTT Positioning

This clause defines the information elements for NR Multi-RTT positioning (TS 38.305 [40]).

6.5.12.1 NR Multi-RTT Assistance Data

– *NR-Multi-RTT-ProvideAssistanceData*

The IE *NR-Multi-RTT-ProvideAssistanceData* is used by the location server to provide assistance data to enable UE-assisted NR Multi-RTT. It may also be used to provide NR Multi-RTT positioning specific error reason.

```

-- ASN1START
NR-Multi-RTT-ProvideAssistanceData-r16 ::= SEQUENCE {
  nr-DL-PRS-AssistanceData-r16      NR-DL-PRS-AssistanceData-r16      OPTIONAL,  -- Need ON
  nr-SelectedDL-PRS-IndexList-r16   NR-SelectedDL-PRS-IndexList-r16 OPTIONAL,  -- Need ON
  nr-Multi-RTT-Error-r16            NR-Multi-RTT-Error-r16        OPTIONAL,  -- Need ON
  ...
}
-- ASN1STOP

```

***NR-Multi-RTT-ProvideAssistanceData* field descriptions**

nr-DL-PRS-AssistanceData

This field specifies the assistance data reference and neighbour TRPs and provides the DL-PRS configuration for the TRPs.

Note, if this field is absent but the *nr-SelectedDL-PRS-IndexList* field is present, the *nr-DL-PRS-AssistanceData* may be provided in IE *NR-DL-TDOA-ProvideAssistanceData* or *NR-DL-AoD-ProvideAssistanceData*.

nr-SelectedDL-PRS-IndexList

This field specifies the DL-PRS Resources which are applicable for this *NR-Multi-RTT-ProvideAssistanceData* message.

nr-Multi-RTT-Error

This field provides Multi-RTT error reasons.

6.5.12.2 NR Multi-RTT Assistance Data Request

– *NR-Multi-RTT-RequestAssistanceData*

The IE *NR-Multi-RTT-RequestAssistanceData* is used by the target device to request assistance data from a location server.

```
-- ASN1START
NR-Multi-RTT-RequestAssistanceData-r16 ::= SEQUENCE {
  nr-PhysCellID-r16          NR-PhysCellID-r16          OPTIONAL,
  nr-AdType-r16             BIT STRING { dl-prs (0),
                                         ul-srs (1) } (SIZE (1..8)),
  ...
}
-- ASN1STOP
```

<i>NR-Multi-RTT-RequestAssistanceData</i> field descriptions
<i>nr-PhysCellID</i> This field specifies the NR physical cell identity of the current primary cell of the target device.

6.5.12.3 NR Multi-RTT Location Information

– *NR-Multi-RTT-ProvideLocationInformation*

The IE *NR-Multi-RTT-ProvideLocationInformation* is used by the target device to provide NR Multi-RTT location measurements to the location server. It may also be used to provide NR Multi-RTT positioning specific error reason.

```
-- ASN1START
NR-Multi-RTT-ProvideLocationInformation-r16 ::= SEQUENCE {
  nr-Multi-RTT-SignalMeasurementInformation-r16
                                         NR-Multi-RTT-SignalMeasurementInformation-r16
                                         OPTIONAL,
  nr-Multi-RTT-Error-r16                NR-Multi-RTT-Error-r16                OPTIONAL,
  ...
}
-- ASN1STOP
```

6.5.12.4 NR Multi-RTT Location Information Elements

– *NR-Multi-RTT-SignalMeasurementInformation*

The IE *NR-Multi-RTT-SignalMeasurementInformation* is used by the target device to provide NR Multi-RTT measurements to the location server. The measurements are provided as a list of TRPs, where the first TRP in the list is used as reference TRP.

```
-- ASN1START
NR-Multi-RTT-SignalMeasurementInformation-r16 ::= SEQUENCE {
  nr-Multi-RTT-MeasList-r16             NR-Multi-RTT-MeasList-r16,
  nr-NTA-Offset-r16                     ENUMERATED { nTA1, nTA2, nTA3, nTA4, ... } OPTIONAL,
  ...
}

NR-Multi-RTT-MeasList-r16 ::= SEQUENCE (SIZE(1..nrMaxTRPs-r16)) OF NR-Multi-RTT-MeasElement-r16

NR-Multi-RTT-MeasElement-r16 ::= SEQUENCE {
  dl-PRS-ID-r16                         INTEGER (0..255),
  nr-PhysCellID-r16                     NR-PhysCellID-r16                     OPTIONAL,
  nr-CellGlobalID-r16                   NCGI-r15                         OPTIONAL,
  nr-ARFCN-r16                           ARFCN-ValueNR-r15                   OPTIONAL,
  nr-DL-PRS-ResourceID-r16               NR-DL-PRS-ResourceID-r16           OPTIONAL,
  nr-DL-PRS-ResourceSetID-r16           NR-DL-PRS-ResourceSetID-r16       OPTIONAL,
}
```

```

nr-UE-RxTxTimeDiff-r16          CHOICE {
    k0-r16                       INTEGER (0..1970049),
    k1-r16                       INTEGER (0..985025),
    k2-r16                       INTEGER (0..492513),
    k3-r16                       INTEGER (0..246257),
    k4-r16                       INTEGER (0..123129),
    k5-r16                       INTEGER (0..61565),
    ...
},
nr-AdditionalPathList-r16       NR-AdditionalPathList-r16          OPTIONAL,
nr-TimeStamp-r16              NR-TimeStamp-r16,
nr-TimingQuality-r16          NR-TimingQuality-r16,
nr-DL-PRS-RSRP-Result-r16     INTEGER (0..126)                   OPTIONAL,
nr-Multi-RTT-AdditionalMeasurements-r16
                                NR-Multi-RTT-AdditionalMeasurements-r16
                                OPTIONAL,
...
}

NR-Multi-RTT-AdditionalMeasurements-r16 ::= SEQUENCE (SIZE (1..3)) OF
    NR-Multi-RTT-AdditionalMeasurementElement-r16

NR-Multi-RTT-AdditionalMeasurementElement-r16 ::= SEQUENCE {
    nr-DL-PRS-ResourceID-r16     NR-DL-PRS-ResourceID-r16          OPTIONAL,
    nr-DL-PRS-ResourceSetID-r16  NR-DL-PRS-ResourceSetID-r16       OPTIONAL,
    nr-DL-PRS-RSRP-ResultDiff-r16 INTEGER (0..61)                   OPTIONAL,
    nr-UE-RxTxTimeDiffAdditional-r16
                                CHOICE {
                                    k0-r16                       INTEGER (0..8191),
                                    k1-r16                       INTEGER (0..4095),
                                    k2-r16                       INTEGER (0..2047),
                                    k3-r16                       INTEGER (0..1023),
                                    k4-r16                       INTEGER (0..511),
                                    k5-r16                       INTEGER (0..255),
                                    ...
                                },
    nr-TimingQuality-r16          NR-TimingQuality-r16,
    nr-AdditionalPathList-r16     NR-AdditionalPathList-r16       OPTIONAL,
    nr-TimeStamp-r16              NR-TimeStamp-r16,
    ...
}
-- ASN1STOP

```

NR-Multi-RTT-SignalMeasurementInformation field descriptions

nr-NTA-Offset

This field provides the $N_{TAOffset}$ used by the target device as specified in TS 38.133 [46], Table 7.1.2-2. Enumerated values nTA1, nTA2, nTA3, and nTA4 correspond to $N_{TAOffset}$ of 25600 Tc, 0 Tc, 39936 Tc, and 13792 Tc, respectively.

dl-PRS-ID

This field is used along with a DL-PRS Resource Set ID and a DL-PRS Resources ID to uniquely identify a DL-PRS Resource. This ID can be associated with multiple DL-PRS Resource Sets associated with a single TRP. Each TRP should only be associated with one such ID.

nr-PhysCellID

This field specifies the physical cell identity of the associated TRP, as defined in TS 38.331 [35].

nr-CellGlobalID

This field specifies the NCGI, the globally unique identity of a cell in NR, of the associated TRP, as defined in TS 38.331 [35].

nr-ARFCN

This field specifies the NR-ARFCN of the TRP's CD-SSB (as defined in TS 38.300 [47]) corresponding to *nr-PhysCellID*.

nr-UE-RxTxTimeDiff

This field specifies the UE Rx-Tx time difference measurement, as defined in TS 38.215 [36].

nr-AdditionalPathList

This field specifies one or more additional detected path timing values for the TRP or resource, relative to the path timing used for determining the *nr-UE-RxTxTimeDiff* value. If this field was requested but is not included, it means the UE did not detect any additional path timing values.

nr-TimeStamp

This field specifies the time instance for which the measurement is performed.

nr-TimingQuality

This field specifies the target device's best estimate of the quality of the measurement.

nr-DL-PRS-RSRP-Result

This field specifies the NR DL-PRS reference signal received power (DL PRS-RSRP) measurement, as defined in TS 38.215 [36]. The mapping of the quantity is defined as in TS 38.133 [46].

NR-Multi-RTT-SignalMeasurementInformation field descriptions
<p>nr-NTA-Offset This field provides the $N_{TAoffset}$ used by the target device as specified in TS 38.133 [46], Table 7.1.2-2. Enumerated values nTA1, nTA2, nTA3, and nTA4 correspond to $N_{TAoffset}$ of 25600 Tc, 0 Tc, 39936 Tc, and 13792 Tc, respectively.</p>
<p>dl-PRS-ID This field is used along with a DL-PRS Resource Set ID and a DL-PRS Resources ID to uniquely identify a DL-PRS Resource. This ID can be associated with multiple DL-PRS Resource Sets associated with a single TRP. Each TRP should only be associated with one such ID.</p>
<p>nr-PhysCellID This field specifies the physical cell identity of the associated TRP, as defined in TS 38.331 [35].</p>
<p>nr-CellGlobalID This field specifies the NCGI, the globally unique identity of a cell in NR, of the associated TRP, as defined in TS 38.331 [35].</p>
<p>nr-ARFCN This field specifies the NR-ARFCN of the TRP's CD-SSB (as defined in TS 38.300 [47]) corresponding to <i>nr-PhysCellID</i>.</p>
<p>nr-DL-PRS-RSRP-ResultDiff This field provides the additional DL-PRS RSRP measurement result relative to <i>nr-DL-PRS-RSRP-Result</i>. The DL-PRS RSRP value of this measurement is obtained by adding the value of this field to the value of the <i>nr-DL-PRS-RSRP-Result</i>. The mapping of this field is defined as in TS 38.133 [46].</p>
<p>nr-UE-RxTxTimeDiffAdditional This field provides the additional UE Rx-Tx Difference measurement result relative to <i>nr-UE-RxTxTimeDiff</i>. The UE Rx-Tx Difference value of this measurement is obtained by adding the value of this field to the value of the <i>nr-UE-RxTxTimeDiff</i> field. The mapping of the field is defined in TS 38.133 [46].</p>

6.5.12.5 NR Multi-RTT Location Information Request

– NR-Multi-RTT-RequestLocationInformation

The IE *NR-Multi-RTT-RequestLocationInformation* is used by the location server to request NR Multi-RTT location measurements from a target device.

```

-- ASN1START
NR-Multi-RTT-RequestLocationInformation-r16 ::= SEQUENCE {
    nr-UE-RxTxTimeDiffMeasurementInfoRequest-r16
        ENUMERATED { true }                                OPTIONAL, -- Need ON
    nr-RequestedMeasurements-r16
        BIT STRING { prsrspReq(0) } (SIZE(1..8)),
    nr-AssistanceAvailability-r16
        BOOLEAN,
    nr-Multi-RTT-ReportConfig-r16
        NR-Multi-RTT-ReportConfig-r16,
    additionalPaths-r16
        ENUMERATED { requested }                            OPTIONAL, -- Need ON
    ...
}

NR-Multi-RTT-ReportConfig-r16 ::= SEQUENCE {
    maxDL-PRS-RxTxTimeDiffMeasPerTRP-r16
        INTEGER (1..4)                                     OPTIONAL, -- Need ON
    timingReportingGranularityFactor-r16
        INTEGER (0..5)                                     OPTIONAL, -- Need ON
}
-- ASN1STOP

```

NR-Multi-RTT-RequestLocationInformation field descriptions
<p>nr-UE-RxTxTimeDiffMeasurementInfoRequest This field, if present, indicates that the target device is requested to report the DL-PRS Resource ID(s) or DL-PRS Resource Set ID(s) associated with the DL-PRS Resources(s) or the DL-PRS Resource Set(s) which are used in determining the UE Rx-Tx time difference measurements.</p>
<p>nr-AssistanceAvailability This field indicates whether the target device may request additional PRS assistance data from the server. TRUE means allowed and FALSE means not allowed.</p>
<p>maxDL-PRS-RxTxTimeDiffMeasPerTRP This field specifies the maximum number of UE-Rx-Tx time difference measurements for different DL-PRS Resources or DL-PRS Resource Sets per TRP.</p>

NR-Multi-RTT-RequestLocationInformation field descriptions
<p>nr-UE-RxTxTimeDiffMeasurementInfoRequest This field, if present, indicates that the target device is requested to report the DL-PRS Resource ID(s) or DL-PRS Resource Set ID(s) associated with the DL-PRS Resources(s) or the DL-PRS Resource Set(s) which are used in determining the UE Rx-Tx time difference measurements.</p>
<p>timingReportingGranularityFactor This field specifies the recommended reporting granularity for the UE Rx-Tx time difference measurements. Value (0.5) corresponds to (k0..k5) used for <i>nr-UE-RxTxTimeDiff</i> and <i>nr-UE-RxTxTimeDiffAdditional</i> in <i>NR-Multi-RTT-MeasElement</i>. The UE may select a different granularity value for <i>nr-UE-RxTxTimeDiff</i> and <i>nr-UE-RxTxTimeDiffAdditional</i>.</p>
<p>additionalPaths This field, if present, indicates that the target device is requested to provide the <i>nr-AdditionalPathList</i> in IE <i>NR-Multi-RTT-SignalMeasurementInformation</i>.</p>

6.5.12.6 NR Multi-RTT Capability Information

– *NR-Multi-RTT-ProvideCapabilities*

The IE *NR-Multi-RTT-ProvideCapabilities* is used by the target device to indicate its capability to support NR Multi-RTT and to provide its NR Multi-RTT positioning capabilities to the location server.

```
-- ASN1START
NR-Multi-RTT-ProvideCapabilities-r16 ::= SEQUENCE {
    nr-Multi-RTT-PRS-Capability-r16          NR-DL-PRS-ResourcesCapability-r16,
    nr-Multi-RTT-MeasurementCapability-r16  NR-Multi-RTT-MeasurementCapability-r16,
    nr-DL-PRS-QCL-ProcessingCapability-r16  NR-DL-PRS-QCL-ProcessingCapability-r16,
    nr-DL-PRS-ProcessingCapability-r16      NR-DL-PRS-ProcessingCapability-r16,
    nr-UL-SRS-Capability-r16                NR-UL-SRS-Capability-r16,
    additionalPathsReport-r16                ENUMERATED { supported }           OPTIONAL,
    periodicalReporting-r16                  ENUMERATED { supported }           OPTIONAL,
    ...
}
-- ASN1STOP
```

– *NR-Multi-RTT-MeasurementCapability*

The IE *NR-Multi-RTT-MeasurementCapability* defines the Multi-RTT measurement capability. The UE can include this IE only if the UE supports *NR-DL-PRS-ResourcesCapability* for Multi-RTT. Otherwise, the UE does not include this IE;

```
-- ASN1START
NR-Multi-RTT-MeasurementCapability-r16 ::= SEQUENCE {
    maxNrOfRx-TX-MeasFR1-r16                INTEGER (1..4) OPTIONAL,
    maxNrOfRx-TX-MeasFR2-r16                INTEGER (1..4) OPTIONAL,
    supportOfRSRP-MeasFR1-r16               ENUMERATED { supported } OPTIONAL,
    supportOfRSRP-MeasFR2-r16               ENUMERATED { supported } OPTIONAL,
    srs-AssocPRS-MultiLayersFR1-r16         ENUMERATED { supported } OPTIONAL,
    srs-AssocPRS-MultiLayersFR2-r16         ENUMERATED { supported } OPTIONAL,
    ...
}
-- ASN1STOP
```

NR-Multi-RTT-MeasurementCapability field descriptions
<p>maxNrOfRx-TX-MeasFR1 Indicates the maximum number of UE Rx-Tx time difference measurements corresponding to a single SRS resource/resource set for positioning with each measurement corresponding to a single DL-PRS resource/resource set on FR1.</p>
<p>maxNrOfRx-TX-MeasFR2 Indicates the maximum number of UE Rx-Tx time difference measurements corresponding to a single SRS resource/resource set for positioning with each measurement corresponding to a single DL-PRS resource/resource set on FR2.</p>

<i>NR-Multi-RTT-MeasurementCapability</i> field descriptions
<p><i>srs-AssocPRS-MultiLayersFR1</i> Indicates whether the UE supports measurements derived on one or more DL-PRS resource/resource sets which may be in different positioning frequency layers for SRS transmitted in a single CC. PRS and SRS may be on different bands. This is for FR1 only.</p>
<p><i>srs-AssocPRS-MultiLayersFR2</i> Indicates whether the UE supports measurements derived on one or more DL-PRS resource/resource sets which may be in different positioning frequency layers for SRS transmitted in a single CC. PRS and SRS may be on different bands. This is for FR2 only.</p>
<p><i>supportOfRSRP-MeasFR1</i> Indicates whether the UE supports RSRP measurement for Multi-RTT on FR1.</p>
<p><i>supportOfRSRP-MeasFR2</i> Indicates whether the UE supports RSRP measurement for Multi-RTT on FR2.</p>

6.5.12.7 NR Multi-RTT Capability Information Request

– *NR-Multi-RTT-RequestCapabilities*

The IE *NR-Multi-RTT-RequestCapabilities* is used by the location server to request the capability of the target device to support NR Multi-RTT and to request NR Multi-RTT positioning capabilities from a target device.

```
-- ASN1START
NR-Multi-RTT-RequestCapabilities-r16 ::= SEQUENCE {
    ...
}
-- ASN1STOP
```

6.5.12.8 NR Multi-RTT Error Elements

– *NR-Multi-RTT-Error*

The IE *NR-Multi-RTT-Error* is used by the location server or target device to provide NR Multi-RTT error reasons to the target device or location server, respectively.

```
-- ASN1START
NR-Multi-RTT-Error-r16 ::= CHOICE {
    locationServerErrorCauses-r16      NR-Multi-RTT-LocationServerErrorCauses-r16,
    targetDeviceErrorCauses-r16       NR-Multi-RTT-TargetDeviceErrorCauses-r16,
    ...
}
-- ASN1STOP
```

– *NR-Multi-RTT-LocationServerErrorCauses*

The IE *NR-Multi-RTT-LocationServerErrorCauses* is used by the location server to provide NR Multi-RTT error reasons to the target device.

```
-- ASN1START
NR-Multi-RTT-LocationServerErrorCauses-r16 ::= SEQUENCE {
    cause-r16      ENUMERATED { undefined,
                                assistanceDataNotSupportedByServer,
                                assistanceDataSupportedButCurrentlyNotAvailableByServer,
                                ...
                              },
    ...
}
-- ASN1STOP
```

– *NR-Multi-RTT-TargetDeviceErrorCauses*

The IE *NR-Multi-RTT-TargetDeviceErrorCauses* is used by the target device to provide NR Multi-RTT error reasons to the location server.

```
-- ASN1START
NR-Multi-RTT-TargetDeviceErrorCauses-r16 ::= SEQUENCE {
  cause-r16      ENUMERATED {
    undefined,
    dl-assistance-data-missing,
    unableToMeasureAnyTRP,
    attemptedButUnableToMeasureSomeNeighbourTRPs,
    ul-srs-configuration-missing,
    unableToTransmit-ul-srs,
    ...
  },
  ...
}
-- ASN1STOP
```

6.6 Multiplicity and type constraint values

– *Multiplicity and type constraint definitions*

```
-- ASN1START
maxEARFCN                INTEGER ::= 65535  -- Maximum value of EUTRA carrier frequency
maxEARFCN-Plus1          INTEGER ::= 65536  -- Lowest value extended EARFCN range
maxEARFCN2                INTEGER ::= 262143 -- Highest value extended EARFCN range

maxMBS-r14                INTEGER ::= 64
maxWLAN-AP-r13            INTEGER ::= 64
maxKnownAPs-r14          INTEGER ::= 2048
maxVisibleAPs-r14        INTEGER ::= 32
maxWLAN-AP-r14            INTEGER ::= 128
maxWLAN-DataSets-r14     INTEGER ::= 8

maxBT-Beacon-r13         INTEGER ::= 32

nrMaxBands-r16            INTEGER ::= 1024  -- Maximum number of supported bands in
                                           -- UE capability.
nrMaxFreqLayers-r16      INTEGER ::= 4      -- Max freq layers
nrMaxFreqLayers-1-r16    INTEGER ::= 3
nrMaxNumDL-PRS-ResourcesPerSet-1-r16  INTEGER ::= 63
nrMaxNumDL-PRS-ResourceSetsPerTRP-1-r16  INTEGER ::= 7
nrMaxResourceIDs-r16     INTEGER ::= 64    -- Max Resource IDs
nrMaxResourceOffsetValue-1-r16  INTEGER ::= 511
nrMaxResourcesPerSet-r16  INTEGER ::= 64   -- Maximum resources for one set
nrMaxSetsPerTrpPerFreqLayer-r16  INTEGER ::= 2   -- Maximum resource sets for one TRP
nrMaxSetsPerTrpPerFreqLayer-1-r16  INTEGER ::= 1
nrMaxTRPs-r16            INTEGER ::= 256   -- Max TRPs per UE
nrMaxTRPsPerFreq-r16     INTEGER ::= 64    -- Max TRPs per freq layers
nrMaxTRPsPerFreq-1-r16   INTEGER ::= 63
maxSimultaneousBands-r16  INTEGER ::= 4    -- Maximum number of simultaneously
                                           -- measured bands

maxBandComb-r16          INTEGER ::= 1024
nrMaxConfiguredBands-r16  INTEGER ::= 16

-- ASN1STOP
```

– *End of LPP-PDU-Definitions*

```
-- ASN1START
END
-- ASN1STOP
```

7 Broadcast of assistance data

7.1 General

Broadcast of positioning assistance data is supported via Positioning System Information Blocks (posSIBs) as specified in TS 36.331 [12] or TS 38.331 [35]. The posSIBs are carried in RRC System Information (SI) messages (TS 36.331 [12] or TS 38.331 [35]).

For LTE RRC System Information (SI), a single *SystemInformationBlockPos* IE is defined in TS 36.331 [12] which is carried in IE *PosSystemInformation-r15-IEs* specified in TS 36.331 [12]. The mapping of positioning SIB type (*posSibType*) to assistance data carried in *SystemInformationBlockPos* is specified in clause 7.2.

For NR RRC System Information (SI), a single *SIBpos* IE is defined in TS 38.331 [35] which is carried in IE *PosSystemInformation-r16-IEs* specified in TS 38.331 [35]. The mapping of positioning SIB type (*posSibType*) to assistance data carried in *SIBpos* is specified in clause 7.2.

7.2 Mapping of *posSibType* to assistance data element

The supported *posSibType*'s are specified in Table 7.2-1. The GNSS Common and Generic Assistance Data IEs are defined in clause 6.5.2.2. The OTDOA Assistance Data IEs and NR DL-TDOA/DL-AoD Assistance Data IEs are defined in clause 7.4.2. The Barometric Assistance Data IEs are defined in clause 6.5.5.8. The TBS (based on MBS signals) Assistance Data IEs are defined in clause 6.5.4.8.

Table 7.2-1: Mapping of *posSibType* to *assistanceDataElement*

	<i>posSibType</i>	<i>assistanceDataElement</i>
GNSS Common Assistance Data (clause 6.5.2.2)	<i>posSibType1-1</i>	<i>GNSS-ReferenceTime</i>
	<i>posSibType1-2</i>	<i>GNSS-ReferenceLocation</i>
	<i>posSibType1-3</i>	<i>GNSS-IonosphericModel</i>
	<i>posSibType1-4</i>	<i>GNSS-EarthOrientationParameters</i>
	<i>posSibType1-5</i>	<i>GNSS-RTK-ReferenceStationInfo</i>
	<i>posSibType1-6</i>	<i>GNSS-RTK-CommonObservationInfo</i>
	<i>posSibType1-7</i>	<i>GNSS-RTK-AuxiliaryStationData</i>
	<i>posSibType1-8</i>	<i>GNSS-SSR-CorrectionPoints</i>
GNSS Generic Assistance Data (clause 6.5.2.2)	<i>posSibType2-1</i>	<i>GNSS-TimeModelList</i>
	<i>posSibType2-2</i>	<i>GNSS-DifferentialCorrections</i>
	<i>posSibType2-3</i>	<i>GNSS-NavigationModel</i>
	<i>posSibType2-4</i>	<i>GNSS-RealTimeIntegrity</i>
	<i>posSibType2-5</i>	<i>GNSS-DataBitAssistance</i>
	<i>posSibType2-6</i>	<i>GNSS-AcquisitionAssistance</i>
	<i>posSibType2-7</i>	<i>GNSS-Almanac</i>
	<i>posSibType2-8</i>	<i>GNSS-UTC-Model</i>
	<i>posSibType2-9</i>	<i>GNSS-AuxiliaryInformation</i>
	<i>posSibType2-10</i>	<i>BDS-DifferentialCorrections</i>
	<i>posSibType2-11</i>	<i>BDS-GridModelParameter</i>
	<i>posSibType2-12</i>	<i>GNSS-RTK-Observations</i>
	<i>posSibType2-13</i>	<i>GLO-RTK-BiasInformation</i>
	<i>posSibType2-14</i>	<i>GNSS-RTK-MAC-CorrectionDifferences</i>
	<i>posSibType2-15</i>	<i>GNSS-RTK-Residuals</i>
	<i>posSibType2-16</i>	<i>GNSS-RTK-FKP-Gradients</i>
	<i>posSibType2-17</i>	<i>GNSS-SSR-OrbitCorrections</i>
	<i>posSibType2-18</i>	<i>GNSS-SSR-ClockCorrections</i>
	<i>posSibType2-19</i>	<i>GNSS-SSR-CodeBias</i>
	<i>posSibType2-20</i>	<i>GNSS-SSR-URA</i>
	<i>posSibType2-21</i>	<i>GNSS-SSR-PhaseBias</i>
	<i>posSibType2-22</i>	<i>GNSS-SSR-STEC-Correction</i>
	<i>posSibType2-23</i>	<i>GNSS-SSR-GriddedCorrection</i>
	<i>posSibType2-24</i>	<i>NavIC-DifferentialCorrections</i>
	<i>posSibType2-25</i>	<i>NavIC-GridModelParameter</i>
OTDOA Assistance Data (clause 7.4.2)	<i>posSibType3-1</i>	<i>OTDOA-UE-Assisted</i>

Barometric Assistance Data (clause 6.5.5.8)	<i>posSibType4-1</i>	<i>Sensor-AssistanceDataList</i>
TBS Assistance Data (clause 6.5.4.8)	<i>posSibType5-1</i>	<i>TBS-AssistanceDataList</i>
NR DL-TDOA/DL-AoD Assistance Data (clauses 6.4.3, 7.4.2)	<i>posSibType6-1</i>	<i>NR-DL-PRS-AssistanceData</i>
	<i>posSibType6-2</i>	<i>NR-UEB-TRP-LocationData</i>
	<i>posSibType6-3</i>	<i>NR-UEB-TRP-RTD-Info</i>

7.3 Procedures related to broadcast information elements

Upon receiving *AssistanceDataSIBelement*, the target device shall:

- 1> if the *segmentationInfo* is not included:
 - 2> if the *cipheringKeyData* is included:
 - 3> if the UE has obtained a valid cipher key value and the first portion of the initial Counter denoted C_0 corresponding to the *cipherSetID* using NAS signalling:
 - 4> if C_0 contains less than 128-bits:
 - 5> pad out the bit string with zeroes in most significant bit positions to achieve 128 bits.
 - 4> if the *d0* field contains less than 128-bits:
 - 5> pad out the bit string with zeroes in least significant bit positions to achieve 128 bits, denoted D_0 .
 - 4> determine the initial Counter $C_1 = (C_0 + D_0) \bmod 2^{128}$ (where all values are treated as non-negative integers);
 - 4> determine any subsequent counter C_i from the previous counter C_{i-1} as $C_i = (C_{i-1} + 1) \bmod 2^{128}$;
 - 4> use the sequence of counters $\langle C_1, C_2, C_3, \dots \rangle$ and the cipher key value to decipher the *assistanceDataElement*;
 - 4> decode the deciphered *assistanceDataElement* and deliver the related assistance data to upper layers.
 - 3> else:
 - 4> discard the *AssistanceDataSIBelement*.
 - 2> else:
 - 3> decode the *assistanceDataElement* and deliver the related assistance data to upper layers.
- 1> else:
 - 2> if *segmentationOption* indicates 'pseudo-seg':
 - 3> if the *cipheringKeyData* is included:
 - 4> if the UE has obtained a valid cipher key value and the first portion of the initial Counter denoted C_0 corresponding to the *cipherSetID* using NAS signalling:
 - 5> if C_0 contains less than 128-bits:
 - 6> pad out the bit string with zeroes in most significant bit positions to achieve 128 bits.
 - 5> if the *d0* field contains less than 128-bits:
 - 6> pad out the bit string with zeroes in least significant bit positions to achieve 128 bits, denoted D_0 .
 - 5> determine the initial Counter $C_1 = (C_0 + D_0) \bmod 2^{128}$ (where all values are treated as non-negative integers);

- 5> determine any subsequent counter C_i from the previous counter C_{i-1} as $C_i = (C_{i-1} + 1) \bmod 2^{128}$;
 - 5> use the sequence of counters $\langle C_1, C_2, C_3, \dots \rangle$ and the cipher key value to decipher the *assistanceDataElement* segment;
 - 5> decode the deciphered *assistanceDataElement* segment and deliver the related assistance data portion together with the *assistanceDataSegmentType* and *assistanceDataSegmentNumber* to upper layers.
- 4> else:
- 5> discard the *AssistanceDataSIBelement* segment.
- 3> else:
- 4> decode the *assistanceDataElement* segment and deliver the related assistance data portion together with the *assistanceDataSegmentType* and *assistanceDataSegmentNumber* to upper layers.
- 2> if *segmentationOption* indicates 'octet-string-seg':
- 3> if all segments of *assistanceDataElement* have been received:
 - 4> assemble the assistance data element from the received *assistanceDataElement* segments;
 - 5> if the *cipheringKeyData* is included in the first segment:
 - 6> if the UE has obtained a valid cipher key value and the first portion of the initial Counter denoted C_0 corresponding to the *cipherSetID* using NAS signalling:
 - 7> if C_0 contains less than 128-bits:
 - 8> pad out the bit string with zeroes in most significant bit positions to achieve 128 bits.
 - 7> if the *d0* field contains less than 128-bits:
 - 8> pad out the bit string with zeroes in least significant bit positions to achieve 128 bits, denoted D_0 .
 - 7> determine the initial Counter $C_1 = (C_0 + D_0) \bmod 2^{128}$ (where all values are treated as non-negative integers);
 - 7> determine any subsequent counter C_i from the previous counter C_{i-1} as $C_i = (C_{i-1} + 1) \bmod 2^{128}$;
 - 7> use the sequence of counters $\langle C_1, C_2, C_3, \dots \rangle$ and the cipher key value to decipher the assembled assistance data element;
 - 7> decode the assembled and deciphered assistance data element and deliver the related assistance data to upper layers.
 - 6> else:
 - 7> discard the assembled assistance data element.
 - 5> else:
 - 6> decode the assembled assistance data element and deliver the related assistance data to upper layers.

NOTE: As an optional optimisation when *segmentationOption* indicates 'octet-string-seg', a target device may verify if the *cipheringKeyData* is included in the first segment as soon as the first segment is received and, if included, may verify that the UE has obtained a valid cipher key value and the first portion of the initial Counter denoted C_0 corresponding to the *cipherSetID* using NAS signalling. When the UE has not obtained a valid cipher key value and initial Counter C_0 using NAS signalling, the UE may discard the first segment and ignore all subsequent segments.

The value for D_0 shall be different for different *AssistanceDataSIBelement*'s to ensure that the counters derived from C_1 for any *assistanceDataElement* are different to the counters for any other *assistanceDataElement* for a given ciphering key.

D_0 shall contain at least 16 least significant bits (LSBs) set to zero to ensure that the values of D_0 differ from another by a large value.

7.4 Broadcast information elements

7.4.1 Basic production

This clause defines the LPP broadcast information elements which are encoded as 'basic production' for system information broadcast purposes (see TS 36.331 [12], TS 38.331 [35]).

The 'basic production' is obtained from their ASN.1 definitions by use of Basic Packed Encoding Rules (BASIC-PER), Unaligned Variant, as specified in ITU-T Rec. X.691 [22]. It always contains a multiple of 8 bits.

– *LPP-Broadcast-Definitions*

This ASN.1 segment is the start of the LPP Broadcast definitions.

```
-- ASN1START
LPP-Broadcast-Definitions
DEFINITIONS AUTOMATIC TAGS ::=
BEGIN
IMPORTS
    OTDOA-ReferenceCellInfo,
    OTDOA-NeighbourCellInfoList,
    NR-TRP-LocationInfo-r16,
    NR-DL-PRS-BeamInfo-r16,
    NR-RTD-Info-r16
FROM LPP-PDU-Definitions;
-- ASN1STOP
```

7.4.2 Element definitions

– *AssistanceDataSIBelement*

The IE *AssistanceDataSIBelement* is used in the IE *SystemInformationBlockPos* as specified in TS 36.331 [12] and IE *SIBpos* as specified in TS 38.331 [35].

```
-- ASN1START
AssistanceDataSIBelement-r15 ::= SEQUENCE {
    valueTag-r15                INTEGER (0..63)                OPTIONAL, -- Need OP
    expirationTime-r15         UTCTime                OPTIONAL, -- Need OP
    cipheringKeyData-r15       CipheringKeyData-r15   OPTIONAL, -- Need OP
    segmentationInfo-r15      SegmentationInfo-r15   OPTIONAL, -- Need OP
    assistanceDataElement-r15  OCTET STRING,
    ...
}
CipheringKeyData-r15 ::= SEQUENCE {
    cipherSetID-r15            INTEGER (0..65535),
    d0-r15                    BIT STRING (SIZE (1..128)),
    ...
}
SegmentationInfo-r15 ::= SEQUENCE {
    segmentationOption-r15    ENUMERATED {pseudo-seg, octet-string-seg},
    assistanceDataSegmentType-r15  ENUMERATED {notLastSegment, lastSegment},
    assistanceDataSegmentNumber-r15  INTEGER (0..63),
}
```

```

}
...
-- ASN1STOP

```

AssistanceDataSIBelement field descriptions

valueTag	This field is used to indicate to the target device any changes in the broadcast assistance data content. The <i>valueTag</i> is incremented by one, by the location server, every time a modified assistance data content is provided. This field is not included if the broadcast assistance data changes too frequently. If <i>valueTag</i> and <i>expirationTime</i> are absent, the UE assumes that the broadcast assistance data content changes at every broadcast interval.
expirationTime	This field indicates how long the broadcast assistance data content is valid. It is specified as UTC time and indicates when the broadcast assistance data content will expire.
cipheringKeyData	If present, indicates that the <i>assistanceDataElement</i> octet string is ciphered.
segmentationInfo	If present, indicates that the <i>assistanceDataElement</i> is one of many segments.
assistanceDataElement	The <i>assistanceDataElement</i> OCTET STRING depends on the <i>posSibType</i> and is specified in Table 7.2-1. NOTE.
cipherSetID	This field identifies a cipher set comprising a cipher key value and the first component C_0 of the initial counter C_1 .
d0	This field provides the second component for the initial ciphering counter C_1 . This field is defined as a bit string with a length of 1 to 128 bits. A target device first pads out the bit string if less than 128 bits with zeroes in least significant bit positions to achieve 128 bits. C_1 is then obtained from D_0 and C_0 (defined by the <i>cipherSetID</i>) as: $C_1 = (D_0 + C_0) \bmod 2^{128}$ (with all values treated as non-negative integers).
segmentationOption	Indicates the used segmentation option.
assistanceDataSegmentType	Indicates whether the included <i>assistanceDataElement</i> segment is the last segment or not.
assistanceDataSegmentNumber	Segment number of the <i>assistanceDataElement</i> segment. A segment number of zero corresponds to the first segment, one corresponds to the second segment, and so on. Segments numbers wraparound should there be more than 64 segments

NOTE: For example, if the *posSibType* in IE *PosSIB-Type* defined in TS 36.331 [12] and TS 38.331 [35] indicates '*posSibType1-7*', the *assistanceDataElement* OCTET STRING includes the LPP IE *GNSS-RTK-AuxiliaryStationData*.

OTDOA-UE-Assisted

The IE *OTDOA-UE-Assisted* is used in the *assistanceDataElement* if the *posSibType* in IE *PosSIB-Type* defined in TS 36.331 [12] indicates '*posSibType3-1*'.

```

-- ASN1START
OTDOA-UE-Assisted-r15 ::= SEQUENCE {
    otdoa-ReferenceCellInfo-r15          OTDOA-ReferenceCellInfo,
    otdoa-NeighbourCellInfo-r15         OTDOA-NeighbourCellInfoList,
    ...
}
-- ASN1STOP

```

OTDOA-UE-Assisted field descriptions

otdoa-ReferenceCellInfo	LPP IE <i>OTDOA-ReferenceCellInfo</i> as defined in clause 6.5.1.2.
otdoa-NeighbourCellInfo	LPP IE <i>OTDOA-NeighbourCellInfoList</i> as defined in clause 6.5.1.2.

– NR-UEB-TRP-LocationData

The IE *NR-UEB-TRP-LocationData* is used in the *assistanceDataElement* if the *posSibType* in IE *PosSIB-Type* defined in TS 38.331 [35] indicates '*posSibType6-2*'.

```
-- ASN1START
NR-UEB-TRP-LocationData-r16 ::= SEQUENCE {
    nr-trp-LocationInfo-r16          NR-TRP-LocationInfo-r16,
    nr-dl-prs-BeamInfo-r16          NR-DL-PRS-BeamInfo-r16          OPTIONAL, -- Need ON
    ...
}
-- ASN1STOP
```

NR-UEB-TRP-LocationData field descriptions

nr-trp-LocationInfo

LPP IE *NR-TRP-LocationInfo* as defined in clause 6.4.2.1.

nr-dl-prs-BeamInfo

LPP IE *NR-DL-PRS-Beam-Info* as defined in clause 6.4.2.1.

– NR-UEB-TRP-RTD-Info

The IE *NR-UEB-TRP-RTD-Info* is used in the *assistanceDataElement* if the *posSibType* in IE *PosSIB-Type* defined in TS 38.331 [35] indicates '*posSibType6-3*'.

```
-- ASN1START
NR-UEB-TRP-RTD-Info-r16 ::= SEQUENCE {
    nr-rtd-Info-r16          NR-RTD-Info-r16,
    ...
}
-- ASN1STOP
```

NR-UEB-TRP-RTD-Info field descriptions

nr-rtd-Info

LPP IE *NR-RTD-Info* as defined in clause 6.4.2.1.

– End of LPP-Broadcast-Definitions

```
-- ASN1START
END
-- ASN1STOP
```

7.5 Broadcast ciphering (informative)

The *assistanceDataElement* OCTET STRING included in IE *AssistanceDataSIBelement* may be ciphered using the 128-bit Advanced Encryption Standard (AES) algorithm (with counter mode).

AES as specified in [32] and [33] is a block mode cipher algorithm that ciphers blocks of 128 bits at a time. However, Counter mode enables usage for a bit string that is not an exact multiple of 128 bits. Further, Counter mode enables a target (or a server) to perform most of the deciphering (or ciphering) processing independently of receipt of the data to be deciphered (or ciphered) which may enable more efficient processing. Provided counters are chosen in a non-repeating manner by the server (which is a requirement for Counter mode), every block of data will be ciphered in a unique manner.

The algorithm makes use of a sequence of counters $\langle C_1, C_2, C_3, \dots \rangle$ each containing 128 bits, where C_1 is specified by the server and each subsequent counter (C_2, C_3 etc.) is obtained from the previous counter by adding one modulo 2^{128} .

Each counter C_i is ciphered using the AES algorithm with a common 128-bit key to produce an output block O_i of 128 bits. To perform ciphering, the *assistanceDataElement* is divided into blocks B_1, B_2, \dots, B_n of 128 bits each, except for the last block B_n which may contain fewer than 128 bits. The ciphered *assistanceDataElement* is obtained as a sequence of n blocks containing 128 bits each (except possibly for the last block) given by $(O_1 \text{ XOR } B_1), (O_2 \text{ XOR } B_2), \dots, (O_n \text{ XOR } B_n)$, where XOR denotes bitwise exclusive OR. In the case of the last block, if B_n contains m bits ($m < 128$), then the m most significant bits of O_n would be used for the exclusive OR. Deciphering is performed in the same way except that the blocks B_1, B_2, \dots, B_n are now obtained from the ciphered message and the result of the exclusive OR operations yields the original unciphered message. Figure 7.5-1 provides an illustration of Counter mode for the generic case of an arbitrary block cipher algorithm CIPH_k .

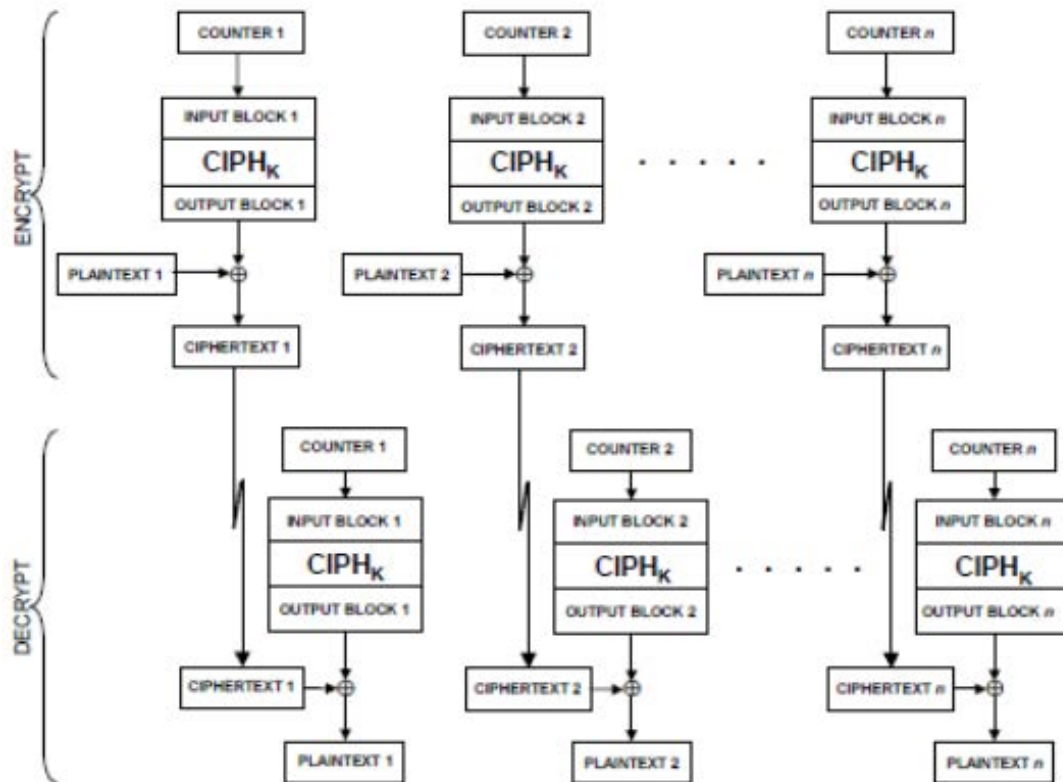

Figure 7.5-1: Illustration of Block Ciphering with Counter Mode [33].

The algorithms require specific conventions for bit ordering. The bit ordering applicable to ciphering for a ASN.1 PER encoded *assistanceDataElement* is the bit ordering produced by the ASN.1 PER encoding where the first bit is the leading bit number zero, the second bit is bit one etc..

The initial counter C_1 used to cipher an entire *assistanceDataElement* is provided to a target by a server in two portions. The first portion, denoted C_0 , is provided using point to point mode along with the 128-bit ciphering key and an identifier for both of these values as specified in TS 23.271 [3]. The second portion, denoted D_0 (d_0), is provided in unciphered form in IE *CipheringKeyData*. A target then obtains C_1 as:

$$C_1 = (C_0 + D_0) \bmod 2^{128} \text{ (where all values are treated as non-negative integers)}$$

To obtain any subsequent counter C_i from the previous counter C_{i-1} for any message, the following operation is used:

$$C_i = (C_{i-1} + 1) \bmod 2^{128}$$

NOTE: As specified in clause 7.3 the value for D_0 is different for different *AssistanceDataElement*'s to ensure that the counters derived from C_1 for any *assistanceDataElement* can be different to the counters for any other *assistanceDataElement*. However, a long *assistanceDataElement* or a segmented *assistanceDataElement* would require the use of consecutive counter values C_1 to C_n , where n is the *assistanceDataElement* size in bits divided by 128 (and rounded up). There would then be a danger of small changes in the value of D_0 for ciphering of different *assistanceDataElement*'s (e.g. D_0 being chosen as 1 larger than a previous D_0 value) reusing previous counter values. To avoid this, the values of D_0 contain 16 least significant bits (LSBs) set to zero, as specified in clause 7.3.

Annex A (informative): Change History

Change history of TS 36.355 up to v15.5.0							
Date	TSG #	TSG Doc.	CR	Rev	Cat	Subject/Comment	New version
2009-10	RAN2 #67bis	R2-096252				RAN2 agreed TS 36.355 v0.1.0	0.1.0
2009-11	RAN2 #68	R2-097492				RAN2 agreed TS 36.355 v2.0.0	2.0.0
2009-12	RP-46	RP-091208				RAN #46 approval of TS 36.355	9.0.0
2010-03	RP-47	RP-100304	0001	-		Clarification on Position location	9.1.0
	RP-47	RP-100304	0002	-		Clarification on UE Rx-Tx time difference supporting capability	9.1.0
	RP-47	RP-100304	0003	2		Completion of LPP common material	9.1.0
	RP-47	RP-100304	0004	5		Completion of OTDOA in LPP	9.1.0
	RP-47	RP-100304	0006	-		Provision of Frame Drift Information in Network Time	9.1.0
	RP-47	RP-100304	0007	-		Clarification of measurement reference point	9.1.0
	RP-47	RP-100304	0010	-		GNSS-DifferentialCorrectionsSupport	9.1.0
	RP-47	RP-100304	0011	-		BSAlign Indication in GNSS Reference Time	9.1.0
	RP-47	RP-100304	0012	1		Changes to reflect LPP ASN.1 review	9.1.0
	RP-47	RP-100304	0013	1		Introduction of LPP reliability sublayer	9.1.0
	RP-47	RP-100304	0015	-		LPP error procedures and conditions	9.1.0
	RP-47	RP-100304	0016	-		Triggered Location Information Transfer due to Cell Change	9.1.0
2010-06	RP-48	RP-100558	0018	2		Addition of need codes to optional LPP information elements	9.2.0
	RP-48	RP-100558	0019	1		Miscellaneous corrections to LPP stage 3	9.2.0
	RP-48	RP-100558	0020	1		Small corrections to LPP specification	9.2.0
	RP-48	RP-100558	0021	-		Clarifications of OTDOA parameters	9.2.0
	RP-48	RP-100558	0022	1		Signalling support for PRS muting in OTDOA	9.2.0
	-	-	-	-		Two times capital R replaced by lower case r in "MeasuredResultsElement" (undoing not intended change)	9.2.1
2010-09	RP-49	RP-100852	0024	-		Addition of an EPDU to an LPP Error and LPP Abort	9.3.0
	RP-49	RP-100852	0026	-		Division of LPP into Separate ASN.1 Modules with a Global Identifier	9.3.0
	RP-49	RP-100852	0028	-		Proposed Corrections to LPP Reliable Transport	9.3.0
	RP-49	RP-100852	0029	-		Proposed Corrections to the PeriodicalReportingCriteria in LPP	9.3.0
	RP-49	RP-100852	0030	1		Various corrections and clarifications to LPP	9.3.0
	RP-49	RP-100852	0031	-		Support of functional components for LPP reliable transport	9.3.0
	RP-49	RP-100852	0032	1		Introduction of EPDU ID requested by OMA LOC	9.3.0
	RP-49	RP-100852	0035	1		Several corrections in LPP	9.3.0
	RP-49	RP-100852	0036	-		Clarification to Assistance Data Transfer Procedure	9.3.0
2010-12	RP-50	RP-101207	0037	-		Correction of reliable transport terminology in description of LPP-Message	9.4.0
	RP-50	RP-101207	0038	-		One cell with known SFN in OTDOA assistance data	9.4.0
	RP-50	RP-101207	0039	1		UE frequency capability for LPP	9.4.0
	RP-50	RP-101207	0041	-		Correction to LPP reliable transport	9.4.0
	RP-50	RP-101207	0042	-		Correction to LPP Error procedure	9.4.0
	RP-50	RP-101207	0043	-		Addition of missing reference to LPPe	9.4.0
	RP-50	RP-101207	0044	2		Correction to the OTDOA assistance data	9.4.0
	RP-50	RP-101226	0040	-		Update of 'serving cell' terminology in 36.355	10.0.0
2011-03	RP-51	RP-110269	0046	-		Editorial corrections to 36.355	10.1.0
	RP-51	RP-110269	0048	-		Removal of FFS for retransmission timer in LPP	10.1.0
	RP-51	RP-110269	0050	-		Correction to code phase encoding in GNSS acquisition assistance	10.1.0
	RP-51	RP-110269	0052	1		Clarification on SFN provided with OTDOA measurement	10.1.0
	RP-51	RP-110269	0053	1		Introduction of OTDOA inter-freq RSTD measurement indication procedure	10.1.0
	RP-51	RP-110269	0057	-		Small corrections in 36.355	10.1.0
	RP-51	RP-110269	0058	3		Further corrections to the OTDOA assistance data	10.1.0
2011-06	RP-52	RP-110830	0060	-		Clarifications to description of OTDOA positioning fields	10.2.0
2011-09	RP-53	RP-111279	0062	1		Various corrections to LPP	10.3.0
	RP-53	RP-111279	0064	-		Mandatory support of PRS for OTDOA measurements	10.3.0
2011-12	RP-54	RP-111709	0066	-		Clarification of packed encoding rules of LPP	10.4.0
	RP-54	RP-111709	0068	-		Clarification of first bit in BIT STRING definitions	10.4.0
2012-06	RP-56	RP-120808	0071	-		Usage of additionalInformation IE	10.5.0
2012-09	RP-57	RP-121424	0074	2		Corrections to GNSS Acquisition Assistance Data	10.6.0
	RP-57	-	-	-		Upgrade to the Release 11 - no technical change	11.0.0

2012-12	RP-58	RP-121931	0077	-		Correcting the referencing of QoS parameters	11.1.0
	RP-58	RP-121931	0080	-		Correction to missing field description in GNSS-AcquisitionAssistance IE	11.1.0
2013-03	RP-59	RP-130237	0083	1		Extending E-UTRA Frequency Band and EARFCN value range	11.2.0
	RP-59	RP-130230	0086	-		Correction to PRS Muting Configuration	11.2.0
2013-06	RP-60	RP-130803	0088	-		Correction for ASN.1 errors from CR0083r1	11.3.0
	RP-60	RP-130803	0091	-		Correction to integer code phase field description in GNSS Acquisition Assistance	11.3.0
	RP-60	RP-130803	0093	-		Correction to serving cell terminology	11.3.0
	RP-60	RP-130803	0094	-		Encoding of LPP IEs	11.3.0
2013-09	RP-61	RP-131314	0098	-		Correction on svReqList	11.4.0
2013-12	RP-62	RP-131984	0103	-		Correction to missing capability indication for inter-frequency RSTD measurements	11.5.0
	RP-62	RP-131984	0107	1		Correction to Galileo assistance data elements	11.5.0
	RP-62	RP-132000	0104	1		Stage 3 CR of TS 36.355 for introducing BDS in LTE	12.0.0
	RP-62	RP-131984	0108	-		Correction to Galileo assistance data elements	12.0.0
2014-03	RP-63	RP-140342	0112	1		Clarification to gnss-DayNumber	12.1.0
2014-06	RP-64	RP-140871	0119	-		Signaling of OTDOA Neighbour Cell Information and Measurements	12.2.0
2014-12	RP-66	RP-142114	0122	-		Correction to Galileo Assistance Data	12.3.0
	RP-66	RP-142114	0123	-		Addition of an Early Position Fix to LPP	12.3.0
	RP-66	RP-142120	0124	-		BDS update to version 2.0	12.3.0
2015-03	RP-67	RP-150369	0126	2		Correction of GLONASS system time	12.4.0
	RP-67	RP-150376	0125	1		LPP clean-up	12.4.0
2015-12	RP-70	RP-152055	0134	1		Correction to the definition of Need codes	12.5.0
2015-12	RP-70	RP-152068	0137	3		RAT-Independent positioning enhancements	13.0.0
2016-03	RP-71	RP-160463	0138	1		Correction to GLONASS IOD value range	13.1.0
	RP-71	RP-160470	0140	1		r13 Information Element correction	13.1.0
	RP-71	RP-160470	0141	-		WLAN AP Identifier correction	13.1.0
	RP-71	RP-160470	0142	1		LPP clean-up	13.1.0
2016-09	RP-73	RP-161750	0143	4		Correction of ECID positioning for TDD	13.2.0
2016-12	RP-74	RP-162317	0160	1		Clarification of WLAN RSSI value range	13.3.0
2016-12	RP-74	RP-162326	0155	1		CR for 36.355 Further Indoor positioning enhancements	14.0.0
	RP-74	RP-162327	0157	-		Barometric Pressure Uncertainty IEs	14.0.0
	RP-74	RP-162326	0161	1		Introduction of Further Indoor Positioning Enhancements	14.0.0
2017-03	RP-75	RP-170636	0162	3	B	Introduction of positioning for further enhanced MTC	14.1.0
	RP-75	RP-170642	0163	-	C	Addition of periodical and triggered reporting capability signalling	14.1.0
	RP-75	RP-170642	0165	2	F	Further Indoor positioning enhancements corrections	14.1.0
	RP-75	RP-170637	0166	-	B	Introduction of positioning support for NB-IoT	14.1.0
2017-06	RP-76	RP-171224	0169	3	F	Compact Signal Measurement Information for OTDOA	14.2.0
	RP-76	RP-171223	0171	1	F	Correction to PRS Subframe Offset	14.2.0
	RP-76	RP-171223	0173	1	F	Correction to SFN time stamp in OTDOA Signal Measurement Information	14.2.0
	RP-76	RP-171223	0174	1	F	Correction to OTDOA capabilities	14.2.0
	RP-76	RP-171224	0175	1	F	Correction to NPRS	14.2.0
	RP-76	RP-171225	0176	2	F	LPP clean-up	14.2.0
	RP-76	RP-171224	0177	-	F	Corrections to number of NPRS carriers and ECID measurements for NB-IoT	14.2.0
	RP-76	RP-171224	0178	1	F	Removal of FFS for retransmission timer in LPP	14.2.0
	RP-76	RP-171224	0181	1	F	Signalling optimisation for NB-IoT Enhancements	14.2.0
2017-09	RP-77	RP-171913	0182	2	F	Clarification on definition of PRS Occasion Group	14.3.0
	RP-77	RP-171914	0183	1	F	Additional OTDOA Capabilities	14.3.0
	RP-77	RP-171911	0184	-	F	Clarification to <i>GNSS-TimeModelList</i>	14.3.0
	RP-77	RP-171913	0185	1	F	Minor corrections on TS 36.355 for Rel-14 MTC	14.3.0
2017-12	RP-78	RP-172616	0187	2	F	Correction on PRS hopping configuration	14.4.0
2018-03	RP-79	RP-180446	0189	1	F	Segmentation of LPP Messages	14.5.0
2018-04	RP-79					New version to fix ASN.1 formatting	14.5.1
2018-06	RP-80	RP-181235	0202	2	F	Clarification for NRSRQ reporting with E-CID	14.6.0
2018-06	RP-80	RP-181219	0204	2	B	Introduction of IMU support for OTDOA	15.0.0
	RP-80	RP-181219	0205	1	B	Addition of RTK and PPP support	15.0.0
	RP-80	RP-181219	0207	1	B	Addition of broadcast of positioning assistance data	15.0.0
	RP-80	RP-181215	0209	1	B	Addition of NR Support	15.0.0
	RP-80	RP-181252	0210	1	B	Addition of NB-IoT TDD support	15.0.0
2018-09	RP-81	RP-181963	0215	1	A	Support for NPRS enhancements	15.1.0
	RP-81	RP-181945	0218	1	F	Corrections to TDD in 36.355	15.1.0
	RP-81	RP-181961	0221	3	A	Correction to RSRQ range in 36.355	15.1.0
	RP-81	RP-181942	0222	1	F	OTDOA Assistance Data Request for NR	15.1.0
	RP-81	RP-181960	0223	-	F	LPP clean-up	15.1.0
	RP-81	RP-181952	0224	1	F	GAD shapes for high accuracy positioning	15.1.0
	RP-81	RP-181952	0226	1	B	Positioning SIB value tag and expiration time	15.1.0
2018-12	RP-82	RP-182672	0213	3	F	Addition of TDD UL/DL configuration to OTDOA assistance data	15.2.0
	RP-82	RP-182681	0228	2	F	Introduction of TDD UL/DL configuration for NB-IoT in 36.355	15.2.0
	RP-82	RP-182659	0229	3	F	SFN offset for OTDOA	15.2.0
	RP-82	RP-182674	0230	1	F	Alignment of IE/field names between LPP and RRC specifications	15.2.0

	RP-82	RP-182672	0232	1	F	Sensor Assistance Data Elements Correction	15.2.0
2019-03	RP-83	RP-190550	0234	3	F	Stage 2 and stage 3 sensor methods description alignment	15.3.0
2019-06	RP-84	RP-191376	0239	1	F	Minor corrections on NR Support	15.4.0
	RP-84	RP-191384	0240	4	F	Periodic assistance data transfer with cell ID change procedure	15.4.0
2019-09	RP-85	RP-192196	0243	1	F	Distinguishing Location Source when sensor method is used	15.5.0

NOTE: The table above will not be further updated in the future. It shows all TS 36.355 CRs taken over into TS 37.355 v1.0.0.

Change history of TS 37.355							
Date	TSG #	TSG Doc.	CR	Rev	Cat	Subject/Comment	New version
2019-12	RP-86	RP-192450	-	-	-	TS 36.355 v15.5.0 contents was transferred into this new TS 37.355 as by definition 36 series specifications cover E-UTRA/LTE only aspects and multi-RAT aspects need to be covered in 37 series specifications. The only changes compared to TS 36.355 v15.5.0: - new 37 series TS number is added: TS 37.355 - "Evolved Universal Terrestrial Radio Access (E-UTRA)" is removed from the TS title as beginning with Rel-15 TS 36.355 needs to cover also NR - clarification in the Scope clause that this TS covers radio access technologies E-UTRA/LTE and NR - the CR history table of TS 36.355 was kept for easier reference of all changes included in TS 37.355 but a new CR history table was added for TS 37.355.	1.0.0
2019-12	RP-86					The approved version upgraded to v15.0.0 by MCC.	15.0.0
2020-03	RP-87	RP-200367	0001	2	C	Addition of broadcast of barometric pressure assistance data	16.0.0
	RP-87	RP-200357	0002	1	F	Sensor Provide Location Information Elements Correction	16.0.0
	RP-87	RP-200365	0247	8	B	CR of TS 37.355 for introducing NavIC in LTE – core part	16.0.0
	RP-87	RP-200357	0248	1	B	Introduction of B1C signal in BDS system in A-GNSS	16.0.0
	RP-87	RP-200367	0249	1	C	Addition of broadcast TBS assistance data	16.0.0
	RP-87	RP-200345	0250	2	B	Introduction of NR positioning	16.0.0
	RP-87	RP-200357	0252	1	B	Introducing support for GNSS Integer Ambiguity Level Indications	16.0.0
2020-07	RP-88	RP-201196	0257	2	F	Introduction of NavIC Keplerian set IE	16.1.0
	RP-88	RP-201190	0259	1	F	Update B1I signal ICD file to v3.0 in BDS system in A-GNSS	16.1.0
	RP-88	RP-201175	0260	-	F	LPP Clean-Up	16.1.0
	RP-88	RP-201175	0261	1	B	Introduction of Release-16 UE positioning capabilities	16.1.0
2020-09	RP-89	RP-201989	0272	-	F	LPP miscellaneous corrections	16.2.0
2020-12	RP-90	RP-202775	0274	-	F	Clarification of quality and time stamp for RSTD measurements	16.3.0
	RP-90	RP-202789	0280	2	F	Correction of hanging ASN.1 code after END	16.3.0
	RP-90	RP-202775	0282	-	F	Correction on LPP spec	16.3.0
2021-03	RP-91	RP-210695	0284	1	F	Corrections on the field description of commonIEsProvideAssistanceData in TS37.355	16.4.0
2021-06	RP-92	RP-211474	0288	4	F	LPP Layer interaction with lower layers for Positioning Frequency layer and Measurement Gap	16.5.0
	RP-92	RP-211482	0292	3	F	Correction to the need code for downlink LPP message-R16	16.5.0
	RP-92	RP-211474	0294	2	F	Miscellaneous corrections on the field description	16.5.0
	RP-92	RP-211474	0300	2	F	Correction to PRS configuration	16.5.0
	RP-92	RP-211474	0301	2	F	Correction to the uplink LPP message	16.5.0
	RP-92	RP-211474	0302	3	F	Correction to DL-PRS capability	16.5.0
	RP-92	RP-211474	0306	2	F	Correction to NR-ARFCN of the TRP	16.5.0
	RP-92	RP-211474	0311	-	F	Description on timestamp reference in NR positioning measurement report	16.5.0
2021-09	RP-93	RP-212443	0305	5	F	Correction to PRS-only TP	16.6.0
	RP-93	RP-212443	0312	1	F	Correction for LPP assistance information	16.6.0
	RP-93	RP-212443	0313	1	F	Corrections on the conditional presence tag clarification for Uplink LPP message	16.6.0
	RP-93	RP-212443	0318	-	F	Correction to the need code in NR-SelectedDL-PRS-IndexList	16.6.0

History

Document history		
V16.1.0	July 2020	Publication
V16.2.0	November 2020	Publication
V16.3.0	January 2021	Publication
V16.4.0	April 2021	Publication
V16.5.0	September 2021	Publication
V16.6.0	October 2021	Publication