

ETSI TS 137 355 V17.9.0 (2025-01)



**LTE;
5G;
LTE Positioning Protocol (LPP)
(3GPP TS 37.355 version 17.9.0 Release 17)**



Reference

RTS/TSGR-0237355vh90

Keywords

5G,LTE

ETSI

650 Route des Lucioles
F-06921 Sophia Antipolis Cedex - FRANCE

Tel.: +33 4 92 94 42 00 Fax: +33 4 93 65 47 16

Siret N° 348 623 562 00017 - APE 7112B
Association à but non lucratif enregistrée à la
Sous-Préfecture de Grasse (06) N° w061004871

Important notice

The present document can be downloaded from the
[ETSI Search & Browse Standards application](#).

The present document may be made available in electronic versions and/or in print. The content of any electronic and/or print versions of the present document shall not be modified without the prior written authorization of ETSI. In case of any existing or perceived difference in contents between such versions and/or in print, the prevailing version of an ETSI deliverable is the one made publicly available in PDF format on [ETSI deliver repository](#).

Users should be aware that the present document may be revised or have its status changed, this information is available in the [Milestones listing](#).

If you find errors in the present document, please send your comments to the relevant service listed under [Committee Support Staff](#).

If you find a security vulnerability in the present document, please report it through our [Coordinated Vulnerability Disclosure \(CVD\)](#) program.

Notice of disclaimer & limitation of liability

The information provided in the present deliverable is directed solely to professionals who have the appropriate degree of experience to understand and interpret its content in accordance with generally accepted engineering or other professional standard and applicable regulations.

No recommendation as to products and services or vendors is made or should be implied.

No representation or warranty is made that this deliverable is technically accurate or sufficient or conforms to any law and/or governmental rule and/or regulation and further, no representation or warranty is made of merchantability or fitness for any particular purpose or against infringement of intellectual property rights.

In no event shall ETSI be held liable for loss of profits or any other incidental or consequential damages.

Any software contained in this deliverable is provided "AS IS" with no warranties, express or implied, including but not limited to, the warranties of merchantability, fitness for a particular purpose and non-infringement of intellectual property rights and ETSI shall not be held liable in any event for any damages whatsoever (including, without limitation, damages for loss of profits, business interruption, loss of information, or any other pecuniary loss) arising out of or related to the use of or inability to use the software.

Copyright Notification

No part may be reproduced or utilized in any form or by any means, electronic or mechanical, including photocopying and microfilm except as authorized by written permission of ETSI.

The content of the PDF version shall not be modified without the written authorization of ETSI.

The copyright and the foregoing restriction extend to reproduction in all media.

© ETSI 2025.
All rights reserved.

Intellectual Property Rights

Essential patents

IPRs essential or potentially essential to normative deliverables may have been declared to ETSI. The declarations pertaining to these essential IPRs, if any, are publicly available for **ETSI members and non-members**, and can be found in ETSI SR 000 314: "*Intellectual Property Rights (IPRs); Essential, or potentially Essential, IPRs notified to ETSI in respect of ETSI standards*", which is available from the ETSI Secretariat. Latest updates are available on the [ETSI IPR online database](#).

Pursuant to the ETSI Directives including the ETSI IPR Policy, no investigation regarding the essentiality of IPRs, including IPR searches, has been carried out by ETSI. No guarantee can be given as to the existence of other IPRs not referenced in ETSI SR 000 314 (or the updates on the ETSI Web server) which are, or may be, or may become, essential to the present document.

Trademarks

The present document may include trademarks and/or tradenames which are asserted and/or registered by their owners. ETSI claims no ownership of these except for any which are indicated as being the property of ETSI, and conveys no right to use or reproduce any trademark and/or tradename. Mention of those trademarks in the present document does not constitute an endorsement by ETSI of products, services or organizations associated with those trademarks.

DECT™, **PLUGTESTS™**, **UMTS™** and the ETSI logo are trademarks of ETSI registered for the benefit of its Members. **3GPP™**, **LTE™** and **5G™** logo are trademarks of ETSI registered for the benefit of its Members and of the 3GPP Organizational Partners. **oneM2M™** logo is a trademark of ETSI registered for the benefit of its Members and of the oneM2M Partners. **GSM®** and the GSM logo are trademarks registered and owned by the GSM Association.

Legal Notice

This Technical Specification (TS) has been produced by ETSI 3rd Generation Partnership Project (3GPP).

The present document may refer to technical specifications or reports using their 3GPP identities. These shall be interpreted as being references to the corresponding ETSI deliverables.

The cross reference between 3GPP and ETSI identities can be found at [3GPP to ETSI numbering cross-referencing](#).

Modal verbs terminology

In the present document "**shall**", "**shall not**", "**should**", "**should not**", "**may**", "**need not**", "**will**", "**will not**", "**can**" and "**cannot**" are to be interpreted as described in clause 3.2 of the [ETSI Drafting Rules](#) (Verbal forms for the expression of provisions).

"**must**" and "**must not**" are **NOT** allowed in ETSI deliverables except when used in direct citation.

Contents

Intellectual Property Rights	2
Legal Notice	2
Modal verbs terminology.....	2
Foreword.....	13
1 Scope	14
2 References	14
3 Definitions and Abbreviations.....	16
3.1 Definitions	16
3.2 Abbreviations	17
4 Functionality of Protocol.....	19
4.1 General	19
4.1.1 LPP Configuration	19
4.1.2 LPP Sessions and Transactions.....	20
4.1.3 LPP Position Methods	20
4.1.4 LPP Messages	20
4.2 Common LPP Session Procedure	21
4.3 LPP Transport	22
4.3.1 Transport Layer Requirements	22
4.3.2 LPP Duplicate Detection	22
4.3.3 LPP Acknowledgement	22
4.3.3.1 General	22
4.3.3.2 Procedure related to Acknowledgement.....	22
4.3.4 LPP Retransmission.....	23
4.3.4.1 General	23
4.3.4.2 Procedure related to Retransmission.....	23
4.3.5 LPP Message Segmentation.....	24
5 LPP Procedures	25
5.1 Procedures related to capability transfer	25
5.1.1 Capability Transfer procedure	25
5.1.2 Capability Indication procedure.....	26
5.1.3 Reception of LPP Request Capabilities	26
5.1.4 Transmission of LPP Provide Capabilities	27
5.2 Procedures related to Assistance Data Transfer	27
5.2.1 Assistance Data Transfer procedure	27
5.2.1a Periodic Assistance Data Transfer procedure	27
5.2.1b Periodic Assistance Data Transfer with Update procedure.....	29
5.2.2 Assistance Data Delivery procedure	30
5.2.2a Periodic Assistance Data Delivery procedure.....	30
5.2.3 Transmission of LPP Request Assistance Data	32
5.2.4 Reception of LPP Provide Assistance Data	32
5.3 Procedures related to Location Information Transfer.....	32
5.3.1 Location Information Transfer procedure.....	32
5.3.2 Location Information Delivery procedure	33
5.3.3 Reception of Request Location Information.....	33
5.3.4 Transmission of Provide Location Information	34
5.4 Error Handling Procedures	34
5.4.1 General.....	34
5.4.2 Procedures related to Error Indication	34
5.4.3 LPP Error Detection.....	34
5.4.4 Reception of an LPP Error Message	35
5.5 Abort Procedure	36
5.5.1 General.....	36
5.5.2 Procedures related to Abort	36

5.5.3	Reception of an LPP Abort Message	36
6	Information Element Abstract Syntax Definition.....	36
6.1	General	36
6.2	LPP PDU Structure	37
–	<i>LPP-PDU-Definitions</i>	37
–	<i>LPP-Message</i>	37
–	<i>LPP-MessageBody</i>	38
–	<i>LPP-TransactionID</i>	38
6.3	Message Body IEs	39
–	<i>RequestCapabilities</i>	39
–	<i>ProvideCapabilities</i>	39
–	<i>RequestAssistanceData</i>	40
–	<i>ProvideAssistanceData</i>	40
–	<i>RequestLocationInformation</i>	41
–	<i>ProvideLocationInformation</i>	42
–	<i>Abort</i>	42
–	<i>Error</i>	43
6.4	Common IEs.....	43
6.4.1	Common Lower-Level IEs	43
–	<i>AccessTypes</i>	43
–	<i>ARFCN-ValueEUTRA</i>	43
–	<i>ARFCN-ValueNR</i>	44
–	<i>ARFCN-ValueUTRA</i>	44
–	<i>CarrierFreq-NB</i>	44
–	<i>CellGlobalIdEUTRA-AndUTRA</i>	45
–	<i>CellGlobalIdGERAN</i>	45
–	<i>ECGI</i>	46
–	<i>Ellipsoid-Point</i>	46
–	<i>Ellipsoid-PointWithUncertaintyCircle</i>	46
–	<i>EllipsoidPointWithUncertaintyEllipse</i>	46
–	<i>EllipsoidPointWithAltitude</i>	47
–	<i>EllipsoidPointWithAltitudeAndUncertaintyEllipsoid</i>	47
–	<i>EllipsoidArc</i>	47
–	<i>EPDU-Sequence</i>	47
–	<i>FreqBandIndicatorNR</i>	48
–	<i>HA-EllipsoidPointWithAltitudeAndScalableUncertaintyEllipsoid</i>	48
–	<i>HA-EllipsoidPointWithScalableUncertaintyEllipse</i>	49
–	<i>HighAccuracyEllipsoidPointWithUncertaintyEllipse</i>	49
–	<i>HighAccuracyEllipsoidPointWithAltitudeAndUncertaintyEllipsoid</i>	49
–	<i>HorizontalVelocity</i>	49
–	<i>HorizontalWithVerticalVelocity</i>	50
–	<i>HorizontalVelocityWithUncertainty</i>	50
–	<i>HorizontalWithVerticalVelocityAndUncertainty</i>	50
–	<i>LocationCoordinateTypes</i>	50
–	<i>NCGI</i>	51
–	<i>NR-PhysCellId</i>	51
–	<i>PeriodicAssistanceDataControlParameters</i>	51
–	<i>Polygon</i>	52
–	<i>PositioningModes</i>	52
–	<i>ScheduledLocationTimeSupport</i>	52
–	<i>ScheduledLocationTimeSupportPerMode</i>	53
–	<i>SegmentationInfo</i>	53
–	<i>VelocityTypes</i>	53
6.4.2	Common Positioning	53
–	<i>CommonIEsRequestCapabilities</i>	53
–	<i>CommonIEsProvideCapabilities</i>	54
–	<i>CommonIEsRequestAssistanceData</i>	54
–	<i>CommonIEsProvideAssistanceData</i>	55
–	<i>CommonIEsRequestLocationInformation</i>	55
–	<i>CommonIEsProvideLocationInformation</i>	60
–	<i>CommonIEsAbort</i>	62

–	<i>CommonIEsError</i>	63
6.4.3	Common NR Positioning Information Elements	63
–	<i>ArealID-CellList</i>	63
–	<i>DL-PRS-ID-Info</i>	64
–	<i>LCS-GCS-TranslationParameter</i>	64
–	<i>LOS-NLOS-Indicator</i>	65
–	<i>LOS-NLOS-IndicatorGranularity1</i>	65
–	<i>LOS-NLOS-IndicatorGranularity2</i>	65
–	<i>LOS-NLOS-IndicatorType1</i>	66
–	<i>LOS-NLOS-IndicatorType2</i>	66
–	<i>NR-AdditionalPathList</i>	66
–	<i>NR-DL-PRS-AssistanceData</i>	67
–	<i>NR-DL-PRS-BeamInfo</i>	70
–	<i>NR-DL-PRS-ExpectedLOS-NLOS-Assistance</i>	71
–	<i>NR-DL-PRS-Info</i>	72
–	<i>NR-DL-PRS-ProcessingCapability</i>	76
–	<i>NR-DL-PRS-QCL-ProcessingCapability</i>	80
–	<i>NR-DL-PRS-ResourceID</i>	81
–	<i>NR-DL-PRS-ResourcesCapability</i>	81
–	<i>NR-DL-PRS-ResourceSetID</i>	82
–	<i>NR-DL-PRS-TRP-TEG-Info</i>	82
–	<i>NR-On-Demand-DL-PRS-Configurations</i>	83
–	<i>NR-On-Demand-DL-PRS-Information</i>	84
–	<i>NR-On-Demand-DL-PRS-Request</i>	85
–	<i>NR-On-Demand-DL-PRS-Configurations-Selected-IndexList</i>	86
–	<i>NR-On-Demand-DL-PRS-Support</i>	86
–	<i>NR-PositionCalculationAssistance</i>	86
–	<i>NR-RTD-Info</i>	87
–	<i>NR-SelectedDL-PRS-IndexList</i>	88
–	<i>NR-SSB-Config</i>	89
–	<i>NR-TimeStamp</i>	90
–	<i>NR-TimingQuality</i>	91
–	<i>NR-TRP-BeamAntennaInfo</i>	91
–	<i>NR-TRP-LocationInfo</i>	94
–	<i>NR-UE-TEG-Capability</i>	95
–	<i>NR-UL-SRS-Capability</i>	96
–	<i>ReferencePoint</i>	101
–	<i>RelativeLocation</i>	102
–	<i>TEG-TimingErrorMargin</i>	103
–	<i>RxTxTEG-TimingErrorMargin</i>	103
6.5	Positioning Method IEs	103
6.5.1	OTDOA Positioning	103
6.5.1.1	OTDOA Assistance Data	104
–	<i>OTDOA-ProvideAssistanceData</i>	104
6.5.1.2	OTDOA Assistance Data Elements	104
–	<i>OTDOA-ReferenceCellInfo</i>	104
–	<i>PRS-Info</i>	106
–	<i>TDD-Config</i>	107
–	<i>OTDOA-NeighbourCellInfoList</i>	108
–	<i>OTDOA-ReferenceCellInfoNB</i>	111
–	<i>PRS-Info-NB</i>	113
–	<i>OTDOA-NeighbourCellInfoListNB</i>	116
6.5.1.3	OTDOA Assistance Data Request	119
–	<i>OTDOA-RequestAssistanceData</i>	119
6.5.1.4	OTDOA Location Information	119
–	<i>OTDOA-ProvideLocationInformation</i>	119
6.5.1.5	OTDOA Location Information Elements	120
–	<i>OTDOA-SignalMeasurementInformation</i>	120
–	<i>OTDOA-SignalMeasurementInformation-NB</i>	123
–	<i>OTDOA-MeasQuality</i>	125
–	<i>AdditionalPath</i>	126
6.5.1.6	OTDOA Location Information Request	126

–	<i>OTDOA-RequestLocationInformation</i>	126
6.5.1.7	<i>OTDOA Capability Information</i>	127
–	<i>OTDOA-ProvideCapabilities</i>	127
6.5.1.8	<i>OTDOA Capability Information Request</i>	130
–	<i>OTDOA-RequestCapabilities</i>	130
6.5.1.9	<i>OTDOA Error Elements</i>	130
–	<i>OTDOA-Error</i>	130
–	<i>OTDOA-LocationServerErrorCauses</i>	130
–	<i>OTDOA-TargetDeviceErrorCauses</i>	131
6.5.2	<i>A-GNSS Positioning</i>	131
6.5.2.1	<i>GNSS Assistance Data</i>	131
–	<i>A-GNSS-ProvideAssistanceData</i>	131
–	<i>GNSS-CommonAssistData</i>	131
–	<i>GNSS-GenericAssistData</i>	132
–	<i>GNSS-PeriodicAssistData</i>	133
6.5.2.2	<i>GNSS Assistance Data Elements</i>	134
–	<i>GNSS-ReferenceTime</i>	134
–	<i>GNSS-SystemTime</i>	135
–	<i>GPS-TOW-Assist</i>	136
–	<i>NetworkTime</i>	136
–	<i>GNSS-ReferenceLocation</i>	139
–	<i>GNSS-IonosphericModel</i>	139
–	<i>KlobucharModelParameter</i>	139
–	<i>KlobucharModel2Parameter</i>	140
–	<i>NeQuickModelParameter</i>	141
–	<i>GNSS-EarthOrientationParameters</i>	141
–	<i>GNSS-RTK-ReferenceStationInfo</i>	142
–	<i>GNSS-RTK-CommonObservationInfo</i>	144
–	<i>GNSS-RTK-AuxiliaryStationData</i>	145
–	<i>GNSS-SSR-CorrectionPoints</i>	147
–	<i>GNSS-Integrity-ServiceParameters</i>	148
–	<i>GNSS-Integrity-ServiceAlert</i>	148
–	<i>GNSS-TimeModelList</i>	149
–	<i>GNSS-DifferentialCorrections</i>	150
–	<i>GNSS-NavigationModel</i>	153
–	<i>StandardClockModelList</i>	155
–	<i>NAV-ClockModel</i>	156
–	<i>CNAV-ClockModel</i>	156
–	<i>GLONASS-ClockModel</i>	157
–	<i>SBAS-ClockModel</i>	158
–	<i>BDS-ClockModel</i>	158
–	<i>BDS-ClockModel2</i>	159
–	<i>NavIC-ClockModel</i>	160
–	<i>NavModelKeplerianSet</i>	160
–	<i>NavModelNAV-KeplerianSet</i>	162
–	<i>NavModelCNAV-KeplerianSet</i>	163
–	<i>NavModel-GLONASS-ECEF</i>	164
–	<i>NavModel-SBAS-ECEF</i>	165
–	<i>NavModel-BDS-KeplerianSet</i>	166
–	<i>NavModel-BDS-KeplerianSet2</i>	168
–	<i>NavModel-NavIC-KeplerianSet</i>	170
–	<i>GNSS-RealTimeIntegrity</i>	171
–	<i>GNSS-DataBitAssistance</i>	172
–	<i>GNSS-AcquisitionAssistance</i>	173
–	<i>GNSS-Almanac</i>	176
–	<i>AlmanacKeplerianSet</i>	177
–	<i>AlmanacNAV-KeplerianSet</i>	178
–	<i>AlmanacReducedKeplerianSet</i>	179
–	<i>AlmanacMidiAlmanacSet</i>	180
–	<i>AlmanacGLONASS-AlmanacSet</i>	181
–	<i>AlmanacECEF-SBAS-AlmanacSet</i>	182
–	<i>AlmanacBDS-AlmanacSet</i>	183

–	<i>AlmanacNavIC-AlmanacSet</i>	184
–	<i>GNSS-UTC-Model</i>	185
–	<i>UTC-ModelSet1</i>	186
–	<i>UTC-ModelSet2</i>	186
–	<i>UTC-ModelSet3</i>	187
–	<i>UTC-ModelSet4</i>	187
–	<i>UTC-ModelSet5</i>	188
–	<i>GNSS-AuxiliaryInformation</i>	189
–	<i>BDS-DifferentialCorrections</i>	190
–	<i>BDS-GridModelParameter</i>	191
–	<i>GNSS-RTK-Observations</i>	191
–	<i>GLO-RTK-BiasInformation</i>	194
–	<i>GNSS-RTK-MAC-CorrectionDifferences</i>	195
–	<i>GNSS-RTK-Residuals</i>	197
–	<i>GNSS-RTK-FKP-Gradients</i>	198
–	<i>GNSS-SSR-OrbitCorrections</i>	200
–	<i>GNSS-SSR-ClockCorrections</i>	203
–	<i>GNSS-SSR-CodeBias</i>	205
–	<i>GNSS-SSR-URA</i>	206
–	<i>GNSS-SSR-PhaseBias</i>	207
–	<i>GNSS-SSR-STECCorrection</i>	209
–	<i>GNSS-SSR-GriddedCorrection</i>	213
–	<i>NavIC-DifferentialCorrections</i>	218
–	<i>NavIC-GridModelParameter</i>	219
–	<i>GNSS-SSR-OrbitCorrectionsSet2</i>	220
–	<i>GNSS-SSR-ClockCorrectionsSet2</i>	221
–	<i>GNSS-SSR-URA-Set2</i>	221
6.5.2.3	<i>GNSS Assistance Data Request</i>	222
–	<i>A-GNSS-RequestAssistanceData</i>	222
–	<i>GNSS-CommonAssistDataReq</i>	222
–	<i>GNSS-GenericAssistDataReq</i>	223
–	<i>GNSS-PeriodicAssistDataReq</i>	225
6.5.2.4	<i>GNSS Assistance Data Request Elements</i>	226
–	<i>GNSS-ReferenceTimeReq</i>	226
–	<i>GNSS-ReferenceLocationReq</i>	227
–	<i>GNSS-IonosphericModelReq</i>	227
–	<i>GNSS-EarthOrientationParametersReq</i>	227
–	<i>GNSS-RTK-ReferenceStationInfoReq</i>	228
–	<i>GNSS-RTK-AuxiliaryStationDataReq</i>	228
–	<i>GNSS-SSR-CorrectionPointsReq</i>	228
–	<i>GNSS-Integrity-ServiceParametersReq</i>	229
–	<i>GNSS-Integrity-ServiceAlertReq</i>	229
–	<i>GNSS-TimeModelListReq</i>	229
–	<i>GNSS-DifferentialCorrectionsReq</i>	229
–	<i>GNSS-NavigationModelReq</i>	230
–	<i>GNSS-RealTimeIntegrityReq</i>	232
–	<i>GNSS-DataBitAssistanceReq</i>	232
–	<i>GNSS-AcquisitionAssistanceReq</i>	233
–	<i>GNSS-AlmanacReq</i>	233
–	<i>GNSS-UTC-ModelReq</i>	233
–	<i>GNSS-AuxiliaryInformationReq</i>	234
–	<i>BDS-DifferentialCorrectionsReq</i>	234
–	<i>BDS-GridModelReq</i>	234
–	<i>GNSS-RTK-ObservationsReq</i>	235
–	<i>GLO-RTK-BiasInformationReq</i>	235
–	<i>GNSS-RTK-MAC-CorrectionDifferencesReq</i>	235
–	<i>GNSS-RTK-ResidualsReq</i>	236
–	<i>GNSS-RTK-FKP-GradientsReq</i>	236
–	<i>GNSS-SSR-OrbitCorrectionsReq</i>	237
–	<i>GNSS-SSR-ClockCorrectionsReq</i>	237
–	<i>GNSS-SSR-CodeBiasReq</i>	238
–	<i>GNSS-SSR-URA-Req</i>	238

–	<i>GNSS-SSR-PhaseBiasReq</i>	238
–	<i>GNSS-SSR-STECCorrectionReq</i>	239
–	<i>GNSS-SSR-GriddedCorrectionReq</i>	239
–	<i>NavIC-DifferentialCorrectionsReq</i>	239
–	<i>NavIC-GridModelReq</i>	240
–	<i>GNSS-SSR-OrbitCorrectionsSet2Req</i>	240
–	<i>GNSS-SSR-ClockCorrectionsSet2Req</i>	240
–	<i>GNSS-SSR-URA-Set2Req</i>	241
6.5.2.5	GNSS Location Information	241
–	<i>A-GNSS-ProvideLocationInformation</i>	241
6.5.2.6	GNSS Location Information Elements	241
–	<i>GNSS-SignalMeasurementInformation</i>	241
–	<i>MeasurementReferenceTime</i>	242
–	<i>GNSS-MeasurementList</i>	244
–	<i>GNSS-LocationInformation</i>	248
–	<i>HA-GNSS-Metrics</i>	249
6.5.2.7	GNSS Location Information Request	249
–	<i>A-GNSS-RequestLocationInformation</i>	249
6.5.2.8	GNSS Location Information Request Elements	250
–	<i>GNSS-PositioningInstructions</i>	250
6.5.2.9	GNSS Capability Information	250
–	<i>A-GNSS-ProvideCapabilities</i>	250
6.5.2.10	GNSS Capability Information Elements	253
–	<i>GNSS-CommonAssistanceDataSupport</i>	253
–	<i>GNSS-ReferenceTimeSupport</i>	253
–	<i>GNSS-ReferenceLocationSupport</i>	254
–	<i>GNSS-IonosphericModelSupport</i>	254
–	<i>GNSS-EarthOrientationParametersSupport</i>	254
–	<i>GNSS-RTK-ReferenceStationInfoSupport</i>	254
–	<i>GNSS-RTK-AuxiliaryStationDataSupport</i>	255
–	<i>GNSS-Integrity-ServiceParametersSupport</i>	255
–	<i>GNSS-Integrity-ServiceAlertSupport</i>	255
–	<i>GNSS-GenericAssistanceDataSupport</i>	255
–	<i>GNSS-TimeModelListSupport</i>	257
–	<i>GNSS-DifferentialCorrectionSupport</i>	257
–	<i>GNSS-NavigationModelSupport</i>	258
–	<i>GNSS-RealTimeIntegritySupport</i>	259
–	<i>GNSS-DataBitAssistanceSupport</i>	259
–	<i>GNSS-AcquisitionAssistanceSupport</i>	259
–	<i>GNSS-AlmanacSupport</i>	259
–	<i>GNSS-UTC-ModelSupport</i>	260
–	<i>GNSS-AuxiliaryInformationSupport</i>	260
–	<i>BDS-DifferentialCorrectionsSupport</i>	260
–	<i>BDS-GridModelSupport</i>	261
–	<i>GNSS-RTK-ObservationsSupport</i>	261
–	<i>GLO-RTK-BiasInformationSupport</i>	261
–	<i>GNSS-RTK-MAC-CorrectionDifferencesSupport</i>	261
–	<i>GNSS-RTK-ResidualsSupport</i>	262
–	<i>GNSS-RTK-FKP-GradientsSupport</i>	262
–	<i>GNSS-SSR-OrbitCorrectionsSupport</i>	262
–	<i>GNSS-SSR-ClockCorrectionsSupport</i>	262
–	<i>GNSS-SSR-URA-Support</i>	263
–	<i>GNSS-SSR-STECCorrectionSupport</i>	264
–	<i>GNSS-SSR-GriddedCorrectionSupport</i>	264
–	<i>NavIC-DifferentialCorrectionsSupport</i>	264
–	<i>NavIC-GridModelSupport</i>	264
–	<i>GNSS-SSR-OrbitCorrectionsSet2Support</i>	265
–	<i>GNSS-SSR-ClockCorrectionsSet2Support</i>	265
–	<i>GNSS-SSR-URA-Set2Support</i>	265
6.5.2.11	GNSS Capability Information Request	265
–	<i>A-GNSS-RequestCapabilities</i>	265
6.5.2.12	GNSS Error Elements	266

–	<i>A-GNSS-Error</i>	266
–	<i>GNSS-LocationServerErrorCauses</i>	266
–	<i>GNSS-TargetDeviceErrorCauses</i>	266
6.5.2.13	Common GNSS Information Elements	267
–	<i>GNSS-FrequencyID</i>	267
–	<i>GNSS-ID</i>	268
–	<i>GNSS-ID-Bitmap</i>	268
–	<i>GNSS-Link-CombinationsList</i>	268
–	<i>GNSS-NavListInfo</i>	268
–	<i>GNSS-NetworkID</i>	269
–	<i>GNSS-PeriodicControlParam</i>	269
–	<i>GNSS-ReferenceStationID</i>	269
–	<i>GNSS-SignalID</i>	270
–	<i>GNSS-SignalIDs</i>	272
–	<i>GNSS-SubNetworkID</i>	273
–	<i>SBAS-ID</i>	273
–	<i>SBAS-IDs</i>	273
–	<i>SV-ID</i>	273
6.5.3	Enhanced Cell ID Positioning	274
6.5.3.1	E-CID Location Information	274
–	<i>ECID-ProvideLocationInformation</i>	274
6.5.3.2	E-CID Location Information Elements	274
–	<i>ECID-SignalMeasurementInformation</i>	274
6.5.3.3	E-CID Location Information Request	276
–	<i>ECID-RequestLocationInformation</i>	276
6.5.3.4	E-CID Capability Information	276
–	<i>ECID-ProvideCapabilities</i>	276
6.5.3.5	E-CID Capability Information Request	277
–	<i>ECID-RequestCapabilities</i>	277
6.5.3.6	E-CID Error Elements	277
–	<i>ECID-Error</i>	277
–	<i>ECID-LocationServerErrorCauses</i>	278
–	<i>ECID-TargetDeviceErrorCauses</i>	278
6.5.4	Terrestrial Beacon System Positioning	278
6.5.4.1	TBS Location Information	278
–	<i>TBS-ProvideLocationInformation</i>	278
6.5.4.2	TBS Location Information Elements	279
–	<i>TBS-MeasurementInformation</i>	279
–	<i>MBS-BeaconMeasList</i>	279
6.5.4.3	TBS Location Information Request	280
–	<i>TBS-RequestLocationInformation</i>	280
6.5.4.4	TBS Capability Information	280
–	<i>TBS-ProvideCapabilities</i>	280
–	<i>MBS-AssistanceDataSupportList</i>	281
6.5.4.5	TBS Capability Information Request	282
–	<i>TBS-RequestCapabilities</i>	282
6.5.4.6	TBS Error Elements	282
–	<i>TBS-Error</i>	282
–	<i>TBS-LocationServerErrorCauses</i>	282
–	<i>TBS-TargetDeviceErrorCauses</i>	282
6.5.4.7	TBS Assistance Data	283
–	<i>TBS-ProvideAssistanceData</i>	283
6.5.4.8	TBS Assistance Data Elements	283
–	<i>TBS-AssistanceDataList</i>	283
–	<i>MBS-AlmanacAssistance</i>	283
–	<i>MBS-AcquisitionAssistance</i>	284
6.5.4.9	TBS Assistance Data Request	284
–	<i>TBS-RequestAssistanceData</i>	284
6.5.5	Sensor based Positioning	285
6.5.5.0	Introduction	285
6.5.5.1	Sensor Location Information	285
–	<i>Sensor-ProvideLocationInformation</i>	285

6.5.5.2	Sensor Location Information Elements	285
–	<i>Sensor-MeasurementInformation</i>	285
–	<i>Sensor-MotionInformation</i>	286
6.5.5.3	Sensor Location Information Request	287
–	<i>Sensor-RequestLocationInformation</i>	287
6.5.5.4	Sensor Capability Information	288
–	<i>Sensor-ProvideCapabilities</i>	288
6.5.5.5	Sensor Capability Information Request	289
–	<i>Sensor-RequestCapabilities</i>	289
6.5.5.6	Sensor Error Elements	289
–	<i>Sensor-Error</i>	289
–	<i>Sensor-LocationServerErrorCauses</i>	289
–	<i>Sensor-TargetDeviceErrorCauses</i>	290
6.5.5.7	Sensor Assistance Data	290
–	<i>Sensor-ProvideAssistanceData</i>	290
6.5.5.8	Sensor Assistance Data Elements	290
–	<i>Sensor-AssistanceDataList</i>	290
6.5.5.9	Sensor Assistance Data Request	291
–	<i>Sensor-RequestAssistanceData</i>	291
6.5.6	WLAN-based Positioning	292
6.5.6.1	WLAN Location Information	292
–	<i>WLAN-ProvideLocationInformation</i>	292
6.5.6.2	WLAN Location Information Elements	292
–	<i>WLAN-MeasurementInformation</i>	292
6.5.6.3	WLAN Location Information Request	293
–	<i>WLAN-RequestLocationInformation</i>	293
6.5.6.4	WLAN Capability Information	294
–	<i>WLAN-ProvideCapabilities</i>	294
6.5.6.5	WLAN Capability Information Request	295
–	<i>WLAN-RequestCapabilities</i>	295
6.5.6.6	WLAN Error Elements	295
–	<i>WLAN-Error</i>	295
–	<i>WLAN-LocationServerErrorCauses</i>	295
–	<i>WLAN-TargetDeviceErrorCauses</i>	296
6.5.7	Bluetooth-based Positioning	299
6.5.7.1	Bluetooth Location Information	299
–	<i>BT-ProvideLocationInformation</i>	299
6.5.7.2	Bluetooth Location Information Elements	299
–	<i>BT-MeasurementInformation</i>	299
6.5.7.3	Bluetooth Location Information Request	300
–	<i>BT-RequestLocationInformation</i>	300
6.5.7.4	Bluetooth Capability Information	300
–	<i>BT-ProvideCapabilities</i>	300
6.5.7.5	Bluetooth Capability Information Request	301
–	<i>BT-RequestCapabilities</i>	301
6.5.7.6	BT Error Elements	301
–	<i>BT-Error</i>	301
–	<i>BT-LocationServerErrorCauses</i>	301
–	<i>BT-TargetDeviceErrorCauses</i>	302
6.5.8	NR UL Positioning	302
6.5.8.1	NR UL Capability Information	302
–	<i>NR-UL-ProvideCapabilities</i>	302
6.5.8.2	NR UL Capability Information Request	303
–	<i>NR-UL-RequestCapabilities</i>	303
6.5.9	NR E-CID Positioning	303
6.5.9.1	NR E-CID Location Information	303
–	<i>NR-ECID-ProvideLocationInformation</i>	303
6.5.9.2	NR E-CID Location Information Elements	303
–	<i>NR-ECID-SignalMeasurementInformation</i>	303
6.5.9.3	NR E-CID Location Information Request	304
–	<i>NR-ECID-RequestLocationInformation</i>	304
6.5.9.4	NR E-CID Capability Information	305

–	<i>NR-ECID-ProvideCapabilities</i>	305
6.5.9.5	NR E-CID Capability Information Request	305
–	<i>NR-ECID-RequestCapabilities</i>	305
6.5.9.6	NR E-CID Error Elements	306
–	<i>NR-ECID-Error</i>	306
–	<i>NR-ECID-LocationServerErrorCauses</i>	306
–	<i>NR-ECID-TargetDeviceErrorCauses</i>	306
6.5.10	NR DL-TDOA Positioning	307
6.5.10.1	NR DL-TDOA Assistance Data	307
–	<i>NR-DL-TDOA-ProvideAssistanceData</i>	307
6.5.10.2	NR DL-TDOA Assistance Data Request	308
–	<i>NR-DL-TDOA-RequestAssistanceData</i>	308
6.5.10.3	NR DL-TDOA Location Information	309
–	<i>NR-DL-TDOA-ProvideLocationInformation</i>	309
6.5.10.4	NR DL-TDOA Location Information Elements.....	309
–	<i>NR-DL-TDOA-SignalMeasurementInformation</i>	309
–	<i>NR-DL-TDOA-LocationInformation</i>	312
6.5.10.5	NR DL-TDOA Location Information Request.....	313
–	<i>NR-DL-TDOA-RequestLocationInformation</i>	313
6.5.10.6	NR DL-TDOA Capability Information.....	314
–	<i>NR-DL-TDOA-ProvideCapabilities</i>	314
6.5.10.6a	NR DL-TDOA Capability Information Elements	316
–	<i>NR-DL-TDOA-MeasurementCapability</i>	316
6.5.10.7	NR DL-TDOA Capability Information Request	317
–	<i>NR-DL-TDOA-RequestCapabilities</i>	317
6.5.10.8	NR DL-TDOA Error Elements	317
–	<i>NR-DL-TDOA-Error</i>	317
–	<i>NR-DL-TDOA-LocationServerErrorCauses</i>	318
–	<i>NR-DL-TDOA-TargetDeviceErrorCauses</i>	318
6.5.11	NR DL-AoD Positioning	318
6.5.11.1	NR DL-AoD Assistance Data	318
–	<i>NR-DL-AoD-ProvideAssistanceData</i>	318
6.5.11.2	NR DL-AoD Assistance Data Request	319
–	<i>NR-DL-AoD-RequestAssistanceData</i>	319
6.5.11.3	NR DL-AoD Location Information.....	320
–	<i>NR-DL-AoD-ProvideLocationInformation</i>	320
6.5.11.4	NR DL-AoD Location Information Elements.....	321
–	<i>NR-DL-AoD-SignalMeasurementInformation</i>	321
–	<i>NR-DL-AoD-LocationInformation</i>	323
6.5.11.5	NR DL-AoD Location Information Request.....	323
–	<i>NR-DL-AoD-RequestLocationInformation</i>	323
6.5.11.6	NR DL-AoD Capability Information	324
–	<i>NR-DL-AoD-ProvideCapabilities</i>	324
6.5.11.6a	NR DL-AoD Capability Information Elements	326
–	<i>NR-DL-AoD-MeasurementCapability</i>	326
6.5.11.7	NR DL-AoD Capability Information Request	327
–	<i>NR-DL-AoD-RequestCapabilities</i>	327
6.5.11.8	NR DL-AoD Error Elements.....	327
–	<i>NR-DL-AoD-Error</i>	327
–	<i>NR-DL-AoD-LocationServerErrorCauses</i>	328
–	<i>NR-DL-AoD-TargetDeviceErrorCauses</i>	328
6.5.12	NR Multi-RTT Positioning	328
6.5.12.1	NR Multi-RTT Assistance Data	328
–	<i>NR-Multi-RTT-ProvideAssistanceData</i>	328
6.5.12.2	NR Multi-RTT Assistance Data Request	329
–	<i>NR-Multi-RTT-RequestAssistanceData</i>	329
6.5.12.3	NR Multi-RTT Location Information	330
–	<i>NR-Multi-RTT-ProvideLocationInformation</i>	330
6.5.12.4	NR Multi-RTT Location Information Elements.....	330
–	<i>NR-Multi-RTT-SignalMeasurementInformation</i>	330
6.5.12.5	NR Multi-RTT Location Information Request.....	334
–	<i>NR-Multi-RTT-RequestLocationInformation</i>	334

6.5.12.6	NR Multi-RTT Capability Information	335
–	<i>NR-Multi-RTT-ProvideCapabilities</i>	335
6.5.12.6a	NR Multi-RTT Capability Information Elements	337
–	<i>NR-Multi-RTT-MeasurementCapability</i>	337
6.5.12.7	NR Multi-RTT Capability Information Request	338
–	<i>NR-Multi-RTT-RequestCapabilities</i>	338
6.5.12.8	NR Multi-RTT Error Elements	339
–	<i>NR-Multi-RTT-Error</i>	339
–	<i>NR-Multi-RTT-LocationServerErrorCauses</i>	339
–	<i>NR-Multi-RTT-TargetDeviceErrorCauses</i>	339
6.6	Multiplicity and type constraint values	340
–	<i>Multiplicity and type constraint definitions</i>	340
–	<i>End of LPP-PDU-Definitions</i>	340
7	Broadcast of assistance data	341
7.1	General	341
7.2	Mapping of <i>posSibType</i> to assistance data element.....	341
7.3	Procedures related to broadcast information elements	342
7.4	Broadcast information elements	344
7.4.1	Basic production	344
–	<i>LPP-Broadcast-Definitions</i>	344
7.4.2	Element definitions	344
–	<i>AssistanceDataSIBelement</i>	344
–	<i>OTDOA-UE-Assisted</i>	345
–	<i>NR-UEB-TRP-LocationData</i>	346
–	<i>NR-UEB-TRP-RTD-Info</i>	346
–	<i>End of LPP-Broadcast-Definitions</i>	346
7.5	Broadcast ciphering (informative).....	346
Annex A (informative):	Change History	349
History		354

Foreword

This Technical Specification has been produced by the 3rd Generation Partnership Project (3GPP).

The contents of the present document are subject to continuing work within the TSG and may change following formal TSG approval. Should the TSG modify the contents of the present document, it will be re-released by the TSG with an identifying change of release date and an increase in version number as follows:

Version x.y.z

where:

- x the first digit:
 - 1 presented to TSG for information;
 - 2 presented to TSG for approval;
 - 3 or greater indicates TSG approved document under change control.
- y the second digit is incremented for all changes of substance, i.e. technical enhancements, corrections, updates, etc.
- z the third digit is incremented when editorial only changes have been incorporated in the document.

1 Scope

The present document contains the definition of the LTE Positioning Protocol (LPP) for the radio access technologies E-UTRA/LTE and NR.

2 References

The following documents contain provisions which, through reference in this text, constitute provisions of the present document.

- References are either specific (identified by date of publication, edition number, version number, etc.) or non specific.
- For a specific reference, subsequent revisions do not apply.
- For a non-specific reference, the latest version applies. In the case of a reference to a 3GPP document (including a GSM document), a non-specific reference implicitly refers to the latest version of that document *in the same Release as the present document*.

- [1] 3GPP TR 21.905: "Vocabulary for 3GPP Specifications".
- [2] 3GPP TS 36.305: "Stage 2 functional specification of User Equipment (UE) positioning in E-UTRAN".
- [3] 3GPP TS 23.271: "Functional stage 2 description of Location Services (LCS)".
- [4] IS-GPS-200, Revision D, Navstar GPS Space Segment/Navigation User Interfaces, March 7th, 2006.
- [5] IS-GPS-705, Navstar GPS Space Segment/User Segment L5 Interfaces, September 22, 2005.
- [6] IS-GPS-800, Navstar GPS Space Segment/User Segment L1C Interfaces, September 4, 2008.
- [7] IS-QZSS, Quasi Zenith Satellite System Navigation Service Interface Specifications for QZSS, Ver.1.1, July 31, 2009.
- [8] Galileo OS Signal in Space ICD (OS SIS ICD), Issue 1.2, February 2014, European Union.
- [9] Global Navigation Satellite System GLONASS Interface Control Document, Version 5.1, 2008.
- [10] Specification for the Wide Area Augmentation System (WAAS), US Department of Transportation, Federal Aviation Administration, DTFA01-96-C-00025, 2001.
- [11] RTCM-SC104, RTCM Recommended Standards for Differential GNSS Service (v.2.3), August 20, 2001.
- [12] 3GPP TS 36.331: "Evolved Universal Terrestrial Radio Access (E-UTRA); "Radio Resource Control (RRC); Protocol specification".
- [13] 3GPP TS 25.331: "Radio Resource Control (RRC); Protocol Specification".
- [14] 3GPP TS 44.031: "Location Services (LCS); Mobile Station (MS) - Serving Mobile Location Centre (SMLC) Radio Resource LCS Protocol (RRLP)".
- [15] 3GPP TS 23.032: "Universal Geographical Area Description (GAD)".
- [16] 3GPP TS 36.211: "Evolved Universal Terrestrial Radio Access (E-UTRA); Physical Channels and Modulation".
- [17] 3GPP TS 36.214: "Evolved Universal Terrestrial Radio Access (E-UTRA); Physical layer – Measurements".

- [18] 3GPP TS 36.133: "Evolved Universal Terrestrial Radio Access (E-UTRA); Requirements for support of radio resource management".
- [19] 3GPP TS 23.003: "Numbering, addressing and identification".
- [20] OMA-TS-LPPe-V1_0, LPP Extensions Specification, Open Mobile Alliance.
- [21] 3GPP TS 36.101: "Evolved Universal Terrestrial Radio Access (E-UTRA); User Equipment (UE) radio transmission and reception".
- [22] ITU-T Recommendation X.691 (07/2002) "Information technology - ASN.1 encoding rules: Specification of Packed Encoding Rules (PER)" (Same as the ISO/IEC International Standard 8825-2).
- [23] BDS-SIS-ICD-B1I-3.0: "BeiDou Navigation Satellite System Signal In Space Interface Control Document Open Service Signal B1I (Version 3.0)", February, 2019.
- [24] ATIS-0500027: "Recommendations for Establishing Wide Scale Indoor Location Performance", May 2015.
- [25] Bluetooth Special Interest Group: "Bluetooth Core Specification v4.2", December 2014.
- [26] IEEE 802.11, Part 11: "Wireless LAN Medium Access Control (MAC) and Physical Layer (PHY) Specifications".
- [27] IETF RFC 6225, "Dynamic Host Configuration Protocol Options for Coordinate-Based Location Configuration Information", July 2011.
- [28] 3GPP TS 36.213: "Evolved Universal Terrestrial Radio Access (E-UTRA); Physical layer procedures".
- [29] "Earth Gravitational Model 96 (EGM96)", National Geospatial-Intelligence Agency, NASA.
- [30] RTCM Standard 10403.3: "Differential GNSS (Global Navigation Satellite Systems) Services" – Version 3, October 7, 2016.
- [31] IGS ANTEX: "The Antenna Exchanged Format" – version 1.4, September 15, 2010.
- [32] Federal Information Processing Standards Publication 197, "Specification for the ADVANCED ENCRYPTION STANDARD (AES)", November 26, 2001.
- [33] NIST Special Publication 800-38A, "Recommendation for Block Cipher Modes of Operation Methods and Techniques", 2001.
- [34] 3GPP TS 38.101-2: "NR; User Equipment (UE) radio transmission and reception; Part 2: Range 2 Standalone".
- [35] 3GPP TS 38.331: "NR; Radio Resource Control (RRC); Protocol specification".
- [36] 3GPP TS 38.215: "NR; Physical layer measurements".
- [37] 3GPP TS 38.101-1: "NR; User Equipment (UE) radio transmission and reception; Part 1: Range 1 Standalone".
- [38] IRNSS Signal-In-Space (SPS) Interface Control Document (ICD) for standard positioning service version 1.1, Aug 2017.
- [39] BDS-SIS-ICD-B1C-1.0: "BeiDou Navigation Satellite System Signal In Space Interface Control Document Open Service Signal B1C (Version 1.0)", December, 2017.
- [40] 3GPP TS 38.305: "NG Radio Access Network (NG-RAN); Stage 2 functional specification of User Equipment (UE) positioning in NG-RAN".
- [41] 3GPP TS 38.211: "3rd Generation Partnership Project; Technical Specification Group Radio Access Network; NR; Physical channels and modulation".
- [42] 3GPP TS 23.273: "5G System (5GS) Location Services (LCS); Stage 2".

- [43] IS-QZSS-L6-001, Quasi-Zenith Satellite System Interface Specification – Centimetre Level Augmentation Service, Cabinet Office, November 5, 2018.
- [44] 3GPP TR 38.901: "Technical Specification Group Radio Access Network; Study on channel model for frequencies from 0.5 to 100 GHz".
- [45] 3GPP TS 38.214: "NR; Physical layer procedures for data".
- [46] 3GPP TS 38.133: "NR; Requirements for support of radio resource management".
- [47] 3GPP TS 38.300: "NR; NR and NG-RAN Overall Description; Stage 2".
- [48] 3GPP TS 38.213: "NR; Physical layer procedures for control".
- [49] BDS-SIS-ICD-B2a-1.0: "BeiDou Navigation Satellite System Signal In Space Interface Control Document Open Service Signal B2a (Version 1.0)", December, 2017.
- [50] BDS-SIS-ICD-B3I-1.0: "BeiDou Navigation Satellite System Signal In Space Interface Control Document Open Service Signal B3I (Version 1.0)", February, 2018.
- [51] NMEA standard 0183, Version 4.11, November 2018.
- [52] BDS-SIS-ICD-PPP-B2b-1.0: "BeiDou Navigation Satellite System Signal In Space Interface Control Document Precise Point Positioning Service Signal PPP-B2b (Version 1.0)", July, 2020.

3 Definitions and Abbreviations

3.1 Definitions

For the purposes of the present document, the terms and definitions given in TR 21.905 [1], TS 36.305 [2], TS 23.271 [3], 38.305 [40] and TS 23.273 [42] apply. Other definitions are provided below.

Anchor carrier: In NB-IoT, a carrier where the UE assumes that NPSS/NSSS/NPBCH/SIB-NB for FDD or NPSS/NSSS/NPBCH for TDD are transmitted.

Location Server: a physical or logical entity (e.g., E-SMLC, SUPL SLP, or LMF) that manages positioning for a target device by obtaining measurements and other location information from one or more positioning units and providing assistance data to positioning units to help determine this. A Location Server may also compute or verify the final location estimate.

NB-IoT: NB-IoT allows access to network services via E-UTRA with a channel bandwidth limited to 200 kHz.

Observed Time Difference Of Arrival (OTDOA): The time interval that is observed by a target device between the reception of downlink signals from two different TPs. If a signal from TP 1 is received at the moment t_1 , and a signal from TP 2 is received at the moment t_2 , the OTDOA is $t_2 - t_1$.

PRS-only TP: A TP which only transmits PRS signals or DL-PRS for PRS-based TBS positioning and is not associated with a cell.

Reference Source: a physical entity or part of a physical entity that provides signals (e.g., RF, acoustic, infra-red) that can be measured (e.g., by a Target Device) in order to obtain the location of a Target Device.

Relative Time Difference (RTD): The relative time difference between a TRP i and a TRP j , is defined as $t_j - t_i$, where t_i and t_j are defined as the time when TRP i and j transmit the start of one subframe respectively.

Rx Time Delay: From a signal reception perspective, there will be a time delay from the time when the RF signal arrives at the Rx antenna to the time when the signal is digitized and time-stamped at the baseband.

Rx Timing Error: Result of Rx Time Delay involved in the reception of a signal before reporting measurements that are obtained from the signal. It is the uncalibrated Rx Time Delay, or the remaining delay after the UE/TRP internal calibration/compensation of the Rx Time Delay, involved in the reception of the DL-PRS/UL SRS signals. The calibration/compensation may also include the calibration/compensation of the relative time delay between different RF

chains in the same UE/TRP and may also possibly consider the offset of the Rx antenna phase centre to the physical antenna centre.

Target Device: the device that is being positioned (e.g., UE or SUPL SET).

Transmission Point (TP): A set of geographically co-located transmit antennas (e.g. antenna array (with one or more antenna elements)) for one cell, part of one cell or one PRS-only TP. Transmission Points can include base station (eNodeB) antennas, remote radio heads, a remote antenna of a base station, an antenna of a PRS-only TP, etc. One cell can be formed by one or multiple transmission points. For a homogeneous deployment, each transmission point may correspond to one cell.

Transmission-Reception Point (TRP): A set of geographically co-located antennas (e.g. antenna array (with one or more antenna elements)) supporting TP and/or RP functionality.

TRP Tx Timing Error Group (TRP Tx TEG): Tx Timing Errors, associated with TRP transmissions on one or more DL-PRS Resources, that are within a certain margin.

Tx Time Delay: From a signal transmission perspective, the time delay from the time when the digital signal is generated at baseband to the time when the RF signal is transmitted from the Tx antenna.

Tx Timing Error: Result of Tx Time Delay involved in the transmission of a signal. It is the uncalibrated Tx Time Delay, or the remaining delay after the TRP/UE internal calibration/compensation of the Tx Time Delay, involved in the transmission of the DL-PRS/UL SRS signals. The calibration/compensation may also include the calibration/compensation of the relative time delay between different RF chains in the same TRP/UE and may also possibly consider the offset of the Tx antenna phase centre to the physical antenna centre.

UE Rx Timing Error Group (UE Rx TEG): Rx Timing Errors, associated with UE reporting of one or more DL measurements, that are within a certain margin.

UE RxTx Timing Error Group (UE RxTx TEG): Rx Timing Errors and Tx Timing Errors, associated with UE reporting of one or more UE Rx-Tx time difference measurements, which have the 'Rx Timing Errors + Tx Timing Errors' differences within a certain margin.

UE Tx Timing Error Group (UE Tx TEG): Tx Timing Errors, associated with UE transmissions on one or more UL SRS resources for positioning purpose, that are within a certain margin.

3.2 Abbreviations

For the purposes of the present document, the following abbreviations apply.

ADR	Accumulated Delta-Range
A-GNSS	Assisted-GNSS
AoA	Angle-of-Arrival
AoD	Angle-of-Departure
AP	Access Point
ARFCN	Absolute Radio Frequency Channel Number
ARP	Antenna Reference Point
BDS	BeiDou Navigation Satellite System
BIPM	Bureau International des Poids et Mesures (International Bureau of Weights and Measures)
BSSID	Basic Service Set Identifier
BTS	Base Transceiver Station (GERAN)
CID	Cell-ID (positioning method)
CNAV	Civil Navigation
CRS	Cell-specific Reference Signals
DL-AoD	Downlink Angle-of-Departure
DL-TDOA	Downlink Time Difference Of Arrival
ECEF	Earth-Centered, Earth-Fixed
ECGI	Evolved Cell Global Identifier
ECI	Earth-Centered-Inertial
E-CID	Enhanced Cell-ID (positioning method)
EGNOS	European Geostationary Navigation Overlay Service
E-SMLC	Enhanced Serving Mobile Location Centre
E-UTRA	Evolved Universal Terrestrial Radio Access

E-UTRAN	Evolved Universal Terrestrial Radio Access Network
EOP	Earth Orientation Parameters
EPDU	External Protocol Data Unit
FDMA	Frequency Division Multiple Access
FEC	Forward Error Correction
FKP	(German) Flächen-Korrektur-Parameter (area correction parameter)
FTA	Fine Time Assistance
GAGAN	GPS Aided Geo Augmented Navigation
GLONASS	GLObal'naya NAVigatsionnaya Sputnikovaya Sistema (Engl.: Global Navigation Satellite System)
GNSS	Global Navigation Satellite System
GPS	Global Positioning System
HA GNSS	High-Accuracy GNSS (RTK, PPP)
HPL	Horizontal Protection Level
ICD	Interface Control Document
IGS	International GNSS Service
IOD	Issue of Data
IRNSS	Indian Regional Navigation Satellite System
IS	Interface Specification
LLA	Latitude Longitude Altitude
LMF	Location Management Function
LOS	Line-of-Sight
LPP	LTE Positioning Protocol
LPPa	LTE Positioning Protocol Annex
LSB	Least Significant Bit
MAC	Master Auxiliary Concept
MBS	Metropolitan Beacon System
MG	Measurement Gap
MO-LR	Mobile Originated Location Request
MSAS	Multi-functional Satellite Augmentation System
MSB	Most Significant Bit
msd	mean solar day
MT-LR	Mobile Terminated Location Request
Multi-RTT	Multiple-Round Trip Time
NAV	Navigation
NavIC	NAVigation with Indian Constellation
NB-IoT	NarrowBand Internet of Things
NCGI	NR Cell Global Identifier
NICT	National Institute of Information and Communications Technology
NI-LR	Network Induced Location Request
NLOS	Non-Line-of-Sight
NPRS	Narrowband Positioning Reference Signals
NR	NR Radio Access
NRSRP	Narrowband Reference Signal Received Power
NRSRQ	Narrowband Reference Signal Received Quality
NTSC	National Time Service Center of Chinese Academy of Sciences
OSR	Observation Space Representation
OTDOA	Observed Time Difference Of Arrival
PBCH	Physical Broadcast Channel
PDU	Protocol Data Unit
PL	Protection Level
PPP	Precise Point Positioning
PPW	PRS Processing Window
PRB	Physical Resource Block
PRC	Pseudo-Range Correction
PRS	Positioning Reference Signals
posSIB	Positioning System Information Block
PZ-90	Parametry Zemli 1990 Goda – Parameters of the Earth Year 1990
QZS	Quasi Zenith Satellite
QZSS	Quasi-Zenith Satellite System
QZST	Quasi-Zenith System Time
RF	Radio Frequency
RP	Reception Point

RRC	Range-Rate Correction Radio Resource Control
RSRP	Reference Signal Received Power
RSRPP	Reference Signal Received Path Power
RSRQ	Reference Signal Received Quality
RSTD	Reference Signal Time Difference
RTK	Real-Time Kinematic
RTT	Round Trip Time
RU	Russia
SBAS	Space Based Augmentation System
SET	SUPL Enabled Terminal
SFN	System Frame Number
SLP	SUPL Location Platform
SRS	Sounding Reference Signal
SS	Synchronization Signal
SSB	Synchronization Signal Block, SS/PBCH Block
SSID	Service Set Identifier
SSR	State Space Representation
STEC	Slant TEC
SUPL	Secure User Plane Location
SV	Space Vehicle
TB	Terrestrial Beacon
TBS	Terrestrial Beacon System
TEC	Total Electron Content
TECU	TEC Units
TEG	Timing Error Group
TIR	Target Integrity Risk
TLM	Telemetry
TOA	Time Of Arrival
TOD	Time Of Day
TOW	Time Of Week
TP	Transmission Point
TRP	Transmission-Reception Point
UDRE	User Differential Range Error
ULP	User Plane Location Protocol
URA	User Range Accuracy
USNO	US Naval Observatory
UT1	Universal Time No.1
UTC	Coordinated Universal Time
VPL	Vertical Protection Level
WAAS	Wide Area Augmentation System
WGS-84	World Geodetic System 1984
WLAN	Wireless Local Area Network

4 Functionality of Protocol

4.1 General

4.1.1 LPP Configuration

LPP is used point-to-point between a location server (E-SMLC, LMF or SLP) and a target device (UE or SET) in order to position the target device using position-related measurements obtained by one or more reference sources. Figure 4.1.1-1 shows the configuration as applied to the control- and user-plane location solutions for E-UTRAN and NG-RAN (as defined in TS 36.305 [2], TS 38.305 [40], TS 23.273 [42] and TS 23.271 [3]).

NB-IoT is a non-backward compatible variant of E-UTRAN supporting a reduced set of functionalities. In this specification, procedures and messages specified for the UE equally apply to the UE in NB-IoT.

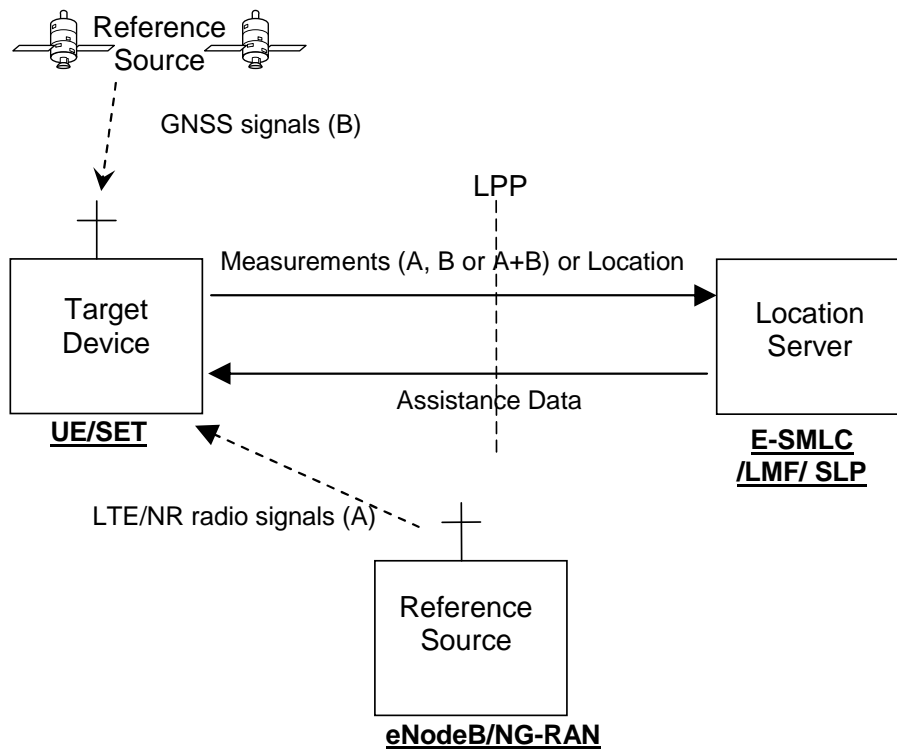

Figure 4.1.1-1: LPP Configuration for Control- and User-Plane Positioning in E-UTRAN or NG-RAN

4.1.2 LPP Sessions and Transactions

An LPP session is used between a Location Server and the target device in order to obtain location related measurements or a location estimate or to transfer assistance data. A single LPP session is used to support a single location request (e.g., for a single MT-LR, MO-LR or NI-LR). Multiple LPP sessions can be used between the same endpoints to support multiple different location requests (as required by TS 23.271 [3]). Each LPP session comprises one or more LPP transactions, with each LPP transaction performing a single operation (capability exchange, assistance data transfer, or location information transfer). In E-UTRAN and NG-RAN, the LPP transactions are realized as LPP procedures. The instigator of an LPP session will always instigate the first LPP transaction, but subsequent transactions may be instigated by either end. LPP transactions within a session may occur serially or in parallel. LPP transactions are indicated at the LPP protocol level with a transaction ID in order to associate messages with one another (e.g., request and response).

Messages within a transaction are linked by a common transaction identifier.

4.1.3 LPP Position Methods

Internal LPP positioning methods and associated signalling content are defined in this specification.

This version of the specification defines OTDOA (based on LTE signals), A-GNSS, E-CID (based on LTE signals), Sensor, TBS, WLAN, Bluetooth, NR E-CID, NR DL-TDOA, NR DL-AoD and NR Multi-RTT positioning methods.

4.1.4 LPP Messages

Each LPP transaction involves the exchange of one or more LPP messages between the location server and the target device. The general format of an LPP message consists of a set of common fields followed by a body. The body (which may be empty) contains information specific to a particular message type. Each message type contains information specific to one or more positioning methods and/or information common to all positioning methods.

The common fields are as follows:

Field	Role
Transaction ID	Identify messages belonging to the same transaction
Transaction End Flag	Indicate when a transaction (e.g. one with periodic responses) has ended
Sequence Number	Enable detection of a duplicate LPP message at a receiver
Acknowledgement	Enable an acknowledgement to be requested and/or returned for any LPP message

NOTE: Use of the Transaction ID and Transaction End fields conform to the procedures in clause 5 and are independent of the means used to transport LPP messages (e.g., whether using a NAS MO-LR Request, NAS Generic Transport or user-plane solution).

The following message types are defined:

- Request Capabilities;
- Provide Capabilities;
- Request Assistance Data;
- Provide Assistance Data;
- Request Location Information;
- Provide Location Information;
- Abort;
- Error.

4.2 Common LPP Session Procedure

The purpose of this procedure is to support an LPP session comprising a sequence of LPP transactions. The procedure is described in Figure 4.2-1.

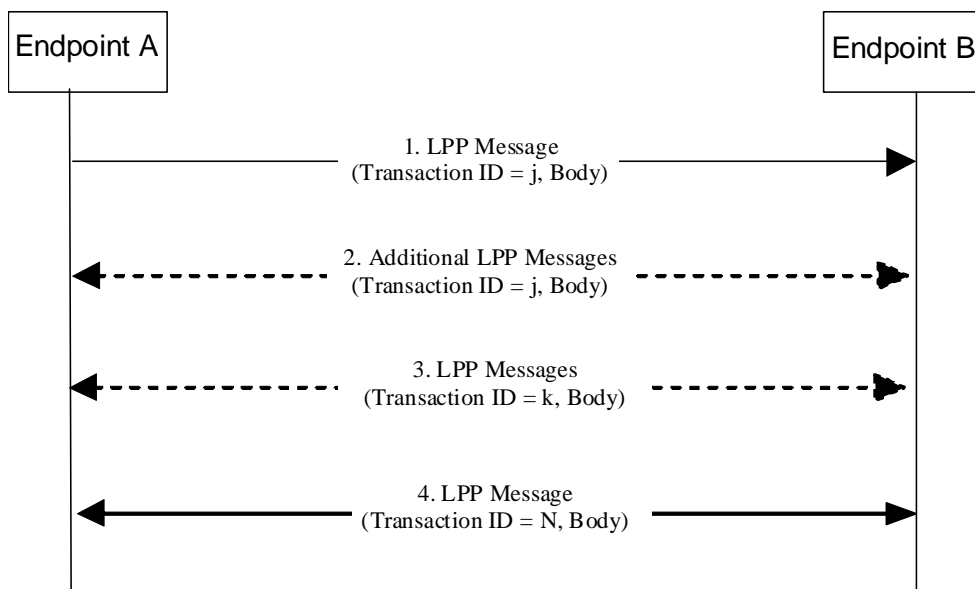

Figure 4.2-1 LPP Session Procedure

1. Endpoint A, which may be either the target or the server, initiates an LPP session by sending an LPP message for an initial LPP transaction j to the other endpoint B (which has an opposite role to A).
2. Endpoints A and B may exchange further messages to continue the transaction started in step 1.
3. Either endpoint may instigate further transactions by sending additional LPP messages.

4. A session is terminated by a final transaction N in which LPP messages will be exchanged between the two endpoints.

Within each transaction, all constituent messages shall contain the same transaction identifier. The last message sent in each transaction shall have the IE *endTransaction* set to TRUE. Transactions that occur in parallel shall use different transaction IDs; transaction IDs for completed transactions may be reused at any time after the final message of the previous transaction with the same ID is known to have been received.

4.3 LPP Transport

4.3.1 Transport Layer Requirements

LPP requires reliable, in-sequence delivery of LPP messages from the underlying transport layers. This clause describes the transport capabilities that are available within LPP. A UE implementing LPP for the control-plane solution shall support LPP reliable transport (including all three of duplicate detection, acknowledgement, and retransmission).

LPP reliable transport functionality is not used in the user-plane solution.

The following requirements in clauses 4.3.2, 4.3.3, and 4.3.4 for LPP reliable transport apply only when the capability is supported.

4.3.2 LPP Duplicate Detection

A sender shall include a sequence number in all LPP messages sent for a particular location session. The sequence number shall be distinct for different LPP messages sent in the same direction in the same location session (e.g., may start at zero in the first LPP message and increase monotonically in each succeeding LPP message). Sequence numbers used in the uplink and downlink are independent (e.g., can be the same).

A receiver shall record the most recent received sequence number for each location session. If a message is received carrying the same sequence number as that last received for the associated location session, it shall be discarded. Otherwise (i.e., if the sequence number is different or if no sequence number was previously received or if no sequence number is included), the message shall be processed.

Sending and receiving sequence numbers shall be deleted in a server when the associated location session is terminated and shall be deleted in a target device when there has been no activity for a particular location session for 10 minutes.

NOTE: For LPP control-plane use, a target device can be aware of a location session from information provided at the NAS level for downlink transport of an LPP message.

4.3.3 LPP Acknowledgement

4.3.3.1 General

Each LPP message may carry an acknowledgement request and/or an acknowledgement indicator. A LPP message including an acknowledgement request (i.e., that include the IE *ackRequested* set to TRUE) shall also include a sequence number. Upon reception of an LPP message which includes the IE *ackRequested* set to TRUE, a receiver returns an LPP message with an acknowledgement response (i.e., that includes the *ackIndicator* IE set to the same sequence number of the message being acknowledged). An acknowledgement response may contain no LPP message body (in which case only the sequence number being acknowledged is significant); alternatively, the acknowledgement may be sent in an LPP message along with an LPP message body. An acknowledgement is returned for each received LPP message that requested an acknowledgement including any duplicate(s). Once a sender receives an acknowledgement for an LPP message, and provided any included sequence number is matching, it is permitted to send the next LPP message. No message reordering is needed at the receiver since this stop-and-wait method of sending ensures that messages normally arrive in the correct order.

When an LPP message is transported via a NAS MO-LR request, the message does not request an acknowledgement.

4.3.3.2 Procedure related to Acknowledgement

Figure 4.3.3.2-1 shows the procedure related to acknowledgement.

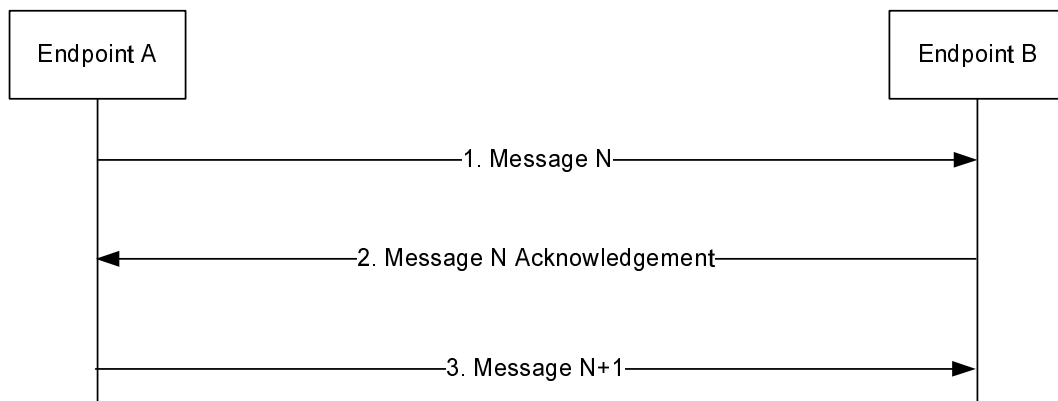

Figure 4.3.3.2-1: LPP Acknowledgement procedure

1. Endpoint A sends an LPP message N to Endpoint B which includes the IE *ackRequested* set to TRUE and a sequence number.
2. If LPP message N is received and Endpoint B is able to decode the *ackRequested* value and sequence number, Endpoint B shall return an acknowledgement for message N . The acknowledgement shall contain the IE *ackIndicator* set to the same sequence number as that in message N .
3. When the acknowledgement for LPP message N is received and provided the included *ackIndicator* IE matches the sequence number sent in message N , Endpoint A sends the next LPP message $N+1$ to Endpoint B when this message is available.

4.3.4 LPP Retransmission

4.3.4.1 General

This capability builds on the acknowledgement and duplicate detection capabilities. When an LPP message which requires acknowledgement is sent and not acknowledged, it is resent by the sender following a timeout period up to three times. If still unacknowledged after that, the sender aborts all LPP activity for the associated session. The timeout period is determined by the sender implementation but shall not be less than a minimum value of 250 ms.

In addition, for NB-IoT the timeout period may be determined by the sender implementation based on e.g., the coverage level of the UE.

4.3.4.2 Procedure related to Retransmission

Figure 4.3.4.2-1 shows the procedure related to retransmission when combined with acknowledgement and duplicate detection.

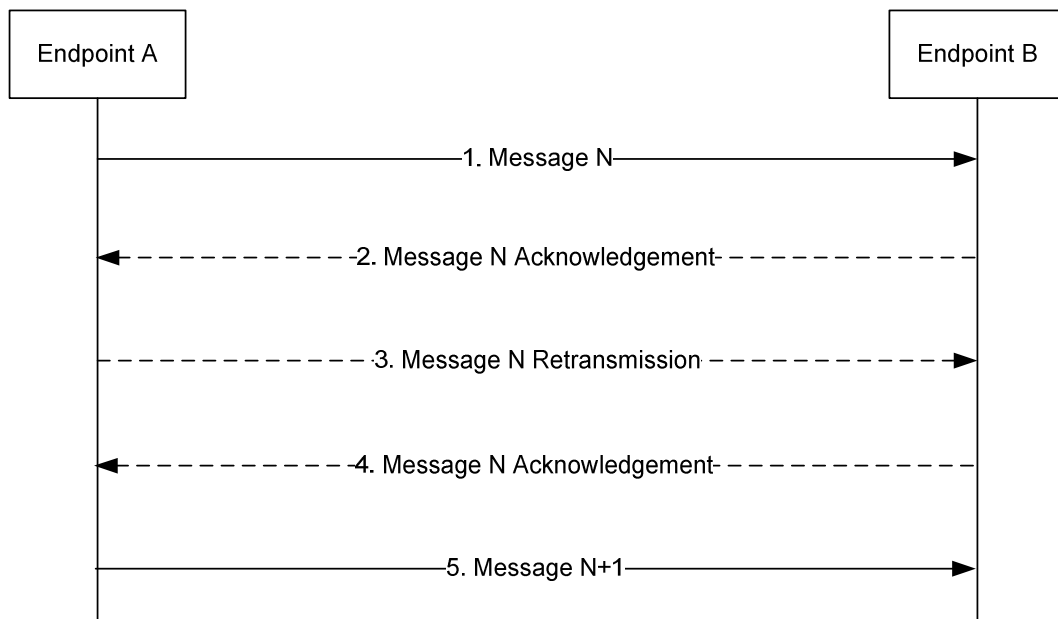

Figure 4.3.4.2-1: LPP Retransmission procedure

1. Endpoint A sends an LPP message N to Endpoint B for a particular location session and includes a request for acknowledgement along with a sequence number.
2. If LPP message N is received and Endpoint B is able to decode the *ackRequested* value and sequence number (regardless of whether the message body can be correctly decoded), Endpoint B shall return an acknowledgement for message N . If the acknowledgement is received by Endpoint A (such that the acknowledged message can be identified and sequence numbers are matching), Endpoint A skips steps 3 and 4.
3. If the acknowledgement in step 2 is not received after a timeout period, Endpoint A shall retransmit LPP message N and shall include the same sequence number as in step 1.
4. If LPP message N in step 3 is received and Endpoint B is able to decode the *ackRequested* value and sequence number (regardless of whether the message body can be correctly decoded and whether or not the message is considered a duplicate), Endpoint B shall return an acknowledgement. Steps 3 may be repeated one or more times if the acknowledgement in step 4 is not received after a timeout period by Endpoint A. If the acknowledgement in step 4 is still not received after sending three retransmissions, Endpoint A shall abort all procedures and activity associated with LPP support for the particular location session.
5. Once an acknowledgement in step 2 or step 4 is received, Endpoint A sends the next LPP message $N+1$ for the location session to Endpoint B when this message is available.

4.3.5 LPP Message Segmentation

An LPP message body may be sent in several shorter LPP messages instead of one long LPP message to deliver a large amount of information (e.g., in case the LPP message size exceeds the maximum message size supported by lower layers). When a sender employs LPP message segmentation, the sender shall include the IE *SegmentationInfo* in each LPP message segment. The sender shall indicate in all but the final message segment that more messages are on the way.

When a receiver receives an LPP message indicating that more messages are on the way, the receiver may store the LPP message. If the receiver receives a subsequent LPP message for the same session and transaction ID, the receiver shall assume that the new LPP message continues the segmentation of the earlier message and may store the new message if the new message indicates that more messages are on the way. If the new message indicates that no more messages are on the way, the receiver shall assume that message segmentation is complete and shall process the new message and any stored message segments for the same session and transaction ID.

The reliable transport rules specified in clause 4.3.2, 4.3.3, and 4.3.4 apply to each individual LPP message segment, independently of the value of the IE *SegmentationInfo*.

The rules for setting the common fields of the LPP message specified in clause 4.1.4 (Transaction ID, Transaction End Flag, Sequence Number, Acknowledgment) apply to each individual LPP message segment, independently of the value of the IE *SegmentationInfo*.

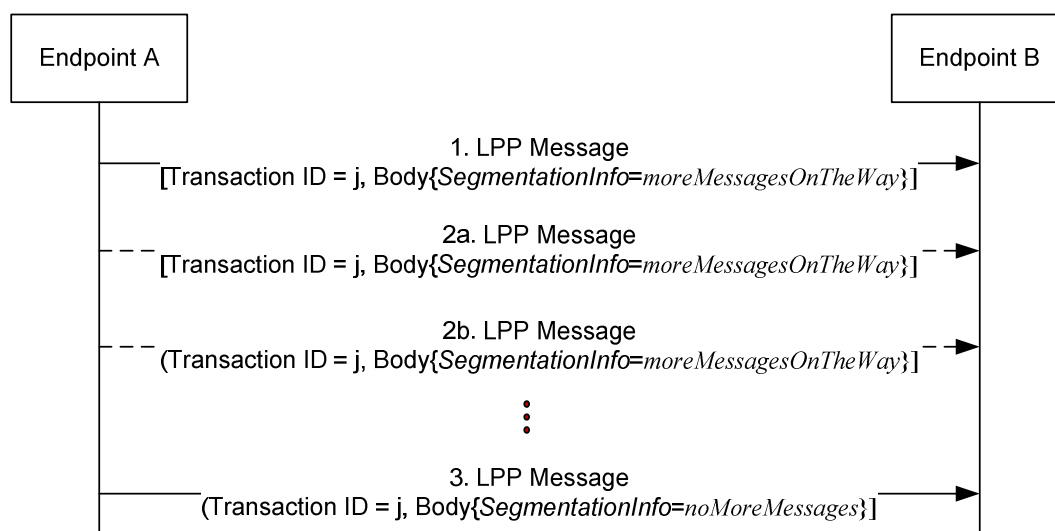

Figure 4.3.5-1: LPP Message Segmentation procedure

1. Endpoint A sends an LPP message to Endpoint B for a particular location session and includes the IE *SegmentationInfo* set to *moreMessagesOnTheWay* to indicate that this is one of many LPP message segments used to deliver the entire LPP message body.
2. Endpoint A may send one or more additional LPP messages to Endpoint B with the IE *SegmentationInfo* set to *moreMessagesOnTheWay* to continue delivering the segmented LPP message.
3. Endpoint A sends the final LPP message segment to Endpoint B and includes the IE *SegmentationInfo* set to *noMoreMessages* to indicate that this is the final LPP message segment. Endpoint B assumes that the complete LPP message body has been received.

5 LPP Procedures

5.1 Procedures related to capability transfer

The purpose of the procedures that are grouped together in this clause is to enable the transfer of capabilities from the target device to the server. Capabilities in this context refer to positioning and protocol capabilities related to LPP and the positioning methods supported by LPP.

These procedures instantiate the Capability Transfer transaction from TS 36.305 [2] and TS 38.305 [40].

5.1.1 Capability Transfer procedure

The Capability Transfer procedure is shown in Figure 5.1.1-1.

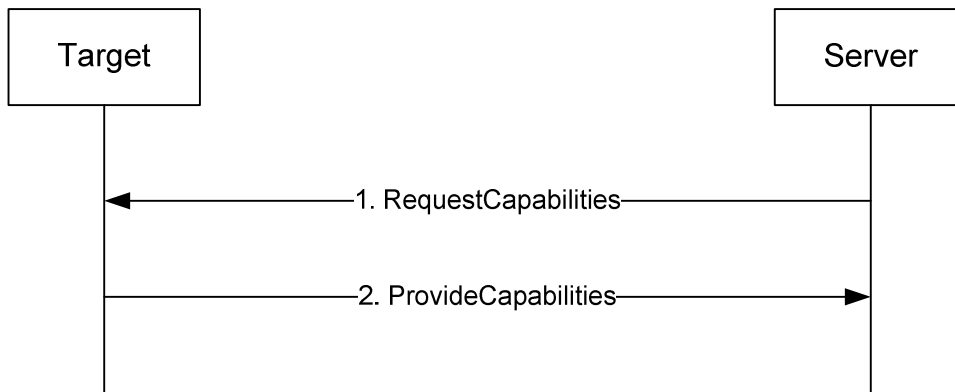

Figure 5.1.1-1: LPP Capability Transfer procedure

1. The server sends a *RequestCapabilities* message to the target. The server may indicate the types of capability needed.
2. The target responds with a *ProvideCapabilities* message to the server. The capabilities shall correspond to any capability types specified in step 1. This message shall include the *endTransaction* IE set to TRUE.

5.1.2 Capability Indication procedure

The Capability Indication procedure allows the target to provide unsolicited capabilities to the server and is shown in Figure 5.1.2-1.

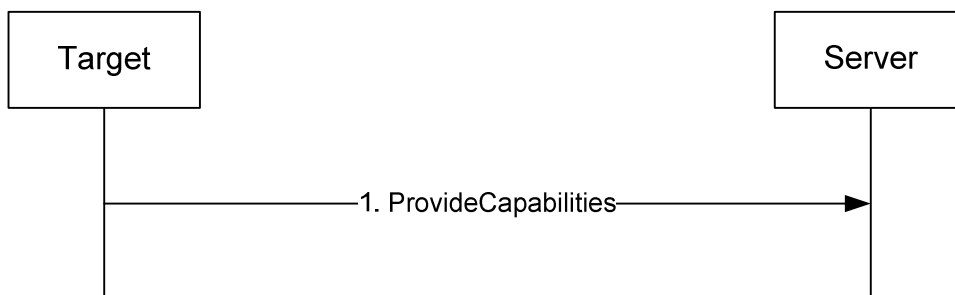

Figure 5.1.2-1: LPP Capability Indication procedure

1. The target sends a *ProvideCapabilities* message to the server. This message shall include the *endTransaction* IE set to TRUE.

5.1.3 Reception of LPP Request Capabilities

Upon receiving a *RequestCapabilities* message, the target device shall generate a *ProvideCapabilities* message as a response.

The target device shall:

- 1> for each positioning method for which a request for capabilities is included in the message:
 - 2> if the target device supports this positioning method:
 - 3> include the capabilities of the device for that supported positioning method in the response message;
- 1> set the IE *LPP-TransactionID* in the response message to the same value as the IE *LPP-TransactionID* in the received message;
- 1> deliver the response message to lower layers for transmission.

5.1.4 Transmission of LPP Provide Capabilities

When triggered to transmit a *ProvideCapabilities* message, the target device shall:

- 1> for each positioning method whose capabilities are to be indicated:
 - 2> set the corresponding IE to include the device's capabilities;
 - 2> if OTDOA capabilities are to be indicated:
 - 3> include the IE *supportedBandListEUTRA*;
- 1> deliver the response to lower layers for transmission.

5.2 Procedures related to Assistance Data Transfer

The purpose of the procedures in this clause is to enable the target to request assistance data from the server to assist in positioning, and to enable the server to transfer assistance data to the target in the absence of a request.

These procedures instantiate the Assistance Data Transfer transaction from TS 36.305 [2] and TS 38.305 [40].

5.2.1 Assistance Data Transfer procedure

The Assistance Data Transfer procedure is shown in Figure 5.2.1-1.

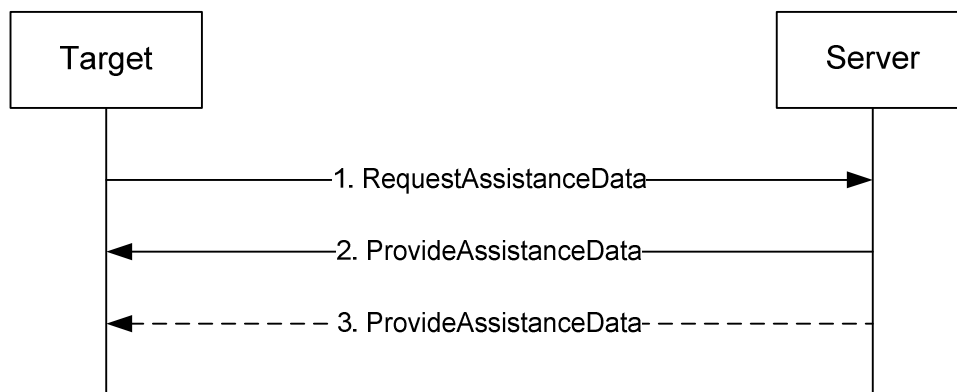

Figure 5.2.1-1: LPP Assistance data transfer procedure

1. The target sends a *RequestAssistanceData* message to the server.
2. The server responds with a *ProvideAssistanceData* message to the target containing assistance data. The transferred assistance data should match or be a subset of the assistance data requested in step 1. The server may also provide any not requested information that it considers useful to the target. If step 3 does not occur, this message shall set the *endTransaction* IE to TRUE.
3. The server may transmit one or more additional *ProvideAssistanceData* messages to the target containing further assistance data. The transferred assistance data should match or be a subset of the assistance data requested in step 1. The server may also provide any not requested information that it considers useful to the target. The last message shall include the *endTransaction* IE set to TRUE.

5.2.1a Periodic Assistance Data Transfer procedure

The Periodic Assistance Data Transfer procedure is shown in Figure 5.2.1a-1. This procedure enables a target to request a server to send assistance data periodically.

NOTE 1: In this version of the specification, periodic assistance data transfer is supported for HA GNSS (e.g., RTK) positioning only.

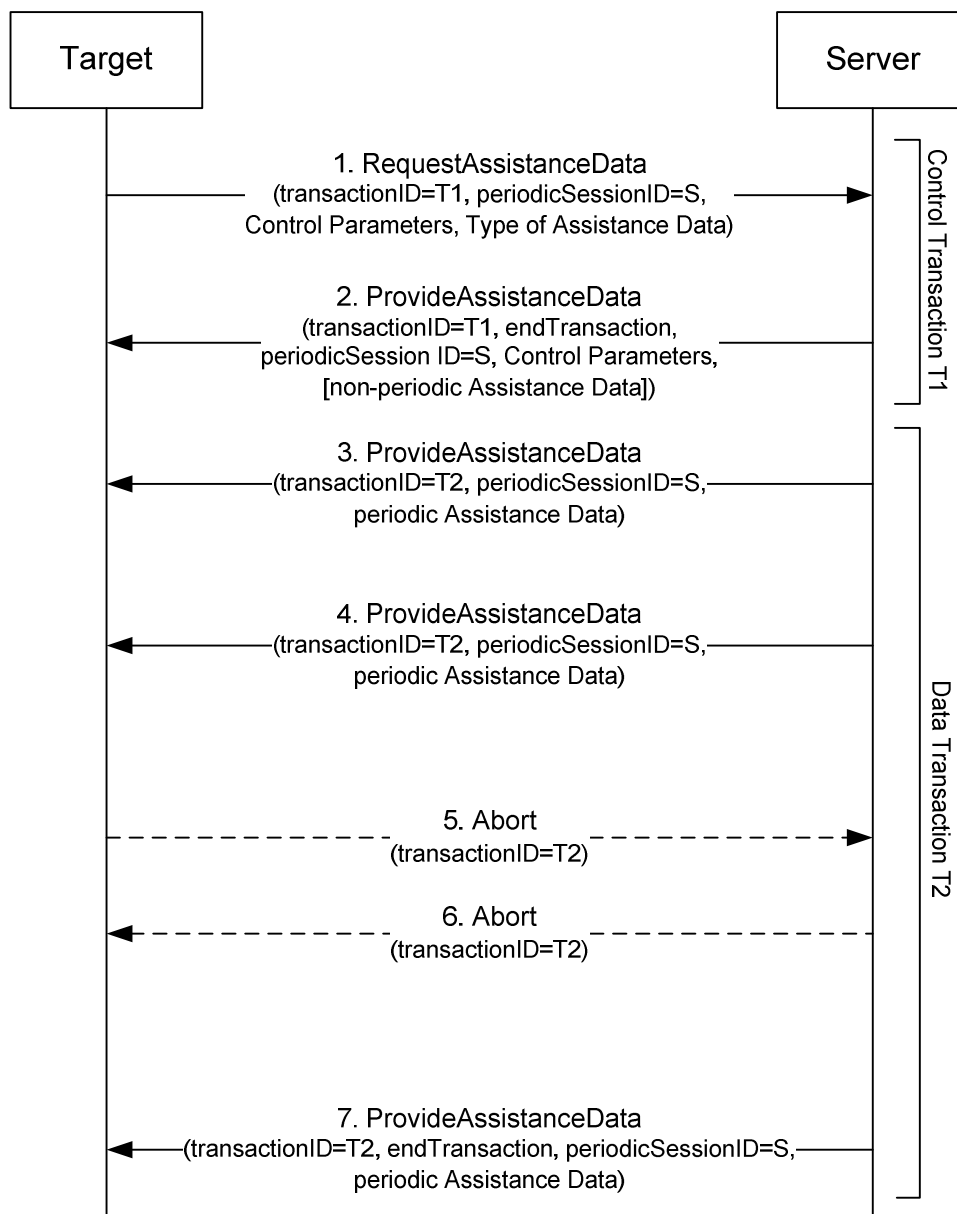

Figure 5.2.1a-1: LPP Periodic Assistance data transfer procedure

1. The target sends a *RequestAssistanceData* message to the server using some available *transactionID* T1. The message contains a *periodicSessionID* S (different to any other *periodicSessionID* currently in use between the target and server) in the IE *CommonIEsRequestAssistanceData*. The message also includes a positioning method specific assistance data request element (e.g., IE *A-GNSS-RequestAssistanceData*) identifying the type of assistance data being requested together with desired periodicity conditions for sending it and a duration for ending the assistance data transfer (e.g., in IE *GNSS-PeriodicAssistDataReq*).
2. The server responds with a *ProvideAssistanceData* message to the target. The message uses the *transactionID* T1 in step 1 and indicates the end of this transaction. The message contains the *periodicSessionID* S in IE *CommonIEsProvideAssistanceData*. If the request can be supported, the message contains the control parameters in the positioning method specific assistance data (e.g., IE *A-GNSS-ProvideAssistanceData*) which may confirm or redefine the type of assistance data or periodicity parameters requested at step 1 (e.g., in IE *GNSS-PeriodicAssistData*). If the target requested non-periodic assistance data in addition to the periodic assistance data in step 1, the *ProvideAssistanceData* message may also include the non-periodic assistance data in this step 2 (but not any periodic assistance data).
If the request cannot be supported (fully or partly), an error reason is provided in the positioning method specific

IE (e.g., IE *A-GNSS-Error*). If the request cannot even partly be supported remaining steps are then not performed.

NOTE 2: The target device infers from an absence of the *periodicSessionID* that the location server does not support periodic assistance data delivery. In that case, the target device does not expect the Data Transaction (Steps 3-7).

- When the first periodic message is available, the server sends an unsolicited *ProvideAssistanceData* message to the target containing the *periodicSessionID* S and the periodic assistance data confirmed in step 2. The message uses some available *transactionID* T2 that may be different to T1.

NOTE 3: The positioning method specific control parameters (e.g., IE *GNSS-PeriodicAssistData*) are not included in the data transaction.

- The server may continue to send further *ProvideAssistanceData* messages to the target containing the periodic assistance data confirmed or redefined in step 2 when each additional periodicity condition occurs.

NOTE 4: The target device expects a *ProvideAssistanceData* messages at the in Step 2 confirmed interval(s). If some or all of the assistance data is not available at each periodic interval, an error indication is provided in the positioning method specific IE (e.g., IE *A-GNSS-Error*).

- If the target requires the session to end, the target sends an *Abort* message to the server for transaction T2 that may optionally include an *abortCause*. Remaining steps are then omitted.
- If the server requires the session to end, the server sends an *Abort* message to the target for transaction T2 that may optionally include an *abortCause*. Remaining steps are then omitted.
- When the duration or other conditions for ending the periodic assistance data transfer occur, the last *ProvideAssistanceData* message transferred indicates the end of transaction T2.

5.2.1b Periodic Assistance Data Transfer with Update procedure

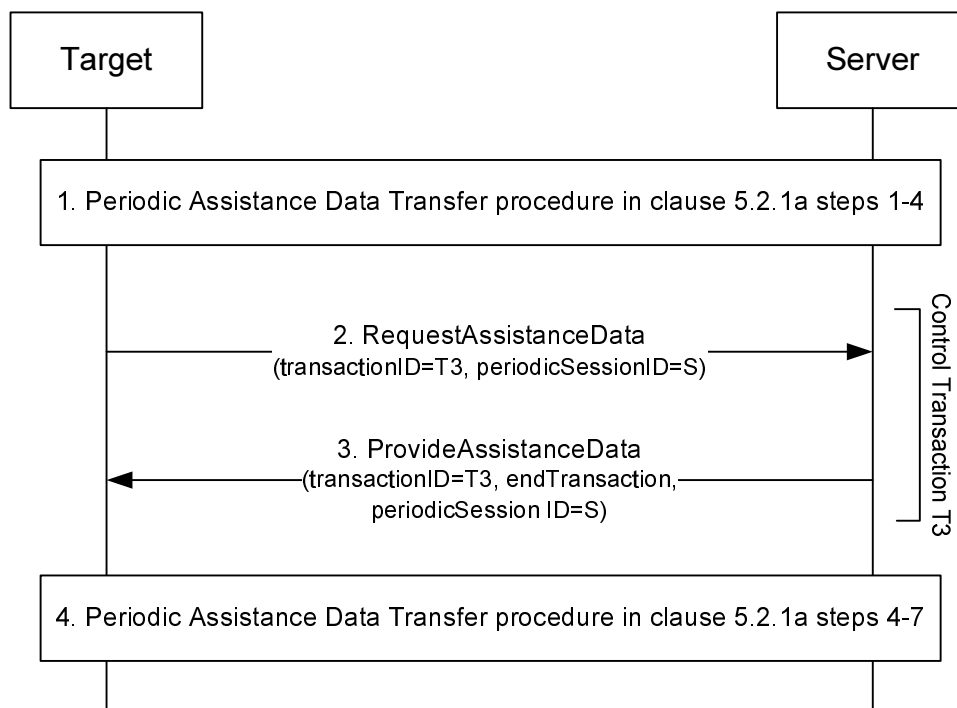

Figure 5.2.1b-1: LPP Periodic Assistance data transfer with update procedure

- Steps 1-2 and optionally steps 3-4 are performed for the Periodic Assistance Data Transfer procedure in clause 5.2.1a with the following exceptions:

- The *RequestAssistanceData* message in step 1 indicates the update capabilities of the target device.
 - The *ProvideAssistanceData* message in step 2 indicates the update capabilities of the target device which are supported by the server.
2. If the target device changes its primary cell and if the update capabilities of the target device supported by the server in step 1 include update of a primary cell ID, the target device sends a *RequestAssistanceData* message to the server using some available *transactionID* T3, which is different from T2 (previously used in step 2). The message contains the *periodicSessionID* S (previously used in step 1) and the new primary cell ID in the IE *CommonIEsRequestAssistanceData*.
 3. The server responds with a *ProvideAssistanceData* message to the target. The message uses the *transactionID* T3 in step 2 and indicates the end of this transaction. The message contains the *periodicSessionID* S in IE *CommonIEsProvideAssistanceData*. Steps 2-3 are repeated each time the target device changes its primary cell.
 4. Steps 4-7 are performed for the Periodic Assistance Data Transfer procedure in clause 5.2.1a.

5.2.2 Assistance Data Delivery procedure

The Assistance Data Delivery procedure allows the server to provide unsolicited assistance data to the target and is shown in Figure 5.2.2-1.

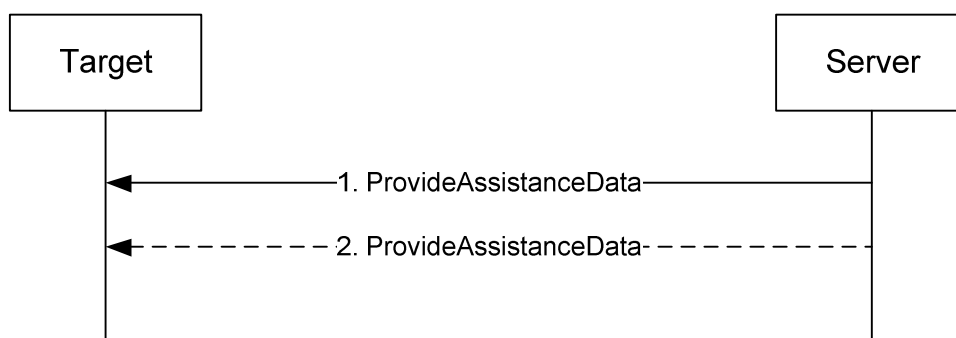

Figure 5.2.2-1: LPP Assistance data transfer procedure

1. The server sends a *ProvideAssistanceData* message to the target containing assistance data. If step 2 does not occur, this message shall set the *endTransaction* IE to TRUE.
2. The server may transmit one or more additional *ProvideAssistanceData* messages to the target containing additional assistance data. The last message shall include the *endTransaction* IE set to TRUE.

5.2.2a Periodic Assistance Data Delivery procedure

The Periodic Assistance Data Delivery procedure allows the server to provide unsolicited periodic assistance data to the target and is shown in Figure 5.2.2a-1.

NOTE 1: In this version of the specification, periodic assistance data delivery is supported for HA GNSS (e.g., RTK) positioning only.

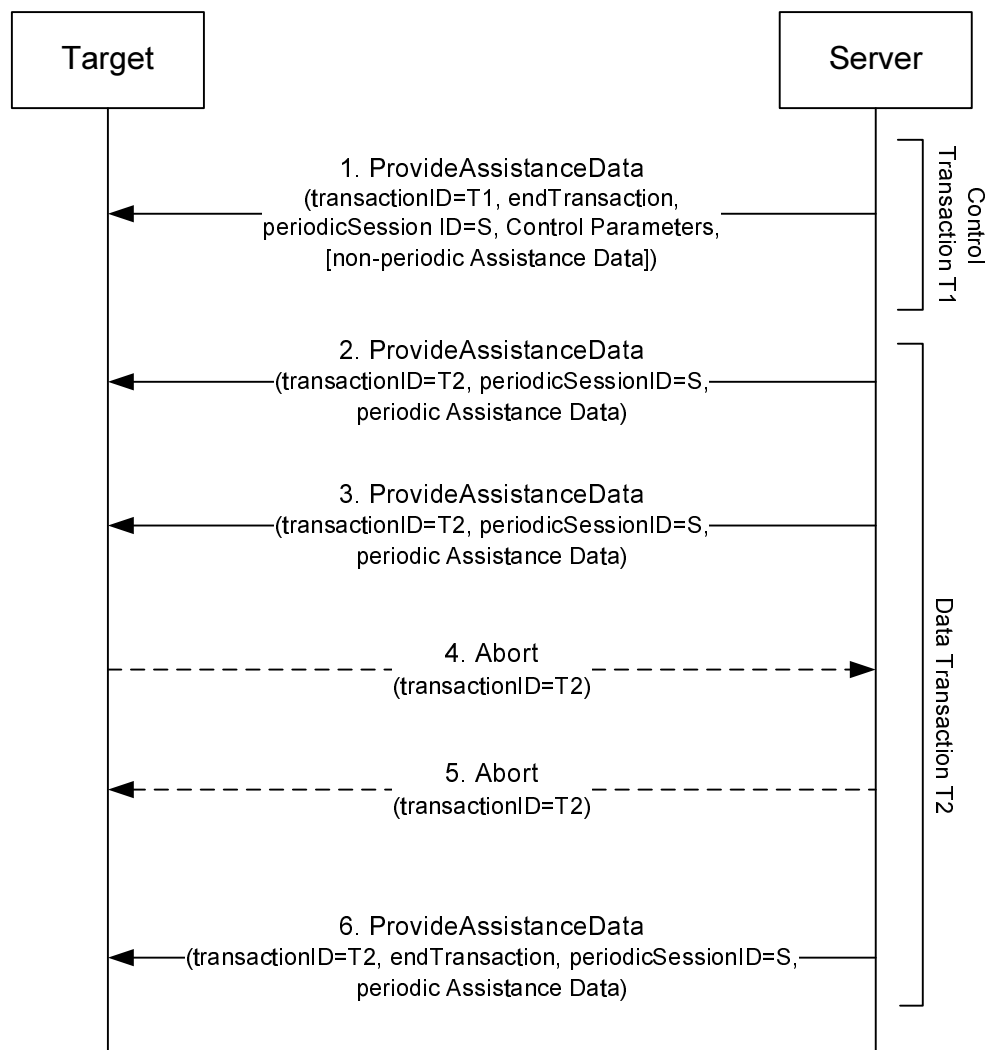

Figure 5.2.2a-1: LPP Periodic Assistance data delivery procedure

1. The server sends a *ProvideAssistanceData* message to the target using some available *transactionID* T1 and indicates the end of this transaction. The message contains a *periodicSessionID* S (different to any other *periodicSessionID* currently in use between the server and target) in the IE *CommonIEsProvideAssistanceData*. The message includes positioning method specific assistance data control parameters (e.g., in IE *A-GNSS-ProvideAssistanceData*) identifying the type of periodic assistance data being delivered together with periodicity conditions for sending it and a duration for ending the assistance data delivery (e.g., in IE *GNSS-PeriodicAssistData*). The *ProvideAssistanceData* message may also include non-periodic assistance data (but not any periodic assistance data).
2. When the first periodic message is available, the server sends an unsolicited *ProvideAssistanceData* message to the target containing the *periodicSessionID* S and the periodic assistance data announced in step 1. The message uses some available *transactionID* T2 that may be different to T1.

NOTE 2: The positioning method specific control parameters (e.g., IE *GNSS-PeriodicAssistData*) are not included in the data transaction.

3. The server may continue to send further *ProvideAssistanceData* messages to the target containing the periodic assistance data announced in step 2 when each additional periodicity condition occurs.

NOTE3: The target device expects a *ProvideAssistanceData* messages at the in Step 2 announced interval(s). If some or all of the assistance data is not available at each periodic interval, an error indication is provided in the positioning method specific IE (e.g., IE *A-GNSS-Error*).

4. If the target requires the session to end, the target sends an *Abort* message to the server for transaction T2 that may optionally include an *abortCause*. Remaining steps are then omitted.
5. If the server requires the session to end, the server sends an *Abort* message to the target for transaction T2 that may optionally include an *abortCause*. Remaining steps are then omitted.
6. When the duration or other conditions for ending the periodic assistance data transfer occur, the last *ProvideAssistanceData* message transferred indicates the end of transaction T2.

5.2.3 Transmission of LPP Request Assistance Data

When triggered to transmit a *RequestAssistanceData* message, the target device shall:

- 1> set the IEs for the positioning-method-specific request for assistance data to request the data indicated by upper layers.

5.2.4 Reception of LPP Provide Assistance Data

Upon receiving a *ProvideAssistanceData* message, the target device shall:

- 1> for each positioning method contained in the message:
 - 2> deliver the related assistance data to upper layers.

5.3 Procedures related to Location Information Transfer

The purpose of the procedures in this clause is to enable the server to request location measurement data and/or a location estimate from the target, and to enable the target to transfer location measurement data and/or a location estimate to a server in the absence of a request.

These procedures instantiate the Location Information Transfer transaction in TS 36.305 [2] and TS 38.305 [40].

NOTE: The service layer (e.g. NAS or OMA SUPL ULP) would be used to transfer information associated with a location request from a target to a server (MO-LR).

5.3.1 Location Information Transfer procedure

The Location Information Transfer procedure is shown in Figure 5.3.1-1.

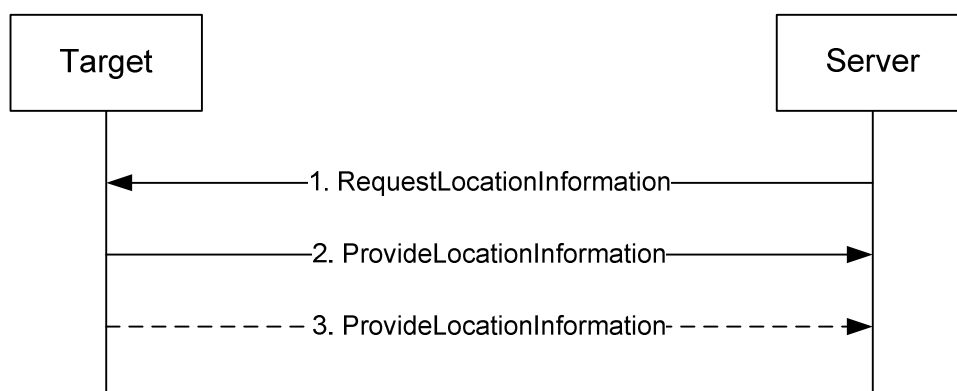

Figure 5.3.1-1: LPP Location Information transfer procedure

1. The server sends a *RequestLocationInformation* message to the target to request location information, indicating the type of location information needed and potentially the associated QoS.

2. The target sends a *ProvideLocationInformation* message to the server to transfer location information. The location information transferred should match or be a subset of the location information requested in step 1 unless the server explicitly allows additional location information. If step 3 does not occur, this message shall set the *endTransaction* IE to TRUE.
3. If requested in step 1, the target sends additional *ProvideLocationInformation* messages to the server to transfer location information. The location information transferred should match or be a subset of the location information requested in step 1 unless the server explicitly allows additional location information. The last message shall include the *endTransaction* IE set to TRUE.

5.3.2 Location Information Delivery procedure

The Location Information Delivery allows the target to provide unsolicited location information to the server. The procedure is shown in Figure 5.3.2-1.

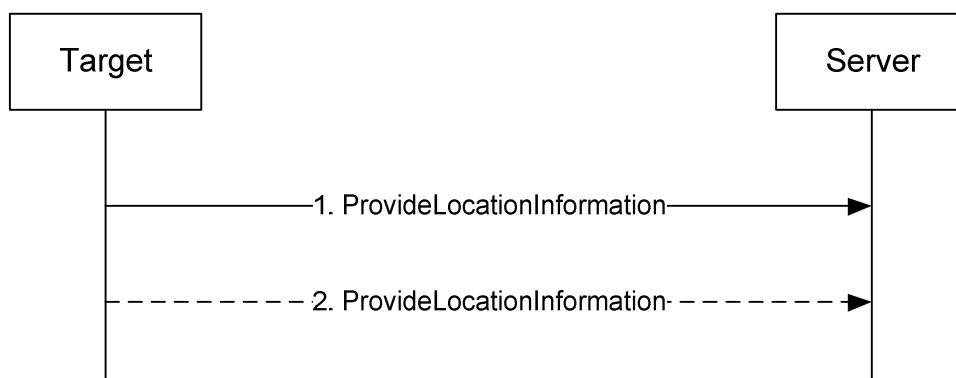

Figure 5.3.2-1: LPP Location Information Delivery procedure

1. The target sends a *ProvideLocationInformation* message to the server to transfer location information. If step 2 does not occur, this message shall set the *endTransaction* IE to TRUE.
2. The target may send one or more additional *ProvideLocationInformation* messages to the server containing additional location information data. The last message shall include the *endTransaction* IE set to TRUE.

5.3.3 Reception of Request Location Information

Upon receiving a *RequestLocationInformation* message, the target device shall:

- 1> if the requested information is compatible with the target device capabilities and configuration:
 - 2> include the requested information in a *ProvideLocationInformation* message;
 - 2> set the IE *LPP-TransactionID* in the response to the same value as the IE *LPP-TransactionID* in the received message;
 - 2> deliver the *ProvideLocationInformation* message to lower layers for transmission.
- 1> otherwise:
 - 2> if one or more positioning methods are included that the target device does not support:
 - 3> continue to process the message as if it contained only information for the supported positioning methods;
 - 3> handle the signaling content of the unsupported positioning methods by LPP error detection as in 5.4.3.

5.3.4 Transmission of Provide Location Information

When triggered to transmit *ProvideLocationInformation* message, the target device shall:

- 1> for each positioning method contained in the message:
 - 2> set the corresponding IE to include the available location information;
- 1> deliver the response to lower layers for transmission.

5.4 Error Handling Procedures

5.4.1 General

This clause describes how a receiving entity (target device or location server) behaves in cases when it receives erroneous or unexpected data or detects that certain data are missing.

5.4.2 Procedures related to Error Indication

Figure 5.4.2-1 shows the Error indication procedure.

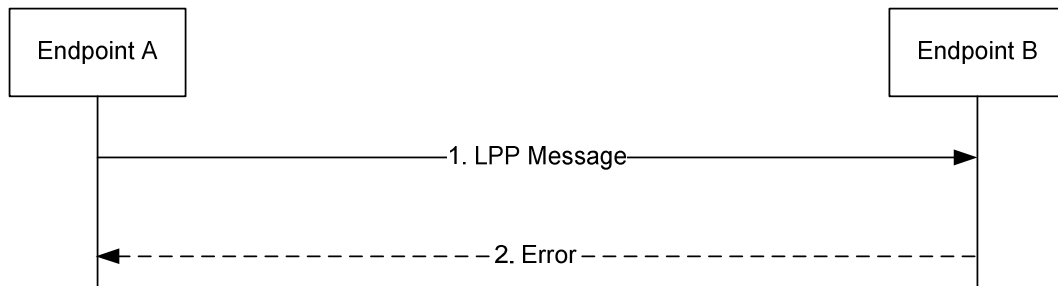

Figure 5.4.2-1: LPP Error Indication procedure

1. Endpoint A sends an LPP message to Endpoint B.
2. Endpoint B determines that the LPP message in step 1 contains an error. Endpoint B returns an *Error* message to Endpoint A indicating the error or errors and discards the message in step 1. If Endpoint B is able to determine that the erroneous LPP message in step 1 is an LPP Error or Abort Message, Endpoint B discards the message in step 1 without returning an *Error* message to Endpoint A.

5.4.3 LPP Error Detection

Upon receiving any LPP message, the receiving entity shall attempt to decode the message and verify the presence of any errors and:

- 1> if decoding errors are encountered:
 - 2> if the receiver can not determine that the received message is an LPP *Error* or *Abort* message:
 - 3> return an LPP *Error* message to the sender and include the received *LPP-TransactionID*, if this was decoded, and type of error;
 - 3> if the receiver can determine the session and the *LPP-TransactionID* and the received message includes the IE *SegmentationInfo* and the receiver has previously stored message segments for this session and *LPP-TransactionID*:
 - 4> discard all stored LPP message segments for this session and *LPP-TransactionID*;
 - 3> discard the received message and stop the error detection procedure;

- 1> if the message is a duplicate of a previously received message:
 - 2> discard the message and stop the error detection procedure;
- 1> if the *LPP-TransactionID* matches the *LPP-TransactionID* for a procedure that is still ongoing for the same session and the message type is invalid for the current state of the procedure:
 - 2> abort the ongoing procedure;
 - 2> return an LPP *Error* message to the sender and include the received transaction ID and type of error;
 - 2> if the message includes the IE *SegmentationInfo* and the receiver has previously stored message segments for this session and *LPP-TransactionID*:
 - 3> discard all stored LPP message segments for this session and *LPP-TransactionID*;
 - 2> discard the message and stop the error detection procedure;
- 1> if the message includes the IE *SegmentationInfo*:
 - 2> if the receiver has previously stored LPP message segments for this session and *LPP-TransactionID*:
 - 3> if the received message type is different to the stored message type:
 - 4> return an LPP *Error* message to the sender and include the received transaction ID and type of error;
 - 4> discard the message and all stored LPP message segments for this session and *LPP-TransactionID* and stop the error detection procedure;
 - 2> if the IE *SegmentationInfo* has the value *moreMessagesOnTheWay*:
 - 3> store the received message;
 - NOTE: As an implementation option, the receiver of an LPP Provide Assistance Data or LPP Provide Location Information message may process the received message segment instead of storing the message.
 - 2> if the IE *SegmentationInfo* has the value *noMoreMessages*:
 - 3> continue error detection for the received message and any stored LPP message segments for this session and *LPP-TransactionID*;
 - 1> if the message type is an LPP *RequestCapabilities* and some of the requested information is not supported:
 - 2> return any information that can be provided in a normal response.
 - 1> if the message type is an LPP *RequestAssistanceData* or *RequestLocationInformation* and some or all of the requested information is not supported:
 - 2> return any information that can be provided in a normal response, which includes indications on other information that is not supported.

5.4.4 Reception of an LPP Error Message

Upon receiving an *Error* message, a device shall:

- 1> abort any ongoing procedure associated with the *LPP-TransactionID* if included in the received message.

The device may:

- 1> restart the aborted procedure taking into consideration the returned error information.

5.5 Abort Procedure

5.5.1 General

The purpose of the abort procedure is to allow the target device or location server to abort an ongoing procedure due to some unexpected event (e.g., cancellation of a location request by an LCS client). It can also be used to stop an ongoing procedure (e.g., periodic location reporting from the target device).

5.5.2 Procedures related to Abort

Figure 5.5.2-1 shows the Abort procedure.

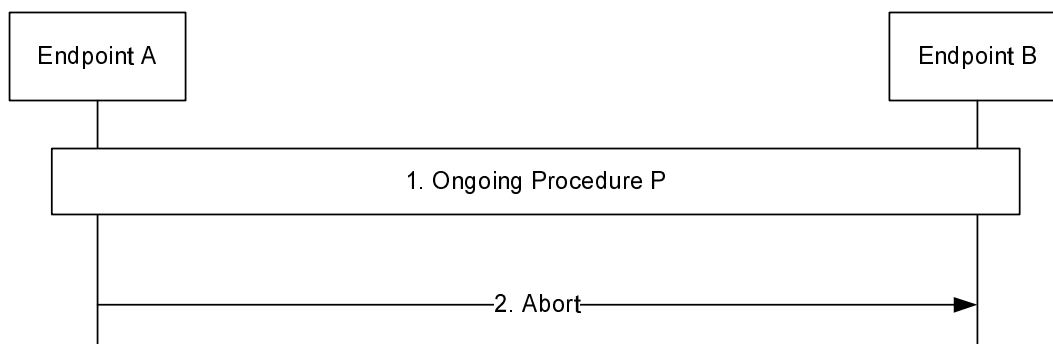

Figure 5.5.2-1: LPP Abort procedure

1. A procedure P is ongoing between endpoints A and B.
2. Endpoint A determines that the procedure must be aborted and sends an *Abort* message to Endpoint B carrying the transaction ID for procedure P. Endpoint B aborts procedure P.

5.5.3 Reception of an LPP Abort Message

Upon receiving an *Abort* message, a device shall:

- 1> abort any ongoing procedure associated with the transaction ID indicated in the message.

6 Information Element Abstract Syntax Definition

6.1 General

The contents of each LPP message is specified in clause 6.2 using ASN.1 to specify the message syntax and using tables when needed to provide further detailed information about the fields specified in the message syntax.

The ASN.1 in this clause uses the same format and coding conventions as described in Annex A of TS 36.331 [12].

Transfer syntax for LPP messages is derived from their ASN.1 definitions by use of Basic Packed Encoding Rules (BASIC-PER), Unaligned Variant, as specified in ITU-T Rec. X.691 [22]. The encoded LPP message always contains a multiple of 8 bits.

Transfer syntax for LPP IEs is derived from their ASN.1 definitions by use of Basic Packed Encoding Rules (BASIC-PER), Unaligned Variant, as specified in ITU-T Rec. X.691 [22]. The encoded LPP IE always contains a multiple of 8 bits. This applies when a single LPP IE is encoded as the basic production, i.e. for other purposes than encoding the LPP IE within an LPP message.

The need for fields to be present in a message or an abstract type, i.e., the ASN.1 fields that are specified as OPTIONAL in the abstract notation (ASN.1), is specified by means of comment text tags attached to the OPTIONAL

statement in the abstract syntax. The meaning of each tag is specified in table 6.1-1. The use of these tags in the uplink (target to server) direction does not impose any requirements on the server.

Table 6.1-1: Meaning of abbreviations used to specify the need for fields to be present

Abbreviation	Meaning
Cond <i>conditionTag</i>	<i>Conditionally present</i> A field for which the need is specified by means of conditions. For each <i>conditionTag</i> , the need is specified in a tabular form following the ASN.1 segment. In case, according to the conditions, a field is not present, the target takes no action and where applicable shall continue to use the existing value (and/or the associated functionality) unless explicitly stated otherwise in the description of the field itself.
Need OP	<i>Optionally present</i> A field that is optional to signal. For downlink messages, the target is not required to take any special action on absence of the field beyond what is specified in the procedural text or the field description table following the ASN.1 segment. The target behaviour on absence should be captured either in the procedural text or in the field description.
Need ON	<i>Optionally present, No action</i> A field that is optional to signal. If the message is received by the target, and in case the field is absent, the target takes no action and where applicable shall continue to use the existing value (and/or the associated functionality).
Need OR	<i>Optionally present, Release</i> A field that is optional to signal. If the message is received by the target, and in case the field is absent, the target shall discontinue/ stop using/ delete any existing value (and/ or the associated functionality).

When specifying information elements which are to be represented by BIT STRINGS, if not otherwise specifically stated in the field description of the concerned IE or elsewhere, the following principle applies with regards to the ordering of bits:

- The first bit (leftmost bit) contains the most significant bit (MSB);
- the last bit (rightmost bit) contains the least significant bit (LSB).

6.2 LPP PDU Structure

– LPP-PDU-Definitions

This ASN.1 segment is the start of the LPP PDU definitions.

```
-- ASN1START
LPP-PDU-Definitions
DEFINITIONS AUTOMATIC TAGS ::=
BEGIN
-- ASN1STOP
```

– LPP-Message

The *LPP-Message* provides the complete set of information for an invocation or response pertaining to an LPP transaction.

```
-- ASN1START
LPP-Message ::= SEQUENCE {
  transactionID      LPP-TransactionID  OPTIONAL,  -- Need ON
  endTransaction     BOOLEAN,
  sequenceNumber     SequenceNumber    OPTIONAL,  -- Need ON
  acknowledgement    Acknowledgement   OPTIONAL,  -- Need ON
  lpp-MessageBody    LPP-MessageBody   OPTIONAL  -- Need ON
}
SequenceNumber ::= INTEGER (0..255)
```

```

Acknowledgement ::= SEQUENCE {
    ackRequested    BOOLEAN,
    ackIndicator    SequenceNumber    OPTIONAL
}
-- ASN1STOP

```

LPP-Message field descriptions

transactionID

This field is omitted if an *lpp-MessageBody* is not present (i.e. in an LPP message sent only to acknowledge a previously received message) or if it is not available to the transmitting entity (e.g., in an *LPP-Error* message triggered by a message that could not be parsed). If present, this field shall be ignored at a receiver in an LPP message for which the *lpp-MessageBody* is not present.

endTransaction

This field indicates whether an LPP message is the last message carrying an *lpp-MessageBody* in a transaction (TRUE) or not last (FALSE). When LPP message segmentation is used, only the final LPP message segment may indicate the end of the transaction.

sequenceNumber

This field may be included when LPP operates over the control plane and an *lpp-MessageBody* is included but shall be omitted otherwise.

acknowledgement

This field is included in an LPP acknowledgement and in any LPP message requesting an acknowledgement when LPP operates over the control plane and is omitted otherwise.

ackRequested

This field indicates whether an LPP acknowledgement is requested (TRUE) or not (FALSE). A value of TRUE may only be included when an *lpp-MessageBody* is included.

ackIndicator

This field indicates the sequence number of the message being acknowledged.

lpp-MessageBody

This field may be omitted in the case the message is sent only to acknowledge a previously received message.

— *LPP-MessageBody*

The *LPP-MessageBody* identifies the type of an LPP message and contains all LPP information specifically associated with that type.

```

-- ASN1START
LPP-MessageBody ::= CHOICE {
    c1 CHOICE {
        requestCapabilities    RequestCapabilities,
        provideCapabilities    ProvideCapabilities,
        requestAssistanceData  RequestAssistanceData,
        provideAssistanceData  ProvideAssistanceData,
        requestLocationInformation RequestLocationInformation,
        provideLocationInformation ProvideLocationInformation,
        abort                  Abort,
        error                  Error,
        spare7 NULL, spare6 NULL, spare5 NULL, spare4 NULL,
        spare3 NULL, spare2 NULL, spare1 NULL, spare0 NULL
    },
    messageClassExtension SEQUENCE {}
}
-- ASN1STOP

```

— *LPP-TransactionID*

The *LPP-TransactionID* identifies a particular LPP transaction and the initiator of the transaction.

```

-- ASN1START
LPP-TransactionID ::= SEQUENCE {
    initiator          Initiator,
    transactionNumber TransactionNumber,
    ...
}

```

```

Initiator ::= ENUMERATED {
    locationServer,
    targetDevice,
    ...
}

TransactionNumber ::= INTEGER (0..255)

-- ASN1STOP

```

6.3 Message Body IEs

– *RequestCapabilities*

The *RequestCapabilities* message body in a LPP message is used by the location server to request the target device capability information for LPP and the supported individual positioning methods.

```

-- ASN1START

RequestCapabilities ::= SEQUENCE {
    criticalExtensions CHOICE {
        cl CHOICE {
            requestCapabilities-r9 RequestCapabilities-r9-IEs,
            spare3 NULL, spare2 NULL, spare1 NULL
        },
        criticalExtensionsFuture SEQUENCE {}
    }
}

RequestCapabilities-r9-IEs ::= SEQUENCE {
    commonIEsRequestCapabilities CommonIEsRequestCapabilities OPTIONAL, -- Need ON
    a-gnss-RequestCapabilities A-GNSS-RequestCapabilities OPTIONAL, -- Need ON
    otdoa-RequestCapabilities OTDOA-RequestCapabilities OPTIONAL, -- Need ON
    ecid-RequestCapabilities ECID-RequestCapabilities OPTIONAL, -- Need ON
    epdu-RequestCapabilities EPDU-Sequence OPTIONAL, -- Need ON
    ...,
    [[ sensor-RequestCapabilities-r13 Sensor-RequestCapabilities-r13 OPTIONAL, -- Need ON
        tbs-RequestCapabilities-r13 TBS-RequestCapabilities-r13 OPTIONAL, -- Need ON
        wlan-RequestCapabilities-r13 WLAN-RequestCapabilities-r13 OPTIONAL, -- Need ON
        bt-RequestCapabilities-r13 BT-RequestCapabilities-r13 OPTIONAL -- Need ON
    ]],
    [[ nr-ECID-RequestCapabilities-r16 NR-ECID-RequestCapabilities-r16 OPTIONAL, -- Need ON
        nr-Multi-RTT-RequestCapabilities-r16
            NR-Multi-RTT-RequestCapabilities-r16 OPTIONAL, -- Need ON
        nr-DL-AoD-RequestCapabilities-r16
            NR-DL-AoD-RequestCapabilities-r16 OPTIONAL, -- Need ON
        nr-DL-TDOA-RequestCapabilities-r16
            NR-DL-TDOA-RequestCapabilities-r16 OPTIONAL, -- Need ON
        nr-UL-RequestCapabilities-r16 NR-UL-RequestCapabilities-r16 OPTIONAL -- Need ON
    ]]
}

-- ASN1STOP

```

– *ProvideCapabilities*

The *ProvideCapabilities* message body in a LPP message indicates the LPP capabilities of the target device to the location server.

```

-- ASN1START

ProvideCapabilities ::= SEQUENCE {
    criticalExtensions CHOICE {
        cl CHOICE {
            provideCapabilities-r9 ProvideCapabilities-r9-IEs,
            spare3 NULL, spare2 NULL, spare1 NULL
        },
        criticalExtensionsFuture SEQUENCE {}
    }
}

```



```

}
}
ProvideCapabilities-r9-IEs ::= SEQUENCE {
  commonIEsProvideCapabilities      CommonIEsProvideCapabilities      OPTIONAL,
  a-gnss-ProvideCapabilities        A-GNSS-ProvideCapabilities        OPTIONAL,
  otdoa-ProvideCapabilities         OTDOA-ProvideCapabilities         OPTIONAL,
  ecid-ProvideCapabilities          ECID-ProvideCapabilities          OPTIONAL,
  epdu-ProvideCapabilities          EPDU-Sequence                    OPTIONAL,
  . . . ,
  [[ sensor-ProvideCapabilities-r13  Sensor-ProvideCapabilities-r13    OPTIONAL,
   tbs-ProvideCapabilities-r13      TBS-ProvideCapabilities-r13      OPTIONAL,
   wlan-ProvideCapabilities-r13     WLAN-ProvideCapabilities-r13     OPTIONAL,
   bt-ProvideCapabilities-r13       BT-ProvideCapabilities-r13       OPTIONAL
  ]],
  [[ nr-ECID-ProvideCapabilities-r16  NR-ECID-ProvideCapabilities-r16   OPTIONAL,
   nr-Multi-RTT-ProvideCapabilities-r16  NR-Multi-RTT-ProvideCapabilities-r16  OPTIONAL,
   nr-DL-AoD-ProvideCapabilities-r16    NR-DL-AoD-ProvideCapabilities-r16    OPTIONAL,
   nr-DL-TDOA-ProvideCapabilities-r16   NR-DL-TDOA-ProvideCapabilities-r16   OPTIONAL,
   nr-UL-ProvideCapabilities-r16       NR-UL-ProvideCapabilities-r16       OPTIONAL
  ]]
}
-- ASN1STOP

```

– *RequestAssistanceData*

The *RequestAssistanceData* message body in a LPP message is used by the target device to request assistance data from the location server.

```

-- ASN1START
RequestAssistanceData ::= SEQUENCE {
  criticalExtensions      CHOICE {
    c1                    CHOICE {
      requestAssistanceData-r9  RequestAssistanceData-r9-IEs,
      spare3 NULL, spare2 NULL, spare1 NULL
    },
    criticalExtensionsFuture  SEQUENCE {}
  }
}
RequestAssistanceData-r9-IEs ::= SEQUENCE {
  commonIEsRequestAssistanceData      CommonIEsRequestAssistanceData      OPTIONAL,
  a-gnss-RequestAssistanceData        A-GNSS-RequestAssistanceData        OPTIONAL,
  otdoa-RequestAssistanceData         OTDOA-RequestAssistanceData         OPTIONAL,
  epdu-RequestAssistanceData          EPDU-Sequence                    OPTIONAL,
  . . . ,
  [[ sensor-RequestAssistanceData-r14  Sensor-RequestAssistanceData-r14    OPTIONAL,
   tbs-RequestAssistanceData-r14      TBS-RequestAssistanceData-r14      OPTIONAL,
   wlan-RequestAssistanceData-r14     WLAN-RequestAssistanceData-r14     OPTIONAL
  ]],
  [[ nr-Multi-RTT-RequestAssistanceData-r16  NR-Multi-RTT-RequestAssistanceData-r16  OPTIONAL,
   nr-DL-AoD-RequestAssistanceData-r16    NR-DL-AoD-RequestAssistanceData-r16    OPTIONAL,
   nr-DL-TDOA-RequestAssistanceData-r16   NR-DL-TDOA-RequestAssistanceData-r16   OPTIONAL
  ]]
}
-- ASN1STOP

```

– *ProvideAssistanceData*

The *ProvideAssistanceData* message body in a LPP message is used by the location server to provide assistance data to the target device either in response to a request from the target device or in an unsolicited manner.

```

-- ASN1START
ProvideAssistanceData ::= SEQUENCE {

```

```

criticalExtensions CHOICE {
  c1 CHOICE {
    provideAssistanceData-r9 ProvideAssistanceData-r9-IEs,
    spare3 NULL, spare2 NULL, spare1 NULL
  },
  criticalExtensionsFuture SEQUENCE {}
}
}

ProvideAssistanceData-r9-IEs ::= SEQUENCE {
  commonIEsProvideAssistanceData CommonIEsProvideAssistanceData OPTIONAL, -- Need ON
  a-gnss-ProvideAssistanceData A-GNSS-ProvideAssistanceData OPTIONAL, -- Need ON
  otdoa-ProvideAssistanceData OTDOA-ProvideAssistanceData OPTIONAL, -- Need ON
  epdu-Provide-Assistance-Data EPDU-Sequence OPTIONAL, -- Need ON
  ...,
  [[
  sensor-ProvideAssistanceData-r14 Sensor-ProvideAssistanceData-r14 OPTIONAL, -- Need ON
  tbs-ProvideAssistanceData-r14 TBS-ProvideAssistanceData-r14 OPTIONAL, -- Need ON
  wlan-ProvideAssistanceData-r14 WLAN-ProvideAssistanceData-r14 OPTIONAL -- Need ON
  ]],
  [[
  nr-Multi-RTT-ProvideAssistanceData-r16
    NR-Multi-RTT-ProvideAssistanceData-r16
    OPTIONAL, -- Need ON

  nr-DL-AoD-ProvideAssistanceData-r16
    NR-DL-AoD-ProvideAssistanceData-r16 OPTIONAL, -- Need ON

  nr-DL-TDOA-ProvideAssistanceData-r16
    NR-DL-TDOA-ProvideAssistanceData-r16
    OPTIONAL -- Need ON
  ]]
}
-- ASN1STOP

```

– RequestLocationInformation

The *RequestLocationInformation* message body in a LPP message is used by the location server to request positioning measurements or a position estimate from the target device.

```

-- ASN1START
RequestLocationInformation ::= SEQUENCE {
  criticalExtensions CHOICE {
    c1 CHOICE {
      requestLocationInformation-r9 RequestLocationInformation-r9-IEs,
      spare3 NULL, spare2 NULL, spare1 NULL
    },
    criticalExtensionsFuture SEQUENCE {}
  }
}

RequestLocationInformation-r9-IEs ::= SEQUENCE {
  commonIEsRequestLocationInformation CommonIEsRequestLocationInformation OPTIONAL, -- Need ON
  a-gnss-RequestLocationInformation A-GNSS-RequestLocationInformation OPTIONAL, -- Need ON
  otdoa-RequestLocationInformation OTDOA-RequestLocationInformation OPTIONAL, -- Need ON
  ecid-RequestLocationInformation ECID-RequestLocationInformation OPTIONAL, -- Need ON
  epdu-RequestLocationInformation EPDU-Sequence OPTIONAL, -- Need ON
  ...,
  [[
  sensor-RequestLocationInformation-r13
    Sensor-RequestLocationInformation-r13
    OPTIONAL, -- Need ON

  tbs-RequestLocationInformation-r13 TBS-RequestLocationInformation-r13 OPTIONAL, -- Need ON
  wlan-RequestLocationInformation-r13 WLAN-RequestLocationInformation-r13 OPTIONAL, -- Need ON
  bt-RequestLocationInformation-r13 BT-RequestLocationInformation-r13 OPTIONAL -- Need ON
  ]],
  [[
  nr-ECID-RequestLocationInformation-r16
    NR-ECID-RequestLocationInformation-r16
    OPTIONAL, -- Need ON

  nr-Multi-RTT-RequestLocationInformation-r16
    NR-Multi-RTT-RequestLocationInformation-r16
    OPTIONAL, -- Need ON

  nr-DL-AoD-RequestLocationInformation-r16
    NR-DL-AoD-RequestLocationInformation-r16
    OPTIONAL, -- Need ON
  ]]
}
-- ASN1STOP

```

```

        nr-DL-TDOA-RequestLocationInformation-r16
                                NR-DL-TDOA-RequestLocationInformation-r16
                                                OPTIONAL      -- Need ON
    ]]
}
-- ASN1STOP

```

RequestLocationInformation field descriptions

commonIEsRequestLocationInformation

This field specifies the location information type requested by the location server and optionally other configuration information associated with the requested location information. This field should always be included in this version of the protocol.

ProvideLocationInformation

The *ProvideLocationInformation* message body in a LPP message is used by the target device to provide positioning measurements or position estimates to the location server.

```

-- ASN1START
ProvideLocationInformation ::= SEQUENCE {
    criticalExtensions      CHOICE {
        c1                  CHOICE {
            provideLocationInformation-r9  ProvideLocationInformation-r9-IEs,
            spare3 NULL, spare2 NULL, spare1 NULL
        },
        criticalExtensionsFuture  SEQUENCE {}
    }
}

ProvideLocationInformation-r9-IEs ::= SEQUENCE {
    commonIEsProvideLocationInformation
        CommonIEsProvideLocationInformation OPTIONAL,
    a-gnss-ProvideLocationInformation  A-GNSS-ProvideLocationInformation  OPTIONAL,
    otdoa-ProvideLocationInformation  OTDOA-ProvideLocationInformation  OPTIONAL,
    ecid-ProvideLocationInformation  ECID-ProvideLocationInformation  OPTIONAL,
    epdu-ProvideLocationInformation  EPDU-Sequence  OPTIONAL,
    ...,
    [[
    sensor-ProvideLocationInformation-r13
        Sensor-ProvideLocationInformation-r13
        OPTIONAL,
    tbs-ProvideLocationInformation-r13  TBS-ProvideLocationInformation-r13  OPTIONAL,
    wlan-ProvideLocationInformation-r13  WLAN-ProvideLocationInformation-r13  OPTIONAL,
    bt-ProvideLocationInformation-r13  BT-ProvideLocationInformation-r13  OPTIONAL
    ]],
    [[
    nr-ECID-ProvideLocationInformation-r16
        NR-ECID-ProvideLocationInformation-r16  OPTIONAL,
    nr-Multi-RTT-ProvideLocationInformation-r16
        NR-Multi-RTT-ProvideLocationInformation-r16  OPTIONAL,
    nr-DL-AoD-ProvideLocationInformation-r16
        NR-DL-AoD-ProvideLocationInformation-r16  OPTIONAL,
    nr-DL-TDOA-ProvideLocationInformation-r16
        NR-DL-TDOA-ProvideLocationInformation-r16  OPTIONAL
    ]]
}
-- ASN1STOP

```

Abort

The *Abort* message body in a LPP message carries a request to abort an ongoing LPP procedure.

```

-- ASN1START
Abort ::= SEQUENCE {
    criticalExtensions      CHOICE {
        c1                  CHOICE {
            abort-r9        Abort-r9-IEs,
            spare3 NULL, spare2 NULL, spare1 NULL
        }
    }
}

```

```

    },
    criticalExtensionsFuture SEQUENCE {}
  }
}
Abort-r9-IEs ::= SEQUENCE {
  commonIEsAbort      CommonIEsAbort      OPTIONAL,  -- Need ON
  ...,
  epdu-Abort          EPDU-Sequence        OPTIONAL  -- Need ON
}
-- ASN1STOP

```

– *Error*

The *Error* message body in a LPP message carries information concerning a LPP message that was received with errors.

```

-- ASN1START
Error ::= CHOICE {
  error-r9              Error-r9-IEs,
  criticalExtensionsFuture SEQUENCE {}
}
Error-r9-IEs ::= SEQUENCE {
  commonIEsError      CommonIEsError      OPTIONAL,  -- Need ON
  ...,
  epdu-Error          EPDU-Sequence        OPTIONAL  -- Need ON
}
-- ASN1STOP

```

6.4 Common IEs

Common IEs comprise IEs that are applicable to more than one LPP positioning method.

6.4.1 Common Lower-Level IEs

– *AccessTypes*

The IE *AccessTypes* is used to indicate several cellular access types using a bit map.

```

-- ASN1START
AccessTypes ::= SEQUENCE {
  accessTypes BIT STRING {
    eutra      (0),
    ultra      (1),
    gsm        (2),
    nb-iot     (3),
    nr-v1510   (4) } (SIZE (1..8)),
  ...
}
-- ASN1STOP

```

AccessTypes field descriptions

accessTypes

This field specifies the cellular access type(s). This is represented by a bit string, with a one-value at the bit position means the particular access type is addressed; a zero-value means not addressed.

– *ARFCN-ValueEUTRA*

The IEs *ARFCN-ValueEUTRA* and *ARFCN-ValueEUTRA-v9a0* are used to indicate the ARFCN of the E-UTRA carrier frequency, as defined in TS 36.331 [12].

```
-- ASN1START
ARFCN-ValueEUTRA ::= INTEGER (0..maxEARFCN)
ARFCN-ValueEUTRA-v9a0 ::= INTEGER (maxEARFCN-Plus1..maxEARFCN2)
ARFCN-ValueEUTRA-r14 ::= INTEGER (0..maxEARFCN2)
-- ASN1STOP
```

NOTE: For fields using the original value range, as defined by IE *ARFCN-ValueEUTRA* i.e. without suffix, value *maxEARFCN* indicates that the E-UTRA carrier frequency is indicated by means of an extension.

– *ARFCN-ValueNR*

The IE *ARFCN-ValueNR* is used to indicate the ARFCN applicable for a downlink, uplink or bi-directional (TDD) NR global frequency raster, as defined in TS 38.101-2 [34] and TS 38.101-1 [37].

```
-- ASN1START
ARFCN-ValueNR-r15 ::= INTEGER (0..3279165)
-- ASN1STOP
```

– *ARFCN-ValueUTRA*

The IE *ARFCN-ValueUTRA* is used to indicate the ARFCN of the UTRA carrier frequency, as defined in TS 25.331 [13].

```
-- ASN1START
ARFCN-ValueUTRA ::= INTEGER (0..16383)
-- ASN1STOP
```

– *CarrierFreq-NB*

The IE *CarrierFreq-NB* is used to provide the NB-IoT carrier frequency, as defined in TS 36.101 [21].

```
-- ASN1START
CarrierFreq-NB-r14 ::= SEQUENCE {
  carrierFreq-r14          ARFCN-ValueEUTRA-r14,
  carrierFreqOffset-r14   CarrierFreqOffsetNB-r14 OPTIONAL,
  ...
}
-- ASN1STOP
```

<i>CarrierFreq-NB</i> field descriptions
<i>carrierFreq</i> This field specifies the ARFCN applicable for the NB-IoT carrier frequency as defined in TS 36.101 [21, Table 5.7.3-1].
<i>carrierFreqOffset</i> This field specifies the offset of the NB-IoT channel number to EARFCN as defined in TS 36.101 [21].

– *CarrierFreqOffsetNB*

The IE *CarrierFreqOffsetNB* is used to provide the offset of the NB-IoT channel number to EARFCN of a NB-IoT carrier.

```
-- ASN1START
CarrierFreqOffsetNB-r14 ::= ENUMERATED {
  v-10, v-9, v-8, v-7, v-6, v-5, v-4, v-3, v-2, v-1, v-0dot5,
  v0, v1, v2, v3, v4, v5, v6, v7, v8, v9
}
-- ASN1STOP
```

```

    }
-- ASN1STOP

```

CarrierFreqOffsetNB field descriptions

CarrierFreqOffsetNB

This field specifies the offset of the NB-IoT channel number to EARFCN as defined in TS 36.101 [21]. Value v-10 means -10, v-9 means -9, and so on.

– *CellGlobalIdEUTRA-AndUTRA*

The IE *CellGlobalIdEUTRA-AndUTRA* specifies the global Cell Identifier for E-UTRA or UTRA, the globally unique identity of a cell in E-UTRA or UTRA.

```

-- ASN1START
CellGlobalIdEUTRA-AndUTRA ::= SEQUENCE {
  plmn-Identity      SEQUENCE {
    mcc      SEQUENCE (SIZE (3)) OF INTEGER (0..9),
    mnc      SEQUENCE (SIZE (2..3)) OF INTEGER (0..9)
  },
  cellIdentity      CHOICE {
    eutra  BIT STRING (SIZE (28)),
    utra   BIT STRING (SIZE (32))
  },
  ...
}
-- ASN1STOP

```

CellGlobalIdEUTRA-AndUTRA field descriptions

plmn-Identity

This field identifies the PLMN of the cell as defined in TS 36.331 [12].

cellIdentity

This field defines the identity of the cell within the context of the PLMN as defined in TS 36.331 [12] and TS 25.331 [13]. The size of the bit string allows for the 32-bit extended UTRAN cell ID; in the case the cell ID is shorter, the first bits of the string are set to 0.

– *CellGlobalIdGERAN*

The IE *CellGlobalIdGERAN* specifies the global Cell Identifier for GERAN, the globally unique identity of a cell in GERAN.

```

-- ASN1START
CellGlobalIdGERAN ::= SEQUENCE {
  plmn-Identity      SEQUENCE {
    mcc      SEQUENCE (SIZE (3)) OF INTEGER (0..9),
    mnc      SEQUENCE (SIZE (2..3)) OF INTEGER (0..9)
  },
  locationAreaCode  BIT STRING (SIZE (16)),
  cellIdentity      BIT STRING (SIZE (16)),
  ...
}
-- ASN1STOP

```

CellGlobalIdGERAN field descriptions

plmn-Identity

This field identifies the PLMN of the cell.

locationAreaCode

This field is a fixed length code identifying the location area within a PLMN.

cellIdentity

This field specifies the cell Identifier which is unique within the context of the GERAN location area.

– *ECGI*

The IE *ECGI* specifies the Evolved Cell Global Identifier (ECGI), the globally unique identity of a cell in E-UTRA (TS 36.331 [12]).

NOTE: The IE *ECGI* is also used for NB-IoT access.

```
-- ASN1START
ECGI ::= SEQUENCE {
    mcc      SEQUENCE (SIZE (3)) OF INTEGER (0..9),
    mnc      SEQUENCE (SIZE (2..3)) OF INTEGER (0..9),
    cellidentity  BIT STRING (SIZE (28))
}
-- ASN1STOP
```

– *Ellipsoid-Point*

The IE *Ellipsoid-Point* is used to describe a geographic shape as defined in TS 23.032 [15].

```
-- ASN1START
Ellipsoid-Point ::= SEQUENCE {
    latitudeSign      ENUMERATED {north, south},
    degreesLatitude   INTEGER (0..8388607),          -- 23 bit field
    degreesLongitude  INTEGER (-8388608..8388607)   -- 24 bit field
}
-- ASN1STOP
```

– *Ellipsoid-PointWithUncertaintyCircle*

The IE *Ellipsoid-PointWithUncertaintyCircle* is used to describe a geographic shape as defined in TS 23.032 [15].

```
-- ASN1START
Ellipsoid-PointWithUncertaintyCircle ::= SEQUENCE {
    latitudeSign      ENUMERATED {north, south},
    degreesLatitude   INTEGER (0..8388607),          -- 23 bit field
    degreesLongitude  INTEGER (-8388608..8388607),   -- 24 bit field
    uncertainty       INTEGER (0..127)
}
-- ASN1STOP
```

– *EllipsoidPointWithUncertaintyEllipse*

The IE *EllipsoidPointWithUncertaintyEllipse* is used to describe a geographic shape as defined in TS 23.032 [15].

```
-- ASN1START
EllipsoidPointWithUncertaintyEllipse ::= SEQUENCE {
    latitudeSign      ENUMERATED {north, south},
    degreesLatitude   INTEGER (0..8388607),          -- 23 bit field
    degreesLongitude  INTEGER (-8388608..8388607),   -- 24 bit field
    uncertaintySemiMajor  INTEGER (0..127),
    uncertaintySemiMinor  INTEGER (0..127),
    orientationMajorAxis  INTEGER (0..179),
    confidence         INTEGER (0..100)
}
-- ASN1STOP
```

– *EllipsoidPointWithAltitude*

The IE *EllipsoidPointWithAltitude* is used to describe a geographic shape as defined in TS 23.032 [15].

```
-- ASN1START
EllipsoidPointWithAltitude ::= SEQUENCE {
  latitudeSign      ENUMERATED {north, south},
  degreesLatitude   INTEGER (0..8388607),           -- 23 bit field
  degreesLongitude  INTEGER (-8388608..8388607),   -- 24 bit field
  altitudeDirection ENUMERATED {height, depth},
  altitude          INTEGER (0..32767)           -- 15 bit field
}
-- ASN1STOP
```

– *EllipsoidPointWithAltitudeAndUncertaintyEllipsoid*

The IE *EllipsoidPointWithAltitudeAndUncertaintyEllipsoid* is used to describe a geographic shape as defined in TS 23.032 [15].

```
-- ASN1START
EllipsoidPointWithAltitudeAndUncertaintyEllipsoid ::= SEQUENCE {
  latitudeSign      ENUMERATED {north, south},
  degreesLatitude   INTEGER (0..8388607),           -- 23 bit field
  degreesLongitude  INTEGER (-8388608..8388607),   -- 24 bit field
  altitudeDirection ENUMERATED {height, depth},
  altitude          INTEGER (0..32767),           -- 15 bit field
  uncertaintySemiMajor    INTEGER (0..127),
  uncertaintySemiMinor    INTEGER (0..127),
  orientationMajorAxis    INTEGER (0..179),
  uncertaintyAltitude     INTEGER (0..127),
  confidence           INTEGER (0..100)
}
-- ASN1STOP
```

– *EllipsoidArc*

The IE *EllipsoidArc* is used to describe a geographic shape as defined in TS 23.032 [15].

```
-- ASN1START
EllipsoidArc ::= SEQUENCE {
  latitudeSign      ENUMERATED {north, south},
  degreesLatitude   INTEGER (0..8388607),           -- 23 bit field
  degreesLongitude  INTEGER (-8388608..8388607),   -- 24 bit field
  innerRadius       INTEGER (0..65535),           -- 16 bit field,
  uncertaintyRadius  INTEGER (0..127),
  offsetAngle       INTEGER (0..179),
  includedAngle     INTEGER (0..179),
  confidence         INTEGER (0..100)
}
-- ASN1STOP
```

– *EPDU-Sequence*

The *EPDU-Sequence* contains IEs that are defined externally to LPP by other organizations.

```
-- ASN1START
EPDU-Sequence ::= SEQUENCE (SIZE (1..maxEPDU)) OF EPDU

maxEPDU INTEGER ::= 16

EPDU ::= SEQUENCE {
  ePDU-Identifier    EPDU-Identifier,
```



```

    ePDU-Body          EPDU-Body
  }
EPDU-Identifier ::= SEQUENCE {
    ePDU-ID            EPDU-ID,
    ePDU-Name         EPDU-Name    OPTIONAL,
    ...
}
EPDU-ID ::= INTEGER (1..256)
EPDU-Name ::= VisibleString (SIZE (1..32))
EPDU-Body ::= OCTET STRING
-- ASN1STOP

```

EPDU-Sequence field descriptions

EPDU-ID

This field provides a unique integer ID for the externally defined positioning method. Its value is assigned to the external entity that defines the EPDU. See table External PDU Identifier Definition for a list of external PDU identifiers defined in this version of the specification.

EPDU-Name

This field provides an optional character encoding which can be used to provide a quasi-unique name for an external PDU – e.g., by containing the name of the defining organization and/or the name of the associated public or proprietary standard for the EPDU.

EPDU-Body

The content and encoding of this field are defined externally to LPP.

External PDU Identifier Definition

EPDU-ID	EPDU Defining entity	Method name	Reference
1	OMA LOC	OMA LPP extensions (LPPe)	OMA-TS-LPPe-V1_0 [20]

– *FreqBandIndicatorNR*

The IE *FreqBandIndicatorNR* specifies the NR band indicator (TS 38.331 [35]).

```

-- ASN1START
FreqBandIndicatorNR-r16 ::= INTEGER (1..1024)
-- ASN1STOP

```

– *HA-EllipsoidPointWithAltitudeAndScalableUncertaintyEllipsoid*

The IE *HA-EllipsoidPointWithAltitudeAndScalableUncertaintyEllipsoid* is used to describe a geographic shape as defined in TS 23.032 [15].

```

-- ASN1START
HA-EllipsoidPointWithAltitudeAndScalableUncertaintyEllipsoid-r16 ::= SEQUENCE {
    degreesLatitude-r16          INTEGER(-2147483648..2147483647),
    degreesLongitude-r16         INTEGER(-2147483648..2147483647),
    altitude-r16                 INTEGER(-64000..1280000),
    uncertaintySemiMajor-r16     INTEGER (0..255),
    uncertaintySemiMinor-r16    INTEGER (0..255),
    orientationMajorAxis-r16     INTEGER (0..179),
    horizontalConfidence-r16     INTEGER (0..100),
    uncertaintyAltitude-r16     INTEGER (0..255),
    verticalConfidence-r16      INTEGER (0..100),
    ha-HorizontalExtendedRangeUsed-r16  BOOLEAN,
    ha-VerticalExtendedRangeUsed-r16    BOOLEAN
}
-- ASN1STOP

```

– *HA-EllipsoidPointWithScalableUncertaintyEllipse*

The IE *HA-EllipsoidPointWithScalableUncertaintyEllipse* is used to describe a geographic shape as defined in TS 23.032 [15].

```
-- ASN1START
HA-EllipsoidPointWithScalableUncertaintyEllipse-r16 ::= SEQUENCE {
  degreesLatitude-r16          INTEGER(-2147483648..2147483647),
  degreesLongitude-r16         INTEGER(-2147483648..2147483647),
  uncertaintySemiMajor-r16     INTEGER (0..255),
  uncertaintySemiMinor-r16     INTEGER (0..255),
  orientationMajorAxis-r16     INTEGER (0..179),
  confidence-r16               INTEGER (0..100),
  ha-ExtendedUncertaintyRangeUsed-r16  BOOLEAN
}
-- ASN1STOP
```

– *HighAccuracyEllipsoidPointWithUncertaintyEllipse*

The IE *HighAccuracyEllipsoidPointWithUncertaintyEllipse* is used to describe a geographic shape as defined in TS 23.032 [15].

```
-- ASN1START
HighAccuracyEllipsoidPointWithUncertaintyEllipse-r15 ::= SEQUENCE {
  degreesLatitude-r15          INTEGER(-2147483648..2147483647),
  degreesLongitude-r15         INTEGER(-2147483648..2147483647),
  uncertaintySemiMajor-r15     INTEGER (0..255),
  uncertaintySemiMinor-r15     INTEGER (0..255),
  orientationMajorAxis-r15     INTEGER (0..179),
  confidence-r15               INTEGER (0..100)
}
-- ASN1STOP
```

– *HighAccuracyEllipsoidPointWithAltitudeAndUncertaintyEllipsoid*

The IE *HighAccuracyEllipsoidPointWithAltitudeAndUncertaintyEllipsoid* is used to describe a geographic shape as defined in TS 23.032 [15].

```
-- ASN1START
HighAccuracyEllipsoidPointWithAltitudeAndUncertaintyEllipsoid-r15 ::= SEQUENCE {
  degreesLatitude-r15          INTEGER(-2147483648..2147483647),
  degreesLongitude-r15         INTEGER(-2147483648..2147483647),
  altitude-r15                 INTEGER(-64000..1280000),
  uncertaintySemiMajor-r15     INTEGER (0..255),
  uncertaintySemiMinor-r15     INTEGER (0..255),
  orientationMajorAxis-r15     INTEGER (0..179),
  horizontalConfidence-r15     INTEGER (0..100),
  uncertaintyAltitude-r15      INTEGER (0..255),
  verticalConfidence-r15       INTEGER (0..100)
}
-- ASN1STOP
```

– *HorizontalVelocity*

The IE *HorizontalVelocity* is used to describe a velocity shape as defined in TS 23.032 [15].

```
-- ASN1START
HorizontalVelocity ::= SEQUENCE {
  bearing                      INTEGER(0..359),
}
```

```

    horizontalSpeed      INTEGER(0..2047)
  }
-- ASN1STOP

```

– *HorizontalWithVerticalVelocity*

The IE *HorizontalWithVerticalVelocity* is used to describe a velocity shape as defined in TS 23.032 [15].

```

-- ASN1START
HorizontalWithVerticalVelocity ::= SEQUENCE {
    bearing                INTEGER(0..359),
    horizontalSpeed        INTEGER(0..2047),
    verticalDirection      ENUMERATED{upward, downward},
    verticalSpeed          INTEGER(0..255)
}
-- ASN1STOP

```

– *HorizontalVelocityWithUncertainty*

The IE *HorizontalVelocityWithUncertainty* is used to describe a velocity shape as defined in TS 23.032 [15].

```

-- ASN1START
HorizontalVelocityWithUncertainty ::= SEQUENCE {
    bearing                INTEGER(0..359),
    horizontalSpeed        INTEGER(0..2047),
    uncertaintySpeed       INTEGER(0..255)
}
-- ASN1STOP

```

– *HorizontalWithVerticalVelocityAndUncertainty*

The IE *HorizontalWithVerticalVelocityAndUncertainty* is used to describe a velocity shape as defined in TS 23.032 [15].

```

-- ASN1START
HorizontalWithVerticalVelocityAndUncertainty ::= SEQUENCE {
    bearing                INTEGER(0..359),
    horizontalSpeed        INTEGER(0..2047),
    verticalDirection      ENUMERATED{upward, downward},
    verticalSpeed          INTEGER(0..255),
    horizontalUncertaintySpeed  INTEGER(0..255),
    verticalUncertaintySpeed  INTEGER(0..255)
}
-- ASN1STOP

```

– *LocationCoordinateTypes*

The IE *LocationCoordinateTypes* defines a list of possible geographic shapes as defined in TS 23.032 [15].

```

-- ASN1START
LocationCoordinateTypes ::= SEQUENCE {
    ellipsoidPoint                BOOLEAN,
    ellipsoidPointWithUncertaintyCircle  BOOLEAN,
    ellipsoidPointWithUncertaintyEllipse  BOOLEAN,
    polygon                        BOOLEAN,
    ellipsoidPointWithAltitude        BOOLEAN,
    ellipsoidPointWithAltitudeAndUncertaintyEllipsoid  BOOLEAN,
    ellipsoidArc                    BOOLEAN,
    ...

```

```

[[
  highAccuracyEllipsoidPointWithUncertaintyEllipse-r15
  highAccuracyEllipsoidPointWithAltitudeAndUncertaintyEllipsoid-r15
  BOOLEAN OPTIONAL, -- Need ON
  BOOLEAN OPTIONAL -- Need ON
]],
[[
  ha-EllipsoidPointWithScalableUncertaintyEllipse-r16
  ha-EllipsoidPointWithAltitudeAndScalableUncertaintyEllipsoid-r16
  BOOLEAN OPTIONAL, -- Need ON
  BOOLEAN OPTIONAL -- Need ON
]]
}
-- ASN1STOP

```

– *NCGI*

The IE *NCGI* specifies the NR Cell Global Identifier (NCGI) which is used to identify NR cells globally (TS 38.331 [35]).

```

-- ASN1START
NCGI-r15 ::= SEQUENCE {
  mcc-r15          SEQUENCE (SIZE (3)) OF INTEGER (0..9),
  mnc-r15          SEQUENCE (SIZE (2..3)) OF INTEGER (0..9),
  nr-cellidentity-r15 BIT STRING (SIZE (36))
}
-- ASN1STOP

```

– *NR-PhysCellId*

The IE *NR-PhysCellId* specifies the NR physical cell identifier (TS 38.331 [35]).

```

-- ASN1START
NR-PhysCellID-r16 ::= INTEGER (0..1007)
-- ASN1STOP

```

– *PeriodicAssistanceDataControlParameters*

The IE *PeriodicAssistanceDataControlParameters* is used in a periodic assistance data delivery procedure as described in clauses 5.2.1a and 5.2.2a.

```

-- ASN1START
PeriodicAssistanceDataControlParameters-r15 ::= SEQUENCE {
  periodicSessionID-r15      PeriodicSessionID-r15,
  ...
  [[
    updateCapabilities-r15    UpdateCapabilities-r15    OPTIONAL    -- Need ON
  ]]
}
PeriodicSessionID-r15 ::= SEQUENCE {
  periodicSessionInitiator-r15  ENUMERATED { locationServer, targetDevice, ... },
  periodicSessionNumber-r15     INTEGER (0..255),
  ...
}
UpdateCapabilities-r15 ::= BIT STRING {primaryCellID-r15 (0)} (SIZE(1..8))
-- ASN1STOP

```

<i>PeriodicAssistanceDataControlParameters</i> field descriptions
<i>periodicSessionID</i> This field identifies a particular periodic assistance data delivery session and the initiator of the session.
<i>updateCapabilities</i> This field identifies the capabilities of the sending entity to support an update of periodic assistance data. A bit value set to one indicates a capability is supported and a bit value set to zero indicates a capability is not supported.

– *Polygon*

The IE *Polygon* is used to describe a geographic shape as defined in TS 23.032 [15].

```
-- ASN1START
Polygon ::= SEQUENCE (SIZE (3..15)) OF PolygonPoints
PolygonPoints ::= SEQUENCE {
    latitudeSign          ENUMERATED {north, south},
    degreesLatitude       INTEGER (0..8388607),          -- 23 bit field
    degreesLongitude      INTEGER (-8388608..8388607)   -- 24 bit field
}
-- ASN1STOP
```

– *PositioningModes*

The IE *PositioningModes* is used to indicate several positioning modes using a bit map.

```
-- ASN1START
PositioningModes ::= SEQUENCE {
    posModes             BIT STRING {
        standalone (0),
        ue-based (1),
        ue-assisted (2)
    } (SIZE (1..8)),
    ...
}
-- ASN1STOP
```

<i>PositioningModes</i> field descriptions
<i>posModes</i> This field specifies the positioning mode(s). This is represented by a bit string, with a one-value at the bit position means the particular positioning mode is addressed; a zero-value means not addressed.

– *ScheduledLocationTimeSupport*

The IE *ScheduledLocationTimeSupport* is used by the target device to indicate the time bases supported for scheduled location requests.

```
-- ASN1START
ScheduledLocationTimeSupport-r17 ::= SEQUENCE {
    utcTime-r17          ENUMERATED { supported }          OPTIONAL,
    gnssTime-r17         GNSS-ID-Bitmap                   OPTIONAL,
    e-utraTime-r17      ENUMERATED { supported }          OPTIONAL,
    nrTime-r17          ENUMERATED { supported }          OPTIONAL,
    relativeTime-r17    ENUMERATED { supported }          OPTIONAL,
    ...
}
-- ASN1STOP
```

– *ScheduledLocationTimeSupportPerMode*

The IE *ScheduledLocationTimeSupportPerMode* is used by the target device to indicate the time bases supported for scheduled location requests for each positioning mode indicated by *PositioningModes*.

```
-- ASN1START
ScheduledLocationTimeSupportPerMode-r17 ::= SEQUENCE {
    utcTime-r17          PositioningModes          OPTIONAL,
    gnsstime-r17        SEQUENCE {
        posModes-r17    PositioningModes,
        gnsstimeIDs-r17 GNSS-ID-Bitmap
    }
    e-utraTime-r17      PositioningModes          OPTIONAL,
    nrTime-r17          PositioningModes          OPTIONAL,
    relativeTime-r17    PositioningModes          OPTIONAL,
    ...
}
-- ASN1STOP
```

– *SegmentationInfo*

The IE *SegmentationInfo* is used by a sender to indicate that LPP message segmentation is used, as specified in clause 4.3.5.

```
-- ASN1START
SegmentationInfo-r14 ::= ENUMERATED { noMoreMessages, moreMessagesOnTheWay }
-- ASN1STOP
```

***SegmentationInfo* field descriptions**

SegmentationInfo

noMoreMessages indicates that this is the only or last LPP message segment used to deliver the entire message body.

moreMessagesOnTheWay indicates that this is one of multiple LPP message segments used to deliver the entire message body.

– *VelocityTypes*

The IE *VelocityTypes* defines a list of possible velocity shapes as defined in TS 23.032 [15].

```
-- ASN1START
VelocityTypes ::= SEQUENCE {
    horizontalVelocity          BOOLEAN,
    horizontalWithVerticalVelocity    BOOLEAN,
    horizontalVelocityWithUncertainty    BOOLEAN,
    horizontalWithVerticalVelocityAndUncertainty    BOOLEAN,
    ...
}
-- ASN1STOP
```

6.4.2 Common Positioning

– *CommonIEsRequestCapabilities*

The *CommonIEsRequestCapabilities* carries common IEs for a Request Capabilities LPP message Type.

```
-- ASN1START
CommonIEsRequestCapabilities ::= SEQUENCE {
    ...
}
```

```

[[
  lpp-message-segmentation-req-r14    BIT STRING {    serverToTarget    (0),
                                          targetToServer    (1) }    OPTIONAL -- Need ON
]]
}
-- ASN1STOP

```

CommonIEsRequestCapabilities field descriptions
<p>lpp-message-segmentation-req This field, if present, indicates that the target device is requested to provide its LPP message segmentation capabilities. If bit 0 is set to value 1, it indicates that the server is able to send segmented LPP messages to the target device; if bit 0 is set to value 0 it indicates that the server is not able to send segmented LPP messages to the target device. If bit 1 is set to value 1, it indicates that the server is able to receive segmented LPP messages from the target device; if bit 1 is set to value 0 it indicates that the server is not able to receive segmented LPP messages from the target device.</p>

– **CommonIEsProvideCapabilities**

The *CommonIEsProvideCapabilities* carries common IEs for a Provide Capabilities LPP message Type.

```

-- ASN1START
CommonIEsProvideCapabilities ::= SEQUENCE {
  ...
  [[
    segmentationInfo-r14          SegmentationInfo-r14          OPTIONAL,    -- Cond Segmentation
    lpp-message-segmentation-r14  BIT STRING { serverToTarget (0),
                                          targetToServer (1) }    OPTIONAL
  ]]
}
-- ASN1STOP

```

Conditional presence	Explanation
<i>Segmentation</i>	This field is optionally present, need OP, if <i>lpp-message-segmentation-req</i> has been received from the location server with bit 1 (<i>targetToServer</i>) set to value 1. The field shall be omitted if <i>lpp-message-segmentation-req</i> has not been received in this location session, or has been received with bit 1 (<i>targetToServer</i>) set to value 0.

CommonIEsProvideCapabilities field descriptions
<p>segmentationInfo This field indicates whether this <i>ProvideCapabilities</i> message is one of many segments, as specified in clause 4.3.5.</p>
<p>lpp-message-segmentation This field, if present, indicates the target device's LPP message segmentation capabilities. If bit 0 is set to value 1, it indicates that the target device supports receiving segmented LPP messages; if bit 0 is set to value 0 it indicates that the target device does not support receiving segmented LPP messages. If bit 1 is set to value 1, it indicates that the target device supports sending segmented LPP messages; if bit 1 is set to value 0 it indicates that the target device does not support sending segmented LPP messages.</p>

– **CommonIEsRequestAssistanceData**

The *CommonIEsRequestAssistanceData* carries common IEs for a Request Assistance Data LPP message Type.

```

-- ASN1START
CommonIEsRequestAssistanceData ::= SEQUENCE {
  primaryCellID          ECGI          OPTIONAL,    -- Cond EUTRA
  ...
  [[
    segmentationInfo-r14          SegmentationInfo-r14          OPTIONAL    -- Cond Segmentation
  ]],
  [[
    periodicAssistanceDataReq-r15
  ]]
}
-- ASN1STOP

```

```

                                PeriodicAssistanceDataControlParameters-r15
                                OPTIONAL,  -- Cond PerADreq
primaryCellID-r15             NCGI-r15    OPTIONAL  -- Cond NR
    ]]
}
-- ASN1STOP
    
```

Conditional presence	Explanation
EUTRA	The field is mandatory present for E-UTRA or NB-IoT access. The field shall be omitted for non-EUTRA and non-NB-IoT user plane support.
Segmentation	This field is optionally present, need OP, if <i>lpp-message-segmentation-req</i> has been received from the location server with bit 1 (<i>targetToServer</i>) set to value 1. The field shall be omitted if <i>lpp-message-segmentation-req</i> has not been received in this location session, or has been received with bit 1 (<i>targetToServer</i>) set to value 0.
PerADreq	The field is mandatory present if the target device requests periodic assistance data delivery. Otherwise it is not present.
NR	The field is mandatory present for NR access. The field shall be omitted for non-NR user plane support.

CommonIEsRequestAssistanceData field descriptions	
primaryCellID	This parameter identifies the current primary cell for the target device.
segmentationInfo	This field indicates whether this <i>RequestAssistanceData</i> message is one of many segments, as specified in clause 4.3.5.
periodicAssistanceDataReq	This field indicates a request for periodic assistance data delivery, as specified in clause 5.2.1a.

CommonIEsProvideAssistanceData

The *CommonIEsProvideAssistanceData* carries common IEs for a Provide Assistance Data LPP message Type.

```

-- ASN1START
CommonIEsProvideAssistanceData ::= SEQUENCE {
    . . .
    [[
        segmentationInfo-r14             SegmentationInfo-r14             OPTIONAL  -- Need ON
    ]],
    [[
        periodicAssistanceData-r15       PeriodicAssistanceDataControlParameters-r15
                                        OPTIONAL  -- Cond PerAD
    ]]
}
-- ASN1STOP
    
```

Conditional presence	Explanation
PerAD	The field is mandatory present in a periodic assistance data delivery session. Otherwise it is not present.

CommonIEsProvideAssistanceData field descriptions	
segmentationInfo	This field indicates whether this <i>ProvideAssistanceData</i> message is one of many segments, as specified in clause 4.3.5.
periodicAssistanceData	This field indicates a periodic assistance data delivery, as specified in clauses 5.2.1a and 5.2.2a.

CommonIEsRequestLocationInformation

The *CommonIEsRequestLocationInformation* carries common IEs for a Request Location Information LPP message Type.

```

-- ASN1START
CommonIEsRequestLocationInformation ::= SEQUENCE {
    locationInformationType      LocationInformationType,
    triggeredReporting           TriggeredReportingCriteria OPTIONAL, -- Cond ECID
    periodicalReporting         PeriodicalReportingCriteria OPTIONAL, -- Need ON
    additionalInformation       AdditionalInformation OPTIONAL, -- Need ON
    qos                         QoS OPTIONAL, -- Need ON
    environment                 Environment OPTIONAL, -- Need ON
    locationCoordinateTypes     LocationCoordinateTypes OPTIONAL, -- Need ON
    velocityTypes               VelocityTypes OPTIONAL, -- Need ON
    ...
    [[
        messageSizeLimitNB-r14 MessageSizeLimitNB-r14 OPTIONAL -- Need ON
    ]],
    [[
        segmentationInfo-r14   SegmentationInfo-r14 OPTIONAL -- Need ON
    ]],
    [[
        scheduledLocationTime-r17
        ScheduledLocationTime-r17 OPTIONAL, -- Need ON
        targetIntegrityRisk-r17
        TargetIntegrityRisk-r17 OPTIONAL -- Need ON
    ]]
}

LocationInformationType ::= ENUMERATED {
    locationEstimateRequired,
    locationMeasurementsRequired,
    locationEstimatePreferred,
    locationMeasurementsPreferred,
    ...
}

PeriodicalReportingCriteria ::= SEQUENCE {
    reportingAmount      ENUMERATED {
        ra1, ra2, ra4, ra8, ra16, ra32,
        ra64, ra-Infinity
    } DEFAULT ra-Infinity,
    reportingInterval    ENUMERATED {
        noPeriodicalReporting, ri0-25,
        ri0-5, ri1, ri2, ri4, ri8, ri16, ri32, ri64
    }
}

TriggeredReportingCriteria ::= SEQUENCE {
    cellChange          BOOLEAN,
    reportingDuration   ReportingDuration,
    ...
}

ReportingDuration ::= INTEGER (0..255)

AdditionalInformation ::= ENUMERATED {
    onlyReturnInformationRequested,
    mayReturnAdditionalInformation,
    ...
}

QoS ::= SEQUENCE {
    horizontalAccuracy      HorizontalAccuracy OPTIONAL, -- Need ON
    verticalCoordinateRequest
    BOOLEAN,
    verticalAccuracy        VerticalAccuracy OPTIONAL, -- Need ON
    responseTime            ResponseTime OPTIONAL, -- Need ON
    velocityRequest         BOOLEAN,
    ...
    [[
        responseTimeNB-r14 ResponseTimeNB-r14 OPTIONAL -- Need ON
    ]],
    [[
        horizontalAccuracyExt-r15 HorizontalAccuracyExt-r15 OPTIONAL, -- Need ON
        verticalAccuracyExt-r15 VerticalAccuracyExt-r15 OPTIONAL -- Need ON
    ]]
}

HorizontalAccuracy ::= SEQUENCE {
    accuracy      INTEGER(0..127),
    confidence    INTEGER(0..100),
    ...
}

```

```

VerticalAccuracy ::= SEQUENCE {
    accuracy          INTEGER(0..127),
    confidence        INTEGER(0..100),
    ...
}

HorizontalAccuracyExt-r15 ::= SEQUENCE {
    accuracyExt-r15   INTEGER(0..255),
    confidence-r15    INTEGER(0..100),
    ...
}

VerticalAccuracyExt-r15 ::= SEQUENCE {
    accuracyExt-r15   INTEGER(0..255),
    confidence-r15    INTEGER(0..100),
    ...
}

ResponseTime ::= SEQUENCE {
    time              INTEGER (1..128),
    ...,
    [[ responseTimeEarlyFix-r12   INTEGER (1..128)           OPTIONAL           -- Need ON
    ]],
    [[ unit-r15                  ENUMERATED { ten-seconds, ... , ten-milli-seconds-v1700 }
    ]],
    [[                          OPTIONAL                       -- Need ON
    ]]
}

ResponseTimeNB-r14 ::= SEQUENCE {
    timeNB-r14        INTEGER (1..512),
    responseTimeEarlyFixNB-r14   INTEGER (1..512)           OPTIONAL,           -- Need ON
    ...,
    [[ unitNB-r15            ENUMERATED { ten-seconds, ... } OPTIONAL
    ]],
    [[                          OPTIONAL                       -- Need ON
    ]]
}

Environment ::= ENUMERATED {
    badArea,
    notBadArea,
    mixedArea,
    ...
}

MessageSizeLimitNB-r14 ::= SEQUENCE {
    measurementLimit-r14   INTEGER (1..512)           OPTIONAL,           -- Need ON
    ...
}

ScheduledLocationTime-r17 ::= SEQUENCE {
    utcTime-r17          UTCTime                       OPTIONAL,           -- Need ON
    gnssTime-r17         SEQUENCE {
        gnss-TOD-msec-r17   INTEGER (0..3599999),
        gnss-TimeID-r17     GNSS-ID
    }
    networkTime-r17     CHOICE {
        e-utraTime-r17      SEQUENCE {
            lte-PhysCellId-r17   INTEGER (0..503),
            lte-ArfcnEUTRA-r17   ARFCN-ValueEUTRA,
            lte-CellGlobalId-r17  CellGlobalIdEUTRA-AndUTRA
            lte-SystemFrameNumber-r17  INTEGER (0..1023)
            OPTIONAL,           -- Need ON
        },
        nrTime-r17          SEQUENCE {
            nr-PhysCellID-r17     NR-PhysCellID-r16,
            nr-ARFCN-r17          ARFCN-ValueNR-r15,
            nr-CellGlobalID-r17   NCGI-r15   OPTIONAL,           -- Need ON
            nr-SFN-r17           INTEGER (0..1023),
            nr-Slot-r17          CHOICE {
                scs15-r17         INTEGER (0..9),
                scs30-r17         INTEGER (0..19),
                scs60-r17         INTEGER (0..39),
                scs120-r17        INTEGER (0..79)
            }
        }
    }
    relativeTime-r17     INTEGER (1..1024)           OPTIONAL,           -- Need ON
    ...
}

```

```

}
TargetIntegrityRisk-r17 ::= INTEGER (10..90)
-- ASN1STOP
    
```

Conditional presence	Explanation
ECID	The field is optionally present, need ON, if E-CID or NR E-CID is requested. Otherwise it is not present.

CommonEsRequestLocationInformation field descriptions	
locationInformationType	This IE indicates whether the server requires a location estimate or measurements. For 'locationEstimateRequired', the target device shall return a location estimate if possible, or indicate a location error if not possible. For 'locationMeasurementsRequired', the target device shall return measurements if possible, or indicate a location error if not possible. For 'locationEstimatePreferred', the target device shall return a location estimate if possible, but may also or instead return measurements for any requested position methods for which a location estimate is not possible. For 'locationMeasurementsPreferred', the target device shall return location measurements if possible, but may also or instead return a location estimate for any requested position methods for which return of location measurements is not possible.
triggeredReporting	This IE indicates that triggered reporting is requested and comprises the following subfields: <ul style="list-style-type: none"> - cellChange: If this field is set to TRUE, the target device provides requested location information each time the primary cell has changed. - reportingDuration: Maximum duration of triggered reporting in seconds. A value of zero is interpreted to mean an unlimited (i.e. "infinite") duration. The target device should continue triggered reporting for the <i>reportingDuration</i> or until an LPP <i>Abort</i> or LPP <i>Error</i> message is received. The <i>triggeredReporting</i> field should not be included by the location server and shall be ignored by the target device if the <i>periodicalReporting</i> IE or <i>responseTime</i> IE or <i>responseTimeNB</i> IE is included in <i>CommonEsRequestLocationInformation</i> .
periodicalReporting	This IE indicates that periodic reporting is requested and comprises the following subfields: <ul style="list-style-type: none"> - reportingAmount indicates the number of periodic location information reports requested. Enumerated values correspond to 1, 2, 4, 8, 16, 32, 64, or infinite/indefinite number of reports. If the <i>reportingAmount</i> is 'infinite/indefinite', the target device should continue periodic reporting until an LPP <i>Abort</i> message is received. The value 'ra1' shall not be used by a sender. - reportingInterval indicates the interval between location information reports and the response time requirement for the first location information report. Enumerated values ri0-25, ri0-5, ri1, ri2, ri4, ri8, ri16, ri32, ri64 correspond to reporting intervals of 1, 2, 4, 8, 10, 16, 20, 32, and 64 seconds, respectively. Measurement reports containing no measurements or no location estimate are required when a <i>reportingInterval</i> expires before a target device is able to obtain new measurements or obtain a new location estimate. The value 'noPeriodicalReporting' shall not be used by a sender.
additionalInformation	This IE indicates whether a target device is allowed to return additional information to that requested. If this IE indicates 'onlyReturnInformationRequested' then the target device shall not return any additional information to that requested by the server. If this IE indicates 'mayReturnAdditionalInformation' then the target device may return additional information to that requested by the server. If a location estimate is returned, any additional information is restricted to that associated with a location estimate (e.g. might include velocity if velocity was not requested but cannot include measurements). If measurements are returned, any additional information is restricted to additional measurements (e.g. might include E-CID measurements if A-GNSS measurements were requested but not E-CID measurements).
qos	This IE indicates the quality of service and comprises a number of sub-fields. In the case of measurements, some of the sub-fields apply to the location estimate that could be obtained by the server from the measurements provided by the target device assuming that the measurements are the only sources of error. Fields are as follows: <ul style="list-style-type: none"> - horizontalAccuracy indicates the maximum horizontal error in the location estimate at an indicated confidence level. The 'accuracy' corresponds to the encoded uncertainty as defined in TS 23.032 [15] and 'confidence' corresponds to confidence as defined in TS 23.032 [15]. - verticalCoordinateRequest indicates whether a vertical coordinate is required (TRUE) or not (FALSE) - verticalAccuracy indicates the maximum vertical error in the location estimate at an indicated confidence level and is only applicable when a vertical coordinate is requested. The 'accuracy' corresponds to the encoded uncertainty altitude as defined in TS 23.032 [15] and 'confidence' corresponds to confidence as defined in TS 23.032 [15]. - responseTime <ul style="list-style-type: none"> - time indicates the maximum response time as measured between receipt of the <i>RequestLocationInformation</i> and transmission of a <i>ProvideLocationInformation</i>. If the <i>unit</i> field is absent,

CommonEsRequestLocationInformation field descriptions

this is given as an integer number of seconds between 1 and 128. If the *unit* field is present with enumerated value '*ten-seconds*', the maximum response time is given in units of 10-seconds, between 10 and 1280 seconds. If the *unit* field is present with enumerated value '*ten-milli-seconds*', the maximum response time is given in units of 10-milli-seconds, between 0.01 and 1.28 seconds. If the *periodicalReporting* IE is included in *CommonEsRequestLocationInformation*, this field should not be included by the location server and shall be ignored by the target device (if included).

- **responseTimeEarlyFix** indicates the maximum response time as measured between receipt of the *RequestLocationInformation* and transmission of a *ProvideLocationInformation* containing early location measurements or an early location estimate. If the *unit* field is absent, this is given as an integer number of seconds between 1 and 128. If the *unit* field is present with enumerated value '*ten-seconds*', the maximum response time is given in units of 10-seconds, between 10 and 1280 seconds. If the *unit* field is present with enumerated value '*ten-milli-seconds*', the maximum response time is given in units of 10-milli-seconds, between 0.01 and 1.28 seconds. When this IE is included, a target should send a *ProvideLocationInformation* (or more than one *ProvideLocationInformation* if location information will not fit into a single message) containing early location information according to the *responseTimeEarlyFix* IE and a subsequent *ProvideLocationInformation* (or more than one *ProvideLocationInformation* if location information will not fit into a single message) containing final location information according to the *time* IE. A target shall omit sending a *ProvideLocationInformation* if the early location information is not available at the expiration of the time value in the *responseTimeEarlyFix* IE. A server should set the *responseTimeEarlyFix* IE to a value less than that for the *time* IE. A target shall ignore the *responseTimeEarlyFix* IE if its value is not less than that for the *time* IE.
- **unit** indicates the unit of the *time* and *responseTimeEarlyFix* fields. Enumerated value '*ten-seconds*' corresponds to a resolution of 10 seconds. Enumerated value '*ten-milli-seconds*' corresponds to a resolution of 0.01 seconds. If this field is absent, the unit/resolution is 1 second. Enumerated value '*ten-milli-seconds*' is only applicable for NR E-CID Positioning, NR DL-TDOA Positioning, NR DL-AoD Positioning, and NR Multi-RTT Positioning. If the enumerated value '*ten-milli-seconds*' is included for methods others than NR E-CID Positioning, NR DL-TDOA Positioning, NR DL-AoD Positioning, and NR Multi-RTT Positioning the target device shall ignore the *unit* field.
- **velocityRequest** indicates whether velocity (or measurements related to velocity) is requested (TRUE) or not (FALSE).
- **responseTimeNB**
If the *periodicalReporting* IE or *responseTime* IE is included in *CommonEsRequestLocationInformation*, this field should not be included by the location server and shall be ignored by the target device (if included).
 - **timeNB** indicates the maximum response time as measured between receipt of the *RequestLocationInformation* and transmission of a *ProvideLocationInformation*. If the *unitNB* field is absent, this is given as an integer number of seconds between 1 and 512. If the *unitNB* field is present, the maximum response time is given in units of 10-seconds, between 10 and 5120 seconds.
 - **responseTimeEarlyFixNB** indicates the maximum response time as measured between receipt of the *RequestLocationInformation* and transmission of a *ProvideLocationInformation* containing early location measurements or an early location estimate. If the *unitNB* field is absent, this is given as an integer number of seconds between 1 and 512. If the *unitNB* field is present, the maximum response time is given in units of 10-seconds, between 10 and 5120 seconds. When this IE is included, a target should send a *ProvideLocationInformation* (or more than one *ProvideLocationInformation* if location information will not fit into a single message) containing early location information according to the *responseTimeEarlyFixNB* IE and a subsequent *ProvideLocationInformation* (or more than one *ProvideLocationInformation* if location information will not fit into a single message) containing final location information according to the *timeNB* IE. A target shall omit sending a *ProvideLocationInformation* if the early location information is not available at the expiration of the time value in the *responseTimeEarlyFixNB* IE. A server should set the *responseTimeEarlyFixNB* IE to a value less than that for the *timeNB* IE. A target shall ignore the *responseTimeEarlyFixNB* IE if its value is not less than that for the *timeNB* IE.
 - **unitNB** indicates the unit of the *timeNB* and *responseTimeEarlyFixNB* fields. Enumerated value '*ten-second*' corresponds to a resolution of 10 seconds. If this field is absent, the unit/resolution is 1 second.
- **horizontalAccuracyExt** indicates the maximum horizontal error in the location estimate at an indicated confidence level. The '*accuracyExt*' corresponds to the encoded high accuracy uncertainty as defined in TS 23.032 [15] and '*confidence*' corresponds to confidence as defined in TS 23.032 [15]. This field should not be included by the location server and shall be ignored by the target device if the *horizontalAccuracy* field is included in QoS.
- **verticalAccuracyExt** indicates the maximum vertical error in the location estimate at an indicated confidence level and is only applicable when a vertical coordinate is requested. The '*accuracyExt*' corresponds to the encoded high accuracy uncertainty as defined in TS 23.032 [15] and '*confidence*' corresponds to confidence as defined in TS 23.032 [15]. This field should not be included by the location server and shall be ignored by the target device if the *verticalAccuracy* field is included in QoS.

All QoS requirements shall be obtained by the target device to the degree possible but it is permitted to return a response that does not fulfill all QoS requirements if some were not attainable. The single exception is *time* and *timeNB* which shall always be fulfilled – even if that means not fulfilling other QoS requirements.

CommonIEsRequestLocationInformation field descriptions
<p>A target device supporting NB-IoT access shall support the <i>responseTimeNB</i> IE.</p> <p>A target device supporting HA GNSS shall support the <i>HorizontalAccuracyExt</i>, <i>VerticalAccuracyExt</i>, and <i>unit</i> fields with enumerated value '<i>ten-seconds</i>'.</p> <p>A target device supporting NB-IoT access and HA GNSS shall support the <i>unitNB</i> field.</p>
<p>environment</p> <p>This field provides the target device with information about expected multipath and non line of sight (NLOS) in the current area. The following values are defined:</p> <ul style="list-style-type: none"> - <i>badArea</i>: possibly heavy multipath and NLOS conditions (e.g. bad urban or urban). - <i>notBadArea</i>: no or light multipath and usually LOS conditions (e.g. suburban or rural). - <i>mixedArea</i>: environment that is mixed or not defined. <p>If this field is absent, a default value of '<i>mixedArea</i>' applies.</p>
<p>locationCoordinateTypes</p> <p>This field provides a list of the types of location estimate that the target device may return when a location estimate is obtained by the target.</p>
<p>velocityTypes</p> <p>This fields provides a list of the types of velocity estimate that the target device may return when a velocity estimate is obtained by the target.</p>
<p>messageSizeLimitNB</p> <p>This field provides an octet limit on the amount of location information a target device can return.</p> <ul style="list-style-type: none"> - measurementLimit indicates the maximum amount of location information the target device should return in response to the <i>RequestLocationInformation</i> message received from the location server. <p>The limit applies to the overall size of the LPP message at LPP level (LPP Provide Location Information), and is specified in steps of 100 octets. The message size limit is then given by the value provided in <i>measurementLimit</i> times 100 octets.</p>
<p>segmentationInfo</p> <p>This field indicates whether this <i>RequestLocationInformation</i> message is one of many segments, as specified in clause 4.3.5</p>
<p>scheduledLocationTime</p> <p>This field indicates that the target device is requested to obtain location measurements or location estimate valid at the <i>scheduledLocationTime</i> <i>T</i> and comprises the following subfields:</p> <ul style="list-style-type: none"> - utcTime provides <i>T</i> in UTC in the form of YYMMDDhhmmssZ. - gnssTime provides <i>T</i> in GNSS system time of the GNSS indicated by <i>gnss-TimeID</i>. - gnss-TOD-msec specifies the GNSS TOD in 1-milli-second resolution rounded down to the nearest millisecond unit. - networkTime provides <i>T</i> in E-UTRA or NR network time. - lte-PhysCellId, lte-ArfcnEUTRA, lte-CellGlobalId identifies the reference cell (E-UTRA) that is used for the network time. - lte-systemFrameNumber specifies the system frame number in E-UTRA. - nr-PhysCellID, nr-ARFCN, nr-CellGlobalID identifies the reference cell (NR) that is used for the network time. - nr-SFN specifies the system frame number in NR. - nr-Slot specifies the slot number in NR for the indicated subcarrier spacing (SCS). The total NR network time is given by <i>nr-SFN</i> + <i>nr-Slot</i>. - relativeTime provides <i>T</i> in seconds from current time, where current time is defined as the time the <i>CommonIEsRequestLocationInformation</i> was received. <p>NOTE 1: A location estimate returned to an LCS Client, AF or UE for a scheduled location time can be treated by the LCS Client, AF or UE as an estimate of the location of the UE at the scheduled location time (see TS 23.273 [42]).</p> <p>NOTE 2: If this field is present, at least one of <i>utcTime</i>, <i>gnssTime</i>, <i>networkTime</i>, or <i>relativeTime</i> shall be present.</p>
<p>targetIntegrityRisk</p> <p>This field indicates the TIR for which the PL is requested. The TIR is calculated by $P=10^{-0.1n}$ [hour⁻¹] where <i>n</i> is the value of <i>targetIntegrityRisk</i> and the range is 10⁻¹ to 10⁻⁹ per hour.</p>

CommonIEsProvideLocationInformation

The *CommonIEsProvideLocationInformation* carries common IEs for a Provide Location Information LPP message Type.

```
-- ASN1START
CommonIEsProvideLocationInformation ::= SEQUENCE {
    locationEstimate          LocationCoordinates    OPTIONAL,
    velocityEstimate          Velocity                OPTIONAL,
    locationError              LocationError          OPTIONAL,
    . . .
    [[ earlyFixReport-r12      EarlyFixReport-r12    OPTIONAL
```

```

    ]],
    [[
        locationSource-r13      LocationSource-r13      OPTIONAL,
        locationTimestamp-r13   UTCTime                OPTIONAL
    ]],
    [[
        segmentationInfo-r14    SegmentationInfo-r14    OPTIONAL      -- Cond Segmentation
    ]],
    [[
        integrityInfo-r17       IntegrityInfo-r17       OPTIONAL
    ]]
}

LocationCoordinates ::= CHOICE {
    ellipsoidPoint                Ellipsoid-Point,
    ellipsoidPointWithUncertaintyCircle  Ellipsoid-PointWithUncertaintyCircle,
    ellipsoidPointWithUncertaintyEllipse  EllipsoidPointWithUncertaintyEllipse,
    polygon                       Polygon,
    ellipsoidPointWithAltitude      EllipsoidPointWithAltitude,
    ellipsoidPointWithAltitudeAndUncertaintyEllipsoid  EllipsoidPointWithAltitudeAndUncertaintyEllipsoid,
    ellipsoidArc                  EllipsoidArc,
    ...,
    highAccuracyEllipsoidPointWithUncertaintyEllipse-v1510
                                HighAccuracyEllipsoidPointWithUncertaintyEllipse-r15,
    highAccuracyEllipsoidPointWithAltitudeAndUncertaintyEllipsoid-v1510
                                HighAccuracyEllipsoidPointWithAltitudeAndUncertaintyEllipsoid-r15,
    ha-EllipsoidPointWithScalableUncertaintyEllipse-v1680
                                HA-EllipsoidPointWithScalableUncertaintyEllipse-r16,
    ha-EllipsoidPointWithAltitudeAndScalableUncertaintyEllipsoid-v1680
                                HA-EllipsoidPointWithAltitudeAndScalableUncertaintyEllipsoid-r16
}

Velocity ::= CHOICE {
    horizontalVelocity            HorizontalVelocity,
    horizontalWithVerticalVelocity  HorizontalWithVerticalVelocity,
    horizontalVelocityWithUncertainty  HorizontalVelocityWithUncertainty,
    horizontalWithVerticalVelocityAndUncertainty  HorizontalWithVerticalVelocityAndUncertainty,
    ...
}

LocationError ::= SEQUENCE {
    locationfailurecause          LocationFailureCause,
    ...
}

LocationFailureCause ::= ENUMERATED {
    undefined,
    requestedMethodNotSupported,
    positionMethodFailure,
    periodicLocationMeasurementsNotAvailable,
    ...
}

EarlyFixReport-r12 ::= ENUMERATED {
    noMoreMessages,
    moreMessagesOnTheWay
}

LocationSource-r13 ::= BIT STRING {
    a-gnss                (0),
    wlan                  (1),
    bt                    (2),
    tbs                   (3),
    sensor                (4),
    ha-gnss-v1510        (5),
    motion-sensor-v1550  (6),
    dl-tdoa-r16          (7),
    dl-aod-r16           (8) } (SIZE(1..16))

IntegrityInfo-r17 ::= SEQUENCE {
    horizontalProtectionLevel-r17  INTEGER (0..50000),
    verticalProtectionLevel-r17    INTEGER (0..50000)      OPTIONAL,
    achievableTargetIntegrityRisk-r17  INTEGER (10..90)      OPTIONAL,
    ...
}

-- ASN1STOP

```

Conditional presence	Explanation
<i>Segmentation</i>	This field is optionally present, need OP, if <i>lpp-message-segmentation-req</i> has been received from the location server with bit 1 (<i>targetToServer</i>) set to value 1. The field shall be omitted if <i>lpp-message-segmentation-req</i> has not been received in this location session, or has been received with bit 1 (<i>targetToServer</i>) set to value 0.

CommonIEsProvideLocationInformation field descriptions	
locationEstimate	This field provides a location estimate using one of the geographic shapes defined in TS 23.032 [15]. Coding of the values of the various fields internal to each geographic shape follow the rules in TS 23.032 [15]. The conditions for including this field are defined for the <i>locationInformationType</i> field in a Request Location Information message.
velocityEstimate	This field provides a velocity estimate using one of the velocity shapes defined in TS 23.032 [15]. Coding of the values of the various fields internal to each velocity shape follow the rules in TS 23.032 [15].
locationError	This field shall be included if and only if a location estimate and measurements are not included in the LPP PDU. The field includes information concerning the reason for the lack of location information. The <i>LocationFailureCause</i> 'periodicLocationMeasurementsNotAvailable' shall be used by the target device if periodic location reporting was requested, but no measurements or location estimate are available when <i>the reportingInterval</i> expired.
earlyFixReport	This field shall be included if and only if the <i>ProvideLocationInformation</i> message contains early location measurements or an early location estimate. The target device shall set the values of this field as follows: <ul style="list-style-type: none"> - <i>noMoreMessages</i>: This is the only or last <i>ProvideLocationInformation</i> message used to deliver the entire set of early location information. - <i>moreMessagesOnTheWay</i>: This is one of multiple <i>ProvideLocationInformation</i> messages used to deliver the entire set of early location information (if early location information will not fit into a single message). If this field is included, the IE <i>SegmentationInfo</i> shall not be included.
locationSource	This field provides the source positioning technology for the location estimate. NOTE 1: In this version of the specification, the entry 'tbs' is used only for TBS positioning based on MBS signals. NOTE 2: The entry 'sensor' is used only for positioning technology that uses barometric pressure sensor. The entry 'motion-sensor' is used for positioning technology that uses sensor(s) to detect displacement and movement, e.g. accelerometers, gyros, magnetometers.
locationTimestamp	This field provides the UTC time when the location estimate is valid and should take the form of <i>YYMMDDhhmmssZ</i> .
segmentationInfo	This field indicates whether this <i>ProvideLocationInformation</i> message is one of many segments, as specified in clause 4.3.5
integrityInfo	This field provides the integrity result for the <i>locationEstimate</i> . <ul style="list-style-type: none"> - horizontalProtectionLevel provides the HPL for the <i>locationEstimate</i> along the semi-major axis of the error ellipse. Scale factor 0.01 metre; range 0 – 500 metres. - verticalProtectionLevel provides the VPL for the <i>locationEstimate</i>. Scale factor 0.01 metre; range 0 – 500 metres. - achievableTargetIntegrityRisk indicates the achievable TIR for which the HPL and VPL are provided. The achievable TIR is given by $P=10^{-0.1n}$ [hour⁻¹] where <i>n</i> is the value of <i>achievableTargetIntegrityRisk</i> and the range is 10⁻¹ to 10⁻⁹ per hour. If this field is absent, the achievable TIR is the same as the <i>targetIntegrityRisk</i> in <i>CommonIEsRequestLocationInformation</i>.

NOTE: Void.

– CommonIEsAbort

The *CommonIEsAbort* carries common IEs for an Abort LPP message Type.

```
-- ASN1START
CommonIEsAbort ::= SEQUENCE {
    abortCause          ENUMERATED {
        undefined,
        stopPeriodicReporting,
        targetDeviceAbort,
    }
}
```

```

        networkAbort,
        ...,
        stopPeriodicAssistanceDataDelivery-v1510
    }
}
-- ASN1STOP

```

CommonIEsAbort field descriptions

abortCause

This IE defines the request to abort an ongoing procedure. The abort cause '*stopPeriodicReporting*' should be used by the location server to stop any ongoing location reporting configured as *periodicalReporting* or *triggeredReporting* in the *CommonIEsRequestLocationInformation*.

The abort cause '*stopPeriodicAssistanceDataDelivery*' should be used by the location server or target device to stop any ongoing periodic assistance data delivery, as specified in clauses 5.2.1a and 5.2.2a.

CommonIEsError

The *CommonIEsError* carries common IEs for an Error LPP message Type.

```

-- ASN1START
CommonIEsError ::= SEQUENCE {
    errorCause      ENUMERATED {
        undefined,
        lppMessageHeaderError,
        lppMessageBodyError,
        epduError,
        incorrectDataValue,
        ...,
        lppSegmentationError-v1450
    }
}
-- ASN1STOP

```

CommonIEsError field descriptions

errorCause

This IE defines the cause for an error. '*lppMessageHeaderError*', '*lppMessageBodyError*' and '*epduError*' is used if a receiver is able to detect a coding error in the LPP header (i.e., in the common fields), LPP message body or in an EPDU, respectively. '*incorrectDataValue*' is used if a receiver receives an incorrect data value. '*lppSegmentationError*' is used if a receiver detects an error in LPP message segmentation.

6.4.3 Common NR Positioning Information Elements

AreaID-CellList

The IE *AreaID-CellList* provides the NR Cell-IDs of the TRPs belonging to a particular network area where the associated assistance data are valid. Each cell is included in only one area.

```

-- ASN1START
AreaID-CellList-r17 ::= SEQUENCE (SIZE(1..maxCellIDsPerArea-r17)) OF NR-Cell-IDs-r17
NR-Cell-IDs-r17 ::= SEQUENCE {
    nr-CellGlobalID-r17      NCGI-r15          OPTIONAL,  -- Need ON
    nr-PhysCellID-r17       NR-PhysCellID-r16   OPTIONAL,  -- Need ON
    nr-ARFCN-r17            ARFCN-ValueNR-r15   OPTIONAL,  -- Need ON
    ...
}
-- ASN1STOP

```

<i>ArealID-CellList</i> field descriptions
<p><i>nr-CellGlobalID</i> This field specifies the NR Cell Global ID of the TRP belonging to a particular network area where the associated assistance data are applicable.</p>
<p><i>nr-PhysCellID</i> This field specifies the physical cell identity of the TRP belonging to a particular network area where the associated assistance data are applicable.</p>
<p><i>nr-ARFCN</i> This field specifies the NR-ARFCN of the TRP's CD-SSB (as defined in TS 38.300 [47]) corresponding to <i>nr-PhysCellID</i>.</p>

– *DL-PRS-ID-Info*

The IE *DL-PRS-ID-Info* provides the IDs of the reference TRPs' DL-PRS Resources.

```
-- ASN1START
DL-PRS-ID-Info-r16 ::= SEQUENCE {
    dl-PRS-ID-r16          INTEGER (0..255),
    nr-DL-PRS-ResourceID-List-r16 SEQUENCE (SIZE (1..nrMaxResourceIDs-r16)) OF
                                NR-DL-PRS-ResourceID-r16
                                OPTIONAL, -- Need ON
    nr-DL-PRS-ResourceSetID-r16 NR-DL-PRS-ResourceSetID-r16
                                OPTIONAL -- Need ON
}
-- ASN1STOP
```

<i>DL-PRS-ID-Info</i> field descriptions
<p><i>nr-DL-PRS-ResourceID-List</i> This field provides a list of DL-PRS Resource IDs under the same DL-PRS Resource Set.</p>

– *LCS-GCS-TranslationParameter*

The IE *LCS-GCS-TranslationParameter* provides the angles α (bearing angle), β (downtilt angle) and γ (slant angle) for the translation of a Local Coordinate System (LCS) to a Global Coordinate System (GCS) as defined in TR 38.901 [44].

```
-- ASN1START
LCS-GCS-TranslationParameter-r16 ::= SEQUENCE {
    alpha-r16          INTEGER (0..359),
    alpha-fine-r16     INTEGER (0..9)          OPTIONAL, -- Cond AzElFine
    beta-r16           INTEGER (0..359),
    beta-fine-r16     INTEGER (0..9)          OPTIONAL, -- Cond AzElFine
    gamma-r16          INTEGER (0..359),
    gamma-fine-r16    INTEGER (0..9)          OPTIONAL, -- Cond AzElFine
    ...
}
-- ASN1STOP
```

Conditional presence	Explanation
<i>AzElFine</i>	The field is mandatory present if the angles where this IE is used are provided with 0.1 degrees resolution; otherwise it is not present.

<i>LCS-GCS-TranslationParameter</i> field descriptions
<p><i>alpha</i> This field specifies the bearing angle α for the translation of the LCS to a GCS as defined in TR 38.901 [44]. Scale factor 1 degree; range 0 to 359 degrees.</p>
<p><i>alpha-fine</i> This field provides finer granularity for the <i>alpha</i>. The total bearing angle α is given by <i>alpha</i> + <i>alpha-fine</i>. Scale factor 0.1 degrees; range 0 to 0.9 degrees.</p>
<p><i>beta</i></p>

<p>This field specifies the downtilt angle β for the translation of the LCS to a GCS as defined in TR 38.901 [44]. Scale factor 1 degree; range 0 to 359 degrees.</p>
<p><i>beta-fine</i> This field provides finer granularity for the <i>beta</i>. The total downtilt angle β is given by <i>beta</i> + <i>beta-fine</i>. Scale factor 0.1 degrees; range 0 to 0.9 degrees.</p>
<p><i>gamma</i> This field specifies the slant angle γ for the translation of the LCS to a GCS as defined in TR 38.901 [44]. Scale factor 1 degree; range 0 to 359 degrees.</p>
<p><i>gamma-fine</i> This field provides finer granularity for the <i>gamma</i>. The total slant angle γ is given by <i>gamma</i> + <i>gamma-fine</i>. Scale factor 0.1 degrees; range 0 to 0.9 degrees.</p>

– *LOS-NLOS-Indicator*

The IE *LOS-NLOS-Indicator* provides information on the likelihood of a Line-of-Sight (LOS) propagation path from the source to the receiver.

```
-- ASN1START
LOS-NLOS-Indicator-r17 ::= SEQUENCE {
    indicator-r17          CHOICE {
        soft-r17           INTEGER (0..10),
        hard-r17           BOOLEAN
    },
    ...
}
-- ASN1STOP
```

***LOS-NLOS-Indicator* field descriptions**

indicator

This field provides information on the likelihood of a Line-of-Sight propagation path from the source to the receiver with a value of 1 corresponding to LoS and a value of 0 corresponding to NLoS.

- ***soft***: Integer value '0' indicates likelihood 0, integer value '10' indicates likelihood 1.
Scale factor 0.1; range 0 to 1.
- ***hard***: FALSE indicates likelihood '0', TRUE indicates likelihood '1'.

– *LOS-NLOS-IndicatorGranularity1*

The IE *LOS-NLOS-IndicatorGranularity1* provides information on the *LOS-NLOS-Indicator* granularity.

```
-- ASN1START
LOS-NLOS-IndicatorGranularity1-r17 ::= ENUMERATED { trpspecific, resourcespecific }
-- ASN1STOP
```

– *LOS-NLOS-IndicatorGranularity2*

The IE *LOS-NLOS-IndicatorGranularity2* provides information on the *LOS-NLOS-Indicator* granularity.

```
-- ASN1START
LOS-NLOS-IndicatorGranularity2-r17 ::= ENUMERATED { trpspecific, resourcespecific, both }
-- ASN1STOP
```

– *LOS-NLOS-IndicatorType1*

The IE *LOS-NLOS-IndicatorType1* provides information on the *LOS-NLOS-Indicator* type that is requested by the location server.

```
-- ASN1START
LOS-NLOS-IndicatorType1-r17 ::= ENUMERATED { hardvalue, softvalue }
-- ASN1STOP
```

– *LOS-NLOS-IndicatorType2*

The IE *LOS-NLOS-IndicatorType2* provides information on the *LOS-NLOS-Indicator* type that is supported by the target device.

```
-- ASN1START
LOS-NLOS-IndicatorType2-r17 ::= ENUMERATED { hardvalue, hardAndsoftvalue }
-- ASN1STOP
```

– *NR-AdditionalPathList*

The IE *NR-AdditionalPathList* is used by the target device to provide information about additional paths in association to the TOA measurements associated to NR positioning in the form of a relative time difference and a quality value. The additional path *nr-RelativeTimeDifference* is the detected path timing relative to the detected path timing used for the TOA value, and each additional path can be associated with a quality value *nr-PathQuality*.

```
-- ASN1START
NR-AdditionalPathList-r16 ::= SEQUENCE (SIZE(1..2)) OF NR-AdditionalPath-r16
NR-AdditionalPathListExt-r17 ::= SEQUENCE (SIZE(1..8)) OF NR-AdditionalPath-r16
NR-AdditionalPath-r16 ::= SEQUENCE {
    nr-RelativeTimeDifference-r16 CHOICE {
        k0-r16 INTEGER(0..16351),
        k1-r16 INTEGER(0..8176),
        k2-r16 INTEGER(0..4088),
        k3-r16 INTEGER(0..2044),
        k4-r16 INTEGER(0..1022),
        k5-r16 INTEGER(0..511),
        ...
    },
    nr-PathQuality-r16 NR-TimingQuality-r16 OPTIONAL,
    ...,
    [[
        nr-DL-PRS-RSRPP-r17 INTEGER (0..126) OPTIONAL
    ]]
}
-- ASN1STOP
```

***NR-AdditionalPathList* field descriptions**

nr-RelativeTimeDifference

This field specifies the additional detected path timing relative to the detected path timing of the reference resource. The mapping of reported values and measured quantity value is defined in TS 38.133 [46] clause 10.1.23.3.3 and 10.1.25.3.3. A positive value indicates that the particular path is later in time than the detected path of the reference; a negative value indicates that the particular path is earlier in time than the detected path of the reference.

nr-PathQuality

This field specifies the target device's best estimate of the quality of the detected timing of the additional path.

nr-DL-PRS-RSRPP

This field specifies the DL PRS reference signal received path power (DL PRS-RSRPP) of the *NR-AdditionalPath* reported, as defined in TS 38.215 [36]. The mapping of the quantity is defined as in TS 38.133 [46].

– NR-DL-PRS-AssistanceData

The IE *NR-DL-PRS-AssistanceData* is used by the location server to provide DL-PRS assistance data.

NOTE 1: The location server should include at least one TRP for which the SFN can be obtained by the target device, e.g. the serving TRP.

NOTE 2: The *nr-DL-PRS-ReferenceInfo* defines the "assistance data reference" TRP whose DL-PRS configuration is included in *nr-DL-PRS-AssistanceDataList*. The *nr-DL-PRS-SFN0-Offset's* and *nr-DL-PRS-expectedRSTD's* in *nr-DL-PRS-AssistanceDataList* are provided relative to the "assistance data reference" TRP.

NOTE 3: The network signals a value of zero for the *nr-DL-PRS-SFN0-Offset*, *nr-DL-PRS-expectedRSTD*, and *nr-DL-PRS-expectedRSTD-uncertainty* of the "assistance data reference" TRP in *nr-DL-PRS-AssistanceDataList*.

NOTE 4: For NR DL-TDOA positioning (see clause 6.5.10) the *nr-DL-PRS-ReferenceInfo* defines also the requested "RSTD reference".

For DL-PRS processing, the LPP layer may inform lower layers to start performing DL-PRS measurements and provide to lower layers the information about the location of DL-PRS, e.g. DL-PRS-PointA, DL-PRS Positioning occasion information.

```
-- ASN1START
NR-DL-PRS-AssistanceData-r16 ::= SEQUENCE {
    nr-DL-PRS-ReferenceInfo-r16      DL-PRS-ID-Info-r16,
    nr-DL-PRS-AssistanceDataList-r16 SEQUENCE (SIZE (1..nrMaxFreqLayers-r16)) OF
                                     NR-DL-PRS-AssistanceDataPerFreq-r16,
    nr-SSB-Config-r16                SEQUENCE (SIZE (1..nrMaxTRPs-r16)) OF
                                     NR-SSB-Config-r16 OPTIONAL, -- Need ON
    ...
}

NR-DL-PRS-AssistanceDataPerFreq-r16 ::= SEQUENCE {
    nr-DL-PRS-PositioningFrequencyLayer-r16
                                     NR-DL-PRS-PositioningFrequencyLayer-r16,
    nr-DL-PRS-AssistanceDataPerFreq-r16 SEQUENCE (SIZE (1..nrMaxTRPsPerFreq-r16)) OF
                                     NR-DL-PRS-AssistanceDataPerTRP-r16,
    ...
}

NR-DL-PRS-AssistanceDataPerTRP-r16 ::= SEQUENCE {
    dl-PRS-ID-r16                    INTEGER (0..255),
    nr-PhysCellID-r16                NR-PhysCellID-r16          OPTIONAL, -- Need ON
    nr-CellGlobalID-r16              NCGI-r15                   OPTIONAL, -- Need ON
    nr-ARFCN-r16                     ARFCN-ValueNR-r15         OPTIONAL, -- Need ON
    nr-DL-PRS-SFN0-Offset-r16        NR-DL-PRS-SFN0-Offset-r16,
    nr-DL-PRS-ExpectedRSTD-r16       INTEGER (-3841..3841),
    nr-DL-PRS-ExpectedRSTD-Uncertainty-r16
                                     INTEGER (0..246),
    nr-DL-PRS-Info-r16               NR-DL-PRS-Info-r16,
    ...
    [[
        prs-OnlyTP-r16                ENUMERATED { true }     OPTIONAL -- Need ON
    ]],
    [[
        nr-DL-PRS-ExpectedAoD-or-AoA-r17
                                     NR-DL-PRS-ExpectedAoD-or-AoA-r17 OPTIONAL -- Need ON
    ]]
}

NR-DL-PRS-PositioningFrequencyLayer-r16 ::= SEQUENCE {
    dl-PRS-SubcarrierSpacing-r16     ENUMERATED {kHz15, kHz30, kHz60, kHz120, ...},
    dl-PRS-ResourceBandwidth-r16     INTEGER (1..63),
    dl-PRS-StartPRB-r16              INTEGER (0..2176),
    dl-PRS-PointA-r16                ARFCN-ValueNR-r15,
    dl-PRS-CombSizeN-r16             ENUMERATED {n2, n4, n6, n12, ...},
    dl-PRS-CyclicPrefix-r16          ENUMERATED {normal, extended, ...},
    ...
}

NR-DL-PRS-SFN0-Offset-r16 ::= SEQUENCE {
    sfn-Offset-r16                   INTEGER (0..1023),

```

```

integerSubframeOffset-r16      INTEGER (0..9),
...
}
NR-DL-PRS-ExpectedAoD-or-AoA-r17 ::= CHOICE {
  expectedAoD-r17              SEQUENCE {
    expectedDL-AzimuthAoD-r17   INTEGER (0..359),
    expectedDL-AzimuthAoD-Unc-r17 INTEGER (0..60) OPTIONAL, -- Need OP
    expectedDL-ZenithAoD-r17    INTEGER (0..180),
    expectedDL-ZenithAoD-Unc-r17 INTEGER (0..30) OPTIONAL -- Need OP
  },
  expectedAoA-r17              SEQUENCE {
    expectedDL-AzimuthAoA-r17   INTEGER (0..359),
    expectedDL-AzimuthAoA-Unc-r17 INTEGER (0..60) OPTIONAL, -- Need OP
    expectedDL-ZenithAoA-r17    INTEGER (0..180),
    expectedDL-ZenithAoA-Unc-r17 INTEGER (0..30) OPTIONAL -- Need OP
  }
}
-- ASN1STOP

```

NR-DL-PRS-AssistanceData field descriptions

nr-DL-PRS-ReferenceInfo

This field specifies the IDs of the assistance data reference TRP.

nr-DL-PRS-AssistanceDataList

This field specifies the DL-PRS resources for each frequency layer.

nr-SSB-Config

This field specifies the SSB configuration of the TRPs.

nr-DL-PRS-PositioningFrequencyLayer

This field specifies the Positioning Frequency Layer for the *nr-DL-PRS-AssistanceDataPerFreq* field.

nr-DL-PRS-AssistanceDataPerFreq

This field specifies the DL-PRS Resources for the TRPs within the Positioning Frequency Layer.

dl-PRS-ID

This field is used along with a DL-PRS Resource Set ID and a DL-PRS Resource ID to uniquely identify a DL-PRS Resource, and is associated with a single TRP.

nr-PhysCellID

This field specifies the physical cell identity of the TRP. When the field *prs-OnlyTP* is included, this field is not included.

nr-CellGlobalID

This field specifies the NCGI, the globally unique identity of a cell in NR, as defined in TS 38.331 [35]. When the field *prs-OnlyTP* is included, this field is not included.

nr-ARFCN

This field specifies the NR-ARFCN of the TRP's CD-SSB (as defined in TS 38.300 [47]) corresponding to *nr-PhysCellID*. When the field *prs-OnlyTP* is included, this field is not included.

nr-DL-PRS-SFN0-Offset

This field specifies the time offset of the SFN#0 slot#0 for the given TRP with respect to SFN#0 slot#0 of the assistance data reference TRP and comprises the following subfields:

- **sfn-Offset** specifies the SFN offset at the TRP antenna location between the assistance data reference TRP and this neighbour TRP.

The offset corresponds to the number of full radio frames counted from the beginning of a radio frame #0 of the assistance data reference TRP to the beginning of the closest subsequent radio frame #0 of this neighbour TRP.

- **integerSubframeOffset** specifies the frame boundary offset at the TRP antenna location between the assistance data reference TRP and this neighbour TRP counted in full subframes.

The offset corresponds to the number of full subframes counted from the beginning of a subframe #0 of the assistance data reference TRP to the beginning of the closest subsequent subframe #0 of this neighbour TRP.

NOTE: The location server sets the value in accordance with the defined search window for the target device using *nr-DL-PRS-ExpectedRSTD* and *nr-DL-PRS-ExpectedRSTD-Uncertainty*.

nr-DL-PRS-ExpectedRSTD

This field indicates the RSTD value that the target device is expected to measure between this TRP and the assistance data reference TRP. The *nr-DL-PRS-ExpectedRSTD* field takes into account the expected propagation time difference as well as transmit time difference of PRS positioning occasions between the two TRPs. The resolution is $4 \times T_s$, with $T_s = 1/(15000 \times 2048)$ seconds.

NR-DL-PRS-AssistanceData field descriptions
<p><i>nr-DL-PRS-ExpectedRSTD-Uncertainty</i> This field indicates the uncertainty in <i>nr-DL-PRS-ExpectedRSTD</i> value. The uncertainty is related to the location server's a-priori estimate of the target device location. The <i>nr-DL-PRS-ExpectedRSTD</i> and <i>nr-DL-PRS-ExpectedRSTD-Uncertainty</i> together define the search window for the target device. The resolution R is</p> <ul style="list-style-type: none"> - T_s if all PRS resources are in frequency range 2, - $4 \times T_s$ otherwise, <p>with $T_s = 1 / (15000 \times 2048)$ seconds. The target device may assume that the beginning of the subframe for the PRS of this TRP is received within the search window of size</p> <ul style="list-style-type: none"> - $[-nr-DL-PRS-ExpectedRSTD-Uncertainty \times R ; nr-DL-PRS-ExpectedRSTD-Uncertainty \times R]$ centred at $T_{REF} + 1$ millisecond $\times N + nr-DL-PRS-ExpectedRSTD \times 4 \times T_s$, <p>where T_{REF} is the reception time of the beginning of the subframe for the PRS of the assistance data reference TRP at the target device antenna connector, and N can be calculated based on</p> <ul style="list-style-type: none"> - <i>nr-DL-PRS-SFN0-Offset</i> - <i>dl-PRS-Periodicity-and-ResourceSetSlotOffset</i> - <i>dl-PRS-ResourceSlotOffset</i>.
<p><i>nr-DL-PRS-Info</i> This field specifies the PRS configuration of the TRP.</p>
<p><i>dl-PRS-SubcarrierSpacing</i> This field specifies the subcarrier spacing of the DL-PRS Resource. 15, 30, 60 kHz for FR1; 60, 120 kHz for FR2. All DL-PRS Resources and DL-PRS Resource Sets in the same Positioning Frequency layer have the same value of <i>dl-PRS-SubcarrierSpacing</i>.</p>
<p><i>dl-PRS-ResourceBandwidth</i> This field specifies the number of PRBs allocated for the DL-PRS Resource (allocated DL-PRS bandwidth) in multiples of 4 PRBs. All DL-PRS Resources of the DL-PRS Resource Set have the same bandwidth. All DL-PRS Resource Sets belonging to the same Positioning Frequency Layer have the same value of DL-PRS Bandwidth and Start PRB. Integer value 1 corresponds to 24 PRBs, value 2 corresponds to 28 PRBs, value 3 corresponds to 32 PRBs and so on.</p>
<p><i>dl-PRS-StartPRB</i> This field specifies the start PRB index defined as offset with respect to reference DL-PRS Point A for the Positioning Frequency Layer. All DL-PRS Resources Sets belonging to the same Positioning Frequency Layer have the same value of <i>dl-PRS-StartPRB</i>.</p>
<p><i>dl-PRS-PointA</i> This field specifies the absolute frequency of the reference resource block for the DL-PRS. Its lowest subcarrier is also known as DL-PRS Point A. A single DL-PRS Point A for DL-PRS Resource allocation is provided per Positioning Frequency Layer. All DL-PRS Resources belonging to the same DL-PRS Resource Set have the same DL-PRS Point A.</p>
<p><i>dl-PRS-CombSizeN</i> This field specifies the Resource Element spacing in each symbol of the DL-PRS Resource. All DL-PRS Resource Sets belonging to the same Positioning Frequency Layer have the same value of comb size N.</p>
<p><i>dl-PRS-CyclicPrefix</i> This field specifies the Cyclic Prefix length of the DL-PRS Resource. All DL-PRS Resources Sets belonging to the same Positioning Frequency Layer have the same value of <i>dl-PRS-CyclicPrefix</i>.</p>

NR-DL-PRS-AssistanceData field descriptions**prs-OnlyTP**

This field, if present, indicates that the *NR-DL-PRS-AssistanceData* is provided for a PRS-only TP. Whether the field is present or absent should be the same for all the *NR-DL-PRS-AssistanceData* of all the PRS transmitted under the same TP.

The target device shall not assume that any other signals or physical channels are present for the TRP other than DL-PRS.

nr-DL-PRS-ExpectedAoD-or-AoA

This field specifies the expected AoD or AoA in the Global Coordinate System (GCS) at the target device location together with uncertainty.

- **expectedDL-AzimuthAoD**: This field specifies the expected azimuth angle of departure. Scale factor 1 degree; range 0 to 359 degrees.
- **expectedDL-AzimuthAoD-Unc**: This field specifies the (single-sided) uncertainty of the expected azimuth angle of departure. If this field is absent, it indicates maximum uncertainty (60 degrees). Scale factor 1 degree; range 0 to 60 degrees.
- **expectedDL-ZenithAoD**: This field specifies the expected elevation angle of departure. Scale factor 1 degree; range 0 to 180 degrees.
- **expectedDL-ZenithAoD-Unc**: This field specifies the (single-sided) uncertainty of the expected elevation angle of departure. If this field is absent, it indicates maximum uncertainty (30 degrees). Scale factor 1 degree; range 0 to 30 degrees.
- **expectedDL-AzimuthAoA**: This field specifies the expected azimuth angle of arrival. Scale factor 1 degree; range 0 to 359 degrees.
- **expectedDL-AzimuthAoA-Unc**: This field specifies the (single-sided) uncertainty of the expected azimuth angle of arrival. If this field is absent, it indicates maximum uncertainty (60 degrees). Scale factor 1 degree; range 0 to 60 degrees.
- **expectedDL-ZenithAoA**: This field specifies the expected elevation angle of arrival. Scale factor 1 degree; range 0 to 180 degrees.
- **expectedDL-ZenithAoA-Unc**: This field specifies the (single-sided) uncertainty of the expected elevation angle of arrival. If this field is absent, it indicates maximum uncertainty (30 degrees). Scale factor 1 degree; range 0 to 30 degrees.

NR-DL-PRS-BeamInfo

The IE *NR-DL-PRS-BeamInfo* is used by the location server to provide spatial direction information of the DL-PRS Resources.

```
-- ASN1START
NR-DL-PRS-BeamInfo-r16 ::= SEQUENCE (SIZE (1..nrMaxFreqLayers-r16)) OF
                                                                    NR-DL-PRS-BeamInfoPerFreqLayer-r16
NR-DL-PRS-BeamInfoPerFreqLayer-r16 ::= SEQUENCE (SIZE (1..nrMaxTRPsPerFreq-r16)) OF
                                                                    NR-DL-PRS-BeamInfoPerTRP-r16
NR-DL-PRS-BeamInfoPerTRP-r16 ::= SEQUENCE {
    dl-PRS-ID-r16                INTEGER (0..255),
    nr-PhysCellID-r16           NR-PhysCellID-r16           OPTIONAL, -- Need ON
    nr-CellGlobalID-r16         NCGI-r15                   OPTIONAL, -- Need ON
    nr-ARFCN-r16                ARFCN-ValueNR-r15          OPTIONAL, -- Need ON
    associated-DL-PRS-ID-r16    INTEGER (0..255)           OPTIONAL, -- Need OP
    lcs-GCS-TranslationParameter-r16
                                LCS-GCS-TranslationParameter-r16
                                OPTIONAL, -- Need OP
    dl-PRS-BeamInfoSet-r16      DL-PRS-BeamInfoSet-r16     OPTIONAL, -- Need OP
    ...
}
DL-PRS-BeamInfoSet-r16 ::= SEQUENCE (SIZE(1..nrMaxSetsPerTrpPerFreqLayer-r16)) OF
                                                                    DL-PRS-BeamInfoResourceSet-r16
DL-PRS-BeamInfoResourceSet-r16 ::= SEQUENCE (SIZE(1..nrMaxResourcesPerSet-r16)) OF
                                                                    DL-PRS-BeamInfoElement-r16
DL-PRS-BeamInfoElement-r16 ::= SEQUENCE {
    dl-PRS-Azimuth-r16          INTEGER (0..359),
    dl-PRS-Azimuth-fine-r16     INTEGER (0..9)           OPTIONAL, -- Need ON
    dl-PRS-Elevation-r16        INTEGER (0..180)           OPTIONAL, -- Need ON
    dl-PRS-Elevation-fine-r16   INTEGER (0..9)           OPTIONAL, -- Need ON
    ...
}
-- ASN1STOP
```

NR-DL-PRS-BeamInfo field descriptions
<p>dl-PRS-ID This field is used along with a DL-PRS Resource Set ID and a DL-PRS Resources ID to uniquely identify a DL-PRS Resource. This ID can be associated with multiple DL-PRS Resource Sets associated with a single TRP. Each TRP should only be associated with one such ID.</p>
<p>nr-PhysCellID This field specifies the physical cell identity of the associated TRP, as defined in TS 38.331 [35].</p>
<p>nr-CellGlobalID This field specifies the NCGI, the globally unique identity of a cell in NR, of the associated TRP, as defined in TS 38.331 [35]. The server should include this field if it considers that it is needed to resolve ambiguity in the TRP indicated by <i>nr-PhysCellID</i>.</p>
<p>nr-ARFCN This field specifies the NR-ARFCN of the TRP's CD-SSB (as defined in TS 38.300 [47]) corresponding to <i>nr-PhysCellID</i>.</p>
<p>associated-DL-PRS-ID This field specifies the <i>dl-PRS-ID</i> of the associated TRP from which the beam information is obtained. See the field descriptions of <i>dl-PRS-BeamInfoSet</i> and <i>lcs-GCS-TranslationParameter</i>.</p>
<p>lcs-GCS-TranslationParameter This field provides the angles α (bearing angle), β (downtilt angle) and γ (slant angle) for the translation of a Local Coordinate System (LCS) to a Global Coordinate System (GCS) as defined in TR 38.901 [44]. If this field and the field <i>associated-DL-PRS-ID</i> are absent, the <i>dl-PRS-Azimuth</i> and <i>dl-PRS-Elevation</i> are provided in a GCS. If this field is absent and the <i>associated-DL-PRS-ID</i> field is present, then the <i>lcs-GCS-TranslationParameter</i> for this TRP is obtained from the <i>lcs-GCS-TranslationParameter</i> of the associated TRP.</p>
<p>dl-PRS-BeamInfoSet This field provides the DL-PRS beam information for each DL-PRS Resource of the DL-PRS Resource Set associated with this TRP. If this field is absent and the field <i>associated-DL-PRS-ID</i> is present, the <i>dl-PRS-BeamInfoSet</i> for this TRP are obtained from the <i>dl-PRS-BeamInfoSet</i> of the associated TRP.</p>
<p>dl-PRS-Azimuth This field specifies the azimuth angle of the boresight direction in which the DL-PRS Resources associated with this DL-PRS Resource ID in the DL-PRS Resource Set are transmitted. For a Global Coordinate System (GCS), the azimuth angle is measured counter-clockwise from geographical North. For a Local Coordinate System (LCS), the azimuth angle is measured measured counter-clockwise from the x-axis of the LCS. Scale factor 1 degree; range 0 to 359 degrees.</p>
<p>dl-PRS-Azimuth-fine This field provides finer granularity for the <i>dl-PRS-Azimuth</i>. The total azimuth angle of the boresight direction is given by <i>dl-PRS-Azimuth</i> + <i>dl-PRS-Azimuth-fine</i>. Scale factor 0.1 degrees; range 0 to 0.9 degrees.</p>
<p>dl-PRS-Elevation This field specifies the elevation angle of the boresight direction in which the DL-PRS Resources associated with this DL-PRS Resource ID in the DL-PRS Resource Set are transmitted. For a Global Coordinate System (GCS), the elevation angle is measured relative to zenith and positive to the horizontal direction (elevation 0 deg. points to zenith, 90 deg to the horizon). For a Local Coordinate System (LCS), the elevation angle is measured relative to the z-axis of the LCS (elevation 0 deg. points to the z-axis, 90 deg to the x-y plane). Scale factor 1 degree; range 0 to 180 degrees.</p>
<p>dl-PRS-Elevation-fine This field provides finer granularity for the <i>dl-PRS-Elevation</i>. The total elevation angle of the boresight direction is given by <i>dl-PRS-Elevation</i> + <i>dl-PRS-Elevation-fine</i>. Scale factor 0.1 degrees; range 0 to 0.9 degrees.</p>

– NR-DL-PRS-ExpectedLOS-NLOS-Assistance

The IE *NR-DL-PRS-ExpectedLOS-NLOS-Assistance* is used by the location server to provide the expected likelihood of a LOS propagation path from a TRP to the target device, or for all DL-PRS Resources of the TRP to the target device.

```
-- ASN1START
NR-DL-PRS-ExpectedLOS-NLOS-Assistance-r17 ::= SEQUENCE (SIZE (1..nrMaxFreqLayers-r16)) OF
    NR-DL-PRS-ExpectedLOS-NLOS-AssistancePerFreqLayer-r17
NR-DL-PRS-ExpectedLOS-NLOS-AssistancePerFreqLayer-r17 ::=
    SEQUENCE (SIZE (1..nrMaxTRPsPerFreq-r16)) OF
    NR-DL-PRS-ExpectedLOS-NLOS-AssistancePerTRP-r17
```



```

NR-DL-PRS-ExpectedLOS-NLOS-AssistancePerTRP-r17 ::= SEQUENCE {
  dl-PRS-ID-r17                INTEGER (0..255),
  nr-PhysCellID-r17            NR-PhysCellID-r16          OPTIONAL,  -- Need ON
  nr-CellGlobalID-r17         NCGI-r15                   OPTIONAL,  -- Need ON
  nr-ARFCN-r17                ARFCN-ValueNR-r15          OPTIONAL,  -- Need ON
  nr-los-nlos-indicator-r17    CHOICE {
    perTrp-r17                 LOS-NLOS-Indicator-r17,
    perResource-r17            SEQUENCE (SIZE (1..nrMaxSetsPerTrpPerFreqLayer-r16)) OF
                                NR-DL-PRS-ExpectedLOS-NLOS-AssistancePerResource-r17
  },
  ...
}

NR-DL-PRS-ExpectedLOS-NLOS-AssistancePerResource-r17 ::=
  SEQUENCE (SIZE (1..nrMaxResourcesPerSet-r16)) OF
  LOS-NLOS-Indicator-r17

-- ASN1STOP

```

NR-DL-PRS-ExpectedLOS-NLOS-Assistance field descriptions

dl-PRS-ID	This field specifies the DL-PRS ID of the TRP for which the LOS/NLOS Information is provided.
nr-PhysCellID	This field specifies the physical Cell-ID of the TRP for which the LOS/NLOS Information is provided, as defined in TS 38.331 [35].
nr-CellGlobalID	This field specifies the NCGI, the globally unique identity of a cell in NR, of the TRP for which the LOS/NLOS Information is provided, as defined in TS 38.331 [35].
nr-ARFCN	This field specifies the NR-ARFCN of the TRP's CD-SSB (as defined in TS 38.300 [47]) corresponding to <i>nr-PhysCellID</i> .
nr-los-nlos-indicator	This field provides the expected likelihood of a LOS propagation path from a TRP to the target device (choice <i>perTrp</i>) or for all DL-PRS Resources of the TRP (choice <i>perResource</i>).

NR-DL-PRS-Info

The IE *NR-DL-PRS-Info* defines downlink PRS configuration.

```

-- ASN1START

NR-DL-PRS-Info-r16 ::= SEQUENCE {
  nr-DL-PRS-ResourceSetList-r16  SEQUENCE (SIZE (1..nrMaxSetsPerTrpPerFreqLayer-r16)) OF
                                NR-DL-PRS-ResourceSet-r16,
  ...
}

NR-DL-PRS-ResourceSet-r16 ::= SEQUENCE {
  nr-DL-PRS-ResourceSetID-r16    NR-DL-PRS-ResourceSetID-r16,
  dl-PRS-Periodicity-and-ResourceSetSlotOffset-r16
                                NR-DL-PRS-Periodicity-and-ResourceSetSlotOffset-r16,
  dl-PRS-ResourceRepetitionFactor-r16  ENUMERATED {n2, n4, n6, n8, n16, n32, ...}
                                OPTIONAL,  -- Need OP
  dl-PRS-ResourceTimeGap-r16       ENUMERATED {s1, s2, s4, s8, s16, s32, ...}
                                OPTIONAL,  -- Cond Rep
  dl-PRS-NumSymbols-r16           ENUMERATED {n2, n4, n6, n12, ...},
  dl-PRS-MutingOption1-r16        DL-PRS-MutingOption1-r16          OPTIONAL,  -- Need OP
  dl-PRS-MutingOption2-r16        DL-PRS-MutingOption2-r16          OPTIONAL,  -- Need OP
  dl-PRS-ResourcePower-r16        INTEGER (-60..50),
  dl-PRS-ResourceList-r16         SEQUENCE (SIZE (1..nrMaxResourcesPerSet-r16)) OF
                                NR-DL-PRS-Resource-r16,
  ...
}

DL-PRS-MutingOption1-r16 ::= SEQUENCE {
  dl-prs-MutingBitRepetitionFactor-r16
                                ENUMERATED { n1, n2, n4, n8, ... } OPTIONAL,  -- Need OP
  nr-option1-muting-r16          NR-MutingPattern-r16,
  ...
}

DL-PRS-MutingOption2-r16 ::= SEQUENCE {

```

```

    nr-option2-muting-r16          NR-MutingPattern-r16,
    ...
}

NR-MutingPattern-r16 ::= CHOICE {
    po2-r16          BIT STRING (SIZE(2)),
    po4-r16          BIT STRING (SIZE(4)),
    po6-r16          BIT STRING (SIZE(6)),
    po8-r16          BIT STRING (SIZE(8)),
    po16-r16         BIT STRING (SIZE(16)),
    po32-r16         BIT STRING (SIZE(32)),
    ...
}

NR-DL-PRS-Resource-r16 ::= SEQUENCE {
    nr-DL-PRS-ResourceID-r16      NR-DL-PRS-ResourceID-r16,
    dl-PRS-SequenceID-r16         INTEGER (0.. 4095),
    dl-PRS-CombSizeN-AndReOffset-r16 CHOICE {
        n2-r16          INTEGER (0..1),
        n4-r16          INTEGER (0..3),
        n6-r16          INTEGER (0..5),
        n12-r16         INTEGER (0..11),
        ...
    },
    dl-PRS-ResourceSlotOffset-r16 INTEGER (0..nrMaxResourceOffsetValue-l-r16),
    dl-PRS-ResourceSymbolOffset-r16 INTEGER (0..12),
    dl-PRS-QCL-Info-r16           DL-PRS-QCL-Info-r16           OPTIONAL,    --Need ON
    ...,
    [[
    dl-PRS-ResourcePrioritySubset-r17 DL-PRS-ResourcePrioritySubset-r17 OPTIONAL -- Need ON
    ]]
}

DL-PRS-QCL-Info-r16 ::= CHOICE {
    ssb-r16          SEQUENCE {
        pci-r16          NR-PhysCellID-r16,
        ssb-Index-r16    INTEGER (0..63),
        rs-Type-r16      ENUMERATED {typeC, typeD, typeC-plus-typeD}
    },
    dl-PRS-r16       SEQUENCE {
        qcl-DL-PRS-ResourceID-r16 NR-DL-PRS-ResourceID-r16,
        qcl-DL-PRS-ResourceSetID-r16 NR-DL-PRS-ResourceSetID-r16
    }
}

NR-DL-PRS-Periodicity-and-ResourceSetSlotOffset-r16 ::= CHOICE {
    scs15-r16        CHOICE {
        n4-r16          INTEGER (0..3),
        n5-r16          INTEGER (0..4),
        n8-r16          INTEGER (0..7),
        n10-r16         INTEGER (0..9),
        n16-r16         INTEGER (0..15),
        n20-r16         INTEGER (0..19),
        n32-r16         INTEGER (0..31),
        n40-r16         INTEGER (0..39),
        n64-r16         INTEGER (0..63),
        n80-r16         INTEGER (0..79),
        n160-r16        INTEGER (0..159),
        n320-r16        INTEGER (0..319),
        n640-r16        INTEGER (0..639),
        n1280-r16       INTEGER (0..1279),
        n2560-r16       INTEGER (0..2559),
        n5120-r16       INTEGER (0..5119),
        n10240-r16      INTEGER (0..10239),
        ...
    },
    scs30-r16        CHOICE {
        n8-r16          INTEGER (0..7),
        n10-r16         INTEGER (0..9),
        n16-r16         INTEGER (0..15),
        n20-r16         INTEGER (0..19),
        n32-r16         INTEGER (0..31),
        n40-r16         INTEGER (0..39),
        n64-r16         INTEGER (0..63),
        n80-r16         INTEGER (0..79),
        n128-r16        INTEGER (0..127),
        n160-r16        INTEGER (0..159),
        n320-r16        INTEGER (0..319),

```

```

n640-r16 INTEGER (0..639),
n1280-r16 INTEGER (0..1279),
n2560-r16 INTEGER (0..2559),
n5120-r16 INTEGER (0..5119),
n10240-r16 INTEGER (0..10239),
n20480-r16 INTEGER (0..20479),
...
},
scs60-r16 CHOICE {
n16-r16 INTEGER (0..15),
n20-r16 INTEGER (0..19),
n32-r16 INTEGER (0..31),
n40-r16 INTEGER (0..39),
n64-r16 INTEGER (0..63),
n80-r16 INTEGER (0..79),
n128-r16 INTEGER (0..127),
n160-r16 INTEGER (0..159),
n256-r16 INTEGER (0..255),
n320-r16 INTEGER (0..319),
n640-r16 INTEGER (0..639),
n1280-r16 INTEGER (0..1279),
n2560-r16 INTEGER (0..2559),
n5120-r16 INTEGER (0..5119),
n10240-r16 INTEGER (0..10239),
n20480-r16 INTEGER (0..20479),
n40960-r16 INTEGER (0..40959),
...
},
scs120-r16 CHOICE {
n32-r16 INTEGER (0..31),
n40-r16 INTEGER (0..39),
n64-r16 INTEGER (0..63),
n80-r16 INTEGER (0..79),
n128-r16 INTEGER (0..127),
n160-r16 INTEGER (0..159),
n256-r16 INTEGER (0..255),
n320-r16 INTEGER (0..319),
n512-r16 INTEGER (0..511),
n640-r16 INTEGER (0..639),
n1280-r16 INTEGER (0..1279),
n2560-r16 INTEGER (0..2559),
n5120-r16 INTEGER (0..5119),
n10240-r16 INTEGER (0..10239),
n20480-r16 INTEGER (0..20479),
n40960-r16 INTEGER (0..40959),
n81920-r16 INTEGER (0..81919),
...
},
...
}
DL-PRS-ResourcePrioritySubset-r17 ::= SEQUENCE (SIZE (1..maxNumPrioResources-r17)) OF
NR-DL-PRSResourcePriorityItem-r17
NR-DL-PRSResourcePriorityItem-r17 ::= SEQUENCE {
nr-DL-PRS-PrioResourceSetID-r17 NR-DL-PRS-ResourceSetID-r16 OPTIONAL, -- Cond NotSame
nr-DL-PRS-PrioResourceID-r17 NR-DL-PRS-ResourceID-r16,
...
}
-- ASN1STOP

```

Conditional presence	Explanation
<i>Rep</i>	The field is mandatory present, if <i>dl-PRS-ResourceRepetitionFactor</i> is present. Otherwise it is not present.
<i>NotSame</i>	The field is optionally present, need OP. If the field is absent, the indicated <i>nr-DL-PRS-PrioResourceID</i> belongs to the same DL-PRS Resource Set as the <i>nr-DL-PRS-ResourceID</i> .

NR-DL-PRS-Info field descriptions

<p>nr-DL-PRS-ResourceSetID This field specifies the DL-PRS Resource Set ID, which is used to identify the DL-PRS Resource Set of the TRP across all the frequency layers.</p>
<p>dl-PRS-Periodicity-and-ResourceSetSlotOffset This field specifies the periodicity of DL-PRS allocation in slots configured per DL-PRS Resource Set and the slot offset with respect to SFN #0 slot #0 for a TRP where the DL-PRS Resource Set is configured (i.e. slot where the first DL-PRS Resource of DL-PRS Resource Set occurs).</p>
<p>dl-PRS-ResourceRepetitionFactor This field specifies how many times each DL-PRS Resource is repeated for a single instance of the DL-PRS Resource Set. It is applied to all resources of the DL-PRS Resource Set. Enumerated values <i>n2</i>, <i>n4</i>, <i>n6</i>, <i>n8</i>, <i>n16</i>, <i>n32</i> correspond to 2, 4, 6, 8, 16, 32 resource repetitions, respectively. If this field is absent, the value for <i>dl-PRS-ResourceRepetitionFactor</i> is 1 (i.e., no resource repetition).</p>
<p>dl-PRS-ResourceTimeGap This field specifies the offset in units of slots between two repeated instances of a DL-PRS Resource corresponding to the same DL-PRS Resource ID within a single instance of the DL-PRS Resource Set. The time duration spanned by one DL-PRS Resource Set containing repeated DL-PRS Resources should not exceed DL-PRS-Periodicity.</p>
<p>dl-PRS-NumSymbols This field specifies the number of symbols per DL-PRS Resource within a slot.</p>
<p>dl-PRS-MutingOption1 This field specifies the DL-PRS muting configuration of the TRP for the Option-1 muting, as specified in TS 38.214 [45], and comprises the following sub-fields:</p> <ul style="list-style-type: none"> - dl-prs-MutingBitRepetitionFactor indicates the number of consecutive instances of the DL-PRS Resource Set corresponding to a single bit of the <i>nr-option1-muting</i> bit map. Enumerated values <i>n1</i>, <i>n2</i>, <i>n4</i>, <i>n8</i> correspond to 1, 2, 4, 8 consecutive instances, respectively. If this sub-field is absent, the value for <i>dl-prs-MutingBitRepetitionFactor</i> is <i>n1</i>. - nr-option1-muting defines a bitmap of the time locations where the DL-PRS Resource is transmitted (value '1') or not (value '0') for a DL-PRS Resource Set, as specified in TS 38.214 [45]. <p>If this field is absent, Option-1 muting is not in use for the TRP.</p>
<p>dl-PRS-MutingOption2 This field specifies the DL-PRS muting configuration of the TRP for the Option-2 muting, as specified in TS 38.214 [45], and comprises the following sub-fields:</p> <ul style="list-style-type: none"> - nr-option2-muting defines a bitmap of the time locations where the DL-PRS Resource is transmitted (value '1') or not (value '0'). Each bit of the bitmap corresponds to a single repetition of the DL-PRS Resource within an instance of a DL-PRS Resource Set, as specified in TS 38.214 [45]. The size of this bitmap should be the same as the value for <i>dl-PRS-ResourceRepetitionFactor</i>. <p>If this field is absent, Option-2 muting is not in use for the TRP.</p>
<p>dl-PRS-ResourcePower This field specifies the average EPRE of the resources elements that carry the PRS in dBm that is used for PRS transmission. The UE assumes constant EPRE is used for all REs of a given DL-PRS resource.</p>
<p>dl-PRS-SequenceID This field specifies the sequence Id used to initialize c_{init} value used in pseudo random generator TS 38.211 [41], clause 5.2.1 for generation of DL-PRS sequence for transmission on a given DL-PRS Resource.</p>
<p>dl-PRS-CombSizeN-AndReOffset This field specifies the Resource Element spacing in each symbol of the DL-PRS Resource and the Resource Element (RE) offset in the frequency domain for the first symbol in a DL-PRS Resource. All DL-PRS Resource Sets belonging to the same Positioning Frequency Layer have the same value of comb size. The relative RE offsets of following symbols are defined relative to the RE Offset in the frequency domain of the first symbol in the DL-PRS Resource according to TS 38.211 [41]. The comb size configuration should be aligned with the comb size configuration for the frequency layer.</p>
<p>dl-PRS-ResourceSlotOffset This field specifies the starting slot of the DL-PRS Resource with respect to the corresponding DL-PRS-Resource Set Slot Offset.</p>
<p>dl-PRS-ResourceSymbolOffset This field specifies the starting symbol of the DL-PRS Resource within a slot determined by <i>dl-PRS-ResourceSlotOffset</i>.</p>

dl-PRS-QCL-Info

This field specifies the QCL indication for a DL-PRS Resource with another DL reference signal from serving or neighbouring cell and comprises the following subfields:

- **ssb** indicates the SSB information for QCL source and comprises the following sub-fields:
 - **pci** specifies the physical cell ID of the cell with the SSB that is configured as the source reference signal for the DL-PRS Resource. The UE obtains the SSB configuration for the SSB configured as source reference signal for the DL-PRS Resource by selecting an SSB configuration from *nr-SSB-Config* with a matching physical cell identity.
 - **ssb-Index** indicates the index for the SSB configured as the source reference signal for the DL-PRS Resource.
 - **rs-Type** indicates the QCL type.
- **dl-PRS** indicates the PRS information for QCL source reference signal and comprises the following sub-fields:
 - **qcl-DL-PRS-ResourceID** specifies DL-PRS Resource ID of the DL-PRS resource used as the source reference signal.
 - **qcl-DL-PRS-ResourceSetID** indicates the DL-PRS Resource Set ID of the DL-PRS Resource Set used as the source reference signal.

dl-PRS-ResourcePrioritySubset

This field provides a subset of DL-PRS Resources, which is associated with *nr-DL-PRS-ResourceID* for the purpose of prioritization of DL-AoD reporting, as specified in TS 38.214 [45].

NOTE: This field is only applicable to DL-AoD positioning method and should be ignored for DL-TDOA and Multi-RTT positioning.

– NR-DL-PRS-ProcessingCapability

The IE *NR-DL-PRS-ProcessingCapability* defines the common DL-PRS Processing capability. In the case of capabilities for multiple NR positioning methods are provided, the IE *NR-DL-PRS-ProcessingCapability* applies across the NR positioning methods and the target device shall indicate the same values for the capabilities in IEs *NR-DL-TDOA-ProvideCapabilities*, *NR-DL-AoD-ProvideCapabilities*, and *NR-Multi-RTT-ProvideCapabilities*.

The *PRS-ProcessingCapabilityPerBand* is defined for a single positioning frequency layer on a certain band (i.e., a target device supporting multiple positioning frequency layers is expected to process one frequency layer at a time).

```

-- ASN1START
NR-DL-PRS-ProcessingCapability-r16 ::= SEQUENCE {
    prs-ProcessingCapabilityBandList-r16      SEQUENCE (SIZE (1..nrMaxBands-r16)) OF
                                             PRS-ProcessingCapabilityPerBand-r16,
    maxSupportedFreqLayers-r16              INTEGER (1..4),
    simulLTE-NR-PRS-r16                     ENUMERATED { supported }           OPTIONAL,
    ...
    [[
    dummy                                  ENUMERATED { m1, m2, ... }           OPTIONAL
    ]]
}

PRS-ProcessingCapabilityPerBand-r16 ::= SEQUENCE {
    freqBandIndicatorNR-r16                 FreqBandIndicatorNR-r16,
    supportedBandwidthPRS-r16              CHOICE {
        fr1                                ENUMERATED { mhz5, mhz10, mhz20, mhz40,
                                                         mhz50, mhz80, mhz100},
        fr2                                ENUMERATED { mhz50, mhz100, mhz200, mhz400},
        ...
    },
    dl-PRS-BufferType-r16                   ENUMERATED { type1, type2, ...},
    durationOfPRS-Processing-r16            SEQUENCE {
        durationOfPRS-ProcessingSymbols-r16 ENUMERATED { nDot125, nDot25, nDot5, n1,
                                                         n2, n4, n6, n8, n12, n16, n20, n25,
                                                         n30, n32, n35, n40, n45, n50},
        durationOfPRS-ProcessingSymbolsInEveryTms-r16
                                             ENUMERATED { n8, n16, n20, n30, n40, n80,
                                                         n160, n320, n640, n1280},
        ...
    },
    maxNumOfDL-PRS-ResProcessedPerSlot-r16 SEQUENCE {
        scs15-r16                           ENUMERATED { n1, n2, n4, n8, n16, n24, n32,
                                                         n48, n64 }           OPTIONAL,
        scs30-r16                           ENUMERATED { n1, n2, n4, n8, n16, n24, n32,
                                                         n48, n64 }           OPTIONAL,
        scs60-r16                           ENUMERATED { n1, n2, n4, n8, n16, n24, n32,
                                                         n48, n64 }           OPTIONAL,
    }
}
-- ASN1END

```

```

        scs120-r16          ENUMERATED {n1, n2, n4, n8, n16, n24, n32,
                                n48, n64}          OPTIONAL,
        ...,
        [[
        scs15-v1690        ENUMERATED {n6, n12}          OPTIONAL,
        scs30-v1690        ENUMERATED {n6, n12}          OPTIONAL,
        scs60-v1690        ENUMERATED {n6, n12}          OPTIONAL,
        scs120-v1690       ENUMERATED {n6, n12}          OPTIONAL
        ]]
    },
    ...,
    [[
    supportedDL-PRS-ProcessingSamples-RRC-CONNECTED-r17 ENUMERATED { supported }          OPTIONAL,
    prs-ProcessingWindowType1A-r17          ENUMERATED { option1, option2, option3}          OPTIONAL,
    prs-ProcessingWindowType1B-r17          ENUMERATED { option1, option2, option3}          OPTIONAL,
    prs-ProcessingWindowType2-r17          ENUMERATED { option1, option2, option3}          OPTIONAL,
    prs-ProcessingCapabilityOutsideMGinPPW-r17
        SEQUENCE (SIZE(1..3)) OF
            PRS-ProcessingCapabilityOutsideMGinPPWperType-r17
                OPTIONAL,
    dl-PRS-BufferType-RRC-Inactive-r17      ENUMERATED { type1, type2, ... }          OPTIONAL,
    durationOfPRS-Processing-RRC-Inactive-r17 SEQUENCE {
        durationOfPRS-ProcessingSymbols-r17  ENUMERATED {nDot125, nDot25, nDot5, n1,
                                n2, n4, n6, n8, n12, n16, n20, n25,
                                n30, n32, n35, n40, n45, n50},
        durationOfPRS-ProcessingSymbolsInEveryTms-r17
            ENUMERATED {n8, n16, n20, n30, n40, n80,
                n160, n320, n640, n1280},
        ...
    }
    maxNumOfDL-PRS-ResProcessedPerSlot-RRC-Inactive-r17 SEQUENCE {
        scs15-r17          ENUMERATED {n1, n2, n4, n6, n8, n12, n16, n24,
                                n32, n48, n64}          OPTIONAL,
        scs30-r17          ENUMERATED {n1, n2, n4, n6, n8, n12, n16, n24,
                                n32, n48, n64}          OPTIONAL,
        scs60-r17          ENUMERATED {n1, n2, n4, n6, n8, n12, n16, n24,
                                n32, n48, n64}          OPTIONAL,
        scs120-r17         ENUMERATED {n1, n2, n4, n6, n8, n12, n16, n24,
                                n32, n48, n64}          OPTIONAL,
        ...
    }
    supportedLowerRxBeamSweepingFactor-FR2-r17 ENUMERATED { n1, n2, n4, n6 }          OPTIONAL
    ]],
    [[
    supportedDL-PRS-ProcessingSamples-RRC-Inactive-r17 ENUMERATED { supported }          OPTIONAL
    ]],
    [[
    prs-MeasurementWithoutMG-r17          ENUMERATED {cp, symbolDot25, symbolDot5,
                                slotDot5}          OPTIONAL
    ]]
}

PRS-ProcessingCapabilityOutsideMGinPPWperType-r17 ::= SEQUENCE {
    prsProcessingType-r17          ENUMERATED { type1A, type1B, type2 },
    ppw-dl-PRS-BufferType-r17      ENUMERATED { type1, type2, ... },
    ppw-durationOfPRS-Processing1-r17 SEQUENCE {
        ppw-durationOfPRS-ProcessingSymbolsN-r17
            ENUMERATED { msDot125, msDot25, msDot5, ms1, ms2, ms4,
                ms6, ms8, ms12, ms16, ms20, ms25, ms30, ms32, ms35,
                ms40, ms45, ms50 },
        ppw-durationOfPRS-ProcessingSymbolsT-r17
            ENUMERATED { ms1, ms2, ms4, ms8, ms16, ms20, ms30, ms40, ms80,
                ms160, ms320, ms640, ms1280 }
    }
    ppw-durationOfPRS-Processing2-r17 SEQUENCE {
        ppw-durationOfPRS-ProcessingSymbolsN2-r17
            ENUMERATED { msDot125, msDot25, msDot5, ms1, ms2, ms3, ms4, ms5,
                ms6, ms8, ms12 },
        ppw-durationOfPRS-ProcessingSymbolsT2-r17
            ENUMERATED { ms4, ms5, ms6, ms8 }
    }
}
ppw-maxNumOfDL-PRS-ResProcessedPerSlot-r17 SEQUENCE {
    scs15-r17          ENUMERATED {n1, n2, n4, n6, n8, n12,
                                n16, n24, n32, n48, n64 }
                                OPTIONAL,
    scs30-r17          ENUMERATED {n1, n2, n4, n6, n8, n12,
                                n16, n24, n32, n48, n64 }
                                OPTIONAL,
}

```

```

scs60-r17          ENUMERATED {n1, n2, n4, n6, n8, n12,
                               n16, n24, n32, n48, n64 }
scs120-r17         ENUMERATED {n1, n2, n4, n6, n8, n12,
                               n16, n24, n32, n48, n64 }
...
},
...
[[
ppw-maxNumOfDL-Bandwidth-r17 CHOICE {
  fr1          ENUMERATED {mhz5, mhz10, mhz20, mhz40,
                          mhz50, mhz80, mhz100},
  fr2          ENUMERATED {mhz50, mhz100, mhz200, mhz400}
}
]]
}
-- ASN1STOP
    
```

NR-DL-PRS-ProcessingCapability field descriptions
<p>maxSupportedFreqLayers Indicates the maximum number of positioning frequency layers supported by UE.</p>
<p>simulLTE-NR-PRS Indicates whether the UE supports parallel processing of LTE PRS and NR PRS.</p>
<p>dummy This field is not used in the specification. If received it shall be ignored by the receiver.</p>
<p>supportedBandwidthPRS Indicates the maximum number of DL-PRS bandwidth in MHz, which is supported and reported by UE.</p>
<p>dl-PRS-BufferType Indicates DL-PRS buffering capability. Value <i>type1</i> indicates sub-slot/symbol level buffering and value <i>type2</i> indicates slot level buffering.</p>
<p>durationOfPRS-Processing Indicates the duration <i>N</i> of DL-PRS symbols in units of ms a UE can process every <i>T</i> ms assuming maximum DL-PRS bandwidth provided in <i>supportedBandwidthPRS</i> and comprises the following subfields:</p> <ul style="list-style-type: none"> - durationOfPRS-ProcessingSymbols: This field specifies the values for <i>N</i>. Enumerated values indicate 0.125, 0.25, 0.5, 1, 2, 4, 6, 8, 12, 16, 20, 25, 30, 32, 35, 40, 45, 50 ms. - durationOfPRS-ProcessingSymbolsInEveryTms: This field specifies the values for <i>T</i>. Enumerated values indicate 8, 16, 20, 30, 40, 80, 160, 320, 640, 1280 ms. <p>See NOTE 9.</p>
<p>maxNumOfDL-PRS-ResProcessedPerSlot Indicates the maximum number of DL-PRS resources that UE can process in a slot. SCS: 15 kHz, 30 kHz, 60 kHz are applicable for FR1 bands. SCS: 60 kHz, 120 kHz are applicable for FR2 bands.</p>
<p>supportedDL-PRS-ProcessingSamples-RRC-CONNECTED Indicates the UE capability for support of measurements based on measuring <i>M=1</i> or <i>M=2</i> (instances) of a DL-PRS Resource Set. The UE can include this field only if the UE supports <i>prs-ProcessingCapabilityBandList</i>. Otherwise, the UE does not include this field. NOTE 1: This feature is supported for both UE-assisted and UE based positioning.</p>
<p>prs-ProcessingWindowType1A Indicates the supported DL-PRS processing types subject to the UE determining that DL-PRS to be higher priority for DL-PRS measurement outside MG and in a DL-PRS Processing Window. Type 1A refers to the determination of prioritization between DL-PRS and other DL signals/channels in all OFDM symbols within the PRS Processing Window. The DL signals/channels from all DL CCs (per UE) are affected across LTE and NR. Enumerated value indicates supported priority handing options of DL-PRS:</p> <ul style="list-style-type: none"> - <i>option1</i>: Support of "st1" and "st3" defined in clause 5.1.6.5 of TS 38.214 [45]. - <i>option2</i>: Support of "st1", "st2", and "st3" defined in clause 5.1.6.5 of TS 38.214 [45]. - <i>option3</i>: Support of "st1" only defined in clause 5.1.6.5 of TS 38.214 [45]. <p>The UE can include this field only if the UE supports <i>prs-ProcessingCapabilityBandList</i>. Otherwise, the UE does not include this field. NOTE 2: Within a PRS processing window, UE measurement is inside the active DL BWP with PRS having the same numerology as the active DL BWP. NOTE 2a: When the UE determines higher priority for other DL signals/channels over the DL-PRS measurement/processing, the UE is not expected to measure/process DL-PRS.</p>

NR-DL-PRS-ProcessingCapability field descriptions
<p><i>prs-ProcessingWindowType1B</i> Indicates the supported DL-PRS processing types subject to the UE determining that DL-PRS to be higher priority for DL-PRS measurement outside MG and in a DL-PRS Processing Window. Type 1B refers to the determination of prioritization between DL-PRS and other DL signals/channels in all OFDM symbols within the PRS processing window. The DL signals/channels from a certain band are affected. Enumerated value indicates supported priority handing options of DL-PRS (see <i>prs-ProcessingWindowType1A</i>). The UE can include this field only if the UE supports <i>prs-ProcessingCapabilityBandList</i>. Otherwise, the UE does not include this field.</p> <p>NOTE 3: Within a PRS processing window, UE measurement is inside the active DL BWP with PRS having the same numerology as the active DL BWP.</p> <p>NOTE 3a: When the UE determines higher priority for other DL signals/channels over the DL-PRS measurement/processing, the UE is not expected to measure/process DL-PRS.</p>
<p><i>prs-ProcessingWindowType2</i> Indicates the supported DL-PRS processing types subject to the UE determining that DL-PRS to be higher priority for DL-PRS measurement outside MG and in a DL-PRS Processing Window. Type 2 refers to the determination of prioritization between DL-PRS and other DL signals/channels only in DL-PRS symbols within the PRS processing window. Enumerated value indicates supported priority handing options of DL-PRS (see <i>prs-ProcessingWindowType1A</i>). The UE can include this field only if the UE supports <i>prs-ProcessingCapabilityBandList</i>. Otherwise, the UE does not include this field.</p> <p>NOTE 4: Within a PRS processing window, UE measurement is inside the active DL BWP with PRS having the same numerology as the active DL BWP.</p> <p>NOTE 4a: When the UE determines higher priority for other DL signals/channels over the DL-PRS measurement/processing, the UE is not expected to measure/process DL-PRS.</p>
<p><i>prs-ProcessingCapabilityOutsideMGinPPW</i> Indicates the DL-PRS Processing Capability outside MG of each of the supported PPW Type in the case the UE supports multiple PPW Types in a band and comprises the following subfields:</p> <ul style="list-style-type: none"> - <i>prsProcessingType</i>: Indicates the DL-PRS Processing Window Type for which the <i>prs-ProcessingCapabilityOutsideMGinPPW</i> are provided. - <i>ppw-dl-PRS-BufferType</i>: Indicates DL-PRS buffering capability. Value '<i>type1</i>' indicates sub-slot/symbol level buffering and value '<i>type2</i>' indicates slot level buffering. - <i>ppw-durationOfPRS-Processing1</i>: Indicates the duration of DL-PRS symbols <i>N</i> in units of ms a UE can process every <i>T</i> ms assuming maximum DL-PRS bandwidth provided in <i>ppw-maxNumOfDL-Bandwidth</i> and comprises the following subfields: <ul style="list-style-type: none"> - <i>ppw-durationOfPRS-ProcessingSymbolsN</i>: This field specifies the values for <i>N</i>. Enumerated values indicate 0.125, 0.25, 0.5, 1, 2, 4, 6, 8, 12, 16, 20, 25, 30, 32, 35, 40, 45, 50 ms. - <i>ppw-durationOfPRS-ProcessingSymbolsT</i>: This field specifies the values for <i>T</i>. Enumerated values indicate 1, 2, 4, 8, 16, 20, 30, 40, 80, 160, 320, 640, 1280 ms. - <i>ppw-durationOfPRS-Processing2</i>: Indicates the duration of DL-PRS symbols <i>N2</i> in units of ms a UE can process in <i>T2</i> ms assuming maximum DL-PRS bandwidth provided in <i>ppw-maxNumOfDL-Bandwidth</i> and comprises the following subfields: <ul style="list-style-type: none"> - <i>ppw-durationOfPRS-ProcessingSymbolsN2</i>: This field specifies the values for <i>N2</i>. Enumerated values indicate 0.125, 0.25, 0.5, 1, 2, 3, 4, 5, 6, 8, 12 ms. - <i>ppw-durationOfPRS-ProcessingSymbolsT2</i>: This field specifies the values for <i>T2</i>. Enumerated values indicate 4, 5, 6, 8 ms. - <i>ppw-maxNumOfDL-PRS-ResProcessedPerSlot</i>: Indicates the maximum number of DL-PRS resources that UE can process in a slot. SCS: 15 kHz, 30 kHz, 60 kHz are applicable for FR1 bands. SCS: 60 kHz, 120 kHz are applicable for FR2 bands. - <i>ppw-maxNumOfDL-Bandwidth</i>: Indicates the maximum number of DL PRS bandwidth in MHz, which is supported and reported by UE for PRS measurement outside MG within the PPW. <p>The UE can include this field only if the UE supports one of <i>prs-ProcessingWindowType1A</i>, <i>prs-ProcessingWindowType1B</i> and <i>prs-ProcessingWindowType2</i>. Otherwise, the UE does not include this field.</p> <p>NOTE 5: A UE that supports one of <i>prs-ProcessingWindowType1A</i>, <i>prs-ProcessingWindowType1B</i> or <i>prs-ProcessingWindowType2</i> shall always include the <i>prs-ProcessingCapabilityOutsideMGinPPW</i>.</p> <p>NOTE 6: The (<i>N</i>, <i>T</i>) UE capability in <i>ppw-durationOfPRS-Processing1</i> is interpreted as in NOTE 9, and the UE is expected to receive the DL-PRS within the PRS processing window but the processing of the received DL-PRS may be outside a DL-PRS processing window.</p> <p>NOTE 7: The (<i>N2</i>, <i>T2</i>) UE capability in <i>ppw-durationOfPRS-Processing2</i> is interpreted such that the UE is capable of measuring up to <i>N2</i> ms DL-PRS within a PPW and is capable of completing the DL-PRS processing within the PPW, e.g., if the time duration from the last symbol of the measured DL-PRS resource(s) inside the PPW to the end of PPW is not smaller than <i>T2</i> ms.</p> <p>NOTE 8: A UE which supports <i>prs-ProcessingCapabilityOutsideMGinPPW</i> shall support either <i>ppw-durationOfPRS-Processing1</i> or <i>ppw-durationOfPRS-Processing2</i>, but not both for each supported type in a band.</p>
<p><i>dl-PRS-BufferType-RRC-Inactive</i> Indicates DL-PRS buffering capability in RRC_INACTIVE state. Value '<i>type1</i>' indicates sub-slot/symbol level buffering and value '<i>type2</i>' indicates slot level buffering.</p>

NR-DL-PRS-ProcessingCapability field descriptions
<p>durationOfPRS-Processing-RRC-Inactive Indicates the duration N of DL-PRS symbols in units of ms a UE can process every T ms in RRC_INACTIVE state assuming maximum DL-PRS bandwidth provided in <i>supportedBandwidthPRS</i> and comprises the following subfields:</p> <ul style="list-style-type: none"> - durationOfPRS-ProcessingSymbols: This field specifies the values for N. Enumerated values indicate 0.125, 0.25, 0.5, 1, 2, 4, 6, 8, 12, 16, 20, 25, 30, 32, 35, 40, 45, 50 ms. - durationOfPRS-ProcessingSymbolsInEveryTms: This field specifies the values for T. Enumerated values indicate 8, 16, 20, 30, 40, 80, 160, 320, 640, 1280 ms. <p>See NOTE 9.</p>
<p>maxNumOfDL-PRS-ResProcessedPerSlot-RRC-Inactive Indicates the maximum number of DL-PRS resources a UE can process in a slot in RRC_INACTIVE state. SCS: 15 kHz, 30 kHz, 60 kHz are applicable for FR1 bands. SCS: 60 kHz, 120 kHz are applicable for FR2 bands.</p>
<p>supportedLowerRxBeamSweepingFactor-FR2 Indicates support of the lower Rx beam sweeping factor than 8 for FR2. Enumerated value indicates the number of Rx beam sweeping factors supported.</p>
<p>supportedDL-PRS-ProcessingSamples-RRC-Inactive Indicates the UE capability for support of reduced number of samples for PRS measurement in RRC_INACTIVE state. The UE can include this field only if the UE supports <i>prs-ProcessingRRC-Inactive</i> defined in TS 38.331 [35]. Otherwise, the UE does not include this field.</p>
<p>prs-MeasurementWithoutMG Indicates the UE capability for support of Rx timing difference between the serving cell and non-serving cell for PRS measurement within a PPW. Value 'cp' indicates one CP length, value 'symbolDot25' indicates 0.25 symbol length, value 'symbolDot5' indicates 0.5 symbol length and value 'slotDot5' indicates 0.5 slot length. The UE can include this field only if the UE supports one of <i>prs-ProcessingWindowType1A</i>, <i>prs-ProcessingWindowType1B</i> and <i>prs-ProcessingWindowType2</i>. Otherwise, the UE does not include this field.</p>
<p>NOTE 9: When the target device provides the <i>durationOfPRS-Processing</i> capability (N, T) for any $P(\geq T)$ time window defined in TS 38.214 [45] clause 5.1.6.5, the target device should be capable of processing all DL-PRS resources within P, if</p> <ul style="list-style-type: none"> - $N \geq K$ where K is defined in the TS 38.214 [45] clause 5.1.6.5, and - the number of DL-PRS Resources in each slot does not exceed the <i>maxNumOfDL-PRS-ResProcessedPerSlot</i>, and - the configured measurement gap and a maximum ratio of measurement gap length (MGL) / measurement gap repetition period (MGRP) is as specified in TS 38.133 [46].

– NR-DL-PRS-QCL-ProcessingCapability

The IE *NR-DL-PRS-QCL-ProcessingCapability* defines the common UE DL-PRS QCL Processing capability. The UE can include this IE only if the UE supports *NR-DL-PRS-ProcessingCapability*. Otherwise, the UE does not include this IE.

In the case of capabilities for multiple NR positioning methods are provided, the IE *NR-DL-PRS-QCL-ProcessingCapability* applies across the NR positioning methods and the target device shall indicate the same values for the capabilities in IEs *NR-DL-TDOA-ProvideCapabilities*, *NR-DL-AoD-ProvideCapabilities*, and *NR-Multi-RTT-ProvideCapabilities*.

```

-- ASN1START
NR-DL-PRS-QCL-ProcessingCapability-r16 ::= SEQUENCE {
    dl-PRS-QCL-ProcessingCapabilityBandList-r16      SEQUENCE (SIZE (1..nrMaxBands-r16)) OF
                                                    DL-PRS-QCL-ProcessingCapabilityPerBand-r16,
    ...
}
DL-PRS-QCL-ProcessingCapabilityPerBand-r16 ::= SEQUENCE {
    freqBandIndicatorNR-r16                        FreqBandIndicatorNR-r16,
    ssb-FromNeighCellAsQCL-r16                    ENUMERATED { supported } OPTIONAL,
    prs-FromServNeighCellAsQCL-r16                ENUMERATED { supported } OPTIONAL,
    ...
}
-- ASN1STOP

```

NR-DL-PRS-QCL-ProcessingCapability field descriptions
<p>ssb-FromNeighCellAsQCL Indicates the support of SSB from neighbour cell as QCL source of a DL-PRS. UE supporting this feature also support reusing SSB measurement from RRM for receiving PRS. Note: It refers to Type-C for FR1 and Type-C & Type-D support for FR2.</p>

NR-DL-PRS-QCL-ProcessingCapability field descriptions**prs-FromServNeighCellAsQCL**

Indicates the support of DL-PRS from serving/neighbour cell as QCL source of a DL-PRS.

Note 1: It refers to Type-D support for FR2.

Note 2: A PRS from a PRS-only TP is treated as PRS from a non-serving cell.

NR-DL-PRS-ResourceID

The IE *NR-DL-PRS-ResourceID* defines the identity of a DL-PRS Resource of a DL-PRS Resource Set of a TRP.

```
-- ASN1START
NR-DL-PRS-ResourceID-r16 ::= INTEGER (0..nrMaxNumDL-PRS-ResourcesPerSet-1-r16)
-- ASN1STOP
```

NR-DL-PRS-ResourcesCapability

The IE *NR-DL-PRS-ResourcesCapability* defines the DL-PRS resources capability for each positioning method. The UE can include this IE only if the UE supports *NR-DL-PRS-ProcessingCapability*. Otherwise, the UE does not include this IE.

```
-- ASN1START
NR-DL-PRS-ResourcesCapability-r16 ::= SEQUENCE {
  maxNrOfDL-PRS-ResourceSetPerTrpPerFrequencyLayer-r16      INTEGER (1..2),
  maxNrOfTRP-AcrossFreqs-r16                                ENUMERATED { n4, n6, n12, n16, n32,
                                                         n64, n128, n256, ..., n24-v1690},
  maxNrOfPosLayer-r16                                       INTEGER (1..4),
  dl-PRS-ResourcesCapabilityBandList-r16                    SEQUENCE (SIZE (1..nrMaxBands-r16)) OF
                                                         DL-PRS-ResourcesCapabilityPerBand-r16,
  dl-PRS-ResourcesBandCombinationList-r16                  DL-PRS-ResourcesBandCombinationList-r16,
  ...
}

DL-PRS-ResourcesCapabilityPerBand-r16 ::= SEQUENCE {
  freqBandIndicatorNR-r16                                  FreqBandIndicatorNR-r16,
  maxNrOfDL-PRS-ResourcesPerResourceSet-r16               ENUMERATED { n1, n2, n4, n8, n16, n32, n64, ...},
  maxNrOfDL-PRS-ResourcesPerPositioningFrequencyLayer-r16 ENUMERATED { n6, n24, n32, n64, n96, n128,
                                                         n256, n512, n1024, ...},
  ...
}

DL-PRS-ResourcesBandCombinationList-r16 ::= SEQUENCE (SIZE (1..maxBandComb-r16)) OF
                                                         DL-PRS-ResourcesBandCombination-r16

DL-PRS-ResourcesBandCombination-r16 ::= SEQUENCE {
  bandList-r16                                             SEQUENCE (SIZE (1..maxSimultaneousBands-r16)) OF
                                                         FreqBandIndicatorNR-r16,
  maxNrOfDL-PRS-ResourcesAcrossAllFL-TRP-ResourceSet-r16 CHOICE {
    fr1-Only-r16                                           ENUMERATED {n6, n24, n64, n128, n192,
                                                         n256, n512, n1024, n2048},
    fr2-Only-r16                                           ENUMERATED {n24, n64, n96, n128, n192,
                                                         n256, n512, n1024, n2048},
    fr1-FR2Mix-r16                                         SEQUENCE {
      fr1-r16                                               ENUMERATED {n6, n24, n64, n96, n128,
                                                         n192, n256, n512, n1024, n2048},
      fr2-r16                                               ENUMERATED {n24, n64, n96, n128, n192,
                                                         n256, n512, n1024, n2048},
      ...
    },
    ...
  },
  ...
}
-- ASN1STOP
```

NR-DL-PRS-ResourcesCapability field descriptions
maxNrOfDL-PRS-ResourceSetPerTrpPerFrequencyLayer Indicates the maximum number of DL-PRS Resource Sets per TRP per positioning frequency layer supported by UE.
maxNrOfTRP-AcrossFreqs Indicates the maximum number of TRPs across all positioning frequency layers.
maxNrOfPosLayer Indicates the maximum number of supported positioning frequency layers.
dl-PRS-ResourcesBandCombinationList Provides the capabilities of DL-PRS Resources for the indicated band combination in <i>bandList</i> . This field is provided for all band combinations for which the target device supports DL-PRS.
maxNrOfDL-PRS-ResourcesPerResourceSet Indicates the maximum number of DL-PRS Resources per DL-PRS Resource Set. Value 16, 32, 64 are only applicable to FR2 bands. Value 1 is not applicable for DL-AoD.
maxNrOfDL-PRS-ResourcesPerPositioningFrequencylayer Indicates the maximum number of DL-PRS resources per positioning frequency layer. Value 6 is only applicable to FR1 bands.
maxNrOfDL-PRS-ResourcesAcrossAllFL-TRP-ResourceSet Indicates the maximum number of DL-PRS Resources supported by UE across all frequency layers, TRPs and DL-PRS Resource Sets. fr1-Only: This is applicable for FR1 only band combinations; fr2-Only: This is applicable for FR2 only band combinations; fr1-FR2Mix: This is applicable for band combinations containing FR1 and FR2 bands. fr1 means for FR1 in FR1/FR2 mixed operation, and fr2 means for FR2 in FR1/FR2 mixed operation.

– NR-DL-PRS-ResourceSetID

The IE *NR-DL-PRS-ResourceSetID* defines the identity of a DL-PRS Resource Set of a TRP.

```
-- ASN1START
NR-DL-PRS-ResourceSetID-r16 ::= INTEGER (0..nrMaxNumDL-PRS-ResourceSetsPerTRP-1-r16)
-- ASN1STOP
```

– NR-DL-PRS-TRP-TEG-Info

The IE *NR-DL-PRS-TRP-TEG-Info* is used by the location server to provide the association information of DL-PRS Resources with TRP Tx TEGs.

```
-- ASN1START
NR-DL-PRS-TRP-TEG-Info-r17 ::= SEQUENCE (SIZE (1..nrMaxFreqLayers-r16)) OF
    NR-DL-PRS-TRP-TEG-InfoPerFreqLayer-r17
NR-DL-PRS-TRP-TEG-InfoPerFreqLayer-r17 ::= SEQUENCE (SIZE (1..nrMaxTRPsPerFreq-r16)) OF
    NR-DL-PRS-TRP-TEG-InfoPerTRP-r17
NR-DL-PRS-TRP-TEG-InfoPerTRP-r17 ::= SEQUENCE {
    dl-PRS-ID-r17                INTEGER (0..255),
    nr-PhysCellID-r17            NR-PhysCellID-r16        OPTIONAL, -- Need ON
    nr-CellGlobalID-r17         NCGI-r15                OPTIONAL, -- Need ON
    nr-ARFCN-r17                ARFCN-ValueNR-r15         OPTIONAL, -- Need ON
    dl-PRS-TEG-InfoSet-r17      SEQUENCE (SIZE(1..nrMaxSetsPerTrpPerFreqLayer-r16)) OF
        DL-PRS-TEG-InfoPerResourceSet-r17,
    ...,
    [[
    nr-TRP-TxTEG-TimingErrorMargin-r17    TEG-TimingErrorMargin-r17        OPTIONAL -- Need ON
    ]]
}
DL-PRS-TEG-InfoPerResourceSet-r17 ::= SEQUENCE (SIZE(1..nrMaxResourcesPerSet-r16)) OF
    DL-PRS-TEG-InfoElement-r17
DL-PRS-TEG-InfoElement-r17 ::= SEQUENCE {
    dl-prs-trp-Tx-TEG-ID-r17        INTEGER (0..maxNumOfTRP-TxTEGs-1-r17),
    ...
}
-- ASN1STOP
```

NR-DL-PRS-TRP-TEG-Info field descriptions	
dl-PRS-ID	This field specifies the DL-PRS ID of the TRP for which the TRP Tx TEG information is provided.
nr-PhysCellID	This field specifies the physical Cell-ID of the TRP for which the TRP Tx TEG information is provided, as defined in TS 38.331 [35].
nr-CellGlobalID	This field specifies the NCGI, the globally unique identity of a cell in NR, of the TRP for which the TRP Tx TEG information is provided, as defined in TS 38.331 [35].
nr-ARFCN	This field specifies the NR-ARFCN of the TRP's CD-SSB (as defined in TS 38.300 [47]) corresponding to <i>nr-PhysCellID</i> .
dl-PRS-TEG-InfoSet	This field specifies the TRP Tx TEG ID associated with the transmissions of each DL-PRS Resource of the TRP. The <i>dl-prs-trp-Tx-TEG-ID</i> in <i>dl-PRS-TEG-InfoSet</i> is associated with the <i>nr-DL-PRS-ResourceID</i> of <i>NR-DL-PRS-Info</i> using the same structure and order.
nr-TRP-TxTEG-TimingErrorMargin	This field specifies the timing error margin value for all the TRP Tx TEGs contained within one <i>NR-DL-PRS-TRP-TEG-InfoPerTRP</i> .

– NR-On-Demand-DL-PRS-Configurations

The IE *NR-On-Demand-DL-PRS-Configurations* provides a set of possible DL-PRS configurations which can be requested by the target device on-demand.

```
-- ASN1START
NR-On-Demand-DL-PRS-Configurations-r17 ::= SEQUENCE {
    on-demand-dl-prs-configuration-list-r17    SEQUENCE (SIZE (1..maxOD-DL-PRS-Configs-r17)) OF
                                                On-Demand-DL-PRS-Configuration-r17,
    ...
}
On-Demand-DL-PRS-Configuration-r17 ::= SEQUENCE {
    dl-prs-configuration-id-r17                DL-PRS-Configuration-ID-r17,
    nr-DL-PRS-PositioningFrequencyLayer-r17   NR-DL-PRS-PositioningFrequencyLayer-r16,
    nr-DL-PRS-Info-r17                        NR-DL-PRS-Info-r16,
    ...
}
DL-PRS-Configuration-ID-r17 ::= SEQUENCE {
    nr-dl-prs-configuration-id-r17            INTEGER (1..maxOD-DL-PRS-Configs-r17),
    ...
}
-- ASN1STOP
```

NR-On-Demand-DL-PRS-Configurations field descriptions	
dl-prs-configuration-id	This field provides an identity for the <i>On-Demand-DL-PRS-Configuration</i> .
nr-DL-PRS-PositioningFrequencyLayer	This field, together with <i>nr-DL-PRS-Info</i> , provides the On-demand DL-PRS Configuration information. Only the following fields in IE <i>NR-DL-PRS-PositioningFrequencyLayer</i> are applicable: <i>dl-PRS-ResourceBandwidth</i> , <i>dl-PRS-CombSizeN</i> . The target device shall ignore the remaining fields in IE <i>NR-DL-PRS-PositioningFrequencyLayer</i> .
nr-DL-PRS-Info	This field, together with <i>nr-DL-PRS-PositioningFrequencyLayer</i> , provides the On-demand DL-PRS Configuration information. Only the following fields in IE <i>NR-DL-PRS-Info</i> are applicable: DL-PRS periodicity in <i>dl-PRS-Periodicity-and-ResourceSetSlotOffset</i> , <i>dl-PRS-ResourceRepetitionFactor</i> , <i>dl-PRS-NumSymbols</i> , comb-size in <i>dl-PRS-CombSizeN-AndReOffset</i> , <i>dl-PRS-QCL-Info</i> . The target device shall ignore the remaining fields in IE <i>NR-DL-PRS-Info</i> .

NR-On-Demand-DL-PRS-Information

The IE *NR-On-Demand-DL-PRS-Information* defines the requested on-demand DL-PRS.

```

-- ASN1START
NR-On-Demand-DL-PRS-Information-r17 ::= SEQUENCE (SIZE (1..nrMaxFreqLayers-r16)) OF
    NR-On-Demand-DL-PRS-PerFreqLayer-r17
NR-On-Demand-DL-PRS-PerFreqLayer-r17 ::= SEQUENCE {
    dl-prs-FrequencyRangeReq-r17      ENUMERATED { fr1, fr2, ...},
    dl-prs-ResourceSetPeriodicityReq-r17  ENUMERATED { p4, p5, p8, p10, p16, p20, p32, p40,
        p64, p80, p160, p320, p640, p1280, p2560,
        p5120, p10240, p20480, p40960, p81920, ...,
        p128-v1760, p256-v1760, p512-v1760}
        OPTIONAL,
    dl-prs-ResourceBandwidthReq-r17      INTEGER (1..63)
        OPTIONAL,
    dl-prs-ResourceRepetitionFactorReq-r17  ENUMERATED {n2, n4, n6, n8, n16, n32, ...}
        OPTIONAL,
    dl-prs-NumSymbolsReq-r17             ENUMERATED {n2, n4, n6, n12, ...}
        OPTIONAL,
    dl-prs-CombSizeN-Req-r17            ENUMERATED {n2, n4, n6, n12, ...}
        OPTIONAL,
    dl-prs-QCL-InformationReqTRPlist-r17  DL-PRS-QCL-InformationReqTRPlist-r17
        OPTIONAL,
    ...
}
DL-PRS-QCL-InformationReqTRPlist-r17 ::= SEQUENCE (SIZE (1..nrMaxTRPsPerFreq-r16)) OF
    DL-PRS-QCL-InformationReqPerTRP-r17
DL-PRS-QCL-InformationReqPerTRP-r17 ::= SEQUENCE {
    dl-PRS-ID-r17                       INTEGER (0..255),
    nr-PhysCellID-r17                   NR-PhysCellID-r16
        OPTIONAL,
    nr-CellGlobalID-r17                 NCGI-r15
        OPTIONAL,
    nr-ARFCN-r17                        ARFCN-ValueNR-r15
        OPTIONAL,
    dl-prs-QCL-InformationReqSet-r17     SEQUENCE (SIZE (1..nrMaxSetsPerTrpPerFreqLayer-r16)) OF
        DL-PRS-QCL-InfoReq-r17,
    ...
}
DL-PRS-QCL-InfoReq-r17 ::= SEQUENCE {
    nr-DL-PRS-ResourceSetID-r17         NR-DL-PRS-ResourceSetID-r16,
    dl-prs-QCL-InformationReq-r17        CHOICE {
        dl-prs-QCL-InfoRecPerResourceSet-r17  DL-PRS-QCL-Info-r16,
        dl-prs-QCL-Info-requested-r17         NULL
    },
    ...,
    [[
    dl-prs-QCL-InfoRecPerResource-r17     SEQUENCE (SIZE (1..nrMaxResourcesPerSet-r16)) OF
        DL-PRS-QCL-Info-r16
        OPTIONAL
    ]]
}
-- ASN1STOP

```

NR-On-Demand-DL-PRS-Information field descriptions

dl-prs-FrequencyRangeReq

This field specifies the frequency range for which the on-demand DL-PRS is requested.

dl-prs-ResourceSetPeriodicityReq

This field specifies the requested periodicity of the DL-PRS Resource Set in slots. The periodicity depends on the subcarrier spacing (SCS) and takes values $2^\mu\{4, 5, 8, 10, 16, 20, 32, 40, 64, 80, 160, 320, 640, 1280, 2560, 5120, 10240\}$ slots, where $\mu = 0, 1, 2, 3$ for SCS of 15, 30, 60 and 120 kHz respectively. μ refers to the SCS of SSB of target device's current primary cell.

dl-prs-ResourceBandwidthReq

This field specifies the requested number of PRBs allocated for the DL-PRS Resource (allocated DL-PRS bandwidth) in multiples of 4 PRBs. Integer value 1 corresponds to 4 PRBs, value 2 corresponds to 8 PRBs, value 3 corresponds to 12 PRBs and so on.

dl-prs-ResourceRepetitionFactorReq

This field specifies the requested DL-PRS Resource repetition. Enumerated values *n2, n4, n6, n8, n16, n32* correspond to 2, 4, 6, 8, 16, 32 resource repetitions, respectively.

dl-prs-NumSymbolsReq

This field specifies the requested number of symbols per DL-PRS Resource within a slot.

dl-prs-CombSizeN-Req

This field specifies the requested Resource Element spacing in each symbol of the DL-PRS Resource.

dl-prs-QCL-InformationReqTRPList

This field specifies the recommended or requested QCL indication with other DL reference signals.

- ***dl-PRS-ID*** indicates the DL-PRS ID of the TRP for which the QCL information is recommended.
- ***nr-PhysCellID*** indicates the physical Cell-ID of the TRP for which the QCL information is recommended, as defined in TS 38.331 [35].
- ***nr-CellGlobalID*** indicates the NCGI, the globally unique identity of a cell in NR, of the TRP for which the QCL information is recommended, as defined in TS 38.331 [35].
- ***nr-ARFCN*** indicates the NR-ARFCN of the TRP's CD-SSB (as defined in TS 38.300 [47]) corresponding to nr-PhysCellID.
- ***dl-prs-QCL-InformationReqSet*** indicates the recommended QCL information per DL-PRS Resource Set.
 - ***nr-DL-PRS-ResourceSetID*** indicates the DL-PRS Resource Set ID for which the QCL information is recommended.
 - ***dl-prs-QCL-InformationReq***
 - ***dl-prs-QCL-InfoRecPerResourceSet*** indicates a single recommended QCL source for the DL-PRS Resource Set.
 - ***dl-prs-QCL-Info-requested*** indicates that the UE requests to provide the QCL information in the assistance data.
 - ***dl-prs-QCL-InfoRecPerResource*** indicates a list of recommended QCL sources for the DL-PRS Resource Set. If this field is present, the *dl-prs-QCL-InformationReq* shall be ignored by the receiver.

– *NR-On-Demand-DL-PRS-Request*

The IE *NR-On-Demand-DL-PRS-Request* is used by the target device to request on-demand DL-PRS from a location server.

```

-- ASN1START
NR-On-Demand-DL-PRS-Request-r17 ::= SEQUENCE {
    dl-prs-StartTime-and-Duration-r17          DL-PRS-StartTime-and-Duration-r17          OPTIONAL,
    nr-on-demand-DL-PRS-Information-r17       NR-On-Demand-DL-PRS-Information-r17        OPTIONAL,
    dl-prs-configuration-id-PrefList-r17      SEQUENCE (SIZE (1..maxOD-DL-PRS-Configs-r17)) OF
                                                DL-PRS-Configuration-ID-r17                OPTIONAL,
    ...
}

DL-PRS-StartTime-and-Duration-r17 ::= SEQUENCE {
    dl-prs-start-time-r17                     INTEGER (1..1024)                            OPTIONAL,
    dl-prs-duration-r17                       SEQUENCE {
        seconds-r17                           INTEGER (0..59)                             OPTIONAL,
        minutes-r17                           INTEGER (0..59)                             OPTIONAL,
        hours-r17                              INTEGER (0..23)                             OPTIONAL,
        ...
    }
    ...
}
-- ASN1STOP

```

***NR-On-Demand-DL-PRS-Request* field descriptions**

dl-prs-StartTime-and-Duration

This field specifies the requested start time and duration for the on-demand DL-PRS and comprises the following subfields:

- **dl-prs-start-time** specifies the desired start time for the requested DL-PRS. It indicates the time in seconds from the time the IE *NR-On-Demand-DL-PRS-Request* was received.
- **dl-prs-duration** specifies the desired duration of the requested DL-PRS. The desired duration is the sum of the *seconds*, *minutes*, *hours* fields. If this field is included, at least one of the *seconds*, *minutes*, *hours* fields shall be present.

nr-on-demand-DL-PRS-Information

This field specifies the on-demand DL-PRS configuration information requested by the target device.

NOTE: If the network provided predefined on-demand DL-PRS configurations (*NR-On-Demand-DL-PRS-Configurations*), the target device can only request explicit parameters (*nr-on-demand-DL-PRS-Information*) within the scope of those configurations.

dl-prs-configuration-id-PrefList

This field specifies the on-demand DL-PRS configuration associated with *DL-PRS-Configuration-ID* in IE *NR-On-Demand-DL-PRS-Configurations* the target device wishes to obtain in the order of preference. The first *DL-PRS-Configuration-ID* in the list is the most preferred configuration, the second *DL-PRS-Configuration-ID* the second most preferred, etc.

– *NR-On-Demand-DL-PRS-Configurations-Selected-IndexList*

The IE *NR-On-Demand-DL-PRS-Configurations-Selected-IndexList* is used by the location server to provide the selected available on-demand DL-PRS configurations to the target device.

In the case of available on-demand DL-PRS configurations for multiple NR positioning methods are provided, the *NR-On-Demand-DL-PRS-Configurations* shall be present in only one of *NR-Multi-RTT-ProvideAssistanceData*, *NR-DL-AoD-ProvideAssistanceData*, or *NR-DL-TDOA-ProvideAssistanceData*.

```
-- ASN1START
NR-On-Demand-DL-PRS-Configurations-Selected-IndexList-r17 ::=
    SEQUENCE (SIZE (1..maxOD-DL-PRS-Configs-r17)) OF
        DL-PRS-Configuration-ID-r17
-- ASN1STOP
```

– *NR-On-Demand-DL-PRS-Support*

The IE *NR-On-Demand-DL-PRS-Support* defines the target device's on-demand DL-PRS capabilities.

```
-- ASN1START
NR-On-Demand-DL-PRS-Support-r17 ::= SEQUENCE {
    nr-on-demand-DL-PRS-InformationSup-r17      ENUMERATED { supported }      OPTIONAL,
    nr-on-demand-DL-PRS-ConfigurationsSup-r17  ENUMERATED { supported }      OPTIONAL,
    ...
}
-- ASN1STOP
```

***NR-On-Demand-DL-PRS-Support* field descriptions**

nr-on-demand-DL-PRS-InformationSup

This field, if present, indicates that the target device supports the IE *NR-On-Demand-DL-PRS-Information* in IE *NR-On-Demand-DL-PRS-Request*.

nr-on-demand-DL-PRS-ConfigurationsSup

This field, if present, specifies that the target device supports the *dl-prs-configuration-id-PrefList* in IE *NR-On-Demand-DL-PRS-Request*.

– *NR-PositionCalculationAssistance*

The IE *NR-PositionCalculationAssistance* is used by the location server to provide assistance data to enable UE-based downlink positioning.

```

-- ASN1START
NR-PositionCalculationAssistance-r16 ::= SEQUENCE {
  nr-TRP-LocationInfo-r16      NR-TRP-LocationInfo-r16      OPTIONAL,  -- Need ON
  nr-DL-PRS-BeamInfo-r16      NR-DL-PRS-BeamInfo-r16      OPTIONAL,  -- Need ON
  nr-RTD-Info-r16             NR-RTD-Info-r16             OPTIONAL,  -- Need ON
  ...
  [
    nr-TRP-BeamAntennaInfo-r17 NR-TRP-BeamAntennaInfo-r17  OPTIONAL,  -- Need ON
    nr-DL-PRS-Expected-LOS-NLOS-Assistance-r17
                                     NR-DL-PRS-ExpectedLOS-NLOS-Assistance-r17
                                     OPTIONAL,  -- Need ON
    nr-DL-PRS-TRP-TEG-Info-r17   NR-DL-PRS-TRP-TEG-Info-r17   OPTIONAL,  -- Need ON
  ]
}
-- ASN1STOP

```

NR-PositionCalculationAssistance field descriptions

nr-TRP-LocationInfo

This field provides the location coordinates of the TRPs and location coordinates of antenna reference points for DL-PRS Resource Set(s) and DL-PRS Resources of the TRPs.

nr-DL-PRS-BeamInfo

This field provides the spatial directions of DL-PRS Resources for TRPs.

nr-RTD-Info

This field provides the time synchronization information between the reference TRP and neighbour TRPs.

nr-TRP-BeamAntennaInfo

This field provides the relative DL-PRS Resource power between PRS resources per angle per TRP.

nr-DL-PRS-ExpectedLOS-NLOS-Assistance

This field provides the expected likelihood of a LOS propagation path from a TRP to the target device. The information is provided per TRP or per DL-PRS Resource.

nr-DL-PRS-TRP-TEG-Info

This field provides the TRP Tx TEG ID associated with the transmission of each DL-PRS Resource of the TRP.

– NR-RTD-Info

The IE *NR-RTD-Info* is used by the location server to provide time synchronization information between a reference TRP and a list of neighbour TRPs.

```

-- ASN1START
NR-RTD-Info-r16 ::= SEQUENCE {
  referenceTRP-RTD-Info-r16      ReferenceTRP-RTD-Info-r16,
  rtd-InfoList-r16              RTD-InfoList-r16,
  ...
}

ReferenceTRP-RTD-Info-r16 ::= SEQUENCE {
  dl-PRS-ID-Ref-r16              INTEGER (0..255),
  nr-PhysCellID-Ref-r16          NR-PhysCellID-r16      OPTIONAL,  -- Need ON
  nr-CellGlobalID-Ref-r16        NCGI-r15              OPTIONAL,  -- Need ON
  nr-ARFCN-Ref-r16              ARFCN-ValueNR-r15          OPTIONAL,  -- Need ON
  refTime-r16                   CHOICE {
    systemFrameNumber-r16        BIT STRING (SIZE (10)),
    utc-r16                       UTCTime,
    ...
  },
  rtd-RefQuality-r16            NR-TimingQuality-r16      OPTIONAL,  -- Need ON
  ...
}

RTD-InfoList-r16 ::= SEQUENCE (SIZE (1..nrMaxFreqLayers-r16)) OF RTD-InfoListPerFreqLayer-r16

RTD-InfoListPerFreqLayer-r16 ::= SEQUENCE (SIZE(1..nrMaxTRPsPerFreq-r16)) OF RTD-InfoElement-r16

RTD-InfoElement-r16 ::= SEQUENCE {
  dl-PRS-ID-r16                  INTEGER (0..255),
  nr-PhysCellID-r16              NR-PhysCellID-r16      OPTIONAL,  -- Need ON
  nr-CellGlobalID-r16            NCGI-r15              OPTIONAL,  -- Need ON
  nr-ARFCN-r16                  ARFCN-ValueNR-r15          OPTIONAL,  -- Need ON
  subframeOffset-r16            INTEGER (0..1966079),
  rtd-Quality-r16               NR-TimingQuality-r16,
  ...
}

```



```
}
-- ASN1STOP
```

NR-RTD-Info field descriptions
<p>referenceTRP-RTD-Info This field defines the reference TRP for the RTD and comprises the following sub-fields:</p> <ul style="list-style-type: none"> - dl-PRS-ID-Ref: This field is used along with a DL-PRS Resource Set ID and a DL-PRS Resources ID to uniquely identify a DL-PRS Resource, and is associated to the reference TRP. - nr-PhysCellId-Ref: This field specifies the physical cell identity of the reference TRP. - nr-CellGlobalId-Ref: This field specifies the NCGI, the globally unique identity of a cell in NR, of the reference TRP. - nr-ARFCN-Ref: This field specifies the NR-ARFCN of the TRP's CD-SSB (as defined in TS 38.300 [47]) corresponding to <i>nr-PhysCellID</i>. - refTime: This field specifies the reference time at which the <i>rtd-InfoList</i> is valid. The <i>systemFrameNumber</i> choice refers to the SFN of the reference TRP. - rtd-RefQuality: This field specifies the quality of the timing of reference TRP, used to determine the RTD values provided in <i>rtd-InfoList</i>.
<p>dl-PRS-ID This field is used along with a DL-PRS Resource Set ID and a DL-PRS Resources ID to uniquely identify a DL-PRS Resource. This ID can be associated with multiple DL-PRS Resource Sets associated with a single TRP for which the <i>RTD-InfoElement</i> is applicable.</p>
<p>nr-PhysCellID This field specifies the physical cell identity of the associated TRP for which the <i>RTD-InfoElement</i> is applicable, as defined in TS 38.331 [35].</p>
<p>nr-CellGlobalID This field specifies the NCGI, the globally unique identity of a cell in NR, of the associated TRP for which the <i>RTD-InfoElement</i> is applicable, as defined in TS 38.331 [35]. The server should include this field if it considers that it is needed to resolve ambiguity in the TRP indicated by <i>nr-PhysCellID</i>.</p>
<p>nr-ARFCN This field specifies the NR-ARFCN of the TRP's CD-SSB (as defined in TS 38.300 [47]) corresponding to <i>nr-PhysCellID</i> for which the <i>RTD-InfoElement</i> is applicable.</p>
<p>subframeOffset This field specifies the subframe boundary offset at the TRP antenna location between the reference TRP and this neighbour TRP in time units $T_c = 1/(\Delta f_{\max} \cdot N_f)$ where $\Delta f_{\max} = 480 \cdot 10^3$ Hz and $N_f = 4096$ (TS 38.211 [41]). The offset is counted from the beginning of a subframe #0 of the reference TRP to the beginning of the closest subsequent subframe of this neighbour TRP. Scale factor 1 T_c.</p>
<p>rtd-Quality This field specifies the quality of the RTD.</p>

– NR-SelectedDL-PRS-IndexList

The IE *NR-SelectedDL-PRS-IndexList* is used by the location server to provide the selected DL-PRS Resource of *nr-DL-PRS-AssistanceDataList* to the target device.

In the case of assistance data for multiple NR positioning methods are provided, the IE *NR-DL-PRS-AssistanceData* shall be present in only one of *NR-Multi-RTT-ProvideAssistanceData*, *NR-DL-AoD-ProvideAssistanceData*, or *NR-DL-TDOA-ProvideAssistanceData*.

```
-- ASN1START
NR-SelectedDL-PRS-IndexList-r16 ::= SEQUENCE (SIZE (1..nrMaxFreqLayers-r16)) OF
    NR-SelectedDL-PRS-PerFreq-r16

NR-SelectedDL-PRS-PerFreq-r16 ::= SEQUENCE {
    nr-SelectedDL-PRS-FrequencyLayerIndex-r16    INTEGER (0..nrMaxFreqLayers-1-r16),
    nr-SelectedDL-PRS-IndexListPerFreq-r16      SEQUENCE (SIZE (1..nrMaxTRPsPerFreq-r16)) OF
                                                NR-SelectedDL-PRS-IndexPerTRP-r16
                                                OPTIONAL,    --Need OP
}

NR-SelectedDL-PRS-IndexPerTRP-r16 ::= SEQUENCE {
    nr-SelectedTRP-Index-r16                    INTEGER (0..nrMaxTRPsPerFreq-1-r16),
    dl-SelectedPRS-ResourceSetIndexList-r16     SEQUENCE (SIZE (1..nrMaxSetsPerTrpPerFreqLayer-r16))
                                                OF DL-SelectedPRS-ResourceSetIndex-r16
}
```

```

...
}
DL-SelectedPRS-ResourceSetIndex-r16 ::= SEQUENCE {
  nr-DL-SelectedPRS-ResourceSetIndex-r16  INTEGER (0..nrMaxSetsPerTrpPerFreqLayer-1-r16),
  dl-SelectedPRS-ResourceIndexList-r16     SEQUENCE (SIZE (1..nrMaxResourcesPerSet-r16)) OF
                                           DL-SelectedPRS-ResourceIndex-r16
}
DL-SelectedPRS-ResourceIndex-r16 ::= SEQUENCE {
  nr-DL-SelectedPRS-ResourceIdIndex-r16   INTEGER (0..nrMaxNumDL-PRS-ResourcesPerSet-1-r16),
  ...
}
-- ASN1STOP

```

NR-SelectedDL-PRS-IndexList field descriptions

nr-SelectedDL-PRS-FrequencyLayerIndex

This field indicates the frequency layer provided in IE *NR-DL-PRS-AssistanceData*. Value 0 corresponds to the first frequency layer provided in *nr-DL-PRS-AssistanceDataList* in IE *NR-DL-PRS-AssistanceData*, value 1 to the second frequency layer in *nr-DL-PRS-AssistanceDataList*, and so on.

nr-SelectedDL-PRS-IndexListPerFreq

This field provides the list of addressed TRPs of the selected frequency layer. If this field is absent, all DL-PRS Resources of all TRPs of the indicated frequency layer are addressed.

nr-SelectedTRP-Index

This field indicates the addressed TRP of the selected frequency layer. Value 0 corresponds to the first entry in *nr-DL-PRS-AssistanceDataPerFreq* provided in IE *NR-DL-PRS-AssistanceData*, value 1 corresponds to the second entry in *nr-DL-PRS-AssistanceDataPerFreq*, and so on.

dl-SelectedPRS-ResourceSetIndexList

This field provides the list of addressed DL-PRS Resource Sets of the selected TRPs of the selected frequency layer. If this field is absent, all DL-PRS Resource Sets and Resources of the indicated TRP are addressed.

nr-DL-SelectedPRS-ResourceSetIndex

This field indicates the addressed DL-PRS Resource Set of the selected TRP of the selected frequency layer. Value 0 corresponds to the first entry in *nr-DL-PRS-ResourceSetList* in IE *NR-DL-PRS-Info* provided in IE *NR-DL-PRS-AssistanceData*. Value 1 corresponds to the second entry in the *nr-DL-PRS-ResourceSetList* in IE *NR-DL-PRS-Info*.

dl-SelectedPRS-ResourceIndexList

This field provides the list of addressed DL-PRS Resources of the selected DL-PRS Resource Set of the selected TRP of the selected frequency layer. If this field is absent, all DL-PRS Resources of the indicated DL-PRS Resource Set are addressed.

nr-dl-SelectedPRS-ResourceIdIndex

This field indicates the addressed DL-PRS Resource of the selected DL-PRS Resource Set of the TRP of the selected frequency layer. Value 0 corresponds to the first entry in *dl-PRS-ResourceList* in IE *NR-DL-PRS-Info* provided in IE *NR-DL-PRS-AssistanceData*. Value 1 corresponds to the second entry in the *dl-PRS-ResourceList* in IE *NR-DL-PRS-Info*, and so on.

– NR-SSB-Config

The IE *NR-SSB-Config* defines SSB configuration.

```

-- ASN1START
NR-SSB-Config-r16 ::= SEQUENCE {
  nr-PhysCellID-r16          NR-PhysCellID-r16,
  nr-ARFCN-r16              ARFCN-ValueNR-r15,
  ss-PECH-BlockPower-r16   INTEGER (-60..50),
  halfFrameIndex-r16       INTEGER (0..1),
  ssb-periodicity-r16      ENUMERATED { ms5, ms10, ms20, ms40, ms80, ms160, ... },
  ssb-PositionsInBurst-r16 CHOICE {
    shortBitmap-r16        BIT STRING (SIZE (4)),
    mediumBitmap-r16      BIT STRING (SIZE (8)),
    longBitmap-r16        BIT STRING (SIZE (64))
  }
  ssb-SubcarrierSpacing-r16 ENUMERATED { kHz15, kHz30, kHz60, kHz120, kHz240, ... },
  sfn-SSB-Offset-r16       INTEGER (0..15),
  ...
}
-- ASN1STOP

```

NR-SSB-Config field descriptions
<p>nr-ARFCN This field specifies the ARFCN of the first RE of SSB's RB#10.</p>
<p>ss-PBCH-BlockPower Average EPRE of the resources elements that carry secondary synchronization signals in dBm that the NW used for SSB transmission, see TS 38.213 [48], clause 7.</p>
<p>halfFrameIndex Indicates the 5 msec offset of the SSB within a 10 msec system frame.</p>
<p>ssb-periodicity The SSB periodicity in ms for the rate matching purpose.</p>
<p>ssb-PositionsInBurst Indicates the time domain positions of the transmitted SS-blocks in a half frame with SS/PBCH blocks as defined in TS 38.213 [48], clause 4.1. The first/leftmost bit corresponds to SS/PBCH block index 0, the second bit corresponds to SS/PBCH block index 1, and so on. Value 0 in the bitmap indicates that the corresponding SS/PBCH block is not transmitted while value 1 indicates that the corresponding SS/PBCH block is transmitted.</p>
<p>ssb-SubcarrierSpacing Subcarrier spacing of SSB. Only the values 15 kHz or 30 kHz (FR1), and 120 kHz or 240 kHz (FR2) are applicable.</p>
<p>sfn-SSB-Offset Indicates the 10 msec system frame offset of the SSB within the SSB periodicity. Value 0 indicates that the SSB is transmitted in the first system frame; 1 indicates that the SSB is transmitted in the second system frame and so on. This field shall be configured according to the field <i>ssb-Periodicity</i> and the indicated system frame shall not exceed the configured SSB periodicity.</p>

– NR-TimeStamp

The IE *NR-TimeStamp* defines the UE measurement associated time stamp.

```

-- ASN1START
NR-TimeStamp-r16 ::= SEQUENCE {
    dl-PRS-ID-r16          INTEGER (0..255),
    nr-PhysCellID-r16     NR-PhysCellID-r16      OPTIONAL, -- Need ON
    nr-CellGlobalID-r16   NCGI-r15              OPTIONAL, -- Need ON
    nr-ARFCN-r16          ARFCN-ValueNR-r15     OPTIONAL, -- Need ON
    nr-SFN-r16            INTEGER (0..1023),
    nr-Slot-r16           CHOICE {
        scs15-r16        INTEGER (0..9),
        scs30-r16        INTEGER (0..19),
        scs60-r16        INTEGER (0..39),
        scs120-r16       INTEGER (0..79)
    },
    ...
}
-- ASN1STOP

```

NR-TimeStamp field descriptions
<p>dl-PRS-ID This field specifies the DL-PRS ID of the TRP for which the <i>nr-SFN</i> is applicable.</p>
<p>nr-PhysCellID This field specifies the physical cell identity of the associated TRP, as defined in TS 38.331 [35].</p>
<p>nr-CellGlobalID This field specifies the NCGI, the globally unique identity of a cell in NR, of the associated TRP, as defined in TS 38.331 [35].</p>
<p>nr-ARFCN This field specifies the ARFCN of the TRP's CD-SSB (as defined in TS 38.300 [47]) corresponding to <i>nr-PhysCellID</i> associated with the <i>dl-PRS-ID</i>.</p>
<p>nr-SFN This field specifies the NR system frame number for the time stamp.</p>
<p>nr-Slot This field specifies the NR slot number within the NR system frame number indicated by <i>nr-SFN</i> for the time stamp.</p>

– NR-TimingQuality

The IE *NR-TimingQuality* defines the quality of a timing value (e.g., of a TOA measurement).

```
-- ASN1START
NR-TimingQuality-r16 ::= SEQUENCE {
    timingQualityValue-r16      INTEGER (0..31),
    timingQualityResolution-r16 ENUMERATED {mdot1, m1, m10, m30, ...},
    ...
}
-- ASN1STOP
```

NR-TimingQuality field descriptions

timingQualityValue

This field provides an estimate of uncertainty of the timing value for which the IE *NR-TimingQuality* is provided in units of metres.

timingQualityResolution

This field provides the resolution used in the *timingQualityValue* field. Enumerated values *mdot1*, *m1*, *m10*, *m30* correspond to 0.1, 1, 10, 30 metres, respectively.

– NR-TRP-BeamAntennaInfo

The IE *NR-TRP-BeamAntennaInfo* is used by the location server to provide beam antenna information of the TRP.

```
-- ASN1START
NR-TRP-BeamAntennaInfo-r17 ::= SEQUENCE (SIZE (1..nrMaxFreqLayers-r16)) OF
    NR-TRP-BeamAntennaInfoPerFreqLayer-r17
NR-TRP-BeamAntennaInfoPerFreqLayer-r17 ::= SEQUENCE (SIZE (1..nrMaxTRPsPerFreq-r16)) OF
    NR-TRP-BeamAntennaInfoPerTRP-r17
NR-TRP-BeamAntennaInfoPerTRP-r17 ::= SEQUENCE {
    dl-PRS-ID-r17                INTEGER (0..255),
    nr-PhysCellID-r17            NR-PhysCellID-r16                OPTIONAL,    -- Need ON
    nr-CellGlobalID-r17         NCGI-r15                        OPTIONAL,    -- Need ON
    nr-ARFCN-r17                ARFCN-ValueNR-r15                OPTIONAL,    -- Need ON
    associated-DL-PRS-ID-r17    INTEGER (0..255)                OPTIONAL,    -- Need OP
    lcs-GCS-TranslationParameter-r17 LCS-GCS-TranslationParameter-r16 OPTIONAL,    -- Need OP
    nr-TRP-BeamAntennaAngles-r17 NR-TRP-BeamAntennaAngles-r17 OPTIONAL,    -- Need OP
    ...
}
NR-TRP-BeamAntennaAngles-r17 ::= SEQUENCE (SIZE(1..3600)) OF
    NR-TRP-BeamAntennaInfoAzimuthElevation-r17
NR-TRP-BeamAntennaInfoAzimuthElevation-r17 ::= SEQUENCE {
    azimuth-r17                INTEGER (0..359)                OPTIONAL,    -- Cond Az
    azimuth-fine-r17           INTEGER (0..9)                OPTIONAL,    -- Cond AzOpt
    elevationList-r17          SEQUENCE (SIZE(1..1801)) OF ElevationElement-R17,
    ...
}
ElevationElement-R17 ::= SEQUENCE {
    elevation-r17              INTEGER (0..180)                OPTIONAL,    -- Cond E1
    elevation-fine-r17         INTEGER (0..9)                OPTIONAL,    -- Cond E1Opt
    beamPowerList-r17          SEQUENCE (SIZE (2..maxNumResourcesPerAngle-r17)) OF
        BeamPowerElement-r17,
    ...
}
BeamPowerElement-r17 ::= SEQUENCE {
    nr-dl-prs-ResourceSetID-r17 NR-DL-PRS-ResourceSetID-r16    OPTIONAL,    -- Need OP
    nr-dl-prs-ResourceID-r17    NR-DL-PRS-ResourceID-r16,
    nr-dl-prs-RelativePower-r17 INTEGER (0..30),
    nr-dl-prs-RelativePowerFine-r17 INTEGER (0..9)                OPTIONAL,    -- Need ON
    ...
}
-- ASN1STOP
```

Conditional presence	Explanation
<i>Az</i>	The field is mandatory present if the field <i>elevation</i> is absent; otherwise it is optionally present, need ON.
<i>AzOpt</i>	The field is optionally present, need ON, when <i>azimuth</i> is present; otherwise it is not present.
<i>EI</i>	The field is mandatory present if the field <i>azimuth</i> is absent; otherwise it is optionally present, need ON.
<i>EIOpt</i>	The field is optionally present, need ON, when <i>elevation</i> is present; otherwise it is not present.

NR-TRP-BeamAntennaInfo field descriptions
<p>dl-PRS-ID This field specifies the DL-PRS ID of the TRP for which the Beam Antenna Information is provided.</p>
<p>nr-PhysCellID This field specifies the physical Cell-ID of the TRP for which the Beam Antenna Information is provided, as defined in TS 38.331 [35].</p>
<p>nr-CellGlobalID This field specifies the NCGI, the globally unique identity of a cell in NR, of the TRP for which the Beam Antenna Information is provided, as defined in TS 38.331 [35].</p>
<p>nr-ARFCN This field specifies the NR-ARFCN of the TRP's CD-SSB (as defined in TS 38.300 [47]) corresponding to <i>nr-PhysCellID</i>.</p>
<p>associated-DL-PRS-ID This field specifies the <i>dl-PRS-ID</i> of the associated TRP from which the beam antenna information is obtained. See the field descriptions for <i>nr-TRP-BeamAntennaAngles</i> and <i>lcs-GCS-TranslationParameter</i>.</p>
<p>lcs-GCS-TranslationParameter This field provides the angles α (bearing angle), β (downtilt angle) and γ (slant angle) for the translation of a Local Coordinate System (LCS) to a Global Coordinate System (GCS) as defined in TR 38.901 [44]. If this field and the <i>associated-DL-PRS-ID</i> field are both absent, the <i>azimuth</i> and <i>elevation</i> are provided in a GCS. If this field is absent and the <i>associated-DL-PRS-ID</i> field is present, then the <i>lcs-GCS-TranslationParameter</i> for this TRP is obtained from the <i>lcs-GCS-TranslationParameter</i> of the associated TRP.</p>
<p>nr-TRP-BeamAntennaAngles This field provides the relative power between DL-PRS Resources per angle per TRP. If this field is absent and the field <i>associated-DL-PRS-ID</i> is present, the <i>nr-TRP-BeamAntennaAngles</i> for this TRP are obtained from the <i>nr-TRP-BeamAntennaAngles</i> of the associated TRP.</p>
<p>azimuth This field specifies the azimuth angle for which the relative power between DL-PRS Resources is provided. For a Global Coordinate System (GCS), the azimuth angle is measured counter-clockwise from geographical North. For a Local Coordinate System (LCS), the azimuth angle is measured counter-clockwise from the x-axis of the LCS. Scale factor 1 degree; range 0 to 359 degrees.</p>
<p>azimuth-fine This field provides finer granularity for the <i>azimuth</i>. The total azimuth angle is given by <i>azimuth</i> + <i>azimuth-fine</i>. Scale factor 0.1 degrees; range 0 to 0.9 degrees.</p>
<p>elevation This field specifies the elevation angle for which the relative power between DL-PRS Resources is provided for the given <i>azimuth</i>. For a Global Coordinate System (GCS), the elevation angle is measured relative to zenith and positive to the horizontal direction (elevation 0 deg. points to zenith, 90 deg to the horizon). For a Local Coordinate System (LCS), the elevation angle is measured relative to the z-axis of the LCS (elevation 0 deg. points to the z-axis, 90 deg to the x-y plane). Scale factor 1 degree; range 0 to 180 degrees.</p>
<p>elevation-fine This field provides finer granularity for the <i>elevation</i>. The total elevation angle is given by <i>elevation</i> + <i>elevation-fine</i>. Scale factor 0.1 degrees; range 0 to 0.9 degrees.</p>
<p>beamPowerList This field provides the relative power between DL-PRS Resources for the angle given by <i>azimuth</i> and <i>elevation</i>. The first <i>BeamPowerElement</i> in this list provides the peak power for this angle and is defined as 0dB power; i.e., the first value is set to '0' by the location server. All the remaining <i>BeamPowerElement</i>'s in this list provide the relative DL-PRS Resource power relative to this first element in the list.</p>
<p>nr-dl-prs-ResourceSetID This field specifies the DL-PRS Resource Set ID of the DL-PRS Resource for which the <i>nr-dl-prs-RelativePower</i> is provided. If this field is absent, the DL-PRS Resource Set ID for this instance of the <i>beamPowerList</i> is the same as the DL-PRS Resource Set ID of the previous instance in the <i>beamPowerList</i>. This field shall be included at least in the first instance of the <i>beamPowerList</i>.</p>
<p>nr-dl-prs-ResourceID This field specifies the DL-PRS Resource for which the <i>nr-dl-prs-RelativePower</i> is provided.</p>
<p>nr-dl-prs-RelativePower Except for the first element in <i>beamPowerList</i>, this field provides the relative power of the DL-PRS Resource, relative to the first element in the <i>beamPowerList</i>. For the first element in <i>beamPowerList</i>, this field provides the peak power for this angle normalised to 0 dB. Scale factor 1 dB; range 0..-30 dB.</p>
<p>nr-dl-prs-RelativePowerFine This field provides finer granularity for the <i>nr-dl-prs-RelativePower</i>. The total relative power of the DL-PRS Resource is given by <i>nr-dl-prs-RelativePower</i> + <i>nr-dl-prs-RelativePowerFine</i>. Scale factor -0.1 dB; range 0 to -0.9 dB. NOTE: For the first element in <i>beamPowerList</i>, this field is not needed.</p>

– NR-TRP-LocationInfo

The IE *NR-TRP-LocationInfo* is used by the location server to provide the coordinates of TRPs and coordinates of the antenna reference points for a set of TRPs. For each TRP, the ARP location can be provided for each associated PRS Resource ID per PRS Resource Set.

```

-- ASN1START
NR-TRP-LocationInfo-r16 ::= SEQUENCE (SIZE (1..nrMaxFreqLayers-r16)) OF
    NR-TRP-LocationInfoPerFreqLayer-r16
NR-TRP-LocationInfoPerFreqLayer-r16 ::= SEQUENCE {
    referencePoint-r16          ReferencePoint-r16          OPTIONAL,    -- Cond NotSameAsPrev
    trp-LocationInfoList-r16   SEQUENCE (SIZE (1..nrMaxTRPsPerFreq-r16)) OF
        TRP-LocationInfoElement-r16,
    ...
}
TRP-LocationInfoElement-r16 ::= SEQUENCE {
    dl-PRS-ID-r16              INTEGER (0..255),
    nr-PhysCellID-r16         NR-PhysCellID-r16           OPTIONAL,    -- Need ON
    nr-CellGlobalID-r16       NCGI-r15                    OPTIONAL,    -- Need ON
    nr-ARFCN-r16              ARFCN-ValueNR-r15           OPTIONAL,    -- Need ON
    associated-DL-PRS-ID-r16   INTEGER (0..255)            OPTIONAL,    -- Need OP
    trp-Location-r16          RelativeLocation-r16        OPTIONAL,    -- Need OP
    trp-DL-PRS-ResourceSets-r16 SEQUENCE (SIZE(1..nrMaxSetsPerTrpPerFreqLayer-r16)) OF
        DL-PRS-ResourceSets-TRP-Element-r16 OPTIONAL,    -- Need OP
    ...
}
DL-PRS-ResourceSets-TRP-Element-r16 ::= SEQUENCE {
    dl-PRS-ResourceSetARP-r16 RelativeLocation-r16        OPTIONAL,    -- Need OP
    dl-PRS-Resource-ARP-List-r16 SEQUENCE (SIZE(1..nrMaxResourcesPerSet-r16)) OF
        DL-PRS-Resource-ARP-Element-r16 OPTIONAL,    -- Need OP
    ...
}
DL-PRS-Resource-ARP-Element-r16 ::= SEQUENCE {
    dl-PRS-Resource-ARP-location-r16 RelativeLocation-r16        OPTIONAL,    -- Need OP
    ...
}
-- ASN1STOP

```

Conditional presence	Explanation
<i>NotSameAsPrev</i>	The field is mandatory present in the first entry of the <i>NR-TRP-LocationInfoPerFreqLayer</i> in the <i>NR-TRP-LocationInfo</i> list; otherwise it is optionally present, need OP.

NR-TRP-LocationInfo field descriptions
<p>referencePoint This field specifies the reference point used to define the location of TRPs provided in the <i>trp-LocationInfoList</i>. If this field is absent, the reference point is the same as in the previous entry of the <i>NR-TRP-LocationInfoPerFreqLayer</i> in the <i>NR-TRP-LocationInfo</i> list.</p>
<p>trp-LocationInfoList This field provides the antenna reference point locations of the DL-PRS Resources for the TRPs and comprises the following sub-fields:</p> <ul style="list-style-type: none"> - dl-PRS-ID: This field is used along with a DL-PRS Resource Set ID and a DL-PRS Resource ID to uniquely identify a DL-PRS Resource, and is associated to a single TRP. - nr-PhysCellID: This field specifies the physical cell identity of the associated TRP. - nr-CellGlobalID: This field specifies the NCGI, the globally unique identity of a cell in NR, of the associated TRP. - nr-ARFCN: This field specifies the NR-ARFCN of the TRP's CD-SSB (as defined in TS 38.300 [47]) corresponding to <i>nr-PhysCellID</i>. - associated-DL-PRS-ID: This field, if present, specifies the <i>dl-PRS-ID</i> of the associated TRP from which the <i>trp-location</i> information is adopted. If the field is present, the field <i>trp-Location</i> shall be absent. - trp-Location: This field provides the location of the TRP relative to the <i>referencePoint</i> location. If this field is absent the TRP location coincides with the <i>referencePoint</i> location, unless the field <i>associated-dl-PRS-ID</i> is present, in which case the <i>trp-Location</i> is adopted from the associated TRP indicated by <i>associated-dl-PRS-ID</i>. - trp-DL-PRS-ResourceSets: This field provides the antenna reference point location(s) of the DL-PRS Resource Set(s) associated with this TRP. If this field is absent, the antenna reference point location(s) of the DL-PRS Resource Set(s) coincides with the <i>trp-Location</i> location. This field comprises the following sub-fields: <ul style="list-style-type: none"> - dl-PRS-ResourceSetARP: This field provides the antenna reference point location of the DL-PRS Resource Set relative to the <i>trp-Location</i> location. If this field is absent, the antenna reference point location of this DL-PRS Resource Set coincides with the <i>trp-Location</i> location. - dl-PRS-Resource-ARP-List: This field provides the antenna reference point location(s) of the DL-PRS Resource(s) associated with this Resource Set of the TRP. If this field is absent, the antenna reference point location(s) of the DL-PRS Resources coincides with the <i>dl-PRS-ResourceSetARP</i> location. This field comprises the following sub-fields: <ul style="list-style-type: none"> - dl-PRS-Resource-ARP-location: This field provides the antenna reference point location of the DL-PRS Resource associated with the DL-PRS Resource Set of the TRP relative to the <i>dl-PRS-ResourceSetARP</i> location. If this field is absent, the antenna reference point location of this DL-PRS Resource coincides with the <i>dl-PRS-ResourceSetARP</i> location.

NR-UE-TEG-Capability

The IE *NR-UE-TEG-Capability* defines the TEG capability of the target device.

```

-- ASN1START
NR-UE-TEG-Capability-r17 ::= SEQUENCE {
    nr-UE-TEG-ID-CapabilityBandList-r17      SEQUENCE (SIZE (1..nrMaxBands-r16)) OF
                                             NR-UE-TEG-ID-CapabilityPerBand-r17  OPTIONAL,
    ...
}
NR-UE-TEG-ID-CapabilityPerBand-r17 ::= SEQUENCE {
    freqBandIndicatorNR-r17                 FreqBandIndicatorNR-r16,
    nr-UE-RxTEG-ID-MaxSupport-r17          ENUMERATED {n1, n2, n3, n4, n6, n8}          OPTIONAL,
    nr-UE-TxTEG-ID-MaxSupport-r17          ENUMERATED {n1, n2, n3, n4, n6, n8}          OPTIONAL,
    nr-UE-RxTxTEG-ID-MaxSupport-r17       ENUMERATED {n1, n2, n4, n6, n8, n12, n16,
                                             n24, n32, n36, n48, n64}          OPTIONAL,
    measureSameDL-PRS-ResourceWithDifferentRxTEGs-r17
                                             ENUMERATED {n2, n3, n4, n6, n8}          OPTIONAL,
    measureSameDL-PRS-ResourceWithDifferentRxTEGsSimul-r17
                                             ENUMERATED {n1, n2, n3, n4, n6, n8}          OPTIONAL,
    ...
}
-- ASN1STOP

```

NR-UE-TEG-Capability field descriptions
<p><i>nr-UE-RxTEG-ID-MaxSupport</i> Indicates the maximum number of UE-RxTEGs, which is supported and reported by the UE. This field is applicable for UE assisted DL-TDOA and Multi-RTT positioning. The UE can include this field only if the UE supports <i>prs-ProcessingCapabilityBandList</i> and any of <i>maxNrOfDL-PRS-ResourceSetPerTrpPerFrequencyLayer</i>, <i>maxNrOfTRP-AcrossFreqs</i>, <i>maxNrOfPosLayer</i>, <i>maxNrOfDL-PRS-ResourcesPerResourceSet</i> and <i>maxNrOfDL-PRS-ResourcesPerPositioningFrequencylayer</i>. Otherwise, the UE does not include this field. NOTE 1: A single value is reported when both Multi-RTT and DL-TDOA are supported.</p>
<p><i>nr-UE-TxTEG-ID-MaxSupport</i> Indicates the maximum number of UE-TxTEGs, which is supported and reported by the UE. This field is applicable for Multi-RTT and UL-TDOA positioning. For UL-TDOA, the UE can include this field only if the UE supports <i>supportedSRS-PosResources</i> defined in TS 38.331 [35]. For Multi-RTT, the UE can include this field only if the UE supports <i>maxNrOfDL-PRS-ResourcesPerResourceSet</i>, <i>maxNrOfDL-PRS-ResourcesPerPositioningFrequencylayer</i> and <i>supportedSRS-PosResources</i> defined in TS 38.331 [35]. Otherwise, the UE does not include this field.</p>
<p><i>nr-UE-RxTxTEG-ID-MaxSupport</i> Indicates the maximum number of UE-RxTxTEGs, which is supported and reported by the UE. This field is applicable for Multi-RTT positioning. The UE can include this field only if the UE supports <i>maxNrOfDL-PRS-ResourcesPerResourceSet</i>, <i>maxNrOfDL-PRS-ResourcesPerPositioningFrequencylayer</i> and <i>supportedSRS-PosResources</i> defined in TS 38.331 [35]. Otherwise, the UE does not include this field.</p>
<p><i>measureSameDL-PRS-ResourceWithDifferentRxTEGs</i> Indicates the maximum number of different UE-RxTEGs that a UE can support to measure the same DL-PRS Resource of a TRP. This field is applicable for UE assisted DL-TDOA and Multi-RTT positioning. The UE can include this field only if the UE supports <i>nr-UE-RxTEG-ID-MaxSupport</i>. Otherwise, the UE does not include this field. NOTE 2: If the UE supports <i>nr-UE-RxTxTEG-ID-MaxSupport</i> and <i>measureSameDL-PRS-ResourceWithDifferentRxTEGs</i>, the enumerated value of this field also corresponds to the maximum number of different UE-RxTx TEGs for measuring the same DL PRS Resource of a TRP with the same UE Tx TEG.</p>
<p><i>measureSameDL-PRS-ResourceWithDifferentRxTEGsSimul</i> Indicates the maximum number of UE Rx TEGs for measuring the same DL-PRS Resource simultaneously. This field is applicable for UE assisted DL-TDOA and Multi-RTT positioning. The UE can include this field only if the UE supports <i>measureSameDL-PRS-ResourceWithDifferentRxTEGs</i>. Otherwise, the UE does not include this field. NOTE 3: If the UE supports <i>nr-UE-RxTxTEG-ID-MaxSupport</i> and <i>measureSameDL-PRS-ResourceWithDifferentRxTEGs</i> and <i>measureSameDL-PRS-ResourceWithDifferentRxTEGsSimul</i>, the enumerated value of this field also corresponds to the maximum number of different UE-RxTx TEGs for measuring the same DL PRS Resource simultaneously with the same UE Tx TEG.</p>

– NR-UL-SRS-Capability

The IE *NR-UL-SRS-Capability* defines the UE uplink SRS capability.

```

-- ASN1START
NR-UL-SRS-Capability-r16 ::= SEQUENCE {
    srs-CapabilityBandList-r16          SEQUENCE (SIZE (1..nrMaxBands-r16)) OF
                                        SRS-CapabilityPerBand-r16,
    srs-PosResourceConfigCA-BandList-r16 SEQUENCE (SIZE (1..nrMaxConfiguredBands-r16)) OF
                                        SRS-PosResourcesPerBand-r16          OPTIONAL,
    maxNumberSRS-PosPathLossEstimateAllServingCells-r16
                                        ENUMERATED {n1, n4, n8, n16}          OPTIONAL,
    maxNumberSRS-PosSpatialRelationsAllServingCells-r16
                                        ENUMERATED {n0, n1, n2, n4, n8, n16}  OPTIONAL,
    ...
}

SRS-CapabilityPerBand-r16 ::= SEQUENCE {
    freqBandIndicatorNR-r16            FreqBandIndicatorNR-r16,
    olpc-SRS-Pos-r16                   OLPC-SRS-Pos-r16                    OPTIONAL,
    spatialRelationsSRS-Pos-r16        SpatialRelationsSRS-Pos-r16        OPTIONAL,
    ...
    [[
        posSRS-RRC-Inactive-InInitialUL-BWP-r17
        PosSRS-RRC-Inactive-InInitialUL-BWP-r17 OPTIONAL,
        posSRS-RRC-Inactive-OutsideInitialUL-BWP-r17
        PosSRS-RRC-Inactive-OutsideInitialUL-BWP-r17
        OPTIONAL,
        olpc-SRS-PosRRC-Inactive-r17
        OLPC-SRS-Pos-r16                    OPTIONAL,
        spatialRelationsSRS-PosRRC-Inactive-r17
        SpatialRelationsSRS-Pos-r16        OPTIONAL
    ]],
    [[
        posSRS-SP-RRC-Inactive-InInitialUL-BWP-r17
        PosSRS-SP-RRC-Inactive-InInitialUL-BWP-r17
        OPTIONAL
    ]]
}
-- ASN1END

```

```

]]
}
OLPC-SRS-Pos-r16 ::= SEQUENCE {
  olpc-SRS-PosBasedOnPRS-Serving-r16      ENUMERATED {supported}          OPTIONAL,
  olpc-SRS-PosBasedOnSSB-Neigh-r16        ENUMERATED {supported}          OPTIONAL,
  olpc-SRS-PosBasedOnPRS-Neigh-r16        ENUMERATED {supported}          OPTIONAL,
  maxNumberPathLossEstimatePerServing-r16 ENUMERATED {n1, n4, n8, n16}    OPTIONAL,
  ...
}

SpatialRelationsSRS-Pos-r16 ::= SEQUENCE {
  spatialRelation-SRS-PosBasedOnSSB-Serving-r16      ENUMERATED {supported}          OPTIONAL,
  spatialRelation-SRS-PosBasedOnCSI-RS-Serving-r16   ENUMERATED {supported}          OPTIONAL,
  spatialRelation-SRS-PosBasedOnPRS-Serving-r16      ENUMERATED {supported}          OPTIONAL,
  spatialRelation-SRS-PosBasedOnSRS-r16              ENUMERATED {supported}          OPTIONAL,
  spatialRelation-SRS-PosBasedOnSSB-Neigh-r16        ENUMERATED {supported}          OPTIONAL,
  spatialRelation-SRS-PosBasedOnPRS-Neigh-r16        ENUMERATED {supported}          OPTIONAL,
  ...
}

SRS-PosResourcesPerBand-r16 ::= SEQUENCE {
  freqBandIndicatorNR-r16                      FreqBandIndicatorNR-r16,
  maxNumberSRS-PosResourceSetsPerBWP-r16      ENUMERATED {n1, n2, n4, n8, n12, n16},
  maxNumberSRS-PosResourcesPerBWP-r16         ENUMERATED {n1, n2, n4, n8, n16, n32, n64},
  maxNumberPeriodicSRS-PosResourcesPerBWP-r16 ENUMERATED {n1, n2, n4, n8, n16, n32, n64},
  maxNumberAP-SRS-PosResourcesPerBWP-r16      ENUMERATED {n1, n2, n4, n8, n16, n32, n64}
  OPTIONAL,
  maxNumberSP-SRS-PosResourcesPerBWP-r16      ENUMERATED {n1, n2, n4, n8, n16, n32, n64}
  OPTIONAL,
  ...
}

PosSRS-RRC-Inactive-InInitialUL-BWP-r17 ::= SEQUENCE {
  maxNumOfSRSposResourceSets-r17              ENUMERATED {n1, n2, n4, n8, n12, n16 }    OPTIONAL,
  maxNumOfPeriodicAndSemiPersistentSRSposResources-r17
  ENUMERATED {n1, n2, n4, n8, n16, n32, n64 }
  OPTIONAL,
  maxNumOfPeriodicAndSemiPersistentSRSposResourcesPerSlot-r17
  ENUMERATED {n1, n2, n3, n4, n5, n6, n8, n10, n12, n14}
  OPTIONAL,
  maxNumOfPeriodicSRSposResources-r17         ENUMERATED {n1, n2, n4, n8, n16, n32, n64 }
  OPTIONAL,
  maxNumOfPeriodicSRSposResourcesPerSlot-r17  ENUMERATED {n1, n2, n3, n4, n5, n6, n8, n10, n12, n14}
  OPTIONAL,
  dummy1                                       ENUMERATED {n1, n2, n4, n8, n16, n32, n64}
  OPTIONAL,
  dummy2                                       ENUMERATED { n1, n2, n3, n4, n5, n6, n8, n10, n12, n14 }
  OPTIONAL,
  ...
}

PosSRS-RRC-Inactive-OutsideInitialUL-BWP-r17 ::= SEQUENCE {
  maxSRSposBandwidthForEachSCS-withinCC-FR1-r17
  ENUMERATED { mhz5, mhz10, mhz15, mhz20, mhz25, mhz30,
  mhz35, mhz40, mhz45, mhz50, mhz60, mhz70,
  mhz80, mhz90, mhz100 }
  OPTIONAL,
  maxSRSposBandwidthForEachSCS-withinCC-FR2-r17
  ENUMERATED {mhz50, mhz100, mhz200, mhz400}
  OPTIONAL,
  maxNumOfSRSposResourceSets-r17              ENUMERATED { n1, n2, n4, n8, n12, n16 }    OPTIONAL,
  maxNumOfPeriodicSRSposResources-r17         ENUMERATED { n1, n2, n4, n8, n16, n32, n64 }
  OPTIONAL,
  maxNumOfPeriodicSRSposResourcesPerSlot-r17  ENUMERATED { n1, n2, n3, n4, n5, n6, n8, n10, n12, n14 }
  OPTIONAL,
  differentNumerologyBetweenSRSposAndInitialBWP-r17
  ENUMERATED { supported }
  OPTIONAL,
  srsPosWithoutRestrictionOnBWP-r17          ENUMERATED { supported }
  OPTIONAL,
  maxNumOfPeriodicAndSemiPersistentSRSposResources-r17
  ENUMERATED {n1, n2, n4, n8, n16, n32, n64}
  OPTIONAL,
  maxNumOfPeriodicAndSemiPersistentSRSposResourcesPerSlot-r17
  ENUMERATED { n1, n2, n3, n4, n5, n6, n8, n10,
  n12, n14 }
  OPTIONAL,
  differentCenterFreqBetweenSRSposAndInitialBWP-r17
  ENUMERATED { supported }
  OPTIONAL,
  maxNumOfSemiPersistentSRSposResources-r17

```

```

                ENUMERATED { n1, n2, n4, n8, n16, n32, n64 }
maxNumOfSemiPersistentSRSPosResourcesPerSlot-r17          OPTIONAL,
                ENUMERATED { n1, n2, n3, n4, n5, n6, n8, n10,
switchingTimeSRS-TX-OtherTX-r17          OPTIONAL,
                n12, n14 }
                ENUMERATED { us100, us140, us200, us300, us500 }
                OPTIONAL,
...
}

PosSRS-SP-RRC-Inactive-InInitialUL-BWP-r17 ::= SEQUENCE {
    maxNumOfSemiPersistentSRSPosResources-r17
                ENUMERATED {n1, n2, n4, n8, n16, n32, n64}          OPTIONAL,
    maxNumOfSemiPersistentSRSPosResourcesPerSlot-r17
                ENUMERATED {n1, n2, n3, n4, n5, n6, n8, n10, n12, n14}
                OPTIONAL,
    ...
}
-- ASN1STOP

```

NR-UL-SRS-Capability field descriptions
--

srs-PosResourceConfigCA-BandList

This field indicates the number of SRS for positioning resources supported by the target device. The target device includes this field for each band which belongs to the *srs-CapabilityBandList* for the current configured CA band combination. The capability signalling comprises the following parameters:

- **freqBandIndicatorNR** indicates the current configured NR band of the target device.
- **maxNumberSRS-PosResourceSetsPerBWP** indicates the maximum number of SRS Resource Sets for positioning supported by the target device per BWP. Enumerated values *n1, n2, n4, n8, n12, n16* correspond to 1, 2, 4, 8, 12, 16 SRS Resource Sets for positioning, respectively.
- **maxNumberSRS-PosResourcesPerBWP** indicates the maximum number of periodic, semi-persistent, and aperiodic SRS Resources for positioning supported by the target device per BWP. Enumerated values *n1, n2, n4, n8, n16, n32, n64* correspond to 1, 2, 4, 8, 16, 32, 64 SRS Resources for positioning, respectively.
- **maxNumberPeriodicSRS-PosResourcesPerBWP** indicates the maximum number of periodic SRS Resources for positioning supported by the target device per BWP. Enumerated values *n1, n2, n4, n8, n16, n32, n64* correspond to 1, 2, 4, 8, 16, 32, 64 periodic SRS Resources for positioning, respectively.
- **maxNumberAP-SRS-PosResourcesPerBWP** indicates the maximum number of aperiodic SRS Resources for positioning supported by the target device per BWP. Enumerated values *n1, n2, n4, n8, n16, n32, n64* correspond to 1, 2, 4, 8, 16, 32, 64 aperiodic SRS Resources for positioning, respectively.
- **maxNumberSP-SRS-PosResourcesPerBWP** indicates the maximum number of semi-persistent SRS Resources for positioning supported by the target device per BWP. Enumerated values *n1, n2, n4, n8, n16, n32, n64* correspond to 1, 2, 4, 8, 16, 32, 64 semi-persistent SRS Resources for positioning, respectively.

maxNumberSRS-PosPathLossEstimateAllServingCells

Indicates the maximum number of pathloss estimates that the UE can simultaneously maintain for all the SRS resource sets for positioning across all cells in addition to the up to four pathloss estimates that the UE maintains per serving cell for the PUSCH/PUCCH/SRS transmissions. The UE shall include this field if the UE supports any of *olpc-SRS-PosBasedOnPRS-Serving*, *olpc-SRS-PosBasedOnSSB-Neigh* and *olpc-SRS-PosBasedOnPRS-Neigh*. Otherwise, the UE does not include this field.

maxNumberSRS-PosSpatialRelationsAllServingCells

indicates the maximum number of maintained spatial relations for all the SRS resource sets for positioning across all serving cells in addition to the spatial relations maintained spatial relations per serving cell for the PUSCH/PUCCH/SRS transmissions. It is only applied for FR2. The UE can include this field only if the UE supports any of *spatialRelation-SRS-PosBasedOnSSB-Serving*, *spatialRelation-SRS-PosBasedOnCSI-RS-Serving*, *spatialRelation-SRS-PosBasedOnPRS-Serving*, *spatialRelation-SRS-PosBasedOnSSB-Neigh* or *spatialRelation-SRS-PosBasedOnPRS-Neigh*. Otherwise, the UE does not include this field.

olpc-SRS-Pos

Indicates whether the UE supports open-loop power control for SRS for positioning. The capability signalling comprises the following parameters:

- **olpc-SRS-PosBasedOnPRS-Serving** indicates whether the UE supports OLPC for SRS for positioning based on PRS from the serving cell in the same band. The UE can include this field only if the UE supports NR-DL-PRS-ProcessingCapability and *srs-PosResources* TS38.331 [35]. Otherwise, the UE does not include this field.
- **olpc-SRS-PosBasedOnSSB-Neigh** indicates whether the UE supports OLPC for SRS for positioning based on SSB from the neighbouring cell in the same band. The UE can include this field only if the UE supports *srs-PosResources* TS 38.331 [35]. Otherwise, the UE does not include this field.
- **olpc-SRS-PosBasedOnPRS-Neigh** indicates whether the UE supports OLPC for SRS for positioning based on PRS from the neighbouring cell in the same band. The UE can include this field only if the UE supports *olpc-SRS-PosBasedOnPRS-Serving*. Otherwise, the UE does not include this field.

Note: A PRS from a PRS-only TP is treated as PRS from a non-serving cell.

- **maxNumberPathLossEstimatePerServing** indicates the maximum number of pathloss estimates that the UE can simultaneously maintain for all the SRS resource sets for positioning per serving cell in addition to the up to four pathloss estimates that the UE maintains per serving cell for the PUSCH/PUCCH/SRS transmissions. The UE shall include this field if the UE supports any of *olpc-SRS-PosBasedOnPRS-Serving*, *olpc-SRS-PosBasedOnSSB-Neigh* and *olpc-SRS-PosBasedOnPRS-Neigh*. Otherwise, the UE does not include this field.

spatialRelationsSRS-Pos

Indicates whether the UE supports spatial relations for SRS for positioning. It is only applicable for FR2. The capability signalling comprises the following parameters:

- ***spatialRelation-SRS-PosBasedOnSSB-Serving*** indicates whether the UE supports spatial relation for SRS for positioning based on SSB from the serving cell in the same band. The UE can include this field only if the UE supports *sr-PosResources* TS 38.331 [35]. Otherwise, the UE does not include this field.
- ***spatialRelation-SRS-PosBasedOnCSI-RS-Serving*** indicates whether the UE supports spatial relation for SRS for positioning based on CSI-RS from the serving cell in the same band. The UE can include this field only if the UE supports *spatialRelation-SRS-PosBasedOnSSB-Serving*. Otherwise, the UE does not include this field.
- ***spatialRelation-SRS-PosBasedOnPRS-Serving*** indicates whether the UE supports spatial relation for SRS for positioning based on PRS from the serving cell in the same band. The UE can include this field only if the UE supports any of DL-PRS Resources for DL-AoD, DL-PRS Resources for DL-TDOA or DL-PRS Resources for Multi-RTT, or *sr-PosResources* TS 38.331 [35]. Otherwise, the UE does not include this field.
- ***spatialRelation-SRS-PosBasedOnSRS*** indicates whether the UE supports spatial relation for SRS for positioning based on SRS in the same band. The UE can include this field only if the UE supports *sr-PosResources* TS 38.331 [35]. Otherwise, the UE does not include this field.
- ***spatialRelation-SRS-PosBasedOnSSB-Neigh*** indicates whether the UE supports spatial relation for SRS for positioning based on SSB from the neighbouring cell in the same band. The UE can include this field only if the UE supports *spatialRelation-SRS-PosBasedOnSSB-Serving*. Otherwise, the UE does not include this field.
- ***spatialRelation-SRS-PosBasedOnPRS-Neigh*** indicates whether the UE supports spatial relation for SRS for positioning based on PRS from the neighbouring cell in the same band. The UE can include this field only if the UE supports *spatialRelation-SRS-PosBasedOnPRS-Serving*. Otherwise, the UE does not include this field.

Note: A PRS from a PRS-only TP is treated as PRS from a non-serving cell.

posSRS-RRC-Inactive-InInitialUL-BWP

Indicates whether the UE supports positioning SRS transmission in RRC_INACTIVE state for initial UL BWP. The capability signalling comprises the following parameters:

- ***maxNumOfSRSpasResourceSets*** indicates the maximum number of SRS Resource Sets for positioning supported by the UE.
- ***maxNumOfPeriodicAndSemiPersistentSRSpasResources*** indicates the maximum number of periodic and semi-persistent SRS Resources for positioning supported by the UE.
- ***maxNumOfPeriodicAndSemiPersistentSRSpasResourcesPerSlot*** indicates the maximum number of periodic and semi-persistent SRS Resources for positioning per slot supported by the UE.
- ***maxNumOfPeriodicSRSpasResources*** indicates the maximum number of periodic SRS Resources for positioning supported by the UE.
- ***maxNumOfPeriodicSRSpasResourcesPerSlot*** indicates the maximum number of periodic SRS Resources for positioning per slot supported by the UE.
- ***dummy1, dummy2*** are not used in the specification. If received they shall be ignored by the receiver.

posSRS-RRC-Inactive-OutsideInitialUL-BWP

Indicates whether the UE supports positioning SRS transmission in RRC_INACTIVE state outside initial UL BWP. The UE can include this field only if the UE supports *posSRS-RRC-Inactive-InInitialUL-BWP*. Otherwise, the UE does not include this field. The capability signalling comprises the following parameters:

- **maxSRSposBandwidthForEachSCS-withinCC-FR1** indicates the maximum SRS bandwidth in MHz supported for each SCS that UE supports within a single CC for FR1.
- **maxSRSposBandwidthForEachSCS-withinCC-FR2** indicates the maximum SRS bandwidth in MHz supported for each SCS that UE supports within a single CC for FR2.
- **maxNumOfSRSposResourceSets** indicates the maximum number of SRS Resource Sets for positioning supported by the UE.
- **maxNumOfPeriodicSRSposResources** indicates the maximum number of periodic SRS Resources for positioning supported by the UE.
- **maxNumOfPeriodicSRSposResourcesPerSlot** indicates the maximum number of periodic SRS Resources for positioning per slot supported by the UE.
- **differentNumerologyBetweenSRSposAndInitialBWP** indicates whether different numerology between the SRS and the initial UL BWP is supported by the UE. If the field is absent, the UE only supports same numerology between the SRS and the initial UL BWP.
- **srsPosWithoutRestrictionOnBWP** indicates whether SRS operation without restriction on the BW is supported by the UE; BW of the SRS may not include BW of the CORESET#0 and SSB. If the field is absent, the UE supports only SRS BW that includes the BW of the CORESET #0 and SSB.
- **maxNumOfPeriodicAndSemiPersistentSRSposResources** indicates the maximum number of periodic and semi-persistent SRS Resources for positioning supported by the UE.
- **maxNumOfPeriodicAndSemiPersistentSRSposResourcesPerSlot** indicates the maximum number of periodic and semi-persistent SRS Resources for positioning per slot supported by the UE.
- **differentCenterFreqBetweenSRSposAndInitialBWP** indicates whether different center frequency between the SRS for positioning and the initial UL BWP is supported by the UE. If the field is absent, the UE only supports same center frequency between the SRS for positioning and initial UL BWP.
- **maxNumOfSemiPersistentSRSposResources** indicates the maximum number of semi-persistent SRS Resources for positioning supported by the UE. The UE can include this field only if the UE supports *posSRS-RRC-Inactive-InInitialUL-BWP*. Otherwise, the UE does not include this field.
- **maxNumOfSemiPersistentSRSposResourcesPerSlot** indicates the maximum number of semi-persistent SRS Resources for positioning per slot supported by the UE. The UE can include this field only if the UE supports *posSRS-RRC-Inactive-InInitialUL-BWP*. Otherwise, the UE does not include this field.
- **switchingTimeSRS-TX-OtherTX** indicates the switching time between SRS Tx and other Tx in initial UL BWP or Rx in initial DL BWP.

olpc-SRS-PosRRC-Inactive

Indicates whether the UE supports open-loop power control for SRS for positioning in RRC_INACTIVE state. The UE can include this field only if the UE supports *posSRS-RRC-Inactive-InInitialUL-BWP*. Otherwise, the UE does not include this field.

spatialRelationsSRS-PosRRC-Inactive

Indicates whether the UE supports spatial relations for SRS for positioning in RRC_INACTIVE state on FR2. The UE can include this field only if the UE supports *posSRS-RRC-Inactive-InInitialUL-BWP*. Otherwise, the UE does not include this field.

posSRS-SP-RRC-Inactive-InInitialUL-BWP

Indicates whether the UE supports positioning SRS transmission in RRC_INACTIVE state for initial UL BWP with semi-persistent SRS. The UE can include this field only if the UE supports *posSRS-RRC-Inactive-InInitialUL-BWP*. Otherwise, the UE does not include this field. The capability signalling comprises the following parameters:

- **maxNumOfSemiPersistentSRSposResources** indicates the maximum number of semi-persistent SRS Resources for positioning supported by the UE.
- **maxNumOfSemiPersistentSRSposResourcesPerSlot** indicates the maximum number of semi-persistent SRS Resources for positioning per slot supported by the UE.

ReferencePoint

The IE *ReferencePoint* provides a well-defined location relative to which other locations may be defined.

```

-- ASN1START
ReferencePoint-r16 ::= SEQUENCE {
    referencePointGeographicLocation-r16      CHOICE {
        location3D-r16                       EllipsoidPointWithAltitudeAndUncertaintyEllipsoid,
        ha-location3D-r16                     HighAccuracyEllipsoidPointWithAltitudeAndUncertaintyEllipsoid-r15,
        ...
    },
    ...
}
-- ASN1STOP

```

ReferencePoint field descriptions
--

referencePointGeographicLocation

This field provides the geodetic location of the reference point.

– *RelativeLocation*

The IE *RelativeLocation* provides a location relative to some known reference location.

```

-- ASN1START
RelativeLocation-r16 ::= SEQUENCE {
    milli-arc-second-units-r16  ENUMERATED { mas0-03, mas0-3, mas3, mas30, ...},
    height-units-r16            ENUMERATED {mm, cm, m, ...},
    delta-latitude-r16         Delta-Latitude-r16,
    delta-longitude-r16       Delta-Longitude-r16,
    delta-height-r16          Delta-Height-r16,
    locationUNC-r16           LocationUncertainty-r16                OPTIONAL,    -- Need OP
    ...
}

Delta-Latitude-r16 ::= SEQUENCE {
    delta-Latitude-r16          INTEGER (-1024..1023),
    coarse-delta-Latitude-r16  INTEGER (0..4095)                OPTIONAL,    -- Need OP
    ...
}

Delta-Longitude-r16 ::= SEQUENCE {
    delta-Longitude-r16        INTEGER (-1024..1023),
    coarse-delta-Longitude-r16 INTEGER (0..4095)                OPTIONAL,    -- Need OP
    ...
}

Delta-Height-r16 ::= SEQUENCE {
    delta-Height-r16           INTEGER (-1024..1023),
    coarse-delta-Height-r16    INTEGER (0..4095)                OPTIONAL,    -- Need OP
    ...
}

LocationUncertainty-r16 ::= SEQUENCE {
    horizontalUncertainty-r16   INTEGER (0..255),
    horizontalConfidence-r16    INTEGER (0..100),
    verticalUncertainty-r16     INTEGER (0..255),
    verticalConfidence-r16      INTEGER (0..100)
}
-- ASN1STOP

```

RelativeLocation field descriptions
--

milli-arc-second-units

This field provides the units and scale factor for the <i>delta-latitude</i> and <i>delta-longitude</i> fields. Enumerated values <i>mas0-03</i> , <i>mas0-3</i> , <i>mas3</i> , and <i>mas30</i> , correspond to 0.03, 0.3, 3, and 30 milliarcseconds, respectively.

height-units

This field provides the units and scale factor for the <i>delta-height</i> field. Enumerated values <i>mm</i> , <i>cm</i> , and <i>m</i> correspond to 10^{-3} metre, 10^{-2} metre, and 1 metres, respectively.
--

delta-latitude

This field specifies the delta value in latitude of the desired location, defined as "desired location" minus "reference point location" and comprises the following sub-fields:
--

- | |
|--|
| <ul style="list-style-type: none"> - delta-Latitude specifies the delta value in latitude in the unit provided in <i>milli-arc-second-units</i> field. - coarse-delta-Latitude specifies the delta value in latitude in 1024 times the size of the unit provided in <i>milli-arc-second-units</i> field and with the same sign as in the <i>delta-Latitude</i> field. If this field is absent, the value for <i>coarse-delta-Latitude</i> is zero. |
|--|

i.e., the full <i>delta-latitude</i> is given by:

$(\text{delta-Latitude} \times \text{milli-arc-second-units}) \pm (\text{coarse-delta-Latitude} \times 1024 \times \text{milli-arc-second-units})$ [milli-arc-seconds]
--

delta-longitude

This field specifies the delta value in longitude of the desired location, defined as "desired location" minus "reference point location" and comprises the following sub-fields:

- | |
|--|
| <ul style="list-style-type: none"> - delta-Longitude specifies the delta value in longitude in the unit provided in <i>milli-arc-second-units</i> field. |
|--|

- **coarse-delta-Longitude** specifies the delta value in longitude in 1024 times the size of the unit provided in *milli-arc-second-units* field and with the same sign as in the *delta-Longitude* field. If this field is absent, the value for *coarse-delta-Longitude* is zero.

I.e., the full *delta-longitude* is given by:

$(\text{delta-Longitude} \times \text{milli-arc-second-units}) \pm (\text{coarse-delta-Longitude} \times 1024 \times \text{milli-arc-second-units})$ [milli-arc-seconds]

delta-height

This field specifies the delta value in ellipsoidal height of the desired location, defined as "desired location" minus "reference point location" and comprises the following sub-fields:

- **delta-Height** specifies the delta value in ellipsoidal height in the unit provided in *height-units* field.
- **coarse-delta-Height** specifies the delta value in ellipsoidal height in 1024 times the size of the unit provided in *height-units* field and with the same sign as in the *delta-Height* field. If this field is absent, the value for *coarse-delta-Height* is zero.

I.e., the full *delta-height* is given by:

$(\text{delta-Height} \times \text{height-units}) \pm (\text{coarse-delta-Height} \times 1024 \times \text{height-units})$ [metres]

locationUNC

This field specifies the uncertainty of the location coordinates and comprises the following sub-fields:

- **horizontalUncertainty** indicates the horizontal uncertainty of the ARP latitude/longitude. The '*horizontalUncertainty*' corresponds to the encoded high accuracy uncertainty as defined in TS 23.032 [15] and '*horizontalConfidence*' corresponds to confidence as defined in TS 23.032 [15].
- **verticalUncertainty** indicates the vertical uncertainty of the ARP altitude. The '*verticalUncertainty*' corresponds to the encoded high accuracy uncertainty as defined in TS 23.032 [15] and '*verticalConfidence*' corresponds to confidence as defined in TS 23.032 [15].

If this field is absent, the uncertainty is the same as for the associated reference point location.

– *TEG-TimingErrorMargin*

The IE *TEG-TimingErrorMargin* defines the timing error margin values of the UE Rx TEGs, UE Tx TEGs, or TRP Tx TEGs. Enumerated value '*tc0*' corresponds to 0 Tc, '*tc2*' corresponds to 2 Tc and so on, where Tc is defined in TS 38.211 [41] clause 4.1.

```
-- ASN1START
TEG-TimingErrorMargin-r17 ::= ENUMERATED { tc0, tc2, tc4, tc6, tc8, tc12, tc16, tc20, tc24,
                                           tc32, tc40, tc48, tc56, tc64, tc72, tc80 }
-- ASN1STOP
```

– *RxTxTEG-TimingErrorMargin*

The IE *RxTxTEG-TimingErrorMargin* defines the timing error margin values of the UE RxTx TEGs. Enumerated value '*tc0-5*' corresponds to 0.5 Tc, '*tc1*' corresponds to 1 Tc and so on, where Tc is defined in TS 38.211 [41] clause 4.1.

```
-- ASN1START
RxTxTEG-TimingErrorMargin-r17 ::= ENUMERATED { tc0-5, tc1, tc2, tc4, tc8, tc12, tc16, tc20,
                                                tc24, tc32, tc40, tc48, tc64, tc80, tc96, tc128 }
-- ASN1STOP
```

6.5 Positioning Method IEs

6.5.1 OTDOA Positioning

This clause defines the information elements for downlink OTDOA positioning, which includes TBS positioning based on PRS signals (TS 36.305 [2]).

6.5.1.1 OTDOA Assistance Data

– *OTDOA-ProvideAssistanceData*

The IE *OTDOA-ProvideAssistanceData* is used by the location server to provide assistance data to enable UE-assisted downlink OTDOA. It may also be used to provide OTDOA positioning specific error reason.

Throughout clause 6.5.1, "assistance data reference cell" refers to the cell defined by the IE *OTDOA-ReferenceCellInfo* and "NB-IoT assistance data reference cell" refers to the cell defined by the IE *OTDOA-ReferenceCellInfoNB* (see clause 6.5.1.2). "RSTD reference cell" applies only in clause 6.5.1.5.

If both IEs, *OTDOA-ReferenceCellInfo* and *OTDOA-ReferenceCellInfoNB* are included in *OTDOA-ProvideAssistanceData*, the assistance data reference cell and NB-IoT assistance data reference cell correspond to the same cell, and the target device may assume that PRS and NPRS antenna ports are quasi co-located, as defined in TS 36.211 [16].

Throughout clause 6.5.1, the term "cell" refers to "transmission point (TP)", unless distinguished in the field description.

NOTE 1: The location server should include at least one cell for which the SFN can be obtained by the target device, e.g. the serving cell, in the assistance data, either as the assistance data reference cell or in the neighbour cell list. Otherwise the target device will be unable to perform the OTDOA measurement and the positioning operation will fail.

NOTE 2: Due to support of cells containing multiple TPs and PRS-only TPs not associated with cells, the term "cell" as used in clause 6.5.1 may not always correspond to a cell for the E-UTRAN.

NOTE 3: For NB-IoT access, due to support of NPRS on multiple carriers, the term "cell" as used in clause 6.5.1 refers to the anchor carrier, unless otherwise stated.

```
-- ASN1START
OTDOA-ProvideAssistanceData ::= SEQUENCE {
    otdoa-ReferenceCellInfo      OTDOA-ReferenceCellInfo      OPTIONAL,  -- Need ON
    otdoa-NeighbourCellInfo     OTDOA-NeighbourCellInfoList  OPTIONAL,  -- Need ON
    otdoa-Error                 OTDOA-Error                 OPTIONAL,  -- Need ON
    ...,
    [
        otdoa-ReferenceCellInfoNB-r14  OTDOA-ReferenceCellInfoNB-r14  OPTIONAL,  -- Need ON
        otdoa-NeighbourCellInfoNB-r14  OTDOA-NeighbourCellInfoListNB-r14  OPTIONAL,  -- Need ON
    ]
}
-- ASN1STOP
```

6.5.1.2 OTDOA Assistance Data Elements

– *OTDOA-ReferenceCellInfo*

The IE *OTDOA-ReferenceCellInfo* is used by the location server to provide assistance data reference cell information for OTDOA assistance data. The slot number offsets and expected RSTDs in *OTDOA-NeighbourCellInfoList* are provided relative to the cell defined by this IE. If *earfcnRef* of this assistance data reference cell is different from that of the serving cell, the LPP layer shall inform lower layers to start performing inter-frequency RSTD measurements with this cell and provide to lower layers the information about this assistance data reference cell, e.g. EARFCN and PRS positioning occasion information.

NOTE: The location server should always include the PRS configuration of the assistance data reference and neighbour cells. Otherwise the UE may not meet the accuracy requirements as defined in TS 36.133 [18].

```
-- ASN1START
OTDOA-ReferenceCellInfo ::= SEQUENCE {
    physCellId          INTEGER (0..503),
    cellGlobalId        ECGI                      OPTIONAL,  -- Need ON
    earfcnRef           ARFCN-ValueEUTRA          OPTIONAL,  -- Cond NotSameAsServ0
    antennaPortConfig  ENUMERATED {ports1-or-2, ports4, ... }
}
```

```

                                OPTIONAL,      -- Cond NotSameAsServ1
cpLength      ENUMERATED { normal, extended, ... },
prsInfo       PRS-Info      OPTIONAL,      -- Cond PRS
...
[[ earfcnRef-v9a0      ARFCN-ValueEUTRA-v9a0  OPTIONAL      -- Cond NotSameAsServ2
]],
[[  tpId-r14           INTEGER (0..4095)          OPTIONAL,      -- Need ON
   cpLengthCRS-r14    ENUMERATED { normal, extended, ... }
                                OPTIONAL,      -- Cond CRS
   sameMBSFNconfigRef-r14  BOOLEAN          OPTIONAL,      -- Need ON
   dlBandwidth-r14     ENUMERATED {n6, n15, n25, n50, n75, n100}
                                OPTIONAL,      -- Cond NotSameAsServ3
   addPRSconfigRef-r14  SEQUENCE (SIZE (1..maxAddPRSconfig-r14)) OF PRS-Info
                                OPTIONAL,      -- Need ON
]],
[[
[[  nr-LTE-SFN-Offset-r15  INTEGER (0..1023)          OPTIONAL      -- Cond NR
]],
[[
[[  tdd-config-v1520      TDD-Config-v1520    OPTIONAL,      -- Need ON
   nr-LTE-fineTiming-Offset-r15  INTEGER (0..19)    OPTIONAL      -- Cond FineOffset
]],
]]
]]
}

maxAddPRSconfig-r14      INTEGER ::= 2

-- ASN1STOP

```

Conditional presence	Explanation
<i>NotSameAsServ0</i>	This field is absent if <i>earfcnRef-v9a0</i> is present. Otherwise, the field is mandatory present if the EARFCN of the OTDOA assistance data reference cell is not the same as the EARFCN of the target devices' current primary cell.
<i>NotSameAsServ1</i>	The field is mandatory present if the antenna port configuration of the OTDOA assistance data reference cell is not the same as the antenna port configuration of the target devices' current primary cell.
<i>NotSameAsServ2</i>	The field is absent if <i>earfcnRef</i> is present. Otherwise, the field is mandatory present if the EARFCN of the OTDOA assistance data reference cell is not the same as the EARFCN of the target devices' current primary cell.
<i>PRS</i>	The field is mandatory present if positioning reference signals are available in the assistance data reference cell (TS 36.211 [16]); otherwise it is not present.
<i>CRS</i>	The field is optionally present, need ON, if <i>prsInfo</i> is present. Otherwise it is not present.
<i>NotSameAsServ3</i>	The field is mandatory present if the downlink bandwidth configuration of the assistance data reference cell is not the same as the downlink bandwidth configuration of the target devices' current primary cell and if PRS frequency hopping is used in the assistance data reference cell (TS 36.211 [16]); otherwise it is not present.
<i>NR</i>	The field is optionally present, need ON, if the target device is served by an NR cell; otherwise it is not present.
<i>FineOffset</i>	The field is optionally present, need ON, if <i>nr-LTE-SFN-Offset</i> is present. Otherwise it is not present.

OTDOA-ReferenceCellInfo field descriptions

physCellId	This field specifies the physical cell identity of the assistance data reference cell, as defined in TS 36.331 [12].
cellGlobalId	This field specifies the ECGI, the globally unique identity of a cell in E-UTRA, of the assistance data reference cell, as defined in TS 36.331 [12]. The server should include this field if it considers that it is needed to resolve ambiguity in the cell indicated by <i>physCellId</i> .
earfcnRef	This field specifies the EARFCN of the assistance data reference cell.
antennaPortConfig	This field specifies whether 1 (or 2) antenna port(s) or 4 antenna ports for cell specific reference signals (CRS) are used in the assistance data reference cell.
cpLength	This field specifies the cyclic prefix length of the assistance data reference cell PRS if the <i>prsInfo</i> field is present, otherwise this field specifies the cyclic prefix length of the assistance data reference cell CRS.
prsInfo	This field specifies the first PRS configuration of the assistance data reference cell.

OTDOA-ReferenceCellInfo field descriptions	
<i>tpld</i>	This field specifies an identity of the transmission point. This field together with the <i>physCellId</i> and/or <i>prsID</i> may be used to identify the transmission point in the case the same physical cell ID is shared by multiple transmission points.
<i>cpLengthCRS</i>	This field specifies the cyclic prefix length of the assistance data reference cell CRS. If this field is present, the target device may assume the CRS and PRS antenna ports of the assistance data reference cell are quasi co-located (as defined in TS 36.211 [16]).
<i>sameMBSFNconfigRef</i>	This field indicates whether the MBSFN subframe configuration of the assistance data reference cell is the same as the current primary cell of the target device. TRUE means the same, and FALSE means not the same.
<i>dlBandwidth</i>	This field specifies the downlink bandwidth configuration of the assistance data reference cell, N_{RB} in downlink, see TS 36.101 [21, table 5.6-1]. Enumerated value n_6 corresponds to 6 resource blocks, n_{15} to 15 resource blocks and so on.
<i>addPRSconfigRef</i>	This field specifies the additional (second and possibly third) PRS configuration(s) of the assistance data reference cell.
<i>nr-LTE-SFN-Offset</i>	This field specifies the SFN offset between the serving NR cell and the LTE assistance data reference cell. The offset corresponds to the number of full radio frames counted from the beginning of a radio frame #0 of the NR serving cell to the beginning of the closest subsequent radio frame #0 of the assistance data reference cell.
<i>tdd-config</i>	This field specifies the TDD specific physical channel configuration of the assistance data reference cell. The field should be present if the assistance data reference cell is a TDD cell and if the TDD UL/DL configuration of the assistance data reference cell is not the same as the target devices' current primary cell or if the target devices' current primary cell is a FDD cell.
<i>nr-LTE-fineTiming-Offset</i>	This field specifies the frame boundary offset between the NR serving cell and the LTE assistance data reference cell in units of 0.5 ms. The offset is counted from the beginning of a subframe #0 of the NR serving cell to the beginning of the closest subsequent subframe #0 of the LTE assistance data reference cell, rounded down to multiples of 0.5 ms. Value 0 corresponds to 0 ms, value 1 corresponds to 0.5 ms, 2 to 1 ms and so on.

– PRS-Info

The IE *PRS-Info* provides the information related to the configuration of PRS in a cell.

```

-- ASN1START
PRS-Info ::= SEQUENCE {
    prs-Bandwidth          ENUMERATED { n6, n15, n25, n50, n75, n100, ... },
    prs-ConfigurationIndex INTEGER (0..4095),
    numDL-Frames          ENUMERATED {sf-1, sf-2, sf-4, sf-6, ..., sf-add-v1420},
    ...,
    prs-MutingInfo-r9     CHOICE {
        po2-r9            BIT STRING (SIZE(2)),
        po4-r9            BIT STRING (SIZE(4)),
        po8-r9            BIT STRING (SIZE(8)),
        po16-r9           BIT STRING (SIZE(16)),
        ...,
        po32-v1420        BIT STRING (SIZE(32)),
        po64-v1420        BIT STRING (SIZE(64)),
        po128-v1420       BIT STRING (SIZE(128)),
        po256-v1420       BIT STRING (SIZE(256)),
        po512-v1420       BIT STRING (SIZE(512)),
        po1024-v1420      BIT STRING (SIZE(1024))
    }
    [,
    prsID-r14              INTEGER (0..4095)                OPTIONAL,           -- Need OP
    add-numDL-Frames-r14  INTEGER (1..160)                  OPTIONAL,           -- Need ON
    prsOccGroupLen-r14    ENUMERATED {g2, g4, g8, g16, g32, g64, g128,... }
                                                                OPTIONAL,           -- Cond sf-add
    prsHoppingInfo-r14    CHOICE {
        nb2-r14            INTEGER (0.. maxAvailNarrowBands-Minus1-r14),
        nb4-r14            SEQUENCE (SIZE (3))
                                                                OF INTEGER (0.. maxAvailNarrowBands-Minus1-r14)
    }
                                                                OPTIONAL           -- Cond PRS-FH
    ]
}
maxAvailNarrowBands-Minus1-r14  INTEGER ::= 15 -- Maximum number of narrowbands minus 1
-- ASN1STOP

```

Conditional presence	Explanation
<i>sf-add</i>	The field is mandatory present if the <i>numDL-Frames</i> field has the value ' <i>sf-add</i> '; otherwise it is not present.
<i>Occ-Grp</i>	The field is mandatory present if a PRS occasion group is configured; otherwise it is not present.
<i>PRS-FH</i>	The field is mandatory present if frequency hopping is used for PRS; otherwise it is not present.

PRS-Info field descriptions
<p><i>prs-Bandwidth</i> This field specifies the bandwidth that is used to configure the positioning reference signals on. Enumerated values are specified in number of resource blocks (<i>n</i>₆ corresponds to 6 resource blocks, <i>n</i>₁₅ to 15 resource blocks and so on) and define 1.4, 3, 5, 10, 15 and 20 MHz bandwidth.</p>
<p><i>prs-ConfigurationIndex</i> This field specifies the positioning reference signals configuration index <i>I</i>_{PRS} as defined in TS 36.211 [16].</p>
<p><i>numDL-Frames</i> This field specifies the number of consecutive downlink subframes <i>N</i>_{PRS} with positioning reference signals, as defined in TS 36.211 [16]. Enumerated values define 1, 2, 4, or 6 consecutive downlink subframes. The value <i>sf-add</i> indicates that <i>N</i>_{PRS} is provided in the field <i>add-numDL-Frames</i>.</p>
<p><i>prs-MutingInfo</i> This field specifies the PRS muting configuration of the cell. The PRS muting configuration is defined by a periodic PRS muting sequence with periodicity <i>T</i>_{REP} where <i>T</i>_{REP}, counted in the number of PRS occasion groups (TS 36.133 [18]), can be 2, 4, 8, 16, 32, 64, 128, 256, 512, or 1024 which is also the length of the selected bit string that represents this PRS muting sequence. If a bit in the PRS muting sequence is set to "0", then the PRS is muted in all the PRS occasions in the corresponding PRS occasion group. A PRS occasion group comprises one or more PRS occasions as indicated by <i>prsOccGroupLen</i>. Each PRS occasion comprises <i>N</i>_{PRS} downlink positioning subframes as defined in TS 36.211 [16]. The first bit of the PRS muting sequence corresponds to the first PRS occasion group that starts after the beginning of the assistance data reference cell SFN=0. The sequence is valid for all subframes after the target device has received the <i>prs-MutingInfo</i>. If this field is not present the target device may assume that the PRS muting is not in use for the cell.</p> <p>When the SFN of the assistance data reference cell is not known to the UE and <i>prs-MutingInfo</i> is provided for a cell in the <i>OTDOA-NeighbourCellInfoList</i> IE, the UE may assume no PRS is transmitted by that cell.</p> <p>When the UE receives a <i>T</i>_{REP}-bit muting pattern together with a PRS periodicity <i>T</i>_{PRS} for the same cell which exceeds 10240 subframes (i.e., <i>T</i>_{REP} × <i>T</i>_{PRS} > 10240 subframes), the UE shall assume an <i>n</i>-bit muting pattern based on the first <i>n</i>-bits, where <i>n</i> = 10240/<i>T</i>_{PRS}.</p>
<p><i>prsID</i> This field specifies the PRS-ID as defined in TS 36.211 [16].</p>
<p><i>add-numDL-Frames</i> This field specifies the number of consecutive downlink subframes <i>N</i>_{PRS} with positioning reference signals, as defined in TS 36.211 [16]. Integer values define 1, 2, 3, ..., 160 consecutive downlink subframes.</p>
<p><i>prsOccGroupLen</i> This field specifies the PRS occasion group length, defined as the number of consecutive PRS occasions comprising a PRS occasion group. Each PRS occasion of the PRS occasion group consists of <i>numDL-Frames</i> or <i>add-numDL-Frames</i> consecutive downlink subframes with positioning reference signals. Enumerated values define 2, 4, 8, 16, 32, 64 or 128 consecutive PRS occasions. If omitted, the PRS occasion group length is 1. The product of the PRS periodicity <i>T</i>_{PRS} from the <i>prs-ConfigurationIndex</i> and the PRS occasion group length cannot exceed 1280.</p>
<p><i>prsHoppingInfo</i> This field specifies the PRS frequency hopping configuration (TS 36.211 [16]). The choice <i>nb2</i> indicates hopping between 2 narrowbands; the choice <i>nb4</i> indicates hopping between 4 narrowbands. The first PRS positioning occasion of the first PRS occasion group that starts after the beginning of SFN=0 of the assistance data reference cell is located at the centre of the system bandwidth. The frequency band of each subsequent PRS occasion is indicated by <i>nb2</i> or <i>nb4</i>, respectively, which defines the narrowband index <i>n</i>_{NB} as specified in TS 36.211 [16]. If this field is absent, no PRS frequency hopping is used.</p>

– TDD-Config

The IE *TDD-Config* is used to specify the TDD specific physical channel configuration.

-- ASN1START

```
TDD-Config-v1520 ::= SEQUENCE {
  subframeAssignment-v1520      ENUMERATED { sa0, sa1, sa2, sa3, sa4, sa5, sa6 },
  ...
}
-- ASN1STOP
```

TDD-Config field descriptions

subframeAssignment

This field specifies the TDD UL/DL subframe configuration where *sa0* points to Configuration 0, *sa1* to Configuration 1 etc. as specified in TS 36.211 [16], table 4.2-2. The target device assumes the same value for all assistance data cells residing on same frequency band.

– OTDOA-NeighbourCellInfoList

The IE *OTDOA-NeighbourCellInfoList* is used by the location server to provide neighbour cell information for OTDOA assistance data. If the target device is not capable of supporting additional neighbour cells (as indicated by the absence of the IE *additionalNeighbourCellInfoList* in *OTDOA-ProvideCapabilities*), the set of cells in the *OTDOA-NeighbourCellInfoList* is grouped per frequency layer and in the decreasing order of priority for measurement to be performed by the target device, with the first cell in the list being the highest priority for measurement and with the same *earfcn* not appearing in more than one instance of *OTDOA-NeighbourFreqInfo*.

If the target device is capable of supporting additional neighbour cells (as indicated by the presence of the IE *additionalNeighbourCellInfoList* in *OTDOA-ProvideCapabilities*), the list may contain all cells (up to 3x24 cells) belonging to the same frequency layer or cells from different frequency layers with the first cell in the list still being the highest priority for measurement.

The prioritization of the cells in the list is left to server implementation. The target device should provide the available measurements in the same order as provided by the server.

If inter-frequency neighbour cells are included in *OTDOA-NeighbourCellInfoList*, where an inter-frequency is a E-UTRA frequency which is different from the E-UTRA serving cell frequency, the LPP layer shall inform lower layers to start performing inter-frequency RSTD measurements for these neighbour cells and also provide to lower layers the information about these neighbour cells, e.g. EARFCN and PRS positioning occasion information.

```
-- ASN1START

OTDOA-NeighbourCellInfoList ::= SEQUENCE (SIZE (1..maxFreqLayers)) OF OTDOA-NeighbourFreqInfo
OTDOA-NeighbourFreqInfo ::= SEQUENCE (SIZE (1..24)) OF OTDOA-NeighbourCellInfoElement

OTDOA-NeighbourCellInfoElement ::= SEQUENCE {
  physCellId                INTEGER (0..503),
  cellGlobalId              ECGI                OPTIONAL,      -- Need ON
  earfcn                    ARFCN-ValueEUTRA    OPTIONAL,      -- Cond NotSameAsRef0
  cpLength                  ENUMERATED {normal, extended, ...}
  prsInfo                   PRS-Info            OPTIONAL,      -- Cond NotSameAsRef2
  antennaPortConfig         ENUMERATED {ports-1-or-2, ports-4, ...}
  slotNumberOffset          INTEGER (0..19)     OPTIONAL,      -- Cond NotsameAsRef3
  prs-SubframeOffset        INTEGER (0..1279)   OPTIONAL,      -- Cond NotSameAsRef4
  expectedRSTD              INTEGER (0..16383),
  expectedRSTD-Uncertainty  INTEGER (0..1023),
  ...
  [[ earfcn-v9a0             ARFCN-ValueEUTRA-v9a0 OPTIONAL      -- Cond NotSameAsRef5
  ]],
  [[ tpId-r14               INTEGER (0..4095)     OPTIONAL,      -- Need ON
  prs-only-tp-r14          ENUMERATED { true }    OPTIONAL,      -- Cond TBS
  cpLengthCRS-r14         ENUMERATED { normal, extended, ... }
  sameMBSFNconfigNeighbour-r14 BOOLEAN          OPTIONAL,      -- Cond CRS
  dlBandwidth-r14         ENUMERATED {n6, n15, n25, n50, n75, n100}
  addPRSconfigNeighbour-r14 SEQUENCE (SIZE (1..maxAddPRSconfig-r14)) OF
  Add-PRSconfigNeighbourElement-r14
  ]],
  [[
  tdd-config-v1520        TDD-Config-v1520     OPTIONAL        -- Need ON
  ]]
```

```

    ]]
  }
Add-PRsconfigNeighbourElement-r14 ::= SEQUENCE {
    add-prsInfo-r14          PRS-Info          OPTIONAL,          -- Cond NotSameAsRef7
    ...
}
maxFreqLayers    INTEGER ::= 3
-- ASN1STOP

```

Conditional presence	Explanation
<i>NotsameAsRef0</i>	The field is absent if <i>earfcn-v9a0</i> is present. If <i>earfcn-v9a0</i> is not present, the field is mandatory present if the EARFCN is not the same as for the assistance data reference cell; otherwise it is not present.
<i>NotsameAsRef1</i>	The field is mandatory present if the cyclic prefix length is not the same as for the assistance data reference cell; otherwise it is not present.
<i>NotsameAsRef2</i>	The field is mandatory present if the first PRS configuration is not the same as for the assistance data reference cell; otherwise it is not present.
<i>NotsameAsRef3</i>	The field is mandatory present if the antenna port configuration is not the same as for the assistance data reference cell; otherwise it is not present.
<i>NotsameAsRef4</i>	The field is mandatory present if the slot timing is not the same as for the assistance data reference cell; otherwise it is not present.
<i>NotSameAsRef5</i>	The field is absent if <i>earfcn</i> is present. If <i>earfcn</i> is not present, the field is mandatory present if the EARFCN is not the same as for the assistance data reference cell; otherwise it is not present.
<i>InterFreq</i>	The field is optionally present, need OP, if the EARFCN is not the same as for the assistance data reference cell; otherwise it is not present.
<i>TBS</i>	The field is mandatory present if the <i>OTDOA-NeighbourCellInfoElement</i> is provided for a PRS-only TP; otherwise it is not present.
<i>CRS</i>	The field is optionally present, need ON, if <i>prsInfo</i> is present. Otherwise it is not present.
<i>NotSameAsRef6</i>	The field is mandatory present if PRS frequency hopping is used on this neighbour cell (TS 36.211 [16]) and if the downlink bandwidth configuration is not the same as for the assistance data reference cell; otherwise it is not present.
<i>NotSameAsRef7</i>	The field is mandatory present if any instance of the additional PRS configurations of <i>addPRsconfigNeighbour</i> is not the same as the corresponding instance of the additional PRS configuration of the <i>addPRsconfigRef</i> for the assistance data reference cell; otherwise it is not present.

OTDOA-NeighbourCellInfoList field descriptions

<i>physCellId</i>	This field specifies the physical cell identity of the neighbour cell, as defined in TS 36.331 [12].
<i>cellGlobalId</i>	This field specifies the ECGI, the globally unique identity of a cell in E-UTRA, of the neighbour cell, as defined in TS 36.331 [12]. The server should provide this field if it considers that it is needed to resolve any ambiguity in the cell identified by <i>physCellId</i> .
<i>earfcn</i>	This field specifies the EARFCN of the neighbour cell.
<i>cpLength</i>	This field specifies the cyclic prefix length of the neighbour cell PRS if PRS are present in this neighbour cell, otherwise this field specifies the cyclic prefix length of CRS in this neighbour cell.
<i>prsInfo</i>	This field specifies the first PRS configuration of the neighbour cell. When the EARFCN of the neighbour cell is the same as for the assistance data reference cell, the target device may assume that each PRS positioning occasion in the neighbour cell at least partially overlaps with a PRS positioning occasion in the assistance data reference cell where the maximum offset between the transmitted PRS positioning occasions may be assumed to not exceed half a subframe. When the EARFCN of the neighbour cell is the same as for the assistance data reference cell, the target may assume that this cell has the same PRS periodicity (T_{PRS}) as the assistance data reference cell.
<i>antennaPortConfig</i>	This field specifies whether 1 (or 2) antenna port(s) or 4 antenna ports for cell specific reference signals are used.

OTDOA-NeighbourCellInfoList field descriptions
<p>slotNumberOffset This field specifies the slot number offset at the transmitter between this cell and the assistance data reference cell. The <i>slotNumberOffset</i> together with the current slot number of the assistance data reference cell may be used to calculate the current slot number of this cell which may further be used to generate the CRS sequence by the target device. The offset corresponds to the number of full slots counted from the beginning of a radio frame of the assistance data reference cell to the beginning of the closest subsequent radio frame of this cell. If this field is absent, the slot timing is the same as for the assistance data reference cell.</p>
<p>prs-SubframeOffset This field specifies the offset between the first PRS subframe of the first PRS occasion group of the first PRS configuration in the assistance data reference cell on the reference carrier frequency layer and the first PRS subframe in the closest subsequent PRS occasion group of the PRS configuration with the longest PRS occasion group periodicity (NOTE 1) of this cell on the other carrier frequency layer. The value is given in number of full sub-frames. If the EARFCN is not the same as for the assistance data reference cell and the field is not present but PRS are available on this cell, the receiver shall consider the PRS subframe offset for this cell to be 0.</p>
<p>expectedRSTD If PRS is transmitted:</p> <p>This field indicates the RSTD value that the target device is expected to measure between this cell and the assistance data reference cell. The <i>expectedRSTD</i> field takes into account the expected propagation time difference as well as transmit time difference of PRS positioning occasions between the two cells. The RSTD value can be negative and is calculated as (<i>expectedRSTD</i>-8192). The resolution is $3 \times T_s$, with $T_s = 1/(15000 \times 2048)$ seconds.</p> <p>If PRS is not transmitted:</p> <p>This field indicates the RSTD value that the target device is expected to measure between this cell and the assistance data reference cell. The <i>expectedRSTD</i> field takes into account the expected propagation time difference as well as transmit time difference between the two cells. The RSTD value can be negative and is calculated as (<i>expectedRSTD</i>-8192). The resolution is $3 \times T_s$, with $T_s = 1/(15000 \times 2048)$ seconds.</p>
<p>expectedRSTD-Uncertainty If PRS is transmitted:</p> <p>This field indicates the uncertainty in <i>expectedRSTD</i> value. The uncertainty is related to the location server's a-priori estimation of the target device location. The <i>expectedRSTD</i> and <i>expectedRSTD-Uncertainty</i> together define the search window for the target device. The scale factor of the <i>expectedRSTD-Uncertainty</i> field is $3 \times T_s$, with $T_s = 1/(15000 \times 2048)$ seconds.</p> <p>The target device may assume that the beginning of the PRS occasion group of the PRS configuration with the longest PRS occasion group periodicity (NOTE) of the neighbour cell is received within the search window of size $[- \text{expectedRSTD-Uncertainty} \times 3 \times T_s, \text{expectedRSTD-Uncertainty} \times 3 \times T_s]$ centred at $T_{\text{REF}} + 1 \text{ millisecond} \times N + (\text{expectedRSTD} - 8192) \times 3 \times T_s$, where T_{REF} is the reception time of the beginning of the first PRS occasion group of the first PRS configuration of the assistance data reference cell at the target device antenna connector, $N = 0$ when the EARFCN of the neighbour cell is equal to that of the assistance data reference cell, and $N = \text{prs-SubframeOffset}$ otherwise.</p> <p>If PRS is not transmitted:</p> <p>This field indicates the uncertainty in <i>expectedRSTD</i> value. The uncertainty is related to the location server's a-priori estimation of the target device location. The <i>expectedRSTD</i> and <i>expectedRSTD-Uncertainty</i> together define the search window for the target device. The scale factor of the <i>expectedRSTD-Uncertainty</i> field is $3 \times T_s$, with $T_s = 1/(15000 \times 2048)$ seconds.</p> <p>If T_x is the reception time of the beginning of the subframe X of the assistance data reference cell at the target device antenna connector, the target device may assume that the beginning of the closest subframe of this neighbour cell to subframe X is received within the search window of size $[- \text{expectedRSTD-Uncertainty} \times 3 \times T_s, \text{expectedRSTD-Uncertainty} \times 3 \times T_s]$ centred at $T_x + (\text{expectedRSTD} - 8192) \times 3 \times T_s$.</p>
<p>tpld This field specifies an identity of the transmission point. This field together with the <i>physCellId</i> and/or <i>prsID</i> may be used to identify the transmission point in the case the same physical cell ID is shared by multiple transmission points.</p>
<p>prs-only-tp This field, if present, indicates that the <i>OTDOA-NeighbourCellInfoElement</i> is provided for a PRS-only TP.</p> <p>For the purpose of RSTD measurements from a PRS-only TP, the target device shall not assume any other signals or physical channels are present other than PRS (TS 36.213 [28]).</p> <p>For the purpose of RSTD measurements from a PRS-only TP, the target device shall use the <i>physCellId</i> only for PRS generation, and only if no PRS-ID is provided for this TP.</p>

OTDOA-NeighbourCellInfoList field descriptions
<p>cpLengthCRS This field specifies the cyclic prefix length of this assistance data neighbour cell CRS. If this field is present, the target device may assume the CRS and PRS antenna ports of this assistance data neighbour cell are quasi co-located (as defined in TS 36.211 [16]).</p>
<p>sameMBSFNconfigNeighbour This field indicates whether the MBSFN subframe configuration of the neighbour cell is the same as the current primary cell of the target device. TRUE means the same, and FALSE means not the same.</p>
<p>dlBandwidth This field specifies the downlink bandwidth configuration of the neighbour cell, N_{RB} in downlink, see TS 36.101 [21, table 5.6-1]. Enumerated value n_6 corresponds to 6 resource blocks, n_{15} to 15 resource blocks and so on.</p>
<p>addPRSconfigNeighbour This field specifies the additional (second and possibly third) PRS configuration(s) of the neighbour cell. When the EARFCN of the neighbour cell is the same as for the assistance data reference cell, the target device may assume that each PRS positioning occasion in each instance of <i>addPRSconfigNeighbour</i> in the neighbour cell at least partially overlaps with a PRS positioning occasion of the same instance of <i>addPRSconfigRef</i> in the assistance data reference cell where the maximum offset between the transmitted PRS positioning occasions may be assumed to not exceed half a subframe. When the EARFCN of the neighbour cell is the same as for the assistance data reference cell, the target may assume that each instance of <i>addPRSconfigNeighbour</i> of this cell has the same PRS periodicity (T_{PRS}) as the corresponding instance of <i>addPRSconfigRef</i> of the assistance data reference cell.</p>
<p>tdd-config This field specifies the TDD specific physical channel configuration of the neighbour cell <i>earfcn</i>. The field should be present if this neighbour cell is a TDD cell and if the TDD UL/DL configuration for assistance data cells on this <i>earfcn</i> has not been provided in any other instance of <i>OTDOA-NeighbourCellInfoElement</i> or in IE <i>OTDOA-ReferenceCellInfo</i>, and is not the same as the target device's current primary cell when this is a TDD cell. NOTE 2.</p>

NOTE 1: If this cell has more than one PRS configuration with equal longest PRS occasion group periodicity (i.e., PRS occasion group length times T_{PRS}), the first such configuration is referenced. In order to avoid ambiguity for frequency hopping, a PRS occasion group should contain at least 2 PRS occasions with hopping between 2 narrowbands and at least 4 PRS occasions with hopping between 4 narrowbands.

NOTE 2: The target device assumes the same TDD UL/DL configuration for all TDD cells residing on same frequency band specified by *earfcn*. Therefore, the location server should include the field *tdd-config* only once for assistance data cells with the same *earfcn* in IE *OTDOA-ProvideAssistanceData*. The location server does not need to include the field *tdd-config* for any assistance data cell in IE *OTDOA-ProvideAssistanceData* with the same *earfcn* or the same TDD UL/DL configuration as the target devices' current primary cell if this is a TDD cell.

OTDOA-ReferenceCellInfoNB

The IE *OTDOA-ReferenceCellInfoNB* is used by the location server to provide NB-IoT assistance data reference cell information for OTDOA assistance data.

```

-- ASN1START
OTDOA-ReferenceCellInfoNB-r14 ::= SEQUENCE {
    physCellIdNB-r14          INTEGER (0..503)          OPTIONAL, -- Cond NoPRS-AD1
    cellGlobalIdNB-r14       ECGI                    OPTIONAL, -- Cond NoPRS-AD2
    carrierFreqRef-r14       CarrierFreq-NB-r14      OPTIONAL, -- Cond NotSameAsServ1
    earfcn-r14               ARFCN-ValueEUTRA-r14    OPTIONAL, -- Cond Inband
    eutra-NumCRS-Ports-r14   ENUMERATED {ports1-or-2, ports4}
                                OPTIONAL, -- Cond NoPRS-AD3
    otdoa-SIB1-NB-repetitions-r14  ENUMERATED { r4, r8, r16 } OPTIONAL, -- Cond NotSameAsServ2
    nprsInfo-r14             PRS-Info-NB-r14         OPTIONAL, -- Cond NPRS-Type1
    ...,
    [
    nprsInfo-Type2-v1470     PRS-Info-NB-r14         OPTIONAL, -- Cond NPRS-Type2
    ],
    [
    tdd-config-r15          TDD-Config-v1520        OPTIONAL, -- Need ON
    ]
}
-- ASN1STOP

```

Conditional presence	Explanation
<i>NoPRs-AD1</i>	This field is mandatory present if the <i>OTDOA-ReferenceCellInfo</i> IE is not included in <i>OTDOA-ProvideAssistanceData</i> , or if the <i>OTDOA-ReferenceCellInfo</i> IE is included in <i>OTDOA-ProvideAssistanceData</i> and the narrowband physical layer cell identity is not the same as the physical cell identity provided in <i>OTDOA-ReferenceCellInfo</i> IE. Otherwise it is not present.
<i>NoPRs-AD2</i>	This field is optionally present, need ON, if the <i>OTDOA-ReferenceCellInfo</i> IE is not included in <i>OTDOA-ProvideAssistanceData</i> , or if the <i>OTDOA-ReferenceCellInfo</i> IE is included in <i>OTDOA-ProvideAssistanceData</i> and the global cell identity is not the same as provided in <i>OTDOA-ReferenceCellInfo</i> IE.
<i>NotSameAsServ1</i>	This field is mandatory present if the carrier frequency of the NB-IoT assistance data reference cell is not the same as the carrier frequency of the target devices' current serving NB-IoT cell. Otherwise it is not present.
<i>Inband</i>	This field is mandatory present, if the NPRS is configured within the LTE spectrum allocation (inband deployment). Otherwise it is not present.
<i>NoPRs-AD3</i>	This field is mandatory present if the <i>OTDOA-ReferenceCellInfo</i> IE is not included in <i>OTDOA-ProvideAssistanceData</i> and if the NB-IoT assistance data reference cell is deployed within the LTE spectrum allocation (inband deployment). Otherwise it is not present.
<i>NotSameAsServ2</i>	This field is mandatory present, if NPRS configuration Part B only is configured on the NB-IoT assistance data reference cell, and if the repetition number of SIB1-NB of the NB-IoT assistance data reference cell is not the same as the repetition number of SIB1-NB of the target devices' current serving NB-IoT cell. Otherwise it is not present.
<i>NPRS-Type1</i>	The field is mandatory present if Type 1 narrowband positioning reference signals are available in the assistance data reference cell (TS 36.211 [16]); otherwise it is not present.
<i>NPRS-Type2</i>	The field is mandatory present if Type 2 narrowband positioning reference signals are available in the assistance data reference cell (TS 36.211 [16]); otherwise it is not present.

***OTDOA-ReferenceCellInfoNB* field descriptions**

<i>physCellIdNB</i>	This field specifies the narrowband physical layer cell identity of the NB-IoT assistance data reference cell, as defined in TS 36.331 [12]. If this field is absent and if the <i>OTDOA-ReferenceCellInfo</i> IE is included in <i>OTDOA-ProvideAssistanceData</i> the narrowband physical layer cell identity is the same as the <i>physCellId</i> provided in <i>OTDOA-ReferenceCellInfo</i> IE.
<i>cellGlobalIdNB</i>	This field specifies the global cell identity of the NB-IoT assistance data reference cell, as defined in TS 36.331 [12]. If this field is absent and if the <i>OTDOA-ReferenceCellInfo</i> IE with <i>cellGlobalId</i> is included in <i>OTDOA-ProvideAssistanceData</i> , the global cell identity is the same as provided in <i>OTDOA-ReferenceCellInfo</i> IE.
<i>carrierFreqRef</i>	This field specifies the carrier frequency of the NB-IoT assistance data reference cell.
<i>earfcn</i>	This field specifies the EARFCN of the E-UTRAN frequency, in which the NB-IoT cell is deployed.
<i>eutra-NumCRS-Ports</i>	This field specifies whether 1 (or 2) antenna port(s) or 4 antenna ports for cell specific reference signals (CRS) are used in the NB-IoT assistance data reference cell. If this field is absent and if the <i>OTDOA-ReferenceCellInfo</i> IE is included in <i>OTDOA-ProvideAssistanceData</i> , the number of CRS antenna ports is the same as provided in <i>OTDOA-ReferenceCellInfo</i> IE.
<i>otdoa-SIB1-NB-repetitions</i>	This field specifies the repetition number of SIB1-NB of the NB-IoT assistance data reference cell. Enumerated values r4 correspond to 4 repetitions, r8 to 8 repetitions, and r16 to 16 repetitions. Note, when NPRS configuration Part B only is configured on the NB-IoT assistance data reference cell (i.e., anchor carrier), <i>nprs-NumSF</i> does also count/include subframes containing NPSS, NSSS, NPBCH, or SIB1-NB, but the UE can assume that no NPRS are transmitted in these subframes (TS 36.211 [16]).

OTDOA-ReferenceCellInfoNB field descriptions
<p>nprsInfo This field specifies the Type 1 NPRS (TS 36.211 [16]) configuration of the NB-IoT assistance data reference cell.</p> <p>When the target device receives this field with <i>operationModelInfoNPRS</i> set to value 'standalone', the target device shall assume no NPRS are transmitted on that NB-IoT carrier.</p>
<p>nprsInfo-Type2 This field specifies the Type 2 NPRS (TS 36.211 [16]) configuration of the NB-IoT assistance data reference cell.</p>
<p>tdd-config Indicates the TDD specific physical channel configuration of the NB-IoT assistance data reference cell operating in TDD mode. This field should be present if the DL/UL subframe configuration of the NB-IoT assistance data reference cell is not the same as the DL/UL subframe configuration of the current serving NB-IoT cell of the target device, or if the current serving NB-IoT cell of the target device operates in FDD mode.</p>

– PRS-Info-NB

The IE *PRS-Info-NB* provides the information related to the configuration of NPRS in a cell. If *PRS-Info-NB* includes configurations for multiple NPRS carrier frequencies, the target device may assume the antenna ports for the NPRS carrier are quasi co-located, as defined in TS 36.211 [16].

```

-- ASN1START
PRS-Info-NB-r14 ::= SEQUENCE (SIZE (1..maxCarrier-r14)) OF NPRS-Info-r14
NPRS-Info-r14 ::= SEQUENCE {
  operationModeInfoNPRS-r14  ENUMERATED { inband, standalone },
  nprs-carrier-r14           CarrierFreq-NB-r14  OPTIONAL, -- Cond Standalone/Guardband
  nprsSequenceInfo-r14     INTEGER (0..174)    OPTIONAL, -- Cond Inband
  nprsID-r14                INTEGER (0..4095)  OPTIONAL, -- Cond NPRS-ID
  partA-r14                 SEQUENCE {
    nprsBitmap-r14         CHOICE {
      subframePattern10-r14  BIT STRING (SIZE (10)),
      subframePattern40-r14  BIT STRING (SIZE (40))
    },
    nprs-MutingInfoA-r14   CHOICE {
      po2-r14               BIT STRING (SIZE(2)),
      po4-r14               BIT STRING (SIZE(4)),
      po8-r14               BIT STRING (SIZE(8)),
      po16-r14              BIT STRING (SIZE(16)),
      ...
    }
  }
}
partB-r14                 SEQUENCE {
  nprs-Period-r14          ENUMERATED { ms160, ms320, ms640, ms1280, ... , ms2560-v1510},
  nprs-startSF-r14         ENUMERATED { zero, one-eighth, two-eighths, three-eighths,
    four-eighths, five-eighths, six-eighths,
    seven-eighths, ...},
  nprs-NumSF-r14           ENUMERATED { sf10, sf20, sf40, sf80, sf160, sf320,
    sf640, sf1280, ... , sf2560-v1510},
  nprs-MutingInfoB-r14    CHOICE {
    po2-r14                BIT STRING (SIZE(2)),
    po4-r14                BIT STRING (SIZE(4)),
    po8-r14                BIT STRING (SIZE(8)),
    po16-r14               BIT STRING (SIZE(16)),
    ...
  }
}
[[ sibi-SF-TDD-r15         ENUMERATED {sf0, sf4, sf0and5}    OPTIONAL -- Cond SIB1-TDD
]]
}
...
[[
partA-TDD-r15             SEQUENCE {
  nprsBitmap-r15         CHOICE {
    subframePattern10-TDD-r15  BIT STRING (SIZE (8)),
    subframePattern40-TDD-r15  BIT STRING (SIZE (32)),
    ...
  },
  nprs-MutingInfoA-r15   CHOICE {
    po2-r15                BIT STRING (SIZE(2)),
    po4-r15                BIT STRING (SIZE(4)),
    po8-r15                BIT STRING (SIZE(8)),
}

```

```

        pol16-r15          BIT STRING (SIZE(16)),
        ...
    }
    ...
}
]]
}
maxCarrier-r14  INTEGER ::= 5
-- ASN1STOP
    
```

Conditional presence	Explanation
<i>Standalone/Guardband</i>	This field is mandatory present, if the NPRS is configured in standalone or guardband operation mode. Otherwise it is not present.
<i>Inband</i>	This field is mandatory present, if the NPRS is configured within the LTE spectrum allocation (inband deployment) and the LTE carrier frequency is not provided in the assistance data. Otherwise it is not present.
<i>NPRS-ID</i>	The field is mandatory present, if the NPRS is generated based on the NPRS-ID (TS 36.211 [16]), different from the PCI. Otherwise the field is not present.
<i>MutingA</i>	The field is mandatory present, if muting is used for the NPRS Part A or Part A TDD configuration. Otherwise the field is not present.
<i>PartA</i>	The field is mandatory present, if NPRS is configured based on a bitmap of subframes which are not NB-IoT DL subframes (i.e., invalid DL subframes) (Part A configuration). Otherwise the field is not present. This field is not applicable for NB-IoT operating in TDD mode.
<i>MutingB</i>	The field is mandatory present, if muting is used for the NPRS Part B configuration. Otherwise the field is not present.
<i>PartB</i>	The field is mandatory present, if NPRS is configured based on a NPRS period, a NPRS subframe offset, and a number of consecutive NPRS downlink subframes per positioning occasion (Part B configuration). Otherwise the field is not present. If NPRS configuration Part A and Part B are both configured, then a subframe contains NPRS if both configurations indicate that it contains NPRS.
<i>PartA-TDD</i>	The field is mandatory present, if NPRS is configured for NB-IoT operating in TDD mode and if NPRS is configured based on a bitmap of subframes which are not NB-IoT DL subframes (i.e., invalid DL subframes) (Part A TDD configuration). Otherwise the field is not present.
<i>SIB1-TDD</i>	The field is mandatory present, if NPRS is configured for NB-IoT operating in TDD mode and if SIB1-NB is transmitted on this carrier frequency. Otherwise the field is not present.

PRs-Info-NB field descriptions
<p>operationModeInfoNPRS This field specifies the operation mode of the NPRS carrier. The value 'standalone' indicates standalone or guardband operation mode.</p>
<p>nprs-carrier This field specifies the NB-IoT carrier frequency for the NPRS.</p>
<p>nprsSequenceInfo This field specifies the index of the PRB containing the NPRS as defined in the table <i>nprsSequenceInfo</i> to E-UTRA PRB index relation below.</p>
<p>nprsID This field specifies the NPRS-ID as defined in TS 36.211 [16].</p>
<p>sib1-SF-TDD This field indicates the subframe(s) used to transmit SIB1-NB. Values <i>sf0</i> and <i>sf4</i> correspond with subframe #0 and #4 respectively. Value <i>sf0and5</i> corresponds with subframes #0 and #5.</p>
<p>subframePattern10, subframePattern40 This field specifies the NPRS subframe Part A configuration over 10 ms or 40 ms. Subframes not containing NPRS are indicated with value '0' in the bitmap; subframes containing NPRS are indicated with value '1' in the bitmap. The first/leftmost bit corresponds to the subframe #0 of the radio frame satisfying SFN mod x = 0, where x is the size of the bit string divided by 10.</p>

PRS-Info-NB field descriptions	
<i>nprs-MutingInfoA</i>	<p>This field specifies the NPRS muting configuration of the NB-IoT carrier Part A configuration. The NPRS muting configuration is defined by a periodic NPRS muting sequence with periodicity T_{REP} where T_{REP}, counted in the number of NPRS positioning occasions, can be 2, 4, 8, or 16 which is also the length of the selected bit string that represents this NPRS muting sequence. If a bit in the NPRS muting sequence is set to '0', then the NPRS is muted in the corresponding NPRS positioning occasion. A NPRS positioning occasion for Part A comprises one radio frame (i.e., 10 subframes). The first/leftmost bit of the NPRS muting sequence corresponds to the first NPRS positioning occasion that starts after the beginning of the NB-IoT assistance data reference cell SFN=0. The sequence is valid for all subframes after the target device has received the <i>nprs-MutingInfoA</i>.</p> <p>When the SFN of the NB-IoT assistance data reference cell is not known to the target device and <i>nprs-MutingInfoA</i> is provided for a cell in the <i>OTDOA-NeighbourCellInfoListNB</i> IE, the target device may assume no NPRS is transmitted by that cell.</p>
<i>nprs-Period</i>	<p>This field specifies the NPRS occasion period T_{NPRS} (TS 36.211 [16]). Enumerated values correspond to 160 ms, 320 ms, 640 ms, 1280 ms, and 2560 ms. The value <i>ms2560</i> is only applicable to TDD mode.</p>
<i>nprs-startSF</i>	<p>This field specifies the subframe offset α_{NPRS} (TS 36.211 [16]). Enumerated values correspond to α of 0, 1/8, 2/8, 3/8, 4/8, 5/8, 6/8, or 7/8.</p>
<i>nprs-NumSF</i>	<p>This field specifies the number of consecutive downlink subframes N_{NPRS} in one NPRS positioning occasion (TS 36.211 [16]). Enumerated values correspond to 10, 20, 40, 80, 160, 320, 640, 1280, and 2560 subframes. The values <i>sf10</i> and <i>sf20</i> are only applicable to FDD mode. The value <i>sf2560</i> is only applicable to TDD mode.</p> <p>When the target device receives a <i>nprs-NumSF</i> which exceeds the <i>nprs-Period</i> (i.e., $N_{NPRS} > T_{NPRS}$), the target device may assume no NPRS is transmitted by that cell.</p>
<i>nprs-MutingInfoB</i>	<p>This field specifies the NPRS muting configuration of the NB-IoT carrier Part B configuration. The NPRS muting configuration is defined by a periodic NPRS muting sequence with periodicity T_{REP} where T_{REP}, counted in the number of NPRS positioning occasions, can be 2, 4, 8, or 16 which is also the length of the selected bit string that represents this NPRS muting sequence. If a bit in the NPRS muting sequence is set to '0', then the NPRS is muted in the corresponding NPRS positioning occasion. A NPRS positioning occasion for Part B comprises N_{NPRS} consecutive downlink positioning subframes, where N_{NPRS} is given by the <i>nprs-NumSF</i> field. The first/leftmost bit of the NPRS muting sequence corresponds to the first NPRS positioning occasion that starts after the beginning of the NB-IoT assistance data reference cell SFN=0. The sequence is valid for all subframes after the target device has received the <i>nprs-MutingInfoB</i>.</p> <p>When the SFN of the NB-IoT assistance data reference cell is not known to the UE and <i>nprs-MutingInfoB</i> is provided for a cell in the <i>OTDOA-NeighbourCellInfoListNB</i> IE, the target device may assume no NPRS is transmitted by that cell.</p> <p>When the UE receives a T_{REP}-bit muting pattern together with a NPRS periodicity T_{NPRS} for the same carrier which exceeds 10240 subframes (i.e., $T_{REP} \times T_{NPRS} > 10240$ subframes), the target device shall assume an n-bit muting pattern based on the first n bits, where $n = 10240/T_{NPRS}$.</p>
<i>subframePattern10-TDD, subframePattern40-TDD</i>	<p>This field specifies the NPRS subframe Part A configuration for TDD over 10 ms or 40 ms. The UE shall assume that subframe number 1 and 2 are not used for NPRS. The MSB of the NPRS bitmap corresponds to subframe 0, the second MSB corresponds to subframe 3, the third MSB corresponds to subframe 4 and so on, as also shown in Figure NPRS bitmap to subframe number mapping below.</p>

***nprsSequenceInfo* to E-UTRA PRB index relation**

<i>nprsSequenceInfo</i>	E-UTRA PRB index n'_{PRB} for odd number of N_{RB}^{DL} [16]	<i>nprsSequenceInfo</i>	E-UTRA PRB index n'_{PRB} for even number of N_{RB}^{DL} [16]
0 - 74	-37, -36, ..., 37	75 - 174	-50, -49, ..., 49

NOTE: Based on the above relation, in inband deployment, the carrier frequency of the NPRS carrier (f_{NB-IoT}) can be calculated as follows:

$$f_{NB-IoT} = \begin{cases} f_{EUTRA} + 7.5 + 180 \cdot n'_{PRB} & \text{if } nprsSequenceInfo \leq 74 \text{ and } n'_{PRB} > 0 \\ f_{EUTRA} - 7.5 + 180 \cdot n'_{PRB} & \text{if } nprsSequenceInfo \leq 74 \text{ and } n'_{PRB} < 0 \\ f_{EUTRA} + 180 \cdot n'_{PRB} & \text{if } nprsSequenceInfo \leq 74 \text{ and } n'_{PRB} = 0 \\ f_{EUTRA} + 97.5 + 180 \cdot n'_{PRB} & \text{if } nprsSequenceInfo \geq 75 \text{ and } n'_{PRB} \geq 0 \\ f_{EUTRA} - 97.5 + 180 \cdot (n'_{PRB} + 1) & \text{if } nprsSequenceInfo \geq 75 \text{ and } n'_{PRB} < 0 \end{cases}$$

where f_{EUTRA} is derived from $earfcn$ according to TS 36.101 [21, 5.7.3].

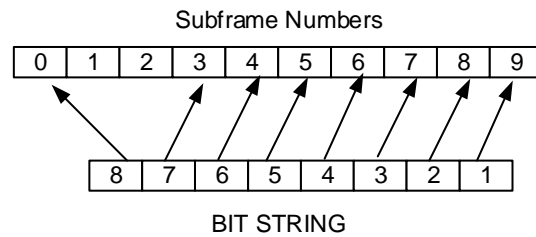

Figure 6.5.1.2-1: NPRS bitmap to subframe number mapping

– OTDOA-NeighbourCellInfoListNB

The IE *OTDOA-NeighbourCellInfoListNB* is used by the location server to provide NB-IoT neighbour cell information for OTDOA assistance data.

```
-- ASN1START
OTDOA-NeighbourCellInfoListNB-r14 ::= SEQUENCE (SIZE (1..maxCells-r14)) OF
    OTDOA-NeighbourCellInfoNB-r14

OTDOA-NeighbourCellInfoNB-r14 ::= SEQUENCE {
    physCellIdNB-r14          INTEGER (0..503)          OPTIONAL,      -- Cond NoPRS-AD1
    cellGlobalIdNB-r14       ECGI                      OPTIONAL,      -- Cond NoPRS-AD2
    carrierFreq-r14          CarrierFreq-NB-r14        OPTIONAL,      -- Cond NotSameAsRef1
    earfcn-r14               ARFCN-ValueEUTRA-r14     OPTIONAL,      -- Cond Inband
    eutra-NumCRS-Ports-r14   ENUMERATED {ports-1-or-2, ports-4, ...}
                                                                    OPTIONAL,      -- Cond NotsameAsRef2
    otdoa-SIB1-NB-repetitions-r14
                                                                    ENUMERATED { r4, r8, r16 }
                                                                    OPTIONAL,      -- Cond NotSameAsRef3
    nprsInfo-r14              PRS-Info-NB-r14          OPTIONAL,      -- Cond NotsameAsRef4
    nprs-slotNumberOffset-r14 INTEGER (0..19)          OPTIONAL,      -- Cond NotsameAsRef5
    nprs-SFN-Offset-r14      INTEGER (0..63)          OPTIONAL,      -- Cond NotsameAsRef6
    nprs-SubframeOffset-r14  INTEGER (0..1279)        OPTIONAL,      -- Need OP
    expectedRSTD-r14         INTEGER (0..16383)       OPTIONAL,      -- Cond NoPRS-AD3
    expectedRSTD-Uncertainty-r14
                                                                    INTEGER (0..1023)
                                                                    OPTIONAL,      -- Cond NoPRS-AD3
    prsNeighbourCellIndex-r14 INTEGER (1..72)          OPTIONAL,      -- Cond PRS-AD
    ...,
    [[
    nprsInfo-Type2-v1470     PRS-Info-NB-r14          OPTIONAL      -- Cond NotSameAsRef4
    ]],
    [[ tdd-config-r15       TDD-Config-v1520          OPTIONAL      -- Need ON
    ]]
}

maxCells-r14    INTEGER ::= 72

-- ASN1STOP
```

Conditional presence	Explanation
<i>NoPRS-AD1</i>	This field is mandatory present if the <i>OTDOA-NeighbourCellInfoList</i> IE is not included in <i>OTDOA-ProvideAssistanceData</i> , or if the <i>OTDOA-NeighbourCellInfoList</i> IE is included in <i>OTDOA-ProvideAssistanceData</i> and the narrowband physical layer cell identity of this cell is not the same as the physical cell identity of the corresponding cell (as indicated by <i>prsNeighbourCellIndex</i>) in <i>OTDOA-NeighbourCellInfoList</i> IE.
<i>NoPRS-AD2</i>	This field is optionally present, need ON, if the <i>OTDOA-NeighbourCellInfoList</i> IE is not included in <i>OTDOA-ProvideAssistanceData</i> , or if the <i>OTDOA-NeighbourCellInfoList</i> IE is included in <i>OTDOA-ProvideAssistanceData</i> and the global cell identity of this cell is not the same as for the corresponding cell (as indicated by <i>prsNeighbourCellIndex</i>) in <i>OTDOA-NeighbourCellInfoList</i> IE.
<i>Inband</i>	This field is mandatory present, if the NPRS is configured within the LTE spectrum allocation (inband deployment). Otherwise it is not present.
<i>NotSameAsRef1</i>	The field is mandatory present if the carrier frequency is not the same as for the NB-IoT assistance data reference cell; otherwise it is not present.
<i>NotSameAsRef2</i>	The field is mandatory present if this cell is deployed within the LTE spectrum allocation (inband deployment) and if the number of E-UTRA CRS antenna ports is not the same as for the NB-IoT assistance data reference cell; otherwise it is not present.
<i>NotSameAsRef3</i>	This field is mandatory present if NPRS configuration Part B only is configured on this neighbour cell, and if the repetition number of SIB1-NB of this neighbor cell is not the same as the repetition number of SIB1-NB of the NB-IoT assistance data reference cell. Otherwise it is not present.
<i>NotSameAsRef4</i>	The field is mandatory present, if the NPRS configuration is not the same as for the NB-IoT assistance data reference cell; otherwise it is not present.
<i>NotSameAsRef5</i>	The field is mandatory present if the slot timing is not the same as for the NB-IoT assistance data reference cell; otherwise it is not present.
<i>NotSameAsRef6</i>	The field is mandatory present if the frame timing is not the same as for the NB-IoT assistance data reference cell; otherwise it is not present.
<i>NoPRS-AD3</i>	This field is mandatory present if the <i>OTDOA-NeighbourCellInfoList</i> IE is not included in <i>OTDOA-ProvideAssistanceData</i> , or if the <i>OTDOA-NeighbourCellInfoList</i> IE is included in <i>OTDOA-ProvideAssistanceData</i> and <i>prsNeighbourCellIndex</i> is absent for this cell.
<i>PRS-AD</i>	This field is optionally present, need OP, if the <i>OTDOA-NeighbourCellInfoList</i> IE is included in <i>OTDOA-ProvideAssistanceData</i> ; otherwise it is not present.

OTDOA-NeighbourCellInfoListNB field descriptions
<p>physCellIdNB This field specifies the narrowband physical cell identity of the NB-IoT neighbour cell, as defined in TS 36.331 [12]. If this field is absent and if the <i>OTDOA-NeighbourCellInfoList</i> IE is included in <i>OTDOA-ProvideAssistanceData</i> the narrowband physical layer cell identity is the same as the <i>physCellId</i> provided for the corresponding cell (as indicated by <i>prsNeighbourCellIndex</i>) in <i>OTDOA-NeighbourCellInfoList</i> IE.</p>
<p>cellGlobalIdNB This field specifies the global cell ID of the NB-IoT neighbour cell, as defined in TS 36.331 [12]. If this field is absent and if the <i>OTDOA-NeighbourCellInfoList</i> IE with <i>cellGlobalId</i> is included in <i>OTDOA-ProvideAssistanceData</i>, the global cell identity of the NB-IoT neighbour cell is the same as provided for the corresponding cell (as indicated by <i>prsNeighbourCellIndex</i>) in <i>OTDOA-NeighbourCellInfoList</i> IE.</p>
<p>carrierFreq This field specifies the carrier frequency of the NB-IoT neighbour cell.</p>
<p>earfcn This field specifies the EARFCN of the E-UTRAN frequency, in which the NB-IoT cell is deployed.</p>
<p>eutra-NumCRS-Ports This field specifies whether 1 (or 2) antenna port(s) or 4 antenna ports for cell specific reference signals are used.</p>
<p>otdoa-SIB1-NB-repetitions This field specifies the repetition number of SIB1-NB of the neighbour cell. Enumerated values r4 correspond to 4 repetitions, r8 to 8 repetitions, and r16 to 16 repetitions. Note, when NPRS configuration Part B only is configured on this NB-IoT neighbour cell (i.e., anchor carrier), <i>nprs-NumSF</i> does also count/include subframes containing NPSS, NSSS, NPBCH, or SIB1-NB, but the UE can assume that no NPRS are transmitted in these subframes (TS 36.211 [16]).</p>

OTDOA-NeighbourCellInfoListNB field descriptions
<p>nprsInfo This field specifies the Type 1 NPRS (TS 36.211 [16]) configuration of the NB-IoT neighbour cell.</p> <p>When the carrier frequency of the NB-IoT neighbour cell is the same as for the NB-IoT assistance data reference cell, the target device may assume that each NPRS positioning occasion for each NPRS carrier frequency in the neighbour cell at least partially overlaps with a NPRS positioning occasion for each NPRS carrier frequency in the NB-IoT assistance data reference cell where the maximum offset between the transmitted NPRS positioning occasions may be assumed to not exceed half a subframe.</p> <p>When the carrier frequency of the neighbour cell is the same as for the NB-IoT assistance data reference cell, and NPRS configuration Part B is configured, the target may assume that this cell has the same NPRS periodicity (T_{NPRS}) as the assistance data reference cell for each NPRS carrier frequency.</p> <p>When the target device receives this field with <i>operationModelInfoNPRS</i> set to value 'standalone', the target device shall assume no NPRS are transmitted on that NB-IoT carrier.</p>
<p>nprs-slotNumberOffset This field specifies the slot number offset at the transmitter between this cell and the NB-IoT assistance data reference cell. The offset corresponds to the number of full slots counted from the beginning of a radio frame of the NB-IoT assistance data reference cell to the beginning of the closest subsequent radio frame of this cell. If this field is absent, the slot timing is the same as for the NB-IoT assistance data reference cell.</p>
<p>nprs-SFN-Offset This field specifies the SFN offset (modulo 64) at the transmitter between this cell and the NB-IoT assistance data reference cell. The offset corresponds to the number of full radio frames counted from the beginning of a radio frame #0 of the NB-IoT assistance data reference cell to the beginning of the closest subsequent radio frame #0 of this cell. The UE may use this field together with the <i>nprs-slotNumberOffset</i> and <i>otdoa-SIB1-NB-repetitions</i> to determine the SIB1-NB subframes of this neighbour cell.</p>
<p>nprs-SubframeOffset This field specifies the offset between the first NPRS subframe in the NB-IoT assistance data reference cell (NOTE 1) and the first NPRS subframe in the closest subsequent NPRS positioning occasion of the NPRS carrier with the longest NPRS periodicity of this cell (NOTE 2). The value is given in number of full sub-frames. If this field is not present, the receiver shall consider the NPRS subframe offset to be 0.</p>
<p>expectedRSTD This field indicates the RSTD value that the target device is expected to measure between this cell and the NB-IoT assistance data reference cell. The <i>expectedRSTD</i> field takes into account the expected propagation time difference as well as transmit time difference of NPRS positioning occasions between the two cells. The RSTD value can be negative and is calculated as (<i>expectedRSTD</i>-8192). The resolution is $3 \times T_s$, with $T_s = 1/(15000 \times 2048)$ seconds. If this field is absent and if the <i>OTDOA-NeighbourCellInfoList</i> IE is included in <i>OTDOA-ProvideAssistanceData</i>, the expected RSTD is the same as provided in <i>OTDOA-NeighbourCellInfoList</i> IE for the corresponding cell (as indicated by <i>prsNeighbourCellIndex</i>).</p>
<p>expectedRSTD-Uncertainty This field indicates the uncertainty in <i>expectedRSTD</i> value. The uncertainty is related to the location server's a-priori estimation of the target device location. The <i>expectedRSTD</i> and <i>expectedRSTD-Uncertainty</i> together define the search window for the target device.</p> <p>The scale factor of the <i>expectedRSTD-Uncertainty</i> field is $3 \times T_s$, with $T_s = 1/(15000 \times 2048)$ seconds.</p> <p>If this field is absent and if the <i>OTDOA-NeighbourCellInfoList</i> IE is included in <i>OTDOA-ProvideAssistanceData</i>, the expected RSTD uncertainty is the same as provided in <i>OTDOA-NeighbourCellInfoList</i> IE for the corresponding cell (as indicated by <i>prsNeighbourCellIndex</i>).</p> <p>The target device may assume that the beginning of the NPRS positioning occasion of the NPRS carrier with the longest NPRS periodicity of the neighbour cell (NOTE 2) is received within the search window of size $[-\text{expectedRSTD-Uncertainty} \times 3 \times T_s, \text{expectedRSTD-Uncertainty} \times 3 \times T_s]$ centred at $T_{REF} + 1 \text{ millisecond} \times N + (\text{expectedRSTD} - 8192) \times 3 \times T_s$, where T_{REF} is the reception time of the beginning of the NPRS positioning occasion of the NB-IoT assistance data reference cell (NOTE 1) at the target device antenna connector, and $N = \text{nprs-SubframeOffset}$.</p>

OTDOA-NeighbourCellInfoListNB field descriptions
<p>prsNeighbourCellIndex This field contains an index of the entry in IE <i>OTDOA-NeighbourCellInfoList</i>. Value 1 corresponds to the first cell in <i>OTDOA-NeighbourCellInfoList</i>, value 2 to the second, and so on. If this field is absent, and if the <i>OTDOA-NeighbourCellInfoList</i> IE is included in <i>OTDOA-ProvideAssistanceData</i>, it means there is no corresponding cell in <i>OTDOA-NeighbourCellInfoList</i> IE for this cell. The target device may assume the antenna ports of the PRS of the cell indicated by <i>prsNeighbourCellIndex</i> and the NPRS of this cell are quasi co-located, as defined in TS 36.211 [16].</p>
<p>nprsInfo-Type2 This field specifies the Type 2 NPRS (TS 36.211 [16]) configuration of the NB-IoT neighbour cell.</p>
<p>tdd-config Indicates the TDD specific physical channel configuration of the NB-IoT assistance data neighbour cell operating in TDD mode. This field should be present if the DL/UL subframe configuration of the NB-IoT assistance data neighbour cell is not the same as for the NB-IoT assistance data reference cell, or if the current serving NB-IoT cell of the target device operates in FDD mode.</p>

NOTE 1: If the NB-IoT assistance data reference cell (i.e., anchor carrier) has no NPRS configured, the first NPRS carrier in *PRS-Info-NB* is referenced.

NOTE 2: "Cell" in this context may not necessarily be the anchor carrier. If this "cell" has more than one NPRS carrier with equal longest periodicity, the first such NPRS carrier in *PRS-Info-NB* is referenced. The length of a NPRS positioning occasion for Part A in this context is the length of the *nprsBitmap* bit string.

6.5.1.3 OTDOA Assistance Data Request

– *OTDOA-RequestAssistanceData*

The IE *OTDOA-RequestAssistanceData* is used by the target device to request assistance data from a location server.

```
-- ASN1START
OTDOA-RequestAssistanceData ::= SEQUENCE {
    physCellId          INTEGER (0..503),
    ...,
    [[
        adType-r14      BIT STRING { prs (0), nprs (1) } (SIZE (1..8))      OPTIONAL
    ]],
    [[
        nrPhysCellId-r15  INTEGER (0..1007)                                OPTIONAL
    ]]
}
-- ASN1STOP
```

OTDOA-RequestAssistanceData field descriptions
<p>physCellId This field specifies the E-UTRA physical cell identity of the current primary cell of the target device.</p>
<p>adType This field specifies the assistance data requested. This is represented by a bit string, with a one-value at the bit position means the particular assistance data is requested; a zero-value means not requested. Bit 0 indicates that PRS assistance data are requested, bit 1 indicates that NPRS assistance data are requested.</p>
<p>nrPhysCellId This field specifies the NR physical cell identity of the current primary cell of the target device. If this field is present, the target device sets the <i>physCellId</i> to an arbitrary value which shall be ignored by the location server.</p>

6.5.1.4 OTDOA Location Information

– *OTDOA-ProvideLocationInformation*

The IE *OTDOA-ProvideLocationInformation* is used by the target device to provide OTDOA location measurements to the location server. It may also be used to provide OTDOA positioning specific error reason.

```
-- ASN1START
```



```

OTDOA-ProvideLocationInformation ::= SEQUENCE {
  otdoaSignalMeasurementInformation  OTDOA-SignalMeasurementInformation  OPTIONAL,
  otdoa-Error                        OTDOA-Error                        OPTIONAL,
  . . . ,
  [[
    otdoaSignalMeasurementInformation-NB-r14  OTDOA-SignalMeasurementInformation-NB-r14
                                               OPTIONAL
  ]]
}
-- ASN1STOP

```

6.5.1.5 OTDOA Location Information Elements

– *OTDOA-SignalMeasurementInformation*

The IE *OTDOA-SignalMeasurementInformation* is used by the target device to provide RSTD measurements to the location server. The RSTD measurements are provided for a neighbour cell and the RSTD reference cell, both of which are provided in the IE *OTDOA-ProvideAssistanceData*. The RSTD reference cell may or may not be the same as the assistance data reference cell provided in *OTDOA-ReferenceCellInfo* or *OTDOA-ReferenceCellInfoNB*. If the target device stops reporting inter-frequency RSTD measurements, where the inter-frequency RSTD measurement is an OTDOA RSTD measurement with at least one cell on a frequency different from the serving cell frequency, the LPP layer shall inform lower layers that inter-frequency RSTD measurements are stopped.

NOTE 1: If there are more than 24 *NeighbourMeasurementElement* to be sent, the target device may send them in multiple *ProvideLocationInformation* messages, as described under clause 5.3.

NOTE 2: If NPRS/PRS antenna ports are quasi co-located, the target device provides a single RSTD measurement for the quasi co-located antenna ports of NPRS/PRS.

```

-- ASN1START
OTDOA-SignalMeasurementInformation ::= SEQUENCE {
  systemFrameNumber      BIT STRING (SIZE (10)),
  physCellIdRef          INTEGER (0..503),
  cellGlobalIdRef        ECGI                OPTIONAL,
  earfcnRef              ARFCN-ValueEUTRA    OPTIONAL,      -- Cond NotSameAsRef0
  referenceQuality       OTDOA-MeasQuality   OPTIONAL,
  neighbourMeasurementList NeighbourMeasurementList,
  . . . ,
  [[ earfcnRef-v9a0       ARFCN-ValueEUTRA-v9a0  OPTIONAL      -- Cond NotSameAsRef1
  ]],
  [[ tpIdRef-r14         INTEGER (0..4095)        OPTIONAL,      -- Cond ProvidedByServer0
    prsIdRef-r14         INTEGER (0..4095)        OPTIONAL,      -- Cond ProvidedByServer1
    additionalPathsRef-r14
                          AdditionalPathList-r14 OPTIONAL,
    nprsIdRef-r14        INTEGER (0..4095)        OPTIONAL,      -- Cond ProvidedByServer2
    carrierFreqOffsetNB-Ref-r14
                          CarrierFreqOffsetNB-r14 OPTIONAL,    -- Cond NB-IoT
    hyperSFN-r14         BIT STRING (SIZE (10))  OPTIONAL      -- Cond H-SFN
  ]],
  [[
  [[
    motionTimeSource-r15      MotionTimeSource-r15      OPTIONAL
  ]]]
}

NeighbourMeasurementList ::= SEQUENCE (SIZE(1..24)) OF NeighbourMeasurementElement

NeighbourMeasurementElement ::= SEQUENCE {
  physCellIdNeighbour      INTEGER (0..503),
  cellGlobalIdNeighbour    ECGI                OPTIONAL,
  earfcnNeighbour          ARFCN-ValueEUTRA    OPTIONAL,      -- Cond NotSameAsRef2
  rstd                     INTEGER (0..12711),
  rstd-Quality             OTDOA-MeasQuality,
  . . . ,
  [[ earfcnNeighbour-v9a0   ARFCN-ValueEUTRA-v9a0  OPTIONAL      -- Cond NotSameAsRef3
  ]],
  [[ tpIdNeighbour-r14     INTEGER (0..4095)        OPTIONAL,      -- Cond ProvidedByServer0
    prsIdNeighbour-r14     INTEGER (0..4095)        OPTIONAL,      -- Cond ProvidedByServer1
    delta-rstd-r14         INTEGER (0..5)          OPTIONAL,
    additionalPathsNeighbour-r14
                          AdditionalPathList-r14 OPTIONAL,

```

```

        nprsIdNeighbour-r14 INTEGER (0..4095)          OPTIONAL,          -- Cond ProvidedByServer2
        carrierFreqOffsetNB-Neighbour-r14
            CarrierFreqOffsetNB-r14 OPTIONAL          -- Cond NB-IoT
    ]],
    [[
        delta-SFN-r15          INTEGER (-8192..8191)  OPTIONAL
    ]]
}

AdditionalPathList-r14 ::= SEQUENCE (SIZE(1..maxPaths-r14)) OF AdditionalPath-r14

maxPaths-r14    INTEGER ::= 2

MotionTimeSource-r15 ::= SEQUENCE {
    timeSource-r15          ENUMERATED {servingCell, referenceCell, gnss, mixed,
                                        other, none, ...}
}

-- ASN1STOP

```

Conditional presence	Explanation
<i>NotSameAsRef0</i>	The field is absent if the corresponding <i>earfcnRef-v9a0</i> is present. Otherwise, the target device shall include this field if the EARFCN of the RSTD reference cell is not the same as the EARFCN of the assistance data reference cell provided in the OTDOA assistance data.
<i>NotSameAsRef1</i>	The field is absent if the corresponding <i>earfcnRef</i> is present. Otherwise, the target device shall include this field if the EARFCN of the RSTD reference cell is not the same as the EARFCN of the assistance data reference cell provided in the OTDOA assistance data.
<i>NotSameAsRef2</i>	The field is absent if the corresponding <i>earfcnNeighbour-v9a0</i> is present. Otherwise, the target device shall include this field if the EARFCN of this neighbour cell is not the same as the <i>earfcnRef</i> for the RSTD reference cell.
<i>NotSameAsRef3</i>	The field is absent if the corresponding <i>earfcnNeighbour</i> is present. Otherwise, the target device shall include this field if the EARFCN of this neighbour cell is not the same as the <i>earfcnRef</i> for the RSTD reference cell.
<i>ProvidedByServer0</i>	The target device shall include this field if a <i>tpld</i> for this transmission point is included in the <i>OTDOA-ProvideAssistanceData</i> . Otherwise the field is absent.
<i>ProvidedByServer1</i>	The target device shall include this field if a <i>prsid</i> for this transmission point is included in the <i>OTDOA-ProvideAssistanceData</i> . Otherwise the field is absent.
<i>ProvidedByServer2</i>	The target device shall include this field if an <i>nprsID</i> for this cell is included in the <i>OTDOA-ProvideAssistanceData</i> and if this cell is a NB-IoT only cell (without associated LTE PRS cell). Otherwise the field is absent.
<i>NB-IoT</i>	The target device shall include this field if the cell is a NB-IoT only cell (without associated LTE PRS cell). Otherwise the field is absent.
<i>H-SFN</i>	The target device shall include this field if it was able to determine a hyper SFN of the RSTD reference cell.

OTDOA-SignalMeasurementInformation field descriptions
<p>systemFrameNumber</p> <p>If the <i>delta-SFN</i> and <i>motionTimeSource</i> fields are not present, this field specifies the SFN of the RSTD reference cell containing the starting subframe of the PRS or NPRS positioning occasion if PRS or NPRS are available on the RSTD reference cell, or subframe of the CRS for RSTD measurements if PRS and NPRS are not available on the RSTD reference cell during which the most recent neighbour cell RSTD measurement was performed. In the case of more than a single PRS configuration on the RSTD reference cell, the first PRS configuration is referenced.</p> <p>If the <i>delta-SFN</i> and <i>motionTimeSource</i> fields are present, this field specifies the SFN of the RSTD reference cell when the TOA measurement for the RSTD reference cell has been made.</p>
<p>physCellIdRef</p> <p>This field specifies the physical cell identity of the RSTD reference cell.</p>
<p>cellGlobalIdRef</p> <p>This field specifies the ECGI, the globally unique identity of a cell in E-UTRA, of the RSTD reference cell. The target shall provide this IE if it knows the ECGI of the RSTD reference cell.</p>
<p>earfcnRef</p> <p>This field specifies the EARFCN of the RSTD reference cell.</p>

OTDOA-SignalMeasurementInformation field descriptions
<p>referenceQuality This field specifies the target device's best estimate of the quality of the TOA measurement from the RSTD reference cell, $T_{\text{SubframeRxRef}}$, where $T_{\text{SubframeRxRef}}$ is the time of arrival of the signal from the RSTD reference cell. When <i>delta-SFN</i> and <i>motionTimeSource</i> are both included, the target device shall not include measurement errors caused by motion of the target device in <i>referenceQuality</i> (e.g. the target device may assume the target device was stationary during OTDOA measurements).</p>
<p>neighbourMeasurementList This list contains the measured RSTD values for neighbour cells together with the RSTD reference cell, along with quality for each measurement.</p>
<p>tpldRef This field specifies the transmission point ID of the RSTD reference cell.</p>
<p>prslidRef This field specifies the PRS-ID of the first PRS configuration of the RSTD reference cell.</p>
<p>additionalPathsRef This field specifies one or more additional detected path timing values for the RSTD reference cell, relative to the path timing used for determining the <i>rstd</i> value. If this field was requested but is not included, it means the UE did not detect any additional path timing values.</p>
<p>nprslidRef This field specifies the NPRS-ID of the RSTD reference cell.</p>
<p>carrierFreqOffsetNB-Ref This field specifies the offset of the NB-IoT channel number to EARFCN given by <i>earfcnRef</i> as defined in TS 36.101 [21].</p>
<p>hyperSFN This field specifies the hyper SFN as defined in TS 36.331 [12] of the RSTD reference cell for the <i>systemFrameNumber</i>.</p>
<p>motionTimeSource This field provides reference information concerning the movement of the target device and comprises the following subfields:</p> <ul style="list-style-type: none"> - timeSource specifies the external time source to which UE time was locked during the OTDOA measurements. Enumerated value "mixed" indicates that UE time was locked to more than one external time source during OTDOA measurements (e.g. is applicable to a change in serving cell when the serving cell was used as a time source). The value "other" indicates some other external time source. The value "none" indicates that UE time was not locked to an external time source. <p>If this field is present, the target device shall also provide the IE <i>Sensor-MotionInformation</i> in IE <i>Sensor-ProvideLocationInformation</i>.</p>
<p>physCellIdNeighbour This field specifies the physical cell identity of the neighbour cell for which the RSTDs are provided.</p>
<p>cellGlobalIdNeighbour This field specifies the ECGI, the globally unique identity of a cell in E-UTRA, of the neighbour cell for which the RSTDs are provided. The target device shall provide this IE if it was able to determine the ECGI of the neighbour cell at the time of measurement.</p>
<p>earfcnNeighbour This field specifies the EARFCN of the neighbour cell used for the RSTD measurements.</p>
<p>rstd This field specifies the relative timing difference between this neighbour cell and the RSTD reference cell, as defined in TS 36.214 [17]. Mapping of the measured quantity is defined as in TS 36.133 [18] clause 9.1.10.3.</p>
<p>rstd-Quality This field specifies the target device's best estimate of the quality of the measured <i>rstd</i>. When <i>delta-SFN</i> and <i>motionTimeSource</i> both included, the target device shall not include measurement errors caused by motion of the target device in <i>rstd-Quality</i> (e.g. the target device may assume the target device was stationary during OTDOA measurements).</p>
<p>tpldNeighbour This field specifies the transmission point ID for the neighbour cell for which the RSTDs are provided.</p>
<p>prslidNeighbour This field specifies the PRS-ID of the first PRS configuration of the neighbour cell for which the RSTDs are provided.</p>
<p>delta-rstd This field specifies the higher-resolution RSTD Δ_{RSTD} as defined in TS 36.133 [18] clause 9.1.10.4. Mapping of the measured quantity is defined as in TS 36.133 [18] clause 9.1.10.4.</p>

OTDOA-SignalMeasurementInformation field descriptions
<p>additionalPathsNeighbour This field specifies one or more additional detected path timing values for the neighbour cell, relative to the path timing used for determining the <i>rstd</i> value. If this field was requested but is not included, it means the UE did not detect any additional path timing values.</p>
<p>nprsdNeighbour This field specifies the NPRS-ID of the neighbour cell for which the RSTDs are provided.</p>
<p>carrierFreqOffsetNB-Neighbour This field specifies the offset of the NB-IoT channel number to EARFCN given by <i>earfcnNeighbour</i> as defined in TS 36.101 [21].</p>
<p>delta-SFN This field provides information concerning the movement of the target device: Together with <i>systemFrameNumber</i> specifies the <i>measurementSFN</i> of the RSTD reference cell when the TOA measurement for this neighbour cell has been made for determining the <i>rstd</i>. The <i>measurementSFN</i> is given by <i>systemFrameNumber</i> + <i>delta-SFN</i>. (The actual SFN is the <i>measurementSFN</i> modulo 1024.). The <i>measurementSFN</i> is used in IE <i>Sensor-MotionInformation</i> to provide movement information corresponding to the TOA measurement time. If this field is present, the target device shall also provide the IE <i>Sensor-MotionInformation</i> in IE <i>Sensor-ProvideLocationInformation</i>.</p>

OTDOA-SignalMeasurementInformation-NB

The IE *OTDOA-SignalMeasurementInformation-NB* is used by the target device to provide RSTD measurements to the location server. The RSTD measurements are provided for a neighbour cell and the RSTD reference cell, both of which are provided in the IE *OTDOA-ProvideAssistanceData*. The RSTD reference cell may or may not be the same as the assistance data reference cell provided in *OTDOA-ReferenceCellInfo* or *OTDOA-ReferenceCellInfoNB*. If the target device stops reporting inter-frequency RSTD measurements, where the inter-frequency RSTD measurement is an OTDOA RSTD measurement with at least one cell on a frequency different from the serving cell frequency, the LPP layer shall inform lower layers that inter-frequency RSTD measurements are stopped.

NOTE 1: If there are more than 24 *NeighbourMeasurementElement-NB* to be sent, the target device may send them in multiple *ProvideLocationInformation* messages, as described under clause 5.3.

NOTE 2: If NPRS/PRS antenna ports are quasi co-located, the target device provides a single RSTD measurement for the quasi co-located antenna ports of NPRS/PRS.

```
-- ASN1START
OTDOA-SignalMeasurementInformation-NB-r14 ::= SEQUENCE {
    systemFrameNumber-r14          BIT STRING (SIZE (10)),
    physCellIdRef-r14              INTEGER (0..503),
    cellGlobalIdRef-r14           ECGI                               OPTIONAL,
    earfcnRef-r14                  ARFCN-ValueEUTRA-r14           OPTIONAL,    -- Cond NotSameAsRef0
    referenceQuality-r14          OTDOA-MeasQuality              OPTIONAL,
    neighbourMeasurementList-r14  NeighbourMeasurementList-NB-r14,
    tpIdRef-r14                    INTEGER (0..4095)                OPTIONAL,    -- Cond ProvidedByServer0
    prsIdRef-r14                   INTEGER (0..4095)                OPTIONAL,    -- Cond ProvidedByServer1
    additionalPathsRef-r14        AdditionalPathList-r14    OPTIONAL,
    nprsdRef-r14                   INTEGER (0..4095)                OPTIONAL,    -- Cond ProvidedByServer2
    carrierFreqOffsetNB-Ref-r14   CarrierFreqOffsetNB-r14  OPTIONAL,    -- Cond NB-IoT
    hyperSFN-r14                  BIT STRING (SIZE (10))          OPTIONAL,    -- Cond H-SFN
    ...
}

NeighbourMeasurementList-NB-r14 ::= SEQUENCE (SIZE(1..24)) OF NeighbourMeasurementElement-NB-r14

NeighbourMeasurementElement-NB-r14 ::= SEQUENCE {
    physCellIdNeighbour-r14       INTEGER (0..503),
    cellGlobalIdNeighbour-r14    ECGI                               OPTIONAL,
    earfcnNeighbour-r14          ARFCN-ValueEUTRA-r14           OPTIONAL,    -- Cond NotSameAsRef2
    rstd-r14                      INTEGER (0..12711),
    rstd-Quality-r14             OTDOA-MeasQuality,
    tpIdNeighbour-r14            INTEGER (0..4095)                OPTIONAL,    -- Cond ProvidedByServer0
    prsIdNeighbour-r14           INTEGER (0..4095)                OPTIONAL,    -- Cond ProvidedByServer1
    delta-rstd-r14               INTEGER (0..5)                   OPTIONAL,
    additionalPathsNeighbour-r14 AdditionalPathList-r14    OPTIONAL,
    nprsdNeighbour-r14           INTEGER (0..4095)                OPTIONAL,    -- Cond ProvidedByServer2
    carrierFreqOffsetNB-Neighbour-r14 CarrierFreqOffsetNB-r14  OPTIONAL,    -- Cond NB-IoT

```

```

}
...
-- ASN1STOP

```

Conditional presence	Explanation
<i>NotSameAsRef0</i>	The target device shall include this field if the EARFCN of the RSTD reference cell is not the same as the EARFCN of the assistance data reference cell provided in the OTDOA assistance data.
<i>NotSameAsRef2</i>	The target device shall include this field if the EARFCN of this neighbour cell is not the same as the <i>earfcnRef</i> for the RSTD reference cell.
<i>ProvidedByServer0</i>	The target device shall include this field if a <i>tpld</i> for this transmission point is included in the <i>OTDOA-ProvideAssistanceData</i> . Otherwise the field is absent.
<i>ProvidedByServer1</i>	The target device shall include this field if a <i>prsid</i> for this transmission point is included in the <i>OTDOA-ProvideAssistanceData</i> . Otherwise the field is absent.
<i>ProvidedByServer2</i>	The target device shall include this field if an <i>nprsid</i> for this cell is included in the <i>OTDOA-ProvideAssistanceData</i> and if this cell is a NB-IoT only cell (without associated LTE PRS cell). Otherwise the field is absent.
<i>NB-IoT</i>	The target device shall include this field if the cell is a NB-IoT only cell (without associated LTE PRS cell). Otherwise the field is absent.
<i>H-SFN</i>	The target device shall include this field if it was able to determine a hyper SFN of the RSTD reference cell.

OTDOA-SignalMeasurementInformation-NB field descriptions	
<i>systemFrameNumber</i>	This field specifies the SFN of the RSTD reference cell containing the starting subframe of the PRS or NPRS positioning occasion if PRS or NPRS are available on the RSTD reference cell, or subframe of the CRS for RSTD measurements if PRS and NPRS are not available on the RSTD reference cell during which the most recent neighbour cell RSTD measurement was performed. In the case of more than a single PRS configuration on the RSTD reference cell, the first PRS configuration is referenced.
<i>physCellIdRef</i>	This field specifies the physical cell identity of the RSTD reference cell.
<i>cellGlobalIdRef</i>	This field specifies the ECGL, the globally unique identity of a cell in E-UTRA, of the RSTD reference cell. The target shall provide this IE if it knows the ECGL of the RSTD reference cell.
<i>earfcnRef</i>	This field specifies the EARFCN of the RSTD reference cell.
<i>referenceQuality</i>	This field specifies the target device's best estimate of the quality of the TOA measurement from the RSTD reference cell, $T_{\text{SubframeRxRef}}$, where $T_{\text{SubframeRxRef}}$ is the time of arrival of the signal from the RSTD reference cell.
<i>neighbourMeasurementList</i>	This list contains the measured RSTD values for neighbour cells together with the RSTD reference cell, along with quality for each measurement.
<i>tpldRef</i>	This field specifies the transmission point ID of the RSTD reference cell.
<i>prsidRef</i>	This field specifies the PRS-ID of the first PRS configuration of the RSTD reference cell.
<i>additionalPathsRef</i>	This field specifies one or more additional detected path timing values for the RSTD reference cell, relative to the path timing used for determining the <i>rstd</i> value. If this field was requested but is not included, it means the UE did not detect any additional path timing values.
<i>nprsidRef</i>	This field specifies the NPRS-ID of the RSTD reference cell.
<i>carrierFreqOffsetNB-Ref</i>	This field specifies the offset of the NB-IoT channel number to EARFCN given by <i>earfcnRef</i> as defined in TS 36.101 [21].
<i>hyperSFN</i>	This field specifies the hyper SFN as defined in TS 36.331 [12] of the RSTD reference cell for the <i>systemFrameNumber</i> .
<i>physCellIdNeighbour</i>	This field specifies the physical cell identity of the neighbour cell for which the RSTDs are provided.
<i>cellGlobalIdNeighbour</i>	This field specifies the ECGL, the globally unique identity of a cell in E-UTRA, of the neighbour cell for which the RSTDs are provided. The target device shall provide this IE if it was able to determine the ECGL of the neighbour cell at the time of measurement.

OTDOA-SignalMeasurementInformation-NB field descriptions	
<i>earfcnNeighbour</i>	This field specifies the EARFCN of the neighbour cell used for the RSTD measurements.
<i>rstd</i>	This field specifies the relative timing difference between this neighbour cell and the RSTD reference cell, as defined in TS 36.214 [17]. Mapping of the measured quantity is defined as in TS 36.133 [18] clause 9.1.10.3.
<i>rstd-Quality</i>	This field specifies the target device's best estimate of the quality of the measured <i>rstd</i> .
<i>tpldNeighbour</i>	This field specifies the transmission point ID for the neighbour cell for which the RSTDs are provided.
<i>prslidNeighbour</i>	This field specifies the PRS-ID of the first PRS configuration of the neighbour cell for which the RSTDs are provided.
<i>delta-rstd</i>	This field specifies the higher-resolution RSTD Δ_{RSTD} as defined in TS 36.133 [18] clause 9.1.10.4. Mapping of the measured quantity is defined as in TS 36.133 [18] clause 9.1.10.4.
<i>additionalPathsNeighbour</i>	This field specifies one or more additional detected path timing values for the neighbour cell, relative to the path timing used for determining the <i>rstd</i> value. If this field was requested but is not included, it means the UE did not detect any additional path timing values.
<i>nprslidNeighbour</i>	This field specifies the NPRS-ID of the neighbour cell for which the RSTDs are provided.
<i>carrierFreqOffsetNB-Neighbour</i>	This field specifies the offset of the NB-IoT channel number to EARFCN given by <i>earfcnNeighbour</i> as defined in TS 36.101 [21].

OTDOA-MeasQuality

```

-- ASN1START
OTDOA-MeasQuality ::= SEQUENCE {
    error-Resolution      BIT STRING (SIZE (2)),
    error-Value          BIT STRING (SIZE (5)),
    error-NumSamples     BIT STRING (SIZE (3))          OPTIONAL,
    ...
}
-- ASN1STOP

```

OTDOA-MeasQuality field descriptions	
<i>error-Resolution</i>	This field specifies the resolution R used in <i>error-Value</i> field. The encoding on two bits is as follows: '00' 5 metres '01' 10 metres '10' 20 metres '11' 30 metres
<i>error-Value</i>	This field specifies the target device's best estimate of the uncertainty of the OTDOA (or TOA) measurement. The encoding on five bits is as follows: '00000' 0 to (R*1-1) metres '00001' R*1 to (R*2-1) metres '00010' R*2 to (R*3-1) metres ... '11111' R*31 metres or more; where R is the resolution defined by <i>error-Resolution</i> field. E.g., R=20 m corresponds to 0-19 m, 20-39 m,...,620+ m.

OTDOA-MeasQuality field descriptions**error-NumSamples**

If the *error-Value* field provides the sample uncertainty of the OTDOA (or TOA) measurement, this field specifies how many measurements have been used by the target device to determine this (i.e., sample size). Following 3 bit encoding is used:

'000'	Not the baseline metric
'001'	5-9
'010'	10-14
'011'	15-24
'100'	25-34
'101'	35-44
'110'	45-54
'111'	55 or more.

In the case of the value '000', the *error-Value* field contains the target device's best estimate of the uncertainty of the OTDOA (or TOA) measurement not based on the baseline metric. E.g., other measurements such as signal-to-noise-ratio or signal strength can be utilized to estimate the *error-Value*.

If this field is absent, the value of this field is '000'.

AdditionalPath

The IE *AdditionalPath* is used by the target device to provide information about additional paths associated with the RSTD measurements in the form of a relative time difference and a quality value. The additional path *relativeTimeDifference* is the detected path timing relative to the detected path timing used for the *rstd* value (TS 36.214 [17]), and each additional path can be associated with a quality value *path-Quality*.

```
-- ASN1START
AdditionalPath-r14 ::= SEQUENCE {
    relativeTimeDifference-r14  INTEGER (-256..255),
    path-Quality-r14           OTDOA-MeasQuality           OPTIONAL,
    ...
}
-- ASN1STOP
```

AdditionalPath field descriptions**relativeTimeDifference**

This field specifies the additional detected path timing relative to the detected path timing used for the *rstd* value in units of 0.5 Ts, with $T_s=1/(15000*2048)$ seconds. A positive value indicates that the particular path is later in time than the detected path used for RSTD; a negative value indicates that the particular path is earlier in time than the detected path used for RSTD.

path-Quality

This field specifies the target device's best estimate of the quality of the detected timing of the additional path.

6.5.1.6 OTDOA Location Information Request**OTDOA-RequestLocationInformation**

The IE *OTDOA-RequestLocationInformation* is used by the location server to request OTDOA location measurements from a target device. Details of the required measurements (e.g. details of assistance data reference cell and neighbour cells) are conveyed in the *OTDOA-ProvideAssistanceData* IE in a separate Provide Assistance Data message.

```
-- ASN1START
OTDOA-RequestLocationInformation ::= SEQUENCE {
    assistanceAvailability  BOOLEAN,
    ...
    [[
        multipathRSTD-r14    ENUMERATED { requested }    OPTIONAL,    -- Need ON
        maxNoOfRSTDmeas-r14 INTEGER (1..32)              OPTIONAL
    ]],
    [[
        motionMeasurements-r15  ENUMERATED { requested }  OPTIONAL    -- Need ON
    ]]
}
-- ASN1STOP
```

```
-- ASN1STOP
```

OTDOA-RequestLocationInformation field descriptions
<p>assistanceAvailability This field indicates whether the target device may request additional OTDOA assistance data from the server. TRUE means allowed and FALSE means not allowed.</p>
<p>multipathRSTD This field, if present, indicates that the target device is requested to report additional detected path timing information per RSTD reference and neighbour cell.</p>
<p>maxNoOfRSTDmeas This field, if present, indicates the maximum number of <i>NeighbourMeasurementElement</i> fields (i.e., RSTD measurements) the target device can provide in <i>OTDOA-SignalMeasurementInformation</i>.</p>
<p>motionMeasurements This field, if present, indicates that the target device is requested to report the motion measurements (<i>delta-SFN</i> and <i>motionTimeSource</i>) in <i>OTDOA-SignalMeasurementInformation</i> as well as the IE <i>Sensor-MotionInformation</i> in IE <i>Sensor-ProvideLocationInformation</i>.</p>

6.5.1.7 OTDOA Capability Information

– OTDOA-ProvideCapabilities

The IE *OTDOA-ProvideCapabilities* is used by the target device to indicate its capability to support OTDOA and to provide its OTDOA positioning capabilities to the location server.

```
-- ASN1START
OTDOA-ProvideCapabilities ::= SEQUENCE {
    otdoa-Mode          BIT STRING { ue-assisted          (0),
                                     ue-assisted-NB-r14    (1),
                                     ue-assisted-NB-TDD-r15 (2) } (SIZE (1..8)),
    ...,
    supportedBandListEUTRA          SEQUENCE (SIZE (1..maxBands)) OF SupportedBandEUTRA          OPTIONAL,
    supportedBandListEUTRA-v9a0    SEQUENCE (SIZE (1..maxBands)) OF SupportedBandEUTRA-v9a0    OPTIONAL,
    interFreqRSTDmeasurement-r10   ENUMERATED { supported } OPTIONAL,
    additionalNeighbourCellInfoList-r10  ENUMERATED { supported } OPTIONAL,
    prs-id-r14                      ENUMERATED { supported } OPTIONAL,
    tp-separation-via-muting-r14     ENUMERATED { supported } OPTIONAL,
    additional-prs-config-r14       ENUMERATED { supported } OPTIONAL,
    prs-based-tbs-r14              ENUMERATED { supported } OPTIONAL,
    additionalPathsReport-r14      ENUMERATED { supported } OPTIONAL,
    densePrsConfig-r14            ENUMERATED { supported } OPTIONAL,
    maxSupportedPrsBandwidth-r14    ENUMERATED { n6, n15, n25, n50, n75, n100, ... } OPTIONAL,
    prsOccGroup-r14               ENUMERATED { supported } OPTIONAL,
    prsFrequencyHopping-r14       ENUMERATED { supported } OPTIONAL,
    maxSupportedPrsConfigs-r14     ENUMERATED { c2, c3 } OPTIONAL,
    periodicalReporting-r14       ENUMERATED { supported } OPTIONAL,
    multiPrbNprs-r14             ENUMERATED { supported } OPTIONAL,
    idleStateForMeasurements-r14   ENUMERATED { required } OPTIONAL,
    numberOfRXantennas-r14        ENUMERATED { rx1, ... } OPTIONAL,
    motionMeasurements-r15        ENUMERATED { supported } OPTIONAL,
    interRAT-RSTDmeasurement-r15   ENUMERATED { supported } OPTIONAL,
    scheduledLocationRequestSupported-r17  ScheduledLocationTimeSupport-r17  OPTIONAL
}

maxBands INTEGER ::= 64

SupportedBandEUTRA ::= SEQUENCE {
    bandEUTRA          INTEGER (1..maxFBI)
}

SupportedBandEUTRA-v9a0 ::= SEQUENCE {
    bandEUTRA-v9a0    INTEGER (maxFBI-Plus1..maxFBI2)    OPTIONAL
}

maxFBI          INTEGER ::= 64 -- Maximum value of frequency band indicator
maxFBI-Plus1    INTEGER ::= 65 -- lowest value extended FBI range
maxFBI2         INTEGER ::= 256 -- highest value extended FBI range

-- ASN1STOP
```

OTDOA-ProvideCapabilities field descriptions
<p>otdoa-Mode This field specifies the OTDOA mode(s) supported by the target device. This is represented by a bit string, with a one value at the bit position means the particular OTDOA mode is supported; a zero value means not supported. A zero-value in all bit positions in the bit string means OTDOA positioning method is not supported by the target device.</p> <p>ue-assisted: Bit 0 indicates that the target device supports UE-assisted OTDOA and LTE PRS. ue-assisted-NB: Bit 1 indicates that the target device supports UE-assisted OTDOA and NB-IoT NPRS. ue-assisted-NB-TDD: Bit 2 indicates that the target device supports UE-assisted OTDOA and NB-IoT NPRS for TDD.</p>
<p>SupportedBandEUTRA This field specifies the frequency bands for which the target device supports RSTD measurements. One entry corresponding to each supported E-UTRA band as defined in TS 36.101 [21]. In the case the target device includes <i>bandEUTRA-v9a0</i>, the target device shall set the corresponding entry of <i>bandEUTRA</i> (i.e. without suffix) to <i>maxFBI</i>.</p>
<p>interFreqRSTDmeasurement This field, if present, indicates that the target device supports inter-frequency RSTD measurements within and between the frequency bands indicated in <i>SupportedBandEUTRA</i>.</p>
<p>additionalNeighbourCellInfoList This field, if present, indicates that the target device supports up to 3x24 <i>OTDOA-NeighbourCellInfoElement</i> in <i>OTDOA-NeighbourCellInfoList</i> in <i>OTDOA-ProvideAssistanceData</i> without any restriction for the <i>earfcn</i> in each <i>OTDOA-NeighbourCellInfoElement</i> as specified in clause 6.5.1.2.</p>
<p>prs-id This field, if present, indicates that the target device supports PRS generation based on the PRS-ID as specified in TS 36.211 [16] and support for TP-ID in <i>OTDOA-ReferenceCellInfo</i> and <i>OTDOA-NeighbourCellInfoList</i>.</p>
<p>tp-separation-via-muting This field, if present, indicates that the target device supports RSTD measurements for cells which have associated transmission points (e.g., Remote Radio Heads) within the cell coverage and where these associated transmission points have the same physical cell identity as the associated cell, and where these transmission points are identified via a different muting pattern. The field also indicates support for TP-ID in <i>OTDOA-ReferenceCellInfo</i> and <i>OTDOA-NeighbourCellInfoList</i>.</p>
<p>additional-prs-config This field, if present, indicates that the target device supports additional PRS configurations. The additional PRS configuration in <i>PRS-Info</i> IE comprise:</p> <ul style="list-style-type: none"> - support for <i>prs-ConfigurationIndex</i> > 2399; - support for N_{PRS} values in addition to 1, 2, 4 and 6 (<i>add-numDL-Frames</i> in <i>PRS-Info</i>); - support for muting bit string lengths > 16 bits.
<p>prs-based-tbs This field, if present, indicates that the target device supports RSTD measurements for PRS-only TPs.</p>
<p>additionalPathsReport This field, if present, indicates that the target device supports reporting of timing information for additional detected paths for RSTD reference and each neighbour cell.</p>
<p>densePrsConfig This field, if present, indicates that the target device supports a subset of the additional PRS configurations associated with capability <i>additional-prs-config</i> which comprises:</p> <ul style="list-style-type: none"> - support for <i>prs-ConfigurationIndex</i> > 2404; - support for N_{PRS} values of 10, 20, 40, 80 and 160 (in addition to 1, 2, 4 and 6). <p>In the case <i>additional-prs-config</i> is present, this field is not present.</p>
<p>maxSupportedPrsBandwidth This field, if present, indicates the maximum PRS bandwidth supported by the target device. Enumerated value n6 corresponds to 6 resource blocks, n15 to 15 resource blocks and so on. If this field is not present, the target device is assumed to support the PRS bandwidth associated with the target device type, which for LTE devices including Cat-M1/M2 is 100 resource blocks and for NB-IoT devices is 1 resource block.</p>
<p>prsOccGroup This field, if present, indicates that the target device supports PRS occasion groups, which implies that each bit of a configured muting pattern applies per PRS occasion group.</p>
<p>prsFrequencyHopping This field, if present, indicates that the target device supports PRS occasion frequency hopping, as specified in TS 36.211 [16].</p>
<p>maxSupportedPrsConfigs This field, if present, indicates that the target device supports multiple PRS configurations per cell. Enumerated value c2 indicates support for up to 2 configurations; c3 indicates support for up to 3 configurations.</p>
<p>periodicalReporting This field, if present, indicates that the target device supports <i>periodicalReporting</i> of RSTD measurements. If this field is absent, the location server may assume that the target device does not support <i>periodicalReporting</i> in <i>CommonEsRequestLocationInformation</i>.</p>
<p>multiPrbNprs This field, if present, indicates that the target device supports NPRS configuration in more than one resource block (i.e., <i>maxCarrier</i> in <i>PRS-Info-NB</i> greater than 1).</p>
<p>idleStateForMeasurements This field, if present, indicates that the target device requires idle state to perform RSTD measurements.</p>

OTDOA-ProvideCapabilities field descriptions
<p>numberOfRXantennas This field is not applicable to NB-IoT devices. This field, if present, indicates the number of UE downlink receive antennas for RSTD measurements (see TS 36.133 [18]). Enumerated value rx1 indicates a single antenna receiver. If this field is absent, the target device is assumed to support two RX antennas for RSTD measurements.</p>
<p>motionMeasurements This field, if present, indicates that the target device supports reporting of motion measurements (<i>delta-SFN</i> and <i>motionTimeSource</i>) in <i>OTDOA-SignalMeasurementInformation</i>. The presence of this field implies presence of <i>sensor-MotionInformationSup</i> in IE <i>Sensor-ProvideCapabilities</i>.</p>
<p>interRAT-RSTDmeasurement This field, if present, indicates that the target device supports inter-RAT RSTD measurements (TS 38.215 [36]); i.e., E-UTRA RSTD measurements when the target device is served by an NR cell.</p>
<p>scheduledLocationRequestSupported This field, if present, indicates that the target device supports scheduled location requests – i.e., supports the IE <i>ScheduledLocationTime</i> in IE <i>CommonIEsRequestLocationInformation</i> – and the time base(s) supported for the scheduled location time.</p>

6.5.1.8 OTDOA Capability Information Request

– *OTDOA-RequestCapabilities*

The IE *OTDOA-RequestCapabilities* is used by the location server to request the capability of the target device to support OTDOA and to request OTDOA positioning capabilities from a target device.

```
-- ASN1START
OTDOA-RequestCapabilities ::= SEQUENCE {
    ...
}
-- ASN1STOP
```

6.5.1.9 OTDOA Error Elements

– *OTDOA-Error*

The IE *OTDOA-Error* is used by the location server or target device to provide OTDOA error reasons to the target device or location server, respectively.

```
-- ASN1START
OTDOA-Error ::= CHOICE {
    locationServerErrorCauses      OTDOA-LocationServerErrorCauses,
    targetDeviceErrorCauses       OTDOA-TargetDeviceErrorCauses,
    ...
}
-- ASN1STOP
```

– *OTDOA-LocationServerErrorCauses*

The IE *OTDOA-LocationServerErrorCauses* is used by the location server to provide OTDOA error reasons to the target device.

```
-- ASN1START
OTDOA-LocationServerErrorCauses ::= SEQUENCE {
    cause      ENUMERATED { undefined,
                           assistanceDataNotSupportedByServer,
                           assistanceDataSupportedButCurrentlyNotAvailableByServer,
                           ...
                           },
    ...
}
-- ASN1STOP
```

```
}
-- ASN1STOP
```

OTDOA-TargetDeviceErrorCauses

The IE *OTDOA-TargetDeviceErrorCauses* is used by the target device to provide OTDOA error reasons to the location server.

```
-- ASN1START
OTDOA-TargetDeviceErrorCauses ::= SEQUENCE {
  cause      ENUMERATED {
    undefined,
    assistance-data-missing,
    unableToMeasureReferenceCell,
    unableToMeasureAnyNeighbourCell,
    attemptedButUnableToMeasureSomeNeighbourCells,
    ...
  },
  ...
}
-- ASN1STOP
```

6.5.2 A-GNSS Positioning

6.5.2.1 GNSS Assistance Data

A-GNSS-ProvideAssistanceData

The IE *A-GNSS-ProvideAssistanceData* is used by the location server to provide assistance data to enable UE-based and UE-assisted A-GNSS. It may also be used to provide GNSS positioning specific error reasons.

```
-- ASN1START
A-GNSS-ProvideAssistanceData ::= SEQUENCE {
  gnss-CommonAssistData      GNSS-CommonAssistData      OPTIONAL, -- Need ON
  gnss-GenericAssistData     GNSS-GenericAssistData     OPTIONAL, -- Need ON
  gnss-Error                 A-GNSS-Error               OPTIONAL, -- Need ON
  ...
  [[
    gnss-PeriodicAssistData-r15 GNSS-PeriodicAssistData-r15 OPTIONAL -- Cond CtrTrans
  ]]
}
-- ASN1STOP
```

Conditional presence	Explanation
<i>CtrTrans</i>	The field is mandatory present in the control transaction of a periodic assistance data delivery session as described in clauses 5.2.1a and 5.2.2a. Otherwise it is not present.

GNSS-CommonAssistData

The IE *GNSS-CommonAssistData* is used by the location server to provide assistance data which can be used for any GNSS.

```
-- ASN1START
GNSS-CommonAssistData ::= SEQUENCE {
  gnss-ReferenceTime      GNSS-ReferenceTime      OPTIONAL, -- Need ON
  gnss-ReferenceLocation  GNSS-ReferenceLocation  OPTIONAL, -- Need ON
  gnss-IonosphericModel   GNSS-IonosphericModel   OPTIONAL, -- Need ON
  gnss-EarthOrientationParameters GNSS-EarthOrientationParameters OPTIONAL, -- Need ON
  ...
  [[
```

```

gnss-RTK-ReferenceStationInfo-r15
    GNSS-RTK-ReferenceStationInfo-r15    OPTIONAL,    -- Need ON
gnss-RTK-CommonObservationInfo-r15
    GNSS-RTK-CommonObservationInfo-r15    OPTIONAL,    -- Cond RTK
gnss-RTK-AuxiliaryStationData-r15
    GNSS-RTK-AuxiliaryStationData-r15     OPTIONAL,    -- Need ON
]],
[[
gnss-SSR-CorrectionPoints-r16
    GNSS-SSR-CorrectionPoints-r16        OPTIONAL,    -- Need ON
]],
[[
gnss-Integrity-ServiceParameters-r17
    GNSS-Integrity-ServiceParameters-r17  OPTIONAL,    -- Need ON
gnss-Integrity-ServiceAlert-r17
    GNSS-Integrity-ServiceAlert-r17       OPTIONAL,    -- Need OR
]]
}
-- ASN1STOP
    
```

Conditional presence	Explanation
RTK	The field is mandatory present if the IE <i>GNSS-RTK-Observations</i> is included in IE <i>GNSS-GenericAssistData</i> ; otherwise it is not present.

– GNSS-GenericAssistData

The IE *GNSS-GenericAssistData* is used by the location server to provide assistance data for a specific GNSS. The specific GNSS for which the provided assistance data are applicable is indicated by the IE *GNSS-ID* and (if applicable) by the IE *SBAS-ID*. Assistance for up to 16 GNSSs can be provided.

```

-- ASN1START
GNSS-GenericAssistData ::= SEQUENCE (SIZE (1..16)) OF GNSS-GenericAssistDataElement
GNSS-GenericAssistDataElement ::= SEQUENCE {
gnss-ID                GNSS-ID,
sbas-ID                SBAS-ID                OPTIONAL,    -- Cond GNSS-ID-SBAS
gnss-TimeModels        GNSS-TimeModelList     OPTIONAL,    -- Need ON
gnss-DifferentialCorrections GNSS-DifferentialCorrections OPTIONAL,    -- Need ON
gnss-NavigationModel   GNSS-NavigationModel   OPTIONAL,    -- Need ON
gnss-RealTimeIntegrity GNSS-RealTimeIntegrity   OPTIONAL,    -- Need ON
gnss-DataBitAssistance GNSS-DataBitAssistance   OPTIONAL,    -- Need ON
gnss-AcquisitionAssistance GNSS-AcquisitionAssistance OPTIONAL,    -- Need ON
gnss-Almanac           GNSS-Almanac           OPTIONAL,    -- Need ON
gnss-UTC-Model         GNSS-UTC-Model         OPTIONAL,    -- Need ON
gnss-AuxiliaryInformation GNSS-AuxiliaryInformation OPTIONAL,    -- Need ON
...
[[
bds-DifferentialCorrections-r12 BDS-DifferentialCorrections-r12 OPTIONAL,    -- Cond GNSS-ID-BDS
bds-GridModel-r12          BDS-GridModelParameter-r12    OPTIONAL,    -- Cond GNSS-ID-BDS
]],
[[
gnss-RTK-Observations-r15 GNSS-RTK-Observations-r15    OPTIONAL,    -- Need ON
glo-RTK-BiasInformation-r15 GLO-RTK-BiasInformation-r15  OPTIONAL,    -- Cond GNSS-ID-GLO
gnss-RTK-MAC-CorrectionDifferences-r15
    GNSS-RTK-MAC-CorrectionDifferences-r15    OPTIONAL,    -- Need ON
gnss-RTK-Residuals-r15    GNSS-RTK-Residuals-r15      OPTIONAL,    -- Need ON
gnss-RTK-FKP-Gradients-r15 GNSS-RTK-FKP-Gradients-r15  OPTIONAL,    -- Need ON
gnss-SSR-OrbitCorrections-r15
    GNSS-SSR-OrbitCorrections-r15            OPTIONAL,    -- Need ON
gnss-SSR-ClockCorrections-r15
    GNSS-SSR-ClockCorrections-r15          OPTIONAL,    -- Need ON
gnss-SSR-CodeBias-r15    GNSS-SSR-CodeBias-r15      OPTIONAL,    -- Need ON
]],
[[
gnss-SSR-URA-r16         GNSS-SSR-URA-r16          OPTIONAL,    -- Need ON
gnss-SSR-PhaseBias-r16   GNSS-SSR-PhaseBias-r16    OPTIONAL,    -- Need ON
gnss-SSR-STEC-Correction-r16
    GNSS-SSR-STEC-Correction-r16          OPTIONAL,    -- Need ON
gnss-SSR-GriddedCorrection-r16
    GNSS-SSR-GriddedCorrection-r16        OPTIONAL,    -- Need ON
    
```

```

        OPTIONAL, -- Need ON
        navic-DifferentialCorrections-r16 NavIC-DifferentialCorrections-r16
        OPTIONAL, -- Cond GNSS-ID-NavIC
        navic-GridModel-r16 NavIC-GridModelParameter-r16
        OPTIONAL -- Cond GNSS-ID-NavIC
    ]],
    [[
        gnss-SSR-OrbitCorrectionsSet2-r17
        GNSS-SSR-OrbitCorrectionsSet2-r17 OPTIONAL, -- Need ON
        gnss-SSR-ClockCorrectionsSet2-r17
        GNSS-SSR-ClockCorrectionsSet2-r17 OPTIONAL, -- Need ON
        gnss-SSR-URA-Set2-r17 GNSS-SSR-URA-Set2-r17 OPTIONAL -- Need ON
    ]]
}
-- ASN1STOP

```

Conditional presence	Explanation
<i>GNSS-ID-SBAS</i>	The field is mandatory present if the <i>GNSS-ID = sbas</i> ; otherwise it is not present.
<i>GNSS-ID-BDS</i>	The field may be present if the <i>GNSS-ID = bds</i> ; otherwise it is not present.
<i>GNSS-ID-GLO</i>	The field is optionally present, need ON, if the <i>GNSS ID = glonass</i> ; otherwise it is not present.
<i>GNSS-ID-NAVIC</i>	The field is optionally present, need ON, if the <i>GNSS-ID = navic</i> ; otherwise it is not present

– *GNSS-PeriodicAssistData*

The IE *GNSS-PeriodicAssistData* is used by the location server to provide control parameters for a periodic assistance data delivery session (e.g., interval and duration) to the target device.

NOTE: Omission of a particular assistance data type field in IE *GNSS-PeriodicAssistData* means that the location server does not provide this assistance data type in a data transaction of a periodic assistance data delivery session, as described in clauses 5.2.1a and 5.2.2a. Inclusion of no assistance data type fields in IE *GNSS-PeriodicAssistData* means that a periodic assistance data delivery session is terminated.

```

-- ASN1START
GNSS-PeriodicAssistData-r15 ::= SEQUENCE {
    gnss-RTK-PeriodicObservations-r15 GNSS-PeriodicControlParam-r15 OPTIONAL, -- Need ON
    glo-RTK-PeriodicBiasInformation-r15 GNSS-PeriodicControlParam-r15 OPTIONAL, -- Need ON
    gnss-RTK-MAC-PeriodicCorrectionDifferences-r15
        GNSS-PeriodicControlParam-r15 OPTIONAL, -- Need ON
    gnss-RTK-PeriodicResiduals-r15 GNSS-PeriodicControlParam-r15 OPTIONAL, -- Need ON
    gnss-RTK-FKP-PeriodicGradients-r15 GNSS-PeriodicControlParam-r15 OPTIONAL, -- Need ON
    gnss-SSR-PeriodicOrbitCorrections-r15
        GNSS-PeriodicControlParam-r15 OPTIONAL, -- Need ON
    gnss-SSR-PeriodicClockCorrections-r15
        GNSS-PeriodicControlParam-r15 OPTIONAL, -- Need ON
    gnss-SSR-PeriodicCodeBias-r15 GNSS-PeriodicControlParam-r15 OPTIONAL, -- Need ON
    ...
    [[
        gnss-SSR-PeriodicURA-r16 GNSS-PeriodicControlParam-r15 OPTIONAL, -- Need ON
        gnss-SSR-PeriodicPhaseBias-r16 GNSS-PeriodicControlParam-r15 OPTIONAL, -- Need ON
        gnss-SSR-PeriodicSTEC-Correction-r16 GNSS-PeriodicControlParam-r15 OPTIONAL, -- Need ON
        gnss-SSR-PeriodicGriddedCorrection-r16 GNSS-PeriodicControlParam-r15 OPTIONAL -- Need ON
    ]],
    [[
        gnss-Integrity-PeriodicServiceAlert-r17 GNSS-PeriodicControlParam-r15 OPTIONAL -- Need ON
    ]],
    [[
        gnss-SSR-PeriodicOrbitCorrectionsSet2-r17
        GNSS-PeriodicControlParam-r15 OPTIONAL, -- Need ON
        gnss-SSR-PeriodicClockCorrectionsSet2-r17
        GNSS-PeriodicControlParam-r15 OPTIONAL, -- Need ON
        gnss-SSR-PeriodicURA-Set2-r17 GNSS-PeriodicControlParam-r15 OPTIONAL -- Need ON
    ]]
}
-- ASN1STOP

```

6.5.2.2 GNSS Assistance Data Elements

– GNSS-ReferenceTime

The IE *GNSS-ReferenceTime* is used by the location server to provide the GNSS specific system time with uncertainty and the relationship between GNSS system time and network air-interface timing of the eNodeB/NodeB/BTS transmission in the reference cell.

If the IE *networkTime* is present, the IEs *gnss-SystemTime* and *networkTime* provide a valid relationship between GNSS system time and air-interface network time, as seen at the approximate location of the target device, i.e. the propagation delay from the gNB/ng-eNB/eNodeB/NodeB/BTS to the target device is compensated for by the location server. Depending on implementation, the relation between GNSS system time and air-interface network time may have varying accuracy. The uncertainty of this timing relation is provided in the IE *referenceTimeUnc*. If the propagation delay from the eNodeB/NodeB/BTS to the target device is not accurately known, the location server uses the best available approximation of the propagation delay and take the corresponding delay uncertainty into account in the calculation of the IE *referenceTimeUnc*.

If the IE *networkTime* is not present, the IE *gnssSystemTime* is an estimate of current GNSS system time at time of reception of the IE *GNSS-ReferenceTime* by the target device. The location server should achieve an accuracy of +/- 3 seconds for this estimate including allowing for the transmission delay between the location server and the target device. Note that the target device should further compensate *gnss-SystemTime* for the time between the reception of *GNSS-ReferenceTime* and the time when the *gnss-SystemTime* is used.

The location server provides a value for the *gnss-TimeID* only for GNSSs supported by the target device.

The IE *GNSS-ReferenceTimeForOneCell* can be provided multiple times (up to 16) to provide fine time assistance for several (neighbour) cells.

```
-- ASN1START
GNSS-ReferenceTime ::= SEQUENCE {
    gnss-SystemTime      GNSS-SystemTime,
    referenceTimeUnc     INTEGER (0..127)           OPTIONAL,  -- Cond noFTA
    gnss-ReferenceTimeForCells SEQUENCE (SIZE (1..16)) OF
                        GNSS-ReferenceTimeForOneCell  OPTIONAL,  -- Need ON
    ...
}

GNSS-ReferenceTimeForOneCell ::= SEQUENCE {
    networkTime          NetworkTime,
    referenceTimeUnc     INTEGER (0..127),
    bsAlign              ENUMERATED {true}  OPTIONAL,
    ...
}
-- ASN1STOP
```

Conditional presence	Explanation
<i>noFTA</i>	The field may be present if <i>gnss-ReferenceTimeForCells</i> is absent; otherwise it is not present.

GNSS-ReferenceTime field descriptions	
<i>gnss-SystemTime</i>	This field provides the specific GNSS system time.
<i>networkTime</i>	This field specifies the cellular network time at the epoch corresponding to <i>gnss-SystemTime</i> .

GNSS-ReferenceTime field descriptions	
referenceTimeUnc	
This field provides the accuracy of the relation between <i>gnssSystemTime</i> and <i>networkTime</i> time if IE <i>networkTime</i> is provided. When IE <i>networkTime</i> is not provided, this field can be included to provide the accuracy of the provided <i>gnssSystemTime</i> .	
If GNSS TOD is the given GNSS time, then the true GNSS time, corresponding to the provided network time as observed at the target device location, lies in the interval [GNSS TOD - <i>referenceTimeUnc</i> , GNSS TOD + <i>referenceTimeUnc</i>].	
The uncertainty <i>r</i> , expressed in microseconds, is mapped to a number <i>K</i> , with the following formula: $r = C * (((1+x)^K) - 1)$ with <i>C</i> = 0.5 and <i>x</i> = 0.14. To encode any higher value of uncertainty than that corresponding in the above formula to <i>K</i> =127, the same value, <i>K</i> =127, shall also be used. The uncertainty is then coded on 7 bits, as the binary encoding of <i>K</i> . Example values for the <i>referenceTimeUnc</i> Format: see table K to uncertainty relation below.	
bsAlign	
This flag, if present, indicates that the transmission timings of all cells sharing, depending on the RAT, the same carrier frequency and Tracking Area/Location Area/Routing Area as the cell indicated, are frame aligned. This information allows the target device to derive the GNSS - cellular time relation for any of these cells based on the timing relation information provided in <i>GNSS-ReferenceTime</i> . The flag should be set consistently in all these cells. This flag does not guarantee SFN alignment.	

K to uncertainty relation

Value of K	Value of uncertainty
0	0 nanoseconds
1	70 nanoseconds
2	149.8 nanoseconds
-	-
50	349.62 microseconds
-	-
127	≥ 8.43 seconds

GNSS-SystemTime

```

-- ASN1START
GNSS-SystemTime ::= SEQUENCE {
    gnss-TimeID          GNSS-ID,
    gnss-DayNumber       INTEGER (0..32767),
    gnss-TimeOfDay       INTEGER (0..86399),
    gnss-TimeOfDayFrac-msec  INTEGER (0..999)          OPTIONAL,    -- Need ON
    notificationOfLeapSecond  BIT STRING (SIZE(2))  OPTIONAL,    -- Cond gnss-TimeID-glonass
    gps-TOW-Assist       GPS-TOW-Assist             OPTIONAL,    -- Cond gnss-TimeID-gps
    ...
}
-- ASN1STOP
    
```

Conditional presence	Explanation
<i>gnss-TimeID-glonass</i>	The field may be present if <i>gnss-TimeID</i> =`glonass`; otherwise it is not present.
<i>gnss-TimeID-gps</i>	The field may be present if <i>gnss-TimeID</i> =`gps`; otherwise it is not present.

GNSS-SystemTime field descriptions	
gnss-TimeID	
This field specifies the GNSS for which the <i>GNSS-SystemTime</i> is provided.	

GNSS-SystemTime field descriptions
<p>gnss-DayNumber This field specifies the sequential number of days (with day count starting at 0) from the origin of the GNSS System Time as follows:</p> <ul style="list-style-type: none"> GPS, QZSS, SBAS – Days from January 6th 1980 00:00:00 UTC (USNO); Galileo – Days from Galileo System Time (GST) start epoch, defined as 13 seconds before midnight between 21st August and 22nd August 1999; i.e., GST was equal to 13 seconds at August 22nd 1999 00:00:00 UTC; GLONASS – Days from December 31st 1995 21:00:00 UTC (SU), which is local UTC Moscow January 1st 1996 00:00:00, defined as UTC(SU) + 3 hours in [9]; BDS – Days from January 1st 2006 00:00:00 UTC (NTSC). NavIC – Days from NavIC System Time start epoch, defined as 13 seconds before midnight between 21st August and 22nd August 1999; i.e., NavIC System Time was equal to 00:00:00 at August 21st, 1999 23:59:47 UTC (BIPM).
<p>gnss-TimeOfDay This field specifies the integer number of seconds from the GNSS day change.</p>
<p>gnss-TimeOfDayFrac-msec This field specifies the fractional part of the <i>gnssTimeOfDay</i> field in 1-milli-seconds resolution. The total GNSS TOD is <i>gnss-TimeOfDay</i> + <i>gnssTimeOfDayFrac-msec</i>.</p>
<p>notificationOfLeapSecond This field specifies the notification of forthcoming leap second correction, as defined by parameter KP in [9, Table 4.7].</p>
<p>gps-TOW-Assist This field contains several fields in the Telemetry (TLM) Word and Handover Word (HOW) that are currently being broadcast by the respective GPS satellites. Combining this information with GPS TOW enables the target device to know the entire 1.2-second (60-bit) pattern of TLM and HOW that is transmitted at the start of each six-second NAV subframe by the particular GPS satellite.</p>

– GPS-TOW-Assist

```

-- ASN1START
GPS-TOW-Assist ::= SEQUENCE (SIZE(1..64)) OF GPS-TOW-AssistElement

GPS-TOW-AssistElement ::= SEQUENCE {
    satelliteID      INTEGER (1..64),
    tlmWord          INTEGER (0..16383),
    antiSpooF       INTEGER (0..1),
    alert            INTEGER (0..1),
    tlmRsvdBits     INTEGER (0..3),
    ...
}
-- ASN1STOP

```

GPS-TOW-Assist field descriptions
<p>satelliteID This field identifies the satellite for which the <i>GPS-TOW-Assist</i> is applicable. This field is identical to the GPS PRN Signal No. defined in [4].</p>
<p>tlmWord This field contains a 14-bit value representing the Telemetry Message (TLM) being broadcast by the GPS satellite identified by the particular <i>satelliteID</i>, with the MSB occurring first in the satellite transmission, as defined in [4].</p>
<p>antiSpooF This field contains the Anti-Spoof flag that is being broadcast by the GPS satellite identified by <i>satelliteID</i>, as defined in [4].</p>
<p>alert This field contains the Alert flag that is being broadcast by the GPS satellite identified by <i>satelliteID</i>, as defined in [4].</p>
<p>tlmRsvdBits This field contains the two reserved bits in the TLM Word being broadcast by the GPS satellite identified by <i>satelliteID</i>, with the MSB occurring first in the satellite transmission, as defined in [4].</p>

– NetworkTime

```

-- ASN1START
NetworkTime ::= SEQUENCE {
    secondsFromFrameStructureStart      INTEGER(0..12533),
    fractionalSecondsFromFrameStructureStart  INTEGER(0..3999999),
}

```

```

frameDrift      INTEGER (-64..63)  OPTIONAL,  -- Cond GNSSsynch
cellID          CHOICE {
  eUTRA         SEQUENCE {
    physCellId  INTEGER (0..503),
    cellGlobalIdEUTRA CellGlobalIdEUTRA-AndUTRA  OPTIONAL,  -- Need ON
    earfcn      ARFCN-ValueEUTRA,
    ...,
    [[ earfcn-v9a0 ARFCN-ValueEUTRA-v9a0  OPTIONAL  -- Cond EARFCN-max
  ]],
  uTRA         SEQUENCE {
    mode        CHOICE {
      fdd       SEQUENCE {
        primary-CPICH-Info  INTEGER (0..511),
        ...,
      },
      tdd       SEQUENCE {
        cellParameters      INTEGER (0..127),
        ...,
      },
    },
    cellGlobalIdUTRA CellGlobalIdEUTRA-AndUTRA  OPTIONAL,  -- Need ON
    uarfcn          ARFCN-ValueUTRA,
    ...,
  },
  gSM              SEQUENCE {
    bcchCarrier    INTEGER (0..1023),
    bsic           INTEGER (0..63),
    cellGlobalIdGERAN CellGlobalIdGERAN      OPTIONAL,  -- Need ON
    ...,
  },
  ...,
  nBiot-r14       SEQUENCE {
    nbPhysCellId-r14  INTEGER (0..503),
    nbCellGlobalId-r14  ECGI                  OPTIONAL,  -- Need ON
    nbCarrierFreq-r14  CarrierFreq-NB-r14,
    ...,
  },
  nr-r15          SEQUENCE {
    nrPhysCellId-r15  INTEGER (0..1007),
    nrCellGlobalID-r15  NCGI-r15              OPTIONAL,  -- Need ON
    nrARFCN-r15       ARFCN-ValueNR-r15,
    ...,
  },
  },
  ...
}
-- ASN1STOP

```

Conditional presence	Explanation
<i>EARFCN-max</i>	The field is mandatory present if the corresponding <i>earfcn</i> (i.e. without suffix) is set to <i>maxEARFCN</i> . Otherwise the field is not present.
<i>GNSSsynch</i>	The field is present and set to 0 if <i>NetworkTime</i> is synchronized to <i>gnss-SystemTime</i> ; otherwise the field is optionally present, need OR.

NetworkTime field descriptions
<p><i>secondsFromFrameStructureStart</i> This field specifies the number of seconds from the beginning of the longest frame structure in the corresponding air interface. In the case of E-UTRA, the SFN cycle length is 10.24 seconds. In the case of UTRA, the SFN cycle length is 40.96 seconds. In the case of GSM, the hyperframe length is 12533.76 seconds. In the case of NB-IoT, the Hyper-SFN cycle lengths is 10485.76 seconds. In the case of NR, the SFN cycle length is 10.24 seconds.</p>
<p><i>fractionalSecondsFromFrameStructureStart</i> This field specifies the fractional part of the <i>secondsFromFrameStructureStart</i> in 250 ns resolution. The total time since the particular frame structure start is <i>secondsFromFrameStructureStart</i> + <i>fractionalSecondsFromFrameStructureStart</i></p>
<p><i>frameDrift</i> This field specifies the drift rate of the GNSS-network time relation with scale factor 2^{-30} seconds/second, in the range from $-5.9605e-8$ to $+5.8673e-8$ sec/sec.</p>
<p><i>cellID</i> This field specifies the cell for which the GNSS-network time relation is provided.</p>
<p><i>physCellId</i> This field specifies the physical cell identity of the reference cell (E-UTRA), as defined in TS 36.331 [12], for which the GNSS network time relation is provided.</p>
<p><i>cellGlobalIdEUTRA</i> This field specifies the Evolved Cell Global Identifier (ECGI), the globally unique identity of a cell in E-UTRA, of the reference cell for the GNSS-network time relation, as defined in TS 36.331 [12].</p>
<p><i>earfcn</i> This field specifies E-ARFCN of the reference cell for the GNSS-network time relation (E-UTRA). In the case the server includes <i>earfcn-v9a0</i>, the server shall set the corresponding <i>earfcn</i> (i.e. without suffix) to <i>maxEARFCN</i>.</p>
<p><i>primary-CPICH-Info</i> This field specifies the physical cell identity of the reference cell (UTRA) for the GNSS-network time relation, as defined in TS 25.331 [13].</p>
<p><i>cellParameters</i> This field specifies the physical cell identity of the reference cell (UTRA) for the GNSS-network time relation, as defined in TS 25.331 [13].</p>
<p><i>cellGlobalIdUTRA</i> The field specifies the global UTRAN Cell Identifier, the globally unique identity of a cell in UTRA, of the reference cell for the GNSS-network time relation, as defined in TS 25.331 [13].</p>
<p><i>uarfcn</i> This field specifies ARFCN of the reference cell for the GNSS-network time relation (UTRA).</p>
<p><i>bcchCarrier</i> This field specifies the absolute GSM RF channel number of the BCCH of the reference base station (GERAN) for the GNSS-network time relation, as defined in TS 44.031 [14].</p>
<p><i>bsic</i> This field specifies the Base Station Identity Code of the reference base station (GERAN) for the GNSS-network time relation, as defined in TS 44.031 [14].</p>
<p><i>cellGlobalIdGERAN</i> This field specifies the Cell Global Identification (CGI), the globally unique identity of a cell in GERAN, of the reference base station for the GNSS-network time relation.</p>
<p><i>nbPhysCellId</i> This field specifies the narrowband physical layer cell identity of the NB-IoT reference cell, as defined in TS 36.331 [12], for which the GNSS network time relation is provided.</p>
<p><i>nbCellGlobalId</i> This field specifies the global cell identifier of the NB-IoT reference cell for which the GNSS-network time relation is provided, as defined in TS 36.331 [12].</p>
<p><i>nbCarrierFreq</i> This field specifies the carrier frequency of the NB-IoT reference cell for which the GNSS-network time relation is provided.</p>
<p><i>nrPhysCellId</i> This field specifies the physical cell identity of the reference cell (NR), as defined in TS 38.331 [35], for which the GNSS network time relation is provided.</p>
<p><i>nrCellGlobalID</i> This field specifies the NR Cell Global Identifier (NCGI) of the reference cell (NR) for the GNSS-network time relation, as defined in TS 38.331 [35].</p>
<p><i>nrARFCN</i> This field specifies NR-ARFCN of the reference cell (NR) for the GNSS-network time relation.</p>

– GNSS-ReferenceLocation

The IE *GNSS-ReferenceLocation* is used by the location server to provide the target device with a-priori knowledge of its location in order to improve GNSS receiver performance. The IE *GNSS-ReferenceLocation* is provided in WGS-84 reference system.

```
-- ASN1START
GNSS-ReferenceLocation ::= SEQUENCE {
    threeDlocation      EllipsoidPointWithAltitudeAndUncertaintyEllipsoid,
    ...
}
-- ASN1STOP
```

– GNSS-IonosphericModel

The IE *GNSS-IonosphericModel* is used by the location server to provide parameters to model the propagation delay of the GNSS signals through the ionosphere. Proper use of these fields allows a single-frequency GNSS receiver to remove parts of the ionospheric delay from the pseudorange measurements. Three Ionospheric Models are supported: The Klobuchar model as defined in [4], the NeQuick model as defined in [8], and the klobucharModel2 as defined in [39].

```
-- ASN1START
GNSS-IonosphericModel ::= SEQUENCE {
    klobucharModel      KlobucharModelParameter      OPTIONAL,  -- Need ON
    neQuickModel        NeQuickModelParameter        OPTIONAL,  -- Need ON
    ...
    [[ klobucharModel2-r16  KlobucharModel2Parameter-r16  OPTIONAL  -- Need ON
    ]]
}
-- ASN1STOP
```

– KlobucharModelParameter

```
-- ASN1START
KlobucharModelParameter ::= SEQUENCE {
    dataID              BIT STRING (SIZE (2)),
    alfa0               INTEGER (-128..127),
    alfa1               INTEGER (-128..127),
    alfa2               INTEGER (-128..127),
    alfa3               INTEGER (-128..127),
    beta0               INTEGER (-128..127),
    beta1               INTEGER (-128..127),
    beta2               INTEGER (-128..127),
    beta3               INTEGER (-128..127),
    ...
}
-- ASN1STOP
```

***KlobucharModelParameter* field descriptions**

dataID

When *dataID* has the value '11' it indicates that the parameters have been generated by QZSS, and the parameters have been specialized and are applicable within the area defined in [7]. When *dataID* has the value '01' it indicates that the parameters have been generated by BDS, and UE shall use these parameters according to the description given in 5.2.4.7 in [23], [50]. When the *dataID* has the value '10', it indicates that the parameters have been generated by NavIC, and UE shall use these parameters according to the description given in [38]. When *dataID* has the value '00' it indicates the parameters are applicable worldwide [4], [7].

alfa0

This field specifies the α_0 parameter of the Klobuchar model, as specified in [4], [23], [38], [50]. Scale factor 2^{-30} seconds.

<i>KlobucharModelParamater</i> field descriptions
<p><i>alfa1</i> This field specifies the α_1 parameter of the Klobuchar model, as specified in [4], [23], [38], [50]. Scale factor 2^{27} seconds/semi-circle.</p>
<p><i>alfa2</i> This field specifies the α_2 parameter of the Klobuchar model, as specified in [4], [23], [38], [50]. Scale factor 2^{24} seconds/semi-circle².</p>
<p><i>alfa3</i> This field specifies the α_3 parameter of the Klobuchar model, as specified in [4], [23], [38], [50]. Scale factor 2^{24} seconds/semi-circle³.</p>
<p><i>beta0</i> This field specifies the β_0 parameter of the Klobuchar model, as specified in [4], [23], [38], [50]. Scale factor 2^{11} seconds.</p>
<p><i>beta1</i> This field specifies the β_1 parameter of the Klobuchar model, as specified in [4], [23], [38], [50]. Scale factor 2^{14} seconds/semi-circle.</p>
<p><i>beta2</i> This field specifies the β_2 parameter of the Klobuchar model, as specified in [4], [23], [38], [50]. Scale factor 2^{16} seconds/semi-circle².</p>
<p><i>beta3</i> This field specifies the β_3 parameter of the Klobuchar model, as specified in [4], [23], [38], [50]. Scale factor 2^{16} seconds/semi-circle³.</p>

KlobucharModel2Parameter

```
-- ASN1START
KlobucharModel2Parameter-r16 ::= SEQUENCE {
    alfa1-r16          INTEGER (0..1023),
    alfa2-r16          INTEGER (-128..127),
    alfa3-r16          INTEGER (0..255),
    alfa4-r16          INTEGER (0..255),
    alfa5-r16          INTEGER (0..255),
    alfa6-r16          INTEGER (-128..127),
    alfa7-r16          INTEGER (-128..127),
    alfa8-r16          INTEGER (-128..127),
    alfa9-r16          INTEGER (-128..127),
    ...
}
-- ASN1STOP
```

<i>KlobucharModel2Parameter</i> field descriptions
<p><i>alfa1</i> This field specifies the α_1 parameter of the Klobuchar model, as specified in 7.8.1 in [39], [49]. Scale factor 2^{-3} TECU.</p>
<p><i>alfa2</i> This field specifies the α_2 parameter of the Klobuchar model, as specified in 7.8.1 in [39], [49]. Scale factor 2^{-3} TECU.</p>
<p><i>alfa3</i> This field specifies the α_3 parameter of the Klobuchar model, as specified in 7.8.1 in [39], [49]. Scale factor 2^{-3} TECU.</p>
<p><i>alfa4</i> This field specifies the α_4 parameter of the Klobuchar model, as specified in 7.8.1 in [39], [49]. Scale factor 2^{-3} TECU.</p>
<p><i>alfa5</i> This field specifies the α_5 parameter of the Klobuchar model, as specified in 7.8.1 in [39], [49]. Scale factor -2^{-3} TECU.</p>
<p><i>alfa6</i> This field specifies the α_6 parameter of the Klobuchar model, as specified in 7.8.1 in [39], [49]. Scale factor 2^{-3} TECU.</p>
<p><i>alfa7</i> This field specifies the α_7 parameter of the Klobuchar model, as specified in 7.8.1 in [39], [49]. Scale factor 2^{-3} TECU.</p>

KlobucharModel2Parameter field descriptions
<p>alfa8 This field specifies the α_8 parameter of the Klobuchar model, as specified in 7.8.1 in [39], [49]. Scale factor 2^{-3} TECU.</p>
<p>alfa9 This field specifies the α_9 parameter of the Klobuchar model, as specified in 7.8.1 in [39], [49]. Scale factor 2^{-3} TECU.</p>

– NeQuickModelParameter

```

-- ASN1START
NeQuickModelParameter ::= SEQUENCE {
    ai0          INTEGER (0..2047),
    ai1          INTEGER (-1024..1023),
    ai2          INTEGER (-8192..8191),
    ionoStormFlag1  INTEGER (0..1)      OPTIONAL,  -- Need OP
    ionoStormFlag2  INTEGER (0..1)      OPTIONAL,  -- Need OP
    ionoStormFlag3  INTEGER (0..1)      OPTIONAL,  -- Need OP
    ionoStormFlag4  INTEGER (0..1)      OPTIONAL,  -- Need OP
    ionoStormFlag5  INTEGER (0..1)      OPTIONAL,  -- Need OP
    ...
}
-- ASN1STOP

```

NeQuickModelParameter field descriptions
<p>ai0 Effective Ionisation Level 1st order parameter. Scale factor 2^{-2} Solar Flux Units (SFUs), [8] clause 5.1.6.</p>
<p>ai1 Effective Ionisation Level 2nd order parameter. Scale factor 2^{-8} Solar Flux Units/degree, [8] clause 5.1.6.</p>
<p>ai2 Effective Ionisation Level 3rd order parameter. Scale factor 2^{-15} Solar Flux Units/degree², [8] clause 5.1.6.</p>
<p>ionoStormFlag1, ionoStormFlag2, ionoStormFlag3, ionoStormFlag4, ionoStormFlag5 These fields specify the ionosphere disturbance flags (1,...,5) for five different regions as described in [8], clause 5.1.6. If the ionosphere disturbance flag for a region is not present the target device shall treat the ionosphere disturbance condition as unknown.</p>

– GNSS-EarthOrientationParameters

The IE *GNSS-EarthOrientationParameters* is used by the location server to provide parameters to construct the ECEF and ECI coordinate transformation as defined in [4]. The IE *GNSS-EarthOrientationParameters* indicates the relationship between the Earth's rotational axis and WGS-84 reference system.

```

-- ASN1START
GNSS-EarthOrientationParameters ::= SEQUENCE {
    teop          INTEGER (0..65535),
    pmX           INTEGER (-1048576..1048575),
    pmXdot        INTEGER (-16384..16383),
    pmY           INTEGER (-1048576..1048575),
    pmYdot        INTEGER (-16384..16383),
    deltaUT1      INTEGER (-1073741824..1073741823),
    deltaUT1dot   INTEGER (-262144..262143),
    ...
}
-- ASN1STOP

```

GNSS-EarthOrientationParameters field descriptions
<p>teop This field specifies the EOP data reference time in seconds, as specified in [4], [39]. Scale factor 2^4 seconds.</p>

GNSS-EarthOrientationParameters field descriptions	
pmX	This field specifies the X-axis polar motion value at reference time in arc-seconds, as specified in [4], [39], [49]. Scale factor 2 ⁻²⁰ arc-seconds.
pmXdot	This field specifies the X-axis polar motion drift at reference time in arc-seconds/day, as specified in [4], [39], [49]. Scale factor 2 ⁻²¹ arc-seconds/day.
pmY	This field specifies the Y-axis polar motion value at reference time in arc-seconds, as specified in [4], [39], [49]. Scale factor 2 ⁻²⁰ arc-seconds.
pmYdot	This field specifies the Y-axis polar motion drift at reference time in arc-seconds/day, as specified in [4], [39], [49]. Scale factor 2 ⁻²¹ arc-seconds/day.
deltaUT1	This field specifies the UT1-UTC difference at reference time in seconds, as specified in [4], [39], [49]. Scale factor 2 ⁻²⁴ seconds.
deltaUT1dot	This field specifies the Rate of UT1-UTC difference at reference time in seconds/day, as specified in [4], [39], [49]. Scale factor 2 ⁻²⁵ seconds/day.

– GNSS-RTK-ReferenceStationInfo

The IE *GNSS-RTK-ReferenceStationInfo* is used by the location server to provide the Earth-centered, Earth-fixed (ECEF) coordinates of the antenna reference point (ARP) of the stationary reference station for which the *GNSS-RTK-Observations* assistance data are provided together with reference station antenna description.

The parameters provided in IE *GNSS-RTK-ReferenceStationInfo* are used as specified for message type 1006, 1033 and 1032 in [30].

```
-- ASN1START
GNSS-RTK-ReferenceStationInfo-r15 ::= SEQUENCE {
    referenceStationID-r15          GNSS-ReferenceStationID-r15,
    referenceStationIndicator-r15   ENUMERATED {physical, non-physical},
    antenna-reference-point-ECEF-X-r15  INTEGER (-137438953472..137438953471),
    antenna-reference-point-ECEF-Y-r15  INTEGER (-137438953472..137438953471),
    antenna-reference-point-ECEF-Z-r15  INTEGER (-137438953472..137438953471),
    antennaHeight-r15               INTEGER (0..65535)                OPTIONAL, -- Need ON
    antennaDescription-r15           AntennaDescription-r15          OPTIONAL, -- Need ON
    antenna-reference-point-unc-r15    AntennaReferencePointUnc-r15  OPTIONAL, -- Need ON
    physical-reference-station-info-r15 PhysicalReferenceStationInfo-r15  OPTIONAL, -- Cond NP
    ...
    [[
    equalIntegerAmbiguityLevel-r16     EqualIntegerAmbiguityLevel-r16  OPTIONAL -- Need ON
    ]]
}

AntennaDescription-r15 ::= SEQUENCE {
    antennaDescriptor-r15             VisibleString (SIZE (1..256)),
    antennaSetUpID-r15                ENUMERATED { non-zero }          OPTIONAL, -- Need OP
    ...
}

AntennaReferencePointUnc-r15 ::= SEQUENCE {
    uncertainty-X-r15                 INTEGER (0..255),
    confidence-X-r15                  INTEGER (0..100),
    uncertainty-Y-r15                 INTEGER (0..255),
    confidence-Y-r15                  INTEGER (0..100),
    uncertainty-Z-r15                 INTEGER (0..255),
    confidence-Z-r15                  INTEGER (0..100),
    ...
}

PhysicalReferenceStationInfo-r15 ::= SEQUENCE {
    physicalReferenceStationID-r15    GNSS-ReferenceStationID-r15,
    physical-ARP-ECEF-X-r15           INTEGER (-137438953472..137438953471),
    physical-ARP-ECEF-Y-r15           INTEGER (-137438953472..137438953471),
    physical-ARP-ECEF-Z-r15           INTEGER (-137438953472..137438953471),
    physical-ARP-unc-r15               AntennaReferencePointUnc-r15  OPTIONAL, -- Need ON
    ...
}
```

```
EqualIntegerAmbiguityLevel-r16 ::= CHOICE {  
    allReferenceStations-r16          NULL,  
    referenceStationList-r16         ReferenceStationList-r16  
}  
  
ReferenceStationList-r16 ::= SEQUENCE (SIZE(1..16)) OF GNSS-ReferenceStationID-r15  
  
-- ASN1STOP
```

Conditional presence	Explanation
NP	The field is optionally present, need ON, if the <i>referenceStationIndicator</i> has the value ' <i>non-physical</i> '; otherwise it is not present.

GNSS-RTK-ReferenceStationInfo field descriptions	
referenceStationID	The Reference Station ID is determined by the RTK service provider.
referenceStationIndicator	This field specifies type of reference station. Enumerated value <i>physical</i> indicates a real, physical reference station; value <i>non-physical</i> indicates a non-physical or computed reference station.
antenna-reference-point-ECEF-X	This field specifies the antenna reference point X-coordinate in the World Geodetic System 1984 (WGS 84) datum. Scale factor 0.0001 m; range $\pm 13,743,895.3471$ m.
antenna-reference-point-ECEF-Y	This field specifies the antenna reference point Y-coordinate in the World Geodetic System 1984 (WGS 84) datum. Scale factor 0.0001 m; range $\pm 13,743,895.3471$ m.
antenna-reference-point-ECEF-Z	This field specifies the antenna reference point Z-coordinate in the World Geodetic System 1984 (WGS 84) datum. Scale factor 0.0001 m; range $\pm 13,743,895.3471$ m.
antennaHeight	This field specifies the height of the Antenna Reference Point above the marker used in the survey campaign. Scale factor 0.0001 m; range 0–6.5535 m.
antennaDescriptor	This field provides an ASCII descriptor of the reference station antenna using IGS naming convention [31]. The descriptor can be used to look up model specific phase centre corrections of that antenna.
antennaSetUpID	This field, if present, indicates that the standard IGS Model is not valid ($\neq 0$ [30]). If this field is absent the standard IGS Model is valid ('0 = Use standard IGS Model' [30]).
antenna-reference-point-unc	This field specifies the uncertainty of the ARP coordinates. <i>uncertainty-X</i> , <i>uncertainty-Y</i> , and <i>uncertainty-Z</i> correspond to the encoded high accuracy uncertainty of the X, Y, and Z-coordinate, respectively, as defined in TS 23.032 [15]. <i>confidence-X</i> , <i>confidence-Y</i> , and <i>confidence-Z</i> corresponds to confidence as defined in TS 23.032 [15].
physical-reference-station-info	This field provides the earth-centred, earth-fixed (ECEF) coordinates of the antenna reference point (ARP) for the real (or "physical") reference station used. This field may be used in the case of the non-physical reference station approach to allow the target device to refer baseline vectors to a physical reference rather than to a non-physical reference without any connection to a physical point.
physicalReferenceStationID	This field specifies the station ID of a real reference station, when the <i>referenceStationIndicator</i> has the value ' <i>non-physical</i> '.
physical-ARP-ECEF-X	This field specifies the antenna reference point X-coordinate in the World Geodetic System 1984 (WGS 84) datum. Scale factor 0.0001 m; range $\pm 13,743,895.3471$ m.
physical-ARP-ECEF-Y	This field specifies the antenna reference point Y-coordinate in the World Geodetic System 1984 (WGS 84) datum. Scale factor 0.0001 m; range $\pm 13,743,895.3471$ m.
physical-ARP-ECEF-Z	This field specifies the antenna reference point Z-coordinate in the World Geodetic System 1984 (WGS 84) datum. Scale factor 0.0001 m; range $\pm 13,743,895.3471$ m.
physical-ARP-unc	This field specifies the uncertainty of the ARP coordinates.
equalIntegerAmbiguityLevel	This field specifies the integer ambiguity level of this reference station in relation to other reference stations. Either, the presence or absence of <i>allReferenceStations</i> indicates whether the integer ambiguity level may be assumed to be aligned between all reference stations or not (interpreted as no alignment is facilitated from the location server), or <i>referenceStationList</i> provides a list of reference stations for which the integer ambiguity level may be assumed to be the same.

– GNSS-RTK-CommonObservationInfo

The IE *GNSS-RTK-CommonObservationInfo* is used by the location server to provide common information applicable to the IE *GNSS-RTK-Observations*.

The parameters provided in IE *GNSS-RTK-CommonObservationInfo* are used as specified for message type 1071-1127 in [30].

```
-- ASN1START
GNSS-RTK-CommonObservationInfo-r15 ::= SEQUENCE {
    referenceStationID-r15          GNSS-ReferenceStationID-r15,
```

```

clockSteeringIndicator-r15      INTEGER (0..3),
externalClockIndicator-r15     INTEGER (0..3),
smoothingIndicator-r15        BIT STRING (SIZE(1)),
smoothingInterval-r15        BIT STRING (SIZE(3)),
...
}
-- ASN1STOP

```

GNSS-RTK-CommonObservationInfo field descriptions	
referenceStationID	This field specifies the Station ID for which the <i>GNSS-RTK-Observations</i> are provided.
clockSteeringIndicator	This field provides the clock steering indicator. The interpretation of the value is as follows: 0 clock steering is not applied In this case, the receiver clock must be kept in the range of ±1 ms (approximately ±300 km) 1 clock steering has been applied In this case, the receiver clock must be kept in the range of ±1 microsecond (approximately ±300 metres). 2 unknown clock steering status 3 reserved
externalClockIndicator	This field provides the external clock indicator. The interpretation of the value is as follows: 0 internal clock is used 1 external clock is used, clock status is "locked" 2 external clock is used, clock status is "not locked", which may indicate external clock failure and that the transmitted data may not be reliable. 3 unknown clock is used
smoothingIndicator	This field provides the GNSS Divergence-free Smoothing Indicator. The interpretation of the value is as follows: 1 Divergence-free smoothing is used 0 Other type of smoothing is used
smoothingInterval	The GNSS Smoothing Interval is the integration period over which the pseudorange code phase measurements are averaged using carrier phase information. Divergence-free smoothing may be continuous over the entire period for which the satellite is visible. A value of zero indicates no smoothing is used. See table " <i>smoothingInterval</i> value to Smoothing Interval relation" below.

smoothingInterval value to Smoothing Interval relation

smoothingInterval value	Smoothing Interval
000 (0)	No smoothing
001 (1)	< 30 s
010 (2)	30-60 s
011 (3)	1-2 min
100 (4)	2-4 min
101 (5)	4-8 min
110 (6)	>8 min
111 (7)	Unlimited smoothing interval

GNSS-RTK-AuxiliaryStationData

The IE *GNSS-RTK-AuxiliaryStationData* is used by the location server to provide the coordinates of the antenna reference point (ARP) of Auxiliary Reference Stations, relative to the coordinates provided in IE *GNSS-RTK-ReferenceStationInfo*. The reference station provided in IE *GNSS-RTK-ReferenceStationInfo* is the Master Reference Station. Therefore, one Master Reference Station with its associated Auxiliary Stations is used in a single Provide Assistance Data message.

The parameters provided in IE *GNSS-RTK-AuxiliaryStationData* are used as specified for message type 1014 in [30].

```

-- ASN1START
GNSS-RTK-AuxiliaryStationData-r15 ::= SEQUENCE {
    networkID-r15          GNSS-NetworkID-r15,
    subNetworkID-r15      GNSS-SubNetworkID-r15          OPTIONAL, -- Need ON
}
-- ASN1STOP

```

```

    master-referenceStationID-r15  GNSS-ReferenceStationID-r15,
    auxiliaryStationList-r15       AuxiliaryStationList-r15,
    ...
}

AuxiliaryStationList-r15 ::= SEQUENCE (SIZE (1..32)) OF AuxiliaryStationElement-r15

AuxiliaryStationElement-r15 ::= SEQUENCE {
    aux-referenceStationID-r15      GNSS-ReferenceStationID-r15,
    aux-master-delta-latitude-r15   INTEGER (-524288..524287),
    aux-master-delta-longitude-r15 INTEGER (-1048576..1048575),
    aux-master-delta-height-r15    INTEGER (-4194304..4194303),
    aux-ARP-unc-r15                 Aux-ARP-Unc-r15                OPTIONAL,  -- Need ON
    ...
}

Aux-ARP-Unc-r15 ::= SEQUENCE {
    horizontalUncertainty-r15      INTEGER (0..255),
    horizontalConfidence-r15       INTEGER (0..100),
    verticalUncertainty-r15        INTEGER (0..255)                OPTIONAL,  -- Need ON
    verticalConfidence-r15        INTEGER (0..100)                OPTIONAL,  -- Need ON
    ...
}

-- ASN1STOP

```

GNSS-RTK-AuxiliaryStationData field descriptions

networkID

This field defines the network and the source of the particular set of reference stations and their observation information. The RTK service provider should ensure that the *networkID* is unique in the region serviced. The *networkID* indicates an area and its reference stations where the service providers will provide a homogenous solution with levelled integer ambiguities between its reference stations. In general, the area indicated by *networkID* will comprise one subnetwork with a unique *subNetworkID*.

subNetworkID

This field identifies the subnetwork of a network identified by *networkID*. In general the area indicated by *networkID* will consist of one subnetwork. The *subNetworkID* indicates the actual solution number of integer ambiguity level. If one network has only one subnetwork, this indicates that an ambiguity level throughout the whole network is established.

master-referenceStationID

This field identifies the Master Reference Station.

aux-referenceStationID

This field identifies the Auxiliary Reference Station.

aux-master-delta-latitude

This field provides the delta value in latitude of Antenna Reference Point of "Auxiliary Reference Station minus Master Reference Station" in geographical coordinates based on GRS80 ellipsoid parameters for the same ECEF system as used in IE *GNSS-RTK-ReferenceStationInfo*.

Scale factor 25×10^{-6} degrees; range ± 13.1071 degrees.

aux-master-delta-longitude

This field provides the delta value in longitude of Antenna Reference Point of "Auxiliary Reference Station minus Master Reference Station" in geographical coordinates based on GRS80 ellipsoid parameters for the same ECEF system as used in IE *GNSS-RTK-ReferenceStationInfo*.

Scale factor 25×10^{-6} degrees; range ± 26.2142 degrees.

aux-master-delta-height

This field provides the delta value in ellipsoidal height of Antenna Reference Point of "Auxiliary Reference Station minus Master Reference Station" in geographical coordinates based on GRS80 ellipsoid parameters for the same ECEF system as used in IE *GNSS-RTK-ReferenceStationInfo*.

Scale factor 1 millimetre; range ± 4194.303 m.

aux-ARP-unc

This field specifies the uncertainty of the auxiliary station ARP coordinates and comprise the following fields:

- **horizontalUncertainty** indicates the horizontal uncertainty of the ARP latitude/longitude. The '*horizontalUncertainty*' corresponds to the encoded high accuracy uncertainty as defined in TS 23.032 [15] and '*horizontalConfidence*' corresponds to confidence as defined in TS 23.032 [15].
- **verticalUncertainty** indicates the vertical uncertainty of the ARP altitude. The '*verticalUncertainty*' corresponds to the encoded high accuracy uncertainty as defined in TS 23.032 [15] and '*verticalConfidence*' corresponds to confidence as defined in TS 23.032 [15].

– GNSS-SSR-CorrectionPoints

The IE *GNSS-SSR-CorrectionPoints* is used by the location server to provide a list of correction point coordinates or an array of correction points ("grid") for which the *GNSS-SSR-GriddedCorrection* are valid.

```
-- ASN1START
GNSS-SSR-CorrectionPoints-r16 ::= SEQUENCE {
    correctionPointSetID-r16      INTEGER (0..16383),
    correctionPoints-r16          CHOICE {
        listOfCorrectionPoints-r16  GNSS-SSR-ListOfCorrectionPoints-r16,
        arrayOfCorrectionPoints-r16  GNSS-SSR-ArrayOfCorrectionPoints-r16
    },
    ...
}

GNSS-SSR-ListOfCorrectionPoints-r16 ::= SEQUENCE {
    referencePointLatitude-r16     INTEGER (-16384..16383),
    referencePointLongitude-r16    INTEGER (-32768..32767),
    relativeLocationsList-r16      SEQUENCE (SIZE (0..63)) OF RelativeLocationElement-r16,
    ...
}

RelativeLocationElement-r16 ::= SEQUENCE {
    deltaLatitude-r16              INTEGER (-512..511),
    deltaLongitude-r16             INTEGER (-1024..1023),
    ...
}

GNSS-SSR-ArrayOfCorrectionPoints-r16 ::= SEQUENCE {
    referencePointLatitude-r16     INTEGER (-16384..16383),
    referencePointLongitude-r16    INTEGER (-32768..32767),
    numberOfStepsLatitude-r16     INTEGER (0..63),
    numberOfStepsLongitude-r16    INTEGER (0..63),
    stepOfLatitude-r16            INTEGER (1..511),
    stepOfLongitude-r16           INTEGER (1..1023),
    bitmaskOfGrids-r16            BIT STRING (SIZE(64))
    ...
}
-- ASN1STOP
```

GNSS-SSR-CorrectionPoints field descriptions

correctionPointSetID

This field provides the ID of the Atmospheric Correction Point set. It is a regionally unique arbitrary number that is used by the UE to ensure that the atmospheric corrections are being applied to the correct set of points.

referencePointLatitude

This field specifies the latitude for the reference point, expressed in the range of -90° , $+90^\circ$, coded as a number between -2^{14} and $2^{14}-1$, coded in 2's complement binary on 15 bits. The relation between the latitude X in the range $[-90^\circ, 90^\circ]$ and the coded number N is:

$$N = \left\lfloor \frac{X}{90^\circ} 2^{14} \right\rfloor$$

where $\lfloor x \rfloor$ denotes the greatest integer less than or equal to x (floor operator).

For the *listOfCorrectionPoints*, the reference point defines the 1st correction point location.

For the *arrayOfCorrectionPoints*, the reference point defines the northwest corner of the correction point array.

referencePointLongitude

This field specifies the longitude for the reference point, expressed in the range -180° , $+180^\circ$, coded as a number between -2^{15} and $2^{15}-1$, coded in 2's complement binary on 16 bits. The relation between the longitude X in the range $[-180^\circ, 180^\circ)$ and the coded number N is:

$$N = \left\lfloor \frac{X}{180^\circ} 2^{15} \right\rfloor$$

For the *listOfCorrectionPoints*, the reference point defines the 1st correction point location.

For the *arrayOfCorrectionPoints*, the reference point defines the northwest corner of the correction point array.

GNSS-SSR-CorrectionPoints field descriptions
<p>relativeLocationsList This field specifies the 2nd, 3rd, ..., 64th correction point location.</p>
<p>deltaLatitude This field specifies the delta value in latitude of this correction point location relative to the previous point on the list or the reference point in the case of the first additional point, defined as "correction point location" minus "previous correction point location" in units of 0.01 degrees.</p>
<p>deltaLongitude This field specifies the delta value in longitude of this correction point location relative to the previous point on the list or the reference point in the case of the first additional point, defined as "correction point location" minus "previous correction point location" in units of 0.01 degrees.</p>
<p>numberOfStepsLatitude, numberOfStepsLongitude These fields specify the number of steps for latitude and longitude direction respectively.</p>
<p>stepOfLatitude, stepOfLongitude These fields specify the spacing of the correction points for latitude and longitude respectively. The unit and scale factor is 0.01 degrees.</p>
<p>bitmaskOfGrids This field specifies the availability of correction data at the correction points in the array. If a specific bit is enabled (set to '1'), the correction is available. Only the first $(numberOfStepsLatitude + 1) \times (numberOfStepsLongitude + 1)$ bits are used, the remainder are set to '0'. Starting with the northwest corner of the array (top left on a north oriented map) the correction points are enumerated with row precedence – first row west to east, second row west to east, until last row west to east – ending with the southeast corner of the array. If the field is omitted all correction points are used and none omitted.</p>

– GNSS-Integrity-ServiceParameters

The IE *GNSS-Integrity-ServiceParameters* is used by the location server to provide the range of Integrity Risk (IR) for which the GNSS integrity assistance data are valid.

```
-- ASN1START
GNSS-Integrity-ServiceParameters-r17 ::= SEQUENCE {
    irMinimum-r17          INTEGER (0..255),
    irMaximum-r17         INTEGER (0..255),
    ...
}
-- ASN1STOP
```

GNSS-Integrity-ServiceParameters field descriptions
<p>irMinimum This field specifies the Minimum Integrity Risk (IR) which is the minimum IR for which the error bounds provided in the IEs <i>SSR-IntegrityOrbitBounds</i>, <i>SSR-IntegrityClockBounds</i>, <i>SSR-IntegrityCodeBiasBounds</i>, <i>SSR-IntegrityPhaseBiasBounds</i>, <i>STEC-IntegrityErrorBounds</i>, and <i>TropoDelayIntegrityErrorBounds</i> are valid. The IR is calculated by $P = 10^{-0.04n}$ where n is the value of <i>irMinimum</i> and the range is $10^{-10.2}$ to 1.</p>
<p>irMaximum This field specifies the Maximum Integrity Risk (IR) which is the maximum IR for which the error bounds provided in the IEs <i>SSR-IntegrityOrbitBounds</i>, <i>SSR-IntegrityClockBounds</i>, <i>SSR-IntegrityCodeBiasBounds</i>, <i>SSR-IntegrityPhaseBiasBounds</i>, <i>STEC-IntegrityErrorBounds</i>, and <i>TropoDelayIntegrityErrorBounds</i> are valid. The IR is calculated by $P = 10^{-0.04n}$ where n is the value of <i>irMaximum</i> and the range is $10^{-10.2}$ to 1.</p>

– GNSS-Integrity-ServiceAlert

The IE *GNSS-Integrity-ServiceAlert* is used by the location server to indicate whether the corresponding assistance data can be used for integrity related applications.

```
-- ASN1START
GNSS-Integrity-ServiceAlert-r17 ::= SEQUENCE {
    ionosphereDoNotUse-r17    BOOLEAN,
    troposphereDoNotUse-r17   BOOLEAN,
    ...
}
-- ASN1STOP
```

GNSS-Integrity-ServiceAlert field descriptions
<p>ionosphereDoNotUse This field indicates whether the ionospheric corrections in IE <i>GNSS-SSR-STECCorrection</i> can be used for integrity related applications (FALSE) or not (TRUE).</p>
<p>troposphereDoNotUse This field indicates whether the tropospheric corrections in IE <i>GNSS-SSR-GriddedCorrection</i> can be used for integrity related applications (FALSE) or not (TRUE).</p>

– GNSS-TimeModelList

The IE *GNSS-TimeModelList* is used by the location server to provide the GNSS-GNSS system time offset between the GNSS system time indicated by IE *GNSS-ID* in IE *GNSS-GenericAssistDataElement* to the GNSS system time indicated by IE *gnss-TO-ID*. Several *GNSS-TimeModelElement* IEs can be included with different *gnss-TO-ID* fields. The location server should provide a *GNSS-TimeModelList* for the same *GNSS-ID* as the *gnss-TimeID* in IE *GNSS-SystemTime* in *GNSS-ReferenceTime* assistance. If the location server does not provide a *GNSS-TimeModelList* for the same *GNSS-ID* as the *gnss-TimeID* in IE *GNSS-SystemTime* in *GNSS-ReferenceTime* assistance the target device assumes *tA1* and *tA2* are equal to zero.

```

-- ASN1START
GNSS-TimeModelList ::= SEQUENCE (SIZE (1..15)) OF GNSS-TimeModelElement
GNSS-TimeModelElement ::= SEQUENCE {
    gnss-TimeModelRefTime    INTEGER (0..65535),
    tA0                      INTEGER (-67108864..67108863),
    tA1                      INTEGER (-4096..4095)                OPTIONAL,    -- Need ON
    tA2                      INTEGER (-64..63)                    OPTIONAL,    -- Need ON
    gnss-TO-ID               INTEGER (1..15),
    weekNumber               INTEGER (0..8191)                    OPTIONAL,    -- Need ON
    deltaT                   INTEGER (-128..127)                 OPTIONAL,    -- Need ON
    ...
}
-- ASN1STOP

```

GNSS-TimeModelElement field descriptions
<p>gnss-TimeModelRefTime This field specifies the reference time of week for <i>GNSS-TimeModelElement</i> and it is given in GNSS specific system time. Scale factor 2^4 seconds.</p>
<p>tA0 This field specifies the bias coefficient of the <i>GNSS-TimeModelElement</i>. Scale factor 2^{-35} seconds.</p>
<p>tA1 This field specifies the drift coefficient of the <i>GNSS-TimeModelElement</i>. Scale factor of 2^{-51} seconds/second.</p>
<p>tA2 This field specifies the drift rate correction coefficient of the <i>GNSS-TimeModelElement</i>. Scale factor of 2^{-68} seconds/second².</p>
<p>gnss-TO-ID This field specifies the GNSS system time of the GNSS for which the <i>GNSS-TimeModelElement</i> is applicable. <i>GNSS-TimeModelElement</i> contains parameters to convert GNSS system time from the system indicated by <i>GNSS-ID</i> to GNSS system time indicated by <i>gnss-TO-ID</i>. The conversion is defined in [4,5,6]. See table of <i>gnss-TO-ID</i> to Indication relation below. NOTE.</p>
<p>weekNumber This field specifies the reference week of the <i>GNSS-TimeModelElement</i> given in GNSS specific system time. The location server should include this field, if <i>tA1</i> or <i>tA2</i> is included. Scale factor 1 week.</p>
<p>deltaT This field specifies the integer number of seconds of the GNSS-GNSS time offset provided in the <i>GNSS-TimeModelElement</i>. Scale factor 1 second.</p>

gnss-TO-ID to Indication relation

Value of <i>gnss-TO-ID</i>	Indication
1	GPS
2	Galileo
3	QZSS
4	GLONASS
5	BDS
6	NavIC
7-15	reserved

NOTE: The time relationship between the system time indicated by *GNSS-ID* and system time indicated by *gnss-TO-ID* is given by the following equation:

$$t_{\text{GNSS}} = t_{\text{E}} - (A_{0\text{GGTO}} + A_{1\text{GGTO}} (t_{\text{E}} - t_{\text{GGTO}} + 604800 (W\text{N} - W\text{N}_{\text{GGTO}})) + A_{2\text{GGTO}} (t_{\text{E}} - t_{\text{GGTO}} + 604800 (W\text{N} - W\text{N}_{\text{GGTO}}))^2)$$

where

t_{GNSS} is the system time of week for the GNSS indicated by *gnss-TO-ID*.

t_{E} is the system time of week for the GNSS indicated by *GNSS-ID*.

$W\text{N}$ is the week number of the GNSS system time indicated by *GNSS-ID* corresponding to the t_{E} .

t_{GGTO} is the system time of week for the time model data in the GNSS time indicated by *GNSS-ID* and given by the *gnss-TimeModelRefTime* field.

$W\text{N}_{\text{GGTO}}$ is the week number for the time model data in the GNSS time indicated by *GNSS-ID* corresponding to the t_{GGTO} and given by the *weekNumber* field.

$A_{0\text{GGTO}}$ is given by the *tA0* field.

$A_{1\text{GGTO}}$ is given by the *tA1* field.

$A_{2\text{GGTO}}$ is given by the *tA2* field.

If the *tA1* and *tA2* are not included in the *GNSS-TimeModelElement*, the target device assumes $A_{1\text{GGTO}}$ and $A_{2\text{GGTO}}$ are equal to zero.

The GNSS system times in the IE *GNSS-TimeModelList* and used in the equation above are all given in Time of Week (TOW) and Week Number (WN) in the indicated GNSS specific system time. For conversion between TOW/WN and Day Number/Time of Day (*gnss-DayNumber/gnss-TimeOfDay*) a GNSS week consists of 7 days since the origin of the particular GNSS System time (with the week number count starting at 0), and a day consists of 86400 seconds.

– GNSS-DifferentialCorrections

The IE *GNSS-DifferentialCorrections* is used by the location server to provide differential GNSS corrections to the target device for a specific GNSS. Differential corrections can be provided for up to 3 signals per GNSS.

```
-- ASN1START

GNSS-DifferentialCorrections ::= SEQUENCE {
    dgnss-RefTime      INTEGER (0..3599),
    dgnss-SgnTypeList  DGNSS-SgnTypeList,
    ...
}

DGNSS-SgnTypeList ::= SEQUENCE (SIZE (1..3)) OF DGNSS-SgnTypeElement

DGNSS-SgnTypeElement ::= SEQUENCE {
    gnss-SignalID      GNSS-SignalID,
    gnss-StatusHealth  INTEGER (0..7),
    dgnss-SatList      DGNSS-SatList,
    ...
}

DGNSS-SatList ::= SEQUENCE (SIZE (1..64)) OF DGNSS-CorrectionsElement

DGNSS-CorrectionsElement ::= SEQUENCE {
    svID              SV-ID,
    iod               BIT STRING (SIZE(11)),
```

```

udre                INTEGER (0..3),
pseudoRangeCor     INTEGER (-2047..2047),
rangeRateCor       INTEGER (-127..127),
udreGrowthRate     INTEGER (0..7)          OPTIONAL,    -- Need ON
udreValidityTime   INTEGER (0..7)          OPTIONAL,    -- Need ON
...
}
-- ASN1STOP

```

GNSS-DifferentialCorrections field descriptions

dgnss-RefTime

This field specifies the time for which the DGNSS corrections are valid, modulo 1 hour. *dgnss-RefTime* is given in GNSS specific system time.

Scale factor 1-second.

dgnss-SgnTypeList

This list includes differential correction data for different GNSS signal types, identified by *GNSS-SignalID*.

gnss-StatusHealth

This field specifies the status of the differential corrections. The values of this field and their respective meanings are defined as in table *gnss-StatusHealth* Value to Indication relation below.

The first six values in this field indicate valid differential corrections. When using the values described below, the "UDRE Scale Factor" value is applied to the UDRE values contained in the element. The purpose is to indicate an estimate in the amount of error in the corrections.

The value "110" indicates that the source of the differential corrections (e.g., reference station or external DGNSS network) is currently not being monitored. The value "111" indicates that the corrections provided by the source are invalid, as judged by the source.

dgnss-SatList

This list includes differential correction data for different GNSS satellites, identified by *SV-ID*.

iod

This field specifies the Issue of Data field which contains the identity for the *GNSS-NavigationModel*.

udre

This field provides an estimate of the uncertainty ($1-\sigma$) in the corrections for the particular satellite. The value in this field shall be multiplied by the UDRE Scale Factor in the *gnss-StatusHealth* field to determine the final UDRE estimate for the particular satellite. The meanings of the values for this field are shown in the table *udre* Value to Indication relation below.

pseudoRangeCor

This field specifies the correction to the pseudorange for the particular satellite at *dgnss-RefTime*, t_0 . The value of this field is given in metres and the scale factor is 0.32 metres in the range of ± 655.04 metres. The method of calculating this field is described in [11].

If the location server has received a request for GNSS assistance data from a target device which included a request for the GNSS Navigation Model and DGNSS, the location server determines, for each satellite, if the navigation model stored by the target device is still suitable for use with DGNSS corrections and if so and if DGNSS corrections are supported the location server should send DGNSS corrections without including the GNSS Navigation Model.

The *iod* value sent for a satellite shall always be the IOD value that corresponds to the navigation model for which the pseudo-range corrections are applicable.

The target device shall only use the *pseudoRangeCor* value when the IOD value received matches its available navigation model.

Pseudo-range corrections are provided with respect to GNSS specific geodetic datum (e.g., PZ-90.02 if *GNSS-ID* indicates GLONASS).

Scale factor 0.32 metres.

rangeRateCor

This field specifies the rate-of-change of the pseudorange correction for the particular satellite, using the satellite ephemeris and clock corrections identified by the *iod* field. The value of this field is given in metres per second and the resolution is 0.032 metres/second in the range of ± 4.064 metres/second. For some time $t_1 > t_0$, the corrections for *iod* are estimated by

$$\text{PRC}(t_1, \text{IOD}) = \text{PRC}(t_0, \text{IOD}) + \text{RRC}(t_0, \text{IOD}) \cdot (t_1 - t_0),$$

and the target device uses this to correct the pseudorange it measures at t_1 , $\text{PR}_m(t_1, \text{IOD})$, by

$$\text{PR}(t_1, \text{IOD}) = \text{PR}_m(t_1, \text{IOD}) + \text{PRC}(t_1, \text{IOD}).$$

The location server always sends the RRC value that corresponds to the PRC value that it sends. The target device shall only use the RRC value when the *iod* value received matches its available navigation model.

Scale factor 0.032 metres/second.

udreGrowthRate

This field provides an estimate of the growth rate of uncertainty ($1-\sigma$) in the corrections for the particular satellite identified by *SV-ID*. The estimated UDRE at time value specified in the *udreValidityTime* t_1 is calculated as follows:

$$\text{UDRE}(t_0+t_1) = \text{UDRE}(t_0) \times \text{udreGrowthRate},$$

where t_0 is the DGNSS Reference Time *dgnss-RefTime* for which the corrections are valid, t_1 is the *udreValidityTime* field, $\text{UDRE}(t_0)$ is the value of the *udre* field, and *udreGrowthRate* field is the factor as shown in the table Value of *udreGrowthRate* to Indication relation below.

GNSS-DifferentialCorrections field descriptions***udreValidityTime***

This field specifies the time when the *udreGrowthRate* field applies and is included if *udreGrowthRate* is included. The meaning of the values for this field is as shown in the table Value of *udreValidityTime* to Indication relation below.

***gnss-StatusHealth* Value to Indication relation**

<i>gnss-StatusHealth</i> Value	Indication
000	UDRE Scale Factor = 1.0
001	UDRE Scale Factor = 0.75
010	UDRE Scale Factor = 0.5
011	UDRE Scale Factor = 0.3
100	UDRE Scale Factor = 0.2
101	UDRE Scale Factor = 0.1
110	Reference Station Transmission Not Monitored
111	Data is invalid - disregard

***udre* Value to Indication relation**

<i>udre</i> Value	Indication
00	UDRE \leq 1.0 m
01	1.0 m < UDRE \leq 4.0 m
10	4.0 m < UDRE \leq 8.0 m
11	8.0 m < UDRE

Value of *udreGrowthRate* to Indication relation

Value of <i>udreGrowthRate</i>	Indication
000	1.5
001	2
010	4
011	6
100	8
101	10
110	12
111	16

Value of *udreValidityTime* to Indication relation

Value of <i>udreValidityTime</i>	Indication [seconds]
000	20
001	40
010	80
011	160
100	320
101	640
110	1280
111	2560

– GNSS-*NavigationModel*

The IE *GNSS-NavigationModel* is used by the location server to provide precise navigation data to the GNSS capable target device. In response to a request from a target device for GNSS Assistance Data, the location server determines whether to send the navigation model for a particular satellite to a target device based upon factors like the T-Toe limit specified by the target device and any request from the target device for DGNSS (see also *GNSS-DifferentialCorrections*). GNSS Orbit Model can be given in Keplerian parameters or as state vector in Earth-Centered Earth-Fixed coordinates, dependent on the *GNSS-ID* and the target device capabilities. The meaning of these parameters is defined in relevant ICDs of the particular GNSS and GNSS specific interpretations apply. For example, GPS and QZSS use the same model parameters but some parameters have a different interpretation [7].

```

-- ASN1START

GNSS-NavigationModel ::= SEQUENCE {
    nonBroadcastIndFlag      INTEGER (0..1),
    gnss-SatelliteList      GNSS-NavModelSatelliteList,
    ...
}

GNSS-NavModelSatelliteList ::= SEQUENCE (SIZE(1..64)) OF GNSS-NavModelSatelliteElement

GNSS-NavModelSatelliteElement ::= SEQUENCE {
    svID                    SV-ID,
    svHealth                BIT STRING (SIZE(8)),
    iod                    BIT STRING (SIZE(11)),
    gnss-ClockModel        GNSS-ClockModel,
    gnss-OrbitModel        GNSS-OrbitModel,
    ...,
    [[ svHealthExt-v1240 BIT STRING (SIZE(4))          OPTIONAL          -- Need ON
    ]]
}

GNSS-ClockModel ::= CHOICE {
    standardClockModelList StandardClockModelList,          -- Model-1
    nav-ClockModel         NAV-ClockModel,                  -- Model-2
    cnav-ClockModel        CNAV-ClockModel,                 -- Model-3
    glonass-ClockModel     GLONASS-ClockModel,              -- Model-4
    sbas-ClockModel        SBAS-ClockModel,                 -- Model-5
    ...,
    bds-ClockModel-r12     BDS-ClockModel-r12,              -- Model-6
    bds-ClockModel2-r16    BDS-ClockModel2-r16,             -- Model-7
    navic-ClockModel-r16   NavIC-ClockModel-r16             -- Model-8
}

GNSS-OrbitModel ::= CHOICE {
    keplerianSet           NavModelKeplerianSet,            -- Model-1
    nav-KeplerianSet       NavModelNAV-KeplerianSet,       -- Model-2
    cnav-KeplerianSet      NavModelCNAV-KeplerianSet,      -- Model-3
    glonass-ECEF           NavModel-GLONASS-ECEF,          -- Model-4
    sbas-ECEF              NavModel-SBAS-ECEF,             -- Model-5
    ...,
    bds-KeplerianSet-r12   NavModel-BDS-KeplerianSet-r12, -- Model-6
    bds-KeplerianSet2-r16  NavModel-BDS-KeplerianSet2-r16, -- Model-7
    navic-KeplerianSet-r16 NavModel-NavIC-KeplerianSet-r16 -- Model-8
}

-- ASN1STOP

```

GNSS-*NavigationModel* field descriptions

nonBroadcastIndFlag

This field indicates if the *GNSS-NavigationModel* elements are not derived from satellite broadcast data or are given in a format not native to the GNSS. A value of 0 means the *GNSS-NavigationModel* data elements correspond to GNSS satellite broadcasted data; a value of 1 means the *GNSS-NavigationModel* data elements are not derived from satellite broadcast.

gnss-SatelliteList

This list provides ephemeris and clock corrections for GNSS satellites indicated by *SV-ID*.

svHealth

This field specifies the satellite's current health. The health values are GNSS system specific. The interpretation of *svHealth* depends on the *GNSS-ID* and is as shown in table GNSS to *svHealth* Bit String(8) relation below.

GNSS-NavigationModel field descriptions	
iod	<p>This field specifies the Issue of Data and contains the identity for GNSS Navigation Model.</p> <p>In the case of broadcasted GPS NAV ephemeris, the <i>iod</i> contains the IODC as described in [4].</p> <p>In the case of broadcasted Modernized GPS ephemeris, the <i>iod</i> contains the 11-bit parameter t_{oe} as defined in [4, Table 30-1] [6, Table 3.5-1].</p> <p>In the case of broadcasted SBAS ephemeris, the <i>iod</i> contains the 8 bits Issue of Data as defined in [10] Message Type 9.</p> <p>In the case of broadcasted QZSS QZS-L1 ephemeris, the <i>iod</i> contains the IODC as described in [7].</p> <p>In the case of broadcasted QZSS QZS-L1C/L2C/L5 ephemeris, the <i>iod</i> contains the 11-bit parameter t_{oe} as defined in [7].</p> <p>In the case of broadcasted GLONASS ephemeris, the <i>iod</i> contains the parameter t_b as defined in [9].</p> <p>In the case of broadcasted Galileo ephemeris, the <i>iod</i> contains the IOD index as described in [8].</p> <p>In the case of broadcasted BDS B1I/B3I ephemeris, the <i>iod</i> contains 11 MSB bits of the t_{oe} as defined in [23], [50].</p> <p>In the case of broadcasted BDS B1C/B2a ephemeris, the <i>iod</i> contains the IODC as described in [39], [49].</p> <p>In the case of broadcasted NavIC ephemeris, the <i>iod</i> contains 11 MSB bits of the t_{oe} as defined in [38].</p> <p>The interpretation of <i>iod</i> depends on the <i>GNSS-ID</i> and is as shown in table GNSS to <i>iod</i> Bit String(11) relation below.</p>
svHealthExt	<p>This field specifies the satellite's additional current health. The health values are GNSS system specific. The interpretation of <i>svHealthExt</i> depends on the <i>GNSS-ID</i> and is as shown in table GNSS to <i>svHealthExt</i> Bit String(4) relation below.</p>

GNSS to svHealth Bit String(8) relation

GNSS	svHealth Bit String(8)							
	Bit 1 (MSB)	Bit 2	Bit 3	Bit 4	Bit 5	Bit 6	Bit 7	Bit 8 (LSB)
GPS L1/CA ⁽¹⁾	SV Health [4]						'0' (reserved)	'0' (reserved)
Modernized GPS ⁽²⁾	L1C Health [6]	L1 Health [4,5]	L2 Health [4,5]	L5 Health [4,5]	'0' (reserved)	'0' (reserved)	'0' (reserved)	'0' (reserved)
SBAS ⁽³⁾	Ranging On (0), Off(1) [10]	Corrections On(0), Off(1) [10]	Integrity On(0), Off(1) [10]	'0' (reserved)	'0' (reserved)	'0' (reserved)	'0' (reserved)	'0' (reserved)
QZSS ⁽⁴⁾ QZS-L1	SV Health [7]						'0' (reserved)	'0' (reserved)
QZSS ⁽⁵⁾ QZS-L1C/L2C/L5	L1C Health [7]	L1 Health [7]	L2 Health [7]	L5 Health [7]	'0' (reserved)	'0' (reserved)	'0' (reserved)	'0' (reserved)
GLONASS	B_n (MSB) [9, page 30]	F_T [9, Table 4.4]				'0' (reserved)	'0' (reserved)	'0' (reserved)
Galileo [8, clause 5.1.9.3]	E5a Data Validity Status	E5b Data Validity Status	E1-B Data Validity Status	E5a Signal Health Status		'0' (reserved)	'0' (reserved)	'0' (reserved)
BDS ⁽⁶⁾ B1I [23]	B1I Health (SatH1) [23], [50]	B3I Health (SatH1) [23], [50]	'0' (reserved)	'0' (reserved)	'0' (reserved)	'0' (reserved)	'0' (reserved)	'0' (reserved)
BDS ⁽⁷⁾ B1C [39]/B2a [49]	Sat Clock Health [39], [49]	B1C Health [39], [49]	B2a Health [39],[49]	'0' (reserved)	'0' (reserved)	'0' (reserved)	'0' (reserved)	'0' (reserved)
NavIC	L5 health	'0' (reserved)	'0' (reserved)	'0' (reserved)	'0' (reserved)	'0' (reserved)	'0' (reserved)	'0' (reserved)
Note 1:	If <i>GNSS-ID</i> indicates 'gps', and GNSS Orbit Model-2 is included, this interpretation of <i>svHealth</i> applies.							
Note 2:	If <i>GNSS-ID</i> indicates 'gps', and GNSS Orbit Model-3 is included, this interpretation of <i>svHealth</i> applies.							
Note 3:	If a certain signal is not supported on the satellite indicated by <i>SV-ID</i> , the corresponding health bit shall be set to '1' (i.e., signal can not be used).							
Note 3:	<i>svHealth</i> , in the case that <i>GNSS-ID</i> indicates 'sbas', includes the 5 LSBs of the Health included in GEO Almanac Message Parameters (Type 17) [10].							
Note 4:	If <i>GNSS-ID</i> indicates 'qzss', and GNSS Orbit Model-2 is included, this interpretation of <i>svHealth</i> applies.							
Note 5:	If <i>GNSS-ID</i> indicates 'qzss', and GNSS Orbit Model-3 is included, this interpretation of <i>svHealth</i> applies.							
Note 6:	If <i>GNSS-ID</i> indicates 'bds', and GNSS Orbit Model-6 is included, this interpretation of <i>svHealth</i> applies.							
Note 7:	If <i>GNSS-ID</i> indicates 'bds', and GNSS Orbit Model-7 is included, this interpretation of <i>svHealth</i> applies.							

GNSS to iod Bit String(11) relation

GNSS	iod Bit String(11)										
	Bit 1 (MSB)	Bit 2	Bit 3	Bit 4	Bit 5	Bit 6	Bit 7	Bit 8	Bit 9	Bit 10	Bit 11 (LSB)

GPS L1/CA	'0'	Issue of Data, Clock [4]		
Modernized GPS	t_{oe} (seconds, scale factor 300, range 0 – 604500) [4,5,6]			
SBAS	'0'	'0'	'0'	Issue of Data ([10], Message Type 9)
QZSS QZS-L1	'0'	Issue of Data, Clock [7]		
QZSS QZS-L1C/L2C/L5	t_{oe} (seconds, scale factor 300, range 0 – 604500) [7]			
GLONASS	'0'	'0'	'0'	t_b (minutes, scale factor 15) [9]
Galileo I/NAV	'0'	IODnav [8]		
BDS B1I/B3I	11 MSB bits of t_{oe} (seconds, scale factor 512, range 0 – 604672) [23], [50]			
BDS B1C/B2a	'0'	Issue of Data, Clock [39], [49]		
NavIC	11 MSB bits of t_{oe} (seconds, scale factor 512) [38]			

GNSS to svHealthExt Bit String(4) relation

GNSS	svHealthExt Bit String(4)			
	Bit 1 (MSB)	Bit 2	Bit 3	Bit 4 (LSB)
Galileo [8, clause 5.1.9.3]	E5b Signal Health Status		E1-B Signal Health Status	

StandardClockModelList

```

-- ASN1START
StandardClockModelList ::= SEQUENCE (SIZE(1..2)) OF StandardClockModelElement
StandardClockModelElement ::= SEQUENCE {
    stanClockToc          INTEGER (0..16383),
    stanClockAF2         INTEGER (-32..31),
    stanClockAF1         INTEGER (-1048576..1048575),
    stanClockAF0         INTEGER (-1073741824..1073741823),
    stanClockTgd         INTEGER (-512..511)           OPTIONAL, -- Need ON
    sisa                 INTEGER (0..255),
    stanModelID          INTEGER (0..1)                 OPTIONAL, -- Need ON
    ...
}
-- ASN1STOP
    
```

StandardClockModelList field descriptions

<p>standardClockModelList <i>gnss-ClockModel</i> Model-1 contains one or two clock model elements. If included, clock Model-1 shall be included once or twice depending on the target device capability. If the target device is supporting multiple Galileo signals, the location server includes both F/Nav and I/Nav clock models in <i>gnss-ClockModel</i> if the location server assumes the target device to perform location information calculation using multiple signals.</p>
<p>stanClockToc Parameter t_{oc} defined in [8]. Scale factor 60 seconds.</p>
<p>stanClockAF2 Parameter af_2 defined in [8]. Scale factor 2^{-59} seconds/second².</p>
<p>stanClockAF1 Parameter af_1 defined in [8]. Scale factor 2^{-46} seconds/second.</p>
<p>stanClockAF0 Parameter af_0 defined in [8]. Scale factor 2^{-34} seconds.</p>
<p>stanClockTgd Parameter T_{GD}, Broadcast Group Delay (BGD), defined in [8]. Scale factor 2^{-32} seconds. This field is required if the target device supports only single frequency Galileo signal.</p>
<p>sisa Signal-In-Space Accuracy (SISA), defined in [8] clause 5.1.11.</p>

StandardClockModelList field descriptions
<p>stanModelID This field specifies the identity of the clock model according to the table Value of <i>stanModelID</i> to Identity relation below. This field is required if the location server includes both F/Nav and I/Nav Galileo clock models in <i>gnss-ClockModel</i>.</p>

Value of *stanModelID* to Identity relation

Value of <i>stanModelID</i>	Identity
0	I/Nav (E1,E5b)
1	F/Nav (E1,E5a)

– **NAV-ClockModel**

```

-- ASN1START
NAV-ClockModel ::= SEQUENCE {
    navToc          INTEGER (0..37799),
    navaf2          INTEGER (-128..127),
    navaf1          INTEGER (-32768..32767),
    navaf0          INTEGER (-2097152..2097151),
    navTgd          INTEGER (-128..127),
    ...
}
-- ASN1STOP
    
```

NAV-ClockModel field descriptions
<p>navToc Parameter t_{oc}, time of clock (seconds) [4,7] Scale factor 2^4 seconds.</p>
<p>navaf2 Parameter a_2, clock correction polynomial coefficient (sec/sec²) [4,7]. Scale factor 2^{-55} seconds/second².</p>
<p>navaf1 Parameter a_1, clock correction polynomial coefficient (sec/sec) [4,7]. Scale factor 2^{-43} seconds/second.</p>
<p>navaf0 Parameter a_0, clock correction polynomial coefficient (seconds) [4,7]. Scale factor 2^{-31} seconds.</p>
<p>navTgd Parameter T_{GD}, group delay (seconds) [4,7]. Scale factor 2^{-31} seconds.</p>

– **CNAV-ClockModel**

```

-- ASN1START
CNAV-ClockModel ::= SEQUENCE {
    cnavToc          INTEGER (0..2015),
    cnavTop          INTEGER (0..2015),
    cnavURA0        INTEGER (-16..15),
    cnavURA1        INTEGER (0..7),
    cnavURA2        INTEGER (0..7),
    cnavAf2          INTEGER (-512..511),
    cnavAf1          INTEGER (-524288..524287),
    cnavAf0          INTEGER (-33554432..33554431),
    cnavTgd          INTEGER (-4096..4095),
    cnavISCl1cp      INTEGER (-4096..4095) OPTIONAL, -- Need ON
    cnavISCl1cd      INTEGER (-4096..4095) OPTIONAL, -- Need ON
    cnavISCl1ca      INTEGER (-4096..4095) OPTIONAL, -- Need ON
    cnavISCl2c       INTEGER (-4096..4095) OPTIONAL, -- Need ON
    cnavISCl5i5      INTEGER (-4096..4095) OPTIONAL, -- Need ON
    cnavISCl5q5      INTEGER (-4096..4095) OPTIONAL, -- Need ON
    ...
}
    
```

```
}
-- ASN1STOP
```

CNAV-ClockModel field descriptions
<p><i>cnavToc</i> Parameter t_{oc}, clock data reference time of week (seconds) [4,5,6,7]. Scale factor 300 seconds.</p>
<p><i>cnavTop</i> Parameter t_{op}, clock data predict time of week (seconds) [4,5,6,7]. Scale factor 300 seconds</p>
<p><i>cnavURA0</i> Parameter URA_{oc} Index, SV clock accuracy index (dimensionless) [4,5,6,7].</p>
<p><i>cnavURA1</i> Parameter URA_{oc1} Index, SV clock accuracy change index (dimensionless) [4,5,6,7].</p>
<p><i>cnavURA2</i> Parameter URA_{oc2} Index, SV clock accuracy change rate index (dimensionless) [4,5,6,7].</p>
<p><i>cnavAf2</i> Parameter a_{f2-n}, SV clock drift rate correction coefficient (sec/sec²) [4,5,6,7]. Scale factor 2^{-60} seconds/second².</p>
<p><i>cnavAf1</i> Parameter a_{f1-n}, SV clock drift correction coefficient (sec/sec) [4,5,6,7]. Scale factor 2^{-48} seconds/second.</p>
<p><i>cnavAf0</i> Parameter a_{f0-n}, SV clock bias correction coefficient (seconds) [4,5,6,7]. Scale factor 2^{-35} seconds.</p>
<p><i>cnavTgd</i> Parameter T_{GD}, Group delay correction (seconds) [4,5,6,7]. Scale factor 2^{-35} seconds.</p>
<p><i>cnavISCI1cp</i> Parameter ISC_{L1CP}, inter signal group delay correction (seconds) [6,7]. Scale factor 2^{-35} seconds. The location server should include this field if the target device is GPS capable and supports the L1c signal.</p>
<p><i>cnavISCI1cd</i> Parameter ISC_{L1CD}, inter signal group delay correction (seconds) [6,7]. Scale factor 2^{-35} seconds. The location server should include this field if the target device is GPS capable and supports the L1c signal.</p>
<p><i>cnavISCI1ca</i> Parameter ISC_{L1CA}, inter signal group delay correction (seconds) [4,5,7]. Scale factor 2^{-35} seconds. The location server should include this field if the target device is GPS capable and supports the L1CA signal.</p>
<p><i>cnavISCI2c</i> Parameter ISC_{L2C}, inter signal group delay correction (seconds) [4,5,7]. Scale factor 2^{-35} seconds. The location server should include this field if the target device is GPS capable and supports the L2c signal.</p>
<p><i>cnavISCI5i5</i> Parameter ISC_{L5i5}, inter signal group delay correction (seconds) [5,7]. Scale factor 2^{-35} seconds. The location server should include this field if the target device is GPS capable and supports the L5 signal.</p>
<p><i>cnavISCI5q5</i> Parameter ISC_{L5Q5}, inter signal group delay correction (seconds) [5,7]. Scale factor 2^{-35} seconds. The location server should include this field if the target device is GPS capable and supports the L5 signal.</p>

GLONASS-ClockModel

```
-- ASN1START
GLONASS-ClockModel ::= SEQUENCE {
    gloTau          INTEGER (-2097152..2097151),
    gloGamma       INTEGER (-1024..1023),
    gloDeltaTau    INTEGER (-16..15)           OPTIONAL,  -- Need ON
    ...
}
-- ASN1STOP
```

GLONASS-ClockModel field descriptions
<p>gloTau Parameter $\tau_n(t_b)$, satellite clock offset (seconds) [9]. Scale factor 2^{-30} seconds.</p>
<p>gloGamma Parameter $\gamma_n(t_b)$, relative frequency offset from nominal value (dimensionless) [9]. Scale factor 2^{-40}.</p>
<p>gloDeltaTau Parameter $\Delta\tau_n$, time difference between transmission in G2 and G1 (seconds) [9]. Scale factor 2^{-30} seconds. The location server should include this parameter if the target device is dual frequency GLONASS receiver capable.</p>

– *SBAS-ClockModel*

```
-- ASN1START
SBAS-ClockModel ::= SEQUENCE {
    sbasTo          INTEGER (0..5399),
    sbasAgfo        INTEGER (-2048..2047),
    sbasAgf1        INTEGER (-128..127),
    ...
}
-- ASN1STOP
```

SBAS-ClockModel field descriptions
<p>sbasTo Parameter t_0 [10]. Scale factor 16 seconds.</p>
<p>sbasAgfo Parameter a_{Gfo} [10]. Scale factor 2^{-31} seconds.</p>
<p>sbasAgf1 Parameter a_{Gf1} [10]. Scale factor 2^{-40} seconds/second.</p>

– *BDS-ClockModel*

The IE *BDS-ClockModel* is used for BDS B1I defined in [23] and BDS B3I defined in [50].

```
-- ASN1START
BDS-ClockModel-r12 ::= SEQUENCE {
    bdsAODC-r12      INTEGER (0..31),
    bdsToc-r12       INTEGER (0..131071),
    bdsA0-r12        INTEGER (-8388608..8388607),
    bdsA1-r12        INTEGER (-2097152..2097151),
    bdsA2-r12        INTEGER (-1024..1023),
    bdsTgd1-r12      INTEGER (-512..511),
    ...,
    [[ bdsTgd2-r16    INTEGER (-512..511)           OPTIONAL    -- Need ON
    ]]
}
-- ASN1STOP
```

BDS-ClockModel field descriptions
<p>bdsAODC Parameter Age of Data, Clock (AODC), see [23], [50], Table 5-6.</p>
<p>bdsToc Parameter T_{oc}, Time of clock (seconds) [23], [50]. Scale factor 2^3 seconds.</p>
<p>bdsA0 Parameter a_0, Clock correction polynomial coefficient (seconds) [23], [50]. Scale factor 2^{-33} seconds.</p>
<p>bdsA1 Parameter a_1, Clock correction polynomial coefficient (sec/sec) [23], [50]. Scale factor 2^{-50} sec/sec.</p>
<p>bdsA2 Parameter a_2, Clock correction polynomial coefficient (sec/sec²) [23], [50]. Scale factor 2^{-66} sec/sec².</p>
<p>bdsTgd1 Parameter Equipment group delay differential T_{GD1} [23], [50]. Scale factor is 0.1 nanosecond.</p>
<p>bdsTgd2 Parameter Equipment group delay differential T_{GD2} [23], [50]. Scale factor is 0.1 nanosecond.</p>

— **BDS-ClockModel2**

The IE *BDS-ClockModel2* is used for BDS B1C defined in [39] and BDS B2a defined in [49].

```

-- ASN1START
BDS-ClockModel2-r16 ::= SEQUENCE {
    bdsToc-r16          INTEGER (0..2047),
    bdsA0-r16          INTEGER (-16777216..16777215),
    bdsA1-r16          INTEGER (-2097152..2097151),
    bdsA2-r16          INTEGER (-1024..1023),
    bdsTgdB1Cp-r16    INTEGER (-2048..2047),
    bdsIscB1Cd-r16    INTEGER (-2048..2047),
    ...,
    [[ bdsTgdB2ap-r17  INTEGER (-2048..2047)          OPTIONAL, -- Need ON
       bdsIscB2ad-r17  INTEGER (-2048..2047)          OPTIONAL  -- Need ON
    ]]
}
-- ASN1STOP

```

BDS-ClockModel2 field descriptions
<p>bdsToc Parameter T_{oc}, Clock correction parameters reference time (seconds), see [39], 7.5.1 and [49], 7.5.1. Scale factor 300 seconds.</p>
<p>bdsA0 Parameter a_0, Satellite clock time bias correction coefficient (seconds), see [39], 7.5.1 and [49], 7.5.1. Scale factor 2^{-34} seconds.</p>
<p>bdsA1 Parameter a_1, Satellite clock time drift correction coefficient (sec/sec), see [39], 7.5.1 and [49], 7.5.1. Scale factor 2^{-50} sec/sec.</p>
<p>bdsA2 Parameter a_2, Satellite clock time drift rate correction coefficient (sec/sec²), see [39], 7.5.1 and [49], 7.5.1. Scale factor 2^{-66} sec/sec².</p>
<p>bdsTgdB1Cp Parameter T_{GDB1Cp} Group delay differential of the B1C pilot component (seconds), see [39], 7.6.1 and [49], 7.6.1. Scale factor is 2^{-34} seconds.</p>
<p>bdsIscB1Cd Parameter ISC_{B1Cd} Group delay differential between the B1C data and pilot components (seconds), see [39], 7.6.1. Scale factor is 2^{-34} seconds.</p>
<p>bdsTgdB2ap Parameter T_{GDB2ap} Group delay differential of the B2a pilot component (seconds), see [39], 7.6.1 and [49], 7.6.1. Scale factor is 2^{-34} seconds.</p>
<p>bdsIscB2ad Parameter ISC_{B2ad} Group delay differential between the B2a data and pilot components (seconds), see [49], 7.6.1. Scale factor is 2^{-34} seconds.</p>

– NavIC-ClockModel

```

-- ASN1START
NavIC-ClockModel-r16 ::= SEQUENCE {
    navic-Toc-r16          INTEGER (0..65535),
    navic-af2-r16         INTEGER (-128..127),
    navic-af1-r16         INTEGER (-32768..32767),
    navic-af0-r16         INTEGER (-2097152..2097151),
    navic-Tgd-r16         INTEGER (-128..127),
    ...
}
-- ASN1STOP

```

NavIC-ClockModel field descriptions
<p>navic-Toc Parameter t_{oc}, time of clock (seconds) [38], Table-11. Scale factor 2^4 seconds.</p>
<p>navic-af2 Parameter a_2, clock correction polynomial coefficient (sec/sec²) [38]. Scale factor 2^{-55} seconds/second².</p>
<p>navic-af1 Parameter a_1, clock correction polynomial coefficient (sec/sec) [38]. Scale factor 2^{-43} seconds/second.</p>
<p>navic-af0 Parameter a_0, clock correction polynomial coefficient (seconds) [38]. Scale factor 2^{-31} seconds.</p>
<p>navic-Tgd Parameter T_{GD}, group delay (seconds) [38]. Scale factor 2^{-31} seconds.</p>

– NavModelKeplerianSet

```

-- ASN1START
NavModelKeplerianSet ::= SEQUENCE {
    keplerToe            INTEGER (0 .. 16383),
    keplerW              INTEGER (-2147483648..2147483647),
}
-- ASN1STOP

```

```

keplerDeltaN    INTEGER (-32768..32767),
keplerM0        INTEGER (-2147483648..2147483647),
keplerOmegaDot  INTEGER (-8388608.. 8388607),
keplerE         INTEGER (0..4294967295),
keplerIDot      INTEGER (-8192..8191),
keplerAPowerHalf INTEGER (0.. 4294967295),
keplerI0        INTEGER (-2147483648..2147483647),
keplerOmega0    INTEGER (-2147483648..2147483647),
keplerCrs       INTEGER (-32768..32767),
keplerCis       INTEGER (-32768..32767),
keplerCus       INTEGER (-32768..32767),
keplerCrc       INTEGER (-32768..32767),
keplerCic       INTEGER (-32768..32767),
keplerCuc       INTEGER (-32768..32767),
...
}
-- ASN1STOP

```

NavModelKeplerianSet field descriptions

<p>keplerToe Parameter t_{0e}, time-of-ephemeris in seconds [8]. Scale factor 60 seconds.</p>
<p>keplerW Parameter ω, argument of perigee (semi-circles) [8]. Scale factor 2^{-31} semi-circles.</p>
<p>keplerDeltaN Parameter Δn, mean motion difference from computed value (semi-circles/sec) [8]. Scale factor 2^{-43} semi-circles/second.</p>
<p>keplerM0 Parameter M_0, mean anomaly at reference time (semi-circles) [8]. Scale factor 2^{-31} semi-circles.</p>
<p>keplerOmegaDot Parameter OMEGADot, rate of change of right ascension (semi-circles/sec) [8]. Scale factor 2^{-43} semi-circles/second.</p>
<p>keplerE Parameter e, eccentricity [8]. Scale factor 2^{-33}.</p>
<p>KeplerIDot Parameter Idot, rate of change of inclination angle (semi-circles/sec) [8]. Scale factor 2^{-43} semi-circles/second.</p>
<p>keplerAPowerHalf Parameter sqrtA, square root of semi-major Axis in (metres)^{1/2} [8]. Scale factor 2^{-19} metres^{1/2}.</p>
<p>keplerI0 Parameter i_0, inclination angle at reference time (semi-circles) [8]. Scale factor 2^{-31} semi-circles.</p>
<p>keplerOmega0 Parameter OMEGA0, longitude of ascending node of orbit plane at weekly epoch (semi-circles) [8]. Scale factor 2^{-31} semi-circles.</p>
<p>keplerCrs Parameter C_{rs}, amplitude of the sine harmonic correction term to the orbit radius (metres) [8]. Scale factor 2^{-5} metres.</p>
<p>keplerCis Parameter C_{is}, amplitude of the sine harmonic correction term to the angle of inclination (radians) [8]. Scale factor 2^{-29} radians.</p>
<p>keplerCus Parameter C_{us}, amplitude of the sine harmonic correction term to the argument of latitude (radians) [8]. Scale factor 2^{-29} radians.</p>
<p>keplerCrc Parameter C_{rc}, amplitude of the cosine harmonic correction term to the orbit radius (metres) [8]. Scale factor 2^{-5} metres.</p>
<p>keplerCic Parameter C_{ic}, amplitude of the cosine harmonic correction term to the angle of inclination (radians) [8]. Scale factor 2^{-29} radians.</p>
<p>keplerCuc Parameter C_{uc}, amplitude of the cosine harmonic correction term to the argument of latitude (radians) [8]. Scale factor 2^{-29} radians.</p>

NavModelNAV-KeplerianSet

```

-- ASN1START
NavModelNAV-KeplerianSet ::= SEQUENCE {
    navURA          INTEGER (0..15),
    navFitFlag      INTEGER (0..1),
    navToe          INTEGER (0..37799),
    navOmega        INTEGER (-2147483648..2147483647),
    navDeltaN       INTEGER (-32768..32767),
    navM0           INTEGER (-2147483648..2147483647),
    navOmegaADot    INTEGER (-8388608..8388607),
    navE            INTEGER (0..4294967295),
    navIDot         INTEGER (-8192..8191),
    navAPowerHalf   INTEGER (0..4294967295),
    navI0           INTEGER (-2147483648..2147483647),
    navOmegaA0      INTEGER (-2147483648..2147483647),
    navCrS          INTEGER (-32768..32767),
    navCis          INTEGER (-32768..32767),
    navCus          INTEGER (-32768..32767),
    navCrc          INTEGER (-32768..32767),
    navCic          INTEGER (-32768..32767),
    navCuc          INTEGER (-32768..32767),
    addNAVparam     SEQUENCE {
        ephemerCodeOnL2  INTEGER (0..3),
        ephemerL2Pflag   INTEGER (0..1),
        ephemerSF1Rsvd   SEQUENCE {
            reserved1    INTEGER (0..8388607),    -- 23-bit field
            reserved2    INTEGER (0..16777215),   -- 24-bit field
            reserved3    INTEGER (0..16777215),   -- 24-bit field
            reserved4    INTEGER (0..65535)       -- 16-bit field
        },
        ephemerAODA      INTEGER (0..31)
    } OPTIONAL, -- Need ON
    ...
}
-- ASN1STOP

```

NavModelNAV-KeplerianSet field descriptions

navURA

Parameter URA Index, SV accuracy (dimensionless) [4,7].

navFitFlag

Parameter Fit Interval Flag, fit interval indication (dimensionless) [4,7]

navToe

Parameter t_{oe} , time of ephemeris (seconds) [4,7].

Scale factor 2^4 seconds.

navOmega

Parameter ω , argument of perigee (semi-circles) [4,7].

Scale factor 2^{-31} semi-circles.

navDeltaN

Parameter Δn , mean motion difference from computed value (semi-circles/sec) [4,7].

Scale factor 2^{-43} semi-circles/second.

navM0

Parameter M_0 , mean anomaly at reference time (semi-circles) [4,7].

Scale factor 2^{-31} semi-circles.

navOmegaADot

Parameter $\dot{\Omega}$, rate of right ascension (semi-circles/sec) [4,7].

Scale factor 2^{-43} semi-circles/second.

navE

Parameter e , eccentricity (dimensionless) [4,7].

Scale factor 2^{-33} .

navIDot

Parameter IDOT, rate of inclination angle (semi-circles/sec) [4,7].

Scale factor 2^{-43} semi-circles/second.

NavModelNAV-KeplerianSet field descriptions
<p>navAPowerHalf Parameter \sqrt{A}, square root of semi-major axis (metres²) [4,7]. Scale factor 2⁻¹⁹ metres^½.</p>
<p>navI0 Parameter i_0, inclination angle at reference time (semi-circles) [4,7]. Scale factor 2⁻³¹ semi-circles.</p>
<p>navOmegaA0 Parameter Ω_0, longitude of ascending node of orbit plane at weekly epoch (semi-circles) [4,7]. Scale factor 2⁻³¹ semi-circles.</p>
<p>navCrs Parameter C_{rs}, amplitude of sine harmonic correction term to the orbit radius (metres) [4,7]. Scale factor 2⁻⁵ metres.</p>
<p>navCis Parameter C_{is}, amplitude of sine harmonic correction term to the angle of inclination (radians) [4,7]. Scale factor 2⁻²⁹ radians.</p>
<p>navCus Parameter C_{us}, amplitude of sine harmonic correction term to the argument of latitude (radians) [4,7]. Scale factor 2⁻²⁹ radians.</p>
<p>navCrc Parameter C_{rc}, amplitude of cosine harmonic correction term to the orbit radius (metres) [4,7]. Scale factor 2⁻⁵ metres.</p>
<p>navCic Parameter C_{ic}, amplitude of cosine harmonic correction term to the angle of inclination (radians) [4,7]. Scale factor 2⁻²⁹ radians.</p>
<p>navCuc Parameter C_{uc}, amplitude of cosine harmonic correction term to the argument of latitude (radians) [4,7]. Scale factor 2⁻²⁹ radians.</p>
<p>addNAVparam These fields include data and reserved bits in the GPS NAV message [4,14]. These additional navigation parameters, if provided by the location server, allow the target device to perform data wipe-off similar to what is done by the target device with the <i>GNSS-DataBitAssistance</i>.</p>

NavModelCNAV-KeplerianSet

```

-- ASN1START
NavModelCNAV-KeplerianSet ::= SEQUENCE {
    cnavTop                INTEGER (0..2015),
    cnavURAindex           INTEGER (-16..15),
    cnavDeltaA             INTEGER (-33554432..33554431),
    cnavAdot               INTEGER (-16777216..16777215),
    cnavDeltaNo            INTEGER (-65536..65535),
    cnavDeltaNoDot         INTEGER (-4194304..4194303),
    cnavMo                  INTEGER (-4294967296..4294967295),
    cnavE                   INTEGER (0..8589934591),
    cnavOmega              INTEGER (-4294967296..4294967295),
    cnavOMEGA0             INTEGER (-4294967296..4294967295),
    cnavDeltaOmegaDot      INTEGER (-65536..65535),
    cnavIo                  INTEGER (-4294967296..4294967295),
    cnavIoDot              INTEGER (-16384..16383),
    cnavCis                 INTEGER (-32768..32767),
    cnavCic                 INTEGER (-32768..32767),
    cnavCrs                 INTEGER (-8388608..8388607),
    cnavCrc                 INTEGER (-8388608..8388607),
    cnavCus                 INTEGER (-1048576..1048575),
    cnavCuc                 INTEGER (-1048576..1048575),
    ...
}
-- ASN1STOP

```

NavModelCNAV-KeplerianSet field descriptions
<p>cnavTop Parameter t_{op}, data predict time of week (seconds) [4,5,6,7]. Scale factor 300 seconds.</p>
<p>cnavURAindex Parameter URA_{oe} Index, SV accuracy (dimensionless) [4,5,6,7].</p>

<i>NavModelCNAV-KeplerianSet</i> field descriptions
<p><i>cnavDeltaA</i> Parameter ΔA, semi-major axis difference at reference time (metres) [4,5,6,7]. Scale factor 2^{-9} metres.</p>
<p><i>cnavAdot</i> Parameter \dot{A}, change rate in semi-major axis (metres/second) [4,5,6,7]. Scale factor 2^{-21} metres/second.</p>
<p><i>cnavDeltaNo</i> Parameter Δn_0, mean motion difference from computed value at reference time (semi-circles/sec) [4,5,6,7]. Scale factor 2^{-44} semi-circles/second.</p>
<p><i>cnavDeltaNoDot</i> Parameter $\Delta \dot{n}_0$, rate of mean motion difference from computed value (semi-circles/sec²) [4,5,6,7]. Scale factor 2^{-57} semi-circles/second².</p>
<p><i>cnavMo</i> Parameter M_{0-n}, mean anomaly at reference time (semi-circles) [4,5,6,7]. Scale factor 2^{-32} semi-circles.</p>
<p><i>cnavE</i> Parameter e_n, eccentricity (dimensionless) [4,5,6,7]. Scale factor 2^{-34}.</p>
<p><i>cnavOmega</i> Parameter ω_n, argument of perigee (semi-circles) [4,5,6,7]. Scale factor 2^{-32} semi-circles.</p>
<p><i>cnavOMEGA0</i> Parameter Ω_{0-n}, reference right ascension angle (semi-circles) [4,5,6,7]. Scale factor 2^{-32} semi-circles.</p>
<p><i>cnavDeltaOmegaDot</i> Parameter $\Delta \dot{\Omega}$, rate of right ascension difference (semi-circles/sec) [4,5,6,7]. Scale factor 2^{-44} semi-circles/second.</p>
<p><i>cnavIo</i> Parameter i_{0-n}, inclination angle at reference time (semi-circles) [4,5,6,7]. Scale factor 2^{-32} semi-circles.</p>
<p><i>cnavIoDot</i> Parameter i_{0-n}-DOT, rate of inclination angle (semi-circles/sec) [4,5,6,7]. Scale factor 2^{-44} semi-circles/second.</p>
<p><i>cnavCis</i> Parameter C_{is-n}, amplitude of sine harmonic correction term to the angle of inclination (radians) [4,5,6,7]. Scale factor 2^{-30} radians.</p>
<p><i>cnavCic</i> Parameter C_{ic-n}, amplitude of cosine harmonic correction term to the angle of inclination (radians) [4,5,6,7]. Scale factor 2^{-30} radians.</p>
<p><i>cnavCrs</i> Parameter C_{rs-n}, amplitude of sine harmonic correction term to the orbit radius (metres) [4,5,6,7]. Scale factor 2^{-8} metres.</p>
<p><i>cnavCrc</i> Parameter C_{rc-n}, amplitude of cosine harmonic correction term to the orbit radius (metres) [4,5,6,7]. Scale factor 2^{-8} metres.</p>
<p><i>cnavCus</i> Parameter C_{us-n}, amplitude of the sine harmonic correction term to the argument of latitude (radians) [4,5,6,7]. Scale factor 2^{-30} radians.</p>
<p><i>cnavCuc</i> Parameter C_{uc-n}, amplitude of cosine harmonic correction term to the argument of latitude (radians) [4,5,6,7]. Scale factor 2^{-30} radians.</p>

NavModel-GLONASS-ECEF

```

-- ASN1START
NavModel-GLONASS-ECEF ::= SEQUENCE {
    gloEn          INTEGER (0..31),
    gloP1         BIT STRING (SIZE(2)),
    gloP2         BOOLEAN,
    gloM          INTEGER (0..3),
    gloX          INTEGER (-67108864..67108863),
    gloXdots      INTEGER (-8388608..8388607),
    gloXdotsdot   INTEGER (-16..15),

```

```

gloY          INTEGER (-67108864..67108863),
gloYdot       INTEGER (-8388608..8388607),
gloYdotdot    INTEGER (-16..15),
gloZ          INTEGER (-67108864..67108863),
gloZdot       INTEGER (-8388608..8388607),
gloZdotdot    INTEGER (-16..15),
...
}
-- ASN1STOP

```

NavModel-GLONASS-ECEF field descriptions

gloEn	Parameter E_n , age of data (days) [9]. Scale factor 1 days.
gloP1	Parameter P1, time interval between two adjacent values of t_b (minutes) [9].
gloP2	Parameter P2, change of t_b flag (dimensionless) [9].
gloM	Parameter M, type of satellite (dimensionless) [9].
gloX	Parameter $x_n(t_b)$, x-coordinate of satellite at time t_b (kilometres) [9]. Scale factor 2^{-11} kilometres.
gloXdot	Parameter $\dot{x}_n(t_b)$, x-coordinate of satellite velocity at time t_b (kilometres/second) [9]. Scale factor 2^{-20} kilometres/second.
gloXdotdot	Parameter $\ddot{x}_n(t_b)$, x-coordinate of satellite acceleration at time t_b (kilometres/second ²) [9]. Scale factor 2^{-30} kilometres/second ² .
gloY	Parameter $y_n(t_b)$, y-coordinate of satellite at time t_b (kilometres) [9]. Scale factor 2^{-11} kilometres.
gloYdot	Parameter $\dot{y}_n(t_b)$, y-coordinate of satellite velocity at time t_b (kilometres/second) [9]. Scale factor 2^{-20} kilometres/second.
gloYdotdot	Parameter $\ddot{y}_n(t_b)$, y-coordinate of satellite acceleration at time t_b (kilometres/second ²) [9]. Scale factor 2^{-30} kilometres/second ² .
gloZ	Parameter $z_n(t_b)$, z-coordinate of satellite at time t_b (kilometres) [9]. Scale factor 2^{-11} kilometres.
gloZdot	Parameter $\dot{z}_n(t_b)$, z-coordinate of satellite velocity at time t_b (kilometres/second) [9]. Scale factor 2^{-20} kilometres/second.
gloZdotdot	Parameter $\ddot{z}_n(t_b)$, z-coordinate of satellite acceleration at time t_b (kilometres/second ²) [9]. Scale factor 2^{-30} kilometres/second ² .

NavModel-SBAS-ECEF

```

-- ASN1START
NavModel-SBAS-ECEF ::= SEQUENCE {
    sbasTo          INTEGER (0..5399)                OPTIONAL,  -- Cond ClockModel
    sbasAccuracy    BIT STRING (SIZE(4)),
    sbasXg          INTEGER (-536870912..536870911),
    sbasYg          INTEGER (-536870912..536870911),
    sbasZg          INTEGER (-16777216..16777215),
    sbasXgDot       INTEGER (-65536..65535),

```

```

sbasYgDot      INTEGER (-65536..65535),
sbasZgDot      INTEGER (-131072..131071),
sbasXgDotDot   INTEGER (-512..511),
sbagYgDotDot   INTEGER (-512..511),
sbasZgDotDot   INTEGER (-512..511),
...
}
-- ASN1STOP

```

Conditional presence	Explanation
<i>ClockModel</i>	This field is mandatory present if <i>gnss-ClockModel</i> Model-5 is not included; otherwise it is not present.

NavModel-SBAS-ECEF field descriptions
<p><i>sbasTo</i> Parameter t_0, time of applicability (seconds) [10]. Scale factor 16 seconds.</p>
<p><i>sbasAccuracy</i> Parameter Accuracy, (dimensionless) [10].</p>
<p><i>sbasXg</i> Parameter X_G, (metres) [10]. Scale factor 0.08 metres.</p>
<p><i>sbasYg</i> Parameter Y_G, (metres) [10]. Scale factor 0.08 metres.</p>
<p><i>sbasZg</i> Parameter Z_G, (metres) [10]. Scale factor 0.4 metres.</p>
<p><i>sbasXgDot</i> Parameter X_G, Rate-of-Change, (metres/second) [10]. Scale factor 0.000625 metres/second.</p>
<p><i>sbasYgDot</i> Parameter Y_G, Rate-of-Change, (metres/second) [10]. Scale factor 0.000625 metres/second.</p>
<p><i>sbasZgDot</i> Parameter Z_G, Rate-of-Change, (metres/second) [10]. Scale factor 0.004 metres/second.</p>
<p><i>sbasXgDotDot</i> Parameter X_G, Acceleration, (metres/second²) [10]. Scale factor 0.0000125 metres/second².</p>
<p><i>sbagYgDotDot</i> Parameter Y_G, Acceleration, (metres/second²) [10]. Scale factor 0.0000125 metres/second².</p>
<p><i>sbasZgDotDot</i> Parameter Z_G Acceleration, (metres/second²) [10]. Scale factor 0.0000625 metres/second².</p>

– *NavModel-BDS-KeplerianSet*

The IE *NavModel-BDS-KeplerianSet* is used for BDS B1I defined in [23], [50].

```

-- ASN1START
NavModel-BDS-KeplerianSet-r12 ::= SEQUENCE {
    bdsAODE-r12      INTEGER (0..31),
    bdsURAI-r12     INTEGER (0..15),
    bdsToe-r12      INTEGER (0..131071),
    bdsAPowerHalf-r12  INTEGER (0..4294967295),
    bdsE-r12        INTEGER (0..4294967295),
    bdsW-r12        INTEGER (-2147483648..2147483647),
    bdsDeltaN-r12   INTEGER (-32768..32767),
    bdsM0-r12       INTEGER (-2147483648..2147483647),
    bdsOmega0-r12   INTEGER (-2147483648..2147483647),
    bdsOmegaDot-r12  INTEGER (-8388608..8388607),
    bdsI0-r12       INTEGER (-2147483648..2147483647),
    bdsIDot-r12     INTEGER (-8192..8191),

```

```

    bdsCuc-r12          INTEGER (-131072..131071),
    bdsCus-r12          INTEGER (-131072..131071),
    bdsCrc-r12          INTEGER (-131072..131071),
    bdsCrs-r12          INTEGER (-131072..131071),
    bdsCic-r12          INTEGER (-131072..131071),
    bdsCis-r12          INTEGER (-131072..131071),
    ...
}
-- ASN1STOP

```

NavModel-BDS-KeplerianSet field descriptions

bdsAODE	Parameter Age of Data, Ephemeris (AODE), see [23], [50], Table 5-8.
bdsURAI	Parameter URA Index, URA is used to describe the signal-in-space accuracy in metres as defined in [23], [50].
bdsToe	Parameter t_{oe} , Ephemeris reference time (seconds) [23], [50]. Scale factor 2^3 seconds.
bdsAPowerHalf	Parameter $A^{1/2}$, Square root of semi-major axis (metres ²) [23], [50]. Scale factor 2^{-19} metres ² .
bdsE	Parameter e , Eccentricity, dimensionless [23], [50]. Scale factor 2^{-33} .
bdsW	Parameter ω , Argument of perigee (semi-circles) [23], [50]. Scale factor 2^{-31} semi-circles.
bdsDeltaN	Parameter Δn , Mean motion difference from computed value (semi-circles/sec) [23], [50]. Scale factor 2^{-43} semi-circles/second.
bdsM0	Parameter M_0 , Mean anomaly at reference time (semi-circles) [23], [50]. Scale factor 2^{-31} semi-circles.
bdsOmega0	Parameter Ω_0 , Longitude of ascending node of orbital of plane computed according to reference time (semi-circles) [23], [50]. Scale factor 2^{-31} semi-circles.
bdsOmegaDot	Parameter $\dot{\Omega}$, Rate of right ascension (semi-circles/sec) [23], [50]. Scale factor 2^{-43} semi-circles/second.
bdsI0	Parameter i_0 , Inclination angle at reference time (semi-circles) [23], [50]. Scale factor 2^{-31} semi-circles.
bdsIDot	Parameter \dot{i} , Rate of inclination angle (semi-circles/sec) [23], [50]. Scale factor 2^{-43} semi-circles/second.
bdsCuc	Parameter C_{uc} , Amplitude of cosine harmonic correction term to the argument of latitude (radians) [23], [50]. Scale factor 2^{-31} radians.
bdsCus	Parameter C_{us} , Amplitude of sine harmonic correction term to the argument of latitude (radians) [23], [50]. Scale factor 2^{-31} radians.
bdsCrc	Parameter C_{rc} , Amplitude of cosine harmonic correction term to the orbit radius (metres) [23], [50]. Scale factor 2^{-6} metres.
bdsCrs	Parameter C_{rs} , Amplitude of sine harmonic correction term to the orbit radius (metres) [23], [50]. Scale factor 2^{-6} metres.
bdsCic	Parameter C_{ic} , Amplitude of cosine harmonic correction term to the angle of inclination (radians) [23], [50]. Scale factor 2^{-31} radians.
bdsCis	Parameter C_{is} , Amplitude of sine harmonic correction term to the angle of inclination (radians) [23], [50]. Scale factor 2^{-31} radians.

– *NavModel-BDS-KeplerianSet2*

The IE *NavModel-BDS-KeplerianSet2* is used for BDS B1C and BDS B2a defined in [39], [49].

```
-- ASN1START
NavModel-BDS-KeplerianSet2-r16 ::= SEQUENCE {
  bdsIODE-r16          INTEGER (0..255),
  bdsToe-r16           INTEGER (0..2047),
  bdsDeltaA-r16        INTEGER (-33554432..33554431),
  bdsAdot-r16          INTEGER (-16777216..16777216),
  bdsDeltaN0-r16       INTEGER (-65536..65535),
  bdsDeltaN0dot-r16    INTEGER (-4194304..4194303),
  bdsM0-r16            INTEGER (-4294967296..4294967295),
  bdsE-r16             INTEGER (0..8589934591),
  bdsOmega-r16         INTEGER (-4294967296..4294967295),
  bdsOmega0-r16        INTEGER (-4294967296..4294967295),
  bdsI0-r16            INTEGER (-4294967296..4294967295),
  bdsOmegaDot-r16      INTEGER (-262144..262143),
  bdsI0Dot-r16         INTEGER (-16384..16383),
  bdsCuc-r16           INTEGER (-1048576..1048575),
  bdsCus-r16           INTEGER (-1048576..1048575),
  bdsCrc-r16           INTEGER (-8388608..8388607),
  bdsCrs-r16           INTEGER (-8388608..8388607),
  bdsCic-r16           INTEGER (-32768..32767),
  bdsCis-r16           INTEGER (-32768..32767),
  ...
}
-- ASN1STOP
```

<i>NavModel-BDS-KeplerianSet2</i> field descriptions
<p><i>bdsIODE</i> Parameter, Issue Of Data, Ephemeris (IODE), see [39], 7.4.1 and [49], 7.4.1.</p>
<p><i>bdsToe</i> Parameter t_{oe}, Ephemeris reference time (seconds), defined in [39], 7.7.1 and [49], 7.7.1. Scale factor 300 seconds.</p>
<p><i>bdsDeltaA</i> Parameter ΔA, Semi-major axis difference at reference time (metre), defined in [39], 7.7.1 and [49], 7.7.1. Scale factor 2^{-9} metres.</p>
<p><i>bdsAdot</i> Parameter \dot{A}, Change rate in semi-major axis (metre/second), defined in [39], 7.7.1 and [49], 7.7.1. Scale factor 2^{21} metre/second. The value 16777216 is not signalled.</p>
<p><i>bdsDeltaN0</i> Parameter Δn_0, Mean motion difference from computed value at reference time (semi-circles /sec), defined in [39], 7.7.1 and [49], 7.7.1. Scale factor 2^{44} semi-circles /second.</p>
<p><i>bdsDeltaN0dot</i> Parameter Δn_{0dot}, Rate of mean motion difference from computed value at reference time (semi-circles /sec²), defined in [39], 7.7.1 and [49], 7.7.1. Scale factor 2^{57} semi-circles /second².</p>
<p><i>bdsM0</i> Parameter M_0, Mean anomaly at reference time (semi-circles) [39], [49]. Scale factor 2^{32} semi-circles.</p>
<p><i>bdsE</i> Parameter e, Eccentricity [39], [49]. Scale factor 2^{-34}.</p>
<p><i>bdsOmega</i> Parameter ω, Argument of perigee (semi-circles) [39], [49]. Scale factor 2^{32} semi-circles.</p>
<p><i>bdsOmega0</i> Parameter Ω_0, Longitude of ascending node of orbital plane at weekly epoch (semi-circles) [39], [49]. Scale factor 2^{32} semi-circles.</p>
<p><i>bdsI0</i> Parameter i_0, Inclination angle at reference time (semi-circles) [39], [49]. Scale factor 2^{32} semi-circles.</p>
<p><i>bdsOmegaDot</i> Parameter $\dot{\Omega}$, Rate of right ascension (semi-circles/sec) [39], [49]. Scale factor 2^{44} semi-circles/second.</p>
<p><i>bdsI0Dot</i> Parameter i_{0dot}, Rate of inclination angle (semi-circles/sec) [39], [49]. Scale factor 2^{44} semi-circles/second.</p>
<p><i>bdsCuc</i> Parameter C_{uc}, Amplitude of cosine harmonic correction to the argument of latitude (radians) [39], [49]. Scale factor 2^{-30} radians.</p>
<p><i>bdsCus</i> Parameter C_{us}, Amplitude of sine harmonic correction to the argument of latitude (radians) [39], [49]. Scale factor 2^{-30} radians.</p>
<p><i>bdsCrc</i> Parameter C_{rc}, Amplitude of cosine harmonic correction term to the orbit radius (metres) [39], [49]. Scale factor 2^{-8} metres.</p>
<p><i>bdsCrs</i> Parameter C_{rs}, Amplitude of sine harmonic correction term to the orbit radius (metres) [39], [49]. Scale factor 2^{-8} metres.</p>
<p><i>bdsCic</i> Parameter C_{ic}, Amplitude of cosine harmonic correction term to the angle of inclination (radians) [39], [49]. Scale factor 2^{-30} radians.</p>
<p><i>bdsCis</i> Parameter C_{is}, Amplitude of sine harmonic correction term to the angle of inclination (radians) [39], [49]. Scale factor 2^{-30} radians.</p>

NavModel-NavIC-KeplerianSet

```

-- ASN1START
NavModel-NavIC-KeplerianSet-r16 ::= SEQUENCE {
    navic-Toe-r16          INTEGER (0..65536),
    navic-URAI-r16        INTEGER (0..15),
    navic-W-r16           INTEGER (-2147483648..2147483647),
    navic-DeltaN-r16      INTEGER (-2097152..2097151),
    navic-M0-r16          INTEGER (-2147483648..2147483647),
    navic-OmegaDot-r16    INTEGER (-2147483648..2147483647),
    navic-E-r16           INTEGER (0..4294967295),
    navic-IDot-r16        INTEGER (-8192..8191),
    navic-APowerHalf-r16  INTEGER (0..4294967295),
    navic-I0-r16          INTEGER (-2147483648..2147483647),
    navic-Omega0-r16      INTEGER (-2147483648..2147483647),
    navic-Crs-r16         INTEGER (-32768..32767),
    navic-Cis-r16         INTEGER (-32768..32767),
    navic-Cus-r16         INTEGER (-32768..32767),
    navic-Crc-r16         INTEGER (-32768..32767),
    navic-Cic-r16         INTEGER (-32768..32767),
    navic-Cuc-r16         INTEGER (-32768..32767),
    ...
}
-- ASN1STOP

```

NavModel-NavIC-KeplerianSet field descriptions

<p>navic-Toe Parameter t_{0e}, time-of-ephemeris in seconds [38]. Scale factor 2^4 seconds.</p>
<p>navic-URAI Parameter User Range Accuracy Index (in metres). This is a one-sigma estimate of the user range errors in the navigation data for the transmitting satellite as described under clause 6.2.1.4 in [38]</p>
<p>navic-W Parameter ω, argument of perigee (semi-circles) [38]. Scale factor 2^{31} semi-circles.</p>
<p>navic-DeltaN Parameter Δn, mean motion difference from computed value (semi-circles/sec) [38] Scale factor 2^{41} semi-circles/second</p>
<p>navic-M0 Parameter M_0, mean anomaly at reference time (semi-circles) [38] Scale factor 2^{31} semi-circles.</p>
<p>navic-OmegaDot Parameter OMEGADot, rate of change of right ascension (semi-circles/sec) [38] Scale factor 2^{41} semi-circles/second</p>
<p>navic-E Parameter e, eccentricity [38] Scale factor 2^{33}.</p>
<p>navic-IDot Parameter I_{dot}, rate of change of inclination angle (semi-circles/sec) [38] Scale factor 2^{43} semi-circles/second.</p>
<p>navic-APowerHalf Parameter \sqrt{a}, square root of semi-major Axis in (metres)^{1/2} [38] Scale factor 2^{19} metres ^{1/2}.</p>
<p>navic-I0 Parameter i_0, inclination angle at reference time (semi-circles) [38] Scale factor 2^{31} semi-circles.</p>
<p>navic-Omega0 Parameter OMEGA0, longitude of ascending node of orbit plane at weekly epoch (semi-circles) [38] Scale factor 2^{31} semi-circles.</p>
<p>navic-Crs Parameter C_{rs}, amplitude of the sine harmonic correction term to the orbit radius (metres) [38] Scale factor 2^4 metres</p>
<p>navic-Cis Parameter C_{is}, amplitude of the sine harmonic correction term to the angle of inclination (radians) [38] Scale factor 2^{28} radians</p>

<i>NavModel-NavIC-KeplerianSet</i> field descriptions
<p><i>navic-Cus</i> Parameter C_{US}, amplitude of the sine harmonic correction term to the argument of latitude (radians) [38] Scale factor 2^{28} radians</p>
<p><i>navic-Crc</i> Parameter C_{RC}, amplitude of the cosine harmonic correction term to the orbit radius (metres) [38] Scale factor 2^4 metres</p>
<p><i>navic-Cic</i> Parameter C_{IC}, amplitude of the cosine harmonic correction term to the angle of inclination (radians) [38] Scale factor 2^{28} radians</p>
<p><i>navic-Cuc</i> Parameter C_{UC}, amplitude of the cosine harmonic correction term to the argument of latitude (radians) [38] Scale factor 2^{28} radians</p>

– *GNSS-RealTimeIntegrity*

The IE *GNSS-RealTimeIntegrity* is used by the location server to provide parameters that describe the real-time status of the GNSS constellations. *GNSS-RealTimeIntegrity* data communicates the health of the GNSS signals to the mobile in real-time.

The location server always transmits the *GNSS-RealTimeIntegrity* with the current list of unhealthy signals (i.e., not only for signals/SVs currently visible at the reference location), for any GNSS positioning attempt and whenever GNSS assistance data are sent. If the number of bad signals is zero, then the *GNSS-RealTimeIntegrity* IE is omitted.

NOTE 1: If GNSS integrity assistance data are provided (i.e., any of *GNSS-Integrity-ServiceParameters*, *GNSS-Integrity-ServiceAlert*, *ORBIT-IntegrityParameters*, *SSR-IntegrityOrbitBounds*, *CLOCK-IntegrityParameters*, *SSR-IntegrityClockBounds*, *SSR-IntegrityCodeBiasBounds*, *SSR-IntegrityPhaseBiasBounds*, *STEC-IntegrityParameters*, *STEC-IntegrityErrorBounds*, *SSR-GriddedCorrectionIntegrityParameters*, *TropoDelayIntegrityErrorBounds*) the following interpretation of the IE *GNSS-RealTimeIntegrity* applies:

- Absence of the IE *GNSS-RealTimeIntegrity* indicates DNU=FALSE according to the Integrity Principle of Operation specified in clause 8.1.1a of TS 38.305 [40] for all GNSS satellites for which integrity assistance data are provided.
- Presence of the IE *GNSS-RealTimeIntegrity* for a GNSS satellite and signal combination indicates DNU=TRUE for this GNSS satellite and signal combination according to the Integrity Principle of Operation specified in clause 8.1.1a of TS 38.305 [40].

NOTE 2: The UE assumes that only those satellites for which the GNSS integrity assistance data are provided are monitored by the network and can be used for integrity related applications.

```

-- ASN1START
GNSS-RealTimeIntegrity ::= SEQUENCE {
    gnss-BadSignalList  GNSS-BadSignalList,
    ...
}
GNSS-BadSignalList ::= SEQUENCE (SIZE(1..64)) OF BadSignalElement
BadSignalElement ::= SEQUENCE {
    badSVID             SV-ID,
    badSignalID        GNSS-SignalIDs  OPTIONAL,  -- Need OP
    ...
}
-- ASN1STOP

```

GNSS-RealTimeIntegrity field descriptions
<p>gnss-BadSignalList This field specifies a list of satellites with bad signal or signals.</p>
<p>badSVID This field specifies the GNSS SV-ID of the satellite with bad signal or signals.</p>
<p>badSignalID This field identifies the bad signal or signals of a satellite. This is represented by a bit string in <i>GNSS-SignalIDs</i>, with a one-value at a bit position means the particular GNSS signal type of the SV is unhealthy; a zero-value means healthy. Absence of this field means that all signals on the specific SV are bad.</p>

– GNSS-DataBitAssistance

The IE *GNSS-DataBitAssistance* is used by the location server to provide data bit assistance data for specific satellite signals for data wipe-off. The data bits included in the assistance data depends on the GNSS and its signal.

```

-- ASN1START
GNSS-DataBitAssistance ::= SEQUENCE {
    gnss-TOD                INTEGER (0..3599),
    gnss-TODfrac            INTEGER (0..999)    OPTIONAL,    -- Need ON
    gnss-DataBitsSatList   GNSS-DataBitsSatList,
    ...
}

GNSS-DataBitsSatList ::= SEQUENCE (SIZE(1..64)) OF GNSS-DataBitsSatElement

GNSS-DataBitsSatElement ::= SEQUENCE {
    svID                    SV-ID,
    gnss-DataBitsSgnList   GNSS-DataBitsSgnList,
    ...
}

GNSS-DataBitsSgnList ::= SEQUENCE (SIZE(1..8)) OF GNSS-DataBitsSgnElement

GNSS-DataBitsSgnElement ::= SEQUENCE {
    gnss-SignalType        GNSS-SignalID,
    gnss-DataBits          BIT STRING (SIZE (1..1024)),
    ...
}
-- ASN1STOP

```

GNSS-DataBitAssistance field descriptions
<p>gnss-TOD This field specifies the reference time of the first bit of the data in <i>GNSS-DataBitAssistance</i> in integer seconds in GNSS specific system time, modulo 1 hour. Scale factor 1 second.</p>
<p>gnss-TODfrac This field specifies the fractional part of the <i>gnss-TOD</i> in 1-milli-second resolution. Scale factor 1 millisecond. The total GNSS TOD is <i>gnss-TOD</i> + <i>gnss-TODfrac</i>.</p>
<p>gnss-DataBitsSatList This list specifies the data bits for a particular GNSS satellite SV-ID and signal <i>GNSS-SignalID</i>.</p>
<p>svID This field specifies the GNSS SV-ID of the satellite for which the <i>GNSS-DataBitAssistance</i> is given.</p>
<p>gnss-SignalType This field identifies the GNSS signal type of the <i>GNSS-DataBitAssistance</i>.</p>

GNSS-DataBitAssistance field descriptions**gnss-DataBits**

Data bits are contained in GNSS system and data type specific format.

In the case of GPS L1 C/A, it contains the NAV data modulation bits as defined in [4] .

In the case of Modernized GPS L1C, it contains the encoded and interleaved modulation symbols as defined in [6] clause 3.2.3.1. In the case of Modernized GPS L2C, it contains either the NAV data modulation bits, the FEC encoded NAV data modulation symbols, or the FEC encoded CNAV data modulation symbols, dependent on the current signal configuration of this satellite as defined in [4, Table 3-III]. In the case of Modernized GPS L5, it contains the FEC encoded CNAV data modulation symbols as defined in [5].

In the case of SBAS, it contains the FEC encoded data modulation symbols as defined in [10].

In the case of QZSS QZS-L1, it contains the NAV data modulation bits as defined in [7] clause 5.2. In the case of QZSS QZS-L1C, it contains the encoded and interleaved modulation symbols as defined in [7] clause 5.3. In the case of QZSS QZS-L2C, it contains the encoded modulation symbols as defined in [7] clause 5.5. In the case of QZSS QZS-L5, it contains the encoded modulation symbols as defined in [7] clause 5.6.

In the case of GLONASS, it contains the 100 sps differentially Manchester encoded modulation symbols as defined in [9] clause 3.3.2.2.

In the case of Galileo, it contains the FEC encoded and interleaved modulation symbols. The logical levels 1 and 0 correspond to signal levels -1 and +1, respectively.

In the case of BDS B1I, it contains the encoded and interleaved modulation symbols as defined in [23], clause 5.1.3. In the case of BDS B1C, it contains the encoded and interleaved modulation symbols as defined in [39], clause 6.2.2. In the case of BDS B2a, it contains the encoded and interleaved modulation symbols as defined in [49], clause 6.2.2. In the case of BDS B3I, it contains the encoded and interleaved modulation symbols as defined in [50], clause 5.1.3. In the case of NavIC, it contains the FEC encoded and interleaved Navigation symbols as defined in [38].

GNSS-AcquisitionAssistance

The IE *GNSS-AcquisitionAssistance* is used by the location server to provide parameters that enable fast acquisition of the GNSS signals. Essentially, these parameters describe the range and derivatives from respective satellites to the reference location at the reference time *GNSS-SystemTime* provided in IE *GNSS-ReferenceTime*.

Whenever *GNSS-AcquisitionAssistance* is provided by the location server, the IE *GNSS-ReferenceTime* is provided as well. E.g., even if the target device request for assistance data includes only a request for *GNSS-AcquisitionAssistance*, the location server also provides the corresponding IE *GNSS-ReferenceTime*.

Figure 6.5.2.2-1 illustrates the relation between some of the fields, using GPS TOW as exemplary reference.

```
-- ASN1START

GNSS-AcquisitionAssistance ::= SEQUENCE {
    gnss-SignalID          GNSS-SignalID,
    gnss-AcquisitionAssistList  GNSS-AcquisitionAssistList,
    ...,
    confidence-r10          INTEGER (0..100)    OPTIONAL    -- Need ON
}

GNSS-AcquisitionAssistList ::= SEQUENCE (SIZE(1..64)) OF GNSS-AcquisitionAssistElement

GNSS-AcquisitionAssistElement ::= SEQUENCE {
    svID                  SV-ID,
    doppler0              INTEGER (-2048..2047),
    doppler1              INTEGER (0..63),
    dopplerUncertainty    INTEGER (0..4),
    codePhase             INTEGER (0..1022),
    intCodePhase          INTEGER (0..127),
    codePhaseSearchWindow  INTEGER (0..31),
    azimuth               INTEGER (0..511),
    elevation             INTEGER (0..127),
    ...,
    codePhase1023         BOOLEAN              OPTIONAL,    -- Need OP
    dopplerUncertaintyExt-r10  ENUMERATED {
        d60,
        d80,
        d100,
        d120,
        noInformation, ... }    OPTIONAL    -- Need ON
}
```

```
}
-- ASN1STOP
```

GNSS-AcquisitionAssistance field descriptions
<p>gnss-SignalID This field specifies the GNSS signal for which the acquisition assistance are provided.</p>
<p>gnss-AcquisitionAssistList These fields provide a list of acquisition assistance data for each GNSS satellite.</p>
<p>confidence This field specifies the confidence level of the reference location area or volume used to calculate the acquisition assistance parameters (search windows). A high percentage value (e.g., 98% or more) indicates to the target device that the provided search windows are reliable. The location server should include this field to indicate the confidence level of the provided information.</p>
<p>svID This field specifies the GNSS SV-ID of the satellite for which the <i>GNSS-AcquisitionAssistance</i> is given.</p>
<p>doppler0 This field specifies the Doppler (0th order term) value. A positive value in Doppler defines the increase in satellite signal frequency due to velocity towards the target device. A negative value in Doppler defines the decrease in satellite signal frequency due to velocity away from the target device. Doppler is given in unit of m/s by multiplying the Doppler value in Hz by the nominal wavelength of the assisted signal. Scale factor 0.5 m/s in the range from -1024 m/s to +1023.5 m/s.</p>
<p>doppler1 This field specifies the Doppler (1st order term) value. A positive value defines the rate of increase in satellite signal frequency due to acceleration towards the target device. A negative value defines the rate of decrease in satellite signal frequency due to acceleration away from the target device. Scale factor 1/210 m/s² in the range from -0.2 m/s² to +0.1 m/s². Actual value of Doppler (1st order term) is calculated as $(-42 + \text{doppler1}) * 1/210 \text{ m/s}^2$, with <i>doppler1</i> in the range of 0...63.</p>
<p>dopplerUncertainty This field specifies the Doppler uncertainty value. It is defined such that the Doppler experienced by a stationary target device is in the range [Doppler–Doppler Uncertainty] to [Doppler+Doppler Uncertainty]. Doppler Uncertainty is given in unit of m/s by multiplying the Doppler Uncertainty value in Hz by the nominal wavelength of the assisted signal. Defined values: 2.5 m/s, 5 m/s, 10 m/s, 20 m/s, 40 m/s as encoded by an integer <i>n</i> in the range 0-4 according to: $2^{-n}(40) \text{ m/s}; n = 0 - 4$. If the <i>dopplerUncertaintyExt</i> field is present, the target device that supports the <i>dopplerUncertaintyExt</i> shall ignore this field.</p>
<p>codePhase This field together with the <i>codePhase1023</i> field specifies the code phase, in units of milli-seconds, in the range from 0 to 1 millisecond scaled by the nominal chipping rate of the GNSS signal, where increasing values of the field signify increasing predicted signal code phases, as seen by a receiver at the reference location at the reference time. The reference location would typically be an <i>a priori</i> estimate of the target device location. Scale factor 2^{-10} ms in the range from 0 to $(1 \cdot 2^{-10})$ ms. Note: The value $(1 \cdot 2^{-10})$ ms is encoded using the <i>codePhase1023</i> IE.</p>
<p>intCodePhase This field contains integer code phase (expressed modulo 128 ms). The satellite integer milli-seconds code phase currently being transmitted at the reference time, as seen by a receiver at the reference location is calculated as reference time (expressed in milli-seconds) minus (<i>intCodePhase</i> + (<i>n</i>×128 ms)), as shown in Figure 6.5.2.2-1, with <i>n</i> = ...-2,-1,0,1,2.... Scale factor 1 ms in the range from 0 to 127 ms.</p>
<p>codePhaseSearchWindow This field contains the code phase search window. The code phase search window accounts for the uncertainty in the estimated target device location but not any uncertainty in reference time. It is defined such that the expected code phase is in the range [Code Phase–Code Phase Search Window] to [Code Phase+Code Phase Search Window] given in units of milli-seconds. Range 0-31, mapping according to the table <i>codePhaseSearchWindow</i> Value to Code Phase Search Window [ms] relation shown below.</p>
<p>azimuth This field specifies the azimuth angle. An angle of <i>x</i> degrees means the satellite azimuth <i>a</i> is in the range $(x \leq a < x+0.703125)$ degrees. Scale factor 0.703125 degrees.</p>
<p>elevation This field specifies the elevation angle. An angle of <i>y</i> degrees means the satellite elevation <i>e</i> is in the range $(y \leq e < y+0.703125)$ degrees. Scale factor 0.703125 degrees.</p>

GNSS-AcquisitionAssistance field descriptions**codePhase1023**

This field if set to TRUE indicates that the code phase has the value $1023 \times 2^{-10} = (1-2^{-10})$ ms. This field may only be set to TRUE if the value provided in the *codePhase* IE is 1022. If this field is set to FALSE, the code phase is the value provided in the *codePhase* IE in the range from 0 to $(1 - 2 \times 2^{-10})$ ms. If this field is not present and the *codePhase* IE has the value 1022, the target device may assume that the code phase is between $(1 - 2 \times 2^{-10})$ and $(1 - 2^{-10})$ ms.

dopplerUncertaintyExt

If this field is present, the target device that supports this field shall ignore the *dopplerUncertainty* field. The location server should include this field only if supported by the target device.
This field specifies the Doppler uncertainty value. It is defined such that the Doppler experienced by a stationary target device is in the range [Doppler–Doppler Uncertainty] to [Doppler+Doppler Uncertainty]. Doppler Uncertainty is given in unit of m/s by multiplying the Doppler Uncertainty value in Hz by the nominal wavelength of the assisted signal.
Enumerated values define 60 m/s, 80 m/s, 100 m/s, 120 m/s, and "No Information".

codePhaseSearchWindow Value to Code Phase Search Window [ms] relation

codePhaseSearchWindow Value	Code Phase Search Window [ms]
'00000'	No information
'00001'	0,002
'00010'	0,004
'00011'	0,008
'00100'	0,012
'00101'	0,016
'00110'	0,024
'00111'	0,032
'01000'	0,048
'01001'	0,064
'01010'	0,096
'01011'	0,128
'01100'	0,164
'01101'	0,200
'01110'	0,250
'01111'	0,300
'10000'	0,360
'10001'	0,420
'10010'	0,480
'10011'	0,540
'10100'	0,600
'10101'	0,660
'10110'	0,720
'10111'	0,780
'11000'	0,850
'11001'	1,000
'11010'	1,150
'11011'	1,300
'11100'	1,450
'11101'	1,600
'11110'	1,800
'11111'	2,000

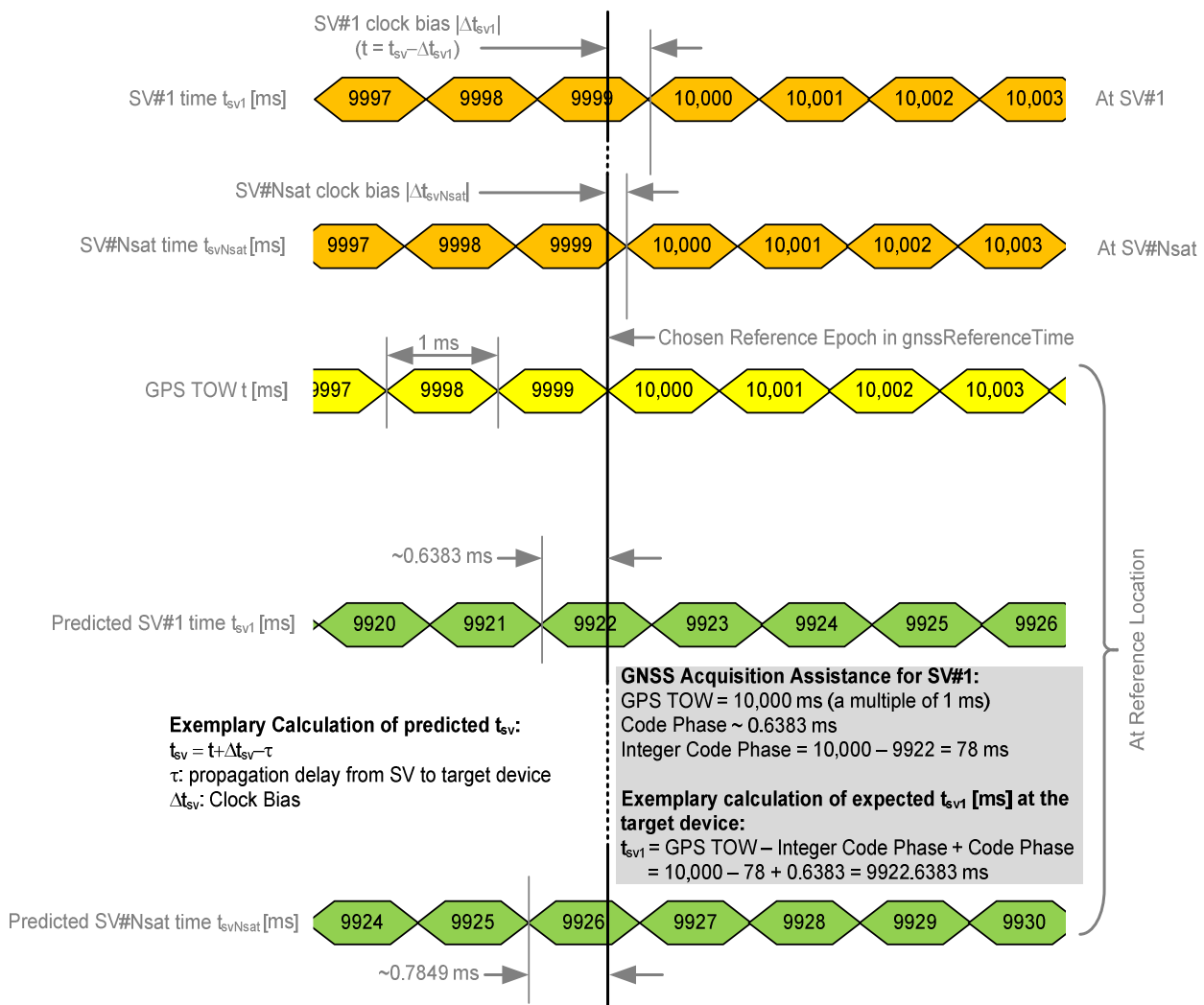

Figure 6.5.2-1: Exemplary calculation of some GNSS Acquisition Assistance fields.

GNSS-Almanac

The IE *GNSS-Almanac* is used by the location server to provide the coarse, long-term model of the satellite positions and clocks. The meaning of these parameters is defined in relevant ICDs of the particular GNSS and GNSS specific interpretations apply. For example, GPS and QZSS use the same model parameters but some parameters have a different interpretation [7]. *GNSS-Almanac* is useful for receiver tasks that require coarse accuracy, such as determining satellite visibility. The model is valid for up to a few weeks, typically. Since it is a long-term model, the field should be provided for all satellites available in the GNSS constellation (i.e., not only for SVs visible at the reference location and including SVs flagged as unhealthy in almanac). The *completeAlmanacProvided* field indicates whether or not the location server provided almanacs for the complete GNSS constellation.

```

-- ASN1START
GNSS-Almanac ::= SEQUENCE {
    weekNumber          INTEGER (0..255)    OPTIONAL,  -- Need ON
    toa                 INTEGER (0..255)    OPTIONAL,  -- Need ON
    ioda                INTEGER (0..3)      OPTIONAL,  -- Need ON
    completeAlmanacProvided BOOLEAN,
    gnss-AlmanacList   GNSS-AlmanacList,
    ...,
    [[ toa-ext-v1240    INTEGER (256..1023)  OPTIONAL,  -- Need ON
      ioda-ext-v1240   INTEGER (4..15)      OPTIONAL,  -- Need ON
    ]],
    [[
      weekNumber-ext-r16 INTEGER (256..8191)   OPTIONAL,  -- Need ON
      toa-ext2-r16      INTEGER (256..65535)   OPTIONAL,  -- Need ON
    ]]]
}
    
```

```

GNSS-AlmanacList ::= SEQUENCE (SIZE(1..64)) OF GNSS-AlmanacElement
GNSS-AlmanacElement ::= CHOICE {
    keplerianAlmanacSet          AlmanacKeplerianSet,          -- Model-1
    keplerianNAV-Almanac         AlmanacNAV-KeplerianSet,      -- Model-2
    keplerianReducedAlmanac      AlmanacReducedKeplerianSet,   -- Model-3
    keplerianMidiAlmanac         AlmanacMidiAlmanacSet,        -- Model-4
    keplerianGLONASS             AlmanacGLONASS-AlmanacSet,    -- Model-5
    ecef-SBAS-Almanac            AlmanacECEF-SBAS-AlmanacSet,   -- Model-6
    . . . ,
    keplerianBDS-Almanac-r12     AlmanacBDS-AlmanacSet-r12,   -- Model-7
    keplerianNavIC-Almanac-r16   AlmanacNavIC-AlmanacSet-r16  -- Model-8
}
-- ASN1STOP

```

GNSS-Almanac field descriptions

weekNumber, weekNumber-ext

This field specifies the almanac reference week number in GNSS specific system time to which the almanac reference time *toa* is referenced, modulo 256 weeks. Either *weekNumber* or *weekNumber-ext* is required for non-GLONASS GNSSs.

In the case of Galileo, the almanac reference week number WN_a natively contains only the 2 LSB's [8], clause 5.1.10].

In the case of BDS B1C and BDS B2a, the almanac reference week number is defined in [39], 7.9.1 and [49], 7.9.1.

In the case of NavIC, the almanac reference week number is defined in [38].

toa, toa-ext, toa-ext2

In the cases that *GNSS-ID* does not indicate Galileo or NavIC, this field specifies the almanac reference time given in GNSS specific system time, in units of seconds with a scale factor of 2^{12} . *toa* is required for non-GLONASS GNSSs when the *toa-ext2* is not present.

In the case that *GNSS-ID* indicates Galileo, this field specifies the almanac reference time given in GNSS specific system time, in units of seconds with a scale factor of 600 seconds. Either *toa* or *toa-ext* is required for Galileo GNSS.

In the case that *GNSS-ID* indicates NavIC, this field specifies the almanac reference time given in GNSS specific system time, in units of seconds with a scale factor of 16 seconds [38]. Either *toa* or *toa-ext2* is required for NavIC GNSS.

ioda, ioda-ext

This field specifies the issue of data. Either *ioda* or *ioda-ext* is required for Galileo GNSS.

completeAlmanacProvided

If set to TRUE, the *gnss-AlmanacList* contains almanacs for the complete GNSS constellation indicated by *GNSS-ID*.

gnss-AlmanacList

This list contains the almanac model for each GNSS satellite in the GNSS constellation.

AlmanacKeplerianSet

```

-- ASN1START
AlmanacKeplerianSet ::= SEQUENCE {
    svID          SV-ID,
    kepAlmanacE   INTEGER (0..2047),
    kepAlmanacDeltaI   INTEGER (-1024..1023),
    kepAlmanacOmegaDot   INTEGER (-1024..1023),
    kepSV-StatusINAV     BIT STRING (SIZE (4)),
    kepSV-StatusFNAV     BIT STRING (SIZE (2))          OPTIONAL,    -- Need ON
    kepAlmanacAPowerHalf   INTEGER (-4096..4095),
    kepAlmanacOmega0       INTEGER (-32768..32767),
    kepAlmanacW            INTEGER (-32768..32767),
    kepAlmanacM0           INTEGER (-32768..32767),
    kepAlmanacAF0          INTEGER (-32768..32767),
    kepAlmanacAF1          INTEGER (-4096..4095),
    . . .
}
-- ASN1STOP

```

AlmanacKeplerianSet field descriptions

svID

This field identifies the satellite for which the GNSS Almanac Model is given.

kepAlmanacE

Parameter *e*, eccentricity, dimensionless [8].

Scale factor 2^{-16} .

<i>AlmanacKeplerianSet</i> field descriptions
<p><i>kepAlmanacDeltaI</i> Parameter δ_i, inclination at reference time relative to $i_0=56^\circ$; semi-circles [8]. Scale factor 2^{-14} semi-circles.</p>
<p><i>kepAlmanacOmegaDot</i> Parameter $\dot{\Omega}$, rate of change of right ascension (semi-circles/sec) [8]. Scale factor 2^{-33} semi-circles/seconds.</p>
<p><i>kepSV-StatusINAV</i> This field contains the I/NAV signal health status [8], clause 5.1.10, E5b_{HS} and E1-B_{HS}, where E5b_{HS} occupies the 2 MSBs in <i>kepSV-StatusINAV</i>, and E1-B_{HS} the two LSBs.</p>
<p><i>kepSV-StatusFNAV</i> This field contains the F/NAV signal health status [8], clause 5.1.10, E5a_{HS}. If the target device is supporting multiple Galileo signals, the location server includes this field.</p>
<p><i>kepAlmanacAPowerHalf</i> Parameter $\Delta(a^{1/2})$, difference with respect to the square root of the nominal semi-major axis, (metres)^{1/2} [8]. Scale factor 2^{-9} metres^{1/2}.</p>
<p><i>kepAlmanacOmegaO</i> Parameter OMEGA₀, longitude of ascending node of orbital plane at weekly epoch (semi-circles) [8]. Scale factor 2^{-15} semi-circles.</p>
<p><i>kepAlmanacW</i> Parameter ω, argument of perigee (semi-circles) [8]. Scale factor 2^{-15} semi-circles.</p>
<p><i>kepAlmanacMO</i> Parameter M₀, mean anomaly at reference time (semi-circles) [8]. Scale factor 2^{-15} semi-circles.</p>
<p><i>kepAlmanacAF0</i> Parameter af₀, satellite clock correction bias, seconds [8]. Scale factor 2^{-19} seconds.</p>
<p><i>kepAlmanacAF1</i> Parameter af₁, satellite clock correction linear, sec/sec [8]. Scale factor 2^{-38} seconds/second.</p>

– *AlmanacNAV-KeplerianSet*

```

-- ASN1START
AlmanacNAV-KeplerianSet ::= SEQUENCE {
    svID                SV-ID,
    navAlmE             INTEGER (0..65535),
    navAlmDeltaI       INTEGER (-32768..32767),
    navAlmOMEGADOT     INTEGER (-32768..32767),
    navAlmSVHealth     INTEGER (0..255),
    navAlmSqrtA        INTEGER (0..16777215),
    navAlmOMEGAo       INTEGER (-8388608..8388607),
    navAlmOmega        INTEGER (-8388608..8388607),
    navAlmMo           INTEGER (-8388608..8388607),
    navAlmaf0          INTEGER (-1024..1023),
    navAlmaf1          INTEGER (-1024..1023),
    ...
}
-- ASN1STOP

```

<i>AlmanacNAV-KeplerianSet</i> field descriptions	
svID	This field identifies the satellite for which the GNSS Almanac Model is given.
navAlmE	Parameter e, eccentricity, dimensionless [4,7]. Scale factor 2^{-21} .
navAlmDeltaI	Parameter δ_i , correction to inclination, semi-circles [4,7]. Scale factor 2^{-19} semi-circles.
navAlmOMEGADOT	Parameter $\dot{\Omega}$, rate of right ascension, semi-circles/sec [4,7]. Scale factor 2^{-38} semi-circles/second.
navAlmSVHealth	Parameter SV Health, satellite health [4,7].
navAlmSqrtA	Parameter \sqrt{A} , square root of the semi-major axis, metres ² [4,7] Scale factor 2^{-11} metres ² .
navAlmOMEGAo	Parameter Ω_0 , longitude of ascending node of orbit plane at weekly epoch, semi-circles [4,7]. Scale factor 2^{-23} semi-circles.
navAlmOmega	Parameter ω , argument of perigee semi-circles [4,7]. Scale factor 2^{-23} semi-circles.
navAlmMo	Parameter M_0 , mean anomaly at reference time semi-circles [4,7]. Scale factor 2^{-23} semi-circles.
navAlmaf0	Parameter a_{f0} , apparent satellite clock correction seconds [4,7]. Scale factor 2^{-20} seconds.
navAlmaf1	Parameter a_{f1} , apparent satellite clock correction sec/sec [4,7]. Scale factor 2^{-38} semi-circles seconds/second.

AlmanacReducedKeplerianSet

```

-- ASN1START
AlmanacReducedKeplerianSet ::= SEQUENCE {
    svID                SV-ID,
    redAlmDeltaA        INTEGER (-128..127),
    redAlmOmega0        INTEGER (-64..63),
    redAlmPhi0          INTEGER (-64..63),
    redAlmL1Health      BOOLEAN,
    redAlmL2Health      BOOLEAN,
    redAlmL5Health      BOOLEAN,
    ...
}
-- ASN1STOP

```

<i>AlmanacReducedKeplerianSet</i> field descriptions
<p>svID This field identifies the satellite for which the GNSS Almanac Model is given.</p>
<p>redAlmDeltaA Parameter δ_A, metres [4], [5], [6], [7], [39], [49]. Scale factor 2^{+9} metres.</p>
<p>redAlmOmega0 Parameter Ω_0, semi-circles [4], [5], [6], [7], [39], [49]. Scale factor 2^{-6} semi-circles.</p>
<p>redAlmPhi0 Parameter Φ_0, semi-circles [4], [5], [6], [7], [39], [49]. Scale factor 2^{-6} semi-circles.</p>
<p>redAlmL1Health Parameter L1 Health, dimensionless [4], [5], [6], [7]. If <i>GNSS-ID</i> = BDS, this field indicates the Satellite clock health state (the 8th bit) defined in table 7-14 [39] for BDS B1C and in table 7-14 [49] for BDS B2a.</p>
<p>redAlmL2Health Parameter L2 Health, dimensionless [4], [5], [6], [7]. If <i>GNSS-ID</i> = BDS, this field indicates the B1C signal health state (the 7th bit) defined in table 7-14 [39] for BDS B1C and in table 7-14 [49] for BDS B2a.</p>
<p>redAlmL5Health Parameter L5 Health, dimensionless [4], [5], [6], [7]. If <i>GNSS-ID</i> = BDS, this field indicates the B2a signal health state (the 6th bit) defined in table 7-14 [39] for BDS B1C and in table 7-14 [49] for BDS B2a.</p>

AlmanacMidiAlmanacSet

```

-- ASN1START
AlmanacMidiAlmanacSet ::= SEQUENCE {
    svID                SV-ID,
    midiAlmE            INTEGER (0..2047),
    midiAlmDeltaI       INTEGER (-1024..1023),
    midiAlmOmegaDot     INTEGER (-1024..1023),
    midiAlmSqrtA        INTEGER (0..131071),
    midiAlmOmega0       INTEGER (-32768..32767),
    midiAlmOmega        INTEGER (-32768..32767),
    midiAlmMo           INTEGER (-32768..32767),
    midiAlmaf0          INTEGER (-1024..1023),
    midiAlmaf1          INTEGER (-512..511),
    midiAlmL1Health     BOOLEAN,
    midiAlmL2Health     BOOLEAN,
    midiAlmL5Health     BOOLEAN,
    ...
}
-- ASN1STOP

```

AlmanacMidiAlmanacSet field descriptions
<p>svID This field identifies the satellite for which the GNSS Almanac Model is given.</p>
<p>midiAlmE Parameter e, dimensionless [4], [5], [6], [7], [39], [49]. Scale factor 2^{-16}.</p>
<p>midiAlmDeltaI Parameter δ_i, semi-circles [4], [5], [6], [7], [39], [49]. Scale factor 2^{-14} semi-circles.</p>
<p>midiAlmOmegaDot Parameter $\dot{\Omega}$, semi-circles/sec [4], [5], [6], [7], [39], [49]. Scale factor 2^{-33} semi-circles/second.</p>
<p>midiAlmSqrtA Parameter \sqrt{A}, metres^{1/2} [4], [5], [6], [7], [39], [49]. Scale factor 2^{-4} metres^{1/2}.</p>
<p>midiAlmOmega0 Parameter Ω_0, semi-circles [4], [5], [6], [7], [39], [49]. Scale factor 2^{-15} semi-circles.</p>
<p>midiAlmOmega Parameter ω, semi-circles [4], [5], [6], [7], [39], [49]. Scale factor 2^{-15} semi-circles.</p>
<p>midiAlmMo Parameter M_0, semi-circles [4], [5], [6], [7], [39], [49]. Scale factor 2^{-15} semi-circles.</p>
<p>midiAlmaf0 Parameter a_{f0}, seconds [4], [5], [6], [7], [39], [49]. Scale factor 2^{-20} seconds.</p>
<p>midiAlmaf1 Parameter a_{f1}, sec/sec [4], [5], [6], [7], [39], [49]. Scale factor 2^{-37} seconds/second.</p>
<p>midiAlmL1Health Parameter L1 Health, dimensionless [4], [5], [6], [7]. If <i>GNSS-ID</i> = BDS, this field indicates the satellite clock health state (the 8th bit) defined in table 7-14 [39] for BDS B1C and in table 7-14 [49] for BDS B2a.</p>
<p>midiAlmL2Health Parameter L2 Health, dimensionless [4], [5], [6], [7]. If <i>GNSS-ID</i> = BDS, this field indicates the B1C signal health state (the 7th bit) defined in table 7-14 [39] for BDS B1C and in table 7-14 [49] for BDS B2a.</p>
<p>midiAlmL5Health Parameter L5 Health, dimensionless [4], [5], [6], [7]. If <i>GNSS-ID</i> = BDS, this field indicates the B2a signal health state (the 6th bit) defined in table 7-14 [39] for BDS B1C and in table 7-14 [49] for BDS B2a.</p>

AlmanacGLONASS-AlmanacSet

```

-- ASN1START
AlmanacGLONASS-AlmanacSet ::= SEQUENCE {
    gloAlm-NA          INTEGER (1..1461),
    gloAlmNA          INTEGER (1..24),
    gloAlmHA          INTEGER (0..31),
    gloAlmLambdaA     INTEGER (-1048576..1048575),
    gloAlmLambdaA     INTEGER (0..2097151),
    gloAlmDeltaIa     INTEGER (-131072..131071),
    gloAlmDeltaTA     INTEGER (-2097152..2097151),
    gloAlmDeltaTdotA  INTEGER (-64..63),
    gloAlmEpsilonA    INTEGER (0..32767),
    gloAlmOmegaA      INTEGER (-32768..32767),
    gloAlmTauA        INTEGER (-512..511),
    gloAlmCA           INTEGER (0..1),
    gloAlmMA           BIT STRING (SIZE(2))
    ...
}
-- ASN1STOP

```

<i>AlmanacGLONASS-AlmanacSet</i> field descriptions
<i>gloAlmNA</i> Parameter N^A , days [9]. Scale factor 1 days.
<i>gloAlmna</i> Parameter n^A , dimensionless [9].
<i>gloAlmHA</i> Parameter H_n^A , dimensionless [9].
<i>gloAlmLambdaA</i> Parameter λ_n^A , semi-circles [9]. Scale factor 2^{20} semi-circles.
<i>gloAlmtlambdaA</i> Parameter $t_{\lambda_n^A}$, seconds [9]. Scale factor 2^{-5} seconds.
<i>gloAlmDeltala</i> Parameter Δi_n^A , semi-circles [9]. Scale factor 2^{20} semi-circles.
<i>gloAlmDeltaTA</i> Parameter ΔT_n^A , sec/orbit period [9]. Scale factor 2^{-9} seconds/orbit period.
<i>gloAlmDeltaTdotA</i> Parameter $\Delta T_DOT_n^A$, sec/orbit period ² [9]. Scale factor 2^{-14} seconds/orbit period ² .
<i>gloAlmEpsilonA</i> Parameter ϵ_n^A , dimensionless [9]. Scale factor 2^{20} .
<i>gloAlmOmegaA</i> Parameter ω_n^A , semi-circles [9]. Scale factor 2^{15} semi-circles.
<i>gloAlmTauA</i> Parameter τ_n^A , seconds [9]. Scale factor 2^{-18} seconds.
<i>gloAlmCA</i> Parameter C_n^A , dimensionless [9].
<i>gloAlmMA</i> Parameter M_n^A , dimensionless [9]. This parameter is present if its value is nonzero; otherwise it is not present.

AlmanacECEF-SBAS-AlmanacSet

```

-- ASN1START
AlmanacECEF-SBAS-AlmanacSet ::= SEQUENCE {
    sbasAlmDataID      INTEGER (0..3),
    svID               SV-ID,
    sbasAlmHealth      BIT STRING (SIZE(8)),
    sbasAlmXg          INTEGER (-16384..16383),
    sbasAlmYg          INTEGER (-16384..16383),
    sbasAlmZg          INTEGER (-256..255),
    sbasAlmXgdot       INTEGER (-4..3),
    sbasAlmYgdot       INTEGER (-4..3),
    sbasAlmZgdot       INTEGER (-8..7),
    sbasAlmTo          INTEGER (0..2047),
    ...
}
-- ASN1STOP

```

AlmanacECEF-SBAS-AlmanacSet field descriptions
<i>sbasAlmDataID</i> Parameter Data ID, dimensionless [10].
<i>svID</i> This field identifies the satellite for which the GNSS Almanac Model is given.
<i>sbasAlmHealth</i> Parameter Health, dimensionless [10].
<i>sbasAlmXg</i> Parameter X_G , metres [10]. Scale factor 2600 metres.
<i>sbasAlmYg</i> Parameter Y_G , metres [10]. Scale factor 2600 metres.
<i>sbasAlmZg</i> Parameter Z_G , metres [10]. Scale factor 26000 metres.
<i>sbasAlmXgdot</i> Parameter X_G Rat-of-Change, metres/second [10]. Scale factor 10 metres/second.
<i>sbasAlmYgDot</i> Parameter Y_G Rate-of-Change, metres/second [10]. Scale factor 10 metres/second.
<i>sbasAlmZgDot</i> Parameter Z_G Rate-of-Change, metres/second [10]. Scale factor 40.96 metres/second.
<i>sbasAlmTo</i> Parameter t_0 , seconds [10]. Scale factor 64 metres/second.

– *AlmanacBDS-AlmanacSet*

```

-- ASN1START
AlmanacBDS-AlmanacSet-r12 ::= SEQUENCE {
    svID                SV-ID,
    bdsAlmToa-r12       INTEGER (0..255)                OPTIONAL,  -- Cond NotSameForAllSV
    bdsAlmSqrtA-r12     INTEGER (0..16777215),
    bdsAlmE-r12         INTEGER (0..131071),
    bdsAlmW-r12         INTEGER (-8388608..8388607),
    bdsAlmM0-r12        INTEGER (-8388608..8388607),
    bdsAlmOmega0-r12    INTEGER (-8388608..8388607),
    bdsAlmOmegaDot-r12  INTEGER (-65536..65535),
    bdsAlmDeltaI-r12    INTEGER (-32768..32767),
    bdsAlmA0-r12        INTEGER (-1024..1023),
    bdsAlmA1-r12        INTEGER (-1024..1023),
    bdsSvHealth-r12     BIT STRING (SIZE(9))          OPTIONAL,  -- Cond SV-ID
    ...
}
-- ASN1STOP

```

Conditional presence	Explanation
<i>NotSameForAllSV</i>	This field may be present if the t_{0a} is not the same for all SVs; otherwise it is not present and the t_{0a} is provided in <i>GNSS-Almanac</i> .
<i>SV-ID</i>	This field is mandatory present if <i>SV-ID</i> is between 0 and 63; otherwise it is not present.

<i>AlmanacBDS-AlmanacSet</i> field descriptions	
svID	This field identifies the satellite for which the GNSS Almanac Model is given.
bdsAlmToa	Parameter t_{oa} , Almanac reference time (seconds) [23], [50]. Scale factor 2^{12} seconds.
bdsAlmSqrtA	Parameter $A^{1/2}$, Square root of semi-major axis (metres ^{1/2}) [23], [50]. Scale factor 2^{11} metres ^{1/2} .
bdsAlmE	Parameter e , Eccentricity, dimensionless [23], [50]. Scale factor 2^{21} .
bdsAlmW	Parameter ω , Argument of Perigee (semi-circles) [23], [50]. Scale factor 2^{23} semi-circles.
bdsAlmM0	Parameter M_0 , Mean anomaly at reference time (semi-circles) [23], [50]. Scale factor 2^{23} semi-circles.
bdsAlmOmega0	Parameter Ω_0 , Longitude of ascending node of orbital plane computed according to reference time (semi-circles) [23], [50]. Scale factor 2^{23} semi-circles.
bdsAlmOmegaDot	Parameter $\dot{\Omega}$, Rate of right ascension (semi-circles/second) [23], [50]. Scale factor 2^{38} semi-circles/second.
bdsAlmDeltaI	Parameter δ_i , Correction of orbit reference inclination at reference time (semi-circles) [23], [50]. Scale factor 2^{19} semi-circles.
bdsAlmA0	Parameter a_0 , Satellite clock bias (seconds) [23], [50]. Scale factor 2^{20} seconds.
bdsAlmA1	Parameter a_1 , Satellite clock rate (sec/sec) [23], [50]. Scale factor 2^{38} seconds/seconds.
bdsSvHealth	This field indicates satellites health information as defined in [23], [50] Table 5-16. The left most bit is the MSB.

– *AlmanacNavIC-AlmanacSet*

The IE *AlmanacNavIC-AlmanacSet* is used for NavIC L5 as defined in [38].

```
-- ASN1START
AlmanacNavIC-AlmanacSet-r16 ::= SEQUENCE {
    svID-r16                SV-ID,
    navic-AlmToa-r16        INTEGER (0..65535)           OPTIONAL,    -- Cond NotSameForAllSV
    navic-AlmE-r16          INTEGER (0..65535),
    navic-AlmOMEGADOT-r16  INTEGER (-32768..32767),
    navic-AlmSqrtA-r16      INTEGER (0..16777215),
    navic-AlmOMEGAo-r16     INTEGER (-8388608..8388607),
    navic-AlmOmega-r16     INTEGER (-8388608..8388607),
    navic-AlmMo-r16         INTEGER (-8388608..8388607),
    navic-Almaf0-r16        INTEGER (-1024..1023),
    navic-Almaf1-r16        INTEGER (-1024..1023),
    ...,
    [
        navicL5-i0-r16       INTEGER (-8388608..8388607) OPTIONAL    -- Need ON
    ]
}
-- ASN1STOP
```

Conditional presence	Explanation
<i>NotSameForAllSV</i>	This field is optionally present, need ON, if the t_{oa} is not the same for all SVs; otherwise it is not present and the t_{oa} is provided in <i>GNSS-Almanac</i> .

AlmanacNavIC-AlmanacSet field descriptions
svID This field identifies the satellite for which the Almanac model is given.
navic-AlmToa This field provides the time of almanac set [38]. Scale factor 16 seconds.
navic-AlmE Parameter e, eccentricity, dimensionless [38]. Scale factor 2^{21} .
navic-AlmOMEGADOT Parameter $\dot{\Omega}$, rate of right ascension, semi-circles/sec [38]. Scale factor 2^{38} semi-circles/second
navic-AlmSqrta Parameter \sqrt{A} , square root of the semi-major axis, metres ^{1/2} [38]. Scale factor 2^{11} metres ^{1/2} .
navic-AlmOMEGAO Parameter Ω_0 , longitude of ascending node of orbit plane at weekly epoch, semi-circles [38]. Scale factor 2^{23} semi-circles.
navic-AlmOmega Parameter ω , argument of perigee semi-circles [38]. Scale factor 2^{23} semi-circles.
navic-AlmMo Parameter M_0 , mean anomaly at reference time semi-circles [38]. Scale factor 2^{23} semi-circles.
navic-Almaf0 Parameter a_0 , apparent satellite clock correction seconds [38]. Scale factor 2^{20} seconds.
navic-Almaf1 Parameter a_1 , apparent satellite clock correction sec/sec [38]. Scale factor 2^{38} semi-circles seconds/second.
navicL5-i0 Parameter I_0 , inclination (semi-circles) as described in clause 6 of [38]. Scale factor 2^{23} semi-circles.

– GNSS-UTC-Model

The IE *GNSS-UTC-Model* is used by the location server to provide several sets of parameters needed to relate GNSS system time to Universal Time Coordinate (UTC), as defined in [4], [5], [6], [7], [8], [9], [10], [23], [38], [39], [49].

The UTC time standard, UTC(k), is GNSS specific. E.g., if *GNSS-ID* indicates GPS, *GNSS-UTC-Model* contains a set of parameters needed to relate GPS system time to UTC(USNO); if *GNSS-ID* indicates QZSS, *GNSS-UTC-Model* contains a set of parameters needed to relate QZST to UTC(NICT); if *GNSS-ID* indicates GLONASS, *GNSS-UTC-Model* contains a set of parameters needed to relate GLONASS system time to UTC(RU); if *GNSS-ID* indicates SBAS, *GNSS-UTC-Model* contains a set of parameters needed to relate SBAS network time for the SBAS indicated by *SBAS-ID* to the UTC standard defined by the UTC Standard ID; if *GNSS-ID* indicates BDS, *GNSS-UTC-Model* contains a set of parameters needed to relate BDS system time to UTC (NTSC), where *UTC-ModelSet2* is used for BDS B1C and BDS B2a, and *UTC-ModelSet5* is used for BDS B1I; if the *GNSS-ID* indicates NavIC, the *GNSS-UTC-Model* contains a set of parameters needed to relate NavIC system time to the UTC (BIPM).

```
-- ASN1START
GNSS-UTC-Model ::= CHOICE {
    utcModel1      UTC-ModelSet1,          -- Model-1
    utcModel2      UTC-ModelSet2,          -- Model-2
    utcModel3      UTC-ModelSet3,          -- Model-3
    utcModel4      UTC-ModelSet4,          -- Model-4
    . . . ,
    utcModel5-r12  UTC-ModelSet5-r12      -- Model-5
}
-- ASN1STOP
```

UTC-ModelSet1

```
-- ASN1START
UTC-ModelSet1 ::= SEQUENCE {
    gnss-Utc-A1      INTEGER (-8388608..8388607),
    gnss-Utc-A0      INTEGER (-2147483648..2147483647),
    gnss-Utc-Tot     INTEGER (0..255),
    gnss-Utc-WNt     INTEGER (0..255),
    gnss-Utc-DeltaTls  INTEGER (-128..127),
    gnss-Utc-WNlsf   INTEGER (0..255),
    gnss-Utc-DN      INTEGER (-128..127),
    gnss-Utc-DeltaTlsf  INTEGER (-128..127),
    ...
}
-- ASN1STOP
```

UTC-ModelSet1 field descriptions

gnss-Utc-A1

Parameter A_1 , scale factor 2^{-50} seconds/second [4,7,8].

gnss-Utc-A0

Parameter A_0 , scale factor 2^{-30} seconds [4,7,8].

gnss-Utc-Tot

Parameter t_{tot} , scale factor 2^{12} seconds [4,7,8].

gnss-Utc-WNt

Parameter WN_t , scale factor 1 week [4,7,8].

gnss-Utc-DeltaTls

Parameter Δ_{tLS} , scale factor 1 second [4,7,8].

gnss-Utc-WNlsf

Parameter WN_{LSF} , scale factor 1 week [4,7,8].

gnss-Utc-DN

Parameter DN , scale factor 1 day [4,7,8].

gnss-Utc-DeltaTlsf

Parameter Δ_{tLSF} , scale factor 1 second [4,7,8].

UTC-ModelSet2

```
-- ASN1START
UTC-ModelSet2 ::= SEQUENCE {
    utcA0      INTEGER (-32768..32767),
    utcA1      INTEGER (-4096..4095),
    utcA2      INTEGER (-64..63),
    utcDeltaTls  INTEGER (-128..127),
    utcTot      INTEGER (0..65535),
    utcWNot     INTEGER (0..8191),
    utcWNlsf    INTEGER (0..255),
    utcDN       BIT STRING (SIZE(4)),
    utcDeltaTlsf  INTEGER (-128..127),
    ...
    [
        utcWNlsf-ext-r16  INTEGER (256..8191) OPTIONAL  -- Need ON
    ]
}
-- ASN1STOP
```

UTC-ModelSet2 field descriptions

utcA0

Parameter A_{0-n} , bias coefficient of GNSS time scale relative to UTC time scale (seconds) [4], [5], [6], [7], [38], [39], [49].
Scale factor 2^{-35} seconds.

utcA1

Parameter A_{1-n} , drift coefficient of GNSS time scale relative to UTC time scale (sec/sec) [4], [5], [6], [7], [38], [39], [49].
Scale factor 2^{-51} seconds/second.

UTC-ModelSet2 field descriptions
<p>utcA2 Parameter A_{2-n}, drift rate correction coefficient of GNSS time scale relative to UTC time scale (sec/sec²) [4], [5], [6], [7], [38], [39], [49]. Scale factor 2^{-68} seconds/second².</p>
<p>utcDeltaTls Parameter Δt_{LS}, current or past leap second count (seconds) [4], [5], [6], [7], [38], [39], [49]. Scale factor 1 second.</p>
<p>utcTot Parameter t_{ot}, time data reference time of week (seconds) [4], [5], [6], [7], [38], [39], [49]. Scale factor 2^4 seconds.</p>
<p>utcWNot Parameter $W_{N_{ot}}$, time data reference week number (weeks) [4], [5], [6], [7], [38], [39], [49]. Scale factor 1 week.</p>
<p>utcWNlsf, utcWNlsf-ext Parameter $W_{N_{LSF}}$, leap second reference week number (weeks) [4], [5], [6], [7], [38], [39], [49]. If the field <i>utcWNlsf-ext</i> is present, the field <i>utcWNlsf</i> shall be ignored by the receiver. Scale factor 1 week.</p>
<p>utcDN Parameter DN, leap second reference day number (days) [4], [5], [6], [7], [38], [39], [49]. Scale factor 1 day.</p>
<p>utcDeltaTlsf Parameter Δt_{LSF}, current or future leap second count (seconds) [4], [5], [6], [7], [38], [39], [49]. Scale factor 1 second.</p>

– UTC-ModelSet3

```
-- ASN1START
UTC-ModelSet3 ::= SEQUENCE {
    nA          INTEGER (1..1461),
    tauC        INTEGER (-2147483648..2147483647),
    b1          INTEGER (-1024..1023)           OPTIONAL, -- Cond GLONASS-M
    b2          INTEGER (-512..511)           OPTIONAL, -- Cond GLONASS-M
    kp          BIT STRING (SIZE(2))         OPTIONAL, -- Cond GLONASS-M
    ...
}
-- ASN1STOP
```

Conditional presence	Explanation
<i>GLONASS-M</i>	The field is mandatory present if GLONASS-M satellites are present in the current GLONASS constellation; otherwise it is not present.

UTC-ModelSet3 field descriptions
<p>nA Parameter N^A, calendar day number within four-year period beginning since the leap year (days) [9]. Scale factor 1 day.</p>
<p>tauC Parameter τ_c, GLONASS time scale correction to UTC(SU) (seconds) [9]. Scale factor 2^{-31} seconds.</p>
<p>b1 Parameter B1, coefficient to determine $\Delta UT1$ (seconds) [9]. Scale factor 2^{-10} seconds.</p>
<p>b2 Parameter B2, coefficient to determine $\Delta UT1$ (seconds/msd) [9]. Scale factor 2^{-16} seconds/msd.</p>
<p>kp Parameter KP, notification of expected leap second correction (dimensionless) [9].</p>

– UTC-ModelSet4

```
-- ASN1START
```

```

UTC-ModelSet4 ::= SEQUENCE {
    utcA1wnt      INTEGER (-8388608..8388607),
    utcA0wnt      INTEGER (-2147483648..2147483647),
    utcTot        INTEGER (0..255),
    utcWNt        INTEGER (0..255),
    utcDeltaTls   INTEGER (-128..127),
    utcWNlsf      INTEGER (0..255),
    utcDN         INTEGER (-128..127),
    utcDeltaTlsf  INTEGER (-128..127),
    utcStandardID INTEGER (0..7),
    ...
}
-- ASN1STOP
    
```

UTC-ModelSet4 field descriptions	
utcA1wnt	Parameter A_{1WNT} , sec/sec ([10], Message Type 12). Scale factor 2^{50} seconds/second.
utcA0wnt	Parameter A_{0WNT} , seconds ([10], Message Type 12). Scale factor 2^{30} seconds.
utcTot	Parameter t_{ot} , seconds ([10], Message Type 12). Scale factor 2^{12} seconds.
utcWNt	Parameter W_{Nt} , weeks ([10], Message Type 12). Scale factor 1 week.
utcDeltaTls	Parameter Δ_{tLS} , seconds ([10], Message Type 12). Scale factor 1 second.
utcWNlsf	Parameter W_{NLSF} , weeks ([10], Message Type 12). Scale factor 1 week.
utcDN	Parameter DN, days ([10], Message Type 12). Scale factor 1 day.
utcDeltaTlsf	Parameter Δ_{tLSF} , seconds ([10], Message Type 12). Scale factor 1 second.
utcStandardID	If <i>GNSS-ID</i> indicates 'sbas', this field indicates the UTC standard used for the SBAS network time indicated by <i>SBAS-ID</i> to UTC relation as defined in the table Value of UTC Standard ID to UTC Standard relation shown below ([10], Message Type 12).

Value of UTC Standard ID to UTC Standard relation

Value of UTC Standard ID	UTC Standard
0	UTC as operated by the Communications Research Laboratory (CRL), Tokyo, Japan
1	UTC as operated by the National Institute of Standards and Technology (NIST)
2	UTC as operated by the U. S. Naval Observatory (USNO)
3	UTC as operated by the International Bureau of Weights and Measures (BIPM)
4-7	Reserved for future definition

UTC-ModelSet5

```

-- ASN1START
UTC-ModelSet5-r12 ::= SEQUENCE {
    utcA0-r12      INTEGER (-2147483648..2147483647),
    utcA1-r12      INTEGER (-8388608..8388607),
    utcDeltaTls-r12 INTEGER (-128..127),
    utcWNlsf-r12   INTEGER (0..255),
    utcDN-r12      INTEGER (0..255),
    utcDeltaTlsf-r12 INTEGER (-128..127),
    ...
}
    
```

```
}
-- ASN1STOP
```

<i>UTC-ModelSet5</i> field descriptions
<p><i>utcA0</i> Parameter A_{0UTC}, BDS clock bias relative to UTC, seconds [23]. Scale factor 2^{-30} seconds.</p>
<p><i>utcA1</i> Parameter A_{1UTC}, BDS clock rate relative to UTC, sec/sec [23]. Scale factor 2^{-50} sec/sec.</p>
<p><i>utcDeltaTls</i> Parameter Δ_{tLS}, delta time due to leap seconds before the new leap second effective, seconds [23]. Scale factor 1 second.</p>
<p><i>utcWNlsf</i> Parameter WN_{LSF}, week number of the new leap second, weeks [23]. Scale factor 1 week.</p>
<p><i>utcDN</i> Parameter DN, day number of week of the new leap second, days [23]. Scale factor 1 day.</p>
<p><i>utcDeltaTlsf</i> Parameter Δ_{tLSF}, delta time due to leap seconds after the new leap second effective, seconds [23]. Scale factor 1 second.</p>

– *GNSS-AuxiliaryInformation*

The IE *GNSS-AuxiliaryInformation* is used by the location server to provide additional information dependent on the *GNSS-ID*. If *GNSS-AuxiliaryInformation* is provided together with other satellite dependent GNSS assistance data (i.e., any of *GNSS-DifferentialCorrections*, *GNSS-NavigationModel*, *GNSS-DataBitAssistance*, or *GNSS-AcquisitionAssistance* IEs), the *GNSS-AuxiliaryInformation* should be provided for the same satellites and in the same LPP message as the other satellite dependent GNSS assistance data.

```
-- ASN1START

GNSS-AuxiliaryInformation ::= CHOICE {
    gnss-ID-GPS      GNSS-ID-GPS,
    gnss-ID-GLONASS GNSS-ID-GLONASS,
    ...,
    [[ gnss-ID-BDS-r16  GNSS-ID-BDS-r16
    ]]
}

GNSS-ID-GPS ::= SEQUENCE (SIZE(1..64)) OF GNSS-ID-GPS-SatElement

GNSS-ID-GPS-SatElement ::= SEQUENCE {
    svID          SV-ID,
    signalsAvailable  GNSS-SignalIDs,
    ...
}

GNSS-ID-GLONASS ::= SEQUENCE (SIZE(1..64)) OF GNSS-ID-GLONASS-SatElement

GNSS-ID-GLONASS-SatElement ::= SEQUENCE {
    svID          SV-ID,
    signalsAvailable  GNSS-SignalIDs,
    channelNumber  INTEGER (-7..13)          OPTIONAL,          -- Cond FDMA
    ...
}

GNSS-ID-BDS-r16 ::= SEQUENCE (SIZE(1..64)) OF GNSS-ID-BDS-SatElement-r16

GNSS-ID-BDS-SatElement-r16 ::= SEQUENCE {
    svID-r16      SV-ID,
    satType-r16   INTEGER (0..3),
    ...
}

-- ASN1STOP
```

Conditional presence	Explanation
FDMA	The field is mandatory present if the GLONASS SV indicated by <i>svID</i> broadcasts FDMA signals; otherwise it is not present.

GNSS-AuxiliaryInformation field descriptions	
gnss-ID-GPS	This choice may only be present if <i>GNSS-ID</i> indicates GPS.
gnss-ID-GLONASS	This choice may only be present if <i>GNSS-ID</i> indicates GLONASS.
gnss-ID-BDS	This choice may only be present if <i>GNSS-ID</i> indicates BDS.
svID	This field specifies the GNSS SV for which the <i>GNSS-AuxiliaryInformation</i> is given.
signalsAvailable	This field indicates the ranging signals supported by the satellite indicated by <i>svID</i> . This field is given as a bit string as defined in <i>GNSS-SignalIDs</i> for a particular GNSS. If a bit is set to '1' it indicates that the satellite identified by <i>svID</i> transmits ranging signals according to the signal correspondence in <i>GNSS-SignalIDs</i> . If a bit is set to '0' it indicates that the corresponding signal is not supported on the satellite identified by <i>svID</i> .
channelNumber	This field indicates the GLONASS carrier frequency number of the satellite identified by <i>svID</i> , as defined in [9].
satType	This field identifies the BDS B1C and BDS B2a Satellite orbit type, defined in [39], [49]. 1 indicates the GEO satellite, 2 indicates the IGSO satellite, 3 indicates the MEO satellite, and 0 is reserved.

– *BDS-DifferentialCorrections*

The IE *BDS-DifferentialCorrections* is used by the location server to provide differential corrections to the target device for BDS B1I and BDS B3I.

```
-- ASN1START
BDS-DifferentialCorrections-r12 ::= SEQUENCE {
    dbds-RefTime-r12          INTEGER (0..3599),
    bds-SgnTypeList-r12      BDS-SgnTypeList-r12,
    ...
}

BDS-SgnTypeList-r12 ::= SEQUENCE (SIZE (1..3)) OF BDS-SgnTypeElement-r12

BDS-SgnTypeElement-r12 ::= SEQUENCE {
    gnss-SignalID            GNSS-SignalID          OPTIONAL,  -- Need ON
    dbds-CorrectionList-r12 DBDS-CorrectionList-r12,
    ...
}

DBDS-CorrectionList-r12 ::= SEQUENCE (SIZE (1..64)) OF DBDS-CorrectionElement-r12

DBDS-CorrectionElement-r12 ::= SEQUENCE {
    svID                    SV-ID,
    bds-UDREI-r12          INTEGER (0..15),
    bds-RURAI-r12          INTEGER (0..15),
    bds-ECC-DeltaT-r12     INTEGER (-4096..4095),
    ...
}
-- ASN1STOP
```

BDS-DifferentialCorrections field descriptions
<p><i>dbds-RefTime</i> This field <i>specifies</i> the time for which the differential corrections are valid, modulo 1 hour. <i>dbds-RefTime</i> is given in BDS system time. Scale factor 1-second.</p>
<p><i>bds-UDREI</i> This field indicates user differential range error information by user differential range error index (UDREI) as defined in [23], [50], clause 5.3.3.8.2.</p>
<p><i>bds-RURAI</i> This field indicates Regional User Range Accuracy (RURA) information by Regional User Range Accuracy Index (UDREI) as defined in [23], [50], clause 5.3.3.7.</p>
<p><i>bds-ECC-DeltaT</i> This field indicates the BDS differential correction information which is expressed in equivalent clock correction (Δt). Add the value of Δt to the observed pseudo-range to correct the effect caused by the satellite clock offset and ephemeris error. Value -4096 means the Δt is not available. The scale factor is 0.1 metre.</p>

– **BDS-GridModelParameter**

The IE *BDS-GridModelParameter* is used by the location server to provide Ionospheric Grid Information to the target device for BDS BII and BDS B3I.

```
-- ASN1START
BDS-GridModelParameter-r12 ::= SEQUENCE {
    bds-RefTime-r12      INTEGER (0..3599),
    gridIonList-r12     GridIonList-r12,
    ...
}
GridIonList-r12 ::= SEQUENCE (SIZE (1..320)) OF GridIonElement-r12
GridIonElement-r12 ::= SEQUENCE {
    igp-ID-r12          INTEGER (1..320),
    dt-r12              INTEGER (0..511),
    givei-r12           INTEGER (0..15),
    ...
}
-- ASN1STOP
```

BDS-GridModelParameter field descriptions
<p><i>bds-RefTime</i> This field specifies the time for which the grid model parameters are valid, modulo 1 hour. <i>bds-RefTime</i> is given in BDS system time. Scale factor 1-second.</p>
<p><i>gridIonList</i> This list provides ionospheric grid point information for each grid point. Up to 16 instances are used in this version of the specification. The values 17 to 320 are reserved for future use.</p>
<p><i>igp-ID</i> This field indicates the ionospheric grid point (IGP) number as defined in [23], [50], clause 5.3.3.9.</p>
<p><i>dt</i> This field indicates d_T as defined in [23], [50], clause 5.3.3.9.1, i.e. the vertical delay at the corresponding IGP indicated by <i>igp-ID</i>. The scale factor is 0.125 metre.</p>
<p><i>givei</i> This field indicates the Grid Ionospheric Vertical Error Index (GIVEI) which is used to describe the delay correction accuracy at ionospheric grid point indicated by <i>igp-ID</i>, the mapping between GIVEI and GIVE is defined in [23], [50], clause 5.3.3.9.2.</p>

– **GNSS-RTK-Observations**

The IE *GNSS-RTK-Observations* is used by the location server to provide GNSS reference station observables (pseudorange, phaserange, phaserange-rate (Doppler), and carrier-to-noise ratio) of the GNSS signals. Essentially, these

parameters describe the range and derivatives from respective satellites to the reference station location provided in IE *GNSS-RTK-ReferenceStationInfo*.

The parameters provided in IE *GNSS-RTK-Observations* are used as specified for message type 1071-1127 in [30].

```
-- ASN1START

GNSS-RTK-Observations-r15 ::= SEQUENCE {
    epochTime-r15                GNSS-SystemTime,
    gnss-ObservationList-r15     GNSS-ObservationList-r15,
    ...
}

GNSS-ObservationList-r15 ::= SEQUENCE (SIZE(1..64)) OF GNSS-RTK-SatelliteDataElement-r15

GNSS-RTK-SatelliteDataElement-r15 ::= SEQUENCE{
    svID-r15                     SV-ID,
    integer-ms-r15               INTEGER (0..254)                OPTIONAL,    -- Need ON
    rough-range-r15             INTEGER (0..1023),
    rough-phase-range-rate-r15  INTEGER (-8192..8191)            OPTIONAL,    -- Need ON
    gnss-rtk-SatelliteSignalDataList-r15  GNSS-RTK-SatelliteSignalDataList-r15,
    ...
}

GNSS-RTK-SatelliteSignalDataList-r15 ::= SEQUENCE (SIZE(1..24)) OF
                                         GNSS-RTK-SatelliteSignalDataElement-r15

GNSS-RTK-SatelliteSignalDataElement-r15 ::= SEQUENCE {
    gnss-SignalID-r15           GNSS-SignalID,
    fine-PseudoRange-r15       INTEGER (-524288..524287),
    fine-PhaseRange-r15       INTEGER (-8388608..8388607),
    lockTimeIndicator-r15     INTEGER (0..1023),
    halfCycleAmbiguityIndicator-r15  BIT STRING (SIZE (1)),
    carrier-to-noise-ratio-r15  INTEGER (0..1023)                OPTIONAL,    -- Need ON
    fine-PhaseRangeRate-r15   INTEGER (-16384..16383)            OPTIONAL,    -- Need ON
    ...
}

-- ASN1STOP
```

***GNSS-RTK-Observations* field descriptions**

epochTime

This field specifies the epoch time of the observations. The *gnss-TimeID* in *GNSS SystemTime* shall be the same as the *GNSS-ID* in IE *GNSS-GenericAssistDataElement*.

GNSS-RTK-Observations field descriptions	
svID	This field specifies the GNSS SV-ID of the satellite for which the GNSS Observations are provided.
integer-ms	This field contains the integer number of milliseconds in the satellite rough range. Rough range can be used to restore complete observables for a given satellite. Scale factor 1 milli-second in the range from 0 to 254 milli-seconds.
rough-range	This field contains the sub-milliseconds in the satellite rough range (modulo 1 millisecond). Scale factor 2^{-10} milli-seconds in the range from 0 to $(1-2^{-10})$ milli-seconds.
rough-phase-range-rate	This field contains the GNSS satellite rough phaserange rate. Scale factor 1 m/s. Range ± 8191 m/s.
gnss-SignalID	This field specifies the GNSS signal for which the GNSS observations are provided.
fine-PseudoRange	This field contains the GNSS signal fine pseudorange. Full pseudorange corresponding to the given signal is the sum of this field and the fields <i>integer-ms</i> and <i>rough-range</i> . NOTE 1. Scale factor 2^{-29} milli-seconds. Range $\pm(2^{-10}-2^{-29})$ milli-seconds.
fine-PhaseRange	This field contains the GNSS signal fine phaserange. Being added to fields <i>integer-ms</i> and <i>rough-range</i> allows getting the full phaserange observable corresponding to given signal. NOTE 2. Scale factor 2^{-31} milli-seconds. Range $\pm(2^{-8}-2^{-31})$ milli-seconds.
lockTimeIndicator	This field provides a measure of the amount of time during which the receiver has maintained continuous lock on that satellite signal. If a cycle slip occurs during the previous measurement cycle, the lock time indicator shall be reset to zero. The mapping of lock-time parameters as defined in [30] is according to the table <i>lockTimeIndicator</i> value to lock-time parameters relation shown below.
halfCycleAmbiguityIndicator	Value 0 indicates no half-cycle ambiguity. Value 1 indicates half-cycle ambiguity. When providing phaserange with unresolved polarity encoding this bit shall be set to 1. A target device that is not capable of handling half-cycle ambiguities shall skip such phaserange observables. If polarity resolution forced phaserange to be corrected by half-a-cycle, then the <i>lockTimeIndicator</i> must be reset to zero, indicating that despite continuous tracking the final phaserange experienced non-continuity.
carrier-to-noise-ratio	This field provides the GNSS signal carrier-to-noise-ratio in dB-Hz. Scale factor 2^{-4} dB-Hz in the range from 0.0625 to 63.9375 dB-Hz.
fine-PhaseRangeRate	This field contains the GNSS signal fine Phase Range Rate. Full phaserange rate is the sum of this field and the <i>rough-phase-range-rate</i> field. NOTE 3. Scale factor 0.0001 m/s. Range ± 1.6383 m/s.

NOTE 1: Complete Pseudorange for each signal (i) of given satellite can be restored as follows:

$$\text{Pseudorange}(i) = c/1000 \times (\text{integer-ms} + \text{rough_range}/1024 + 2^{-29} \times \text{fine_Pseudorange}(i)), \text{ metre.}$$

NOTE 2: Complete Phaserange for each signal (i) of given satellite can be restored as follows:

$$\text{Phaserange}(i) = c/1000 \times (\text{integer-ms} + \text{rough_range}/1024 + 2^{-31} \times \text{fine_Phaserange}(i)), \text{ metre.}$$

NOTE 3: Complete PhaseRangeRate for each signal (i) of given satellite can be restored as follows:

$$\text{PhaseRangeRate}(i) = \text{rough-phase-range-rate} + 0.0001 * \text{fine-PhaseRangeRate} (i), \text{ metre/second.}$$

NOTE 4: The speed of light c is 299,792,458 metres per second.

lockTimeIndicator value to lock-time parameters relation

lockTimeIndicator value (i)	Supplementary coefficient (k) [30]	Minimum Lock Time (ms) [30]	Range of Indicated Lock Times (t) (ms) [30]
0 – 63	1	i	$0 \leq t < 64$
64 – 95	2	$2 \times i - 64$	$64 \leq t < 128$
96 – 127	4	$4 \times i - 256$	$128 \leq t < 256$
128 – 159	8	$8 \times i - 768$	$256 \leq t < 512$
160 – 191	16	$16 \times i - 2048$	$512 \leq t < 1024$
192 – 223	32	$32 \times i - 5120$	$1024 \leq t < 2048$
224 – 255	64	$64 \times i - 12288$	$2048 \leq t < 4096$
256 – 287	128	$128 \times i - 28672$	$4096 \leq t < 8192$
288 – 319	256	$256 \times i - 65536$	$8192 \leq t < 16384$
320 – 351	512	$512 \times i - 147456$	$16384 \leq t < 32768$
352 – 383	1024	$1024 \times i - 327680$	$32768 \leq t < 65536$
384 – 415	2048	$2048 \times i - 720896$	$65536 \leq t < 131072$
416 – 447	4096	$4096 \times i - 1572864$	$131072 \leq t < 262144$
448 – 479	8192	$8192 \times i - 3407872$	$262144 \leq t < 524288$
480 – 511	16384	$16384 \times i - 7340032$	$524288 \leq t < 1048576$
512 – 543	32768	$32768 \times i - 15728640$	$1048576 \leq t < 2097152$
544 – 575	65536	$65536 \times i - 33554432$	$2097152 \leq t < 4194304$
576 – 607	131072	$131072 \times i - 71303168$	$4194304 \leq t < 8388608$
608 – 639	262144	$262144 \times i - 150994944$	$8388608 \leq t < 16777216$
640 – 671	524288	$524288 \times i - 318767104$	$16777216 \leq t < 33554432$
672 – 703	1048576	$1048576 \times i - 671088640$	$33554432 \leq t < 67108864$
704	2097152	$2097152 \times i - 1409286144$	$67108864 \leq t$
705 – 1023		Reserved	

GLO-RTK-BiasInformation

The IE *GLO-RTK-BiasInformation* is used by the location server to provide the so-called "GLONASS Code-Phase bias values" (CPB) for up to all FDMA GLONASS observations.

If IE *GNSS-RTK-Observations* for *gnss-ID = glonass* are provided, but IE *GLO-RTK-BiasInformation* is not provided, the target device assumes that the CPB information has been applied to the GLONASS observation data a priori.

The parameters provided in IE *GLO-RTK-BiasInformation* are used as specified for message type 1230 in [30].

```
-- ASN1START
GLO-RTK-BiasInformation-r15 ::= SEQUENCE{
  referenceStationID-r15      GNSS-ReferenceStationID-r15,
  cpbIndicator-r15           BIT STRING (SIZE(1)),
  l1-ca-cpBias-r15          INTEGER (-32768..32767)          OPTIONAL,      -- Need ON
  l1-p-cpBias-r15          INTEGER (-32768..32767)          OPTIONAL,      -- Need ON
  l2-ca-cpBias-r15          INTEGER (-32768..32767)          OPTIONAL,      -- Need ON
  l2-p-cpBias-r15          INTEGER (-32768..32767)          OPTIONAL,      -- Need ON
  ...
}
-- ASN1STOP
```

GLO-RTK-BiasInformation field descriptions**referenceStationID**

This field specifies the Station ID for which the *GLO-RTK-BiasInformation* is provided.

cpbIndicator

This field specifies the GLONASS Code-Phase Bias Indicator. The interpretation of the value is as follows:

0 – The GLONASS Pseudorange and Phasorange observations in IE *GNSS-RTK-Observations* are not aligned to the same measurement epoch.

1 – The GLONASS Pseudorange and Phasorange observations in IE *GNSS-RTK-Observations* are aligned to the same measurement epoch.

GLO-RTK-BiasInformation field descriptions
<p>I1-ca-cpBias</p> <p>This field specifies the GLONASS L1 C/A Code-Phase Bias, which represents the offset between the L1 C/A Pseudorange and L1 Phasorange measurement epochs in metres.</p> <p>If <i>cpbIndicator</i> is set to 0, the measurement epoch of the GLONASS L1 Phasorange measurements may be aligned using:</p> <p style="padding-left: 2em;">Aligned GLONASS L1 Phasorange = Full GLONASS L1 Phasorange + GLONASS L1 C/A Code-Phase Bias.</p> <p>If <i>cpbIndicator</i> is set to 1, the measurement epoch of the GLONASS L1 Phasorange measurements may be unaligned using:</p> <p style="padding-left: 2em;">Unaligned GLONASS L1 Phasorange = Full GLONASS L1 Phasorange – GLONASS L1 C/A Code-Phase Bias.</p> <p>Scale factor 0.02 m. Range ± 655.34 m.</p>
<p>I1-p-cpBias</p> <p>This field specifies the GLONASS L1 P Code-Phase Bias, which represents the offset between the L1 P Pseudorange and L1 Phasorange measurement epochs in metres.</p> <p>If <i>cpbIndicator</i> is set to 0, the measurement epoch of the GLONASS L1 Phasorange measurements may be aligned using:</p> <p style="padding-left: 2em;">Aligned GLONASS L1 Phasorange = Full GLONASS L1 Phasorange + GLONASS L1 P Code-Phase Bias.</p> <p>If <i>cpbIndicator</i> is set to 1, the measurement epoch of the GLONASS L1 Phasorange measurements may be unaligned using:</p> <p style="padding-left: 2em;">Unaligned GLONASS L1 Phasorange = Full GLONASS L1 Phasorange – GLONASS L1 P Code-Phase Bias.</p> <p>Scale factor 0.02 m. Range ± 655.34 m.</p>
<p>I2-ca-cpBias</p> <p>This field specifies the GLONASS L2 C/A Code-Phase Bias, which represents the offset between the L2 C/A Pseudorange and L2 Phasorange measurement epochs in metres.</p> <p>If <i>cpbIndicator</i> is set to 0, the measurement epoch of the GLONASS L2 Phasorange measurements may be aligned using:</p> <p style="padding-left: 2em;">Aligned GLONASS L2 Phasorange = Full GLONASS L2 Phasorange + GLONASS L2 C/A Code-Phase Bias.</p> <p>If <i>cpbIndicator</i> is set to 1, the measurement epoch of the GLONASS L2 Phasorange measurements may be unaligned using:</p> <p style="padding-left: 2em;">Unaligned GLONASS L2 Phasorange = Full GLONASS L2 Phasorange – GLONASS L2 C/A Code-Phase Bias.</p> <p>Scale factor 0.02 m. Range ± 655.34 m.</p>
<p>I2-p-cpBias</p> <p>This field specifies the GLONASS L2 P Code-Phase Bias, which represents the offset between the L2 P Pseudorange and L2 Phasorange measurement epochs in metres.</p> <p>If <i>cpbIndicator</i> is set to 0, the measurement epoch of the GLONASS L2 Phasorange measurements may be aligned using:</p> <p style="padding-left: 2em;">Aligned GLONASS L2 Phasorange = Full GLONASS L2 Phasorange + GLONASS L2 P Code-Phase Bias.</p> <p>If <i>cpbIndicator</i> is set to 1, the measurement epoch of the GLONASS L2 Phasorange measurements may be unaligned using:</p> <p style="padding-left: 2em;">Unaligned GLONASS L2 Phasorange = Full GLONASS L2 Phasorange – GLONASS L2 P Code-Phase Bias.</p> <p>Scale factor 0.02 m. Range ± 655.34 m.</p>

– GNSS-RTK-MAC-CorrectionDifferences

The IE *GNSS-RTK-MAC-CorrectionDifferences* is used by the location server to provide dispersive (ionospheric) and non-dispersive (geometric) correction difference components for up to 32 pairs of Auxiliary and Master Reference Stations. The Master Reference Station coordinates are provided in IE *GNSS-RTK-ReferenceStationInfo* and the Auxiliary Station coordinates are provided in IE *GNSS-RTK-AuxiliaryStationData*.

The parameters provided in IE *GNSS-RTK-MAC-CorrectionDifferences* are used as specified for message type 1017 and 1039 in [30] and apply to all GNSSs.

```

-- ASN1START
GNSS-RTK-MAC-CorrectionDifferences-r15 ::= SEQUENCE {
    networkID-r15                GNSS-NetworkID-r15,
    subNetworkID-r15            GNSS-SubNetworkID-r15,
    master-ReferenceStationID-r15 GNSS-ReferenceStationID-r15,
    l1-r15                      GNSS-FrequencyID-r15,
    l2-r15                      GNSS-FrequencyID-r15,
    rtkCorrectionDifferencesList-r15 RTK-CorrectionDifferencesList-r15,
    ...
}
RTK-CorrectionDifferencesList-r15 ::= SEQUENCE (SIZE (1..32)) OF
    RTK-CorrectionDifferencesElement-r15
RTK-CorrectionDifferencesElement-r15 ::= SEQUENCE {

```

```

epochTime-r15                GNSS-SystemTime ,
auxiliary-referenceStationID-r15 GNSS-ReferenceStationID-r15,
geometric-ionospheric-corrections-differences-r15
                                Geometric-Ionospheric-Corrections-Differences-r15,
...
}

Geometric-Ionospheric-Corrections-Differences-r15 ::= SEQUENCE (SIZE(1..64)) OF
    Geometric-Ionospheric-Corrections-Differences-Element-r15

Geometric-Ionospheric-Corrections-Differences-Element-r15 ::= SEQUENCE {
    svID-r15                SV-ID,
    ambiguityStatusFlag-r15 INTEGER (0..3),
    non-synch-count-r15    INTEGER (0..7),
    geometricCarrierPhaseCorrectionDifference-r15 INTEGER (-65536..65535),
    iod-r15                BIT STRING (SIZE(11)),
    ionosphericCarrierPhaseCorrectionDifference-r15 INTEGER (-65536..65535),
    ...
}

-- ASN1STOP

```

GNSS-RTK-MAC-CorrectionDifferences field descriptions	
networkID	This field provides the network ID.
subNetworkID	This field identifies the subnetwork of a network identified by <i>networkID</i> .
master-ReferenceStationID	This field specifies the station ID of the Master Reference Station.
I1, I2	These fields specify the dual-frequency combination of L1 and L2 link/frequencies for which the <i>rtkCorrectionDifferencesList</i> is provided. If the fields are absent, the default interpretation in table 'L1/L2 default interpretation' applies.
rtkCorrectionDifferencesList	This field provides the correction differences for Auxiliary-Master Reference Station pairs.
epochTime	This field specifies the epoch time of observations used to derive the correction differences. The <i>gnss-TimeID</i> in <i>GNSS-SystemTime</i> shall be the same as the <i>GNSS-ID</i> in IE <i>GNSS-GenericAssistDataElement</i> .
auxiliary-referenceStationID	This field specifies the station ID of the Auxiliary Reference Station.
svID	This field specifies the satellite for which the data is provided.
ambiguityStatusFlag	This field provides the ambiguity status. 'L1' below corresponds to the link indicated by the <i>I1</i> field; 'L2' below corresponds to the link indicated by the <i>I2</i> field. 0 - Reserved for future use (artificial observations) 1 - Correct Integer Ambiguity Level for L1 and L2 2 - Correct Integer Ambiguity Level for L1-L2 widelane 3 - Uncertain Integer Ambiguity Level. Only a likely guess is used.
non-synch-count	This field provides the count of unrecoverable cycle slips. Whenever an unrecoverable cycle slip occurs this count shall be increased. The counter shall not be increased more than once per minute. Data for satellites with cycle slips more frequent than once per minute should not be provided.
geometricCarrierPhaseCorrectionDifference	This field provides the Geometric Carrier Phase Correction Difference (GCPD), which is the Correction Difference for the geometric part (troposphere and orbits) calculated based on integer leveled L1 and L2 correction differences (L1CD and L2CD). $GCPD = \frac{f_1^2}{f_1^2 - f_2^2} L1CD - \frac{f_2^2}{f_1^2 - f_2^2} L2CD$ L1CD, L2CD, and ICPCD are presented in metres. 'L1' below corresponds to the link indicated by the <i>I1</i> field; 'L2' below corresponds to the link indicated by the <i>I2</i> field. Scale factor 0.5 millimetre; range ± 32.767 metres.
iod	This field specifies the IOD value of the broadcast ephemeris used for calculation of Correction Differences (see IE <i>GNSS-NavigationModel</i>).

GNSS-RTK-MAC-CorrectionDifferences field descriptions**Ionospheric Carrier Phase Correction Difference**

This field provides the Ionospheric Carrier Phase Correction Difference (ICPCD), which is the Correction Difference for the ionospheric part calculated based on integer leveled L1 and L2 correction differences (L1CD and L2CD).

$$ICPCD = \frac{f_2^2}{f_2^2 - f_1^2} L1CD - \frac{f_1^2}{f_2^2 - f_1^2} L2CD$$

L1CD, L2CD, and ICPCD are presented in metres. 'L1' below corresponds to the link indicated by the *l1* field; 'L2' below corresponds to the link indicated by the *l2* field.

Scale factor 0.5 millimetre; range ± 32.767 metres.

L1/L2 default interpretation

GNSS	<i>l1</i>	<i>l2</i>
GPS	L1	L2
SBAS	L1	L5
QZSS	L1	L2
Galileo	E1	E5a
GLONASS	G1	G2
BDS	B1	B2

GNSS-RTK-Residuals

The IE *GNSS-RTK-Residuals* is used by the location server to provide Network RTK correction residual error information.

If the interpolation of the corrections for the target device location is performed at the location server, resulting in a non-physical reference station, the *GNSS-RTK-Residuals* are referenced to the non-physical reference station.

If the interpolation of the corrections is performed by the target device (e.g., using *GNSS-RTK-MAC-CorrectionDifferences*), the *GNSS-RTK-Residuals* are referenced to the closest master or auxiliary station to the target device.

The parameters provided in IE *GNSS-RTK-Residuals* are used as specified for message type 1030 and 1031 in [30] and apply to all GNSSs.

```
-- ASN1START
GNSS-RTK-Residuals-r15 ::= SEQUENCE {
    epochTime-r15          GNSS-SystemTime,
    referenceStationID-r15 GNSS-ReferenceStationID-r15,
    n-Refs-r15             INTEGER (0..127),
    l1-r15                 GNSS-FrequencyID-r15           OPTIONAL, -- Need OP
    l2-r15                 GNSS-FrequencyID-r15           OPTIONAL, -- Need OP
    rtk-residuals-list-r15 RTK-Residuals-List-r15,
    ...
}
RTK-Residuals-List-r15 ::= SEQUENCE (SIZE(1..64)) OF RTK-Residuals-Element-r15
RTK-Residuals-Element-r15 ::= SEQUENCE {
    svID-r15          SV-ID,
    s-oc-r15          INTEGER (0..255),
    s-od-r15          INTEGER (0..511),
    s-oh-r15          INTEGER (0..63),
    s-lc-r15          INTEGER (0..1023),
    s-ld-r15          INTEGER (0..1023),
    ...
}
-- ASN1STOP
```

GNSS-RTK-Residuals field descriptions	
epochTime	This field specifies the epoch time of the Network RTK Residual Error data. The <i>gnss-TimeID</i> in <i>GNSS-SystemTime</i> shall be the same as the <i>GNSS-ID</i> in IE <i>GNSS-GenericAssistDataElement</i> .
referenceStationID	This field specifies the Reference Station ID. The Reference Station may be a physical or non-physical station.
n-Refs	This field specifies the number of reference stations used to derive the residual statistics (1 to 127; 127 indicates 127 or more stations). The number of reference stations should never be zero. If zero is encountered the target device should ignore the message.
l1, l2	These fields specify the dual-frequency combination of L1 and L2 link/frequencies for which the <i>rtk residuals-list</i> is provided. If the fields are absent, the default interpretation in table 'L1/L2 default interpretation' in IE <i>GNSS-RTK-MAC-CorrectionDifferences</i> applies.
svID	This field specifies the satellite for which the data is provided.
s-oc	This field specifies the constant term of standard deviation (1 sigma) for non-dispersive interpolation residuals, <i>s_{oc}</i> . Scale factor 0.5 millimetre; range 0–127 millimetre. NOTE 1.
s-od	This field specifies the distance dependent term of standard deviation (1 sigma) for nondispersive interpolation residuals, <i>s_{od}</i> . Scale factor 0.01 ppm; range 0–5.11 ppm. NOTE 1.
s-oh	This field specifies the height dependent term of standard deviation (1 sigma) for nondispersive interpolation residuals, <i>s_{oh}</i> . Scale factor 0.1 ppm; range 0–5.1 ppm. NOTE 1.
s-lc	This field specifies the constant term of standard deviation (1 sigma) for dispersive interpolation residuals (as affecting L1 frequency), <i>s_{lc}</i> . 'L1' corresponds to the link indicated by the <i>l1</i> field. Scale factor 0.5 millimetre; range 0–511 millimetre
s-lid	This field specifies the distance dependent term of standard deviation (1 sigma) for dispersive interpolation residuals (as affecting L1 frequency), <i>s_{lid}</i> . 'L1' corresponds to the link indicated by the <i>l1</i> field. NOTE 2.

NOTE 1: The complete standard deviation for the expected non-dispersive interpolation residual is computed from *s-oc*, *s-od* and *s-oh* using the formula:

$$s_o = \sqrt{s_{oc}^2 + s_{od}^2 \cdot d_{Ref}^2 + s_{oh}^2 \cdot dh_{Ref}^2} \quad [\text{mm}]$$

where d_{Ref} is the distance of the target device from the nearest physical reference station in [km] and $|dh_{Ref}|$ is the absolute value of the height difference between the nearest physical reference station and the target device in [km].

NOTE 2: The complete standard deviation for the expected dispersive interpolation residual is computed from *s-lc* and *s-lid* using the formula:

$$s_l(L1) = \sqrt{s_{lc}^2 + s_{lid}^2 \cdot d_{Ref}^2} \quad [\text{mm}]$$

where d_{Ref} is the distance of the target device from the nearest physical reference station in [km].

The standard deviation for the L2 frequency is calculated using the formula:

$$s_l(L2) = s_l(L1) \cdot \frac{\lambda_2^2}{\lambda_1^2} \quad [\text{mm}] \cdot \text{'L2' corresponds to the link indicated by the } l2 \text{ field; } \lambda_1=c/f_1, \lambda_2=c/f_2 \text{ are the}$$

nominal wavelengths of the links indicated by the *l1*, *l2* fields, respectively.

– GNSS-RTK-FKP-Gradients

The IE *GNSS-RTK-FKP-Gradients* is used by the location server to provide the FKP Network RTK gradients of distance-dependent errors like ionosphere, troposphere and orbits. The target device may use the gradients to compute the influence of the distance dependent errors for its own position.

The parameters provided in IE *GNSS-RTK-FKP-Gradients* are used as specified for message type 1034 and 1035 in [30] and apply to all GNSSs.

```
-- ASN1START
```

```
GNSS-RTK-FKP-Gradients-r15 ::= SEQUENCE {
```

```

referenceStationID-r15          GNSS-ReferenceStationID-r15,
epochTime-r15                  GNSS-SystemTime,
l1-r15                          GNSS-FrequencyID-r15          OPTIONAL,  -- Need OP
l2-r15                          GNSS-FrequencyID-r15          OPTIONAL,  -- Need OP
fkp-gradients-list-r15         FKP-Gradients-List-r15,
...
}

FKP-Gradients-List-r15 ::= SEQUENCE (SIZE(1..64)) OF FKP-Gradients-Element-r15

FKP-Gradients-Element-r15 ::= SEQUENCE {
    svID-r15                     SV-ID,
    iod-r15                      BIT STRING (SIZE(11)),
    north-geometric-gradient-r15  INTEGER (-2048..2047),
    east-geometric-gradient-r15   INTEGER (-2048..2047),
    north-ionospheric-gradient-r15 INTEGER (-8192..8191),
    east-ionospheric-gradient-r15 INTEGER (-8192..8191),
    ...
}

-- ASN1STOP

```

GNSS-RTK-FKP-Gradients field descriptions

referenceStationID	This field specifies the Reference Station ID. The Reference Station may be a physical or non-physical station.
epochTime	This field specifies the epoch time of the FKP data. The <i>gnss-TimeID</i> in <i>GNSS-SystemTime</i> shall be the same as the <i>GNSS-ID</i> in IE <i>GNSS-GenericAssistDataElement</i> .
l1, l2	These fields specify the dual-frequency combination of L1 and L2 link/frequencies for which the <i>fkp-gradients-list</i> is provided. If the fields are absent, the default interpretation in table 'L1/L2 default interpretation' in IE <i>GNSS-RTK-MAC-CorrectionDifferences</i> applies. NOTE.
svID	This field specifies the satellite for which the data is provided.
iod	This field specifies the IOD value of the broadcast ephemeris used for calculation of FKP data (see IE <i>GNSS-NavigationModel</i>).
north-geometric-gradient	This field specifies the gradient (FKP) of the geometric (non-dispersive) error components in South-North direction in parts per million of the south-north distance to the reference station. Scale factor 0.01 ppm; range ± 20.47 ppm.
east-geometric-gradient	This field specifies the gradient (FKP) of the geometric (non-dispersive) error components in West-East direction in parts per million of the west-east distance to the reference station. Scale factor 0.01 ppm; range ± 20.47 ppm.
north-ionospheric-gradient	This field specifies the gradient (FKP) of the ionospheric (dispersive) error component in South-North direction. Scale factor 0.01 ppm; range ± 81.91 ppm.
east-ionospheric-gradient	This field specifies the gradient (FKP) of the ionospheric (dispersive) error component in West-East direction. Scale factor 0.01 ppm; range ± 81.91 ppm.

NOTE: As described in [30], the distance dependent error for the geometric part $\delta\rho_0$ and ionospheric part $\delta\rho_I$ is computed from the gradients provided in *FKP-Gradients-Element*. The distance dependent error for a carrier phase measurements Φ on a signal with frequency f can be computed by:

$$\delta\rho_{\phi,f} = \delta\rho_0 + \left(\frac{f_1}{f}\right)^2 \delta\rho_I$$

where f_1, f is the link/frequency indicated by the *l1, l2* fields, respectively.

GNSS-SSR-OrbitCorrections

The IE *GNSS-SSR-OrbitCorrections* is used by the location server to provide radial, along-track and cross-track orbit corrections together with integrity information. The target device may use the *SSR-OrbitCorrectionList* to compute a satellite position correction to be combined with the satellite position calculated from broadcast ephemeris.

The parameters provided in IE *GNSS-SSR-OrbitCorrections* – except for *ORBIT-IntegrityParameters* and *SSR-IntegrityOrbitBounds* – are used as specified for SSR Orbit Messages (e.g., message type 1057 and 1063) in [30] and apply to all GNSSs.

```
-- ASN1START

GNSS-SSR-OrbitCorrections-r15 ::= SEQUENCE {
    epochTime-r15                GNSS-SystemTime,
    ssrUpdateInterval-r15        INTEGER (0..15),
    satelliteReferenceDatum-r15  ENUMERATED { itrfr, regional, ... },
    iod-ssr-r15                  INTEGER (0..15),
    ssr-OrbitCorrectionList-r15  SSR-OrbitCorrectionList-r15,
    ...,
    [
        orbit-IntegrityParameters-r17  ORBIT-IntegrityParameters-r17  OPTIONAL -- Need OR
    ]
}

SSR-OrbitCorrectionList-r15 ::= SEQUENCE (SIZE(1..64)) OF SSR-OrbitCorrectionSatelliteElement-r15

SSR-OrbitCorrectionSatelliteElement-r15 ::= SEQUENCE {
    svID-r15                      SV-ID,
    iod-r15                       BIT STRING (SIZE(11)),
    delta-radial-r15               INTEGER (-2097152..2097151),
    delta-AlongTrack-r15          INTEGER (-524288..524287),
    delta-CrossTrack-r15          INTEGER (-524288..524287),
    dot-delta-radial-r15          INTEGER (-1048576..1048575)  OPTIONAL, -- Need ON
    dot-delta-AlongTrack-r15     INTEGER (-262144..262143)    OPTIONAL, -- Need ON
    dot-delta-CrossTrack-r15     INTEGER (-262144..262143)    OPTIONAL, -- Need ON
    ...,
    [
        ssr-IntegrityOrbitBounds-r17  SSR-IntegrityOrbitBounds-r17  OPTIONAL -- Cond Integrity1
    ]
}

ORBIT-IntegrityParameters-r17 ::= SEQUENCE {
    probOnsetConstFault-r17       INTEGER (0..255),
    meanConstFaultDuration-r17    INTEGER (1..3600),
    probOnsetSatFault-r17         INTEGER (0..255),
    meanSatFaultDuration-r17      INTEGER (1..3600),
    orbitRangeErrorCorrelationTime-r17  INTEGER (0..255)  OPTIONAL, -- Need OR
    orbitRangeRateErrorCorrelationTime-r17  INTEGER (0..255)  OPTIONAL, -- Cond Integrity2
    ...
}

SSR-IntegrityOrbitBounds-r17 ::= SEQUENCE {
    meanOrbitError-r17            RAC-OrbitalErrorComponents-r17,
    stdDevOrbitError-r17          RAC-OrbitalErrorComponents-r17,
    meanOrbitRateError-r17        RAC-OrbitalErrorComponents-r17,
    stdDevOrbitRateError-r17      RAC-OrbitalErrorComponents-r17,
    ...
}

RAC-OrbitalErrorComponents-r17 ::= SEQUENCE {
    radial-r17                    INTEGER (0..255),
    alongTrack-r17                INTEGER (0..255),
    crossTrack-r17                INTEGER (0..255)
}

-- ASN1STOP
```

Conditional presence	Explanation
<i>Integrity1</i>	The field is mandatory present if <i>ORBIT-IntegrityParameters</i> is present; otherwise it is not present.
<i>Integrity2</i>	The field is mandatory present if <i>orbitRangeErrorCorrelationTime</i> is present; otherwise it is not present.

GNSS-SSR-OrbitCorrections field descriptions
<p>epochTime This field specifies the epoch time of the orbit corrections. The <i>gnss-TimeID</i> in <i>GNSS-SystemTime</i> shall be the same as the <i>GNSS-ID</i> in IE <i>GNSS-GenericAssistDataElement</i>.</p>
<p>ssrUpdateInterval This field specifies the SSR Update Interval. The SSR Update Intervals for all SSR parameters start at time 00:00:00 of the GPS time scale. A change of the SSR Update Interval during the transmission of SSR data should ensure consistent data for a target device. See table Value of <i>ssrUpdateInterval</i> to SSR Update Interval relation below. NOTE 1.</p>
<p>satelliteReferenceDatum This field specifies the satellite reference datum for the orbit corrections.</p>
<p>iod-ssr This field specifies the Issue of Data number for the SSR data. A change of <i>iod-ssr</i> is used to indicate a change in the SSR generating configuration.</p>
<p>svID This field specifies the satellite for which the orbit corrections are provided.</p>
<p>iod This field specifies the IOD value of the broadcast ephemeris for which the orbit corrections are valid (see IE <i>GNSS-NavigationModel</i>). NOTE 2, NOTE 4.</p>
<p>delta-radial This field specifies the radial orbit correction for broadcast ephemeris. NOTE 3. Scale factor 0.1 mm; range ± 209.7151 m.</p>
<p>delta-AlongTrack This field specifies the along-track orbit correction for broadcast ephemeris. NOTE 3. Scale factor 0.4 mm; range ± 209.7148 m.</p>
<p>delta-CrossTrack This field specifies the cross-track orbit correction for broadcast ephemeris. NOTE 3. Scale factor 0.4 mm; range ± 209.7148 m.</p>
<p>dot-delta-radial This field specifies the velocity of radial orbit correction for broadcast ephemeris. NOTE 3. Scale factor 0.001 mm/s; range ± 1.048575 m/s.</p>
<p>dot-delta-AlongTrack This field specifies the velocity of along-track orbit correction for broadcast ephemeris. NOTE 3. Scale factor 0.004 mm/s; range ± 1.048572 m/s.</p>
<p>dot-delta-CrossTrack This field specifies the velocity of cross-track orbit correction for broadcast ephemeris. NOTE 3. Scale factor 0.004 mm/s; range ± 1.048572 m/s.</p>
<p>probOnsetConstFault This field specifies the Probability of Onset of Constellation Fault per Time Unit where a constellation fault is at least two satellites being faulty simultaneously due to the same event. This field specifies the onset probability that the residual range or range rate error exceeds a bound created using the minimum allowed inflation factor K_{min}, and bounding parameters as $mean + K_{min} * stdDev$ where $K_{min} = normInv(irMaximum / 2)$, with <i>irMaximum</i> as provided in IE <i>GNSS-Integrity-ServiceParameters</i>. The probability is calculated by $P=10^{-0.04n}$ [hour⁻¹] where <i>n</i> is the value of <i>probOnsetConstFault</i> and the range is $10^{-10.2}$ to 1 per hour.</p>
<p>meanConstFaultDuration This field specifies the Mean Constellation Fault Duration which is the mean duration between when a constellation fault occurs, and the user is alerted by IE <i>GNSS-RealTimeIntegrity</i> (or the integrity violation is over). Scale factor 1 s; range 1-3600 s.</p>
<p>probOnsetSatFault This field specifies the Probability of Onset of Satellite Fault per Time Unit which is the probability of occurrence of satellite error to exceed the residual error bound for more than the Time to Alert (TTA). This field specifies the onset probability that the residual range or range rate error exceeds a bound created using the minimum allowed inflation factor K_{min}, and bounding parameters as $mean + K_{min} * stdDev$ where $K_{min} = normInv(irMaximum / 2)$, with <i>irMaximum</i> as provided in IE <i>GNSS-Integrity-ServiceParameters</i>. The probability is calculated by $P=10^{-0.04n}$ [hour⁻¹] where <i>n</i> is the value of <i>probOnsetSatFault</i> and the range is $10^{-10.2}$ to 1 per hour.</p>
<p>meanSatFaultDuration This field specifies the Mean Satellite Fault Duration which is the mean duration between when a satellite fault occurs, and the user is alerted by IE <i>GNSS-RealTimeIntegrity</i> (or the integrity violation is over). Scale factor 1 s; range 1-3,600 s.</p>

GNSS-SSR-OrbitCorrections field descriptions
<p>orbitRangeErrorCorrelationTime This field specifies the Orbit Range Error Correlation Time which is the upper bound of the correlation time of the satellite residual range error due to orbit. The time is calculated using:</p> $t = \begin{cases} 10i, & i \leq 180 \\ 1800 + 100(i - 180), & 180 < i \leq 234 \\ 7200 + 1000(i - 234), & i > 234 \end{cases} [s]$ <p>Range is 1-28,200 s.</p>
<p>orbitRangeRateErrorCorrelationTime This field specifies the Orbit Range Rate Error Correlation Time which is the upper bound of the correlation time of the satellite residual range rate error due to orbit. The time is calculated using:</p> $t = \begin{cases} 10i, & i \leq 180 \\ 1800 + 100(i - 180), & 180 < i \leq 234 \\ 7200 + 1000(i - 234), & i > 234 \end{cases} [s]$ <p>Range is 1-28,200 s.</p>
<p>meanOrbitError This field specifies the Mean Orbit Error bound in satellite radial, along-track and cross-track coordinates, which are the mean values for a set of three overbounding models that bound the residual orbit error in satellite radial, along-track and cross-track directions. Each mean is calculated using:</p> $\mu = \begin{cases} 0.01i, & i \leq 200 \\ 2 + 0.1(i - 200), & 200 < i \leq 230 \\ 5 + 0.5(i - 230), & i > 230 \end{cases} [m]$ <p>Range is 0-17.5 m.</p>
<p>stdDevOrbitError This field specifies the Standard Deviation Orbit Error bound in satellite radial, along-track and cross-track coordinates, which are the standard deviation values for a set of three overbounding models that bound the residual orbit error in satellite radial, along-track and cross-track directions. Each standard deviation is calculated using:</p> $\sigma = \begin{cases} 0.01i, & i \leq 200 \\ 2 + 0.1(i - 200), & 200 < i \leq 230 \\ 5 + 0.5(i - 230), & i > 230 \end{cases} [m]$ <p>Range is 0-17.5 m.</p>
<p>meanOrbitRateError This field specifies the Mean Orbit Rate Error in satellite radial, along-track and cross-track coordinates, which are the mean values for a set of three overbounding models that bound the residual satellite orbit rate error in satellite radial, along-track and cross-track directions. Scale factor 0.001 m/s; range 0-0.255 m/s.</p>
<p>stdDevOrbitRateError This field specifies the Standard Deviation Orbit Rate Error in satellite radial, along-track and cross-track coordinates, which are the standard deviation values for a set of three overbounding models that bound the residual satellite orbit rate error in satellite radial, along-track and cross-track directions. Scale factor 0.001 m/s; range 0-0.255 m/s.</p>

NOTE 1: The update intervals are aligned to the GPS time scale for all GNSSs in order to allow synchronous operation for multiple GNSS services. This means that the update intervals may not be aligned to the beginning of the day for another GNSS. Due to the leap seconds, this is generally the case for GLONASS.

NOTE 2: In the cases that *gnss-ID* indicates 'gps', 'qzss' or 'bds', the *iod* refers to the NAV broadcast ephemeris (GPS L1 C/A, QZSS QZS-L1 or BDS B1I/B3I, respectively, in table GNSS to iod Bit String(11) relation in IE *GNSS-NavigationModel*).

NOTE 3: The reference time t_0 is $epochTime + \frac{1}{2} \times ssrUpdateInterval$. The reference time t_0 for *ssrUpdateInterval* '0' is *epochTime*.

NOTE 4: In the cases that the *GNSS-SSR-OrbitCorrection* IE is contained within a *GNSS-SSR-OrbitCorrectionsSet2* IE, then the reference ephemeris is denoted by the *refEph* field within the *GNSS-SSR-OrbitCorrectionsSet2* IE, not the default as per NOTE 2. In the case *gnss-ID* indicates 'bds' and if *refEph* is set to *b1c*, the *iod* refers to the B-CNAV1 broadcast ephemeris (BDS B1C/B2a in table GNSS to iod Bit String (11) relation in IE *GNSS-NavigationModel*).

Value of *ssrUpdateInterval* to SSR Update Interval relation

Value of <i>ssrUpdateInterval</i>	SSR Update Interval
0	1 second
1	2 seconds
2	5 seconds
3	10 seconds
4	15 seconds
5	30 seconds
6	60 seconds
7	120 seconds
8	240 seconds
9	300 seconds
10	600 seconds
11	900 seconds
12	1800 seconds
13	3600 seconds
14	7200 seconds
15	10800 seconds

– *GNSS-SSR-ClockCorrections*

The IE *GNSS-SSR-ClockCorrections* is used by the location server to provide clock correction parameters together with integrity information. The target device may use the *SSR-ClockCorrectionList* to compute a clock correction to be applied to the broadcast satellite clock parameters, identified by *iod* of corresponding *GNSS-SSR-OrbitCorrections*.

The parameters provided in IE *GNSS-SSR-ClockCorrections* – except for *CLOCK-IntegrityParameters* and *SSR-IntegrityClockBounds* – are used as specified for SSR Clock Messages (e.g., message type 1058 and 1064) in [30] and apply to all GNSSs.

```
-- ASN1START

GNSS-SSR-ClockCorrections-r15 ::= SEQUENCE {
    epochTime-r15                GNSS-SystemTime,
    ssrUpdateInterval-r15        INTEGER (0..15),
    iod-ssr-r15                  INTEGER (0..15),
    ssr-ClockCorrectionList-r15  SSR-ClockCorrectionList-r15,
    ...
    [[
        clock-IntegrityParameters-r17  CLOCK-IntegrityParameters-r17      OPTIONAL  -- Need OR
    ]]
}

SSR-ClockCorrectionList-r15 ::= SEQUENCE (SIZE(1..64)) OF SSR-ClockCorrectionSatelliteElement-r15

SSR-ClockCorrectionSatelliteElement-r15 ::= SEQUENCE {
    svID-r15                      SV-ID,
    delta-Clock-C0-r15            INTEGER (-2097152..2097151),
    delta-Clock-C1-r15            INTEGER (-1048576..1048575)      OPTIONAL, -- Need ON
    delta-Clock-C2-r15            INTEGER (-67108864..67108863)   OPTIONAL, -- Need ON
    ...
    [[
        ssr-IntegrityClockBounds-r17  SSR-IntegrityClockBounds-r17      OPTIONAL  -- Need OR
    ]]
}

CLOCK-IntegrityParameters-r17 ::= SEQUENCE {
    clockRangeErrorCorrelationTime-r17  INTEGER (0..255),
    clockRangeRateErrorCorrelationTime-r17  INTEGER (0..255),
    ...
}

SSR-IntegrityClockBounds-r17 ::= SEQUENCE {
    meanClock-r17                INTEGER (0..255),
    stdDevClock-r17              INTEGER (0..255),
    meanClockRate-r17            INTEGER (0..255),
    stdDevClockRate-r17          INTEGER (0..255),
    ...
}

-- ASN1END
```

-- ASN1STOP

GNSS-SSR-ClockCorrections field descriptions	
epochTime	This field specifies the epoch time of the clock corrections. The gns-TimeID in <i>GNSS-SystemTime</i> shall be the same as the <i>GNSS-ID</i> in IE <i>GNSS-GenericAssistDataElement</i> .
ssrUpdateInterval	This field specifies the SSR Update Interval. The SSR Update Intervals for all SSR parameters start at time 00:00:00 of the GPS time scale. A change of the SSR Update Interval during the transmission of SSR data should ensure consistent data for a target device. See table Value of <i>ssrUpdateInterval</i> to SSR Update Interval relation in IE <i>GNSS-SSR-OrbitCorrections</i> .
iod-ssr	This field specifies the Issue of Data number for the SSR data. A change of iod-ssr is used to indicate a change in the SSR generating configuration.
svID	This field specifies the satellite for which the clock corrections are provided.
delta-Clock-C0	This field specifies the C ₀ polynomial coefficient for correction of broadcast satellite clock. NOTE 1. Scale factor 0.1 mm; range ±209.7151 m.
delta-Clock-C1	This field specifies the C ₁ polynomial coefficient for correction of broadcast satellite clock. NOTE 1. Scale factor 0.001 mm/s; range ±1.048575 m/s.
delta-Clock-C2	This field specifies the C ₂ polynomial coefficient for correction of broadcast satellite clock. NOTE 1. Scale factor 0.00002 mm/s ² ; range ±1.34217726 m/s ² .
clockRangeErrorCorrelationTime	This field specifies the Clock Range Error Correlation Time which is the upper bound of the correlation time of the satellite residual range error due to clock. The time is calculated using: $t = \begin{cases} 10i, & i \leq 180 \\ 1800 + 100(i - 180), & 180 < i \leq 234 \text{ [s]} \\ 7200 + 1000(i - 234), & i > 234 \end{cases}$
	Range is 1-28,200 s.
clockRangeRateErrorCorrelationTime	This field specifies the Clock Range Rate Error Correlation Time which is the upper bound of the correlation time of the satellite residual range rate error due to clock. The time is calculated using: $t = \begin{cases} 10i, & i \leq 180 \\ 1800 + 100(i - 180), & 180 < i \leq 234 \text{ [s]} \\ 7200 + 1000(i - 234), & i > 234 \end{cases}$
	Range is 1-28,200 s.
meanClock	This field specifies the Mean Clock Error bound which is the mean value for an overbounding model that bounds the residual clock error. The bound is <i>meanClock</i> + K * <i>stdDevClock</i> and shall be so that the probability of it to be exceeded shall be lower than IRallocation for <i>irMinimum</i> < IRallocation < <i>irMaximum</i> , where K = normInv(IRallocation / 2) and <i>irMinimum</i> , <i>irMaximum</i> as provided in IE <i>GNSS-Integrity-ServiceParameters</i> . This IRallocation is a fraction of the Target Integrity Risk that represents the integrity risk budget available. The mean is calculated using: $\mu = \begin{cases} 0.01i, & i \leq 200 \\ 2 + 0.1(i - 200), & 200 < i \leq 230 \text{ [m]} \\ 5 + 0.5(i - 230), & i > 230 \end{cases}$
	Range is 0-17.5 m.
stdDevClock	This field specifies the Standard Deviation Clock Error bound which is the standard deviation for an overbounding model that bounds the residual clock error. The standard deviation is calculated using: $\sigma = \begin{cases} 0.01i, & i \leq 200 \\ 2 + 0.1(i - 200), & 200 < i \leq 230 \text{ [m]} \\ 5 + 0.5(i - 230), & i > 230 \end{cases}$
	Range is 0-17.5 m.

GNSS-SSR-ClockCorrections field descriptions
<p>meanClockRate This field specifies the Mean Clock Rate Error bound which is the mean value for an overbounding model that bounds the residual clock rate error. The bound is $meanClockRate + K * stdDevClockRate$ and shall be so that the probability of it to be exceeded shall be lower than $IRallocation$ for $irMinimum < IRallocation < irMaximum$, where $K = normInv(IRallocation / 2)$ and $irMinimum$, $irMaximum$ as provided in IE <i>GNSS-Integrity-ServiceParameters</i>. This $IRallocation$ is a fraction of the Target Integrity Risk that represents the integrity risk budget available. Scale factor 0.001 m/s; range 0.000-0.255 m/s.</p>
<p>stdDevClockRate This field specifies the Standard Deviation Clock Rate Error bound which is the standard deviation for an overbounding model that bounds the residual clock rate error. Scale factor 0.001 m/s; range 0.000-0.255 m/s.</p>

NOTE 1: The reference time t_0 is $epochTime + \frac{1}{2} \times ssrUpdateInterval$. The reference time t_0 for $ssrUpdateInterval$ '0' is $epochTime$.

– GNSS-SSR-CodeBias

The IE *GNSS-SSR-CodeBias* is used by the location server to provide GNSS signal code bias together with integrity information. The target device may add the code bias to the pseudo-range measurement of the corresponding code signal to get corrected pseudo-ranges.

NOTE: Any code biases transmitted in the broadcast messages (e.g., the GPS group delay differential T_{GD} [4] (*NAV-ClockModel*)) are not applied at all by the target device.

The parameters provided in IE *GNSS-SSR-CodeBias* – except for *SSR-IntegrityCodeBiasBounds* – are used as specified for SSR Code Bias Messages (e.g., message type 1059 and 1065) in [30] and apply to all GNSSs.

```
-- ASN1START
GNSS-SSR-CodeBias-r15 ::= SEQUENCE {
    epochTime-r15                GNSS-SystemTime,
    ssrUpdateInterval-r15        INTEGER (0..15),
    iod-ssr-r15                  INTEGER (0..15),
    ssr-CodeBiasSatList-r15      SSR-CodeBiasSatList-r15,
    ...
}

SSR-CodeBiasSatList-r15 ::= SEQUENCE (SIZE(1..64)) OF SSR-CodeBiasSatElement-r15

SSR-CodeBiasSatElement-r15 ::= SEQUENCE {
    svID-r15                      SV-ID,
    ssr-CodeBiasSignalList-r15    SSR-CodeBiasSignalList-r15,
    ...
}

SSR-CodeBiasSignalList-r15 ::= SEQUENCE (SIZE(1..16)) OF SSR-CodeBiasSignalElement-r15

SSR-CodeBiasSignalElement-r15 ::= SEQUENCE {
    signal-and-tracking-mode-ID-r15  GNSS-SignalID,
    codeBias-r15                     INTEGER (-8192..8191),
    ...
    [[
        ssr-IntegrityCodeBiasBounds-r17  SSR-IntegrityCodeBiasBounds-r17    OPTIONAL    -- Need OR
    ]]
}

SSR-IntegrityCodeBiasBounds-r17 ::= SEQUENCE {
    meanCodeBias-r17                INTEGER (0..255),
    stdDevCodeBias-r17              INTEGER (0..255),
    meanCodeBiasRate-r17            INTEGER (0..255),
    stdDevCodeBiasRate-r17          INTEGER (0..255),
    ...
}
-- ASN1STOP
```

GNSS-SSR-CodeBias field descriptions	
epochTime	This field specifies the epoch time of the code bias data. The <i>gnss-TimeID</i> in <i>GNSS-SystemTime</i> shall be the same as the <i>GNSS-ID</i> in IE <i>GNSS-GenericAssistDataElement</i> .
ssrUpdateInterval	This field specifies the SSR Update Interval. The SSR Update Intervals for all SSR parameters start at time 00:00:00 of the GPS time scale. A change of the SSR Update Interval during the transmission of SSR data should ensure consistent data for a target device. See table Value of <i>ssrUpdateInterval</i> to SSR Update Interval relation in IE <i>GNSS-SSR-OrbitCorrections</i> .
iod-ssr	This field specifies the Issue of Data number for the SSR data. A change of <i>iod-ssr</i> is used to indicate a change in the SSR generating configuration.
svID	This field specifies the GNSS satellite for which the code biases are provided.
signal-and-tracking-mode-ID	This field specifies the GNSS signal for which the code biases are provided.
codeBias	This field provides the code bias for the GNSS signal indicated by <i>signal-and-tracking-mode-ID</i> . Scale factor 0.01 m; range ± 81.91 m.
meanCodeBias	This field specifies the Mean Code Bias Error bound which is the mean value for an overbounding model that bounds the residual code bias error. The bound is $meanCodeBias + K * stdDevCodeBias$ and shall be so that the probability of it to be exceeded shall be lower than $IR_{allocation}$ for $irMinimum < IR_{allocation} < irMaximum$, where $K = normInv(IR_{allocation} / 2)$ and <i>irMinimum</i> , <i>irMaximum</i> as provided in IE <i>GNSS-Integrity-ServiceParameters</i> . This $IR_{allocation}$ is a fraction of the Target Integrity Risk that represents the integrity risk budget available. Scale factor 0.005 m; range 0-1.275 m.
stdDevCodeBias	This field specifies the Standard Deviation Code Bias Error bound which is the standard deviation for an overbounding model that bounds the residual code bias error. Scale factor 0.005 m; range 0-1.275 m.
meanCodeBiasRate	This field specifies the Mean Code Bias Rate Error bound which is the mean value for an overbounding model that bounds the residual code bias rate error. The bound is $meanCodeBiasRate + K * stdDevCodeBiasRate$ and shall be so that the probability of it to be exceeded shall be lower than $IR_{allocation}$ for $irMinimum < IR_{allocation} < irMaximum$, where $K = normInv(IR_{allocation} / 2)$ and <i>irMinimum</i> , <i>irMaximum</i> as provided in IE <i>GNSS-Integrity-ServiceParameters</i> . This $IR_{allocation}$ is a fraction of the Target Integrity Risk that represents the integrity risk budget available. Scale factor 0.00005 m/s; range 0-0.01275 m/s.
stdDevCodeBiasRate	This field specifies the Standard Deviation Code Bias Rate Error bound which is the standard deviation for an overbounding model that bounds the residual code bias rate error. Scale factor 0.00005 m/s; range 0-0.01275 m/s.

– GNSS-SSR-URA

The IE *GNSS-SSR-URA* is used by the location server to provide quality information for the provided SSR assistance data.

The parameters provided in IE *GNSS-SSR-URA* are used as specified for the SSR URA Messages (e.g., message type 1061 and 1067) in [30] and apply to all GNSSs.

```
-- ASN1START
GNSS-SSR-URA-r16 ::= SEQUENCE {
    epochTime-r16                GNSS-SystemTime,
    ssrUpdateInterval-r16        INTEGER (0..15),
    iod-ssr-r16                  INTEGER (0..15),
    ssr-URA-SatList-r16         SSR-URA-SatList-r16,
    ...
}

SSR-URA-SatList-r16 ::= SEQUENCE (SIZE(1..64)) OF SSR-URA-SatElement-r16

SSR-URA-SatElement-r16 ::= SEQUENCE {
    svID-r16                     SV-ID,
    ssr-URA-r16                 BIT STRING (SIZE (6)),
    ...
}
```

```
}
-- ASN1STOP
```

GNSS-SSR-URA field descriptions	
epochTime	This field specifies the epoch time of the SSR User Range Accuracy (URA). The <i>gnss-TimeID</i> in <i>GNSS-SystemTime</i> shall be the same as the <i>GNSS-ID</i> in IE <i>GNSS-GenericAssistDataElement</i> .
ssrUpdateInterval	This field specifies the SSR Update Interval. The SSR Update Intervals for all SSR parameters start at time 00:00:00 of the GPS time scale. A change of the SSR Update Interval during the transmission of SSR data should ensure consistent data for a target device. See table Value of <i>ssrUpdateInterval</i> to SSR Update Interval relation in IE <i>GNSS-SSR-OrbitCorrections</i> .
iod-ssr	This field specifies the Issue of Data number for the SSR data. A change of <i>iod-ssr</i> is used to indicate a change in the SSR generating configuration.
svID	This field specifies the GNSS satellite for which the SSR URA is provided.
ssr-URA	This field specifies the User Range Accuracy (URA) (1-sigma) for the range correction provided in the SSR assistance data. The URA is represented by a combination of CLASS and VALUE. The 3 MSB define the CLASS with a range of 0-7 and the 3 LSB define the VALUE with a range of 0-7. The URA is computed by: <div style="text-align: center;"> $SSR\ URA\ [mm] \leq 3^{CLASS} \left(1 + \frac{VALUE}{4} \right) - 1\ [mm]$ </div> See Table 'Relationship between SSR troposphere quality and URA indicator and physical quantity' in IE <i>GNSS-SSR-GriddedCorrection</i> .

– GNSS-SSR-PhaseBias

The IE *GNSS-SSR-PhaseBias* is used by the location server to provide GNSS signal phase bias together with integrity information. The target device may add the phase bias to the phase-range measurement of the corresponding phase signal to get corrected phase-ranges.

The parameters provided in IE *GNSS-SSR-PhaseBias* – except for *SSR-IntegrityPhaseBiasBounds* – are used as specified for Compact SSR GNSS Satellite Phase Bias Messages (e.g., message type 4073,5) in [43] and apply to all GNSSs.

```
-- ASN1START

GNSS-SSR-PhaseBias-r16 ::= SEQUENCE {
    epochTime-r16                GNSS-SystemTime,
    ssrUpdateInterval-r16        INTEGER (0..15),
    iod-ssr-r16                  INTEGER (0..15),
    ssr-PhaseBiasSatList-r16     SSR-PhaseBiasSatList-r16,
    ...
}

SSR-PhaseBiasSatList-r16 ::= SEQUENCE (SIZE(1..64)) OF SSR-PhaseBiasSatElement-r16

SSR-PhaseBiasSatElement-r16 ::= SEQUENCE {
    svID-r16                      SV-ID,
    ssr-PhaseBiasSignalList-r16   SSR-PhaseBiasSignalList-r16,
    ...
}

SSR-PhaseBiasSignalList-r16 ::= SEQUENCE (SIZE(1..16)) OF SSR-PhaseBiasSignalElement-r16

SSR-PhaseBiasSignalElement-r16 ::= SEQUENCE {
    signal-and-tracking-mode-ID-r16  GNSS-SignalID,
    phaseBias-r16                    INTEGER (-16384..16383),
    phaseDiscontinuityIndicator-r16  INTEGER (0..3),
    phaseBiasIntegerIndicator-r16    INTEGER (0..3) OPTIONAL, -- Need OP
    ...
    [
        ssr-IntegrityPhaseBiasBounds-r17  SSR-IntegrityPhaseBiasBounds-r17  OPTIONAL -- Need OR
    ]
}
```



```

SSR-IntegrityPhaseBiasBounds-r17 ::= SEQUENCE {
    meanPhaseBias-r17          INTEGER (0..255),
    stdDevPhaseBias-r17       INTEGER (0..255),
    meanPhaseBiasRate-r17     INTEGER (0..255),
    stdDevPhaseBiasRate-r17   INTEGER (0..255),
    ...
}
-- ASN1STOP

```

GNSS-SSR-PhaseBias field descriptions

<p>epochTime This field specifies the epoch time of the phase bias data. The <i>gnss-TimeID</i> in <i>GNSS-SystemTime</i> shall be the same as the <i>GNSS-ID</i> in IE <i>GNSS-GenericAssistDataElement</i>.</p>
<p>ssrUpdateInterval This field specifies the SSR Update Interval. The SSR Update Intervals for all SSR parameters start at time 00:00:00 of the GPS time scale. A change of the SSR Update Interval during the transmission of SSR data should ensure consistent data for a target device. See table Value of <i>ssrUpdateInterval</i> to SSR Update Interval relation in IE <i>GNSS-SSR-OrbitCorrections</i>.</p>
<p>iod-ssr This field specifies the Issue of Data number for the SSR data. A change of <i>iod-ssr</i> is used to indicate a change in the SSR generating configuration.</p>
<p>svID This field specifies the GNSS satellite for which the phase biases are provided.</p>
<p>signal-and-tracking-mode-ID This field specifies the GNSS signal for which the phase biases are provided.</p>
<p>phaseBias This field provides the phase bias for the GNSS signal indicated by <i>signal-and-tracking-mode-ID</i>. Scale factor 0.001 m; range ± 16.383 m.</p>
<p>phaseDiscontinuityIndicator This field provides the phase discontinuity counter for the GNSS signal indicated by <i>signal-and-tracking-mode-ID</i>. This counter is increased for every discontinuity in phase (roll-over from 3 to 0).</p>
<p>phaseBiasIntegerIndicator This field informs whether the phase bias is Undifferenced Integer (Value 0), Widelane Integer (Value 1) or Non-Integer (Value 2): Value 0: The Undifferenced Integer Phase Bias supports PPP-RTK fixed, widelane or float mode. Value 1: The Widelane Integer Phase Bias indicates that after application of the Phase Bias value, this signal can be differenced with any other signal from the same satellite that also has Widelane Integer Phase Bias indicated to form a new combined carrier phase measurement of integer quality, supporting PPP-RTK widelane fixed mode. Value 2: The Non-Integer Phase Bias supports PPP-RTK float mode. Value 3: Reserved. If the <i>phaseBiasIntegerIndicator</i> field is not present then it is interpreted as having Value 0 (Undifferenced Integer).</p>
<p>meanPhaseBias This field specifies the Mean Phase Bias Error bound which is the mean value for an overbounding model that bounds the residual phase bias error. The bound is $meanPhaseBias + K * stdDevPhaseBias$ and shall be so that the probability of it to be exceeded shall be lower than $IR_{allocation}$ for $irMinimum < IR_{allocation} < irMaximum$, where $K = normlnv(IR_{allocation} / 2)$ and <i>irMinimum</i>, <i>irMaximum</i> as provided in IE <i>GNSS-Integrity-ServiceParameters</i>. This $IR_{allocation}$ is a fraction of the Target Integrity Risk that represents the integrity risk budget available. Scale factor 0.005 m; range 0-1.275 m.</p>
<p>stdDevPhaseBias This field specifies the Standard Deviation Phase Bias Error bound which is the standard deviation for an overbounding model that bounds the residual phase bias error. Scale factor 0.005 m; range 0-1.275 m.</p>
<p>meanPhaseBiasRate This field specifies the Mean Phase Bias Rate Error bound which is the mean value for an overbounding model that bounds the residual phase bias rate error. The bound is $meanPhaseBiasRate + K * stdDevPhaseBiasRate$ and shall be so that the probability of it to be exceeded shall be lower than $IR_{allocation}$ for $irMinimum < IR_{allocation} < irMaximum$, where $K = normlnv(IR_{allocation} / 2)$ and <i>irMinimum</i>, <i>irMaximum</i> as provided in IE <i>GNSS-Integrity-ServiceParameters</i>. This $IR_{allocation}$ is a fraction of the Target Integrity Risk that represents the integrity risk budget available. Scale factor 0.00005 m/s; range 0-0.01275 m/s.</p>
<p>stdDevPhaseBiasRate This field specifies the Standard Deviation Phase Bias Rate Error bound which is the standard deviation for an overbounding model that bounds the residual phase bias rate error. Scale factor 0.00005 m/s; range 0-0.01275 m/s.</p>

– GNSS-SSR-STECCorrection

The IE *GNSS-SSR-STECCorrection* is used by the location server to provide ionosphere slant delay correction together with integrity information. The ionosphere slant delay (STEC) consists of the polynomial part provided in *GNSS-SSR-STECCorrection* and the residual part provided in *GNSS-SSR-GriddedCorrection*.

The parameters provided in IE *GNSS-SSR-STECCorrection* – except for *STEC-IntegrityParameters* and *STEC-IntegrityErrorBounds* – are used as specified for Compact SSR STEC Correction Messages (e.g., message type 4073,8) in [43] and apply to all GNSSs.

```

-- ASN1START
GNSS-SSR-STECCorrection-r16 ::= SEQUENCE {
    epochTime-r16                GNSS-SystemTime,
    ssrUpdateInterval-r16        INTEGER (0..15),
    iod-ssr-r16                   INTEGER (0..15),
    correctionPointSetID-r16     INTEGER (0..16383),
    stec-SatList-r16             STEC-SatList-r16,
    ...
    [[
        stec-IntegrityParameters-r17  STEC-IntegrityParameters-r17    OPTIONAL    -- Need OR
    ]]
}

STEC-SatList-r16 ::= SEQUENCE (SIZE(1..64)) OF STEC-SatElement-r16

STEC-SatElement-r16 ::= SEQUENCE {
    svID-r16                      SV-ID,
    stecQualityIndicator-r16      BIT STRING (SIZE(6)),
    stec-C00-r16                  INTEGER (-8192..8191),
    stec-C01-r16                  INTEGER (-2048..2047)                OPTIONAL, -- Need ON
    stec-C10-r16                  INTEGER (-2048..2047)                OPTIONAL, -- Need ON
    stec-C11-r16                  INTEGER (-512..511)                  OPTIONAL, -- Need ON
    ...
    [[
        stec-IntegrityErrorBounds-r17  STEC-IntegrityErrorBounds-r17  OPTIONAL    -- Cond Integrity1
    ]]
}

STEC-IntegrityParameters-r17 ::= SEQUENCE {
    probOnsetIonoFault-r17        INTEGER (0..255),
    meanIonoFaultDuration-r17     INTEGER (1..256),
    ionoRangeErrorCorrelationTime-r17  INTEGER (1..255)                OPTIONAL, -- Need OR
    ionoRangeRateErrorCorrelationTime-r17  INTEGER (1..255)                OPTIONAL, -- Cond Integrity2
    ...
}

STEC-IntegrityErrorBounds-r17 ::= SEQUENCE {
    meanIonosphere-r17            INTEGER (0..255),
    stdDevIonosphere-r17          INTEGER (0..255),
    meanIonosphereRate-r17        INTEGER (0..255),
    stdDevIonosphereRate-r17      INTEGER (0..255),
    ...
}
-- ASN1STOP

```

Conditional presence	Explanation
<i>Integrity1</i>	The field is mandatory present if <i>STEC-IntegrityParameters</i> is present; otherwise it is not present.
<i>Integrity2</i>	The field is mandatory present if <i>ionoRangeErrorCorrelationTime</i> is present; otherwise it is not present.

GNSS-SSR-STECCorrection field descriptions	
epochTime	This field specifies the epoch time of the STEC correction data. The <i>gnss-TimeID</i> in <i>GNSS-SystemTime</i> shall be the same as the <i>GNSS-ID</i> in IE <i>GNSS-GenericAssistDataElement</i> .
ssrUpdateInterval	This field specifies the SSR Update Interval. The SSR Update Intervals for all SSR parameters start at time 00:00:00 of the GPS time scale. A change of the SSR Update Interval during the transmission of SSR data should ensure consistent data for a target device. See table Value of <i>ssrUpdateInterval</i> to SSR Update Interval relation in IE <i>GNSS-SSR-OrbitCorrections</i> .
correctionPointSetID	This field provides the ID of the <i>GNSS-SSR-CorrectionPoints</i> set. The reference point used for the STEC calculations (see NOTE below) is the reference point provided in IE <i>GNSS-SSR-CorrectionPoints</i> with the same <i>correctionPointSetID</i> .
iod-ssr	This field specifies the Issue of Data number for the SSR data. A change of <i>iod-ssr</i> is used to indicate a change in the SSR generating configuration.
svID	This field specifies the GNSS satellite for which the STEC corrections are provided.
stecQualityIndicator	This field specifies SSR STEC quality indicator. The STEC quality indicator is represented by a combination of CLASS and VALUE. The 3 MSB define the CLASS with a range of 0-7 and the 3 LSB define the VALUE with a range of 0-7. See Table 'Relationship between SSR STEC quality indicator and physical quantity' below.
stec-C00	This field provides the polynomial coefficient C_{00} used to define the STEC. as defined in [43]. NOTE Scale factor 0.05 TECU; range ± 409.55 TECU.
stec-C01	This field provides the polynomial coefficient C_{01} used to define the STEC as defined in [43]. NOTE Scale factor 0.02 TECU/deg; range ± 40.94 TECU/deg.
stec-C10	This field provides the polynomial coefficient C_{10} used to define the STEC as defined in [43]. NOTE Scale factor 0.02 TECU/deg; range ± 40.94 TECU/deg.
stec-C11	This field provides the polynomial coefficient C_{11} used to define the STEC as defined in [43]. NOTE Scale factor 0.02 TECU/deg ² ; range ± 10.22 TECU/deg ² .
probOnsetIonoFault	This field specifies the Probability of Onset of Ionosphere Fault per Time Unit which is the probability of occurrence of ionosphere error to exceed the residual error bound for more than the Time to Alert (TTA). This field specifies the onset probability that the residual range or range rate error exceeds a bound created using the minimum allowed inflation factor K_{min} , and bounding parameters as $mean + K_{min} * stdDev$ where $K_{min} = normInv(irMaximum / 2)$, with <i>irMaximum</i> as provided in IE <i>GNSS-Integrity-ServiceParameters</i> . The probability is calculated by $P=10^{-0.04n}$ [hour ⁻¹] where n is the value of <i>probOnsetIonoFault</i> and the range is $10^{-10.2}$ to 1 per hour.
meanIonoFaultDuration	This field specifies the Mean Ionosphere Fault Duration which is the mean duration between when an ionosphere integrity violation occurs, and the user is alerted through <i>GNSS-Integrity-ServiceAlert</i> (or the integrity violation is over). Scale factor 1 s; range 1-256 s.
ionoRangeErrorCorrelationTime	This field specifies the Ionosphere Range Error Correlation Time which is the upper bound of the correlation time of the ionosphere residual range error. The time is calculated using: $t = \begin{cases} 10i, & i \leq 180 \\ 1800 + 100(i - 180), & 180 < i \leq 234 \\ 7200 + 1000(i - 234), & i > 234 \end{cases} [s]$
	Range is 1-28,200 s.
ionoRangeRateErrorCorrelationTime	This field specifies the Ionosphere Range Rate Error Correlation Time which is the upper bound of the correlation time of the ionosphere residual range rate error. The time is calculated using: $t = \begin{cases} 10i, & i \leq 180 \\ 1800 + 100(i - 180), & 180 < i \leq 234 \\ 7200 + 1000(i - 234), & i > 234 \end{cases} [s]$
	Range is 1-28,200 s.

GNSS-SSR-STECCorrection field descriptions	
<p>meanlonosphere</p> <p>This field specifies the Mean Ionosphere Error bound which is the mean value for an overbounding model that bounds the residual ionosphere error.</p> <p>The bound is $meanlonosphere + K * stdDevlonosphere$ and shall be so that the probability of it to be exceeded shall be lower than $IR_{allocation}$ for $irMinimum < IR_{allocation} < irMaximum$, where $K = normInv(IR_{allocation} / 2)$ and $irMinimum$, $irMaximum$ as provided in IE <i>GNSS-Integrity-ServiceParameters</i>.</p> <p>This $IR_{allocation}$ is a fraction of the Target Integrity Risk that represents the integrity risk budget available.</p> <p>The mean is calculated using:</p> $\mu = \begin{cases} 0.01i, & i \leq 200 \\ 2 + 0.1(i - 200), & 200 < i \leq 230 \\ 5 + 0.5(i - 230), & i > 230 \end{cases} [m]$ <p>Range is 0-17.5 m.</p>	
<p>stdDevlonosphere</p> <p>This field specifies the Standard Deviation Ionosphere Error bound which is the standard deviation for an overbounding model that bounds the residual ionosphere error.</p> <p>The standard deviation is calculated using:</p> $\sigma = \begin{cases} 0.01i, & i \leq 200 \\ 2 + 0.1(i - 200), & 200 < i \leq 230 \\ 5 + 0.5(i - 230), & i > 230 \end{cases} [m]$ <p>Range is 0-17.5 m.</p>	
<p>meanlonosphereRate</p> <p>This field specifies the Mean Ionosphere Rate Error which is the mean value for an overbounding model that bounds the residual ionosphere rate error.</p> <p>The bound is $meanlonosphereRate + K * stdDevlonosphereRate$ and shall be so that the probability of it to be exceeded shall be lower than $IR_{allocation}$ for $irMinimum < IR_{allocation} < irMaximum$, where $K = normInv(IR_{allocation} / 2)$ and $irMinimum$, $irMaximum$ as provided in IE <i>GNSS-Integrity-ServiceParameters</i>.</p> <p>This $IR_{allocation}$ is a fraction of the Target Integrity Risk that represents the integrity risk budget available.</p> <p>Scale factor 0.00005 m/s; range 0-0.01275 m/s.</p>	
<p>stdDevlonosphereRate</p> <p>This field specifies the Standard Deviation Ionosphere Rate Error which is the standard deviation for an overbounding model that bounds the residual ionosphere rate error.</p> <p>Scale factor 0.00005 m/s; range 0-0.01275 m/s.</p>	

NOTE: The polynomial coefficients C_{00} , C_{01} , C_{10} , C_{11} are used to define the STEC as follows:

(1) If only C_{00} is included in *STEC-SatElement*:

$$\delta I_{ai} = C_{00}.$$

(2) If only C_{00} , C_{01} and C_{10} are included in *STEC-SatElement*:

$$\delta I_{ai} = C_{00} + C_{01}(\phi - \phi_0) + C_{10}(\lambda - \lambda_0).$$

(3) If all of C_{00} , C_{01} , C_{10} and C_{11} are included in *STEC-SatElement*:

$$\delta I_{ai} = C_{00} + C_{01}(\phi - \phi_0) + C_{10}(\lambda - \lambda_0) + C_{11}(\phi - \phi_0)(\lambda - \lambda_0).$$

Other combinations of C_{00} , C_{01} , C_{10} , C_{11} than (1)-(3) above are undefined in this version of the specification.

The equations above depend on the latitude ϕ and longitude λ of an evaluated point and latitude ϕ_0 and longitude λ_0 of the reference point which is defined in IE *GNSS-SSR-CorrectionPoints* (*referencePointLatitude* and *referencePointLongitude*).

Relationship between SSR STEC quality indicator and physical quantity

CLASS	VALUE	Index	SSR STEC Quality Indicator Q [TECU]
7	7	63	33.6664 < Q
7	6	62	30.2992 < Q ≤ 33.6664
7	5	61	26.9319 < Q ≤ 30.2992
7	4	60	23.5647 < Q ≤ 26.9319
7	3	59	20.1974 < Q ≤ 23.5647
7	2	58	16.8301 < Q ≤ 20.1974
7	1	57	13.4629 < Q ≤ 16.8301
7	0	56	12.3405 < Q ≤ 13.4629
6	7	55	11.2180 < Q ≤ 12.3405
6	6	54	10.0956 < Q ≤ 11.2180
6	5	53	8.9732 < Q ≤ 10.0956
6	4	52	7.8508 < Q ≤ 8.9732
6	3	51	6.7284 < Q ≤ 7.8508
6	2	50	5.6059 < Q ≤ 6.7284
6	1	49	4.4835 < Q ≤ 5.6059
6	0	48	4.1094 < Q ≤ 4.4835
5	7	47	3.7352 < Q ≤ 4.1094
5	6	46	3.3611 < Q ≤ 3.7352
5	5	45	2.9870 < Q ≤ 3.3611
5	4	44	2.6128 < Q ≤ 2.9870
5	3	43	2.2387 < Q ≤ 2.6128
5	2	42	1.8645 < Q ≤ 2.2387
5	1	41	1.4904 < Q ≤ 1.8645
5	0	40	1.3657 < Q ≤ 1.4904
4	7	39	1.2410 < Q ≤ 1.3657
4	6	38	1.1163 < Q ≤ 1.2410
4	5	37	0.9915 < Q ≤ 1.1163
4	4	36	0.8668 < Q ≤ 0.9915
4	3	35	0.7421 < Q ≤ 0.8668
4	2	34	0.6174 < Q ≤ 0.7421
4	1	33	0.4927 < Q ≤ 0.6174
4	0	32	0.4511 < Q ≤ 0.4927
3	7	31	0.4096 < Q ≤ 0.4511
3	6	30	0.3680 < Q ≤ 0.4096
3	5	29	0.3264 < Q ≤ 0.3680
3	4	28	0.2848 < Q ≤ 0.3264
3	3	27	0.2433 < Q ≤ 0.2848
3	2	26	0.2017 < Q ≤ 0.2433
3	1	25	0.1601 < Q ≤ 0.2017
3	0	24	0.1463 < Q ≤ 0.1601
2	7	23	0.1324 < Q ≤ 0.1463
2	6	22	0.1186 < Q ≤ 0.1324
2	5	21	0.1047 < Q ≤ 0.1186
2	4	20	0.0908 < Q ≤ 0.1047
2	3	19	0.0770 < Q ≤ 0.0908
2	2	18	0.0631 < Q ≤ 0.0770
2	1	17	0.0493 < Q ≤ 0.0631
2	0	16	0.0447 < Q ≤ 0.0493
1	7	15	0.0400 < Q ≤ 0.0447
1	6	14	0.0354 < Q ≤ 0.0400
1	5	13	0.0308 < Q ≤ 0.0354
1	4	12	0.0262 < Q ≤ 0.0308
1	3	11	0.0216 < Q ≤ 0.0262
1	2	10	0.0169 < Q ≤ 0.0216
1	1	9	0.0123 < Q ≤ 0.0169
1	0	8	0.0108 < Q ≤ 0.0123
0	7	7	0.0092 < Q ≤ 0.0108
0	6	6	0.0077 < Q ≤ 0.0092
0	5	5	0.0062 < Q ≤ 0.0077
0	4	4	0.0046 < Q ≤ 0.0062
0	3	3	0.0031 < Q ≤ 0.0046

0	2	2	$0.0015 < Q \leq 0.0031$
0	1	1	$Q \leq 0.0015$
0	0	0	undefined/unknown

– GNSS-SSR-GriddedCorrection

The IE *GNSS-SSR-GriddedCorrection* is used by the location server to provide troposphere delay correction, together with the residual part of the STEC corrections and integrity information.

The parameters provided in IE *GNSS-SSR-GriddedCorrection* – except for *SSR-GriddedCorrectionIntegrityParameters* and *TropoDelayIntegrityErrorBounds* – are used as specified for Compact SSR Gridded Correction Message (e.g., message type 4073,9) in [43] and apply to all GNSSs.

```
-- ASN1START

GNSS-SSR-GriddedCorrection-r16 ::= SEQUENCE {
    epochTime-r16                GNSS-SystemTime,
    ssrUpdateInterval-r16        INTEGER (0..15),
    iod-ssr-r16                  INTEGER (0..15),
    troposphericDelayQualityIndicator-r16  BIT STRING (SIZE(6))          OPTIONAL, -- Cond Tropo
    correctionPointSetID-r16     INTEGER (0..16383),
    gridList-r16                 GridList-r16,
    ...
    [[
        ssr-GriddedCorrectionIntegrityParameters-r17
                                     SSR-GriddedCorrectionIntegrityParameters-r17
                                     OPTIONAL -- Need OR
    ]]
}

GridList-r16 ::= SEQUENCE (SIZE(1..64)) OF GridElement-r16

GridElement-r16 ::= SEQUENCE {
    troposphericDelayCorrection-r16  TroposphericDelayCorrection-r16  OPTIONAL, -- Need ON
    stec-ResidualSatList-r16        STEC-ResidualSatList-r16        OPTIONAL, -- Need ON
    ...
}

TroposphericDelayCorrection-r16 ::= SEQUENCE {
    tropoHydroStaticVerticalDelay-r16  INTEGER (-256..255),
    tropoWetVerticalDelay-r16         INTEGER (-128..127),
    ...
    [[
        tropoDelayIntegrityErrorBounds-r17  TropoDelayIntegrityErrorBounds-r17
                                             OPTIONAL -- Cond Integrity1
    ]]
}

STEC-ResidualSatList-r16 ::= SEQUENCE (SIZE(1..64)) OF STEC-ResidualSatElement-r16

STEC-ResidualSatElement-r16 ::= SEQUENCE {
    svID-r16                SV-ID,
    stecResidualCorrection-r16  CHOICE {
        b7-r16                INTEGER (-64..63),
        b16-r16               INTEGER (-32768..32767)
    },
    ...
}

SSR-GriddedCorrectionIntegrityParameters-r17 ::= SEQUENCE {
    probOnsetTroposphereFault-r17  INTEGER (0..255),
    meanTroposphereFaultDuration-r17  INTEGER (1..256),
    troposphereRangeErrorCorrelationTime-r17  INTEGER (1..255)  OPTIONAL, -- Need OR
    troposphereRangeRateErrorCorrelationTime-r17  INTEGER (1..255)  OPTIONAL, -- Cond Integrity2
    ...
}

TropoDelayIntegrityErrorBounds-r17 ::= SEQUENCE {
    meanTroposphereVerticalHydroStaticDelay-r17  INTEGER (0..255),
    stdDevTroposphereVerticalHydroStaticDelay-r17  INTEGER (0..255),
    meanTroposphereVerticalWetDelay-r17          INTEGER (0..255),
    stdDevTroposphereVerticalWetDelay-r17        INTEGER (0..255),
    meanTroposphereVerticalHydroStaticDelayRate-r17  INTEGER (0..255),
    stdDevTroposphereVerticalHydroStaticDelayRate-r17  INTEGER (0..255),
}
-- ASN1END
```

```

    meanTroposphereVerticalWetDelayRate-r17      INTEGER (0..255),
    stdDevTroposphereVerticalWetDelayRate-r17    INTEGER (0..255),
    ...
}
-- ASN1STOP

```

Conditional presence	Explanation
<i>Tropo</i>	The field is mandatory present if <i>troposphericDelayCorrection</i> is included in <i>gridList</i> . Otherwise it is not present.
<i>Integrity1</i>	The field is mandatory present if <i>SSR-GriddedCorrectionIntegrityParameters</i> is present; otherwise it is not present.
<i>Integrity2</i>	The field is mandatory present if <i>troposphereRangeErrorCorrelationTime</i> is present; otherwise it is not present.

GNSS-SSR-GriddedCorrection field descriptions	
epochTime	This field specifies the epoch time of the gridded correction data. The <i>gnss-TimeID</i> in <i>GNSS-SystemTime</i> shall be the same as the <i>GNSS-ID</i> in IE <i>GNSS-GenericAssistDataElement</i> .
ssrUpdateInterval	This field specifies the SSR Update Interval. The SSR Update Intervals for all SSR parameters start at time 00:00:00 of the GPS time scale. A change of the SSR Update Interval during the transmission of SSR data should ensure consistent data for a target device. See table Value of <i>ssrUpdateInterval</i> to SSR Update Interval relation in IE <i>GNSS-SSR-OrbitCorrections</i> .
iod-ssr	This field specifies the Issue of Data number for the SSR data. A change of <i>iod-ssr</i> is used to indicate a change in the SSR generating configuration.
troposphericDelayQualityIndicator	This field specifies the quality indicator of the tropospheric delay. The troposphere quality indicator is represented by a combination of CLASS and VALUE. The 3 MSB define the CLASS with a range of 0-7 and the 3 LSB define the VALUE with a range of 0-7. The troposphere quality indicator is computed by: $\text{SSR Troposphere Quality [mm]} \leq 3^{\text{CLASS}} \left(1 + \frac{\text{VALUE}}{4} \right) - 1 \text{ [mm]}$ See Table 'Relationship between SSR troposphere quality and URA indicator and physical quantity' below.
correctionPointSetID	This field provides the ID of the <i>GNSS-SSR-CorrectionPoints</i> set. The <i>GNSS-SSR-GriddedCorrection</i> are valid for the correction points provided in IE <i>GNSS-SSR-CorrectionPoints</i> with the same <i>correctionPointSetID</i> .
gridList	This field provides the troposphere delay correction together with the residual part of the STEC corrections for up to 64 correction points defined in IE <i>GNSS-SSR-CorrectionPoints</i> . If the IE <i>GNSS-SSR-CorrectionPoints</i> , which belongs to the <i>correctionPointSetID</i> , includes the <i>listOfCorrectionPoints</i> , the <i>gridList</i> includes the same number of entries, and listed in the same order, as in the <i>listOfCorrectionPoints</i> . If the IE <i>GNSS-SSR-CorrectionPoints</i> , which belongs to this <i>correctionPointSetID</i> , includes the <i>arrayOfCorrectionPoints</i> the <i>gridList</i> includes the same number of entries, and listed in the same order, as defined by the enabled bits in the <i>bitmaskOfGrids</i> .
tropoHydroStaticVerticalDelay	This field specifies the variation in the hydro static troposphere vertical delay relative to nominal value. The target device should add the constant nominal value of 2.3 m to calculate the tropospheric hydro-static vertical delay. Scale factor 0.004 m; range ± 1.02 m.
tropoWetVerticalDelay	This field specifies the variation in the wet troposphere vertical delay relative to nominal value. The target device should add the constant value of 0.252 m to calculate the tropospheric wet (non hydro-static) vertical delay. Scale factor 0.004 m; range ± 0.508 m.
svID	This field specifies the GNSS satellite for which the STEC residual corrections are provided.
stecResidualCorrection	This field specifies the STEC residual correction. Scale factor 0.04 TECU; range ± 2.52 TECU (b7) or ± 1310.68 TECU (b16).
probOnsetTroposphereFault	This field specifies the Probability of Onset of Troposphere Fault per Time Unit which is the probability of occurrence of troposphere error to exceed the residual error bound for more than the Time to Alert (TTA) This field specifies the onset probability that the residual range or range rate error exceeds a bound created using the minimum allowed inflation factor K_{min} , and bounding parameters as $mean + K_{min} * stdDev$ where $K_{min} = \text{normInv}(irMaximum / 2)$ and $irMaximum$ as provided in IE <i>GNSS-Integrity-ServiceParameters</i> . The probability is calculated by $P=10^{-0.04n}$ [hour ⁻¹] where n is the value of <i>probOnsetTroposphereFault</i> and the range is $10^{-10.2}$ to 1 per hour.
meanTroposphereFaultDuration	This field specifies the Mean Troposphere Fault Duration which is the mean duration between when a troposphere integrity violation occurs, and the user is alerted through <i>GNSS-Integrity-ServiceAlert</i> (or the integrity violation is over). Scale factor 1 s; range 1-256 s.
troposphereRangeErrorCorrelationTime	This field specifies the Troposphere Range Error Correlation Time which is the upper bound of the correlation time of the troposphere residual range error. The time is calculated using: $t = \begin{cases} 10i, & i \leq 180 \\ 1800 + 100(i - 180), & 180 < i \leq 234 \\ 7200 + 1000(i - 234), & i > 234 \end{cases} \text{ [s]}$ Range is 1-28,200 s.

GNSS-SSR-GriddedCorrection field descriptions	
<p>troposphereRangeRateErrorCorrelationTime</p> <p>This field specifies the Troposphere Range Rate Error Correlation Time which is the upper bound of the correlation time of the troposphere residual range rate error. The time is calculated using:</p> $t = \begin{cases} 10i, & i \leq 180 \\ 1800 + 100(i - 180), & 180 < i \leq 234 \\ 7200 + 1000(i - 234), & i > 234 \end{cases} [s]$ <p>Range is 1-28,200 s.</p>	
<p>meanTroposphereVerticalHydroStaticDelay</p> <p>This field specifies the Mean Troposphere Vertical Hydro Static Delay Error bound which is the mean value for an overbounding model that bounds the residual troposphere error in the vertical hydro static delay component. The bound is $meanTroposphereVerticalHydroStaticDelay + K * stdDevTroposphereVerticalHydroStaticDelay$ and shall be so that the probability of it to be exceeded shall be lower than IRallocation for $irMinimum < IRallocation < irMaximum$, where $K = normlnv(IRallocation / 2)$ and $irMinimum, irMaximum$ as provided in IE GNSS-Integrity-ServiceParameters. This IRallocation is a fraction of the Target Integrity Risk that represents the integrity risk budget available. Scale factor 0.005 m; range 0-1.275 m.</p>	
<p>stdDevTroposphereVerticalHydroStaticDelay</p> <p>This field specifies the Standard Deviation Troposphere Vertical Hydro Static Delay Error bound which is the standard deviation for an overbounding model that bounds the residual troposphere error in the vertical hydro static delay component. Scale factor 0.005 m; range 0-1.275 m.</p>	
<p>meanTroposphereVerticalWetDelay</p> <p>This field specifies the Mean Troposphere Vertical Wet Static Delay Error bound which is the mean value for an overbounding model that bounds the residual troposphere error in the vertical wet delay component. The bound is $meanTroposphereVerticalWetDelay + K * stdDevTroposphereVerticalWetDelay$ and shall be so that the probability of it to be exceeded shall be lower than IRallocation for $irMinimum < IRallocation < irMaximum$, where $K = normlnv(IRallocation / 2)$ and $irMinimum, irMaximum$ as provided in IE GNSS-Integrity-ServiceParameters. This IRallocation is a fraction of the Target Integrity Risk that represents the integrity risk budget available. Scale factor 0.005 m; range 0-1.275 m.</p>	
<p>stdDevTroposphereVerticalWetDelay</p> <p>This field specifies the Standard Deviation Troposphere Vertical Wet Static Delay Error bound which is the standard deviation for an overbounding model that bounds the residual troposphere error in the vertical wet delay component. Scale factor 0.005 m; range 0-1.275 m.</p>	
<p>meanTroposphereVerticalHydroStaticDelayRate</p> <p>This field specifies the Mean Troposphere Vertical Hydro Static Delay Rate Error bound which is the mean value for an overbounding model that bounds the residual troposphere rate error in the vertical hydro static delay component. The bound is $meanTroposphereVerticalHydroStaticDelayRate + K * stdDevTroposphereVerticalHydroStaticDelayRate$ and shall be so that the probability of it to be exceeded shall be lower than IRallocation for $irMinimum < IRallocation < irMaximum$, where $K = normlnv(IRallocation / 2)$ and $irMinimum, irMaximum$ as provided in IE GNSS-Integrity-ServiceParameters. This IRallocation is a fraction of the Target Integrity Risk that represents the integrity risk budget available. Scale factor 0.00005 m/s; range 0-0.01275 m/s.</p>	
<p>stdDevTroposphereVerticalHydroStaticDelayRate</p> <p>This field specifies the Standard Deviation Troposphere Vertical Hydro Static Delay Rate Error bound which is the standard deviation for an overbounding model that bounds the residual troposphere rate error in the vertical hydro static delay component. Scale factor 0.00005 m/s; range 0-0.01275 m/s.</p>	
<p>meanTroposphereVerticalWetDelayRate</p> <p>This field specifies the Mean Troposphere Vertical Wet Static Delay Rate Error bound which is the mean value for an overbounding model that bounds the residual troposphere rate error in the vertical wet delay component. The bound is $meanTroposphereVerticalWetDelayRate + K * stdDevTroposphereVerticalWetDelayRate$ and shall be so that the probability of it to be exceeded shall be lower than IRallocation for $irMinimum < IRallocation < irMaximum$, where $K = normlnv(IRallocation / 2)$ and $irMinimum, irMaximum$ as provided in IE GNSS-Integrity-ServiceParameters. This IRallocation is a fraction of the Target Integrity Risk that represents the integrity risk budget available. Scale factor 0.00005 m/s; range 0-0.01275 m/s.</p>	
<p>stdDevTroposphereVerticalWetDelayRate</p> <p>This field specifies the Standard Deviation Troposphere Vertical Wet Static Delay Rate Error bound which is the standard deviation for an overbounding model that bounds the residual troposphere rate error in the vertical wet delay component. Scale factor 0.00005 m/s; range 0-0.01275 m/s.</p>	

Relationship between SSR troposphere quality and URA indicator and physical quantity

CLASS	VALUE	Index	SSR troposphere quality indicator and
-------	-------	-------	---------------------------------------

			SSR URA Q [mm]
7	7	63	5466.50 < Q
7	6	62	4919.75 < Q ≤ 5466.50
7	5	61	4373.75 < Q ≤ 4919.75
7	4	60	3826.25 < Q ≤ 4373.00
7	3	59	3279.50 < Q ≤ 3826.25
7	2	58	2732.75 < Q ≤ 3279.50
7	1	57	2186.00 < Q ≤ 2732.75
7	0	56	2003.75 < Q ≤ 2186.00
6	7	55	1821.50 < Q ≤ 2003.75
6	6	54	1639.25 < Q ≤ 1821.50
6	5	53	1457.00 < Q ≤ 1639.25
6	4	52	1274.75 < Q ≤ 1457.00
6	3	51	1092.50 < Q ≤ 1274.75
6	2	50	910.25 < Q ≤ 1092.50
6	1	49	728.00 < Q ≤ 910.25
6	0	48	667.25 < Q ≤ 728.00
5	7	47	606.50 < Q ≤ 667.25
5	6	46	545.75 < Q ≤ 606.50
5	5	45	485.00 < Q ≤ 545.75
5	4	44	424.25 < Q ≤ 485.00
5	3	43	363.50 < Q ≤ 425.25
5	2	42	302.75 < Q ≤ 363.50
5	1	41	242.00 < Q ≤ 302.75
5	0	40	221.75 < Q ≤ 242.00
4	7	39	201.50 < Q ≤ 221.75
4	6	38	181.25 < Q ≤ 201.50
4	5	37	161.00 < Q ≤ 181.25
4	4	36	140.75 < Q ≤ 161.00
4	3	35	120.50 < Q ≤ 140.75
4	2	34	100.25 < Q ≤ 120.50
4	1	33	80.00 < Q ≤ 100.25
4	0	32	73.25 < Q ≤ 80.00
3	7	31	66.50 < Q ≤ 73.25
3	6	30	59.75 < Q ≤ 66.50
3	5	29	53.00 < Q ≤ 59.75
3	4	28	46.25 < Q ≤ 53.00
3	3	27	39.50 < Q ≤ 46.25
3	2	26	32.75 < Q ≤ 39.50
3	1	25	26.00 < Q ≤ 32.75
3	0	24	23.75 < Q ≤ 26.00
2	7	23	21.50 < Q ≤ 23.75
2	6	22	19.25 < Q ≤ 21.50
2	5	21	17.00 < Q ≤ 19.25
2	4	20	14.75 < Q ≤ 17.00
2	3	19	12.50 < Q ≤ 14.75
2	2	18	10.25 < Q ≤ 12.50
2	1	17	8.00 < Q ≤ 10.25
2	0	16	7.25 < Q ≤ 8.00
1	7	15	6.50 < Q ≤ 7.25
1	6	14	5.75 < Q ≤ 6.50
1	5	13	5.00 < Q ≤ 5.75
1	4	12	4.25 < Q ≤ 5.00
1	3	11	3.50 < Q ≤ 4.25
1	2	10	2.75 < Q ≤ 3.50
1	1	9	2.00 < Q ≤ 2.75
1	0	8	1.75 < Q ≤ 2.00
0	7	7	1.50 < Q ≤ 1.75
0	6	6	1.25 < Q ≤ 1.50
0	5	5	1.00 < Q ≤ 1.25
0	4	4	0.75 < Q ≤ 1.00
0	3	3	0.50 < Q ≤ 0.75
0	2	2	0.25 < Q ≤ 0.50
0	1	1	Q ≤ 0.25

0	0	0	undefined/unknown
---	---	---	-------------------

– *NavIC-DifferentialCorrections*

The IE *NavIC-DifferentialCorrections* parameters provide users with sets of correction terms that apply to the clock and ephemeris data transmitted by other satellites in the AutoNav mode as defined in [38] under clause 6.2.6.

```
-- ASN1START

NavIC-DifferentialCorrections-r16 ::= SEQUENCE {
    navic-RefTOWC-r16          INTEGER (0..50400),
    navic-CorrectionListAutoNav-r16 NavIC-CorrectionListAutoNav-r16,
    ...
}

NavIC-CorrectionListAutoNav-r16 ::= SEQUENCE (SIZE (1..64)) OF NavIC-CorrectionElementAutoNav-r16

NavIC-CorrectionElementAutoNav-r16 ::= SEQUENCE {
    svID                      SV-ID,
    navic-Tod-r16             INTEGER (0..65535),
    navic-iodec-r16           INTEGER (0..255),
    navic-UDRAI-r16           INTEGER (-16..15),
    navic-UDRArateI-r16       INTEGER (-16..15),
    navic-EDC-r16             NavIC-EDC-r16,
    navic-CDC-r16             NavIC-CDC-r16,
    ...
}

NavIC-EDC-r16 ::= SEQUENCE {
    navic-AlphaEDC-r16        INTEGER (-8192..8191),
    navic-BetaEDC-r16         INTEGER (-8192..8191),
    navic-GammaEDC-r16        INTEGER (-16384..16383),
    navic-AoIcorrection-r16   INTEGER (-2048..2047),
    navic-AoRAcorrection-r16  INTEGER (-2048..2047),
    navic-SemiMajorcorrection-r16  INTEGER (-2048..2047),
    ...
}

NavIC-CDC-r16 ::= SEQUENCE {
    navic-ClockBiasCorrection-r16  INTEGER (-4096..4095),
    navic-ClockDriftCorrection-r16  INTEGER (-128..127),
    ...
}

-- ASN1STOP
```

NavIC-DifferentialCorrections field descriptions
<p>navic-RefTOWC The transmission timing of the navigation message provided through the Time of Week Count (TOWC) corresponding to the given set of grid ionospheric parameters. It indicates the number of 12 second counts represented in 17 bits. The TOW count value ranges from 1 to 50400 to cover one entire week. The Time of Week (TOW) in seconds is obtained by multiplying TOWC with 12 as defined in [38], clause 5.7.</p>
<p>navic-Tod This field indicates the NavIC Time of Differential Correction in seconds. Scale factor 16 seconds</p>
<p>navic-iodec This field indicates Issue of Data Ephemeris and Clock which provides the user with a convenient means of detecting any change in the ephemeris and clock parameters as described under clause 6.2.1.3 in [38]</p>
<p>navic-UDRAI This field indicates the index for the User Differential Range Accuracy (in metres) value which enables users to estimate the accuracy obtained after differential corrections are applied as described under clause 6.2.6 in [38]</p>
<p>navic-UDRARatel This field indicates the index for the change rate of User Differential Range Accuracy (metres/second) value which enables users to estimate the accuracy obtained after differential corrections are applied as described under clause 6.2.6 in [38]</p>
<p>navic-AlphaEDC This field indicates the Alpha correction to Ephemeris parameter ($\Delta\alpha$), which is one of the six keplerian elements defining the ephemeris differential corrections (EDC) for NavIC as defined under clause 6.1.3.5 in [38]. Scale factor 2^{-34}</p>
<p>navic-BetaEDC This field indicates Beta correction to Ephemeris parameter ($\Delta\beta$), which is one of the six keplerian elements defining the ephemeris differential corrections (EDC) for NavIC as defined under clause 6.1.3.5 in [38]. Scale factor 2^{-34}</p>
<p>navic-GammaEDC This field indicates the Gamma correction to Ephemeris parameter ($\Delta\gamma$), which is one of the six keplerian elements defining the ephemeris differential corrections (EDC) for NavIC as defined under clause 6.1.3.5 in [38]. Scale factor 2^{-32} semi-circles.</p>
<p>navic-Aolcorrection This field indicates the Angle of inclination correction (Δi), which is one of the six keplerian elements defining the ephemeris differential corrections (EDC) for NavIC as defined under clause 6.1.3.5 in [38]. Scale factor 2^{-32} semi-circles.</p>
<p>navic-AoRAcorrection This field indicates the Angle of right ascension correction ($\Delta\Omega$), which is one of the six keplerian elements defining the ephemeris differential corrections (EDC) for NavIC as defined under clause 6.1.3.5 in [38]. Scale factor 2^{-32} semi-circles.</p>
<p>navic-SemiMajorcorrection This field indicates the Semi-major correction (ΔA), which is one of the six keplerian elements defining the ephemeris differential corrections (EDC) for NavIC as defined under clause 6.1.3.5 in [38]. Scale factor 2^{-9} metres.</p>
<p>navic-ClockBiasCorrection This field indicates correction to the satellite clock bias coefficient (δaf_0), which is one of the two Satellite clock differential corrections (CDC) containing corrections to the NavIC satellite clock polynomial coefficients as defined under clause 6.1.3.5 in [38]. Scale factor 2^{-35} seconds.</p>
<p>navic-ClockDriftCorrection This field indicates correction to the satellite clock drift coefficient (δaf_1), which is one of the two Satellite clock differential corrections (CDC) containing corrections to the NavIC satellite clock polynomial coefficients as defined under clause 6.1.3.5 in [38]. Scale factor 2^{-51} sec / sec.</p>

NavIC-GridModelParameter

```

-- ASN1START
NavIC-GridModelParameter-r16 ::= SEQUENCE {
    navic-RefTOWC-r16    INTEGER (0..50400),
    regionMasked-r16    INTEGER (0..1023),
    regionIgpList-r16   RegionIgpList-r16,
    ...
}
RegionIgpList-r16 ::= SEQUENCE (SIZE (1..16)) OF RegionIgpElement-r16
RegionIgpElement-r16 ::= SEQUENCE {

```

```

regionID-r16    INTEGER (0..15),
givei1-r16     INTEGER (0..15),
givd1-r16      INTEGER (0..511),
givei2-r16     INTEGER (0..15),
givd2-r16      INTEGER (0..511),
givei3-r16     INTEGER (0..15),
givd3-r16      INTEGER (0..511),
givei4-r16     INTEGER (0..15),
givd4-r16      INTEGER (0..511),
givei5-r16     INTEGER (0..15),
givd5-r16      INTEGER (0..511),
givei6-r16     INTEGER (0..15),
givd6-r16      INTEGER (0..511),
givei7-r16     INTEGER (0..15),
givd7-r16      INTEGER (0..511),
givei8-r16     INTEGER (0..15),
givd8-r16      INTEGER (0..511),
givei9-r16     INTEGER (0..15),
givd9-r16      INTEGER (0..511),
givei10-r16    INTEGER (0..15),
givd10-r16     INTEGER (0..511),
givei11-r16    INTEGER (0..15),
givd11-r16     INTEGER (0..511),
givei12-r16    INTEGER (0..15),
givd12-r16     INTEGER (0..511),
givei13-r16    INTEGER (0..15),
givd13-r16     INTEGER (0..511),
givei14-r16    INTEGER (0..15),
givd14-r16     INTEGER (0..511),
givei15-r16    INTEGER (0..15),
givd15-r16     INTEGER (0..511),
...
}
-- ASN1STOP

```

NavIC-GridModelParameter field descriptions

navic-RefTOWC

The transmission timing of the navigation message provided through the Time of Week Count (TOWC) corresponding to the given set of grid ionospheric parameters. It indicates the number of 12 second counts represented in 17 bits. The TOW count value ranges from 1 to 50400 to cover one entire week. The Time of Week (TOW) in seconds is obtained by multiplying TOWC with 12 as defined in [38], clause 5.7.

regionMasked

Total 90 Ionospheric Grid Points (IGP) are defined in [38] clause 6.2.3 table 25. 15 IGP points are grouped into a single region. The region masked indicates the total number of regions for which the corrections are provided. For the current service area of the IRNSS, regions masked are 6.

regionIgpList

This list provides the set of IGPs corresponding to each region. Up to 6 instances (0 to 5) are used in this version of the specification. The values 6 to 15 are reserved for future use.

regionID

regionID along with index of the IGPS point corresponding gives the location of IGPS point as defined in [38], table 25, clause 6.2.3.

givei1, givei2, .. , givei15

This field indicates the Grid Ionospheric Vertical Error Index (GIVEI) which is used to describe the delay correction accuracy at ionospheric grid point indicated by the *igp-ID*, the mapping between GIVEI and GIVE is defined in [38], clause 6.2.2 and table 27.

givd1, givd2, ... , givd15

This field indicates the Grid Ionospheric Vertical Delay (GIVD) as defined in [38], clause 5.3.3.8.1, i.e. the vertical delay at the corresponding Ionospheric Grid points (IGPs) indicated by *igp-ID*. The scale factor is 0.125 metre.

— GNSS-SSR-OrbitCorrectionsSet2

The IE *GNSS-SSR-OrbitCorrectionsSet2* is used by the location server to provide SSR orbit correction parameters in the cases where a reference ephemeris is used other than the default ephemeris type used in *GNSS-SSR-OrbitCorrections*.

```

-- ASN1START
GNSS-SSR-OrbitCorrectionsSet2-r17 ::= SEQUENCE {
    refEph-r17          ENUMERATED { b1c,...},
    gnss-SSR-OrbitCorrections-r17  GNSS-SSR-OrbitCorrections-r15,

```

```

}
...
-- ASN1STOP

```

GNSS-SSR-OrbitCorrectionsSet2 field descriptions

refEph

This field specifies the reference ephemeris that the SSR orbit corrections refer to. In the case that *gnss-ID* indicates 'bds' and *refEph* indicates b1c, the SSR orbit corrections are referenced to BDS B1C/B2a in table GNSS to iod Bit String (11) relation in IE *GNSS-NavigationModel* (i.e. the B-CNAV1 broadcast ephemeris [52]).

gnss-SSR-OrbitCorrections

This field specifies the orbit correction parameters which refer to the reference ephemeris indicated by *refEph*.

– GNSS-SSR-ClockCorrectionsSet2

The IE *GNSS-SSR-ClockCorrectionsSet2* is used by the location server to provide SSR clock correction parameters in the cases where a reference ephemeris is used other than the default ephemeris type used in *GNSS-SSR-ClockCorrections*.

```

-- ASN1START
GNSS-SSR-ClockCorrectionsSet2-r17 ::= SEQUENCE {
    refEph-r17          ENUMERATED { b1c,...},
    gnss-SSR-ClockCorrections-r17  GNSS-SSR-ClockCorrections-r15,
    ...
}
-- ASN1STOP

```

GNSS-SSR-ClockCorrectionsSet2 field descriptions

refEph

This field specifies the reference ephemeris that the SSR clock corrections refer to. In the case that *gnss-ID* indicates 'bds' and *refEph* indicates b1c, the SSR clock corrections are referenced to BDS B1C/B2a in table GNSS to iod Bit String (11) relation in IE *GNSS-NavigationModel* (i.e. the B-CNAV1 broadcast ephemeris [52]).

gnss-SSR-ClockCorrections

This field specifies the clock correction parameters which refer to the reference ephemeris indicated by *refEph*.

– GNSS-SSR-URA-Set2

The IE *GNSS-SSR-URA-Set2* is used by the location server to provide quality information for the provided SSR assistance data in the cases where a reference ephemeris is used other than the default ephemeris type used in *GNSS-SSR-URA*.

```

-- ASN1START
GNSS-SSR-URA-Set2-r17 ::= SEQUENCE {
    refEph-r17          ENUMERATED { b1c,...},
    gnss-SSR-URA-r17  GNSS-SSR-URA-r16,
    ...
}
-- ASN1STOP

```

GNSS-SSR-URA-Set2 field descriptions

refEph

This field specifies the reference ephemeris that quality information for the provided SSR assistance data refers to. In the case that *gnss-ID* indicates 'bds' and *refEph* indicates b1c, the SSR User Range Accuracy corrections are referenced to BDS B1C/B2a in table GNSS to iod Bit String (11) relation in IE *GNSS-NavigationModel* (i.e. the B-CNAV1 broadcast ephemeris [52]).

gnss-SSR-URA

This field specifies the quality information which refers to the reference ephemeris indicated by *refEph*.

6.5.2.3 GNSS Assistance Data Request

– *A-GNSS-RequestAssistanceData*

The IE *A-GNSS-RequestAssistanceData* is used by the target device to request GNSS assistance data from a location server.

```
-- ASN1START
A-GNSS-RequestAssistanceData ::= SEQUENCE {
  gnss-CommonAssistDataReq      GNSS-CommonAssistDataReq      OPTIONAL, -- Cond CommonADReq
  gnss-GenericAssistDataReq     GNSS-GenericAssistDataReq  OPTIONAL, -- Cond GenADReq
  ...,
  [
    gnss-PeriodicAssistDataReq-r15
                                GNSS-PeriodicAssistDataReq-r15 OPTIONAL -- Cond PerADReq
  ]
}
-- ASN1STOP
```

Conditional presence	Explanation
<i>CommonADReq</i>	The field is mandatory present if the target device requests <i>GNSS-CommonAssistData</i> ; otherwise it is not present.
<i>GenADReq</i>	This field is mandatory present if the target device requests <i>GNSS-GenericAssistData</i> for one or more specific GNSS; otherwise it is not present.
<i>PerADReq</i>	This field is mandatory present if the target device requests periodic GNSS assistance data delivery. This field may only be included if any of the fields are included in IE <i>GNSS-GenericAssistDataReq</i> : <ul style="list-style-type: none"> - <i>GNSS-RTK-ObservationsReq</i>, - <i>GLO-RTK-BiasInformationReq</i>, - <i>GNSS-RTK-MAC-CorrectionDifferencesReq</i>, - <i>GNSS-RTK-ResidualsReq</i>, - <i>GNSS-RTK-FKP-GradientsReq</i>, - <i>GNSS-SSR-OrbitCorrectionsReq</i>, - <i>GNSS-SSR-ClockCorrectionsReq</i>, - <i>GNSS-SSR-CodeBiasReq</i>. - <i>GNSS-SSR-URA-Req</i>, - <i>GNSS-SSR-PhaseBiasReq</i>, - <i>GNSS-SSR-STECCorrectionReq</i>, - <i>GNSS-SSR-GriddedCorrectionReq</i>, - <i>GNSS-Integrity-ServiceAlerReq</i>, - <i>GNSS-SSR-OrbitCorrectionsSet2Req</i>, - <i>GNSS-SSR-ClockCorrectionsSet2Req</i>, or - <i>GNSS-SSR-URA-Set2Req</i>.

– *GNSS-CommonAssistDataReq*

The IE *GNSS-CommonAssistDataReq* is used by the target device to request assistance data that are applicable to any GNSS from a location server.

```
-- ASN1START
GNSS-CommonAssistDataReq ::= SEQUENCE {
  gnss-ReferenceTimeReq      GNSS-ReferenceTimeReq      OPTIONAL, -- Cond RefTimeReq
  gnss-ReferenceLocationReq  GNSS-ReferenceLocationReq  OPTIONAL, -- Cond RefLocReq
  gnss-IonosphericModelReq   GNSS-IonosphericModelReq   OPTIONAL, -- Cond IonoModReq
  gnss-EarthOrientationParametersReq GNSS-EarthOrientationParametersReq OPTIONAL, -- Cond EOPReq
  ...,
  [
    gnss-RTK-ReferenceStationInfoReq-r15
                                GNSS-RTK-ReferenceStationInfoReq-r15
                                OPTIONAL, -- Cond ARPreq
    gnss-RTK-AuxiliaryStationDataReq-r15
  ]
}
```

```

                                GNSS-RTK-AuxiliaryStationDataReq-r15
                                OPTIONAL -- Cond AuxARPreq
    ]],
    [[
        gnss-SSR-CorrectionPointsReq-r16
                                GNSS-SSR-CorrectionPointsReq-r16
                                OPTIONAL -- Cond PointsReq
    ]],
    [[
        gnss-Integrity-ServiceParametersReq-r17
                                GNSS-Integrity-ServiceParametersReq-r17
                                OPTIONAL, -- Cond IntServiceReq
        gnss-Integrity-ServiceAlertReq-r17
                                GNSS-Integrity-ServiceAlertReq-r17
                                OPTIONAL -- Cond IntAlertReq
    ]]
}
-- ASN1STOP

```

Conditional presence	Explanation
<i>RefTimeReq</i>	The field is mandatory present if the target device requests <i>GNSS-ReferenceTime</i> ; otherwise it is not present.
<i>RefLocReq</i>	This field is mandatory present if the target device requests <i>GNSS-ReferenceLocation</i> ; otherwise it is not present.
<i>IonoModReq</i>	This field is mandatory present if the target device requests <i>GNSS-IonosphericModel</i> ; otherwise it is not present.
<i>EOPReq</i>	This field is mandatory present if the target device requests <i>GNSS-EarthOrientationParameters</i> ; otherwise it is not present.
<i>ARPreq</i>	This field is mandatory present if the target device requests <i>GNSS-RTK-ReferenceStationInfo</i> ; otherwise it is not present.
<i>AuxARPreq</i>	This field is mandatory present if the target device requests <i>GNSS-RTK-AuxiliaryStationData</i> ; otherwise it is not present.
<i>PointsReq</i>	This field is mandatory present if the target device requests <i>GNSS-SSR-CorrectionPoints</i> ; otherwise it is not present.
<i>IntServiceReq</i>	This field is mandatory present if the target device requests <i>GNSS-Integrity-ServiceParameters</i> ; otherwise it is not present.
<i>IntAlertReq</i>	This field is mandatory present if the target device requests <i>GNSS-Integrity-ServiceAlert</i> ; otherwise it is not present.

GNSS-GenericAssistDataReq

The IE *GNSS-GenericAssistDataReq* is used by the target device to request assistance data from a location server for one or more specific GNSSs. The specific GNSS for which the assistance data are requested is indicated by the IE *GNSS-ID* and (if applicable) by the IE *SBAS-ID*. Assistance for up to 16 GNSSs can be requested.

```

-- ASN1START
GNSS-GenericAssistDataReq ::= SEQUENCE (SIZE (1..16)) OF GNSS-GenericAssistDataReqElement
GNSS-GenericAssistDataReqElement ::= SEQUENCE {
    gnss-ID                GNSS-ID,
    sbas-ID                SBAS-ID                                OPTIONAL, -- Cond GNSS-ID-SBAS
    gnss-TimeModelsReq    GNSS-TimeModelListReq                OPTIONAL, -- Cond TimeModReq
    gnss-DifferentialCorrectionsReq GNSS-DifferentialCorrectionsReq    OPTIONAL, -- Cond DGNSS-Req
    gnss-NavModelReq      GNSS-NavModelReq                    OPTIONAL, -- Cond NavModReq
    gnss-RealTimeIntegrityReq GNSS-RealTimeIntegrityReq    OPTIONAL, -- Cond RTIReq
    gnss-DataBitAssistanceReq GNSS-DataBitAssistanceReq    OPTIONAL, -- Cond DataBitsReq
    gnss-AcquisitionAssistanceReq GNSS-AcquisitionAssistanceReq    OPTIONAL, -- Cond AcquAssistReq
    gnss-AlmanacReq      GNSS-AlmanacReq                      OPTIONAL, -- Cond AlmanacReq
    gnss-UTCModelReq     GNSS-UTC-ModelReq                    OPTIONAL, -- Cond UTCModReq
    gnss-AuxiliaryInformationReq GNSS-AuxiliaryInformationReq    OPTIONAL, -- Cond AuxInfoReq
    ...
    [[
        bds-DifferentialCorrectionsReq-r12
                                BDS-DifferentialCorrectionsReq-r12
                                OPTIONAL, -- Cond DBDS-Req
        bds-GridModelReq-r12    BDS-GridModelReq-r12            OPTIONAL, -- Cond BDS-GridModReq
    ]],
    [[
        gnss-RTK-ObservationsReq-r15

```



```

        GNSS-RTK-ObservationsReq-r15    OPTIONAL,  -- Cond RTK-OSR-Req
glo-RTK-BiasInformationReq-r15
        GLO-RTK-BiasInformationReq-r15  OPTIONAL,  -- Cond GLO-CPB-Req
gnss-RTK-MAC-CorrectionDifferencesReq-r15
        GNSS-RTK-MAC-CorrectionDifferencesReq-r15
                                           OPTIONAL,  -- Cond MAC-Req
gnss-RTK-ResidualsReq-r15    GNSS-RTK-ResidualsReq-r15    OPTIONAL,  -- Cond Res-Req
gnss-RTK-FKP-GradientsReq-r15
        GNSS-RTK-FKP-GradientsReq-r15  OPTIONAL,  -- Cond FKP-Req
gnss-SSR-OrbitCorrectionsReq-r15
        GNSS-SSR-OrbitCorrectionsReq-r15
                                           OPTIONAL,  -- Cond OC-Req
gnss-SSR-ClockCorrectionsReq-r15
        GNSS-SSR-ClockCorrectionsReq-r15
                                           OPTIONAL,  -- Cond CC-Req
gnss-SSR-CodeBiasReq-r15    GNSS-SSR-CodeBiasReq-r15    OPTIONAL,  -- Cond CB-Req
]],
[[
gnss-SSR-URA-Req-r16       GNSS-SSR-URA-Req-r16       OPTIONAL,  -- Cond URA-Req
gnss-SSR-PhaseBiasReq-r16  GNSS-SSR-PhaseBiasReq-r16  OPTIONAL,  -- Cond PB-Req
gnss-SSR-STECCorrectionReq-r16
        GNSS-SSR-STECCorrectionReq-r16 OPTIONAL,  -- Cond STEC-Req
gnss-SSR-GriddedCorrectionReq-r16  GNSS-SSR-GriddedCorrectionReq-r16
                                           OPTIONAL,  -- Cond Grid-Req
navic-DifferentialCorrectionsReq-r16
        NavIC-DifferentialCorrectionsReq-r16
                                           OPTIONAL,  -- Cond DNavIC-Req
navic-GridModelReq-r16     NavIC-GridModelReq-r16     OPTIONAL,  -- Cond NavIC-GridModReq
]],
[[
gnss-SSR-OrbitCorrectionsSet2Req-r17
        GNSS-SSR-OrbitCorrectionsSet2Req-r17
                                           OPTIONAL,  -- Cond OC2-Req
gnss-SSR-ClockCorrectionsSet2Req-r17
        GNSS-SSR-ClockCorrectionsSet2Req-r17
                                           OPTIONAL,  -- Cond CC2-Req
gnss-SSR-URA-Set2Req-r17  GNSS-SSR-URA-Set2Req-r17  OPTIONAL,  -- Cond URA2-Req
]]
}
-- ASN1STOP

```

Conditional presence	Explanation
<i>GNSS-ID-SBAS</i>	The field is mandatory present if the <i>GNSS-ID</i> = <i>sbas</i> ; otherwise it is not present.
<i>TimeModReq</i>	The field is mandatory present if the target device requests <i>GNSS-TimeModelList</i> ; otherwise it is not present.
<i>DGNSS-Req</i>	The field is mandatory present if the target device requests <i>GNSS-DifferentialCorrections</i> ; otherwise it is not present.
<i>NavModReq</i>	The field is mandatory present if the target device requests <i>GNSS-NavigationModel</i> ; otherwise it is not present.
<i>RTIReq</i>	The field is mandatory present if the target device requests <i>GNSS-RealTimeIntegrity</i> ; otherwise it is not present.
<i>DataBitsReq</i>	The field is mandatory present if the target device requests <i>GNSS-DataBitAssistance</i> ; otherwise it is not present.
<i>AcquAssistReq</i>	The field is mandatory present if the target device requests <i>GNSS-AcquisitionAssistance</i> ; otherwise it is not present.
<i>AlmanacReq</i>	The field is mandatory present if the target device requests <i>GNSS-Almanac</i> ; otherwise it is not present.
<i>UTCModReq</i>	The field is mandatory present if the target device requests <i>GNSS-UTCModel</i> ; otherwise it is not present.
<i>AuxInfoReq</i>	The field is mandatory present if the target device requests <i>GNSS-AuxiliaryInformation</i> ; otherwise it is not present.
<i>DBDS-Req</i>	The field is mandatory present if the target device requests <i>BDS-DifferentialCorrections</i> ; otherwise it is not present. This field may only be present if <i>gnss-ID</i> indicates 'bds'.
<i>BDS-GridModReq</i>	The field is mandatory present if the target device requests <i>BDS-GridModel</i> ; otherwise it is not present. This field may only be present if <i>gnss-ID</i> indicates 'bds'.
<i>RTK-OSR-Req</i>	The field is mandatory present if the target device requests <i>GNSS-RTK-Observations</i> ; otherwise it is not present.
<i>GLO-CPB-Req</i>	The field is mandatory present if the target device requests <i>GLO-RTK-BiasInformation</i> ; otherwise it is not present.
<i>MAC-Req</i>	The field is mandatory present if the target device requests <i>GNSS-RTK-MAC-CorrectionDifferences</i> ; otherwise it is not present.

Conditional presence	Explanation
<i>Res-Req</i>	The field is mandatory present if the target device requests <i>GNSS-RTK-Residuals</i> ; otherwise it is not present.
<i>FKP-Req</i>	The field is mandatory present if the target device requests <i>GNSS-RTK-FKP-Gradients</i> ; otherwise it is not present.
<i>OC-Req</i>	The field is mandatory present if the target device requests <i>GNSS-SSR-OrbitCorrections</i> ; otherwise it is not present.
<i>CC-Req</i>	The field is mandatory present if the target device requests <i>GNSS-SSR-ClockCorrections</i> ; otherwise it is not present.
<i>CB-Req</i>	The field is mandatory present if the target device requests <i>GNSS-SSR-CodeBias</i> ; otherwise it is not present.
<i>URA-Req</i>	The field is mandatory present if the target device requests <i>GNSS-SSR-URA</i> ; otherwise it is not present.
<i>PB-Req</i>	The field is mandatory present if the target device requests <i>GNSS-SSR-PhaseBias</i> ; otherwise it is not present.
<i>STEC-Req</i>	The field is mandatory present if the target device requests <i>GNSS-SSR-STEC-Correction</i> ; otherwise it is not present.
<i>Grid-Req</i>	The field is mandatory present if the target device requests <i>GNSS-SSR-GriddedCorrection</i> ; otherwise it is not present.
<i>DNavIC-Req</i>	The field is mandatory present if the target device requests <i>NavIC-DifferentialCorrections</i> ; otherwise it is not present. This field may only be present if the <i>gnss-ID</i> indicates 'navic'.
<i>NavIC-GridModReq</i>	The field is mandatory present if the target device requests <i>NavIC-GridModel</i> ; otherwise it is not present. This field may only be present if the <i>gnss-ID</i> indicates 'navic'.
<i>OC2-Req</i>	The field is mandatory present if the target device requests <i>GNSS-SSR-OrbitCorrectionsSet2</i> ; otherwise it is not present.
<i>CC2-Req</i>	The field is mandatory present if the target device requests <i>GNSS-SSR-ClockCorrectionsSet2</i> ; otherwise it is not present.
<i>URA2-Req</i>	The field is mandatory present if the target device requests <i>GNSS-SSR-URA-Set2</i> ; otherwise it is not present.

– *GNSS-PeriodicAssistDataReq*

The IE *GNSS-PeriodicAssistDataReq* is used by the target device to request periodic assistance data delivery from a location server.

```
-- ASN1START
GNSS-PeriodicAssistDataReq-r15 ::= SEQUENCE {
  gnss-RTK-PeriodicObservationsReq-r15  GNSS-PeriodicControlParam-r15  OPTIONAL, -- Cond pOSR
  glo-RTK-PeriodicBiasInformationReq-r15 GNSS-PeriodicControlParam-r15  OPTIONAL, -- Cond pCPB
  gnss-RTK-MAC-PeriodicCorrectionDifferencesReq-r15
                                     GNSS-PeriodicControlParam-r15  OPTIONAL, -- Cond pMAC
  gnss-RTK-PeriodicResidualsReq-r15     GNSS-PeriodicControlParam-r15  OPTIONAL, -- Cond pRes
  gnss-RTK-FKP-PeriodicGradientsReq-r15 GNSS-PeriodicControlParam-r15  OPTIONAL, -- Cond pFKP
  gnss-SSR-PeriodicOrbitCorrectionsReq-r15
                                     GNSS-PeriodicControlParam-r15  OPTIONAL, -- Cond pOC
  gnss-SSR-PeriodicClockCorrectionsReq-r15
                                     GNSS-PeriodicControlParam-r15  OPTIONAL, -- Cond pCC
  gnss-SSR-PeriodicCodeBiasReq-r15      GNSS-PeriodicControlParam-r15  OPTIONAL, -- Cond pCB
  ...
  [[
  gnss-SSR-PeriodicURA-Req-r16          GNSS-PeriodicControlParam-r15  OPTIONAL, -- Cond pURA
  gnss-SSR-PeriodicPhaseBiasReq-r16     GNSS-PeriodicControlParam-r15  OPTIONAL, -- Cond pPB
  gnss-SSR-PeriodicSTEC-CorrectionReq-r16 GNSS-PeriodicControlParam-r15  OPTIONAL, -- Cond pSTEC
  gnss-SSR-PeriodicGriddedCorrectionReq-r16
                                     GNSS-PeriodicControlParam-r15  OPTIONAL -- Cond pGrid
  ]],
  [[
  gnss-Integrity-PeriodicServiceAlertReq-r17
                                     GNSS-PeriodicControlParam-r15  OPTIONAL -- Cond pDNU
  ]],
  [[
  gnss-SSR-PeriodicOrbitCorrectionsSet2Req-r17
                                     GNSS-PeriodicControlParam-r15  OPTIONAL, -- Cond pOC2
  gnss-SSR-PeriodicClockCorrectionsSet2Req-r17
                                     GNSS-PeriodicControlParam-r15  OPTIONAL, -- Cond pCC2
  gnss-SSR-PeriodicURA-Set2Req-r17    GNSS-PeriodicControlParam-r15  OPTIONAL -- Cond pURA2
  ]],
}
```

```
-- ASN1STOP
```

Conditional presence	Explanation
<i>pOSR</i>	The field is mandatory present if the target device requests periodic <i>GNSS-RTK-Observations</i> ; otherwise it is not present.
<i>pCPB</i>	The field is mandatory present if the target device requests periodic <i>GLO-RTK-BiasInformation</i> ; otherwise it is not present.
<i>pMAC</i>	The field is mandatory present if the target device requests periodic <i>GNSS-RTK-MAC-CorrectionDifferences</i> ; otherwise it is not present.
<i>pRes</i>	The field is mandatory present if the target device requests periodic <i>GNSS-RTK-Residuals</i> ; otherwise it is not present.
<i>pFKP</i>	The field is mandatory present if the target device requests periodic <i>GNSS-RTK-FKP-Gradients</i> ; otherwise it is not present.
<i>pOC</i>	The field is mandatory present if the target device requests periodic <i>GNSS-SSR-OrbitCorrections</i> ; otherwise it is not present.
<i>pCC</i>	The field is mandatory present if the target device requests periodic <i>GNSS-SSR-ClockCorrections</i> ; otherwise it is not present.
<i>pCB</i>	The field is mandatory present if the target device requests periodic <i>GNSS-SSR-CodeBias</i> ; otherwise it is not present.
<i>pURA</i>	The field is mandatory present if the target device requests periodic <i>GNSS-SSR-URA</i> ; otherwise it is not present.
<i>pPB</i>	The field is mandatory present if the target device requests periodic <i>GNSS-SSR-PhaseBias</i> ; otherwise it is not present.
<i>pSTEC</i>	The field is mandatory present if the target device requests periodic <i>GNSS-SSR-STEC-Correction</i> ; otherwise it is not present.
<i>pGrid</i>	The field is mandatory present if the target device requests periodic <i>GNSS-SSR-GriddedCorrection</i> ; otherwise it is not present.
<i>pDNU</i>	The field is mandatory present if the target device requests periodic <i>GNSS-Integrity-ServiceAlert</i> ; otherwise it is not present.
<i>pOC2</i>	The field is mandatory present if the target device requests periodic <i>GNSS-SSR-OrbitCorrectionsSet2</i> ; otherwise it is not present.
<i>pCC2</i>	The field is mandatory present if the target device requests periodic <i>GNSS-SSR-ClockCorrectionsSet2</i> ; otherwise it is not present.
<i>pURA2</i>	The field is mandatory present if the target device requests periodic <i>GNSS-SSR-URA-Set2</i> ; otherwise it is not present.

6.5.2.4 GNSS Assistance Data Request Elements

– *GNSS-ReferenceTimeReq*

The IE *GNSS-ReferenceTimeReq* is used by the target device to request the *GNSS-ReferenceTime* assistance from the location server.

```
-- ASN1START
GNSS-ReferenceTimeReq ::= SEQUENCE {
    gnss-TimeReqPrefList SEQUENCE (SIZE (1..8)) OF GNSS-ID,
    gps-TOW-assistReq    BOOLEAN                OPTIONAL, -- Cond gps
    notOfLeapSecReq     BOOLEAN                OPTIONAL, -- Cond glonass
    ...
}
-- ASN1STOP
```

Conditional presence	Explanation
<i>gps</i>	The field is mandatory present if <i>gnss-TimeReqPrefList</i> includes a <i>GNSS-ID= 'gps'</i> ; otherwise it is not present.
<i>glonass</i>	The field is mandatory present if <i>gnss-TimeReqPrefList</i> includes a <i>GNSS-ID= 'glonass'</i> ; otherwise it is not present.

GNSS-ReferenceTimeReq field descriptions
<p>gnss-TimeReqPrefList This field is used by the target device to request the system time for a specific GNSS, specified by GNSS-ID in the order of preference. The first <i>GNSS-ID</i> in the list is the most preferred GNSS for reference time, the second <i>GNSS-ID</i> is the second most preferred, etc.</p>
<p>gps-TOW-assistReq This field is used by the target device to request the <i>gps-TOW-Assist</i> field in <i>GNSS-SystemTime</i>. TRUE means requested.</p>
<p>notOfLeapSecReq This field is used by the target device to request the <i>notificationOfLeapSecond</i> field in <i>GNSS-SystemTime</i>. TRUE means requested.</p>

– GNSS-ReferenceLocationReq

The IE *GNSS-ReferenceLocationReq* is used by the target device to request the *GNSS-ReferenceLocation* assistance from the location server.

```
-- ASN1START
GNSS-ReferenceLocationReq ::= SEQUENCE {
    ...
}
-- ASN1STOP
```

– GNSS-IonosphericModelReq

The IE *GNSS-IonosphericModelReq* is used by the target device to request the *GNSS-IonosphericModel* assistance from the location server.

```
-- ASN1START
GNSS-IonosphericModelReq ::= SEQUENCE {
    klobucharModelReq BIT STRING (SIZE(2)) OPTIONAL, -- Cond klobuchar
    neQuickModelReq NULL OPTIONAL, -- Cond nequick
    ...,
    [[ klobucharModel2Req-r16 NULL OPTIONAL -- Cond klobuchar2
    ]]
}
-- ASN1STOP
```

Conditional presence	Explanation
<i>klobuchar</i>	The field is mandatory present if the target device requests <i>klobucharModel</i> ; otherwise it is not present. The BIT STRING defines the <i>dataID</i> requested, defined in IE <i>KlobucharModelParameter</i> .
<i>nequick</i>	The field is mandatory present if the target device requests <i>neQuickModel</i> ; otherwise it is not present.
<i>klobuchar2</i>	The field is mandatory present if the target device requests <i>klobucharModel2</i> ; otherwise it is not present.

– GNSS-EarthOrientationParametersReq

The IE *GNSS-EarthOrientationParametersReq* is used by the target device to request the *GNSS-EarthOrientationParameters* assistance from the location server.

```
-- ASN1START
GNSS-EarthOrientationParametersReq ::= SEQUENCE {
    ...
}
-- ASN1STOP
```

– GNSS-RTK-ReferenceStationInfoReq

The IE *GNSS-RTK-ReferenceStationInfoReq* is used by the target device to request the *GNSS-RTK-ReferenceStationInfo* assistance from the location server.

```
-- ASN1START
GNSS-RTK-ReferenceStationInfoReq-r15 ::= SEQUENCE {
  antennaDescriptionReq-r15      BOOLEAN,
  antennaHeightReq-r15          BOOLEAN,
  physicalReferenceStationReq-r15  BOOLEAN,
  stationID-r15                 GNSS-ReferenceStationID-r15  OPTIONAL,
  ...
}
-- ASN1STOP
```

GNSS-RTK-ReferenceStationInfoReq field descriptions

antennaDescriptionReq

This field specifies whether or not the location server is requested to include the field *AntennaDescription* in the *GNSS-RTK-ReferenceStationInfo* IE. TRUE means requested.

antennaHeightReq

This field specifies whether or not the location server is requested to include the field *antennaHeight* in the *GNSS-RTK-ReferenceStationInfo* IE. TRUE means requested.

physicalReferenceStationReq

This field specifies whether or not the location server is requested to include the field *physical-reference-station-info* in the *GNSS-RTK-ReferenceStationInfo* IE. TRUE means requested.

stationID

This field specifies the Station ID for which the *GNSS-RTK-ReferenceStationInfo* is requested.

– GNSS-RTK-AuxiliaryStationDataReq

The IE *GNSS-RTK-AuxiliaryStationDataReq* is used by the target device to request the *GNSS-RTK-AuxiliaryStationData* assistance from the location server.

```
-- ASN1START
GNSS-RTK-AuxiliaryStationDataReq-r15 ::= SEQUENCE {
  master-referenceStationID-r15  GNSS-ReferenceStationID-r15  OPTIONAL,
  ...
}
-- ASN1STOP
```

GNSS-RTK-AuxiliaryStationDataReq field descriptions

master-referenceStationID

This field specifies the Master Reference Station ID for which the Auxiliary Stations are requested.

– GNSS-SSR-CorrectionPointsReq

The IE *GNSS-SSR-CorrectionPointsReq* is used by the target device to request the *GNSS-SSR-CorrectionPoints* assistance from the location server.

```
-- ASN1START
GNSS-SSR-CorrectionPointsReq-r16 ::= SEQUENCE {
  correctionPointSetID-Req-r16  INTEGER (0..16383)  OPTIONAL,
  ...
}
-- ASN1STOP
```

GNSS-SSR-CorrectionPointsReq field descriptions**correctionPointSetID-Req**

This field specifies the ID of the Atmospheric Correction Point set for which the *GNSS-SSR-CorrectionPoints* are requested.

– **GNSS-Integrity-ServiceParametersReq**

The IE *GNSS-Integrity-ServiceParametersReq* is used by the target device to request the *GNSS-Integrity-ServiceParameters* assistance from the location server.

```
-- ASN1START
GNSS-Integrity-ServiceParametersReq-r17 ::= SEQUENCE {
    ...
}
-- ASN1STOP
```

– **GNSS-Integrity-ServiceAlertReq**

The IE *GNSS-Integrity-ServiceAlertReq* is used by the target device to request the *GNSS-Integrity-ServiceAlert* assistance from the location server.

```
-- ASN1START
GNSS-Integrity-ServiceAlertReq-r17 ::= SEQUENCE {
    ...
}
-- ASN1STOP
```

– **GNSS-TimeModelListReq**

The IE *GNSS-TimeModelListReq* is used by the target device to request the *GNSS-TimeModelElement* assistance from the location server.

```
-- ASN1START
GNSS-TimeModelListReq ::= SEQUENCE (SIZE(1..15)) OF GNSS-TimeModelElementReq
GNSS-TimeModelElementReq ::= SEQUENCE {
    gnss-TO-IDsReq  INTEGER (1..15),
    deltaTreq       BOOLEAN,
    ...
}
-- ASN1STOP
```

GNSS-TimeModelElementReq field descriptions**gnss-TO-IDsReq**

This field specifies the requested *gnss-TO-ID*. The meaning and encoding is the same as the *gnss-TO-ID* field in the *GNSS-TimeModelElement* IE.

deltaTreq

This field specifies whether or not the location server is requested to include the *deltaT* field in the *GNSS-TimeModelElement* IE. TRUE means requested.

– **GNSS-DifferentialCorrectionsReq**

The IE *GNSS-DifferentialCorrectionsReq* is used by the target device to request the *GNSS-DifferentialCorrections* assistance from the location server.

```
-- ASN1START
```

```

GNSS-DifferentialCorrectionsReq ::= SEQUENCE {
  dgnss-SignalsReq      GNSS-SignalIDs,
  dgnss-ValidityTimeReq  BOOLEAN,
  ...
}
-- ASN1STOP
    
```

GNSS-DifferentialCorrectionsReq field descriptions
<p>dgnss-SignalsReq This field specifies the GNSS Signal(s) for which the <i>GNSS-DifferentialCorrections</i> are requested. A one-value at a bit position means DGNSS corrections for the specific signal are requested; a zero-value means not requested. The target device shall set a maximum of three bits to value 'one'.</p>
<p>dgnss-ValidityTimeReq This field specifies whether the <i>udreGrowthRate</i> and <i>udreValidityTime</i> in <i>GNSS-DifferentialCorrections</i> are requested or not. TRUE means requested.</p>

GNSS-NavigationModelReq

The IE *GNSS-NavigationModelReq* is used by the target device to request the *GNSS-NavigationModel* assistance from the location server.

```

-- ASN1START
GNSS-NavigationModelReq ::= CHOICE {
  storedNavList      StoredNavListInfo,
  reqNavList         ReqNavListInfo,
  ...
}

StoredNavListInfo ::= SEQUENCE {
  gnss-WeekOrDay      INTEGER (0..4095),
  gnss-Toe             INTEGER (0..255),
  t-toeLimit          INTEGER (0..15),
  satListRelatedDataList  SatListRelatedDataList OPTIONAL,
  ...
}

SatListRelatedDataList ::= SEQUENCE (SIZE (1..64)) OF SatListRelatedDataElement

SatListRelatedDataElement ::= SEQUENCE {
  svID                SV-ID,
  iod                 BIT STRING (SIZE(11)),
  clockModelID        INTEGER (1..8) OPTIONAL,
  orbitModelID        INTEGER (1..8) OPTIONAL,
  ...
}

ReqNavListInfo ::= SEQUENCE {
  svReqList           BIT STRING (SIZE (64)),
  clockModelID-PrefList  SEQUENCE (SIZE (1..8)) OF INTEGER (1..8) OPTIONAL,
  orbitModelID-PrefList SEQUENCE (SIZE (1..8)) OF INTEGER (1..8) OPTIONAL,
  addNavparamReq      BOOLEAN OPTIONAL, -- Cond orbitModelID-2
  ...
}
-- ASN1STOP
    
```

Conditional presence	Explanation
<i>orbitModelID-2</i>	The field is mandatory present if <i>orbitModelID-PrefList</i> is absent or includes a Model-ID = '2'; otherwise it is not present.

GNSS-NavigationModelReq field descriptions
<p>storedNavList This list provides information to the location server about which <i>GNSS-NavigationModel</i> data the target device has currently stored for the particular GNSS indicated by <i>GNSS-ID</i>.</p>

GNSS-<i>NavigationModelReq</i> field descriptions	
reqNavList	This list provides information to the location server which <i>GNSS-NavigationModel</i> data are requested by the target device.
gnss-WeekOrDay	If <i>GNSS-ID</i> does not indicate 'glonass', this field defines the GNSS Week number of the assistance currently held by the target device. If <i>GNSS-ID</i> is set to 'glonass', this field defines the calendar number of day within the four-year interval starting from 1 st of January in a leap year, as defined by the parameter N_T in [9] of the assistance currently held by the target device.
gnss-Toe	If <i>GNSS-ID</i> does not indicate 'glonass', this field defines the GNSS time of ephemeris in hours of the latest ephemeris set contained by the target device. If <i>GNSS-ID</i> is set to 'glonass', this field defines the time of ephemeris in units of 15 minutes of the latest ephemeris set contained by the target device (range 0 to 95 representing time values between 0 and 1425 minutes). In this case, values 96 to 255 shall not be used by the sender.
t-toeLimit	If <i>GNSS-ID</i> does not indicate 'glonass', this IE defines the ephemeris age tolerance of the target device in units of hours. If <i>GNSS-ID</i> is set to 'glonass', this IE defines the ephemeris age tolerance of the target device in units of 30 minutes.
satListRelatedDataList	This list defines the clock and orbit models currently held by the target device for each SV. This field is not included if the target device does not have any stored clock and orbit models for any SV.
svID	This field identifies the particular GNSS satellite.
iod	This field identifies the issue of data currently held by the target device.
clockModelID, orbitModelID	These fields define the clock and orbit model number currently held by the target device. If these fields are absent, the default interpretation of the table GNSS-ID to clockModelID & orbitModelID relation below applies.
svReqList	This field defines the SV for which the navigation model assistance is requested. Each bit position in this BIT STRING represents a <i>SV-ID</i> . Bit 0 represents <i>SV-ID</i> =0 and bit 63 represents <i>SV-ID</i> =63. A one-value at a bit position means the navigation model data for the corresponding <i>SV-ID</i> is requested, a zero-value means not requested.
clockModelIDPrefList, orbitModelID-PrefList	These fields define the Model-IDs of the clock and orbit models that the target device wishes to obtain in the order of preference. The first Model-ID in the list is the most preferred model, the second Model-ID the second most preferred, etc. If these fields are absent, the default interpretation of the table GNSS-ID to clockModelID-PrefList & orbitModelIDPrefList relation below applies.
addNavparamReq	This field specifies whether the location server is requested to include the <i>addNAVparam</i> fields in <i>GNSS-NavigationModel</i> IE (<i>NavModel-NAVKeplerianSet</i> field) or not. TRUE means requested.

GNSS-ID to clockModelID & orbitModelID relation

GNSS-ID	clockModelID	orbitModelID
gps	2	2
sbas	5	5
qzss	2	2
galileo	1	1
glonass	4	4
bds	6	6
navic	8	8

GNSS-ID to clockModelID-PrefList & orbitModelID-PrefList relation

<i>GNSS-ID</i>	<i>clockModelID-PrefList</i>	<i>orbitModelID-PrefList</i>
gps	Model-2	Model-2
sbas	Model-5	Model-5
qzss	Model-2	Model-2
galileo	Model-1	Model-1
glonass	Model-4	Model-4
bds	Model-6	Model-6
navic	Model-8	Model-8

– *GNSS-RealTimeIntegrityReq*

The IE *GNSS-RealTimeIntegrityReq* is used by the target device to request the *GNSS-RealTimeIntegrity* assistance from the location server.

```
-- ASN1START
GNSS-RealTimeIntegrityReq ::= SEQUENCE {
    ...
}
-- ASN1STOP
```

– *GNSS-DataBitAssistanceReq*

The IE *GNSS-DataBitAssistanceReq* is used by the target device to request the *GNSS-DataBitAssistance* assistance from the location server.

```
-- ASN1START
GNSS-DataBitAssistanceReq ::= SEQUENCE {
    gnss-TOD-Req          INTEGER (0..3599),
    gnss-TOD-FracReq     INTEGER (0..999)          OPTIONAL,
    dataBitInterval      INTEGER (0..15),
    gnss-SignalType      GNSS-SignalIDs,
    gnss-DataBitsReq     GNSS-DataBitsReqSatList OPTIONAL,
    ...
}
GNSS-DataBitsReqSatList ::= SEQUENCE (SIZE(1..64)) OF GNSS-DataBitsReqSatElement
GNSS-DataBitsReqSatElement ::= SEQUENCE {
    svID                 SV-ID,
    ...
}
-- ASN1STOP
```

GNSS-DataBitAssistanceReq field descriptions

gnss-TOD-Req

This field specifies the reference time for the first data bit requested in GNSS specific system time, modulo 1 hour. Scale factor 1 second.

gnss-TOD-FracReq

This field specifies the fractional part of *gnss-TOD-Req* in 1-milli-second resolution. Scale factor 1 millisecond.

dataBitInterval

This field specifies the time length for which the Data Bit Assistance is requested. The *GNSS-DataBitAssistance* shall be relative to the time interval (*gnss-TOD-Req*, *gnss-TOD-Req* + *dataBitInterval*).

The *dataBitInterval* r , expressed in seconds, is mapped to a binary number K with the following formula:

$$r = 0.1 \times 2^K$$

Value $K=15$ means that the time interval is not specified.

gnss-SignalType

This field specifies the GNSS Signal(s) for which the *GNSS-DataBitAssistance* are requested. A one-value at a bit position means *GNSS-DataBitAssistance* for the specific signal is requested; a zero-value means not requested.

GNSS-DataBitAssistanceReq field descriptions**gnss-DataBitsReq**

This list contains the SV-IDs for which the *GNSS-DataBitAssistance* is requested.

– **GNSS-AcquisitionAssistanceReq**

The IE *GNSS-AcquisitionAssistanceReq* is used by the target device to request the *GNSS-AcquisitionAssistance* assistance from the location server.

```
-- ASN1START
GNSS-AcquisitionAssistanceReq ::= SEQUENCE {
    gnss-SignalID-Req    GNSS-SignalID,
    ...
}
-- ASN1STOP
```

GNSS-AcquisitionAssistanceReq field descriptions**gnss-SignalID-Req**

This field specifies the GNSS signal type for which *GNSSAcquisitionAssistance* is requested.

– **GNSS-AlmanacReq**

The IE *GNSS-AlmanacReq* is used by the target device to request the *GNSS-Almanac* assistance from the location server.

```
-- ASN1START
GNSS-AlmanacReq ::= SEQUENCE {
    modelID              INTEGER(1..8)    OPTIONAL,
    ...
}
-- ASN1STOP
```

GNSS-AlmanacReq field descriptions**modelID**

This field specifies the Almanac Model ID requested. If this field is absent, the default interpretation as in the table GNSS-ID to modelID relation below applies.

GNSS-ID to modelID relation

GNSS-ID	modelID
gps	2
sbas	6
qzss	2
galileo	1
glonass	5
bds	7
navic	8

– **GNSS-UTC-ModelReq**

The IE *GNSS-UTC-ModelReq* is used by the target device to request the *GNSS-UTC-Model* assistance from the location server.

```
-- ASN1START
GNSS-UTC-ModelReq ::= SEQUENCE {
    modelID              INTEGER(1..8)    OPTIONAL,

```

```

}
...
-- ASN1STOP
    
```

GNSS-UTC-ModelReq field descriptions
<p>modelID This field specifies the <i>GNSS-UTCModel</i> set requested. If this field is absent, the default interpretation as in the table GNSS-ID to modelID relation below applies.</p>

GNSS-ID to modelID relation

<i>GNSS-ID</i>	<i>modelID</i>
gps	1
sbas	4
qzss	1
galileo	1
glonass	3
bds	5
navic	2

– ***GNSS-AuxiliaryInformationReq***

The IE *GNSS-AuxiliaryInformationReq* is used by the target device to request the *GNSS-AuxiliaryInformation* assistance from the location server.

```

-- ASN1START
GNSS-AuxiliaryInformationReq ::= SEQUENCE {
    ...
}
-- ASN1STOP
    
```

– ***BDS-DifferentialCorrectionsReq***

The IE *BDS-DifferentialCorrectionsReq* is used by the target device to request the *BDS-DifferentialCorrections* assistance from the location server.

```

-- ASN1START
BDS-DifferentialCorrectionsReq-r12 ::= SEQUENCE {
    dgnss-SignalsReq          GNSS-SignalIDs,
    ...
}
-- ASN1STOP
    
```

BDS-DifferentialCorrectionsReq field descriptions
<p>dgnss-SignalsReq This field specifies the BDS Signal(s) for which the <i>BDS-DifferentialCorrections</i> are requested. A one-value at a bit position means BDS differential corrections for the specific signal are requested; a zero-value means not requested. The target device shall set a maximum of three bits to value 'one'. This only applies for the B1I/B3I signal.</p>

– ***BDS-GridModelReq***

The IE *BDS-GridModelReq* is used by the target device to request the *BDS-GridModel* assistance from the location server.

```

-- ASN1START
BDS-GridModelReq-r12 ::= SEQUENCE {
    ...
}
    
```

```

}
...
-- ASN1STOP

```

– GNSS-RTK-ObservationsReq

The IE *GNSS-RTK-ObservationsReq* is used by the target device to request the *GNSS-RTK-Observations* assistance from the location server.

```

-- ASN1START
GNSS-RTK-ObservationsReq-r15 ::= SEQUENCE {
    gnss-RTK-SignalsReq-r15          GNSS-SignalIDs,
    gnss-RTK-Integer-ms-Req-r15     BOOLEAN,
    gnss-RTK-PhaseRangeRateReq-r15  BOOLEAN,
    gnss-RTK-CNR-Req-r15            BOOLEAN,
    stationID-r15                   GNSS-ReferenceStationID-r15  OPTIONAL,
    ...
}
-- ASN1STOP

```

GNSS-RTK-ObservationsReq field descriptions

gnss-RTK-SignalsReq

This field specifies the GNSS Signal(s) for which the *GNSS-RTK-Observations* are requested. A one-value at a bit position means RTK observations for the specific signal are requested; a zero-value means not requested.

gnss-RTK-Integer-ms-Req

This field specifies whether the integer-ms is requested or not. TRUE means requested.

gnss-RTK-PhaseRangeRateReq

This field specifies whether the *rough-phase-range-rate* and *fine-PhaseRangeRate* are requested or not. TRUE means requested.

gnss-RTK-CNR-Req

This field specifies whether the *carrier-to-noise-ratio* is requested or not. TRUE means requested.

stationID

This field specifies the Station ID for which the *GNSS-RTK-Observations* are requested.

– GLO-RTK-BiasInformationReq

The IE *GLO-RTK-BiasInformationReq* is used by the target device to request the *GLO-RTK-BiasInformation* assistance from the location server.

```

-- ASN1START
GLO-RTK-BiasInformationReq-r15 ::= SEQUENCE {
    stationID-r15                   GNSS-ReferenceStationID-r15  OPTIONAL,
    ...
}
-- ASN1STOP

```

GLO-RTK-BiasInformationReq field descriptions

stationID

This field specifies the Station ID for which the *GLO-RTK-BiasInformation* is requested.

– GNSS-RTK-MAC-CorrectionDifferencesReq

The IE *GNSS-RTK-MAC-CorrectionDifferencesReq* is used by the target device to request the *GNSS-RTK-MAC-CorrectionDifferences* assistance from the location server.

```

-- ASN1START
GNSS-RTK-MAC-CorrectionDifferencesReq-r15 ::= SEQUENCE {
    master-ReferenceStationID-r15   GNSS-ReferenceStationID-r15  OPTIONAL,
    ...
}

```

```

    aux-ReferenceStationList-r15      AUX-ReferenceStationList-r15      OPTIONAL,
    linkCombinations-PrefList-r15    GNSS-Link-CombinationsList-r15    OPTIONAL,
    ...
}

AUX-ReferenceStationList-r15 ::= SEQUENCE (SIZE (1..32)) OF AUX-ReferenceStationID-Element-r15

AUX-ReferenceStationID-Element-r15 ::= SEQUENCE {
    aux-stationID-r15                GNSS-ReferenceStationID-r15,
    ...
}

-- ASN1STOP

```

GNSS-RTK-MAC-CorrectionDifferencesReq field descriptions

master-ReferenceStationID, aux-ReferenceStationList

These fields specify the Master and Auxiliary Reference Station IDs for which the *GNSS-RTK-MAC-CorrectionDifferences* are requested.

linkCombinations-PrefList

This field specifies the dual-frequency combination of L1 and L2 link/frequencies for which the target device wishes to obtain the *GNSS-RTK-MAC-CorrectionDifferences* in the order of preference. The first *GNSS-Link-Combinations* in *GNSS-Link-CombinationsList* is the most preferred combination, the second *GNSS-Link-Combinations* in *GNSS-Link-CombinationsList* is the second most preferred, etc.

– *GNSS-RTK-ResidualsReq*

The IE *GNSS-RTK-ResidualsReq* is used by the target device to request the *GNSS-RTK-Residuals* assistance from the location server.

```

-- ASN1START

GNSS-RTK-ResidualsReq-r15 ::= SEQUENCE {
    stationID-r15                GNSS-ReferenceStationID-r15    OPTIONAL,
    linkCombinations-PrefList-r15 GNSS-Link-CombinationsList-r15  OPTIONAL,
    ...
}

-- ASN1STOP

```

GNSS-RTK-ResidualsReq field descriptions

stationID

This field specifies the Station ID for which the *GNSS-RTK-Residuals* are requested.

linkCombinations-PrefList

This field specifies the dual-frequency combination of L1 and L2 link/frequencies for which the target device wishes to obtain the *GNSS-RTK-Residuals* in the order of preference. The first *GNSS-Link-Combinations* in *GNSS-Link-CombinationsList* is the most preferred combination, the second *GNSS-Link-Combinations* in *GNSS-Link-CombinationsList* is the second most preferred, etc.

– *GNSS-RTK-FKP-GradientsReq*

The IE *GNSS-RTK-FKP-GradientsReq* is used by the target device to request the *GNSS-RTK-FKP-Gradients* assistance from the location server.

```

-- ASN1START

GNSS-RTK-FKP-GradientsReq-r15 ::= SEQUENCE {
    stationID-r15                GNSS-ReferenceStationID-r15    OPTIONAL,
    linkCombinations-PrefList-r15 GNSS-Link-CombinationsList-r15  OPTIONAL,
    ...
}

-- ASN1STOP

```

GNSS-RTK-FKP-GradientsReq field descriptions
<p>stationID This field specifies the Station ID for which the <i>GNSS-RTK-FKP-Gradients</i> are requested.</p>
<p>linkCombinations-PrefList This field specifies the dual-frequency combination of L1 and L2 link/frequencies for which the target device wishes to obtain the <i>GNSS-RTK-FKP-Gradients</i> in the order of preference. The first <i>GNSS-Link-Combinations</i> in <i>GNSS-Link-CombinationsList</i> is the most preferred combination, the second <i>GNSS-Link-Combinations</i> in <i>GNSS-Link-CombinationsList</i> is the second most preferred, etc.</p>

– GNSS-SSR-OrbitCorrectionsReq

The IE *GNSS-SSR-OrbitCorrectionsReq* is used by the target device to request the *GNSS-SSR-OrbitCorrections* assistance from the location server.

```
-- ASN1START
GNSS-SSR-OrbitCorrectionsReq-r15 ::= SEQUENCE {
    storedNavList-r15          GNSS-NavListInfo-r15          OPTIONAL,
    . . .
    [[
        orbit-IntegrityReq-r17 BIT STRING { correlationTimeReq (0)
                                           } (SIZE(1..8))          OPTIONAL
    ]]
}
-- ASN1STOP
```

GNSS-SSR-OrbitCorrectionsReq field descriptions
<p>storedNavList This list provides information to the location server about which NAV data the target device has currently stored for the particular GNSS indicated by <i>GNSS-ID</i>.</p>
<p>orbit-IntegrityReq This field, if present, indicates that the target device requests the IEs <i>ORBIT-IntegrityParameters</i> and <i>SSR-IntegrityOrbitBounds</i>. A one-value at the bit position '0' means that the target device requests the fields <i>orbitRangeErrorCorrelationTime</i> and <i>orbitRangeRateErrorCorrelationTime</i> in IE <i>ORBIT-IntegrityParameters</i>.</p>

– GNSS-SSR-ClockCorrectionsReq

The IE *GNSS-SSR-ClockCorrectionsReq* is used by the target device to request the *GNSS-SSR-ClockCorrections* assistance from the location server.

```
-- ASN1START
GNSS-SSR-ClockCorrectionsReq-r15 ::= SEQUENCE {
    storedNavList-r15          GNSS-NavListInfo-r15          OPTIONAL,
    . . .
    [[
        clock-IntegrityParametersReq-r17 ENUMERATED { true }          OPTIONAL,
        ssr-IntegrityClockBoundsReq-r17  ENUMERATED { true }          OPTIONAL
    ]]
}
-- ASN1STOP
```

GNSS-SSR-ClockCorrectionsReq field descriptions
<p>storedNavList This list provides information to the location server about which NAV data the target device has currently stored for the particular GNSS indicated by <i>GNSS-ID</i>.</p>
<p>clock-IntegrityParametersReq This field, if present, indicates that the target device requests the <i>CLOCK-IntegrityParameters</i> in IE <i>GNSS-SSR-ClockCorrections</i>.</p>
<p>ssr-IntegrityClockBoundsReq This field, if present, indicates that the target device requests the <i>SSR-IntegrityClockBounds</i> in IE <i>GNSS-SSR-ClockCorrections</i>.</p>

– GNSS-SSR-CodeBiasReq

The IE *GNSS-SSR-CodeBiasReq* is used by the target device to request the *GNSS-SSR-CodeBias* assistance from the location server.

```
-- ASN1START
GNSS-SSR-CodeBiasReq-r15 ::= SEQUENCE {
    signal-and-tracking-mode-ID-Map-r15    GNSS-SignalIDs,
    storedNavList-r15                      GNSS-NavListInfo-r15          OPTIONAL,
    . . . ,
    [[
    ssr-IntegrityCodeBiasBoundsReq-r17    ENUMERATED { requested }    OPTIONAL
    ]]
}
-- ASN1STOP
```

GNSS-SSR-CodeBiasReq field descriptions
<p>signal-and-tracking-mode-ID-Map This field specifies the GNSS signal(s) for which the <i>GNSS-SSR-CodeBias</i> is requested.</p>
<p>storedNavList This list provides information to the location server about which NAV data the target device has currently stored for the particular GNSS indicated by <i>GNSS-ID</i>.</p>
<p>ssr-IntegrityCodeBiasBoundsReq This field, if present, indicates that the <i>SSR-IntegrityCodeBiasBounds</i> are requested.</p>

– GNSS-SSR-URA-Req

The IE *GNSS-SSR-URA-Req* is used by the target device to request the *GNSS-SSR-URA* assistance from the location server.

```
-- ASN1START
GNSS-SSR-URA-Req-r16 ::= SEQUENCE {
    . . .
}
-- ASN1STOP
```

– GNSS-SSR-PhaseBiasReq

The IE *GNSS-SSR-PhaseBiasReq* is used by the target device to request the *GNSS-SSR-PhaseBias* assistance from the location server.

```
-- ASN1START
GNSS-SSR-PhaseBiasReq-r16 ::= SEQUENCE {
    signal-and-tracking-mode-ID-Map-r16    GNSS-SignalIDs,
    storedNavList-r16                      GNSS-NavListInfo-r15          OPTIONAL,
    . . . ,
    [[
    ssr-IntegrityPhaseBiasBoundsReq-r17    ENUMERATED { requested }    OPTIONAL
    ]]
}
-- ASN1STOP
```

```
}
-- ASN1STOP
```

GNSS-SSR-PhaseBiasReq field descriptions

signal-and-tracking-mode-ID-Map

This field specifies the GNSS signal(s) for which the *GNSS-SSR-PhaseBias* is requested.

storedNavList

This list provides information to the location server about which NAV data the target device has currently stored for the particular GNSS indicated by *GNSS-ID*.

ssr-IntegrityPhaseBiasBoundsReq

This field, if present, indicates that the *SSR-IntegrityPhaseBiasBounds* are requested.

– *GNSS-SSR-STECCorrectionReq*

The IE *GNSS-SSR-STECCorrectionReq* is used by the target device to request the *GNSS-SSR-STECCorrection* assistance from the location server.

```
-- ASN1START
GNSS-SSR-STECCorrectionReq-r16 ::= SEQUENCE {
    . . .
    [[
        stec-IntegrityReq-r17    BIT STRING {    correlationTimeReq    (0)
                                } (SIZE(1..8))                                OPTIONAL
    ]]
}
-- ASN1STOP
```

GNSS-SSR-STECCorrectionReq field descriptions

stec-IntegrityReq

This field, if present, indicates that the target device requests the IEs *STEC-IntegrityParameters* and *STEC-IntegrityErrorBounds*.

A one-value at the bit position '0' means that the target device requests the fields *ionoRangeErrorCorrelationTime* and *ionoRangeRateErrorCorrelationTime* in IE *STEC-IntegrityParameters*.

– *GNSS-SSR-GriddedCorrectionReq*

The IE *GNSS-SSR-GriddedCorrectionReq* is used by the target device to request the *GNSS-SSR-GriddedCorrection* assistance from the location server.

```
-- ASN1START
GNSS-SSR-GriddedCorrectionReq-r16 ::= SEQUENCE {
    . . .
    [[
        griddedCorrectionIntegrityReq-r17    ENUMERATED { requested }
    ]]
}
-- ASN1STOP
```

GNSS-SSR-GriddedCorrectionReq field descriptions

griddedCorrectionIntegrityReq

This field, if present, indicates that the target device requests the IEs *SSR-GriddedCorrectionIntegrityParameters* and *TropoDelayIntegrityErrorBounds*.

– *NavIC-DifferentialCorrectionsReq*

The IE *NavIC-DifferentialCorrectionsReq* is used by the target device to request the *NavIC-DifferentialCorrections* assistance from the location server.

```
-- ASN1START
NavIC-DifferentialCorrectionsReq-r16 ::= SEQUENCE {
    dgnss-SignalsReq-r16          GNSS-SignalIDs,
    ...
}
-- ASN1STOP
```

<i>NavIC-DifferentialCorrectionsReq</i> field descriptions
<p><i>dgnss-SignalsReq</i> This field specifies the NavIC Signal(s) for which the <i>NavIC-DifferentialCorrections</i> are requested. A one-value at a bit position means the NavIC differential corrections for the specific signal are requested; a zero-value means not requested. The target device shall set a maximum of three bits to value 'one'.</p>

– *NavIC-GridModelReq*

The IE *NavIC-GridModelReq* is used by the target device to request the *NavIC-GridModel* assistance from the location server.

```
-- ASN1START
NavIC-GridModelReq-r16 ::= SEQUENCE {
    ...
}
-- ASN1STOP
```

– *GNSS-SSR-OrbitCorrectionsSet2Req*

The IE *GNSS-SSR-OrbitCorrectionsSet2Req* is used by the target device to request the *GNSS-SSR-OrbitCorrectionsSet2* assistance from the location server.

```
-- ASN1START
GNSS-SSR-OrbitCorrectionsSet2Req-r17 ::= SEQUENCE {
    refEphReq-r17                ENUMERATED { b1c,...},
    gnss-SSR-OrbitCorrectionsSet2Req-r17
                                GNSS-SSR-OrbitCorrectionsReq-r15  OPTIONAL,  -- Cond OC2-Req
    ...
}
-- ASN1STOP
```

Conditional presence	Explanation
<i>OC2-Req</i>	The field is mandatory present if the target device requests <i>GNSS-SSR-OrbitCorrectionsSet2</i> ; otherwise it is not present.

<i>GNSS-SSR-OrbitCorrectionsSet2Req</i> field descriptions
<p><i>refEphReq</i> This field, if present, indicates that the reference broadcast ephemeris that target device requests the <i>GNSS-SSR-OrbitCorrectionsSet2</i> for.</p>

– *GNSS-SSR-ClockCorrectionsSet2Req*

The IE *GNSS-SSR-ClockCorrectionsSet2Req* is used by the target device to request the *GNSS-SSR-ClockCorrectionsSet2* assistance from the location server.

```
-- ASN1START
GNSS-SSR-ClockCorrectionsSet2Req-r17 ::= SEQUENCE {
    refEphReq-r17                ENUMERATED { b1c,...},
    gnss-SSR-ClockCorrectionsSet2Req-r17
}
-- ASN1STOP
```

```

    GNSS-SSR-ClockCorrectionsReq-r15    OPTIONAL,    -- Cond CC2-Req
}
-- ASN1STOP

```

Conditional presence	Explanation
CC2-Req	The field is mandatory present if the target device requests <i>GNSS-SSR-ClockCorrectionsSet2</i> ; otherwise it is not present.

GNSS-SSR-ClockCorrectionsSet2Req field descriptions

refEphReq

This field, if present, indicates that the reference broadcast ephemeris that target device requests the *GNSS-SSR-ClockCorrectionsSet2* for.

– GNSS-SSR-URA-Set2Req

The IE *GNSS-SSR-URA-Set2Req* is used by the target device to request the *GNSS-SSR-URA-Set2* assistance from the location server.

```

-- ASN1START
GNSS-SSR-URA-Set2Req-r17 ::= SEQUENCE {
    refEphReq-r17          ENUMERATED { b1c,...},
    ...
}
-- ASN1STOP

```

GNSS-SSR-URA-Set2Req field descriptions

refEphReq

This field, if present, indicates that the reference broadcast ephemeris that target device requests the *GNSS-SSR-URA-Set2* for.

6.5.2.5 GNSS Location Information

– A-GNSS-ProvideLocationInformation

The IE *A-GNSS-ProvideLocationInformation* is used by the target device to provide location measurements (e.g., pseudo-ranges, location estimate, velocity) to the location server, together with time information. It may also be used to provide GNSS positioning specific error reason.

```

-- ASN1START
A-GNSS-ProvideLocationInformation ::= SEQUENCE {
    gnss-SignalMeasurementInformation    GNSS-SignalMeasurementInformation    OPTIONAL,
    gnss-LocationInformation              GNSS-LocationInformation              OPTIONAL,
    gnss-Error                            A-GNSS-Error                            OPTIONAL,
    ...
}
-- ASN1STOP

```

6.5.2.6 GNSS Location Information Elements

– GNSS-SignalMeasurementInformation

The IE *GNSS-SignalMeasurementInformation* is used by the target device to provide GNSS signal measurement information to the location server and GNSS-network time association if requested by the location server. This information includes the measurements of code phase, Doppler, C/N₀ and optionally accumulated carrier phase, also

called accumulated deltarange (ADR), which enable the UE-assisted GNSS method where position is computed in the location server. Figure 6.5.2.6-1 illustrates the relation between some of the fields.

```
-- ASN1START
GNSS-SignalMeasurementInformation ::= SEQUENCE {
    measurementReferenceTime      MeasurementReferenceTime,
    gnss-MeasurementList          GNSS-MeasurementList,
    ...
}
-- ASN1STOP
```

GNSS-SignalMeasurementInformation field descriptions

measurementReferenceTime

This field specifies the GNSS system time for which the information provided in *gnss-MeasurementList* is valid. It may also include network time, if requested by the location server and supported by the target device.

gnss-MeasurementList

This field provides GNSS signal measurement information for up to 16 GNSSs.

– *MeasurementReferenceTime*

The IE *MeasurementReferenceTime* is used to specify the time when the measurements provided in *A-GNSS-ProvideLocationInformation* are valid. It may also include GNSS-network time association, in which case reported measurements shall be valid for the cellular frame boundary defined in the network time association.

```
-- ASN1START
MeasurementReferenceTime ::= SEQUENCE {
    gnss-TOD-msec      INTEGER (0..3599999),
    gnss-TOD-frac     INTEGER (0..3999)          OPTIONAL,
    gnss-TOD-unc      INTEGER (0..127)          OPTIONAL,
    gnss-TimeID       GNSS-ID,
    networkTime       CHOICE {
        eUTRA         SEQUENCE {
            physCellId      INTEGER (0..503),
            cellGlobalId    CellGlobalIdEUTRA-AndUTRA          OPTIONAL,
            systemFrameNumber BIT STRING (SIZE (10)),
            ...
        },
        uTRA           SEQUENCE {
            mode            CHOICE {
                fdd         SEQUENCE {
                    primary-CPICH-Info INTEGER (0..511),
                    ...
                },
                tdd         SEQUENCE {
                    cellParameters    INTEGER (0..127),
                    ...
                }
            },
            cellGlobalId    CellGlobalIdEUTRA-AndUTRA          OPTIONAL,
            referenceSystemFrameNumber
                INTEGER (0..4095),
            ...
        },
        gSM            SEQUENCE {
            bcchCarrier     INTEGER (0..1023),
            bsic            INTEGER (0..63),
            cellGlobalId    CellGlobalIdGERAN                  OPTIONAL,
            referenceFrame  SEQUENCE {
                referenceFN      INTEGER (0..65535),
                referenceFNMSB    INTEGER (0..63)              OPTIONAL,
                ...
            },
            deltaGNSS-TOD   INTEGER (0 .. 127)          OPTIONAL,
            ...
        },
        ...
    },
    ...,
    nbIoT-r14          SEQUENCE {
        nbPhysCellId-r14    INTEGER (0..503),
        ...
    }
}
```

```

        nbCellGlobalId-r14  ECGI                                OPTIONAL,
        sfm-r14             BIT STRING (SIZE (10)),
        hyperSFN-r14       BIT STRING (SIZE (10))              OPTIONAL,
        ...
    },
    nr-r15 SEQUENCE {
        nrPhysCellId-r15    INTEGER (0..1007),
        nrCellGlobalID-r15  NCGI-r15                                OPTIONAL,
        nr-sfm-r15          BIT STRING (SIZE (10)),
        ...
    }
    OPTIONAL,
    ...
}
-- ASN1STOP

```

MeasurementReferenceTime field descriptions	
gnss-TOD-msec	<p>This field specifies the GNSS TOD for which the measurements and/or location estimate are valid. The 22 bits of GNSS TOD are the least significant bits. The most significant bits are derived by the location server to unambiguously derive the GNSS TOD.</p> <p>The value for GNSS TOD is derived from the GNSS specific system time indicated in <i>gnss-TimeID</i> rounded down to the nearest millisecond unit.</p> <p>Scale factor 1 millisecond.</p>
gnss-TOD-frac	<p>This field specifies the fractional part of the GNSS TOD in 250 ns resolution. The total GNSS TOD is given by <i>gnss-TOD-msec</i> + <i>gnss-TOD-frac</i>.</p> <p>Scale factor 250 nanoseconds.</p>
gnss-TOD-unc	<p>This field provides the accuracy of the relation GNSS-network time when GNSS-network time association is provided. When GNSS-network time association is not provided, this element can be included to provide the accuracy of the reported <i>gnss-TOD-msec</i>.</p> <p>If GNSS TOD is the given GNSS time, then the true GNSS time, corresponding to the provided network time if applicable, as observed at the target device location, lies in the interval [GNSS TOD – <i>gnss-TOD-unc</i>, GNSS TOD + <i>gnss-TOD-unc</i>].</p> <p>The uncertainty <i>r</i>, expressed in microseconds, is mapped to a number K, with the following formula:</p> $r = C * (((1+x)^K) - 1)$ <p>with C = 0.5 and x = 0.14. To encode any higher value of uncertainty than that corresponding in the above formula to K=127, the same value, K=127, shall also be used. The uncertainty is then coded on 7 bits, as the binary encoding of K. Examples of <i>gnss-TOD-unc</i> value are as in the table Value of K to Value of uncertainty relation below.</p> <p>This field shall be included if the target device provides GNSS-network time relationship.</p>
gnss-TimeID	<p>This field specifies the GNSS system time for which the <i>gnss-TOD-msec</i> (and <i>gnss-TOD-frac</i> if applicable) is provided.</p>
networkTime	<p>These fields specify the network time event which the GNSS TOD time stamps.</p> <p>This field shall be included if the target device provides GNSS-network time relationship.</p>
physCellId	<p>This field identifies the reference cell (E-UTRA), as defined in TS 36.331 [12], that is used for the GNSS-network time relation.</p>
cellGlobalId	<p>This field specifies the globally unique cell identifier (Evolved Cell Global Identifier (ECGI) in E-UTRA, global UTRAN Cell Identifier in UTRA, or Cell Global Identification (CGI) in GERAN) of the reference cell, as defined in TS 36.331 [12] for E-UTRA and in TS 25.331 [13] for UTRA, for which the GNSS network time relation is provided.</p>
systemFrameNumber	<p>This field specifies the system frame number in E-UTRA which the GNSS time time stamps, as defined in TS 36.331 [12].</p>
mode	<p>This field identifies the reference cell for the GNSS-network time relation, as defined in TS 25.331 [13].</p>
referenceSystemFrameNumber	<p>This field specifies the system frame number in UTRA, as defined in TS 25.331 [13], which is used for time stamping.</p>
bcchCarrier, bsic	<p>This field identifies the reference cell for the GNSS-network time relation in GERAN, as defined in TS 44.031 [14].</p>

MeasurementReferenceTime field descriptions
<p>referenceFN, referenceFNMSB</p> <p>These fields specify the frame number in GERAN which the GNSS time time stamps, as defined in TS 44.031 [14]. The time of the reference frame boundary is as observed by the target device, i.e. without Timing Advance compensation. The <i>referenceFNMSB</i> field indicates the most significant bits of the frame number of the reference BTS corresponding to the <i>GNSS-MeasurementList</i>. Starting from the complete GSM frame number denoted FN, the target device calculates Reference FN MSB as</p> $\text{Reference FN MSB} = \text{floor}(\text{FN}/42432)$ <p>The complete GSM frame number FN can then be reconstructed in the location server by combining the fields <i>referenceFN</i> with <i>referenceFNMSB</i> in the following way</p> $\text{FN} = \text{referenceFNMSB} * 42432 + \text{referenceFN}$
<p>deltaGNSS-TOD</p> <p>This field specifies the difference in milliseconds between <i>gnss-TOD-msec</i> reported and the milli-second part of the SV time <i>tsv_1</i> of the first SV in the list reported from the target device, as defined in TS 44.031 [14]. The <i>deltaGNSS-TOD</i> is defined as</p> $\text{deltaGNSS-TOD} = \text{gnss-TOD-msec} - \text{fix}(\text{tsv}_1)$ <p>where <i>fix()</i> denotes rounding to the nearest integer towards zero.</p>
<p>nbPhysCellId</p> <p>This field identifies the reference cell, as defined in TS 36.331 [12] that is used for the GNSS-network time relation.</p>
<p>nbCellGlobalId</p> <p>This field specifies the global cell identifier of the NB-IoT reference cell, as defined in TS 36.331 [12], for which the GNSS network time relation is provided.</p>
<p>sfn</p> <p>This field specifies the system frame number in NB-IoT which the GNSS time time stamps, as defined in TS 36.331 [12].</p>
<p>hyperSFN</p> <p>This field specifies the hyper-SFN in NB-IoT which the GNSS time time stamps, as defined in TS 36.331 [12].</p>
<p>nrPhysCellId</p> <p>This field identifies the reference cell (NR), as defined in TS 38.331 [35], that is used for the GNSS-network time relation.</p>
<p>nrCellGlobalId</p> <p>This field specifies the NR Cell Global Identifier (NCGI) of the reference cell, as defined in TS 38.331 [35], for which the GNSS network time relation is provided.</p>
<p>nr-sfn</p> <p>This field specifies the system frame number in NR which the GNSS time time stamps, as defined in TS 38.331 [35].</p>

Value of K to Value of uncertainty relation

Value of K	Value of uncertainty
0	0 microseconds
1	0.07 microseconds
2	0.1498 microseconds
-	-
50	349.62 microseconds
-	-
127	≥ 8430000 microseconds

– GNSS-MeasurementList

The IE *GNSS-MeasurementList* is used by the target device to provide measurements of code phase, Doppler, C/N_0 and optionally accumulated carrier phase, also called accumulated deltarange (ADR).

```
-- ASN1START
GNSS-MeasurementList ::= SEQUENCE (SIZE(1..16)) OF GNSS-MeasurementForOneGNSS
GNSS-MeasurementForOneGNSS ::= SEQUENCE {
    gnss-ID                GNSS-ID,
    gnss-SgnMeasList       GNSS-SgnMeasList,
    ...
}
GNSS-SgnMeasList ::= SEQUENCE (SIZE(1..8)) OF GNSS-SgnMeasElement
GNSS-SgnMeasElement ::= SEQUENCE {
    gnss-SignalID          GNSS-SignalID,
```

```

    gnss-CodePhaseAmbiguity INTEGER (0..127)          OPTIONAL,
    gnss-SatMeasList       GNSS-SatMeasList,
    ...
}

GNSS-SatMeasList ::= SEQUENCE (SIZE(1..64)) OF GNSS-SatMeasElement

GNSS-SatMeasElement ::= SEQUENCE {
    svID                SV-ID,
    cNo                 INTEGER (0..63),
    mpathDet            ENUMERATED {notMeasured (0), low (1), medium (2), high (3), ...},
    carrierQualityInd   INTEGER (0..3)              OPTIONAL,
    codePhase           INTEGER (0..2097151),
    integerCodePhase    INTEGER (0..127)           OPTIONAL,
    codePhaseRMSError   INTEGER (0..63),
    doppler             INTEGER (-32768..32767)    OPTIONAL,
    adr                 INTEGER (0..33554431)      OPTIONAL,
    ...
    [[
        adrMSB-r15      INTEGER (0..15)           OPTIONAL,
        adrSign-r15     ENUMERATED {positive, negative} OPTIONAL,
        adrRMSerror-r15 INTEGER (0..127)          OPTIONAL,
        delta-codePhase-r15 INTEGER (0..7)        OPTIONAL
    ]]
}

-- ASN1STOP

```

GNSS-MeasurementList field descriptions

gnss-ID

This field identifies the GNSS constellation on which the GNSS signal measurements were measured. Measurement information for up to 16 GNSSs can be included.

gnss-SgnMeasList

This list provides GNSS signal measurement information for up to 8 GNSS signal types per GNSS.

gnss-SignalID

This field identifies the signal on which GNSS signal measurement parameters were measured.

gnss-CodePhaseAmbiguity

This field provides the ambiguity of the code phase measurement. It is given in units of milli-seconds in the range between 0 and 127 milli-seconds.

The total code phase for a satellite k (Satk) is given modulo this *gnss-CodePhaseAmbiguity* and is reconstructed with:
 $Code_Phase_Tot(Satk) = codePhase(Satk) + integerCodePhase(Satk) + n * gnss-CodePhaseAmbiguity$, $n = 0, 1, 2, \dots$
 If there is no code phase ambiguity, the *gnss-CodePhaseAmbiguity* shall be set to 0.

The field is optional. If *gnss-CodePhaseAmbiguity* is absent, the default value is 1 milli-second.

gnss-SatMeasList

This list provides GNSS signal measurement information for up to 64 GNSS satellites.

svID

This field identifies the satellite on which the GNSS signal measurements were measured.

cNo

This field provides an estimate of the carrier-to-noise ratio of the received signal from the particular satellite. The target device shall set this field to the value of the satellite C/N_0 , as referenced to the antenna connector, in units of 1 dB-Hz, in the range from 0 to 63 dB-Hz.

Scale factor 1 dB-Hz.

mpathDet

This field contains the multipath indicator value, defined in the table Value of *mpathDet* to Multipath Indication relation below.

GNSS-MeasurementList field descriptions	
carrierQualityInd	
If the fields <i>adrMSB</i> , <i>adrSign</i> , <i>adrRMSError</i> , and <i>delta-codePhase</i> are not present: This field indicates the quality of a carrier phase measurement. The LSB indicates the data polarity, that is, if the data from a specific satellite is received inverted, this is indicated by setting the LSB value to '1'. In the case the data is not inverted, the LSB is set to '0'. The MSB indicates if accumulation of the carrier phase has been continuous, that is, without cycle slips since the previous measurement report. If the carrier phase accumulation has been continuous, the MSB value is set to '1X'. Otherwise, the MSB is set to '0X'. This field is optional but shall be included if the <i>adr</i> field is included. See table Bit to Polarity Indication relation below. If any of the fields <i>adrMSB</i> , <i>adrSign</i> , <i>adrRMSError</i> , or <i>delta-codePhase</i> are present: This field indicates the quality of a carrier phase measurement. The LSB indicates the half-cycle ambiguity, that is, if there are no half-cycle ambiguities present in the ADR measurement report the LSB is set to '0'. In the case there are half-cycle ambiguities present in the ADR measurement report the LSB is set to '1'. When reporting ADR with unresolved polarity encoding the target device shall set this bit to 1. The MSB indicates if accumulation of the carrier phase has been continuous, that is, without cycle slips since the previous measurement report. If the carrier phase accumulation has been continuous (no cycle slips), the MSB value is set to '1X'. Otherwise, the MSB is set to '0X'. If polarity resolution forced the ADR measurement to be corrected by half-a-cycle, then the MSB must be set to '0', indicating that despite continuous tracking the reported ADR experienced non-continuity. See table Bit to Ambiguity Indication relation below. The target device shall include this field if the <i>adr</i> field is included.	
codePhase	
This field contains the whole and fractional value of the code-phase measurement made by the target device for the particular satellite signal at the time of measurement in the units of ms. GNSS specific code phase measurements (e.g. chips) are converted into unit of ms by dividing the measurements by the nominal values of the measured signal chipping rate. Scale factor 2^{-21} milli-seconds, in the range from 0 to $(1-2^{-21})$ milli-seconds.	
integerCodePhase	
This field indicates the integer milli-second part of the code phase that is expressed modulo the <i>gnss-CodePhaseAmbiguity</i> . The value of the ambiguity is given in the <i>gnss-CodePhaseAmbiguity</i> field. The <i>integerCodePhase</i> is optional. If <i>integerCodePhase</i> is absent, the default value is 0 milli-second. Scale factor 1 milli-second, in the range from 0 to 127 milli-seconds.	
codePhaseRMSError	
This field contains the pseudorange RMS error value. This parameter is specified according to a floating-point representation shown in the table below.	
doppler	
This field contains the Doppler measured by the target device for the particular satellite signal. This information can be used to compute the 3-D velocity of the target device. Doppler measurements are converted into unit of m/s by multiplying the Doppler measurement in Hz by the nominal wavelength of the measured signal. Scale factor 0.04 metre/second. This field is optional, but shall be included, if the <i>velocityRequest</i> in <i>CommonIESRequestLocationInformation</i> is set to TRUE.	
adr	
This field contains the absolute value of the ADR measurement measured by the target device for the particular satellite signal. This information can be used to compute the 3-D velocity or high-accuracy position of the target device. ADR measurements are converted into units of metre by multiplying the ADR measurement by the nominal wavelength of the measured signal. Scale factor 2^{-10} metres, in the range from 0 to 32767.5 metres. This field is optional, but shall be included, if the <i>adrMeasReq</i> in <i>GNSS-PositioningInstructions</i> is set to TRUE and if ADR measurements are supported by the target device (i.e., <i>adr-Support</i> is set to TRUE in <i>A-GNSS-ProvideCapabilities</i>).	
adrMSB	
This field contains the 4-MSBs of the ADR measurement in the case the ADR measurement is outside the range of the field <i>adr</i> alone. Scale factor 32768 metres. If present, the full ADR measurement is constructed as $adrMSB \times 32768 + adr \times 2^{-10}$ metres, representing measurements in the range from 0 to 524287.9990234375 metres. This field is optional, but shall be included, if the capability <i>adrEnhancementsSupport</i> is set to TRUE and the ADR measurement is outside the range of the <i>adr</i> field.	
adrSign	
This field indicates the sign of the ADR measurement.	
adrRMSError	
This field contains the ADR root mean squared error value. Scale factor 2^{-10} metres.	
delta-codePhase	
This field specifies the higher resolution of the <i>codePhase</i> measurement. Scale factor 2^{-24} milli-seconds. The full code phase measurement is constructed as $codePhase \times 2^{-21} + delta-codePhase \times 2^{-24}$ milli-seconds, in the range from 0 to $(1-2^{-24})$ milli-seconds.	

Value of *mpathDet* to Multipath Indication relation

Value of	Multipath Indication
----------	----------------------

<i>mpathDet</i>	
00	Not measured
01	Low, MP error < 5m
10	Medium, 5m < MP error < 43m
11	High, MP error > 43m

Bit to Polarity Indication relation

Value	Polarity Indication
0	Data Direct, carrier phase not continuous
1	Data Inverted, carrier phase not continuous
2	Data Direct, carrier phase continuous
3	Data Inverted, carrier phase continuous

Bit to Ambiguity Indication relation

Value	Value MSB, LSB	Polarity Indication
0	00	carrier phase not continuous, no half-cycle ambiguity
1	01	carrier phase not continuous, half-cycle ambiguity
2	10	carrier phase continuous, no half-cycle ambiguity
3	11	carrier phase continuous, half-cycle ambiguity

floating-point representation

Index	Mantissa	Exponent	Floating-Point value, x_i	Pseudorange value, P
0	000	000	0.5	$P < 0.5$
1	001	000	0.5625	$0.5 \leq P < 0.5625$
l	x	y	$0.5 * (1 + x/8) * 2^y$	$x_{i-1} \leq P < x_i$
62	110	111	112	$104 \leq P < 112$
63	111	111	--	$112 \leq P$

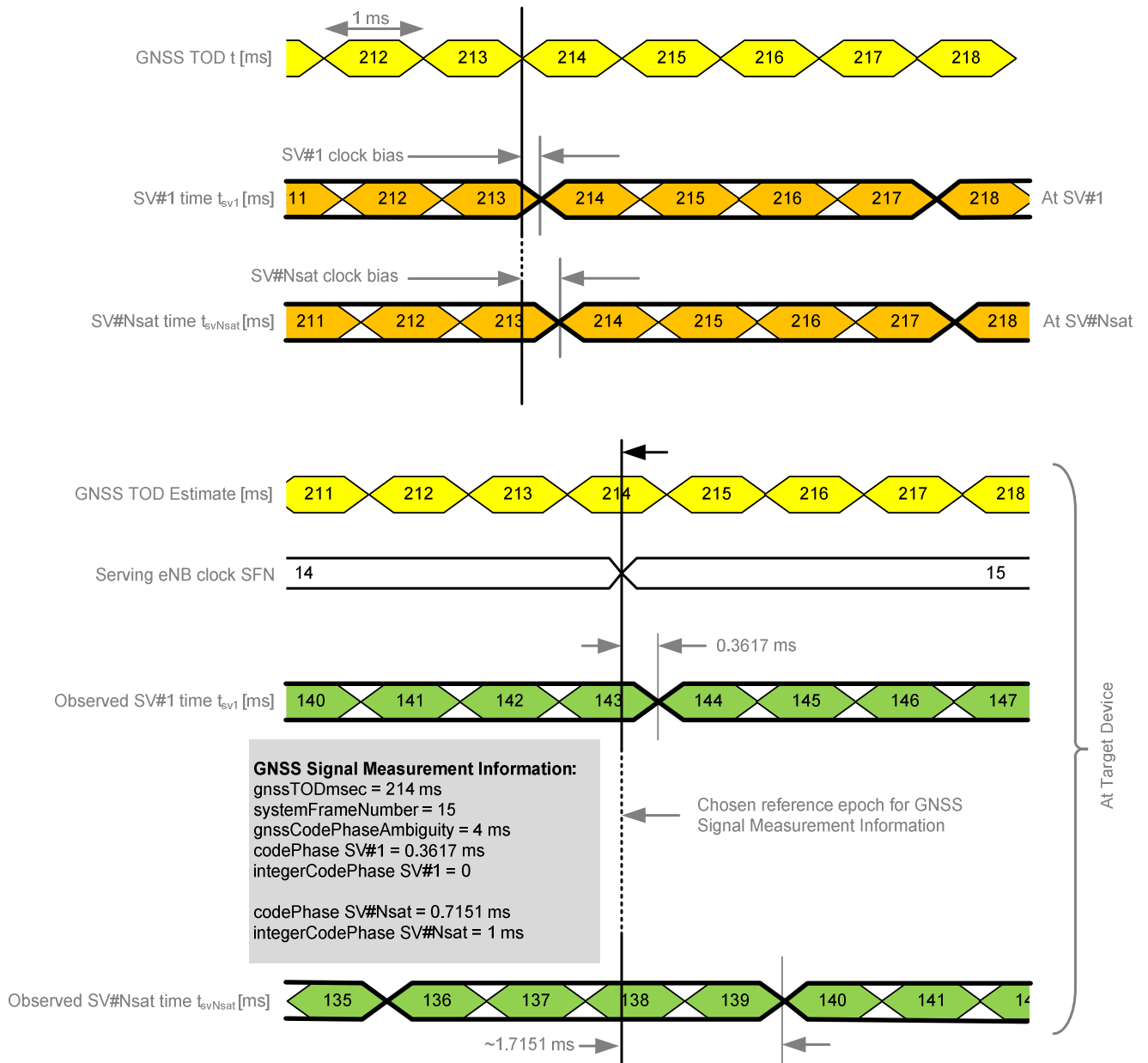

Figure 6.5.2.6-1: Exemplary calculation of some GNSS Signal Measurement Information fields.

GNSS-LocationInformation

The IE *GNSS-LocationInformation* is included by the target device when location and optionally velocity information derived using GNSS or hybrid GNSS and other measurements is provided to the location server.

```

-- ASN1START
GNSS-LocationInformation ::= SEQUENCE {
    measurementReferenceTime      MeasurementReferenceTime,
    agnss-List                    GNSS-ID-Bitmap,
    ...
    [[
        ha-GNSS-Metrics-r17      HA-GNSS-Metrics-r17      OPTIONAL
    ]]
}
-- ASN1STOP
    
```

GNSS-LocationInformation field descriptions
<p>measurementReferenceTime This field specifies the GNSS system time for which the location estimate and optionally velocity are valid. It may also include GNSS-network time relationship, if requested by the location server and supported by the target device.</p>
<p>agnss-List This field provides a list of satellite systems used by the target device to calculate the location estimate and velocity estimate, if included. This is represented by a bit string in <i>GNSS-ID-Bitmap</i>, with a one-value at the bit position means the particular method has been used; a zero-value means not used.</p>
<p>ha-GNSS-Metrics This field provides high accuracy GNSS positioning metrics associated to the reported location estimate.</p>

– HA-GNSS-Metrics

The IE *HA-GNSS-Metrics* is included by the target device when high accuracy GNSS positioning metrics associated to a location estimate is provided to the location server. The parameters provided in IE *HA-GNSS-Metrics* are used as specified for sentence type GGA in [51] and apply to all GNSSs and types of high accuracy GNSS assistance data.

```
-- ASN1START
HA-GNSS-Metrics-r17 ::= SEQUENCE {
    nrOfUsedSatellites-r17  INTEGER (0..64),
    hdopi-r17               INTEGER (1..256)           OPTIONAL,
    pdopi-r17               INTEGER (1..256)           OPTIONAL,
    age-r17                 INTEGER (0..99)             OPTIONAL,
    fixType-r17             ENUMERATED {carrier-phase-float,
                                        carrier-phase-fix, ...}  OPTIONAL,
    ...
}
-- ASN1STOP
```

HA-GNSS-Metrics field descriptions
<p>nrOfUsedSatellites This field specifies number of used GNSS satellites for the location estimate provided by the target device.</p>
<p>hdopi This field specifies the horizontal dilution of precision for the location estimate, scale factor 0.1.</p>
<p>pdopi This field specifies the 3D position dilution of precision, scale factor 0.1.</p>
<p>age This field, if supported by the device, specifies the age of the most recent used assistance data for high accuracy GNSS, scale factor 0.1 second.</p>
<p>fixType This field specifies the positioning fix type, based on the positioning fix quality indicators RTK float and RTK fix of [51]. Specifically:</p> <ul style="list-style-type: none"> - <i>carrier-phase-float</i> - converged carrier phase floating point ambiguity resolution - <i>carrier-phase-fix</i> - converging carrier phase integer ambiguity resolution

6.5.2.7 GNSS Location Information Request

– A-GNSS-RequestLocationInformation

The IE *A-GNSS-RequestLocationInformation* is used by the location server to request location information from the target device using GNSS.

```
-- ASN1START
A-GNSS-RequestLocationInformation ::= SEQUENCE {
    gnss-PositioningInstructions  GNSS-PositioningInstructions,
    ...
}
-- ASN1STOP
```

6.5.2.8 GNSS Location Information Request Elements

– *GNSS-PositioningInstructions*

The IE *GNSS-PositioningInstructions* is used to provide GNSS measurement instructions.

```
-- ASN1START
GNSS-PositioningInstructions ::= SEQUENCE {
  gnss-Methods          GNSS-ID-Bitmap,
  fineTimeAssistanceMeasReq  BOOLEAN,
  adrMeasReq           BOOLEAN,
  multiFreqMeasReq     BOOLEAN,
  assistanceAvailability  BOOLEAN,
  ...
  [[
    ha-GNSS-Req-r15      ENUMERATED { true }    OPTIONAL  -- Cond UEB
  ]],
  [[
    ha-GNSS-MetricsReq-r17  ENUMERATED { true }  OPTIONAL  -- Cond UEB
  ]]
}
-- ASN1STOP
```

Conditional presence	Explanation
<i>UEB</i>	The field is optionally present, need OP, if the <i>locationInformationType</i> is set to <i>locationEstimateRequired</i> , <i>locationEstimatePreferred</i> , or <i>locationMeasurementsPreferred</i> ; otherwise it is not present.

***GNSS-PositioningInstructions* field descriptions**

<i>gnssMethods</i>	This field indicates the satellite systems allowed by the location server. This is represented by a bit string in <i>GNSS-ID-Bitmap</i> , with a one-value at the bit position means the particular GNSS is allowed; a zero-value means not allowed. The target device shall not request assistance data or report or obtain measurements for systems that are not indicated in this bit map. At least one of the bits in this bit map shall be set to value one.
<i>fineTimeAssistanceMeasReq</i>	This field indicates whether the target device is requested to report GNSS-network time association. TRUE means requested.
<i>adrMeasReq</i>	This field indicates whether the target device is requested to include ADR measurements in <i>GNSS-MeasurementList</i> IE or not. TRUE means requested.
<i>multiFreqMeasReq</i>	This field indicates whether the target device is requested to report measurements on multiple supported GNSS signal types in <i>GNSS-MeasurementList</i> IE or not. TRUE means requested.
<i>assistanceAvailability</i>	This field indicates whether the target device may request additional GNSS assistance data from the server. TRUE means allowed and FALSE means not allowed.
<i>ha-GNSS-Req</i>	This field, if present, indicates that any location estimate provided by the target device should be obtained using high accuracy RTK/PPP methods.
<i>ha-GNSS-MetricsReq</i>	This field, if present, indicates that any location estimate provided by the target device should be reported with high accuracy GNSS positioning metrics.

6.5.2.9 GNSS Capability Information

– *A-GNSS-ProvideCapabilities*

The IE *A-GNSS-Provide-Capabilities* is used by the target device to indicate its capability to support A-GNSS and to provide its A-GNSS location capabilities (e.g., GNSSs and assistance data supported) to the location server.

```
-- ASN1START
A-GNSS-ProvideCapabilities ::= SEQUENCE {
```

```

gnss-SupportList          GNSS-SupportList          OPTIONAL,
assistanceDataSupportList AssistanceDataSupportList  OPTIONAL,
locationCoordinateTypes   LocationCoordinateTypes  OPTIONAL,
velocityTypes             VelocityTypes             OPTIONAL,
...
[[ periodicalReportingNotSupported-r14
    PositioningModes          OPTIONAL,
    idleStateForMeasurements-r14
    ENUMERATED { required }  OPTIONAL
]],
[[ periodicAssistanceData-r15
    BIT STRING { solicited (0),
                unsolicited (1) } (SIZE (1..8))  OPTIONAL
]],
[[ scheduledLocationRequestSupported-r17
    ScheduledLocationTimeSupportPerMode-r17          OPTIONAL
]]
}

GNSS-SupportList ::= SEQUENCE (SIZE(1..16)) OF GNSS-SupportElement

GNSS-SupportElement ::= SEQUENCE {
    gnss-ID          GNSS-ID,
    sbas-IDs         SBAS-IDs          OPTIONAL,    -- Cond GNSS-ID-SBAS
    agnss-Modes     PositioningModes,
    gnss-Signals    GNSS-SignalIDs,
    fta-MeasSupport SEQUENCE {
        cellTime    AccessTypes,
        mode        PositioningModes,
        ...
    }          OPTIONAL,    -- Cond fta
    adr-Support     BOOLEAN,
    velocityMeasurementSupport
    BOOLEAN,
    ...
    [[
        adrEnhancementsSupport-r15  ENUMERATED { true }    OPTIONAL,
        ha-gnss-Modes-r15           PositioningModes    OPTIONAL
    ]],
    [[
        ha-gnss-MetricsSupport-r17  ENUMERATED { true }    OPTIONAL
    ]]
}

AssistanceDataSupportList ::= SEQUENCE {
    gnss-CommonAssistanceDataSupport  GNSS-CommonAssistanceDataSupport,
    gnss-GenericAssistanceDataSupport  GNSS-GenericAssistanceDataSupport,
    ...
}

-- ASN1STOP

```

Conditional presence	Explanation
<i>GNSS-ID-SBAS</i>	The field is mandatory present if the <i>GNSS-ID = sbas</i> ; otherwise it is not present.
<i>fta</i>	The field is mandatory present if the target device supports the reporting of fine time assistance measurements; otherwise it is not present.

A-GNSS-ProvideCapabilities field descriptions	
<i>gnss-SupportList</i>	This field specifies the list of GNSS supported by the target device and the target device capabilities associated with each of the supported GNSS. This field shall be present if the <i>gnss-SupportListReq</i> in the A-GNSS - <i>RequestCapabilities</i> IE is set to TRUE and if the target device supports the A-GNSS positioning method. If the IE <i>A-GNSS-Provide-Capabilities</i> is provided unsolicited, this field shall be included if the target device supports the assisted GNSS positioning method.
<i>gnss-ID</i>	This field specifies the GNSS supported by the target device for which the capabilities in <i>GNSS-SupportElement</i> are provided.
<i>sbas-IDs</i>	This field specifies the SBAS(s) supported by the target device. This is represented by a bit string, with a one-value at the bit position means the particular SBAS is supported; a zero-value means not supported.

A-GNSS-ProvideCapabilities field descriptions
<p>agnss-Modes This field specifies the GNSS mode(s) supported by the target device for the GNSS indicated by <i>gnss-ID</i>. This is represented by a bit string, with a one-value at the bit position means the particular GNSS mode is supported; a zero-value means not supported.</p>
<p>gnss-Signals This field specifies the GNSS signal(s) supported by the target device for the GNSS indicated by <i>gnss-ID</i>. This is represented by a bit string, with a one-value at the bit position means the particular GNSS signal type is supported; a zero-value means not supported.</p>
<p>fta-MeasSupport This field specifies that the target device is capable of performing fine time assistance measurements (i.e., GNSS-cellular time association reporting). The <i>cellTime</i> field specifies for which cellular network(s) this capability is supported. This is represented by a bit string, with a one-value at the bit position means FTA measurements for the specific cellular network time is supported; a zero-value means not supported. The <i>mode</i> field specifies for which GNSS mode(s) FTA measurements are supported by the target device. This is represented by a bit string, with a one-value at the bit position means FTA measurements for the GNSS mode is supported; a zero-value means not supported.</p>
<p>adr-Support This field specifies whether the target device supports ADR measurement reporting. TRUE means supported.</p>
<p>velocityMeasurementSupport This field specifies whether the target device supports measurement reporting related to velocity. TRUE means supported.</p>
<p>assistanceDataSupportList This list defines the assistance data and assistance data choices supported by the target device. This field shall be present if the <i>assistanceDataSupportListReq</i> in the A-GNSS-RequestCapabilities IE is set to TRUE and if the target device supports GNSS assistance data. If the IE A-GNSS-Provide-Capabilities is provided unsolicited, this field shall be included if the target device supports any GNSS assistance data.</p>
<p>locationCoordinateTypes This parameter identifies the geographical location coordinate types that a target device supports for GNSS. TRUE indicates that a location coordinate type is supported and FALSE that it is not. This field shall be present if the <i>locationVelocityTypesReq</i> in the A-GNSS-RequestCapabilities IE is set to TRUE and if the target device supports UE-based or standalone GNSS positioning method. If the IE A-GNSS-Provide-Capabilities is provided unsolicited, this field shall be included if the target device supports UE-based or standalone GNSS positioning method.</p>
<p>velocityTypes This parameter identifies the velocity types that a target device supports for GNSS. TRUE indicates that a velocity type is supported and FALSE that it is not. FALSE for all velocity types indicates that velocity reporting is not supported. This field shall be present if the <i>locationVelocityTypesReq</i> in the A-GNSS-RequestCapabilities IE is set to TRUE and if the target device supports UE-based or standalone GNSS positioning method. If the IE A-GNSS-Provide-Capabilities is provided unsolicited, this field shall be included if the target device supports UE-based or standalone GNSS positioning method.</p>
<p>periodicalReportingNotSupported This field, if present, specifies the positioning modes for which the target device does not support <i>periodicalReporting</i>. This is represented by a bit string, with a one-value at the bit position means <i>periodicalReporting</i> for the positioning mode is not supported; a zero-value means supported. If this field is absent, the location server may assume that the target device supports <i>periodicalReporting</i> in <i>CommonIEsRequestLocationInformation</i> for each supported positioning mode.</p>
<p>idleStateForMeasurements This field, if present, indicates that the target device requires idle state to perform GNSS measurements.</p>
<p>periodicAssistanceData This field identifies the periodic assistance data delivery procedures supported by the target device. This is represented by a bit string, with a one value at the bit position means the periodic assistance data delivery procedure is supported; a zero value means not supported. Bit 0 (solicited) represents the procedure according to clause 5.2.1a; bit (1) (unsolicited) represents the procedure according to clause 5.2.2a.</p>
<p>adrEnhancementsSupport This field, if present, indicates that the target device supports the fields <i>adrMSB</i>, <i>adrSign</i>, <i>adrRMSerror</i>, and <i>delta-codePhase</i> in IE <i>GNSS-MeasurementList</i>. This field may only be present if <i>adr-Support</i> is set to TRUE, and shall be absent if <i>adr-Support</i> is set to FALSE.</p>
<p>ha-gnss-Modes This field specifies the High-Accuracy GNSS mode(s) supported by the target device for the GNSS indicated by <i>gnss-ID</i>. This is represented by a bit string, with a one-value at the bit position means the particular GNSS mode is supported; a zero-value means not supported.</p>
<p>ha-gnss-MetricsSupport This field specifies that high accuracy GNSS positioning metrics are supported by the target device.</p>
<p>scheduledLocationRequestSupported This field, if present, specifies the positioning modes for which the target device supports scheduled location requests – i.e., supports the IE <i>ScheduledLocationTime</i> in IE <i>CommonIEsRequestLocationInformation</i> – and the time base(s) supported for the scheduled location time for each positioning mode. If this field is absent, the target device does not support scheduled location requests.</p>

6.5.2.10 GNSS Capability Information Elements

– GNSS-CommonAssistanceDataSupport

The IE *GNSS-CommonAssistanceDataSupport* is used by the target device to provide information on supported GNSS common assistance data types to the location server.

```

-- ASN1START
GNSS-CommonAssistanceDataSupport ::= SEQUENCE {
    gnss-ReferenceTimeSupport          GNSS-ReferenceTimeSupport
                                     OPTIONAL, -- Cond RefTimeSup
    gnss-ReferenceLocationSupport      GNSS-ReferenceLocationSupport
                                     OPTIONAL, -- Cond RefLocSup
    gnss-IonosphericModelSupport       GNSS-IonosphericModelSupport
                                     OPTIONAL, -- Cond IonoModSup
    gnss-EarthOrientationParametersSupport GNSS-EarthOrientationParametersSupport
                                     OPTIONAL, -- Cond EOPSup
    ...
    [[
        gnss-RTK-ReferenceStationInfoSupport-r15
                                     GNSS-RTK-ReferenceStationInfoSupport-r15
                                     OPTIONAL, -- Cond ARPSup
        gnss-RTK-AuxiliaryStationDataSupport-r15
                                     GNSS-RTK-AuxiliaryStationDataSupport-r15
                                     OPTIONAL -- Cond AuxARPSup
    ]],
    [[
        gnss-Integrity-ServiceParametersSupport-r17
                                     GNSS-Integrity-ServiceParametersSupport-r17
                                     OPTIONAL, -- Cond IntServiceSup
        gnss-Integrity-ServiceAlertSupport-r17
                                     GNSS-Integrity-ServiceAlertSupport-r17
                                     OPTIONAL -- Cond IntAlertSup
    ]]
}
-- ASN1STOP

```

Conditional presence	Explanation
<i>RefTimeSup</i>	The field is mandatory present if the target device supports <i>GNSS-ReferenceTime</i> ; otherwise it is not present.
<i>RefLocSup</i>	This field is mandatory present if the target device supports <i>GNSS-ReferenceLocation</i> ; otherwise it is not present.
<i>IonoModSup</i>	This field is mandatory present if the target device supports <i>GNSS-IonosphericModel</i> ; otherwise it is not present.
<i>EOPSup</i>	This field is mandatory present if the target device supports <i>GNSS-EarthOrientationParameters</i> ; otherwise it is not present.
<i>ARPSup</i>	This field is mandatory present if the target device supports <i>GNSS-RTK-ReferenceStationInfo</i> ; otherwise it is not present.
<i>AuxARPSup</i>	This field is mandatory present if the target device supports <i>GNSS-RTK-AuxiliaryStationData</i> ; otherwise it is not present.
<i>IntServiceSup</i>	This field is mandatory present if the target device supports <i>GNSS-Integrity-ServiceParameters</i> ; otherwise it is not present.
<i>IntAlertSup</i>	This field is mandatory present if the target device supports <i>GNSS-Integrity-ServiceAlert</i> ; otherwise it is not present.

– GNSS-ReferenceTimeSupport

```

-- ASN1START
GNSS-ReferenceTimeSupport ::= SEQUENCE {
    gnss-SystemTime      GNSS-ID-Bitmap,
    fta-Support           AccessTypes
                                     OPTIONAL, -- Cond fta
    ...
}

```

```
-- ASN1STOP
```

Conditional presence	Explanation
<i>fta</i>	The field is mandatory present if the target device supports fine time assistance in <i>GNSSReferenceTime</i> IE; otherwise it is not present.

GNSS-ReferenceTimeSupport field descriptions

gnss-SystemTime

This field specifies the GNSS system time(s) supported by the target device. This is represented by a bit string in *GNSS-ID-Bitmap*, with a one-value at the bit position means the particular GNSS system time is supported; a zero-value means not supported.

fta-Support

This field specifies that the target device supports fine time assistance (i.e., GNSS-cellular time association) in *GNSS-ReferenceTime* IE. This is represented by a bit string in *AccessTypes*, with a one-value at the bit position means FTA for the specific cellular network time is supported; a zero-value means not supported.

– *GNSS-ReferenceLocationSupport*

```
-- ASN1START
GNSS-ReferenceLocationSupport ::= SEQUENCE {
    ...
}
-- ASN1STOP
```

– *GNSS-IonosphericModelSupport*

```
-- ASN1START
GNSS-IonosphericModelSupport ::= SEQUENCE {
    ionoModel BIT STRING {
        klobuchar (0),
        neQuick (1),
        klobuchar2-r16 (2) } (SIZE (1..8)),
    ...
}
-- ASN1STOP
```

GNSS-IonosphericModelSupport field descriptions

ionoModel

This field specifies the ionospheric model(s) supported by the target device. This is represented by a bit string, with a one-value at the bit position means the particular ionospheric model is supported; a zero-value means not supported.

– *GNSS-EarthOrientationParametersSupport*

```
-- ASN1START
GNSS-EarthOrientationParametersSupport ::= SEQUENCE {
    ...
}
-- ASN1STOP
```

– *GNSS-RTK-ReferenceStationInfoSupport*

```
-- ASN1START
GNSS-RTK-ReferenceStationInfoSupport-r15 ::= SEQUENCE {
    ...
}
-- ASN1STOP
```

```
-- ASN1STOP
```

– *GNSS-RTK-AuxiliaryStationDataSupport*

```
-- ASN1START
GNSS-RTK-AuxiliaryStationDataSupport-r15 ::= SEQUENCE {
    ...
}
-- ASN1STOP
```

– *GNSS-Integrity-ServiceParametersSupport*

```
-- ASN1START
GNSS-Integrity-ServiceParametersSupport-r17 ::= SEQUENCE {
    ...
}
-- ASN1STOP
```

– *GNSS-Integrity-ServiceAlertSupport*

```
-- ASN1START
GNSS-Integrity-ServiceAlertSupport-r17 ::= SEQUENCE {
    ...
}
-- ASN1STOP
```

– *GNSS-GenericAssistanceDataSupport*

The IE *GNSS-GenericAssistanceDataSupport* is used by the target device to provide information on supported GNSS generic assistance data types to the location server for each supported GNSS.

```
-- ASN1START
GNSS-GenericAssistanceDataSupport ::=
    SEQUENCE (SIZE (1..16)) OF GNSS-GenericAssistDataSupportElement
GNSS-GenericAssistDataSupportElement ::= SEQUENCE {
    gnss-ID                GNSS-ID,
    sbas-ID                SBAS-ID                OPTIONAL, -- Cond GNSS-ID-SBAS
    gnss-TimeModelsSupport GNSS-TimeModelListSupport
                                OPTIONAL, -- Cond TimeModSup
    gnss-DifferentialCorrectionsSupport GNSS-DifferentialCorrectionsSupport
                                OPTIONAL, -- Cond DGNSS-Sup
    gnss-NavigationModelSupport GNSS-NavigationModelSupport
                                OPTIONAL, -- Cond NavModSup
    gnss-RealTimeIntegritySupport GNSS-RealTimeIntegritySupport
                                OPTIONAL, -- Cond RTISup
    gnss-DataBitAssistanceSupport GNSS-DataBitAssistanceSupport
                                OPTIONAL, -- Cond DataBitsSup
    gnss-AcquisitionAssistanceSupport GNSS-AcquisitionAssistanceSupport
                                OPTIONAL, -- Cond AcquAssistSup
    gnss-AlmanacSupport     GNSS-AlmanacSupport
                                OPTIONAL, -- Cond AlmanacSup
    gnss-UTC-ModelSupport   GNSS-UTC-ModelSupport
                                OPTIONAL, -- Cond UTCModSup
    gnss-AuxiliaryInformationSupport GNSS-AuxiliaryInformationSupport
                                OPTIONAL, -- Cond AuxInfoSup
    ...
    [[
        bds-DifferentialCorrectionsSupport-r12
                                BDS-DifferentialCorrectionsSupport-r12
                                OPTIONAL, -- Cond DBDS-Sup
    ]]
```



```

    bds-GridModelSupport-r12          BDS-GridModelSupport-r12          OPTIONAL -- Cond BDS-GridModSup
  ]],
  [[
    gnss-RTK-ObservationsSupport-r15  GNSS-RTK-ObservationsSupport-r15  OPTIONAL, -- Cond RTK-OSR-Sup
    glo-RTK-BiasInformationSupport-r15  GLO-RTK-BiasInformationSupport-r15  OPTIONAL, -- Cond GLO-CPB-Sup
    gnss-RTK-MAC-CorrectionDifferencesSupport-r15  GNSS-RTK-MAC-CorrectionDifferencesSupport-r15  OPTIONAL, -- Cond MAC-Sup
    gnss-RTK-ResidualsSupport-r15      GNSS-RTK-ResidualsSupport-r15      OPTIONAL, -- Cond Res-Sup
    gnss-RTK-FKP-GradientsSupport-r15   GNSS-RTK-FKP-GradientsSupport-r15   OPTIONAL, -- Cond FKP-Sup
    gnss-SSR-OrbitCorrectionsSupport-r15  GNSS-SSR-OrbitCorrectionsSupport-r15  OPTIONAL, -- Cond OC-Sup
    gnss-SSR-ClockCorrectionsSupport-r15  GNSS-SSR-ClockCorrectionsSupport-r15  OPTIONAL, -- Cond CC-Sup
    gnss-SSR-CodeBiasSupport-r15        GNSS-SSR-CodeBiasSupport-r15        OPTIONAL -- Cond CB-Sup
  ]],
  [[
    gnss-SSR-URA-Support-r16          GNSS-SSR-URA-Support-r16          OPTIONAL, -- Cond URA-Sup
    gnss-SSR-PhaseBiasSupport-r16      GNSS-SSR-PhaseBiasSupport-r16      OPTIONAL, -- Cond PB-Sup
    gnss-SSR-STECCorrectionSupport-r16  GNSS-SSR-STECCorrectionSupport-r16  OPTIONAL, -- Cond STEC-Sup
    gnss-SSR-GriddedCorrectionSupport-r16  GNSS-SSR-GriddedCorrectionSupport-r16  OPTIONAL, -- Cond Grid-Sup
    navic-DifferentialCorrectionsSupport-r16  NavIC-DifferentialCorrectionsSupport-r16  OPTIONAL, -- Cond DNavIC-Sup
    navic-GridModelSupport-r16         NavIC-GridModelSupport-r16         OPTIONAL -- Cond NavIC-GridModSup
  ]],
  [[
    gnss-SSR-OrbitCorrectionsSet2Support-r17  GNSS-SSR-OrbitCorrectionsSet2Support-r17  OPTIONAL, -- Cond OC2-Sup
    gnss-SSR-ClockCorrectionsSet2Support-r17  GNSS-SSR-ClockCorrectionsSet2Support-r17  OPTIONAL, -- Cond CC2-Sup
    gnss-SSR-URA-Set2Support-r17          GNSS-SSR-URA-Set2Support-r17          OPTIONAL -- Cond URA2-Sup
  ]],
}
-- ASN1STOP

```

Conditional presence	Explanation
<i>GNSS-ID-SBAS</i>	The field is mandatory present if the <i>GNSS-ID = sbas</i> ; otherwise it is not present.
<i>TimeModSup</i>	The field is mandatory present if the target device supports <i>GNSS-TimeModelList</i> ; otherwise it is not present.
<i>DGNSS-Sup</i>	The field is mandatory present if the target device supports <i>GNSS-DifferentialCorrections</i> ; otherwise it is not present.
<i>NavModSup</i>	The field is mandatory present if the target device supports <i>GNSS-NavigationModel</i> ; otherwise it is not present.
<i>RTISup</i>	The field is mandatory present if the target device supports <i>GNSS-RealTimeIntegrity</i> ; otherwise it is not present.
<i>DataBitsSup</i>	The field is mandatory present if the target device supports <i>GNSS-DataBitAssistance</i> ; otherwise it is not present.
<i>AcquAssistSup</i>	The field is mandatory present if the target device supports <i>GNSS-AcquisitionAssistance</i> ; otherwise it is not present.
<i>AlmanacSup</i>	The field is mandatory present if the target device supports <i>GNSS-Almanac</i> ; otherwise it is not present.

Conditional presence	Explanation
<i>UTCModSup</i>	The field is mandatory present if the target device supports <i>GNSS-UTC-Model</i> ; otherwise it is not present.
<i>AuxInfoSup</i>	The field is mandatory present if the target device supports <i>GNSS-AuxiliaryInformation</i> ; otherwise it is not present.
<i>DBDS-Sup</i>	The field is mandatory present if the target device supports <i>BDS-DifferentialCorrections</i> ; otherwise it is not present. This field may only be present if <i>gnss-ID</i> indicates 'bds'.
<i>BDS-GridModSup</i>	The field is mandatory present if the target device supports <i>BDS-GridModel</i> ; otherwise it is not present. This field may only be present if <i>gnss-ID</i> indicates 'bds'.
<i>RTK-OSR-Sup</i>	The field is mandatory present if the target device supports <i>GNSS-RTK-Observations</i> ; otherwise it is not present. Note, support for <i>GNSS-RTK-Observations</i> implies support for <i>GNSS-RTK-CommonObservationInfo</i> as well.
<i>GLO-CPB-Sup</i>	The field is mandatory present if the target device supports <i>GLO-RTK-BiasInformation</i> ; otherwise it is not present. This field may only be present if <i>gnss-ID</i> indicates 'glonass'.
<i>MAC-Sup</i>	The field is mandatory present if the target device supports <i>GNSS-RTK-MAC-CorrectionDifferences</i> ; otherwise it is not present.
<i>Res-Sup</i>	The field is mandatory present if the target device supports <i>GNSS-RTK-Residuals</i> ; otherwise it is not present.
<i>FKP-Sup</i>	The field is mandatory present if the target device supports <i>GNSS-RTK-FKP-Gradients</i> ; otherwise it is not present.
<i>OC-Sup</i>	The field is mandatory present if the target device supports <i>GNSS-SSR-OrbitCorrections</i> ; otherwise it is not present.
<i>CC-Sup</i>	The field is mandatory present if the target device supports <i>GNSS-SSR-ClockCorrections</i> ; otherwise it is not present.
<i>CB-Sup</i>	The field is mandatory present if the target device supports <i>GNSS-SSR-CodeBias</i> ; otherwise it is not present.
<i>URA-Sup</i>	The field is mandatory present if the target device supports <i>GNSS-SSR-URA</i> ; otherwise it is not present.
<i>PB-Sup</i>	The field is mandatory present if the target device supports <i>GNSS-SSR-PhaseBias</i> ; otherwise it is not present.
<i>STEC-Sup</i>	The field is mandatory present if the target device supports <i>GNSS-SSR-STEC-Correction</i> ; otherwise it is not present.
<i>Grid-Sup</i>	The field is mandatory present if the target device supports <i>GNSS-SSR-GriddedCorrection</i> ; otherwise it is not present. Note, support for <i>GNSS-SSR-GriddedCorrection</i> implies support for <i>GNSS-SSR-CorrectionPoints</i> as well.
<i>DNavIC-Sup</i>	The field is mandatory present if the target device supports <i>NavIC-DifferentialCorrections</i> ; otherwise it is not present. This field may only be present if the <i>gnss-ID</i> indicates 'navic'.
<i>NavIC-GridModSup</i>	The field is mandatory present if the target device supports <i>NavIC-GridModel</i> ; otherwise it is not present. This field may only be present if the <i>gnss-ID</i> indicates 'navic'.
<i>OC2-Sup</i>	The field is mandatory present if the target device supports <i>GNSS-SSR-OrbitCorrectionsSet2</i> ; otherwise it is not present.
<i>CC2-Sup</i>	The field is mandatory present if the target device supports <i>GNSS-SSR-ClockCorrectionsSet2</i> ; otherwise it is not present.
<i>URA2-Sup</i>	The field is mandatory present if the target device supports <i>GNSS-SSR-URA-Set2</i> ; otherwise it is not present.

– *GNSS-TimeModelListSupport*

```
-- ASN1START
GNSS-TimeModelListSupport ::= SEQUENCE {
    ...
}
-- ASN1STOP
```

– *GNSS-DifferentialCorrectionSupport*

```
-- ASN1START
GNSS-DifferentialCorrectionsSupport ::= SEQUENCE {
    gnssSignalIDs          GNSS-SignalIDs,
    dgnss-ValidityTimeSup  BOOLEAN,
    ...
}
-- ASN1STOP
```

```
-- ASN1STOP
```

GNSS-DifferentialCorrectionsSupport field descriptions

gnssSignalIDs

This field specifies the GNSS signal types for which differential corrections are supported by the target device. This is represented by a bit string in *GNSS-SignalIDs*, with a one-value at the bit position means differential corrections for the particular GNSS signal type is supported; a zero-value means not supported.

dgnss-ValidityTimeSup

This field specifies if the target device supports estimation of UDRE based on growth rate and validity time for differential corrections. TRUE means supported.

GNSS-NavigationModelSupport

```
-- ASN1START
```

```
GNSS-NavigationModelSupport ::= SEQUENCE {
  clockModel      BIT STRING {
    model-1      (0),
    model-2      (1),
    model-3      (2),
    model-4      (3),
    model-5      (4),
    model-6      (5),
    model-7-r16  (6),
    model-8-r16  (7) } (SIZE (1..8))      OPTIONAL,
  orbitModel      BIT STRING {
    model-1      (0),
    model-2      (1),
    model-3      (2),
    model-4      (3),
    model-5      (4),
    model-6      (5),
    model-7-r16  (6),
    model-8-r16  (7) } (SIZE (1..8))      OPTIONAL,
  ...
}
```

```
-- ASN1STOP
```

GNSS-NavigationModelSupport field descriptions

clockModel

This field specifies the *gnss-ClockModel* choice(s) in *GNSS-NavigationModel* IE supported by the target device for the GNSS indicated by *GNSS-ID*. This is represented by a bit string, with a one-value at the bit position means the particular clock model is supported; a zero-value means not supported.

If the target device supports GPS and *GNSS-NavigationModel* assistance, it shall support *clockModel* Model-2.

If the target device supports SBAS and *GNSS-NavigationModel* assistance, it shall support *clockModel* Model-5.

If the target device supports QZSS and *GNSS-NavigationModel* assistance, it shall support *clockModel* Model-2.

If the target device supports Galileo and *GNSS-NavigationModel* assistance, it shall support *clockModel* Model-1.

If the target device supports GLONASS and *GNSS-NavigationModel* assistance, it shall support *clockModel* Model-4.

If the target device supports BDS and *GNSS-NavigationModel* assistance, it shall support *clockModel* Model-6.

If the target device supports NavIC and *GNSS-NavigationModel* assistance, it shall support *clockModel* Model-8.

If this field is absent, the target device supports the mandatory (native) *clockModel* choice only as listed above for the GNSS indicated by *GNSS-ID*.

orbitModel

This field specifies the *gnss-OrbitModel* choice(s) in *GNSS-NavigationModel* IE supported by the target device for the GNSS indicated by *GNSS-ID*. This is represented by a bit string, with a one-value at the bit position means the particular orbit model is supported; a zero-value means not supported.

If the target device supports GPS and *GNSS-NavigationModel* assistance, it shall support *orbitModel* Model-2.

If the target device supports SBAS and *GNSS-NavigationModel* assistance, it shall support *orbitModel* Model-5.

If the target device supports QZSS and *GNSS-NavigationModel* assistance, it shall support *orbitModel* Model-2.

If the target device supports Galileo and *GNSS-NavigationModel* assistance, it shall support *orbitModel* Model-1.

If the target device supports GLONASS and *GNSS-NavigationModel* assistance, it shall support *orbitModel* Model-4.

If the target device supports BDS and *GNSS-NavigationModel* assistance, it shall support *orbitModel* Model-6.

If the target device supports NavIC and *GNSS-NavigationModel* assistance, it shall support *orbitModel* Model-8.

If this field is absent, the target device supports the mandatory (native) *orbitModel* choice only as listed above for the GNSS indicated by *GNSS-ID*.

– **GNSS-RealTimeIntegritySupport**

```
-- ASN1START
GNSS-RealTimeIntegritySupport ::= SEQUENCE {
    ...
}
-- ASN1STOP
```

– **GNSS-DataBitAssistanceSupport**

```
-- ASN1START
GNSS-DataBitAssistanceSupport ::= SEQUENCE {
    ...
}
-- ASN1STOP
```

– **GNSS-AcquisitionAssistanceSupport**

```
-- ASN1START
GNSS-AcquisitionAssistanceSupport ::= SEQUENCE {
    ...,
    confidenceSupport-r10          ENUMERATED { true }      OPTIONAL,
    dopplerUncertaintyExtSupport-r10  ENUMERATED { true }  OPTIONAL
}
-- ASN1STOP
```

GNSS-AcquisitionAssistanceSupport field descriptions
confidenceSupport If this field is present, the target device supports the <i>confidence</i> field in <i>GNSS-AcquisitionAssistance</i> .
dopplerUncertaintyExtSupport If this field is present, the target device supports the <i>dopplerUncertaintyExt</i> field in <i>GNSS-AcquisitionAssistance</i> .

– **GNSS-AlmanacSupport**

```
-- ASN1START
GNSS-AlmanacSupport ::= SEQUENCE {
    almanacModel          BIT STRING {
        model-1          (0),
        model-2          (1),
        model-3          (2),
        model-4          (3),
        model-5          (4),
        model-6          (5),
        model-7          (6),
        model-8-v16e0    (7) } (SIZE (1..8))  OPTIONAL,
    ...
}
-- ASN1STOP
```

GNSS-AlmanacSupport field descriptions***almanacModel***

This field specifies the *almanacModel* choice(s) in *GNSS-Almanac* IE supported by the target device for the GNSS indicated by *GNSS-ID*. This is represented by a bit string, with a one-value at the bit position means the particular almanac model is supported; a zero-value means not supported.

If the target device supports GPS and *GNSS-Almanac* assistance, it shall support Model-2.

If the target device supports SBAS and *GNSS-Almanac* assistance, it shall support Model-6.

If the target device supports QZSS and *GNSS-Almanac* assistance, it shall support Model-2.

If the target device supports Galileo and *GNSS-Almanac* assistance, it shall support Model-1.

If the target device supports GLONASS and *GNSS-Almanac* assistance, it shall support Model-5.

If the target device supports BDS and *GNSS-Almanac* assistance, it shall support Model-7.

If the target device supports NavIC and *GNSS-Almanac* assistance, it shall support Model-8.

If this field is absent, the target device supports the mandatory (native) *almanacModel* choice only as listed above for the GNSS indicated by *GNSS-ID*.

GNSS-UTC-ModelSupport

```
-- ASN1START
GNSS-UTC-ModelSupport ::= SEQUENCE {
    utc-Model      BIT STRING {
        model-1      (0),
        model-2      (1),
        model-3      (2),
        model-4      (3),
        model-5      (4) } (SIZE (1..8))    OPTIONAL,
    ...
}
-- ASN1STOP
```

GNSS-UTC-ModelSupport field descriptions***utc-Model***

This field specifies the *GNSS-UTC-Model* choice(s) in *GNSS-UTC-Model* IE supported by the target device for the GNSS indicated by *GNSS-ID*. This is represented by a bit string, with a one-value at the bit position means the particular UTC model is supported; a zero-value means not supported.

If the target device supports GPS and *GNSS-UTC-Model* assistance, it shall support Model-1.

If the target device supports SBAS and *GNSS-UTC-Model* assistance, it shall support Model-4.

If the target device supports QZSS and *GNSS-UTC-Model* assistance, it shall support Model-1.

If the target device supports Galileo and *GNSS-UTC-Model* assistance, it shall support Model-1.

If the target device supports GLONASS and *GNSS-UTC-Model* assistance, it shall support Model-3.

If the target device supports BDS and *GNSS-UTC-Model* assistance, it shall support Model-5.

If the target device supports NavIC and *GNSS-UTC-Model* assistance, it shall support Model-2.

If this field is absent, the target device supports the mandatory (native) *utc-Model* choice only as listed above for the GNSS indicated by *GNSS-ID*.

GNSS-AuxiliaryInformationSupport

```
-- ASN1START
GNSS-AuxiliaryInformationSupport ::= SEQUENCE {
    ...
}
-- ASN1STOP
```

BDS-DifferentialCorrectionsSupport

```
-- ASN1START
BDS-DifferentialCorrectionsSupport-r12 ::= SEQUENCE {
    gnssSignalIDs      GNSS-SignalIDs,
    ...
}
-- ASN1STOP
```

BDS-DifferentialCorrectionsSupport field descriptions**gnssSignalIDs**

This field specifies the BDS signal types for which differential corrections are supported by the target device. This is represented by a bit string in *GNSS-SignalIDs*, with a one-value at the bit position means differential corrections for the particular BDS signal type is supported; a zero-value means not supported.

BDS-GridModelSupport

```
-- ASN1START
BDS-GridModelSupport-r12 ::= SEQUENCE {
    ...
}
-- ASN1STOP
```

GNSS-RTK-ObservationsSupport

```
-- ASN1START
GNSS-RTK-ObservationsSupport-r15 ::= SEQUENCE {
    gnssSignalIDs-r15          GNSS-SignalIDs,
    ...
}
-- ASN1STOP
```

GNSS-RTK-ObservationsSupport field descriptions**gnssSignalIDs**

This field specifies the GNSS signal types for which *GNSS-RTK-Observations* are supported by the target device. This is represented by a bit string in *GNSS-SignalIDs*, with a one-value at the bit position means *GNSS-RTK-Observations* for the particular GNSS signal type is supported; a zero-value means not supported.

GLO-RTK-BiasInformationSupport

```
-- ASN1START
GLO-RTK-BiasInformationSupport-r15 ::= SEQUENCE {
    ...
}
-- ASN1STOP
```

GNSS-RTK-MAC-CorrectionDifferencesSupport

```
-- ASN1START
GNSS-RTK-MAC-CorrectionDifferencesSupport-r15 ::= SEQUENCE {
    link-combinations-support-r15          GNSS-Link-CombinationsList-r15,
    ...
}
-- ASN1STOP
```

GNSS-RTK-MAC-CorrectionDifferencesSupport field descriptions**link-combinations-support**

This field specifies the GNSS link/frequency combinations for which *GNSS-RTK-MAC-CorrectionDifferences* are supported by the target device for the GNSS indicated by *GNSS-ID*.

– GNSS-RTK-ResidualsSupport

```
-- ASN1START
GNSS-RTK-ResidualsSupport-r15 ::= SEQUENCE {
    link-combinations-support-r15    GNSS-Link-CombinationsList-r15,
    ...
}
-- ASN1STOP
```

GNSS-RTK-ResidualsSupport field descriptions

link-combinations-support

This field specifies the GNSS link/frequency combinations for which *GNSS-RTK-Residuals* are supported by the target device for the GNSS indicated by *GNSS-ID*.

– GNSS-RTK-FKP-GradientsSupport

```
-- ASN1START
GNSS-RTK-FKP-GradientsSupport-r15 ::= SEQUENCE {
    link-combinations-support-r15    GNSS-Link-CombinationsList-r15,
    ...
}
-- ASN1STOP
```

GNSS-RTK-FKP-GradientsSupport field descriptions

link-combinations-support

This field specifies the GNSS link/frequency combinations for which *GNSS-RTK-FKP-Gradients* are supported by the target device for the GNSS indicated by *GNSS-ID*.

– GNSS-SSR-OrbitCorrectionsSupport

```
-- ASN1START
GNSS-SSR-OrbitCorrectionsSupport-r15 ::= SEQUENCE {
    ...
    [[
        orbit-IntegritySup-r17 BIT STRING { correlationTimeSup (0)
                                           } (SIZE(1..8)) OPTIONAL
    ]]
}
-- ASN1STOP
```

GNSS-SSR-OrbitCorrectionsSupport field descriptions

orbit-IntegritySup

This field, if present, indicates that the target device supports the IEs *ORBIT-IntegrityParameters* and *SSR-IntegrityOrbitBounds*.

A one-value at the bit position '0' means that the target device supports the fields *orbitRangeErrorCorrelationTime* and *orbitRangeRateErrorCorrelationTime* in IE *ORBIT-IntegrityParameters*.

– GNSS-SSR-ClockCorrectionsSupport

```
-- ASN1START
GNSS-SSR-ClockCorrectionsSupport-r15 ::= SEQUENCE {
    ...
    [[
        clock-IntegrityParameterSupport-r17 ENUMERATED { supported } OPTIONAL,
        ssr-IntegrityClockBoundsSupport-r17  ENUMERATED { supported } OPTIONAL
    ]]
}
-- ASN1STOP
```

```
-- ASN1STOP
```

GNSS-SSR-ClockCorrectionsSupport field descriptions
clock-IntegrityParameterSupport This field, if present, indicates that the target device supports the <i>CLOCK-IntegrityParameters</i> in IE <i>GNSS-SSR-ClockCorrections</i> .
ssr-IntegrityClockBoundsSupports This field, if present, indicates that the target device supports the <i>SSR-IntegrityClockBounds</i> in IE <i>GNSS-SSR-ClockCorrections</i> .

– GNSS-SSR-CodeBiasSupport

```
-- ASN1START
```

```
GNSS-SSR-CodeBiasSupport-r15 ::= SEQUENCE {
    signal-and-tracking-mode-ID-Sup-r15    GNSS-SignalIDs,
    . . . ,
    [[
    ssr-IntegrityCodeBiasBoundsSup-r17    ENUMERATED { supported }           OPTIONAL
    ]]
}
```

```
-- ASN1STOP
```

GNSS-SSR-CodeBiasSupport field descriptions
signal-and-tracking-mode-ID-Sup This field specifies the GNSS signal(s) for which the <i>GNSS-SSR-CodeBias</i> is supported by the target device.
ssr-IntegrityCodeBiasBoundsSup This field, if present, indicates that the target device supports the IE <i>SSR-IntegrityCodeBiasBounds</i> .

– GNSS-SSR-URA-Support

```
-- ASN1START
```

```
GNSS-SSR-URA-Support-r16 ::= SEQUENCE {
    . . .
}
```

```
-- ASN1STOP
```

– GNSS-SSR-PhaseBiasSupport

```
-- ASN1START
```

```
GNSS-SSR-PhaseBiasSupport-r16 ::= SEQUENCE {
    signal-and-tracking-mode-ID-Sup-r16    GNSS-SignalIDs,
    . . . ,
    [[
    ssr-IntegrityPhaseBiasBoundsSup-r17    ENUMERATED { supported }           OPTIONAL
    ]]
}
```

```
-- ASN1STOP
```

GNSS-SSR-PhaseBiasSupport field descriptions
signal-and-tracking-mode-ID-Sup This field specifies the GNSS signal(s) for which the <i>GNSS-SSR-PhaseBias</i> is supported by the target device.
ssr-IntegrityPhaseBiasBoundsSup This field, if present, indicates that the target device supports the IE <i>SSR-IntegrityPhaseBiasBounds</i> .

– GNSS-SSR-STECCorrectionSupport

```

-- ASN1START
GNSS-SSR-STECCorrectionSupport-r16 ::= SEQUENCE {
    . . .
    [[
        stec-IntegritySup-r17 BIT STRING { correlationTimeSup (0)
                                         } (SIZE(1..8)) OPTIONAL
    ]]
}
-- ASN1STOP

```

GNSS-SSR-STECCorrectionSupport field descriptions

stec-IntegritySup

This field, if present, indicates that the target device supports the IEs *STEC-IntegrityParameters* and *STEC-IntegrityErrorBounds*.

A one-value at the bit position '0' means that the target device supports the fields *ionoRangeErrorCorrelationTime* and *ionoRangeRateErrorCorrelationTime* in IE *STEC-IntegrityParameters*.

– GNSS-SSR-GriddedCorrectionSupport

```

-- ASN1START
GNSS-SSR-GriddedCorrectionSupport-r16 ::= SEQUENCE {
    . . .
    [[
        griddedCorrectionIntegritySup-r17 ENUMERATED { supported } OPTIONAL
    ]]
}
-- ASN1STOP

```

GNSS-SSR-GriddedCorrectionSupport field descriptions

griddedCorrectionIntegritySup

This field, if present, indicates that the target device supports the IEs *SSR-GriddedCorrectionIntegrityParameters* and *TropoDelayIntegrityErrorBounds*.

– NavIC-DifferentialCorrectionsSupport

```

-- ASN1START
NavIC-DifferentialCorrectionsSupport-r16 ::= SEQUENCE {
    gnssSignalIDs-r16 GNSS-SignalIDs,
    . . .
}
-- ASN1STOP

```

NavIC-DifferentialCorrectionsSupport field descriptions

gnssSignalIDs

This field specifies the NavIC signal types for which differential corrections are supported by the target device. This is represented by a bit string in *GNSS-SignalIDs*, with a one-value at the bit position means differential corrections for the particular NavIC signal type is supported; a zero-value means not supported.

– NavIC-GridModelSupport

```

-- ASN1START
NavIC-GridModelSupport-r16 ::= SEQUENCE {
    . . .
}

```

```
-- ASN1STOP
```

– GNSS-SSR-OrbitCorrectionsSet2Support

```
-- ASN1START
GNSS-SSR-OrbitCorrectionsSet2Support-r17 ::= SEQUENCE {
    ...
}
-- ASN1STOP
```

– GNSS-SSR-ClockCorrectionsSet2Support

```
-- ASN1START
GNSS-SSR-ClockCorrectionsSet2Support-r17 ::= SEQUENCE {
    ...
}
-- ASN1STOP
```

– GNSS-SSR-URA-Set2Support

```
-- ASN1START
GNSS-SSR-URA-Set2Support-r17 ::= SEQUENCE {
    ...
}
-- ASN1STOP
```

6.5.2.11 GNSS Capability Information Request

– A-GNSS-RequestCapabilities

The IE *A-GNSS-Request-Capabilities* is used by the location server to request A-GNSS location capabilities (e.g., GNSSs and assistance data supported) from the target device.

```
-- ASN1START
A-GNSS-RequestCapabilities ::= SEQUENCE {
    gnss-SupportListReq          BOOLEAN,
    assistanceDataSupportListReq  BOOLEAN,
    locationVelocityTypesReq     BOOLEAN,
    ...
}
-- ASN1STOP
```

A-GNSS-RequestCapabilities field descriptions

gnss-SupportListReq

This field specifies whether the target device is requested to include the *gnss-SupportList* field in the *A-GNSS-ProvideCapabilities* IE or not. TRUE means requested.

assistanceDataSupportListReq

This field specifies whether the target device is requested to include the *assistanceDataSupportList* field in the *A-GNSS-ProvideCapabilities* IE or not. TRUE means requested.

locationVelocityTypesReq

This field specifies whether the target device is requested to include the *locationCoordinateTypes* field and *velocityTypes* field in the *A-GNSS-ProvideCapabilities* IE or not. TRUE means requested.

6.5.2.12 GNSS Error Elements

– *A-GNSS-Error*

The IE *A-GNSS-Error* is used by the location server or target device to provide GNSS error reasons.

```
-- ASN1START
A-GNSS-Error ::= CHOICE {
    locationServerErrorCauses      GNSS-LocationServerErrorCauses,
    targetDeviceErrorCauses       GNSS-TargetDeviceErrorCauses,
    ...
}
-- ASN1STOP
```

– *GNSS-LocationServerErrorCauses*

The IE *GNSS-LocationServerErrorCauses* is used by the location server to provide GNSS error reasons to the target device.

```
-- ASN1START
GNSS-LocationServerErrorCauses ::= SEQUENCE {
    cause      ENUMERATED {
        undefined,
        undeliveredAssistanceDataIsNotSupportedByServer,
        undeliveredAssistanceDataIsSupportedButCurrentlyNotAvailableByServer,
        undeliveredAssistanceDataIsPartlyNotSupportedAndPartlyNotAvailableByServer,
        ...,
        unconfirmedPeriodicAssistanceDataIsNotSupported-v1510,
        unconfirmedPeriodicAssistanceDataIsSupportedButCurrentlyNotAvailable-v1510,
        unconfirmedPeriodicAssistanceDataIsPartlyNotSupportedAndPartlyNotAvailable-v1510,
        undeliveredPeriodicAssistanceDataIsCurrentlyNotAvailable-v1510
    },
    ...
}
-- ASN1STOP
```

GNSS-LocationServerErrorCauses field descriptions

cause

This field provides a GNSS specific error cause. The cause values

'*unconfirmedPeriodicAssistanceDataIsNotSupported*',

'*unconfirmedPeriodicAssistanceDataIsSupportedButCurrentlyNotAvailable*' and

'*unconfirmedPeriodicAssistanceDataIsPartlyNotSupportedAndPartlyNotAvailable*' may only be included in the control transaction of a periodic assistance data transfer procedure, as described in clause 5.2.1a.

The cause value '*undeliveredPeriodicAssistanceDataIsCurrentlyNotAvailable*' may only be included in the data transaction of a periodic assistance data transfer procedure when periodic assistance data are not available when the periodicity condition occurs, as described in clauses 5.2.1a and 5.2.2a.

– *GNSS-TargetDeviceErrorCauses*

The IE *GNSS-TargetDeviceErrorCauses* is used by the target device to provide GNSS error reasons to the location server.

```
-- ASN1START
GNSS-TargetDeviceErrorCauses ::= SEQUENCE {
    cause      ENUMERATED {
        undefined,
        thereWereNotEnoughSatellitesReceived,
        assistanceDataMissing,
        notAllRequestedMeasurementsPossible,
        ...
    },
    fineTimeAssistanceMeasurementsNotPossible      NULL      OPTIONAL,
    adrMeasurementsNotPossible                     NULL      OPTIONAL,
    multiFrequencyMeasurementsNotPossible          NULL      OPTIONAL,
}
```

```

...
}
-- ASN1STOP

```

GNSS-TargetDeviceErrorCauses field descriptions
<p>cause This field provides a GNSS specific error cause. If the cause value is 'notAllRequestedMeasurementsPossible', the target device was not able to provide all requested GNSS measurements (but may be able to report a location estimate or location measurements). In this case, the target device should include any of the <i>fineTimeAssistanceMeasurementsNotPossible</i>, <i>adrMeasurementsNotPossible</i>, or <i>multiFrequencyMeasurementsNotPossible</i> fields, as applicable.</p>

6.5.2.13 Common GNSS Information Elements

– **GNSS-FrequencyID**

The IE *GNSS-FrequencyID* is used to indicate a specific GNSS link/frequency. The interpretation of *GNSS-FrequencyID* depends on the *GNSS-ID*.

```

-- ASN1START
GNSS-FrequencyID-r15 ::= SEQUENCE {
    gnss-FrequencyID-r15 INTEGER (0 .. 7),
    ...
}
-- ASN1STOP

```

GNSS-FrequencyID field descriptions
<p>gnss-FrequencyID This field specifies a particular GNSS link/frequency. The interpretation of <i>gnss-FrequencyID</i> depends on the <i>GNSS-ID</i> and is as shown in the table Value & Explanation relation below.</p>

Value & Explanation relation

System	Value	Explanation	
		Link	Centre Frequency [MHz]
GPS	0	L1	1575.42
	1	L2	1227.60
	2	L5	1176.45
	3-7	reserved	
SBAS	0	L1	1575.42
	1	L5	1176.45
	2-7	reserved	
QZSS	0	L1	1575.42
	1	L2	1227.60
	2	L5	1176.45
	3-7	reserved	
GLONASS k = -7..13	0	G1	1602+kx0.5625
	1	G2	1246+kx0.4375
	2	G3	1202.025
	3-7	reserved	
Galileo	0	E1	1575.420
	1	E6	1278.750
	2	E5a	1176.450
	3	E5b	1207.140
	4	E5	1191.795
	5-7	reserved	
BDS	0	B1I	1561.098
	1	B1C	1575.420

	2	B2	1207.140
	3	B3	1268.520
	4	B2a	1176.450
	5-7	reserved	
NavIC	0	L5	1176.450
	1-7	reserved	

– GNSS-ID

The IE *GNSS-ID* is used to indicate a specific GNSS.

```
-- ASN1START
GNSS-ID ::= SEQUENCE {
    gnss-id      ENUMERATED{ gps, sbas, qzss, galileo, glonass, ..., bds, navic-v1610 },
    ...
}
-- ASN1STOP
```

– GNSS-ID-Bitmap

The IE *GNSS-ID-Bitmap* is used to indicate several GNSSs using a bit map.

```
-- ASN1START
GNSS-ID-Bitmap ::= SEQUENCE {
    gnss-ids      BIT STRING {
        gps      (0),
        sbas     (1),
        qzss     (2),
        galileo  (3),
        glonass  (4),
        bds      (5),
        navic-v1610 (6) } (SIZE (1..16)),
    ...
}
-- ASN1STOP
```

GNSS-ID-Bitmap field descriptions

gnss-ids

This field specifies the GNSS(s). This is represented by a bit string, with a one-value at the bit position means the particular GNSS is addressed; a zero-value means not addressed.

– GNSS-Link-CombinationsList

```
-- ASN1START
GNSS-Link-CombinationsList-r15 ::= SEQUENCE (SIZE(1..8)) OF GNSS-Link-Combinations-r15
GNSS-Link-Combinations-r15 ::= SEQUENCE {
    l1-r15      GNSS-FrequencyID-r15,
    l2-r15      GNSS-FrequencyID-r15,
    ...
}
-- ASN1STOP
```

– GNSS-NavListInfo

```
-- ASN1START
GNSS-NavListInfo-r15 ::= SEQUENCE (SIZE (1..64)) OF SatListElement-r15
SatListElement-r15 ::= SEQUENCE {
```

```

    svID-r15          SV-ID,
    iod-r15           BIT STRING (SIZE(11)),
    ...
}
-- ASN1STOP

```

– *GNSS-NetworkID*

The IE *GNSS-NetworkID* defines the reference network and the source of the particular set of reference stations and their observation information. This IE is used for MAC Network RTK as described in [30].

```

-- ASN1START
GNSS-NetworkID-r15 ::= SEQUENCE {
    networkID-r15          INTEGER (0..255),
    ...
}
-- ASN1STOP

```

– *GNSS-PeriodicControlParam*

The IE *GNSS-PeriodicControlParam* is used to specify control parameters for a periodic assistance data delivery.

```

-- ASN1START
GNSS-PeriodicControlParam-r15 ::= SEQUENCE {
    deliveryAmount-r15     INTEGER (1..32),
    deliveryInterval-r15   INTEGER (1..64),
    ...
}
-- ASN1STOP

```

GNSS-PeriodicControlParam field descriptions

deliveryAmount

This field specifies the number of periodic assistance data deliveries. Integer values $N=1..31$ correspond to an amount of 2^N . Integer value $N=32$ indicates an 'infinite/indefinite' amount, which means that the assistance data delivery should continue until a LPP *Abort* message is received.

deliveryInterval

This field specifies the interval between assistance data deliveries in seconds.

– *GNSS-ReferenceStationID*

The IE *GNSS-ReferenceStationID* is used to identify a specific GNSS Reference Station.

```

-- ASN1START
GNSS-ReferenceStationID-r15 ::= SEQUENCE {
    referenceStationID-r15  INTEGER (0..65535),
    providerName-r15       VisibleString (SIZE (1..32))    OPTIONAL, -- Need ON
    ...
}
-- ASN1STOP

```

GNSS-ReferenceStationID field descriptions

referenceStationID

This field provides the reference station identity.

providerName

This field is associated with a GNSS correction data provider to ensure that the *referenceStationID*'s are unique from a target device perspective.

GNSS-SignalID

The IE *GNSS-SignalID* is used to indicate a specific GNSS signal type. The interpretation of *GNSS-SignalID* depends on the *GNSS-ID*.

```

-- ASN1START
GNSS-SignalID ::= SEQUENCE {
    gnss-SignalID      INTEGER (0 .. 7),
    ...
    [
        gnss-SignalID-Ext-r15  INTEGER (8..23)          OPTIONAL  -- Need ON
    ]
}
-- ASN1STOP
    
```

GNSS-SignalID field descriptions

gnss-SignalID, gnss-SignalID-Ext

This field specifies a particular GNSS signal. The interpretation of *gnss-SignalID* and *gnss-SignalID-Ext* depends on the *GNSS-ID* and is as shown in the table System to Value & Explanation relation below. If the field *gnss-SignalID-Ext* is present, the *gnss-SignalID* should be set to value 7 and shall be ignored by the receiver.

System to Value & Explanation relation

System	Value	Explanation
GPS	0	GPS L1 C/A
	1	GPS L1C
	2	GPS L2C
	3	GPS L5
	4	GPS L1 P
	5	GPS L1 Z-tracking
	6	GPS L2 C/A
	7	GPS L2 P
	8	GPS L2 Z-tracking
	9	GPS L2 L2C(M)
	10	GPS L2 L2C(L)
	11	GPS L2 L2C(M+L)
	12	GPS L5 I
	13	GPS L5 Q
	14	GPS L5 I+Q
	15	GPS L1 L1C(D)
	16	GPS L1 L1C(P)
	17	GPS L1 L1C(D+P)
18-23	Reserved	
SBAS	0	L1 C/A
	1	L5 I
	2	L5 Q
	3	L5 I+Q
	4-7	Reserved
QZSS	0	QZS-L1 C/A
	1	QZS-L1C
	2	QZS-L2C
	3	QZS-L5
	4	QZS-LEX S
	5	QZS-LEX L
	6	QZS-LEX S+L
	7	QZS-L2 L2C(M)
	8	QZS-L2 L2C(L)
	9	QZS-L2 L2C(M+L)
	10	QZS-L5 I
	11	QZS-L5 Q
12	QZS-L5 I+Q	

	13	QZS L1 L1C(D)
	14	QZS L1 L1C(P)
	15	QZS L1 L1C(D+P)
	16-23	Reserved
GLONASS	0	GLONASS G1 C/A
	1	GLONASS G2 C/A
	2	GLONASS G3
	3	GLONASS G1 P
	4	GLONASS G2 P
	5	GLONASS G1a(D)
	6	GLONASS G1a(P)
	7	GLONASS G1a (D+P)
	8	GLONASS G2a(I)
	9	GLONASS G2a(P)
	10	GLONASS G2a(I+P)
	11	GLONASS G3 I
	12	GLONASS G3 Q
	13	GLONASS G3 I+Q
	14-23	Reserved
Galileo	0	Galileo E1
	1	Galileo E5A
	2	Galileo E5B
	3	Galileo E6
	4	Galileo E5A + E5B
	5	Galileo E1 C No data
	6	Galileo E1 A
	7	Galileo E1 B I/NAV OS/CS/SoL
	8	Galileo E1 B+C
	9	Galileo E1 A+B+C
	10	Galileo E6 C
	11	Galileo E6 A
	12	Galileo E6 B
	13	Galileo E6 B+C
	14	Galileo E6 A+B+C
	15	Galileo E5B I
	16	Galileo E5B Q
	17	Galileo E5B I+Q
	18	Galileo E5(A+B) I
	19	Galileo E5(A+B) Q
	20	Galileo E5(A+B) I+Q
	21	Galileo E5A I
	22	Galileo E5A Q
	23	Galileo E5A I+Q
BDS	0	B1 I
	1	B1 Q
	2	B1 I+Q
	3	B3 I
	4	B3 Q
	5	B3 I+Q
	6	B2 I
	7	B2 Q
	8	B2 I+Q
	9	B1C(D)
	10	B1C(P)
	11	B1C(D+P)
	12	B2a(D)
	13	B2a(P)
	14	B2a(D+P)
	15-23	Reserved
NavIC	0	NavIC L5 SPS
	1-23	Reserved

GNSS-SignalIDs

The IE *GNSSSignal-IDs* is used to indicate several GNSS signals using a bit map. The interpretation of *GNSSSignal-IDs* depends on the *GNSS-ID*.

```

-- ASN1START
GNSS-SignalIDs ::= SEQUENCE {
    gnss-SignalIDs      BIT STRING (SIZE(8)),
    ...
    [[
        gnss-SignalIDs-Ext-r15 BIT STRING (SIZE(16))           OPTIONAL  -- Need ON
    ]]
}
-- ASN1STOP
    
```

GNSS-SignalIDs field descriptions

gnss-SignalIDs, gnss-SignalIDs-Ext

This field specifies one or several GNSS signals using a bit map. A one-value at the bit position means the particular signal is addressed; a zero-value at the particular bit position means the signal is not addressed. The interpretation of the bit map in *gnssSignalIDs* and *gnss-SignalIDs-Ext* depends on the *GNSS-ID* and is shown in the table below. Unfilled table entries indicate no assignment and shall be set to zero.

Interpretation of the bit map in *gnssSignalIDs*

GNSS	Bit 1 (MSB)	Bit 2	Bit 3	Bit 4	Bit 5	Bit 6	Bit 7	Bit 8 (LSB)
GPS	L1 C/A	L1C	L2C	L5	L1P	L1 Z	L2 C/A	L2 P
SBAS	L1 C/A	L5 I	L5 Q	L5 I+Q				
QZSS	QZS-L1 C/A	QZS-L1C	QZS-L2C	QZS-L5	LEX S	LEX L	LEX S+L	L2C(M)
GLONASS	G1 C/A	G2 C/A	G3	G1 P	G2 P	G1a(D)	G1a(P)	G1a(D+P)
Galileo	E1	E5a	E5b	E6	E5a+E5b	E1 C No Data	E1 A	E1 B I/NAV OS/CS/SoL
BDS	B1 I	B1 Q	B1 I+Q	B3 I	B3 Q	B3 I+Q	B2 I	B2 Q
NavIC	L5 SPS							

Interpretation of the bit map in *gnssSignalIDs-Ext*

GNSS	Bit 1 (MSB)	Bit 2	Bit 3	Bit 4	Bit 5	Bit 6	Bit 7	Bit 8
GPS	L2 Z	L2C(M)	L2C(L)	L2C(M+L)	L5 I	L5 Q	L5 I+Q	L1C(D)
SBAS								
QZSS	L2C(L)	L2C(M+L)	L5 I	L5 Q	L5 I+Q	L1C(D)	L1C(P)	L1C(D+P)
GLONASS	G2a(I)	G2a(P)	G2a(I+P)	G3 I	G3 Q	G3(I+Q)		
Galileo	E1 B+C	E1 A+B+C	E6C	E6A	E6B	E6 B+C	E6 A+B+C	E5B I
BDS	B2 I+Q	B1C(D)	B1C(P)	B1C(D+P)	B2a(D)	B2a(P)	B2a(D+P)	
NavIC								

GNSS	Bit 9	Bit 10	Bit 11	Bit 12	Bit 13	Bit 14	Bit 15	Bit 16 (LSB)
GPS	L1C(P)	L1C(D+P)						
SBAS								
QZSS								
GLONASS								
Galileo	E5B Q	E5B I+Q	E5(A+B) I	E5(A+B) Q	E5(A+B) I+Q	E5A I	E5A Q	E5A I+Q
BDS								
NavIC								

– GNSS-SubNetworkID

The IE *GNSS-SubNetworkID* defines the subnetwork of a network identified by *GNSS-NetworkID*. This IE is used for MAC Network RTK as described in [30].

```
-- ASN1START
GNSS-SubNetworkID-r15 ::= SEQUENCE {
    subNetworkID-r15          INTEGER (0..15),
    ...
}
-- ASN1STOP
```

– SBAS-ID

The IE *SBAS-ID* is used to indicate a specific SBAS.

```
-- ASN1START
SBAS-ID ::= SEQUENCE {
    sbas-id          ENUMERATED { waas, egnos, msas, gagan, ...},
    ...
}
-- ASN1STOP
```

– SBAS-IDs

The IE *SBAS-IDs* is used to indicate several SBASs using a bit map.

```
-- ASN1START
SBAS-IDs ::= SEQUENCE {
    sbas-IDs          BIT STRING {
        waas          (0),
        egnos         (1),
        msas          (2),
        gagan         (3) } (SIZE (1..8)),
    ...
}
-- ASN1STOP
```

SBAS-IDs field descriptions

sbas-IDs

This field specifies one or several SBAS(s) using a bit map. A one-value at the bit position means the particular SBAS is addressed; a zero-value at the particular bit position means the SBAS is not addressed.

– SV-ID

The IE *SV-ID* is used to indicate a specific GNSS satellite. The interpretation of *SV-ID* depends on the *GNSS-ID*.

```
-- ASN1START
SV-ID ::= SEQUENCE {
    satellite-id      INTEGER(0..63),
    ...
}
-- ASN1STOP
```

SV-ID field descriptions**satellite-id**

This field specifies a particular satellite within a specific GNSS. The interpretation of *satellite-id* depends on the *GNSS-ID* see the table below.

Interpretation of *satellite-id*

System	Value of <i>satellite-id</i>	Interpretation of <i>satellite-id</i>
GPS	'0' – '62' '63'	Satellite PRN Signal No. 1 to 63 Reserved
SBAS	'0' – '38' '39' – '63'	Satellite PRN Signal No. 120 to 158 Reserved
QZSS	'0' – '9' '10' – '63'	Satellite PRN Signal No. 193 to 202 Reserved
GLONASS	'0' – '23' '24' – '63'	Slot Number 1 to 24 Reserved
Galileo	'0' – '35' '36' – '63'	Code No. 1 to 36 Reserved
BDS	'0' – '62' '63'	Satellite ranging code number No.1 to 63 Reserved
NavIC	'0' – '13' '14'–'63'	Satellite PRN Signal No. 1 to 14 Reserved

6.5.3 Enhanced Cell ID Positioning

6.5.3.1 E-CID Location Information

– *ECID-ProvideLocationInformation*

The IE *ECID-ProvideLocationInformation* is used by the target device to provide E-CID location measurements to the location server. It may also be used to provide E-CID positioning specific error reason.

```
-- ASN1START
ECID-ProvideLocationInformation ::= SEQUENCE {
    ecid-SignalMeasurementInformation    ECID-SignalMeasurementInformation    OPTIONAL,
    ecid-Error                            ECID-Error                            OPTIONAL,
    ...
}
-- ASN1STOP
```

6.5.3.2 E-CID Location Information Elements

– *ECID-SignalMeasurementInformation*

The IE *ECID-SignalMeasurementInformation* is used by the target device to provide various UE-measurements to the location server.

```
-- ASN1START
ECID-SignalMeasurementInformation ::= SEQUENCE {
    primaryCellMeasuredResults    MeasuredResultsElement    OPTIONAL,
    measuredResultsList          MeasuredResultsList,
    ...
}
MeasuredResultsList ::= SEQUENCE (SIZE(1..32)) OF MeasuredResultsElement
MeasuredResultsElement ::= SEQUENCE {
    physCellId                    INTEGER (0..503),
    cellGlobalId                 CellGlobalIdEUTRA-AndUTRA    OPTIONAL,
    ...
}
```

```

arfcnEUTRA          ARFCN-ValueEUTRA,
systemFrameNumber  BIT STRING (SIZE (10))  OPTIONAL,
rsrp-Result        INTEGER (0..97)          OPTIONAL,
rsrq-Result        INTEGER (0..34)        OPTIONAL,
ue-RxTxTimeDiff   INTEGER (0..4095)       OPTIONAL,
...
[[ arfcnEUTRA-v9a0  ARFCN-ValueEUTRA-v9a0  OPTIONAL  -- Cond EARFCN-max
]],
[[ nrsrp-Result-r14  INTEGER (0..113)          OPTIONAL,
   nrsrq-Result-r14  INTEGER (0..74)          OPTIONAL,
   carrierFreqOffsetNB-r14  CarrierFreqOffsetNB-r14  OPTIONAL,  -- Cond NB-IoT
   hyperSFN-r14      BIT STRING (SIZE (10))  OPTIONAL
]],
[[
  [[
    rsrp-Result-v1470  INTEGER (-17..-1)  OPTIONAL,
    rsrq-Result-v1470  INTEGER (-30..46)  OPTIONAL
  ]]
]]
}
-- ASN1STOP

```

Conditional presence	Explanation
<i>EARFCN-max</i>	The field is mandatory present if the corresponding <i>arfcnEUTRA</i> (i.e. without suffix) is set to <i>maxEARFCN</i> . Otherwise the field is not present.
<i>NB-IoT</i>	The field is mandatory present if the measured cell is a NB-IoT cell. Otherwise it is not present.

ECID-SignalMeasurementInformation field descriptions
<p>primaryCellMeasuredResults This field contains measurements for the primary cell (if the primary cell is a E-UTRA or NB-IoT cell), when the target device reports measurements for both primary cell (E-UTRA or NB-IoT) and neighbour cells. This field shall be omitted when the target device reports measurements for the primary cell (E-UTRA or NB-IoT) only, in which case the measurements for the primary cell (E-UTRA or NB-IoT) is reported in the <i>measuredResultsList</i>. This field shall be omitted when the primary cell is not a E-UTRA or NB-IoT cell.</p>
<p>measuredResultsList This list contains the E-CID measurements for up to 32 E-UTRA or NB-IoT cells.</p>
<p>physCellId This field specifies the physical cell identity of the measured cell.</p>
<p>cellGlobalId This field specifies cell global ID of the measured cell. The target device shall provide this field if it was able to determine the ECGI of the measured cell at the time of measurement.</p>
<p>arfcnEUTRA This field specifies the ARFCN of the measured E-UTRA carrier frequency, as defined in TS 36.331 [12]. In the case the target device includes <i>arfcnEUTRA-v9a0</i>, the target device shall set the corresponding <i>arfcnEUTRA</i> (i.e. without suffix) to <i>maxEARFCN</i>.</p>
<p>systemFrameNumber This field specifies the system frame number of the measured cell during which the measurements have been performed. The target device shall include this field if it was able to determine the SFN of the cell at the time of measurement.</p>
<p>rsrp-Result This field specifies the reference signal received power (RSRP) measurement, as defined in TS 36.331 [12], TS 36.214 [17]. In the case the target device includes <i>rsrp-Result-v1470</i>, the target device shall set the corresponding <i>rsrp-Result</i> (i.e. without suffix) to value 0.</p>
<p>rsrq-Result This field specifies the reference signal received quality (RSRQ) measurement, as defined in TS 36.331 [12], TS 36.214 [17]. In the case the target device includes <i>rsrq-Result-v1470</i>, the target device shall set the corresponding <i>rsrq-Result</i> (i.e. without suffix) to value 0 or 34.</p>
<p>ue-RxTxTimeDiff This field specifies the UE Rx-Tx time difference measurement, as defined in TS 36.214 [17]. It is provided only for measurements on the UE's primary cell. Measurement report mapping is according to TS 36.133 [18].</p>
<p>nrsrp-Result This field specifies the narrowband reference signal received power (NRSRP) measurement, as defined in TS 36.214 [17]. Measurement report mapping is according to TS 36.133 [18].</p>

<i>ECID-SignalMeasurementInformation</i> field descriptions
<p><i>nrsrq-Result</i> This field specifies the narrowband reference signal received quality (NRSRQ) measurement, as defined in TS 36.214 [17]. Measurement report mapping to the value defined in TS 36.133 [18]. Values 0..29 map to values NRSRQ_-30..NRSRQ_-1. Values 30..62 map to NRSRQ_01..NRSRQ_33. Values 63..74 map to NRSRQ_35..NRSRQ_46. The UE does not report NRSRQ_00 nor NRSRQ_34.</p>
<p><i>carrierFreqOffsetNB</i> This field specifies the offset of the NB-IoT channel number to ARFCN given by <i>arfcnEUTRA</i> as defined in TS 36.101 [21].</p>
<p><i>hyperSFN</i> This field specifies the hyper-SFN of the measured cell during which the measurements have been performed. The target device shall include this field if it was able to determine the hyper-SFN of the cell at the time of measurement.</p>

6.5.3.3 E-CID Location Information Request

– *ECID-RequestLocationInformation*

The IE *ECID-RequestLocationInformation* is used by the location server to request E-CID location measurements from a target device.

```
-- ASN1START
ECID-RequestLocationInformation ::= SEQUENCE {
    requestedMeasurements    BIT STRING {
        rsrpReq              (0),
        rsrqReq              (1),
        ueRxTxReq            (2),
        nrsrpReq-r14         (3),
        nrsrqReq-r14         (4)} (SIZE(1..8)),
    ...
}
-- ASN1STOP
```

<i>ECID-RequestLocationInformation</i> field descriptions
<p><i>requestedMeasurements</i> This field specifies the E-CID measurements requested. This is represented by a bit string, with a one-value at the bit position means the particular measurement is requested; a zero-value means not requested.</p>

6.5.3.4 E-CID Capability Information

– *ECID-ProvideCapabilities*

The IE *ECID-ProvideCapabilities* is used by the target device to indicate its capability to support E-CID and to provide its E-CID location capabilities to the location server.

```
-- ASN1START
ECID-ProvideCapabilities ::= SEQUENCE {
    ecid-MeasSupported    BIT STRING {
        rsrpSup              (0),
        rsrqSup              (1),
        ueRxTxSup            (2),
        nrsrpSup-r14         (3),
        nrsrqSup-r14         (4)} (SIZE(1..8)),
    ...
    [[ ueRxTxSupTDD-r13      ENUMERATED { true }           OPTIONAL
    ]],
    [[ periodicalReporting-r14  ENUMERATED { supported }     OPTIONAL,
    triggeredReporting-r14     ENUMERATED { supported }     OPTIONAL,
    idleStateForMeasurements-r14  ENUMERATED { required }   OPTIONAL
    ]],
    [[ scheduledLocationRequestSupported-r17  ScheduledLocationTimeSupport-r17  OPTIONAL
    ]],
}
-- ASN1STOP
```

<i>ECID-Provide-Capabilities</i> field descriptions
<p><i>ecid-MeasSupported</i> This field specifies the E-CID measurements supported by the target device. This is represented by a bit string, with a one-value at the bit position means the particular measurement is supported; a zero-value means not supported. A zero-value in all bit positions in the bit string means only the basic Cell ID positioning method is supported by the target device. If the UE Rx-Tx time difference measurement is supported by the target device (i.e., <i>ueRxTxSup</i> field is set to one), it means that the UE supports the UE Rx-Tx time difference measurement reporting via both LPP signaling and RRC signalling. If a target device doesn't support LPP, the E-SMLC may assume the target device can not report the UE Rx-Tx time difference measurement results via RRC signalling.</p>
<p><i>ueRxTxSupTDD</i> This field, if present, indicates that any UE Rx-Tx time difference measurement reporting for TDD from the target device includes the $N_{TAoffset}$ according to TS 36.211 [16], TS 36.214 [17] and uses the UE Rx-Tx time difference measurement report mapping for TDD as specified in TS 36.133 [18]. This field may only be included if the <i>ueRxTxSup</i> field in <i>ecid-MeasSupported</i> is set to value one.</p>
<p><i>periodicalReporting</i> This field, if present, indicates that the target device supports <i>periodicalReporting</i> of E-CID measurements. If this field is absent, the location server may assume that the target device does not support <i>periodicalReporting</i> in <i>CommonIEsRequestLocationInformation</i>.</p>
<p><i>triggeredReporting</i> This field, if present, indicates that the target device supports <i>triggeredReporting</i> for the <i>cellChange</i> event. If this field is absent, the location server may assume that the target device does not support <i>triggeredReporting</i> in <i>CommonIEsRequestLocationInformation</i>.</p>
<p><i>idleStateForMeasurements</i> This field, if present, indicates that the target device requires idle state to perform E-CID measurements.</p>
<p><i>scheduledLocationRequestSupported</i> This field, if present, indicates that the target device supports scheduled location requests – i.e., supports the IE <i>ScheduledLocationTime</i> in IE <i>CommonIEsRequestLocationInformation</i> – and the time base(s) supported for the scheduled location time.</p>

6.5.3.5 E-CID Capability Information Request

– *ECID-RequestCapabilities*

The IE *ECID-RequestCapabilities* is used by the location server to request E-CID positioning capabilities from a target device.

```
-- ASN1START
ECID-RequestCapabilities ::= SEQUENCE {
    ...
}
-- ASN1STOP
```

6.5.3.6 E-CID Error Elements

– *ECID-Error*

The IE *ECID-Error* is used by the location server or target device to provide E-CID error reasons to the target device or location server, respectively.

```
-- ASN1START
ECID-Error ::= CHOICE {
    locationServerErrorCauses          ECID-LocationServerErrorCauses,
    targetDeviceErrorCauses           ECID-TargetDeviceErrorCauses,
    ...
}
-- ASN1STOP
```

– *ECID-LocationServerErrorCauses*

The IE *ECID-LocationServerErrorCauses* is used by the location server to provide E-CID error reasons to the target device.

```
-- ASN1START
ECID-LocationServerErrorCauses ::= SEQUENCE {
  cause      ENUMERATED {  undefined,
                          ...
                          },
  ...
}
-- ASN1STOP
```

– *ECID-TargetDeviceErrorCauses*

The IE *ECID-TargetDeviceErrorCauses* is used by the target device to provide E-CID error reasons to the location server.

```
-- ASN1START
ECID-TargetDeviceErrorCauses ::= SEQUENCE {
  cause      ENUMERATED {  undefined,
                          requestedMeasurementNotAvailable,
                          notAllRequestedMeasurementsPossible,
                          ...
                          },
  rsrpMeasurementNotPossible      NULL      OPTIONAL,
  rsrqMeasurementNotPossible      NULL      OPTIONAL,
  ueRxTxMeasurementNotPossible    NULL      OPTIONAL,
  ...
  [[
  nrsrpMeasurementNotPossible-r14  NULL      OPTIONAL,
  nrsrqMeasurementNotPossible-r14  NULL      OPTIONAL
  ]]
}
-- ASN1STOP
```

ECID-TargetDeviceErrorCauses field descriptions

cause

This field provides a E-CID specific error cause. If the cause value is 'notAllRequestedMeasurementsPossible', the target device was not able to provide all requested E-CID measurements (but may be able to provide some measurements). In this case, the target device should include any of the *rsrpMeasurementNotPossible*, *rsrqMeasurementNotPossible*, *ueRxTxMeasurementNotPossible*, *nrsrpMeasurementNotPossible*, or *nrsrqMeasurementNotPossible* fields, as applicable.

6.5.4 Terrestrial Beacon System Positioning

6.5.4.1 TBS Location Information

– *TBS-ProvideLocationInformation*

The IE *TBS-ProvideLocationInformation* is used by the target device to provide TBS location measurements to the location server. It may also be used to provide TBS positioning specific error reason.

```
-- ASN1START
TBS-ProvideLocationInformation-r13 ::= SEQUENCE {
  tbs-MeasurementInformation-r13  TBS-MeasurementInformation-r13  OPTIONAL,
  tbs-Error-r13                   TBS-Error-r13                   OPTIONAL,
  ...
}
-- ASN1STOP
```

-- ASN1STOP

6.5.4.2 TBS Location Information Elements

– *TBS-MeasurementInformation*

The IE *TBS-MeasurementInformation* is used by the target device to provide TBS location measurements to the location server.

```
-- ASN1START
TBS-MeasurementInformation-r13 ::= SEQUENCE {
    measurementReferenceTime-r13    UTCTime                OPTIONAL,
    mbs-SgnMeasList-r13             MBS-BeaconMeasList-r13  OPTIONAL, -- Cond MBS
    ...
}
-- ASN1STOP
```

Conditional presence	Explanation
MBS	The field is mandatory present if the <i>TBS-MeasurementInformation</i> is provided for an MBS system; otherwise it is not present.

<i>TBS-MeasurementInformation</i> field descriptions
measurementReferenceTime This field provides the UTC time when the TBS measurements are performed and should take the form of <i>YYMMDDhhmmssZ</i> .
mbs-SgnMeasList This field provides the MBS measurements for up to 64 MBS beacons.

– *MBS-BeaconMeasList*

The IE *MBS-BeaconMeasList* is used by the target device to provide MBS location measurements to the location server, as defined in the MBS ICD [24].

```
-- ASN1START
MBS-BeaconMeasList-r13 ::= SEQUENCE (SIZE(1..64)) OF MBS-BeaconMeasElement-r13
MBS-BeaconMeasElement-r13 ::= SEQUENCE {
    transmitterID-r13            INTEGER (0..32767),
    codePhase-r13                INTEGER (0..2097151),
    codePhaseRMSError-r13       INTEGER (0..63),
    ...
    [[ rssi-r14                   INTEGER (-130..-30)    OPTIONAL
    ]]
}
-- ASN1STOP
```

<i>MBS-BeaconMeasList</i> field descriptions
transmitterID This field contains the MBS transmitter identifier.
codePhase This field contains the value of the code-phase measurement made by the target device for the particular beacon signal at the time of measurement in the units of ms. MBS specific code phase measurements (e.g. chips) are converted into unit of ms by dividing the measurements by the nominal values of the measured signal chipping rate. Scale factor 2^{-21} milli-seconds, in the range from 0 to $(1-2^{-21})$ milli-seconds.
codePhaseRMSError This field contains the pseudorange RMS error value. This parameter is specified according to a floating-point representation shown in the table below.

MBS-BeaconMeasList field descriptions	
rssI	This field provides an estimate of the received signal strength from the MBS beacon as referenced to the UE antenna connector. If the estimated received signal strength for the MBS beacon is less than -130 dBm, the UE shall report an RSSI value of -130. If the estimated received signal strength for the MBS beacon is greater than -30 dBm, the UE shall report an RSSI value of -30. Scale factor 1 dBm.

floating-point representation

Index	Mantissa	Exponent	Floating-Point value, x_i	Pseudorange value, P [m]
0	000	000	0.5	$P < 0.5$
1	001	000	0.5625	$0.5 \leq P < 0.5625$
i	x	y	$0.5 * (1 + x/8) * 2^y$	$x_{i-1} \leq P < x_i$
62	110	111	112	$104 \leq P < 112$
63	111	111	--	$112 \leq P$

6.5.4.3 TBS Location Information Request

– *TBS-RequestLocationInformation*

The IE *TBS-RequestLocationInformation* is used by the location server to request location information for TBS-based methods from the target device.

```

-- ASN1START
TBS-RequestLocationInformation-r13 ::= SEQUENCE {
    mbsSgnMeasListReq-r13          BOOLEAN,
    ...
    [ [ mbsAssistanceAvailability-r14  BOOLEAN                                OPTIONAL, -- Need ON
        mbsRequestedMeasurements-r14  BIT STRING {
            rssi          (0) } (SIZE(1..8))  OPTIONAL -- Need ON
        ] ]
}
-- ASN1STOP
    
```

TBS-RequestLocationInformation field descriptions	
mbsSgnMeasListReq	This field indicates whether the target device is requested to report MBS measurements in <i>TBS-MeasurementInformation</i> IE or not. TRUE means requested.
mbsAssistanceAvailability	This field indicates whether the target device may request additional MBS assistance data from the server. TRUE means allowed and FALSE means not allowed.
mbsRequestedMeasurements	This field indicates the additional MBS measurements requested and may only be included if <i>mbsSgnMeasListReq</i> is set to TRUE. This field is represented by a bit string, with a one-value at the bit position means the particular measurement is requested; a zero-value means not requested. The following measurement requests can be included. rssi: Beacon signal strength at the target

6.5.4.4 TBS Capability Information

– *TBS-ProvideCapabilities*

The IE *TBS-ProvideCapabilities* is used by the target device to indicate its capability to support TBS and to provide its TBS location capabilities to the location server.

```

-- ASN1START
TBS-ProvideCapabilities-r13 ::= SEQUENCE {
    tbs-Modes-r13          BIT STRING {   standalone      (0),
                                          ue-assisted      (1),
                                          ue-based        (2)} (SIZE (1..8)),
    ...,
    [[ mbs-AssistanceDataSupportList-r14  MBS-AssistanceDataSupportList-r14  OPTIONAL,
       periodicalReportingSupported-r14  PositioningModes                    OPTIONAL,
       mbs-ConfigSupport-r14            BIT STRING {   tb1      (0),
                                                         tb2      (1),
                                                         tb3      (2),
                                                         tb4      (3)} (SIZE (1..8))          OPTIONAL,
       mbs-IdleStateForMeasurements-r14  ENUMERATED { required }             OPTIONAL
    ]],
    [[ scheduledLocationRequestSupported-r17  ScheduledLocationTimeSupportPerMode-r17  OPTIONAL
    ]]
}
-- ASN1STOP

```

TBS-ProvideCapabilities field descriptions

tbs-Modes

This field specifies the TBS mode(s) supported by the target device. This is represented by a bit string, with a one-value at the bit position means the particular TBS mode is supported; a zero-value means not supported.

mbs-AssistanceDataSupportList

This list defines the MBS assistance data supported by the target device. This field shall be present if the target device supports MBS assistance data.

periodicalReportingSupported

This field, if present, specifies the positioning modes for which the target device supports *periodicalReporting*. This is represented by a bit string, with a one-value at the bit position means *periodicalReporting* for the positioning mode is supported; a zero-value means not supported. If this field is absent, the location server may assume that the target device does not support *periodicalReporting* in *CommonIEsRequestLocationInformation*.

mbs-ConfigSupport

This field specifies the MBS configurations supported by the target device. This field shall be present if the target device supports MBS [24].

mbs-IdleStateForMeasurements

This field, if present, indicates that the target device requires idle state to perform MBS measurements.

scheduledLocationRequestSupported

This field, if present, specifies the positioning modes for which the target device supports scheduled location requests – i.e., supports the IE *ScheduledLocationTime* in IE *CommonIEsRequestLocationInformation* – and the time base(s) supported for the scheduled location time for each positioning mode. If this field is absent, the target device does not support scheduled location requests.

- ***MBS-AssistanceDataSupportList***

The IE *MBS-AssistanceDataSupportList* is used by the target device to indicate its capability to support MBS Assistance Data and to provide its capabilities to the location server.

```

-- ASN1START
MBS-AssistanceDataSupportList-r14 ::= SEQUENCE {
    mbs-AcquisitionAssistanceDataSupport-r14  BOOLEAN,
    mbs-AlmanacAssistanceDataSupport-r14      BOOLEAN,
    ...
}
-- ASN1STOP

```

MBS-AssistanceDataSupportList field descriptions

mbs-AcquisitionAssistanceDataSupport

This field specifies whether the target device supports MBS Acquisition Assistance Data. TRUE means supported.

mbs-AlmanacAssistanceDataSupport

This field specifies whether the target device supports MBS Almanac Assistance Data. TRUE means supported.

6.5.4.5 TBS Capability Information Request

– *TBS-RequestCapabilities*

The IE *TBS-RequestCapabilities* is used by the location server to request TBS positioning capabilities from a target device.

```
-- ASN1START
TBS-RequestCapabilities-r13 ::= SEQUENCE {
    ...
}
-- ASN1STOP
```

6.5.4.6 TBS Error Elements

– *TBS-Error*

The IE *TBS-Error* is used by the location server or target device to provide TBS error reasons to the target device or location server, respectively.

```
-- ASN1START
TBS-Error-r13 ::= CHOICE {
    locationServerErrorCauses-r13      TBS-LocationServerErrorCauses-r13,
    targetDeviceErrorCauses-r13       TBS-TargetDeviceErrorCauses-r13,
    ...
}
-- ASN1STOP
```

– *TBS-LocationServerErrorCauses*

The IE *TBS-LocationServerErrorCauses* is used by the location server to provide error reasons for TBS positioning to the target device.

```
-- ASN1START
TBS-LocationServerErrorCauses-r13 ::= SEQUENCE {
    cause-r13      ENUMERATED {
        undefined,
        ...,
        assistanceDataNotSupportedByServer-v1420,
        assistanceDataSupportedButCurrentlyNotAvailableByServer-v1420
    },
    ...
}
-- ASN1STOP
```

– *TBS-TargetDeviceErrorCauses*

The IE *TBS-TargetDeviceErrorCauses* is used by the target device to provide error reasons for TBS positioning to the location server.

```
-- ASN1START
TBS-TargetDeviceErrorCauses-r13 ::= SEQUENCE {
    cause-r13      ENUMERATED {
        undefined,
        thereWereNotEnoughMBSBeaconsReceived,
        ...,
        assistanceDataMissing-v1420
    },
    ...
}
-- ASN1STOP
```

```
-- ASN1STOP
```

<i>TBS-TargetDeviceErrorCauses</i> field descriptions
<p>cause This field provides a TBS specific error cause.</p>

6.5.4.7 TBS Assistance Data

– *TBS-ProvideAssistanceData*

The IE *TBS-ProvideAssistanceData* is used by the location server to provide assistance data to assist in position estimation at the UE (e.g. for UE-based mode) and/or to expedite the acquisition of TBS signals. It may also be used to provide TBS positioning specific error reasons.

```
-- ASN1START
TBS-ProvideAssistanceData-r14 ::= SEQUENCE {
    tbs-AssistanceDataList-r14 TBS-AssistanceDataList-r14 OPTIONAL, -- Need ON
    tbs-Error-r14 TBS-Error-r13 OPTIONAL, -- Need ON
    ...
}
-- ASN1STOP
```

6.5.4.8 TBS Assistance Data Elements

– *TBS-AssistanceDataList*

The IE *TBS-AssistanceDataList* is used by the location server to provide the TBS specific assistance data to the UE.

```
-- ASN1START
TBS-AssistanceDataList-r14 ::= SEQUENCE {
    mbs-AssistanceDataList-r14 MBS-AssistanceDataList-r14 OPTIONAL, -- Need ON
    ...
}
MBS-AssistanceDataList-r14 ::= SEQUENCE (SIZE (1..maxMBS-r14)) OF MBS-AssistanceDataElement-r14
MBS-AssistanceDataElement-r14 ::= SEQUENCE {
    mbs-AlmanacAssistance-r14 MBS-AlmanacAssistance-r14 OPTIONAL, -- Need ON
    mbs-AcquisitionAssistance-r14 MBS-AcquisitionAssistance-r14 OPTIONAL, -- Need ON
    ...
}
-- ASN1STOP
```

– *MBS-AlmanacAssistance*

The IE *MBS-AlmanacAssistance* is used by the location server to provide LLA of MBS transmitters to enable position estimation at the UE.

```
-- ASN1START
MBS-AlmanacAssistance-r14 ::= SEQUENCE {
    transmitterID-r14 INTEGER (0..32767),
    transmitterLatitude-r14 BIT STRING (SIZE (26)),
    transmitterLongitude-r14 BIT STRING (SIZE (27)),
    transmitterAltitude-r14 BIT STRING (SIZE (15)),
    timeCorrection-r14 INTEGER (0..25) OPTIONAL, -- Need ON
    ...
}
-- ASN1STOP
```

MBS-AlmanacAssistance field descriptions	
transmitterID	This field specifies the MBS transmitter ID [24].
transmitterLatitude	This field specifies latitude of the MBS transmitter, degrees. Scale factor $4/2^{20}$ decimal degrees, added to -90° . Valid range -90° to 90° [24].
transmitterLongitude	This field specifies longitude of the MBS transmitter, degrees. Scale factor $4/2^{20}$ decimal degrees, added to -180° . Valid range -180° to 180° [24].
transmitterAltitude	This field specifies altitude of the MBS transmitter, metres. Scale factor 0.29 metres, added to -500 metres. Valid range -500 to 9002.43 metres [24].
timeCorrection	This field contains the residual timing error for a particular beacon, in units of nano-seconds, in the range from 0 to 25. This field is used for UE-based mode only, by subtracting from the <i>codePhase</i> measurement made by the target device [24].

– MBS-AcquisitionAssistance

The IE *MBS-AcquisitionAssistance* is used by the location server to provide parameters that support acquisition of the MBS signals [24].

```
-- ASN1START
MBS-AcquisitionAssistance-r14 ::= SEQUENCE {
    transmitterID-r14          INTEGER (0..32767)           OPTIONAL, -- Need ON
    mbsConfiguration-r14      ENUMERATED {tb1, tb2, tb3, tb4, ...} OPTIONAL, -- Need ON
    pnCodeIndex-r14          INTEGER (1..128)           OPTIONAL, -- Need ON
    freq-r14                  INTEGER (919750000..927250000) OPTIONAL, -- Need ON
    ...
}
-- ASN1STOP
```

MBS-AcquisitionAssistance field descriptions	
transmitterID	This field contains the MBS transmitter identifier [24].
mbsConfiguration	This field specifies MBS configuration as defined in the MBS ICD [24].
pnCodeIndex	This field specifies the index of the MBS PN code [24].
freq	This field specifies the MBS signal centre frequency in units of Hz [24].

6.5.4.9 TBS Assistance Data Request

– TBS-RequestAssistanceData

The IE *TBS-RequestAssistanceData* is used by the target device to request TBS assistance data from a location server.

```
-- ASN1START
TBS-RequestAssistanceData-r14 ::= SEQUENCE {
    mbs-AlmanacAssistanceDataReq-r14  BOOLEAN,
    mbs-AcquisitionAssistanceDataReq-r14  BOOLEAN,
    ...
}
-- ASN1STOP
```

6.5.5 Sensor based Positioning

6.5.5.0 Introduction

This clause defines support for sensor-based positioning. The supported sensor methods are "Barometric pressure sensor" and "Motion sensor" as described in TS 36.305, clauses 8.6 and 8.10 respectively [2].

6.5.5.1 Sensor Location Information

– *Sensor-ProvideLocationInformation*

The IE *Sensor-ProvideLocationInformation* is used by the target device to provide location information for sensor-based methods to the location server. It may also be used to provide sensor specific error reason.

```
-- ASN1START
Sensor-ProvideLocationInformation-r13 ::= SEQUENCE {
  sensor-MeasurementInformation-r13  Sensor-MeasurementInformation-r13  OPTIONAL,
  sensor-Error-r13                   Sensor-Error-r13              OPTIONAL,
  . . . ,
  [[
    sensor-MotionInformation-r15      Sensor-MotionInformation-r15  OPTIONAL
  ]]
}
-- ASN1STOP
```

6.5.5.2 Sensor Location Information Elements

– *Sensor-MeasurementInformation*

The IE *Sensor-MeasurementInformation* is used by the target device to provide UE sensor measurements to the location server.

```
-- ASN1START
Sensor-MeasurementInformation-r13 ::= SEQUENCE {
  measurementReferenceTime-r13      UTCTime                        OPTIONAL,
  uncompensatedBarometricPressure-r13 INTEGER (30000..115000)        OPTIONAL, -- Cond Barometer
  . . . ,
  [[
    uncertainty-r14                  SEQUENCE {
      range-r14                      INTEGER (0..1000),
      confidence-r14                 INTEGER (1..100)
    }
  ]],
  [[ adjustment-r16                  INTEGER (-5000..5000)          OPTIONAL
  ]]
}
-- ASN1STOP
```

Conditional presence	Explanation
<i>Barometer</i>	The field is mandatory present if the <i>Sensor-MeasurementInformation</i> is provided for barometric pressure; otherwise it is not present.

Sensor-MeasurementInformation field descriptions
<p>measurementReferenceTime This field provides the UTC time when the sensor measurements are performed and should take the form of <i>YYMMDDhhmmssZ</i>.</p>
<p>uncompensatedBarometricPressure This field provides the uncompensated barometric pressure as measured by the UE sensor, in units of Pa.</p>
<p>uncertainty This field provides the expected range for the pressure measurement in units of Pa and the confidence as a percentage that the true pressure lies in a range of (measurement – range) to (measurement + range).</p>
<p>adjustment This field provides any adjustment available in the UE, in units of Pa, to allow the production of a compensated atmospheric pressure measurement where compensated atmospheric pressure = <i>uncompensatedBarometricPressure</i> + <i>adjustment</i></p>

– Sensor-MotionInformation

The IE *Sensor-MotionInformation* is used by the target device to provide UE movement information to the location server. The movement information comprises an ordered series of points. This information may be obtained by the target device using one or more motion sensors.

```
-- ASN1START

Sensor-MotionInformation-r15 ::= SEQUENCE {
    refTime-r15           DisplacementTimeStamp-r15,
    displacementInfoList-r15  DisplacementInfoList-r15,
    ...
}

DisplacementInfoList-r15 ::= SEQUENCE (SIZE (1..128)) OF DisplacementInfoListElement-r15

DisplacementInfoListElement-r15 ::= SEQUENCE {
    deltaTimeStamp-r15    DeltaTime-r15,
    displacement-r15      Displacement-r15           OPTIONAL,
    ...
}

DisplacementTimeStamp-r15 ::= CHOICE {
    utcTime-r15           UTC-Time-r15,
    gnssTime-r15          MeasurementReferenceTime,
    systemFrameNumber-r15 SFN-r15,
    measurementSFN-r15    INTEGER(-8192..9214),
    ...
}

DeltaTime-r15 ::= CHOICE {
    deltaTimeSec-r15      INTEGER (1..16384),
    deltaTimeSFN-r15     INTEGER (1..4096),
    ...
}

SFN-r15 ::= SEQUENCE {
    sfn-r15               BIT STRING (SIZE (10)),
    hyperSFN-r15         BIT STRING (SIZE (10))   OPTIONAL,
    ...
}

Displacement-r15 ::= SEQUENCE {
    bearing-r15           INTEGER (0..3599),
    bearingUncConfidence-r15  INTEGER (0..100)           OPTIONAL,
    bearingRef-r15        ENUMERATED { geographicNorth, magneticNorth, local },
    horizontalDistance-r15  INTEGER (0..8191),
    horizontalDistanceUnc-r15  INTEGER (0..255)           OPTIONAL,
    horizontalUncConfidence-r15  INTEGER (0..100)           OPTIONAL,
    verticalDirection-r15    ENUMERATED{upward, downward}  OPTIONAL,
    verticalDistance-r15     INTEGER(0..8191)             OPTIONAL,
    verticalDistanceUnc-r15   INTEGER (0..255)           OPTIONAL,
    verticalUncConfidence-r15  INTEGER (0..100)           OPTIONAL,
    ...
}

UTC-Time-r15 ::= SEQUENCE {
    utcTime-r15           UTCTime,
    utcTime-ms-r15        INTEGER (0..999),
    ...
}
```

```
}
-- ASN1STOP
```

Sensor-MotionInformation field descriptions
<p>refTime This field provides the reference time t_0 associated with the starting position of the first displacement in the displacement list.</p>
<p>displacementInfoList This field provides an ordered series of direction and distance travelled by the target device and comprises the following subfields:</p> <ul style="list-style-type: none"> - deltaTimeStamp specifies the time between t_{n-1} and t_n, where n corresponds to the order of entry in the <i>DisplacementInfoList</i> ($n=0$ correspond to the time provided in <i>refTime</i>). - displacement provides the direction and distance travelled between time t_{n-1} and t_n.
<p>utcTime This field provides the time stamp of the <i>refTime</i> in UTC time and comprises the following subfields:</p> <ul style="list-style-type: none"> - <i>utcTime</i> in the form of YYMMDDhhmmssZ. - <i>utcTime-ms</i> specifies the fractional part of the UTC time in ms resolution.
<p>gnssTime This field provides the time stamp of the <i>refTime</i> in GNSS time.</p>
<p>systemFrameNumber This field provides the time stamp of the <i>refTime</i> in serving cell SFN time.</p>
<p>measurementSFN This field provides the time stamp of the <i>refTime</i> in form of the measurement SFN as defined in <i>delta-SFN</i> in IE <i>OTDOA-SignalMeasurementInformation</i>. This field may be included when OTDOA measurements are included.</p>
<p>deltaTimeSec This field provides the time between t_{n-1} and t_n in units of milliseconds.</p>
<p>deltaTimeSFN This field provides the time between t_{n-1} and t_n in units of system frame numbers.</p>
<p>bearing This field specifies the direction (heading) of the horizontal displacement measured clockwise from <i>bearingRef</i>. Scale factor 0.1 degree.</p>
<p>bearingRef This field specifies the reference direction for the <i>bearing</i>. Enumerated value 'geographicNorth' indicates that the <i>bearing</i> is measured clockwise from the Geographic North; 'magneticNorth' indicates that the <i>bearing</i> is measured clockwise from the Magnetic North; 'local' indicates that the <i>bearing</i> is measured clockwise from an arbitrary (undefined) reference direction.</p>
<p>horizontalDistance This field specifies the horizontal distance travelled between time t_{n-1} and t_n. Scale factor 1 cm.</p>
<p>horizontalDistanceUnc, horizontalUncConfidence This field specifies the horizontal uncertainty of the displacement (corresponding to t_n). <i>horizontalDistanceUnc</i> correspond to the encoded high accuracy uncertainty as defined in TS 23.032 [15]. <i>horizontalUncConfidence</i> corresponds to confidence as defined in TS 23.032 [15].</p>
<p>verticalDistance This field specifies the vertical distance travelled between time t_{n-1} and t_n. Scale factor 1 cm.</p>
<p>verticalDistanceUnc, verticalUncConfidence This field specifies the vertical uncertainty of the displacement (corresponding to t_n). <i>verticalDistanceUnc</i> correspond to the encoded high accuracy uncertainty as defined in TS 23.032 [15]. <i>verticalUncConfidence</i> corresponds to confidence as defined in TS 23.032 [15].</p>

6.5.5.3 Sensor Location Information Request

– *Sensor-RequestLocationInformation*

The IE *Sensor-RequestLocationInformation* is used by the location server to request location information for sensor-based methods from a target device.

```
-- ASN1START
Sensor-RequestLocationInformation-r13 ::= SEQUENCE {
    uncompensatedBarometricPressureReq-r13    BOOLEAN,
    . . . ,
    [[ assistanceAvailability-r14                BOOLEAN    OPTIONAL    -- Need ON
    ]],
    [[ sensor-MotionInformationReq-r15          BOOLEAN    OPTIONAL    -- Need ON
```



```

    ]],
    [[ adjustmentReq-r16          BOOLEAN    OPTIONAL    -- Need ON
    ]]
}
-- ASN1STOP

```

Sensor-RequestLocationInformation field descriptions

uncompensatedBarometricPressureReq

This field indicates whether the target device is requested to report Barometric pressure measurements in *Sensor-MeasurementInformation* IE or not. TRUE means requested.

assistanceAvailability

This field indicates whether the target device may request additional Sensor assistance data from the server. TRUE means allowed and FALSE means not allowed.

sensor-MotionInformationReq

This field indicates whether the target device is requested to report movement information in IE *Sensor-MotionInformation* or not. TRUE means requested.

adjustmentReq

This field indicates whether the target device is requested to report *adjustment* in IE *Sensor-MeasurementInformation* or not. TRUE means requested.

6.5.5.4 Sensor Capability Information

– *Sensor-ProvideCapabilities*

The IE *Sensor-ProvideCapabilities* is used by the target device to provide capabilities for sensor-based methods from to the location server.

```

-- ASN1START
Sensor-ProvideCapabilities-r13 ::= SEQUENCE {
    sensor-Modes-r13          BIT STRING {
        standalone (0),
        ue-assisted (1),
        ue-based (2)} (SIZE (1..8)),
    ...,
    [[ sensor-AssistanceDataSupportList-r14  Sensor-AssistanceDataSupportList-r14  OPTIONAL,
    periodicalReportingSupported-r14        PositioningModes                        OPTIONAL,
    idleStateForMeasurements-r14            ENUMERATED { required }                OPTIONAL
    ]],
    [[ sensor-MotionInformationSup-r15        ENUMERATED { true }                      OPTIONAL
    ]],
    [[ adjustmentSupported-r16               ENUMERATED { true }                      OPTIONAL
    ]],
    [[ scheduledLocationRequestSupported-r17 ScheduledLocationTimeSupportPerMode-r17 OPTIONAL
    ]]
}

Sensor-AssistanceDataSupportList-r14 ::= SEQUENCE {
    ...,
    [[ validityPeriodSupported-v1520         ENUMERATED { true }                      OPTIONAL,
    validityAreaSupported-v1520             ENUMERATED { true }                      OPTIONAL
    ]]
}
-- ASN1STOP

```

Sensor-ProvideCapabilities field descriptions

sensor-Modes

This field specifies the sensor mode(s) supported by the target device. This is represented by a bit string, with a one-value at the bit position means the particular sensor mode is supported; a zero-value means not supported.

sensor-AssistanceDataSupportList

This field specifies a list of sensor assistance data supported by the target device. This field shall be present if the target device supports assistance data for Barometric pressure sensor.

validityPeriodSupported

This field, if present, indicates that the target device supports *period* i.e. pressure validity period and pressure rate as part of the *Sensor-AssistanceDataList*.

Sensor-ProvideCapabilities field descriptions
<p>validityAreaSupported This field, if present, indicates that the target device supports <i>area</i> i.e. pressure validity area and North/East pressure gradient as part of the <i>Sensor-AssistanceDataList</i>.</p>
<p>periodicalReportingSupported This field, if present, specifies the positioning modes for which the target device supports <i>periodicalReporting</i>. This is represented by a bit string, with a one-value at the bit position means <i>periodicalReporting</i> for the positioning mode is supported; a zero-value means not supported. If this field is absent, the location server may assume that the target device does not support <i>periodicalReporting</i> in <i>CommonEsRequestLocationInformation</i>.</p>
<p>idleStateForMeasurements This field, if present, indicates that the target device requires idle state to perform sensor measurements.</p>
<p>sensor-MotionInformationSup This field, if present, indicates that the target device supports displacement reporting in IE <i>Sensor-MotionInformation</i>.</p>
<p>adjustmentSupported This field, if present, indicates that the target device supports the <i>adjustment</i> IE in <i>Sensor-MeasurementInformation</i>.</p>
<p>scheduledLocationRequestSupported This field, if present, specifies the positioning modes for which the target device supports scheduled location requests – i.e., supports the IE <i>ScheduledLocationTime</i> in IE <i>CommonEsRequestLocationInformation</i> – and the time base(s) supported for the scheduled location time for each positioning mode. If this field is absent, the target device does not support scheduled location requests.</p>

6.5.5.5 Sensor Capability Information Request

– *Sensor-RequestCapabilities*

The IE *Sensor-RequestCapabilities* is used by the location server to request capabilities for sensor-based methods from the target device.

```
-- ASN1START
Sensor-RequestCapabilities-r13 ::= SEQUENCE {
    ...
}
-- ASN1STOP
```

6.5.5.6 Sensor Error Elements

– *Sensor-Error*

The IE *Sensor-Error* is used by the location server or target device to provide Sensor Error Reasons to the target device or location server, respectively.

```
-- ASN1START
Sensor-Error-r13 ::= CHOICE {
    locationServerErrorCauses-r13      Sensor-LocationServerErrorCauses-r13,
    targetDeviceErrorCauses-r13       Sensor-TargetDeviceErrorCauses-r13,
    ...
}
-- ASN1STOP
```

– *Sensor-LocationServerErrorCauses*

The IE *Sensor-LocationServerErrorCauses* is used by the location server to provide error reasons for Sensor positioning to the target device.

```
-- ASN1START
Sensor-LocationServerErrorCauses-r13 ::= SEQUENCE {
    cause-r13      ENUMERATED { undefined,
    ...,
    assistanceDataNotSupportedByServer-v1420,

```

```

        assistanceDataSupportedButCurrentlyNotAvailableByServer-v1420
    },
    ...
}
-- ASN1STOP

```

– *Sensor-TargetDeviceErrorCauses*

The IE *Sensor-TargetDeviceErrorCauses* is used by the target device to provide error reasons for Sensor positioning to the location server.

```

-- ASN1START
Sensor-TargetDeviceErrorCauses-r13 ::= SEQUENCE {
    cause-r13          ENUMERATED      { undefined,
        ...,
        assistanceDataMissing-v1420
    },
    ...
}
-- ASN1STOP

```

6.5.5.7 Sensor Assistance Data

– *Sensor-ProvideAssistanceData*

The IE *Sensor-ProvideAssistanceData* is used by the location server to provide assistance data to assist in altitude computation at the UE (e.g. for UE-based mode). It may also be used to provide Sensor positioning specific error reasons.

```

-- ASN1START
Sensor-ProvideAssistanceData-r14 ::= SEQUENCE {
    sensor-AssistanceDataList-r14      Sensor-AssistanceDataList-r14      OPTIONAL,  -- Need ON
    sensor-Error-r14                   Sensor-Error-r13                   OPTIONAL,  -- Need ON
    ...
}
-- ASN1STOP

```

6.5.5.8 Sensor Assistance Data Elements

– *Sensor-AssistanceDataList*

The IE *Sensor-AssistanceDataList* is used by the location server to provide the Sensor specific assistance data to the UE.

```

-- ASN1START
Sensor-AssistanceDataList-r14 ::= SEQUENCE {
    refPressure-r14          INTEGER (-20000..10000),
    refPosition-r14         EllipsoidPointWithAltitudeAndUncertaintyEllipsoid  OPTIONAL,  -- Need ON
    refTemperature-r14      INTEGER (-64..63)                                     OPTIONAL,  -- Need ON
    ...,
    [[
    period-v1520             SEQUENCE {
        pressureValidityPeriod-v1520      PressureValidityPeriod-v1520,
        referencePressureRate-v1520       INTEGER (-128..127)                                     OPTIONAL,  -- Need ON
        ...
    }
    area-v1520              SEQUENCE {
        pressureValidityArea-v1520        PressureValidityArea-v1520,
        gN-pressure-v1520                 INTEGER (-1024..1023)                                     OPTIONAL,  -- Need ON
        gE-pressure-v1520                 INTEGER (-1024..1023)                                     OPTIONAL,  -- Need ON
        ...
    ]
}
-- ASN1STOP

```

```

    }
  ]]
}
PressureValidityArea-v1520 ::= SEQUENCE {
  centerPoint-v1520           Ellipsoid-Point,
  validityAreaWidth-v1520     INTEGER (1..128),
  validityAreaHeight-v1520    INTEGER (1..128),
  ...
}
PressureValidityPeriod-v1520 ::= SEQUENCE {
  beginTime-v1520             GNSS-SystemTime,
  beginTimeAlt-v1520          INTEGER (0..2881) OPTIONAL, -- Need ON
  duration-v1520              INTEGER (1..2881),
  ...
}
-- ASN1STOP

```

Sensor-AssistanceDataList field descriptions
<p>refPressure This field specifies the atmospheric pressure (Pa) nominal at sea level, EGM96 [29] to the target. The scale factor is 1 Pa. The value is added to the nominal pressure of 101325 Pa.</p>
<p>refPosition This field specifies the reference position at which the pressure measurement is made, as an ellipsoid point with altitude and uncertainty ellipsoid.</p>
<p>refTemperature Local temperature measurement at the reference where the pressure measurement is made. The scale factor 1K. The value is added to 273K.</p>
<p>period This field specifies the pressure validity period and reference pressure rate.</p>
<p>pressureValidityPeriod</p> <ul style="list-style-type: none"> - beginTime: this field specifies the start time of the pressure validity period in <i>GNSS System Time</i>. - beginTimeAlt: this field specifies an alternative start time. It may be used by the target device if <i>GNSS-System Time</i> is not available. The alternative start time is relative to the time the message was received. The scale factor is 15 min. The range is from 0 minutes to 43215 minutes = 30 days. - duration: this field specifies the duration of the validity period after the begin time. The scale factor is 15 minutes. The range is from 15 minutes to 43215 minutes = 30 days.
<p>referencePressureRate This field specifies the rate of change of pressure. When this field is included, the reference pressure applies only at the start of the pressure validity period. The scale factor is 10Pa/hour.</p>
<p>area This field specifies the area within which the provided atmospheric reference pressure is valid and any spatial drift.</p>
<p>pressureValidityArea</p> <ul style="list-style-type: none"> - centerPoint: this field specifies the coordinates of the centre of the rectangular validity area. - validityAreaWidth: this field specifies the width of the rectangular validity area. Width is measured from the centre along the latitude and is measured as the total width of the rectangle. The scale factor is 1km. The range is from 1km to 128km. - validityAreaHeight: this fields specifies the height of the rectangular validity area. Height is measured from the centre along the longitude and is measured as the total height of the rectangle. The scale factor is 1km. The range is from 1km to 128km. <p>If this field is present, <i>refPosition</i> should not be provided by the location server and if provided, shall be ignored by the target device.</p>
<p>gN-pressure This field specifies the northward gradient of the reference pressure calculated from the centre of the <i>pressureValidityArea</i>. The scale factor is 1 Pa/km. If this field is not provided, the gradient is assumed to be zero.</p>
<p>gE-pressure This field specifies the eastward gradient of the reference pressure calculated from the centre of the <i>pressureValidityArea</i>. The scale factor is 1 Pa/km. If this field is not provided, the gradient is assumed to be zero.</p>

6.5.5.9 Sensor Assistance Data Request

– *Sensor-RequestAssistanceData*

The IE *Sensor-RequestAssistanceData* is used by the target device to request Sensor assistance data from a location server.

```
-- ASN1START
Sensor-RequestAssistanceData-r14 ::= SEQUENCE {
    ...
}
-- ASN1STOP
```

6.5.6 WLAN-based Positioning

This clause defines support for positioning using measurements related to WLAN access points.

6.5.6.1 WLAN Location Information

– *WLAN-ProvideLocationInformation*

The IE *WLAN-ProvideLocationInformation* is used by the target device to provide measurements for one or more WLANs to the location server. It may also be used to provide WLAN positioning specific error reason.

```
-- ASN1START
WLAN-ProvideLocationInformation-r13 ::= SEQUENCE {
    wlan-MeasurementInformation-r13    WLAN-MeasurementInformation-r13    OPTIONAL,
    wlan-Error-r13                    WLAN-Error-r13                    OPTIONAL,
    ...
}
-- ASN1STOP
```

6.5.6.2 WLAN Location Information Elements

– *WLAN-MeasurementInformation*

```
-- ASN1START
WLAN-MeasurementInformation-r13 ::= SEQUENCE {
    measurementReferenceTime-r13      UTCTime                        OPTIONAL,
    wlan-MeasurementList-r13          WLAN-MeasurementList-r13     OPTIONAL,
    ...
}
WLAN-MeasurementList-r13 ::= SEQUENCE (SIZE(1..maxWLAN-AP-r13)) OF WLAN-MeasurementElement-r13
WLAN-MeasurementElement-r13 ::= SEQUENCE {
    wlan-AP-Identifier-r13            WLAN-AP-Identifier-r13,
    rssi-r13                          INTEGER (-127..128)            OPTIONAL,
    rtt-r13                            WLAN-RTT-r13                OPTIONAL,
    apChannelFrequency-r13            INTEGER (0..256)             OPTIONAL,
    servingFlag-r13                   BOOLEAN                       OPTIONAL,
    ...
}
WLAN-AP-Identifier-r13 ::= SEQUENCE {
    bssid-r13                         OCTET STRING (SIZE (6)),
    ssid-r13                           OCTET STRING (SIZE (1..32))  OPTIONAL,
    ...
}
WLAN-RTT-r13 ::= SEQUENCE {
    rttValue-r13                      INTEGER (0..16777215),
    rttUnits-r13                      ENUMERATED {
        microseconds,
        hundredsofnanoseconds,
        tensofnanoseconds,
        nanoseconds,
        tenthsofnanoseconds,
        ... },
    rttAccuracy-r13                   INTEGER (0..255)             OPTIONAL,
    ...
}
```

```
-- ASN1STOP
```

WLAN-MeasurementInformation field descriptions	
measurementReferenceTime	This field provides the UTC time when the WLAN measurements are performed and should take the form of <i>YYMMDDhhmmssZ</i> .
wlan-MeasurementList	This field provides the WLAN measurements for up to 64 WLAN APs.
wlan-AP-Identifier	This field provides the BSSID and optionally the SSID of the wireless network served by the WLAN AP [26].
rssti	This field provides the AP signal strength (RSSI) of a beacon frame, probe response frame or measurement pilot frame measured at the target in dBm as defined in Table 6-7 of [26].
rtt	This field provides the measured round trip time between the target device and WLAN AP and optionally the accuracy expressed as the standard deviation of the delay. Units for each of these are 1000ns, 100ns, 10ns, 1ns, and 0.1ns.
apChannelFrequency	This field provides the AP channel number identification of the reported WLAN AP.
servingFlag	This parameter indicates whether a set of WLAN AP measurements were obtained for a serving WLAN AP (TRUE) or a non-serving WLAN AP (FALSE). A target device with multiple radio support may indicate more than one type of serving access for the same time instant.
rttValue	This field specifies the Round Trip Time (RTT) measurement between the target device and WLAN AP in units given by the field <i>rttUnits</i> .
rttUnits	This field specifies the Units for the fields <i>rttValue</i> and <i>rttAccuracy</i> . The available Units are 1000ns, 100ns, 10ns, 1ns, and 0.1ns.
rttAccuracy	This field provides the estimated accuracy of the provided <i>rttValue</i> expressed as the standard deviation in units given by the field <i>rttUnits</i> .

6.5.6.3 WLAN Location Information Request

– *WLAN-RequestLocationInformation*

The IE *WLAN-RequestLocationInformation* is used by the location server to request WLAN measurements from a target device.

```
-- ASN1START
WLAN-RequestLocationInformation-r13 ::= SEQUENCE {
    requestedMeasurements-r13 BIT STRING {
        rssi          (0),
        rtt           (1)} (SIZE(1..8)),
    ...,
    [[ assistanceAvailability-r14 BOOLEAN OPTIONAL -- Need ON
    ]]
}
-- ASN1STOP
```

WLAN-RequestLocationInformation field descriptions	
requestedMeasurements	This field specifies the WLAN measurements requested. This is represented by a bit string, with a one-value at the bit position means the particular measurement is requested; a zero-value means not requested. The following measurement requests can be included. rssi: AP signal strength at the target rtt: Round Trip Time between target and AP
assistanceAvailability	This field indicates whether the target device may request additional WLAN assistance data from the server. TRUE means allowed and FALSE means not allowed.

6.5.6.4 WLAN Capability Information

– *WLAN-ProvideCapabilities*

The IE *WLAN-ProvideCapabilities* is used by the target device to provide its capabilities for WLAN positioning to the location server.

```
-- ASN1START
WLAN-ProvideCapabilities-r13 ::= SEQUENCE {
  wlan-Modes-r13          BIT STRING {  standalone      (0),
                                         ue-assisted     (1),
                                         ue-based       (2) }      (SIZE (1..8)),

  wlan-MeasSupported-r13 BIT STRING {  rssi-r13        (0),
                                         rtt-r13        (1) }      (SIZE(1..8)),

  ... ,
  [[ wlan-AP-AD-Supported-r14
     BIT STRING {  ap-identifier  (0),
                  ap-location    (1) }      (SIZE (1..8))
     OPTIONAL,

   periodicalReportingSupported-r14 PositioningModes
   idleStateForMeasurements-r14    ENUMERATED {  required    }
   OPTIONAL

  ]],
  [[ scheduledLocationRequestSupported-r17 ScheduledLocationTimeSupportPerMode-r17 OPTIONAL
  ]]
}
-- ASN1STOP
```

WLAN-ProvideCapabilities field descriptions

wlan-Modes

This field specifies the WLAN mode(s) supported by the target device. This is represented by a bit string, with a one value at the bit position means the WLAN mode is supported; a zero value means not supported.

wlan-MeasSupported

This field specifies the measurements supported by the target device when accessing a WLAN. This is represented by a bit string, with a one-value at the bit position means the particular measurement is supported; a zero-value means not supported. A zero-value in all bit positions in the bit string means only the basic WLAN positioning method is supported by the target device which is reporting of the WLAN identity. The following bits are assigned for the indicated measurements.

rssi: AP signal strength at the target
rtt: Round Trip Time between target and AP

wlan-AP-AD-Supported

This field specifies the WLAN AP assistance data supported by the target device. This is represented by a bit string, with a one-value at the bit position means the particular assistance data is supported; a zero-value means not supported. A zero-value in all bit positions or absence of this field means no assistance data is supported. The following bits are assigned for the indicated assistance data.

ap-identifier: WLAN AP identity information
ap-location: WLAN AP location information

periodicalReportingSupported

This field, if present, specifies the positioning modes for which the target device supports *periodicalReporting*. This is represented by a bit string, with a one value at the bit position means *periodicalReporting* for the positioning mode is supported; a zero value means not supported. If this field is absent, the location server may assume that the target device does not support *periodicalReporting* in *CommonIEsRequestLocationInformation*.

idleStateForMeasurements

This field, if present, indicates that the target device requires idle state to perform WLAN measurements.

scheduledLocationRequestSupported

This field, if present, specifies the positioning modes for which the target device supports scheduled location requests – i.e., supports the IE *ScheduledLocationTime* in IE *CommonIEsRequestLocationInformation* – and the time base(s) supported for the scheduled location time for each positioning mode. If this field is absent, the target device does not support scheduled location requests.

6.5.6.5 WLAN Capability Information Request

– *WLAN-RequestCapabilities*

The IE *WLAN-RequestCapabilities* is used by the location server to request WLAN positioning capabilities information from a target device.

```
-- ASN1START
WLAN-RequestCapabilities-r13 ::= SEQUENCE {
    ...
}
-- ASN1STOP
```

6.5.6.6 WLAN Error Elements

– *WLAN-Error*

The IE *WLAN-Error* is used by the location server or target device to provide error reasons for WLAN positioning to the target device or location server, respectively.

```
-- ASN1START
WLAN-Error-r13 ::= CHOICE {
    locationServerErrorCauses-r13          WLAN-LocationServerErrorCauses-r13,
    targetDeviceErrorCauses-r13           WLAN-TargetDeviceErrorCauses-r13,
    ...
}
-- ASN1STOP
```

– *WLAN-LocationServerErrorCauses*

The IE *WLAN-LocationServerErrorCauses* is used by the location server to provide error reasons for WLAN positioning to the target device.

```
-- ASN1START
WLAN-LocationServerErrorCauses-r13 ::= SEQUENCE {
    cause-r13                               ENUMERATED {undefined,
    ... ,
    requestedADNotAvailable-v1420,
    notAllrequestedADAvailable-v1420
    },
    ... ,
    [[ apLocationDataUnavailable-r14        NULL    OPTIONAL    -- Need ON
    ]]
}
-- ASN1STOP
```

WLAN-LocationServerErrorCauses field descriptions

cause

This field provides a WLAN AP specific error cause for the server applicable to provision of assistance data. If the cause value is '*requestedADNotAvailable*', none of the requested assistance data could be provided and no further information needs to be included. If the cause value is '*notAllRequestedADAvailable*', the server was able to provide some but not all requested WLAN AP assistance data. In this case, the server should include any of the specific error indications as applicable. Note that inclusion of these fields is applicable when some of the associated information can be provided for some WLAN APs but not for all WLAN APs.

– WLAN-TargetDeviceErrorCauses

The IE *WLAN-TargetDeviceErrorCauses* is used by the target device to provide error reasons for WLAN positioning to the location server.

```
-- ASN1START
WLAN-TargetDeviceErrorCauses-r13 ::= SEQUENCE {
  cause-r13          ENUMERATED {undefined,
                                requestedMeasurementsNotAvailable,
                                notAllRequestedMeasurementsPossible,
                                ...
                                },
  wlan-AP-RSSI-MeasurementNotPossible-r13  NULL          OPTIONAL,
  wlan-AP-RTT-MeasurementNotPossible-r13  NULL          OPTIONAL,
  ...
}
-- ASN1STOP
```

WLAN-TargetDeviceErrorCauses field descriptions

cause

This field provides a WLAN specific error cause. If the cause value is 'notAllRequestedMeasurementsPossible', the target device was not able to provide all requested WLAN measurements (but may be able to provide some measurements). In this case, the target device should include any of the *wlan-AP-RSSI-MeasurementNotPossible*, or *wlan-AP-RTT-MeasurementNotPossible* fields, as applicable.

6.5.6.7 WLAN Assistance Data

– WLAN-ProvideAssistanceData

The IE *WLAN-ProvideAssistanceData* is used by the location server to provide assistance data to enable UE-based and UE-assisted WLAN positioning. It may also be used to provide WLAN positioning specific error reason.

```
-- ASN1START
WLAN-ProvideAssistanceData-r14 ::= SEQUENCE {
  wlan-DataSet-r14  SEQUENCE (SIZE (1..maxWLAN-Datasets-r14)) OF WLAN-DataSet-r14          OPTIONAL,  -- Need ON
  wlan-Error-r14    WLAN-Error-r13          OPTIONAL,  -- Need ON
  ...
}
-- ASN1STOP
```

WLAN-ProvideAssistanceData field descriptions

wlan-DataSet

This field provides data for sets of WLAN APs.

wlan-Error

This field provides error information and may be included when a Provide Assistance Data is sent in response to a Request Assistance Data. It is allowed to include both a *wlan-DataSet* field and a *wlan-Error* field (e.g. when only some requested WLAN assistance data is provided).

6.5.6.8 WLAN Assistance Data Elements

– WLAN-DataSet

The IE *WLAN-DataSet* is used by the location server to provide WLAN AP information for one set of WLAN APs.

```
-- ASN1START
WLAN-DataSet-r14 ::= SEQUENCE {
  wlan-AP-List-r14          SEQUENCE (SIZE (1..maxWLAN-AP-r14)) OF WLAN-AP-Data-r14,
  supportedChannels-11a-r14 SupportedChannels-11a-r14          OPTIONAL,  -- Need ON
  supportedChannels-11bg-r14 SupportedChannels-11bg-r14          OPTIONAL,  -- Need ON
}
-- ASN1STOP
```

```

}
...
SupportedChannels-11a-r14 ::= SEQUENCE {
  ch34-r14      BOOLEAN,
  ch36-r14      BOOLEAN,
  ch38-r14      BOOLEAN,
  ch40-r14      BOOLEAN,
  ch42-r14      BOOLEAN,
  ch44-r14      BOOLEAN,
  ch46-r14      BOOLEAN,
  ch48-r14      BOOLEAN,
  ch52-r14      BOOLEAN,
  ch56-r14      BOOLEAN,
  ch60-r14      BOOLEAN,
  ch64-r14      BOOLEAN,
  ch149-r14     BOOLEAN,
  ch153-r14     BOOLEAN,
  ch157-r14     BOOLEAN,
  ch161-r14     BOOLEAN
}

SupportedChannels-11bg-r14 ::= SEQUENCE {
  ch1-r14       BOOLEAN,
  ch2-r14       BOOLEAN,
  ch3-r14       BOOLEAN,
  ch4-r14       BOOLEAN,
  ch5-r14       BOOLEAN,
  ch6-r14       BOOLEAN,
  ch7-r14       BOOLEAN,
  ch8-r14       BOOLEAN,
  ch9-r14       BOOLEAN,
  ch10-r14      BOOLEAN,
  ch11-r14      BOOLEAN,
  ch12-r14      BOOLEAN,
  ch13-r14      BOOLEAN,
  ch14-r14      BOOLEAN
}

-- ASN1STOP

```

WLAN-DataSet field descriptions

wlan-AP-List

This field provides information for WLAN APs in the data set.

supportedChannels-11a

This field defines the superset of all channels supported by all WLAN APs in the data set of type 801.11a (5GHz band).

supportedChannels-11bg

This field defines the superset of all channels supported by all WLAN APs in the data set of type 801.11b or 802.11g (2.4 GHz band).

– WLAN-AP-Data

The IE *WLAN-AP-Data* is used by the location server to provide information for one WLAN AP as part of WLAN AP assistance data.

```

-- ASN1START
WLAN-AP-Data-r14 ::= SEQUENCE {
  wlan-AP-Identifier-r14      WLAN-AP-Identifier-r13,
  wlan-AP-Location-r14       WLAN-AP-Location-r14      OPTIONAL,  -- Need ON
  ...
}

WLAN-AP-Location-r14 ::= SEQUENCE {
  locationDataLCI-r14        LocationDataLCI-r14,
  ...
}

LocationDataLCI-r14 ::= SEQUENCE {
  latitudeUncertainty-r14    BIT STRING (SIZE (6)),
  latitude-r14               BIT STRING (SIZE (34)),
  longitudeUncertainty-r14   BIT STRING (SIZE (6)),

```

```

longitude-r14          BIT STRING (SIZE (34)),
altitudeUncertainty-r14 BIT STRING (SIZE (6))    OPTIONAL, -- Need ON
altitude-r14          BIT STRING (SIZE (30))    OPTIONAL, -- Need ON
datum-r14             BIT STRING (SIZE (8)),
...
}
-- ASN1STOP

```

WLAN-AP-Data field descriptions

wlan-AP-Location

- locationDataLCI

This field provides the location of the WLAN AP in the form of Location Configuration Information (LCI) defined in [27] and includes the following subfields:

- latitudeUncertainty: 6-bits quantifying the amount of uncertainty in latitude. A value of 0 is reserved to indicate that the uncertainty is unknown; values greater than 34 are reserved. Its relation with the corresponding value in degrees is expressed with the following formula:

$$\text{latitudeUncertainty} = 8 - \text{ceil}(\log_2(\text{uncertainty in degrees}))$$
- latitude: A 34-bits fixed point value consisting of 9-bits of integer and 25-bits of fraction indicating the Latitude (+/- 90 degrees) of the AP.
- longitudeUncertainty: 6-bits quantifying the amount of uncertainty in longitude. A value of 0 is reserved to indicate that the uncertainty is unknown; values greater than 34 are reserved. Its relation with the corresponding value in degrees is expressed with the following formula:

$$\text{longitudeUncertainty} = 8 - \text{ceil}(\log_2(\text{uncertainty in degrees}))$$
- longitude: A 34-bits fixed point value consisting of 9-bits of integer and 25-bits of fraction indicating the Longitude (+/- 180 degrees) of the AP.
- altitudeUncertainty: 6-bits value quantifying the amount of uncertainty in the altitude value. A value of 0 is reserved to indicate that the uncertainty is unknown; values greater than 30 are reserved. Its relation with the corresponding value in metres is expressed with the following formula:

$$\text{altitudeUncertainty} = 21 - \text{ceil}(\log_2(\text{uncertainty in metres}))$$
- altitude: A 30-bit fixed point value consisting of 22-bits of integer and 8-bits of fraction indicating the altitude of the AP in metres.
- datum: 8-bits indicating the map datum used for the coordinates. Defined codes are:
 Bit 1: World Geodetic System 1984 (WGS-84)
 Bit 2: North American Datum 1983 (NAD-83) with North American Vertical Datum 1988 (NAVD-88)
 Bit 3: North American Datum 1983 (NAD-83) with Mean Lower Low Water (MLLW) vertical datum.
 Bits 4 – 8 are reserved.

6.5.6.9 WLAN Assistance Data Request

– WLAN-RequestAssistanceData

The IE *WLAN-RequestAssistanceData* is used by the target device to request WLAN assistance data from a location server.

```

-- ASN1START
WLAN-RequestAssistanceData-r14 ::= SEQUENCE {
  requestedAD-r14          BIT STRING {
    ap-identifier          (0),
    ap-location            (1)} (SIZE (1..8)),
  visibleAPs-r14          SEQUENCE (SIZE (1..maxVisibleAPs-r14)) OF WLAN-AP-Identifier-r13
  OPTIONAL,
  wlan-AP-StoredData-r14 SEQUENCE (SIZE (1..maxKnownAPs-r14)) OF WLAN-AP-Identifier-r13
  OPTIONAL,
  ...
}
-- ASN1STOP

```

WLAN-RequestAssistanceData field descriptions
<p>requestedAD This field specifies the WLAN AP assistance data requested. This is represented by a bit string, with a one-value at the bit position means the particular assistance data is requested; a zero-value means not requested. The following assistance data types are included:</p> <p style="padding-left: 40px;">ap-identifier: WLAN AP identity information ap-location: WLAN AP location information</p>
<p>visibleAPs This field enables a target to indicate to a server the identities of currently visible WLAN APs. This may assist a server to provide assistance data for WLAN APs nearby to the target. A target shall provide visible APs in order of received signal strength with the AP with the highest signal strength provided first.</p>
<p>wlan-AP-StoredData This field enables a target to indicate to a server the identities of WLAN APs for which the target has stored assistance data received previously from the server. This may enable the server to avoid resending data for the same APs.</p>

6.5.7 Bluetooth-based Positioning

6.5.7.1 Bluetooth Location Information

– *BT-ProvideLocationInformation*

The IE *BT-ProvideLocationInformation* is used by the target device to provide measurements for one or more Bluetooth beacons to the location server. It may also be used to provide Bluetooth positioning specific error reason.

```
-- ASN1START
BT-ProvideLocationInformation-r13 ::= SEQUENCE {
    bt-MeasurementInformation-r13    BT-MeasurementInformation-r13    OPTIONAL,
    bt-Error-r13                    BT-Error-r13                OPTIONAL,
    ...
}
-- ASN1STOP
```

6.5.7.2 Bluetooth Location Information Elements

– *BT-MeasurementInformation*

```
-- ASN1START
BT-MeasurementInformation-r13 ::= SEQUENCE {
    measurementReferenceTime-r13    UTCTime                    OPTIONAL,
    bt-MeasurementList-r13          BT-MeasurementList-r13    OPTIONAL,
    ...
}
BT-MeasurementList-r13 ::= SEQUENCE (SIZE(1..maxBT-Beacon-r13)) OF BT-MeasurementElement-r13

BT-MeasurementElement-r13 ::= SEQUENCE {
    btAddr-r13                      BIT STRING (SIZE (48)),
    rssi-r13                        INTEGER (-128..127)        OPTIONAL,
    ...
}
-- ASN1STOP
```

<i>BT-MeasurementInformation</i> field descriptions
<i>measurementReferenceTime</i> This field provides the UTC time when the Bluetooth measurements are performed and should take the form of <i>YYMMDDhhmmssZ</i> .
<i>bt-MeasurementList</i> This field provides the Bluetooth measurements for up to 32 Bluetooth beacons.
<i>btAddr</i> This field specifies the Bluetooth public address of the Bluetooth beacon [25].
<i>rsi</i> This field provides the beacon received signal strength indicator (RSSI) in dBm.

6.5.7.3 Bluetooth Location Information Request

– *BT-RequestLocationInformation*

The IE *BT-RequestLocationInformation* is used by the location server to request Bluetooth measurements from a target device.

```
-- ASN1START
BT-RequestLocationInformation-r13 ::= SEQUENCE {
    requestedMeasurements-r13 BIT STRING {
        ...
        rssi (0)} (SIZE(1..8)),
    ...
}
-- ASN1STOP
```

<i>BT-RequestLocationInformation</i> field descriptions
<i>requestedMeasurements</i> This field specifies the Bluetooth measurements requested. This is represented by a bit string, with a one-value at the bit position means the particular measurement is requested; a zero-value means not requested. The following measurement requests can be included. rssi: Bluetooth beacon signal strength at the target

6.5.7.4 Bluetooth Capability Information

– *BT-ProvideCapabilities*

The IE *BT-ProvideCapabilities* is used by the target device to provide its capabilities for Bluetooth positioning to the location server.

```
-- ASN1START
BT-ProvideCapabilities-r13 ::= SEQUENCE {
    bt-Modes-r13 BIT STRING {
        standalone (0),
        ue-assisted (1)} (SIZE (1..8)),
    bt-MeasSupported-r13 BIT STRING {
        rssi-r13 (0)} (SIZE (1..8)),
    ...
    [[
        idleStateForMeasurements-r14
            ENUMERATED { required } OPTIONAL,
        periodicalReportingSupported-r14
            PositioningModes OPTIONAL
    ]],
    [[
        scheduledLocationRequestSupported-r17
        ScheduledLocationTimeSupportPerMode-r17 OPTIONAL
    ]]
}
-- ASN1STOP
```

BT-ProvideCapabilities field descriptions
<p>bt-Modes This field specifies the Bluetooth mode(s) supported by the target device. This is represented by a bit string, with a one value at the bit position means the Bluetooth mode is supported; a zero value means not supported.</p>
<p>bt-MeasSupported This field specifies the Bluetooth measurements supported by the target device. This is represented by a bit string, with a one-value at the bit position means the particular measurement is supported; a zero-value means not supported. A zero-value in all bit positions in the bit string means only the basic Bluetooth positioning method is supported by the target device which is reporting of the Bluetooth beacon identity. The following bits are assigned for the indicated measurements.</p> <p style="padding-left: 40px;">rssi: Bluetooth beacon signal strength at the target device</p>
<p>idleStateForMeasurements This field, if present, indicates that the target device requires idle state to perform BT measurements.</p>
<p>periodicalReportingSupported This field, if present, specifies the positioning modes for which the target device supports <i>periodicalReporting</i>. This is represented by a bit string, with a one value at the bit position means <i>periodicalReporting</i> for the positioning mode is supported; a zero value means not supported. If this field is absent, the location server may assume that the target device does not support <i>periodicalReporting</i> in <i>CommonIEsRequestLocationInformation</i>.</p>
<p>scheduledLocationRequestSupported This field, if present, specifies the positioning modes for which the target device supports scheduled location requests – i.e., supports the IE <i>ScheduledLocationTime</i> in IE <i>CommonIEsRequestLocationInformation</i> – and the time base(s) supported for the scheduled location time for each positioning mode. If this field is absent, the target device does not support scheduled location requests.</p>

6.5.7.5 Bluetooth Capability Information Request

– *BT-RequestCapabilities*

The IE *BT-RequestCapabilities* is used by the location server to request Bluetooth positioning capabilities from a target device.

```
-- ASN1START
BT-RequestCapabilities-r13 ::= SEQUENCE {
    ...
}
-- ASN1STOP
```

6.5.7.6 BT Error Elements

– *BT-Error*

The IE *BT-Error* is used by the location server or target device to provide error reasons for Bluetooth positioning to the target device or location server, respectively.

```
-- ASN1START
BT-Error-r13 ::= CHOICE {
    locationServerErrorCauses-r13      BT-LocationServerErrorCauses-r13,
    targetDeviceErrorCauses-r13       BT-TargetDeviceErrorCauses-r13,
    ...
}
-- ASN1STOP
```

– *BT-LocationServerErrorCauses*

The IE *BT-LocationServerErrorCauses* is used by the location server to provide error reasons for Bluetooth positioning to the target device.

```
-- ASN1START
```

```

BT-LocationServerErrorCauses-r13 ::= SEQUENCE {
    cause-r13          ENUMERATED {undefined, ...},
    ...
}
-- ASN1STOP

```

– *BT-TargetDeviceErrorCauses*

The IE *BT-TargetDeviceErrorCauses* is used by the target device to provide error reasons for Bluetooth positioning to the location server.

```

-- ASN1START
BT-TargetDeviceErrorCauses-r13 ::= SEQUENCE {
    cause-r13          ENUMERATED {undefined,
                                   requestedMeasurementsNotAvailable,
                                   notAllRequestedMeasurementsPossible,
                                   ...
                                   },
    bt-Beacon-rssiMeasurementNotPossible-r13  NULL          OPTIONAL,
    ...
}
-- ASN1STOP

```

***BT-TargetDeviceErrorCauses* field descriptions**

cause

This field provides a Bluetooth specific error cause. If the cause value is 'notAllRequestedMeasurementsPossible', the target device was not able to provide all requested Bluetooth measurements (but may be able to provide some measurements). In this case, the target device should include *bt-Beacon-rssiMeasurementNotPossible* field.

6.5.8 NR UL Positioning

6.5.8.1 NR UL Capability Information

– *NR-UL-ProvideCapabilities*

The IE *NR-UL-ProvideCapabilities* is used by the target device to indicate its capability to support UL SRS for positioning and to provide its UL SRS for positioning capabilities to the location server.

```

-- ASN1START
NR-UL-ProvideCapabilities-r16 ::= SEQUENCE {
    nr-UL-SRS-Capability-r16      NR-UL-SRS-Capability-r16,
    ...
    [[
    nr-UE-TEG-Capability-r17      NR-UE-TEG-Capability-r17          OPTIONAL
    ]]
}
-- ASN1STOP

```

***NR-UL-ProvideCapabilities* field descriptions**

nr-UE-TEG-Capability

Indicates the UE TEG capability.

6.5.8.2 NR UL Capability Information Request

– *NR-UL-RequestCapabilities*

The IE *NR-UL-RequestCapabilities* is used by the location server to request the capability of the target device to support UL SRS for positioning and to request UL SRS for positioning capabilities from a target device.

```
-- ASN1START
NR-UL-RequestCapabilities-r16 ::= SEQUENCE {
    ...
}
-- ASN1STOP
```

6.5.9 NR E-CID Positioning

This clause defines the information elements for NR E-CID positioning (TS 38.305 [40]).

6.5.9.1 NR E-CID Location Information

– *NR-ECID-ProvideLocationInformation*

The IE *NR-ECID-ProvideLocationInformation* is used by the target device to provide NR E-CID location measurements to the location server. It may also be used to provide NR E-CID positioning specific error reason.

```
-- ASN1START
NR-ECID-ProvideLocationInformation-r16 ::= SEQUENCE {
    nr-ECID-SignalMeasurementInformation-r16    NR-ECID-SignalMeasurementInformation-r16 OPTIONAL,
    nr-ECID-Error-r16                          NR-ECID-Error-r16                          OPTIONAL,
    ...
}
-- ASN1STOP
```

6.5.9.2 NR E-CID Location Information Elements

– *NR-ECID-SignalMeasurementInformation*

The IE *NR-ECID-SignalMeasurementInformation* is used by the target device to provide NR E-CID measurements to the location server.

```
-- ASN1START
NR-ECID-SignalMeasurementInformation-r16 ::= SEQUENCE {
    nr-PrimaryCellMeasuredResults-r16    NR-MeasuredResultsElement-r16,
    nr-MeasuredResultsList-r16          NR-MeasuredResultsList-r16          OPTIONAL,
    ...
}

NR-MeasuredResultsList-r16 ::= SEQUENCE (SIZE(1..32)) OF NR-MeasuredResultsElement-r16

NR-MeasuredResultsElement-r16 ::= SEQUENCE {
    nr-PhysCellID-r16                    NR-PhysCellID-r16,
    nr-ARFCN-r16                          CHOICE {
        ssb-ARFCN-r16                    ARFCN-ValueNR-r15,
        csi-RS-pointA-r16                 ARFCN-ValueNR-r15
    },
    nr-CellGlobalID-r16                  NCGI-r15                                OPTIONAL,
    systemFrameNumber-r16                BIT STRING (SIZE (10))                OPTIONAL,
    resultsSSB-Cell-r16                   MeasQuantityResults-r16                OPTIONAL,
    resultsCSI-RS-Cell-r16                MeasQuantityResults-r16                OPTIONAL,
    resultsSSB-Indexes-r16                ResultsPerSSB-IndexList-r16            OPTIONAL,
    resultsCSI-RS-Indexes-r16             ResultsPerCSI-RS-IndexList-r16        OPTIONAL,
    ...
}
```



```

MeasQuantityResults-r16 ::= SEQUENCE {
    nr-RSRP-r16                INTEGER (0..127)                OPTIONAL,
    nr-RSRQ-r16                INTEGER (0..127)                OPTIONAL
}

ResultsPerSSB-IndexList-r16 ::= SEQUENCE (SIZE (1..64)) OF ResultsPerSSB-Index-r16

ResultsPerSSB-Index-r16 ::= SEQUENCE {
    ssb-Index-r16              INTEGER (0..63),
    ssb-Results-r16            MeasQuantityResults-r16
}

ResultsPerCSI-RS-IndexList-r16 ::= SEQUENCE (SIZE (1..64)) OF ResultsPerCSI-RS-Index-r16

ResultsPerCSI-RS-Index-r16 ::= SEQUENCE {
    csi-RS-Index-r16          INTEGER (0..95),
    csi-RS-Results-r16        MeasQuantityResults-r16
}

-- ASN1STOP

```

NR-ECID-SignalMeasurementInformation field descriptions

nr-PrimaryCellMeasuredResults
This field contains the NR E-CID measurements for the primary cell.
nr-MeasuredResultsList
This field contains the NR E-CID measurements for up to 32 neighbour cells.
nr-PhysCellID
This field specifies the NR physical cell identity of the measured cell.
nr-ARFCN
This field specifies the ARFCN of the first RE of SSB's RB#10 or the point A of CSI-RS.
nr-CellGlobalID
This field specifies the NR cell global ID of the measured cell. The target device shall provide this field if it was able to determine the NCGI of the measured cell at the time of measurement.
systemFrameNumber
This field specifies the system frame number of the measured cell during which the measurements have been performed. The target device shall include this field if it was able to determine the SFN of the cell at the time of measurement.
resultsSSB-Cell
This field specifies the SS reference signal received power (SS-RSRP) and quality (SS-RSRQ) measurement aggregated at cell level, as defined in TS 38.331 [35].
resultsCSI-RS-Cell
This field specifies the CSI-RS reference signal received power (CSI-RSRP) and quality (CSI-RSRQ) measurement aggregated at cell level, as defined in TS 38.331 [35].
resultsSSB-Indexes
This field specifies the SS reference signal received power (SS-RSRP) and quality (SS-RSRQ) measurement per SSB resource, as defined in TS 38.331 [35].
resultsCSI-RS-Indexes
This field specifies the CSI-RS reference signal received power (CSI-RSRP) and quality (CSI-RSRQ) per CSI-RS resource, as defined in TS 38.331 [35].
nr-RSRP
This field specifies the integer value for RSRP measurements according to Table 10.1.6.1-1 in TS 38.133 [46].
nr-RSRQ
This field specifies the integer value for RSRQ measurements according to Table 10.1.11.1-1 in TS 38.133 [46].

6.5.9.3 NR E-CID Location Information Request

– NR-ECID-RequestLocationInformation

The IE *NR-ECID-RequestLocationInformation* is used by the location server to request NR E-CID location measurements from a target device.

```

-- ASN1START
NR-ECID-RequestLocationInformation-r16 ::= SEQUENCE {
    requestedMeasurements-r16    BIT STRING {
        ssrsrpReq                (0),
        ssrsrqReq                (1),
        csirsrpReq                (2),

```

```

    csirsrqReq      (3) (SIZE(1..8)),
  }
  ...
}
-- ASN1STOP

```

NR-ECID-RequestLocationInformation field descriptions

requestedMeasurements

This field specifies the NR E-CID measurements requested. This is represented by a bit string, with a one-value at the bit position means the particular measurement is requested; a zero-value means not requested.

6.5.9.4 NR E-CID Capability Information

– NR-ECID-ProvideCapabilities

The IE *NR-ECID-ProvideCapabilities* is used by the target device to indicate its capability to support NR E-CID and to provide its NR E-CID positioning capabilities to the location server.

```

-- ASN1START
NR-ECID-ProvideCapabilities-r16 ::= SEQUENCE {
  nr-ECID-MeasSupported-r16      BIT STRING {
    ssrsrpSup      (0),
    ssrsrqSup      (1),
    csirsrpSup     (2),
    csirsrqSup     (3) (SIZE(1..8)),
  }
  periodicalReporting-r16        ENUMERATED { supported } OPTIONAL,
  triggeredReporting-r16        ENUMERATED { supported } OPTIONAL,
  ...
  [[
    ten-ms-unit-ResponseTime-r17 ENUMERATED { supported } OPTIONAL,
    scheduledLocationRequestSupported-r17
                                     ScheduledLocationTimeSupport-r17 OPTIONAL
  ]]
}
-- ASN1STOP

```

NR-ECID-ProvideCapabilities field descriptions

nr-ECID-MeasSupported:

Indicates the supported NR ECID measurements:

- *ssrsrpSup* indicates the UE supports SSB based cell/beam specific RSRP measurement;
- *ssrsrqSup* indicates the UE supports SSB based cell/beam specific RSRQ measurement;
- *csirsrpSup* indicates the UE supports CSI-RS based cell/beam specific RSRP measurement;
- *csirsrqSup* indicates the UE supports CSI-RS based cell/beam specific RSRQ measurement.

ten-ms-unit-ResponseTime

This field, if present, indicates that the target device supports the enumerated value 'ten-milli-seconds' in the IE *ResponseTime* in IE *CommonIEsRequestLocationInformation*.

scheduledLocationRequestSupported

This field, if present, indicates that the target device supports scheduled location requests – i.e., supports the IE *ScheduledLocationTime* in IE *CommonIEsRequestLocationInformation* – and the time base(s) supported for the scheduled location time.

6.5.9.5 NR E-CID Capability Information Request

– NR-ECID-RequestCapabilities

The IE *NR-ECID-RequestCapabilities* is used by the location server to request the capability of the target device to support NR E-CID and to request NR E-CID positioning capabilities from a target device.

```

-- ASN1START
NR-ECID-RequestCapabilities-r16 ::= SEQUENCE {
  ...
}

```

```
-- ASN1STOP
```

6.5.9.6 NR E-CID Error Elements

– *NR-ECID-Error*

The IE *NR-ECID-Error* is used by the location server or target device to provide NR E-CID error reasons to the target device or location server, respectively.

```
-- ASN1START
NR-ECID-Error-r16 ::= CHOICE {
  locationServerErrorCauses-r16      NR-ECID-LocationServerErrorCauses-r16,
  targetDeviceErrorCauses-r16       NR-ECID-TargetDeviceErrorCauses-r16,
  ...
}
-- ASN1STOP
```

– *NR-ECID-LocationServerErrorCauses*

The IE *NR-ECID-LocationServerErrorCauses* is used by the location server to provide NR E-CID error reasons to the target device.

```
-- ASN1START
NR-ECID-LocationServerErrorCauses-r16 ::= SEQUENCE {
  cause-r16      ENUMERATED { undefined,
  ...
  },
  ...
}
-- ASN1STOP
```

– *NR-ECID-TargetDeviceErrorCauses*

The IE *NR-ECID-TargetDeviceErrorCauses* is used by the target device to provide NR E-CID error reasons to the location server.

```
-- ASN1START
NR-ECID-TargetDeviceErrorCauses-r16 ::= SEQUENCE {
  cause-r16      ENUMERATED { undefined,
  requestedMeasurementNotAvailable,
  notAllRequestedMeasurementsPossible,
  ...
  },
  ss-RSRPMeasurementNotPossible-r16      NULL      OPTIONAL,
  ss-RSRQMeasurementNotPossible-r16      NULL      OPTIONAL,
  csi-RSRPMeasurementNotPossible-r16      NULL      OPTIONAL,
  csi-RSRQMeasurementNotPossible-r16      NULL      OPTIONAL,
  ...
}
-- ASN1STOP
```

***NR-ECID-TargetDeviceErrorCauses* field descriptions**

cause

This field provides a NR E-CID specific error cause. If the cause value is 'notAllRequestedMeasurementsPossible', the target device was not able to provide all requested NR E-CID measurements (but may be able to provide some measurements). In this case, the target device should include any of the *ss-RSRPMeasurementNotPossible*, *ss-RSRQMeasurementNotPossible*, *csi-RSRPMeasurementNotPossible*, or *csi-RSRQMeasurementNotPossible* fields, as applicable.

6.5.10 NR DL-TDOA Positioning

This clause defines the information elements for NR downlink TDOA positioning (TS 38.305 [40]).

6.5.10.1 NR DL-TDOA Assistance Data

– *NR-DL-TDOA-ProvideAssistanceData*

The IE *NR-DL-TDOA-ProvideAssistanceData* is used by the location server to provide assistance data to enable UE-assisted and UE-based NR DL-TDOA. It may also be used to provide NR DL-TDOA positioning specific error reason.

```
-- ASN1START
NR-DL-TDOA-ProvideAssistanceData-r16 ::= SEQUENCE {
    nr-DL-PRS-AssistanceData-r16          NR-DL-PRS-AssistanceData-r16          OPTIONAL,  -- Need ON
    nr-SelectedDL-PRS-IndexList-r16      NR-SelectedDL-PRS-IndexList-r16      OPTIONAL,  -- Need ON
    nr-PositionCalculationAssistance-r16 NR-PositionCalculationAssistance-r16
    nr-DL-TDOA-Error-r16                 NR-DL-TDOA-Error-r16                 OPTIONAL,  -- Cond UEB
    . . .
    [ [
        nr-On-Demand-DL-PRS-Configurations-r17
        NR-On-Demand-DL-PRS-Configurations-r17
        OPTIONAL,  -- Need ON
        nr-On-Demand-DL-PRS-Configurations-Selected-IndexList-r17
        NR-On-Demand-DL-PRS-Configurations-Selected-IndexList-r17
        OPTIONAL,  -- Need ON
        assistanceDataValidityArea-r17   AreaID-CellList-r17
        OPTIONAL  -- Need ON
    ] ]
}
-- ASN1STOP
```

Conditional presence	Explanation
<i>UEB</i>	The field is optionally present, need ON, for UE based NR DL-TDOA; otherwise it is not present.

<i>NR-DL-TDOA-ProvideAssistanceData</i> field descriptions
<p><i>nr-DL-PRS-AssistanceData</i> This field specifies the assistance data reference and neighbour TRPs and provides the DL-PRS configuration for the TRPs. Note, if this field is absent but the <i>nr-SelectedDL-PRS-IndexList</i> field is present, the <i>nr-DL-PRS-AssistanceData</i> may be provided in IE <i>NR-Multi-RTT-ProvideAssistanceData</i> or <i>NR-DL-AoD-ProvideAssistanceData</i>.</p>
<p><i>nr-SelectedDL-PRS-IndexList</i> This field specifies the DL-PRS Resources which are applicable for this <i>NR-DL-TDOA-ProvideAssistanceData</i> message.</p>
<p><i>nr-PositionCalculationAssistance</i> This field provides position calculation assistance data for UE-based mode.</p>
<p><i>nr-DL-TDOA-Error</i> This field provides DL-TDOA error reasons.</p>
<p><i>nr-On-Demand-DL-PRS-Configurations</i> This field provides a set of available DL-PRS configurations which can be requested by the target device on-demand.</p> <p>NOTE 1: Void NOTE 2: If this field is absent but the <i>nr-On-Demand-DL-PRS-Configurations-Selected-IndexList</i> is present, the <i>nr-On-Demand-DL-PRS-Configurations</i> may be provided in IE <i>NR-Multi-RTT-ProvideAssistanceData</i> or <i>NR-DL-AoD-ProvideAssistanceData</i>.</p>
<p><i>nr-On-Demand-DL-PRS-Configurations-Selected-IndexList</i> This field specifies the selected available on-demand DL-PRS configurations which are applicable for this <i>NR-DL-TDOA-ProvideAssistanceData</i> message.</p>
<p><i>assistanceDataValidityArea</i> This field specifies the network area for which this <i>NR-DL-TDOA-ProvideAssistanceData</i> is valid.</p>

6.5.10.2 NR DL-TDOA Assistance Data Request

– *NR-DL-TDOA-RequestAssistanceData*

The IE *NR-DL-TDOA-RequestAssistanceData* is used by the target device to request assistance data from a location server.

```
-- ASN1START
NR-DL-TDOA-RequestAssistanceData-r16 ::= SEQUENCE {
  nr-PhysCellID-r16          NR-PhysCellID-r16          OPTIONAL,
  nr-AdType-r16             BIT STRING { dl-prs (0),
                                         posCalc (1) } (SIZE (1..8)),
  . . .
  [[
  nr-PosCalcAssistanceRequest-r17 BIT STRING { trpLoc (0),
                                                beamInfo (1),
                                                rtdInfo (2),
                                                losNlosInfo (3),
                                                trpTEG-Info (4)
                                                } (SIZE (1..8))
  nr-on-demand-DL-PRS-Request-r17 NR-On-Demand-DL-PRS-Request-r17 OPTIONAL,
  nr-DL-PRS-ExpectedAoD-or-AoA-Request-r17
  ENUMERATED { eAoD, eAoA } OPTIONAL,
  pre-configured-AssistanceDataRequest-r17
  ENUMERATED { true } OPTIONAL
  ]]
}
-- ASN1STOP
```

NR-DL-TDOA-RequestAssistanceData field descriptions

nr-PhysCellID

This field specifies the NR physical cell identity of the current primary cell of the target device.

nr-AdType

This field indicates the requested assistance data. *dl-prs* means requested assistance data is *nr-DL-PRS-AssistanceData*, *posCalc* means requested assistance data is *nr-PositionCalculationAssistance* for UE based positioning.

nr-PosCalcAssistanceRequest

This field indicates the Position Calculation Assistance Data requested. This is represented by a bit string, with a one-value at the bit position means the particular assistance data is requested; a zero-value means not requested.

- bit 0 indicates whether the field *nr-TRP-LocationInfo* in IE *NR-PositionCalculationAssistance* is requested or not;
- bit 1 indicates whether the field *nr-DL-PRS-BeamInfo* in IE *NR-PositionCalculationAssistance* is requested or not;
- bit 2 indicates whether the field *nr-RTD-Info* in IE *NR-PositionCalculationAssistance* is requested or not;
- bit 3 indicates whether the field *nr-DL-PRS-Expected-LOS-NLOS-Assistance* in IE *NR-PositionCalculationAssistance* is requested or not;
- bit 4 indicates whether the field *nr-DL-PRS-TRP-TEG-Info* in IE *NR-PositionCalculationAssistance* is requested or not.

This field may only be present if the 'posCalc' bit in *nr-AdType* is set to value '1'.

nr-on-demand-DL-PRS-Request

This field indicates the on-demand DL-PRS requested for DL-TDOA. This field may be included when the *dl-prs* bit in *nr-AdType* is set to value '1'.

nr-DL-PRS-ExpectedAoD-or-AoA-Request

This field, if present, indicates that the IE *NR-DL-PRS-ExpectedAoD-or-AoA* in *NR-DL-PRS-AssistanceData* is requested. Enumerated value 'eAoD' indicates that expected AoD information is requested; value 'eAoA' indicates that expected AoA information is requested.

This field may only be present if the 'dl-prs' bit in *nr-AdType* is set to value '1'.

pre-configured-AssistanceDataRequest

This field, if present, indicates that the target device requests pre-configured assistance data with area validity.

6.5.10.3 NR DL-TDOA Location Information

– *NR-DL-TDOA-ProvideLocationInformation*

The IE *NR-DL-TDOA-ProvideLocationInformation* is used by the target device to provide NR DL-TDOA location measurements to the location server. It may also be used to provide NR DL-TDOA positioning specific error reason.

```
-- ASN1START
NR-DL-TDOA-ProvideLocationInformation-r16 ::= SEQUENCE {
    nr-DL-TDOA-SignalMeasurementInformation-r16
        NR-DL-TDOA-SignalMeasurementInformation-r16
        OPTIONAL,
    nr-dl-tdoa-LocationInformation-r16
        NR-DL-TDOA-LocationInformation-r16
        OPTIONAL,
    nr-DL-TDOA-Error-r16
        NR-DL-TDOA-Error-r16
        OPTIONAL,
    . . . ,
    [[
    nr-DL-TDOA-SignalMeasurementInstances-r17
        SEQUENCE (SIZE (1..maxMeasInstances-r17)) OF
        NR-DL-TDOA-SignalMeasurementInformation-r16
        OPTIONAL, -- Cond batchUEA
    nr-DL-TDOA-LocationInformationInstances-r17
        SEQUENCE (SIZE (1..maxMeasInstances-r17)) OF
        NR-DL-TDOA-LocationInformation-r16
        OPTIONAL -- Cond batchUEB
    ]]
}
-- ASN1STOP
```

Conditional presence	Explanation
<i>batchUEA</i>	The field is optionally present if the field <i>nr-DL-TDOA-SignalMeasurementInformation</i> is absent; otherwise it is not present.
<i>batchUEB</i>	The field is optionally present if the field <i>nr-dl-tdoa-LocationInformation</i> is absent; otherwise it is not present.

6.5.10.4 NR DL-TDOA Location Information Elements

– *NR-DL-TDOA-SignalMeasurementInformation*

The IE *NR-DL-TDOA-SignalMeasurementInformation* is used by the target device to provide NR DL-TDOA measurements to the location server.

NOTE 1: The *dl-PRS-ReferenceInfo* defines the "RSTD reference" TRP. The *nr-RSTD*'s and *nr-RSTD-ResultDiff*'s in *nr-DL-TDOA-MeasList* are provided relative to the "RSTD reference" TRP.

NOTE 2: The "RSTD reference" TRP may or may not be the same as the "assistance data reference" TRP provided by *nr-DL-PRS-ReferenceInfo* in IE *NR-DL-PRS-AssistanceData*.

NOTE 3: The target device includes a value of zero for the *nr-RSTD* and *nr-RSTD-ResultDiff* of the "RSTD reference" TRP in *nr-DL-TDOA-MeasList*.

```
-- ASN1START
NR-DL-TDOA-SignalMeasurementInformation-r16 ::= SEQUENCE {
    dl-PRS-ReferenceInfo-r16
        DL-PRS-ID-Info-r16,
    nr-DL-TDOA-MeasList-r16
        NR-DL-TDOA-MeasList-r16,
    . . . ,
    [[
    nr-UE-RxTEG-TimingErrorMargin-r17
        TEG-TimingErrorMargin-r17
        OPTIONAL -- Cond UERxTEG
    ]]
}
NR-DL-TDOA-MeasList-r16 ::= SEQUENCE (SIZE(1..nrMaxTRPs-r16)) OF NR-DL-TDOA-MeasElement-r16
```

```

NR-DL-TDOA-MeasElement-r16 ::= SEQUENCE {
  dl-PRS-ID-r16                INTEGER (0..255),
  nr-PhysCellID-r16            NR-PhysCellID-r16                OPTIONAL,
  nr-CellGlobalID-r16          NCGI-r15                      OPTIONAL,
  nr-ARFCN-r16                 ARFCN-ValueNR-r15              OPTIONAL,
  nr-DL-PRS-ResourceID-r16     NR-DL-PRS-ResourceID-r16        OPTIONAL,
  nr-DL-PRS-ResourceSetID-r16  NR-DL-PRS-ResourceSetID-r16  OPTIONAL,
  nr-TimeStamp-r16             NR-TimeStamp-r16,
  nr-RSTD-r16                  CHOICE {
    k0-r16                     INTEGER (0..1970049),
    k1-r16                     INTEGER (0..985025),
    k2-r16                     INTEGER (0..492513),
    k3-r16                     INTEGER (0..246257),
    k4-r16                     INTEGER (0..123129),
    k5-r16                     INTEGER (0..61565),
    ...
  },
  nr-AdditionalPathList-r16     NR-AdditionalPathList-r16        OPTIONAL,
  nr-TimingQuality-r16         NR-TimingQuality-r16,
  nr-DL-PRS-RSRP-Result-r16    INTEGER (0..126)                OPTIONAL,
  nr-DL-TDOA-AdditionalMeasurements-r16
                                NR-DL-TDOA-AdditionalMeasurements-r16  OPTIONAL,
  ...,
  [[
  nr-UE-Rx-TEG-ID-r17          INTEGER (0..maxNumOfRxTEGs-1-r17)  OPTIONAL,
  nr-DL-PRS-FirstPathRSRP-Result-r17
                                INTEGER (0..126)                OPTIONAL,
  nr-los-nlos-Indicator-r17    CHOICE {
    perTRP-r17                 LOS-NLOS-Indicator-r17,
    perResource-r17            LOS-NLOS-Indicator-r17
  }
  nr-AdditionalPathListExt-r17  NR-AdditionalPathListExt-r17    OPTIONAL,
  nr-DL-TDOA-AdditionalMeasurementsExt-r17
                                NR-DL-TDOA-AdditionalMeasurementsExt-r17  OPTIONAL
  ]]
}

NR-DL-TDOA-AdditionalMeasurements-r16 ::= SEQUENCE (SIZE (1..3)) OF
                                         NR-DL-TDOA-AdditionalMeasurementElement-r16

NR-DL-TDOA-AdditionalMeasurementsExt-r17 ::= SEQUENCE (SIZE (1..maxAddMeasTDOA-r17)) OF
                                              NR-DL-TDOA-AdditionalMeasurementElement-r16

NR-DL-TDOA-AdditionalMeasurementElement-r16 ::= SEQUENCE {
  nr-DL-PRS-ResourceID-r16     NR-DL-PRS-ResourceID-r16        OPTIONAL,
  nr-DL-PRS-ResourceSetID-r16  NR-DL-PRS-ResourceSetID-r16    OPTIONAL,
  nr-TimeStamp-r16             NR-TimeStamp-r16,
  nr-RSTD-ResultDiff-r16       CHOICE {
    k0-r16                     INTEGER (0..8191),
    k1-r16                     INTEGER (0..4095),
    k2-r16                     INTEGER (0..2047),
    k3-r16                     INTEGER (0..1023),
    k4-r16                     INTEGER (0..511),
    k5-r16                     INTEGER (0..255),
    ...
  },
  nr-TimingQuality-r16         NR-TimingQuality-r16,
  nr-DL-PRS-RSRP-ResultDiff-r16
                                INTEGER (0..61)                OPTIONAL,
  nr-AdditionalPathList-r16     NR-AdditionalPathList-r16        OPTIONAL,
  ...,
  [[
  nr-UE-Rx-TEG-ID-r17          INTEGER (0..maxNumOfRxTEGs-1-r17)  OPTIONAL,
  nr-DL-PRS-FirstPathRSRP-ResultDiff-r17
                                INTEGER (0..61)                OPTIONAL,
  nr-los-nlos-IndicatorPerResource-r17
                                LOS-NLOS-Indicator-r17          OPTIONAL,
  nr-AdditionalPathListExt-r17  NR-AdditionalPathListExt-r17    OPTIONAL
  ]]
}
-- ASN1STOP

```

Conditional presence	Explanation
<i>UERxTEG</i>	The field is optionally present, need OP, if the field <i>nr-UE-Rx-TEG-ID</i> is present; otherwise it is not present.

NR-DL-TDOA-SignalMeasurementInformation field descriptions
<p>nr-UE-RxTEG-TimingErrorMargin This field specifies the UE Rx TEG timing error margin value for all the UE Rx TEGs within one <i>NR-DL-TDOA-SignalMeasurementInformation</i>. If the <i>nr-UE-Rx-TEG-ID</i> is present and this field is absent, the receiver should consider the UE Rx TEG timing error margin value to be the maximum applicable value as defined in TS 38.133 [46].</p>
<p>dl-PRS-ID This field is used along with a DL-PRS Resource Set ID and a DL-PRS Resources ID to uniquely identify a DL-PRS Resource. This ID can be associated with multiple DL-PRS Resource Sets associated with a single TRP. Each TRP should only be associated with one such ID.</p>
<p>nr-PhysCellID This field specifies the physical cell identity of the associated TRP, as defined in TS 38.331 [35].</p>
<p>nr-CellGlobalID This field specifies the NCGI, the globally unique identity of a cell in NR, of the associated TRP, as defined in TS 38.331 [35].</p>
<p>nr-ARFCN This field specifies the NR-ARFCN of the TRP's CD-SSB (as defined in TS 38.300 [47]) corresponding to <i>nr-PhysCellID</i>.</p>
<p>nr-TimeStamp This field specifies the time instance at which the TOA and DL PRS-RSRP/RSRPP (if included) measurement is performed. The <i>nr-SFN</i> and <i>nr-Slot</i> in IE <i>NR-TimeStamp</i> correspond to the TRP provided in <i>dl-PRS-ReferenceInfo</i> as specified in TS 38.214 [45]. Note, the TOA measurement refers to the TOA of this neighbour TRP or the reference TRP, as applicable, used to determine the <i>nr-RSTD</i> or <i>nr-RSTD-ResultDiff</i>.</p>
<p>nr-RSTD This field specifies the relative timing difference between this neighbour TRP and the PRS reference TRP, as defined in TS 38.215 [36]. Mapping of the measured quantity is defined as in TS 38.133 [46].</p>
<p>nr-AdditionalPathList This field specifies one or more additional detected path timing values for the TRP or resource, relative to the path timing used for determining the <i>nr-RSTD</i> value. If this field was requested but is not included, it means the UE did not detect any additional path timing values. If this field is present, the field <i>nr-AdditionalPathListExt</i> shall be absent.</p>
<p>nr-TimingQuality This field specifies the target device's best estimate of the quality of the TOA measurement. Note, the TOA measurement refers to the TOA of this neighbour TRP or the reference TRP, as applicable, used to determine the <i>nr-RSTD</i> or <i>nr-RSTD-ResultDiff</i>.</p>
<p>nr-DL-PRS-RSRP-Result This field specifies the NR DL-PRS reference signal received power (DL PRS-RSRP) measurement, as defined in TS 38.215 [36]. The mapping of the quantity is defined as in TS 38.133 [46].</p>
<p>nr-DL-TDOA-AdditionalMeasurements This field provides up to 3 additional RSTD measurements per pair of TRPs, with each measurement between a different pair of DL-PRS Resources or DL-PRS Resource Sets of the DL-PRS for those TRPs [45]. If this field is present, the field <i>nr-DL-TDOA-AdditionalMeasurementsExt</i> shall be absent.</p>
<p>nr-UE-Rx-TEG-ID This field provides the ID of the UE Rx TEG associated with the TOA measurement. Note, the TOA measurement refers to the TOA of this neighbour TRP or the reference TRP, as applicable, used to determine the <i>nr-RSTD</i> or <i>nr-RSTD-ResultDiff</i>. When different UE Rx TEGs for RSTD measurements are requested, the maximum number of reported RSTD measurements associated with different DL-PRS Resources per UE Rx TEG per target TRP is 4.</p>
<p>nr-DL-PRS-FirstPathRSRP-Result This field specifies the NR DL-PRS reference signal received path power (DL PRS-RSRPP) of the first detected path in time, as defined in TS 38.215 [36]. The mapping of the measured quantity is defined as in TS 38.133 [46].</p>
<p>nr-los-nlos-Indicator This field specifies the target device's best estimate of the LOS or NLOS of the TOA measurement for the TRP or resource. Note, the TOA measurement refers to the TOA of this neighbour TRP or the reference TRP, as applicable, used to determine the <i>nr-RSTD</i> or <i>nr-RSTD-ResultDiff</i>. NOTE: If the requested type or granularity in <i>nr-los-nlos-IndicatorRequest</i> is not possible, the target device may provide a different type and granularity for the estimated <i>LOS-NLOS-Indicator</i>.</p>
<p>nr-AdditionalPathListExt This field provides up to 8 additional detected path timing values for the TRP or resource, relative to the path timing used for determining the <i>nr-RSTD</i> value. If this field was requested but is not included, it means the UE did not detect any additional path timing values. If this field is present, the field <i>nr-AdditionalPathList</i> shall be absent.</p>

<p><i>nr-DL-TDOA-AdditionalMeasurementsExt</i> This field, in addition to the measurements provided in <i>NR-DL-TDOA-MeasElement</i>, provides TOA measurements of up to 4 DL-PRS Resources of a TRP with different UE Rx TEGs. For a certain DL-PRS Resource, there can be up to 8 TOA measurement results with respect to different Rx TEGs. If this field is present, the field <i>nr-DL-TDOA-AdditionalMeasurements</i> shall be absent.</p>
<p><i>nr-RSTD-ResultDiff</i> This field provides the additional DL RSTD measurement result relative to <i>nr-RSTD</i>. The RSTD value of this measurement is obtained by adding the value of this field to the value of the <i>nr-RSTD</i> field. The mapping of the field is defined in TS 38.133 [46].</p>
<p><i>nr-DL-PRS-RSRP-ResultDiff</i> This field provides the additional DL-PRS RSRP measurement result relative to <i>nr-DL-PRS-RSRP-Result</i>. The DL-PRS RSRP value of this measurement is obtained by adding the value of this field to the value of the <i>nr-DL-PRS-RSRP-Result</i> field. The mapping of the field is defined in TS 38.133 [46].</p>
<p><i>nr-DL-PRS-FirstPathRSRP-ResultDiff</i> This field specifies the additional NR DL PRS reference signal received path power (DL PRS-RSRPP) of the first detected path in time relative to <i>nr-DL-PRS-FirstPathRSRP-Result</i>. The DL-PRS RSRPP of first path value of this measurement is obtained by adding the value of this field to the value of the <i>nr-DL-PRS-FirstPathRSRP-Result</i> field. The mapping of the field is defined in TS 38.133 [46].</p>
<p><i>nr-los-nlos-IndicatorPerResource</i> This field specifies the target device's best estimate of the LOS or NLOS of the TOA measurement for the resource. Note, the TOA measurement refers to the TOA of this neighbour TRP or the reference TRP, as applicable, used to determine the <i>nr-RSTD</i> or <i>nr-RSTD-ResultDiff</i>. This field may only be present if the field <i>nr-LOS-NLOS-Indicator</i> choice indicates <i>perResource</i>.</p>

– NR-DL-TDOA-LocationInformation

The IE *NR-DL-TDOA-LocationInformation* is included by the target device when location information derived using NR DL-TDOA is provided to the location server.

```

-- ASN1START
NR-DL-TDOA-LocationInformation-r16 ::= SEQUENCE {
    measurementReferenceTime-r16 CHOICE {
        systemFrameNumber-r16 NR-TimeStamp-r16,
        utc-time-r16 UTCTime,
        ...
    } OPTIONAL,
    ...
    [[
        locationCoordinates-r17 LocationCoordinates OPTIONAL, -- Cond batch1
        locationSource-r17 LocationSource-r13 OPTIONAL -- Cond batch2
    ]]
}
-- ASN1STOP

```

Conditional presence	Explanation
<i>batch1</i>	The field is mandatory present if the field <i>nr-DL-TDOA-LocationInformationInstances</i> is present in IE <i>NR-DL-TDOA-ProvideLocationInformation</i> ; otherwise it is not present.
<i>batch2</i>	The field is optionally present, need ON, if the field <i>nr-DL-TDOA-LocationInformationInstances</i> is present in IE <i>NR-DL-TDOA-ProvideLocationInformation</i> ; otherwise it is not present.

NR-DL-TDOA-LocationInformation field descriptions	
<i>measurementReferenceTime</i>	This field specifies the time for which the location estimate is valid.
<i>locationCoordinates</i>	This field provides a location estimate using one of the geographic shapes defined in TS 23.032 [15]. NOTE 1.
<i>locationSource</i>	This field provides the source positioning technology for the location estimate. NOTE 1.

NOTE 1: In the case of *locationCoordinates* for multiple NR positioning methods are provided, the *locationCoordinates* and *locationSource* shall be present in only one of *NR-DL-TDOA-ProvideLocationInformation* or *NR-DL-AoD-ProvideLocationInformation*.

6.5.10.5 NR DL-TDOA Location Information Request

– *NR-DL-TDOA-RequestLocationInformation*

The IE *NR-DL-TDOA-RequestLocationInformation* is used by the location server to request NR DL-TDOA location measurements from a target device.

```
-- ASN1START
NR-DL-TDOA-RequestLocationInformation-r16 ::= SEQUENCE {
  nr-DL-PRS-RstdMeasurementInfoRequest-r16  ENUMERATED { true }          OPTIONAL, -- Need ON
  nr-RequestedMeasurements-r16              BIT STRING { prsrsrcReq (0),
                                                    firstPathRsrpReq-r17 (1)
                                                    } (SIZE(1..8)),
  nr-AssistanceAvailability-r16              BOOLEAN,
  nr-DL-TDOA-ReportConfig-r16              NR-DL-TDOA-ReportConfig-r16  OPTIONAL, -- Need ON
  additionalPaths-r16                       ENUMERATED { requested }    OPTIONAL, -- Need ON
  ... ,
  [[
  nr-UE-RxTEG-Request-r17                   ENUMERATED { requested }    OPTIONAL, -- Need ON
  nr-los-nlos-IndicatorRequest-r17          SEQUENCE {
    type-r17                                 LOS-NLOS-IndicatorType1-r17,
    granularity-r17 LOS-NLOS-IndicatorGranularity1-r17,
    ...
  }
  ]]
  additionalPathsExt-r17                     ENUMERATED { requested }    OPTIONAL, -- Need ON
  additionalPathsDL-PRS-RSRP-Request-r17    ENUMERATED { requested }    OPTIONAL, -- Need ON
  multiMeasInSameReport-r17                 ENUMERATED { requested }    OPTIONAL, -- Need ON
  ]]
}

NR-DL-TDOA-ReportConfig-r16 ::= SEQUENCE {
  maxDL-PRS-RSTD-MeasurementsPerTRP-Pair-r16 INTEGER (1..4)          OPTIONAL, -- Need ON
  timingReportingGranularityFactor-r16        INTEGER (0..5)              OPTIONAL, -- Need ON
  ... ,
  [[
  measureSameDL-PRS-ResourceWithDifferentRxTEGs-r17
    ENUMERATED { n0, n2, n3, n4, n6, n8, ... }
    OPTIONAL, -- Need ON
  reducedDL-PRS-ProcessingSamples-r17         ENUMERATED { requested, ... } OPTIONAL, -- Need ON
  lowerRxBeamSweepingFactor-FR2-r17          ENUMERATED { requested }    OPTIONAL, -- Need ON
  ]]
}
-- ASN1STOP
```

***NR-DL-TDOA-RequestLocationInformation* field descriptions**

nr-DL-PRS-RstdMeasurementInfoRequest

This field indicates whether the target device is requested to report DL-PRS Resource ID(s) or DL-PRS Resource Set ID(s) used for determining the timing of each TRP in RSTD measurements.

nr-RequestedMeasurements

This field specifies the NR DL-TDOA measurements requested. This is represented by a bit string, with a one-value at the bit position means the particular measurement is requested; a zero-value means not requested.

nr-AssistanceAvailability

This field indicates whether the target device may request additional PRS assistance data from the server. TRUE means allowed and FALSE means not allowed.

additionalPaths
This field, if present, indicates that the target device is requested to provide the <i>nr-AdditionalPathList</i> in IE <i>NR-DL-TDOA-SignalMeasurementInformation</i> . If this field is present, the field <i>additionalPathsExt</i> shall be absent.
nr-UE-RxTEG-Request
This field, if present, indicates that the target device is requested to provide the <i>nr-UE-Rx-TEG-ID</i> in IE <i>NR-DL-TDOA-SignalMeasurementInformation</i> .
nr-los-nlos-IndicatorRequest
This field, if present, indicates that the target device is requested to provide the indicated type and granularity of the estimated <i>LOS-NLOS-Indicator</i> in the <i>NR-DL-TDOA-SignalMeasurementInformation</i> .
additionalPathsExt
This field, if present, indicates that the target device is requested to provide the <i>nr-AdditionalPathListExt</i> in IE <i>NR-DL-TDOA-SignalMeasurementInformation</i> . If this field is present, the field <i>additionalPaths</i> shall be absent.
additionalPathsDL-PRS-RSRP-Request
This field, if present, indicates that the target device is requested to provide the <i>nr-DL-PRS-RSRPP</i> for the additional paths in fields <i>nr-AdditionalPathList</i> or <i>nr-AdditionalPathListExt</i> .
multiMeasInSameReport
This field, if present, indicates that the target device is requested to provide multiple measurement instances in a single measurement report; i.e., include the <i>nr-DL-TDOA-SignalMeasurementInstances</i> (in the case of UE-assisted mode is requested) or <i>nr-DL-TDOA-LocationInformationInstances</i> (in the case of UE-based mode is requested) in IE <i>NR-DL-TDOA-ProvideLocationInformation</i> .
maxDL-PRS-RSTD-MeasurementsPerTRP-Pair
This field specifies the maximum number of DL-PRS RSTD measurements per pair of TRPs. The maximum number is defined across all Positioning Frequency Layers.
timingReportingGranularityFactor
This field specifies the recommended reporting granularity for the DL RSTD measurements. Value (0.5) corresponds to (<i>k0..k5</i>) used for <i>nr-RSTD</i> and <i>nr-RSTD-ResultDiff</i> in <i>NR-DL-TDOA-MeasElement</i> . The UE may select a different granularity value for <i>nr-RSTD</i> and <i>nr-RSTD-ResultDiff</i> .
measureSameDL-PRS-ResourceWithDifferentRxTEGs
This field, if present, indicates that the target device is requested to measure the same DL-PRS Resource of a TRP with <i>N</i> different UE Rx TEGs. Enumerated value ' <i>n0</i> ' indicates that the number <i>N</i> of different UE Rx TEGs to measure the same DL PRS Resource can be determined by the target device, value ' <i>n2</i> ' indicates that the target device is requested to measure the same DL-PRS Resource of a TRP with 2 different UE Rx TEGs, value ' <i>n3</i> ' indicates that the target device is requested to measure the same DL-PRS Resource of a TRP with 3 different UE Rx TEGs, and so on. If this field is present, the field <i>nr-UE-RxTEG-Request</i> should also be present.
reducedDL-PRS-ProcessingSamples
This field, if present and set to ' <i>requested</i> ', indicates that the target device is requested to perform the requested measurements with reduced number of samples (<i>M=1</i> or <i>M=2</i>) as specified in TS 38.133 [46].
lowerRxBeamSweepingFactor-FR2
This field, if present, indicates that the target device is requested to use a lower Rx beam sweeping factor than 8 for FR2 according to UE's capability.

6.5.10.6 NR DL-TDOA Capability Information

– NR-DL-TDOA-ProvideCapabilities

The IE *NR-DL-TDOA-ProvideCapabilities* is used by the target device to indicate its capability to support NR DL-TDOA and to provide its NR DL-TDOA positioning capabilities to the location server.

```
-- ASN1START
NR-DL-TDOA-ProvideCapabilities-r16 ::= SEQUENCE {
    nr-DL-TDOA-Mode-r16                PositioningModes,
    nr-DL-TDOA-PRS-Capability-r16     NR-DL-PRS-ResourcesCapability-r16,
    nr-DL-TDOA-MeasurementCapability-r16 NR-DL-TDOA-MeasurementCapability-r16,
    nr-DL-PRS-QCL-ProcessingCapability-r16 NR-DL-PRS-QCL-ProcessingCapability-r16,
    nr-DL-PRS-ProcessingCapability-r16 NR-DL-PRS-ProcessingCapability-r16,
    additionalPathsReport-r16         ENUMERATED { supported }                OPTIONAL,
    periodicalReporting-r16           PositioningModes                OPTIONAL,
    . . .
    [
    ten-ms-unit-ResponseTime-r17      PositioningModes                OPTIONAL,
    nr-PosCalcAssistanceSupport-r17    BIT STRING {
        trpLocSup          (0),
        beamInfoSup       (1),
        rtdInfoSup        (2),
        trpTEG-InfoSup    (3)
    } (SIZE (1..8))                OPTIONAL,
    nr-los-nlos-AssistanceDataSupport-r17 SEQUENCE {
        type-r17          LOS-NLOS-IndicatorType2-r17,

```

```

        granularity-r17 LOS-NLOS-IndicatorGranularity2-r17,
        ...
    } OPTIONAL,
nr-DL-PRS-ExpectedAoD-or-AoA-Sup-r17 BIT STRING {
    eAoD (0),
    eAoA (1)
    } (SIZE (1..8)) OPTIONAL,
nr-DL-TDOA-On-Demand-DL-PRS-Support-r17 NR-On-Demand-DL-PRS-Support-r17 OPTIONAL,
nr-los-nlos-IndicatorSupport-r17 SEQUENCE {
    type-r17 LOS-NLOS-IndicatorType2-r17,
    granularity-r17 LOS-NLOS-IndicatorGranularity2-r17,
    ...
} OPTIONAL,
additionalPathsExtSupport-r17 ENUMERATED { n4, n6, n8 } OPTIONAL,
scheduledLocationRequestSupported-r17 ScheduledLocationTimeSupportPerMode-r17 OPTIONAL,
nr-dl-prs-AssistanceDataValidity-r17 SEQUENCE {
    area-validity-r17 INTEGER (1..maxNrOfAreas-r17) OPTIONAL,
    ...
} OPTIONAL,
multiMeasInSameMeasReport-r17 ENUMERATED { supported } OPTIONAL,
mg-ActivationRequest-r17 ENUMERATED { supported } OPTIONAL,
]],
[[
posMeasGapSupport-r17 ENUMERATED { supported } OPTIONAL
]],
[[
multiLocationEstimateInSameMeasReport-r17 ENUMERATED { supported } OPTIONAL
]]
}
-- ASN1STOP

```

NR-DL-TDOA-ProvideCapabilities field descriptions	
nr-DL-TDOA-Mode	This field specifies the NR DL-TDOA mode(s) supported by the target device.
periodicalReporting	This field, if present, specifies the positioning modes for which the target device supports <i>periodicalReporting</i> . This is represented by a bit string, with a one-value at the bit position means <i>periodicalReporting</i> for the positioning mode is supported; a zero-value means not supported. If this field is absent, the target device does not support <i>periodicalReporting</i> in <i>CommonEsRequestLocationInformation</i> .
ten-ms-unit-ResponseTime	This field, if present, specifies the positioning modes for which the target device supports the enumerated value ' <i>ten-milli-seconds</i> ' in the IE <i>ResponseTime</i> in IE <i>CommonEsRequestLocationInformation</i> . This is represented by a bit string, with a one-value at the bit position means ' <i>ten-milli-seconds</i> ' response time unit for the positioning mode is supported; a zero-value means not supported. If this field is absent, the target device does not support ' <i>ten-milli-seconds</i> ' response time unit in <i>CommonEsRequestLocationInformation</i> .
nr-PosCalcAssistanceSupport	This field indicates the Position Calculation Assistance Data supported by the target device for UE-based DL-TDOA. This is represented by a bit string, with a one-value at the bit position means the particular assistance data is supported; a zero-value means not supported. <ul style="list-style-type: none"> - bit 0 indicates whether the field <i>nr-TRP-LocationInfo</i> in IE <i>NR-PositionCalculationAssistance</i> is supported or not; - bit 1 indicates whether the field <i>nr-DL-PRS-BeamInfo</i> in IE <i>NR-PositionCalculationAssistance</i> is supported or not; - bit 2 indicates whether the field <i>nr-RTD-Info</i> in IE <i>NR-PositionCalculationAssistance</i> is supported or not; - bit 3 indicates whether the field <i>nr-DL-PRS-TRP-TEG-Info</i> in IE <i>NR-PositionCalculationAssistance</i> is supported or not. The UE can indicate this bit only if the UE supports <i>prs-ProcessingCapabilityBandList</i> and any of <i>maxNrOfDL-PRS-ResourceSetPerTrpPerFrequencyLayer</i>, <i>maxNrOfTRP-AcrossFreqs</i>, <i>maxNrOfPosLayer</i>, <i>maxNrOfDL-PRS-ResourcesPerResourceSet</i> and <i>maxNrOfDL-PRS-ResourcesPerPositioningFrequencyLayer</i>. Otherwise, the UE does not include this field.
nr-los-nlos-AssistanceDataSupport	This field, if present, indicates that the target device supports the <i>NR-DL-PRS-ExpectedLOS-NLOS-Assistance</i> in IE <i>NR-PositionCalculationAssistance</i> : <ul style="list-style-type: none"> - <i>type</i> indicates whether the target device supports '<i>hard</i>' value or '<i>hard</i>' and '<i>soft</i>' value in <i>LOS-NLOS-Indicator</i> in IE <i>NR-DL-PRS-ExpectedLOS-NLOS-Assistance</i>. - <i>granularity</i> indicates whether the target device supports <i>nr-los-nlos-indicator</i> in IE <i>NR-DL-PRS-ExpectedLOS-NLOS-Assistance</i> '<i>per-trp</i>', '<i>per-resource</i>', or both. The UE can include this field only if the UE supports one of <i>maxDL-PRS-RSRP-MeasurementFR1</i> , <i>maxDL-PRS-RSRP-MeasurementFR2</i> , <i>dl-RSTD-MeasurementPerPairOfTRP-FR1</i> , <i>dl-RSTD-MeasurementPerPairOfTRP-FR2</i> , <i>maxNrOfRx-TX-MeasFR1</i> , <i>maxNrOfRx-TX-MeasFR2</i> , <i>supportOfRSRP-MeasFR1</i> and <i>supportOfRSRP-MeasFR2</i> . Otherwise, the UE does not include this field.

<p>nr-DL-PRS-ExpectedAoD-or-AoA-Sup This field, if present, indicates that the target device supports the <i>nr-DL-PRS-ExpectedAoD-or-AoA</i> in <i>nr-DL-PRS-AssistanceData</i>.</p>
<p>nr-DL-TDOA-On-Demand-DL-PRS-Support This field, if present, indicates that the target device supports on-demand DL-PRS requests.</p>
<p>nr-los-nlos-IndicatorSupport This field, if present, indicates that the target device supports <i>nr-los-nlos-Indicator</i> reporting in IE <i>nr-DL-TDOA-SignalMeasurementInformation</i>.</p> <ul style="list-style-type: none"> - <i>type</i> indicates whether the target device supports 'hard' value or 'hard' and 'soft' value in IE <i>LOS-NLOS-Indicator</i>. - <i>granularity</i> indicates whether the target device supports <i>LOS-NLOS-Indicator</i> reporting per TRP, per DL-PRS Resource, or both. <p>NOTE: A single value is reported when both Multi-RTT and DL-TDOA are supported.</p>
<p>additionalPathsExtSupport This field, if present, indicates that the target device supports the <i>nr-AdditionalPathListExt</i> reporting in IE <i>nr-DL-TDOA-SignalMeasurementInformation</i>. The enumerated value indicates the number of additional paths supported by the target device.</p> <p>NOTE: The <i>supportOfDL-PRS-FirstPathRSRP</i> in IE <i>nr-DL-TDOA-MeasurementCapability</i> also applies to the additional paths.</p>
<p>scheduledLocationRequestSupported This field, if present, specifies the positioning modes for which the target device supports scheduled location requests – i.e., supports the IE <i>ScheduledLocationTime</i> in IE <i>CommonIEsRequestLocationInformation</i> – and the time base(s) supported for the scheduled location time for each positioning mode. If this field is absent, the target device does not support scheduled location requests.</p>
<p>nr-dl-prs-AssistanceDataValidity This field, if present, indicates that the target device supports validity conditions for pre-configured assistance data and comprises the following subfields:</p> <ul style="list-style-type: none"> - area-validity indicates that the target device supports pre-configured assistance data with area validity. The integer number indicates the maximum number of areas the target device supports.
<p>multiMeasInSameMeasReport This field, if present, indicates that the target device supports multiple measurement instances in a single measurement report.</p>
<p>mg-ActivationRequest This field, if present, indicates that the target device supports UL MAC CE for positioning measurement gap activation/deactivation request for DL-PRS measurements. The UE can include this field only if the UE supports <i>mg-ActivationRequestPRS-Meas</i> and <i>mg-ActivationCommPRS-Meas</i> defined in TS 38.331 [35].</p>
<p>posMeasGapSupport This field, if present, indicates that the target device supports pre-configured positioning measurement gap for DL-PRS measurements. The UE can include this field only if the UE supports <i>mg-ActivationCommPRS-Meas</i> defined in TS 38.331 [35].</p>
<p>multiLocationEstimateInSameMeasReport This field, if present, indicates that the target device supports multiple location estimate instances in a single measurement report.</p>

6.5.10.6a NR DL-TDOA Capability Information Elements

– *nr-DL-TDOA-MeasurementCapability*

The IE *nr-DL-TDOA-MeasurementCapability* defines the DL-TDOA measurement capability. The UE can include this IE only if the UE supports *nr-DL-PRS-ResourcesCapability* for DL-TDOA. Otherwise, the UE does not include this IE.

```
-- ASN1START
NR-DL-TDOA-MeasurementCapability-r16 ::= SEQUENCE {
    dl-RSTD-MeasurementPerPairOfTRP-FR1-r16      INTEGER (1..4),
    dl-RSTD-MeasurementPerPairOfTRP-FR2-r16      INTEGER (1..4),
    supportOfDL-PRS-RSRP-MeasFR1-r16             ENUMERATED { supported } OPTIONAL,
    supportOfDL-PRS-RSRP-MeasFR2-r16             ENUMERATED { supported } OPTIONAL,
    . . . ,
    [ ]
    nr-UE-TEG-Capability-r17                      NR-UE-TEG-Capability-r17          OPTIONAL,
    dl-tdoa-MeasCapabilityBandList-r17            SEQUENCE (SIZE (1..nrMaxBands-r16)) OF
                                                DL-TDOA-MeasCapabilityPerBand-r17  OPTIONAL
}
-- ASN1END
```

```
DL-TDOA-MeasCapabilityPerBand-r17 ::= SEQUENCE {
    freqBandIndicatorNR-r17          FreqBandIndicatorNR-r16,
    supportOfDL-PRS-FirstPathRSRP-r17  ENUMERATED { supported }           OPTIONAL,
    dl-PRS-MeasRRC-Inactive-r17        ENUMERATED { supported }           OPTIONAL,
    ...
}
-- ASN1STOP
```

NR-DL-TDOA-MeasurementCapability field descriptions

dl-RSTD-MeasurementPerPairOfTRP-FR1

Indicates number of DL RSTD measurements per pair of TRPs on FR1.

dl-RSTD-MeasurementPerPairOfTRP-FR2

Indicates number of DL RSTD measurements per pair of TRPs on FR2.

supportOfDL-PRS-RSRP-MeasFR1

Indicates whether the UE supports DL-PRS RSRP measurement for DL-TDOA on FR1.

supportOfDL-PRS-RSRP-MeasFR2

Indicates whether the UE supports DL-PRS RSRP measurement for DL-TDOA on FR2.

nr-UE-TEG-Capability

Indicates the UE TEG capability.

supportOfDL-PRS-FirstPathRSRP

Indicates whether the target device supports DL-PRS RSRPP of first path measurement for DL-TDOA. The UE can include this field only if the UE supports *prs-ProcessingCapabilityBandList*. Otherwise, the UE does not include this field. The UE supporting *additionalPathsReport* and *supportOfDL-PRS-FirstPathRSRP* shall support RSRPP reporting for K=1 or 2 additional paths.

dl-PRS-MeasRRC-Inactive

This field, if present, indicates that the target device supports DL-PRS measurement in RRC_INACTIVE state. The UE can include this field only if the UE supports *maxNrOfDL-PRS-ResourceSetPerTrpPerFrequencyLayer*, *maxNrOfTRP-AcrossFreqs*, *maxNrOfPosLayer* and *dl-PRS-BufferType-RRC-Inactive*. Otherwise, the UE does not include this field.

NOTE 1: This capability is applicable to both, UE-assisted and UE-based DL-TDOA.

NOTE 2: The capabilities *NR-DL-PRS-ResourcesCapability*, *dl-RSTD-MeasurementPerPairOfTRP-FR1*, *dl-RSTD-MeasurementPerPairOfTRP-FR2*, *supportOfDL-PRS-RSRP-MeasFR1*, *supportOfDL-PRS-RSRP-MeasFR2*, *simul-NR-DL-AoD-DL-TDOA* are the same in RRC_INACTIVE state.

6.5.10.7 NR DL-TDOA Capability Information Request

– NR-DL-TDOA-RequestCapabilities

The IE *NR-DL-TDOA-RequestCapabilities* is used by the location server to request the capability of the target device to support NR DL-TDOA and to request NR DL-TDOA positioning capabilities from a target device.

```
-- ASN1START
NR-DL-TDOA-RequestCapabilities-r16 ::= SEQUENCE {
    ...
}
-- ASN1STOP
```

6.5.10.8 NR DL-TDOA Error Elements

– NR-DL-TDOA-Error

The IE *NR-DL-TDOA-Error* is used by the location server or target device to provide NR DL-TDOA error reasons to the target device or location server, respectively.

```
-- ASN1START
NR-DL-TDOA-Error-r16 ::= CHOICE {
    locationServerErrorCauses-r16          NR-DL-TDOA-LocationServerErrorCauses-r16,
    targetDeviceErrorCauses-r16           NR-DL-TDOA-TargetDeviceErrorCauses-r16,
    ...
}
-- ASN1STOP
```

– NR-DL-TDOA-LocationServerErrorCauses

The IE *NR-DL-TDOA-LocationServerErrorCauses* is used by the location server to provide NR DL-TDOA error reasons to the target device.

```
-- ASN1START
NR-DL-TDOA-LocationServerErrorCauses-r16 ::= SEQUENCE {
  cause-r16      ENUMERATED {
    undefined,
    assistanceDataNotSupportedByServer,
    assistanceDataSupportedButCurrentlyNotAvailableByServer,
    notProvidedAssistanceDataNotSupportedByServer,
    ...,
    on-demand-dl-prs-NotSupportedByServer-v1700,
    on-demand-dl-prs-SupportedButCurrentlyNotAvailableByServer-v1700
  },
  ...
}
-- ASN1STOP
```

– NR-DL-TDOA-TargetDeviceErrorCauses

The IE *NR-DL-TDOA-TargetDeviceErrorCauses* is used by the target device to provide NR DL-TDOA error reasons to the location server.

```
-- ASN1START
NR-DL-TDOA-TargetDeviceErrorCauses-r16 ::= SEQUENCE {
  cause-r16      ENUMERATED {
    undefined,
    assistance-data-missing,
    unableToMeasureAnyTRP,
    attemptedButUnableToMeasureSomeNeighbourTRPs,
    thereWereNotEnoughSignalsReceivedForUeBasedDL-TDOA,
    locationCalculationAssistanceDataMissing,
    ...
  },
  ...
}
-- ASN1STOP
```

6.5.11 NR DL-AoD Positioning

This clause defines the information elements for NR downlink AoD positioning (TS 38.305 [40]).

6.5.11.1 NR DL-AoD Assistance Data

– NR-DL-AoD-ProvideAssistanceData

The IE *NR-DL-AoD-ProvideAssistanceData* is used by the location server to provide assistance data to enable UE-assisted and UE-based NR DL-AoD. It may also be used to provide NR DL-AoD positioning specific error reason.

```
-- ASN1START
NR-DL-AoD-ProvideAssistanceData-r16 ::= SEQUENCE {
  nr-DL-PRS-AssistanceData-r16      NR-DL-PRS-AssistanceData-r16      OPTIONAL,  -- Need ON
  nr-SelectedDL-PRS-IndexList-r16    NR-SelectedDL-PRS-IndexList-r16  OPTIONAL,  -- Need ON
  nr-PositionCalculationAssistance-r16
                                     NR-PositionCalculationAssistance-r16
                                     OPTIONAL,  -- Cond UEB
  nr-DL-AoD-Error-r16                NR-DL-AoD-Error-r16            OPTIONAL,  -- Need ON
  ...,
  [
    nr-DL-PRS-BeamInfo-r17            NR-DL-PRS-BeamInfo-r16        OPTIONAL,  -- Cond UEA
    nr-On-Demand-DL-PRS-Configurations-r17
  ]
}
-- ASN1STOP
```

```

NR-On-Demand-DL-PRS-Configurations-r17
nr-On-Demand-DL-PRS-Configurations-Selected-IndexList-r17
NR-On-Demand-DL-PRS-Configurations-Selected-IndexList-r17
assistanceDataValidityArea-r17
AreaID-CellList-r17
]]
}
-- ASN1STOP
    
```

Conditional presence	Explanation
UEB	The field is optionally present, need ON, for UE based NR DL-AoD; otherwise it is not present.
UEA	The field is optionally present, need ON, for UE-assisted NR DL-AoD; otherwise it is not present.

NR-DL-AoD-ProvideAssistanceData field descriptions	
nr-DL-PRS-AssistanceData	This field specifies the assistance data reference and neighbour TRPs and provides the DL-PRS configuration for the TRPs. Note, if this field is absent but the <i>nr-SelectedDL-PRS-IndexList</i> field is present, the <i>nr-DL-PRS-AssistanceData</i> may be provided in IE <i>NR-Multi-RTT-ProvideAssistanceData</i> or <i>NR-DL-TDOA-ProvideAssistanceData</i> .
nr-SelectedDL-PRS-IndexList	This field specifies the DL-PRS Resources which are applicable for this <i>NR-DL-AoD-ProvideAssistanceData</i> message.
nr-PositionCalculationAssistance	This field provides position calculation assistance data for UE-based mode.
nr-DL-AoD-Error	This field provides DL-AoD error reasons.
nr-DL-PRS-BeamInfo	This field provides spatial direction information of the DL-PRS Resources included in <i>nr-DL-PRS-AssistanceData</i> or indicated by <i>nr-SelectedDL-PRS-IndexList</i> .
nr-On-Demand-DL-PRS-Configurations	This field provides a set of available DL-PRS configurations which can be requested by the target device on-demand. NOTE 1: Void. NOTE 2: If this field is absent but the <i>nr-On-Demand-DL-PRS-Configurations-Selected-IndexList</i> is present, the <i>nr-On-Demand-DL-PRS-Configurations</i> may be provided in IE <i>NR-Multi-RTT-ProvideAssistanceData</i> or <i>NR-DL-TDOA-ProvideAssistanceData</i> .
nr-On-Demand-DL-PRS-Configurations-Selected-IndexList	This field specifies the selected available on-demand DL-PRS configurations which are applicable for this <i>NR-DL-AoD-ProvideAssistanceData</i> message.
assistanceDataValidityArea	This field specifies the network area for which this <i>NR-DL-AoD-ProvideAssistanceData</i> is valid.

6.5.11.2 NR DL-AoD Assistance Data Request

– NR-DL-AoD-RequestAssistanceData

The IE *NR-DL-AoD-RequestAssistanceData* is used by the target device to request assistance data from a location server.

```

-- ASN1START
NR-DL-AoD-RequestAssistanceData-r16 ::= SEQUENCE {
  nr-PhysCellID-r16          NR-PhysCellID-r16          OPTIONAL,
  nr-AdType-r16             BIT STRING { dl-prs (0),
                                         posCalc (1) } (SIZE (1..8)),
  ...,
  [[
  nr-PosCalcAssistanceRequest-r17 BIT STRING { trpLoc (0),
                                                  beamInfo (1),
                                                  rtdInfo (2),
                                                  beamAntInfo (3),
                                                  losNlosInfo (4)
                                                  } (SIZE (1..8)) OPTIONAL,
  ]
    
```



```

nr-DL-PRS-ExpectedAoD-or-AoA-Request-r17    ENUMERATED { eAoD, eAoA }    OPTIONAL,
nr-DL-PRS-BeamInfoRequest-r17             ENUMERATED { requested }    OPTIONAL,
nr-on-demand-DL-PRS-Request-r17          NR-On-Demand-DL-PRS-Request-r17 OPTIONAL,
pre-configured-AssistanceDataRequest-r17  ENUMERATED { true }        OPTIONAL
]]
}
-- ASN1STOP

```

NR-DL-AoD-RequestAssistanceData field descriptions

nr-PhysCellID

This field specifies the NR physical cell identity of the current primary cell of the target device.

nr-AdType

This field indicates the requested assistance data. *dl-prs* means requested assistance data is *nr-DL-PRS-AssistanceData*, *posCalc* means requested assistance data is *nr-PositionCalculationAssistance* for UE based positioning.

nr-PosCalcAssistanceRequest

This field indicates the Position Calculation Assistance Data requested. This is represented by a bit string, with a one-value at the bit position means the particular assistance data is requested; a zero-value means not requested.

- bit 0 indicates whether the field *nr-TRP-LocationInfo* in IE *NR-PositionCalculationAssistance* is requested or not;
- bit 1 indicates whether the field *nr-DL-PRS-BeamInfo* in IE *NR-PositionCalculationAssistance* is requested or not;
- bit 2 indicates whether the field *nr-RTD-Info* in IE *NR-PositionCalculationAssistance* is requested or not;
- bit 3 indicates whether the field *nr-TRP-BeamAntennaInfo* in IE *NR-PositionCalculationAssistance* is requested or not;
- bit 4 indicates whether the field *nr-DL-PRS-Expected-LOS-NLOS-Assistance* in IE *NR-PositionCalculationAssistance* is requested or not.

This field may only be present if the '*posCalc*' bit in *nr-AdType* is set to value '1'.

nr-DL-PRS-ExpectedAoD-or-AoA-Request

This field, if present, indicates that the IE *NR-DL-PRS-ExpectedAoD-or-AoA* in *NR-DL-PRS-AssistanceData* is requested. Enumerated value '*eAoD*' indicates that expected AoD information is requested; value '*eAoA*' indicates that expected AoA information is requested.

This field may only be present if the '*dl-prs*' bit in *nr-AdType* is set to value '1'.

nr-DL-PRS-BeamInfoRequest

This field, if present, indicates that the IE *NR-DL-PRS-BeamInfo* is requested.

nr-on-demand-DL-PRS-Request

This field indicates the on-demand DL-PRS requested for DL-AoD. This field may be included when the *dl-prs* bit in *nr-AdType* is set to value '1'.

pre-configured-AssistanceDataRequest

This field, if present, indicates that the target device requests pre-configured assistance data with area validity.

6.5.11.3 NR DL-AoD Location Information

– NR-DL-AoD-ProvideLocationInformation

The IE *NR-DL-AoD-ProvideLocationInformation* is used by the target device to provide NR DL-AoD location measurements to the location server. It may also be used to provide NR DL-AoD positioning specific error reason.

```

-- ASN1START
NR-DL-AoD-ProvideLocationInformation-r16 ::= SEQUENCE {
    nr-DL-AoD-SignalMeasurementInformation-r16
        NR-DL-AoD-SignalMeasurementInformation-r16
        OPTIONAL,
    nr-dl-AoD-LocationInformation-r16         NR-DL-AoD-LocationInformation-r16
        OPTIONAL,
    nr-DL-AoD-Error-r16                     NR-DL-AoD-Error-r16
        OPTIONAL,
    ...
    [[
    nr-DL-AoD-SignalMeasurementInstances-r17 SEQUENCE (SIZE (1..maxMeasInstances-r17)) OF
        NR-DL-AoD-SignalMeasurementInformation-r16 OPTIONAL, -- Cond batchUEA
    nr-DL-AoD-LocationInformationInstances-r17 SEQUENCE (SIZE (1..maxMeasInstances-r17)) OF
        NR-DL-AoD-LocationInformation-r16
        OPTIONAL -- Cond batchUEB
    ]]
}
-- ASN1STOP

```

Conditional presence	Explanation
<i>batchUEA</i>	The field is optionally present if the field <i>nr-DL-AoD-SignalMeasurementInformation</i> is absent; otherwise it is not present.
<i>batchUEB</i>	The field is optionally present if the field <i>nr-dl-AoD-LocationInformation</i> is absent; otherwise it is not present.

6.5.11.4 NR DL-AoD Location Information Elements

– *NR-DL-AoD-SignalMeasurementInformation*

The IE *NR-DL-AoD-SignalMeasurementInformation* is used by the target device to provide NR DL-AoD measurements to the location server.

```
-- ASN1START

NR-DL-AoD-SignalMeasurementInformation-r16 ::= SEQUENCE {
    nr-DL-AoD-MeasList-r16          NR-DL-AoD-MeasList-r16,
    ...
}

NR-DL-AoD-MeasList-r16 ::= SEQUENCE (SIZE(1..nrMaxTRPs-r16)) OF NR-DL-AoD-MeasElement-r16

NR-DL-AoD-MeasElement-r16 ::= SEQUENCE {
    dl-PRS-ID-r16                  INTEGER (0..255),
    nr-PhysCellID-r16              NR-PhysCellID-r16                OPTIONAL,
    nr-CellGlobalID-r16            NCGI-r15                        OPTIONAL,
    nr-ARFCN-r16                   ARFCN-ValueNR-r15                OPTIONAL,
    nr-DL-PRS-ResourceID-r16        NR-DL-PRS-ResourceID-r16    OPTIONAL,
    nr-DL-PRS-ResourceSetID-r16     NR-DL-PRS-ResourceSetID-r16  OPTIONAL,
    nr-TimeStamp-r16               NR-TimeStamp-r16,
    nr-DL-PRS-RSRP-Result-r16       INTEGER (0..126),
    nr-DL-PRS-RxBeamIndex-r16       INTEGER (1..8)              OPTIONAL,
    nr-DL-AoD-AdditionalMeasurements-r16
                                    NR-DL-AoD-AdditionalMeasurements-r16  OPTIONAL,
    ...,
    [[
    nr-DL-PRS-FirstPathRSRP-Result-r17
                                    INTEGER (0..126)                  OPTIONAL,
    nr-los-nlos-Indicator-r17        CHOICE {
        perTRP-r17                    LOS-NLOS-Indicator-r17,
        perResource-r17                LOS-NLOS-Indicator-r17
    }                                OPTIONAL,
    nr-DL-AoD-AdditionalMeasurementsExt-r17
                                    NR-DL-AoD-AdditionalMeasurementsExt-r17  OPTIONAL
    ]]
}

NR-DL-AoD-AdditionalMeasurements-r16 ::= SEQUENCE (SIZE (1..7)) OF
    NR-DL-AoD-AdditionalMeasurementElement-r16

NR-DL-AoD-AdditionalMeasurementsExt-r17 ::= SEQUENCE (SIZE (1..maxAddMeasAoD-r17)) OF
    NR-DL-AoD-AdditionalMeasurementElement-r17

NR-DL-AoD-AdditionalMeasurementElement-r16 ::= SEQUENCE {
    nr-DL-PRS-ResourceID-r16        NR-DL-PRS-ResourceID-r16    OPTIONAL,
    nr-DL-PRS-ResourceSetID-r16     NR-DL-PRS-ResourceSetID-r16  OPTIONAL,
    nr-TimeStamp-r16                NR-TimeStamp-r16,
    nr-DL-PRS-RSRP-ResultDiff-r16   INTEGER (0..30),
    nr-DL-PRS-RxBeamIndex-r16       INTEGER (1..8)              OPTIONAL,
    ...
}

NR-DL-AoD-AdditionalMeasurementElement-r17 ::= SEQUENCE {
    nr-DL-PRS-ResourceID-r17        NR-DL-PRS-ResourceID-r16    OPTIONAL,
    nr-DL-PRS-ResourceSetID-r17     NR-DL-PRS-ResourceSetID-r16  OPTIONAL,
    nr-TimeStamp-r17                NR-TimeStamp-r16,
    nr-DL-PRS-RSRP-ResultDiff-r17   INTEGER (0..30)              OPTIONAL, -- Cond rsrp
    nr-DL-PRS-RxBeamIndex-r17       INTEGER (1..8)              OPTIONAL,
    nr-DL-PRS-FirstPathRSRP-ResultDiff-r17
                                    INTEGER (0..61)                    OPTIONAL, -- Cond rsrpp
    nr-los-nlos-IndicatorPerResource-r17
                                    LOS-NLOS-Indicator-r17            OPTIONAL,
    ...
}
```

```
}
-- ASN1STOP
```

Conditional presence	Explanation
<i>rsrp</i>	The field is mandatory present if the field <i>nr-DL-PRS-FirstPathRSRP-ResultDiff-r17</i> is absent; otherwise it is optionally present, need ON.
<i>rsrpp</i>	The field is mandatory present if the field <i>nr-DL-PRS-RSRP-ResultDiff-r17</i> is absent; otherwise it is optionally present, need ON.

NR-DL-AoD-SignalMeasurementInformation field descriptions	
<i>dl-PRS-ID</i>	This field is used along with a DL-PRS Resource Set ID and a DL-PRS Resource ID to uniquely identify a DL-PRS Resource. This ID can be associated with multiple DL-PRS Resource Sets associated with a single TRP. Each TRP should only be associated with one such ID.
<i>nr-PhysCellID</i>	This field specifies the physical cell identity of the associated TRP, as defined in TS 38.331 [35].
<i>nr-CellGlobalID</i>	This field specifies the NCGI, the globally unique identity of a cell in NR, of the associated TRP, as defined in TS 38.331 [35].
<i>nr-ARFCN</i>	This field specifies the NR-ARFCN of the TRP's CD-SSB (as defined in TS 38.300 [47]) corresponding to <i>nr-PhysCellID</i> .
<i>nr-TimeStamp</i>	This field specifies the time instance at which the measurement is performed.
<i>nr-DL-PRS-RSRP-Result</i>	This field specifies the NR DL-PRS reference signal received power (DL-PRS RSRP) measurement, as defined in TS 38.215 [36]. The mapping of the measured quantity is defined as in TS 38.133 [46].
<i>nr-DL-PRS-RxBeamIndex</i>	This field provides an index of the target device receive beam used for DL-PRS measurements associated with a single TRP in <i>nr-DL-AoD-MeasList-r16</i> when additional DL-PRS measurements are also included in either <i>nr-DL-AoD-AdditionalMeasurements-r16</i> or <i>nr-DL-AoD-AdditionalMeasurementsExt-r17</i> . If the value of the receive beam index for two or more DL-PRS measurements is the same, it indicates that the target device receive beam for the two or more DL-PRS measurements associated with a TRP were made with the same RX beam. The field is mandatory present if at least two DL-PRS RSRP measurements and/or DL-PRS RSRPP measurements from the same DL-PRS Resource Set associated with a TRP have been made with the same RX beam by the target device; otherwise it is not present.
<i>nr-DL-AoD-AdditionalMeasurements</i>	This field specifies a list of additional DL-PRS RSRP measurements of different DL-PRS resources for the same TRP. If this field is present, the field <i>nr-DL-AoD-AdditionalMeasurementsExt</i> should not be present.
<i>nr-DL-PRS-FirstPathRSRP-Result</i>	This field specifies the NR DL-PRS reference signal received path power (DL-PRS RSRPP) of the first detected path in time, as defined in TS 38.215 [36]. The mapping of the measured quantity is defined as in TS 38.133 [46].
<i>nr-los-nlos-Indicator</i>	This field specifies the target device's best estimate of the LOS or NLOS of the RSRP or RSRPP of first path measurement for the TRP or resource. NOTE: If the requested type or granularity in <i>nr-los-nlos-IndicatorRequest</i> is not possible, the target device may provide a different type and granularity for the estimated <i>LOS-NLOS-Indicator</i> .
<i>nr-DL-AoD-AdditionalMeasurementsExt</i>	This field specifies a list of additional DL-PRS RSRP and/or DL-PRS RSRPP measurements of different DL-PRS resources for the same TRP. If this field is present, the field <i>nr-DL-AoD-AdditionalMeasurements</i> should not be present.
<i>nr-DL-PRS-RSRP-ResultDiff</i>	This field provides the additional DL-PRS RSRP measurement result relative to <i>nr-DL-PRS-RSRP-Result</i> . The DL-PRS RSRP value of this measurement is obtained by adding the value of this field to the value of the <i>nr-DL-PRS-RSRP-Result</i> field. The mapping of the field is defined in TS 38.133 [46].
<i>nr-DL-PRS-FirstPathRSRP-ResultDiff</i>	This field specifies the additional NR DL-PRS reference signal received path power (DL-PRS RSRPP) of the first detected path in time relative to <i>nr-DL-PRS-FirstPathRSRP-Result</i> . The DL-PRS RSRPP of first path value of this measurement is obtained by adding the value of this field to the value of the <i>nr-DL-PRS-FirstPathRSRP-Result</i> field. The mapping of the field is defined in TS 38.133 [46].
<i>nr-los-nlos-IndicatorPerResource</i>	This field specifies the target device's best estimate of the LOS or NLOS of the RSRP or RSRPP of first path measurement for the resource. This field may only be present if the field <i>nr-LOS-NLOS-Indicator</i> choice indicates <i>perResource</i> .

– NR-DL-AoD-LocationInformation

The IE *NR-DL-AoD-LocationInformation* is included by the target device when location information derived using NR DL-AoD is provided to the location server.

```
-- ASN1START
NR-DL-AoD-LocationInformation-r16 ::= SEQUENCE {
  measurementReferenceTime-r16      CHOICE {
    sfn-time-r16                     NR-TimeStamp-r16,
    utc-time-r16                     UTCTime,
    ...
  }                                  OPTIONAL,
  ...
  [[
  locationCoordinates-r17            LocationCoordinates      OPTIONAL, -- Cond batch1
  locationSource-r17                LocationSource-r13        OPTIONAL  -- Cond batch2
  ]]
}
-- ASN1STOP
```

Conditional presence	Explanation
<i>batch1</i>	The field is mandatory present if the field <i>nr-DL-AoD-LocationInformationInstances</i> is present in IE <i>NR-DL-AoD-ProvideLocationInformation</i> ; otherwise it is not present.
<i>batch2</i>	The field is optionally present, need ON, if the field <i>nr-DL-AoD-LocationInformationInstances</i> is present in IE <i>NR-DL-AoD-ProvideLocationInformation</i> ; otherwise it is not present.

NR-DL-AoD-LocationInformation field descriptions

measurementReferenceTime	This field specifies the time for which the location estimate is valid.
locationCoordinates	This field provides a location estimate using one of the geographic shapes defined in TS 23.032 [15]. NOTE 1.
locationSource	This field provides the source positioning technology for the location estimate. NOTE 1.

NOTE 1: In the case of *locationCoordinates* for multiple NR positioning methods are provided, the *locationCoordinates* and *locationSource* shall be present in only one of *NR-DL-TDOA-ProvideLocationInformation* or *NR-DL-AoD-ProvideLocationInformation*.

6.5.11.5 NR DL-AoD Location Information Request

– NR-DL-AoD-RequestLocationInformation

The IE *NR-DL-AoD-RequestLocationInformation* is used by the location server to request NR DL-AoD location measurements from a target device.

```
-- ASN1START
NR-DL-AoD-RequestLocationInformation-r16 ::= SEQUENCE {
  nr-AssistanceAvailability-r16      BOOLEAN,
  nr-DL-AoD-ReportConfig-r16        NR-DL-AoD-ReportConfig-r16,
  ...
  [[
  multiMeasInSameReport-r17         ENUMERATED { requested }    OPTIONAL -- Need ON
  ]]
}

NR-DL-AoD-ReportConfig-r16 ::= SEQUENCE {
  maxDL-PRS-RSRP-MeasurementsPerTRP-r16  INTEGER (1..8)              OPTIONAL, -- Need ON
  ...
  [[
  maxDL-PRS-RSRP-MeasurementsPerTRP-r17  INTEGER (9..24)            OPTIONAL, -- Need ON
  maxDL-PRS-RSRPP-MeasurementsPerTRP-r17  INTEGER (1..24)            OPTIONAL, -- Need ON
  nr-los-nlos-IndicatorRequest-r17        SEQUENCE {
    type-r17                             LOS-NLOS-IndicatorType1-r17,

```

```

        granularity-r17
        LOS-NLOS-IndicatorGranularity1-r17,
        ...
    }
    reducedDL-PRS-ProcessingSamples-r17    ENUMERATED { requested, ... }    OPTIONAL, -- Need ON
    lowerRxBeamSweepingFactor-FR2-r17    ENUMERATED { requested }    OPTIONAL -- Need ON
    ]]
}
-- ASN1STOP

```

NR-DL-AoD-RequestLocationInformation field descriptions

nr-AssistanceAvailability

This field indicates whether the target device may request additional PRS assistance data from the server. TRUE means allowed and FALSE means not allowed.

multiMeasInSameReport

This field, if present, indicates that the target device is requested to provide multiple measurement instances in a single measurement report; i.e., include the *nr-DL-AoD-SignalMeasurementInstances* (in the case of UE-assisted mode is requested) or *nr-DL-AoD-LocationInformationInstances* (in the case of UE-based mode is requested) in IE *NR-DL-AoD-ProvideLocationInformation*.

maxDL-PRS-RSRP-MeasurementsPerTRP

This field specifies the maximum number of DL-PRS RSRP measurements on different DL-PRS Resources from the same TRP. If this field with -r17 suffix is present, the field with -r16 suffix should not be present.

maxDL-PRS-RSRPP-MeasurementsPerTRP

This field specifies the maximum number of DL-PRS RSRPP measurements on different DL-PRS Resources from the same TRP.

nr-los-nlos-IndicatorRequest

This field, if present, indicates that the target device is requested to provide the indicated type and granularity of the estimated *LOS-NLOS-Indicator* in the *NR-DL-AoD-SignalMeasurementInformation*.

reducedDL-PRS-ProcessingSamples

This field, if present and set to 'requested', indicates that the target device is requested to perform the requested measurements with reduced number of samples (M=1 or M=2) as specified in TS 38.133 [46].

lowerRxBeamSweepingFactor-FR2

This field, if present, indicates that the target device is requested to use a lower Rx beam sweeping factor than 8 for FR2 according to UE's capability.

6.5.11.6 NR DL-AoD Capability Information

– NR-DL-AoD-ProvideCapabilities

The IE *NR-DL-AoD-ProvideCapabilities* is used by the target device to indicate its capability to support NR DL-AoD and to provide its NR DL-AoD positioning capabilities to the location server.

```

-- ASN1START
NR-DL-AoD-ProvideCapabilities-r16 ::= SEQUENCE {
    nr-DL-AoD-Mode-r16                PositioningModes,
    nr-DL-AoD-PRS-Capability-r16     NR-DL-PRS-ResourcesCapability-r16,
    nr-DL-AoD-MeasurementCapability-r16 NR-DL-AoD-MeasurementCapability-r16,
    nr-DL-PRS-QCL-ProcessingCapability-r16 NR-DL-PRS-QCL-ProcessingCapability-r16,
    nr-DL-PRS-ProcessingCapability-r16 NR-DL-PRS-ProcessingCapability-r16,
    periodicalReporting-r16          PositioningModes                OPTIONAL,
    ...
    [[
    ten-ms-unit-ResponseTime-r17     PositioningModes                OPTIONAL,
    nr-PosCalcAssistanceSupport-r17   BIT STRING {
        trpLocSup      (0),
        beamInfoSup    (1),
        rtdInfoSup     (2),
        beamAntInfoSup (3)
    } (SIZE (1..8))                OPTIONAL,
    nr-los-nlos-AssistanceDataSupport-r17 SEQUENCE {
        type-r17      LOS-NLOS-IndicatorType2-r17,
        granularity-r17 LOS-NLOS-IndicatorGranularity2-r17,
        ...
    }                                OPTIONAL,
    nr-DL-PRS-ExpectedAoD-or-AoA-Sup-r17 BIT STRING {
        eAoD          (0),
        eAoA          (1)
    } (SIZE (1..8))                OPTIONAL,

```

```

dl-PRS-ResourcePrioritySubset-Sup-r17    ENUMERATED { sameSet, differentSet, sameOrDifferentSet }
                                          OPTIONAL,
nr-DL-PRS-BeamInfoSup-r17                ENUMERATED { supported }                    OPTIONAL,
nr-DL-AoD-On-Demand-DL-PRS-Support-r17  NR-On-Demand-DL-PRS-Support-r17            OPTIONAL,
nr-los-nlos-IndicatorSupport-r17         SEQUENCE {
                                          type-r17          LOS-NLOS-IndicatorType2-r17,
                                          granularity-r17 LOS-NLOS-IndicatorGranularity2-r17,
                                          ...
                                          }
                                          OPTIONAL,
scheduledLocationRequestSupported-r17    ScheduledLocationTimeSupportPerMode-r17    OPTIONAL,
nr-dl-prs-AssistanceDataValidity-r17     SEQUENCE {
                                          area-validity-r17  INTEGER (1..maxNrOfAreas-r17)
                                          ...
                                          }
                                          OPTIONAL,
multiMeasInSameMeasReport-r17           ENUMERATED { supported }                    OPTIONAL,
mg-ActivationRequest-r17                 ENUMERATED { supported }                    OPTIONAL,
]],
[[
posMeasGapSupport-r17                    ENUMERATED { supported }                    OPTIONAL
]],
[[
multiLocationEstimateInSameMeasReport-r17  ENUMERATED { supported }                    OPTIONAL
]]
}
-- ASN1STOP

```

NR-DL-AoD-ProvideCapabilities field descriptions

nr-DL-AoD-Mode

This field specifies the NR DL-AoD mode(s) supported by the target device.

periodicalReporting

This field, if present, specifies the positioning modes for which the target device supports *periodicalReporting*. This is represented by a bit string, with a one-value at the bit position means *periodicalReporting* for the positioning mode is supported; a zero-value means not supported. If this field is absent, the target device does not support *periodicalReporting* in *CommonEsRequestLocationInformation*.

ten-ms-unit-ResponseTime

This field, if present, specifies the positioning modes for which the target device supports the enumerated value '*ten-milli-seconds*' in the IE *ResponseTime* in IE *CommonEsRequestLocationInformation*. This is represented by a bit string, with a one-value at the bit position means '*ten-milli-seconds*' response time unit for the positioning mode is supported; a zero-value means not supported. If this field is absent, the target device does not support '*ten-milli-seconds*' response time unit in *CommonEsRequestLocationInformation*.

nr-PosCalcAssistanceSupport

This field indicates the Position Calculation Assistance Data supported by the target device for UE-based DL-AoD. This is represented by a bit string, with a one-value at the bit position means the particular assistance data is supported; a zero-value means not supported.

- bit 0 indicates whether the field *nr-TRP-LocationInfo* in IE *NR-PositionCalculationAssistance* is supported or not;
- bit 1 indicates whether the field *nr-DL-PRS-BeamInfo* in IE *NR-PositionCalculationAssistance* is supported or not;
- bit 2 indicates whether the field *nr-RTD-Info* in IE *NR-PositionCalculationAssistance* is supported or not. The UE can indicate this bit only if the UE supports *prs-ProcessingCapabilityBandList* and any of *maxNrOfDL-PRS-ResourceSetPerTrpPerFrequencyLayer*, *maxNrOfTRP-AcrossFreqs*, *maxNrOfPosLayer*, *maxNrOfDL-PRS-ResourcesPerResourceSet* and *maxNrOfDL-PRS-ResourcesPerPositioningFrequencyLayer*. Otherwise, the UE does not include this field;
- bit 3 indicates whether the field *nr-TRP-BeamAntennaInfo* in IE *NR-PositionCalculationAssistance* is supported or not.

nr-los-nlos-AssistanceDataSupport

This field, if present, indicates that the target device supports the *NR-DL-PRS-ExpectedLOS-NLOS-Assistance* in IE *NR-PositionCalculationAssistance*:

- *type* indicates whether the target device supports '*hard*' value or '*hard*' and '*soft*' value in *LOS-NLOS-Indicator* in IE *NR-DL-PRS-ExpectedLOS-NLOS-Assistance*.
- *granularity* indicates whether the target device supports *nr-los-nlos-indicator* in IE *NR-DL-PRS-ExpectedLOS-NLOS-Assistance* '*per-trp*', '*per-resource*', or both.

The UE can include this field only if the UE supports one of *maxDL-PRS-RSRP-MeasurementFR1*, *maxDL-PRS-RSRP-MeasurementFR2*, *dl-RSTD-MeasurementPerPairOfTRP-FR1*, *dl-RSTD-MeasurementPerPairOfTRP-FR2*, *maxNrOfRx-TX-MeasFR1*, *maxNrOfRx-TX-MeasFR2*, *supportOfRSRP-MeasFR1* and *supportOfRSRP-MeasFR2*. Otherwise, the UE does not include this field.

<p>nr-DL-PRS-ExpectedAoD-or-AoA-Sup This field, if present, indicates that the target device supports the <i>NR-DL-PRS-ExpectedAoD-or-AoA</i> in <i>NR-DL-PRS-AssistanceData</i>.</p>
<p>dl-PRS-ResourcePrioritySubset-Sup This field, if present, indicates that the target device supports the <i>DL-PRS-ResourcePrioritySubset</i> in IE <i>NR-DL-PRS-Info</i>. Enumerated value indicates the supported resource set relationship for the target DL-PRS Resource and the associated subset.</p>
<p>nr-DL-PRS-BeamInfoSup This field, if present, indicates that the target device supports the <i>NR-DL-PRS-BeamInfo</i> in IE <i>NR-DL-AoD-ProvideAssistanceData</i>.</p>
<p>nr-DL-AoD-On-Demand-DL-PRS-Support This field, if present, indicates that the target device supports on-demand DL-PRS requests.</p>
<p>nr-los-nlos-IndicatorSupport This field, if present, indicates that the target device supports <i>nr-los-nlos-Indicator</i> reporting in IE <i>NR-DL-AoD-SignalMeasurementInformation</i>.</p> <ul style="list-style-type: none"> - <i>type</i> indicates whether the target device supports 'hard' value or 'hard' and 'soft' value in IE <i>LOS-NLOS-Indicator</i>. - <i>granularity</i> indicates whether the target device supports <i>LOS-NLOS-Indicator</i> reporting per TRP, per DL-PRS Resource, or both.
<p>scheduledLocationRequestSupported This field, if present, specifies the positioning modes for which the target device supports scheduled location requests – i.e., supports the IE <i>ScheduledLocationTime</i> in IE <i>CommonIESRequestLocationInformation</i> – and the time base(s) supported for the scheduled location time for each positioning mode. If this field is absent, the target device does not support scheduled location requests.</p>
<p>nr-dl-prs-AssistanceDataValidity This field, if present, indicates that the target device supports validity conditions for pre-configured assistance data and comprises the following subfields:</p> <ul style="list-style-type: none"> - area-validity indicates that the target device supports pre-configured assistance data with area validity. The integer number indicates the maximum number of areas the target device supports.
<p>multiMeasInSameMeasReport This field, if present, indicates that the target device supports multiple measurement instances in a single measurement report.</p>
<p>mg-ActivationRequest This field, if present, indicates that the target device supports UL MAC CE for positioning measurement gap activation/deactivation request for DL-PRS measurements. The UE can include this field only if the UE supports <i>mg-ActivationRequestPRS-Meas</i> and <i>mg-ActivationCommPRS-Meas</i> defined in TS 38.331 [35].</p>
<p>posMeasGapSupport This field, if present, indicates that the target device supports pre-configured positioning measurement gap for DL-PRS measurements. The UE can include this field only if the UE supports <i>mg-ActivationCommPRS-Meas</i> defined in TS 38.331 [35].</p>
<p>multiLocationEstimateInSameMeasReport This field, if present, indicates that the target device supports multiple location estimate instances in a single measurement report.</p>

6.5.11.6a NR DL-AoD Capability Information Elements

– *NR-DL-AoD-MeasurementCapability*

The IE *NR-DL-AoD-MeasurementCapability* defines the DL-AoD measurement capability. The UE can include this IE only if the UE supports *NR-DL-PRS-ResourcesCapability* for DL-AoD. Otherwise, the UE does not include this IE;

```
-- ASN1START
NR-DL-AoD-MeasurementCapability-r16 ::= SEQUENCE {
    maxDL-PRS-RSRP-MeasurementFR1-r16    INTEGER (1..8),
    maxDL-PRS-RSRP-MeasurementFR2-r16    INTEGER (1..8),
    dl-AoD-MeasCapabilityBandList-r16     SEQUENCE (SIZE (1..nrMaxBands-r16)) OF
                                          DL-AoD-MeasCapabilityPerBand-r16,
    . . .
    [ [
        maxDL-PRS-RSRP-MeasurementFR1-v1730    ENUMERATED { n16, n24 }    OPTIONAL,
        maxDL-PRS-RSRP-MeasurementFR2-v1730    ENUMERATED { n16, n24 }    OPTIONAL
    ] ]
}

DL-AoD-MeasCapabilityPerBand-r16 ::= SEQUENCE {
    freqBandIndicatorNR-r16                FreqBandIndicatorNR-r16,
```

```

simul-NR-DL-AoD-DL-TDOA-r16      ENUMERATED { supported }      OPTIONAL,
simul-NR-DL-AoD-Multi-RTT-r16   ENUMERATED { supported }      OPTIONAL,
...
[[
maxDL-PRS-FirstPathRSRP-MeasPerTRP-r17  ENUMERATED { n1, n2, n4, n8, n16, n24 } OPTIONAL,
dl-PRS-MeasRRC-Inactive-r17          ENUMERATED { supported }      OPTIONAL
]]
}
-- ASN1STOP

```

NR-DL-AoD-MeasurementCapability field descriptions

maxDL-PRS-RSRP-MeasurementFR1

Indicates the maximum number of DL-PRS RSRP measurements on different PRS resources from the same TRP supported by the UE on FR1. If this field with suffix -v1730 is present, the target device should set the field with suffix -r16 to value '8'.

maxDL-PRS-RSRP-MeasurementFR2

Indicates the maximum number of DL-PRS RSRP measurements on different PRS resources from the same TRP supported by the UE on FR2. If this field with suffix -v1730 is present, the target device should set the field with suffix -r16 to value '8'.

simul-NR-DL-AoD-DL-TDOA

Indicates whether the UE supports simultaneous processing for DL-AoD and DL-TDOA measurements. The UE can include this field only if the UE supports DL-TDOA and DL-AoD. Otherwise, the UE does not include this field.

simul-NR-DL-AoD-Multi-RTT

Indicates whether the UE supports simultaneous processing for DL-AoD and UE Multi-RTT measurements. The UE can include this field only if the UE supports Multi-RTT and DL-AoD. Otherwise, the UE does not include this field.

maxDL-PRS-FirstPathRSRP-MeasPerTRP

This field, if present, indicates that the target device supports measuring and reporting the PRS RSRPP of the first path. The enumerated value indicates the maximum number of RSRPP of first path per TRP supported. The UE can include this field only if the UE supports one of *maxDL-PRS-RSRP-MeasurementFR1* and *maxDL-PRS-RSRP-MeasurementFR2*. Otherwise, the UE does not include this field.

NOTE 1: The maximum number of first path PRS RSRP per TRP should be less than or equal to the maximum number of PRS RSRP defined in *maxDL-PRS-RSRP-MeasurementFR1* and *maxDL-PRS-RSRP-MeasurementFR2*.

dl-PRS-MeasRRC-Inactive

This field, if present, indicates that the target device supports DL-PRS measurement in RRC_INACTIVE state. The UE can include this field only if the UE supports *maxNrOfDL-PRS-ResourceSetPerTrpPerFrequencyLayer*, *maxNrOfTRP-AcrossFreqs*, *maxNrOfPosLayer* and *dl-PRS-BufferType-RRC-Inactive*. Otherwise, the UE does not include this field.

NOTE 1: This capability is applicable to both, UE-assisted and UE-based DL-AoD.

NOTE 2: The capabilities *NR-DL-PRS-ResourcesCapability*, *simul-NR-DL-AoD-DL-TDOA* are the same in RRC_INACTIVE state.

6.5.11.7 NR DL-AoD Capability Information Request

– *NR-DL-AoD-RequestCapabilities*

The IE *NR-DL-AoD-RequestCapabilities* is used by the location server to request the capability of the target device to support NR DL-AoD and to request NR DL-AoD positioning capabilities from a target device.

```

-- ASN1START
NR-DL-AoD-RequestCapabilities-r16 ::= SEQUENCE {
    ...
}
-- ASN1STOP

```

6.5.11.8 NR DL-AoD Error Elements

– *NR-DL-AoD-Error*

The IE *NR-DL-AoD-Error* is used by the location server or target device to provide NR DL-AoD error reasons to the target device or location server, respectively.

```

-- ASN1START
NR-DL-AoD-Error-r16 ::= CHOICE {
    locationServerErrorCauses-r16      NR-DL-AoD-LocationServerErrorCauses-r16,
    targetDeviceErrorCauses-r16       NR-DL-AoD-TargetDeviceErrorCauses-r16,
    ...
}
-- ASN1STOP

```

– *NR-DL-AoD-LocationServerErrorCauses*

The IE *NR-DL-AoD-LocationServerErrorCauses* is used by the location server to provide NR DL-AoD error reasons to the target device.

```

-- ASN1START
NR-DL-AoD-LocationServerErrorCauses-r16 ::= SEQUENCE {
    cause-r16      ENUMERATED {
        undefined,
        assistanceDataNotSupportedByServer,
        assistanceDataSupportedButCurrentlyNotAvailableByServer,
        notProvidedAssistanceDataNotSupportedByServer,
        ...,
        on-demand-dl-prs-NotSupportedByServer-v1700,
        on-demand-dl-prs-SupportedButCurrentlyNotAvailableByServer-v1700
    },
    ...
}
-- ASN1STOP

```

– *NR-DL-AoD-TargetDeviceErrorCauses*

The IE *NR-DL-AoD-TargetDeviceErrorCauses* is used by the target device to provide NR DL-AoD error reasons to the location server.

```

-- ASN1START
NR-DL-AoD-TargetDeviceErrorCauses-r16 ::= SEQUENCE {
    cause-r16      ENUMERATED {
        undefined,
        assistance-data-missing,
        unableToMeasureAnyTRP,
        attemptedButUnableToMeasureSomeNeighbourTRPs,
        thereWereNotEnoughSignalsReceivedForUeBasedDL-AoD,
        locationCalculationAssistanceDataMissing,
        ...
    },
    ...
}
-- ASN1STOP

```

6.5.12 NR Multi-RTT Positioning

This clause defines the information elements for NR Multi-RTT positioning (TS 38.305 [40]).

6.5.12.1 NR Multi-RTT Assistance Data

– *NR-Multi-RTT-ProvideAssistanceData*

The IE *NR-Multi-RTT-ProvideAssistanceData* is used by the location server to provide assistance data to enable UE-assisted NR Multi-RTT. It may also be used to provide NR Multi-RTT positioning specific error reason.

```

-- ASN1START
NR-Multi-RTT-ProvideAssistanceData-r16 ::= SEQUENCE {
    nr-DL-PRS-AssistanceData-r16      NR-DL-PRS-AssistanceData-r16      OPTIONAL,  -- Need ON

```

```

nr-SelectedDL-PRS-IndexList-r16      NR-SelectedDL-PRS-IndexList-r16      OPTIONAL,  -- Need ON
nr-Multi-RTT-Error-r16              NR-Multi-RTT-Error-r16              OPTIONAL,  -- Need ON
...
[[
nr-On-Demand-DL-PRS-Configurations-r17  NR-On-Demand-DL-PRS-Configurations-r17
                                          OPTIONAL,  -- Need ON
nr-On-Demand-DL-PRS-Configurations-Selected-IndexList-r17
                                          NR-On-Demand-DL-PRS-Configurations-Selected-IndexList-r17
                                          OPTIONAL,  -- Need ON
assistanceDataValidityArea-r17  AreaID-CellList-r17
]]
}
-- ASN1STOP

```

NR-Multi-RTT-ProvideAssistanceData field descriptions

nr-DL-PRS-AssistanceData

This field specifies the assistance data reference and neighbour TRPs and provides the DL-PRS configuration for the TRPs.

Note, if this field is absent but the *nr-SelectedDL-PRS-IndexList* field is present, the *nr-DL-PRS-AssistanceData* may be provided in IE *NR-DL-TDOA-ProvideAssistanceData* or *NR-DL-AoD-ProvideAssistanceData*.

nr-SelectedDL-PRS-IndexList

This field specifies the DL-PRS Resources which are applicable for this *NR-Multi-RTT-ProvideAssistanceData* message.

nr-Multi-RTT-Error

This field provides Multi-RTT error reasons.

nr-On-Demand-DL-PRS-Configurations

This field provides a set of available DL-PRS configurations which can be requested by the target device on-demand.
NOTE 1: Void.

NOTE 2: If this field is absent but the *nr-On-Demand-DL-PRS-Configurations-Selected-IndexList* is present, the *nr-On-Demand-DL-PRS-Configurations* may be provided in IE *NR-DL-AoD-ProvideAssistanceData* or *NR-DL-TDOA-ProvideAssistanceData*.

nr-On-Demand-DL-PRS-Configurations-Selected-IndexList

This field specifies the selected available on-demand DL-PRS configurations which are applicable for this *NR-Multi-RTT-ProvideAssistanceData* message.

assistanceDataValidityArea

This field specifies the network area for which this *NR-Multi-RTT-ProvideAssistanceData* is valid.

6.5.12.2 NR Multi-RTT Assistance Data Request

– *NR-Multi-RTT-RequestAssistanceData*

The IE *NR-Multi-RTT-RequestAssistanceData* is used by the target device to request assistance data from a location server.

```

-- ASN1START
NR-Multi-RTT-RequestAssistanceData-r16 ::= SEQUENCE {
  nr-PhysCellID-r16          NR-PhysCellID-r16          OPTIONAL,
  nr-AdType-r16             BIT STRING { dl-prs (0),
                                          ul-srs (1) } (SIZE (1..8)),
  ...
  [[
  nr-on-demand-DL-PRS-Request-r17      NR-On-Demand-DL-PRS-Request-r17      OPTIONAL,
  nr-DL-PRS-ExpectedAoD-or-AoA-Request-r17  ENUMERATED { eAoD, eAoA }          OPTIONAL,
  pre-configured-AssistanceDataRequest-r17  ENUMERATED { true }                OPTIONAL
  ]]
}
-- ASN1STOP

```

NR-Multi-RTT-RequestAssistanceData field descriptions

nr-PhysCellID

This field specifies the NR physical cell identity of the current primary cell of the target device.

NR-Multi-RTT-RequestAssistanceData field descriptions
<p>nr-AdType This field indicates the requested assistance data and/or configuration. <i>dl-prs</i> means requested assistance data is <i>nr-DL-PRS-AssistanceData</i>, <i>ul-srs</i> means a request for UL-SRS configuration. NOTE: UL-SRS is configured via NRPPa and RRC signalling as specified in clause 8.10.4 of TS 38.305 [40].</p>
<p>nr-on-demand-DL-PRS-Request This field indicates the on-demand DL-PRS requested for Multi-RTT. This field may be included when the <i>dl-prs</i> bit in <i>nr-AdType</i> is set to value '1'.</p>
<p>nr-DL-PRS-ExpectedAoD-or-AoA-Request This field, if present, indicates that the IE <i>NR-DL-PRS-ExpectedAoD-or-AoA</i> in <i>NR-DL-PRS-AssistanceData</i> is requested. Enumerated value 'eAoD' indicates that expected AoD information is requested; value 'eAoA' indicates that expected AoA information is requested. This field may only be present if the 'dl-prs' bit in <i>nr-AdType</i> is set to value '1'.</p>
<p>pre-configured-AssistanceDataRequest This field, if present, indicates that the target device requests pre-configured assistance data with area validity.</p>

6.5.12.3 NR Multi-RTT Location Information

– *NR-Multi-RTT-ProvideLocationInformation*

The IE *NR-Multi-RTT-ProvideLocationInformation* is used by the target device to provide NR Multi-RTT location measurements to the location server. It may also be used to provide NR Multi-RTT positioning specific error reason.

```
-- ASN1START
NR-Multi-RTT-ProvideLocationInformation-r16 ::= SEQUENCE {
    nr-Multi-RTT-SignalMeasurementInformation-r16
        NR-Multi-RTT-SignalMeasurementInformation-r16
        OPTIONAL,
    nr-Multi-RTT-Error-r16
        NR-Multi-RTT-Error-r16
        OPTIONAL,
    ...
    [[
    nr-Multi-RTT-SignalMeasurementInstances-r17
        SEQUENCE (SIZE (1..maxMeasInstances-r17)) OF
        NR-Multi-RTT-SignalMeasurementInformation-r16
        OPTIONAL --Cond batchUEA
    ]]
}
-- ASN1STOP
```

Conditional presence	Explanation
<i>batchUEA</i>	The field is optionally present if the field <i>nr-Multi-RTT-SignalMeasurementInformation</i> is absent; otherwise it is not present.

6.5.12.4 NR Multi-RTT Location Information Elements

– *NR-Multi-RTT-SignalMeasurementInformation*

The IE *NR-Multi-RTT-SignalMeasurementInformation* is used by the target device to provide NR Multi-RTT measurements to the location server.

```
-- ASN1START
NR-Multi-RTT-SignalMeasurementInformation-r16 ::= SEQUENCE {
    nr-Multi-RTT-MeasList-r16
        NR-Multi-RTT-MeasList-r16,
    nr-NTA-Offset-r16
        ENUMERATED { nTA1, nTA2, nTA3, nTA4, ... }
        OPTIONAL,
    ...
    [[
    nr-SRS-TxTEG-Set-r17
        SEQUENCE (SIZE(1..maxTxTEG-Sets-r17)) OF
        NR-SRS-TxTEG-Element-r17
        OPTIONAL
        -- Cond Case2-3
    ]],
    [[
    nr-UE-RxTEG-TimingErrorMargin-r17
        TEG-TimingErrorMargin-r17
        OPTIONAL, -- Cond TEGCase3
    nr-UE-TxTEG-TimingErrorMargin-r17
        TEG-TimingErrorMargin-r17
        OPTIONAL, -- Cond TEGCase2-3
    ]]
```

```

nr-UE-RxTxTEG-TimingErrorMargin-r17 RxTxTEG-TimingErrorMargin-r17 OPTIONAL -- Cond TEGCase1-2
]]
}

NR-Multi-RTT-MeasList-r16 ::= SEQUENCE (SIZE(1..nrMaxTRPs-r16)) OF NR-Multi-RTT-MeasElement-r16

NR-Multi-RTT-MeasElement-r16 ::= SEQUENCE {
  dl-PRS-ID-r16 INTEGER (0..255),
  nr-PhysCellID-r16 NR-PhysCellID-r16 OPTIONAL,
  nr-CellGlobalID-r16 NCGI-r15 OPTIONAL,
  nr-ARFCN-r16 ARFCN-ValueNR-r15 OPTIONAL,
  nr-DL-PRS-ResourceID-r16 NR-DL-PRS-ResourceID-r16 OPTIONAL,
  nr-DL-PRS-ResourceSetID-r16 NR-DL-PRS-ResourceSetID-r16 OPTIONAL,
  nr-UE-RxTxTimeDiff-r16 CHOICE {
    k0-r16 INTEGER (0..1970049),
    k1-r16 INTEGER (0..985025),
    k2-r16 INTEGER (0..492513),
    k3-r16 INTEGER (0..246257),
    k4-r16 INTEGER (0..123129),
    k5-r16 INTEGER (0..61565),
    ...
  },
  nr-AdditionalPathList-r16 NR-AdditionalPathList-r16 OPTIONAL,
  nr-TimeStamp-r16 NR-TimeStamp-r16,
  nr-TimingQuality-r16 NR-TimingQuality-r16,
  nr-DL-PRS-RSRP-Result-r16 INTEGER (0..126) OPTIONAL,
  nr-Multi-RTT-AdditionalMeasurements-r16 NR-Multi-RTT-AdditionalMeasurements-r16 OPTIONAL,
  ...,
  [[
  nr-UE-RxTx-TEG-Info-r17 NR-UE-RxTx-TEG-Info-r17 OPTIONAL,
  nr-DL-PRS-FirstPathRSRP-Result-r17 INTEGER (0..126) OPTIONAL,
  nr-los-nlos-Indicator-r17 CHOICE {
    perTRP-r17 LOS-NLOS-Indicator-r17,
    perResource-r17 LOS-NLOS-Indicator-r17
  } OPTIONAL,
  nr-AdditionalPathListExt-r17 NR-AdditionalPathListExt-r17 OPTIONAL,
  nr-Multi-RTT-AdditionalMeasurementsExt-r17 NR-Multi-RTT-AdditionalMeasurementsExt-r17 OPTIONAL
  ]]
}

NR-Multi-RTT-AdditionalMeasurements-r16 ::= SEQUENCE (SIZE (1..3)) OF
  NR-Multi-RTT-AdditionalMeasurementElement-r16

NR-Multi-RTT-AdditionalMeasurementsExt-r17 ::= SEQUENCE (SIZE (1..maxAddMeasRTT-r17)) OF
  NR-Multi-RTT-AdditionalMeasurementElement-r16

NR-Multi-RTT-AdditionalMeasurementElement-r16 ::= SEQUENCE {
  nr-DL-PRS-ResourceID-r16 NR-DL-PRS-ResourceID-r16 OPTIONAL,
  nr-DL-PRS-ResourceSetID-r16 NR-DL-PRS-ResourceSetID-r16 OPTIONAL,
  nr-DL-PRS-RSRP-ResultDiff-r16 INTEGER (0..61) OPTIONAL,
  nr-UE-RxTxTimeDiffAdditional-r16 CHOICE {
    k0-r16 INTEGER (0..8191),
    k1-r16 INTEGER (0..4095),
    k2-r16 INTEGER (0..2047),
    k3-r16 INTEGER (0..1023),
    k4-r16 INTEGER (0..511),
    k5-r16 INTEGER (0..255),
    ...
  },
  nr-TimingQuality-r16 NR-TimingQuality-r16,
  nr-AdditionalPathList-r16 NR-AdditionalPathList-r16 OPTIONAL,
  nr-TimeStamp-r16 NR-TimeStamp-r16,
  ...,
  [[
  nr-UE-RxTx-TEG-Info-r17 NR-UE-RxTx-TEG-Info-r17 OPTIONAL,
  nr-DL-PRS-FirstPathRSRP-ResultDiff-r17 INTEGER (0..61) OPTIONAL,
  nr-los-nlos-IndicatorPerResource-r17 LOS-NLOS-Indicator-r17 OPTIONAL,
  nr-AdditionalPathListExt-r17 NR-AdditionalPathListExt-r17 OPTIONAL
  ]]
}

NR-SRS-TxTEG-Element-r17 ::= SEQUENCE {
  nr-TimeStamp-r17 NR-TimeStamp-r16 OPTIONAL, -- Need OP
  nr-UE-Tx-TEG-ID-r17 INTEGER (0..maxNumOfTxTEGs-1-r17),
  carrierFreq-r17 SEQUENCE {
    absoluteFrequencyPointA-r17 ARFCN-ValueNR-r15,

```

```

        offsetToPointA-r17                INTEGER (0..2199)
        }
        srs-PosResourceList-r17          SEQUENCE (SIZE (1..maxNumOfSRS-PosResources-r17)) OF
        INTEGER (0..maxNumOfSRS-PosResources-1-r17),
        ...
    }
NR-UE-RxTx-TEG-Info-r17 ::= CHOICE {
    case1-r17                SEQUENCE {
        nr-UE-RxTx-TEG-ID-r17  INTEGER (0..maxNumOfRxTxTEGs-1-r17)
    },
    case2-r17                SEQUENCE {
        nr-UE-RxTx-TEG-ID-r17  INTEGER (0..maxNumOfRxTxTEGs-1-r17),
        nr-UE-Tx-TEG-Index-r17  INTEGER (1..maxTxTEG-Sets-r17)
    },
    case3-r17                SEQUENCE {
        nr-UE-Rx-TEG-ID-r17     INTEGER (0..maxNumOfRxTEGs-1-r17),
        nr-UE-Tx-TEG-Index-r17  INTEGER (1..maxTxTEG-Sets-r17)
    },
    ...
}
-- ASN1STOP

```

Conditional presence	Explanation
Case2-3	The field is mandatory present if the IE <i>NR-UE-RxTx-TEG-Info</i> is provided for choice's <i>case2</i> and <i>case3</i> . Otherwise it is not present.
TEGCase3	The field is optionally present, need OP, if the IE <i>NR-UE-RxTx-TEG-Info</i> is provided for choice <i>case3</i> . Otherwise it is not present.
TEGCase2-3	The field is optionally present, need OP, if the IE <i>NR-UE-RxTx-TEG-Info</i> is provided for choice's <i>case2</i> and <i>case3</i> . Otherwise it is not present.
TEGCase1-2	The field is optionally present, need OP, if the IE <i>NR-UE-RxTx-TEG-Info</i> is provided for choice's <i>case1</i> and <i>case2</i> . Otherwise it is not present.

NR-Multi-RTT-SignalMeasurementInformation field descriptions	
nr-NTA-Offset	This field provides the $N_{TAOffset}$ used by the target device as specified in TS 38.133 [46], Table 7.1.2-2. Enumerated values nTA1, nTA2, nTA3, and nTA4 correspond to $N_{TAOffset}$ of 25600 Tc, 0 Tc, 39936 Tc, and 13792 Tc, respectively.
nr-SRS-TxTEG-Set	This field provides the SRS for Positioning Resources associated with a particular UE Tx TEG and comprises the following subfields: <ul style="list-style-type: none"> - nr-TimeStamp specifies the start time for which the <i>NR-SRS-TxTEG-Element</i> is valid. If this field is absent, the <i>nr-TimeStamp</i> of this instance of the <i>NR-SRS-TxTEG-Element</i> of the <i>nr-SRS-TxTEG-Set</i> is the same as the <i>nr-TimeStamp</i> of the previous instance of the <i>NR-SRS-TxTEG-Element</i>. If this field is also absent in the first <i>NR-SRS-TxTEG-Element</i> of the <i>nr-SRS-TxTEG-Set</i>, all <i>NR-SRS-TxTEG-Element</i>s provided are valid for the measurement period of the <i>NR-Multi-RTT-SignalMeasurementInformation</i>. - nr-UE-Tx-TEG-ID specifies the ID of this UE Tx TEG. - carrierFreq specifies the frequency of the SRS for positioning resources. - srs-PosResourceList specifies the SRS for Positioning Resources belonging to this UE Tx TEG. For each UE Tx TEG, there may be up to 8 changes (different <i>nr-TimeStamp</i>) of the TEG-SRS association information provided in <i>nr-SRS-TxTEG-Set</i> , i.e., the maximum value for <i>maxTxTEG-Sets</i> is 64.
nr-UE-RxTEG-TimingErrorMargin	This field specifies the UE Rx TEG timing error margin value for all the UE Rx TEGs within one <i>NR-Multi-RTT-SignalMeasurementInformation</i> . If the IE <i>NR-UE-RxTx-TEG-Info</i> is present with choice <i>case3</i> and this field is absent, the receiver should consider the UE Rx TEG timing error margin value to be the maximum value available in IE <i>TEG-TimingErrorMargin</i> .
nr-UE-TxTEG-TimingErrorMargin	This field specifies the UE Tx TEG timing error margin value for all the UE Tx TEGs within one <i>NR-Multi-RTT-SignalMeasurementInformation</i> . If the IE <i>NR-UE-RxTx-TEG-Info</i> is present with choice <i>case2</i> or <i>case3</i> and this field is absent, the receiver should consider the UE Tx TEG timing error margin value to be the maximum value available in IE <i>TEG-TimingErrorMargin</i> .
nr-UE-RxTxTEG-TimingErrorMargin	This field specifies the UE RxTx TEG timing error margin value for all the UE RxTx TEGs within one <i>NR-Multi-RTT-SignalMeasurementInformation</i> . If the IE <i>NR-UE-RxTx-TEG-Info</i> is present with choice <i>case1</i> or <i>case2</i> and this field is absent, the receiver should consider the UE RxTx TEG timing error margin value to be the maximum applicable value as defined in TS 38.133 [46].

<p>dl-PRS-ID This field is used along with a DL-PRS Resource Set ID and a DL-PRS Resources ID to uniquely identify a DL-PRS Resource. This ID can be associated with multiple DL-PRS Resource Sets associated with a single TRP. Each TRP should only be associated with one such ID.</p>
<p>nr-PhysCellID This field specifies the physical cell identity of the associated TRP, as defined in TS 38.331 [35].</p>
<p>nr-CellGlobalID This field specifies the NCGI, the globally unique identity of a cell in NR, of the associated TRP, as defined in TS 38.331 [35].</p>
<p>nr-ARFCN This field specifies the NR-ARFCN of the TRP's CD-SSB (as defined in TS 38.300 [47]) corresponding to <i>nr-PhysCellID</i>.</p>
<p>nr-UE-RxTxTimeDiff This field specifies the UE Rx–Tx time difference measurement, as defined in TS 38.215 [36].</p>
<p>nr-AdditionalPathList This field specifies one or more additional detected path timing values for the TRP or resource, relative to the path timing used for determining the <i>nr-UE-RxTxTimeDiff</i> value. If this field was requested but is not included, it means the UE did not detect any additional path timing values. If this field is present, the field <i>nr-AdditionalPathListExt</i> shall be absent.</p>
<p>nr-TimeStamp This field specifies the time instance for which the measurement is performed.</p>
<p>nr-TimingQuality This field specifies the target device's best estimate of the quality of the measurement.</p>
<p>nr-DL-PRS-RSRP-Result This field specifies the NR DL-PRS reference signal received power (DL PRS-RSRP) measurement, as defined in TS 38.215 [36]. The mapping of the quantity is defined as in TS 38.133 [46].</p>
<p>nr-Multi-RTT-AdditionalMeasurements This field provides up to 3 additional UE Rx-Tx time difference measurements corresponding to a single configured SRS Resource or Resource Set for positioning. Each measurement corresponds to a single received DL-PRS Resource or DL-PRS Resource Set [45]. If this field is present, the field <i>nr-Multi-RTT-AdditionalMeasurementsExt</i> shall be absent.</p>
<p>nr-UE-RxTx-TEG-Info This field provides the ID(s) of the UE TEG associated with the <i>nr-UE-RxTxTimeDiff</i> or <i>nr-UE-RxTxTimeDiffAdditional</i> measurement. One of the following combinations of TEG IDs can be provided:</p> <ul style="list-style-type: none"> - case1 provides the UE RxTx TEG ID; - case2 provides the UE RxTx TEG ID together with the UE Tx TEG ID. The <i>nr-UE-Tx-TEG-Index</i> provides the index to the <i>nr-SRS-TxTEG-Set</i> field for the applicable UE Tx TEG ID, where value '1' indicates the first <i>NR-SRS-TxTEG-Element</i> in <i>nr-SRS-TxTEG-Set</i>, value '2' indicates the second <i>NR-SRS-TxTEG-Element</i> in <i>nr-SRS-TxTEG-Set</i>, and so on; - case3 provides the UE Rx TEG ID together with the UE Tx TEG ID. The <i>nr-UE-Tx-TEG-Index</i> provides the index to the <i>nr-SRS-TxTEG-Set</i> field for the applicable UE Tx TEG ID, where value '1' indicates the first <i>NR-SRS-TxTEG-Element</i> in <i>nr-SRS-TxTEG-Set</i>, value '2' indicates the second <i>NR-SRS-TxTEG-Element</i> in <i>nr-SRS-TxTEG-Set</i>, and so on.
<p>nr-DL-PRS-FirstPathRSRP-Result This field specifies the NR DL PRS reference signal received path power (DL PRS-RSRPP) of the first detected path in time, as defined in TS 38.215 [36]. The mapping of the measured quantity is defined as in TS 38.133 [46].</p>
<p>nr-los-nlos-Indicator This field specifies the target device's best estimate of the LOS or NLOS of the UE Rx-Tx Time Difference, RSRP or RSRPP of first path measurement for the TRP or resource. NOTE: If the requested type or granularity in <i>nr-los-nlos-IndicatorRequest</i> is not possible, the target device may provide a different type and granularity for the estimated <i>LOS-NLOS-Indicator</i>.</p>
<p>nr-AdditionalPathListExt This field provides up to 8 additional detected path timing values for the TRP or resource, relative to the path timing used for determining the <i>nr-UE-RxTxTimeDiff</i> value. If this field was requested but is not included, it means the UE did not detect any additional path timing values. If this field is present, the field <i>nr-AdditionalPathList</i> shall be absent.</p>
<p>nr-Multi-RTT-AdditionalMeasurementsExt This field, in addition to the measurements provided in <i>NR-Multi-RTT-MeasElement</i>, provides UE Rx-Tx time difference measurements of up to 4 DL-PRS Resources of a TRP with different UE RxTx or UE Rx TEGs. For a certain DL-PRS Resource, there can be up to 8 measurement results with respect to different UE RxTx or UE Rx TEGs. If this field is present, the field <i>nr-Multi-RTT-AdditionalMeasurements</i> shall be absent.</p>
<p>nr-DL-PRS-RSRP-ResultDiff This field provides the additional DL-PRS RSRP measurement result relative to <i>nr-DL-PRS-RSRP-Result</i>. The DL-PRS RSRP value of this measurement is obtained by adding the value of this field to the value of the <i>nr-DL-PRS-RSRP-Result</i>. The mapping of this field is defined as in TS 38.133 [46].</p>
<p>nr-UE-RxTxTimeDiffAdditional This field provides the additional UE Rx-Tx Difference measurement result relative to <i>nr-UE-RxTxTimeDiff</i>. The UE Rx-Tx Difference value of this measurement is obtained by adding the value of this field to the value of the <i>nr-UE-RxTxTimeDiff</i> field. The mapping of the field is defined in TS 38.133 [46].</p>

nr-DL-PRS-FirstPathRSRP-ResultDiff

This field specifies the additional NR DL-PRS reference signal received path power (DL PRS-RSRPP) of the first detected path in time relative to *nr-DL-PRS-FirstPathRSRP-Result*. The DL-PRS RSRPP of first path value of this measurement is obtained by adding the value of this field to the value of the *nr-DL-PRS-FirstPathRSRP-Result* field. The mapping of the field is defined in TS 38.133 [46].

nr-los-nlos-IndicatorPerResource

This field specifies the target device's best estimate of the LOS or NLOS of the UE Rx-Tx Time Difference, RSRP or RSRPP of first path measurement for the resource.

This field may only be present if the field *nr-LOS-NLOS-Indicator* choice indicates *perResource*.

6.5.12.5 NR Multi-RTT Location Information Request

– *NR-Multi-RTT-RequestLocationInformation*

The IE *NR-Multi-RTT-RequestLocationInformation* is used by the location server to request NR Multi-RTT location measurements from a target device.

```
-- ASN1START
NR-Multi-RTT-RequestLocationInformation-r16 ::= SEQUENCE {
  nr-UE-RxTxTimeDiffMeasurementInfoRequest-r16
    ENUMERATED { true } OPTIONAL, -- Need ON
  nr-RequestedMeasurements-r16
    BIT STRING { prsrsrpReq (0),
                firstPathRsrpReq-r17 (1) } (SIZE(1..8)),
  nr-AssistanceAvailability-r16
    BOOLEAN,
  nr-Multi-RTT-ReportConfig-r16
    NR-Multi-RTT-ReportConfig-r16,
  additionalPaths-r16
    ENUMERATED { requested } OPTIONAL, -- Need ON
  . . .
  [[
  nr-UE-RxTxTEG-Request-r17
    ENUMERATED { case1, case2, case3, . . . }
    OPTIONAL, -- Need ON
  measureSameDL-PRS-ResourceWithDifferentRxTxTEGs-r17
    ENUMERATED { n0, n2, n3, n4, n6, n8, . . . }
    OPTIONAL, -- Need ON
  measureSameDL-PRS-ResourceWithDifferentRxTEGs-r17
    ENUMERATED { n0, n2, n3, n4, n6, n8, . . . }
    OPTIONAL, -- Need ON
  reducedDL-PRS-ProcessingSamples-r17
    ENUMERATED { requested, . . . } OPTIONAL, -- Need ON
  nr-los-nlos-IndicatorRequest-r17
    SEQUENCE {
      type-r17
        LOS-NLOS-IndicatorType1-r17,
      granularity-r17
        LOS-NLOS-IndicatorGranularity1-r17,
      . . .
    }
    OPTIONAL, -- Need ON
  additionalPathsExt-r17
    ENUMERATED { requested } OPTIONAL, -- Need ON
  additionalPathsDL-PRS-RSRP-Request-r17
    ENUMERATED { requested } OPTIONAL, -- Need ON
  multiMeasInSameReport-r17
    ENUMERATED { requested } OPTIONAL, -- Need ON
  lowerRxBeamSweepingFactor-FR2-r17
    ENUMERATED { requested } OPTIONAL, -- Need ON
  ]]
}

NR-Multi-RTT-ReportConfig-r16 ::= SEQUENCE {
  maxDL-PRS-RxTxTimeDiffMeasPerTRP-r16
    INTEGER (1..4) OPTIONAL, -- Need ON
  timingReportingGranularityFactor-r16
    INTEGER (0..5) OPTIONAL, -- Need ON
}
-- ASN1STOP
```

***NR-Multi-RTT-RequestLocationInformation* field descriptions**

nr-UE-RxTxTimeDiffMeasurementInfoRequest

This field, if present, indicates that the target device is requested to report the DL-PRS Resource ID(s) or DL-PRS Resource Set ID(s) associated with the DL-PRS Resources(s) or the DL-PRS Resource Set(s) which are used in determining the UE Rx-Tx time difference measurements.

nr-AssistanceAvailability

This field indicates whether the target device may request additional PRS assistance data from the server. TRUE means allowed and FALSE means not allowed.

maxDL-PRS-RxTxTimeDiffMeasPerTRP

This field specifies the maximum number of UE-Rx-Tx time difference measurements for different DL-PRS Resources or DL-PRS Resource Sets per TRP.

<p>timingReportingGranularityFactor This field specifies the recommended reporting granularity for the UE Rx-Tx time difference measurements. Value (0..5) corresponds to ($k0..k5$) used for <i>nr-UE-RxTxTimeDiff</i> and <i>nr-UE-RxTxTimeDiffAdditional</i> in <i>NR-Multi-RTT-MeasElement</i>. The UE may select a different granularity value for <i>nr-UE-RxTxTimeDiff</i> and <i>nr-UE-RxTxTimeDiffAdditional</i>.</p>
<p>additionalPaths This field, if present, indicates that the target device is requested to provide the <i>nr-AdditionalPathList</i> in IE <i>NR-Multi-RTT-SignalMeasurementInformation</i>. If this field is present, the field <i>additionalPathsExt</i> shall be absent.</p>
<p>nr-UE-RxTxTEG-Request This field, if present, indicates that the target device is requested to provide the <i>NR-UE-RxTx-TEG-Info</i> in IE <i>NR-Multi-RTT-SignalMeasurementInformation</i>. Enumerated value 'case1' indicates that the target device is requested to provide the case1 choice in <i>NR-UE-RxTx-TEG-Info</i>, enumerated value 'case2' indicates that the target device is requested to provide the case2 choice in <i>NR-UE-RxTx-TEG-Info</i>, and so on.</p>
<p>measureSameDL-PRS-ResourceWithDifferentRxTxTEGs This field, if present, indicates that the target device is requested to measure the same DL-PRS Resource of a TRP with <i>N</i> different UE RxTx TEGs and with the same UE Tx TEG. Enumerated value 'n0' indicates that the number <i>N</i> of different UE RxTx TEGs to measure the same DL PRS Resource can be determined by the target device, value 'n2' indicates that the target device is requested to measure the same DL-PRS Resource of a TRP with 2 different UE RxTx TEGs, value 'n3' indicates that the target device is requested to measure the same DL-PRS Resource of a TRP with 3 different UE RxTx TEGs, and so on. If this field is present, the field <i>nr-UE-RxTxTEG-Request</i> should also be present. If this field is present, the field <i>measureSameDL-PRS-ResourceWithDifferentRxTxTEGs</i> should not be present.</p>
<p>measureSameDL-PRS-ResourceWithDifferentRxTEGs This field, if present, indicates that the target device is requested to measure the same DL-PRS Resource of a TRP with <i>N</i> different UE Rx TEGs. Enumerated value 'n0' indicates that the number <i>N</i> of different UE Rx TEGs to measure the same DL PRS Resource can be determined by the target device, value 'n2' indicates that the target device is requested to measure the same DL-PRS Resource of a TRP with 2 different UE Rx TEGs, value 'n3' indicates that the target device is requested to measure the same DL-PRS Resource of a TRP with 3 different UE Rx TEGs, and so on. If this field is present, the field <i>nr-UE-RxTxTEG-Request</i> should also be present. If this field is present, the field <i>measureSameDL-PRS-ResourceWithDifferentRxTxTEGs</i> should not be present.</p>
<p>reducedDL-PRS-ProcessingSamples This field, if present and set to 'requested', indicates that the target device is requested to perform the requested measurements with reduced number of samples ($M=1$ or $M=2$) as specified in TS 38.133 [46].</p>
<p>nr-los-nlos-IndicatorRequest This field, if present, indicates that the target device is requested to provide the indicated type and granularity of the estimated <i>LOS-NLOS-Indicator</i> in the <i>NR-Multi-RTT-SignalMeasurementInformation</i>.</p>
<p>additionalPathsExt This field, if present, indicates that the target device is requested to provide the <i>nr-AdditionalPathListExt</i> in IE <i>NR-Multi-RTT-SignalMeasurementInformation</i>. If this field is present, the field <i>additionalPaths</i> shall be absent.</p>
<p>additionalPathsDL-PRS-RSRP-Request This field, if present, indicates that the target device is requested to provide the <i>nr-DL-PRS-RSRPP</i> for the additional paths in the field <i>nr-AdditionalPathList</i> or <i>nr-AdditionalPathListExt</i>.</p>
<p>multiMeasInSameReport This field, if present, indicates that the target device is requested to provide multiple measurement instances in a single measurement report; i.e., include the <i>nr-Multi-RTT-SignalMeasurementInstances</i> in IE <i>NR-Multi-RTT-ProvideLocationInformation</i>.</p>
<p>lowerRxBeamSweepingFactor-FR2 This field, if present, indicates that the target device is requested to use a lower Rx beam sweeping factor than 8 for FR2 according to UE's capability.</p>

6.5.12.6 NR Multi-RTT Capability Information

– *NR-Multi-RTT-ProvideCapabilities*

The IE *NR-Multi-RTT-ProvideCapabilities* is used by the target device to indicate its capability to support NR Multi-RTT and to provide its NR Multi-RTT positioning capabilities to the location server.

```
-- ASN1START
NR-Multi-RTT-ProvideCapabilities-r16 ::= SEQUENCE {
    nr-Multi-RTT-PRS-Capability-r16          NR-DL-PRS-ResourcesCapability-r16,
    nr-Multi-RTT-MeasurementCapability-r16  NR-Multi-RTT-MeasurementCapability-r16,
    nr-DL-PRS-QCL-ProcessingCapability-r16  NR-DL-PRS-QCL-ProcessingCapability-r16,
    nr-DL-PRS-ProcessingCapability-r16      NR-DL-PRS-ProcessingCapability-r16,
    nr-UL-SRS-Capability-r16                NR-UL-SRS-Capability-r16,
    additionalPathsReport-r16                ENUMERATED { supported }           OPTIONAL,
    periodicalReporting-r16                  ENUMERATED { supported }           OPTIONAL,
}
```



```

...
[[
ten-ms-unit-ResponseTime-r17          ENUMERATED { supported }          OPTIONAL,
nr-DL-PRS-ExpectedAoD-or-AoA-Sup-r17  BIT STRING { eAoD (0),                OPTIONAL,
                                                eAoA (1)
                                                } (SIZE (1..8))
nr-Multi-RTT-On-Demand-DL-PRS-Support-r17
NR-On-Demand-DL-PRS-Support-r17        OPTIONAL,
nr-UE-RxTx-TEG-ID-ReportingSupport-r17 BIT STRING { case1 (0),                OPTIONAL,
                                                case2 (1),
                                                case3 (2)
                                                } (SIZE (1..8))
nr-los-nlos-IndicatorSupport-r17      SEQUENCE {
type-r17                                LOS-NLOS-IndicatorType2-r17,
granularity-r17                          LOS-NLOS-IndicatorGranularity2-r17,
...
}
additionalPathsExtSupport-r17          ENUMERATED { n4, n6, n8 }          OPTIONAL,
scheduledLocationRequestSupported-r17  ScheduledLocationTimeSupport-r17  OPTIONAL,
nr-dl-prs-AssistanceDataValidity-r17  SEQUENCE {
area-validity-r17                        INTEGER (1..maxNrOfAreas-r17)    OPTIONAL,
...
}
multiMeasInSameMeasReport-r17         ENUMERATED { supported }          OPTIONAL,
mg-ActivationRequest-r17                ENUMERATED { supported }          OPTIONAL
]],
[[
posMeasGapSupport-r17                  ENUMERATED { supported }          OPTIONAL
]]
}
-- ASN1STOP

```

NR-Multi-RTT-ProvideCapabilities field descriptions
<p>ten-ms-unit-ResponseTime This field, if present, indicates that the target device supports the enumerated value 'ten-milli-seconds' in the IE <i>ResponseTime</i> in IE <i>CommonIEsRequestLocationInformation</i>.</p>
<p>nr-DL-PRS-ExpectedAoD-or-AoA-Sup This field, if present, indicates that the target device supports the <i>NR-DL-PRS-ExpectedAoD-or-AoA</i> in <i>NR-DL-PRS-AssistanceData</i>.</p>
<p>nr-Multi-RTT-On-Demand-DL-PRS-Support This field, if present, indicates that the target device supports on-demand DL-PRS requests.</p>
<p>nr-UE-RxTx-TEG-ID-ReportingSupport This field, if present, indicates that the target device supports <i>nr-UE-RxTx-TEG-Info</i> reporting in IE <i>NR-Multi-RTT-SignalMeasurementInformation</i>. This is represented by a bit string, with a one-value at the bit position means the particular case is supported; a zero-value means not supported:</p> <ul style="list-style-type: none"> - bit 0 indicates that the target device supports the 'case1' choice in <i>NR-UE-RxTx-TEG-Info</i>. - bit 1 indicates that the target device supports the 'case2' choice in <i>NR-UE-RxTx-TEG-Info</i>. - bit 2 indicates that the target device supports the 'case3' choice in <i>NR-UE-RxTx-TEG-Info</i>.
<p>nr-los-nlos-IndicatorSupport This field, if present, indicates that the target device supports <i>nr-los-nlos-Indicator</i> reporting in IE <i>NR-Multi-RTT-SignalMeasurementInformation</i>.</p> <ul style="list-style-type: none"> - <i>type</i> indicates whether the target device supports 'hard' value or 'hard' and 'soft' value in IE <i>LOS-NLOS-Indicator</i>. - <i>granularity</i> indicates whether the target device supports <i>LOS-NLOS-Indicator</i> reporting per TRP, per DL-PRS Resource, or both. <p>NOTE: A single value is reported when both Multi-RTT and DL-TDOA are supported.</p>
<p>additionalPathsExtSupport This field, if present, indicates that the target device supports the <i>nr-AdditionalPathListExt</i> reporting in IE <i>NR-Multi-RTT-SignalMeasurementInformation</i>. The enumerated value indicates the number of additional paths supported by the target device.</p> <p>NOTE: The <i>supportOfDL-PRS-FirstPathRSRP</i> in IE <i>NR-Multi-RTT-MeasurementCapability</i> also applies to the additional paths.</p>
<p>scheduledLocationRequestSupported This field, if present, indicates that the target device supports scheduled location requests – i.e., supports the IE <i>ScheduledLocationTime</i> in IE <i>CommonIEsRequestLocationInformation</i> – and the time base(s) supported for the scheduled location time.</p>
<p>nr-dl-prs-AssistanceDataValidity This field, if present, indicates that the target device supports validity conditions for pre-configured assistance data and comprises the following subfields:</p> <ul style="list-style-type: none"> - area-validity indicates that the target device supports pre-configured assistance data with area validity. The integer number indicates the maximum number of areas the target device supports.
<p>multiMeasInSameMeasReport This field, if present, indicates that the target device supports multiple measurement instances in a single measurement report.</p>
<p>mg-ActivationRequest This field, if present, indicates that the target device supports UL MAC CE for positioning measurement gap activation/deactivation request for DL-PRS measurements. The UE can include this field only if the UE supports <i>mg-ActivationRequestPRS-Meas</i> and <i>mg-ActivationCommPRS-Meas</i> defined in TS 38.331 [35].</p>
<p>posMeasGapSupport This field, if present, indicates that the target device supports pre-configured positioning measurement gap for DL-PRS measurements. The UE can include this field only if the UE supports <i>mg-ActivationCommPRS-Meas</i> defined in TS 38.331 [35].</p>

6.5.12.6a NR Multi-RTT Capability Information Elements

– *NR-Multi-RTT-MeasurementCapability*

The IE *NR-Multi-RTT-MeasurementCapability* defines the Multi-RTT measurement capability. The UE can include this IE only if the UE supports *NR-DL-PRS-ResourcesCapability* for Multi-RTT. Otherwise, the UE does not include this IE;

```
-- ASN1START
NR-Multi-RTT-MeasurementCapability-r16 ::= SEQUENCE {
    maxNrOfRx-TX-MeasFR1-r16          INTEGER (1..4)          OPTIONAL,
    maxNrOfRx-TX-MeasFR2-r16          INTEGER (1..4)          OPTIONAL,
    supportOfRSRP-MeasFR1-r16          ENUMERATED { supported }  OPTIONAL,
    supportOfRSRP-MeasFR2-r16          ENUMERATED { supported }  OPTIONAL,
```

```

srs-AssocPRS-MultiLayersFR1-r16      ENUMERATED { supported }      OPTIONAL,
srs-AssocPRS-MultiLayersFR2-r16      ENUMERATED { supported }      OPTIONAL,
...
[[
nr-UE-TEG-Capability-r17              NR-UE-TEG-Capability-r17      OPTIONAL,
multi-RTT-MeasCapabilityBandList-r17  SEQUENCE (SIZE (1..nrMaxBands-r16)) OF
                                         Multi-RTT-MeasCapabilityPerBand-r17
                                         OPTIONAL
]]
}
Multi-RTT-MeasCapabilityPerBand-r17 ::= SEQUENCE {
  freqBandIndicatorNR-r17              FreqBandIndicatorNR-r16,
  supportOfDL-PRS-FirstPathRSRP-r17    ENUMERATED { supported }      OPTIONAL,
  dl-PRS-MeasRRC-Inactive-r17          ENUMERATED { supported }      OPTIONAL,
  ...
}
-- ASN1STOP

```

NR-Multi-RTT-MeasurementCapability field descriptions

maxNrOfRx-TX-MeasFR1

Indicates the maximum number of UE Rx-Tx time difference measurements corresponding to a single SRS resource/resource set for positioning with each measurement corresponding to a single DL-PRS resource/resource set on FR1.

maxNrOfRx-TX-MeasFR2

Indicates the maximum number of UE Rx-Tx time difference measurements corresponding to a single SRS resource/resource set for positioning with each measurement corresponding to a single DL-PRS resource/resource set on FR2.

srs-AssocPRS-MultiLayersFR1

Indicates whether the UE supports measurements derived on one or more DL-PRS resource/resource sets which may be in different positioning frequency layers for SRS transmitted in a single CC. PRS and SRS may be on different bands. This is for FR1 only.

srs-AssocPRS-MultiLayersFR2

Indicates whether the UE supports measurements derived on one or more DL-PRS resource/resource sets which may be in different positioning frequency layers for SRS transmitted in a single CC. PRS and SRS may be on different bands. This is for FR2 only.

supportOfRSRP-MeasFR1

Indicates whether the UE supports RSRP measurement for Multi-RTT on FR1.

supportOfRSRP-MeasFR2

Indicates whether the UE supports RSRP measurement for Multi-RTT on FR2.

nr-UE-TEG-Capability

Indicates the UE TEG capability.

supportOfDL-PRS-FirstPathRSRP

Indicates whether the target device supports DL-PRS RSRPP of first path measurement for Multi-RTT. The UE can include this field only if the UE supports *prs-ProcessingCapabilityBandList*. Otherwise, the UE does not include this field. The UE supporting *additionalPathsReport* and *supportOfDL-PRS-FirstPathRSRP* shall support RSRPP reporting for K=1 or 2 additional paths.

dl-PRS-MeasRRC-Inactive

This field, if present, indicates that the target device supports DL-PRS measurement in RRC_INACTIVE state. The UE can include this field only if the UE supports *maxNrOfDL-PRS-ResourceSetPerTrpPerFrequencyLayer*, *maxNrOfTRP-AcrossFreqs*, *maxNrOfPosLayer* and *dl-PRS-BufferType-RRC-Inactive*. Otherwise, the UE does not include this field.

NOTE: The capabilities *NR-DL-PRS-ResourcesCapability*, *maxNrOfRx-TX-MeasFR1*, *maxNrOfRx-TX-MeasFR2*, *supportOfRSRP-MeasFR1*, *supportOfRSRP-MeasFR2*, *srs-AssocPRS-MultiLayersFR1*, *srs-AssocPRS-MultiLayersFR2*, *simul-NR-DL-AoD-Multi-RTT* are the same in RRC_INACTIVE state.

6.5.12.7 NR Multi-RTT Capability Information Request

– NR-Multi-RTT-RequestCapabilities

The IE *NR-Multi-RTT-RequestCapabilities* is used by the location server to request the capability of the target device to support NR Multi-RTT and to request NR Multi-RTT positioning capabilities from a target device.

```

-- ASN1START
NR-Multi-RTT-RequestCapabilities-r16 ::= SEQUENCE {
  ...

```

```
}
-- ASN1STOP
```

6.5.12.8 NR Multi-RTT Error Elements

– *NR-Multi-RTT-Error*

The IE *NR-Multi-RTT-Error* is used by the location server or target device to provide NR Multi-RTT error reasons to the target device or location server, respectively.

```
-- ASN1START
NR-Multi-RTT-Error-r16 ::= CHOICE {
  locationServerErrorCauses-r16      NR-Multi-RTT-LocationServerErrorCauses-r16,
  targetDeviceErrorCauses-r16       NR-Multi-RTT-TargetDeviceErrorCauses-r16,
  ...
}
-- ASN1STOP
```

– *NR-Multi-RTT-LocationServerErrorCauses*

The IE *NR-Multi-RTT-LocationServerErrorCauses* is used by the location server to provide NR Multi-RTT error reasons to the target device.

```
-- ASN1START
NR-Multi-RTT-LocationServerErrorCauses-r16 ::= SEQUENCE {
  cause-r16      ENUMERATED {
    undefined,
    assistanceDataNotSupportedByServer,
    assistanceDataSupportedButCurrentlyNotAvailableByServer,
    ...,
    on-demand-dl-prs-NotSupportedByServer-v1700,
    on-demand-dl-prs-SupportedButCurrentlyNotAvailableByServer-v1700
  },
  ...
}
-- ASN1STOP
```

– *NR-Multi-RTT-TargetDeviceErrorCauses*

The IE *NR-Multi-RTT-TargetDeviceErrorCauses* is used by the target device to provide NR Multi-RTT error reasons to the location server.

```
-- ASN1START
NR-Multi-RTT-TargetDeviceErrorCauses-r16 ::= SEQUENCE {
  cause-r16      ENUMERATED {
    undefined,
    dl-assistance-data-missing,
    unableToMeasureAnyTRP,
    attemptedButUnableToMeasureSomeNeighbourTRPs,
    ul-srs-configuration-missing,
    unableToTransmit-ul-srs,
    ...
  },
  ...
}
-- ASN1STOP
```

6.6 Multiplicity and type constraint values

– *Multiplicity and type constraint definitions*

```

-- ASN1START
maxEARFCN                INTEGER ::= 65535  -- Maximum value of EUTRA carrier frequency
maxEARFCN-Plus1          INTEGER ::= 65536  -- Lowest value extended EARFCN range
maxEARFCN2               INTEGER ::= 262143 -- Highest value extended EARFCN range

maxMBS-r14               INTEGER ::= 64
maxWLAN-AP-r13           INTEGER ::= 64
maxKnownAPs-r14          INTEGER ::= 2048
maxVisibleAPs-r14        INTEGER ::= 32
maxWLAN-AP-r14           INTEGER ::= 128
maxWLAN-DataSets-r14     INTEGER ::= 8

maxBT-Beacon-r13         INTEGER ::= 32

nrMaxBands-r16           INTEGER ::= 1024  -- Maximum number of supported bands in
-- UE capability.
nrMaxFreqLayers-r16      INTEGER ::= 4    -- Max freq layers
nrMaxFreqLayers-l-r16    INTEGER ::= 3
nrMaxNumDL-PRS-ResourcesPerSet-l-r16  INTEGER ::= 63
nrMaxNumDL-PRS-ResourceSetsPerTRP-l-r16 INTEGER ::= 7
nrMaxResourceIDs-r16     INTEGER ::= 64    -- Max Resource IDs
nrMaxResourceOffsetValue-l-r16  INTEGER ::= 511
nrMaxResourcesPerSet-r16  INTEGER ::= 64    -- Maximum resources for one set
nrMaxSetsPerTrpPerFreqLayer-r16  INTEGER ::= 2    -- Maximum resource sets for one TRP
nrMaxSetsPerTrpPerFreqLayer-l-r16  INTEGER ::= 1
nrMaxTRPs-r16            INTEGER ::= 256  -- Max TRPs per UE
nrMaxTRPsPerFreq-r16     INTEGER ::= 64   -- Max TRPs per freq layers
nrMaxTRPsPerFreq-l-r16   INTEGER ::= 63
maxSimultaneousBands-r16  INTEGER ::= 4    -- Maximum number of simultaneously
-- measured bands

maxBandComb-r16          INTEGER ::= 1024
nrMaxConfiguredBands-r16  INTEGER ::= 16

maxNumOfRxTEGs-r17      INTEGER ::= 32
maxNumOfRxTEGs-l-r17    INTEGER ::= 31
maxNumOfTxTEGs-l-r17    INTEGER ::= 7
maxTxTEG-Sets-r17       INTEGER ::= 256  -- Maximum applicable number is 64
maxNumOfRxTxTEGs-l-r17  INTEGER ::= 255
maxNumOfTRP-TxTEGs-l-r17  INTEGER ::= 7
maxNumOfSRS-PosResources-r17  INTEGER ::= 64
maxNumOfSRS-PosResources-l-r17  INTEGER ::= 63

maxNumResourcesPerAngle-r17  INTEGER ::= 24
maxNumPrioResources-r17     INTEGER ::= 24

maxAddMeasTDOA-r17        INTEGER ::= 31
maxAddMeasAoD-r17         INTEGER ::= 23
maxAddMeasRTT-r17         INTEGER ::= 31

maxOD-DL-PRS-Configs-r17  INTEGER ::= 8

maxCellIDsPerArea-r17     INTEGER ::= 256
maxNrOfAreas-r17         INTEGER ::= 16
maxMeasInstances-r17      INTEGER ::= 32

-- ASN1STOP

```

– *End of LPP-PDU-Definitions*

```

-- ASN1START
END
-- ASN1STOP

```

7 Broadcast of assistance data

7.1 General

Broadcast of positioning assistance data is supported via Positioning System Information Blocks (posSIBs) as specified in TS 36.331 [12] or TS 38.331 [35]. The posSIBs are carried in RRC System Information (SI) messages (TS 36.331 [12] or TS 38.331 [35]).

For LTE RRC System Information (SI), a single *SystemInformationBlockPos* IE is defined in TS 36.331 [12] which is carried in IE *PosSystemInformation-r15-IEs* specified in TS 36.331 [12]. The mapping of positioning SIB type (*posSibType*) to assistance data carried in *SystemInformationBlockPos* is specified in clause 7.2.

For NR RRC System Information (SI), a single *SIBpos* IE is defined in TS 38.331 [35] which is carried in IE *PosSystemInformation-r16-IEs* specified in TS 38.331 [35]. The mapping of positioning SIB type (*posSibType*) to assistance data carried in *SIBpos* is specified in clause 7.2.

7.2 Mapping of *posSibType* to assistance data element

The supported *posSibType*'s are specified in Table 7.2-1. The GNSS Common and Generic Assistance Data IEs are defined in clause 6.5.2.2. The OTDOA Assistance Data IEs and NR DL-TDOA/DL-AoD Assistance Data IEs are defined in clause 7.4.2. The Barometric Assistance Data IEs are defined in clause 6.5.5.8. The TBS (based on MBS signals) Assistance Data IEs are defined in clause 6.5.4.8.

Table 7.2-1: Mapping of *posSibType* to *assistanceDataElement*

	<i>posSibType</i>	<i>assistanceDataElement</i>
GNSS Common Assistance Data (clause 6.5.2.2)	<i>posSibType1-1</i>	<i>GNSS-ReferenceTime</i>
	<i>posSibType1-2</i>	<i>GNSS-ReferenceLocation</i>
	<i>posSibType1-3</i>	<i>GNSS-IonosphericModel</i>
	<i>posSibType1-4</i>	<i>GNSS-EarthOrientationParameters</i>
	<i>posSibType1-5</i>	<i>GNSS-RTK-ReferenceStationInfo</i>
	<i>posSibType1-6</i>	<i>GNSS-RTK-CommonObservationInfo</i>
	<i>posSibType1-7</i>	<i>GNSS-RTK-AuxiliaryStationData</i>
	<i>posSibType1-8</i>	<i>GNSS-SSR-CorrectionPoints</i>
	<i>posSibType1-9</i>	<i>GNSS-Integrity-ServiceParameters</i>
	<i>posSibType1-10</i>	<i>GNSS-Integrity-ServiceAlert</i>
GNSS Generic Assistance Data (clause 6.5.2.2)	<i>posSibType2-1</i>	<i>GNSS-TimeModelList</i>
	<i>posSibType2-2</i>	<i>GNSS-DifferentialCorrections</i>
	<i>posSibType2-3</i>	<i>GNSS-NavigationModel</i>
	<i>posSibType2-4</i>	<i>GNSS-RealTimeIntegrity</i>
	<i>posSibType2-5</i>	<i>GNSS-DataBitAssistance</i>
	<i>posSibType2-6</i>	<i>GNSS-AcquisitionAssistance</i>
	<i>posSibType2-7</i>	<i>GNSS-Almanac</i>
	<i>posSibType2-8</i>	<i>GNSS-UTC-Model</i>
	<i>posSibType2-9</i>	<i>GNSS-AuxiliaryInformation</i>
	<i>posSibType2-10</i>	<i>BDS-DifferentialCorrections</i>
	<i>posSibType2-11</i>	<i>BDS-GridModelParameter</i>
	<i>posSibType2-12</i>	<i>GNSS-RTK-Observations</i>
	<i>posSibType2-13</i>	<i>GLO-RTK-BiasInformation</i>
	<i>posSibType2-14</i>	<i>GNSS-RTK-MAC-CorrectionDifferences</i>
	<i>posSibType2-15</i>	<i>GNSS-RTK-Residuals</i>
	<i>posSibType2-16</i>	<i>GNSS-RTK-FKP-Gradients</i>
	<i>posSibType2-17</i>	<i>GNSS-SSR-OrbitCorrections</i>
	<i>posSibType2-17a</i>	<i>GNSS-SSR-OrbitCorrectionsSet2</i>
	<i>posSibType2-18</i>	<i>GNSS-SSR-ClockCorrections</i>
	<i>posSibType2-18a</i>	<i>GNSS-SSR-ClockCorrectionsSet2</i>
	<i>posSibType2-19</i>	<i>GNSS-SSR-CodeBias</i>
	<i>posSibType2-20</i>	<i>GNSS-SSR-URA</i>
<i>posSibType2-20a</i>	<i>GNSS-SSR-URA-Set2</i>	
<i>posSibType2-21</i>	<i>GNSS-SSR-PhaseBias</i>	
<i>posSibType2-22</i>	<i>GNSS-SSR-STECCorrection</i>	

	<i>posSibType2-23</i>	<i>GNSS-SSR-GriddedCorrection</i>
	<i>posSibType2-24</i>	<i>NavIC-DifferentialCorrections</i>
	<i>posSibType2-25</i>	<i>NavIC-GridModelParameter</i>
OTDOA Assistance Data (clause 7.4.2)	<i>posSibType3-1</i>	<i>OTDOA-UE-Assisted</i>
Barometric Assistance Data (clause 6.5.5.8)	<i>posSibType4-1</i>	<i>Sensor-AssistanceDataList</i>
TBS Assistance Data (clause 6.5.4.8)	<i>posSibType5-1</i>	<i>TBS-AssistanceDataList</i>
NR DL-TDOA/DL-AoD Assistance Data (clauses 6.4.3, 7.4.2)	<i>posSibType6-1</i>	<i>NR-DL-PRS-AssistanceData</i>
	<i>posSibType6-2</i>	<i>NR-UEB-TRP-LocationData</i>
	<i>posSibType6-3</i>	<i>NR-UEB-TRP-RTD-Info</i>
	<i>posSibType6-4</i>	<i>NR-TRP-BeamAntennaInfo</i>
	<i>posSibType6-5</i>	<i>NR-DL-PRS-TRP-TEG-Info</i>
On-demand DL-PRS Configurations (clause 6.4.3)	<i>posSibType6-6</i>	<i>NR-On-Demand-DL-PRS-Configurations</i>

7.3 Procedures related to broadcast information elements

Upon receiving *AssistanceDataSIBelement*, the target device shall:

1> if the *segmentationInfo* is not included:

2> if the *cipheringKeyData* is included:

3> if the UE has obtained a valid cipher key value and the first portion of the initial Counter denoted C_0 corresponding to the *cipherSetID* using NAS signalling:

4> if C_0 contains less than 128-bits:

5> pad out the bit string with zeroes in most significant bit positions to achieve 128 bits.

4> if the *d0* field contains less than 128-bits:

5> pad out the bit string with zeroes in least significant bit positions to achieve 128 bits, denoted D_0 .

4> determine the initial Counter $C_1 = (C_0 + D_0) \bmod 2^{128}$ (where all values are treated as non-negative integers);

4> determine any subsequent counter C_i from the previous counter C_{i-1} as $C_i = (C_{i-1} + 1) \bmod 2^{128}$;

4> use the sequence of counters $\langle C_1, C_2, C_3, \dots \rangle$ and the cipher key value to decipher the *assistanceDataElement*;

4> decode the deciphered *assistanceDataElement* and deliver the related assistance data to upper layers.

3> else:

4> discard the *AssistanceDataSIBelement*.

2> else:

3> decode the *assistanceDataElement* and deliver the related assistance data to upper layers.

1> else:

2> if *segmentationOption* indicates 'pseudo-seg':

3> if the *cipheringKeyData* is included:

4> if the UE has obtained a valid cipher key value and the first portion of the initial Counter denoted C_0 corresponding to the *cipherSetID* using NAS signalling:

5> if C_0 contains less than 128-bits:

- 6> pad out the bit string with zeroes in most significant bit positions to achieve 128 bits.
- 5> if the *d0* field contains less than 128-bits:
 - 6> pad out the bit string with zeroes in least significant bit positions to achieve 128 bits, denoted D_0 .
 - 5> determine the initial Counter $C_1 = (C_0 + D_0) \bmod 2^{128}$ (where all values are treated as non-negative integers);
 - 5> determine any subsequent counter C_i from the previous counter C_{i-1} as $C_i = (C_{i-1} + 1) \bmod 2^{128}$;
 - 5> use the sequence of counters $\langle C_1, C_2, C_3, \dots \rangle$ and the cipher key value to decipher the *assistanceDataElement* segment;
 - 5> decode the deciphered *assistanceDataElement* segment and deliver the related assistance data portion together with the *assistanceDataSegmentType* and *assistanceDataSegmentNumber* to upper layers.
- 4> else:
 - 5> discard the *AssistanceDataSIBelement* segment.
- 3> else:
 - 4> decode the *assistanceDataElement* segment and deliver the related assistance data portion together with the *assistanceDataSegmentType* and *assistanceDataSegmentNumber* to upper layers.
- 2> if *segmentationOption* indicates 'octet-string-seg':
 - 3> if all segments of *assistanceDataElement* have been received:
 - 4> assemble the assistance data element from the received *assistanceDataElement* segments;
 - 5> if the *cipheringKeyData* is included in the first segment:
 - 6> if the UE has obtained a valid cipher key value and the first portion of the initial Counter denoted C_0 corresponding to the *cipherSetID* using NAS signalling:
 - 7> if C_0 contains less than 128-bits:
 - 8> pad out the bit string with zeroes in most significant bit positions to achieve 128 bits.
 - 7> if the *d0* field contains less than 128-bits:
 - 8> pad out the bit string with zeroes in least significant bit positions to achieve 128 bits, denoted D_0 .
 - 7> determine the initial Counter $C_1 = (C_0 + D_0) \bmod 2^{128}$ (where all values are treated as non-negative integers);
 - 7> determine any subsequent counter C_i from the previous counter C_{i-1} as $C_i = (C_{i-1} + 1) \bmod 2^{128}$;
 - 7> use the sequence of counters $\langle C_1, C_2, C_3, \dots \rangle$ and the cipher key value to decipher the assembled assistance data element;
 - 7> decode the assembled and deciphered assistance data element and deliver the related assistance data to upper layers.
 - 6> else:
 - 7> discard the assembled assistance data element.
- 5> else:

6> decode the assembled assistance data element and deliver the related assistance data to upper layers.

NOTE: As an optional optimisation when *segmentationOption* indicates 'octet-string-seg', a target device may verify if the *cipheringKeyData* is included in the first segment as soon as the first segment is received and, if included, may verify that the UE has obtained a valid cipher key value and the first portion of the initial Counter denoted C_0 corresponding to the *cipherSetID* using NAS signalling. When the UE has not obtained a valid cipher key value and initial Counter C_0 using NAS signalling, the UE may discard the first segment and ignore all subsequent segments.

The value for D_0 shall be different for different *AssistanceDataSIBelement*'s to ensure that the counters derived from C_1 for any *assistanceDataElement* are different to the counters for any other *assistanceDataElement* for a given ciphering key.

D_0 shall contain at least 16 least significant bits (LSBs) set to zero to ensure that the values of D_0 differ from another by a large value.

7.4 Broadcast information elements

7.4.1 Basic production

This clause defines the LPP broadcast information elements which are encoded as 'basic production' for system information broadcast purposes (see TS 36.331 [12], TS 38.331 [35]).

The 'basic production' is obtained from their ASN.1 definitions by use of Basic Packed Encoding Rules (BASIC-PER), Unaligned Variant, as specified in ITU-T Rec. X.691 [22]. It always contains a multiple of 8 bits.

– *LPP-Broadcast-Definitions*

This ASN.1 segment is the start of the LPP Broadcast definitions.

```
-- ASN1START
LPP-Broadcast-Definitions
DEFINITIONS AUTOMATIC TAGS ::=
BEGIN
IMPORTS
    OTDOA-ReferenceCellInfo,
    OTDOA-NeighbourCellInfoList,
    NR-TRP-LocationInfo-r16,
    NR-DL-PRS-BeamInfo-r16,
    NR-RTD-Info-r16
FROM LPP-PDU-Definitions;
-- ASN1STOP
```

7.4.2 Element definitions

– *AssistanceDataSIBelement*

The IE *AssistanceDataSIBelement* is used in the IE *SystemInformationBlockPos* as specified in TS 36.331 [12] and IE *SIBpos* as specified in TS 38.331 [35].

```
-- ASN1START
AssistanceDataSIBelement-r15 ::= SEQUENCE {
    valueTag-r15                INTEGER (0..63)                OPTIONAL, -- Need OP
    expirationTime-r15          UTCTime                        OPTIONAL, -- Need OP
    cipheringKeyData-r15        CipheringKeyData-r15          OPTIONAL, -- Need OP
    segmentationInfo-r15        SegmentationInfo-r15           OPTIONAL, -- Need OP
    assistanceDataElement-r15   OCTET STRING,
    ...
}
```

```

}
CipheringKeyData-r15 ::= SEQUENCE {
  cipherSetID-r15          INTEGER (0..65535),
  d0-r15                   BIT STRING (SIZE (1..128)),
  ...
}
SegmentationInfo-r15 ::= SEQUENCE {
  segmentationOption-r15  ENUMERATED {pseudo-seg, octet-string-seg},
  assistanceDataSegmentType-r15  ENUMERATED {notLastSegment, lastSegment},
  assistanceDataSegmentNumber-r15  INTEGER (0..63),
  ...
}
-- ASN1STOP

```

AssistanceDataSIBelement field descriptions

valueTag

This field is used to indicate to the target device any changes in the broadcast assistance data content. The *valueTag* is incremented by one, by the location server, every time a modified assistance data content is provided. This field is not included if the broadcast assistance data changes too frequently. If *valueTag* and *expirationTime* are absent, the UE assumes that the broadcast assistance data content changes at every broadcast interval.

expirationTime

This field indicates how long the broadcast assistance data content is valid. It is specified as UTC time and indicates when the broadcast assistance data content will expire.

cipheringKeyData

If present, indicates that the *assistanceDataElement* octet string is ciphered.

segmentationInfo

If present, indicates that the *assistanceDataElement* is one of many segments.

assistanceDataElement

The *assistanceDataElement* OCTET STRING depends on the *posSibType* and is specified in Table 7.2-1. NOTE.

cipherSetID

This field identifies a cipher set comprising a cipher key value and the first component C_0 of the initial counter C_1 .

d0

This field provides the second component for the initial ciphering counter C_1 . This field is defined as a bit string with a length of 1 to 128 bits. A target device first pads out the bit string if less than 128 bits with zeroes in least significant bit positions to achieve 128 bits. C_1 is then obtained from D_0 and C_0 (defined by the *cipherSetID*) as:
 $C_1 = (D_0 + C_0) \bmod 2^{128}$ (with all values treated as non-negative integers).

segmentationOption

Indicates the used segmentation option.

assistanceDataSegmentType

Indicates whether the included *assistanceDataElement* segment is the last segment or not.

assistanceDataSegmentNumber

Segment number of the *assistanceDataElement* segment. A segment number of zero corresponds to the first segment, one corresponds to the second segment, and so on. Segments numbers wraparound should there be more than 64 segments

NOTE: For example, if the *posSibType* in IE *PosSIB-Type* defined in TS 36.331 [12] and TS 38.331 [35] indicates '*posSibType1-7*', the *assistanceDataElement* OCTET STRING includes the LPP IE *GNSS-RTK-AuxiliaryStationData*.

— OTDOA-UE-Assisted

The IE *OTDOA-UE-Assisted* is used in the *assistanceDataElement* if the *posSibType* in IE *PosSIB-Type* defined in TS 36.331 [12] indicates '*posSibType3-1*'.

```

-- ASN1START
OTDOA-UE-Assisted-r15 ::= SEQUENCE {
  otdoa-ReferenceCellInfo-r15      OTDOA-ReferenceCellInfo,
  otdoa-NeighbourCellInfo-r15      OTDOA-NeighbourCellInfoList,
  ...
}
-- ASN1STOP

```

OTDOA-UE-Assisted field descriptions
otdoa-ReferenceCellInfo LPP IE <i>OTDOA-ReferenceCellInfo</i> as defined in clause 6.5.1.2.
otdoa-NeighbourCellInfo LPP IE <i>OTDOA-NeighbourCellInfoList</i> as defined in clause 6.5.1.2.

– NR-UEB-TRP-LocationData

The IE *NR-UEB-TRP-LocationData* is used in the *assistanceDataElement* if the *posSibType* in IE *PosSIB-Type* defined in TS 38.331 [35] indicates '*posSibType6-2*'.

```
-- ASN1START
NR-UEB-TRP-LocationData-r16 ::= SEQUENCE {
    nr-trp-LocationInfo-r16          NR-TRP-LocationInfo-r16,
    nr-dl-prs-BeamInfo-r16          NR-DL-PRS-BeamInfo-r16          OPTIONAL, -- Need ON
    ...
}
-- ASN1STOP
```

NR-UEB-TRP-LocationData field descriptions
nr-trp-LocationInfo LPP IE <i>NR-TRP-LocationInfo</i> as defined in clause 6.4.2.1.
nr-dl-prs-BeamInfo LPP IE <i>NR-DL-PRS-Beam-Info</i> as defined in clause 6.4.2.1.

– NR-UEB-TRP-RTD-Info

The IE *NR-UEB-TRP-RTD-Info* is used in the *assistanceDataElement* if the *posSibType* in IE *PosSIB-Type* defined in TS 38.331 [35] indicates '*posSibType6-3*'.

```
-- ASN1START
NR-UEB-TRP-RTD-Info-r16 ::= SEQUENCE {
    nr-rtd-Info-r16          NR-RTD-Info-r16,
    ...
}
-- ASN1STOP
```

NR-UEB-TRP-RTD-Info field descriptions
nr-rtd-Info LPP IE <i>NR-RTD-Info</i> as defined in clause 6.4.2.1.

– End of LPP-Broadcast-Definitions

```
-- ASN1START
END
-- ASN1STOP
```

7.5 Broadcast ciphering (informative)

The *assistanceDataElement* OCTET STRING included in IE *AssistanceDataSIBelement* may be ciphered using the 128-bit Advanced Encryption Standard (AES) algorithm (with counter mode).

AES as specified in [32] and [33] is a block mode cipher algorithm that ciphers blocks of 128 bits at a time. However, Counter mode enables usage for a bit string that is not an exact multiple of 128 bits. Further, Counter mode enables a

target (or a server) to perform most of the deciphering (or ciphering) processing independently of receipt of the data to be deciphered (or ciphered) which may enable more efficient processing. Provided counters are chosen in a non-repeating manner by the server (which is a requirement for Counter mode), every block of data will be ciphered in a unique manner.

The algorithm makes use of a sequence of counters $\langle C_1, C_2, C_3, \dots \rangle$ each containing 128 bits, where C_1 is specified by the server and each subsequent counter (C_2, C_3 etc.) is obtained from the previous counter by adding one modulo 2^{128} . Each counter C_i is ciphered using the AES algorithm with a common 128-bit key to produce an output block O_i of 128 bits. To perform ciphering, the *assistanceDataElement* is divided into blocks B_1, B_2, \dots, B_n of 128 bits each, except for the last block B_n which may contain fewer than 128 bits. The ciphered *assistanceDataElement* is obtained as a sequence of n blocks containing 128 bits each (except possibly for the last block) given by $(O_1 \text{ XOR } B_1), (O_2 \text{ XOR } B_2), \dots, (O_n \text{ XOR } B_n)$, where XOR denotes bitwise exclusive OR. In the case of the last block, if B_n contains m bits ($m < 128$), then the m most significant bits of O_n would be used for the exclusive OR. Deciphering is performed in the same way except that the blocks B_1, B_2, \dots, B_n are now obtained from the ciphered message and the result of the exclusive OR operations yields the original unciphered message. Figure 7.5-1 provides an illustration of Counter mode for the generic case of an arbitrary block cipher algorithm $CIPH_K$.

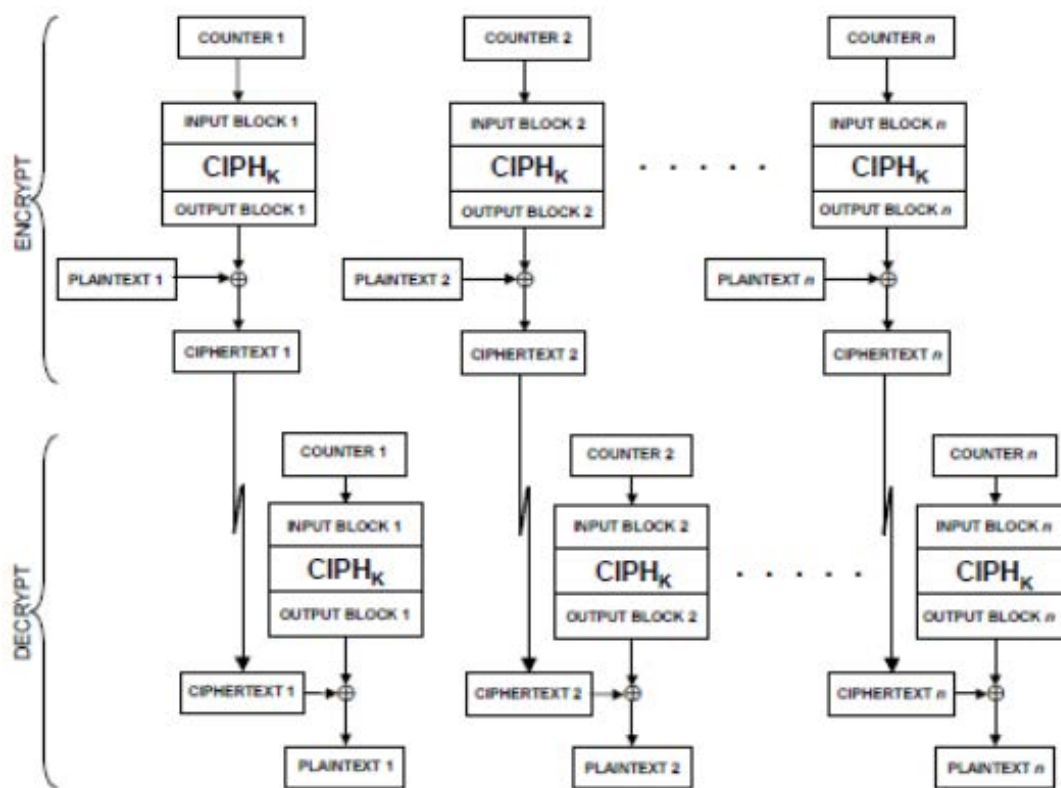

Figure 7.5-1: Illustration of Block Ciphering with Counter Mode [33].

The algorithms require specific conventions for bit ordering. The bit ordering applicable to ciphering for a ASN.1 PER encoded *assistanceDataElement* is the bit ordering produced by the ASN.1 PER encoding where the first bit is the leading bit number zero, the second bit is bit one etc..

The initial counter C_1 used to cipher an entire *assistanceDataElement* is provided to a target by a server in two portions. The first portion, denoted C_0 , is provided using point to point mode along with the 128-bit ciphering key and an identifier for both of these values as specified in TS 23.271 [3]. The second portion, denoted D_0 (d_0), is provided in unciphered form in IE *CipheringKeyData*. A target then obtains C_1 as:

$$C_1 = (C_0 + D_0) \text{ mod } 2^{128} \text{ (where all values are treated as non-negative integers)}$$

To obtain any subsequent counter C_i from the previous counter C_{i-1} for any message, the following operation is used:

$$C_i = (C_{i-1} + 1) \text{ mod } 2^{128}$$

NOTE: As specified in clause 7.3 the value for D_0 is different for different *AssistanceDataElement*'s to ensure that the counters derived from C_1 for any *assistanceDataElement* can be different to the counters for any other *assistanceDataElement*. However, a long *assistanceDataElement* or a segmented *assistanceDataElement* would require the use of consecutive counter values C_1 to C_n , where n is the *assistanceDataElement* size in bits divided by 128 (and rounded up). There would then be a danger of small changes in the value of D_0 for ciphering of different *assistanceDataElement*'s (e.g. D_0 being chosen as 1 larger than a previous D_0 value) reusing previous counter values. To avoid this, the values of D_0 contain 16 least significant bits (LSBs) set to zero, as specified in clause 7.3.

Annex A (informative): Change History

Change history of TS 36.355 up to v15.5.0							
Date	TSG #	TSG Doc.	CR	Rev	Cat	Subject/Comment	New version
2009-10	RAN2 #67bis	R2-096252				RAN2 agreed TS 36.355 v0.1.0	0.1.0
2009-11	RAN2 #68	R2-097492				RAN2 agreed TS 36.355 v2.0.0	2.0.0
2009-12	RP-46	RP-091208				RAN #46 approval of TS 36.355	9.0.0
2010-03	RP-47	RP-100304	0001	-		Clarification on Position location	9.1.0
	RP-47	RP-100304	0002	-		Clarification on UE Rx-Tx time difference supporting capability	9.1.0
	RP-47	RP-100304	0003	2		Completion of LPP common material	9.1.0
	RP-47	RP-100304	0004	5		Completion of OTDOA in LPP	9.1.0
	RP-47	RP-100304	0006	-		Provision of Frame Drift Information in Network Time	9.1.0
	RP-47	RP-100304	0007	-		Clarification of measurement reference point	9.1.0
	RP-47	RP-100304	0010	-		GNSS-DifferentialCorrectionsSupport	9.1.0
	RP-47	RP-100304	0011	-		BSAlign Indication in GNSS Reference Time	9.1.0
	RP-47	RP-100304	0012	1		Changes to reflect LPP ASN.1 review	9.1.0
	RP-47	RP-100304	0013	1		Introduction of LPP reliability sublayer	9.1.0
	RP-47	RP-100304	0015	-		LPP error procedures and conditions	9.1.0
	RP-47	RP-100304	0016	-		Triggered Location Information Transfer due to Cell Change	9.1.0
2010-06	RP-48	RP-100558	0018	2		Addition of need codes to optional LPP information elements	9.2.0
	RP-48	RP-100558	0019	1		Miscellaneous corrections to LPP stage 3	9.2.0
	RP-48	RP-100558	0020	1		Small corrections to LPP specification	9.2.0
	RP-48	RP-100558	0021	-		Clarifications of OTDOA parameters	9.2.0
	RP-48	RP-100558	0022	1		Signalling support for PRS muting in OTDOA	9.2.0
	-	-	-	-		Two times capital R replaced by lower case r in "MeasuredResultsElement" (undoing not intended change)	9.2.1
2010-09	RP-49	RP-100852	0024	-		Addition of an EPDU to an LPP Error and LPP Abort	9.3.0
	RP-49	RP-100852	0026	-		Division of LPP into Separate ASN.1 Modules with a Global Identifier	9.3.0
	RP-49	RP-100852	0028	-		Proposed Corrections to LPP Reliable Transport	9.3.0
	RP-49	RP-100852	0029	-		Proposed Corrections to the PeriodicalReportingCriteria in LPP	9.3.0
	RP-49	RP-100852	0030	1		Various corrections and clarifications to LPP	9.3.0
	RP-49	RP-100852	0031	-		Support of functional components for LPP reliable transport	9.3.0
	RP-49	RP-100852	0032	1		Introduction of EPDU ID requested by OMA LOC	9.3.0
	RP-49	RP-100852	0035	1		Several corrections in LPP	9.3.0
	RP-49	RP-100852	0036	-		Clarification to Assistance Data Transfer Procedure	9.3.0
2010-12	RP-50	RP-101207	0037	-		Correction of reliable transport terminology in description of LPP-Message	9.4.0
	RP-50	RP-101207	0038	-		One cell with known SFN in OTDOA assistance data	9.4.0
	RP-50	RP-101207	0039	1		UE frequency capability for LPP	9.4.0
	RP-50	RP-101207	0041	-		Correction to LPP reliable transport	9.4.0
	RP-50	RP-101207	0042	-		Correction to LPP Error procedure	9.4.0
	RP-50	RP-101207	0043	-		Addition of missing reference to LPPe	9.4.0
	RP-50	RP-101207	0044	2		Correction to the OTDOA assistance data	9.4.0
	RP-50	RP-101226	0040	-		Update of 'serving cell' terminology in 36.355	10.0.0
2011-03	RP-51	RP-110269	0046	-		Editorial corrections to 36.355	10.1.0
	RP-51	RP-110269	0048	-		Removal of FFS for retransmission timer in LPP	10.1.0
	RP-51	RP-110269	0050	-		Correction to code phase encoding in GNSS acquisition assistance	10.1.0
	RP-51	RP-110269	0052	1		Clarification on SFN provided with OTDOA measurement	10.1.0
	RP-51	RP-110269	0053	1		Introduction of OTDOA inter-freq RSTD measurement indication procedure	10.1.0
	RP-51	RP-110269	0057	-		Small corrections in 36.355	10.1.0
	RP-51	RP-110269	0058	3		Further corrections to the OTDOA assistance data	10.1.0
2011-06	RP-52	RP-110830	0060	-		Clarifications to description of OTDOA positioning fields	10.2.0
2011-09	RP-53	RP-111279	0062	1		Various corrections to LPP	10.3.0
	RP-53	RP-111279	0064	-		Mandatory support of PRS for OTDOA measurements	10.3.0
2011-12	RP-54	RP-111709	0066	-		Clarification of packed encoding rules of LPP	10.4.0
	RP-54	RP-111709	0068	-		Clarification of first bit in BIT STRING definitions	10.4.0
2012-06	RP-56	RP-120808	0071	-		Usage of additionalInformation IE	10.5.0
2012-09	RP-57	RP-121424	0074	2		Corrections to GNSS Acquisition Assistance Data	10.6.0
	RP-57	-	-	-		Upgrade to the Release 11 - no technical change	11.0.0

2012-12	RP-58	RP-121931	0077	-		Correcting the referencing of QoS parameters	11.1.0
	RP-58	RP-121931	0080	-		Correction to missing field description in GNSS-AcquisitionAssistance IE	11.1.0
2013-03	RP-59	RP-130237	0083	1		Extending E-UTRA Frequency Band and EARFCN value range	11.2.0
	RP-59	RP-130230	0086	-		Correction to PRS Muting Configuration	11.2.0
2013-06	RP-60	RP-130803	0088	-		Correction for ASN.1 errors from CR0083r1	11.3.0
	RP-60	RP-130803	0091	-		Correction to integer code phase field description in GNSS Acquisition Assistance	11.3.0
	RP-60	RP-130803	0093	-		Correction to serving cell terminology	11.3.0
	RP-60	RP-130803	0094	-		Encoding of LPP IEs	11.3.0
2013-09	RP-61	RP-131314	0098	-		Correction on svReqList	11.4.0
2013-12	RP-62	RP-131984	0103	-		Correction to missing capability indication for inter-frequency RSTD measurements	11.5.0
	RP-62	RP-131984	0107	1		Correction to Galileo assistance data elements	11.5.0
	RP-62	RP-132000	0104	1		Stage 3 CR of TS 36.355 for introducing BDS in LTE	12.0.0
	RP-62	RP-131984	0108	-		Correction to Galileo assistance data elements	12.0.0
2014-03	RP-63	RP-140342	0112	1		Clarification to gnss-DayNumber	12.1.0
2014-06	RP-64	RP-140871	0119	-		Signaling of OTDOA Neighbour Cell Information and Measurements	12.2.0
2014-12	RP-66	RP-142114	0122	-		Correction to Galileo Assistance Data	12.3.0
	RP-66	RP-142114	0123	-		Addition of an Early Position Fix to LPP	12.3.0
	RP-66	RP-142120	0124	-		BDS update to version 2.0	12.3.0
2015-03	RP-67	RP-150369	0126	2		Correction of GLONASS system time	12.4.0
	RP-67	RP-150376	0125	1		LPP clean-up	12.4.0
2015-12	RP-70	RP-152055	0134	1		Correction to the definition of Need codes	12.5.0
2015-12	RP-70	RP-152068	0137	3		RAT-Independent positioning enhancements	13.0.0
2016-03	RP-71	RP-160463	0138	1		Correction to GLONASS IOD value range	13.1.0
	RP-71	RP-160470	0140	1		r13 Information Element correction	13.1.0
	RP-71	RP-160470	0141	-		WLAN AP Identifier correction	13.1.0
	RP-71	RP-160470	0142	1		LPP clean-up	13.1.0
2016-09	RP-73	RP-161750	0143	4		Correction of ECID positioning for TDD	13.2.0
2016-12	RP-74	RP-162317	0160	1		Clarification of WLAN RSSI value range	13.3.0
2016-12	RP-74	RP-162326	0155	1		CR for 36.355 Further Indoor positioning enhancements	14.0.0
	RP-74	RP-162327	0157	-		Barometric Pressure Uncertainty IEs	14.0.0
	RP-74	RP-162326	0161	1		Introduction of Further Indoor Positioning Enhancements	14.0.0
2017-03	RP-75	RP-170636	0162	3	B	Introduction of positioning for further enhanced MTC	14.1.0
	RP-75	RP-170642	0163	-	C	Addition of periodical and triggered reporting capability signalling	14.1.0
	RP-75	RP-170642	0165	2	F	Further Indoor positioning enhancements corrections	14.1.0
	RP-75	RP-170637	0166	-	B	Introduction of positioning support for NB-IoT	14.1.0
2017-06	RP-76	RP-171224	0169	3	F	Compact Signal Measurement Information for OTDOA	14.2.0
	RP-76	RP-171223	0171	1	F	Correction to PRS Subframe Offset	14.2.0
	RP-76	RP-171223	0173	1	F	Correction to SFN time stamp in OTDOA Signal Measurement Information	14.2.0
	RP-76	RP-171223	0174	1	F	Correction to OTDOA capabilities	14.2.0
	RP-76	RP-171224	0175	1	F	Correction to NPRS	14.2.0
	RP-76	RP-171225	0176	2	F	LPP clean-up	14.2.0
	RP-76	RP-171224	0177	-	F	Corrections to number of NPRS carriers and ECID measurements for NB-IoT	14.2.0
	RP-76	RP-171224	0178	1	F	Removal of FFS for retransmission timer in LPP	14.2.0
	RP-76	RP-171224	0181	1	F	Signalling optimisation for NB-IoT Enhancements	14.2.0
2017-09	RP-77	RP-171913	0182	2	F	Clarification on definition of PRS Occasion Group	14.3.0
	RP-77	RP-171914	0183	1	F	Additional OTDOA Capabilities	14.3.0
	RP-77	RP-171911	0184	-	F	Clarification to <i>GNSS-TimeModelList</i>	14.3.0
	RP-77	RP-171913	0185	1	F	Minor corrections on TS 36.355 for Rel-14 MTC	14.3.0
2017-12	RP-78	RP-172616	0187	2	F	Correction on PRS hopping configuration	14.4.0
2018-03	RP-79	RP-180446	0189	1	F	Segmentation of LPP Messages	14.5.0
2018-04	RP-79					New version to fix ASN.1 formatting	14.5.1
2018-06	RP-80	RP-181235	0202	2	F	Clarification for NRSRQ reporting with E-CID	14.6.0
2018-06	RP-80	RP-181219	0204	2	B	Introduction of IMU support for OTDOA	15.0.0
	RP-80	RP-181219	0205	1	B	Addition of RTK and PPP support	15.0.0
	RP-80	RP-181219	0207	1	B	Addition of broadcast of positioning assistance data	15.0.0
	RP-80	RP-181215	0209	1	B	Addition of NR Support	15.0.0
	RP-80	RP-181252	0210	1	B	Addition of NB-IoT TDD support	15.0.0
2018-09	RP-81	RP-181963	0215	1	A	Support for NPRS enhancements	15.1.0
	RP-81	RP-181945	0218	1	F	Corrections to TDD in 36.355	15.1.0
	RP-81	RP-181961	0221	3	A	Correction to RSRQ range in 36.355	15.1.0
	RP-81	RP-181942	0222	1	F	OTDOA Assistance Data Request for NR	15.1.0
	RP-81	RP-181960	0223	-	F	LPP clean-up	15.1.0
	RP-81	RP-181952	0224	1	F	GAD shapes for high accuracy positioning	15.1.0
	RP-81	RP-181952	0226	1	B	Positioning SIB value tag and expiration time	15.1.0
2018-12	RP-82	RP-182672	0213	3	F	Addition of TDD UL/DL configuration to OTDOA assistance data	15.2.0
	RP-82	RP-182681	0228	2	F	Introduction of TDD UL/DL configuration for NB-IoT in 36.355	15.2.0
	RP-82	RP-182659	0229	3	F	SFN offset for OTDOA	15.2.0
	RP-82	RP-182674	0230	1	F	Alignment of IE/field names between LPP and RRC specifications	15.2.0

	RP-82	RP-182672	0232	1	F	Sensor Assistance Data Elements Correction	15.2.0
2019-03	RP-83	RP-190550	0234	3	F	Stage 2 and stage 3 sensor methods description alignment	15.3.0
2019-06	RP-84	RP-191376	0239	1	F	Minor corrections on NR Support	15.4.0
	RP-84	RP-191384	0240	4	F	Periodic assistance data transfer with cell ID change procedure	15.4.0
2019-09	RP-85	RP-192196	0243	1	F	Distinguishing Location Source when sensor method is used	15.5.0

NOTE: The table above will not be further updated in the future. It shows all TS 36.355 CRs taken over into TS 37.355 v1.0.0.

Change history of TS 37.355							
Date	TSG #	TSG Doc.	CR	Rev	Cat	Subject/Comment	New version
2019-12	RP-86	RP-192450	-	-	-	TS 36.355 v15.5.0 contents was transferred into this new TS 37.355 as by definition 36 series specifications cover E-UTRA/LTE only aspects and multi-RAT aspects need to be covered in 37 series specifications. The only changes compared to TS 36.355 v15.5.0: - new 37 series TS number is added: TS 37.355 - "Evolved Universal Terrestrial Radio Access (E-UTRA)" is removed from the TS title as beginning with Rel-15 TS 36.355 needs to cover also NR - clarification in the Scope clause that this TS covers radio access technologies E-UTRA/LTE and NR - the CR history table of TS 36.355 was kept for easier reference of all changes included in TS 37.355 but a new CR history table was added for TS 37.355.	1.0.0
2019-12	RP-86					The approved version upgraded to v15.0.0 by MCC.	15.0.0
2020-03	RP-87	RP-200367	0001	2	C	Addition of broadcast of barometric pressure assistance data	16.0.0
	RP-87	RP-200357	0002	1	F	Sensor Provide Location Information Elements Correction	16.0.0
	RP-87	RP-200365	0247	8	B	CR of TS 37.355 for introducing NavIC in LTE – core part	16.0.0
	RP-87	RP-200357	0248	1	B	Introduction of B1C signal in BDS system in A-GNSS	16.0.0
	RP-87	RP-200367	0249	1	C	Addition of broadcast TBS assistance data	16.0.0
	RP-87	RP-200345	0250	2	B	Introduction of NR positioning	16.0.0
	RP-87	RP-200357	0252	1	B	Introducing support for GNSS Integer Ambiguity Level Indications	16.0.0
2020-07	RP-88	RP-201196	0257	2	F	Introduction of NavIC Keplerian set IE	16.1.0
	RP-88	RP-201190	0259	1	F	Update B1I signal ICD file to v3.0 in BDS system in A-GNSS	16.1.0
	RP-88	RP-201175	0260	-	F	LPP Clean-Up	16.1.0
	RP-88	RP-201175	0261	1	B	Introduction of Release-16 UE positioning capabilities	16.1.0
2020-09	RP-89	RP-201989	0272	-	F	LPP miscellaneous corrections	16.2.0
2020-12	RP-90	RP-202775	0274	-	F	Clarification of quality and time stamp for RSTD measurements	16.3.0
	RP-90	RP-202789	0280	2	F	Correction of hanging ASN.1 code after END	16.3.0
	RP-90	RP-202775	0282	-	F	Correction on LPP spec	16.3.0
2021-03	RP-91	RP-210695	0284	1	F	Corrections on the field description of commonIEsProvideAssistanceData in TS37.355	16.4.0
2021-06	RP-92	RP-211474	0288	4	F	LPP Layer interaction with lower layers for Positioning Frequency layer and Measurement Gap	16.5.0
	RP-92	RP-211482	0292	3	F	Correction to the need code for downlink LPP message-R16	16.5.0
	RP-92	RP-211474	0294	2	F	Miscellaneous corrections on the field description	16.5.0
	RP-92	RP-211474	0300	2	F	Correction to PRS configuration	16.5.0
	RP-92	RP-211474	0301	2	F	Correction to the uplink LPP message	16.5.0
	RP-92	RP-211474	0302	3	F	Correction to DL-PRS capability	16.5.0
	RP-92	RP-211474	0306	2	F	Correction to NR-ARFCN of the TRP	16.5.0
	RP-92	RP-211474	0311	-	F	Description on timestamp reference in NR positioning measurement report	16.5.0
2021-09	RP-93	RP-212443	0305	5	F	Correction to PRS-only TP	16.6.0
	RP-93	RP-212443	0312	1	F	Correction for LPP assistance information	16.6.0
	RP-93	RP-212443	0313	1	F	Corrections on the conditional presence tag clarification for Uplink LPP message	16.6.0
	RP-93	RP-212443	0318	-	F	Correction to the need code in NR-SelectedDL-PRS-IndexList	16.6.0
2021-12	RP-94	RP-213344	0321	2	F	Updates based on RAN1 NR positioning features list	16.7.0
	RP-94	RP-213345	0323	3	F	Correction on BDS B2I clock model [Rel16BDS]	16.7.0
2022-03	RP-95	RP-220835	0326	-	F	Addition of missing need code for the BDS TGD2 parameter	16.8.0
	RP-95	RP-220472	0329	1	A	Correction on the object identifier of LPP ASN.1 for R16	16.8.0
	RP-95	RP-220835	0330	-	F	Correction of reference TRP for DL-AoD and Multi-RTT measurement report	16.8.0
	RP-95	RP-220835	0331	-	F	Correction to NR-DL-PRS-ResourcesCapability field description	16.8.0
	RP-95	RP-220835	0333	1	F	Introducing new high accuracy GAD shape with scalable uncertainty	16.8.0
2022-03	RP-95	RP-220479	0332	-	B	Introduction of R17 Positioning Enhancements in LPP	17.0.0
2022-06	RP-96	RP-221725	0347	-	F	LPP Updates and ASN.1 Corrections	17.1.0
	RP-96	RP-221736	0349	2	B	NMEA GGA sentence info in high accuracy GNSS location estimates [HA-GNSS-NMEA]	17.1.0
2022-09	RP-97	RP-222524	0359	2	F	Corrections on LPP capabilities	17.2.0
	RP-97	RP-222524	0377	1	F	Correction on the GNSS Orbit and Clock Integrity Bounds in TS 37.355	17.2.0
	RP-97	RP-222524	0378	1	F	Miscellaneous LPP Corrections	17.2.0
2022-12	RP-98	RP-223411	0379	3	F	Correction to UE capability for DL-AoD	17.3.0
	RP-98	RP-223411	0386	3	F	Various LPP Corrections	17.3.0
	RP-98	RP-223408	0389	1	A	Corrections of LPP capabilities on DL-RPS	17.3.0
	RP-98	RP-223408	0392	-	A	Correction to DL-PRS Search Window calculation	17.3.0
	RP-98	RP-223408	0394	1	A	Correction of NR DL-PRS BeamInfo attribute associated-DL-PRS-ID field description	17.3.0
	RP-98	RP-223408	0400	1	A	Correcting field description and definition of GNSS-SSR-URA	17.3.0
2023-03	RP-99	RP-230688	0404	1	F	Miscellaneous Corrections to LPP	17.4.0
	RP-99	RP-230688	0405	3	F	Correction to UE capability for MG (de-)activation	17.4.0
	RP-99	RP-230688	0408	1	F	Miscellaneous corrections for Positioning capabilities	17.4.0

	RP-99	RP-230686	0412	1	A	Clarifying Galileo NAV message in the GNSS Navigation model to clarify SSR clock correction signal reference	17.4.0
	RP-99	RP-230686	0413	1	A	Correction of Note in NR-DL-PRS-AssistanceData field descriptions and Addition of missing field description	17.4.0
	RP-99	RP-230688	0416	-	F	Correction to UE capability for PRS measurement within a PPW	17.4.0
	RP-99	RP-230720	0418	-	A	Correction for SRS-PosResourcesPerBand	17.4.0
2023-06	RP-100	RP-231412	0431	2	F	Corrections on applicability of timing error margin of RxTEG in NR-Multi-RTT-SignalMeasurementInformation field descriptions and other Miscellaneous corrections	17.5.0
	RP-100	RP-231412	0432	1	F	Miscellaneous corrections on LPP	17.5.0
	RP-100	RP-231412	0442	2	F	LOS-NLOS-Indicator Types	17.5.0
	RP-100	RP-231412	0445	1	F	LPP capability for FGs27-13a,14a and 14-2	17.5.0
	RP-100	RP-231412	0448	1	F	Miscellaneous LPP Corrections	17.5.0
	RP-100	RP-231411	0452	1	A	GNSS Tropospheric Delay Correction field description	17.5.0
2023-09	RP-101	RP-232667	0455	2	F	Correction to Multi-RTT	17.6.0
	RP-101	RP-232567	0461	2	F	GNSS SSR BDS orbit ephemeris reference clarification to align with RTCM	17.6.0
	RP-101	RP-232667	0464	1	F	Addition of missing values for dl-prs-ResourceSetPeriodicityReq-r17	17.6.0
2023-12	RP-102	RP-233888	0474	2	F	Field description correction for HA-GNSS metrics	17.7.0
	RP-102	RP-233888	0475	1	F	Correction to UE TEG Capability	17.7.0
	RP-102	RP-233888	0477	1	F	Clarification on the field description of dl-prs-ResourceSetPeriodicityReq	17.7.0
	RP-102	RP-233888	0478	-	F	Correction to UE capability for batch reporting	17.7.0
	RP-102	RP-233888	0485	2	F	Correction on transmission of SSR Assistance Data based on BDS B1C	17.7.0
2024-03	RP-103	RP-240652	0497	-	A	Corrections to NR-DL-PRS-Info	17.8.0
2024-12	RP-106	RP-243222	0517	2	A	Correction on GNSS-AlmanacSupport and GNSS-UTC-ModelSupport in A-GNSS positioning	17.9.0
	RP-106	RP-243222	0533	3	A	Correction on NavIC L5 almanac set IE, and field descriptions under KlobucharModelParameter, and GNSS-SystemTime.	17.9.0

History

Document history		
V17.0.0	May 2022	Publication
V17.1.0	August 2022	Publication
V17.2.0	October 2022	Publication
V17.3.0	January 2023	Publication
V17.4.0	April 2023	Publication
V17.5.0	July 2023	Publication
V17.6.0	October 2023	Publication
V17.7.0	February 2024	Publication
V17.8.0	May 2024	Publication
V17.9.0	January 2025	Publication