

ETSI TS 137 461 V10.3.0 (2019-05)



**Universal Mobile Telecommunications System (UMTS);
LTE;
5G;
Luant interface: Layer 1
(3GPP TS 37.461 version 10.3.0 Release 10)**



Reference

RTS/TSGR-0337461va30

Keywords

5G,LTE,UMTS

ETSI

650 Route des Lucioles
F-06921 Sophia Antipolis Cedex - FRANCE

Tel.: +33 4 92 94 42 00 Fax: +33 4 93 65 47 16

Siret N° 348 623 562 00017 - NAF 742 C
Association à but non lucratif enregistrée à la
Sous-Préfecture de Grasse (06) N° 7803/88

Important notice

The present document can be downloaded from:

<http://www.etsi.org/standards-search>

The present document may be made available in electronic versions and/or in print. The content of any electronic and/or print versions of the present document shall not be modified without the prior written authorization of ETSI. In case of any existing or perceived difference in contents between such versions and/or in print, the prevailing version of an ETSI deliverable is the one made publicly available in PDF format at www.etsi.org/deliver.

Users of the present document should be aware that the document may be subject to revision or change of status.

Information on the current status of this and other ETSI documents is available at

<https://portal.etsi.org/TB/ETSIDeliverableStatus.aspx>

If you find errors in the present document, please send your comment to one of the following services:

<https://portal.etsi.org/People/CommitteeSupportStaff.aspx>

Copyright Notification

No part may be reproduced or utilized in any form or by any means, electronic or mechanical, including photocopying and microfilm except as authorized by written permission of ETSI.

The content of the PDF version shall not be modified without the written authorization of ETSI.

The copyright and the foregoing restriction extend to reproduction in all media.

© ETSI 2019.

All rights reserved.

DECT™, **PLUGTESTS™**, **UMTS™** and the ETSI logo are trademarks of ETSI registered for the benefit of its Members.

3GPP™ and **LTE™** are trademarks of ETSI registered for the benefit of its Members and of the 3GPP Organizational Partners.

oneM2M™ logo is a trademark of ETSI registered for the benefit of its Members and of the oneM2M Partners.

GSM® and the GSM logo are trademarks registered and owned by the GSM Association.

Intellectual Property Rights

Essential patents

IPRs essential or potentially essential to normative deliverables may have been declared to ETSI. The information pertaining to these essential IPRs, if any, is publicly available for **ETSI members and non-members**, and can be found in ETSI SR 000 314: "*Intellectual Property Rights (IPRs); Essential, or potentially Essential, IPRs notified to ETSI in respect of ETSI standards*", which is available from the ETSI Secretariat. Latest updates are available on the ETSI Web server (<https://ipr.etsi.org/>).

Pursuant to the ETSI IPR Policy, no investigation, including IPR searches, has been carried out by ETSI. No guarantee can be given as to the existence of other IPRs not referenced in ETSI SR 000 314 (or the updates on the ETSI Web server) which are, or may be, or may become, essential to the present document.

Trademarks

The present document may include trademarks and/or tradenames which are asserted and/or registered by their owners. ETSI claims no ownership of these except for any which are indicated as being the property of ETSI, and conveys no right to use or reproduce any trademark and/or tradename. Mention of those trademarks in the present document does not constitute an endorsement by ETSI of products, services or organizations associated with those trademarks.

Foreword

This Technical Specification (TS) has been produced by ETSI 3rd Generation Partnership Project (3GPP).

The present document may refer to technical specifications or reports using their 3GPP identities, UMTS identities or GSM identities. These should be interpreted as being references to the corresponding ETSI deliverables.

The cross reference between GSM, UMTS, 3GPP and ETSI identities can be found under <http://webapp.etsi.org/key/queryform.asp>.

Modal verbs terminology

In the present document "**shall**", "**shall not**", "**should**", "**should not**", "**may**", "**need not**", "**will**", "**will not**", "**can**" and "**cannot**" are to be interpreted as described in clause 3.2 of the [ETSI Drafting Rules](#) (Verbal forms for the expression of provisions).

"**must**" and "**must not**" are **NOT** allowed in ETSI deliverables except when used in direct citation.

Contents

Intellectual Property Rights	2
Foreword.....	2
Modal verbs terminology.....	2
Foreword.....	4
1 Scope	5
2 References	5
3 Definitions and abbreviations.....	5
3.1 Definitions	5
3.2 Abbreviations	5
4 Iuant layer 1.....	6
4.1 General	6
4.2 RS485 option.....	7
4.3 Modem option	7
4.3.1 Interference with existing systems.....	9
4.3.1.1 Carrier frequency and frequency stability	9
4.3.1.2 Modem isolation and modem emissions	9
4.3.1.3 Modem intermodulation attenuation	10
4.3.2 Recovery time	10
4.3.3 Impedance.....	10
4.3.4 Modulator characteristics.....	11
4.3.4.1 Levels	11
4.3.4.2 Spectrum emission mask.....	11
4.3.5 Demodulator characteristics.....	11
4.3.6 Duty cycle variation.....	11
4.3.7 Operating bands	12
4.3.8 Time delay and accuracy	13
4.3.9 Insertion Loss.....	13
4.3.10 DC port isolation.....	13
4.3.11 RET control unit spurious emission.....	14
4.3.12 Control unit spurious emission	14
4.4 DC power supply.....	14
4.4.1 Power consumption.....	14
4.4.2 Conducted emission.....	15
4.4.3 Power-up characteristics	15
Annex A (normative): Test procedures.....	16
Annex B (informative): Change history	17
History	18

Foreword

This Technical Specification has been produced by the 3rd Generation Partnership Project (3GPP).

The contents of the present document are subject to continuing work within the TSG and may change following formal TSG approval. Should the TSG modify the contents of the present document, it will be re-released by the TSG with an identifying change of release date and an increase in version number as follows:

Version x.y.z

where:

- x the first digit:
 - 1 presented to TSG for information;
 - 2 presented to TSG for approval;
 - 3 or greater indicates TSG approved document under change control.
- y the second digit is incremented for all changes of substance, i.e. technical enhancements, corrections, updates, etc.
- z the third digit is incremented when editorial only changes have been incorporated in the document.

1 Scope

The present document specifies the standards allowed to implement layer 1 on the Iuant interface for UTRA & E-UTRA. The specification of transmission delay requirements and O&M requirements are not in the scope of the present document.

2 References

The following documents contain provisions which, through reference in this text, constitute provisions of the present document.

- References are either specific (identified by date of publication, edition number, version number, etc.) or non-specific.
- For a specific reference, subsequent revisions do not apply.
- For a non-specific reference, the latest version applies. In the case of a reference to a 3GPP document (including a GSM document), a non-specific reference implicitly refers to the latest version of that document *in the same Release as the present document*.

- [1] 3GPP TS 37.462: "Iuant interface: Signalling transport".
- [2] ISO/IEC 8482 (1993-12): "Information technology - Telecommunications and information exchange between systems - Twisted pair multipoint interconnections".
- [3] TIA/EIA TSB89: "Application guidelines for TIA/EIA-485-A".

3 Definitions and abbreviations

3.1 Definitions

For the purposes of the present document, the following terms and definitions apply:

On-Off-Keying: A modulation system in which a carrier is switched between two states, ON and OFF.

Common feeder cable: Feeder cable where some antenna line devices (e.g. RET, TMA) are connected via the same feeder cable.

3.2 Abbreviations

For the purposes of the present document, the following abbreviations apply:

BS	Base Station
DC	Direct Current
DL	Downlink
FDD	Frequency Division Duplex
ISB	Idle-State Biasing
OOK	On-Off-Keying
RET	Remote Electrical Tilting
RF	Radio Frequency
TMA	Tower Mounted Amplifier
UE	User Equipment
UL	Uplink
UMTS	Universal Mobile Telecommunications System
UTRA	UMTS Terrestrial Radio Access

4 Luant layer 1

4.1 General

There are two layer 1 options:

- RS485 option: A screened multicore cable, which supports a conventional RS485 serial multi-drop bus.
- Modem option: A connection to a RET and/or a TMA control unit by way of a coaxial cable which is shared with DC supply and RF signals.

Both layer 1 options support the connection of two-way serial data and DC power to the RET and/or TMA antenna device.

At least one of these two layer 1 options shall be supported.

The default data rate for both layer 1 options shall be 9.6 kbps. Higher data rates of 38.4 kbps for both layer 1 options and 115.2 kbps only for the RS485 layer 1 option may optionally be supported. Each unit communicates on one of the three data rates, but different units on the same interface may use different data rates.

After a reset, a secondary device shall alternate between supported data rates. When alternating between data rates, the data rate shall be held constant for 300 ms. After every correctly received device scan command (see TS 37.462 [1]) independent of whether it matches or not, at one of the supported data rates, that data rate shall be held constant for 1.5 seconds. After successful reception of an address assignment frame, the secondary device shall use that data rate until it is reset.

Data rates:

- 9.6 kbps \pm 3 %
- 38.4 kbps \pm 3 %
- 115.2 kbps \pm 3 %

The format of the data octet shall be as shown in figure 4.1.1:

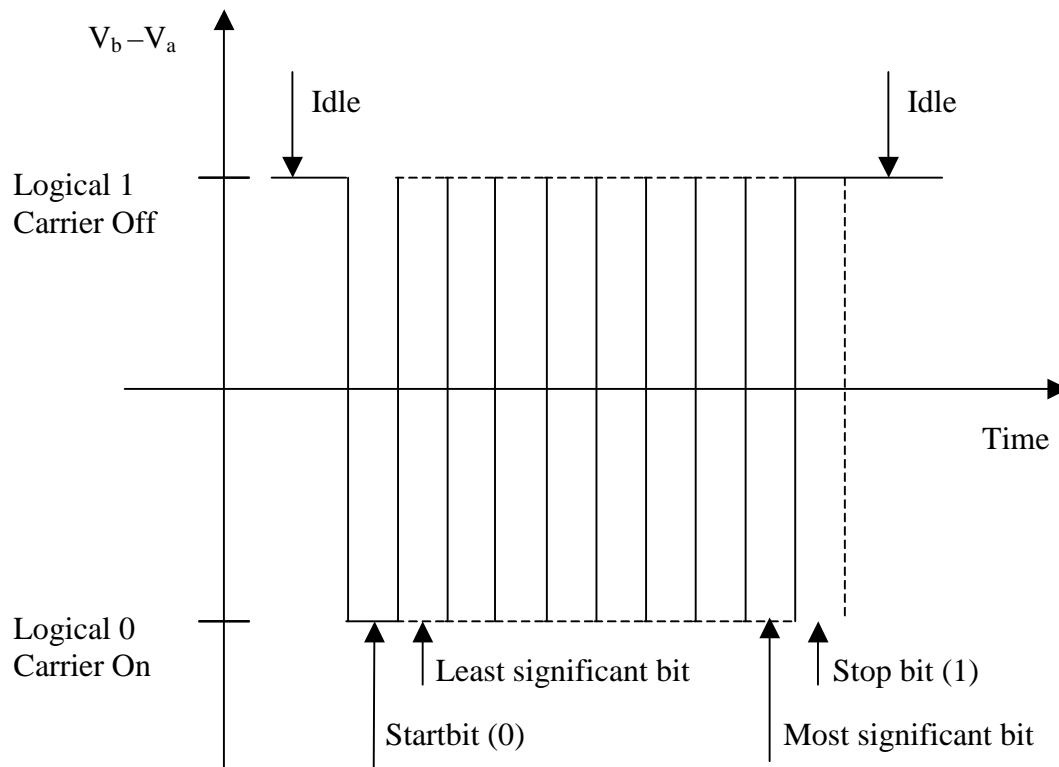

Figure 4.1.1: Format and order of transmitted data

4.2 RS485 option

This option is constituted by a two wire bi-directional multi-drop configuration conforming to ISO/IEC 8482 [2]. The mapping of mark/space to logical one and zero as referred to in ISO/IEC 8482 [2] shall be according to figure 4.1.1.

The use of ISB, also called idle-line failsafe in TIA/EIA TSB89 [3], is mandatory. The bias voltages shall be applied only by the primary device to any separate RS485 bus. The polarity of the idle-state bias is defined as a transmitted 1.

The RS485 transmitter shall be set to drive the bus before the first start bit is sent and held active until the last stop bit is sent. The RS485 transmitter shall stop driving the bus within 20 bit-times after the last stop bit is sent.

If an antenna modem is used ISB shall be implemented by the antenna modem.

4.3 Modem option

The connection to a RET and/or a TMA control unit by way of a coaxial cable which is shared with DC supply and RF signals is provided by two modems, a BS modem and an antenna modem. The BS modem shall be either connected to the antenna connector of the BS or integrated in the BS. It provides signal transmission to the antenna modem and signal reception from the antenna modem over the antenna feeder cable. The antenna modem is located between the antenna feeder cable and the antenna. Modem configurations and reference points for modem characteristics are specified in figure 4.3.1 and figure 4.3.2. Unless otherwise stated, requirements in this section apply to both BS modem and antenna modem.

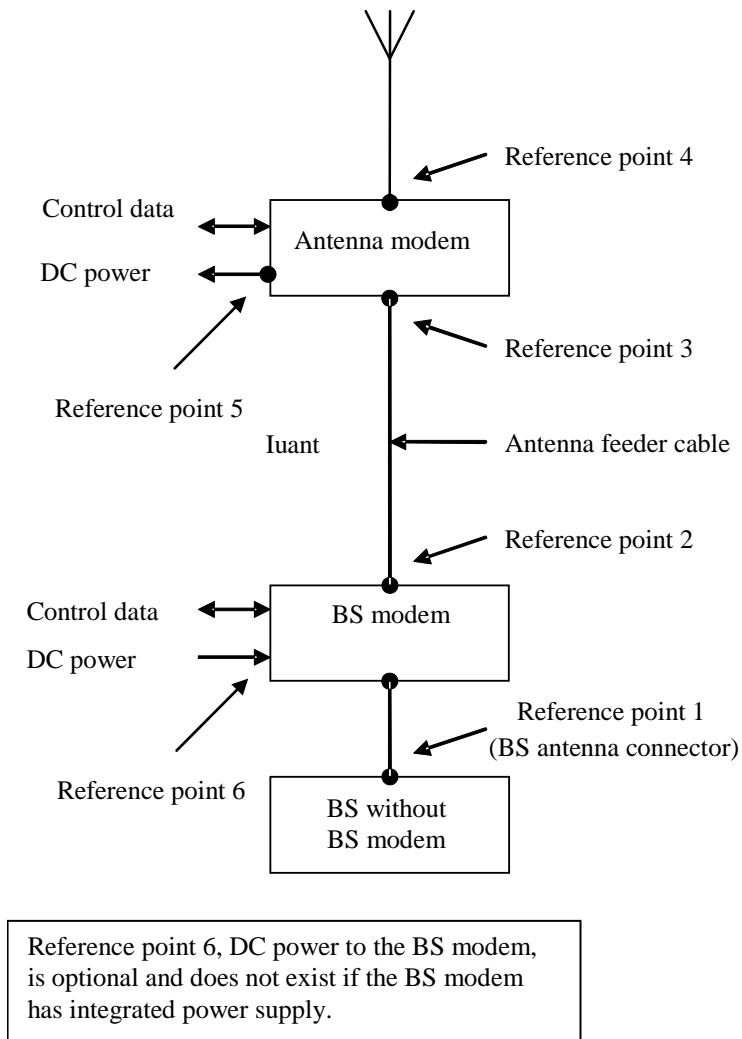

Figure 4.3.1: Modem configuration and modem reference points for a BS without BS modem

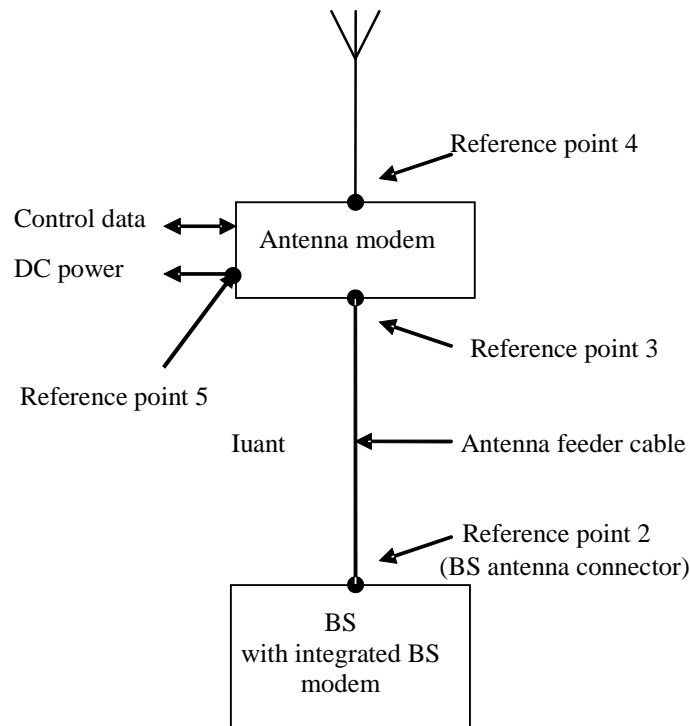

Figure 4.3.2: Modem configuration and modem reference points for a BS with integrated BS modem

4.3.1 Interference with existing systems

The modem circuit shall be capable of managing its transmitting characteristic according to subclause 4.3.5.

4.3.1.1 Carrier frequency and frequency stability

The following carrier frequency shall be used for this application:

$$2.176 \text{ MHz} \pm 100 \text{ ppm}$$

4.3.1.2 Modem isolation and modem emissions

The external BS modem shall provide minimum attenuation according to figure 4.3.1.2.1 between reference point 2 and reference point 1 to protect the BS from emissions of the antenna modem.

External BS modem emissions at reference point 1 shall be attenuated at least according to the modem attenuation in figure 4.3.1.2.1 below the levels specified for the modem spectrum emission mask in subclause 4.3.4.2 to protect the BS from emissions of the BS modem.

The antenna modem shall provide minimum attenuation according to figure 4.3.1.2.1 between reference point 3 and reference point 4 to protect other radio systems from emission of the BS modem.

Antenna modem emissions at reference point 4 shall be attenuated at least according to the modem attenuation in figure 4.3.1.2.1 below the levels specified for the modem spectrum emission mask in subclause 4.3.4.2 to protect other radio systems from emission of the antenna modem.

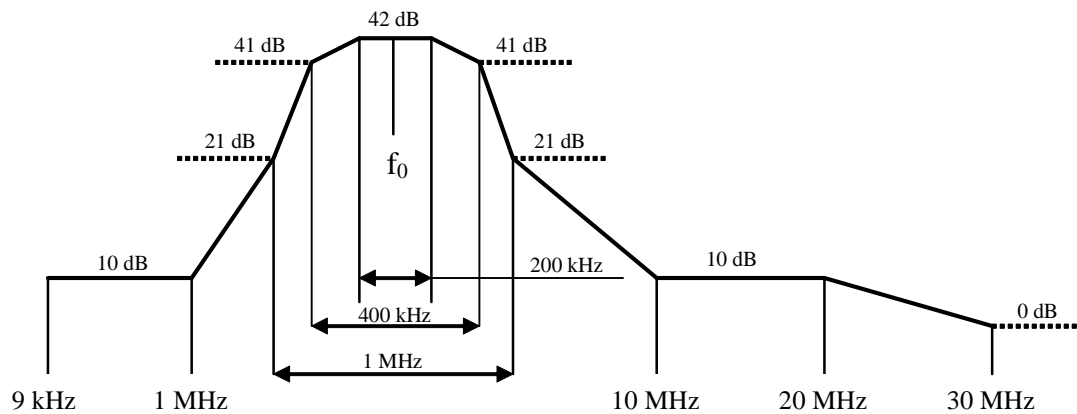

Figure 4.3.1.2.1: Modem attenuation

4.3.1.3 Modem intermodulation attenuation

The modem intermodulation attenuation is specified in terms of the power in intermodulation products of WCDMA modulated carriers present at reference point 1 or reference point 3.

For 2 downlink carriers of 43 dBm the power of third order intermodulation products in the UL operating bands for the external BS modem and antenna modem shall not exceed:

- - 130 dBm/100 kHz for frequencies < 1 GHz
- - 120 dBm/1 MHz for frequencies \geq 1 GHz

NOTE: Using the modem with higher power than 43 dBm and or with more carriers than 2 carriers at 43dBm/carrier may increase intermodulation products and may degrade the receiver sensitivity of the BS if these intermodulation products fall at BS receive frequencies.

For the worst input configuration of power and number of carriers declared by the modem manufacturer the power of any intermodulation product for the external BS modem and antenna modem shall not exceed:

- - 98dBm/100kHz

In addition, for the worst input configuration of power and number of carriers declared by the modem manufacturer the power of fifth or higher order intermodulation products in the UL operating bands for the external BS modem and antenna modem shall not exceed:

- - 135 dBm/100 kHz for frequencies < 1 GHz
- - 125 dBm/1 MHz for frequencies \geq 1 GHz

4.3.2 Recovery time

A minimum recovery time shall be allowed between receiving and transmitting messages on the bus. For this reason a minimum permitted response time is specified in subclause 4.5 in TS 37.462 [1].

4.3.3 Impedance

The modem transceiver shall provide constant impedance in both transmitting and receiving modes:

- Nominal impedance Z_0 : 50 Ω ;
- Return loss at modem carrier frequency \pm 0.1 MHz > 10 dB;
- Return loss in external BS and antenna modem operating bands > 20 dB.

4.3.4 Modulator characteristics

4.3.4.1 Levels

ON-Level: +3 dBm ± 2 dB

OFF-Level: ≤ -40 dBm

4.3.4.2 Spectrum emission mask

The modem spectrum emission mask is specified in figure 4.3.4.2.1. Intermediate values may be obtained by linear interpolation between the points shown. The corresponding measurement bandwidths are specified in table 4.3.4.2.1. For modem configurations according to figure 4.3.1 the BS modem emissions shall not exceed the limits of the spectrum emission mask at reference point 2. For modem configurations according to figure 4.3.2 the BS with integrated BS modem emissions shall not exceed the limits of the spectrum emission mask at reference point 2 only for frequencies below 20 MHz. Antenna modem emissions shall not exceed the limits of the spectrum emission mask at reference point 3.

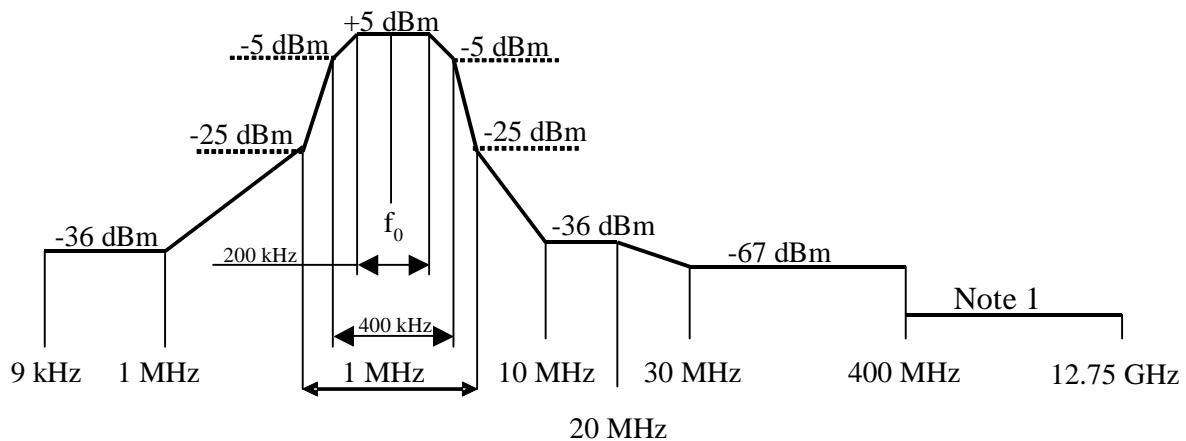

Figure 4.3.4.2.1: Modem spectrum emission mask.

Note 1: For frequencies <1GHz the general emission limit is -108dBm, except modem operating band UL frequencies where the emission limit is -135 dBm.
For frequencies ≥1GHz the general emission limit is -98dBm, except modem operating band UL frequencies where the emission limit is -125 dBm.

Table 4.3.4.2.1: Modem spectrum emission mask measurement bandwidth

Band	Measurement Bandwidth
9 kHz - 150 kHz	1 kHz
150 kHz - 30 MHz	10 kHz
30 MHz - 1 GHz	100 kHz
1 GHz - 12.75 GHz	1 MHz

4.3.5 Demodulator characteristics

The demodulator shall fulfil the requirement in subclause 4.3.6 for a carrier ON-Level within +5 dBm to -12 dBm and a carrier OFF-Level less than -18 dBm. The levels within -12 dBm to -18 dBm are undefined.

4.3.6 Duty cycle variation

In order to guarantee proper transmission of data bits through the processes of modulation and demodulation, the following limit shall be met for the duty cycle variation:

$$\Delta DC_{SYSTEM} = |DC_{RX} - DC_{TX}| \leq 10 \%$$

Where: ΔDC_{SYSTEM} is the difference between the duty cycles of the transmitted and received bit streams,
 DC_{TX} = Duty cycle for the input bit stream, and
 DC_{RX} = Duty cycle for the output bit stream.

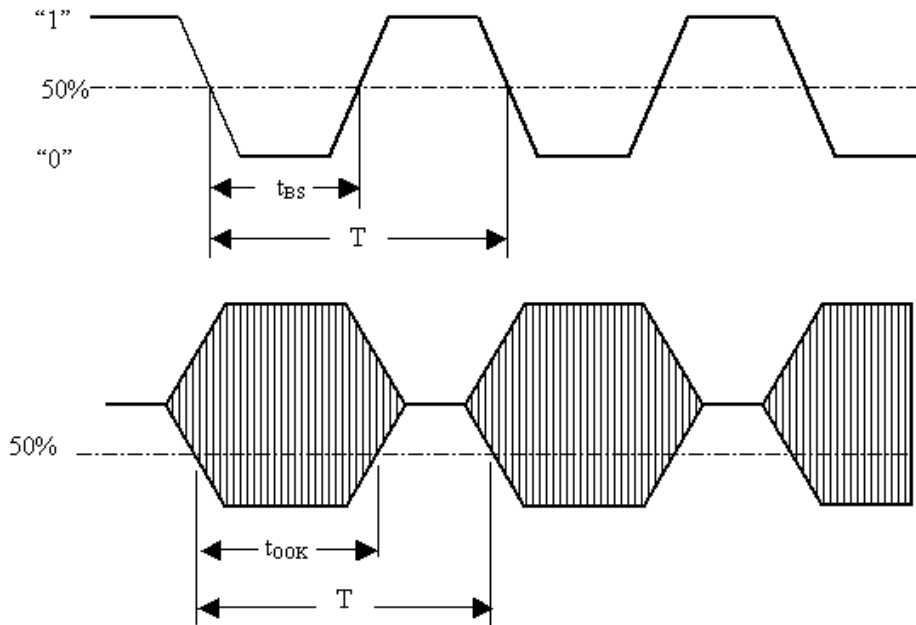

Duty cycle for bit stream = t_{BS}/T ; duty cycle for OOK = T_{OOK}/T

Figure 4.3.6.1: Duty cycles of the bit stream and OOK modulated subcarrier

For transmission through a coaxial cable, two converters are required, one from a bit stream to OOK (modulator) and one from OOK back to a bit stream (demodulator). Therefore half of the total duty cycle tolerance is available for each converter.

For an input bit stream with a duty ratio of 50 %, the cascaded modulator and demodulator shall provide an output bit stream with a duty ratio within the limits 40 % - 60 %, measured in each case at 0.5 times peak amplitude (see figure 4.3.6.1).

4.3.7 Operating bands

A UTRA/FDD BS, UTRA/TDD BS, E-UTRA BS or antenna modem is designed to operate in one or several of the following frequency bands:

Table 4.3.7.1: Frequency bands

UTRA Operating Band	E-UTRA Operating Band	UL operating band UE transmit, BS receive	DL operating band UE receive, BS transmit
I	1	1920 – 1980 MHz	2110 – 2170 MHz
II	2	1850 – 1910 MHz	1930 – 1990 MHz
III	3	1710 – 1785 MHz	1805 – 1880 MHz
IV	4	1710 – 1755 MHz	2110 – 2155 MHz
V	5	824 – 849 MHz	869 – 894 MHz
VI	6 ^{Note 1}	830 – 840 MHz	875 – 885 MHz
VII	7	2500 – 2570 MHz	2620 – 2690 MHz
VIII	8	880 – 915 MHz	925 – 960 MHz
IX	9	1749.9 – 1784.9 MHz	1844.9 – 1879.9 MHz
X	10	1710 – 1770 MHz	2110 – 2170 MHz
XI	11	1427.9 - 1447.9 MHz	1475.9 - 1495.9 MHz
XII	12	699 – 716 MHz	729 – 746 MHz
XIII	13	777 – 787 MHz	746 – 756 MHz
XIV	14	788 – 798 MHz	758 – 768 MHz
XV	15	Reserved	Reserved
XVI	16	Reserved	Reserved
XVII ^{Note 2}	17	704 – 716 MHz	734 – 746 MHz
XVIII ^{Note 2}	18	815 – 830 MHz	860 – 875 MHz
XIX	19	830 – 845 MHz	875 – 890 MHz
XX	20	832 - 862 MHz	791 - 821 MHz
XXI	21	1447.9 - 1462.9 MHz	1495.9 - 1510.9 MHz
	...		
–	23	2000 – 2020 MHz	2180 – 2200 MHz
–	24	1626.5 – 1660.5 MHz	1525 – 1559 MHz
XXV	25	1850 – 1915 MHz	1930 – 1995 MHz
	...		
a)	33	1900 – 1920 MHz	1900 – 1920 MHz
a)	34	2010 – 2025 MHz	2010 – 2025 MHz
b)	35	1850 – 1910 MHz	1850 – 1910 MHz
b)	36	1930 – 1990 MHz	1930 – 1990 MHz
c)	37	1910 – 1930 MHz	1910 – 1930 MHz
d)	38	2570 – 2620 MHz	2570 – 2620 MHz
f)	39	1880 – 1920 MHz	1880 – 1920 MHz
e)	40	2300 – 2400 MHz	2300 – 2400 MHz
-	41	2496 – 2690 MHz	2496 – 2690 MHz
-	42	3400 – 3600 MHz	3400 – 3600 MHz
-	43	3600 – 3800 MHz	3600 – 3800 MHz
Note 1: Band 6 is not applicable.			
Note 2: UTRA Operating Band XVII and XVIII are Reserved.			

The operating bands of the BS modem or antenna modem shall be declared by the manufacturer.

4.3.8 Time delay and accuracy

The time delay in the operating bands shall be declared by the manufacturer with ± 1 ns accuracy. The time delay shall not exceed 30 ns. This requirement is only applicable to external BS modem and antenna modem.

4.3.9 Insertion Loss

The insertion loss in the external BS modem or antenna modem operating band shall be ≤ 0.3 dB.

The actual insertion loss shall be declared by the manufacturer.

4.3.10 DC port isolation

The isolation between DC port and RF ports shall meet the minimum values in figure 4.3.10.1 and 4.3.10.2. Figure 4.3.10.1 is valid for antenna modems between reference point 5 and 4 as well as 5 and 3 and for BS modems without

integrated power supply between reference point 6 and 2 as well as 6 and 1. Figure 4.3.10.2 is valid as additional requirement for antenna modems between reference point 5 and 3 and for BS modems without integrated power supply between reference point 6 and 2.

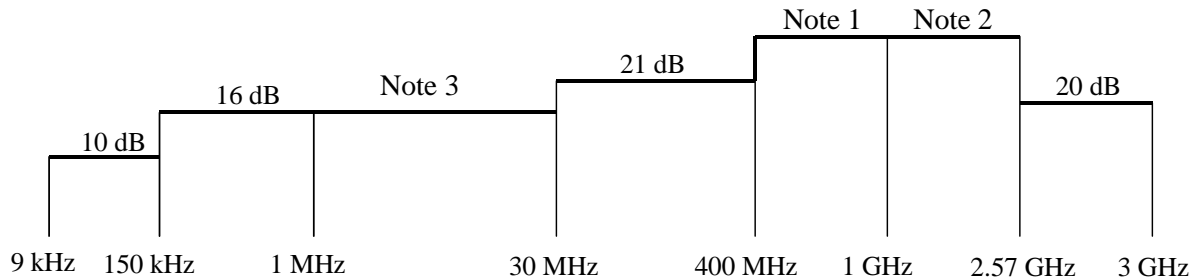

Note 1: 38 dB, except for UL and DL operating bands where it is 65 dB
 Note 2: 38 dB, except for UL and DL operating bands where it is 65 dB
 Note 3: 16 dB. Between reference point 5 and 3 as well as 6 and 2 see figure 4.3.10.2.

Figure 4.3.10.1: DC port isolation

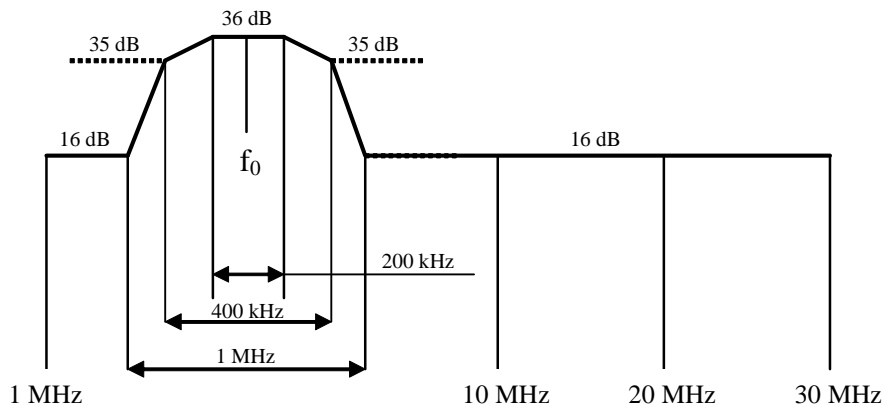

Figure 4.3.10.2: DC port isolation

4.3.11 RET control unit spurious emission

Void.

4.3.12 Control unit spurious emission

The control unit, or a combination of control units, shall not generate spurious emission, at reference point 5, above a level that will violate the spectrum emission mask requirement according to chapter 4.3.4.2. The DC port isolation according to chapter 4.3.10 shall be taken into account.

4.4 DC power supply

4.4.1 Power consumption

The DC supply requirements refers to reference points 3 and 5 in subclause 4.3.

BS modem and an antenna modem shall be able to operate with a DC supply voltage range of 10 V – 30 V.

Power consumption modes are specified in table 4.4.1.1. and table 4.4.1.2.

Table 4.4.1.1: Power consumption modes for RET

RET Power mode	Maximum power consumption
High	< 13 W
Low	< 2 W

Table 4.4.1.2: Power consumption modes for TMA

TMA Type	Maximum power consumption
Single Unit	< 7,5 W
Multi Unit (N)	< N * 7,5 W

BS modem and antenna modem maximum power consumption shall be < 2 W.

BS modem and antenna modem shall impose a voltage drop less than 2 V between reference point 3 and 5.

A Single Unit considers one RF amplifier in one TMA. A Multi Unit considers N RF amplifiers in equal or less than N TMAs.

4.4.2 Conducted emission

The levels of generated conducted noise and ripple on DC Power supply shall be within the limits given in table 4.4.2.1.

Table 4.4.2.1: Noise and ripple

Item	Limit	Frequency	Remarks
RET power mode High	70 mV _{pp}	0.15 - 30 MHz	Only one operating unit a time
RET power mode Low	20 mV _{pp}	0.15 - 30 MHz	
TMA	20 mV _{pp}	0.15 - 30 MHz	
Antenna modem, RF port	15 mV _{pp}	0.15 - 30 MHz	Generated Noise and Ripple at RF feeder (in RX mode)
Antenna modem, DC port	20 mV _{pp}	0.15 - 30 MHz	Allowed Noise and Ripple at external DC port (in TX mode)

All units connected to a DC supply bus shall exhibit full performance up to the limit of 112 mV_{pp} total noise and ripple within 0.15 - 30 MHz.

4.4.3 Power-up characteristics

A BS modem, antenna modem or RET/TMA control units shall have a power-up period of 3 s.

During the power-up period a BS modem, antenna modem or a RET control unit shall exhibit the circuit equivalent of a DC power consumer with a current consumption of maximum 400 mA in parallel with a capacitor of maximum 0.5 µF.

During the power-up period the TMA control unit shall exhibit the circuit equivalent of a DC power consumer with a current consumption of maximum 1A in parallel with a capacitor of maximum 0.5 µF.

After the power-up period, the unit shall be fully functional and the power consumption requirement as described in subclause 4.4.1 applies.

Annex A (normative): Test procedures

Test pattern

Spectrum mask and emission requirement shall be tested both with a consecutive series of “0” and an alternating sequence of “0” and “1”.

Emission requirement below noise floor

As a general rule, the resolution bandwidth of the measuring equipment should be equal to the measurement bandwidth. However, to improve measurement accuracy and sensitivity when measuring close to or below the noise floor, the resolution bandwidth may be smaller than the measurement bandwidth. When the resolution bandwidth is smaller than the measurement bandwidth, the result should be integrated over the measurement bandwidth in order to obtain the equivalent noise bandwidth of the measurement bandwidth.

Conversion between modulated and CW for IM measurement

The requirement for IM3 below 1 GHz shall be relaxed 15 dB and tested with CW interferers at the specified levels. The requirement for IM3 above 1 GHz shall be relaxed 5 dB and tested with CW interferers at the specified levels.

The requirement for IM5 or higher below 1 GHz shall be relaxed 10 dB and tested with CW interferers at the specified levels.

The requirement for IM5 or higher above 1 GHz shall be relaxed 0 dB and tested with CW interferers at the specified levels.

Example: A -130 dBm/100 kHz requirement below 1 GHz with two WCDMA-modulated carriers at 43 dBm is converted to a -115 dBm requirement with two CW carriers at 43 dBm.

Annex B (informative): Change history

Change history							
Date	Meeting	TDoc	CR	Rev	Cat	Subject/Comment	New version
2019-02	R3-103	R3-190082				Text transferred from 25.461 v10.3.0 (changes shown with rev marks)	1.10.0
2019-04	RAN#83	RP-190585				Specification approved by RAN plenary	10.3.0

History

Document history		
V10.3.0	May 2019	Publication