

ETSI TS 138 101-1 V16.21.0 (2024-10)



**5G;
NR;
User Equipment (UE) radio transmission and reception;
Part 1: Range 1 Standalone
(3GPP TS 38.101-1 version 16.21.0 Release 16)**



Reference

RTS/TSGR-0438101-1vgl0

Keywords

5G

ETSI

650 Route des Lucioles
F-06921 Sophia Antipolis Cedex - FRANCE

Tel.: +33 4 92 94 42 00 Fax: +33 4 93 65 47 16

Siret N° 348 623 562 00017 - APE 7112B
Association à but non lucratif enregistrée à la
Sous-Préfecture de Grasse (06) N° w061004871

Important notice

The present document can be downloaded from the
[ETSI Search & Browse Standards](#) application.

The present document may be made available in electronic versions and/or in print. The content of any electronic and/or print versions of the present document shall not be modified without the prior written authorization of ETSI. In case of any existing or perceived difference in contents between such versions and/or in print, the prevailing version of an ETSI deliverable is the one made publicly available in PDF format on [ETSI deliver](#).

Users should be aware that the present document may be revised or have its status changed,
this information is available in the [Milestones listing](#).

If you find errors in the present document, please send your comments to
the relevant service listed under [Committee Support Staff](#).

If you find a security vulnerability in the present document, please report it through our
[Coordinated Vulnerability Disclosure \(CVD\)](#) program.

Notice of disclaimer & limitation of liability

The information provided in the present deliverable is directed solely to professionals who have the appropriate degree of experience to understand and interpret its content in accordance with generally accepted engineering or other professional standard and applicable regulations.

No recommendation as to products and services or vendors is made or should be implied.

No representation or warranty is made that this deliverable is technically accurate or sufficient or conforms to any law and/or governmental rule and/or regulation and further, no representation or warranty is made of merchantability or fitness for any particular purpose or against infringement of intellectual property rights.

In no event shall ETSI be held liable for loss of profits or any other incidental or consequential damages.

Any software contained in this deliverable is provided "AS IS" with no warranties, express or implied, including but not limited to, the warranties of merchantability, fitness for a particular purpose and non-infringement of intellectual property rights and ETSI shall not be held liable in any event for any damages whatsoever (including, without limitation, damages for loss of profits, business interruption, loss of information, or any other pecuniary loss) arising out of or related to the use of or inability to use the software.

Copyright Notification

No part may be reproduced or utilized in any form or by any means, electronic or mechanical, including photocopying and microfilm except as authorized by written permission of ETSI.

The content of the PDF version shall not be modified without the written authorization of ETSI.

The copyright and the foregoing restriction extend to reproduction in all media.

© ETSI 2024.
All rights reserved.

Intellectual Property Rights

Essential patents

IPRs essential or potentially essential to normative deliverables may have been declared to ETSI. The declarations pertaining to these essential IPRs, if any, are publicly available for **ETSI members and non-members**, and can be found in ETSI SR 000 314: "*Intellectual Property Rights (IPRs); Essential, or potentially Essential, IPRs notified to ETSI in respect of ETSI standards*", which is available from the ETSI Secretariat. Latest updates are available on the ETSI Web server (<https://ipr.etsi.org/>).

Pursuant to the ETSI Directives including the ETSI IPR Policy, no investigation regarding the essentiality of IPRs, including IPR searches, has been carried out by ETSI. No guarantee can be given as to the existence of other IPRs not referenced in ETSI SR 000 314 (or the updates on the ETSI Web server) which are, or may be, or may become, essential to the present document.

Trademarks

The present document may include trademarks and/or tradenames which are asserted and/or registered by their owners. ETSI claims no ownership of these except for any which are indicated as being the property of ETSI, and conveys no right to use or reproduce any trademark and/or tradename. Mention of those trademarks in the present document does not constitute an endorsement by ETSI of products, services or organizations associated with those trademarks.

DECT™, **PLUGTESTS™**, **UMTS™** and the ETSI logo are trademarks of ETSI registered for the benefit of its Members. **3GPP™** and **LTE™** are trademarks of ETSI registered for the benefit of its Members and of the 3GPP Organizational Partners. **oneM2M™** logo is a trademark of ETSI registered for the benefit of its Members and of the oneM2M Partners. **GSM®** and the GSM logo are trademarks registered and owned by the GSM Association.

Legal Notice

This Technical Specification (TS) has been produced by the ETSI 3rd Generation Partnership Project (3GPP).

The present document may refer to technical specifications or reports using their 3GPP identities. These shall be interpreted as being references to the corresponding ETSI deliverables.

The cross reference between 3GPP and ETSI identities can be found under <https://webapp.etsi.org/key/queryform.asp>.

Modal verbs terminology

In the present document "**shall**", "**shall not**", "**should**", "**should not**", "**may**", "**need not**", "**will**", "**will not**", "**can**" and "**cannot**" are to be interpreted as described in clause 3.2 of the [ETSI Drafting Rules](#) (Verbal forms for the expression of provisions).

"**must**" and "**must not**" are **NOT** allowed in ETSI deliverables except when used in direct citation.

Contents

Intellectual Property Rights	2
Legal Notice	2
Modal verbs terminology.....	2
Foreword.....	16
1 Scope	18
2 References	18
3 Definitions, symbols and abbreviations	18
3.1 Definitions	18
3.2 Symbols.....	20
3.3 Abbreviations	22
4 General	23
4.1 Relationship between minimum requirements and test requirements	23
4.2 Applicability of minimum requirements	23
4.3 Specification suffix information.....	23
5 Operating bands and channel arrangement.....	24
5.1 General	24
5.2 Operating bands.....	24
5.2A Operating bands for CA	26
5.2A.0 General.....	26
5.2A.1 Intra-band CA	26
5.2A.2 Inter-band CA	27
5.2A.2.1 Inter-band CA (two bands).....	27
5.2A.2.2 Inter-band CA (three bands).....	29
5.2A.2.3 Inter-band CA (four bands).....	29
5.2B Operating bands for DC	30
5.2C Operating band combination for SUL	30
5.2D Operating bands for UL MIMO	31
5.2E Operating band for V2X.....	31
5.2E.1 V2X operating bands	31
5.2E.2 V2X operating bands for concurrent operation.....	32
5.3 UE channel bandwidth	32
5.3.1 General.....	32
5.3.2 Maximum transmission bandwidth configuration	32
5.3.3 Minimum guardband and transmission bandwidth configuration.....	33
5.3.4 RB alignment.....	35
5.3.5 UE channel bandwidth per operating band.....	35
5.3.6 Asymmetric channel bandwidths	38
5.3A UE channel bandwidth for CA	39
5.3A.1 General.....	39
5.3A.2 Maximum transmission bandwidth configuration for CA	39
5.3A.3 Minimum guardband and transmission bandwidth configuration for CA	39
5.3A.4 Void	41
5.3A.5 UE channel bandwidth per operating band for CA.....	41
5.3E Channel bandwidth for V2X	42
5.3E.1 General.....	42
5.3E.2 Channel bandwidth for V2X concurrent operation.....	42
5.4 Channel arrangement.....	42
5.4.1 Channel spacing.....	42
5.4.1.1 Channel spacing for adjacent NR carriers	42
5.4.2 Channel raster	43
5.4.2.1 NR-ARFCN and channel raster.....	43
5.4.2.2 Channel raster to resource element mapping.....	43
5.4.2.3 Channel raster entries for each operating band	44

5.4.3	Synchronization raster	46
5.4.3.1	Synchronization raster and numbering.....	46
5.4.3.3	Synchronization raster entries for each operating band.....	46
5.4.4	TX–RX frequency separation	47
5.4A	Channel arrangement for CA.....	48
5.4A.1	Channel spacing for CA.....	48
5.4A.2	Channel raster for CA.....	49
5.4A.3	Synchronization raster for CA	49
5.4A.4	Tx-Rx frequency separation for CA.....	49
5.4B	Reserved.....	49
5.4C	Reserved.....	49
5.4D	Reserved.....	49
5.4E	Channel arrangement for V2X	49
5.4E.1	Channel spacing.....	49
5.4E.2	Channel raster	50
5.4E.2.1	NR-ARFCN and channel raster.....	50
5.4E.2.2	Channel raster to resource element mapping.....	50
5.4E.2.3	Channel raster entries for each operating band	50
5.4E.3	Synchronization raster for V2X.....	50
5.5	Void.....	50
5.5A	Configurations for CA.....	50
5.5A.0	General.....	50
5.5A.1	Configurations for intra-band contiguous CA.....	51
5.5A.2	Configurations for intra-band non-contiguous CA	52
5.5A.3	Configurations for inter-band CA.....	53
5.5A.3.1	Configurations for inter-band CA (two bands)	53
5.5A.3.2	Configurations for inter-band CA (three bands)	63
5.5A.3.3	Configurations for inter-band CA (four bands).....	69
5.5B	Configurations for DC.....	72
5.5C	Configurations for SUL.....	72
6	Transmitter characteristics	74
6.1	General	74
6.1A	General	74
6.1F	General	74
6.2	Transmitter power	74
6.2.1	UE maximum output power.....	74
6.2.2	UE maximum output power reduction.....	76
6.2.3	UE additional maximum output power reduction.....	78
6.2.3.1	General	78
6.2.3.2	A-MPR for NS_04	81
6.2.3.3	A-MPR for NS_10	82
6.2.3.4	A-MPR for NS_05 and NS_05U.....	82
6.2.3.5	A-MPR for NS_40	84
6.2.3.6	A-MPR for NS_43 and NS_43U.....	85
6.2.3.7	A-MPR for NS_03 and NS_03U.....	86
6.2.3.8	A-MPR for NS_37	86
6.2.3.9	A-MPR for NS_38	87
6.2.3.10	A-MPR for NS_39	87
6.2.3.11	A-MPR for NS_41	87
6.2.3.12	A-MPR for NS_42	88
6.2.3.13	A-MPR for NS_18	88
6.2.3.14	A-MPR for NS_21	89
6.2.3.15	A-MPR for NS_24	89
6.2.3.16	A-MPR for NS_27	90
6.2.3.17	A-MPR for NS_46.....	91
6.2.3.18	A-MPR for NS_47	92
6.2.3.19	A-MPR for NS_50	93
6.2.3.20	A-MPR for NS_44	93
6.2.3.21	A-MPR for NS_12	94
6.2.3.22	A-MPR for NS_13	94
6.2.3.23	A-MPR for NS_14	95

6.2.3.24	A-MPR for NS_15	95
6.2.3.25	A-MPR for NS_45	96
6.2.3.26	A-MPR for NS_48	96
6.2.3.27	A-MPR for NS_49	97
6.2.3.28	A-MPR for NS_51	98
6.2.4	Configured transmitted power	98
6.2A	Transmitter power for CA	100
6.2A.1	UE maximum output power for CA	100
6.2A.1.1	UE maximum output power for Intra-band contiguous CA	100
6.2A.1.2	UE maximum output power for Intra-band non-contiguous CA	101
6.2A.1.3	UE maximum output power for Inter-band CA	101
6.2A.1.4	Void	103
6.2A.1.5	Void	103
6.2A.2	UE maximum output power reduction for CA	103
6.2A.2.1	UE maximum output power reduction for Intra-band contiguous CA	103
6.2A.2.2	UE maximum output power reduction for Intra-band non-contiguous CA	105
6.2A.2.2.0	General	105
6.2A.2.2.1	MPR to meet -30dBm/MHz	105
6.2A.2.2.2	MPR to meet -13dBm/MHz	106
6.2A.2.3	UE maximum output power reduction for Inter-band CA	106
6.2A.2.4	Void	106
6.2A.3	UE additional maximum output power reduction for CA	106
6.2A.3.1.1	UE additional maximum output power reduction for Intra-band contiguous CA	106
6.2A.3.1.1.1	A-MPR for CA_NS_04	107
6.2A.3.1.2	UE additional maximum output power reduction for Intra-band non-contiguous CA	113
6.2A.3.1.3	UE additional maximum output power reduction for Inter-band CA	115
6.2A.4	Configured output power for CA	116
6.2A.4.1	Configured transmitted power level	116
6.2A.4.1.1	Configured transmitted power for Intra-band contiguous CA	116
6.2A.4.1.2	Configured transmitted power for Intra-band non-contiguous CA	119
6.2A.4.1.3	Configured transmitted power for Inter-band CA	121
6.2A.4.1.4	Void	123
6.2A.4.2	$\Delta T_{IB,c}$ for CA	123
6.2A.4.2.1	Void	123
6.2A.4.2.2	Void	123
6.2A.4.2.3	$\Delta T_{IB,c}$ for Inter-band CA (two bands)	123
6.2A.4.2.4	$\Delta T_{IB,c}$ for Inter-band CA (three bands)	126
6.2A.4.2.5	$\Delta T_{IB,c}$ for Inter-band CA (four bands)	128
6.2B	Transmitter power for NR-DC	128
6.2B.0	General	128
6.2B.1	UE maximum output power for NR-DC	129
6.2B.2	UE maximum output power reduction for NR-DC	129
6.2B.3	UE additional maximum output power reduction for NR-DC	129
6.2B.4	Configured output power for NR-DC	129
6.2B.4.1	Configured transmitted power level for NR-DC	129
6.2B.4.2	$\Delta T_{IB,c}$ for NR-DC	132
6.2C	Transmitter power for SUL	132
6.2C.1	Configured transmitted power for SUL	132
6.2C.2	$\Delta T_{IB,c}$	132
6.2D	Transmitter power for UL MIMO	133
6.2D.1	UE maximum output power for UL MIMO	133
6.2D.2	UE maximum output power reduction for UL MIMO	134
6.2D.3	UE additional maximum output power reduction for UL MIMO	134
6.2D.4	Configured transmitted power for UL MIMO	135
6.2E	Transmitter power for V2X	136
6.2E.1	UE maximum output power for V2X	136
6.2E.1.1	General	136
6.2E.1.2	UE maximum output power for V2X con-current operation	136
6.2E.2	UE maximum output power reduction for V2X	137
6.2E.2.1	General	137
6.2E.2.2	MPR for Power class 3 V2X UE	137
6.2E.2.3	MPR for Power class 3 V2X concurrent operation	138

6.2E.3	UE additional maximum output power reduction for V2X.....	138
6.2E.3.1	General	138
6.2E.3.2	A-MPR for Power class 3 V2X UE by NS_33	139
6.2E.3.3	A-MPR for Power class 3 V2X UE by NS_52	141
6.2E.3.4	A-MPR for power class 3 V2X concurrent operation	142
6.2E.4	Configured transmitted power for V2X	142
6.2E.4.1	General	142
6.2E.4.2	Configured transmitted power for V2X concurrent operation	143
6.2F	Transmitter power for shared spectrum channel access	144
6.2F.1	UE maximum output power	144
6.2F.1A	UE maximum output power for CA.....	145
6.2F.1A.1	UE maximum output power for inter-band CA.....	145
6.2F.2	UE maximum output power reduction.....	145
6.2F.2A	UE maximum output power reduction for CA.....	146
6.2F.2A.1	UE maximum output power reduction for inter-band CA.....	146
6.2F.3	UE additional maximum output power reduction	146
6.2F.3.1	General	146
6.2F.3.2	A-MPR for NS_28	147
6.2F.3.3	A-MPR for NS_29	147
6.2F.3.4	A-MPR for NS_30	148
6.2F.3.5	A-MPR for NS_31	148
6.2F.3.6	A-MPR for NS_53	149
6.2F.3.7	A-MPR for NS_54	149
6.2F.3A	UE additional maximum output power reduction for CA.....	150
6.2F.3A.1	UE additional maximum output power reduction for inter-band CA.....	150
6.2F.4	Configured transmitted power	150
6.3	Output power dynamics.....	150
6.3.1	Minimum output power	150
6.3.2	Transmit OFF power.....	150
6.3.3	Transmit ON/OFF time mask	151
6.3.3.1	General	151
6.3.3.2	General ON/OFF time mask	151
6.3.3.3	Transmit power time mask for slot and short or long subslot boundaries.....	152
6.3.3.4	PRACH time mask.....	152
6.3.3.5	Void.....	153
6.3.3.6	SRS time mask	153
6.3.3.7	PUSCH-PUCCH and PUSCH-SRS time masks	155
6.3.3.8	Transmit power time mask for consecutive slot or long subslot transmission and short subslot transmission boundaries	156
6.3.3.9	Transmit power time mask for consecutive short subslot transmissions boundaries	156
6.3.4	Power control.....	157
6.3.4.1	General	157
6.3.4.2	Absolute power tolerance.....	157
6.3.4.3	Relative power tolerance	158
6.3.4.4	Aggregate power tolerance.....	158
6.3A	Output power dynamics for CA	158
6.3A.1	Minimum output power for CA	158
6.3A.1.1	Minimum output power for intra-band contiguous CA.....	158
6.3A.1.2	Minimum output power for intra-band non-contiguous CA	159
6.3A.1.3	Minimum output power for inter-band CA	159
6.3A.1.4	Void.....	159
6.3A.2	Transmit OFF power for CA.....	159
6.3A.2.1	Transmit OFF power for intra-band contiguous CA	159
6.3A.2.2	Transmit OFF power for intra-band non-contiguous CA.....	159
6.3A.2.3	Transmit OFF power for inter-band CA.....	159
6.3A.2.4	Void.....	159
6.3A.3	Transmit ON/OFF time mask for CA	159
6.3A.3.1	Transmit ON/OFF time mask for intra-band contiguous CA.....	159
6.3A.3.2	Transmit ON/OFF time mask for intra-band non-contiguous CA	160
6.3A.3.3	Transmit ON/OFF time mask for inter-band CA	160
6.3A.3.3.1	General	160
6.3A.3.3.2	Time mask for switching between two uplink carriers	160

6.3A.3.4	Void.....	162
6.3A.4	Power control for CA.....	162
6.3A.4.1	Power control for intra-band contiguous CA	162
6.3A.4.1.1	Absolute power tolerance	162
6.3A.4.1.2	Relative power tolerance	162
6.3A.4.1.3	Aggregate power control tolerance.....	162
6.3A.4.2	Power control for intra-band non-contiguous CA	162
6.3A.4.2.1	Absolute power tolerance.....	162
6.3A.4.2.1.1	Minimum requirements	162
6.3A.4.2.2	Relative power tolerance	163
6.3A.4.2.2.1	Minimum requirements	163
6.3A.4.2.3	Aggregate power control tolerance	163
6.3A.4.3	Power control for inter-band CA.....	163
6.3A.4.4	Void.....	163
6.3B	Output power dynamics for NR-DC.....	163
6.3C	Output power dynamics for SUL	163
6.3C.1	Void	163
6.3C.2	Void	163
6.3C.3	Transmit ON/OFF time mask for SUL	163
6.3C.3.1	Time mask for switching between two uplink carriers.....	163
6.3D	Output power dynamics for UL MIMO	165
6.3D.1	Minimum output power for UL MIMO	165
6.3D.2	Transmit OFF power for UL MIMO.....	165
6.3D.3	Transmit ON/OFF time mask for UL MIMO	165
6.3D.4	Power control for UL MIMO.....	165
6.3E	Output power dynamics for V2X	165
6.3E.1	Minimum output power for V2X.....	165
6.3E.1.1	General	165
6.3E.1.2	Minimum output power for V2X concurrent operation	166
6.3E.2	Transmit OFF power for V2X	166
6.3E.2.1	General	166
6.3E.2.2	Transmit OFF power for V2X concurrent operation.....	166
6.3E.3	Transmit ON/OFF time mask for V2X.....	166
6.3E.3.1	General	166
6.3E.3.2	General time mask.....	166
6.3E.3.3	S-SSB time mask	167
6.3E.3.4	Transmit ON/OFF time mask for V2X concurrent operation	167
6.3E.4	Power control for V2X	168
6.3E.4.1	General	168
6.3E.4.2	Absolute power tolerance.....	168
6.3E.4.3	Power control for V2X concurrent operation.....	168
6.3F	Output power dynamics for shared spectrum channel access.....	168
6.3F.1	Minimum output power	168
6.3F.2	Transmit OFF power.....	168
6.3F.3	Transmit ON/OFF time mask	168
6.3F.3.1	General	168
6.3F.3.2	General ON/OFF time mask	168
6.3F.3A	General ON/OFF mask for CA	169
6.3F.3A.1	General ON/OFF mask for inter-band CA	169
6.3F.4	Power control.....	169
6.3F.4.1	General	169
6.3F.4.2	Absolute power tolerance.....	169
6.3F.4.3	Relative power tolerance	169
6.3F.4.4	Aggregate power tolerance.....	169
6.4	Transmit signal quality	169
6.4.1	Frequency error.....	169
6.4.2	Transmit modulation quality.....	170
6.4.2.0	General	170
6.4.2.1	Error Vector Magnitude	170
6.4.2.1a	Error Vector Magnitude including symbols with transient period	171
6.4.2.2	Carrier leakage	171
6.4.2.3	In-band emissions	172

6.4.2.4	EVM equalizer spectrum flatness	173
6.4.2.4.1	Requirements for Pi/2 BPSK modulation.....	174
6.4A	Transmit signal quality for CA.....	175
6.4A.1	Frequency error for CA.....	175
6.4A.1.1	Frequency error for intra-band contiguous CA	175
6.4A.1.2	Frequency error for intra-band non-contiguous CA.....	175
6.4A.1.3	Frequency error for inter-band CA.....	175
6.4A.1.4	Void.....	175
6.4A.2	Transmit modulation quality for CA.....	175
6.4A.2.1	Transmit modulation quality for intra-band contiguous CA	175
6.4A.2.1.0	General	175
6.4A.2.1.1	Error Vector Magnitude.....	176
6.4A.2.1.2	In-band emissions.....	176
6.4A.2.1.3	Carrier leakage.....	178
6.4A.2.2	Transmit modulation quality for intra-band non-contiguous CA	178
6.4A.2.2.0	General	178
6.4A.2.2.1	Error Vector Magnitude.....	178
6.4A.2.2.2	In-band emissions	179
6.4A.2.2.3	Carrier leakage.....	179
6.4A.2.3	Transmit modulation quality for inter-band CA.....	179
6.4A.2.4	Void.....	179
6.4B	Transmit signal quality for NR-DC.....	179
6.4D	Transmit signal quality for UL MIMO.....	180
6.4D.0	General.....	180
6.4D.1	Frequency error for UL MIMO.....	180
6.4D.2	Transmit modulation quality for UL MIMO.....	180
6.4D.2.0	General	180
6.4D.2.1	Error Vector Magnitude	180
6.4D.2.2	Carrier leakage	181
6.4D.2.3	In-band emissions	181
6.4D.2.4	EVM equalizer spectrum flatness for UL MIMO	181
6.4D.3	Time alignment error for UL MIMO	181
6.4D.4	Requirements for coherent UL MIMO	181
6.4E	Transmit signal quality for V2X.....	182
6.4E.1	Frequency error for V2X	182
6.4E.1.1	General	182
6.4E.1.2	Frequency error for V2X concurrent operation.....	182
6.4E.2	Transmit modulation quality for V2X	182
6.4E.2.1	General	182
6.4E.2.2	Error Vector Magnitude for V2X.....	182
6.4E.2.3	Carrier leakage for V2X.....	182
6.4E.2.4	In-band emissions for V2X	182
6.4E.2.5	EVM equalizer spectrum flatness for V2X	183
6.4E.2.6	Transmit modulation quality for V2X concurrent operation.....	183
6.4F	Transmit signal quality for shared spectrum channel access.....	183
6.4F.1	Frequency error.....	183
6.4F.2	Transmit modulation quality.....	183
6.4F.2.0	General	183
6.4F.2.1	Error Vector Magnitude	183
6.4F.2.2	Carrier leakage	183
6.4F.2.3	In-band emissions	183
6.4F.2.4	EVM equalizer spectrum flatness	184
6.4F.2A	Transmit modulation quality for CA.....	184
6.4F.2A.1	Transmit modulation quality for inter-band CA.....	184
6.5	Output RF spectrum emissions.....	185
6.5.1	Occupied bandwidth	185
6.5.2	Out of band emission	185
6.5.2.1	General	185
6.5.2.2	Spectrum emission mask.....	185
6.5.2.3	Additional spectrum emission mask	186
6.5.2.3.1	Requirements for network signalling value "NS_35".....	186
6.5.2.3.2	Requirements for network signalling value "NS_04".....	186

6.5.2.3.3	Requirements for network signalling values "NS_03", "NS_03U", and "NS_21"	187
6.5.2.3.4	Requirements for network signalling value "NS_06"	188
6.5.2.3.5	Void	188
6.5.2.3.6	Void	188
6.5.2.3.7	Void	188
6.5.2.3.8	Requirements for network signalling value "NS_27"	188
6.5.2.4	Adjacent channel leakage ratio	189
6.5.2.4.1	NR ACLR	189
6.5.2.4.2	UTRA ACLR	189
6.5.3	Spurious emissions	190
6.5.3.0	General	190
6.5.3.1	General spurious emissions	190
6.5.3.2	Spurious emissions for UE co-existence	191
6.5.3.3	Additional spurious emissions	197
6.5.3.3.1	Requirement for network signalling value "NS_04"	197
6.5.3.3.2	Requirement for network signalling value "NS_17"	197
6.5.3.3.3	Requirement for network signalling value "NS_18"	198
6.5.3.3.4	Requirement for network signalling values "NS_05" and "NS_05U"	198
6.5.3.3.5	Requirement for network signalling values "NS_43" and "NS_43U"	198
6.5.3.3.6	Requirement for network signalling value "NS_37"	198
6.5.3.3.7	Requirement for network signalling value "NS_38"	199
6.5.3.3.8	Requirement for network signalling value "NS_39"	199
6.5.3.3.9	Requirement for network signalling value "NS_40"	199
6.5.3.3.10	Requirement for network signalling value "NS_41"	199
6.5.3.3.11	Requirement for network signalling value "NS_42"	200
6.5.3.3.12	Requirement for network signalling value "NS_21"	200
6.5.3.3.13	Requirement for network signalling value "NS_24"	200
6.5.3.3.14	Requirement for network signalling value "NS_27"	201
6.5.3.3.15	Requirement for network signalling value "NS_47"	201
6.5.3.3.16	Requirement for network signalling value "NS_50"	201
6.5.3.3.17	Requirement for network signalling value "NS_12"	201
6.5.3.3.18	Requirement for network signalling value "NS_13"	202
6.5.3.3.19	Requirement for network signalling value "NS_14"	202
6.5.3.3.20	Requirement for network signalling value "NS_15"	202
6.5.3.3.21	Requirement for network signalling value "NS_45"	203
6.5.3.3.22	Requirement for network signalling values "NS_48" and "NS_51"	203
6.5.3.3.23	Requirement for network signalling value "NS_49"	203
6.5.3.3.24	Requirement for network signalling value "NS_44"	204
6.5.3.3.25	Requirement for network signalling value "NS_46"	204
6.5.4	Transmit intermodulation	204
6.5.A	Output RF spectrum emissions for CA	205
6.5.A.0	General	205
6.5.A.1	Occupied bandwidth for CA	205
6.5.A.1.1	Void	205
6.5.A.1.1a	Occupied bandwidth for Intra-band contiguous CA	205
6.5.A.1.2	Occupied bandwidth for Intra-band non-contiguous CA	205
6.5.A.1.3	Occupied bandwidth for Inter-band CA	205
6.5.A.2	Out of band emission for CA	205
6.5.A.2.1	General	205
6.5.A.2.2	Spectrum emission mask	205
6.5.A.2.2.1	Spectrum emission mask for intra-band contiguous CA	205
6.5.A.2.2.2	Spectrum emission mask for intra-band non-contiguous CA	206
6.5.A.2.2.3	Spectrum emission mask for Inter-band CA	206
6.5.A.2.2.4	Void	206
6.5.A.2.3	Additional spectrum emission mask for CA	206
6.5.A.2.3.1	Additional spectrum emission mask for intra-band contiguous CA	206
6.5.A.2.3.1	Void	207
6.5.A.2.3.2	Additional spectrum emission mask for Intra-band non-contiguous CA	207
6.5.A.2.3.2.1	Minimum requirement (network signalling value "CA_NC_NS_04")	207
6.5.A.2.3.3	Additional spectrum emission mask for Inter-band CA	207
6.5.A.2.4	Adjacent channel leakage ratio	207
6.5.A.2.4.1	NR ACLR	207

6.5A.2.4.2	UTRA ACLR	208
6.5A.3	Spurious emission for CA.....	208
6.5A.3.1	General spurious emissions.....	208
6.5A.3.2	Spurious emissions for UE co-existence.....	209
6.5A.3.2.1	Spurious emissions for UE co-existence for intra-band contiguous CA.....	209
6.5A.3.2.2	Spurious emissions for UE co-existence for intra-band non-contiguous CA	210
6.5A.3.2.3	Spurious emissions for UE co-existence for Inter-band CA.....	211
6.5A.3.2.4	Void.....	213
6.5A.3.2.5	Void.....	213
6.5A.3.2.6	Void.....	213
6.5A.3.3	Additional spurious emissions for CA	213
6.5A.3.3.1	Additional spurious emissions for intra-band contiguous CA.....	213
6.5A.3.3.2	Additional spurious emissions for intra-band non-contiguous CA.....	214
6.5A.4	Transmit intermodulation for CA	214
6.5A.4.2.1	Transmit intermodulation for intra-band contiguous CA	214
6.5A.4.2.2	Void.....	214
6.5B	Output RF spectrum emissions for NR-DC.....	215
6.5D	Output RF spectrum emissions for UL MIMO.....	215
6.5D.1	Occupied bandwidth for UL MIMO	215
6.5D.2	Out of band emission for UL MIMO.....	215
6.5D.3	Spurious emission for UL MIMO.....	215
6.5D.4	Transmit intermodulation for UL MIMO	215
6.5E	Output RF spectrum emissions for V2X	216
6.5E.1	Occupied bandwidth for V2X.....	216
6.5E.1.1	General.....	216
6.5E.1.2	Occupied bandwidth for V2X concurrent operation	216
6.5E.2	Out of band emission for V2X.....	216
6.5E.2.1	General.....	216
6.5E.2.2	Spectrum emission mask.....	216
6.5E.2.2.1	General	216
6.5E.2.2.2	Spectrum emission mask for V2X concurrent operation.....	216
6.5E.2.3	Additional Spectrum emission mask.....	217
6.5E.2.3.1	Requirements for network signalling value "NS_33".....	217
6.5E.2.3.2	Requirements for network signalling value "NS_52".....	217
6.5E.2.4	Adjacent channel leakage ratio	218
6.5E.2.4.1	General	218
6.5E.2.4.2	ACLR for V2X concurrent operation.....	218
6.5E.3	Spurious emissions for V2X.....	218
6.5E.3.1	General spurious emissions.....	218
6.5E.3.2	Spurious emissions for UE co-existence.....	218
6.5E.3.3	Spurious emissions for UE co-existence for V2X concurrent operation.....	218
6.5E.3.4	Additional spurious emissions requirements for V2X	219
6.5E.3.4.1	General	219
6.5E.3.4.2	Requirements for network signalling value "NS_33".....	219
6.5E.3.4.3	Void.....	220
6.5E.4	Transmit intermodulation	220
6.5E.4.1	General.....	220
6.5E.4.2	Transmit intermodulation for V2X concurrent operation.....	220
6.5F	Output RF spectrum emissions.....	220
6.5F.1	Occupied bandwidth	220
6.5F.2	Out of band emission	220
6.5F.2.1	General.....	220
6.5F.2.2	Spectrum emission mask for operation with shared spectrum channel access.....	220
6.5F.2.2.0	General	220
6.5F.2.2.1	Spectrum emission mask for non-transmitted channels.....	221
6.5F.2.3	Additional spectrum emission mask	221
6.5F.2.4	Adjacent channel leakage ratio	221
6.5F.2.4.0	General	221
6.5F.2.4.1	Shared spectrum channel access ACLR	222
6.5F.2.4.2	Additional requirement for network signaled value "NS_29"	222
6.5F.3	Spurious emissions	222
6.5F.3.0	General.....	222

6.5F.3.1	General spurious emissions	222
6.5F.3.2	Spurious emissions for UE co-existence	222
6.5F.3.3	Additional spurious emissions	223
6.5F.3.3.0	General	223
6.5F.3.3.1	Requirement for network signalling value "NS_28"	223
6.5F.3.3.2	Requirement for network signalling value "NS_29"	223
6.5F.3.3.3	Requirement for network signalling value "NS_30"	225
6.5F.3.3.4	Requirement for network signalling value "NS_31"	225
6.5F.3.3.5	Requirements for network signalling value "NS_53" or "NS_54"	226
6.5F.4	Transmit intermodulation	226
6.6	Void	226
6.6E	Time alignment error	226
7	Receiver characteristics	227
7.1	General	227
7.1A	General	227
7.1F	General	228
7.2	Diversity characteristics	228
7.3	Reference sensitivity	228
7.3.1	General	228
7.3.2	Reference sensitivity power level	228
7.3.3	$\Delta R_{IB,c}$	235
7.3A	Reference sensitivity for CA	235
7.3A.1	General	235
7.3A.2	Reference sensitivity power level for CA	236
7.3A.2.1	Reference sensitivity power level for Intra-band contiguous CA	236
7.3A.2.2	Reference sensitivity power level for Intra-band non-contiguous CA	236
7.3A.2.3	Reference sensitivity power level for Inter-band CA	237
7.3A.2.4	Void	237
7.3A.3	$\Delta R_{IB,c}$ for CA	237
7.3A.3.1	General	237
7.3A.3.2	$\Delta R_{IB,c}$ for Inter-band CA	237
7.3A.3.2.1	$\Delta R_{IB,c}$ for two bands	238
7.3A.3.2.2	Void	239
7.3A.3.2.3	$\Delta R_{IB,c}$ for three bands	239
7.3A.3.2.4	$\Delta R_{IB,c}$ for four bands	241
7.3A.4	Reference sensitivity exceptions due to UL harmonic interference for CA	241
7.3A.5	Reference sensitivity exceptions due to intermodulation interference due to 2UL CA	244
7.3A.6	Reference sensitivity exceptions due to cross band isolation for CA	248
7.3B	Reference sensitivity for NR-DC	249
7.3C	Reference sensitivity for SUL	249
7.3C.1	General	249
7.3C.2	Reference sensitivity power level for SUL	249
7.3C.3	$\Delta R_{IB,c}$ for SUL	251
7.3C.3.1	General	251
7.3C.3.2	SUL band combination	251
7.3C.3.2.1	$\Delta R_{IB,c}$ for two bands	252
7.3D	Reference sensitivity for UL MIMO	252
7.3E	Reference sensitivity for V2X	252
7.3E.1	General	252
7.3E.2	Minimum requirements	252
7.3F	Reference sensitivity for shared spectrum channel access	254
7.3F.1	General	254
7.3F.2	Reference sensitivity power level	254
7.3F.3	$\Delta R_{IB,c}$	255
7.3F.4	Intra-band contiguous shared spectrum channel access CA	255
7.3F.5	Inter-band CA with shared spectrum channel access	256
7.3F.5.1	Reference sensitivity exceptions due to UL harmonic interference	256
7.3F.5.2	Reference sensitivity exceptions due to receiver harmonic mixing	256
7.3F.5.3	Reference sensitivity exceptions due to cross band isolation	257
7.4	Maximum input level	257
7.4A	Maximum input level for CA	258

7.4A.1	Maximum input level for Intra-band contiguous CA	258
7.4A.2	Maximum input level for Intra-band non-contiguous CA	258
7.4A.3	Maximum input level for Inter-band CA	258
7.4B	Maximum input level for NR-DC	258
7.4D	Maximum input level for UL MIMO	259
7.4E	Maximum input level for V2X	259
7.4E.1	General.....	259
7.4E.2	Maximum input level for V2X concurrent operation	259
7.5	Adjacent channel selectivity.....	259
7.5A	Adjacent channel selectivity for CA.....	263
7.5A.1	Adjacent channel selectivity for Intra-band contiguous CA	263
7.5A.2	Adjacent channel selectivity Intra-band non-contiguous CA	264
7.5A.3	Adjacent channel selectivity Inter-band CA	265
7.5B	Adjacent channel selectivity for NR-DC.....	265
7.5D	Adjacent channel selectivity for UL MIMO.....	265
7.5E	Adjacent channel selectivity for V2X	265
7.5E.1	General.....	265
7.5E.2	Adjacent channel selectivity for V2X concurrent operation.....	266
7.5F	Adjacent channel selectivity.....	267
7.5F.1	General.....	267
7.5F.2	Intra-band contiguous shared spectrum channel access CA	267
7.6	Blocking characteristics	268
7.6.1	General.....	268
7.6.2	In-band blocking	268
7.6.3	Out-of-band blocking.....	271
7.6.4	Narrow band blocking	273
7.6A	Blocking characteristics for CA	274
7.6A.1	General.....	274
7.6A.2	In-band blocking for CA.....	274
7.6A.2.1	In-band blocking for Intra-band contiguous CA	274
7.6A.2.2	In-band blocking for Intra-band non-contiguous CA	276
7.6A.2.3	In-band blocking for Inter-band CA.....	276
7.6A.3	Out-of-band blocking for CA.....	276
7.6A.3.1	Out-of-band blocking for Intra-band contiguous CA	276
7.6A.3.2	Out-of-band blocking for Intra-band non-contiguous CA.....	277
7.6A.3.3	Out-of-band blocking for Inter-band CA	278
7.6A.4	Narrow band blocking for CA	279
7.6A.4.1	Narrow band blocking for Intra-band contiguous CA.....	279
7.6A.4.2	Narrow band blocking for Intra-band non-contiguous CA	279
7.6A.4.3	Narrow band blocking for Inter-band CA	280
7.6B	Blocking characteristics for NR-DC.....	280
7.6C	Blocking characteristics for SUL	280
7.6C.1	General.....	280
7.6C.2	In-band blocking for SUL.....	280
7.6C.3	Out-of-band blocking for SUL.....	280
7.6C.4	Narrow band blocking for SUL	281
7.6D	Blocking characteristics for UL MIMO	281
7.6E	Blocking characteristics for V2X	281
7.6E.1	General.....	281
7.6E.2	In-band blocking	281
7.6E.2.1	General	281
7.6E.2.2	In-band blocking for V2X concurrent operation.....	282
7.6E.3	Out-of-band blocking.....	282
7.6E.3.1	General	282
7.6E.3.2	Out-of-band blocking for V2X concurrent operation.....	283
7.6F	Blocking characteristics	283
7.6F.1	General.....	283
7.6F.2	In-band blocking	283
7.6F.2.1	General	283
7.6F.2.2	Intra-band contiguous shared spectrum channel access CA.....	284
7.6F.3	Out-of-band blocking.....	284
7.6F.3.1	General	284

7.6F.3.2	Intra-band contiguous shared spectrum channel access CA.....	285
7.7	Spurious response.....	286
7.7A	Spurious response for CA.....	287
7.7A.1	Spurious response for Intra-band contiguous CA.....	287
7.7A.2	Spurious response for Intra-band non-contiguous CA.....	288
7.7A.3	Spurious response for Inter-band CA.....	288
7.7B	Spurious response for NR-DC.....	288
7.7D	Spurious response for UL MIMO.....	288
7.7E	Spurious response for V2X.....	288
7.7E.1	General.....	288
7.7E.2	Spurious response for V2X concurrent operation.....	289
7.7F	Spurious response for shared spectrum channel access.....	289
7.7F.1	General.....	289
7.7F.2	Intra-band contiguous shared spectrum channel access CA.....	289
7.8	Intermodulation characteristics.....	290
7.8.1	General.....	290
7.8.2	Wide band Intermodulation.....	290
7.8A	Intermodulation characteristics for CA.....	291
7.8A.1	General.....	291
7.8A.2	Wide band intermodulation for CA.....	291
7.8A.2.1	Wide band intermodulation for Intra-band contiguous CA.....	291
7.8A.2.2	Wide band intermodulation for Intra-band non-contiguous CA.....	292
7.8A.2.3	Wide band intermodulation for Inter-band CA.....	292
7.8B	Intermodulation characteristics for NR-DC.....	293
7.8D	Intermodulation characteristics for UL MIMO.....	293
7.8E	Intermodulation characteristics for V2X.....	293
7.8E.1	General.....	293
7.8E.2	Wide band Intermodulation.....	293
7.8E.2.1	General.....	293
7.8E.2.2	Wide band Intermodulation for V2X concurrent operation.....	293
7.8F	Intermodulation characteristics for shared spectrum channel access.....	294
7.8F.1	General.....	294
7.8F.2	Wide band Intermodulation.....	294
7.9	Spurious emissions.....	294
7.9A	Spurious emissions for CA.....	295
7.9A.1	Void.....	295
7.9A.2	Void.....	295
7.9A.3	Spurious emissions for Inter-band CA.....	295
7.9B	Spurious emissions for NR-DC.....	295
Annex A (normative): Measurement channels.....		296
A.1	General.....	296
A.2	UL reference measurement channels.....	296
A.2.1	General.....	296
A.2.2	Reference measurement channels.....	298
A.2.2.1	DFT-s-OFDM Pi/2-BPSK.....	298
A.2.2.2	DFT-s-OFDM QPSK.....	299
A.2.2.3	DFT-s-OFDM 16QAM.....	300
A.2.2.4	DFT-s-OFDM 64QAM.....	301
A.2.2.5	DFT-s-OFDM 256QAM.....	302
A.2.2.6	CP-OFDM QPSK.....	303
A.2.2.7	CP-OFDM 16QAM.....	305
A.2.2.8	CP-OFDM 64QAM.....	307
A.2.2.9	CP-OFDM 256QAM.....	309
A.2.3	Reference measurement channels for TDD.....	311
A.2.3.1	DFT-s-OFDM Pi/2-BPSK.....	311
A.2.3.2	DFT-s-OFDM QPSK.....	311
A.2.3.3	DFT-s-OFDM 16QAM.....	311
A.2.3.4	DFT-s-OFDM 64QAM.....	311
A.2.3.5	DFT-s-OFDM 256QAM.....	312
A.2.3.6	CP-OFDM QPSK.....	312

A.2.3.7	CP-OFDM 16QAM	312
A.2.3.8	CP-OFDM 64QAM	312
A.2.3.9	CP-OFDM 256QAM	313
A.3	DL reference measurement channels	314
A.3.1	General	314
A.3.2	DL reference measurement channels for FDD	316
A.3.2.1	General.....	316
A.3.2.2	FRC for receiver requirements for QPSK.....	316
A.3.2.3	FRC for maximum input level for 64QAM	318
A.3.2.4	FRC for maximum input level for 256 QAM	321
A.3.3	DL reference measurement channels for TDD.....	324
A.3.3.1	General.....	324
A.3.3.2	FRC for receiver requirements for QPSK.....	324
A.3.3.3	FRC for maximum input level for 64QAM	328
A.3.3.4	FRC for maximum input level for 256 QAM	331
A.4	CSI reference measurement channels.....	334
A.5	OFDMA Channel Noise Generator (OCNG)	334
A.5.1	OCNG Patterns for FDD	334
A.5.1.1	OCNG FDD pattern 1: Generic OCNG FDD Pattern for all unused REs.....	334
A.5.2	OCNG Patterns for TDD.....	334
A.5.2.1	OCNG TDD pattern 1: Generic OCNG TDD Pattern for all unused REs	334
A.6	Void.....	335
A.7	V2X reference measurement channels	335
A.7.1	General	335
A.7.2	FRC for V2X receiver requirements for QPSK.....	335
A.7.3	FRC for maximum input level for 64QAM.....	337
A.7.4	FRC for maximum input level for 256QAM.....	338
Annex B (informative):	Void	340
Annex C (informative):	Downlink physical channels.....	341
C.1	General	341
C.2	Setup.....	341
C.3	Connection	341
C.3.1	Measurement of Receiver Characteristics	341
Annex D (normative):	Characteristics of the interfering signal	342
D.1	General.....	342
D.2	Interference signals.....	342
Annex E (normative):	Environmental conditions	344
E.1	General	344
E.2	Environmental	344
E.2.1	Temperature	344
E.2.2	Voltage	344
E.2.3	Vibration.....	345
Annex F (normative):	Transmit modulation.....	346
F.0	General	346
F.1	Measurement Point.....	346
F.2	Basic Error Vector Magnitude measurement	346
F.3	Basic in-band emissions measurement.....	347

F.4	Modified signal under test	348
F.5	Window length	350
F.5.1	Timing offset	350
F.5.2	Window length	350
F.5.3	Window length for normal CP	350
F.5.4	Window length for Extended CP	351
F.5.5	Window length for PRACH	352
F.6	Averaged EVM	352
F.7	Spectrum Flatness	354
F.8	354	
F.9	354	
F.10	EVM for UL MIMO	354
F10.1	General	354
F10.2	MIMO Equalization	355
F10.3	Layer processing	355
Annex G (normative):		356
G.0	General	356
G.1	Measurement Point	356
G.2	Relative Phase Error Measurement	357
G.2.1	Symbols and subcarriers used	357
G.2.2	CFO (carrier frequency offset) correction	357
G.2.3	Steps of the measurement method	357
Annex H (informative):		Void
Annex I (informative):		Void
Annex J (informative):		Void
Annex K (informative):		Void
Annex L (normative):		ModifiedMPR-Behavior
L.1	Indication of modified MPR behavior	363
Annex M (informative):		Change history
History		381

Foreword

This Technical Specification has been produced by the 3rd Generation Partnership Project (3GPP).

The contents of the present document are subject to continuing work within the TSG and may change following formal TSG approval. Should the TSG modify the contents of the present document, it will be re-released by the TSG with an identifying change of release date and an increase in version number as follows:

Version x.y.z

where:

- x the first digit:
 - 1 presented to TSG for information;
 - 2 presented to TSG for approval;
 - 3 or greater indicates TSG approved document under change control.
- y the second digit is incremented for all changes of substance, i.e. technical enhancements, corrections, updates, etc.
- z the third digit is incremented when editorial only changes have been incorporated in the document.

In the present document, modal verbs have the following meanings:

- shall** indicates a mandatory requirement to do something
- shall not** indicates an interdiction (prohibition) to do something

The constructions "shall" and "shall not" are confined to the context of normative provisions, and do not appear in Technical Reports.

The constructions "must" and "must not" are not used as substitutes for "shall" and "shall not". Their use is avoided insofar as possible, and they are not used in a normative context except in a direct citation from an external, referenced, non-3GPP document, or so as to maintain continuity of style when extending or modifying the provisions of such a referenced document.

- should** indicates a recommendation to do something
- should not** indicates a recommendation not to do something
- may** indicates permission to do something
- need not** indicates permission not to do something

The construction "may not" is ambiguous and is not used in normative elements. The unambiguous constructions "might not" or "shall not" are used instead, depending upon the meaning intended.

- can** indicates that something is possible
- cannot** indicates that something is impossible

The constructions "can" and "cannot" are not substitutes for "may" and "need not".

- will** indicates that something is certain or expected to happen as a result of action taken by an agency the behaviour of which is outside the scope of the present document
- will not** indicates that something is certain or expected not to happen as a result of action taken by an agency the behaviour of which is outside the scope of the present document
- might** indicates a likelihood that something will happen as a result of action taken by some agency the behaviour of which is outside the scope of the present document

might not indicates a likelihood that something will not happen as a result of action taken by some agency the behaviour of which is outside the scope of the present document

In addition:

is (or any other verb in the indicative mood) indicates a statement of fact

is not (or any other negative verb in the indicative mood) indicates a statement of fact

The constructions "is" and "is not" do not indicate requirements.

1 Scope

The present document establishes the minimum RF requirements for NR User Equipment (UE) operating on frequency Range 1.

2 References

The following documents contain provisions which, through reference in this text, constitute provisions of the present document.

References are either specific (identified by date of publication, edition number, version number, etc.) or non-specific.

For a specific reference, subsequent revisions do not apply.

For a non-specific reference, the latest version applies. In the case of a reference to a 3GPP document (including a GSM document), a non-specific reference implicitly refers to the latest version of that document in the same Release as the present document.

- [1] 3GPP TR 21.905: "Vocabulary for 3GPP Specifications".
- [2] 3GPP TS 38.101-2: "NR; User Equipment (UE) radio transmission and reception; Part 2: Range 2 Standalone".
- [3] 3GPP TS 38.101-3: "NR; User Equipment (UE) radio transmission and reception; Part 3: Range 1 and Range 2 Interworking operation with other radios".
- [4] 3GPP TS 38.521-1: "NR; User Equipment (UE) conformance specification; Radio transmission and reception; Part 1: Range 1 Standalone".
- [5] Recommendation ITU-R M.1545: "Measurement uncertainty as it applies to test limits for the terrestrial component of International Mobile Telecommunications-2000".
- [6] 3GPP TS 38.211: "NR; Physical channels and modulation".
- [7] 3GPP TS 38.331: "Radio Resource Control (RRC) protocol specification".
- [8] 3GPP TS 38.213: "NR; Physical layer procedures for control".
- [9] ITU-R Recommendation SM.329-10, "Unwanted emissions in the spurious domain".
- [10] 3GPP TS 38.214: "NR; Physical layer procedures for data".
- [11] 3GPP TS 36.101: Evolved Universal Terrestrial Radio Access (E-UTRA); User Equipment (UE) radio transmission and reception;
- [12] ETSI TS 102 792: "Intelligent Transport Systems (ITS); Mitigation techniques to avoid interference between European CEN Dedicated Short Range Communication (CEN DSRC) equipment and Intelligent Transport Systems (ITS) operating in the 5 GHz frequency range".
- [13] 3GPP TS 38.133: "NR; Requirements for support of radio resource management".
- [14] 3GPP TS 37.213: "Physical layer procedures for shared spectrum channel access".

3 Definitions, symbols and abbreviations

3.1 Definitions

For the purposes of the present document, the terms and definitions given in 3GPP TR 21.905 [1] and the following apply. A term defined in the present document takes precedence over the definition of the same term, if any, in 3GPP TR 21.905 [1].

Aggregated Allocation Bandwidth: Total bandwidth of all allocated RBs in a transmission occasion. Can be calculated for two aggregated CCs as $L_{CRB,1} * 12 * SCS_1 + L_{CRB,2} * 12 * SCS_2$.

Aggregated Channel Bandwidth: The RF bandwidth in which a UE transmits and receives multiple contiguously aggregated carriers.

Carrier aggregation: Aggregation of two or more component carriers in order to support wider transmission bandwidths.

Carrier aggregation band: A set of one or more operating bands across which multiple carriers are aggregated with a specific set of technical requirements.

Carrier aggregation bandwidth class: A class defined by the aggregated transmission bandwidth configuration and maximum number of component carriers supported by a UE.

Carrier aggregation configuration: A combination of CA operating band(s) and CA bandwidth class(es) supported by a UE.

Concurrent operation: The simultaneous transmission and reception of sidelink and Uu interfaces while operation is agnostic of the service used on each interface.

Contiguous carriers: A set of two or more carriers configured in a spectrum block where there are no RF requirements based on co-existence for un-coordinated operation within the spectrum block.

Contiguous resource allocation: A resource allocation of consecutive resource blocks within one carrier or across contiguously aggregated carriers. The gap between contiguously aggregated carriers due to the nominal channel spacing is allowed.

Contiguous spectrum: Spectrum consisting of a contiguous block of spectrum with no sub-block gaps.

Inter-band carrier aggregation: Carrier aggregation of component carriers in different operating bands.

NOTE: Carriers aggregated in each band can be contiguous or non-contiguous.

Intra-band contiguous carrier aggregation: Contiguous carriers aggregated in the same operating band.

Intra-band non-contiguous carrier aggregation: Non-contiguous carriers aggregated in the same operating band.

Sub-band: For a UE that supports shared spectrum channel access in wideband operation, a sub-band is the set of RBs within an approximately 20 MHz segment of the channel where the wideband channel is uniformly divided into an integer number of 20 MHz sub-bands. Sub-bands may be separately allocated in uplink and downlink.

Sub-block: This is one contiguous allocated block of spectrum for transmission and reception by the same UE. There may be multiple instances of sub-blocks within an RF bandwidth.

Sub-block bandwidth: The bandwidth of one sub-block.

Sub-block gap: A frequency gap between two consecutive sub-blocks within an RF bandwidth, where the RF requirements in the gap are based on co-existence for un-coordinated operation.

UE transmission bandwidth configuration: Set of resource blocks located within the UE channel bandwidth which may be used for transmitting or receiving by the UE.

Vehicular UE: A UE embedded in a vehicle, permanently connected to an embedded antenna system that radiates externally for NR operating bands.

NOTE: Vehicular UE does not refer to other UE form factors placed inside the vehicle.

Wideband operation: For a UE that supports shared spectrum channel access, wideband operation refers to operation within a channel larger than 20 MHz in which intra-cell guard bands may be configured to distinguish individual RB-sets

3.2 Symbols

For the purposes of the present document, the following symbols apply:

ΔF_{Global}	Granularity of the global frequency raster
ΔF_{Raster}	Band dependent channel raster granularity
Δf_{OOB}	Δ Frequency of Out Of Band emission
$\Delta F_{\text{TX-RX}}$	Δ Frequency of default TX-RX separation of the FDD <i>operating band</i>
ΔMPR_c	Allowed Maximum Power Reduction relaxation for serving cell c
$\Delta P_{\text{PowerClass}}$	Adjustment to maximum output power for a given power class
Δ_{RB}	The starting frequency offset between the allocated RB and the measured non-allocated RB
$\Delta R_{\text{IB},c}$	Allowed reference sensitivity relaxation due to support for inter-band CA operation, for serving cell c
ΔR_{IBC}	Allowed reference sensitivity relaxation due to support for intra-band contiguous CA operation
ΔR_{IBNC}	Allowed reference sensitivity relaxation due to support for intra-band non-contiguous CA operation
$\Delta R_{\text{IB},4R}$	Reference sensitivity adjustment due to support for 4 antenna ports
Δ_{Shift}	Channel raster offset
ΔT_{C}	Allowed operating band edge transmission power relaxation
$\Delta T_{\text{C},c}$	Allowed operating band edge transmission power relaxation for serving cell c
$\Delta T_{\text{IB},c}$	Allowed maximum configured output power relaxation due to support for inter-band CA operation, inter-band NR-DC operation and due to support for SUL operations, for serving cell c
BW_{Channel}	Channel bandwidth
$BW_{\text{Channel,block}}$	Sub-block bandwidth, expressed in MHz. $BW_{\text{Channel,block}} = F_{\text{edge,block,high}} - F_{\text{edge,block,low}}$
$BW_{\text{Channel_CA}}$	Aggregated channel bandwidth, expressed in MHz
$BW_{\text{Channel,max}}$	Maximum channel bandwidth supported among all bands in a release
BW_{GB}	$\max(BW_{\text{GB,Channel}(k)})$
$BW_{\text{GB,Channel}(k)}$	Minimum guard band defined in clause 5.3A.1 of carrier k
BW_{DL}	Channel bandwidth for DL
BW_{UL}	Channel bandwidth for UL
$BW_{\text{interferer}}$	Bandwidth of the interferer
$\text{Ceil}(x)$	Rounding upwards; $\text{ceil}(x)$ is the smallest integer such that $\text{ceil}(x) \geq x$
$\text{Floor}(x)$	Rounding downwards; $\text{floor}(x)$ is the greatest integer such that $\text{floor}(x) \leq x$
F_{C}	Center frequency of a carrier for a numerology defined by the <i>RF reference frequency</i> on the channel raster mapped to the carrier according to sub-clause 5.4.2.2
$F_{\text{C,block, high}}$	F_{C} of the highest transmitted/received carrier in a <i>sub-block</i>
$F_{\text{C,block, low}}$	F_{C} of the lowest transmitted/received carrier in a <i>sub-block</i>
$F_{\text{C,low}}$	The F_{C} of the lowest carrier, expressed in MHz
$F_{\text{C,high}}$	The F_{C} of the highest carrier, expressed in MHz
$F_{\text{DL_low}}$	The lowest frequency of the downlink <i>operating band</i>
$F_{\text{DL_high}}$	The highest frequency of the downlink <i>operating band</i>
$F_{\text{UL_low}}$	The lowest frequency of the uplink <i>operating band</i>
$F_{\text{UL_high}}$	The highest frequency of the uplink <i>operating band</i>
$F_{\text{edge,block,low}}$	The lower <i>sub-block</i> edge, where $F_{\text{edge,block,low}} = F_{\text{C,block,low}} - F_{\text{offset, low}}$.
$F_{\text{edge,block,high}}$	The upper <i>sub-block</i> edge, where $F_{\text{edge,block,high}} = F_{\text{C,block,high}} + F_{\text{offset, high}}$.
$F_{\text{edge, low}}$	The <i>lower edge of aggregated channel bandwidth</i> , expressed in MHz. $F_{\text{edge,low}} = F_{\text{C,low}} - F_{\text{offset,low}}$.
$F_{\text{edge, high}}$	The <i>higher edge of aggregated channel bandwidth</i> , expressed in MHz. $F_{\text{edge,high}} = F_{\text{C,high}} + F_{\text{offset,high}}$.
$F_{\text{Interferer (offset)}}$	Frequency offset of the interferer (between the center frequency of the interferer and the carrier frequency of the carrier measured). For intra-band contiguous CA, the $F_{\text{Interferer (offset)}}$ is the frequency separation of the center frequency of the carrier closest to the interferer and the center frequency of the interferer
$F_{\text{Interferer}}$	Frequency of the interferer
F_{Ioffset}	Frequency offset of the interferer (between the center frequency of the interferer and the closest edge of the carrier measured)
F_{offset}	Frequency offset from $F_{\text{C,high}}$ to the <i>higher edge</i> or $F_{\text{C,low}}$ to the <i>lower edge</i> .
$F_{\text{offset,high}}$	Frequency offset from $F_{\text{C,high}}$ to the upper <i>UE RF Bandwidth edge</i> , or from $F_{\text{C,block, high}}$ to the upper sub-block edge
$F_{\text{offset,low}}$	Frequency offset from $F_{\text{C,low}}$ to the lower <i>UE RF Bandwidth edge</i> , or from $F_{\text{C,block, low}}$ to the lower sub-block edge
F_{OOB}	The boundary between the NR out of band emission and spurious emission domains
F_{REF}	RF reference frequency

$F_{\text{REF-Offs}}$	Offset used for calculating F_{REF}
$F_{\text{REF, shift}}$	RF reference frequency for Supplementary Uplink (SUL) bands, the uplink of all FDD bands, and TDD bands
F_{uw} (offset)	The frequency separation of the center frequency of the carrier closest to the interferer and the center frequency of the interferer
GB_{Channel}	Minimum guard band defined in clause 5.3.3, expressed in kHz
L_{CRB}	Transmission bandwidth which represents the length of a contiguous resource block allocation expressed in units of resources blocks
$\text{Max}()$	The largest of given numbers
$\text{Min}()$	The smallest of given numbers
n_{PRB}	Physical resource block number
NR_{ACLR}	NR ACLR
NR_{RB}	Transmission bandwidth configuration, expressed in units of resource blocks
$NR_{\text{RB_agg}}$	The number of the aggregated RBs within the fully allocated aggregated channel bandwidth $N_{\text{RB_agg}} = \sum_{i=1}^j N_{\text{RB}_i} * 2^{\mu_i}$ for carrier 1 to j, where μ is defined in TS 38.211 [6]
$NR_{\text{RB,c}}$	The transmission bandwidth configuration of component carrier c, expressed in units of resource blocks $N_{\text{RB,cj}} = N_{\text{RB}_j} * 2^{\mu_j}$ for carrier j, where μ is defined in TS 38.211 [6]
$NR_{\text{RB,largest BW}}$	The largest transmission bandwidth configuration of the component carriers in the bandwidth combination, expressed in units of resource blocks
$NR_{\text{RB,low}}$	The transmission bandwidth configurations according to Table 5.3.2-1 for the lowest assigned component carrier in clause 5.3A.1
$NR_{\text{RB,high}}$	The transmission bandwidth configurations according to Table 5.3.2-1 for the highest assigned component carrier in clause 5.3A.1
N_{REF}	NR Absolute Radio Frequency Channel Number (NR-ARFCN)
$N_{\text{REF-Offs}}$	Offset used for calculating N_{REF}
P_{CMAX}	The configured maximum UE output power
$P_{\text{CMAX,c}}$	The configured maximum UE output power for serving cell c
$P_{\text{CMAX,f,c}}$	The configured maximum UE output power for carrier f of serving cell c in each slot
P_{EMAX}	Maximum allowed UE output power signalled by higher layers
$P_{\text{EMAX,c}}$	Maximum allowed UE output power signalled by higher layers for serving cell c
$P_{\text{Interferer}}$	Modulated mean power of the interferer
$P_{\text{largest BW}}$	Power of the largest transmission bandwidth configuration of the component carriers in the bandwidth combination
$P_{\text{PowerClass}}$	The nominal UE power (i.e., no tolerance)
$P\text{-MPR}_c$	Power Management Maximum Power Reduction for serving cell c
P_{RB}	The transmitted power per allocated RB, measured in dBm
P_{UMAX}	The measured configured maximum UE output power
P_{uw}	Power of an unwanted DL signal
P_{w}	Power of a wanted DL signal
RB_{start}	The lowest RB index of transmitted resource blocks
$RB_{\text{start_CA}}$	The lowest RB index of transmitted resource blocks for intra-band contiguous CA
SCS_c	SCS for the component carrier c, expressed in kHz
$SCS_{\text{largest BW}}$	SCS for the largest transmission bandwidth configuration of the component carriers in the bandwidth combination, expressed in kHz
SCS_{low}	SCS for the lowest assigned component carrier in clause 5.3A.1, expressed in kHz
SCS_{high}	SCS for the highest assigned component carrier in clause 5.3A.1, expressed in kHz
tp	Transient Period value signalled by the UE
tp_{start}	Start position of transient period relative to the symbol boundary
$T(P_{\text{CMAX,f,c}})$	Tolerance for applicable values of $P_{\text{CMAX,f,c}}$ for configured maximum UE output power for carrier f of serving cell c
$T_{\text{L,c}}$	Absolute value of the lower tolerance for the applicable <i>operating band</i> as specified in clause 6.2.1
SS_{REF}	SS block reference frequency position
$UTRA_{\text{ACLR}}$	UTRA ACLR

3.3 Abbreviations

For the purposes of the present document, the abbreviations given in 3GPP TR 21.905 [1] and the following apply. An abbreviation defined in the present document takes precedence over the definition of the same abbreviation, if any, in 3GPP TR 21.905 [1].

ACLR	Adjacent Channel Leakage Ratio
ACS	Adjacent Channel Selectivity
A-MPR	Additional Maximum Power Reduction
BS	Base Station
BW	Bandwidth
BWP	Bandwidth Part
CA	Carrier Aggregation
CA_nX-nY	Inter-band CA of component carrier(s) in one sub-block within Band nX and component carrier(s) in one sub-block within Band nY where nX and nY are the applicable NR <i>operating bands</i>
CC	Component Carriers
CG	Carrier Group
CP-OFDM	Cyclic Prefix-OFDM
CW	Continuous Wave
DC	Dual Connectivity
DFT-s-OFDM	Discrete Fourier Transform-spread-OFDM
DM-RS	Demodulation Reference Signal
DTX	Discontinuous Transmission
E-UTRA	Evolved UTRA
EIRP	Equivalent Isotropically Radiated Power
EVM	Error Vector Magnitude
FR	Frequency Range
FRC	Fixed Reference Channel
FWA	Fixed Wireless Access
GSCN	Global Synchronization Channel Number
IBB	In-band Blocking
IDFT	Inverse Discrete Fourier Transformation
ITS	Intelligent Transportation System
ITU-R	Radiocommunication Sector of the International Telecommunication Union
MBW	Measurement bandwidth defined for the protected band
MCG	Master Cell Group
MOP	Maximum Output Power
MPR	Allowed maximum power reduction
MSD	Maximum Sensitivity Degradation
NR	New Radio
NR-ARFCN	NR Absolute Radio Frequency Channel Number
NS	Network Signalling
OCNG	OFDMA Channel Noise Generator
OOB	Out-of-band
P-MPR	Power Management Maximum Power Reduction
PRB	Physical Resource Block
PSCCH	Physical Sidelink Control CHannel
PSSCH	Physical Sidelink Shared CHannel
QAM	Quadrature Amplitude Modulation
RE	Resource Element
REFSENS	Reference Sensitivity
RF	Radio Frequency
RMS	Root Mean Square (value)
RSRP	Reference Signal Receiving Power
Rx	Receiver
SC	Single Carrier
SCG	Secondary Cell Group
SCS	Subcarrier spacing
SDL	Supplementary Downlink
SEM	Spectrum Emission Mask
SL	Sidelink

SL-MIMO	Sidelink-Multiple Antenna transmission
SNR	Signal-to-Noise Ratio
SRS	Sounding Reference Symbol
SS	Synchronization Symbol
SUL	Supplementary uplink
TAE	Time Alignment Error
TAG	Timing Advance Group
Tx	Transmitter
UL MIMO	Uplink Multiple Antenna transmission
ULFPTx	Uplink Full Power Transmission
V2X	Vehicle to Everything

4 General

4.1 Relationship between minimum requirements and test requirements

The present document is a Single-RAT specification for NR UE, covering RF characteristics and minimum performance requirements. Conformance to the present specification is demonstrated by fulfilling the test requirements specified in the conformance specification 3GPP TS 38.521-1 [4].

The Minimum Requirements given in this specification make no allowance for measurement uncertainty. The test specification TS 38.521-1 [4] defines test tolerances. These test tolerances are individually calculated for each test. The test tolerances are used to relax the minimum requirements in this specification to create test requirements. For some requirements, including regulatory requirements, the test tolerance is set to zero.

The measurement results returned by the test system are compared - without any modification - against the test requirements as defined by the shared risk principle.

The shared risk principle is defined in Recommendation ITU-R M.1545 [5].

4.2 Applicability of minimum requirements

- In this specification the Minimum Requirements are specified as general requirements and additional requirements. Where the Requirement is specified as a general requirement, the requirement is mandated to be met in all scenarios
- For specific scenarios for which an additional requirement is specified, in addition to meeting the general requirement, the UE is mandated to meet the additional requirements.
- The spurious emissions power requirements are for the long-term average of the power. For the purpose of reducing measurement uncertainty it is acceptable to average the measured power over a period of time sufficient to reduce the uncertainty due to the statistical nature of the signal
- All the requirements for intra-band contiguous and non-contiguous CA apply under the assumption of the same slot format indicated by *TDD-UL-DL-ConfigurationCommon* and *TDD-UL-DL-ConfigurationDedicated* in the PCell and SCells for NR SA.

4.3 Specification suffix information

Unless stated otherwise the following suffixes are used for indicating at 2nd level clause, shown in Table 4.3-1.

Table 4.3-1: Definition of suffixes

Clause suffix	Variant
None	Single Carrier
A	Carrier Aggregation (CA)
B	Dual-Connectivity (DC)
C	Supplementary Uplink (SUL)

D	UL MIMO
E	V2X
F	Shared spectrum channel access

A terminal which supports the above features needs to meet both the general requirements and the additional requirement applicable to the additional clause (suffixes A to F) in clauses 5, 6 and 7. Where there is a difference in requirement between the general requirements and the additional clause requirements (suffixes A to F) in clauses 5, 6 and 7, the tighter requirements are applicable unless stated otherwise in the additional clause.

A terminal which supports more than one feature in clauses 5, 6 and 7 shall meet all of the separate corresponding requirements.

For a terminal that supports SUL for the band combination specified in Table 5.2C-1, the current version of the specification assumes the terminal is configured with active transmission either on UL carrier or SUL carrier at any time in one serving cell and the UE requirements for single carrier shall apply for the active UL or SUL carrier accordingly. For a terminal that supports SUL, the current version of the specification assumes the terminal is not configured with UL MIMO on SUL carrier.

For a terminal that supports operation in shared spectrum, the current version of this specification assumes in the uplink sub-bands within a wideband channel shall be contiguously allocated to the UE. The uplink requirements for one or more non-transmitted sub-bands between two transmitted sub-bands does not form a part of the current version of this specification.

5 Operating bands and channel arrangement

5.1 General

The channel arrangements presented in this clause are based on the operating bands and channel bandwidths defined in the present release of specifications.

NOTE: Other operating bands and channel bandwidths may be considered in future releases.

Requirements throughout the RF specifications are in many cases defined separately for different frequency ranges (FR). The frequency ranges in which NR can operate according to this version of the specification are identified as described in Table 5.1-1.

Table 5.1-1: Definition of frequency ranges

Frequency range designation	Corresponding frequency range
FR1	410 MHz – 7125 MHz
FR2	24250 MHz – 52600 MHz

The present specification covers FR1 operating bands.

5.2 Operating bands

NR is designed to operate in the FR1 operating bands defined in Table 5.2-1.

Table 5.2-1: NR operating bands in FR1

NR operating band	Uplink (UL) <i>operating band</i> BS receive / UE transmit $F_{UL_low} - F_{UL_high}$	Downlink (DL) <i>operating band</i> BS transmit / UE receive $F_{DL_low} - F_{DL_high}$	Duplex Mode
n1	1920 MHz – 1980 MHz	2110 MHz – 2170 MHz	FDD
n2	1850 MHz – 1910 MHz	1930 MHz – 1990 MHz	FDD

n3	1710 MHz – 1785 MHz	1805 MHz – 1880 MHz	FDD
n5	824 MHz – 849 MHz	869 MHz – 894 MHz	FDD
n7	2500 MHz – 2570 MHz	2620 MHz – 2690 MHz	FDD
n8	880 MHz – 915 MHz	925 MHz – 960 MHz	FDD
n12	699 MHz – 716 MHz	729 MHz – 746 MHz	FDD
n14	788 MHz – 798 MHz	758 MHz – 768 MHz	FDD
n18	815 MHz – 830 MHz	860 MHz – 875 MHz	FDD
n20	832 MHz – 862 MHz	791 MHz – 821 MHz	FDD
n25	1850 MHz – 1915 MHz	1930 MHz – 1995 MHz	FDD
n26	814 MHz – 849 MHz	859 MHz – 894 MHz	FDD
n28	703 MHz – 748 MHz	758 MHz – 803 MHz	FDD
n29 ¹⁵	N/A	717 MHz – 728 MHz	SDL
n30 ³	2305 MHz – 2315 MHz	2350 MHz – 2360 MHz	FDD
n34	2010 MHz – 2025 MHz	2010 MHz – 2025 MHz	TDD
n38 ¹⁰	2570 MHz – 2620 MHz	2570 MHz – 2620 MHz	TDD
n39	1880 MHz – 1920 MHz	1880 MHz – 1920 MHz	TDD
n40	2300 MHz – 2400 MHz	2300 MHz – 2400 MHz	TDD
n41	2496 MHz – 2690 MHz	2496 MHz – 2690 MHz	TDD
n46 ^{13,14}	5150 MHz – 5925 MHz	5150 MHz – 5925 MHz	TDD
n47 ¹¹	5855 MHz – 5925 MHz	5855 MHz – 5925 MHz	TDD
n48	3550 MHz – 3700 MHz	3550 MHz – 3700 MHz	TDD
n50 ¹	1432 MHz – 1517 MHz	1432 MHz – 1517 MHz	TDD
n51	1427 MHz – 1432 MHz	1427 MHz – 1432 MHz	TDD
n53	2483.5 MHz – 2495 MHz	2483.5 MHz – 2495 MHz	TDD
n65 ⁴	1920 MHz – 2010 MHz	2110 MHz – 2200 MHz	FDD
n66	1710 MHz – 1780 MHz	2110 MHz – 2200 MHz	FDD ^{6,7}
n70	1695 MHz – 1710 MHz	1995 MHz – 2020 MHz	FDD
n71	663 MHz – 698 MHz	617 MHz – 652 MHz	FDD
n74	1427 MHz – 1470 MHz	1475 MHz – 1518 MHz	FDD
n75 ¹⁵	N/A	1432 MHz – 1517 MHz	SDL ²
n76 ¹⁵	N/A	1427 MHz – 1432 MHz	SDL
n77 ¹²	3300 MHz – 4200 MHz	3300 MHz – 4200 MHz	TDD
n78	3300 MHz – 3800 MHz	3300 MHz – 3800 MHz	TDD
n79	4400 MHz – 5000 MHz	4400 MHz – 5000 MHz	TDD
n80	1710 MHz – 1785 MHz	N/A	SUL
n81	880 MHz – 915 MHz	N/A	SUL
n82	832 MHz – 862 MHz	N/A	SUL
n83	703 MHz – 748 MHz	N/A	SUL
n84	1920 MHz – 1980 MHz	N/A	SUL
n86	1710 MHz – 1780 MHz	N/A	SUL
n89	824 MHz – 849 MHz	N/A	SUL
n90 ⁵	2496 MHz – 2690 MHz	2496 MHz – 2690 MHz	TDD
n91 ⁹	832 MHz – 862 MHz	1427 MHz – 1432 MHz	FDD
n92 ⁹	832 MHz – 862 MHz	1432 MHz – 1517 MHz	FDD
n93 ⁹	880 MHz – 915 MHz	1427 MHz – 1432 MHz	FDD
n94 ⁹	880 MHz – 915 MHz	1432 MHz – 1517 MHz	FDD
n95 ⁸	2010 MHz – 2025 MHz	N/A	SUL
n96 ^{13,14}	5925 MHz – 7125 MHz	5925 MHz – 7125 MHz	TDD
NOTE 1: UE that complies with the NR Band n50 minimum requirements in this specification shall also comply with the NR Band n51 minimum requirements.			
NOTE 2: UE that complies with the NR Band n75 minimum requirements in this specification shall also comply with the NR Band n76 minimum requirements.			
NOTE 3: Uplink transmission is not allowed at this band for UE with external vehicle-mounted antennas.			
NOTE 4: A UE that complies with the NR Band n65 minimum requirements in this specification shall also comply with the NR Band n1 minimum requirements.			
NOTE 5: Unless otherwise stated, the applicability of requirements for Band n90 is in accordance with that for Band n41; a UE supporting Band n90 shall meet the requirements for Band n41. A UE supporting Band n90 shall also support band n41.			
NOTE 6: A UE that supports NR Band n66 shall receive in the entire DL operating band.			
NOTE 7: A UE that supports NR Band n66 and CA operation in any CA band shall also comply with the minimum requirements specified for the DL CA configurations CA_n66B and CA_n66(2A) in the current version of the specification.			
NOTE 8: This band is applicable in China only.			
NOTE 9: Variable duplex operation does not enable dynamic variable duplex configuration by the network, and is used such that DL and UL frequency ranges are supported			

independently in any valid frequency range for the band.

NOTE 10: When this band is used for V2X SL service, the band is exclusively used for NR V2X in particular regions.

NOTE 11: This band is unlicensed band used for V2X service. There is no expected network deployment in this band.

NOTE 12: In the USA this band is restricted to 3450 – 3550 MHz and 3700 – 3980 MHz.

NOTE 13: This band is restricted to operation with shared spectrum channel access as defined in TS 37.213 [14].

NOTE 14: This band is applicable only in countries/regions designating this band for shared-spectrum access use subject to country-specific conditions.

NOTE 15: For SDL bands, downlink configuration for RRM performance testing is same as FDD.

5.2A Operating bands for CA

5.2A.0 General

CA operating bands including Band n90 are defined by the corresponding CA operating bands including Band n41 with Band n90 replacing Band n41. For brevity the said CA operating bands including Band n90 are not listed in the tables below but are covered by this specification.

5.2A.1 Intra-band CA

NR intra-band carrier aggregation is designed to operate in the operating bands defined in Table 5.2A.1-1 and Table 5.2A.1-2, where all operating bands are within FR1.

Table 5.2A.1-1: Intra-band contiguous CA operating bands in FR1

NR CA Band	NR Band (Table 5.2-1)
CA_n1	n1
CA_n7	n7
CA_n40	n40
CA_n41	n41
CA_n46	n46
CA_n48	n48
CA_n66	n66
CA_n71	n71
CA_n77	n77
CA_n78	n78
CA_n79	n79

NOTE 1: The minimum requirements only apply for non simultaneous Tx/Rx between all carriers for TDD combinations.

Table 5.2A.1-2: Intra-band non-contiguous CA operating bands in FR1

NR CA Band	NR Band (Table 5.2-1)
CA_n3(*)	n3
CA_n7(*)	n7
CA_n25(*)	n25
CA_n41(*)	n41
CA_n48(*)	n48
CA_n66(*)	n66
CA_n77(*)	n77
CA_n78(*)	n78

NOTE 1: The minimum requirements only apply for non simultaneous Tx/Rx between all carriers for TDD combinations.

NOTE 2: The notation CA_nX(*) in this table indicates intra-band non-contiguous CA for band nX. The configurations for each band are in 5.5A.2.

5.2A.2 Inter-band CA

NR inter-band carrier aggregation is designed to operate in the operating bands defined in Table 5.2A.2.1-1, Table 5.2A.2.2-1 and Table 5.2A.2.3-1, where all operating bands are within FR1.

If the mandatory simultaneous Rx/Tx capability applies for a lower order band combination, when the applicable lower order band combination is a band pair in a higher order band combination, the mandatory simultaneous Rx/Tx capability also applies for the band pair in the higher order band combination.

Table 5.2A.2-1: Void

Table 5.2A.2-2: Void

Table 5.2A.2-3: Void

5.2A.2.1 Inter-band CA (two bands)

Table 5.2A.2.1-1: Inter-band CA operating bands involving FR1 (two bands)

NR CA Band	NR Band (Table 5.2-1)	DL interruption allowed (Note 8)
CA_n1-n3	n1, n3	
CA_n1-n7	n1, n7	
CA_n1-n8	n1, n8	
CA_n1-n28	n1, n28	
CA_n1-n40	n1, n40	
CA_n1-n41 ¹	n1, n41	
CA_n1-n77 ¹	n1, n77	No
CA_n1-n78 ¹	n1, n78	No
CA_n1-n79 ¹	n1, n79	No
CA_n2-n5	n2, n5	
CA_n2-n48	n2, n48	
CA_n2-n66	n2, n66	
CA_n2-n77	n2, n77	
CA_n2-n78	n2, n78	
CA_n3-n7	n3, n7	
CA_n3-n8	n3, n8	
CA_n3-n28	n3, n28	
CA_n3-n38	n3, n38	
CA_n3-n40 ¹	n3, n40	
CA_n3-n41 ¹	n3, n41	No
CA_n3-n77 ¹	n3, n77	No
CA_n3-n78 ¹	n3, n78	No
CA_n3-n79 ¹	n3, n79	No
CA_n5-n7	n5, n7	
CA_n5-n66	n5, n66	
CA_n5-n77 ¹	n5, n77	
CA_n5-n78 ¹	n5, n78	No
CA_n5-n79 ¹	n5, n79	No
CA_n7-n25	n7, n25	
CA_n7-n28	n7, n28	
CA_n7-n66	n7, n66	
CA_n7-n78 ¹	n7, n78	
CA_n8-n39 ¹	n8, n39	

CA_n8-n40 ¹	n8, n40	
CA_n8-n41 ¹	n8, n41	No
CA_n8-n75 ¹	n8, n75	
CA_n8-n78 ¹	n8, n78	No
CA_n8-n79 ¹	n8, n79	No
CA_n20-n28 ²	n20, n28	
CA_n20-n75	n20, n75	
CA_n20-n78	n20, n78	
CA_n25-n41	n25, n41	
CA_n25-n46 ⁶	n25, n46	
CA_n25-n66	n25, n66	
CA_n25-n71	n25, n71	
CA_n25-n78	n25, n78	
CA_n28-n40 ¹	n28, n40	
CA_n28-n41 ¹	n28, n41	
CA_n28-n50	n28, n50	
CA_n28-n75 ²	n28, n75	
CA_n28-n77 ¹	n28, n77	No
CA_n28-n78 ¹	n28, n78	No
CA_n29-n66	n29, n66	
CA_n29-n70	n29, n70	
CA_n38-n66	n38, n66	
CA_n38-n78 ¹	n38, n78	
CA_n39-n40	n39, n40	
CA_n39-n41	n39, n41	No
CA_n39-n79 ¹	n39, n79	No
CA_n40-n41	n40, n41	
CA_n40-n78 ¹	n40, n78	
CA_n40-n79 ^{1,4}	n40, n79	No
CA_n41-n50 ¹	n41, n50	
CA_n41-n66	n41, n66	
CA_n41-n71 ¹	n41, n71	
CA_n41-n78 ¹	n41, n78	
CA_n41-n79 ^{1,3}	n41, n79	No
CA_n46-n48 ⁶	n46, n48	
CA_n46-n66 ⁶	n46, n66	
CA_n48-n66	n48, n66	
CA_n50-n78	n50, n78	
CA_n66-n70	n66, n70	
CA_n66-n71	n66, n71	
CA_n66-n77	n66, n77	
CA_n66-n78	n66, n78	
CA_n70-n71	n70, n71	
CA_n75-n78 ¹	n75, n78	
CA_n76-n78 ¹	n76, n78	
CA_n77-n78 ⁷	n77, n78	
CA_n77-n79 ⁷	n77, n79	
CA_n78-n79 ⁹	n78, n79	
CA_n78-n92	n78, n92	
NOTE 1: Applicable for UE supporting inter-band carrier aggregation with mandatory simultaneous Rx/Tx capability.		
NOTE 2: The frequency range in band n28 is restricted for this band combination to 703-733 MHz for the UL and 758-788 MHz for the DL.		
NOTE 3: The frequency range below 2506 MHz for Band n41 is not used in this combination.		
NOTE 4: Applicable for frequency range above 4800 MHz for Band n79 in this combination.		
NOTE 5: For UEs supporting band n77, the minimum requirements apply only when there is non-simultaneous Rx/Tx operation between n78-n79 NR carriers. This restriction applies also for these carriers when applicable NR CA configuration is part of a higher order configuration.		
NOTE 6: The PCell is allocated in the licensed band in this combination.		
NOTE 7: The minimum requirements apply only when there is non-simultaneous Rx/Tx operation between n77-n78 or n77-n79 NR carriers. This restriction applies also for these carriers when applicable NR CA configuration is part of a higher order configuration.		

NOTE 8: Applicable when dynamic switching between two uplink carriers is conducted.
The DL interruption requirement is specified in clause 8.2.2.2.10 of 38.133 [13].

5.2A.2.2 Inter-band CA (three bands)

Table 5.2A.2.2-1: Inter-band CA operating bands involving FR1 (three bands)

NR CA Band	NR Band (Table 5.2-1)
CA_n1-n3-n7	n1, n3, n7
CA_n1-n3-n8	n1, n3, n8
CA_n1-n3-n28	n1, n3, n28
CA_n1-n3-n41 ³	n1, n3, n41
CA_n1-n3-n78 ³	n1, n3, n78
CA_n1-n7-n28	n1, n7, n28
CA_n1-n7-n78 ³	n1, n7, n78
CA_n1-n8-n78 ³	n1, n8, n78
CA_n1-n28-n78 ³	n1, n28, n78
CA_n1-n40-n78 ³	n1, n40, n78
CA_n3-n7-n28	n3, n7, n28
CA_n3-n7-n78 ³	n3, n7, n78
CA_n3-n8-n78 ³	n3, n8, n78
CA_n3-n28-n77 ³	n3, n28, n77
CA_n3-n28-n78 ³	n3, n28, n78
CA_n3-n40-n41	n3, n40, n41
CA_n3-n41-n79 ³	n3, n41, n79
CA_n5-n66-n78	n5, n66, n78
CA_n7-n25-n66	n7, n25, n66
CA_n7-n28-n78	n7, n28, n78
CA_n7-n66-n78	n7, n66, n78
CA_n8-n39-n41	n8, n39, n41
CA_n8-n41-n79 ³	n8, n41, n79
CA_n20-n28-n78	n20, n28, n78
CA_n25-n41-n66	n25, n41, n66
CA_n25-n41-n71	n41, n66, n71
CA_n25-n66-n71	n25, n66, n71
CA_n25-n66-n78	n25, n66, n78
CA_n28-n40-n78	n28, n40, n78
CA_n28-n41-n78 ³	n28, n41, n78
CA_n29-n66-n70	n29, n66, n70
CA_n39-n41-n79	n39, n41, n79
CA_n40-n41-n79 ^{1,2}	n40, n41, n79
CA_n41-n66-n71	n41, n66, n71
CA_n66-n70-n71	n66, n70, n71
NOTE 1: The frequency range below 2506 MHz for Band n41 is not used in this band combination.	
NOTE 2: Applicable for frequency range above 4800 MHz for Band n79 in this band combination.	
NOTE 3: Applicable for UE supporting inter-band carrier aggregation with mandatory simultaneous Rx/Tx capability.	

5.2A.2.3 Inter-band CA (four bands)

Table 5.2A.2.3-1: Inter-band CA operating bands involving FR1 (four bands)

NR CA Band	NR Band (Table 5.2-1)
CA_n1-n3-n7-n28	n1, n3, n7, n28
CA_n1-n3-n7-n78 ¹	n1, n3, n7, n78
CA_n1-n3-n8-n78 ¹	n1, n3, n8, n78

CA_n1-n3-n28-n78 ¹	n1, n3, n28, n78
CA_n3-n7-n28-n78	n3, n7, n28, n78
CA_n7-n25-n66-n78	n7, n25, n66, n78
NOTE 1: Applicable for UE supporting inter-band carrier aggregation with mandatory simultaneous Rx/Tx capability.	

5.2B Operating bands for DC

The operating bands are specified in clause 5.5B for operation with NR dual connectivity configured, where all operating bands are within FR1.

5.2C Operating band combination for SUL

NR operation is designed to operate in the operating band combination defined in Table 5.2C-1 and Table 5.2C-2, where all operating bands are within FR1.

If the mandatory simultaneous Rx/Tx capability applies for a lower order band combination, when the applicable lower order band combination is a band pair in a higher order band combination, the mandatory simultaneous Rx/Tx capability also applies for the band pair in the higher order band combination.

Table 5.2C-1: Operating band combination for SUL in FR1

NR Band combination for SUL	NR Band (Table 5.2-1)
SUL_n41-n80 ²	n41, n80
SUL_n41-n81 ²	n41, n81
SUL_n41-n95 ²	n41, n95
SUL_n77-n80 ²	n77, n80
SUL_n77-n84 ²	n77, n84
SUL_n78-n80 ²	n78, n80
SUL_n78-n81 ²	n78, n81
SUL_n78-n82 ²	n78, n82
SUL_n78-n83 ²	n78, n83
SUL_n78-n84 ²	n78, n84
SUL_n78-n86 ²	n78, n86
SUL_n79-n80 ²	n79, n80
SUL_n79-n81 ²	n79, n81
SUL_n79-n84 ²	n79, n84
SUL_n79-n95 ²	n79, n95
NOTE 1: If a UE is configured with both NR UL and NR SUL carriers in a cell, the switching time between NR UL carrier and NR SUL carrier is 0 us.	
NOTE 2: For UE supporting SUL band combination simultaneous Rx/Tx capability is mandatory.	
NOTE 3: For UE supporting SUL band combination, UL MIMO is not configured on SUL carrier	

Table 5.2C-2: Operating SUL band combination with intra-band non-contiguous CA in FR1

NR Band combination for SUL	NR Band (Table 5.2-1)
CA_n78(*)-n86 ²	n78, n86
NOTE 1: If a UE is configured with both NR UL and NR SUL carriers in a cell, the switching time between NR UL carrier and NR SUL carrier is 0 us.	

NOTE 2: For UE supporting SUL band combination simultaneous Rx/Tx capability is mandatory.
 NOTE 3: For UE supporting SUL band combination, UL MIMO is not configured on SUL carrier.
 NOTE 4: The notation CA_nX(*) in this table indicates intra-band non-contiguous CA for band nX. The configurations for each band are in table 5.5C-2.

5.2D Operating bands for UL MIMO

NR is designed to support UL MIMO where all of the operating bands are in FR1 defined in Table 5.2D-1.

Table 5.2D-1: NR operating bands for UL MIMO in FR1

NR operating band
n1
n2
n3
n7
n25
n30 ¹
n34
n38
n39
n40
n41
n46
n48
n66
n70
n71 ²
n77
n78
n79
n96
NOTE 1: Uplink transmission is not allowed at this band for UE with external vehicle-mounted antennas. NOTE 2: UL MIMO is targeted for FWA form factor.

5.2E Operating band for V2X

5.2E.1 V2X operating bands

NR V2X is designed to operate in the operating bands in FR1 defined in Table 5.2E.1-1.

Table 5.2E.1-1 V2X operating bands in FR1

V2X Operating Band	Sidelink (SL) Transmission operating band	Sidelink (SL) Reception operating band	Duplex Mode	Interface
	F _{UL_low} - F _{UL_high}	F _{DL_low} - F _{DL_high}		
n38 ¹	2570 MHz - 2620 MHz	2570 MHz - 2620 MHz	HD	PC5
n47	5855 MHz - 5925 MHz	5855 MHz - 5925 MHz	HD	PC5
Note 1: When this band is used for V2X SL service, the band is exclusively used for NR V2X in particular regions.				

5.2E.2 V2X operating bands for concurrent operation

NR V2X operation is designed to operate concurrent with NR uplink/downlink on the operating bands combinations listed in Table 5.2E.2-1.

Table 5.2E.2-1 Inter-band concurrent V2X operating bands

V2X concurrent operating Band	NR or V2X Operating Band	Interface
V2X_n71-n47	n71	Uu
	n47	PC5

5.3 UE channel bandwidth

5.3.1 General

The UE channel bandwidth supports a single NR RF carrier in the uplink or downlink at the UE. From a BS perspective, different UE channel bandwidths may be supported within the same spectrum for transmitting to and receiving from UEs connected to the BS. Transmission of multiple carriers to the same UE (CA) or multiple carriers to different UEs within the BS channel bandwidth can be supported.

From a UE perspective, the UE is configured with one or more BWP / carriers, each with its own UE channel bandwidth. The UE does not need to be aware of the BS channel bandwidth or how the BS allocates bandwidth to different UEs.

The placement of the UE channel bandwidth for each UE carrier is flexible but can only be completely within the BS channel bandwidth.

The relationship between the channel bandwidth, the guardband and the maximum transmission bandwidth configuration is shown in Figure 5.3.1-1.

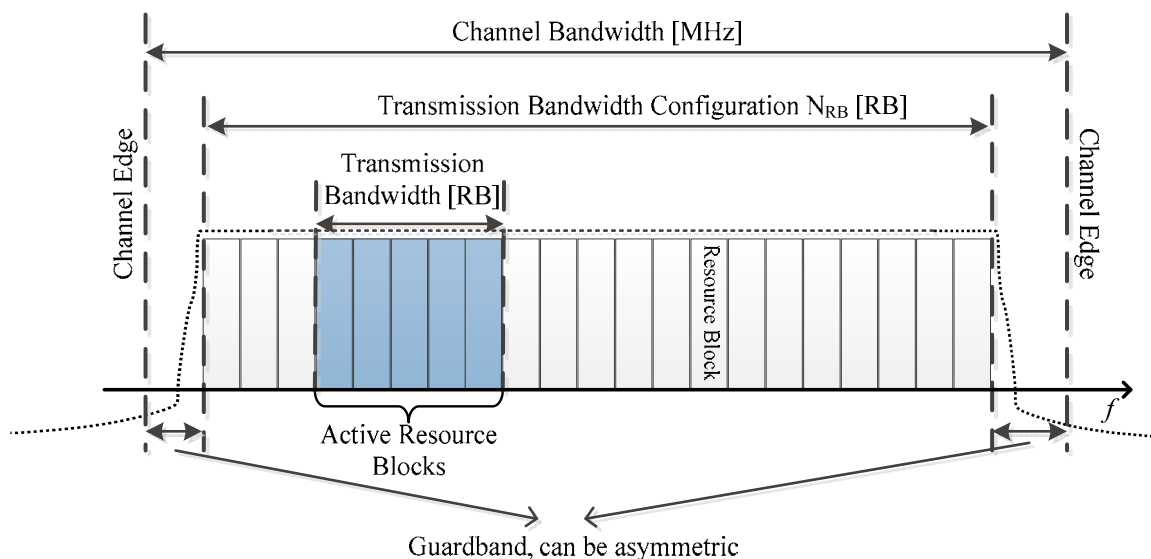

Figure 5.3.1-1: Definition of the channel bandwidth and the maximum transmission bandwidth configuration for one NR channel

5.3.2 Maximum transmission bandwidth configuration

The maximum transmission bandwidth configuration N_{RB} for each UE channel bandwidth and subcarrier spacing is specified in Table 5.3.2-1.

Table 5.3.2-1: Maximum transmission bandwidth configuration N_{RB}

SCS (kHz)	5 MHz	10 MHz	15 MHz	20 MHz	25 MHz	30 MHz	40 MHz	50 MHz	60 MHz	70 MHz	80 MHz	90 MHz	100 MHz
	N_{RB}	N_{RB}	N_{RB}	N_{RB}	N_{RB}	N_{RB}	N_{RB}	N_{RB}	N_{RB}	N_{RB}	N_{RB}	N_{RB}	N_{RB}
15	25	52	79	106	133	160	216	270	N/A	N/A	N/A	N/A	N/A
30	11	24	38	51	65	78	106	133	162	189	217	245	273
60	N/A	11	18	24	31	38	51	65	79	93	107	121	135

5.3.3 Minimum guardband and transmission bandwidth configuration

The minimum guardband for each UE channel bandwidth and SCS is specified in Table 5.3.3-1,

Table 5.3.3-1: Minimum guardband for each UE channel bandwidth and SCS (kHz)

SCS (kHz)	5 MHz	10 MHz	15 MHz	20 MHz	25 MHz	30 MHz	40 MHz	50 MHz	60 MHz	70 MHz	80 MHz	90 MHz	100 MHz
15	242.5	312.5	382.5	452.5	522.5	592.5	552.5	692.5	N/A	N/A	N/A	N/A	N/A
30	505	665	645	805	785	945	905	1045	825	965	925	885	845
60	N/A	1010	990	1330	1310	1290	1610	1570	1530	1490	1450	1410	1370

NOTE: The minimum guardbands have been calculated using the following equation: $GB_{channel} = (BW_{Channel} \times 1000 \text{ (kHz)} - N_{RB} \times SCS \times 12) / 2 - SCS/2$, where N_{RB} are from Table 5.3.2-1 and $GB_{channel}$ expressed in kHz.

Figure 5.3.3-1: Void

The number of RBs configured in any channel bandwidth shall ensure that the minimum guardband specified in this clause is met.

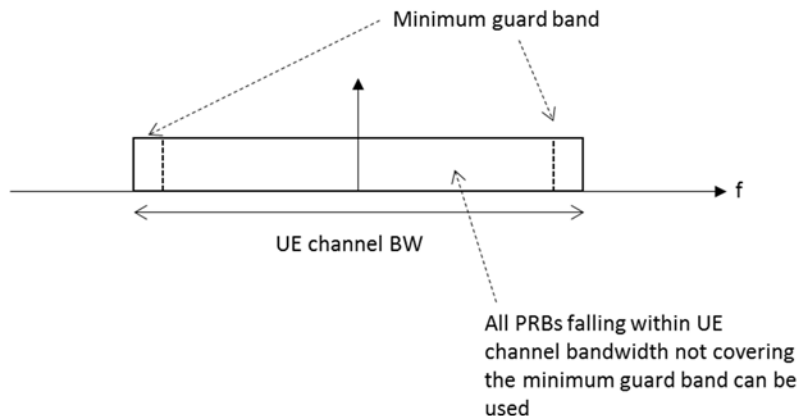

Figure 5.3.3-2: UE PRB utilization

In the case that multiple numerologies are multiplexed in the same symbol due to BS transmission of SSB, the minimum guardband on each side of the carrier is the guardband applied at the configured channel bandwidth for the numerology that is received immediately adjacent to the guard.

If multiple numerologies are multiplexed in the same symbol and the UE channel bandwidth is >50 MHz, the minimum guardband applied adjacent to 15 kHz SCS shall be the same as the minimum guardband defined for 30 kHz SCS for the same UE channel bandwidth.

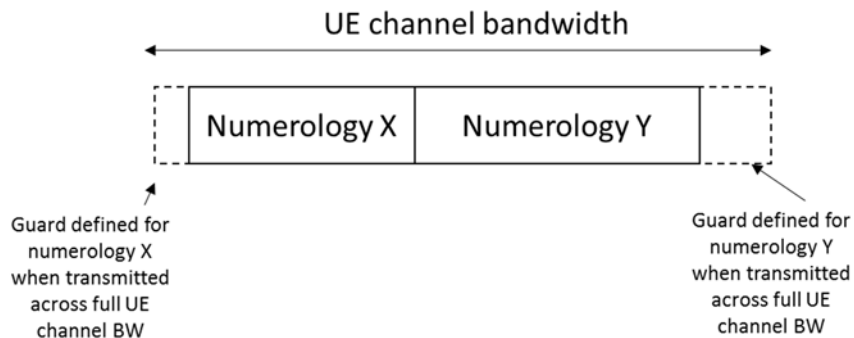

Figure 5.3.3-3 Guard band definition when transmitting multiple numerologies

NOTE: Figure 5.3.3-3 is not intended to imply the size of any guard between the two numerologies. Inter-numerology guard band within the carrier is implementation dependent.

For a UE supporting wideband operation, the nominal intra-cell guard bands and the corresponding sizes of the RB sets separated by the said guard bands are as specified in Table 5.3.3-2 for each UE channel bandwidth and sub-carrier spacing for the downlink and uplink. The nominal intra-cell guard bands in Table 5.3.3-2 are applicable when the respective IE *intraCellGuardBandsUL-List* and *intraCellGuardBandsDL-List* [7] for the uplink and downlink are not provided, as specified in [10] clause 7.

Table 5.3.3-2: Nominal intra-cell guard bands for wideband operation

SCS (kHz)	40 MHz	60 MHz	80 MHz
15	105-6-105 (216)	N/A	N/A
30	50-6-50 (106)	50-6-50-6-50 (162)	50-6-50-5-50-6-50 (217)
60	23-5-23 (51)	23-5-23-5-23 (79)	23-5-23-5-23-5-23 (107)

NOTE 1: The intra-cell guard band is denoted $TBW_0-GB_0-\dots-GB_{N_RBset-2}-TBW_{N_RBset-1}$ for $N_RBset > 1$ number of RB-sets with TBW_r the maximum transmission bandwidth (PRB) of RB-set r and GB_r the guard band (PRB) above the upper edge of RB-set r . The RB-set 0 is starting at the first common resource block (CRB) of the carrier as indicated by *offsetToCarrier*. The total transmission bandwidth configuration (size of resource grid) including guard bands is given in between parentheses.

For a UE that supports shared spectrum channel access, there are no uplink or downlink intra-cell guard bands for operation with 10 MHz and 20 MHz channel bandwidths; the maximum transmission bandwidth configurations for these channel bandwidths are in accordance with clause 5.3.2.

For each UE channel bandwidth and sub-carrier spacing given by Table 5.3.3-2, the maximum transmission bandwidth configuration of the carrier including intra-cell guard bands, if configured for the uplink and downlink by the respective IE *intraCellGuardBandsUL-List* and *intraCellGuardBandsDL-List* [7], and corresponding RB-set(s) shall be in accordance with clause 5.3.2 with a minimum inter-cell guard band of the UE channel bandwidth as specified in Table 5.3.3-1 for the uplink and downlink. Minimum requirements specified for wideband operation in Clause 6 and Clause 7 also apply for intra-cell guard bands larger than the nominal sizes in Table 5.3.3-2 as listed in Table 5.3.3-3 for each sub-carrier spacing; each guard band in order of CRB index must be larger than or equal to the corresponding nominal guard band specified in Table 5.3.3-2 for each channel bandwidth.

Table 5.3.3-3: Applicable intra-cell guard bands for wideband operation

Parameter	Unit	SCS	
		15 kHz	30 kHz
Intra-cell guard band (size)	PRB	6,7	5,6,7
Transmission bandwidth (size) of RB-set	PRB	104,105	49,50,51

If the UE is configured with zero width intra-cell guard bands for the uplink and downlink by the IE *intraCellGuardBandsUL-List* and *intraCellGuardBandsDL-List* [7] on a carrier greater than 20 MHz, the maximum transmission bandwidth configuration for the uplink and downlink shall be in accordance with clause 5.3.2 with a minimum inter-cell guard band of the UE channel bandwidth as specified in Table 5.3.3-1.

5.3.4 RB alignment

For each numerology, its common resource blocks are specified in Clause 4.4.4.3 in TS 38.211 [6], and the starting point of its transmission bandwidth configuration on the common resource block grid for a given channel bandwidth is indicated by an offset to "Reference point A" in the unit of the numerology. The *UE transmission bandwidth configuration* is indicated by the higher layer parameter *carrierBandwidth* [7] and will fulfil the minimum UE guardband requirement specified in Clause 5.3.3.

5.3.5 UE channel bandwidth per operating band

The requirements in this specification apply to the combination of channel bandwidths, SCS and operating bands shown in Table 5.3.5-1. The transmission bandwidth configuration in Table 5.3.2-1 shall be supported for each of the specified channel bandwidths. The channel bandwidths are specified for both the TX and RX path.

Table 5.3.5-1 Channel bandwidths for each NR band

NR Band	NR band / SCS / UE Channel bandwidth													
	SCS kHz	5 MHz	10 MHz	15 MHz	20 MHz	25 MHz	30 MHz	40 MHz	50 MHz	60 MHz	70 MHz	80 MHz	90 MHz	100 MHz
n1	15	Yes	Yes	Yes	Yes	Yes	Yes	Yes	Yes					
	30		Yes	Yes	Yes	Yes	Yes	Yes	Yes					
	60		Yes	Yes	Yes	Yes	Yes	Yes	Yes					
n2	15	Yes	Yes	Yes	Yes									
	30		Yes	Yes	Yes									
	60		Yes	Yes	Yes									
n3	15	Yes	Yes	Yes	Yes	Yes	Yes	Yes						
	30		Yes	Yes	Yes	Yes	Yes	Yes						
	60		Yes	Yes	Yes	Yes	Yes	Yes						
n5	15	Yes	Yes	Yes	Yes									
	30		Yes	Yes	Yes									
	60													
n7	15	Yes	Yes	Yes	Yes	Yes	Yes	Yes	Yes					
	30		Yes	Yes	Yes	Yes	Yes	Yes	Yes					
	60		Yes	Yes	Yes	Yes	Yes	Yes	Yes					
n8	15	Yes	Yes	Yes	Yes									
	30		Yes	Yes	Yes									
	60													
n12	15	Yes	Yes	Yes										
	30		Yes	Yes										
	60													
n14	15	Yes	Yes											
	30		Yes											
	60													
n18	15	Yes	Yes	Yes										
	30		Yes	Yes										
	60													
n20	15	Yes	Yes	Yes	Yes									
	30		Yes	Yes	Yes									
	60													
n25	15	Yes	Yes	Yes	Yes	Yes	Yes	Yes						
	30		Yes	Yes	Yes	Yes	Yes	Yes						
	60		Yes	Yes	Yes	Yes	Yes	Yes						
n26	15	Yes	Yes	Yes	Yes									
	30		Yes	Yes	Yes									
n28	15	Yes	Yes	Yes	Yes ⁷		Yes ⁷							
	30		Yes	Yes	Yes ⁷		Yes ⁷							

NR band / SCS / UE Channel bandwidth														
NR Band	SCS kHz	5 MHz	10 MHz	15 MHz	20 MHz	25 MHz	30 MHz	40 MHz	50 MHz	60 MHz	70 MHz	80 MHz	90 MHz	100 MHz
n29	60													
	15	Yes	Yes											
	30		Yes											
n30	60													
	15	Yes	Yes											
	30		Yes											
n34	60													
	15	Yes	Yes	Yes										
	30		Yes	Yes										
n38 ¹⁰	60		Yes	Yes										
	15	Yes	Yes	Yes	Yes	Yes	Yes	Yes						
	30		Yes	Yes	Yes	Yes	Yes	Yes						
n39	60		Yes	Yes	Yes	Yes	Yes	Yes						
	15	Yes	Yes	Yes	Yes	Yes	Yes	Yes						
	30		Yes	Yes	Yes	Yes	Yes	Yes						
n40	60		Yes	Yes	Yes	Yes	Yes	Yes	Yes	Yes		Yes		
	15	Yes ⁵	Yes	Yes	Yes	Yes	Yes	Yes	Yes					
	30		Yes	Yes	Yes	Yes	Yes	Yes	Yes	Yes		Yes		
n41	60		Yes	Yes	Yes		Yes	Yes	Yes	Yes		Yes	Yes	Yes
	15		Yes	Yes	Yes		Yes	Yes	Yes					
	30		Yes	Yes	Yes		Yes	Yes	Yes	Yes		Yes	Yes	Yes
n46	60		Yes ⁵		Yes			Yes		Yes		Yes		
	15		Yes ⁵		Yes			Yes						
	30		Yes ⁵		Yes			Yes		Yes		Yes		
n47 ¹⁰	60		Yes		Yes		Yes	Yes						
	15		Yes		Yes		Yes	Yes						
	30		Yes		Yes		Yes	Yes						
n48	60		Yes	Yes	Yes		Yes	Yes ⁶	Yes ⁶	Yes ⁶		Yes ⁶	Yes ^{6,4}	Yes ⁶
	15	Yes ⁵	Yes	Yes	Yes			Yes	Yes ⁶	Yes ⁶		Yes ⁶	Yes ^{6,4}	Yes ⁶
	30		Yes	Yes	Yes			Yes	Yes ⁶	Yes ⁶		Yes ⁶	Yes ^{6,4}	Yes ⁶
n50	60		Yes	Yes	Yes		Yes	Yes	Yes	Yes		Yes ³		
	15	Yes ⁵	Yes	Yes	Yes		Yes	Yes	Yes					
	30		Yes	Yes	Yes		Yes	Yes	Yes	Yes		Yes ³		
n51	60													
	15	Yes												
	30													
n53	60		Yes											
	15	Yes	Yes											
	30		Yes											
n65	60		Yes	Yes	Yes				Yes					
	15	Yes	Yes	Yes	Yes				Yes					
	30		Yes	Yes	Yes				Yes					
n66	60		Yes	Yes	Yes	Yes	Yes	Yes						
	15	Yes	Yes	Yes	Yes	Yes	Yes	Yes						
	30		Yes	Yes	Yes	Yes	Yes	Yes						
n70	60		Yes	Yes	Yes ³	Yes ³								
	15	Yes	Yes	Yes	Yes ³	Yes ³								
	30		Yes	Yes	Yes ³	Yes ³								
n71	60		Yes	Yes	Yes									
	15	Yes	Yes	Yes	Yes									
	30		Yes	Yes	Yes									
n74	60		Yes	Yes	Yes									
	15	Yes	Yes	Yes	Yes									
	30		Yes	Yes	Yes									
n75	60		Yes	Yes	Yes	Yes	Yes	Yes	Yes					
	15	Yes	Yes	Yes	Yes	Yes	Yes	Yes	Yes					
	30		Yes	Yes	Yes	Yes	Yes	Yes	Yes					
n76	60													
	15	Yes												
	30													
n77	15		Yes	Yes	Yes	Yes	Yes	Yes	Yes					

NR band / SCS / UE Channel bandwidth														
NR Band	SCS kHz	5 MHz	10 MHz	15 MHz	20 MHz	25 MHz	30 MHz	40 MHz	50 MHz	60 MHz	70 MHz	80 MHz	90 MHz	100 MHz
	30		Yes	Yes	Yes	Yes	Yes	Yes	Yes	Yes	Yes	Yes	Yes ⁴	Yes
	60		Yes	Yes	Yes	Yes	Yes	Yes	Yes	Yes	Yes	Yes	Yes ⁴	Yes
n78	15		Yes	Yes	Yes	Yes	Yes	Yes	Yes					
	30		Yes	Yes	Yes	Yes	Yes	Yes	Yes	Yes	Yes ⁴	Yes	Yes	Yes
n79	15							Yes	Yes					
	30							Yes	Yes	Yes		Yes		Yes
n80	15	Yes	Yes	Yes	Yes	Yes	Yes							
	30		Yes	Yes	Yes	Yes	Yes							
n81	15	Yes	Yes	Yes	Yes									
	30		Yes	Yes	Yes									
n82	15	Yes	Yes	Yes	Yes									
	30		Yes	Yes	Yes									
n83	15	Yes	Yes	Yes	Yes ⁷									
	30		Yes	Yes	Yes ⁷									
n84	15	Yes	Yes	Yes	Yes									
	30		Yes	Yes	Yes									
n86	15	Yes	Yes	Yes	Yes			Yes						
	30		Yes	Yes	Yes			Yes						
n89	15	Yes	Yes	Yes	Yes									
	30		Yes	Yes	Yes									
n90	15		Yes	Yes	Yes		Yes	Yes	Yes					
	30		Yes	Yes	Yes		Yes	Yes	Yes	Yes		Yes	Yes	Yes
n91	15	Yes	Yes ⁸											
	30													
n92	15	Yes	Yes	Yes	Yes									
	30		Yes	Yes	Yes									
n93	15	Yes	Yes ⁸											
	30													
n94	15	Yes	Yes	Yes	Yes									
	30		Yes	Yes	Yes									
n95	15	Yes	Yes	Yes										
	30		Yes	Yes										
n96	15				Yes			Yes						
	30				Yes			Yes		Yes		Yes		
	60				Yes			Yes		Yes		Yes		

NOTE 1: Void.
 NOTE 2: Void.
 NOTE 3: This UE channel bandwidth is applicable only to downlink.
 NOTE 4: This UE channel bandwidth is optional in this release of the specification.
 NOTE 5: For this bandwidth, the minimum requirements are restricted to operation when carrier is configured as an SCell part of DC or CA configuration.
 NOTE 6: For this bandwidth, the minimum requirements are restricted to operation when carrier is configured as a downlink SCell part of CA configuration.
 NOTE 7: For the 20 MHz bandwidth, the minimum requirements are specified for NR UL carrier frequencies confined to either 713-723 MHz or 728-738 MHz. For the 30MHz bandwidth, the minimum requirements are specified for NR UL transmission bandwidth configuration confined to either 703-733 or 718-748 MHz.
 NOTE 8: This UE channel bandwidth is applicable only to uplink.
 NOTE 9: Void.

NR band / SCS / UE Channel bandwidth														
NR Band	SCS kHz	5 MHz	10 MHz	15 MHz	20 MHz	25 MHz	30 MHz	40 MHz	50 MHz	60 MHz	70 MHz	80 MHz	90 MHz	100 MHz
NOTE 10: For this band, UE channel bandwidths which are applicable to sidelink operation are specified in Table 5.3E.1-1.														

5.3.6 Asymmetric channel bandwidths

The UE channel bandwidth can be asymmetric in downlink and uplink. In asymmetric channel bandwidth operation, the narrower carrier shall be confined within the frequency range of the wider channel bandwidth.

In FDD, the confinement is defined as a deviation to the Tx-Rx carrier center frequency separation (defined in table 5.4.4-1) as following:

$$\Delta F_{TX-RX} = |(BW_{DL} - BW_{UL})/2|$$

The operating bands and supported asymmetric channel bandwidth combinations are defined in table 5.3.6-1.

Table 5.3.6-1: FDD asymmetric UL and DL channel bandwidth combinations

NR Band	Channel bandwidths for UL (MHz)	Channel bandwidths for DL (MHz)	Asymmetric channel bandwidth combination set
n66	5, 10	20, 40	0
	20	40	
	5, 10	20, 25, 30, 40	1
	20, 25, 30	40	
n70	5, 10	15	0
	5, 10, 15	20, 25	
n71	5	10	0
	10	15	
	15	20	
n91 ¹	10	5	0
n92 ¹	5	10, 15, 20	0
	10	15, 20	
n93 ¹	10	5	0
n94 ¹	5	10, 15, 20	0
	10	15, 20	
NOTE 1: The assignment of the paired UL and DL channels are subject to a TX-RX separation as specified in clause 5.4.4.			

In TDD, the operating bands and supported asymmetric channel bandwidth combinations are defined in table 5.3.6-2.

In TDD, the operating bands and supported asymmetric channel bandwidth combinations are defined in table 5.3.6-2.

Table 5.3.6-2: TDD asymmetric UL and DL channel bandwidth combinations

NR Band	Channel bandwidths for UL (MHz)	Channel bandwidths for DL (MHz)	Asymmetric channel bandwidth combination set
n50	60	80	0
NOTE 1: Both centre frequency and BWP-ID shall match between DL and UL carriers as defined in TS 38.331 [7] cl. 6.3.2 and TS 38.213 [8] clause 12.			
NOTE 2: In a case a UE is configured with a full width of BWP within both UL/ DL channels, the centre frequency of UL/ DL channels shall be same.			
NOTE 3: A position of Point A is common between UL and DL carriers as defined in TS 38.331 [7] cl. 6.3.2.			

5.3A UE channel bandwidth for CA

5.3A.1 General

Figure 5.3A.1-1: Void

Figure 5.3A.1-2: Void

5.3A.2 Maximum transmission bandwidth configuration for CA

For carrier aggregation, the maximum transmission bandwidth configuration is defined per component carrier and the requirement is specified in clause 5.3.2.

5.3A.3 Minimum guardband and transmission bandwidth configuration for CA

For intra-band contiguous carrier aggregation, *Aggregated Channel Bandwidth* and *Guard Bands* are defined as follows, see Figure 5.3A.3-1.

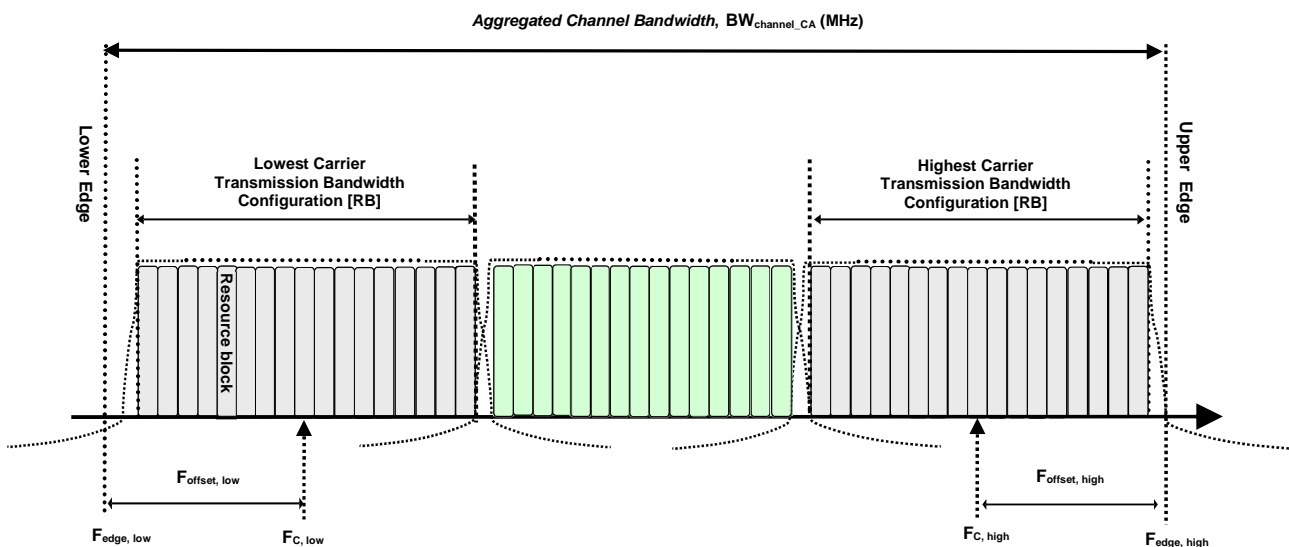

Figure 5.3A.3-1: Definition of *Aggregated Channel Bandwidth* for intra-band carrier aggregation

The *aggregated channel bandwidth*, $BW_{Channel_CA}$, is defined as

$$BW_{Channel_CA} = F_{edge,high} - F_{edge,low} \text{ (MHz)}$$

The lower bandwidth edge $F_{edge,low}$ and the upper bandwidth edge $F_{edge,high}$ of the aggregated channel bandwidth are used as frequency reference points for transmitter and receiver requirements and are defined by

$$F_{edge,low} = F_{C,low} - F_{offset,low}$$

$$F_{edge,high} = F_{C,high} + F_{offset,high}$$

The lower and upper frequency offsets depend on the transmission bandwidth configurations of the lowest and highest assigned edge component carrier and are defined as

$$F_{offset,low} = (N_{RB,low} * 12 + 1) * SCS_{low} / 2 + BW_{GB} \text{ (MHz)}$$

$$F_{offset,high} = (N_{RB,high} * 12 - 1) * SCS_{high} / 2 + BW_{GB} \text{ (MHz)}$$

$$BW_{GB} = \max(BW_{GB,Channel(k)})$$

$N_{RB,low}$ and $N_{RB,high}$ are the transmission bandwidth configurations according to Table 5.3.2-1 for the lowest and highest assigned component carrier, SCS_{low} and SCS_{high} are the sub-carrier spacing for the lowest and highest assigned component carrier respectively. SCS_{low} , SCS_{high} , $N_{RB,low}$, $N_{RB,high}$, and $BW_{GB,Channel(k)}$ use the largest μ value among the subcarrier spacing configurations supported in the operating band for both of the channel bandwidths according to Table 5.3.5-1 and $BW_{GB,Channel(k)}$ is the minimum guard band for carrier k according to Table 5.3.3-1 for the said μ value. In case there is no common μ value for both of the channel bandwidths, $\mu=1$ is used for SCS_{low} , SCS_{high} , $N_{RB,low}$, $N_{RB,high}$, and $BW_{GB,Channel(k)}$.

For intra-band non-contiguous carrier aggregation *Sub-block Bandwidth* and *Sub-block edges* are defined as follows, see Figure 5.3A.3-2.

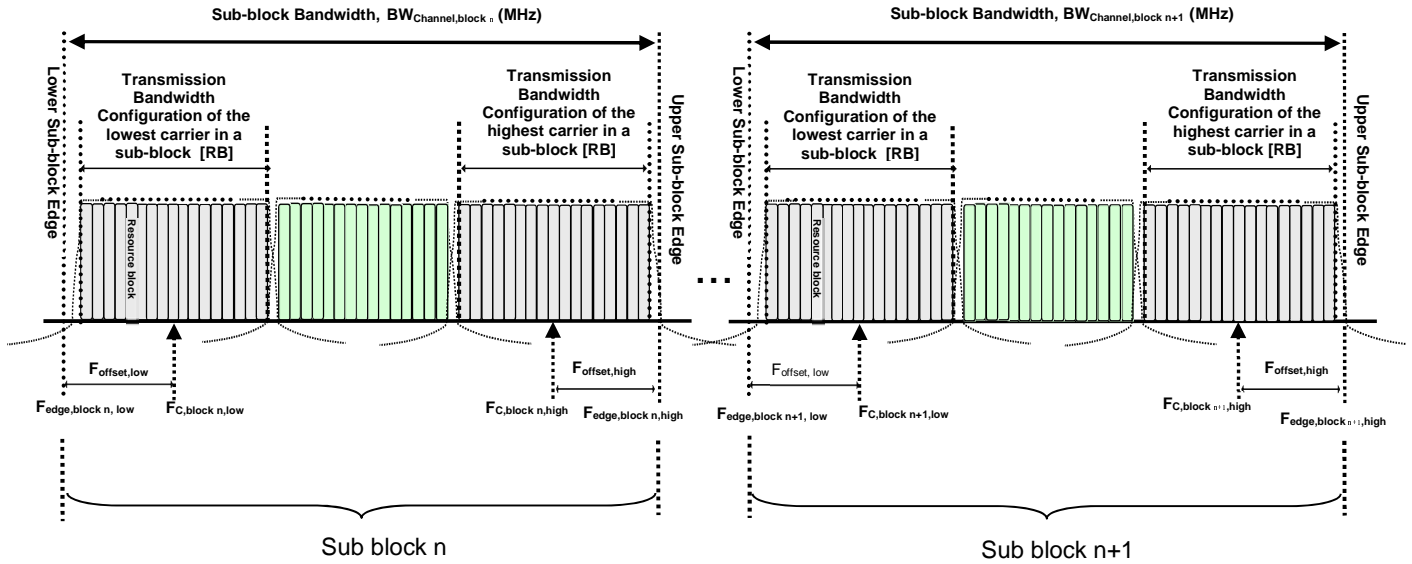

Figure 5.3A.3-2: Definition of sub-block bandwidth for intra-band non-contiguous spectrum

The lower sub-block edge of the Sub-block Bandwidth ($BW_{Channel,block}$) is defined as

$$F_{edge,block, low} = F_{C,block,low} - F_{offset, low}.$$

The upper sub-block edge of the Sub-block Bandwidth is defined as

$$F_{edge,block,high} = F_{C,block,high} + F_{offset,high}.$$

The Sub-block Bandwidth, $BW_{Channel,block}$, is defined as follows:

$$BW_{Channel,block} = F_{edge,block,high} - F_{edge,block,low} \text{ (MHz)}$$

The lower and upper frequency offsets $F_{offset,block,low}$ and $F_{offset,block,high}$ depend on the transmission bandwidth configurations of the lowest and highest assigned edge component carriers within a sub-block and are defined as

$$F_{offset,block,low} = (N_{RB,low} * 12 + 1) * SCS_{low} / 2 + BW_{GB} \text{ (MHz)}$$

$$F_{offset,block,high} = (N_{RB,high} * 12 - 1) * SCS_{high} / 2 + BW_{GB} \text{ (MHz)}$$

$$BW_{GB} = \max(BW_{GB,Channel(k)})$$

where $N_{RB,low}$ and $N_{RB,high}$ are the transmission bandwidth configurations according to Table 5.3.2-1 for the lowest and highest assigned component carrier within a sub-block, respectively. SCS_{low} and SCS_{high} are the sub-carrier spacing for the lowest and highest assigned component carrier within a sub-block, respectively. SCS_{low} , SCS_{high} , $N_{RB,low}$, $N_{RB,high}$, and $BW_{GB,Channel(k)}$ use the largest μ value among the subcarrier spacing configurations supported in the operating band for both of the channel bandwidths according to Table 5.3.5-1 and $BW_{GB,Channel(k)}$ is the minimum guard band for carrier k according to Table 5.3.3-1 for the said μ value. In case there is no common μ value for both of the channel bandwidths, $\mu=1$ is used for SCS_{low} , SCS_{high} , $N_{RB,low}$, $N_{RB,high}$, and $BW_{GB,Channel(k)}$.

The sub-block gap size between two consecutive sub-blocks W_{gap} is defined as

$$W_{gap} = F_{edge,block n+1, low} - F_{edge,block n, high} \text{ (MHz)}$$

5.3A.4 Void

5.3A.5 UE channel bandwidth per operating band for CA

The requirements for carrier aggregation in this specification are defined for carrier aggregation configurations.

For intra-band contiguous carrier aggregation, a carrier aggregation configuration is a single operating band supporting a carrier aggregation bandwidth class with associated bandwidth combination sets specified in clause 5.5A.1. For each carrier aggregation configuration, requirements are specified for all aggregated channel bandwidths contained in a bandwidth combination set, a UE can indicate support of several bandwidth combination sets per carrier aggregation configuration. For intra-band non-contiguous carrier aggregation, a carrier aggregation configuration is a single operating band supporting two or more sub-blocks, each supporting a carrier aggregation bandwidth class.

For intra-band non-contiguous uplink carrier aggregation, frequency separation class (Fs) specified in Table 5.3A.5-2 indicates the maximum frequency span between lower edge of lowest component carrier and upper edge of highest component carrier that UE can support per band combination in uplink in non-contiguous intra-band operation when the signalling is absent for dualPA-Architecture IE.

For inter-band carrier aggregation, a carrier aggregation configuration is a combination of operating bands, each supporting a carrier aggregation bandwidth class.

Table 5.3A.5-1: NR CA bandwidth classes

NR CA bandwidth class	Aggregated channel bandwidth	Number of contiguous CC	Fallback group	
A	$BW_{\text{Channel}} \leq BW_{\text{Channel,max}}$	1	1, 2, 3 ⁴	
B	$20 \text{ MHz} \leq BW_{\text{Channel,CA}} \leq 100 \text{ MHz}$	2	2, 3 ⁴	
C	$100 \text{ MHz} < BW_{\text{Channel,CA}} \leq 2 \times BW_{\text{Channel,max}}$	2	1, 3 ⁴	
D	$200 \text{ MHz} < BW_{\text{Channel,CA}} \leq 3 \times BW_{\text{Channel,max}}$	3		
E	$300 \text{ MHz} < BW_{\text{Channel,CA}} \leq 4 \times BW_{\text{Channel,max}}$	4		
G	$100 \text{ MHz} < BW_{\text{Channel,CA}} \leq 150 \text{ MHz}$	3		
H	$150 \text{ MHz} < BW_{\text{Channel,CA}} \leq 200 \text{ MHz}$	4	2	
I	$200 \text{ MHz} < BW_{\text{Channel,CA}} \leq 250 \text{ MHz}$	5		
J	$250 \text{ MHz} < BW_{\text{Channel,CA}} \leq 300 \text{ MHz}$	6		
K	$300 \text{ MHz} < BW_{\text{Channel,CA}} \leq 350 \text{ MHz}$	7		
L	$350 \text{ MHz} < BW_{\text{Channel,CA}} \leq 400 \text{ MHz}$	8		
M ³	$50 \text{ MHz} \leq BW_{\text{Channel,CA}} \leq 200 \text{ MHz}$	3		3 ⁴
N ³	$80 \text{ MHz} \leq BW_{\text{Channel,CA}} \leq 300 \text{ MHz}$	4		
O ³	$100 \text{ MHz} \leq BW_{\text{Channel,CA}} \leq 400 \text{ MHz}$	5		
NOTE 1: $BW_{\text{Channel,max}}$ is maximum channel bandwidth supported among all bands in a release				
NOTE 2: It is mandatory for a UE to be able to fallback to lower order NR CA bandwidth class configuration within a fallback group. It is not mandatory for a UE to be able to fallback to lower order NR CA bandwidth class configuration that belong to a different fallback group.				
NOTE 3: This bandwidth class is only applicable to bands identified for use with shared spectrum channel access in Table 5.2-1.				
NOTE 4: Fallback group 3 is only applicable to bands identified for use with shared spectrum channel access in Table 5.2-1.				

Table 5.3A.5-2: NR intra-band non-contiguous UL CA frequency separation classes

NR NC UL CA frequency separation class	Maximum allowed frequency separation
I	100 MHz
II	200 MHz
III	[600 MHz]

5.3E Channel bandwidth for V2X

5.3E.1 General

NR V2X operation channel bandwidths for each operating band is specified in Table 5.3E.1-1. The same (symmetrical) channel bandwidth is specified for both the transmission and reception path.

Table 5.3E.1-1 NR V2X operation channel bandwidths for each operating band

NR band / SCS / UE Channel bandwidth					
NR Band	SCS kHz	10 MHz	20 MHz	30 MHz	40 MHz
n38	15	Yes	Yes	Yes	Yes
	30	Yes	Yes	Yes	Yes
	60	Yes	Yes	Yes	Yes
n47	15	Yes	Yes	Yes	Yes
	30	Yes	Yes	Yes	Yes
	60	Yes	Yes	Yes	Yes

5.3E.2 Channel bandwidth for V2X concurrent operation

For NR V2X inter-band concurrent operation in FR1, the NR V2X channel bandwidths for each operating band is specified in Table 5.3E.2-1.

Table 5.3E.2-1: Inter-band concurrent operation configurations

V2X concurrent operating band Configuration	NR Bands	SCS kHz	5 MHz	10 MHz	15 MHz	20 MHz	30 MHz	40 MHz	50 MHz	Maximum bandwidth [MHz]	Bandwidth combination set
V2X_n71A-n47A	n71	15	Yes	Yes	Yes	Yes				60	0
		30		Yes	Yes	Yes					
		60									
	n47	15		Yes		Yes	Yes	Yes			
		30		Yes		Yes	Yes	Yes			
		60		Yes		Yes	Yes	Yes			

5.4 Channel arrangement

5.4.1 Channel spacing

5.4.1.1 Channel spacing for adjacent NR carriers

The spacing between carriers will depend on the deployment scenario, the size of the frequency block available and the channel bandwidths. The nominal channel spacing between two adjacent NR carriers is defined as following:

- For NR operating bands with 100 kHz channel raster,

$$\text{Nominal Channel spacing} = (\text{BW}_{\text{Channel}(1)} + \text{BW}_{\text{Channel}(2)})/2$$

- For NR operating bands with 15 kHz channel raster,

$$\text{Nominal Channel spacing} = (\text{BW}_{\text{Channel}(1)} + \text{BW}_{\text{Channel}(2)})/2 + \{-5 \text{ kHz}, 0 \text{ kHz}, 5 \text{ kHz}\} \text{ for } \Delta F_{\text{Raster}} \text{ equals } 15 \text{ kHz}$$

$$\text{Nominal Channel spacing} = (\text{BW}_{\text{Channel}(1)} + \text{BW}_{\text{Channel}(2)})/2 + \{-10 \text{ kHz}, 0 \text{ kHz}, 10 \text{ kHz}\} \text{ for } \Delta F_{\text{Raster}} \text{ equals } 30 \text{ kHz}$$

where $\text{BW}_{\text{Channel}(1)}$ and $\text{BW}_{\text{Channel}(2)}$ are the channel bandwidths of the two respective NR carriers. The channel spacing can be adjusted depending on the channel raster to optimize performance in a particular deployment scenario.

For NR bands restricted to operation with shared-spectrum channel access, the maximum deviation from the nominal channel spacing is 40 kHz.

5.4.2 Channel raster

5.4.2.1 NR-ARFCN and channel raster

The global frequency channel raster defines a set of RF reference frequencies F_{REF} . The RF reference frequency is used in signalling to identify the position of RF channels, SS blocks and other elements.

The global frequency raster is defined for all frequencies from 0 to 100 GHz. The granularity of the global frequency raster is ΔF_{Global} .

RF reference frequencies are designated by an NR Absolute Radio Frequency Channel Number (NR-ARFCN) in the range (0...2016666) on the global frequency raster. The relation between the NR-ARFCN and the RF reference frequency F_{REF} in MHz is given by the following equation, where $F_{\text{REF-Offs}}$ and $N_{\text{REF-Offs}}$ are given in table 5.4.2.1-1 and N_{REF} is the NR-ARFCN.

$$F_{\text{REF}} = F_{\text{REF-Offs}} + \Delta F_{\text{Global}} (N_{\text{REF}} - N_{\text{REF-Offs}})$$

Table 5.4.2.1-1: NR-ARFCN parameters for the global frequency raster

Frequency range (MHz)	ΔF_{Global} (kHz)	$F_{\text{REF-Offs}}$ (MHz)	$N_{\text{REF-Offs}}$	Range of N_{REF}
0 – 3000	5	0	0	0 – 599999
3000 – 24250	15	3000	600000	600000 – 2016666

The channel raster defines a subset of RF reference frequencies that can be used to identify the RF channel position in the uplink and downlink. The RF reference frequency for an RF channel maps to a resource element on the carrier. For each operating band, a subset of frequencies from the global frequency raster are applicable for that band and forms a channel raster with a granularity ΔF_{Raster} , which may be equal to or larger than ΔF_{Global} .

For SUL bands except n95, for the uplink of all FDD bands defined in Table 5.2-1, and for TDD bands n34, n39, n48, n90 and n38,

$$F_{\text{REF, shift}} = F_{\text{REF}} + \Delta_{\text{shift}}, \Delta_{\text{shift}} = 0 \text{ kHz or } 7.5 \text{ kHz.}$$

where Δ_{shift} is signalled by the network in higher layer parameter *frequencyShift7p5khz* [7]. For Band n34, n38, n39 and n48 $F_{\text{REF, shift}}$ is only applicable to uplink transmissions using a 15 kHz SCS.

The mapping between the channel raster and corresponding resource element is given in Clause 5.4.2.2. The applicable entries for each operating band are defined in Clause 5.4.2.3.

5.4.2.2 Channel raster to resource element mapping

The mapping between the RF reference frequency on the channel raster and the corresponding resource element is given in Table 5.4.2.2-1 and can be used to identify the RF channel position. The mapping depends on the total number of RBs that are allocated in the channel and applies to both UL and DL. The mapping must apply to at least one numerology supported by the UE.

Table 5.4.2.2-1: Channel raster to resource element mapping

	$N_{\text{RB}} \bmod 2 = 0$	$N_{\text{RB}} \bmod 2 = 1$
Resource element index k	0	6
Physical resource block index n_{PRB}	$n_{\text{PRB}} = \left\lfloor \frac{N_{\text{RB}}}{2} \right\rfloor$	$n_{\text{PRB}} = \left\lfloor \frac{N_{\text{RB}}}{2} \right\rfloor$

N_{RB} is the maximum transmission bandwidth configuration specified in sub-clause 5.3.2, n_{PRB} is the PRB index within the N_{RB} , and k is the resource element index within this PRB.

5.4.2.3 Channel raster entries for each operating band

The RF channel positions on the channel raster in each NR operating band are given through the applicable NR-ARFCN in Table 5.4.2.3-1, using the channel raster to resource element mapping in clause 5.4.2.2.

For NR operating bands with 100 kHz channel raster, $\Delta F_{\text{Raster}} = 20 \times \Delta F_{\text{Global}}$. In this case every 20th NR-ARFCN within the operating band are applicable for the channel raster within the operating band and the step size for the channel raster in Table 5.4.2.3-1 is given as <20>.

For NR operating bands with 15 kHz channel raster below 3GHz, $\Delta F_{\text{Raster}} = I \times \Delta F_{\text{Global}}$, where $I \in \{3,6\}$. Every I^{th} NR-ARFCN within the operating band are applicable for the channel raster within the operating band and the step size for the channel raster in Table 5.4.2.3-1 is given as <I>.

For NR operating bands with 15 kHz channel raster above 3GHz, $\Delta F_{\text{Raster}} = I \times \Delta F_{\text{Global}}$, where $I \in \{1,2\}$. Every I^{th} NR-ARFCN within the operating band are applicable for the channel raster within the operating band and the step size for the channel raster in table 5.4.2.3-1 is given as <I>.

In frequency bands with two or more ΔF_{Raster} : For 15 kHz and 30 kHz channel raster the higher ΔF_{Raster} applies to channels using only the SCS that is equal to or larger than the higher ΔF_{Raster} and SSB SCS is equal to the higher ΔF_{Raster} .

Table 5.4.2.3-1: Applicable NR-ARFCN per operating band

NR operating band	ΔF_{Raster} (kHz)	Uplink Range of N_{REF} (First – <Step size> – Last)	Downlink Range of N_{REF} (First – <Step size> – Last)
n1	100	384000 – <20> – 396000	422000 – <20> – 434000
n2	100	370000 – <20> – 382000	386000 – <20> – 398000
n3	100	342000 – <20> – 357000	361000 – <20> – 376000
n5	100	164800 – <20> – 169800	173800 – <20> – 178800
n7	100	500000 – <20> – 514000	524000 – <20> – 538000
n8	100	176000 – <20> – 183000	185000 – <20> – 192000
n12	100	139800 – <20> – 143200	145800 – <20> – 149200
n14	100	157600 – <20> – 159600	151600 – <20> – 153600
n18	100	163000 – <20> – 166000	172000 – <20> – 175000
n20	100	166400 – <20> – 172400	158200 – <20> – 164200
n25	100	370000 – <20> – 383000	386000 – <20> – 399000
n26	100	162800 – <20> – 169800	171800 – <20> – 178800
n28	100	140600 – <20> – 149600	151600 – <20> – 160600
n29	100	N/A	143400 – <20> – 145600
n30	100	461000 – <20> – 463000	470000 – <20> – 472000
n34	100	402000 – <20> – 405000	402000 – <20> – 405000
n38	100	514000 – <20> – 524000	514000 – <20> – 524000
n39	100	376000 – <20> – 384000	376000 – <20> – 384000
n40	100	460000 – <20> – 480000	460000 – <20> – 480000
n41	15	499200 – <3> – 537999	499200 – <3> – 537999
	30	499200 – <6> – 537996	499200 – <6> – 537996
n46 ²	15	743334 – <1> – 795000	743334 – <1> – 795000
n47	15	790334 – <1> – 795000	790334 – <1> – 795000
n48	15	636667 – <1> – 646666	636667 – <1> – 646666
	30	636668 – <2> – 646666	636668 – <2> – 646666
n50	100	286400 – <20> – 303400	286400 – <20> – 303400
n51	100	285400 – <20> – 286400	285400 – <20> – 286400
n53	100	496700 – <20> – 499000	496700 – <20> – 499000
n65	100	384000 – <20> – 402000	422000 – <20> – 440000
n66	100	342000 – <20> – 356000	422000 – <20> – 440000
n70	100	339000 – <20> – 342000	399000 – <20> – 404000
n71	100	132600 – <20> – 139600	123400 – <20> – 130400
n74	100	285400 – <20> – 294000	295000 – <20> – 303600
n75	100	N/A	286400 – <20> – 303400
n76	100	N/A	285400 – <20> – 286400
n77	15	620000 – <1> – 680000	620000 – <1> – 680000
	30	620000 – <2> – 680000	620000 – <2> – 680000
n78	15	620000 – <1> – 653333	620000 – <1> – 653333
	30	620000 – <2> – 653332	620000 – <2> – 653332

n79	15	693334 – <1> – 733333	693334 – <1> – 733333
	30	693334 – <2> – 733332	693334 – <2> – 733332
n80	100	342000 – <20> – 357000	N/A
n81	100	176000 – <20> – 183000	N/A
n82	100	166400 – <20> – 172400	N/A
n83	100	140600 – <20> – 149600	N/A
n84	100	384000 – <20> – 396000	N/A
n86	100	342000 – <20> – 356000	N/A
n89	100	164800 – <20> – 169800	N/A
n90	15	499200 – <3> – 537999	499200 – <3> – 537999
	30	499200 – <6> – 537996	499200 – <6> – 537996
	100	499200 – <20> – 538000	499200 – <20> – 538000
n91	100	166400 – <20> – 172400	285400 – <20> – 286400
n92	100	166400 – <20> – 172400	286400 – <20> – 303400
n93	100	176000 – <20> – 183000	285400 – <20> – 286400
n94	100	176000 – <20> – 183000	286400 – <20> – 303400
n95	100	402000 – <20> – 405000	N/A
n96 ³	15	795000 – <1> – 875000	795000 – <1> – 875000

NOTE 1: The channel numbers that designate carrier frequencies so close to the operating band edges that the carrier extends beyond the operating band edge shall not be used.
 NOTE 2: The following N_{REF} are allowed for operation in Band n46: see Table 5.4.2.3-2.
 NOTE 3: The following N_{REF} are allowed for operation in Band n96: see Table 5.4.2.3-3.

Table 5.4.2.3-2: Allowed N_{REF} (NR-ARFCN) for operation in Band n46

Channel Bandwidth	Allowed N _{REF}
10 MHz	782000, 788668
20 MHz	744000, 745332, 746668, 748000, 749332, 750668, 752000, 753332, 754668, 756000, 765332, 766668, 768000, 769332, 770668, 772000, 773332, 774668, 776000, 777332, 778668, 780000, 781332, 783000, 784332, 785668, 787000, 788332, 789668, 791000, 792332, 793668
40 MHz	744668, 746000, 748668, 751332, 754000, 755332, 766000, 767332, 770000, 772668, 775332, 778000, 780668, 783668, 786332, 787668, 790332, 793000
60 MHz	745332, 746668, 748000, 752000, 753332, 754668, 766668, 768000, 769332, 773332, 774668, 778668, 780000, 784332, 785668, 791000, 792332
80 MHz	746000, 747332, 752668, 754000, 767332, 768668, 774000, 779332, 785000, 791668

NOTE: 10 MHz channel bandwidth shall only apply in certain regions where the absence of non 3GPP technologies can be guaranteed on a long-term basis in this version of specification.

Table 5.4.2.3-3: Allowed N_{REF} (NR-ARFCN) for operation in Band n96

Channel Bandwidth	Allowed N _{REF}
20 MHz	797000, 798332, 799668, 801000, 802332, 803668, 805000, 806332, 807668, 809000, 810332, 811668, 813000, 814332, 815668, 817000, 818332, 819668, 821000, 822332, 823668, 825000, 826332, 827668, 829000, 830332, 831668, 833000, 834332, 835668, 837000, 838332, 839668, 841000, 842332, 843668, 845000, 846332, 847668, 849000, 850332, 851668, 853000, 854332, 855668, 857000, 858332, 859668, 861000, 862332, 863668, 865000, 866332, 867668, 869000, 870332, 871668, 873000, 874332
40 MHz	797668, 800332, 803000, 805668, 808332, 811000, 813668, 816332, 819000, 821668, 824332, 827000, 829668, 832332, 835000, 837668, 840332, 843000, 845668, 848332, 851000, 853668, 856332, 859000, 861668, 864332, 867000, 869668, 872332

60 MHz	798332, 799668, 803668, 805000, 809000, 810332, 814332, 815668, 819668, 821000, 825000, 826332, 830332, 831668, 835668, 837000, 841000, 842332, 846332, 847668, 851668, 853000, 857000, 858332, 862332, 863668, 867668, 869000, 873000
80 MHz	799000, 804332, 809668, 815000, 820332, 825668, 831000, 836332, 841668, 847000, 852332, 857668, 863000, 868332

5.4.3 Synchronization raster

5.4.3.1 Synchronization raster and numbering

The synchronization raster indicates the frequency positions of the synchronization block that can be used by the UE for system acquisition when explicit signalling of the synchronization block position is not present.

A global synchronization raster is defined for all frequencies. The frequency position of the SS block is defined as SS_{REF} with corresponding number GSCN. The parameters defining the SS_{REF} and GSCN for all the frequency ranges are in Table 5.4.3.1-1.

The resource element corresponding to the SS block reference frequency SS_{REF} is given in clause 5.4.3.2. The synchronization raster and the subcarrier spacing of the synchronization block is defined separately for each band.

Table 5.4.3.1-1: GSCN parameters for the global frequency raster

Frequency range	SS Block frequency position SS_{REF}	GSCN	Range of GSCN
0 – 3000 MHz	$N * 1200\text{kHz} + M * 50\text{ kHz}$, $N=1:2499$, $M \in \{1,3,5\}$ (Note 1)	$3N + (M-3)/2$	2 – 7498
3000 – 24250 MHz	$3000\text{ MHz} + N * 1.44\text{ MHz}$ $N = 0:14756$	$7499 + N$	7499 – 22255

NOTE 1: The default value for operating bands with which only support SCS spaced channel raster(s) is $M=3$.

5.4.3.2 Synchronization raster to synchronization block resource element mapping

The mapping between the synchronization raster and the corresponding resource element of the SS block is given in Table 5.4.3.2-1.

Table 5.4.3.2-1: Synchronization raster to SS block resource element mapping

Resource element index k	120
----------------------------	-----

k is the subcarrier number of SS/PBCH block defined in TS 38.211 clause 7.4.3.1 [6].

5.4.3.3 Synchronization raster entries for each operating band

The synchronization raster for each band is give in Table 5.4.3.3-1. The distance between applicable GSCN entries is given by the <Step size> indicated in Table 5.4.3.3-1.

Table 5.4.3.3-1: Applicable SS raster entries per operating band

NR operating band	SS Block SCS	SS Block pattern ¹	Range of GSCN (First – <Step size> – Last)
n1	15 kHz	Case A	5279 – <1> – 5419
n2	15 kHz	Case A	4829 – <1> – 4969
n3	15 kHz	Case A	4517 – <1> – 4693
n5	15 kHz	Case A	2177 – <1> – 2230
	30 kHz	Case B	2183 – <1> – 2224
n7	15 kHz	Case A	6554 – <1> – 6718

n8	15 kHz	Case A	2318 – <1> – 2395
n12	15 kHz	Case A	1828 – <1> – 1858
n14	15 kHz	Case A	1901 – <1> – 1915
n18	15 kHz	Case A	2156 – <1> – 2182
n20	15 kHz	Case A	1982 – <1> – 2047
n25	15 kHz	Case A	4829 – <1> – 4981
n26	15 kHz	Case A	2153 – <1> – 2230
n28	15 kHz	Case A	1901 – <1> – 2002
n29	15 kHz	Case A	1798 – <1> – 1813
n30	15 kHz	Case A	5879 – <1> – 5893
n34	15 kHz	Case A	NOTE 5
	30 kHz	Case C	5036 – <1> – 5050
n38	15 kHz	Case A	NOTE 2
	30 kHz	Case C	6437 – <1> – 6538
n39	15 kHz	Case A	NOTE 6
	30 kHz	Case C	4712 – <1> – 4789
n40	30 kHz	Case C	5762 – <1> – 5989
n41	15 kHz	Case A	6246 – <3> – 6717
	30 kHz	Case C	6252 – <3> – 6714
n46 ³	30 kHz	Case C	8993 – <1> – 9530
n48	30 kHz	Case C	7884 – <1> – 7982
n50	30 kHz	Case C	3590 – <1> – 3781
n51	15 kHz	Case A	3572 – <1> – 3574
n53	15 kHz	Case A	6215 – <1> – 6232
	30 kHz	Case C	6221 – <1> – 6226
n65	15 kHz	Case A	5279 – <1> – 5494
n66	15 kHz	Case A	5279 – <1> – 5494
	30 kHz	Case B	5285 – <1> – 5488
n70	15 kHz	Case A	4993 – <1> – 5044
n71	15 kHz	Case A	1547 – <1> – 1624
n74	15 kHz	Case A	3692 – <1> – 3790
n75	15 kHz	Case A	3584 – <1> – 3787
n76	15 kHz	Case A	3572 – <1> – 3574
n77	30 kHz	Case C	7711 – <1> – 8329
n78	30 kHz	Case C	7711 – <1> – 8051
n79	30 kHz	Case C	8480 – <16> – 8880
n90	15 kHz	Case A	6246 – <1> – 6717
	30 kHz	Case C	6252 – <1> – 6714
n91	15 kHz	Case A	3572 – <1> – 3574
n92	15 kHz	Case A	3584 – <1> – 3787
n93	15 kHz	Case A	3572 – <1> – 3574
n94	15 kHz	Case A	3584 – <1> – 3787
n96 ⁴	30 kHz	Case C	9531 – <1> – 10363
NOTE 1: SS Block pattern is defined in clause 4.1 in TS 38.213 [8].			
NOTE 2: The applicable SS raster entries are GSCN = {6432, 6443, 6457, 6468, 6479, 6493, 6507, 6518, 6532, 6543}.			
NOTE 3: The following GSCN are allowed for operation in band n46: GSCN = {8996, 9010, 9024, 9038, 9051, 9065, 9079, 9093, 9107, 9121, 9218, 9232, 9246, 9260, 9274, 9288, 9301, 9315, 9329, 9343, 9357, 9371, 9385, 9402, 9416, 9430, 9444, 9458, 9472, 9485, 9499, 9513}.			
NOTE 4: The following GSCN are allowed for operation in band n96: GSCN = {9548, 9562, 9576, 9590, 9603, 9617, 9631, 9645, 9659, 9673, 9687, 9701, 9714, 9728, 9742, 9756, 9770, 9784, 9798, 9812, 9826, 9840, 9853, 9867, 9881, 9895, 9909, 9923, 9937, 9951, 9964, 9978, 9992, 10006, 10020, 10034, 10048, 10062, 10076, 10090, 10103, 10117, 10131, 10145, 10159, 10173, 10187, 10201, 10214, 10228, 10242, 10256, 10270, 10284, 10298, 10312, 10325, 10339, 10353}.			
NOTE 5: The applicable SS raster entries are GSCN = {5032, 5043, 5054}			
NOTE 6: The applicable SS raster entries are GSCN = {4707, 4715, 4718, 4729, 4732, 4743, 4747, 4754, 4761, 4768, 4772, 4782, 4786, 4793}			

5.4.4 TX–RX frequency separation

The default TX channel (carrier centre frequency) to RX channel (carrier centre frequency) separation for operating bands is specified in Table 5.4.4-1.

Table 5.4.4-1: UE TX-RX frequency separation

NR Operating Band	TX – RX carrier centre frequency separation
n1	190 MHz
n2	80 MHz
n3	95 MHz
n5	45 MHz
n7	120 MHz
n8	45 MHz
n12	30 MHz
n14	-30 MHz
n18	45 MHz
n20	-41 MHz
n25	80 MHz
n26	45 MHz
n28	55 MHz
n30	45 MHz
n65	190 MHz
n66	400 MHz
n70	300 MHz
n71	-46 MHz
n74	48 MHz
n91	570 MHz – 595 MHz (NOTE 2)
n92	575 MHz – 680 MHz ($\mu = 0$) 580 MHz – 675 MHz ($\mu = 1$) (NOTE 2)
n93	517 MHz – 547 MHz (NOTE 2)
n94	522 MHz – 632 MHz ($\mu = 0$) 527 MHz – 627 MHz ($\mu = 1$) (NOTE 2)
NOTE 1: Void	
NOTE 2: The range of TX-RX frequency separation given paired UL and DL channel bandwidths BW_{UL} and BW_{DL} is given by the respective lower and upper limit $F_{DL_low} - F_{UL_high} + 0.5(BW_{DL} + BW_{UL})$ and $F_{DL_high} - F_{UL_low} - 0.5(BW_{DL} + BW_{UL})$. The UL and DL channel bandwidth combinations specified in Table 5.3.5-1 and 5.3.6-1 depend on the subcarrier spacing configuration μ [6].	

5.4A Channel arrangement for CA

5.4A.1 Channel spacing for CA

For intra-band contiguous carrier aggregation with two or more component carriers, the nominal channel spacing between two adjacent NR component carriers is defined as the following unless stated otherwise:

For NR operating bands with a 100 kHz channel raster:

$$\text{Nominal channel spacing} = \left\lceil \frac{BW_{Channel(1)} + BW_{Channel(2)} - 2|GB_{Channel(1)} - GB_{Channel(2)}|}{0.6} \right\rceil 0.3 \text{ [MHz]}$$

while for NR operating bands without a 100 kHz channel raster:

$$\text{Nominal channel spacing} = \left\lceil \frac{BW_{Channel(1)} + BW_{Channel(2)} - 2|GB_{Channel(1)} - GB_{Channel(2)}|}{0.015 * 2^{n+1}} \right\rceil 0.015 * 2^n \text{ [MHz]}$$

with

$$n = \mu_0$$

where $BW_{\text{Channel}(1)}$ and $BW_{\text{Channel}(2)}$ are the channel bandwidths of the two respective NR component carriers according to Table 5.3.2-1 with values in MHz, μ_0 is the largest μ value among the subcarrier spacing configurations supported in the operating band for both of the channel bandwidths according to Table 5.3.5-1 and $GB_{\text{Channel}(i)}$ is the minimum guard band for channel bandwidth i according to Table 5.3.3-1 for the said μ value with μ as defined in TS 38.211. In case there is no common μ value for both of the channel bandwidths, $\mu_0=1$ is selected and $GB_{\text{Channel}(i)}$ is the minimum guard band for channel bandwidth i according to Table 5.3.3-1 for $\mu=1$ with μ as defined in TS 38.211.

The channel spacing for intra-band contiguous carrier aggregation can be adjusted to any multiple of least common multiple of channel raster and sub-carrier spacing less than the nominal channel spacing to optimize performance in a particular deployment scenario.

For intra-band contiguous carrier aggregation in NR bands restricted to operation with shared-spectrum channel access, the maximum deviation from the nominal channel spacing is 300 kHz.

For intra-band non-contiguous carrier aggregation, the channel spacing between two NR component carriers in different sub-blocks shall be larger than the nominal channel spacing defined in this clause.

5.4A.2 Channel raster for CA

For inter-band and intra-band contiguous carrier aggregation, the channel raster requirements in clause 5.4.2 apply for each operating band.

5.4A.3 Synchronization raster for CA

For inter-band and intra-band contiguous carrier aggregation, the synchronization raster requirements in clause 5.4.3 apply for each operating band.

5.4A.4 Tx-Rx frequency separation for CA

For inter-band carrier aggregation, the Tx-Rx frequency separation requirements in clause 5.4.4 apply for each operating band.

For intra-band contiguous carrier aggregation, the same TX-RX frequency separation as specified in Table 5.4.4-1 is applied to PCC and SCC, respectively.

5.4B Reserved

5.4C Reserved

5.4D Reserved

5.4E Channel arrangement for V2X

5.4E.1 Channel spacing

For NR V2X, the channel spacing requirements in clause 5.4.1 apply for each operating band.

5.4E.2 Channel raster

5.4E.2.1 NR-ARFCN and channel raster

For NR V2X, the NR-ARFCN and channel raster requirements in clause 5.4.2.1 apply for each operating band.

For NR V2X UE, the reference frequency can be shifted by configuration.

$$F_{\text{REF_V2X}} = F_{\text{REF}} + \Delta_{\text{shift}} + N * 5 \text{ kHz}$$

where

$\Delta_{\text{shift}} = 0 \text{ kHz}$ or 7.5 kHz indicated in IE (*frequencyShift7p5khz*), and

N can be set as one of following values $\{-1, 0, 1\}$, which are signalled by the network in higher layer parameters or configured by pre-configuration parameters.

5.4E.2.2 Channel raster to resource element mapping

For NR V2X, the channel raster to resource element mapping requirements in clause 5.4.2.2 apply for each operating band.

5.4E.2.3 Channel raster entries for each operating band

For NR V2X, the channel raster entries, the channel raster entries requirements in clause 5.4.2.3 apply for each operating band.

The RF channel positions on the channel raster in each NR V2X operating band are given through the applicable NR-ARFCN in Table 5.4.2.3-1, using the channel raster to resource element mapping in clause 5.4E.2.2.

For NR V2X operating band n47, $\Delta F_{\text{Raster}} = I \times \Delta F_{\text{Global}}$, where $I \in \{1\}$. Every I^{th} NR-ARFCN within the operating band are applicable for the channel raster within the operating band and the step size for the channel raster in Table 5.4.2.3-1 is given as $\langle I \rangle$.

5.4E.3 Synchronization raster for V2X

There is no synchronization raster definition for NR V2X for both licensed bands and unlicensed bands.

5.5 Void

5.5A Configurations for CA

5.5A.0 General

The configurations for CA operating band including Band n41 also apply for the corresponding CA operating bands with Band n90 replacing Band n41 but with otherwise identical parameters. For brevity the said configuration for CA operating bands with Band n90 are not listed in the tables below but are covered by this specification.

Non-contiguous resource allocation and almost contiguous allocation are not applicable for each NR carrier of intra-band contiguous and non-contiguous CA configurations.

For a CA configuration with one or more operating band supporting asymmetric channel bandwidths as specified in sub-clause 5.3.6, requirements are defined for an asymmetric UL and DL channel bandwidth combination of a supported asymmetric channel bandwidth combination set for an operating band of the CA configuration when the said UL and DL channel bandwidths are also contained in a supported bandwidth combination set of the CA configuration.

For a higher order band combination of which CA_n20-n28 is a subset, the frequency range in band n28 is restricted for the higher order band combination to 703-733 MHz for the UL and 758-788 MHz for the DL.

5.5A.1 Configurations for intra-band contiguous CA

Table 5.5A.1-1: NR CA configurations and bandwidth combination sets defined for intra-band contiguous CA

NR CA configuration / Bandwidth combination set								
NR CA configuration	Uplink CA configurations	Channel bandwidths for carrier (MHz)	Channel bandwidths for carrier (MHz)	Channel bandwidths for carrier (MHz)	Channel bandwidths for carrier (MHz)	Channel bandwidths for carrier (MHz)	Maximum aggregated bandwidth (MHz)	Bandwidth combination set
CA_n1B	-	10	10,15				40	0
		15	15,20					
		20	20					
CA_n7B	CA_n7B	10	10, 15, 20, 30, 40				50	0
		15	15, 20, 30					
		20	20, 30					
CA_n40B	-	20	80				100	0
		50	50					
CA_n41B	CA_n41B	10, 20, 30, 40, 50	10, 20, 30, 40, 50				100	0
CA_n41C	CA_n41C	40	80, 100				180	0
		50, 60, 80	60, 80, 100					
		10	100				190	1
		15, 20	90, 100					
		40	80, 90, 100					
50, 60, 80, 90	60, 80, 90, 100							
CA_n46B	-	20, 40, 60	20, 40				100	0
CA_n46C	-	60, 80	60, 80				160	0
CA_n46D	-	60, 80	80	80			240	0
CA_n46M	-	20, 40, 60	20, 40	20, 40			140	0
CA_n46N	-	Void						0
	-	20, 40, 60	20, 40	20, 40	20, 40		180	1
CA_n46O	-	20, 60	20, 40	20, 40	20, 40	20, 40	220	0
CA_n48B	CA_n48B	5	15, 20				40	0
		10, 15, 20	10, 15, 20					
		15, 20	15, 20					
	-	10	50, 60, 80, 90				100	1
		15, 20	40, 50, 60, 80					
40	40, 50, 60							
CA_n48C	-	10	100				140	0
		15	90,100					
		20	90, 100					
		40	80, 90, 100					
CA_n66B	-	5	20, 40				50	0
		10	15, 20, 40					
		15	15, 20					
CA_n71B	-	5	20				25	0
		10	15					
		10	20				35	1
		15	15, 20					

CA_n77C	CA_n77C	50	60, 80, 100				200	0		
		60	60, 80, 100							
		80	80, 100							
		100	100							
				10	100				200	1
				15, 20	90, 100					
				25, 30	80, 90, 100					
				40	70, 80, 90, 100					
				50, 60, 70, 80, 90, 100	60, 70, 80, 90, 100					
CA_n77D	-	100	100	100			300	0		
CA_n78B	-	20	50				70	0		
CA_n78C	CA_n78C	50	60, 80, 100				200	0		
		60	60, 80, 100							
		80	80, 100							
		100	100							
				10	100				200	1
				15, 20	90, 100					
				25, 30	80, 90, 100					
				40	70, 80, 90, 100					
				50, 60, 70, 80, 90, 100	60, 70, 80, 90, 100					
CA_n78D	-	100	100	100			300	0		
CA_n79C	CA_n79C	50	60, 80, 100				200	0		
		60	60, 80, 100							
		80	80, 100							
		100	100							
CA_n79D	-	100	100	100			300	0		

NOTE 1: For each channel bandwidth of each component carrier, refer to Table 5.3.5-1 for the applicable SCSs. For a given band, not all UE channel bandwidths support the same SCSs.

Table 5.5A.1-2: Void

5.5A.2 Configurations for intra-band non-contiguous CA

Table 5.5A.2-1: NR CA configurations and bandwidth combination sets defined for intra-band non-contiguous CA

NR CA Configuration	Uplink Configurations	Channel bandwidths for carrier (MHz)	Channel bandwidths for carrier (MHz)	Channel bandwidths for carrier (MHz)	Channel bandwidths for carrier (MHz)	Maximum Aggregated bandwidth (MHz)	Bandwidth combination set
CA_n3(2A)	-	5, 10, 15, 20	5, 10, 15, 20			40	0
CA_n7(2A)	-	5, 10, 15, 20	5, 10, 15, 20			40	0
CA_n25(2A)	-	5, 10, 15, 20	5, 10, 15, 20			40	0
CA_n41(2A)	CA_n41(2A)	40, 50, 60, 80	40, 50, 60, 80, 100			180	0
		10, 15, 20, 40, 50, 60, 80, 90	10, 15, 20, 40, 50, 60, 80, 90, 100			190	1
CA_n48(2A)	-	10, 15, 20, 40, 50, 60	10, 15, 20, 40, 50, 60, 80, 90, 100			140 ²	0
CA_n48(3A)	-	10, 15, 20, 40, 50, 60, 80, 90, 100	10, 15, 20, 40, 50, 60, 80, 90, 100	10, 15, 20, 40, 50, 60, 80, 90, 100		140 ²	0

CA_n48(4A)	-	10, 15, 20, 40, 50, 60, 80, 90, 100	10, 15, 20, 40, 50, 60, 80, 90, 100	10, 15, 20, 40, 50, 60, 80, 90, 100	10, 15, 20, 40, 50, 60, 80, 90, 100	135 ²	0
CA_n66(2A)	-	5, 10, 15, 20	5, 10, 15, 20, 40			60	0
CA_n77(2A)	CA_n77(2A)	20, 40, 80, 100	20, 40, 80, 100			200	0
CA_n78(2A)	CA_n78(2A)	10, 20, 40, 50, 60, 80, 90, 100	10, 20, 40, 50, 60, 80, 90, 100			200	0
		10, 20, 25, 30, 40, 50, 60, 80, 90, 100	10, 20, 25, 30, 40, 50, 60, 80, 90, 100			200	1
		10, 20, 25, 30, 40, 50, 60, 70, 80, 90, 100	10, 20, 25, 30, 40, 50, 60, 70, 80, 90, 100			200	2

NOTE 1: Void.
 NOTE 2: Parameter value accounts for both, the maximum frequency range of band n48 (150 MHz), and the minimum frequency gaps in between NR non-contiguous component carriers.
 NOTE 3: For each channel bandwidth of each component carrier, refer to Table 5.3.5-1 for the applicable SCSs. For a given band, not all UE channel bandwidths support the same SCSs.

5.5A.3 Configurations for inter-band CA

Table 5.5A.3-1: Void

Table 5.5A.3-2: Void

Table 5.5A.3-3: Void

5.5A.3.1 Configurations for inter-band CA (two bands)

Table 5.5A.3.1-1: NR CA configurations and bandwidth combinations sets defined for inter-band CA (two bands)

NR CA configuration	Uplink CA configuration	NR Band	Channel bandwidth (MHz) (NOTE 3)													Bandwidth combination set
			5	10	15	20	25	30	40	50	60	70	80	90	100	
CA_n1A-n3A	CA_n1A-n3A	n1	5	10	15	20										0
		n3	5	10	15	20	25	30								
CA_n1B-n3A	CA_n1A-n3A	n1	See CA_n1B Bandwidth Combination Set 0 in Table 5.5A.1-1													0
		n3	5	10	15	20	25	30								
CA_n1A-n3(2A)	CA_n1A-n3A	n1	5	10	15	20										0
		n3	See CA_n3(2A) bandwidth combination set 0 in Table 5.5A.2-1													
CA_n1A-n7A	CA_n1A-n7A	n1	5	10	15	20										0
		n7	5	10	15	20	25	30	40	50						
CA_n1A-n7B	-	n1	5	10	15	20										0
		n7	See CA_n7B Bandwidth Combination Set 0 in Table 5.5A.1-1													
CA_n1A-n8A	CA_n1A-n8A	n1	5	10	15	20										0
		n8	5	10	15	20										
CA_n1A-n28A	CA_n1A-n28A	n1	5	10	15	20										0
		n28	5	10	15	20										
CA_n1A-n40A	CA_n1A-n40A	n1	5	10	15	20										0
		n40	5	10	15	20	25	30	40	50	60		80			
CA_n1A-n41A	CA_n1A-n41A	n1	5	10	15	20										0
		n41	5	10	15	20			40	50	60		80	90	100	
CA_n1A-n77A	-	n1	5	10	15	20										0
		n77		10	15	20			40	50	60		80	90	100	
CA_n1A-n78A	CA_n1A-n78A	n1	5	10	15	20										0
		n78		10	15	20			40	50	60		80	90	100	
CA_n1A-n78(2A)	CA_n1A-n78A	n1	5	10	15	20										0
		n78	See CA_n78(2A) Bandwidth Combination Set 0 in Table 5.5A.2-1													
CA_n1A-n78C	CA_n1A-n78A	n1	5	10	15	20										0
		n78	See CA_n78C Bandwidth Combination Set 0 in Table 5.5A.1-1													
CA_n1A-n79A	CA_n1A-n79A	n1	5	10	15	20										0
		n79							40	50	60		80		100	
CA_n1A-n79C	CA_n1A-n79A	n1	5	10	15	20										0
		n79	See CA_n79C Bandwidth Combination Set 0 in Table 5.5A.1-1													
CA_n2A-n5A	CA_n2A-n5A	n2	5	10	15	20										0
		n5	5	10	15	20										
CA_n2A-n48A	CA_n2A-n48A	n2	5	10	15	20										0
		n48	5	10	15	20			40	50 ⁴	60 ⁴		80 ⁴	90 ⁴	100 ⁴	
CA_n2A-n48C	CA_n2A-n48A	n2	5	10	15	20										0
		n48	See CA_n48C Bandwidth Combination Set 0 in Table 5.5A.1-1													

CA_n2A-n66A	-	n2	5	10	15	20											0	
		n66	5	10	15	20			40									
CA_n2A-n77A	CA_n2A-n77A	n2	5	10	15	20												0
		n77		10	15	20	25	30	40	50	60	70	80	90	100			
CA_n2A-n78A	CA_n2A-n78A	n2	5	10	15	20												0
		n78		10	15	20	25	30	40	50	60		80	90	100			
CA_n2A-n78(2A)	CA_n2A-n78A	n2	5	10	15	20												0
		n78	See CA_n78(2A) Bandwidth Combination Set 1 in Table 5.5A.2-1															
CA_n3A-n7A	CA_n3A-n7A	n3	5	10	15	20	25	30										0
		n7	5	10	15	20	25	30	40	50								
CA_n3A-n7B	-	n3	5	10	15	20	25	30										0
		n7	See CA_n7B Bandwidth Combination Set 0 in Table 5.5A.1-1															
CA_n3A-n8A	CA_n3A-n8A	n3	5	10	15	20	25	30										0
		n8	5	10	15	20												
CA_n3A-n28A	CA_n3A-n28A	n3	5	10	15	20	25	30										0
		n28	5	10	15	20												
CA_n3A-n38A	CA_n3A-n38A	n3	5	10	15	20	25	30										0
		n38	5	10	15	20			40									
CA_n3A-n40A	CA_n3A-n40A	n3	5	10	15	20	25	30										0
		n40	5	10	15	20	25	30	40	50	60		80					
CA_n3A-n41A	CA_n3A-n41A	n3	5	10	15	20	25	30										0
		n41		10	15	20			40	50	60		80	90	100			
		n3	5	10	15	20	25	30										1
		n41		10	15	20			40	50	60							
CA_n3A-n41C	CA_n3A-n41A	n3	5	10	15	20	25	30										0
		n41	See CA_n41C Bandwidth Combination Set 0 in Table 5.5A.1-1															
CA_n3A-n41(2A)	CA_n3A-n41A	n3	5	10	15	20	25	30										0
		n41	See CA_n41(2A) Bandwidth Combination Set 0 in Table 5.5A.2-1															
CA_n3A-n77A	CA_n3A-n77A	n3	5	10	15	20	25	30										0
		n77		10	15	20			40	50	60		80	90	100			
CA_n3A-n77(2A)	CA_n3A-n77A	n3	5	10	15	20	25	30										0
		n77	See CA_n77(2A) Bandwidth Combination Set 0 in Table 5.5A.2-1															
CA_n3A-n78A	CA_n3A-n78A	n3	5	10	15	20	25	30										0
		n78		10	15	20			40	50	60		80	90	100			
CA_n3A-n78C	CA_n3A-n78A	n3	5	10	15	20	25	30										0
		n78	See CA_n78C Bandwidth Combination Set 0 in Table 5.5A.1-1															
CA_n3A-n78(2A)	-	n3	5	10	15	20	25	30										0
		n78	See CA_n78(2A) Bandwidth Combination Set 0 in Table 5.5A.2-1															
CA_n3A-n79A	CA_n3A-n79A	n3	5	10	15	20	25	30										0
		n79							40	50	60		80		100			
CA_n3A-n79C	CA_n3A-n79A	n3	5	10	15	20	25	30										0
		n79	See CA_n79C Bandwidth Combination Set 0 in Table 5.5A.1-1															
CA_n5A-n7A	-	n5	5	10	15	20												0
		n7	5	10	15	20	25	30	40	50								

CA_n5A-n7B	-	n5	5	10	15	20											0
		n7	See CA_n7B Bandwidth Combination Set 0 in Table 5.5A.1-1														
CA_n5A-n66A	CA_n5A-n66A	n5	5	10	15	20											0
		n66	5	10	15	20			40								
CA_n5A-n77A	CA_n5A-n77A	n5	5	10	15	20											0
		n77		10	15	20	25	30	40	50	60	70	80	90	100		
CA_n5A-n78A	CA_n5A-n78A	n5	5	10	15	20											0
		n78		10	15	20			40	50	60		80	90	100		
CA_n5A-n78C	CA_n5A-n78A	n5	5	10	15	20											0
		n78	See CA_n78C Bandwidth Combination Set 0 in Table 5.5A.1-1														
CA_n5A-n79A	CA_n5A-n79A	n5	5	10	15	20											0
		n79							40	50	60		80		100		
CA_n5A-n79C	CA_n5A-n79A	n5	5	10	15	20											0
		n79	See CA_n79C Bandwidth Combination Set 0 in Table 5.5A.1-1														
CA_n7A-n25A	CA_n7A-n25A	n7	5	10	15	20	25	30	40								0
		n25	5	10	15	20	25	30	40								
CA_n7A-n25(2A)	CA_n7A-n25A	n7	5	10	15	20	25	30	40								0
		n25	See CA_n25(2A) Bandwidth Combination Set 0 in Table 5.5A.2-1														
CA_n7(2A)-n25A	CA_n7A-n25A	n25	5	10	15	20	25	30	40								0
		n7	See CA_n7(2A) Bandwidth Combination Set 0 in Table 5.5A.2-1														
CA_n7(2A)-n25(2A)	CA_n7A-n25A	n7	See CA_n7(2A) Bandwidth Combination Set 0 in Table 5.5A.2-1														
		n25	See CA_n25(2A) Bandwidth Combination Set 0 in Table 5.5A.2-1														
CA_n7A-n28A	CA_n7A-n28A	n7	5	10	15	20	25	30	40	50							0
		n28	5	10	15	20											
CA_n7B-n28A	-	n7	See CA_n7B Bandwidth Combination Set 0 in Table 5.5A.1-1														
		n28	5	10	15	20											
CA_n7A-n66A	CA_n7A-n66A	n7	5	10	15	20											0
		n66		10	15	20			40								
CA_n7A-n78A	CA_n7A-n78A	n7	5	10	15	20											0
		n78		10	15	20			40	50	60		80	90	100		
CA_n7A-n78(2A)	CA_n7A-n78A	n7	5	10	15	20	25	30	40	50							0
		n78	See CA_n78(2A) Bandwidth Combination Set 0 in Table 5.5A.2-1														
CA_n7(2A)-n78A	CA_n7A-n78A	n7	See CA_n7(2A) Bandwidth Combination Set 0 in Table 5.5A.2-1														
		n78		10	15	20			40	50	60		80	90	100		
CA_n7(2A)-n78(2A)	CA_n7A-n78A	n7	See CA_n7(2A) Bandwidth Combination Set 0 in Table 5.5A.2-1														
		n78	See CA_n78(2A) Bandwidth Combination Set 0 in Table 5.5A.2-1														
CA_n8A-n39A	CA_n8A-n39A	n8	5	10	15	20											0
		n39	5	10	15	20	25	30	40								
CA_n8A-n40A	CA_n8A-n40A	n8	5	10	15	20											0
		n40	5	10	15	20	25	30	40	50	60		80				
CA_n8A-n41A	CA_n8A-n41A	n8	5	10	15	20											0
		n41		10	15	20			40	50	60		80	90	100		

		n8	5	10	15	20										1
		n41		10	15	20			40	50	60					
CA_n8A-n75A	-	n8	5	10	15	20										0
		n75	5	10	15	20										
CA_n8A-n78A	CA_n8A-n78A	n8	5	10	15	20										0
		n78		10	15	20			40	50	60		80	90	100	
CA_n8A-n79A	CA_n8A-n79A	n8	5	10	15	20										0
		n79							40	50	60		80		100	
CA_n20A-n28A	CA_n20A-n28A	n20	5	10	15	20										0
		n28	5	10	15	20										
CA_n20A-n75A	-	n20	5	10	15	20										0
		n75	5	10	15	20										
CA_n20A-n78A	CA_n20A-n78A	n20	5	10	15	20										0
		n78		10	15	20			40	50	60		80	90	100	
CA_n25A-n41A	CA_n25A-n41A	n25	5	10	15	20										0
		n41		10	15	20			40	50	60		80	90	100	
CA_n25(2A)-n41A	CA_n25A-n41A	n25	See CA_n25(2A) Bandwidth Combination Set 0 in Table 5.5A.2-1													0
		n41		10	15	20			40	50	60		80	90	100	
CA_n25A-n41C	CA_n25A-n41A	n25	5	10	15	20										0
		n41	See CA_n41C Bandwidth Combination Set 0 in Table 5.5A.1-1													
CA_n25A-n41(2A)	CA_n25A-n41A	n25	5	10	15	20										0
		n41	See CA_n41(2A) Bandwidth Combination Set 1 in Table 5.5A.2-1													
CA_n25A-n66A	CA_n25A-n66A	n25	5	10	15	20	25	30	40							0
		n66	5	10	15	20		30	40							
CA_n25A-n66(2A)	CA_n25A-n66A	n25	5	10	15	20	25	30	40							0
		n66	See CA_n66(2A) Bandwidth Combination Set 0 in Table 5.5A.2-1													
CA_n25(2A)-n66A	CA_n25A-n66A	n25	See CA_n25(2A) Bandwidth Combination Set 0 in Table 5.5A.2-1													0
		n66		10	15	20		30	40							
CA_n25(2A)-n66(2A)	CA_n25A-n66A	n25	See CA_n25(2A) Bandwidth Combination Set 0 in Table 5.5A.2-1													0
		n66	See CA_n66(2A) Bandwidth Combination Set 0 in Table 5.5A.2-1													
CA_n25A-n71A	CA_n25A-n71A	n25	5	10	15	20										0
		n71	5	10	15	20										

CA_n25A-n78A	CA_n25A-n78A	n25	5	10	15	20	25	30	40							0
		n78		10	15	20	25	30	40	50	60		80	90	100	
CA_n25A-n78(2A)	CA_n25A-n78A	n25	5	10	15	20	25	30	40							0
		n78	See CA_n78(2A) Bandwidth Combination Set 0 in Table 5.5A.2-1													
CA_n25(2A)-n78A	CA_n25A-n78A	n25	See CA_n25(2A) Bandwidth Combination Set 0 in Table 5.5A.2-1													0
		n78		10	15	20	25	30	40	50	60		80	90	100	
CA_n25(2A)-n78(2A)	CA_n25A-n78A	n25	See CA_n25(2A) Bandwidth Combination Set 0 in Table 5.5A.2-1													0
		n78	See CA_n78(2A) Bandwidth Combination Set 1 in Table 5.5A.2-1													
CA_n25A-n46A	-	n25	5	10	15	20										0
		n46				20			40		60		80			
CA_n28A-n40A	CA_n28A-n40A	n28	5	10	15	20										0
		n40	5	10	15	20	25	30	40	50	60		80			
CA_n28A-n41A	CA_n28A-n41A	n28	5	10	15	20										0
		n41		10	15	20			40	50	60		80	90	100	
CA_n28A-n50A	CA_n28A-n50A	n28	5	10	15	20										0
		n50	5	10	15	20			40	50	60		80 ¹			
CA_n28A-n75A	-	n28	5	10	15	20										0
		n75	5	10	15	20										
CA_n28A-n75A	-	n28	5	10	15	20										1
		n75	5	10	15	20	25	30	40	50						
CA_n28A-n77A	CA_n28A-n77A	n28	5	10	15	20										0
		n77		10	15	20			40	50	60		80	90	100	
CA_n28A-n77(2A)	CA_n28A-n77A	n28	5	10	15	20										0
		n77	See CA_n77(2A) Bandwidth Combination Set 0 in Table 5.5A.2-1													
CA_n28A-n78A	CA_n28A-n78A	n28	5	10	15	20										0
		n78		10	15	20			40	50	60		80	90	100	
CA_n28A-n78(2A)	CA_n28A-n78A	n28	5	10	15	20										0
		n78	See CA_n78(2A) Bandwidth Combination Set 0 in Table 5.5A.2-1													
CA_n29A-n66A	-	n29	5	10												0
		n66	5	10	15	20			40							
CA_n29A-n66B	-	n29	5	10												0
		n66	See CA_n66B Bandwidth Combination Set 0 in Table 5.5A.1-1													

CA_n29A-n66(2A)	-	n29	5	10												0
		n66	See CA_n66(2A) Bandwidth Combination Set 0 in Table 5.5A.2-1													
CA_n29A-n70A	-	n29	5	10												0
		n70	5	10	15	20 ¹	25 ¹									
CA_n38A-n66A	CA_n38A-n66A	n38	5	10	15	20										0
		n66	5	10	15	20		30	40							
CA_n38A-n78A	CA_n38A-n78A	n38	5	10	15	20										0
		n78		10	15	20	25	30	40	50	60		80	90	100	
CA_n38A-n78(2A)	CA_n38A-n78A	n38	5	10	15	20										0
		n78	See CA_n78(2A) Bandwidth Combination 0 in Table 5.5A.2-1													
CA_n39A-n40A	CA_n39A-n40A	n39	5	10	15	20	25	30	40							0
		n40	5	10	15	20	25	30	40	50	60		80			
CA_n39A-n41A	CA_n39A-n41A	n39	5	10	15	20	25	30	40							0
		n41		10	15	20			40	50	60		80	90	100	
CA_n39A-n41C	CA_n39A-n41A	n39	5	10	15	20	25	30	40							0
		n41	See CA_n41C Bandwidth Combination Set 0 in Table 5.5A.1-1													
CA_n39A-n41(2A)	CA_n39A-n41A	n39	5	10	15	20	25	30	40							0
		n41	See CA_n41(2A) Bandwidth Combination Set 0 in Table 5.5A.2-1													
CA_n39A-n79A	CA_n39A-n79A	n39	5	10	15	20	25	30	40							0
		n79							40	50	60		80		100	
CA_n40A-n41A	CA_n40A-n41A	n40	5	10	15	20	25	30	40	50	60		80			0
		n41		10	15	20			40	50	60		80	90	100	
		n40	5	10	15	20	25	30	40							1
CA_n40A-n78A	CA_n40A-n78A	n40	5	10	15	20	25	30	40	50	60		80			0
		n78		10	15	20			40	50	60		80	90	100	
CA_n40A-n78(2A)	CA_n40A-n78A	n40	5	10	15	20	25	30	40	50	60		80			0
		n78	See CA_n78(2A) Bandwidth Combination Set 1 in Table 5.5A.2-1													
CA_n40A-n79A	CA_n40A-n79A	n40	5	10	15	20	25	30	40	50	60		80			0
		n79							40	50	60		80		100	
		n40	5	10	15	20	25	30	40							1

CA_n41A-n50A	CA_n41A-n50A	n79						40	50	60		80		100	0	
		n41		10	15	20			40	50	60		80	90		100
		n50	5	10	15	20			40	50	60		80 ¹			
CA_n41A-n66A	CA_n41A-n66A	n41		10	15	20			40	50	60		80	90	100	0
		n66	5	10	15	20			40							
CA_n41(2A)-n66A	-	n41	See CA_n41(2A) Bandwidth Combination Set 1 in Table 5.5A.2-1												0	
		n66	5	10	15	20			40							
CA_n41C-n66A	-	n41	See CA_n41C Bandwidth Combination Set 0 in Table 5.5A.1-1												0	
		n66	5	10	15	20			40							
CA_n41A-n71A	CA_n41A-n71A	n41		10	15	20			40	50	60		80	90	100	0
		n71	5	10	15	20										
CA_n41A-n71B	-	n41		10	15	20		30	40	50	60		80	90	100	0
		n71	See CA_n71B Bandwidth Combination Set 0 in Table 5.5A.1-1													
CA_n41C-n71A	-	n41	See CA_n41C Bandwidth Combination Set 0 in Table 5.5A.1-1												0	
		n71	5	10	15	20										
CA_n41(2A)-n71A	-	n41	See CA_n41(2A) Bandwidth Combination Set 1 in Table 5.5A.2-1												0	
		n71	5	10	15	20										
CA_n41(2A)-n71B	-	n41	See CA_n41(2A) Bandwidth Combination Set 1 in Table 5.5A.2-1												0	
		n71	See CA_n71B Bandwidth Combination Set 0 in Table 5.5A.1-1													
CA_n41C-n71B	-	n41	See CA_n41C Bandwidth Combination Set 0 in Table 5.5A.1-1												0	
		n71	See CA_n71B Bandwidth Combination Set 0 in Table 5.5A.1-1													
CA_n41A-n78A	CA_n41A-n78A	n41		10	15	20			40	50	60		80		100	0
		n78		10	15	20			40	50	60		80	90	100	
CA_n41A-n78A	CA_n41A-n78A	n41		10	15	20		30	40	50	60		80	90	100	1
		n78		10	15	20	25	30	40	50	60	70	80	90	100	
CA_n41A-n79A	CA_n41A-n79A	n41		10	15	20			40	50	60		80	90	100	0
		n79							40	50	60		80		100	
		n41		10	15	20			40	50	60					1
		n79							40	50	60		80		100	
CA_n41C-n79A	CA_n41A-n79A CA_n41C	n41	See CA_n41C Bandwidth Combination Set 0 in Table 5.5A.1-1												0	
		n79							40	50	60		80			100
CA_n46A-n48A	CA_n46A-n48A	n46				20			40		60		80			0

		n48				20												
CA_n46B-n48A	CA_n46A-n48A	n46	See CA_n46B Bandwidth Combination Set 0 in 38.101-1 Table 5.5A.1-1													0		
		n48				20												
CA_n46C-n48A	CA_n46A-n48A	n46	See CA_n46C Bandwidth Combination Set 0 in 38.101-1 Table 5.5A.1-1													0		
		n48				20												
CA_n46D-n48A	CA_n46A-n48A	n46	See CA_n46D Bandwidth Combination Set 0 in 38.101-1 Table 5.5A.1-1													0		
		n48				20												
CA_n46A-n66A	-	n46				20			40		60		80					0
		n66	5	10	15	20	25	30	40									
CA_n48A-n66A	CA_n48A-n66A	n48	5	10	15	20			40	50 ⁴	60 ⁴		80 ⁴	90 ⁴	100 ⁴			0
		n66	5	10	15	20			40									
CA_n48C-n66A	CA_n48A-n66A	n48	See CA_n48C Bandwidth Combination Set 0 in Table 5.5A.1-1													0		
		n66	5	10	15	20			40									
CA_n48(2A)-n66A	CA_n48A-n66A	n48	See CA_n48(2A) Bandwidth Combination Set 0 in Table 5.5A.2-1													0		
		n66	5	10	15	20			40									
CA_n50A-n78A	CA_n50A-n78A	n50	5	10	15	20		30	40	50	60		80 ¹					0
		n78		10	15	20			40	50	60		80	90	100			
CA_n66A-n70A	-	n66	5	10	15	20			40									0
		n70	5	10	15	20 ¹	25 ¹											
CA_n66B-n70A	-	n66	See CA_n66B Bandwidth Combination Set 0 in Table 5.5A.1-1													0		
		n70	5	10	15	20 ¹	25 ¹											
CA_n66(2A)-n70A	-	n66	See CA_n66(2A) Bandwidth Combination Set 0 in Table 5.5A.2-1													0		
		n70	5	10	15	20 ¹	25 ¹											
CA_n66A-n71A	CA_n66A-n71A	n66	5	10	15	20			40									0
		n71	5	10	15	20												
CA_n66(2A)-n71A	CA_n66A-n71A	n66	See CA_n66(2A) Bandwidth Combination Set 0 in Table 5.5A.2-1													0		
		n71	5	10	15	20												
CA_n66B-n71A	CA_n66A-n71A	n66	See CA_n66B Bandwidth Combination Set 0 in Table 5.5A.1-1													0		
		n71	5	10	15	20												
CA_n66A-n77A	CA_n66A-n77A	n66	5	10	15	20			40									0
		n77		10	15	20	25	30	40	50	60	70	80	90	100			

CA_n66A-n78A	CA_n66A-n78A	n66	5	10	15	20			40						0	
		n78		10	15	20			40	50	60		80	90	100	
CA_n66A-n78(2A)	CA_n66A-n78A	n66	5	10	15	20		30	40						0	
		n78	See CA_n78(2A) Bandwidth Combination Set 1 in Table 5.5A.2-1													
CA_n66(2A)-n78A	CA_n66A-n78A	n66	See CA_n66(2A) Bandwidth Combination Set 0 in Table 5.5A.2-1													0
		n78		10	15	20	25	30	40	50	60		80	90	100	
CA_n66(2A)-n78(2A)	CA_n66A-n78A	n66	See CA_n66(2A) Bandwidth Combination Set 0 in Table 5.5A.2-1													0
		n78	See CA_n78(2A) Bandwidth Combination Set 1 in Table 5.5A.2-1													
CA_n70A-n71A	CA_n70A-n71A	n70	5	10	15	20 ¹	25 ¹								0	
		n71	5	10	15	20										
CA_n75A-n78A	-	n75	5	10	15	20									0	
		n78		10	15	20			40	50	60		80	90	100	
CA_n75A-n78(2A)	-	n75	5	10	15	20									0	
		n78	See CA_n78(2A) Bandwidth Combination Set 1 in Table 5.5A.2-1													
CA_n76A-n78A	-	n76	5												0	
		n78		10	15	20			40	50	60		80	90	100	
CA_n77A-n78A ²	-	n77		10	15	20			40	50	60		80	90	100	
		n78		10	15	20			40	50	60		80	90	100	
CA_n77A-n79A	-	n77		10	15	20			40	50	60		80	90	100	
		n79							40	50	60		80		100	
CA_n78A-n79A	-	n78		10	15	20			40	50	60		80	90	100	
		n79							40	50	60		80		100	
CA_n78A-n92A	CA_n78A-n92A	n78		10	15	20			40	50	60		80	90	100	
		n92	5	10	15	20										
CA_n78(2A)-n92A	CA_n78A-n92A	n78	See CA_n78(2A) Bandwidth Combination Set 0 in Table 5.5A.2-1													0
		n92	5	10	15	20										

NOTE 1: This UE channel bandwidth is applicable only to downlink.

NOTE 2: The minimum requirements for intra-band contiguous or non-contiguous CA apply.

NOTE 3: The SCS of each channel bandwidth for NR band refers to Table 5.3.5-1.

NOTE 4: For this bandwidth, the minimum requirements are restricted to operation when carrier is configured as a downlink SCell part of CA configuration.

5.5A.3.2 Configurations for inter-band CA (three bands)

Table 5.5A.3.2-1: NR CA configurations and bandwidth combinations sets defined for inter-band CA (three bands)

NR CA configuration	Uplink CA configuration	NR Band	Channel bandwidth (MHz) (NOTE 3)											Bandwidth combination set	
			5	10	15	20	25	30	40	50	60	80	90		100
CA_n1A-n3A-n7A	-	n1	5	10	15	20									0
		n3	5	10	15	20	25	30							
		n7	5	10	15	20	25	30	40	50					
CA_n1A-n3A-n7B	-	n1	5	10	15	20									0
		n3	5	10	15	20	25	30							
		n7	See CA_n7B Bandwidth Combination Set 0 in Table 5.5A.1-1												
CA_n1A-n3A-n8A	-	n1	5	10	15	20									0
		n3	5	10	15	20	25	30							
		n8	5	10	15	20									
CA_n1A-n3A-n28A	-	n1	5	10	15	20									0
		n3	5	10	15	20	25	30							
		n28	5	10	15	20 ²									
CA_n1A-n3A-n41A	CA_n1A-n3A- CA_n1A-n41A CA_n3A-n41A	n1	5	10	15	20									0
		n3	5	10	15	20	25	30							
		n41		10	15	20		30	40	50	60	80	90	100	
CA_n1A-n3A-n78A	CA_n1A-n3A- CA_n1A-n78A CA_n3A-n78A	n1	5	10	15	20									0
		n3	5	10	15	20	25	30							
		n78		10	15	20			40	50	60	80	90	100	
CA_n1A-n8A-n78A	-	n1	5	10	15	20									0
		n8	5	10	15	20									
		n78		10	15	20			40	50	60	80	90	100	
CA_n1A-n7A-n28A	CA_n1A-n7A- CA_n1A-n28A CA_n7A-n28A	n1	5	10	15	20									0

		n7	5	10	15	20	25	30	40	50					
		n28	5	10	15	20									
CA_n1A-n7A-n78A	CA_n1A-n7A CA_n1A-n78A CA_n7A-n78A	n1	5	10	15	20									0
		n7	5	10	15	20	25	30	40	50					
		n78		10	15	20			40	50	60	80	90 ¹	100	
CA_n1A-n7A-n78(2A)	CA_n1A-n7A CA_n1A-n78A CA_n7A-n78A	n1	5	10	15	20									0
		n7	5	10	15	20	25	30	40	50					
		n78	See CA_n78(2A) Bandwidth Combination Set 0 in Table 5.5A.2-1 in TS 38.101-1												
CA_n1A-n28A-n78A	-	n1	5	10	15	20									0
		n28	5	10	15	20 ²									
		n78		10	15	20			40	50	60	80	90	100	
CA_n1A-n40A-n78A	-	n1	5	10	15	20									0
		n40	5	10	15	20	25	30	40	50					
		n78		10	15	20			40	50	60	80	90	100	
CA_n3A-n7A-n28A	-	n3	5	10	15	20	25	30							0
		n7	5	10	15	20	25	30	40	50					
		n28	5	10	15	20									
CA_n3A-n7B-n28A	-	n3	5	10	15	20	25	30							0
		n7	See CA_n7B Bandwidth Combination Set 0 in Table 5.5A.1-1												
		n28	5	10	15	20									
CA_n3A-n7A-n78A	-	n3	5	10	15	20	25	30							0
		n7	5	10	15	20	25	30	40	50					
		n78		10	15	20	25	30	40	50	60	80	90	100	
CA_n3A-n7B-n78A	-	n3	5	10	15	20	25	30							0
		n7	See CA_n7B Bandwidth Combination Set 0 in Table 5.5A.1-1												
		n78		10	15	20	25	30	40	50	60	80	90	100	
CA_n3A-n8A-n78A	CA_n3A-n8A CA_3A-n78A CA_n8A-n78A	n3	5	10	15	20	25	30							0
		n8	5	10	15	20									

CA_n3A-n28A-n77A	CA_n3A-n28A-n77A CA_n3A-n77A CA_n28A-n77A	n78		10	15	20			40	50	60	80	90	100	0
		n3	5	10	15	20	25	30							
		n28	5	10	15	20									
CA_n3A-n28A-n77(2A)	CA_n3A-n28A-n77A CA_n3A-n77A CA_n28A-n77A	n77		10	15	20			40	50	60	80	90	100	0
		n3	5	10	15	20	25	30							
		n28	5	10	15	20									
CA_n3A-n28A-n78A	-	n77	See CA_n77(2A) Bandwidth Combination Set 0 in Table 5.5A.2-1												0
		n3	5	10	15	20									
		n28	5	10	15	20 ²									
CA_n3A-n28A-n78(2A)	-	n78		10	15	20			40	50	60	80	90	100	0
		n3	5	10	15	20									
		n28	5	10	15	20 ²									
CA_n3A-n40A-n41A	CA_n3A-n40A-n41A CA_n3A-n41A CA_n40A-n41A	n78	See CA_n78(2A) Bandwidth Combination Set 0 in Table 5.5A.2-1												0
		n3	5	10	15	20	25	30							
		n40	5	10	15	20	25	30	40	50	60	80			
CA_n3A-n41A-n79A	-	n41		10	15	20			40	50	60	80		100	0
		n3	5	10	15	20	25	30							
		n79							40	50	60	80		100	
		n41		10	15	20			40	50	60	80			
		n3	5	10	15	20	25	30							
CA_n5A-n66A-n78A	CA_n5A-n66A-n78A	n79							40	50	60	80		100	1
		n5	5	10	15	20									
		n41		10	15	20			40	50	60	80			

	CA_n66A-n78A														
		n66	5	10	15	20	25	30	40						
		n78		10	15	20	25	30	40	50	60	80	90	100	
CA_n7A-n25A-n66A	CA_n7A-n25A CA_n7A-n66A CA_n25A-n66A	n7	5	10	15	20	25	30	40	50					0
		n25	5	10	15	20	25	30	40						
		n66	5	10	15	20	25	30	40						
CA_n7A-n28A-n78A	-	n7	5	10	15	20	25	30	40	50					0
		n28	5	10	15	20									
		n78		10	15	20	25	30	40	50	60	80	90	100	
CA_n7B-n28A-n78A	-	n7	See CA_n7B Bandwidth Combination Set 0 in Table 5.5A.1-1												0
		n28	5	10	15	20									
		n78		10	15	20	25	30	40	50	60	80	90	100	
CA_n7A-n66A-n78A	CA_n7A-n66A CA_n7A-n78A CA_n66A-n78A	n7	5	10	15	20	25	30	40	50					0
		n66	5	10	15	20	25	30	40						
		n78		10	15	20	25	30	40	50	60	80	90	100	
CA_n7A-n66A-n78(2A)	CA_n7A-n66A CA_n7A-n78A CA_n66A-n78A	n7	5	10	15	20	25	30	40	50					0
		n66	5	10	15	20	25	30	40						
		n78	See CA_n78(2A) Bandwidth Combination Set 1 in Table 5.5A.2-1												
CA_n8A-n39A-n41A	-	n8	5	10	15	20									0
		n39	5	10	15	20	25	30	40						
		n41		10	15	20			40	50	60	80		100	
		n8	5	10	15	20									1
		n39	5	10	15	20	25	30	40						
CA_n8A-n41A-n79A	-	n41		10	15	20			40	50	60				0
		n8	5	10	15	20									
		n41		10	15	20			40	50	60	80		100	

		n79						40	50	60	80		100	
		n8	5	10	15	20								1
		n41		10	15	20		40	50	60				
		n79						40	50	60	80		100	
CA_n20A-n28A-n78A	-	n20	5	10	15	20								0
		n28	5	10	15	20								
		n78		10	15	20		30	40	50	60	80	90	100
CA_n25A-n41A-n66A	-	n25	5	10	15	20								0
		n41		10	15	20		30	40	50	60	80	90	100
		n66	5	10	15	20		40						
CA_n25A-n41C-n66A	-	n25	5	10	15	20								0
		n41	See CA_n41C Bandwidth Combination Set 0 in 38.101-1 Table 5.5A.1-1											
		n66	5	10	15	20		40						
CA_n25A-n41(2A)-n66A	-	n25	5	10	15	20								0
		n41	See CA_n41(2A) Bandwidth Combination Set 1 in 38.101-1 Table 5.5A.2-1											
		n66	5	10	15	20		40						
CA_n25A-n41A-n71A	-	n25	5	10	15	20								0
		n41		10	15	20		30	40	50	60	80	90	100
		n71	5	10	15	20								
CA_n25A-n41(2A)-n71A	-	n25	5	10	15	20								0
		n41	See CA_n41(2A) Bandwidth Combination Set 1 in 38.101-1 Table 5.5A.2-1											
		n71	5	10	15	20								
CA_n25A-n41C-n71A	-	n25	5	10	15	20								0
		n41	See CA_n41C Bandwidth Combination Set 0 in 38.101-1 Table 5.5A.1-1											
		n71	5	10	15	20								
CA_n25A-n66A-n71A	-	n25	5	10	15	20								0
		n66	5	10	15	20		40						
		n71	5	10	15	20								
CA_n25A-n66A-n78A	CA_n25A-n66A CA_n25A-n78A CA_n66A-n78A -	n25	5	10	15	20	25	30	40					0
		n66	5	10	15	20	25	30	40					
		n78		10	15	20	25	30	40	50	60	80	90	100

CA_n28A-n40A-n78A	-	n28	5	10	15	20									0
		n40	5	10	15	20	25	30	40	50					
		n78		10	15	20			40	50	60	80	90	100	
CA_n28A-n41A-n78A	CA_n28A-n41A CA_n41A-n78A CA_n28A-n78A	n28	5	10	15	20									0
		n41		10	15	20		30	40	50	60		90	100	
		n78		10	15	20	25	30	40	50	60	80	90	100	
CA_n29A-n66A-n70A	-	n29	5	10											0
		n66	5	10	15	20			40						
		n70	5	10	15	20 ¹	25 ¹								
CA_n29A-n66B-n70A	-	n29	5	10											0
		n66	See CA_n66B Bandwidth Combination Set 0 in Table 5.5A.1-1 in TS38.101-1												
		n70	5	10	15	20 ¹	25 ¹								
CA_n29A-n66(2A)-n70A	-	n29	5	10											0
		n66	See CA_n66(2A) Bandwidth Combination Set 0 in Table 5.5A.2-1 in TS38.101-1												
		n70	5	10	15	20 ¹	25 ¹								
CA_n39A-n41A-n79A	-	n39	5	10	15	20	25	30	40						0
		n41		10	15	20			40	50	60	80	90	100	
		n79							40	50	60	80			
		n39	5	10	15	20	25	30	40						1
		n41		10	15	20			40	50	60			100	
CA_n40A-n41A-n79A	CA_n40A-n41A CA_n40A-n79A CA_n41A-n79A	n40	5	10	15	20	25	30	40	50	60	80			0
		n41		10	15	20			40	50	60	80		100	
		n79							40	50	60	80		100	
		n40	5	10	15	20	25	30	40						1
		n41		10	15	20			40	50	60				
CA_n41A-n66A-n71A	-	n41		10	15	20		30	40	50	60	80	90	100	0
		n66	5	10	15	20			40						

		n7	5	10	15	20	25	30	40	50							
		n28	5	10	15	20											
CA_n1A-n3A-n7B-n28A	-	n1	5	10	15	20											0
		n3	5	10	15	20	25	30									
		n7	See CA_n7B Bandwidth Combination Set 0 in Table 5.5A.1-1														
		n28	5	10	15	20											
CA_n1A-n3A-n7A-n78A	-	n1	5	10	15	20											0
		n3	5	10	15	20	25	30									
		n7	5	10	15	20	25	30	40	50							
		n78		10	15	20	25	30	40	50	60	70	80	90	100		
CA_n1A-n3A-n7B-n78A	-	n1	5	10	15	20											0
		n3	5	10	15	20	25	30									
		n7	See CA_n7B Bandwidth Combination Set 0 in Table 5.5A.1-1														
		n78		10	15	20	25	30	40	50	60	70	80	90	100		
CA_n1A-n3A-n8A-n78A	-	n1	5	10	15	20											0
		n3	5	10	15	20	25	30									
		n8	5	10	15	20											
		n78		10	15	20			40	50	60		80	90 ¹	100		
CA_n1A-n3A-n28A-n78A	-	n1	5	10	15	20											0
		n3	5	10	15	20	25	30									
		n28	5	10	15	20 ²											
		n78		10	15	20			40	50	60		80	90 ¹	100		
CA_n3A-n7A-n28A-n78A	-	n3	5	10	15	20	25	30									0
		n7	5	10	15	20	25	30	40	50							
		n28	5	10	15	20											
		n78		10	15	20	25	30	40	50	60	70	80	90	100		
CA_n3A-n7B-n28A-n78A	-	n3	5	10	15	20	25	30									0
		n7	See CA_n7B Bandwidth Combination Set 0 in Table 5.5A.1-1														
		n28	5	10	15	20											
		n78		10	15	20	25	30	40	50	60	70	80	90	100		
CA_n7A-n25A-n66A-n78A	-	n7	5	10	15	20	25	30	40	50							0
		n25	5	10	15	20	25	30	40								
		n66	5	10	15	20	25	30	40								
		n78		10	15	20	25	30	40	50	60	70	80	90	100		

NOTE 1: This UE channel bandwidth is optional in this release of the specification.

NOTE 2: For the 20 MHz bandwidth, the minimum requirements are specified for NR UL carrier frequencies confined to either 713-723 MHz or 728-738 MHz.

NOTE 3: The SCS of each channel bandwidth for NR band refers to Table 5.3.5-1.

5.5B Configurations for DC

For an NR DC configuration specified in Table 5.5B-1, the bandwidth combination sets for the corresponding NR CA configuration in 5.5A.3, i.e. dual uplink inter-band carrier aggregation with uplink assigned to two NR bands, are applicable to Dual Connectivity.

Table 5.5B-1: Inter-band NR DC configurations (two bands)

NR DC configuration	Uplink NR DC configuration
DC_n2A-n5A	DC_n2A-n5A

5.5C Configurations for SUL

Table 5.5C-1: Supported channel bandwidths per SUL band combination

SUL configuration	NR Band	Channel bandwidth (MHz) (NOTE 1)												Bandwidth combination set
		5	10	15	20	25	30	40	50	60	80	90	100	
SUL_n41A-n80A	n41		10	15	20			40	50	60	80	90	100	0
	n80	5	10	15	20	25	30							
SUL_n41A-n81A	n41		10	15	20			40	50	60	80	90	100	0
	n81	5	10	15	20									
SUL_n41A-n95A	n41		10	15	20		30	40	50	60	80	90	100	0
	n95	5	10	15										
SUL_n77A-n80A	n77		10	15	20			40	50	60	80	90	100	0
	n80	5	10	15	20	25	30							
SUL_n77A-n84A	n77		10	15	20			40	50	60	80	90	100	0
	n84	5	10	15	20									
SUL_n78A-n80A	n78		10	15	20			40	50	60	80	90	100	0
	n80	5	10	15	20	25	30							
SUL_n78A-n81A	n78		10	15	20			40	50	60	80	90	100	0
	n81	5	10	15	20									
SUL_n78A-n82A	n78		10	15	20			40	50	60	80	90	100	0
	n82	5	10	15	20									
SUL_n78A-n83A	n78		10	15	20			40	50	60	80	90	100	0
	n83	5	10	15	20									
SUL_n78A-n84A	n78		10	15	20			40	50	60	80	90	100	0
	n84	5	10	15	20									
SUL_n78A-n86A	n78		10	15	20			40	50	60	80	90	100	0
	n86	5	10	15	20									
SUL_n79A-n80A	n79							40	50	60	80		100	0
	n80	5	10	15	20	25	30							
SUL_n79A-n81A	n79							40	50	60	80		100	0
	n81	5	10	15	20									

SUL_n79A-n84A	n79							40	50	60	80		100	0
	n84	5	10	15	20									
SUL_n79A-n95A	n79							40	50	60	80		100	0
	n95	5	10	15										

NOTE 1: The SCS of each channel bandwidth for NR band refers to Table 5.3.5-1.

Table 5.5C-2: Supported channel bandwidths per SUL band combination with intra-band non-contiguous CA

SUL band combination with intra-band non-contiguous CA	SUL configuration	NR Band	Channel bandwidth (MHz) (NOTE 1)											Bandwidth combination set
			5	10	15	20	25	30	40	50	60	80	90	
CA_n78(2A)-n86A	SUL_n78A-n86A	n78	See CA_n78(2A) Bandwidth Combination Set 0 in Table 5.5A.2-1											0
		n86	5	10	15	20								

NOTE 1: The SCS of each channel bandwidth for NR band refers to Table 5.3.5-1.

6 Transmitter characteristics

6.1 General

Unless otherwise stated, the transmitter characteristics are specified at the antenna connector of the UE with a single or multiple transmit antenna(s). For UE with integral antenna only, a reference antenna with a gain of 0 dBi is assumed.

For UEs that do not indicate IE *dualPA-Architecture*, transmitter requirements for CA operation apply only when the DMRS initialization parameters (including the case when the UE applies cell ID as DMRS scrambling ID) are different across all CCs. The UE may use higher MPR values outside this limitation.

Transmitter requirements for UL MIMO operation apply when the UE transmits on 2 ports on the same CDM group. The UE may use higher MPR values outside this limitation.

The applicability of transmitter requirements for Band n90 is in accordance with that for Band n41; a UE supporting Band n90 shall meet the minimum requirements for Band n41.

Unless otherwise stated, reference to power-class parameters in [7] also applies to extended versions with value(s) in accordance with the (extended) UE power class specified.

6.1A General

The minimum requirements for band combinations including Band n41 also apply for the corresponding band combinations with Band n90 replacing Band n41 but with otherwise identical parameters. For brevity the said band combinations with Band n90 are not listed in the tables below but are covered by this specification.

6.1F General

For wideband operations, the minimum requirements for the transmitter characteristics are specified for transmissions on one scheduled RB set or ≥ 1 scheduled contiguous RB set(s) within the UE channel. The requirements apply with configured UL intra-cell guard bands of non-zero size according to Table 5.3.3-2, with the union of the scheduled RB sets and the intra-cell guard bands between the said RB sets scheduled and available for transmission according to the channel access procedures in [14].

6.2 Transmitter power

6.2.1 UE maximum output power

The following UE Power Classes define the maximum output power for any transmission bandwidth within the channel bandwidth of NR carrier unless otherwise stated. The period of measurement shall be at least one sub frame (1 ms).

Table 6.2.1-1: UE Power Class

NR band	Class 1 (dBm)	Tolerance (dB)	Class 1.5 (dBm)	Tolerance (dB)	Class 2 (dBm)	Tolerance (dB)	Class 3 (dBm)	Tolerance (dB)
n1							23	± 2
n2							23	$\pm 2^3$
n3							23	$\pm 2^3$
n5							23	± 2
n7							23	$\pm 2^3$
n8							23	$\pm 2^3$
n12							23	$\pm 2^3$
n14	31 ^{6,7}	+2/-3					23	± 2
n18							23	± 2
n20							23	$\pm 2^3$

n25							23	$\pm 2^3$
n26							23	$\pm 2^3$
n28							23	+2/-2.5
n30							23	± 2
n34							23	± 2
n38							23	± 2
n39							23	± 2
n40					26	+2/-3	23	± 2
n41			29 ⁵	+2/-3 ³	26	+2/-3 ³	23	$\pm 2^3$
n47							23	± 2
n48							23	+2/-3
n50							23	± 2
n51							23	± 2
n53							23	± 2
n65							23	± 2
n66							23	± 2
n70							23	± 2
n71							23	+2/-2.5
n74							23	± 2
n77					26	+2/-3	23	+2/-3
n78					26	+2/-3	23	+2/-3
n79					26	+2/-3	23	+2/-3
n80							23	$\pm 2^3$
n81							23	± 2
n82							23	± 2
n83							23	+2/-2.5
n84							23	± 2
n86							23	± 2
n89							23	± 2
n91							23	$\pm 2^{3,4}$
n92							23	$\pm 2^{3,4}$
n93							23	$\pm 2^{3,4}$
n94							23	$\pm 2^{3,4}$
n95							23	± 2

NOTE 1: P_{PowerClass} is the maximum UE power specified without taking into account the tolerance.
NOTE 2: Power class 3 is default power class unless otherwise stated.
NOTE 3: Refers to the transmission bandwidths confined within F_{UL_low} and F_{UL_low} + 4 MHz or F_{UL_high} - 4 MHz and F_{UL_high}, the maximum output power requirement is relaxed by reducing the lower tolerance limit by 1.5 dB.
NOTE 4: The maximum output power requirement is relaxed by reducing the lower tolerance limit by 0.3 dB.
NOTE 5: Achieved via dual Tx.
NOTE 6: Generally, PC1 UE is not targeted for smartphone form factor.
NOTE 7: The UE power class 1 requirements for Band n14 are applicable for public safety scenario only.

For UE power class 1.5 the maximum output power for single-port transmission is defined as the sum of the maximum output power from both UE antenna connectors. For PUSCH transmissions, a UEs supporting PC1.5 shall meet the maximum output power requirement when scheduled by DCI format 0_0 or by DCI format 0_1 configured for single antenna port.

If a UE supports a different power class than the default UE power class for the band and the supported power class enables the higher maximum output power than that of the default power class:

- if the field of UE capability *maxUplinkDutyCycle-PC2-FR1* is absent and the percentage of uplink symbols transmitted in a certain evaluation period is larger than 50% (The exact evaluation period is no less than one radio frame); or
- if the field of UE capability *maxUplinkDutyCycle-PC2-FR1* is not absent and the percentage of uplink symbols transmitted in a certain evaluation period is larger than *maxUplinkDutyCycle-PC2-FR1* as defined in TS 38.331 (The exact evaluation period is no less than one radio frame); or
- if the IE P-Max as defined in TS 38.331 [7] is provided and set to the maximum output power of the default power class or lower;
- shall apply all requirements for the default power class to the supported power class and set the configured transmitted power as specified in clause 6.2.4;

- else if the UE does not support a power class with higher maximum output power than PC2; or
- if the field of UE capability *maxUplinkDutyCycle-PC2-FR1* is absent and the percentage of uplink symbols transmitted in a certain evaluation period is larger than 25% (The exact evaluation period is no less than one radio frame); or
- if the field of UE capability *maxUplinkDutyCycle-PC2-FR1* is not absent and the percentage of uplink symbols transmitted in a certain evaluation period is larger than $0.5 * \text{maxUplinkDutyCycle-PC2-FR1}$. (The exact evaluation period is no less than one radio frame); or
 if the IE P-Max as defined in TS 38.331 [7] is provided and set to the maximum output power of the power class 2 or lower;
 shall apply all requirements for power class 2 to the supported power class and set the configured transmitted power as specified in clause 6.2.4;
- else shall apply all requirements for the supported power class and set the configured transmitted power as specified in clause 6.2.4.

6.2.2 UE maximum output power reduction

UE is allowed to reduce the maximum output power due to higher order modulations and transmit bandwidth configurations. For UE power class 1.5, 2 and 3 and UE power class 1 in Band n14, the allowed maximum power reduction (MPR) is defined in Table 6.2.2-4, Table 6.2.2-2, Table 6.2.2-1 and Table 6.2.2-5, respectively for channel bandwidths ≤ 100 MHz.

If the relative channel bandwidth $\leq 4\%$ for TDD bands or $\leq 3\%$ for FDD bands, the Δ MPR is set to zero.

If the relative channel bandwidth $> 4\%$ for TDD bands or $> 3\%$ for FDD bands, the Δ MPR is defined in Table 6.2.2-3.

Where relative channel bandwidth = $2 * BW_{\text{Channel}} / (F_{\text{UL_low}} + F_{\text{UL_high}})$

The allowed MPR for SRS, PUCCH formats 0, 1, 3 and 4, and PRACH shall be as specified for QPSK modulated DFT-s-OFDM of equivalent RB allocation. The allowed MPR for PUCCH format 2 shall be as specified for QPSK modulated CP-OFDM of equivalent RB allocation.

Table 6.2.2-1 Maximum power reduction (MPR) for power class 3

Modulation		MPR (dB)		
		Edge RB allocations	Outer RB allocations	Inner RB allocations
DFT-s-OFDM	Pi/2 BPSK	$\leq 3.5^1$	$\leq 1.2^1$	$\leq 0.2^1$
		$\leq 0.5^2$	$\leq 0.5^2$	0^2
	Pi/2 BPSK w Pi/2 BPSK DMRS	$\leq 0.5^2$	0^2	0^2
	QPSK	≤ 1		0
	16 QAM	≤ 2		≤ 1
	64 QAM	≤ 2.5		
CP-OFDM	256 QAM	≤ 4.5		
	QPSK	≤ 3		≤ 1.5
	16 QAM	≤ 3		≤ 2
	64 QAM	≤ 3.5		
	256 QAM	≤ 6.5		

NOTE 1: Applicable for UE operating in TDD mode with Pi/2 BPSK modulation and UE indicates support for UE capability *powerBoosting-pi2BPSK* and if the IE *powerBoostPi2BPSK* is set to 1 and 40 % or less slots in radio frame are used for UL transmission for bands n40, n41, n77, n78 and n79. The reference power of 0 dB MPR is 26 dBm.

NOTE 2: Applicable for conditions where note 1 does not apply.

Table 6.2.2-2 Maximum power reduction (MPR) for power class 2

Modulation		MPR (dB)		
		Edge RB allocations	Outer RB allocations	Inner RB allocations
DFT-s-OFDM	Pi/2 BPSK	≤ 3.5	≤ 0.5	0

CP-OFDM	QPSK	≤ 3.5	≤ 1	0
	16 QAM	≤ 3.5	≤ 2	≤ 1
	64 QAM	≤ 3.5	≤ 2.5	
	256 QAM	≤ 4.5		
	QPSK	≤ 3.5	≤ 3	≤ 1.5
	16 QAM	≤ 3.5	≤ 3	≤ 2
	64 QAM	≤ 3.5		
	256 QAM	≤ 6.5		

Table 6.2.2-3: Δ MPR

NR Band	Power class	Channel bandwidth	Δ MPR (dB)
n28	Power class 3	30 MHz	0.5

Table 6.2.2-4 Maximum power reduction (MPR) for power class 1.5 with dual Tx

Modulation		MPR (dB)		
		Edge RB allocations	Outer RB allocations	Inner RB allocations
DFT-s-OFDM	Pi/2 BPSK	≤ 6.5	≤ 3.5	≤ 1.5
	QPSK	≤ 6.5	≤ 4	≤ 1.5
	16 QAM	≤ 6.5	≤ 5	≤ 2.5
	64 QAM	≤ 6.5	≤ 5.5	≤ 4
	256 QAM	≤ 7.5	≤ 7.5	≤ 7.5
CP-OFDM	QPSK	≤ 6.5	≤ 6	≤ 3
	16 QAM	≤ 6.5	≤ 6	≤ 3.5
	64 QAM	≤ 6.5	≤ 6.5	≤ 5
	256 QAM	≤ 9.5	≤ 9.5	≤ 9.5

Table 6.2.2-5 Maximum power reduction (MPR) for power class 1 for Band n14

Modulation		MPR (dB)		
		Edge RB allocations	Outer RB allocations	Inner RB allocations
DFT-s-OFDM	Pi/2 BPSK	≤ 0.5	≤ 0.5	0
	Pi/2 BPSK w Pi/2 BPSK DMRS	≤ 0.5	0	0
	QPSK	≤ 1		0
	16 QAM	≤ 2		≤ 1
	64 QAM	≤ 2.5		
	256 QAM	≤ 4.5		
CP-OFDM	QPSK	≤ 3		≤ 1.5
	16 QAM	≤ 3		≤ 2
	64 QAM	≤ 3.5		
	256 QAM	≤ 6.5		

Where the following parameters are defined to specify valid RB allocation ranges for Outer and Inner RB allocations:

N_{RB} is the maximum number of RBs for a given Channel bandwidth and sub-carrier spacing defined in Table 5.3.2-1.
 $RB_{Start,Low} = \max(1, \text{floor}(L_{CRB}/2))$

where $\max()$ indicates the largest value of all arguments and $\text{floor}(x)$ is the greatest integer less than or equal to x .

$$RB_{Start,High} = N_{RB} - RB_{Start,Low} - L_{CRB}$$

The RB allocation is an Inner RB allocation if the following conditions are met

$$RB_{Start,Low} \leq RB_{Start} \leq RB_{Start,High}, \text{ and}$$

$$L_{CRB} \leq \text{ceil}(N_{RB}/2)$$

where $\text{ceil}(x)$ is the smallest integer greater than or equal to x .

An Edge RB allocation is the one for which the RB(s) is (are) allocated at the lowermost or uppermost edge of the channel with $L_{CRB} \leq 2$ RBs.

The RB allocation is an Outer RB allocation for all other allocations which are not an Inner RB allocation or Edge RB allocation.

If CP-OFDM allocation satisfies following conditions, it is considered as almost contiguous allocation

$$N_{RB_gap} / (N_{RB_alloc} + N_{RB_gap}) \leq 0.25$$

and $N_{RB_alloc} + N_{RB_gap}$ is larger than 106, 51 or 24 RBs for 15 kHz, 30 kHz or 60 kHz respectively where N_{RB_gap} is the total number of unallocated RBs between allocated RBs and N_{RB_alloc} is the total number of allocated RBs. The size and location of allocated and unallocated RBs are restricted by RBG parameters specified in clause 6.1.2.2 of TS 38.214 [10]. For UE that indicates support for *almostContiguousCP-OFDM-UL*, the almost contiguous signals in power class 1.5, 2 and 3, the allowed maximum power reduction defined in Table 6.2.2-4, Table 6.2.2-2 and Table 6.2.2-1 are increased by

$$CEIL\{ 10 \log_{10}(1 + N_{RB_gap} / N_{RB_alloc}), 0.5 \} \text{ dB,}$$

where $CEIL\{x, 0.5\}$ means x rounding upwards to closest 0.5dB. The parameter of L_{CRB} which is used to specify valid RB allocation ranges for Outer and Inner RB allocations is replaced by $(N_{RB_alloc} + N_{RB_gap})$ for almost contiguous allocation cases

For the UE maximum output power modified by MPR, the power limits specified in clause 6.2.4 apply.

6.2.3 UE additional maximum output power reduction

6.2.3.1 General

Additional emission requirements can be signalled by the network. Each additional emission requirement is associated with a unique network signalling (NS) value indicated in RRC signalling by an NR frequency band number of the applicable operating band and an associated value in the field *additionalSpectrumEmission*. Throughout this specification, the notion of indication or signalling of an NS value refers to the corresponding indication of an NR frequency band number of the applicable operating band, the IE field *freqBandIndicatorNR* and an associated value of *additionalSpectrumEmission* in the relevant RRC information elements [7].

To meet the additional requirements, additional maximum power reduction (A-MPR) is allowed for the maximum output power as specified in Table 6.2.1-1. Unless stated otherwise, the total reduction to UE maximum output power is $\max(MPR + \Delta MPR, A-MPR)$ where MPR and ΔMPR are defined in clause 6.2.2. Outer and inner allocation notation used in clause 6.2.3 is defined in clause 6.2.2. Unless stated otherwise, Edge RB allocations get the same AMPR as Outer RB allocations. In absence of modulation and waveform types the A-MPR applies to all modulation and waveform types.

Table 6.2.3.1-1 specifies the additional requirements with their associated network signalling values and the allowed A-MPR and applicable operating band(s) for each NS value. In case of a power class 3 UE, when IE *powerBoostPi2BPSK* is set to 1, power class 2 A-MPR values apply. The mapping of NR frequency band numbers and values of the *additionalSpectrumEmission* to network signalling labels is specified in Table 6.2.3.1-1A.

For almost contiguous allocations in CP-OFDM waveforms in power class 1.5, 2 and 3, the allowed A-MPR defined in clause 6.2.3 is increased by $CEIL\{ 10 \log_{10}(1 + N_{RB_gap} / N_{RB_alloc}), 0.5 \}$ dB, where $CEIL\{x, 0.5\}$ means x rounding upwards to closest 0.5dB, N_{RB_gap} is the total number of unallocated RBs between allocated RBs and N_{RB_alloc} is the total number of allocated RBs, and the parameter L_{CRB} is replaced by $N_{RB_alloc} + N_{RB_gap}$ in specifying the RB allocation regions.

Unless otherwise specified, pi/2 BPSK in following A-MPR tables refers to both variants of pi/2 BPSK referenced in 6.2.2 tables 6.2.2-1.

Table 6.2.3.1-1: Additional maximum power reduction (A-MPR)

Network signalling label	Requirements (clause)	NR Band	Channel bandwidth (MHz)	Resources blocks (N_{RB})	A-MPR (dB)

NS_01		Table 5.2-1 (NOTE 7)	5, 10, 15, 20, 25, 30, 40, 50, 60, 70, 80, 90, 100	Table 5.3.2-1	N/A
NS_03	6.5.2.3.3	n2, n25, n66, n70, n86			Clause 6.2.3.7
NS_03U	6.5.2.3.3, 6.5.2.4.2	n2, n25, n66, n86 (NOTE 1)			Clause 6.2.3.7
NS_04	6.5.2.3.2, 6.5.3.3.1	n41	10, 15, 20, 30, 40, 50, 60 80, 90, 100		Clause 6.2.3.2
NS_05	6.5.3.3.4	n1, n65, n84	5, 10, 15, 20 (NOTE 2)		Clause 6.2.3.4
NS_05U	6.5.3.3.4, 6.5.2.4.2	n1, n65, n84 (NOTE 1)	5, 10, 15, 20		Clause 6.2.3.4
NS_06	6.5.2.3.4	n12	5, 10, 15		N/A
		n14	5,10		
NS_10		n20, n82	15, 20	Table 6.2.3.3-1	Table 6.2.3.3-1
NS_12	6.5.3.3.17	n26	5,10	Table 6.2.3.21-1	Table 6.2.3.21-2
NS_13	6.5.3.3.18	n26	5	Table 6.2.3.22-1	Table 6.2.3.22-2
NS_14	6.5.3.3.19	n26	10,15,20	Table 6.2.3.23-1	Table 6.2.3.23-2
NS_15	6.5.3.3.20	n26	5,10,15,20	Table 6.2.3.24-1	Table 6.2.3.24-2
NS_17	6.5.3.3.2	n28, n83	5,10	Table 5.3.2-1	N/A
NS_18	6.5.3.3.3	n28, n83	5		Table 6.2.3.13-1, A1
			10, 15, 20		Table 6.2.3.13-1, A2
			30		Table 6.2.3.13-1, A3, A4, A5
NS_21	6.5.3.3.12	n30	5, 10		Clause 6.2.3.14
NS_24	6.5.3.3.13	n65 (NOTE 4)	5, 10, 15, 20	Table 6.2.3.15-1	Clause 6.2.3.15
NS_27	6.5.2.3.8 6.5.3.3.14	n48	5, 10, 15, 20, 40	Table 6.2.3.16-1	Table 6.2.3.16-2
NS_35	6.5.2.3.1	n71	5, 10, 15, 20	Table 5.3.2-1	N/A
NS_37	6.5.3.3.6	n74 (NOTE 3)	10, 15	Table 6.2.3.8-1	Table 6.2.3.8-1
NS_38	6.5.3.3.7	n74	5, 10, 15, 20	Table 6.2.3.9-1	Table 6.2.3.9-1
NS_39	6.5.3.3.8	n74	10, 15, 20	Table 6.2.3.10-1	Table 6.2.3.10-1
NS_40	6.5.3.3.9	n51	5		Table 6.2.3.5-1
NS_41	6.5.3.3.10	n50	5, 10, 15, 20, 30, 40, 50, 60		Table 6.2.3.11-1
NS_42	6.5.3.3.11	n50	5, 10, 15, 20, 30, 40, 50, 60		Table 6.2.3.12-1
NS_43	6.5.3.3.5	n8, n81	5, 10, 15		Clause 6.2.3.6
NS_43U	6.5.3.3.5, 6.5.2.4.2	n8, n81 (NOTE 1)	5, 10, 15		Clause 6.2.3.6
NS_44	6.5.3.3.24	n38	25, 30, 40	Table 6.2.3.20-1	Table 6.2.3.20-1
NS_45	6.5.3.3.21	n53	5, 10		Clause 6.2.3.25
NS_46	6.5.3.3.25	n7	25, 30, 40, 50	Table 6.2.3.17-1	Table 6.2.3.17-2
NS_47	6.5.3.3.15	n41 (Note 5)	30 (Note 5)	Table 6.2.3.18-1 Table 6.2.3.18-3	Table 6.2.3.18-2 Table 6.2.3.18-4

NS_48	6.5.3.3.22	n1	25, 30, 40, 50	Table 6.2.3.26-1	Table 6.2.3.26-1
NS_49	6.5.3.3.23	n1	25, 30, 40, 50	Table 6.2.3.27-1	Table 6.2.3.27-1
NS_50	6.5.3.3.16	n39	25, 30, 40		Clause 6.2.3.19
NS_51	6.5.3.3.22	n65	50	Table 6.2.3.28-1	Table 6.2.3.28-2
NS_55	NOTE 6	n77	10, 15, 20, 25, 30, 40, 50, 60, 70, 80, 90, 100		N/A
NS_100	6.5.2.4.2	n1, n2, n3, n5, n8, n18, n25, n26, n65, n66, n80, n81, n84, n86, n89 (NOTE 1)			Table 6.2.3.1-2

NOTE 1: This NS can be signalled for NR bands that have UTRA services deployed.
 NOTE 2: No A-MPR is applied for 5 MHz $BW_{Channel}$ where the upper channel edge is ≥ 1930 MHz, 10 MHz $BW_{Channel}$ where the upper channel edge is ≥ 1950 MHz and 15 MHz $BW_{Channel}$ where the upper channel edge is ≥ 1955 MHz and 20 MHz $BW_{Channel}$ where the upper channel edge is ≥ 1970 MHz.
 NOTE 3: Applicable when the NR carrier is within 1447.9 – 1462.9 MHz.
 NOTE 4: Applicable when the upper edge of the channel bandwidth frequency is greater than 1980 MHz.
 NOTE 5: Applicable when the NR carrier is within 2545 – 2575 MHz. $BW_{Channel}$ less than 30 MHz are addressed in Table 6.5.3.2-1.
 NOTE 6: This NS value is applicable for cells in the range 3450 – 3550 MHz for operations in the USA. This NS value does not indicate any additional spurious emission and maximum output power reduction requirements.
 NOTE 7: The NS_01 label with the field *additionalPmax* [7] absent is default for all NR bands.

Table 6.2.3.1-1A: Mapping of network signalling label

NR band	Value of <i>additionalSpectrumEmission</i>							
	0	1	2	3	4	5	6	7
n1	NS_01	NS_100	NS_05	NS_05U	NS_48	NS_49		
n2	NS_01	NS_100	NS_03	NS_03U				
n3	NS_01	NS_100						
n5	NS_01	NS_100						
n7	NS_01	NS_46						
n8	NS_01	NS_100	NS_43	NS_43U				
n12	NS_01	NS_06						
n14	NS_01	NS_06						
n18	NS_01	NS_100						
n20	NS_01	Void	NS_10					
n25	NS_01	NS_100	NS_03	NS_03U				
n26	NS_01	NS_100	NS_12	NS_13	NS_14	NS_15		
n28	NS_01	NS_17	NS_18					
n30	NS_01	NS_21						
n34	NS_01							
n38	NS_01	NS_44						
n39	NS_01	NS_50						
n40	NS_01							
n41	NS_01	NS_04	NS_47					
n48	NS_01	NS_27						
n50	NS_01	NS_41	NS_42					
n51	NS_01	NS_40						
n53	NS_01	NS_45						
n65	NS_01	NS_24	NS_100	NS_05	NS_05U	NS_51		
n66	NS_01	NS_100	NS_03	NS_03U				
n70	NS_01	NS_03						
n71	NS_01	NS_35						
n74	NS_01	NS_37	NS_38	NS_39				
n77	NS_01	NS_55						
n78	NS_01							
n79	NS_01							
n80	NS_01	NS_100						
n81	NS_01	NS_100	NS_43	NS_43U				

n82	NS_01	Void	NS_10					
n83	NS_01	NS_17	NS_18					
n84	NS_01	NS_100	NS_05	NS_05U				
n86	NS_01	NS_100	NS_03	NS_03U				
n89	NS_01	NS_100						
n91	NS_01							
n92	NS_01							
n93	NS_01							
n94	NS_01							
n95	NS_01							

NOTE: *additionalSpectrumEmission* corresponds to an information element of the same name defined in clause 6.3.2 of TS 38.331 [7].

Table 6.2.3.1-2: A-MPR for NS_100 (UTRA protection)

Modulation/Waveform	Outer (dB)	
$\Delta \mu \mu \phi$	Pi/2 BPSK	≤ 2
	QPSK	≤ 2
	16 QAM	≤ 2.5
	64 QAM	≤ 3
	256 QAM	≤ 4.5
$\cup \mu \cup \mu$	QPSK	≤ 4
	16 QAM	≤ 4
	64 QAM	≤ 4
	256 QAM	≤ 6.5

NOTE 1: Void
NOTE 2: Void

6.2.3.2 A-MPR for NS_04

For NS_04, A-MPR is not added to MPR. Also, when NS_04 is signalled, MPR shall be set to zero in the P_{CMAX} equations to avoid double counting MPR.

Allowed maximum power reduction is defined as $A-MPR = \max(MPR, A-MPR')$,

Note that $A-MPR' = 0$ dB means only MPR is applied,

where $A-MPR'$ is defined as

```

if  $RB_{start} \leq f_{start,max,IMD3} / (12 \cdot SCS)$  and  $L_{CRB} \leq AW_{max,IMD3} / (12 \cdot SCS)$  and  $F_c - BW_{channel}/2 < F_{UL,low} + offset_{IMD3}$ ,
then
    the  $A-MPR'$  is defined according to Table 6.2.3.2-2 PC3_A2 relative to 23 dBm for power class 3,
    PC2_A4 relative to 26 dBm for power class 2, and PC1.5_A6 relative to 29 dBm for power class 1.5,
    else,
if  $RB_{start} \leq L_{CRB}/2 + \Delta_{start} / (12 \cdot SCS)$  and  $L_{CRB} \leq AW_{max,regrowth} / (12 \cdot SCS)$  and  $F_c - BW_{channel}/2 < F_{UL,low} + offset_{regrowth}$ ,
then
    the  $A-MPR'$  is defined according to Table 6.2.3.2-2 PC3_A1 relative to 23 dBm for power class 3,
    PC2_A3 relative to 26 dBm for power class 2, , and PC1.5_A5 relative to 29 dBm for power class 1.5,
    else
     $A-MPR' = 0$  dB and apply MPR.
    
```

With the parameters defined in Table 6.2.3.2-1.

Table 6.2.3.2-1: Parameters for region edges and frequency offsets

Parameter	Symbol	Value		Related condition
		CP-OFDM	DFT-s-OFDM	
Max allocation start in IMD3 region	$f_{start,max,IMD3}$	0.33 $BW_{channel}$		$RB_{start} \leq f_{start,max,IMD3} / (12SCS)$
Max allocation BW in IMD3 region	$AW_{max,IMD3}$	4 MHz		$L_{CRB} \leq AW_{max,IMD3} / (12SCS)$

Freq. offset required to avoid A-MPR in IMD3 region	$\text{offset}_{\text{IMD3}}$	$BW_{\text{Channel}} - 6 \text{ MHz}$		$F_C - BW_{\text{Channel}}/2 \geq F_{\text{UL_low}} + \text{offset}_{\text{IMD3}}$
Right edge of regrowth region	Δ_{start}	0.08 BW_{Channel}		$RB_{\text{start}} \leq L_{\text{CRB}}/2 + \Delta_{\text{start}} / (12\text{SCS})$
Max allocation BW in regrowth region	$AW_{\text{max,regrowth}}$	100 MHz		$L_{\text{CRB}} \leq \text{Min}(L_{\text{CRB,Max}}, AW_{\text{max,regrowth}} / (12\text{SCS}))$
Freq. offset required to avoid A-MPR in regrowth region	$\text{offset}_{\text{regrowth}}$	Max (10 MHz, $0.25 * BW_{\text{Channel}}$ MHz)	Max (10 MHz, $0.45 * BW_{\text{Channel}}$ MHz)	$F_C - BW_{\text{Channel}}/2 \geq F_{\text{UL_low}} + \text{offset}_{\text{regrowth}}$

Table 6.2.3.2-2: A-MPR' values Access

Modulation/Waveform		A-MPR' (dB)					
		PC3_A1	PC3_A2	PC2_A3	PC2_A4	PC1.5_A5 ¹	PC1.5_A6 ¹
DFT-s-OFDM	Pi/2-BPSK	≤ 3.5	≤ 3.5	≤ 3.5	≤ 5.5	≤ 5	≤ 7
	QPSK	≤ 4	≤ 4	≤ 4.5	≤ 6	≤ 6	≤ 7.5
	16 QAM	≤ 4	≤ 4	≤ 5	≤ 6	≤ 6.5	≤ 7.5
	64 QAM	≤ 4	≤ 4.5	≤ 5	≤ 6.5	≤ 6.5	≤ 8
	256 QAM	≤ 4.5	≤ 6	≤ 6.5	≤ 8	≤ 8	≤ 9.5
CP-OFDM	QPSK	≤ 5.5	≤ 5.5	≤ 6.5	≤ 7.5	≤ 8	≤ 9
	16 QAM	≤ 5.5	≤ 5.5	≤ 6.5	≤ 7.5	≤ 8	≤ 9
	64 QAM	≤ 5.5	≤ 5.5	≤ 6.5	≤ 7.5	≤ 8	≤ 9
	256 QAM	≤ 6.5	≤ 8	≤ 7.5	≤ 10	≤ 9	≤ 11.5

NOTE 1: PC1.5 assumes dual Tx.

6.2.3.3 A-MPR for NS_10

Table 6.2.3.3-1: A-MPR for NS_10

Channel bandwidth (MHz)	Parameters	Region A
15	RB_{start}	0 – 10
	L_{CRB} (RBs)	1 – 20
	A (dB)	≤ 3
20	RB_{start}	0 – 15
	L_{CRB} (RBs)	1 – 20
	A (dB)	≤ 6

NOTE 1: RB_{start} indicates the lowest RB index of transmitted resource blocks

NOTE 2: L_{CRB} is the length of a contiguous resource block allocation

NOTE 3: For intra-subframe frequency hopping which intersects Region A, notes 1 and 2 apply on a per slot basis. For intra-slot or intra-subslot frequency hopping which intersects Region A, notes 1 and 2 apply on a $T_{\text{no_hopping}}$ basis.

NOTE 4: For intra-subframe frequency hopping which intersect Region A, the larger A-MPR value may be applied for both slots in the subframe. For intra-slot frequency hopping which intersects Region A, the larger A-MPR value may be applied for the slot. For intra-subslot frequency hopping which intersects Region A, the larger A-MPR value may be applied for the subslot.

NOTE 5: The A-MPR for DFT-s-OFDM is the total backoff and is obtained by taking the maximum value of MPR + A-MPR specified in Table 6.2.3-1 and Table 6.2.4-1 in TS 36.101 and A value specified in Table 6.2.3.3-1.

NOTE 6: The A-MPR for CP-OFDM is the total backoff and is obtained by adding the A value in Table 6.2.3.3-1 to the corresponding MPR specified in Table 6.2.2-1.

6.2.3.4 A-MPR for NS_05 and NS_05U

Table 6.2.3.4-1: A-MPR regions for NS_05 and NS_05U

Channel Bandwidth (MHz)	Carrier Centre Frequency, F_c (MHz)	Region A			Region B			Region C		
		RB_{start}	LCRB	A-MPR	RB_{start}	LCRB	A-MPR	RB_{start}	LCRB	A-MPR
5	$1922.5 \leq F_c < 1927.5$	$< 1.62 \text{ MHz}/12/\text{SCS}$	$> 2.52 \text{ MHz}/12/\text{SCS}$	A3						
10	$1925 \leq F_c < 1935$	$\leq 1.62 \text{ MHz}/12/\text{SCS}$	> 0	A1	$> 1.62 \text{ MHz}/12/\text{SCS}$ $\leq 3.60 \text{ MHz}/12/\text{SCS}$	$> 5.4 \text{ MHz}/12/\text{SCS}$	A7	$\geq 7.2 \text{ MHz}/12/\text{SCS}$	$\leq 1.08 \text{ MHz}/12/\text{SCS}$	A2
10	$1935 \leq F_c < 1945$		$> 4.5 \text{ MHz}/12/\text{SCS}$	A4						
15	$1927.5 \leq F_c < 1932.5$	$\leq 3.24 \text{ MHz}/12/\text{SCS}$	> 0	A1	$> 3.24 \text{ MHz}/12/\text{SCS}$ $\leq 5.40 \text{ MHz}/12/\text{SCS}$	$> 8.1 \text{ MHz}/12/\text{SCS}$	A7	$\geq 10.08 \text{ MHz}/12/\text{SCS}$	$\leq 1.08 \text{ MHz}/12/\text{SCS}$	A2
15	$1932.5 \leq F_c < 1942.5$	$< 1.62 \text{ MHz}/12/\text{SCS}$	> 0	A1				$\geq 12.24 \text{ MHz}/12/\text{SCS}$	$\leq 1.08 \text{ MHz}/12/\text{SCS}$	A2
15	$1942.5 \leq F_c < 1947.5$		$> 7.2 \text{ MHz}/12/\text{SCS}$	A5						
20	$1930 \leq F_c < 1950$	$\leq 4.86 \text{ MHz}/12/\text{SCS}$	> 0	A1	$> 4.86 \text{ MHz}/12/\text{SCS}$ $\leq 7.20 \text{ MHz}/12/\text{SCS}$	$> 9.0 \text{ MHz}/12/\text{SCS}$	A7	$\geq 13.68 \text{ MHz}/12/\text{SCS}$	$\leq 1.08 \text{ MHz}/12/\text{SCS}$	A2
20	$1950 \leq F_c < 1960$		$> 9.0 \text{ MHz}/12/\text{SCS}$	A6						

NOTE 1: The A-MPR values are specified in Table 6.2.3.4-2, 6.2.3.4-3 and 6.2.3.4-10.
NOTE 2: Void

Table 6.2.3.4-2: A-MPR for NS_05 and NS_05U

Modulation/Waveform		A1 (dB)		A2 (dB)		A3 (dB)	
		Outer/Inner	Outer/Inner	Outer/Inner	Outer	Outer	Outer
DFT-s-OFDM	Pi/2 BPSK	≤ 10		≤ 5		≤ 4	
	QPSK	≤ 10		≤ 5		≤ 4.5	
	16 QAM	≤ 10		≤ 5		≤ 6	
	64 QAM	≤ 11		≤ 5		≤ 6	
	256 QAM	≤ 13		≤ 5		≤ 7	
CP-OFDM	QPSK	≤ 10		≤ 5		≤ 7.5	
	16 QAM	≤ 10		≤ 5		≤ 7.5	
	64 QAM	≤ 11		≤ 5		≤ 8	
	256 QAM	≤ 13				≤ 10	

NOTE 1: Void
NOTE 2: Void

Table 6.2.3.4-3: A-MPR for NS_05

Modulation/Waveform		A4 (dB)		A5 (dB)	A6 (dB)		A7 (dB)
		Outer	Inner	Outer	Outer	Inner	Outer/Inner
DFT-s-OFDM	Pi/2 BPSK	≤ 1	N/A	≤ 1	≤ 1	N/A	≤ 6
	QPSK			≤ 1.5	≤ 1.5		≤ 6
	16 QAM						≤ 6
	64 QAM						≤ 6
	256 QAM						≤ 6
CP-OFDM	QPSK	≤ 3.5		≤ 3.5	≤ 3.5		≤ 6
	16 QAM	≤ 3.5		≤ 3.5	≤ 3.5		≤ 6
	64 QAM						≤ 6
	256 QAM						≤ 6

NOTE 1: Void
NOTE 2: Void

Table 6.2.3.4-4 - Table 6.2.3.4-9: Void

Table 6.2.3.4-10: A-MPR for modulation and waveform type for NS_05U

Modulation/Waveform		A4 (dB)		A5 (dB)	A6 (dB)		A7 (dB)
		Outer	Inner	Outer	Outer	Inner	Outer/Inner
DFT-s-OFDM	Pi/2 BPSK	≤ 2	N/A	≤ 2	≤ 2	N/A	≤ 6
	QPSK	≤ 2		≤ 2	≤ 2		≤ 6
	16 QAM	≤ 2.5		≤ 2.5	≤ 2.5		≤ 6
	64 QAM	≤ 3		≤ 3	≤ 3		≤ 6
	256 QAM	≤ 4.5		≤ 4.5	≤ 4.5		≤ 6
CP-OFDM	QPSK	≤ 4		≤ 4	≤ 4		≤ 6
	16 QAM	≤ 4		≤ 4	≤ 4		≤ 6
	64 QAM	≤ 4		≤ 4	≤ 4		≤ 6
	256 QAM	≤ 6.5		≤ 6.5	≤ 6.5		≤ 6.5

NOTE 1: Void
NOTE 2: Void

6.2.3.5 A-MPR for NS_40

Table 6.2.3.5-1: A-MPR for NS_40

Modulation/ Waveform	A (dB)
----------------------	--------

		Channel bandwidth: 5 MHz	
		Outer	Inner
DFT-s-OFDM	QPSK	≤ 15.5	≤ 12
	16 QAM	≤ 14.5	≤ 11
	64 QAM	≤ 14.5	≤ 10
	256 QAM	≤ 12.5	≤ 7.5
CP-OFDM	QPSK	≤ 14.5	≤ 10
	16 QAM	≤ 14.5	≤ 10
	64 QAM	≤ 14	≤ 8
	256 QAM	≤ 11	≤ 5.5

NOTE 1: The A-MPR for NS_40 is the total backoff and is obtained by taking the maximum value of MPR + A-MPR specified in Table 6.2.3-1 and Table 6.2.4-30a in TS 36.101 and MPR + A specified in Table 6.2.2-1 and Table 6.2.3.5-1.

6.2.3.6 A-MPR for NS_43 and NS_43U

Table 6.2.3.6-1: A-MPR regions for NS_43

Channel Bandwidth (MHz)	Carrier Centre Frequency, F _c (MHz)	Region A			Region B		
		RB _{start}	LCRB	A-MPR	RB _{start}	LCRB	A-MPR
5 MHz	902.5 ≤ F _c < 912.5		> 15	A1			
10 MHz	F _c = 910		> 40	A2		> 5.4 MHz/12/SCS	A4
			> 45	A3		> 7.2 MHz/12/SCS	A5
15 MHz	F _c = 907.5	< 1.8 MHz /12/SCS	> 0	A6	> 1.8 MHz/12/SCS	≥ 7.2 MHz/12/SCS	A6
		> 12.24 MHz/12/SCS	> 0	A6	< 6.12 MHz/12/SCS		

NOTE 1: The A-MPR values are specified in Table 6.2.3.6-2.
 NOTE 2: 15 kHz SCS unless otherwise stated
 NOTE 3: Void

Table 6.2.3.6-2: A-MPR for NS_43

Modulation/Waveform		A1 (dB)		A2 (dB)		A3 (dB)		A4 (dB)		A5 (dB)		A6 (dB)
		Outer	Inner	Outer	Inner	Outer	Inner	Outer	Inner	Outer	Inner	Outer / Inner
DFT-s-OFDM	Pi/2 BPSK		N/A	≤ 1.5	N/A				N/A		N/A	≤ 9
	QPSK	≤ 2						≤ 2.5				≤ 9
	16 QAM									≤ 2.5		≤ 9
	64 QAM					≤ 2.5						≤ 9
	256 QAM											≤ 9
CP-OFDM	QPSK	≤ 3.5								≤ 4		≤ 9
	16 QAM	≤ 3.5								≤ 4		≤ 9
	64 QAM					≤ 4						≤ 9
	256 QAM											≤ 9

Table 6.2.3.6-3: Void

When NS_43U is signalled for 5 and 10 MHz channel bandwidths A-MPR is defined in Table 6.2.3.1-2 except for DFT-s-OFDM QPSK when L_{CRB} > 5.4 MHz/12/SCS the A-MPR is 2.5 dB. For 15 MHz channel bandwidth Table 6.2.3.6-4 applies.

Table 6.2.3.6-4: A-MPR for NS_43U

Modulation/Waveform		15 MHz
		Outer / Inner (dB)
DFT-s-OFDM	Pi/2 BPSK	≤ 9
	QPSK	≤ 9
	16 QAM	≤ 9
	64 QAM	≤ 9
	256 QAM	≤ 9
CP-OFDM	QPSK	≤ 9
	16 QAM	≤ 9
	64 QAM	≤ 9
	256 QAM	≤ 9

6.2.3.7 A-MPR for NS_03 and NS_03U

Table 6.2.3.7-1 A-MPR for NS_03

Modulation/Waveform	Outer (dB)	Inner (dB)	
DFT-s-OFDM	Pi/2 BPSK	≤ 1.5	N/A
	QPSK	≤ 2	
	16 QAM	≤ 3	
	64 QAM	≤ 3.5	
	256 QAM	≤ 5.5	
CP-OFDM	QPSK	≤ 4	
	16 QAM	≤ 4	
	64 QAM	≤ 4.5	
	256 QAM	≤ 7.5	
NOTE 1: Void			
NOTE 2: Void			

In case UE operates in a band where NS_03U applies and it receives *additionalSpectrumEmission* value of 3 then A-MPR values specified in Table 6.2.3.7-1 apply with an exception that DFT-s-OFDM Pi/2 BPSK A-MPR is 2 dB.

6.2.3.8 A-MPR for NS_37

Table 6.2.3.8-1: A-MPR regions for B11/B21 protection (NS_37) (1447.9 - 1462.9 MHz)

Channel Bandwidth (MHz)	Carrier Centre Frequency, F _c (MHz)	Region A (Outer/Inner)			Region B (Outer/Inner)			Region C (Outer/Inner)		
		RB _{start}	LCRB	A-MPR	RB _{start}	LCRB	A-MPR	RB _{start}	LCRB	A-MPR
10	1452.9 < F _c ≤ 1457.9	≥ 0	> 7.2 MHz/12/SCS	≤ A1	N/A	N/A	N/A	N/A	N/A	N/A
15	F _c = 1455.4	≥ 0	> 9.9 MHz/12/SCS	≤ A1	< 0.54 MHz/12/SCS	< 1.08 MHz/12/SCS	≤ A2	> 13.86 MHz/12/SCS	< 1.08 MHz/12/SCS	≤ A2
NOTE 1: The A-MPR values are specified in Table 6.2.3.8-2										
NOTE 2: Void										
NOTE 3: Void										
NOTE 4: No A-MPR for SCS = 60 kHz for region B and C only.										

Table 6.2.3.8-2: A-MPR for NS_37

Modulation/Waveform		A1 (dB)		A2 (dB)
		Outer	Inner	Outer/Inner
DFT-s-OFDM	Pi/2 BPSK	≤ 1	N/A	≤ 3
	QPSK	≤ 1.5		≤ 3
	16 QAM	≤ 2.5		≤ 3
	64 QAM	≤ 3		≤ 3
	256 QAM			
CP-OFDM	QPSK	≤ 3.5		≤ 3
	16 QAM	≤ 3.5		≤ 3
	64 QAM			
	256 QAM			

NOTE 1: Void
NOTE 2: Void

6.2.3.9 A-MPR for NS_38

Table 6.2.3.9-1: A-MPR for EESS (NS_38) Protection (1430 – 1470 MHz)

Channel Bandwidth (MHz)	Carrier Centre Frequency, F _c (MHz)	Region A Outer/Inner			Region B Outer/Inner		
		RB _{start}	LCRB	A-MPR (dB)	RB _{start}	RB _{start} +LCRB	A-MPR (dB)
5	1432.5 ≤ F _c < 1437.5	≤ -3.6 MHz/12/SCS + LCRB	≥ 3.6 MHz/12/SCS	≤ 7	> -3.6 MHz/12/SCS + LCRB)	≤ 2.16 MHz/12/SCS	≤ 5.5
10	1435 ≤ F _c < 1442	≤ -3.6 MHz/12/SCS + LCRB	≥ 3.6 MHz/12/SCS	≤ 12	> -3.6 MHz/12/SCS + LCRB)	≤ 2.16 MHz/12/SCS	≤ 9
15	1437.5 ≤ F _c < 1447.5	≤ -3.6 MHz/12/SCS + LCRB	≥ 3.6 MHz/12/SCS	≤ 13	> -3.6 MHz/12/SCS + LCRB)	≤ 3.6 MHz/12/SCS	≤ 10
20	1440 ≤ F _c < 1450	≤ -3.6 MHz/12/SCS + LCRB	≥ 3.6 MHz/12/SCS	≤ 13	> -3.6 MHz/12/SCS + LCRB)	≤ 5.4 MHz/12/SCS	≤ 10

NOTE 1 - 4: Void

6.2.3.10 A-MPR for NS_39

Table 6.2.3.10-1: A-MPR for own RX (NS_39) Protection (1440 – 1470 MHz)

Channel Bandwidth, MHz	Carrier Centre Frequency, F _c , MHz	Region A (Outer/Inner)	
		RB _{start} +LCRB	A-MPR (dB)
10	1460 < F _c ≤ 1465	> 7.9 MHz/12/SCS	≤ 6
15	1452.5 < F _c ≤ 1462.5	> 11.2 MHz/12/SCS	≤ 6
20	1450 < F _c ≤ 1460	> 12.6 MHz/12/SCS	≤ 6

NOTE 1 - 4: Void

6.2.3.11 A-MPR for NS_41

Table 6.2.3.11-1: A-MPR for NS_41

Channel Bandwidth (MHz)	Carrier Centre Frequency, F _c (MHz)	Region A Outer/Inner	Region B Outer/Inner
-------------------------	------------------------------------------------	----------------------	----------------------

		RB_{start}	L_{CRB}	A-MPR (dB)	$RB_{start}+L_{CRB}$	A-MPR (dB)
5	-	-	-	-	-	-
10	$1437 \leq F_C < 1442$	$\leq -4.5 \text{ MHz}/12/\text{SCS} + L_{CRB}$	$> 4.5 \text{ MHz}/12/\text{SCS}$	≤ 9	$< 1.8 \text{ MHz}/12/\text{SCS}$	≤ 9
15	$1439.5 \leq F_C < 1447.5$	$\leq -5.4 \text{ MHz}/12/\text{SCS} + L_{CRB}$	$> 5.4 \text{ MHz}/12/\text{SCS}$	≤ 11	$< 3.42 \text{ MHz}/12/\text{SCS}$	≤ 9
20	$1442 \leq F_C < 1450$	$\leq -5.4 \text{ MHz}/12/\text{SCS} + L_{CRB}$	$> 5.4 \text{ MHz}/12/\text{SCS}$	≤ 12	$< 5.04 \text{ MHz}/12/\text{SCS}$	≤ 9
30	$1452 \leq F_C < 1502$	$\leq -7.2 \text{ MHz}/12/\text{SCS} + L_{CRB}$	$> 7.2 \text{ MHz}/12/\text{SCS}$	≤ 13.5	$< 11.7 \text{ MHz}/12/\text{SCS}$	≤ 13.5
40	$1452 \leq F_C < 1497$	$\leq -7.2 \text{ MHz}/12/\text{SCS} + L_{CRB}$	$> 7.2 \text{ MHz}/12/\text{SCS}$	≤ 13.5	$< 11.7 \text{ MHz}/12/\text{SCS}$	≤ 13.5
50	$1457 \leq F_C < 1492$	$\leq -7.2 \text{ MHz}/12/\text{SCS} + L_{CRB}$	$> 7.2 \text{ MHz}/12/\text{SCS}$	≤ 13.5	$< 15.12 \text{ MHz}/12/\text{SCS}$	≤ 13.5
60	$1462 \leq F_C < 1487$	$\leq -7.2 \text{ MHz}/12/\text{SCS} + L_{CRB}$	$> 7.2 \text{ MHz}/12/\text{SCS}$	≤ 13.5	$< 18.72 \text{ MHz}/12/\text{SCS}$	≤ 13.5

NOTE 1 - 4: Void

6.2.3.12 A-MPR for NS_42

Table 6.2.3.12-1: A-MPR for NS_42

Channel Bandwidth (MHz)	Carrier Centre Frequency, F_C (MHz)	Region A		Region B			
		$RB_{start}+L_{CRB}$	A-MPR Outer/Inner (dB)	RB_{start}	$RB_{start}+L_{CRB}$	A-MPR Inner (dB)	A-MPR Outer (dB)
5	$1512 \leq F_C \leq 1514.5$	$> 3.1 \text{ MHz} / 12 / \text{SCS}$	≤ 7	$< 0.90 \text{ MHz} / 12 / \text{SCS}$	$\leq 3.1 \text{ MHz} / 12 / \text{SCS}$	≤ 1.5	≤ 4
10	$1497 \leq F_C \leq 1512$	$> 6.2 \text{ MHz} / 12 / \text{SCS}$	≤ 8	$< 0.90 \text{ MHz} / 12 / \text{SCS}$	$\leq 6.2 \text{ MHz} / 12 / \text{SCS}$	≤ 1.5	≤ 5
15	$1502 \leq F_C \leq 1509.5$	$> 9.3 \text{ MHz} / 12 / \text{SCS}$	≤ 8	$< 3.06 \text{ MHz} / 12 / \text{SCS}$	$\leq 9.3 \text{ MHz} / 12 / \text{SCS}$	≤ 1.5	≤ 5
20	$1497 \leq F_C \leq 1507$	$> 12.4 \text{ MHz} / 12 / \text{SCS}$	≤ 8	$< 4.50 \text{ MHz} / 12 / \text{SCS}$	$\leq 12.4 \text{ MHz} / 12 / \text{SCS}$	≤ 1.5	≤ 5
30	$1477 \leq F_C \leq 1502$	$> 24.8 \text{ MHz} / 12 / \text{SCS}$	≤ 8	$< 5.40 \text{ MHz} / 12 / \text{SCS}$	$\leq 24.8 \text{ MHz} / 12 / \text{SCS}$	≤ 1.5	≤ 5
40	$1477 \leq F_C \leq 1497$	$> 24.8 \text{ MHz} / 12 / \text{SCS}$	≤ 8	$< 5.40 \text{ MHz} / 12 / \text{SCS}$	$\leq 24.8 \text{ MHz} / 12 / \text{SCS}$	≤ 1.5	≤ 5
50	$1467 \leq F_C \leq 1492$	$> 31 \text{ MHz} / 12 / \text{SCS}$	≤ 8	$< 7.20 \text{ MHz} / 12 / \text{SCS}$	$\leq 31 \text{ MHz} / 12 / \text{SCS}$	≤ 1.5	≤ 5
60	$1462 \leq F_C \leq 1487$	$> 37.2 \text{ MHz} / 12 / \text{SCS}$	≤ 8	$< 7.20 \text{ MHz} / 12 / \text{SCS}$	$\leq 37.2 \text{ MHz} / 12 / \text{SCS}$	≤ 1.5	≤ 5

NOTE 1 - 5: Void

6.2.3.13 A-MPR for NS_18

Table 6.2.3.13-0: Band n28 30MHz A-MPR regions for NS_18

Channel Bandwidth, MHz	Frequency range of UL transmission bandwidth configuration, MHz	Regions		A-MPR
		$RB_{start} * 12 * \text{SCS}$ MHz	$L_{CRB} * 12 * \text{SCS}$ MHz	
30	703~733	$> (L_{CRB} * 12 * \text{SCS}) / 2 + 5.22$	$\geq \text{Max}(0, 12 * \text{SCS} * N_{RB} - 1.8 - RB_{start} * 12 * \text{SCS})$	A3
		$\leq (L_{CRB} * 12 * \text{SCS}) / 2 + 5.22$	≥ 5.4	A4
		≤ 7.92	< 5.4	A5

Table 6.2.3.13-1: A-MPR for NS_18

Modulation/Waveform		A1 (dB)		A2 (dB)	A3 (dB)	A4 (dB)	A5 (dB)
		Outer	Inner	Inner/Outer	Outer/Inner	Outer/Inner	Outer/Inner
DFT-s-OFDM	Pi/2 BPSK	≤ 2	N/A	≤ 5	3	8	3
	QPSK	≤ 2		≤ 5	3	8	3
	16 QAM	≤ 3		≤ 6	3	8	3
	64 QAM	≤ 4		≤ 7	3	8	4.5
	256 QAM	≤ 6		≤ 9	3	8	5.5
CP-OFDM	QPSK	≤ 5	≤ 6.5	4.5	9.5	5	
	16 QAM	≤ 5	≤ 7	4.5	9.5	5	
	64 QAM	≤ 5.5	≤ 8.5	4.5	9.5	5.5	
	256 QAM	≤ 8.5	≤ 11.5	4.5	9.5	7.5	

NOTE 1: Void
NOTE 2: Void

6.2.3.14 A-MPR for NS_21

Table 6.2.3.14-1: A-MPR for "NS_21"

Channel Bandwidth (MHz)	Modulation/Waveform	Region A1a	Region A1b	Region A2	Region A3b	Region A3a	
		RB _{start} ≤ 1.44MHz/12/SCS LCRB ≤ [0.54] MHz/12/SCS	RB _{start} ≤ 1.44MHz/12/SCS LCRB > [0.54] MHz/12/SCS LCRB ≤ 2.16MHz/12/SCS	LCRB > 5.4MHz/12/SCS	RB _{end} ≥ 7.74MHz/12/SCS LCRB > [0.54] MHz/12/SCS LCRB ≤ 2.16MHz/12/SCS	RB _{end} ≥ 7.74MHz/12/SCS LCRB ≤ [0.54] MHz/12/SCS	
		Outer/Inner	Outer	Outer/Inner			
10	DFT-s-OFDM	PI/2 BPSK	6	3	4	3	6
		QPSK	6	3	4	3	6
		16 QAM	6	3	4	3	6
		64 QAM	6	3	4	3	6
		256 QAM	6	3	4	3	6
	CP-OFDM	QPSK	6	4	5.5	4	6
		16 QAM	6	4	5.5	4	6
		64 QAM	6	4	5.5	4	6
	256 QAM	6	4	5.5	4	6	

6.2.3.15 A-MPR for NS_24

Table 6.2.3.15-1: A-MPR for NS_24

Channel Bandwidth, MHz	Carrier Centre Frequency, F _c , MHz	Region A			Region B			Region C		
		RB _{end} *12* SCS MHz	LCRB*12* SCS MHz	A-MPR	RB _{end} *12*S CS MHz	LCRB*12* SCS MHz	A-MPR	RB _{end} *12*S CS MHz	LCRB*12* SCS MHz	A-MPR
5MHz	1987.5 < F _c ≤ 1992.5		>3.24	A7						
5MHz	1992.5 < F _c ≤ 1997.5		>3.24	A4						
5MHz	1997.5 < F _c ≤ 2002.5		>1.98	A1	>3.6	>1.08	A2	≤3.6	≤1.98	A3
						≤1.08				
10MHz	1975 < F _c ≤ 1985	>5.4		A4						
10MHz	1985 < F _c ≤ 1995		>4.32	A1	≥7.20	>1.08	A2	<7.20	≤4.32	A3

10MHz	1995 < Fc ≤ 2000	≥5.76		A5	<3.06	≤1.08	A6	≥3.06 <5.76	>1.44	A6
15MHz	1972.5 < Fc ≤ 1987.5		>6.84	A1	≥10.8	>1.08 ≤6.84	A2	<10.8	≤6.84	A3
15MHz	1987.5 < Fc ≤ 1997.5	≥8.64		A5	<3.78	≤1.08	A6	≥3.78 <8.64	>1.44	A6
20MHz	1970 < Fc ≤ 1990	≥12.96		A5	<4.68		A5	≥4.68 <12.96	>2.16	A6
20MHz	1990 < Fc ≤ 1995	≥11.52		A5	<5.58		A5	≥5.58 <11.52	>1.44	A6

NOTE 1: The A-MPR values are listed in Table 6.2.3.15-2.
NOTE 2: For any undefined region, MPR applies

Table 6.2.3.15-2: A-MPR for modulation and waveform type

Modulation/Waveform	A1	A2	A3	A4	A5	A6	A7
	Outer/Inner	Outer/Inner	Outer/Inner	Outer	Outer/Inner	Outer/Inner	Outer
DFT-s-OFDM PI/2 BPSK	≤ 11	≤ 5	≤ 4	≤ 8.5	≤ 18	≤ 10	≤ 3.5
DFT-s-OFDM QPSK	≤ 11	≤ 5	≤ 4	≤ 8.5	≤ 18	≤ 10	≤ 3.5
DFT-s-OFDM 16 QAM	≤ 11	≤ 5	≤ 4	≤ 8.5	≤ 18	≤ 10	≤ 3.5
DFT-s-OFDM 64 QAM	≤ 11	≤ 5	≤ 4	≤ 8.5	≤ 19	≤ 10	≤ 3.5
DFT-s-OFDM 256 QAM	≤ 11	≤ 5		≤ 8.5	≤ 20	≤ 10	
CP-OFDM QPSK	≤ 13	≤ 6.5	≤ 4	≤ 8.5	≤ 19	≤ 12	≤ 5.5
CP-OFDM 16 QAM	≤ 13	≤ 6.5	≤ 4	≤ 8.5	≤ 19	≤ 12	≤ 5.5
CP-OFDM 64 QAM	≤ 13	≤ 6.5	≤ 4	≤ 8.5	≤ 19	≤ 12	≤ 5.5
CP-OFDM 256 QAM	≤ 13	≤ 6.5		≤ 8.5	≤ 20	≤ 12	

NOTE 1: The backoff applied is max(MPR, A-MPR) where MPR is defined in Table 6.2.2-1
NOTE 2: Outer and inner allocations are defined in clause 6.2.2

6.2.3.16 A-MPR for NS_27

Table 6.2.3.16-1: A-MPR for NS_27

Channel Bandwidth, MHz	Carrier Centre Frequency, Fc, MHz	Region A				Region B	
		RBstart*12* SCS	RBend*12*S CS	LCRB*12* SCS	A-MPR	LCRB*12* SCS	A-MPR
15 MHz	3557.5 ≤ Fc < 3562.5	<1.8 MHz			A3	≥10.8 MHz z	A3
	3687.5 < Fc ≤ 3692.5	>11.52 MHz					
15 MHz	3562.5 ≤ Fc < 3567.5	≤1.08 MHz		<1.44 MHz z	A4	≥11.52 MHz	2
	3682.5 < Fc ≤ 3687.5		≥13.22 MHz z				
20 MHz	3560 ≤ Fc < 3570	<3.6 MHz			A5	≥10.8 MHz z	A5
	3680 < Fc ≤ 3690	>12.96 MHz					
20 MHz	3570 ≤ Fc < 3580	≤2.16 MHz		<1.44 MHz z	A6	≥14.4 MHz z	2
	3670 < Fc ≤ 3680		≥16.92				
40 MHz	3570 ≤ Fc < 3600	<11.34 MHz			A7		
		≥11.34 MHz, ≤31.0 MHz		≥18 MHz	A2		
		>31.0 MHz		<18 MHz	A1		
	3650 < Fc ≤ 3680		>24.48 MHz z		A7		
		≤24.48 MHz z, ≥6.48 MHz		≥18 MHz	A2		

				<18 MHz	A1		
			<6.48 MHz	<3.6 MHz	A7		
40 MHz	$3600 \leq F_c \leq 3650$	≤ 6.12 MHz		<1.44 MHz z	A8	>20 MHz	4.5
			≥ 32.76				

NOTE 1: Void
NOTE 2: Void

Table 6.2.3.16-2: A-MPR for modulation and waveform type

Modulation/Waveform		A1	A2	A3	A4	A5	A6	A7	A8
		Outer	Outer	Outer/Inner	Outer/Inner	Outer/Inner	Outer/Inner	Outer/Inner	Outer/Inner
DFT-s-OFDM	PI/2 BPSK	4.5	6	4	4	4	4	10.5	4
	QPSK	4.5	6	4	4	4	4	10.5	4
	16 QAM	4.5	6	5	4	5	4	11	4
	64 QAM	4.5	6	5	4	5	4	11	4
	256 QAM		6					11	
CP-OFDM	QPSK	5.5	7	6	4	6	4	11.5	4
	16 QAM	5.5	7	6	4	6	4	11.5	4
	64 QAM	5.5	7	6	4	6	4	11.5	4
	256 QAM		7					11.5	

NOTE 1: The backoff applied is max (MPR, A-MPR) where MPR is defined in Table 6.2.2-1
NOTE 2: Outer and inner allocations are defined in clause 6.2.2

6.2.3.17 A-MPR for NS_46

Table 6.2.3.17-1: A-MPR regions for NS_46

Channel Bandwidth, MHz	Carrier Center Frequency, F _c , MHz	Regions		A-MPR
		RB _{end} *12*SCS MHz	L _{CRB} *12*SCS MHz	
25 MHz	$2534.5 \leq F_c \leq 2557.5$		Note 1	A3
30 MHz	$2515 \leq F_c \leq 2555$	$\geq 0, <1.44$	>0	A4
		$\geq 1.44, <13.5$	$>\max(0, 12*SCS*RB_{end} - 1.8)$	A5
		$\geq 13.5, <19.8$	>11.52	A6
		$\geq 19.8, <25.92$	>6.3	A7
		≥ 25.92	>0	A8
40 MHz	$2520 \leq F_c \leq 2550$	$\geq 0, <4.14$	>0	A4
		$\geq 4.14, <18$	$>\max(0, 12*SCS*RB_{end} - 4.5)$	A5
		$\geq 18, <25.74$	>13.5	A6
		$\geq 25.74, <32.4$	>12.6	A7
50 MHz	$2525 \leq F_c \leq 2545$	$\geq 0, <9$	>0	A4
		$\geq 9, <21.6$	$>\max(0, 12*SCS*RB_{end} - 7.2)$	A5
		$\geq 21.6, <31.5$	>18	A6
		$\geq 31.5, <39.6$	>16.2	A7
		≥ 39.6	>0	A8

NOTE 1: > 9.72 MHz for DFT-s-OFDM, > 16.02 MHz for CP-OFDM.

Table 6.2.3.17-2: A-MPR for NS_46

Modulation/Waveform	A3	A4	A5	A6	A7	A8
	Outer	Outer/Inner	Outer/Inner	Outer/Inner	Outer/Inner	Outer/Inner

DFT-s-OFDM	PI/2 BPSK	4.5	5	2	3.5	6	10
	QPSK	4.5	5	2	3.5	6	10
	16 QAM	4.5	5	2	3.5	6	10
	64 QAM	4.5	5		3.5	6	10
CP-OFDM	256 QAM					6	10
	QPSK	6	5	3.5	5.5	7	11
	16 QAM	6	5	3.5	5.5	7	11
	64 QAM	6	5	3.5	5.5	7	11
	256 QAM	6				7	11

6.2.3.18 A-MPR for NS_47

Table 6.2.3.18-1: A-MPR regions and types for NS_47 (Power Class 2 and 3)

Channel Bandwidth, (MHz)	Carrier Centre Frequency, Fc, (MHz)	RBstart*12*SCS (MHz)	LCRB*12*SCS (MHz)	A-MPR
30MHz	Fc=2560-2560.020	≤5.04	≤1.44	A1
		>5.04, ≤9.6	≤1.44	A2
		>24.48	≤1.44	A3
		≤9.6	>21	A2
			>14.4, <21	A4
		≤6.12	>10, ≤14.4	A4
>1.44, <10	A2			

NOTE: The A-MPR values are listed in Table 6.2.3.18-2.

Table 6.2.3.18-2: A-MPR for modulation and waveform type (Power Class 2 and 3)

Modulation/Waveform	A1(dB)		A2(dB)		A3(dB)		A4(dB)	
	PC3	PC2	PC3	PC2	PC3	PC2	PC3	PC2
	Outer/Inner	Outer/Inner	Outer/Inner	Outer/Inner	Outer/Inner	Outer/Inner	Outer/Inner	Outer/Inner
DFT-s-OFDM PI/2 BPSK	≤ 7	≤ 10	≤ 5.5	≤ 8.5	≤ 2	≤ 5	≤ 3	≤ 6
DFT-s-OFDM QPSK	≤ 7	≤ 10	≤ 5.5	≤ 8.5	≤ 2	≤ 5	≤ 3	≤ 6
DFT-s-OFDM 16 QAM	≤ 7	≤ 10	≤ 5.5	≤ 8.5		≤ 5	≤ 3	≤ 6
DFT-s-OFDM 64 QAM	≤ 7	≤ 10	≤ 6	≤ 8.5		≤ 5	≤ 3	≤ 6
DFT-s-OFDM 256 QAM	≤ 7	≤ 10	≤ 6	≤ 8.5		≤ 5		≤ 6
CP-OFDM QPSK	≤ 7	≤ 10	≤ 7	≤ 10		≤ 5	≤ 4	≤ 7
CP-OFDM 16 QAM	≤ 7	≤ 10	≤ 7	≤ 10		≤ 5	≤ 4	≤ 7
CP-OFDM 64 QAM	≤ 7	≤ 10	≤ 7	≤ 10		≤ 5		≤ 7
CP-OFDM 256 QAM	≤ 7	≤ 10	≤ 7	≤ 10				≤ 7

Table 6.2.3.18-3: A-MPR regions and types for NS_47 (Power Class 1.5)

Channel Bandwidth, (MHz)	Carrier Centre Frequency, Fc, (MHz)	RBstart*12*SCS (MHz)	LCRB*12*SCS (MHz)	A-MPR
30MHz	Fc=2560-2560.020	≤5.04	≤1.44	A1
		>5.04, ≤9.6	≤1.44	A2
		>24.48	≤1.44	A3
		≤9.6	>21	A2
			>14.4, <21	A4
		>6.12, ≤7.92	>10, ≤14.4	A5
≤6.12	>10, ≤14.4	A4		
	>1.44, <10	A2		

NOTE: The A-MPR values are listed in Table 6.2.3.18-4.

Table 6.2.3.18-4: A-MPR for NS_47 (Power Class 1.5)

Modulation/Waveform		A1(dB)	A2(dB)	A3(dB)	A4(dB)	A5(dB)
		Outer/Inner	Outer/Inner	Outer/Inner	Outer/Inner	Outer/Inner
DFT-s-OFDM	PI/2 BPSK	≤ 13	≤ 11	≤ 8	≤ 8.5	≤ 3
	QPSK	≤ 13	≤ 11	≤ 8	≤ 8.5	≤ 3
	16 QAM	≤ 13	≤ 11	≤ 8	≤ 8.5	≤ 3
	64 QAM	≤ 13	≤ 11	≤ 8	≤ 8.5	
	256 QAM	≤ 13	≤ 11	≤ 8	≤ 8.5	
CP-OFDM	QPSK	≤ 13	≤ 12.5	≤ 8	≤ 9.5	≤ 4
	16 QAM	≤ 13	≤ 12.5	≤ 8	≤ 9.5	≤ 4
	64 QAM	≤ 13	≤ 12.5	≤ 8	≤ 9.5	
	256 QAM	≤ 13	≤ 12.5	≤ 8	≤ 9.5	

NOTE 1: PC1.5 assumes dual Tx.

6.2.3.19 A-MPR for NS_50

Table 6.2.3.19-1: A-MPR regions for NS_50

Channel Bandwidth (MHz)	RB _{start} *12*SCS (MHz)	L _{CRB} *12*SCS (MHz)	A-MPR
25 MHz	≤ L _{CRB} *12*SCS - 5	> 5	A7
	≤ 6.48	≤ 1.44	A8
		≤ 3.6	A9
30 MHz	≤ L _{CRB} *12*SCS - 5	> 5	A7
	≤ 8.64	≤ 1.44	A8
		≤ 3.6	A9
40 MHz	≤ 4.32	> 0	A1
	> 4.32, ≤ 10.44	≤ 10.8	A3
	> 4.32, ≤ 18	> 10.8	A2
	> 18, ≤ 31.68	> max(31.68 - RB _{start} *12*SCS, 0)	A6
	> 31.68	> 0	A5

NOTE 1: The A-MPR values are specified in Table 6.2.3.19-2.

Table 6.2.3.19-2: A-MPR for NS_50

Modulation/Waveform		A1 (dB)	A2 (dB)	A3 (dB)	A5 (dB)	A6 (dB)	A7 (dB)	A8 (dB)	A9 (dB)
		Outer/Inner	Outer/Inner	Outer/Inner	Outer/Inner	Outer/Inner	Outer/Inner	Outer/Inner	Inner
DFT-s-OFDM	Pi/2 BPSK	≤ 11	≤ 7	≤ 3	≤ 5	≤ 2	≤ 4	≤ 2	
	QPSK	≤ 11	≤ 7	≤ 3	≤ 5	≤ 2	≤ 5	≤ 2	
	16 QAM	≤ 11	≤ 7	≤ 3	≤ 5	≤ 2	≤ 5	≤ 2.5	
	64 QAM	≤ 11	≤ 7	≤ 3	≤ 5		≤ 5		
	256 QAM	≤ 11	≤ 7		≤ 5		≤ 5		
CP-OFDM	QPSK	≤ 12	≤ 8	≤ 4.5	≤ 5	≤ 3.5	≤ 6.5		≤ 3.0
	16 QAM	≤ 12	≤ 8	≤ 4.5	≤ 5	≤ 3.5	≤ 6.5		≤ 3.0
	64 QAM	≤ 12	≤ 8	≤ 4.5	≤ 5		≤ 6.5		
	256 QAM	≤ 12	≤ 8				≤ 6.5		

6.2.3.20 A-MPR for NS_44

Table 6.2.3.20-1: A-MPR regions for NS_44

Channel Bandwidth, MHz	Carrier Center Frequency, F _c , MHz	Regions		A-MPR
		RB _{end} *12*SCS MHz	L _{CRB} *12*SCS MHz	

25 MHz	$2582.5 \leq F_c \leq 2602.5$	<18.0	$>\max(0, 12 \cdot \text{SCS} \cdot \text{RB}_{\text{end}} - 3.6)$	A3
		≥ 18.0	<7.2	A3
		≥ 18.0	≥ 7.2	A6
30 MHz	$2585 \leq F_c \leq 2600$	<21.6	$>\max(0, 12 \cdot \text{SCS} \cdot \text{RB}_{\text{end}} - 3.6)$	A3
		≥ 21.6	<12.6	A3
		≥ 21.6	≥ 12.6	A6
40 MHz	$2590 \leq F_c \leq 2595$	$\geq 0, <2.88$	>0	A1
		$\geq 2.88, <14.4$	$>\max(0, 12 \cdot \text{SCS} \cdot \text{RB}_{\text{end}} - 3.6)$	A2
		$\geq 14.4, <23.4$	>10.8	A3
		$\geq 23.4, <32.4$	>16.2	A4
		≥ 32.4	>0	A5

Table 6.2.3.20-2: A-MPR for NS_44

Modulation/Waveform		A1	A2	A3	A4	A5	A6
		Outer/Inner	Outer/Inner	Outer/Inner	Outer/Inner	Outer/Inner	Outer/Inner
DFT-s-OFDM	PI/2 BPSK	5	2	3	7	12	4
	QPSK	5	2	3	7	12	4
	16 QAM	5	2	3	7	12	4
	64 QAM	5		3	7	12	4
	256 QAM	5			7	12	
CP-OFDM	QPSK	5	4	5	8	12	6
	16 QAM	5	4	5	8	12	6
	64 QAM	5	4	5	8	12	6
	256 QAM				8	12	

6.2.3.21 A-MPR for NS_12

Table 6.2.3.21-1: A-MPR regions for NS_12

Channel BW	$\text{RB}_{\text{Start}} \cdot 12 \cdot \text{SCS}$ (MHz)	$\text{LCRB} \cdot 12 \cdot \text{SCS}$ (MHz)	A-MPR
5MHz	≤ 1.8	>0	A1
10MHz	≤ 3.6	>0	A1

Table 6.2.3.21-2: A-MPR for NS_12

Modulation/Waveform	A1
	Outer/Inner
DFT-s-OFDM PI/2 BPSK	≤ 5
DFT-s-OFDM QPSK	≤ 5
DFT-s-OFDM 16 QAM	≤ 5.5
DFT-s-OFDM 64 QAM	≤ 5.5
DFT-s-OFDM 256 QAM	≤ 9.5
CP-OFDM QPSK	≤ 7
CP-OFDM 16 QAM	≤ 7
CP-OFDM 64 QAM	≤ 7
CP-OFDM 256 QAM	≤ 9.5

6.2.3.22 A-MPR for NS_13

Table 6.2.3.22-1: A-MPR regions for NS_13

Channel BW	Carrier Frequency, F_c , MHz	$\text{RB}_{\text{Start}} \cdot 12 \cdot \text{SCS}$ (MHz)	$\text{LCRB} \cdot 12 \cdot \text{SCS}$ (MHz)	A-MPR
5MHz	$819.5 \leq F_c < 821.5$	≤ 1.44	<1.08	A1
		≤ 1.44	≥ 1.08	A2
5MHz	$F_c \geq 821.5$	≤ 0.54	<1.08	A1

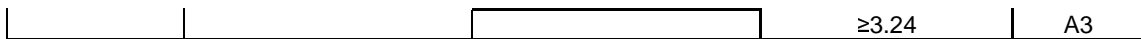

Table 6.2.3.22-2: A-MPR for NS_13

Modulation/Waveform	A1	A2	A3
	Outer/Inner	Outer/Inner	Outer
DFT-s-OFDM PI/2 BPSK	≤ 3.5	≤ 4.5	≤ 3
DFT-s-OFDM QPSK	≤ 3.5	≤ 4.5	≤ 3
DFT-s-OFDM 16 QAM	≤ 3.5	≤ 5	≤ 3
DFT-s-OFDM 64 QAM	≤ 4.5	≤ 5	≤ 3
DFT-s-OFDM 256 QAM	≤ 8	≤ 6	
CP-OFDM QPSK	≤ 5	≤ 6.5	≤ 4.5
CP-OFDM 16 QAM	≤ 5	≤ 6.5	≤ 4.5
CP-OFDM 64 QAM	≤ 6	≤ 6.5	≤ 4.5
CP-OFDM 256 QAM	≤ 8	≤ 8	

6.2.3.23 A-MPR for NS_14

Table 6.2.3.23-1: A-MPR regions for NS_14

Channel BW	RB _{Start} *12*SCS (MHz)	L _{CRB} *12*SCS (MHz)	A-MPR
10MHz	≤0.18	<1.08	A1
	≥0	≥9	A2
15MHz	≤1.8	<1.8	A1
	≥0	≥9	A2
20MHz	≤3.42	<1.8	A3
	≥0	≥9	A2

Table 6.2.3.23-2: A-MPR for NS_14

Modulation/Waveform	A1	A2	A3
	Outer/Inner	Outer	Outer/Inner
DFT-s-OFDM PI/2 BPSK	≤ 3	≤ 2	≤ 3
DFT-s-OFDM QPSK	≤ 3	≤ 2	≤ 3
DFT-s-OFDM 16 QAM	≤ 3	≤ 2	≤ 3
DFT-s-OFDM 64 QAM	≤ 3		≤ 3
DFT-s-OFDM 256 QAM			≤ 8
CP-OFDM QPSK	≤ 5	≤ 4	≤ 5
CP-OFDM 16 QAM	≤ 5	≤ 4	≤ 5
CP-OFDM 64 QAM	≤ 6		≤ 6
CP-OFDM 256 QAM	≤ 8		≤ 8

6.2.3.24 A-MPR for NS_15

Table 6.2.3.24-1: A-MPR regions for NS_15

Channel BW	Carrier Frequency, F _c , MHz	RB _{end} *12*SCS (MHz)	L _{CRB} *12*SCS (MHz)	A-MPR
5MHz	840.5 < F _c ≤ 846.5	≥3.24	>0	A1
		<3.24, ≥2.52	≥1.44	A2
		<0.9	≤0.36	A3
10MHz	840 < F _c ≤ 844	≥5.76	>1.08	A1
		≥5.76	≤1.08	A4
		<5.76, ≥4.14	≥2.7	A2
	835 < F _c ≤ 840	<2.52	≤0.36	A3
		≥7.2	>0	A1
		<7.2, ≥5.22	≥4.32	A2
15MHz	837.5 < F _c ≤ 841.5	<1.08	≤0.36	A3
		≥9.36	>1.08	A1
		≥9.36	≤1.08	A4

	831.5 < Fc ≤ 837.5	<9.36, ≥4.68	≥3.6	A2
		<3.96	≤0.36	A3
		≥10.8	>1.08	A1
		≥10.8	≤1.08	A4
		<10.8, ≥6.48	≥3.6	A2
	Fc ≤ 831.5	<2.7	≤0.36	A3
		≥13.14	>0	A1
		<13.14, ≥7.92	≥3.6	A2
		<0.72	≤0.36	A3
20MHz	835 < Fc ≤ 839	≥12.24	>1.08	A1
		≥12.24	≤1.08	A4
		<12.24, ≥8.46	≥5.4	A2
		<5.58	≤0.36	A3
	Fc ≤ 835	≥13.68	>1.08	A1
		≥13.68	≤1.08	A4
		<13.68, ≥8.46	≥5.4	A2
		<4.32	≤0.36	A3

Table 6.2.3.24-2: A-MPR for NS_15

Modulation/Waveform	A1	A2	A3	A4
	Outer/Inner	Outer/Inner	Outer/Inner	Outer/Inner
DFT-s-OFDM Pi/2 BPSK	≤ 9	≤ 5	≤ 4	≤ 9
DFT-s-OFDM QPSK	≤ 9	≤ 5	≤ 4	≤ 9
DFT-s-OFDM 16 QAM	≤ 9	≤ 5	≤ 4	≤ 9
DFT-s-OFDM 64 QAM	≤ 9	≤ 5	≤ 4	≤ 9
DFT-s-OFDM 256 QAM	≤ 9	≤ 5	≤ 9	≤ 13.5
CP-OFDM QPSK	≤ 10.5	≤ 6.5	≤ 4	≤ 10.5
CP-OFDM 16 QAM	≤ 10.5	≤ 6.5	≤ 4	≤ 10.5
CP-OFDM 64 QAM	≤ 10.5	≤ 6.5	≤ 4	≤ 10.5
CP-OFDM 256 QAM	≤ 10.5	≤ 6.5	≤ 9	≤ 13.5

6.2.3.25 A-MPR for NS_45

Table 6.2.3.25-1: A-MPR for NS_45

Modulation/Waveform		Outer
DFT-s-OFDM	Pi/2 BPSK	≤ 1.5
	QPSK	≤ 2
	16 QAM	≤ 2.5
	64 QAM	≤ 3

6.2.3.26 A-MPR for NS_48

Table 6.2.3.26-1: A-MPR regions for NS_48

Channel Bandwidth, MHz	Carrier Center Frequency, Fc, MHz	Regions		A-MPR
		RB _{end} *12*SCS MHz	L _{CRB} *12*SCS MHz	
25 MHz	1932.5 ≤ Fc ≤ 1967.5	≥0	≥9.72	A3
		≥18.72	<1.08	A3
30 MHz	1935 ≤ Fc ≤ 1965	≥0	≥13.5	A3
		≥21.6	<1.08	A5
40 MHz	1940 ≤ Fc ≤ 1960	≥0, <2.88	≥0	A2
		≥2.88, <17.1	≥max (0, 12*SCS*RB _{end} - 3.6)	A3
		≥17.1, <27.36	≥13.5	A4
		≥27.36, <34.56	≥13.5	A2
		≥27.36, <34.56	<1.08	A3

50 MHz	$1945 \leq F_c \leq 1955$	≥ 34.56	≥ 0	A1
		$\geq 0, < 6.12$	> 0	A2
		$\geq 6.12, < 20.7$	$\geq \max(0, 12 \cdot \text{SCS} \cdot \text{RB}_{\text{end}} - 3.6)$	A4
		$\geq 20.7, < 41.04$	≥ 17.1	A2
		$\geq 33.84, < 41.04$	< 1.08	A5
		≥ 41.04	> 0	A1

Table 6.2.3.26-2: A-MPR for NS_48

Modulation/Waveform		A1	A2	A3	A4	A5
		Outer/Inner	Outer/Inner	Outer/Inner	Outer/Inner	Outer/Inner
DFT-s-OFDM	PI/2 BPSK	≤ 10	≤ 6	≤ 3	≤ 4	≤ 5
	QPSK	≤ 10	≤ 6	≤ 3	≤ 4	≤ 5
	16 QAM	≤ 10	≤ 6	≤ 3	≤ 4	≤ 5
	64 QAM	≤ 10	≤ 6	≤ 3	≤ 4	≤ 5
	256 QAM	≤ 10	≤ 6	≤ 3	≤ 4	≤ 5
CP-OFDM	QPSK	≤ 11	≤ 7	≤ 4.5	≤ 5.5	≤ 5
	16 QAM	≤ 11	≤ 7	≤ 4.5	≤ 5.5	≤ 5
	64 QAM	≤ 11	≤ 7	≤ 4.5	≤ 5.5	≤ 5
	256 QAM	≤ 11	≤ 7	≤ 4.5	≤ 5.5	≤ 5

6.2.3.27 A-MPR for NS_49

Table 6.2.3.27-1: A-MPR regions for NS_49

Channel Bandwidth, MHz	Carrier Center Frequency, F_c , MHz	Regions		A-MPR
		$\text{RB}_{\text{end}} \cdot 12 \cdot \text{SCS}$ MHz	$L_{\text{CRB}} \cdot 12 \cdot \text{SCS}$ MHz	
25 MHz	$1932.5 \leq F_c \leq 1967.5$	≥ 0	≥ 9.72	A3
		≥ 18.72	< 1.08	A3
		≥ 3.96	< 1.08	A3
30 MHz	$1935 \leq F_c \leq 1965$	$\geq 0, < 3.6$	≥ 0	A1
		$\geq 3.6, < 6.48$	≥ 0	A5
		$\geq 6.48, < 14.4$	$\geq \max(0, 12 \cdot \text{SCS} \cdot \text{RB}_{\text{end}} - 3.6)$	A3
		$\geq 14.4, < 21.6$	≥ 10.8	A4
		≥ 21.6	≥ 10.8	A2
40 MHz	$1940 \leq F_c \leq 1960$	≥ 21.6		A5
		$\geq 0, < 7.2$	≥ 0	A1
		$\geq 7.2, < 10.44$	< 1.08	A5
		$\geq 7.2, < 18$	$\geq \max(0, 12 \cdot \text{SCS} \cdot \text{RB}_{\text{end}} - 3.6)$	A4
		$\geq 18, < 34.56$	$\geq 14.4, < 28.8$	A2
		$\geq 27.36, < 34.56$	< 1.08	A5
50 MHz	$1945 \leq F_c \leq 1955$	< 34.56	≥ 28.8	A1
		≥ 34.56	≥ 0	A1
		$\geq 7.74, < 14.4$	$< \min[1.08, \max(0, 12 \cdot \text{SCS} \cdot \text{RB}_{\text{end}} - 7.74)]$	A5
		$\geq 36, < 39.6$	< 1.08	A5
		< 39.6	$\geq 18, < \max(0, 12 \cdot \text{SCS} \cdot \text{RB}_{\text{end}} - 7.74)$	A2
		< 39.6	$\geq \max(0, 12 \cdot \text{SCS} \cdot \text{RB}_{\text{end}} - 7.74)$	A1
		≥ 39.6	> 0	A1

Table 6.2.3.27-2: A-MPR for NS_49

Modulation/Waveform		A1	A2	A3	A4	A5
		Outer/Inner	Outer/Inner	Outer/Inner	Outer/Inner	Outer/Inner
	PI/2 BPSK	≤ 10	≤ 6	≤ 3	≤ 4	≤ 5

DFT-s-OFDM	QPSK	≤10	≤6	≤3	≤4	≤5
	16 QAM	≤10	≤6	≤3	≤4	≤5
	64 QAM	≤10	≤6	≤3	≤4	≤5
	256 QAM	≤10	≤6	≤3	≤4	≤5
CP-OFDM	QPSK	≤11	≤7	≤4.5	≤5.5	≤5
	16 QAM	≤11	≤7	≤4.5	≤5.5	≤5
	64 QAM	≤11	≤7	≤4.5	≤5.5	≤5
	256 QAM	≤11	≤7	≤4.5	≤5.5	≤5

6.2.3.28 A-MPR for NS_51

Table 6.2.3.28-1: A-MPR regions for NS_51

Channel Bandwidth, MHz	Carrier Center Frequency, F _c , MHz	Regions		A-MPR
		RB _{end} *12*SCS MHz	L _{CRB} *12*SCS MHz	
50 MHz	F _c ≤ 1945	≤ 4.5	> 0	A7
		>4.5, < 32.4	≥ max(0, 12*SCS*RB _{end} - 14.4)	A4
		< 32.4	< max(0, 12*SCS*RB _{end} - 14.4)	A5
		≥ 32.4	> 0	A6
50 MHz	1945 < F _c ≤ 1980	< 27	≥ max(0, 12*SCS*RB _{end} - 14.4)	A1
		< 27	< max(0, 12*SCS*RB _{end} - 14.4)	A2
		≥ 27	> 0	A3

Table 6.2.3.28-2: A-MPR for NS_51

Modulation/Waveform		A1	A2	A3	A4	A5	A6	A7
		Outer/Inner	Outer/Inner	Outer/Inner	Outer/Inner	Outer/Inner	Outer/Inner	Outer/Inner
DFT-s-OFDM	PI/2 BPSK	17	12.5	22	7	4.5	16	14
	QPSK	17	12.5	22	7	4.5	16	14
	16 QAM	17	12.5	22	7	4.5	16	14
	64 QAM	17	12.5	22	7	4.5	16	14
	256 QAM	17	12.5	22	7	4.5	16	14
CP-OFDM	QPSK	17	12.5	22	8.5	4.5	17	14
	16 QAM	17	12.5	22	8.5	4.5	17	14
	64 QAM	17	12.5	22	8.5	4.5	17	14
	256 QAM	17	12.5	22	8.5	4.5	17	14

6.2.4 Configured transmitted power

The UE is allowed to set its configured maximum output power P_{C_{MAX},f,c} for carrier f of serving cell c in each slot. The configured maximum output power P_{C_{MAX},f,c} is set within the following bounds:

$$P_{C_{MAX},L,f,c} \leq P_{C_{MAX},f,c} \leq P_{C_{MAX},H,f,c} \text{ with}$$

$$P_{C_{MAX},L,f,c} = \text{MIN} \{ P_{EMAX,c} - \Delta T_{C,c}, (P_{PowerClass} - \Delta P_{PowerClass}) - \text{MAX}(\text{MAX}(MPR_c + \Delta MPR_c, A-MPR_c) + \Delta T_{IB,c} + \Delta T_{C,c} + \Delta T_{RxsRS}, P-MPR_c) \}$$

$$P_{C_{MAX},H,f,c} = \text{MIN} \{ P_{EMAX,c}, P_{PowerClass} - \Delta P_{PowerClass} \}$$

where

P_{EMAX,c} is the value given by either the *p-Max* IE or the field *additionalPmax* of the *NR-NS-PmaxList* IE, whichever is applicable according to TS 38.331[7];

P_{PowerClass} is the maximum UE power specified in Table 6.2.1-1 without taking into account the tolerance specified in the Table 6.2.1-1;

When the IE *powerBoostPi2BPSK* is set to 1, P_{EMAX,c} is increased by +3 dB for a power class 3 UE operating in TDD bands n40, n41, n77, n78, and n79 with PI/2 BPSK modulation and UE indicates support for UE capability

powerBoosting-pi2BPSK and 40% or less symbols in certain evaluation period are used for UL transmission when $P_{EMAX,c} \geq 20$ dBm (The exact evaluation period is no less than one radio frame).

When the IE *powerBoostPi2BPSK* is set to 1, $\Delta P_{PowerClass} = -3$ dB for a power class 3 UE operating in TDD bands n40, n41, n77, n78, and n79 with Pi/2 BPSK modulation and UE indicates support for UE capability *powerBoosting-pi2BPSK* and 40% or less slots in radio frame are used for UL transmission.

$\Delta P_{PowerClass} = 3$ dB for a power class 2 UE or 6 dB for a power class 1.5 UE when P-max of 23 dBm or lower is indicated; or when the field of UE capability *maxUplinkDutyCycle-PC2-FR1* is absent and the percentage of uplink symbols transmitted in a certain evaluation period is larger than 50%; or when the field of UE capability *maxUplinkDutyCycle-PC2-FR1* is not absent and the percentage of uplink symbols transmitted in a certain evaluation period is larger than *maxUplinkDutyCycle-PC2-FR1* as defined in TS 38.331 (The exact evaluation period is no less than one radio frame); 3 dB for a power class 1.5 UE when P-max of between 23 dBm and 26 dB is indicated; or when the field of UE capability *maxUplinkDutyCycle-PC2-FR1* is absent and the percentage of uplink symbols transmitted in a certain evaluation period is between 25% and 50%; or when the field of UE capability *maxUplinkDutyCycle-PC2-FR1* is not absent and the percentage of uplink symbols transmitted in a certain evaluation period is between *maxUplinkDutyCycle-PC2-FR1* and *maxUplinkDutyCycle-PC2-FR1/2* as defined in TS 38.331 (The exact evaluation period is no less than one radio frame); otherwise $\Delta P_{PowerClass} = 0$ dB;

$\Delta T_{IB,c}$ is the additional tolerance for serving cell c as specified in clause 6.2A.4.2 for NR CA, clause 6.2C.2 for SUL, or TS 38.101-3 clause 6.2B.4.2 for EN-DC; $\Delta T_{IB,c} = 0$ dB otherwise; In case the UE supports more than one of band combinations for V2X operating bands for concurrent operation, CA, SUL or DC, and an operating band belongs to more than one band combinations then

- a) When the operating band frequency range is ≤ 1 GHz, the applicable additional $\Delta T_{IB,c}$ shall be the average value for all band combinations defined in clause 6.2A.4.2, 6.2C.2 in this specification and 6.2B.4.2 in TS 38.101-3 [3], truncated to one decimal place that apply for that operating band among the supported band combinations. In case there is a harmonic relation between low band UL and high band DL, then the maximum $\Delta T_{IB,c}$ among the different supported band combinations involving such band shall be applied
- b) When the operating band frequency range is > 1 GHz, the applicable additional $\Delta T_{IB,c}$ shall be the maximum value for all band combinations defined in clause 6.2A.4.2, 6.2C.2 in this specification and 6.2B.4.2 in TS 38.101-3 [3] for the applicable operating bands.

$\Delta T_{C,c} = 1.5$ dB when NOTE 3 in Table 6.2.1-1 in 38.101-1 applies for a serving cell c, otherwise $\Delta T_{C,c} = 0$ dB ;

MPR_c and $A-MPR_c$ for serving cell c are specified in clause 6.2.2 and clause 6.2.3, respectively;

ΔMPR_c for serving cell c is specified in clause 6.2.2.

ΔT_{RxSRS} is applied during SRS transmission occasions with *usage* in *SRS-ResourceSet* set as 'antennaSwitching' when

when

- a) UE transmits SRS on the second SRS resource in every configured SRS resource set when the *SRS-TxSwitch* capability is indicated as 't1r2'
- b) UE transmits SRS on the second, third and fourth SRS resources of the total 4 SRS resources from all configured SRS resource set(s) consisting of one SRS port when the *SRS-TxSwitch* capability is indicated as 't1r4' or 't1r4-t2r4' but in 't1r4' mode.
- c) UE transmits SRS from the SRS port pair on the second SRS resource in every configured SRS resource set consisting of two SRS ports when the *SRS-TxSwitch* capability is indicated as 't2r4' or 't1r4-t2r4' but in 't2r4' mode, or
- d) UE transmits SRS to a DL-only carrier

The value of ΔT_{RxSRS} is 4.5dB for bands whose F_{UL_high} is higher than the F_{UL_low} of n79 and 3 dB for bands whose F_{UL_high} is lower than the F_{UL_low} of n79 when the device is power class 3 or power class 5 in the band, or when the device is power class 2 in the band and $\Delta P_{PowerClass} = 3$ dB. The value of ΔT_{RxSRS} is 7.5dB for bands whose F_{UL_high} is higher than the F_{UL_low} of n79 and 6 dB for bands whose F_{UL_high} is lower than the F_{UL_low} of n79 when the device is power class 2 in the band and $\Delta P_{PowerClass} = 0$ dB.

For other SRS transmissions ΔT_{RxSRS} is zero;

P-MPR_c is the power management maximum power reduction for

- a) ensuring compliance with applicable electromagnetic energy absorption requirements and addressing unwanted emissions / self desense requirements in case of simultaneous transmissions on multiple RAT(s) for scenarios not in scope of 3GPP RAN specifications;
- b) ensuring compliance with applicable electromagnetic energy absorption requirements in case of proximity detection is used to address such requirements that require a lower maximum output power.

The UE shall apply P-MPR_c for serving cell c only for the above cases. For UE conducted conformance testing P-MPR_c shall be 0 dB

NOTE 1: P-MPR_c was introduced in the P_{CMAX,f,c} equation such that the UE can report to the gNB the available maximum output transmit power. This information can be used by the gNB for scheduling decisions.

NOTE 2: P-MPR_c may impact the maximum uplink performance for the selected UL transmission path.

T_{REF} and T_{eval} are specified in Table 6.2.4-1. For each T_{REF}, the P_{CMAX,L,c} for serving cell c are evaluated per T_{eval} and given by the minimum value taken over the transmission(s) within the T_{eval}; the minimum P_{CMAX,L,f,c} over one or more T_{eval} is then applied for the entire T_{REF}.

Table 6.2.4-1: Evaluation and reference periods for P_{cm}

T _{REF}	T _{eval}	T _{eval} with frequency hopping
Physical channel length	Physical channel length	Min(T _{no_hopping} , Physical Channel Length)

The measured configured maximum output power P_{UMAX,f,c} shall be within the following bounds:

$$P_{CMAX,L,f,c} - \text{MAX}\{T_{L,c}, T(P_{CMAX,L,f,c})\} \leq P_{UMAX,f,c} \leq P_{CMAX,H,f,c} + T(P_{CMAX,H,f,c}).$$

where the tolerance T(P_{CMAX,f,c}) for applicable values of P_{CMAX,f,c} is specified in Table 6.2.4-1. The tolerance T_{L,c} is the absolute value of the lower tolerance for the applicable operating band as specified in Table 6.2.1-1.

Table 6.2.4-1: P_{CMAX} tolerance

P _{CMAX,f,c} (dBm)	Tolerance T(P _{CMAX,f,c}) (dB)
23 < P _{CMAX,c} ≤ 33	2.0
21 ≤ P _{CMAX,c} ≤ 23	2.0
20 ≤ P _{CMAX,c} < 21	2.5
19 ≤ P _{CMAX,c} < 20	3.5
18 ≤ P _{CMAX,c} < 19	4.0
13 ≤ P _{CMAX,c} < 18	5.0
8 ≤ P _{CMAX,c} < 13	6.0
-40 ≤ P _{CMAX,c} < 8	7.0

6.2A Transmitter power for CA

6.2A.1 UE maximum output power for CA

6.2A.1.1 UE maximum output power for Intra-band contiguous CA

For uplink intra-band contiguous carrier aggregation, the maximum output power is specified in Table 6.2A.1.1-1. For downlink intra-band contiguous carrier aggregation with a single uplink component carrier configured in the NR band, the maximum output power is specified in Table 6.2.1-1.

Table 6.2A.1.1-1: UE Power Class for intra-band contiguous CA

NR CA Configuration	Class 1 (dBm)	Tolerance (dB)	Class 2 (dBm)	Tolerance (dB)	Class 3 (dBm)	Tolerance (dB)	Class 5 (dBm)	Tolerance (dB)
CA_n7B					23	+2/-2 ¹		
CA_n41B					23	+2/-2 ¹		
CA_n41C					23	+2/-2 ¹		
CA_n48B					23	+2/-3		
CA_n77C					23	+2/-3		
CA_n78C					23	+2/-3		
CA_n79C					23	+2/-3		

NOTE 1: If all transmitted resource blocks over all component carriers are confined within F_{UL_low} and $F_{UL_low} + 4$ MHz or/and $F_{UL_high} - 4$ MHz and F_{UL_high} , the maximum output power requirement is relaxed by reducing the lower tolerance limit by 1.5 dB

NOTE 2: $P_{PowerClass}$ is the maximum UE power specified without taking into account the tolerance

NOTE 3: For intra-band contiguous carrier aggregation the maximum power requirement shall apply to the total transmitted power over all component carriers (per UE).

6.2A.1.2 UE maximum output power for Intra-band non-contiguous CA

For intra-band non-contiguous carrier aggregation with one uplink carrier on the PCC, the requirements in clause 6.2.1 apply. For intra-band non-contiguous carrier aggregation with two uplink carriers the maximum output power is specified in Table 6.2A.1.2-1.

Table 6.2A.1.2-1: UE Power Class for intraband non-contiguous CA

NR CA Configuration	Class 1 (dBm)	Tolerance (dB)	Class 2 (dBm)	Tolerance (dB)	Class 3 (dBm)	Tolerance (dB)	Class 5 (dBm)	Tolerance (dB)
CA_n41(2A)					23	+2/-3 ¹		
CA_n77(2A)					23	+2/-3		
CA_n78(2A)					23	+2/-3		

NOTE 1: For transmission bandwidths confined within F_{UL_low} and $F_{UL_low} + 4$ MHz or $F_{UL_high} - 4$ MHz and F_{UL_high} , the maximum output power requirement is relaxed by reducing the lower tolerance limit by 1.5 dB

NOTE 2: $P_{PowerClass}$ is the maximum UE power specified without taking into account the tolerance

NOTE 3: For intra-band non-contiguous carrier aggregation the maximum power requirement shall apply to the total transmitted power over all component carriers (per UE).

6.2A.1.3 UE maximum output power for Inter-band CA

For inter-band downlink carrier aggregation with one uplink carrier assigned to one NR band, the transmitter power requirements in clause 6.2 apply.

For inter-band carrier aggregation with two uplink contiguous carrier assigned to one NR band, the transmitter power requirements specified in subclause 6.2A.1.1 apply.

For inter-band uplink carrier aggregation with uplink assigned to two NR bands, UE maximum output power shall be measured over all component carriers from different bands. If each band has separate antenna connectors, maximum output power is defined as the sum of maximum output power from each UE antenna connector. The period of measurement shall be at least one sub frame (1 ms). The maximum output power is specified in Table 6.2A.1.3-1.

For PC3 inter-band carrier aggregation with one uplink component carrier assigned to one NR band in NR band n41, n77, n78, and n79, the requirements for power class 2 are not applicable and the corresponding requirements for a power class 3 UE shall apply.

Table 6.2A.1.3-1 UE Power Class for uplink inter-band CA (two bands)

Uplink CA Configuration	Class 1 (dBm)	Tolerance (dB)	Class 2 (dBm)	Tolerance (dB)	Class 3 (dBm)	Tolerance (dB)	Class 5 (dBm)	Tolerance (dB)
CA_n1A-n3A					23	+2/-3		
CA_n1A-n7A					23	+2/-3		
CA_n1A-n8A					23	+2/-3		
CA_n1A-n28A					23	+2/-3		
CA_n1A-n40A					23	+2/-3		
CA_n1A-n41A					23	+2/-3		

CA_n1A-n78A				23	+2/-3		
CA_n1A-n79A				23	+2/-3		
CA_n2A-n5A				23	+2/-3		
CA_n2A-n48A				23	+2/-3		
CA_n2A-n77A				23	+2/-3		
CA_n2A-n78A				23	+2/-3		
CA_n3A-n7A				23	+2/-3		
CA_n3A-n8A				23	+2/-3		
CA_n3A-n28A				23	+2/-3		
CA_n3-n38A				23	+2/-3		
CA_n3A-n40A				23	+2/-3		
CA_n3A-n41A				23	+2/-3		
CA_n3A-n77A				23	+2/-3		
CA_n3A-n78A				23	+2/-3		
CA_n3A-n79A				23	+2/-3		
CA_n5A-n66A				23	+2/-3		
CA_n5A-n77A				23	+2/-3		
CA_n5A-n78A				23	+2/-3		
CA_n5A-n79A				23	+2/-3		
CA_n7A-n25A				23	+2/-3		
CA_n7A-n28A				23	+2/-3		
CA_n7A-n66A				23	+2/-3		
CA_n7A-n78A				23	+2/-3		
CA_n8A-n39A				23	+2/-3		
CA_n8A-n40A				23	+2/-3		
CA_n8A-n41A				23	+2/-3		
CA_n8A-n77A				23	+2/-3		
CA_n8A-n78A				23	+2/-3		
CA_n8A-n79A				23	+2/-3		
CA_n20A-n28A				23	+2/-3		
CA_n20A-n78A				23	+2/-3		
CA_n25A-n41A				23	+2/-3		
CA_n25A-n66A				23	+2/-3		
CA_n25A-n71A				23	+2/-3		
CA_n25A-n78A				23	+2/-3		
CA_n28A-n40A				23	+2/-3		
CA_n28A-n41A				23	+2/-3		
CA_n28A-n50A				23	+2/-3		
CA_n28A-n77A				23	+2/-3		
CA_n28A-n78A				23	+2/-3		
CA_n38A-n66A				23	+2/-3		
CA_n38A-n78A				23	+2/-3		
CA_n39A-n40A				23	+2/-3		
CA_n39A-n41A				23	+2/-3		
CA_n39A-n79A				23	+2/-3		
CA_n40A-n41A				23	+2/-3		
CA_n40A-n78A				23	+2/-3		
CA_n40A-n79A				23	+2/-3		
CA_n41A-n66A				23	+2/-3		
CA_n41A-n71A				23	+2/-3		
CA_n41A-n78A				23	+2/-3		
CA_n41A-n79A				23	+2/-3		
CA_n41A-n50A				23	+2/-3		
CA_n48A-n66A				23	+2/-3		
CA_n50A-n78A				23	+2/-3		
CA_n66A-n71A				23	+2/-3		
CA_n66A-n77A				23	+2/-3		
CA_n66A-n78A				23	+2/-3		
CA_n70A-n71A				23	+2/-3		
CA_n78A-n92A				23	+2/-3		

NOTE 1: Void

NOTE 2: For an NR CA configuration with one uplink carrier assigned to one NR band, if the uplink NR band has NOTE 3 in Table 6.2.1-1, the band is allowed to reduce the lower tolerance limit by 1.5 dB when the transmission bandwidths of the band(s) is confined within F_{UL_low} and $F_{UL_low} + 4$ MHz or $F_{UL_high} - 4$ MHz and F_{UL_high} .
An uplink CA configuration in which at least one of the bands has NOTE 3 in Table 6.2.1-1 is allowed to

reduce the lower tolerance limit by 1.5 dB when the transmission bandwidths of at least one of the bands is confined within F_{UL_low} and $F_{UL_low} + 4$ MHz or $F_{UL_high} - 4$ MHz and F_{UL_high} .

NOTE 3: $P_{PowerClass}$ is the maximum UE power specified without taking into account the tolerance

NOTE 4: For inter-band carrier aggregation the maximum power requirement should apply to the total transmitted power over all component carriers (per UE).

NOTE 5: Power class 3 is the default power class unless otherwise stated

6.2A.1.4 Void

6.2A.1.5 Void

6.2A.2 UE maximum output power reduction for CA

6.2A.2.1 UE maximum output power reduction for Intra-band contiguous CA

For intra-band contiguous carrier aggregation the allowed Maximum Power Reduction (MPR) for the maximum output power in Table 6.2A.1.1-1 with contiguous RB allocation is specified in Table 6.2A.2.1-1 for UE power class 3 CA bandwidth classes B and C.

In case the modulation format or waveform type is different on different component carriers then the requirement is set by rules applied to the waveform type (DFT-s-OFDM or CP-OFDM) and modulation order used in the configuration with the largest MPR..

Unless otherwise specified, pi/2 BPSK in following MPR tables refers to both variants of pi/2 BPSK referenced in 6.2.2 tables 6.2.2-1.

Table 6.2A.2.1-1: Contiguous RB allocation for Power Class 3

Modulation		MPR for bandwidth class B(dB)		MPR for bandwidth class C(dB)	
		inner	outer	inner	outer
DFT-s-OFDM	Pi/2 BPSK	1.0	3.5	2.5	7
	QPSK	1.0	3.5	2.5	7
	16QAM	1.5	3.5	2.5	7
	64QAM	3.0	4.0	5	7
	256QAM	5.5	6.0	7	7.5
CP-OFDM	QPSK	2.0	4.0	3.5	8
	16QAM	2.5	4.0	3.5	8
	64QAM	3.5	4.0	5	8
	256QAM	6.5	6.5	7	8

For CA bandwidth class B and bandwidth class C with contiguous RB allocation, the following parameters are defined to specify valid RB allocation ranges for Inner and Outer RB allocations:

An RB allocation is contiguous if $L_{CRB1} = 0$ or $L_{CRB2} = 0$ or ($L_{CRB1} \neq 0$ and $L_{CRB2} \neq 0$ and $RB_{Start1} + L_{CRB1} = N_{RB1}$ and $RB_{Start2} = 0$), where RB_{Start1} , L_{CRB1} , and N_{RB1} are for CC1, RB_{Start2} , L_{CRB2} , and N_{RB2} are for CC2, CC1 is the component carrier with lower frequency.

In contiguous CA, a contiguous allocation is an inner allocation if

$$RB_{Start,Low} \leq RB_{Start,CA} \leq RB_{Start,High}, \text{ and } N_{RB_alloc} \leq \text{ceil}(N_{RB,agg}/2),$$

where

$$RB_{Start,Low} = \max(1, \text{floor}(N_{RB_alloc}/2))$$

$$RB_{Start,High} = N_{RB,agg} - RB_{Start,Low} - N_{RB,alloc},$$

with

$$N_{RB_alloc} = L_{CRB1} \cdot 2^{\mu_1} + L_{CRB2} \cdot 2^{\mu_2},$$

$$N_{RB,agg} = N_{RB1} \cdot 2^{\mu_1} + N_{RB2} \cdot 2^{\mu_2}.$$

$$\text{If } L_{CRB1} = 0, RB_{Start,CA} = N_{RB1} \cdot 2^{\mu_1} + RB_{Start2} \cdot 2^{\mu_2},$$

if $L_{CRB1} > 0$, $RB_{Start_CA} = RB_{Start1} \cdot 2^{\mu_1}$.

A contiguous allocation that is not an Inner contiguous allocation is an Outer contiguous allocation.

For intra-band contiguous carrier aggregation the allowed Maximum Power Reduction (MPR) for the maximum output power in Table 6.2A.1.1-1 with non-contiguous RB allocation is specified in Table 6.2A.2.1-2 for UE power class 3 CA bandwidth classes B and C.

Table 6.2A.2.1-2: non-contiguous RB allocation for Power Class 3

Modulation		MPR for bandwidth class B(dB)			MPR for bandwidth class C(dB)		
		inner	Outer1 ¹	Outer2 ²	inner	Outer1 ¹	Outer2 ²
DFT-s-OFDM	Pi/2 BPSK	2	5.5	11.5	2.5	6	13
	QPSK	2	5.5		2.5	6	
	16QAM	2.5	5.5		3	6	
	64QAM	4.5	6		5	6	
	256QAM	6	6.5		6.5	6.5	
CP-OFDM	QPSK	2.5	6.5	12	3.5	7	14
	16QAM	3	7		3.5	7	
	64QAM	5	7		5	7	
	256QAM	7.5	7.5		7.5	7.5	

NOTE 1: Outer 1 MPR for Pi/2 BPSK and QPSK is reduced by 2dB for aggregated allocation bandwidth > 10MHz
NOTE 2: Outer 2 MPR is reduced by 4.5dB for aggregated allocation bandwidth > 10MHz

For CA bandwidth classes B and C with non-contiguous RB allocation, the following parameters are defined to specify valid RB allocation ranges for Inner, Outer1 and Outer2 RB allocations:

Non-Contiguous RB allocation is defined as $RB_{Start1} + L_{CRB1} < N_{RB1}$, or $RB_{Start2} > 0$, when both uplink CCs are activated and allocated with RB(s), where RB_{Start1} , L_{CRB1} , and N_{RB1} are for CC1, RB_{Start2} , L_{CRB2} , and N_{RB2} are for CC2, CC1 is the component carrier with lower frequency.

In contiguous CA, a non-contiguous RB allocation is a non-contiguous Inner RB allocation if the following conditions are met:

$$RB_{Start,Low} \leq RB_{Start_CA} \leq RB_{Start,High} \text{ and } N_{RB_alloc} \leq \text{ceil}((BW_{Channel_CA} / 3 - BW_{gap}) / 0.18\text{MHz}),$$

where

$$N_{RB_alloc} = (N_{RB1} - RB_{Start1}) \cdot 2^{\mu_1} + (RB_{Start2} + L_{CRB2}) \cdot 2^{\mu_2}$$

$$RB_{Start_CA} = RB_{Start1} \cdot 2^{\mu_1}$$

$$RB_{Start,Low} = \max(1, \text{floor}(N_{RB_alloc} + (BW_{gap} - BW_{GB,low}) / 0.18\text{MHz}))$$

$$RB_{Start,High} = \text{floor}((BW_{Channel_CA} - 2 \cdot BW_{gap} - BW_{GB,low}) / 0.18\text{MHz} - 2 \cdot N_{RB_alloc})$$

$$BW_{GB,low} = F_{\text{offset,low}} - (N_{RB1} \cdot 12 + 1) \cdot SCS_1 / 2$$

BW_{gap} is the bandwidth of the gap between the upper edge of the Transmission Bandwidth Configuration N_{RB1} of CC1 and the lower edge of the Transmission Bandwidth Configuration N_{RB2} of CC2.

In contiguous CA, a non-contiguous RB allocation is a non-contiguous outer 1 RB allocation when it is not satisfying inner allocation conditions and when the following conditions are met:

$$RB_{Start,Low} \leq RB_{Start_CA} \leq RB_{Start,High} \text{ and } N_{RB_alloc} \leq \text{ceil}((3 \cdot BW_{Channel_CA} / 5 - BW_{gap}) / 0.18\text{MHz})$$

where

$$RB_{Start,Low} = \max(1, 2 \cdot N_{RB_alloc} - \text{floor}((BW_{Channel_CA} - 2 \cdot BW_{gap} + BW_{GB,low}) / 0.18\text{MHz})),$$

$$RB_{Start,High} = \text{floor}((2 \cdot BW_{Channel_CA} - 3 \cdot BW_{gap} - BW_{GB,low}) / 0.18\text{MHz} - 3 \cdot N_{RB_alloc})$$

N_{RB_alloc} , RB_{Start_CA} , BW_{gap} and $BW_{GB,low}$ are as defined for the Inner region.

In contiguous CA, a non-contiguous allocation is an Outer 2 allocation if it is neither a non-contiguous Inner allocation nor an Outer 1 allocation.

6.2A.2.2 UE maximum output power reduction for Intra-band non-contiguous CA

6.2A.2.2.0 General

For intra-band non-contiguous CA, the allowed Maximum Power Reduction (MPR) for the maximum output power is specified into 2 types: MPR to meet -30dBm/MHz and -13dBm/MHz. The UE determines the MPR type as follows:

If OR($L_{CRB1} = 0$, $L_{CRB2} = 0$)

MPR defined in Table 6.2.2-1 for PC3

Else If AND($F_{IM3,low_block,low} > SEM_{-13,low}$, $F_{IM3,high_block,high} < SEM_{-13,high}$)

MPR defined in Clause 6.2A.2.2.2

Else

MPR defined in Clause 6.2A.2.2.1

where

- L_{CRB1} is for CC1 which is the component carrier with lower frequency
- L_{CRB2} is for CC2 which is the component carrier with higher frequency
- $B = (L_{CRB1} * 12 * SCS_1 + L_{CRB2} * 12 * SCS_2) / 1,000$ (MHz), where SCS_1 and SCS_2 are expressed in kHz.
- $F_{IM3,high_block,high} = (2 * F_{high_alloc,high_edge}) - F_{low_alloc,low_edge}$
- $F_{IM3,low_block,low} = (2 * F_{low_alloc,low_edge}) - F_{high_alloc,high_edge}$
- F_{low_alloc,low_edge} is the lowermost frequency of the lower transmission bandwidth allocation.
- $F_{low_alloc,high_edge}$ is the uppermost frequency of the lower transmission bandwidth allocation.
- F_{high_alloc,low_edge} is the lowermost frequency of the upper transmission bandwidth allocation.
- $F_{high_alloc,high_edge}$ is the uppermost frequency of the upper transmission bandwidth allocation.
- $SEM_{-13,low}$ = Threshold frequency where lower spectral emission mask below the lower channel drops from -13 dBm / MHz to -25 dBm / MHz, as specified in Clause 6.5A.2.2.2.
- $SEM_{-13,high}$ = Threshold frequency where upper spectral emission mask above the upper channel drops from -13 dBm / MHz to -25 dBm / MHz, as specified in Clause 6.5A.2.2.2.

6.2A.2.2.1 MPR to meet -30dBm/MHz

MPR in this clause is for intra-band non-contiguous CA power class 3 for UEs indicating IE *dualPA-Architecture* supported. The allowed maximum output power reduction is defined as:

$MPR = M_A$ Where M_A is defined as follows

$M_A =$	15;	$0 \leq B < 1.08$
	14.5;	$1.08 \leq B < 2.16$
	13.5;	$2.16 \leq B < 3.24$
	12.5;	$3.24 \leq B < 5.04$
	11.5;	$5.04 \leq B < 10.08$

10.5; $10.08 \leq B < 16.38$

10; $16.38 \leq B < 21.78$

9; $21.78 \leq B$

6.2A.2.2.2 MPR to meet -13dBm/MHz

MPR in this clause is for intra-band non-contiguous CA power class 3 for UEs indicating IE *dualPA-Architecture* supported. The allowed maximum output power reduction is defined as:

$$\text{MPR} = M_A$$

Where M_A is defined as follows

$M_A = 9$; $0 \leq B < 0.54$

8 ; $0.54 \leq B < 1.08$

7 ; $1.08 \leq B < 2.16$

6.5; $2.16 \leq B < 3.24$

5.5; $3.24 \leq B < 5.4$

4 ; $5.4 \leq B$

6.2A.2.3 UE maximum output power reduction for Inter-band CA

For inter-band carrier aggregation with one uplink carrier assigned to one NR band, the requirements in subclause 6.2.2 apply.

For inter-band carrier aggregation with two uplink contiguous carrier assigned to one NR band, the maximum output power reduction requirements for intra-band contiguous carrier aggregation in subclause 6.2A.2.1 apply for that band.

For inter-band carrier aggregation with uplink assigned to two NR bands, the requirements in clause 6.2.2 apply for each uplink component carrier.

6.2A.2.4 Void

6.2A.3 UE additional maximum output power reduction for CA

6.2A.3.1.1 UE additional maximum output power reduction for Intra-band contiguous CA

Additional emission requirements can be signalled by the network. Each additional emission requirement is associated with a unique network signalling (NS) value indicated in RRC signalling by an NR frequency band number of the applicable operating band and an associated value in the field *additionalSpectrumEmission*. Throughout this specification, the notion of indication or signalling of an NS value refers to the corresponding indication of an NR frequency band number of the applicable operating band, the IE field *freqBandIndicatorNR* and an associated value of *additionalSpectrumEmission* in the relevant RRC information elements [7]. Relation between NR CA band and NR frequency band is specified in Table 5.2A.1-1.

To meet the additional requirements, additional maximum power reduction (A-MPR) is allowed for the maximum output power as specified in Table 6.2A.1.1-1. Unless stated otherwise, the total reduction to UE maximum output power is $\max(\text{MPR}, \text{A-MPR})$ where MPR is defined in clause 6.2A.2.1. In absence of modulation and waveform types the A-MPR applies to all modulation and waveform types.

Table 6.2A.3.1.1-1 specifies the additional requirements with their associated network signalling values and the allowed A-MPR and applicable CA band(s) for each CA_NS value. The CA_NS_xy value indicates the additional unwanted

emissions requirements that apply for intra-band contiguous CA bands with NS_{xy} indicated or configured in multiple uplink serving cells, except CA_NS_01 that indicates the general emission requirements for intra-band contiguous CA bands. The mapping of NR CA band numbers and values of the *additionalSpectrumEmission* to network signalling labels is specified in Table 6.2A.3.1.1-2. For any NR CA band not listed in Table 6.2A.3.1.1-2 the network signalling label CA_NS_01 applies.

Table 6.2A.3.1.1-1: Additional maximum power reduction (A-MPR)

Network signalling label	Requirements (clause)	NR CA Band	Aggregated channel bandwidth (MHz)	Resources blocks (N_{RB})	A-MPR (dB)
CA_NS_01	6.5A.2.2.1 6.5A.3.2.1	Table 5.2A.1-1	All applicable NR CA bands	All applicable NR CA configurations	N/A
CA_NS_04	6.5A.2.3.1.1 6.5A.3.3.1.1	CA_n41	Table 5.5A.1-1	6.2A.3.1.1.1	6.2A.3.1.1.1
CA_NS_27	6.5A.2.3.1.2 6.5A.3.3.1.2	CA_n48	Table 5.5A.1-1	6.2A.3.1.1.2	6.2A.3.1.1.2
CA_NS_46	6.5A.3.3.1.3	CA_n7	Table 5.5A.1-1	6.2A.3.1.1.3	6.2A.3.1.1.3
CA_NS_55	See CA_NS_01	CA_n77	Table 5.5A.1-1	6.2A.2.1	See CA_NS_01

Table 6.2A.3.1.1-2: Mapping of network signaling label

NR CA band	Value of additionalSpectrumEmission							
	0	1	2	3	4	5	6	7
CA_n41	CA_NS_01	CA_NS_04						
CA_n48	CA_NS_01	CA_NS_27						
CA_n7	CA_NS_01	CA_NS_46						
CA_n77	CA_NS_01	CA_NS_55						

NOTE: *additionalSpectrumEmission* corresponds to an information element of the same name defined in clause 6.3.2 of TS 38.331 [7].

6.2A.3.1.1.1 A-MPR for CA_NS_04

6.2A.3.1.1.1.1 Contiguous allocations

For all waveform type, modulations and scs when $F_{\text{edge, low}} - BW_{\text{Channel_CA}} \geq 2490.5$ MHz, A-MPR = MPR

For all modulations and SCS when $F_{\text{edge, low}} - BW_{\text{Channel_CA}} < 2490.5$ MHz

if the RB allocation is an inner allocation as defined in clause 6.2A.2.1, then A-MPR = MPR

Except for $RB_{\text{start}} \leq 0.33 * BW_{\text{channel_CA}} / 0.18 \text{ MHz}$, $AMPR = \max(MPR, AMPR_{cc})$.

if the RB allocation is an outer allocation as defined in clause 6.2A.2.1,

then A-MPR = MPR+1.5dB for BW Class B A-MPR = MPR for BW class C.

Where

- MPR is the MPR as defined in Table 6.2A.2.1-1 for the respective CA bandwidth class
- $AMPR_{cc}$ is defined as the PC3_A2 AMPR in table 6.2.3.2-2.

6.2A.3.1.1.1.2 Non-contiguous allocations

For intra-band contiguous CA_n41B and CA_n41C and it receives IE CA_NS_04, the UE determines the allowed Additional Maximum Power Reduction (AMPR) for the maximum output power as specified in this clause. The AMPR is specified by $AMPR_{IM3}$ to meet -25dBm/MHz when IM3 falls in -25dBm/MHz region of Table 6.5A.2.3.1.1-1 or Table 6.5A.3.3.1.1-1. And uses MPR for all other cases.

The UE determines the AMPR type as follows:

For all waveform types, modulations and SCS when $F_{\text{edge, low}} - \text{BW}_{\text{Channel_CA}} \geq 2490.5$ MHz,

if allocation is an inner or outer 1 allocation as defined in clause 6.2A.2.1 then A-MPR = MPR

if allocation is an outer 2 allocation as defined in clause 6.2A.2.1 then A-MPR = MPR+1dB

For all waveform types, modulations and SCS when $F_{\text{edge, low}} - \text{BW}_{\text{Channel_CA}} < 2490.5$ MHz

If $\text{AND}(\text{MIN}(F_{\text{IM3,low_block,high}}, \text{SEM}_{-13,\text{low}}) < F_{\text{filter,low}}, \text{MAX}(\text{SEM}_{-13,\text{high}}, F_{\text{IM3,high_block,low}}) > F_{\text{filter,high}})$

if RB allocation is an inner or outer 1 allocation as defined in clause 6.2A.2.1 then A-MPR = MPR

if RB allocation is an outer 2 allocation as defined in clause 6.2A.2.1 then A-MPR = MPR+1dB

Else

A-MPR = A-MPR_{IM3} defined in Clause 6.2A.3.1.1.1.3

where

- MPR is the MPR as defined in Table 6.2A.2.1-2 for the respective CA bandwidth class
- $F_{\text{IM3,low_block,high}} = (2 * F_{\text{low_alloc,high_edge}}) - F_{\text{high_alloc,low_edge}}$
- $F_{\text{IM3,high_block,low}} = (2 * F_{\text{high_alloc,low_edge}}) - F_{\text{low_alloc,high_edge}}$
- $F_{\text{low_alloc,low_edge}}$ is the lowermost frequency of lower transmission bandwidth allocation.
- $F_{\text{low_alloc,high_edge}}$ is the uppermost frequency of lower transmission bandwidth allocation.
- $F_{\text{high_alloc,low_edge}}$ is the lowermost frequency of upper transmission bandwidth allocation.
- $F_{\text{high_alloc,high_edge}}$ is the uppermost frequency of upper transmission bandwidth allocation.
- $F_{\text{filter,low}} = 2480$ MHz
- $F_{\text{filter,high}} = 2745$ MHz
- $\text{SEM}_{-13,\text{high}}$ = Threshold frequency where upper spectral emission mask for upper channel drops from -13 dBm / 1MHz to -25 dBm / 1MHz, as specified in Clause 6.5A.2.3.1.1
- $\text{SEM}_{-13,\text{low}}$ = Threshold frequency where lower spectral emission mask below the lower channel drops from -13 dBm / MHz to -25 dBm / MHz, as specified in Clause 6.5A.2.3.1.1

6.2A.3.1.1.1.3 AMPR_{IM3} to meet -25dBm/MHz

AMPR in this clause is for intra-band contiguous CA_{n41B} and CA_{n41C}. The allowed maximum output power reduction is defined as:

AMPR_{IM3}=M_A, Where M_A is defined as follows

$$M_A = \begin{cases} 13; & 0 \leq B < 2.16 \\ 11.5; & 2.16 \leq B < 3.24 \\ 10.5; & 3.24 \leq B < 5.04 \\ 9.5; & 5.04 \leq B < 10.08 \\ 8; & 10.08 \leq B < 16.56 \\ 7; & 16.56 \leq B < 21.96 \\ 6; & 21.96 \leq B \end{cases}$$

Where:

$B = (L_{CRB1} * 12 * SCS_1 + L_{CRB2} * 12 * SCS_2) / 1,000$ (MHz), where SCS_1 and SCS_2 are expressed in kHz.

and L_{CRB1} , SCS_1 are for CC1, L_{CRB2} , SCS_2 are for CC2, CC1 is the component carrier with lower frequency.

6.2A.3.1.1.2 A-MPR for CA_NS_27

6.2A.3.1.1.2.1 Contiguous allocations

For all modulations and scs when $F_{edge, low} - BW_{Channel_CA} \geq 3540$ MHz AND $F_{edge, high} + BW_{Channel_CA} \leq 3710$ MHz
if allocation is inner 1 then A-MPR = 0 dB where inner 1 is defined as

$$RB_{Start,Low} = \max(1, \text{floor}(LCRB/2))$$

where $\max()$ indicates the largest value of all arguments and $\text{floor}(x)$ is the greatest integer less than or equal to x .

$$RB_{Start,High} = N_{RB_agg} - RB_{Start,Low} - LCRB$$

with following conditions

$$RB_{Start,Low} \leq RB_{Start} \leq RB_{Start,High}, \text{ and}$$

$$LCRB \leq \text{ceil}(N_{RB_agg} / 2)$$

AMPR = 5 dB for some exceptions for inner 1 region. These exceptions are defined when $LCRB < 8$ any of the following conditions are met:

$$RB_{start} \leq 30 \text{ or } RB_{end} \geq 164 \text{ for } BW_{Channel_CA} = 40\text{MHz or}$$

for the subset of frequencies that satisfy $3540 \text{ MHz} + BW_{Channel_CA} \leq F_{edge, low} < 3530 \text{ MHz} + 2 * BW_{Channel_CA}$, the following exception thresholds apply

for $BW_{Channel_CA} = 35\text{MHz}$ threshold of $RB_{start} \leq 25$, and

for $BW_{Channel_CA} = 30\text{MHz}$ threshold of $RB_{start} \leq 19$, and

for $BW_{Channel_CA} = 25\text{MHz}$ threshold of $RB_{start} \leq 14$, and

for $BW_{Channel_CA} = 20\text{MHz}$ threshold of $RB_{start} \leq 9$, and

for $BW_{Channel_CA} = 15\text{MHz}$ threshold of $RB_{start} \leq 3$

or for the subset of frequencies that satisfy $3720 \text{ MHz} - 2 * BW_{Channel_CA} < F_{edge, high} \leq 3710 \text{ MHz} - BW_{Channel_CA}$, the following exception thresholds apply

for $BW_{Channel_CA} = 35\text{MHz}$ threshold of $RB_{end} \geq 144$, and

for $BW_{Channel_CA} = 30\text{MHz}$ threshold of $RB_{end} \geq 124$, and

for $BW_{Channel_CA} = 25\text{MHz}$ threshold of $RB_{end} \geq 104$, and

for $BW_{Channel_CA} = 20\text{MHz}$ threshold of $RB_{end} \geq 80$, and

for $BW_{Channel_CA} = 15\text{MHz}$ threshold of $RB_{end} \geq 68$,

else for non-inner 1 allocations A-MPR= 5 dB when $F_{edge, low} - BW_{Channel_CA} \geq 3540$ MHz AND $F_{edge, high} + BW_{Channel_CA} \leq 3710$ MHz

For all modulations and scs when $3550 \text{ MHz} \leq F_{edge, low} < 3540 \text{ MHz} + BW_{Channel_CA}$

if allocation is inner 3 then A-MPR = 0 dB, where inner 3 is defined as

$$N_{RB_agg}/4 < RB_{Start} < N_{RB_agg} 3/4 - L_{CRB} \text{ AND } L_{CRB} < N_{RB_agg}/4$$

Inner 3 region exceptions thresholds are

for $BW_{Channel_CA} = 40\text{MHz}$ threshold of $RB_{start} \leq 63$, and

for $BW_{Channel_CA} = 35\text{MHz}$ threshold of $RB_{start} \leq 52$, and

for $BW_{Channel_CA} = 30\text{MHz}$ threshold of $RB_{start} \leq 42$, and

For which $AMPR = 11.5\text{dB}$

else for non-inner 3 allocations when $BW_{agg} \leq 20\text{ MHz}$, $A\text{-MPR} = 7\text{ dB}$ or when $BW_{agg} > 20\text{ MHz}$, $A\text{-MPR} = 11.5\text{dB}$ when $3550\text{ MHz} \leq F_{edge, low} < 3540\text{ MHz} + BW_{Channel_CA}$.

For all modulations and scs when $3710\text{ MHz} - BW_{Channel_CA} < F_{edge, high} \leq 3700$

if allocation is inner 3 then $A\text{-MPR} = 0\text{ dB}$.

Inner 3 region exceptions thresholds are

for $BW_{Channel_CA} = 40\text{MHz}$ threshold of $RB_{end} \geq 132$, and

for $BW_{Channel_CA} = 35\text{MHz}$ threshold of $RB_{end} \geq 121$, and

for $BW_{Channel_CA} = 30\text{MHz}$ threshold of $RB_{end} \geq 110$, and

For which $AMPR = 11.5\text{dB}$

else for non-inner 3 allocation when $BW_{agg} \leq 20\text{ MHz}$, $A\text{-MPR} = 7\text{ dB}$ or when $BW_{agg} > 20\text{ MHz}$, $A\text{-MPR} = 11.5\text{dB}$ when $3710\text{ MHz} - BW_{Channel_CA} < F_{edge, high} \leq 3700$.

6.2A.3.1.1.2.2 Non-contiguous allocations

For all modulations and scs when $F_{edge, low} - BW_{Channel_CA} \geq 3540\text{ MHz}$ AND $F_{edge, high} + BW_{Channel_CA} \leq 3710\text{ MHz}$

A-MPR=

13; $0 \leq B < 1.08$

12; $1.08 \leq B < 2.16$

11; $2.16 \leq B < 3.24$

10.5; $3.24 \leq B < 5.04$

9.5; $5.04 \leq B < 10.08$

8; $10.08 \leq B < 16.56$

7; $16.56 \leq B < 21.96$

6.5; $21.96 \leq B$

For all modulations and scs when $3550\text{ MHz} \leq F_{edge, low} < 3540\text{ MHz} + BW_{Channel_CA}$ or $3710\text{ MHz} - BW_{Channel_CA} < F_{edge, high} \leq 3700$

when $BW_{Channel_CA} \leq 20\text{ MHz}$

A-MPR=

13;	$0 \leq B < 1.08$
12;	$1.08 \leq B < 2.16$
11;	$2.16 \leq B < 3.24$
10.5;	$3.24 \leq B < 5.04$
9.5;	$5.04 \leq B < 10.08$
8;	$10.08 \leq B < 16.56$
7;	$16.56 \leq B < 21.96$
6.5;	$21.96 \leq B$

or when $BW_{\text{Channel_CA}} > 20$ MHz

A-MPR =

20;	$0 \leq B < 1.08$
19.5;	$1.08 \leq B < 2.16$
19;	$2.16 \leq B < 3.24$
18.5;	$3.24 \leq B < 5.04$
18;	$5.04 \leq B < 10.08$
17;	$10.08 \leq B < 16.56$
16;	$16.56 \leq B < 21.96$
13;	$21.96 \leq B$

Where:

$B = (LCRB_1 * 12 * SCS_1 + LCRB_2 * 12 * SCS_2) / 1,000$ (MHz), where SCS_1 and SCS_2 are expressed in kHz.

and $LCRB_1$, SCS_1 are for CC1, $LCRB_2$, SCS_2 are for CC2, CC1 is the component carrier with lower frequency.

6.2A.3.1.1.3 A-MPR for CA_NS_46

6.2A.3.1.1.3.1 Contiguous allocations

For all modulations and scs when $BW_{\text{Channel_CA}} > 25$ MHz

IF $RBend > NRB_agg / 6$ for all BW's except for $BW_{\text{Channel_CA}} = 50$ MHz where the threshold is $RBend > NRB_agg / 4$ OR for all BW's $RBend > 4/3 NRB_agg - LCRB$

THEN A-MPR = 11 dB

ELSE IF $RBend < NRB_agg / 6$ AND $LCRB < 5$

THEN A-MPR = 5 dB

ELSE IF $LCRB / 3 < RBend < NRB_agg / 4$ AND $LCRB < NRB_agg / 4$

THEN A-MPR = 0 dB,

OTHERWISE A-MPR = 7 dB.

For all modulations and scs when $BWChannel_CA \leq 25$ MHz and 2595 MHz $- 2 * BWChannel_CA < Fedge_high \leq 2570$ MHz

IF $RBend \geq 4/3 NRB_agg - LCRB$

THEN A-MPR = 6 dB.

OTHERWISE A-MPR = 0 dB.

For all modulations and scs when $BWChannel_CA \leq 25$ MHz and $Fedge_high \leq 2595$ MHz $- 2 * BWChannel_CA$,
A-MPR = 0 dB.

6.2A.3.1.1.3.2 Non-contiguous allocations

[For all modulations and scs when $BWChannel_CA > 25$ MHz and 2595 MHz $- BWChannel_CA \leq Fedge_high \leq 2570$ MHz

A-MPR_{CA_IM3} =

20;	$0 \leq B < 1.08$
19.5;	$1.08 \leq B < 2.16$
19;	$2.16 \leq B < 3.24$
18.5;	$3.24 \leq B < 5.04$
18;	$5.04 \leq B < 10.08$
17;	$10.08 \leq B < 16.56$
16;	$16.56 \leq B < 21.96$
13;	$21.96 \leq B$

For all modulations and scs when $BWChannel_CA > 25$ MHz and $Fedge_high < 2595$ MHz $- BWChannel_CA$

A-MPR_{CA_IM5} =

13;	$0 \leq B < 1.08$
12;	$1.08 \leq B < 2.16$
11;	$2.16 \leq B < 3.24$
10.5;	$3.24 \leq B < 5.04$
9.5;	$5.04 \leq B < 10.08$
8;	$10.08 \leq B < 16.56$
7.5;	$16.56 \leq B < 21.96$
7;	$21.96 \leq B$

For all modulations and scs when $BWChannel_CA \leq 25$ MHz and 2595 MHz $- 2 * BWChannel_CA \leq Fedge_high \leq 2570$ MHz

A-MPR_{CA_IM5} =

13;	$0 \leq B < 1.08$
12;	$1.08 \leq B < 2.16$
11;	$2.16 \leq B < 3.24$

- 10.5; $3.24 \leq B < 5.04$
- 9.5; $5.04 \leq B < 10.08$
- 8; $10.08 \leq B < 16.56$
- 7.5; $16.56 \leq B < 21.96$
- 7; $21.96 \leq B$

Where:

$$B = (L_{CRB1} * 12 * SCS_1 + L_{CRB2} * 12 * SCS_2) / 1,000 \text{ (MHz)}, \text{ where } SCS_1 \text{ and } SCS_2 \text{ are expressed in kHz.}$$

and L_{CRB1} , SCS_1 are for CC1, L_{CRB2} , SCS_2 are for CC2, CC1 is the component carrier with lower frequency.]

6.2A.3.1.2 UE additional maximum output power reduction for Intra-band non-contiguous CA

6.2A.3.1.2.0 General

Table 6.2A.3.1.2-1 specifies the additional requirements with their associated network signalling values and the allowed A-MPR and applicable CA band(s) for each CA_NC_NS value. The CA_NC_NS_xy value indicates the additional unwanted emissions requirements that apply for intra-band non-contiguous CA bands with NS_xy indicated or configured in multiple uplink serving cells, except CA_NC_NS_01 that indicates the general emission requirements for intra-band non-contiguous CA bands. The mapping of NR CA band numbers and values of the *additionalSpectrumEmission* to network signalling labels is specified in Table 6.2A.3.1.2-2. For any NR CA band not listed in Table 6.2A.3.1.2-2 the network signalling label CA_NC_NS_01 applies.

Table 6.2A.3.1.2-1: Additional Maximum Power Reduction (A-MPR) for intra-band non-contiguous CA

CA Network Signalling value	Requirements (clause)	Uplink CA Configuration	A-MPR for sub-blocks in order of increasing uplink carrier frequency
			A-MPR [dB] (clause)
CA_NC_NS_01	6.5A.2.2.2 6.5A.3.2.2	All applicable NR CA configurations	N/A
CA_NC_NS_04	6.5A.2.3.2.1 6.5A.3.3.2.1	CA_n41(2A)	6.2A.3.1.2.1
CA_NC_NS_55	See CA_NC_NS_01	CA_n77(2A)	See CA_NC_NS_01

For UEs configured with intra-band non-contiguous CA in n77 and if NS_01 is indicated for an uplink component carrier in the range 3700-3980 MHz and NS_01 or NS_55 for another uplink component carrier in the range 3450-3550 MHz, the allowed additional spurious emission and maximum output power reduction requirements are according to CA_NC_NS_01.

Table 6.2A.3.1.2-2: Mapping of network signaling label

NR CA band	Value of additionalSpectrumEmission							
	0	1	2	3	4	5	6	7
CA_n41	CA_NC_NS_01	CA_NC_NS_04						
CA_n77	CA_NC_NS_01	CA_NC_NS_55						

NOTE: *additionalSpectrumEmission* corresponds to an information element of the same name defined in clause 6.3.2 of TS 38.331 [7].

6.2A.3.1.2.1 AMPR for CA_NC_NS_04 (CA_n41(2A))

For intra-band non-contiguous CA_n41(2A) and it receives IE CA_NC_NS_04, the UE determines the allowed Additional Maximum Power Reduction (AMPR) for the maximum output power as specified in this clause. The AMPR

is specified into 2 types: AMPR to meet -25dBm/MHz and -13dBm/MHz. The A-MPR defined in this clause is used instead of MPR defined in 6.2A.2.2, not additively, so CA MPR=0 when CA_NC_NS_04 is signaled.

The UE determines the AMPR type as follows:

If $\text{AND}(\text{MIN}(F_{\text{IM3,low_block,high}}, \text{SEM}_{.13,\text{low}}) < F_{\text{filter,low}}, \text{MAX}(\text{SEM}_{.13,\text{high}}, F_{\text{IM3,high_block,low}}) > F_{\text{filter,high}})$

A-MPR_{IM3} defined in Clause 6.2A.3.1.2.1.2

Else

A-MPR_{IM3} defined in Clause 6.2A.3.1.2.1.1

where

- L_{CRB1} is for CC1 which is the component carrier with lower frequency
- L_{CRB2} is for CC2 which is the component carrier with higher frequency
- $B = (\text{L}_{\text{CRB1}} * 12 * \text{SCS}_1 + \text{L}_{\text{CRB2}} * 12 * \text{SCS}_2) / 1,000$ (MHz), where SCS₁ and SCS₂ are expressed in kHz.
- $F_{\text{IM3,low_block,high}} = (2 * F_{\text{low_alloc,high_edge}}) - F_{\text{high_alloc,low_edge}}$
- $F_{\text{IM3,high_block,low}} = (2 * F_{\text{high_alloc,low_edge}}) - F_{\text{low_alloc,high_edge}}$
- F_{low_alloc,low_edge} is the lowermost frequency of lower transmission bandwidth allocation.
- F_{low_alloc,high_edge} is the uppermost frequency of lower transmission bandwidth allocation.
- F_{high_alloc,low_edge} is the lowermost frequency of upper transmission bandwidth allocation.
- F_{high_alloc,high_edge} is the uppermost frequency of upper transmission bandwidth allocation.
- F_{filter,low} = 2480 MHz
- F_{filter,high} = 2745 MHz
- SEM_{.13,high} = Threshold frequency where upper spectral emission mask for upper channel drops from -13 dBm / 1MHz to -25 dBm / 1MHz, as specified in Clause 6.5A.2.3.2.
- SEM_{.13,low} = Threshold frequency where lower spectral emission mask below the lower channel drops from -13 dBm / MHz to -25 dBm / MHz, as specified in Clause 6.5A.2.3.2.

6.2A.3.1.2.1.1 AMPR_{IM3} to meet -25dBm/MHz

AMPR in this clause is for intra-band non-contiguous CA_n41(2A) power class 3 for UEs indicating *IE dualPA-Architecture* supported. The allowed maximum output power reduction is defined as:

AMPR_{IM3}=M_A Where M_A is defined as follows

M _A =	12;	0 ≤ B < 1.08
	12;	1.08 ≤ B < 2.16
	11;	2.16 ≤ B < 3.24
	10;	3.24 ≤ B < 5.04
	9;	5.04 ≤ B < 10.08
	8;	10.08 ≤ B < 16.38
	7;	16.38 ≤ B < 21.78

$$6; \quad 21.78 \leq B$$

6.2A.3.1.2.1.2 $AMPR_{IM3}$ to meet -13dBm/MHz

$AMPR$ in this clause is for intra-band non-contiguous CA_n41(2A) power class 3 for UEs indicating IE *dualPA-Architecture* supported. The allowed maximum output power reduction is defined as:

$$AMPR_{IM3} = M_A$$

Where M_A is defined as follows

$$M_A = \begin{cases} 9 & ; \quad 0 \leq B < 0.54 \\ 8 & ; \quad 0.54 \leq B < 1.08 \\ 7 & ; \quad 1.08 \leq B < 2.16 \\ 6.5 & ; \quad 2.16 \leq B < 3.24 \\ 5.5 & ; \quad 3.24 \leq B < 5.4 \\ 4 & ; \quad 5.4 \leq B \end{cases}$$

6.2A.3.1.3 UE additional maximum output power reduction for Inter-band CA

Unless otherwise stated, for inter-band carrier aggregation with one uplink carrier assigned to one NR band, the requirements in subclause 6.2.3 apply.

Unless otherwise stated, for inter-band carrier aggregation with two uplink contiguous carrier assigned to one NR band, the additional maximum output power reduction requirements for intra-band contiguous carrier aggregation in subclause 6.2A.3.1.1 apply for that band.

Unless specified in Table 6.2A.3.1.3-1, for inter-band carrier aggregation with uplink assigned to two NR bands, the requirements in clause 6.2.3 apply only to the indicated carrier. The requirements in Table 6.2A.3.1.3-1 are specified in terms of an additional spectrum emission requirement with their associated network signalling values and the allowed A-MPR. Unless otherwise stated, the combined requirements and allowed A-MPR are applicable on both bands when both component carriers are active. Additional spurious emission requirements are signalled by the network to indicate that the UE shall meet the additional requirement for a specific deployment scenario as part of the cell handover/broadcast message.

To meet the additional requirements, additional maximum power reduction (A-MPR) is allowed for the maximum output power as specified in Table 6.2.1-1. Unless stated otherwise, the total reduction to UE maximum output power is $\max(MPR + \Delta MPR, A-MPR)$ where MPR and ΔMPR are defined in clause 6.2.2. In case of a power class 3 UE, when IE *powerBoostPi2BPSK* is set to 1, power class 2 A-MPR values apply.

For almost contiguous allocations in CP-OFDM waveforms in power class 1.5, 2 and 3, the allowed A-MPR defined in clause 6.2.3 is increased by $\text{CEIL}\{10 \log_{10}(1 + NRB_gap / NRB_alloc), 0.5\}$ dB, where NRB_gap is the total number of unallocated RBs between allocated RBs and NRB_alloc is the total number of allocated RBs, and the parameter $LCRB$ is replaced by $NRB_alloc + NRB_gap$ in specifying the RB allocation regions.

Unless otherwise specified, pi/2 BPSK in following A-MPR tables refers to both variants of pi/2 BPSK referenced in 6.2.2 tables 6.2.2-1.

The emission requirements specified in Table 6.2A.3.1.3-1 also apply for the frequency ranges that are less than F_{OOB} (MHz) in Table 6.5.3.1-1 from the edge of the channel bandwidth.

Table 6.2A.3.1.3-1: Additional Requirements for uplink inter-band carrier aggregation (two-bands)

NR CA combination	Band	Applied NS	Requirements (clause)	A-MPR (table/clause)	Note
CA_n1-n3	n1	05	6.5.3.3.4	Clause 6.2.3.4	1

		05U	6.5.3.3.4, 6.5.2.4.2	Clause 6.2.3.4	
	n3	100	6.5.2.4.2	Table 6.2.3.1-2	
CA_n1-n8	n1	05	6.5.3.3.4	Clause 6.2.3.4	1
		05U	6.5.3.3.4, 6.5.2.4.2	Clause 6.2.3.4	
	n8	43	6.5.3.3.5	Clause 6.2.3.6	
		43U	6.5.3.3.5, 6.5.2.4.2	Clause 6.2.3.6	
CA_n1-n28	n1	05	6.5.3.3.4	Clause 6.2.3.4	1,2
		05U	6.5.3.3.4, 6.5.2.4.2	Clause 6.2.3.4	
	n28	17	6.5.3.3.2	N/A	
CA_n1-n40	n1	05	6.5.3.3.4	Clause 6.2.3.4	1
		05U	6.5.3.3.4, 6.5.2.4.2	Clause 6.2.3.4	
CA_n1-n41	n1	05	6.5.3.3.4	Clause 6.2.3.4	1
		05U	6.5.3.3.4, 6.5.2.4.2	Clause 6.2.3.4	
	n41	47	6.5.3.3.15	Table 6.2.3.18-2	
CA_n1-n78	n1	05	6.5.3.3.4	Clause 6.2.3.4	1
		05U	6.5.3.3.4, 6.5.2.4.2	Clause 6.2.3.4	
CA_n1-n79	n1	05	6.5.3.3.4	Clause 6.2.3.4	1
		05U	6.5.3.3.4, 6.5.2.4.2	Clause 6.2.3.4	
CA_n3-n8	n3	100	6.5.2.4.2	Table 6.2.3.1-2	1
		43	6.5.3.3.5	Clause 6.2.3.6	
	n8	43U	6.5.3.3.5, 6.5.2.4.2	Clause 6.2.3.6	
CA_n3-n28	n3	100	6.5.2.4.2	Table 6.2.3.1-2	1,2
	n28	17	6.5.3.3.2	N/A	
CA_n3-n40	n3	100	6.5.2.4.2	Table 6.2.3.1-2	1
CA_n3-n41	n3	100	6.5.2.4.2	Table 6.2.3.1-2	1
	n41	47	6.5.3.3.15	Table 6.2.3.18-2	
CA_n3-n77	n3	100	6.5.2.4.2	Table 6.2.3.1-2	1
CA_n3-n78	n3	100	6.5.2.4.2	Table 6.2.3.1-2	1
CA_n3-n79	n3	100	6.5.2.4.2	Table 6.2.3.1-2	1
CA_n5-n77	n5	100	6.5.2.4.2	Table 6.2.3.1-2	1
CA_n5-n78	n5	100	6.5.2.4.2	Table 6.2.3.1-2	1
CA_n5-n79	n5	100	6.5.2.4.2	Table 6.2.3.1-2	1
CA_n8-n40	n8	43	6.5.3.3.5	Clause 6.2.3.6	1
		43U	6.5.3.3.5, 6.5.2.4.2	Clause 6.2.3.6	
CA_n8-n41	n8	43	6.5.3.3.5	Clause 6.2.3.6	1
		43U	6.5.3.3.5, 6.5.2.4.2	Clause 6.2.3.6	
	n41	47	6.5.3.3.15	Table 6.2.3.18-2	
CA_n8-n78	n8	43	6.5.3.3.5	Clause 6.2.3.6	1
		43U	6.5.3.3.5, 6.5.2.4.2	Clause 6.2.3.6	
CA_n8-n79	n8	43	6.5.3.3.5	Clause 6.2.3.6	1
		43U	6.5.3.3.5, 6.5.2.4.2	Clause 6.2.3.6	
CA_n28-n40	n28	17	6.5.3.3.2	N/A	2
CA_n28-n41	n28	17	6.5.3.3.2	N/A	2
	n41	47	6.5.3.3.15	Table 6.2.3.18-2	
CA_n28-n77	n28	17	6.5.3.3.2	N/A	2
CA_n28-n78	n28	17	6.5.3.3.2	N/A	2
CA_n40-n41	n41	47	6.5.3.3.15	Table 6.2.3.18-2	
CA_n41-n78	n41	47	6.5.3.3.15	Table 6.2.3.18-2	
CA_n41-n79	n41	47	6.5.3.3.15	Table 6.2.3.18-2	
NOTE 1: NS_05U, NS_43U and NS_100 can be signalled for NR bands that have UTRA services deployed and the requirements in clause 6.5.2.4.2 are only applicable to the signalling carrier.					
NOTE 2: Applicable when the assigned NR carrier is confined within 718 MHz and 748 MHz and when the channel bandwidth used is 5 or 10 MHz.					

6.2A.4 Configured output power for CA

6.2A.4.1 Configured transmitted power level

6.2A.4.1.1 Configured transmitted power for Intra-band contiguous CA

For uplink carrier aggregation the UE is allowed to set its configured maximum output power $P_{\text{CMAX},c}$ for serving cell c and its total configured maximum output power P_{CMAX} .

The configured maximum output power $P_{\text{CMAX},c}$ on serving cell c shall be set as specified in clause 6.2.4, but with $\text{MPR}_c = \text{MPR}$ and $\text{A-MPR}_c = \text{A-MPR}$ with MPR and A-MPR as determined by subclause 6.2A.2 and 6.2A.3, respectively. For PH reporting the following exception applies: if the UE is configured with multiple uplink serving cells, the power $P_{\text{CMAX},c}$ used for the purpose of PH reporting on first serving cell $c = c_1$ does not consider for computation of the PH report transmissions on a second serving cell c_2 as exempted in subclause 7.7.1 in [8]. There is one power management term for the UE, denoted P-MPR, and $\text{P-MPR}_c = \text{P-MPR}$.

The total configured maximum output power P_{CMAX} shall be set within the following bounds:

$$P_{\text{CMAX}_L} \leq P_{\text{CMAX}} \leq P_{\text{CMAX}_H}$$

For uplink intra-band contiguous carrier aggregation when same slot pattern is used in all aggregated serving cells,

$$P_{\text{CMAX}_L} = \text{MIN}\{10 \log_{10} \sum p_{\text{EMAX},c} - \Delta T_C, P_{\text{EMAX,CA}}, P_{\text{PowerClass,CA}} - \text{MAX}(\text{MAX}(\text{MPR}, \text{A-MPR}) + \Delta T_{\text{IB},c} + \Delta T_C + \Delta T_{\text{RxSRS}}, \text{P-MPR}_c) \}$$

$$P_{\text{CMAX}_H} = \text{MIN}\{10 \log_{10} \sum p_{\text{EMAX},c}, P_{\text{EMAX,CA}}, P_{\text{PowerClass,CA}}\}$$

where

- $p_{\text{EMAX},c}$ is the linear value of $P_{\text{EMAX},c}$ which is given by IE *P-Max* for serving cell c in [7];
- $P_{\text{PowerClass,CA}}$ is the maximum UE power specified in Table 6.2A.1.1-1 without taking into account the tolerance;
- MPR and A-MPR are specified in clause 6.2A.2 and 6.2A.3, respectively;
- $\Delta T_{\text{IB},c}$ is the additional tolerance for serving cell c as specified in clause 6.2A.4.2 for NR CA, clause 6.2C.2 for SUL, or TS 38.101-3 clause 6.2B.4.2 for EN-DC; In case the UE supports more than one of band combinations for CA, SUL or DC, and an operating band belongs to more than one band combinations then
 - a) When the operating band frequency range is ≤ 1 GHz, the applicable additional $\Delta T_{\text{IB},c}$ shall be the average value for all band combinations defined in clause 6.2A.4.2, 6.2C.2 in this specification and 6.2B.4.2 in TS 38.101-3 [3], truncated to one decimal place that apply for that operating band among the supported band combinations. In case there is a harmonic relation between low band UL and high band DL, then the maximum $\Delta T_{\text{IB},c}$ among the different supported band combinations involving such band shall be applied
 - b) When the operating band frequency range is > 1 GHz, the applicable additional $\Delta T_{\text{IB},c}$ shall be the maximum value for all band combinations defined in clause 6.2A.4.2, 6.2C.2 in this specification and 6.2B.4.2 in TS 38.101-3 [3] for the applicable operating bands.
- P-MPR is the power management term for the UE;
- ΔT_C is the highest value $\Delta T_{C,c}$ among all serving cells c ;
- ΔT_{RxSRS} is the highest value among all serving cells c ;
- $P_{\text{EMAX,CA}}$ is the value indicated by *p-NR-FRI* or by *p-UE-FRI* whichever is the smallest if both are present.

For uplink intra-band contiguous carrier aggregation, when at least one different numerology/slot pattern is used in aggregated cells, the UE is allowed to set its configured maximum output power $P_{\text{CMAX},c(i),i}$ for serving cell $c(i)$ of slot numerology type i , and its total configured maximum output power P_{CMAX} .

The configured maximum output power $P_{\text{CMAX},c(i),i}(p)$ in slot p of serving cell $c(i)$ on slot numerology type i shall be set within the following bounds:

$$P_{\text{CMAX_L,f,c(i),i}}(p) \leq P_{\text{CMAX,f,c(i),i}}(p) \leq P_{\text{CMAX_H,f,c(i),i}}(p)$$

where $P_{\text{CMAX_L,f,c(i),i}}(p)$ and $P_{\text{CMAX_H,f,c(i),i}}(p)$ are the limits for a serving cell $c(i)$ of slot numerology type i as specified in clause 6.2.4.

The total UE configured maximum output power $P_{\text{CMAX}}(p,q)$ in a slot p of slot numerology or symbol pattern i , and a slot q of slot numerology or symbol pattern j that overlap in time shall be set within the following bounds unless stated otherwise:

$$P_{\text{CMAX_L}}(p,q) \leq P_{\text{CMAX}}(p,q) \leq P_{\text{CMAX_H}}(p,q)$$

When slots p and q have different transmissions lengths and belong to different cells on different or same bands:

$$P_{\text{CMAX_L}}(p,q) = \text{MIN} \{ 10 \log_{10} [p_{\text{CMAX_L,f,c(i),i}}(p) + p_{\text{CMAX_L,f,c(i),j}}(q)], P_{\text{PowerClass,CA}}, P_{\text{EMAX,CA}} \}$$

$$P_{\text{CMAX_H}}(p,q) = \text{MIN} \{ 10 \log_{10} [p_{\text{CMAX_H,f,c(i),i}}(p) + p_{\text{CMAX_H,f,c(i),j}}(q)], P_{\text{PowerClass,CA}}, P_{\text{EMAX,CA}} \}$$

where $p_{\text{CMAX_L,f,c(i),i}}$ and $p_{\text{CMAX_H,f,c(i),i}}$ are the respective limits $P_{\text{CMAX_L,f,c(i),i}}$ and $P_{\text{CMAX_H,f,c(i),i}}$ expressed in linear scale.

T_{REF} and T_{eval} are specified in Table 6.2A.4.1.1-0 when same and different slot patterns are used in aggregated carriers. For each T_{REF} , the $P_{\text{CMAX_L}}$ is evaluated per T_{eval} and given by the minimum value taken over the transmission(s) within the T_{eval} ; the minimum $P_{\text{CMAX_L}}$ over the one or more T_{eval} is then applied for the entire T_{REF} . The lesser of $P_{\text{PowerClass,CA}}$ and $P_{\text{EMAX,CA}}$ shall not be exceeded by the UE during any period of time.

Table 6.2A.4.1.1-0: P_{CMAX} evaluation window for different slot and channel durations

T_{REF}	T_{eval}	T_{eval} with frequency hopping
T_{REF} of largest slot duration over both UL CCs	Physical channel length	$\text{Min}(T_{\text{no_hopping}}, \text{Physical Channel Length})$

If the UE is configured with multiple TAGs and transmissions of the UE on slot i for any serving cell in one TAG overlap some portion of the first symbol of the transmission on slot $i+1$ for a different serving cell in another TAG, the UE minimum of $P_{\text{CMAX_L}}$ for slots i and $i+1$ applies for any overlapping portion of slots i and $i+1$. The lesser of $P_{\text{PowerClass,CA}}$ and $P_{\text{EMAX,CA}}$ shall not be exceeded by the UE during any period of time.

The measured maximum output power P_{UMAX} over all serving cells with same slot pattern shall be within the following range:

$$P_{\text{CMAX_L}} - \text{MAX}\{T_{\text{L}}, T_{\text{LOW}}(P_{\text{CMAX_L}})\} \leq P_{\text{UMAX}} \leq P_{\text{CMAX_H}} + T_{\text{HIGH}}(P_{\text{CMAX_H}})$$

$$P_{\text{UMAX}} = 10 \log_{10} \sum p_{\text{UMAX,c}}$$

where $p_{\text{UMAX,c}}$ denotes the measured maximum output power for serving cell c expressed in linear scale. The tolerances $T_{\text{LOW}}(P_{\text{CMAX}})$ and $T_{\text{HIGH}}(P_{\text{CMAX}})$ for applicable values of P_{CMAX} are specified in Table 6.2A.4.1.1-1. The tolerance T_{L} is the absolute value of the lower tolerance for applicable NR CA configuration as specified in Table 6.2A.1.1-1 for intra-band carrier aggregation.

The measured maximum output power P_{UMAX} over all serving cells, when at least one slot has a different transmission numerology or slot pattern, shall be within the following range:

$$P'_{\text{CMAX_L}} - \text{MAX}\{T_{\text{L}}, T_{\text{LOW}}(P'_{\text{CMAX_L}})\} \leq P'_{\text{UMAX}} \leq P'_{\text{CMAX_H}} + T_{\text{HIGH}}(P'_{\text{CMAX_H}})$$

$$P'_{\text{UMAX}} = 10 \log_{10} \sum p'_{\text{UMAX,c}}$$

where $p'_{\text{UMAX,c}}$ denotes the average measured maximum output power for serving cell c expressed in linear scale over T_{REF} . The tolerances $T_{\text{LOW}}(P'_{\text{CMAX}})$ and $T_{\text{HIGH}}(P'_{\text{CMAX}})$ for applicable values of P'_{CMAX} are specified in Table 6.2A.4.1.1-1 for intra-band carrier aggregation. The tolerance T_{L} is the absolute value of the lower tolerance for applicable NR CA configuration as specified in Table 6.2A.1.1-1 for intra-band carrier aggregation.

where:

$$P'_{\text{CMAX_L}} = \text{MIN}\{ \text{MIN}\{ 10 \log_{10} \sum (p_{\text{CMAX_L,f,c(i),i}}), P_{\text{PowerClass,CA}} \} \text{ over all overlapping slots in } T_{\text{REF}} \}$$

$$P'_{\text{CMAX_H}} = \text{MAX}\{ \text{MIN}\{ 10 \log_{10} \sum p_{\text{EMAX,c}}, P_{\text{PowerClass,CA}} \} \text{ over all overlapping slots in } T_{\text{REF}} \}$$

Table 6.2A.4.1.1-1: P_{CMAX} tolerance for uplink intra-band contiguous CA

P _{CMAX} (dBm)	Tolerance T _{LOW} (P _{CMAX}) (dB)	Tolerance T _{HIGH} (P _{CMAX}) (dB)
21 ≤ P _{CMAX} ≤ 23		2.0
20 ≤ P _{CMAX} < 21		2.5
19 ≤ P _{CMAX} < 20		3.5
18 ≤ P _{CMAX} < 19		4.0
13 ≤ P _{CMAX} < 18		5.0
8 ≤ P _{CMAX} < 13		6.0
-40 ≤ P _{CMAX} < 8		7.0

6.2A.4.1.2 Configured transmitted power for Intra-band non-contiguous CA

For uplink carrier aggregation the UE is allowed to set its configured maximum output power P_{CMAX,c} for serving cell *c* and its total configured maximum output power P_{CMAX}.

The configured maximum output power P_{CMAX,c} on serving cell *c* shall be set as specified in subclause 6.2.4.

The configured maximum output power P_{CMAX,c} on serving cell *c* shall be set as specified in subclause 6.2.4, but with MPR_c = MPR and A-MPR_c = A-MPR with MPR and A-MPR as determined by subclause 6.2A.2 and 6.2A.3, respectively. For PH reporting the following exception applies: if the UE is configured with multiple uplink serving cells, the power P_{CMAX,c} used for the purpose of PH reporting on first serving cell *c* = *c*₁ does not consider for computation of the PH report transmissions on a second serving cell *c*₂ as exempted in subclause 7.7.1 in [8]. There is one power management term for the UE, denoted P-MPR, and P-MPR *c* = P-MPR.

The total configured maximum output power P_{CMAX} shall be set within the following bounds:

$$P_{CMAX,L} \leq P_{CMAX} \leq P_{CMAX,H}$$

For uplink intra-band non-contiguous carrier aggregation when same slot pattern is used in all aggregated serving cells,

$$P_{CMAX,L} = \text{MIN}\{10 \log_{10} \sum p_{EMAX,c} - \Delta T_C, P_{EMAX,CA}, P_{PowerClass,CA} - \text{MAX}(\text{MAX}(\text{MPR}, \text{A-MPR}) + \Delta T_{IB,c} + \Delta T_C + \Delta T_{RxsRS}, \text{P-MPR})\}$$

$$P_{CMAX,H} = \text{MIN}\{10 \log_{10} \sum p_{EMAX,c}, P_{EMAX,CA}, P_{PowerClass,CA}\}$$

where

- p_{EMAX,c} is the linear value of P_{EMAX,c} which is given by IE *P-Max* for serving cell *c* in [7];
- P_{PowerClass,CA} is the maximum UE power specified in Table 6.2A.1.2-1 without taking into account the tolerance;
- MPR and A-MPR are specified in subclause 6.2A.2 and subclause 6.2A.3 respectively;
- ΔT_{IB,c} is the additional tolerance for serving cell *c* as specified in clause 6.2A.4.2 for NR CA, clause 6.2C.2 for SUL, or TS 38.101-3 clause 6.2B.4.2 for EN-DC; In case the UE supports more than one of band combinations for CA, SUL or DC, and an operating band belongs to more than one band combinations then
 - a) When the operating band frequency range is ≤ 1 GHz, the applicable additional ΔT_{IB,c} shall be the average value for all band combinations defined in clause 6.2A.4.2, 6.2C.2 in this specification and 6.2B.4.2 in TS 38.101-3 [3], truncated to one decimal place that apply for that operating band among the supported band combinations. In case there is a harmonic relation between low band UL and high band DL, then the maximum ΔT_{IB,c} among the different supported band combinations involving such band shall be applied
 - b) When the operating band frequency range is > 1 GHz, the applicable additional ΔT_{IB,c} shall be the maximum value for all band combinations defined in clause 6.2A.4.2, 6.2C.2 in this specification and 6.2B.4.2 in TS 38.101-3 [3] for the applicable operating bands.
- P-MPR is the power management term for the UE;
- ΔT_C is the highest value ΔT_{C,c} among all serving cells *c*;

- $\Delta T_{R_{xSRS}}$ is the highest value among all serving cells c ;
- $P_{EMAX,CA}$ is the value indicated by p -NR-FRI or by p -UE-FRI whichever is the smallest if both are present. [For uplink intra-band non-contiguous carrier aggregation, when at least one different numerology/slot pattern is used in aggregated cells, the UE is allowed to set its configured maximum output power $P_{CMAX,c(i),i}$ for serving cell $c(i)$ of slot numerology type i , and its total configured maximum output power P_{CMAX} .

The configured maximum output power $P_{CMAX,c(i),i}(p)$ in slot p of serving cell $c(i)$ on slot numerology type i shall be set within the following bounds:

$$P_{CMAX_L,f,c(i),i}(p) \leq P_{CMAX,f,c(i),i}(p) \leq P_{CMAX_H,f,c(i),i}(p)$$

where $P_{CMAX_L,f,c(i),i}(p)$ and $P_{CMAX_H,f,c(i),i}(p)$ are the limits for a serving cell $c(i)$ of slot numerology type i as specified in subclause 6.2.4.

The total UE configured maximum output power $P_{CMAX}(p,q)$ in a slot p of slot numerology or symbol pattern i , and a slot q of slot numerology or symbol pattern j that overlap in time shall be set within the following bounds unless stated otherwise:

$$P_{CMAX_L}(p,q) \leq P_{CMAX}(p,q) \leq P_{CMAX_H}(p,q)$$

When slots p and q have different transmissions lengths and belong to different cells on different or same bands:

$$P_{CMAX_L}(p,q) = \text{MIN} \{ 10 \log_{10} [p_{CMAX_L,f,c(i),i}(p) + p_{CMAX_L,f,c(i),j}(q)], P_{PowerClass,CA}, P_{EMAX,CA} \}$$

$$P_{CMAX_H}(p,q) = \text{MIN} \{ 10 \log_{10} [p_{CMAX_H,f,c(i),i}(p) + p_{CMAX_H,f,c(i),j}(q)], P_{PowerClass,CA}, P_{EMAX,CA} \}$$

where $p_{CMAX_L,f,c(i),i}$ and $p_{CMAX_H,f,c(i),i}$ are the respective limits $P_{CMAX_L,f,c(i),i}$ and $P_{CMAX_H,f,c(i),i}$ expressed in linear scale.]

T_{REF} and T_{eval} are specified in Table 6.2A.4.1.2-1 when same and different slot patterns are used in aggregated carriers. For each T_{REF} , the P_{CMAX_L} is evaluated per T_{eval} and given by the minimum value taken over the transmission(s) within the T_{eval} ; the minimum P_{CMAX_L} over the one or more T_{eval} is then applied for the entire T_{REF} . The lesser of $P_{PowerClass,CA}$ and $P_{EMAX,CA}$ shall not be exceeded by the UE during any period of time.

Table 6.2A.4.1.2-1: P_{CMAX} evaluation window for different slot and channel durations

T_{REF}	T_{eval}	T_{eval} with frequency hopping
T_{REF} of largest slot duration over both UL CCs	Physical channel length	$\text{Min}(T_{no_hopping}, \text{Physical Channel Length})$

If the UE is configured with multiple TAGs and transmissions of the UE on slot i for any serving cell in one TAG overlap some portion of the first symbol of the transmission on slot $i+1$ for a different serving cell in another TAG, the UE minimum of P_{CMAX_L} for slots i and $i+1$ applies for any overlapping portion of slots i and $i+1$. The lesser of $P_{PowerClass,CA}$ and $P_{EMAX,CA}$ shall not be exceeded by the UE during any period of time.

The measured maximum output power P_{UMAX} over all serving cells with same slot pattern shall be within the following range:

$$P_{CMAX_L} - \text{MAX}\{T_L, T_{LOW}(P_{CMAX_L})\} \leq P_{UMAX} \leq P_{CMAX_H} + T_{HIGH}(P_{CMAX_H})$$

$$P_{UMAX} = 10 \log_{10} \sum p_{UMAX,c}$$

where $p_{UMAX,c}$ denotes the measured maximum output power for serving cell c expressed in linear scale. The tolerances $T_{LOW}(P_{CMAX})$ and $T_{HIGH}(P_{CMAX})$ for applicable values of P_{CMAX} are specified in Table 6.2A.4.1.2-2. The tolerance T_L is the absolute value of the lower tolerance for applicable NR CA configuration as specified in Table 6.2A.1.2-1 for intra-band carrier aggregation.

The measured maximum output power P_{UMAX} over all serving cells, when at least one slot has a different transmission numerology or slot pattern, shall be within the following range:

$$P'_{CMAX_L} - \text{MAX}\{T_L, T_{LOW}(P'_{CMAX_L})\} \leq P'_{UMAX} \leq P'_{CMAX_H} + T_{HIGH}(P'_{CMAX_H})$$

$$P'_{UMAX} = 10 \log_{10} \sum p'_{UMAX,c}$$

where $p'_{UMAX,c}$ denotes the average measured maximum output power for serving cell c expressed in linear scale over T_{REF} . The tolerances $T_{LOW}(P'_{CMAX})$ and $T_{HIGH}(P'_{CMAX})$ for applicable values of P'_{CMAX} are specified in Table 6.2A.4.1.2-2 for intra-band carrier aggregation. The tolerance T_L is the absolute value of the lower tolerance for applicable NR CA configuration as specified in Table 6.2A.1.2-1 for intra-band carrier aggregation.

where:

$$P'_{CMAX_L} = \text{MIN}\{ \text{MIN}\{ 10\log_{10}\sum (P_{CMAX_L,f,c(i,i)}, P_{PowerClass,CA}) \} \text{ over all overlapping slots in } T_{REF}\}$$

$$P'_{CMAX_H} = \text{MAX}\{ \text{MIN}\{ 10\log_{10}\sum p_{EMAX,c}, P_{PowerClass,CA} \} \text{ over all overlapping slots in } T_{REF}\}$$

Table 6.2A.4.1.2-2: P_{CMAX} tolerance for uplink intra-band non-contiguous CA

P_{CMAX} (dBm)	Tolerance $T_{LOW}(P_{CMAX})$ (dB)	Tolerance $T_{HIGH}(P_{CMAX})$ (dB)
$21 \leq P_{CMAX} \leq 23$	3.0	2.0
$20 \leq P_{CMAX} < 21$		2.5
$19 \leq P_{CMAX} < 20$		3.5
$18 \leq P_{CMAX} < 19$		4.0
$13 \leq P_{CMAX} < 18$		5.0
$8 \leq P_{CMAX} < 13$		6.0
$-40 \leq P_{CMAX} < 8$		7.0

6.2A.4.1.3 Configured transmitted power for Inter-band CA

For uplink carrier aggregation the UE is allowed to set its configured maximum output power $P_{CMAX,c}$ for serving cell c and its total configured maximum output power P_{CMAX} .

The configured maximum output power $P_{CMAX,c}$ on serving cell c shall be set as specified in clause 6.2.4.

For uplink inter-band carrier aggregation, MPR_c and A- MPR_c apply per serving cell c and are specified in clause 6.2.2 and clause 6.2.3, respectively. P- MPR_c accounts for power management for serving cell c . $P_{CMAX,c}$ is calculated under the assumption that the transmit power is increased independently on all component carriers.

The total configured maximum output power P_{CMAX} shall be set within the following bounds:

$$P_{CMAX_L} \leq P_{CMAX} \leq P_{CMAX_H}$$

For uplink inter-band carrier aggregation with one serving cell c per operating band when same slot symbol pattern is used in all aggregated serving cells,

$$P_{CMAX_L} = \text{MIN}\{ 10\log_{10}\sum \text{MIN}\{ p_{EMAX,c}/(\Delta t_{C,c}), p_{PowerClass,c}/(\text{MAX}(mpr_c \cdot \Delta mpr_c, a-mpr_c) \cdot \Delta t_{C,c} \cdot \Delta t_{IB,c} \cdot \Delta t_{RXSRS,c}), p_{PowerClass,c}/pmpr_c\}, P_{EMAX,CA}, P_{PowerClass,CA}\}$$

$$P_{CMAX_H} = \text{MIN}\{ 10\log_{10}\sum p_{EMAX,c}, P_{EMAX,CA}, P_{PowerClass,CA}\}$$

where

- $p_{EMAX,c}$ is the linear value of $P_{EMAX,c}$ which is given by IE *P-Max* for serving cell c in [7];
- $P_{PowerClass,CA}$ is the maximum UE power specified in Table 6.2A.1.3-1 without taking into account the tolerance specified in the Table 6.2A.1.3-1;
- $p_{PowerClass,c}$ is the linear value of the maximum UE power for serving cell c specified in Table 6.2.1-1 without taking into account the tolerance;
- mpr_c and $a-mpr_c$ are the linear values of MPR_c and A- MPR_c as specified in clause 6.2.2 and clause 6.2.3, respectively;
- Δmpr_c is the linear value of ΔMPR_c as specified in clause 6.2.2;
- $pmpr_c$ is the linear value of P- MPR_c ;

- $\Delta t_{\text{RxsRS},c}$ is the linear value of $\Delta T_{\text{RxsRS},c}$;
- $\Delta t_{C,c}$ is the linear value of $\Delta T_{C,c}$. $\Delta t_{C,c} = 1.41$ when NOTE 2 in Table 6.2A.1.3-1 applies for a serving cell c , otherwise $\Delta t_{C,c} = 1$;
- $\Delta t_{\text{IB},c}$ is the linear value of the inter-band relaxation term $\Delta T_{\text{IB},c}$ of the serving cell c as specified in clause 6.2A.4.2 for NR CA, clause 6.2C.2 for SUL, or TS 38.101-3 clause 6.2B.4.2 for EN-DC; otherwise $\Delta t_{\text{IB},c} = 1$; In case the UE supports more than one of band combinations for CA, SUL or DC, and an operating band belongs to more than one band combinations then
 - a) When the operating band frequency range is ≤ 1 GHz, the applicable additional $\Delta T_{\text{IB},c}$ shall be the average value for all band combinations defined in clause 6.2A.4.2, 6.2C.2 in this specification and 6.2B.4.2 in TS 38.101-3 [3], truncated to one decimal place that apply for that operating band among the supported band combinations. In case there is a harmonic relation between low band UL and high band DL, then the maximum $\Delta T_{\text{IB},c}$ among the different supported band combinations involving such band shall be applied
 - b) When the operating band frequency range is > 1 GHz, the applicable additional $\Delta T_{\text{IB},c}$ shall be the maximum value for all band combinations defined in clause 6.2A.4.2, 6.2C.2 in this specification and 6.2B.4.2 in TS 38.101-3 [3] for the applicable operating bands.
- $P_{\text{EMAX},CA}$ is the value indicated by p -NR-FRI or by p -UE-FRI whichever is the smallest if both are present. For uplink inter-band carrier aggregation with one serving cell c per operating band when at least one different numerology/slot pattern is used in aggregated cells, the UE is allowed to set its configured maximum output power $P_{\text{CMAX},c(i),i}$ for serving cell $c(i)$ of slot numerology type i , and its total configured maximum output power P_{CMAX} .

The configured maximum output power $P_{\text{CMAX},c(i),i}(p)$ in slot p of serving cell $c(i)$ on slot numerology type i shall be set within the following bounds:

$$P_{\text{CMAX}_L,f,c(i),i}(p) \leq P_{\text{CMAX},f,c(i),i}(p) \leq P_{\text{CMAX}_H,f,c(i),i}(p)$$

where $P_{\text{CMAX}_L,f,c(i),i}(p)$ and $P_{\text{CMAX}_H,f,c(i),i}(p)$ are the limits for a serving cell $c(i)$ of slot numerology type i as specified in clause 6.2.4.

The total UE configured maximum output power $P_{\text{CMAX}}(p,q)$ in a slot p of slot numerology or symbol pattern i , and a slot q of slot numerology or symbol pattern j that overlap in time shall be set within the following bounds unless stated otherwise:

$$P_{\text{CMAX}_L}(p,q) \leq P_{\text{CMAX}}(p,q) \leq P_{\text{CMAX}_H}(p,q)$$

When slots p and q have different transmissions lengths and belong to different cells on different bands:

$$P_{\text{CMAX}_L}(p,q) = \text{MIN} \{ 10 \log_{10} [P_{\text{CMAX}_L,f,c(i),i}(p) + P_{\text{CMAX}_L,f,c(i),j}(q)], P_{\text{PowerClass},CA}, P_{\text{EMAX},CA} \}$$

$$P_{\text{CMAX}_H}(p,q) = \text{MIN} \{ 10 \log_{10} [P_{\text{CMAX}_H,f,c(i),i}(p) + P_{\text{CMAX}_H,f,c(i),j}(q)], P_{\text{PowerClass},CA}, P_{\text{EMAX},CA} \}$$

where $p_{\text{CMAX}_L,f,c(i),i}$ and $p_{\text{CMAX}_H,f,c(i),i}$ are the respective limits $P_{\text{CMAX}_L,f,c(i),i}$ and $P_{\text{CMAX}_H,f,c(i),i}$ expressed in linear scale.

T_{REF} and T_{eval} are specified in Table 6.2A.4.1.3-0 when same and different slot patterns are used in aggregated carriers. For each T_{REF} , the P_{CMAX_L} is evaluated per T_{eval} and given by the minimum value taken over the transmission(s) within the T_{eval} ; the minimum P_{CMAX_L} over the one or more T_{eval} is then applied for the entire T_{REF} . The lesser of $P_{\text{PowerClass},CA}$ and $P_{\text{EMAX},CA}$ shall not be exceeded by the UE during any period of time.

Table 6.2A.4.1.3-0: P_{CMAX} evaluation window for different slot and channel durations

T_{REF}	T_{eval}	T_{eval} with frequency hopping
T_{REF} of largest slot duration over both UL CCs	Physical channel length	Min($T_{\text{no_hopping}}$, Physical Channel Length)

If the UE is configured with multiple TAGs and transmissions of the UE on slot i for any serving cell in one TAG overlap some portion of the first symbol of the transmission on slot $i+1$ for a different serving cell in another TAG, the UE minimum of P_{CMAX_L} for slots i and $i+1$ applies for any overlapping portion of slots i and $i+1$. The lesser of $P_{\text{PowerClass},CA}$ and $P_{\text{EMAX},CA}$ shall not be exceeded by the UE during any period of time.

The measured maximum output power P_{UMAX} over all serving cells with same slot pattern shall be within the following range:

$$P_{CMAX_L} - \text{MAX}\{T_L, T_{LOW}(P_{CMAX_L})\} \leq P_{UMAX} \leq P_{CMAX_H} + T_{HIGH}(P_{CMAX_H})$$

$$P_{UMAX} = 10 \log_{10} \sum P_{UMAX,c}$$

where $p_{UMAX,c}$ denotes the measured maximum output power for serving cell c expressed in linear scale. The tolerances $T_{LOW}(P_{CMAX})$ and $T_{HIGH}(P_{CMAX})$ for applicable values of P_{CMAX} are specified in Table 6.2A.4.1.3-1. The tolerance T_L is the absolute value of the lower tolerance for applicable NR CA configuration as specified in Table 6.2A.1.3-1 for inter-band carrier aggregation.

The measured maximum output power P_{UMAX} over all serving cells, when at least one slot has a different transmission numerology or symbol pattern, shall be within the following range:

$$P'_{CMAX_L} - \text{MAX}\{T_L, T_{LOW}(P'_{CMAX_L})\} \leq P'_{UMAX} \leq P'_{CMAX_H} + T_{HIGH}(P'_{CMAX_H})$$

$$P'_{UMAX} = 10 \log_{10} \sum p'_{UMAX,c}$$

where $p'_{UMAX,c}$ denotes the average measured maximum output power for serving cell c expressed in linear scale over T_{REF} . The tolerances $T_{LOW}(P'_{CMAX})$ and $T_{HIGH}(P'_{CMAX})$ for applicable values of P'_{CMAX} are specified in Table 6.2A.4.1.3-1 for inter-band carrier aggregation. The tolerance T_L is the absolute value of the lower tolerance for applicable NR CA configuration as specified in Table 6.2A.1.3-1 for inter-band carrier aggregation.

where:

$$P'_{CMAX_L} = \text{MIN}\{ \text{MIN}\{10 \log_{10} \sum (P_{CMAX_L,f,c(i),i}), P_{PowerClass,CA}\} \text{ over all overlapping slots in } T_{REF}\}$$

$$P'_{CMAX_H} = \text{MAX}\{ \text{MIN}\{10 \log_{10} \sum P_{EMAX,c}, P_{PowerClass,CA}\} \text{ over all overlapping slots in } T_{REF}\}$$

Table 6.2A.4.1.3-1: P_{CMAX} tolerance for uplink inter-band CA (two bands)

P_{CMAX} (dBm)	Tolerance $T_{LOW}(P_{CMAX})$ (dB)	Tolerance $T_{HIGH}(P_{CMAX})$ (dB)
$P_{CMAX} = 23$	3.0	2.0
$22 \leq P_{CMAX} < 23$	5.0	2.0
$21 \leq P_{CMAX} < 22$	5.0	3.0
$20 \leq P_{CMAX} < 21$	5.0	4.0
$16 \leq P_{CMAX} < 20$	5.0	
$11 \leq P_{CMAX} < 16$	6.0	
$-40 \leq P_{CMAX} < 11$	7.0	

6.2A.4.1.4 Void

6.2A.4.2 $\Delta T_{IB,c}$ for CA

For the UE which supports inter-band NR CA configuration, $\Delta T_{IB,c}$ in tables below applies. Unless otherwise stated, $\Delta T_{IB,c}$ is set to zero.

6.2A.4.2.1 Void

6.2A.4.2.2 Void

6.2A.4.2.3 $\Delta T_{IB,c}$ for Inter-band CA (two bands)

Table 6.2A.4.2.3-1: $\Delta T_{IB,c}$ due to NR CA (two bands)

Inter-band CA combination	NR Band	$\Delta T_{IB,c}$ (dB)
CA_n1-n3	n1	0.3
	n3	0.3
CA_n1-n7	n1	0.5
	n7	0.6
CA_n1-n8	n1	0.3
	n8	0.3
CA_n1-n28	n1	0.3
	n28	0.6
CA_n1-n40	n1	0.5
	n40	0.5
CA_n1-n41	n1	0.5
	n41	0.5
CA_n1-n77	n1	0.6
	n77	0.8
CA_n1-n78	n1	0.3
	n78	0.8
CA_n2-n5	n2	0.3
	n5	0.3
CA_n2-n48	n2	0.6
	n48	0.8
CA_n2-n66	n2	0.5
	n66	0.5
CA_n2-n77	n2	0.6
	n77	0.8
CA_n2-n78	n2	0.6
	n78	0.8
CA_n3-n7	n3	0.5
	n7	0.5
CA_n3-n8	n3	0.3
	n8	0.3
CA_n3-n28	n3	0.3
	n28	0.3
CA_n3-n38	n3	0.5
	n38	0.5
CA_n3-n40	n3	0.5
	n40	0.5
CA_n3-n41	n3	0.5
	n41	0.3 ⁴
		0.8 ⁵
CA_n3-n77	n3	0.6
	n77	0.8
CA_n3-n78	n3	0.6
	n78	0.8
CA_n3-n79	n3	0.3
	n79	0.8
CA_n5-n7	n5	0.3
	n7	0.3
CA_n5-n66	n5	0.3
	n66	0.3
CA_n5-n77	n5	0.6
	n77	0.8
CA_n5-n78	n5	0.6
	n78	0.8
CA_n7-n25	n7	0.5
	n25	0.5
CA_n7-n28	n7	0.3
	n28	0.3
CA_n7-n66	n7	0.5
	n66	0.5
CA_n7-n78	n7	0.5
	n78	0.8

CA_n8-n39	n8	0.3
	n39	0.3
CA_n8-n40	n8	0.3
	n40	0.3
CA_n8-n41	n8	0.6
	n41	0.3
CA_n8-n75	n8	0.3
CA_n8-n78	n8	0.6
	n78	0.8
CA_n8-n79	n8	0.3
	n79	0.8
CA_n20-n28	n20	0.5
	n28	0.5
CA_n20-n75	n20	0.3
CA_n20-n78	n20	0.6
	n78	0.8
CA_n25-n41	n25	0.5
	n41	0.4 ⁶
		0.9 ⁷
CA_n25-n66	n25	0.5
	n66	0.5
CA_n25-n71	n25	0.3
	n71	0.6
CA_n28-n40	n28	0.3
	n40	0.3
CA_n28-n41	n28	0.3
	n41	0.3
CA_n28-n50	n28	0.3
	n50	0.4
CA_n28-n75	n28	0.3
CA_n28-n77	n28	0.5
	n77	0.8
CA_n28-n78	n28	0.5
	n78	0.8
CA_n29-n66	n66	0.3
CA_n29-n70	n70	0.3
CA_n38-n66	n38	0.5
	n66	0.5
CA_n38-n78	n38	0.3
	n78	0.8
CA_n39-n41	n39	0 ²
	n41	0 ²
	n39	0.5 ³
	n41	0.5 ³
CA_n39-n79	n39	0.3
	n79	0.8
CA_n40-n41	n40	0.5 ³
	n41	0.5 ³
CA_n40-n78	n40	0
	n78	0.5
CA_n40-n79	n40	0.3
	n79	0.8
CA_n41-n50	n41	0.3
	n50	0.4
CA_n41-n66	n41	0.8 ⁶
		1.3 ⁷
	n66	0.5
CA_n41-n71	n41	0.3
	n71	0.6
CA_n41-n78 ¹	n41	0.3
	n78	0.8
CA_n41-n79	n41	0.3
	n79	0.8
CA_n48-n66	n48	0.8
	n66	0.6

CA_n50-n78	n50	0 ²
	n78	0 ²
	n50	0.5 ³
	n78	0.5 ³
CA_n66-n70	n66	0.5
	n70	0.5
CA_n66-n71	n66	0.3
	n71	0.3
CA_n66-n77	n66	0.6
	n77	0.8
CA_n66-n78	n66	0.6
	n78	0.8
CA_n70-n71	n70	0.3
	n71	0.6
CA_n75-n78	n78	0.8
CA_n76-n78	n78	0.8
CA_n77-n79	n77	0.5
	n79	0.5
CA_n78-n79	n78	0.5
		1.5 ⁸
	n79	0.5
CA_n78-n92	n78	0.8
		1.5 ⁸
	n92	0.6
<p>NOTE 1: The requirements only apply when the sub-frame and Tx-Rx timings are synchronized between the component carriers. In the absence of synchronization, the requirements are not within scope of these specifications.</p> <p>NOTE 2: Only applicable for UE supporting inter-band carrier aggregation with uplink in one NR band and without simultaneous Rx/Tx.</p> <p>NOTE 3: Applicable for UE supporting inter-band carrier aggregation without simultaneous Rx/Tx.</p> <p>NOTE 4: The requirement is applied for UE transmitting on the frequency range of 2515-2690 MHz.</p> <p>NOTE 5: The requirement is applied for UE transmitting on the frequency range of 2496-2515 MHz.</p> <p>NOTE 6: The requirement is applied for UE transmitting on the frequency range of 2545-2690 MHz.</p> <p>NOTE 7: The requirement is applied for UE transmitting on the frequency range of 2496-2545 MHz.</p> <p>NOTE 8: The requirements only apply for UE supporting inter-band carrier aggregation with simultaneous Rx/Tx capability, and NR UL carrier frequencies are confined to 3700 MHz-3800MHz for n78 and 4400 MHz-4500MHz for n79. Simultaneous Rx/Tx capability does not apply for UEs supporting band n78 with a n77 implementation.</p>		

Table 6.2A.4.2.3-2: Void

Table 6.2A.4.2.3-3: Void

6.2A.4.2.4 $\Delta T_{IB,c}$ for Inter-band CA (three bands)

Table 6.2A.4.2.4-1: $\Delta T_{IB,c}$ due to NR CA (three bands)

Inter-band CA combination	NR Band	$\Delta T_{IB,c}$ (dB)
CA_n1-n3-n7	n1	0.6
	n3	0.6
	n7	0.6
CA_n1-n3-n8	n1	0.3
	n3	0.3
	n8	0.3
CA_n1-n3-n28	n1	0.3
	n3	0.3
	n28	0.6
CA_n1-n3-n41	n1	0.5
	n3	0.5
	n41	0.3 ¹
		0.8 ²
CA_n1-n3-n78	n1	0.6

	n3	0.6
	n78	0.8
CA_n1-n8-n78	n1	0.3
	n8	0.6
	n78	0.8
CA_n1-n28-n78	n1	0.3
	n28	0.6
	n78	0.8
CA_n3-n8-n78	n3	0.6
	n8	0.6
	n78	0.8
CA_n1-n7-n28	n1	0.5
	n7	0.6
	n28	0.6
CA_n1-n7-n78	n1	0.6
	n7	0.6
	n78	0.8
CA_n1-n40-n78	n1	0.3
	n40	0.5
	n78	0.8
CA_n3-n7-n28	n3	0.5
	n7	0.5
	n28	0.3
CA_n3-n7-n78	n3	0.6
	n7	0.6
	n78	0.8
CA_n3-n28-n77	n3	0.6
	n28	0.5
	n77	0.8
CA_n3-n28-n78	n3	0.5
	n28	0.3
	n78	0.8
CA_n3-n40-n41	n3	0.5
	n40	0.5
	n41	0.5 ^{1,3}
		0.8 ^{2,3}
CA_n3-n41-n79	n3	0.3
	n41	0.3 ¹
		0.8 ²
	n79	0.8
CA_n5-n66-n78	n5	0.6
	n66	0.6
	n78	0.8
CA_n7-n25-n66	n7	0.5
	n25	0.5
	n66	0.5
CA_n7-n28-n78	n7	0.3
	n28	0.3
	n78	0.8
CA_n7-n66-n78	n7	0.5
	n66	0.6
	n78	0.8
CA_n8-n39-n41	n8	0.6
	n39	0.5 ⁴
	n41	0.5 ⁴
CA_n8-n41-n79	n8	0.6
	n41	0.3
	n79	0.8
CA_n20-n28-n78	n20	0.6
	n28	0.5
	n78	0.8
CA_n25-n41-n66	n25	0.5
	n41	0.8 ⁵
		1.3 ⁶
	n66	0.5

CA_n25-n41-n71	n25	0.5	
	n41	0.5	
	n71	0.6	
CA_n25-n66-n71	n25	0.5	
	n66	0.5	
	n71	0.6	
CA_n25-n66-n78	n25	0.6	
	n66	0.6	
	n78	0.8	
CA_n28-n40-n78	n28	0.5	
	n40	0.3	
	n78	0.8	
CA_n28-n41-n78	n28	0.5	
	n41	0.3	
	n78	0.8	
CA_n29-n66-n70	n29	0	
	n66	0.5	
	n70	0.5	
CA_n39-n41-n79	n39	0.3	
	n41	0.3 ⁴	
	n79	0.8 ⁴	
CA_n40-n41-n79	n40	0.5 ³	
	n41	0.5 ³	
	n79	0.8	
CA_n41-n66-n71	n41	0.8 ⁵	
		1.3 ⁶	
	n66	0.5	
CA_n41-n66-n71	n71	0.3	
	CA_n66-n70-n71	n66	0.5
		n70	0.5
n71		0.6	

NOTE 1: The requirement is applied for UE transmitting on the frequency range of 2515-2690 MHz.
 NOTE 2: The requirement is applied for UE transmitting on the frequency range of 2496-2515 MHz.
 NOTE 3: Only applicable for UE supporting inter-band carrier aggregation without simultaneous Rx/Tx among band 40 and 41.
 NOTE 4: Applicable for UE supporting inter-band carrier aggregation without simultaneous Rx/Tx between n39 and n41.
 NOTE 5: The requirement is applied for UE transmitting on the frequency range of 2545 - 2690 MHz.
 NOTE 6: The requirement is applied for UE transmitting on the frequency range of 2496 - 2545 MHz.

6.2A.4.2.5 $\Delta T_{IB,c}$ for Inter-band CA (four bands)

Table 6.2A.4.2.5-1: $\Delta T_{IB,c}$ due to NR CA (four bands)

Inter-band CA combination	NR Band	$\Delta T_{IB,c}$ (dB)
CA_n1-n3-n7-n28	n1	0.6
	n3	0.6
	n7	0.6
	n28	0.6
CA_n1-n3-n7-n78	n1	0.7
	n3	0.7
	n7	0.7
	n78	0.8
CA_n1-n3-n8-n78	n1	0.6
	n3	0.6
	n8	0.6
	n78	0.8
CA_n1-n3-n28-n78	n1	0.6
	n3	0.6
	n28	0.6
	n78	0.8

CA_n3-n7-n28-n78	n3	0.6
	n7	0.6
	n28	0.6
	n78	0.6
CA_n7-n25-n66-n78	n7	0.5
	n25	0.6
	n66	0.6
	n78	0.8

6.2B Transmitter power for NR-DC

6.2B.0 General

The requirements apply for inter-band NR-DC with one uplink serving cell configured per CG.

6.2B.1 UE maximum output power for NR-DC

For inter-band NR-DC with one uplink carrier assigned per NR band, the transmitter power requirements in clause 6.2 apply per band.

For inter-band NR-DC with one uplink assigned per band, the UE maximum output power shall be measured over all component carriers from different bands. If each band has separate antenna connectors, the maximum output power is defined as the sum of maximum output power from each UE antenna connector. The period of measurement shall be at least one sub frame (1 ms). The maximum output power is specified in Table 6.2B.1.3-1.

Table 6.2B.1.3-1 UE Power Class for inter-band NR-DC

Uplink CA Configuration	Class 1 (dBm)	Tolerance (dB)	Class 2 (dBm)	Tolerance (dB)	Class 3 (dBm)	Tolerance (dB)	Class 5 (dBm)	Tolerance (dB)
DC_n2A-n5A					23	+2/-3		
NOTE 1: An uplink DC configuration in which at least one of the bands has NOTE 3 in Table 6.2.1-1 is allowed to reduce the lower tolerance limit by 1.5 dB when the transmission bandwidths of at least one of the bands is confined within F_{UL_low} and $F_{UL_low} + 4$ MHz or $F_{UL_high} - 4$ MHz and F_{UL_high} . NOTE 2: $P_{PowerClass}$ is the maximum UE power specified without account of the tolerance NOTE 3: The maximum power requirement applies to the total transmitted power over both the MCG and SCG. NOTE 4: Power class 3 is the default power class unless otherwise stated.								

6.2B.2 UE maximum output power reduction for NR-DC

For inter-band NR-DC with one uplink assigned per band, the requirements in clause 6.2.2 apply for each uplink component carrier.

6.2B.3 UE additional maximum output power reduction for NR-DC

For inter-band NR-DC with one uplink assigned per band, the requirements in clause 6.2.3 apply for each uplink component carrier.

6.2B.4 Configured output power for NR-DC

6.2B.4.1 Configured transmitted power level for NR-DC

The UE is allowed to set its configured maximum output power $P_{CMAX,f,c,MCG}$ and $P_{CMAX,f,c,SCG}$ for the respective MCG and SCG and its total configured maximum output power for NR-DC operation $P_{Total}^{NR-DC} = 10 \log_{10}(\hat{P}_{Total}^{NR-DC})$ with \hat{P}_{Total}^{NR-DC} as specified in clause 7.6.2 of [8]. The UE is configured with an inter-CG power sharing mode by *NR-DC-PC-mode*. The requirements apply for one uplink serving cell configured per CG and for asynchronous and synchronous NR-DC if not otherwise stated.

Unless otherwise stated, the configured maximum output power $P_{\text{CMAX},f,c,\text{MCG}}(q)$ in physical-channel q for carrier f of serving cell c shall be set within the bounds if contained in the MCG,

$$P_{\text{CMAX},L,f,c,\text{MCG}}(q) \leq P_{\text{CMAX},f,c,\text{MCG}}(q) \leq P_{\text{CMAX},H,f,c,\text{MCG}}(q)$$

and the corresponding $P_{\text{CMAX},L,f,c,\text{SCG}}(q)$ for a serving cell contained in the SCG,

$$P_{\text{CMAX},L,f,c,\text{SCG}}(q) \leq P_{\text{CMAX},f,c,\text{SCG}}(q) \leq P_{\text{CMAX},H,f,c,\text{SCG}}(q)$$

where $P_{\text{CMAX},L,f,c,\text{MCG}}$, $P_{\text{CMAX},H,f,c,\text{MCG}}$, $P_{\text{CMAX},L,f,c,\text{SCG}}$ and $P_{\text{CMAX},H,f,c,\text{SCG}}$ are the limits for a serving cell c as specified in clause 6.2.4 modified as follows:

$$P_{\text{CMAX},L,f,c,\text{MCG}} = \text{MIN}\{\text{MIN}(P_{\text{EMAX},c}, P_{\text{EMAX},\text{NR-DC}}, P_{\text{NR}}) - \Delta T_{C,c}, (P_{\text{PowerClass},\text{NR-DC}} - \Delta P_{\text{PowerClass},\text{NR-DC}}) - \text{MAX}(\text{MAX}(\text{MPR}_c + \Delta \text{MPR}_c, \text{A-MPR}_c) + \Delta T_{\text{IB},c} + \Delta T_{C,c} + \Delta T_{\text{RxsRS}}, P\text{-MPR}_c)\}$$

$$P_{\text{CMAX},H,f,c,\text{MCG}} = \text{MIN}\{P_{\text{EMAX},c}, P_{\text{EMAX},\text{NR-DC}}, P_{\text{NR}}, P_{\text{PowerClass},\text{NR-DC}} - \Delta P_{\text{PowerClass},\text{NR-DC}}\}$$

for the MCG and

$$P_{\text{CMAX},L,f,c,\text{SCG}} = \text{MIN}\{\text{MIN}(P_{\text{EMAX},c}, P_{\text{EMAX},\text{NR-DC}}, P_{\text{NR}}) - \Delta T_{C,c}, (P_{\text{PowerClass},\text{NR-DC}} - \Delta P_{\text{PowerClass},\text{NR-DC}}) - \text{MAX}(\text{MAX}(\text{MPR}_c + \Delta \text{MPR}_c, \text{A-MPR}_c) + \Delta T_{\text{IB},c} + \Delta T_{C,c} + \Delta T_{\text{RxsRS}}, P\text{-MPR}_c)\}$$

$$P_{\text{CMAX},H,f,c,\text{SCG}} = \text{MIN}\{P_{\text{EMAX},c}, P_{\text{EMAX},\text{NR-DC}}, P_{\text{NR}}, P_{\text{PowerClass},\text{NR-DC}} - \Delta P_{\text{PowerClass},\text{NR-DC}}\}$$

for the SCG, where

- $P_{\text{EMAX},\text{NR-DC}}$ is the value given by the field *p-UE-FR1* of the *PhysicalCellGroupConfig* IE for the MCG as defined in [7];
- P_{NR} is the value given by the field *p-NR-FR1* of the *PhysicalCellGroupConfig* IE as defined in [7];
- $P_{\text{PowerClass},\text{NR-DC}}$ is the maximum UE power specified in Table 6.2B.1.3-1 without taking into account the tolerance specified in the Table 6.2B.1.3-1;
- $\Delta T_{\text{IB},c}$ is the additional tolerance for serving cell c as specified in clause 6.2B.4.2 for NR-DC; $\Delta T_{\text{IB},c} = 0$ dB otherwise;
- $\Delta T_{C,c} = 1.5$ dB when NOTE 2 in Table 6.2B.1.3-1 applies for a serving cell c , otherwise $\Delta T_{C,c} = 0$ dB ;
- ΔMPR_c for serving cell c is specified in clause 6.2.2.
- $\Delta P_{\text{PowerClass},\text{NR-DC}} = 0$ dB for a power class 3 UE.

For a UE provided with *NR-DC-PC-mode = Semi-static-mode1*,

$$P_{\text{Total}}^{\text{NR-DC}} = \text{MIN}\{P_{\text{EMAX},\text{NR-DC}}, P_{\text{PowerClass},\text{NR-DC}}\} + 0.3 \text{ dB}$$

with $P_{\text{PowerClass},\text{NR-DC}}$ set to power class 3 in case the UE indicates a higher power class in any CG. The UE determines the maximum transmission power for the MCG and the SCG using the respective configured maximum power $P_{\text{CMAX},f,c,\text{MCG}}$ and $P_{\text{CMAX},f,c,\text{SCG}}$.

If for synchronous NR-DC operation a UE is provided *NR-DC-PC-mode = Semi-static-mode2*, the $P_{\text{Total}}^{\text{NR-DC}}$ is determined as above and

- if at least one symbol of slot i_1 of the MCG/SCG is indicated as uplink or flexible to a UE by *tdd-UL-DL-ConfigurationCommon* and *tdd-UL-DL-ConfigurationDedicated*, if provided, overlaps with a symbol for any ongoing transmission overlapping with slot i_2 of the SCG/MCG, the UE determines a maximum power for the transmission on the SCG/MCG overlapping with slot i_2 using the configured maximum power $P_{\text{CMAX},f,c,\text{SCG}}$ or $P_{\text{CMAX},f,c,\text{MCG}}$ for the SCG or MCG, respectively,
- otherwise (i.e. an ongoing transmission overlapping with slot i_2 of the SCG/MCG overlaps with only semi-static downlink symbols within slot i_1 of the MCG/SCG), the UE determines a maximum power for the transmission on MCG or the SCG overlapping with slot i_2 using the configured maximum power as specified in clause 6.2.4.

If a UE indicates a capability for dynamic power sharing between the MCG and the SCG and is provided with *NR-DC-PC-mode = Dynamic*,

$$P_{\text{Total}}^{\text{NR-DC}} = \text{MIN}\{P_{\text{EMAX},\text{NR-DC}}, P_{\text{PowerClass},\text{NR-DC}}\}$$

with $P_{\text{PowerClass,NR-DC}}$ set to power class 3 in case the UE indicates a higher power class in any CG. The UE determines the maximum transmission power for the MCG and the SCG using the respective configured maximum power $P_{\text{CMAX,f,c,MCG}}$ and $P_{\text{CMAX,f,c,SCG}}$ except

- if UE transmission(s) in slot i_1 of the MCG or in slot i_2 of the SCG do not overlap in time with any UE transmission(s) on the SCG or the MCG, respectively, the UE determines a maximum transmission power in slot i_1 of the MCG or in slot i_2 of the SCG using the configured maximum power as specified in clause 6.2.4.

If a UE indicates a capability to determine a total transmission power on the SCG at a first symbol of a transmission occasion on the SCG by determining transmissions on the MCG as specified in clause 7.6.2 of [8], and is provided with $\text{NR-DC-PC-mode} = \text{Dynamic}$,

$$P_{\text{Total}}^{\text{NR-DC}} = \text{MIN}\{P_{\text{EMAX,NR-DC}}, P_{\text{PowerClass,NR-DC}}\}$$

with $P_{\text{PowerClass,NR-DC}}$ set to power class 3 in case the UE indicates a higher power class in any CG. The UE determines the maximum transmission power for the MCG and the SCG using the respective configured maximum power $P_{\text{CMAX,f,c,MCG}}$ and $P_{\text{CMAX,f,c,SCG}}$.

The measured total maximum output power P_{UMAX} over both CGs measured over the transmission reference time duration is

$$P_{\text{UMAX}} = 10 \log_{10} (p_{\text{UMAX,c,MCG}} + p_{\text{UMAX,c,SCG}}),$$

where $p_{\text{UMAX,c,MSG}}$ and $p_{\text{UMAX,c,SCG}}$ denote the measured output power of serving cells c contained in the respective MSG and SCG expressed in linear scale.

The measured total configured maximum output power P_{UMAX} shall be within the following bounds:

$$P_{\text{CMAX_L}} - T_{\text{LOW}}(P_{\text{CMAX_L}}) \leq P_{\text{UMAX}} \leq P_{\text{CMAX_H}} + T_{\text{HIGH}}(P_{\text{CMAX_H}})$$

with the tolerances $T_{\text{LOW}}(P_{\text{CMAX_H}})$ and $T_{\text{HIGH}}(P_{\text{CMAX_H}})$ for applicable values of P_{CMAX} specified in Table 6.2B.4.1.3-2.

When a subframe p on the MSG overlap with a physical-channel q on the SCG, then for P_{UMAX} evaluation, the subframe p on the MCG is taken as reference period T_{REF} and always considered as the reference measurement duration and the following rules are applicable.

T_{REF} and T_{eval} are specified in Table 6.2B.4.1.3-1 when same or different subframe and physical-channel durations are used on the carriers. The $P_{\text{PowerClass}}$ shall not be exceeded by the UE during any evaluation period of time.

Table 6.2B.4.1.3-1: P_{CMAX} evaluation window

Transmission duration	T_{REF}	T_{eval}
Different transmission duration in different CG carriers	MCG subframe	$\text{MIN}(T_{\text{no_hopping}}, \text{Physical Channel Length})$

For each T_{REF} , the $P_{\text{CMAX_H}}$ is evaluated per T_{eval} and given by the maximum value over the transmission(s) within the T_{eval} as follows:

$$P_{\text{CMAX_H}} = \text{MAX}\{P_{\text{CMAX_NR-DC_H}}(p,q), P_{\text{CMAX_NR-DC_H}}(p,q+I), \dots, P_{\text{CMAX_NR-DC_H}}(p,q+n)\}$$

where $P_{\text{CMAX_NR-DC_H}}$ entries are the applicable upper limits for each overlapping scheduling unit pairs (p,q) , $(p, q+I)$, up to $(p, q+n)$ for each applicable T_{eval} duration, where $q+n$ is the last physical-channel on the SCG overlapping with subframe p on the MCG, while $P_{\text{CMAX_L}}$ is computed as follows:

$$P_{\text{CMAX_L}} = \text{MIN}\{P_{\text{CMAX_NR-DC_L}}(p,q), P_{\text{CMAX_NR-DC_L}}(p,q+I), \dots, P_{\text{CMAX_NR-DC_L}}(p,q+n)\}$$

where $P_{\text{CMAX_NR-DC_L}}$ entries are the applicable lower limits for each overlapping scheduling unit pairs (p,q) , $(p, q+I)$ up to $(p, q+n)$ for each applicable T_{eval} duration, where $q+n$ is the last physical-channel on the SCG overlapping with subframe p on the MCG.

For a UE provided with $\text{NR-DC-PC-mode} = \text{Semi-static-mode1}$ and configured with $p_{\text{NR,MCG}} + p_{\text{NR,SCG}} \leq \hat{P}_{\text{Total}}^{\text{NR-DC}}$ with $p_{\text{NR,MCG}}$ and $p_{\text{NR,SCG}}$ the values of the P_{NR} for the respective MCG and SCG expressed in linear scale

$$P_{\text{CMAX_NR-DC_L}}(p,q) = 10 \log_{10} [p_{\text{CMAX_L,f,c,MCG}}(p) + p_{\text{CMAX_L,f,c,SCG}}(q)]$$

$$P_{\text{CMAX_NR-DC_H}}(p,q) = 10 \log_{10} [p_{\text{CMAX_H,f,c,MCG}}(p) + p_{\text{CMAX_H,f,c,SCG}}(q)]$$

with $p_{\text{CMAX_L,f,c,MCG}}$, $p_{\text{CMAX_H,f,c,MCG}}$, $p_{\text{CMAX_L,f,c,SCG}}$, and $p_{\text{CMAX_H,f,c,SCG}}$ the values of the respective $P_{\text{CMAX_L,f,c,MCG}}$, $P_{\text{CMAX_H,f,c,MCG}}$, $P_{\text{CMAX_L,f,c,SCG}}$, and $P_{\text{CMAX_H,f,c,SCG}}$ expressed in linear scale, while the measured configured maximum power P_{UMAX} for each CG shall meet the requirements as specified in clause 6.2.4 but with bounds for $P_{\text{CMAX,f,c,MCG}}(p)$ and $P_{\text{CMAX,f,c,SCG}}$ as specified in this clause.

If for synchronized NR-DC a UE is provided with *NR-DC-PC-mode* = *Semi-static-mode2* and configured with $p_{\text{NR,MCG}} + p_{\text{NR,SCG}} \leq \hat{P}_{\text{Total}}^{\text{NR-DC}}$ with $p_{\text{NR,MCG}}$ and $p_{\text{NR,SCG}}$ the linear-scale values of the P_{NR} for the respective MCG and SCG

$$P_{\text{CMAX_NR-DC_L}}(p,q) = 10 \log_{10} [p_{\text{CMAX_L,f,c,MCG}}(p) + p_{\text{CMAX_L,f,c,SCG}}(q)]$$

$$P_{\text{CMAX_NR-DC_H}}(p,q) = 10 \log_{10} [p_{\text{CMAX_H,f,c,MCG}}(p) + p_{\text{CMAX_H,f,c,SCG}}(q)]$$

while the measured configured maximum power P_{UMAX} for each CG shall meet the requirements specified in Table 6.2.4-2 but with bounds for $P_{\text{CMAX,f,c,MCG}}(p)$ and $P_{\text{CMAX,f,c,SCG}}$ as specified in this clause except

- if an ongoing transmission overlapping with physical channel q of the SCG or subframe p of the MCG overlaps with only semi-static downlink symbols within the respective subframe p of the MCG or physical channel q of the SCG as indicated to a UE by *tdd-UL-DL-ConfigurationCommon* and *tdd-UL-DL-ConfigurationDedicated*, if provided,

then the measured configured maximum power P_{UMAX} for the transmission subframe p on the MCG or physical channel q on the SCG shall meet the requirements as specified in clause 6.2.4 and with bounds for $P_{\text{CMAX,f,c,MCG}}(p)$ or $P_{\text{CMAX,f,c,SCG}}$ as specified in clause 6.2.4.

For a UE provided with *NR-DC-PC-mode* = *Dynamic*,

$$P_{\text{CMAX_NR-DC_L}}(p,q) = \text{MIN}\{10 \log_{10} [p_{\text{CMAX_L,f,c,MCG}}(p) + p_{\text{CMAX_L,f,c,SCG}}(q)], P_{\text{Total}}^{\text{NR-DC}}\}$$

$$P_{\text{CMAX_NR-DC_H}}(p,q) = \text{MIN}\{10 \log_{10} [p_{\text{CMAX_H,f,c,MCG}}(p) + p_{\text{CMAX_H,f,c,SCG}}(q)], P_{\text{Total}}^{\text{NR-DC}}\}$$

while the measured configured maximum power P_{UMAX} on the MCG shall meet the requirements as specified in clause 6.2.4-2 but with bounds for $P_{\text{CMAX,f,c,MCG}}(p)$ as specified in this clause, and the P_{UMAX} on the SCG shall be within

$$P_{\text{CMAX_L,f,c}} - \text{MAX}\{T_{\text{L,c}}, T(P_{\text{CMAX_L,f,c}})\} \leq P_{\text{UMAX,f,c}} \leq P_{\text{CMAX_H,f,c}} + T(P_{\text{CMAX_H,f,c}}).$$

where

$$P_{\text{CMAX_L,f,c}} = \text{MIN}\{P_{\text{CMAX_L,f,c,SCG}}(p), 10 \log_{10} (\hat{P}_{\text{Total}}^{\text{NR-DC}} - p_{\text{NR,MSG}})\}$$

$$P_{\text{CMAX_H,f,c}} = \text{MIN}\{P_{\text{CMAX_H,f,c,SCG}}(p), 10 \log_{10} (\hat{P}_{\text{Total}}^{\text{NR-DC}} - p_{\text{NR,MSG}})\}$$

with limits as specified in Table 6.2.4-2 and $p_{\text{NR,MCG}}$ the value of the P_{NR} for the MCG expressed in linear scale.

Table 6.2B.4.1.3-2: P_{CMAX} tolerance for NR-DC

$P_{\text{CMAX}}(\text{dBm})$	Tolerance $T_{\text{LOW}}(P_{\text{CMAX_L}})$ (dB)	Tolerance $T_{\text{HIGH}}(P_{\text{CMAX_H}})$ (dB)
$23 \leq P_{\text{CMAX}} \leq 33$	3.0	2.0
$22 \leq P_{\text{CMAX}} < 23$	5.0	2.0
$21 \leq P_{\text{CMAX}} < 22$	5.0	3.0
$20 \leq P_{\text{CMAX}} < 21$	5.0	4.0
$16 \leq P_{\text{CMAX}} < 20$		5.0
$11 \leq P_{\text{CMAX}} < 16$		6.0
$-40 \leq P_{\text{CMAX}} < 11$		7.0
NOTE 1: For UEs provided with <i>NR-DC-PC-mode</i> = <i>Semi-static-mode1</i> or with <i>NR-DC-PC-mode</i> = <i>Semi-static-mode2</i> , the upper tolerance T_{high} shall be reduced by 0.3 dB for $P \geq 20$ dBm.		

6.2B.4.2 $\Delta T_{\text{IB,c}}$ for NR-DC

For inter-band NR-DC with one uplink carrier assigned per NR band, the $\Delta T_{\text{IB,c}}$ for the corresponding inter-band CA configuration as specified in clause 6.2A.4.2 applies.

6.2C Transmitter power for SUL

6.2C.1 Configured transmitted power for SUL

When a UE is configured with both NR UL and NR SUL carriers in a serving cell with active transmission either on the UL carrier or SUL carrier, the configured transmit power requirements specified in clause 6.2.4 are applicable for the UL carrier and the SUL carrier, respectively.

6.2C.2 $\Delta T_{IB,c}$

For the UE which supports SUL band combination, $\Delta T_{IB,c}$ in Tables below applies. Unless otherwise stated, $\Delta T_{IB,c}$ is set to zero.

Table 6.2C.2-1: $\Delta T_{IB,c}$ due to SUL

Band combination for SUL	NR Band	$\Delta T_{IB,c}$ (dB)
SUL_n41-n80	n41	0.3 ¹
		0.8 ²
	n80	0.5
SUL_n41-n81	n41	0.3
	n81	0.3
SUL_n77-n80	n77	0.8
	n80	0.6
SUL_n77-n84	n77	0.8
	n84	0.6
SUL_n78-n80	n78	0.8
	n80	0.6
SUL_n78-n81	n78	0.8
	n81	0.6
SUL_n78-n82	n78	0.8
	n82	0.6
SUL_n78-n83	n78	0.8
	n83	0.5
SUL_n78-n84	n78	0.8
	n84	0.3
SUL_n78-n86	n78	0.8
	n86	0.6
NOTE 1: The requirement is applied for UE transmitting on the frequency range of 2515 – 2690 MHz.		
NOTE 2: The requirement is applied for UE transmitting on the frequency range of 2496 - 2515 MHz.		

6.2D Transmitter power for UL MIMO

6.2D.1 UE maximum output power for UL MIMO

For UE with two transmit antenna connectors in closed-loop spatial multiplexing scheme, the maximum output power for any transmission bandwidth within the channel bandwidth is specified in Table 6.2D.1-1. The requirements shall be met with the UL MIMO configurations specified in Table 6.2D.1-2. For UE supporting UL MIMO, the maximum output power is defined as the sum of the maximum output power from both UE antenna connectors. The period of measurement shall be at least one sub frame (1 ms).

The requirements shall be met with the UL MIMO configurations of using 2-layer UL MIMO transmission with codebook of $\frac{1}{\sqrt{2}} \begin{bmatrix} 1 & 0 \\ 0 & 1 \end{bmatrix}$. DCI Format for UE configured in PUSCH transmission mode for uplink single-user MIMO shall be used.

Table 6.2D.1-1: UE Power Class for UL MIMO in closed loop spatial multiplexing scheme

NR band	Class 1.5 (dBm)	Tolerance (dB)	Class 2 (dBm)	Tolerance (dB)	Class 3 (dBm)	Tolerance (dB)	Class 5 (dBm)	Tolerance (dB)
n1					23	+2/-3		
n2					23	+2/-3 ¹		
n3					23	+2/-3 ¹		
n7					23	+2/-3 ¹		
n25					23	+2/-3 ¹		
n30					23	+2/-3		
n34					23	+2/-3		
n38					23	+2/-3		
n39					23	+2/-3		
n40					23	+2/-3		
n41	29	+2/-3 ¹	26	+2/-3 ¹	23	+2/-3 ¹		
n48					23	+2/-3		
n66					23	+2/-3		
n70					23	+2/-3		
n71					23	+2/-3		
n77			26	+2/-3	23	+2/-3		
n78			26	+2/-3	23	+2/-3		
n79			26	+2/-3	23	+2/-3		

NOTE 1: The transmission bandwidths confined within F_{UL_low} and $F_{UL_low} + 4$ MHz or $F_{UL_high} - 4$ MHz and F_{UL_high} , the maximum output power requirement is relaxed by reducing the lower tolerance limit by 1.5 dB

NOTE 2: Power class 3 is the default power class unless otherwise stated

Table 6.2D.1-2: UL MIMO configuration in closed-loop spatial multiplexing scheme

Transmission scheme	DCI format	Number of layers	TPMI index
Codebook based uplink	DCI format 0_1	2	0

NOTE 1: The UE is configured with one SRS resource with the parameter *nrofSRS-Ports* set to 2.

For UE support uplink full power transmission (ULFPTx) for UL MIMO, the maximum output power requirements specified in Table 6.2D.1-1 shall be met with the PUSCH configurations specified in Table 6.2D.1-3, based upon UE's support of uplink full power transmission mode.

Table 6.2D.1-3: PUSCH Configuration for uplink full power transmission (ULFPTx)

ULFPTx Mode	Transmission scheme	DCI format	Modulation	Number of layers	Number of Tx Port	TPMI index
Mode-1	Codebook based uplink	DCI format 0_1	DFT-s-OFDM, CP-OFDM ^{NOTE3}	1	2	2
Mode-2	Codebook based uplink	DCI format 0_1	DFT-s-OFDM, CP-OFDM	1	2	0 or 1 ^{NOTE2}
Mode-full power	Codebook based uplink	DCI format 0_1	DFT-s-OFDM, CP-OFDM	1	2	0,1

NOTE 1: The UE is configured with one SRS resource with the parameter *nrofSRS-Ports* set to 2.

NOTE 2: TPMI index selected shall be based upon the full power TPMI reported by the UE [8, TS 38.213].

NOTE 3: For PUSCH configured with ULFPTxModes set to Mode-1, all the transmitter requirement for CP-OFDM based modulation is not needed to be verified if the requirement for UL MIMO has been validated.

If UE is scheduled for single antenna-port PUSCH transmission by DCI format 0_0 or by DCI format 0_1 for single antenna port codebook based transmission, the requirements in clause 6.2.1 apply for the power class as indicated by the *ue-PowerClass* field in capability signalling.

6.2D.2 UE maximum output power reduction for UL MIMO

For UE with two transmit antenna connectors in closed-loop spatial multiplexing scheme, the allowed Maximum Power Reduction (MPR) for the maximum output power in Table 6.2D.1-1 is specified in Table 6.2.2-1. The requirements shall be met with UL MIMO configurations defined in Table 6.2D.1-2. For UE supporting UL MIMO, the maximum output power is defined as the sum of the maximum output power from both UE antenna connectors.

For UE support uplink full power transmission (ULFPTx) for UL MIMO, the allowed MPR for the maximum output power in Table 6.2D.1-1 is specified in Table 6.2.2-1, and the requirements shall be met with the PUSCH configurations specified in Table 6.2D.1-3, based upon UE's support of uplink full power transmission mode.

For the UE maximum output power modified by MPR, the power limits specified in clause 6.2D.4 apply.

If UE is scheduled for single antenna-port PUSCH transmission by DCI format 0_0 or by DCI format 0_1 for single antenna port codebook based transmission, the requirements in clause 6.2.2 apply for the power class as indicated by the *ue-PowerClass* field in capability signaling.

6.2D.3 UE additional maximum output power reduction for UL MIMO

For UE with two transmit antenna connectors in closed-loop spatial multiplexing scheme, the A-MPR values specified in clause 6.2.3 shall apply to the maximum output power specified in Table 6.2D.1-1. The requirements shall be met with the UL MIMO configurations specified in Table 6.2D.1-2. For UE supporting UL MIMO, the maximum output power is defined as the sum of the maximum output power from both UE antenna connector. Unless stated otherwise, an A-MPR of 0 dB shall be used.

For UE support uplink full power transmission (ULFPTx) for UL MIMO, the A-MPR values specified in clause 6.2.3 shall apply to the maximum output power specified in Table 6.2D.1-1. The requirements shall be met with the PUSCH configurations specified in Table 6.2D.1-3, based upon UE's support of uplink full power transmission mode.

For the UE maximum output power modified by A-MPR, the power limits specified in clause 6.2D.4 apply.

If UE is scheduled for single antenna-port PUSCH transmission by DCI format 0_0 or by DCI format 0_1 for single antenna port codebook based transmission, the requirements in clause 6.2.4 apply for the power class as indicated by the *ue-PowerClass* field in capability signaling.

6.2D.4 Configured transmitted power for UL MIMO

For UE supporting UL MIMO, the transmitted power is configured per each UE.

The definitions of configured maximum output power $P_{\text{CMAX},c}$, the lower bound $P_{\text{CMAX},L,c}$, and the higher bound $P_{\text{CMAX},H,c}$ specified in clause 6.2.4 shall apply to UE supporting UL MIMO, where

- $P_{\text{PowerClass}}$, $\Delta P_{\text{PowerClass}}$ and $\Delta T_{C,c}$ are specified in clause 6.2.4 unless otherwise stated;
- MPR_c is specified in clause 6.2D.2;
- A-MPR_c is specified in clause 6.2D.3.

The measured configured maximum output power $P_{\text{UMAX},c}$ for serving cell c shall be within the following bounds:

$$P_{\text{CMAX},L,c} - \text{MAX}\{T_L, T_{\text{LOW}}(P_{\text{CMAX},L,c})\} \leq P_{\text{UMAX},c} \leq P_{\text{CMAX},H,c} + T_{\text{HIGH}}(P_{\text{CMAX},H,c})$$

where $T_{\text{LOW}}(P_{\text{CMAX},L,c})$ and $T_{\text{HIGH}}(P_{\text{CMAX},H,c})$ are defined as the tolerance and applies to $P_{\text{CMAX},L,c}$ and $P_{\text{CMAX},H,c}$ separately, while T_L is the absolute value of the lower tolerance in Table 6.2D.1-1 for the applicable operating band.

For UE with two transmit antenna connectors in closed-loop spatial multiplexing scheme, the tolerance is specified in Table 6.2D.4-1. The requirements shall be met with UL MIMO configurations specified in Table 6.2D.1-2.

For UE support uplink full power transmission (ULFPTx) for UL MIMO, the tolerance is specified in Table 6.2D.4-1. The requirements shall be met with the PUSCH configurations specified in Table 6.2D.1-3, based upon UE's support of uplink full power transmission mode.

Table 6.2D.4-1: $P_{\text{CMAX},c}$ tolerance in closed-loop spatial multiplexing scheme

$P_{\text{CMAX},c}$ (dBm)	Tolerance $T_{\text{LOW}}(P_{\text{CMAX},L,c})$ (dB)	Tolerance $T_{\text{HIGH}}(P_{\text{CMAX},H,c})$ (dB)
$23 \leq P_{\text{CMAX},c} \leq 29$	3.0	2.0
$22 \leq P_{\text{CMAX},c} < 23$	5.0	2.0
$21 \leq P_{\text{CMAX},c} < 22$	5.0	3.0
$20 \leq P_{\text{CMAX},c} < 21$	5.0	4.0

$16 \leq P_{\text{CMAX},c} < 20$	5.0
$11 \leq P_{\text{CMAX},c} < 16$	6.0
$-40 \leq P_{\text{CMAX},c} < 11$	7.0

If UE is scheduled for single antenna-port PUSCH transmission by DCI format 0_0 or by DCI format 0_1 for single antenna port codebook based transmission, the requirements in clause 6.2.4 apply for the power class as indicated by the *ue-PowerClass* field in capability signaling.

6.2E Transmitter power for V2X

6.2E.1 UE maximum output power for V2X

6.2E.1.1 General

When NR V2X UE is configured for NR V2X sidelink transmissions non-concurrent with NR uplink transmissions for NR V2X operating bands specified in Table 5.2E.1-1, the allowed NR V2X UE maximum output power is specified in Table 6.2E.1.1-0.

Table 6.2E.1.1-0: NR V2X UE Power Class

NR band	Class 1 (dBm)	Tolerance (dB)	Class 2 (dBm)	Tolerance (dB)	Class 3 (dBm)	Tolerance (dB)
n38					23	±2
n47					23	±2

When a UE is configured for NR V2X sidelink transmissions in NR Band n47, the V2X UE shall meet the following additional requirements for transmission within the frequency ranges 5855-5925 MHz:

- The maximum mean power spectral density shall be restricted to 23 dBm/MHz EIRP when the network signaling value NS_33 is indicated.

where the network signaling values are specified in clause 6.2E.3.

NOTE: The PSD limit in EIRP shall be converted to conducted requirement depend on the supported post antenna connector gain $G_{\text{post connector}}$ declared by the UE following the principle described in annex I in [11].

For NR V2X UE supporting SL MIMO, the maximum output power requirements in Table 6.2E.1.1-1 shall be met with the SL MIMO configurations specified in Table 6.2D.1-2. The maximum output power is defined as the sum of the maximum output power from each UE antenna connector. The period of measurement shall be at least one sub frame (1 ms).

Table 6.2E.1.1-1: NR V2X UE Power Class for SL-MIMO

NR band	Class 1 (dBm)	Tolerance (dB)	Class 2 (dBm)	Tolerance (dB)	Class 3 (dBm)	Tolerance (dB)	Class 5 (dBm)	Tolerance (dB)
n38					23	+2/-3		
n47					23	+2/-3		

If the UE transmits on one antenna connector at a time, the requirements in Table 6.2E.1.1-0 shall apply to the active antenna connector.

6.2E.1.2 UE maximum output power for V2X con-current operation

For the NR V2X inter-band con-current operation, the maximum output power is specified in Table 6.2E.1.2-1 for each operating band. The period of measurement shall be at least one sub frame (1ms).

Table 6.2E.1.2-1: Power Class for NR V2X inter-band concurrent combination (two bands)

NR V2X concurrent operating band Configuration	NR band	Class 1 (dBm)	Tolerance (dB)	Class 2 (dBm)	Tolerance (dB)	Class 3 (dBm)	Tolerance (dB)	Class 5 (dBm)	Tolerance (dB)
V2X_n71A-n47A	n71					23	+2/-3 ⁴		
	n47					23	+2/-3		

NOTE 1: For the concurrent band combinations, the simultaneous transmission and reception of sidelink and Uu interfaces can be supported while operation is agnostic of the service used on each interface.

NOTE 2: $P_{PowerClass}$ is the maximum output power specified without taking into account the tolerance for each operating band.

NOTE 3: For inter-band concurrent operation, the aggregation power apply to the total transmitted power over all component carriers (per UE).

NOTE 4: ⁴ refers to the transmission bandwidths (Figure 5.6-1) confined within F_{UL_low} and $F_{UL_low} + 4$ MHz or $F_{UL_high} - 4$ MHz and F_{UL_high} , the maximum output power requirement is relaxed by reducing the lower tolerance limit by 1.5 dB

6.2E.2 UE maximum output power reduction for V2X

6.2E.2.1 General

When UE is configured for NR V2X sidelink transmissions non-concurrent with NR uplink transmissions for NR V2X operating bands specified in Table 5.2E.1-1, this clause specifies the allowed Maximum Power Reduction (MPR) power for V2X physical channels and signals due to PSCCH/PSSCH, PSFCH and S-SSB transmission.

6.2E.2.2 MPR for Power class 3 V2X UE

For contiguous allocation of PSCCH and PSSCH simultaneous transmission, the allowed MPR for the maximum output power for NR V2X physical channels PSCCH and PSSCH shall be as specified in Table 6.2E.2.2-1 for Power class 3 NR V2X UE.

Table 6.2E.2.2-1: Maximum Power Reduction (MPR) for power class 3 NR V2X

Modulation		Channel bandwidth/MPR (dB)	
		Outer RB allocations	Inner RB allocations
CP-OFDM	QPSK	≤ 4.5	≤ 2.5
	16QAM	≤ 4.5	≤ 2.5
	64 QAM	≤ 4.5	
	256 QAM	≤ 7.0	

Where the following parameters are defined to specify valid RB allocation ranges for Outer and Inner RB allocations:

N_{RB} is the maximum number of RBs for a given Channel bandwidth and sub-carrier spacing defined in Table 5.3.2-1.

$$RB_{Start,Low} = \max(1, \text{floor}(L_{CRB}/2))$$

where $\max()$ indicates the largest value of all arguments and $\text{floor}(x)$ is the greatest integer less than or equal to x .

$$RB_{Start,High} = N_{RB} - RB_{Start,Low} - L_{CRB}$$

The RB allocation is an Inner RB allocation if the following conditions are met

$$RB_{Start,Low} \leq RB_{Start} \leq RB_{Start,High}, \text{ and}$$

$$L_{CRB} \leq \text{ceil}(N_{RB}/2)$$

where $\text{ceil}(x)$ is the smallest integer greater than or equal to x .

The RB allocation is an Outer RB allocation for all other allocations which are not an Inner RB allocation.

For PSFCH with single RB transmission for PC3 NR V2X UE, the required MPR is defined as follow

$$\text{MPR}_{\text{PSFCH}} = 3.5 \text{ dB}$$

For contiguous and non-contiguous allocation for simultaneous PSFCH transmission for PC3 NR V2X UE, the required MPR are specified as follow

$$\text{MPR}_{\text{PSFCH}} = \text{CEIL} \{M_{\text{A_PSFCH}}, 0.5\}$$

Where $M_{\text{A_PSFCH}}$ is defined as follows

$$\begin{aligned} M_{\text{A_PSFCH}} &= 7.5 && ; 0.00 < N_{\text{Gap}}/N_{\text{RB}} \leq 0.55 \\ &= 12.0 && ; 0.55 < N_{\text{Gap}}/N_{\text{RB}} \leq 1.0 \end{aligned}$$

Where,

N_{Gap} is the gap RB amount between RB_{start} and RB_{end} for contiguous and non-contiguous allocation simultaneous PSFCH transmission. ($N_{\text{Gap}} = \text{RB}_{\text{end}} - \text{RB}_{\text{start}}$)

$\text{CEIL}\{M_{\text{A}}, 0.5\}$ means rounding upwards to closest 0.5dB.

The allowed MPR for the maximum output power for NR V2X physical channels on S-SSB transmission shall be specified in Table 6.2E.2.2-2.

Table 6.2E.2.2-2: Maximum Power Reduction (MPR) for S-SSB transmission for power class 3 NR V2X

Channel	MPR _{S-SSB} (dB)	
	Outer RB allocations	Inner RB allocations
S-SSB	≤ 6.0	≤ 2.5

For NR V2X UE with two transmit antenna connectors, the allowed Maximum Power Reduction (MPR) values specified in current clause shall apply to the maximum output power specified in Table 6.2E.1.1-1. The requirements shall be met with SL MIMO configurations defined in Table 6.2D.1-2. For UE supporting SL MIMO, the maximum output power is defined as the sum of the maximum output power from each UE antenna connector.

For the UE maximum output power modified by MPR, the power limits specified in clause 6.2E.4 apply.

6.2E.2.3 MPR for Power class 3 V2X concurrent operation

For the inter-band con-current NR V2X operation, the allowed maximum power reduction (MPR) for the maximum output power shall be applied per each component carrier. The MPR requirements in clause 6.2.2 apply for NR Uu operation in licensed band, and the MPR requirements in clause 6.2E.2 apply for NR sidelink operation in licensed band or Band n47.

6.2E.3 UE additional maximum output power reduction for V2X

6.2E.3.1 General

For the applied maximum output power reduction is obtained by taking the maximum value of MPR requirements specified in clause 6.2E.2 and A-MPR requirements specified in current clause.

Additional emission requirements can be indicated by the network or pre-configured radio parameters. Each additional emission requirement is associated with a unique network signalling (NS) value indicated in RRC signalling by an NR frequency band number of the applicable operating band and an associated value in the field [*additionalSpectrumEmission*]. Throughout this specification, the notion of indication or signalling of an NS value refers to the corresponding indication of an NR V2X frequency band number of the applicable operating band, the IE field [*freqBandIndicatorNR*] and an associated value of [*additionalSpectrumEmission*] in the relevant RRC information elements [7].

To meet the additional requirements, additional maximum power reduction (A-MPR) is allowed for the maximum output power as specified in Table 6.2.1-1. Unless stated otherwise, the total reduction to UE maximum output power is

$\max(\text{MPR}, \text{A-MPR})$ where MPR is defined in clause 6.2E.2. Outer and inner allocation notation used in clause 6.2E.3.2 is defined in clause 6.2E.2. In absence of modulation and waveform types the A-MPR applies to all modulation and waveform types.

Table 6.2E.3.1-1: Additional Maximum Power Reduction (A-MPR) for PC3 NR V2X

Network Signalling value	Requirements (clause)	NR Band	Channel bandwidth (MHz)	Resources Blocks (M_{RB})	A-MPR (dB)
NS_01		Table 5.2E.1-1	10, 20, 30, 40	Table 5.3.2-1	N/A
NS_33	6.5E.2.3.1 (A-SEM) 6.5E.3.4 (A-SE)	n47	10	Clause 6.2E.3.2	
NS_52	6.5E.2.3.2 (A-SEM)	n47	40	Clause 6.2E.3.3	

Table 6.2E.3.1-2: Mapping of network signaling label

NR V2X operating bands	Value of additionalSpectrumEmission							
	0	1	2	3	4	5	6	7
n38	NS_01							
n47	NS_01	NS_33	NS_52					
NOTE:	[additionalSpectrumEmission] corresponds to an information element of the same name defined in clause 6.3.2 of TS 38.331 [7].							

For UE with two transmit antenna connectors, the A-MPR values specified in clause 6.2E.3.2 and 6.2E.3.3 shall apply to the maximum output power specified in Table 6.2E.1.1-1. The requirements shall be met with the SL MIMO configurations specified in Table 6.2D.1-2. For UE supporting SL MIMO, the maximum output power is defined as the sum of the maximum output power from each UE antenna connector. Unless stated otherwise, an A-MPR of 0 dB shall be used.

For the UE maximum output power modified by A-MPR, the power limits specified in clause 6.2E.4 apply.

6.2E.3.2 A-MPR for Power class 3 V2X UE by NS_33

When NS_33 is indicated by the network or pre-configured radio parameters for NR V2X UE, the additional maximum output power reduction specified as

$$\text{A-MPR} = \text{CEIL} \{M_A, 0.5\}$$

Where M_A is defined as follows

$$M_A = \text{A-MPR}_{\text{Base}} + G_{\text{post connector}} * \text{A-MPR}_{\text{Step}}$$

$\text{CEIL}\{M_A, 0.5\}$ means rounding upwards to closest 0.5dB.

$\text{A-MPR}_{\text{Base}}$ and $\text{A-MPR}_{\text{Step}}$ are specified in Tables 6.2E.3.2-1, 6.2E.3.2-2 is allowed when network signalling value is provided. $\text{A-MPR}_{\text{Base}}$ is the default A-MPR value when no $G_{\text{post connector}}$ is declared. The supported post antenna connector gain $G_{\text{post connector}}$ is declared by the UE following the principle described in annex I in [11]. The $\text{A-MPR}_{\text{Step}}$ is the increase in A-MPR allowance to allow UE to meet tighter conducted A-SE and A-SEM requirements with higher value of declared $G_{\text{post connector}}$.

For the contiguous PSSCH and PSCCH transmission when NS_33 is indicated by the network or pre-configured radio parameters for NR V2X UE, the NR UE allow the follow A-MPR requirements.

Table 6.2E.3.2-1: A-MPR for PSSCH/PSCCH by NS_33 (at $F_c = 5860\text{MHz}$)

Carrier frequency [MHz]	Resources Blocks (L_{CRB})	Start Resource Block	A-MPR _{Base} (dB)		
			QPSK/16QAM	64QAM	256QAM

5860	≥ 10 and ≤ 15	0	≤ 24
		≥ 1 and ≤ 3	≤ 19
	≥ 10 and ≤ 15	≥ 26 and ≤ 38	≤ 6
	≥ 10 and ≤ 15	≥ 38	≤ 6
	≥ 10 and ≤ 20	≥ 12 and ≤ 14	≤ 11
		≥ 15 and ≤ 19	≤ 9.5
		≥ 20 and ≤ 25	≤ 8.0
	> 15 and < 25	≥ 25	≤ 8
	≥ 10 and < 40	≥ 4 and ≤ 7	≤ 16
		≥ 8 and ≤ 11	≤ 13.5
	≥ 20 and < 40	≥ 0 and ≤ 3	≤ 22
	≥ 25 and < 40	≥ 16 and ≤ 21	≤ 9.5
		≥ 22 and ≤ 27	≤ 8.0
	≥ 24 and ≤ 40	≥ 12 and ≤ 15	≤ 12
	40 and 45	0 and 1	≤ 19
≥ 2 and ≤ 5		≤ 16	
≥ 6 and ≤ 11		≤ 13.5	
> 45	≥ 0	≤ 16	

NOTE 1: A-MPR_{step} = 1.2 dB is applied for RB_{start} 0 and 1 and A-MPR_{step} = 0.7 dB is applied for all other RB_{start}

NOTE 2: Applicable for Channel Bandwidth = 10 MHz

Table 6.2E.3.2-2: A-MPR for PSSCH/PSCCH by NS_33 (at other carrier frequency)

Carrier frequency [MHz]	RB allocations	A-MPR _{Base} (dB)				A-MPR _{step} (dB)
		QPSK	16QAM	64QAM	256QAM	
5870, 5880, 5890, 5900, 5910, 5920	Inner	≤ 3.0		≤ 5.0	≤ 6.0	0.5
	Outer	≤ 4.5				

NOTE 1: Inner and Outer RB allocations are defined in clause 6.2E.2.2

NOTE 2: Applicable for Channel Bandwidth = 10 MHz

For the simultaneous PSFCH transmission when NS_33 is indicated by the network or pre-configured radio parameters for NR V2X UE, the NR UE allow the follow A-MPR requirements

Table 6.2E.3.2-3: A-MPR for simultaneous PSFCH by NS_33

Channel Bandwidth [MHz]	Center Frequency [MHz]	RB allocation	A-MPR _{Base} (dB)			A-MPR _{step} (dB)
			$0 \leq N_{Gap} / N_{RB} < 0.15$	$0.15 \leq N_{Gap} / N_{RB} < 0.3$	$0.3 \leq N_{Gap} / N_{RB} \leq 1$	
10	5860	N _{RB} = 1	19.0			1.0
		N _{RB} > 1	22.0			
	5870, 5880, 5890, 5900, 5910, 5920	N _{RB} = 1	5			0.8
		N _{RB} > 1	14	7	18.5	

Note 1: N_{Gap} is the gap RB amount between RB_{start} and RB_{end} for contiguous and non-contiguous allocation simultaneous PSFCH transmission. (N_{Gap} = RB_{end} - RB_{start})

For the S-SSB transmission when NS_33 is indicated by the network or pre-configured radio parameters for NR V2X UE, the NR UE allow the follow A-MPR requirements.

Table 6.2E.3.2-4: A-MPR for S-SSB transmission by NS_33

Carrier Frequency (MHz)	RBStart * 12*SCS [MHz]	A-MPR _{Base} (dB)	AMP _{Step} (dB)
5860	≤ 1.0	≤ 25	0.6
	> 1.0 and ≤ 2.0	≤ 19	

	>2.0 and ≤3.24	≤ 12	
	>3.24 and ≤3.6	≤ 10	
	>3.6	≤ 9	
5870, 5880, 5890, 5900, 5910, 5920	≤1.0	≤ 7.0	0.85
	>1.0 and ≤1.6	≤ 6.5	
	>1.6 and ≤2.6	≤ 5.8	
	>2.6 and ≤3.24	≤ 4.5	
	>3.24 and ≤4.32	≤ 5.5	
	>4.32	≤ 6.5	

6.2E.3.3 A-MPR for Power class 3 V2X UE by NS_52

When NS_52 is indicated by the network or pre-configured radio parameters for NR V2X UE, the additional maximum output power reduction specified as

$$A\text{-MPR} = \text{CEIL} \{M_A, 0.5\}$$

Where M_A is defined as follows

$$M_A = A\text{-MPR}$$

CEIL{ M_A , 0.5} means rounding upwards to closest 0.5dB.

For the contiguous PSSCH and PSCCH transmission when NS_52 is indicated by the network or pre-configured radio parameters for NR V2X UE, the NR UE allow the follow A-MPR requirements.

Table 6.2E.3.3-1: A-MPR for PSSCH/PSCCH by NS_52

Carrier frequency(MHz)	Modulation	A-MPR(dB)		
		Region 1	Region 2	Region 3
5885	QPSK	≤ 15	≤ 8.0	≤ 5.5
	16QAM		≤ 8.0	≤ 5.5
	64QAM		≤ 8.5	≤ 5.5
	256QAM		≤ 8.5	≤ 6.0
Note1: Void.				

Where the following parameters are defined to specify valid RB allocation ranges for Region1, Region2 and Region3 according to RB allocations:

Table 6.2E.3.3-1a: A-MPR Region definitions for PSSCH/PSCCH by NS_52

Channel Bandwidth, MHz	Carrier frequency (MHz)	A-MPR parameters for region definitions		A-MPR
		RB _{start} or RB _{end}	L _{CRB}	
40	5885	RB _{start} ≤ floor(N _{RB} *0.2) or RB _{end} ≥ N _{RB} - floor(N _{RB} *0.2)	L _{CRB} ≤ floor(N _{RB} *0.2)	Region 1
		The RB allocation is in Region 2 allocation for all other allocations which are not a Region1 or Region3 allocation.		Region 2
		floor(N _{RB} /3.5) ≤ RB _{start} ≤ N _{RB} - floor(N _{RB} /3.5) - L _{CRB}	L _{CRB} ≤ ceil(N _{RB} /3.5)	Region 3

N_{RB} is the maximum number of RBs for a given Channel bandwidth and sub-carrier spacing defined in Table 5.3.2-1 [3].

For the simultaneous PSFCH transmission when NS_52 is indicated by the network or pre-configured radio parameters for NR V2X UE, the NR UE allow the follow A-MPR requirements

Table 6.2E.3.3-2: A-MPR for simultaneous PSFCH by NS_52

Channel Bandwidth [MHz]	Carrier frequency [MHz]	A-MPR (dB)
40 MHz	5885	23.5

For the S-SSB transmission when NS_52 is indicated by the network or pre-configured radio parameters for NR V2X UE, the NR UE allow the follow A-MPR requirements

Table 6.2E.3.2-3: A-MPR for S-SSB transmission by NS_52

Carrier Frequency [MHz]	RB _{Start} * 12*SCS [MHz]	A-MPR (dB)
5885	≤ 7	≤ 16
	> 7 and ≤ 12	≤ 10.5
	> 12 and ≤ 19	≤ 4.0
	> 19 and ≤ 25	≤ 10.5
	> 25	≤ 16

6.2E.3.4 A-MPR for power class 3 V2X concurrent operation

For the inter-band con-current NR V2X operation, the allowed additional maximum power reduction (A-MPR) for the maximum output power shall be applied per each component carrier. The A-MPR requirements in clause 6.2.3 apply for NR Uu operation in licensed band, and the A-MPR requirements in clause 6.2E.3.2 and 6.2E.3.3 apply for NR sidelink operation in Band n47.

6.2E.4 Configured transmitted power for V2X

6.2E.4.1 General

The NR V2X UE is allowed to set its configured maximum output power $P_{\text{CMAX},f,c}$ for carrier f of serving cell c in each slot. The configured maximum output power $P_{\text{CMAX},f,c}$ is set within the following bounds:

$$P_{\text{CMAX}_L,f,c} \leq P_{\text{CMAX},f,c} \leq P_{\text{CMAX}_H,f,c} \text{ with}$$

$$P_{\text{CMAX}_L,f,c} = \text{MIN} \{ P_{\text{EMAX},c}, P_{\text{PowerClass},V2X} - \text{MAX}(\text{MAX}(\text{MPR}_c, \text{A-MPR}_c) + \Delta T_{\text{IB},c}, \text{P-MPR}_c), P_{\text{Regulatory},c} \}$$

$$P_{\text{CMAX}_H,f,c} = \text{MIN} \{ P_{\text{EMAX},c}, P_{\text{PowerClass},V2X}, P_{\text{Regulatory},c} \}$$

where

- $P_{\text{CMAX},f,c}$ is configured for PSSCH\PSCCH, S-SSB and PSFCH, respectively;
- For the total transmitted power $P_{\text{CMAX},\text{PSSCH}/\text{PSCCH}}$, $P_{\text{EMAX},c}$ is the value given by IE *sl-maxTransPower*, defined by TS 38.331.
- For the total transmitted power $P_{\text{CMAX},\text{S-SSB}}$, the $P_{\text{CMAX}_L,f,c}$ and $P_{\text{CMAX}_H,f,c}$ are defined as follows:

$$P_{\text{CMAX}_L,f,c} = \text{MIN} \{ P_{\text{PowerClass},V2X} - \text{MAX}(\text{MAX}(\text{MPR}_c, \text{A-MPR}_c) + \Delta T_{\text{IB},c}, \text{P-MPR}_c), P_{\text{Regulatory},c} \}$$

$$P_{\text{CMAX}_H,f,c} = \text{MIN} \{ P_{\text{PowerClass},V2X}, P_{\text{Regulatory},c} \}$$
- For the total transmitted power $P_{\text{CMAX},\text{PSFCH}}$, $P_{\text{EMAX},c}$ is the value given by IE *sl-maxTransPower* when single resource pool configured is transmitted at a given time and sum of the IEs *sl-maxTransPower* when multiple resource pools configured are transmitted at a given time, defined by TS 38.331.
- $P_{\text{PowerClass},V2X}$ is the maximum UE power specified in Table 6.2E.1.1-1 without taking into account the tolerance specified in the Table 6.2E.1.1-1;
- MPR_c and A-MPR_c for serving cell c are specified in clause 6.2E.2 and clause 6.2E.3 for PSSCH\PSCCH, S-SSB and PSFCH, respectively;
- $\Delta T_{\text{IB},c}$ and P-MPR_c are specified in clause 6.2.4

- $P_{\text{Regulatory},c} = 10 - G_{\text{post connector}}$ dBm the V2X UE is within the protected zone [12] of CEN DSRC tolling system and operating in Band n47; $P_{\text{Regulatory},c} = 33 - G_{\text{post connector}}$ dBm otherwise.

The maximum output power $P_{\text{CMAX},\text{PSSCH}}$ and $P_{\text{CMAX},\text{PSCCH}}$ are derived from $P_{\text{CMAX},c}$ based on 0dB PSD offset between PSSCH and PSCCH.

For the measured configured maximum output power $P_{\text{UMAX},c}$ for NR V2X sidelink transmissions non-concurrent with NR uplink transmissions, the same requirement as in clause 6.2.4 shall be applied.

For NR V2X UE supporting SL MIMO, the transmitted power is configured per each UE.

For NR V2X UE with two transmit antenna connectors, the tolerance is specified in Table 6.2E.4.1-1. The requirements shall be met with SL MIMO configurations specified in Table 6.2D.1-2.

If the UE transmits on two antenna connectors at the same time, the tolerance is specified in Table 6.2E.4.1-1.

Table 6.2E.4.1-1: $P_{\text{CMAX},c}$ tolerance schemes for NR V2X

$P_{\text{CMAX},c}$ (dBm)	Tolerance $T_{\text{LOW}}(P_{\text{CMAX},L,c})$ (dB)	Tolerance $T_{\text{HIGH}}(P_{\text{CMAX},H,c})$ (dB)
$P_{\text{CMAX},c} = 26$	3.0	2.0
$23 \leq P_{\text{CMAX},c} < 26$	3.0	2.0
$22 \leq P_{\text{CMAX},c} < 23$	5.0	2.0
$21 \leq P_{\text{CMAX},c} < 22$	5.0	3.0
$20 \leq P_{\text{CMAX},c} < 21$	5.0	4.0
$16 \leq P_{\text{CMAX},c} < 20$	5.0	
$11 \leq P_{\text{CMAX},c} < 16$	6.0	
$-40 \leq P_{\text{CMAX},c} < 11$	7.0	

6.2E.4.2 Configured transmitted power for V2X concurrent operation

When a UE is configured for simultaneous NR V2X sidelink and NR uplink transmissions for inter-band concurrent operation, the UE is allowed to set its configured maximum output power $P_{\text{CMAX},c,\text{NR}}$ and $P_{\text{CMAX},c,\text{V2X}}$ for the configured NR uplink carrier and the configured NR V2X carrier, respectively, and its total configured maximum output power $P_{\text{CMAX},c}$.

The configured maximum output power $P_{\text{CMAX},c,\text{NR}}(p)$ in slot p for the configured NR uplink carrier shall be set within the bounds:

$$P_{\text{CMAX},L,c,\text{NR}}(p) \leq P_{\text{CMAX},c,\text{NR}}(p) \leq P_{\text{CMAX},H,c,\text{NR}}(p)$$

where $P_{\text{CMAX},L,c,\text{NR}}$ and $P_{\text{CMAX},H,c,\text{NR}}$ are the limits for a serving cell c as specified in clause 6.2.4.

The configured maximum output power $P_{\text{CMAX},c,\text{V2X}}(q)$ in slot q for the configured NR V2X carrier shall be set within the bounds:

$$P_{\text{CMAX},c,\text{V2X}}(q) \leq P_{\text{CMAX},H,c,\text{V2X}}(q)$$

where $P_{\text{CMAX},H,c,\text{V2X}}$ is the limit as specified in clause 6.2E.4.1.

The total UE configured maximum output power $P_{\text{CMAX}}(p,q)$ in a slot p of NR uplink carrier and a slot q of NR V2X sidelink that overlap in time shall be set within the following bounds for synchronous and asynchronous operation unless stated otherwise:

$$P_{\text{CMAX},L}(p,q) \leq P_{\text{CMAX}}(p,q) \leq P_{\text{CMAX},H}(p,q)$$

with

$$P_{\text{CMAX},L}(p,q) = P_{\text{CMAX},L,c,\text{NR}}(p)$$

$$P_{\text{CMAX},H}(p,q) = 10 \log_{10} [p_{\text{CMAX},H,c,\text{NR}}(p) + p_{\text{CMAX},H,c,\text{V2X}}(q)]$$

where $p_{\text{CMAX},H,c,\text{V2X}}$ and $p_{\text{CMAX},H,c,\text{NR}}$ are the limits $P_{\text{CMAX},H,c,\text{V2X}}(q)$ and $P_{\text{CMAX},H,c,\text{NR}}(p)$ expressed in linear scale.

The measured total maximum output power P_{UMAX} over both the NR uplink and NR V2X carriers is

$$P_{UMAX} = 10 \log_{10} [p_{UMAX,c,NR} + p_{UMAX,c,V2X}],$$

where $p_{UMAX,c,NR}$ denotes the measured output power of serving cell c for the configured NR uplink carrier, and $p_{UMAX,c,V2X}$ denotes the measured output power for the configured NR V2X carrier expressed in linear scale.

When a UE is configured for synchronous V2X sidelink and uplink transmissions,

$$P_{CMAX_L}(p, q) - T_{LOW}(P_{CMAX_L}(p, q)) \leq P_{UMAX} \leq P_{CMAX_H}(p, q) + T_{HIGH}(P_{CMAX_H}(p, q))$$

where $P_{CMAX_L}(p, q)$ and $P_{CMAX_H}(p, q)$ are the limits for the pair (p, q) and with the tolerances $T_{LOW}(P_{CMAX})$ and $T_{HIGH}(P_{CMAX})$ for applicable values of P_{CMAX} specified in Table 6.2E.4.1-1. P_{CMAX_L} may be modified for any overlapping portion of slots (p, q) and $(p + I, q + I)$.

6.2F Transmitter power for shared spectrum channel access

6.2F.1 UE maximum output power

The following UE Power Classes define the maximum output power for any transmission bandwidth within the channel bandwidth of shared spectrum channel access carrier unless otherwise stated. The period of measurement shall be at least one sub frame (1ms).

Table 6.2F.1-1: UE Power Class

NR band	Class 1 (dBm)	Tolerance (dB)	Class 2 (dBm)	Tolerance (dB)	Class 3 (dBm)	Tolerance (dB)	Class 5 (dBm)	Tolerance (dB)
n46							20	+2/-3
n96							20	+2/-3

NOTE 1: $P_{PowerClass}$ is the maximum UE power specified without taking into account the tolerance
 NOTE 2: Power class 5 is default power class unless otherwise stated.

The UE operating shall meet the following additional requirements for maximum mean transmission power density specified in Table 6.2F.1-2 when NS is signalled and when transmission overlaps with any portion of the specified frequency range. In case transmission overlaps multiple frequency ranges, the lowest power density requirement applies.

Table 6.2F.1-2: Additional requirements for transmit power density

NR Band	NS value	Channel bandwidth (MHz)	Frequency range (MHz)	Maximum mean power density (dBm/MHz)		
n46	NS_28	20, 40, 60, 80	5150 – 5350	10		
			5470 – 5725			
	NS_29	20	5170 – 5330	10		
			5490 – 5730			
		40	5170 – 5330	7		
			5490 – 5730			
		60, 80	5170 – 5330	4		
			5490 – 5730			
	NS_30	20, 40, 60, 80	5150 – 5350	11		
			5470 – 5725			
	NS_31	20	5150 - 5230	10		
			5250 – 5350			
			5470 – 5725			
			5725 - 5850			
			5230 – 5250		4	
			5150 - 5230			
			40		5250 – 5350	7
					5470 – 5725	
		5725 - 5850				
		5230 – 5250		4		
5150 - 5230						
60, 80		5250 – 5350		4		
		5470 – 5725				

n96	NS_53	20, 40, 60, 80	5725 - 5850	-1	
			5230 - 5250		
	NS_54	20, 40, 60, 80	5925 - 7125		17
			5925 - 6425		
			6525 - 6875		

6.2F.1A UE maximum output power for CA

6.2F.1A.1 UE maximum output power for inter-band CA

For inter-band carrier aggregation with one uplink carrier assigned to one NR band, the transmitter power requirements in clause 6.2 apply.

For inter-band carrier aggregation with uplink assigned to two NR bands, UE maximum output power shall be measured over all component carriers from different bands. If each band has separate antenna connectors, maximum output power is defined as the sum of maximum output power from each UE antenna connector. The period of measurement shall be at least one sub frame (1 ms). The maximum output power is specified in Table 6.2F.1.3A-1.

Table 6.2F.1A.1-1 UE Power Class for uplink inter-band CA (two bands)

Uplink CA Configuration	Class 1 (dBm)	Tolerance (dB)	Class 2 (dBm)	Tolerance (dB)	Class 3 (dBm)	Tolerance (dB)	Class 5 (dBm)	Tolerance (dB)
CA_n46A-n48A					23	+2/-3 ²		

6.2F.2 UE maximum output power reduction

For UE maximum output power reduction, the general requirements of clause 6.2.2 do not apply but instead the UE is allowed to reduce the maximum output power due to higher order modulations and transmit bandwidth configurations for power class 5 according to Table 6.2F.2-1 and Table 6.2F.2-2.

Table 6.2F.2-1 Maximum power reduction (MPR) for shared spectrum access UE power class 5

Pre-coding	Modulation	RB Allocation	
		Full ² (dB)	Partial ³ (dB)
DFT-s-OFDM	Pi/2 BPSK ⁴	≤ 1.5	≤ 2.5
	QPSK	≤ 1.5	≤ 2.5
	16 QAM	≤ 2.0	≤ 3.0
	64 QAM	≤ 3.5	≤ 4.5
	256 QAM	≤ 5.0	≤ 5.5
CP-OFDM	QPSK	≤ 3.5	≤ 3.5
	16 QAM	≤ 4.0	≤ 4.0
	64 QAM	≤ 5.5	≤ 5.5
	256 QAM	≤ 7.0	≤ 7.0
NOTE 1: The MPR shall apply to all SCS in all active 20 MHz sub-bands contiguously allocated in the channel. The MPR applies to interlaced allocations with uplink resource allocation type 2 as specified in TS 38.214 [10]. NOTE 2: Full RB allocation MPR applies when all RB's in a 20 MHz channel or all RB's in all sub-bands for wideband operation are fully allocated and sub-bands are transmitted according to configuration A in Table 6.2F.2-2. NOTE 3: Partial RB allocation MPR applies when one or more RB's in one or more sub-bands are not allocated or when the transmitted sub-bands for wideband operation are transmitted according to configuration B in Table 6.2F.2-2. NOTE 4: Applicable to Pi/2-BPSK modulation when IE powerBoostPi2BPSK is set to 0.			

Table 6.2F.2-2 MPR mapping for wideband operation

Wideband operation channel bandwidth (MHz)	Sub-band configuration	
	A	B
40	11	10, 01
60	111, 011, 110, 001, 010, 100	None
80	1111, 0111, 1110, 0110, 0001, 1000	1100, 0011, 0100, 0010
NOTE 1: The sub-band configuration is represented as a bitmap where '1' indicates that a sub-band is transmitted and '0' indicates a sub-band is not transmitted. The bitmap is ordered with MSB mapped to the lowest frequency sub-band and LSB mapped to highest frequency sub-band within the wideband channel.		

For the UE maximum output power modified by MPR, the power limits specified in clause 6.2F.4 apply.

6.2F.2A UE maximum output power reduction for CA

6.2F.2A.1 UE maximum output power reduction for inter-band CA

For inter-band carrier aggregation with uplink assigned to two bands, the requirements in clause 6.2.2 apply for the NR uplink carrier and clause 6.2F.2 for the carrier operating with shared spectrum access.

6.2F.3 UE additional maximum output power reduction

6.2F.3.1 General

Additional emission requirements can be signalled by the network. Each additional emission requirement is associated with a unique network signalling (NS) value indicated in RRC signalling by an NR frequency band number of the applicable operating band and an associated value in the field *additionalSpectrumEmission*. Throughout this specification, the notion of indication or signalling of an NS value refers to the corresponding indication of an NR frequency band number of the applicable operating band, the IE field *freqBandIndicatorNR* and an associated value of *additionalSpectrumEmission* in the relevant RRC information elements [7].

To meet the additional requirements, additional maximum power reduction (A-MPR) is allowed for the maximum output power as specified in Table 6.2F.1-1. Unless stated otherwise, the total reduction to UE maximum output power is $\max(\text{MPR}, \text{A-MPR})$ where MPR is defined in clause 6.2F.2.

Table 6.2F.3.1-1 specifies the additional requirements with their associated network signalling values and the allowed A-MPR and applicable operating band(s) for each NS value. The mapping of NR frequency band numbers and values of the *additionalSpectrumEmission* to network signalling labels is specified in Table 6.2F.3.1-1A.

Table 6.2F.3.1-1: Additional maximum power reduction (A-MPR)

Network signalling label	Requirements (clause)	NR Band	Channel bandwidth (MHz)	Resources blocks (N_{RB})	A-MPR (clause)
NS_01		n46, n96	20, 40, 60, 80		N/A
NS_28	6.5F.3.3.1, 6.2F.1	n46	20, 40, 60, 80		6.2F.3.2
NS_29	6.5F.3.3.2, 6.2F.1	n46	20, 40, 60, 80		6.2F.3.3
NS_30	6.5F.3.3.3, 6.2F.1	n46	20, 40, 60, 80		6.2F.3.4
NS_31	6.5F.3.3.4, 6.2F.1	n46	20, 40, 60, 80		6.2F.3.5
NS_53	6.5F.3.3.5, 6.2F.1	n96	20, 40, 60, 80		6.2F.3.6
NS_54	6.5F.3.3.5, 6.2F.1	n96	20, 40, 60, 80		6.2F.3.7
NOTE 1: The A-MPR shall apply to all active 20 MHz sub-bands contiguously allocated in the channel.					

[The NS_01 label with the field *additionalPmax* [7] absent is default for all NR bands.]

Table 6.2F.3.1-1A: Mapping of network signaling label

NR band	Value of additionalSpectrumEmission							
	0	1	2	3	4	5	6	7
n46	NS_01	NS_28	NS_29	NS_30	NS_31			
n96	NS_01	NS_53	NS_54					

NOTE: *additionalSpectrumEmission* corresponds to an information element of the same name defined in clause 6.3.2 of TS 38.331 [7].

6.2F.3.2 A-MPR for NS_28

When "NS_28" is indicated in the cell, the A-MPR is specified in Table 6.2F.3.2-1.

Table 6.2F.3.2-1: A-MPR for NS_28 power class 5

Pre-coding	Modulation	RB Allocation (Note 2)		RB Allocation (Note 3)
		Full (dB)	Partial (dB)	Full/Partial
DFT-s-OFDM	QPSK	≤ 4.0	≤ 6.0	See Table 6.2F.2-1
	16 QAM	≤ 4.5	≤ 6.0	
	64 QAM	≤ 4.5	≤ 6.5	
	256 QAM	≤ 5.5	≤ 6.5	
CP-OFDM	QPSK	≤ 6.0	≤ 7.0	
	16 QAM	≤ 6.0	≤ 7.5	
	64 QAM	≤ 6.5	≤ 7.5	
	256 QAM	≤ 7.0	≤ 7.5	

NOTE 1: Full allocation A-MPR applies when all RB's in a 20 MHz channel or all RB's in all sub-bands for wideband operation are fully allocated and all sub-bands are transmitted. Partial allocation A-MPR applies when one or more RB's in one or more sub-bands are not allocated or when not all transmitted sub-bands for wideband operation are transmitted.

NOTE 2: Applicable for 20 MHz channels centered at the nearest NR-ARFCN corresponding to 5160, 5340, 5480, and 5700 MHz, 40 MHz channels centered at the nearest NR-ARFCN corresponding to 5170, 5190, 5310, 5330, 5490, and 5510 MHz, 60 MHz channels centered at the nearest NR-ARFCN corresponding to 5180, 5200, 5220, 5280, 5300, 5320, 5500, 5520, 5540, 5680 MHz, and 80 MHz channels centered at the nearest NR-ARFCN corresponding to 5190, 5210, 5290, 5310, 5510, and 5530 MHz.

NOTE 3: Applicable for all valid channels other than those enumerated under NOTE 2.

6.2F.3.3 A-MPR for NS_29

When "NS_29" is indicated in the cell, the A-MPR is specified in Table 6.2F.3.3-1.

Table 6.2F.3.3-1: A-MPR for NS_29 power class 5

Pre-coding	Modulation	Channel bandwidth (Sub-band allocation) / RB Allocation				
		20 MHz	40 MHz		60 MHz, 80 MHz	
			Full/Partial	Full (dB)	Partial (dB)	Full (dB)
DFT-s-OFDM	QPSK	See Table 6.2F.2-1	≤ 2.0	≤ 4.0	≤ 4.0	≤ 6.0
	16 QAM		≤ 2.5	≤ 4.0	≤ 4.0	≤ 6.0
	64 QAM		≤ 3.5	≤ 4.0	≤ 4.5	≤ 6.0
	256 QAM		≤ 5.0	≤ 5.5	≤ 5.5	≤ 6.0
CP-OFDM	QPSK		≤ 3.5	≤ 4.5	≤ 4.0	≤ 6.0
	16 QAM		≤ 4.0	≤ 4.5	≤ 4.0	≤ 6.0
	64 QAM		≤ 5.5	≤ 5.0	≤ 5.5	≤ 6.5
	256 QAM		≤ 7.0	≤ 6.5	≤ 7.0	≤ 7.0

NOTE 1: Full allocation A-MPR applies when all RB's in a 20 MHz channel or all RB's in all sub-bands for wideband operation are fully allocated and all sub-bands are transmitted. Partial allocation A-MPR applies when one or more RB's in one or more sub-bands are not allocated but when

all sub-bands within the channel are transmitted. When not all sub-bands within the channel are transmitted, the A-MPR associated with the channel bandwidth according to the bandwidth of the contiguously transmitted sub-bands and according to the allocation type applies.

6.2F.3.4 A-MPR for NS_30

When "NS_30" is indicated in the cell, the A-MPR is specified in Table 6.2F.3.4-1.

Table 6.2F.3.4-1: A-MPR for NS_30 power class 5

Pre-coding	Modulation	RB Allocation (Note 2)		RB Allocation (Note 3)		RB Allocation (Note 4)
		Full (dB)	Partial (dB)	Full (dB)	Partial (dB)	Full/Partial
DFT-s-OFDM	QPSK	≤ 9.0	≤ 15.0	≤ 2.5	≤ 5.0	See Table 6.2F.2-1
	16 QAM	≤ 9.0	≤ 15.5	≤ 3.0	≤ 5.0	
	64 QAM	≤ 9.0	≤ 15.5	≤ 4.5	≤ 5.5	
	256 QAM	≤ 9.0	≤ 16.0	≤ 5.5	≤ 5.5	
CP-OFDM	QPSK	≤ 9.0	≤ 14.0	≤ 4.0	≤ 6.0	
	16 QAM	≤ 9.5	≤ 14.5	≤ 4.0	≤ 6.0	
	64 QAM	≤ 9.5	≤ 15.0	≤ 5.5	≤ 6.5	
	256 QAM	≤ 9.5	≤ 15.0	≤ 7.0	≤ 7.0	

NOTE 1: Full allocation A-MPR applies when all RB's in a 20 MHz channel or all RB's in all sub-bands for wideband operation are fully allocated and all sub-bands are transmitted. Partial allocation A-MPR applies when one or more RB's in one or more sub-bands are not allocated or when not all transmitted sub-bands for wideband operation are transmitted.

NOTE 2: Applicable for 20 MHz channels centered at the nearest NR-ARFCN corresponding to 5160, 5340, 5480, and 5700 MHz, 40 MHz channels centered at the nearest NR-ARFCN corresponding to 5170, 5190, 5310, 5330, 5490, and 5510 MHz, 60 MHz channels centered at the nearest NR-ARFCN corresponding to 5180, 5200, 5220, 5280, 5300, 5320, 5500, 5520, 5540, 5680 MHz, and 80 MHz channels centered at the nearest NR-ARFCN corresponding to 5190, 5210, 5290, 5310, 5510, and 5530 MHz.

NOTE 3: Applicable for 20 MHz channels centered at the nearest NR-ARFCN corresponding to 5180 and 5320 MHz, and 40 MHz channels centered at the nearest NR-ARFCN corresponding to 5230 and 5270 MHz.

NOTE 4: Applicable for all valid channels other than those enumerated under NOTE 2 and NOTE 3.

6.2F.3.5 A-MPR for NS_31

When "NS_31" is indicated in the cell, the A-MPR is specified in Table 6.2F.3.5-1.

Table 6.2F.3.5-1: A-MPR for NS_31 power class 5

Pre-coding	Modulation	RB Allocation (Note 2)	RB Allocation (Note 3)	
		Full/Partial	Full (dB)	Partial (dB)
DFT-s-OFDM	QPSK	See Table 6.2F.2-1	≤ 4.0	≤ 6.5
	16 QAM		≤ 4.0	≤ 6.5
	64 QAM		≤ 4.0	≤ 6.5
	256 QAM		≤ 5.0	≤ 6.5
CP-OFDM	QPSK		≤ 5.5	≤ 6.5
	16 QAM		≤ 5.5	≤ 7.0
	64 QAM		≤ 5.5	≤ 7.0
	256 QAM		≤ 7.0	≤ 7.0

NOTE 1: Full allocation A-MPR applies when all RB's in a 20 MHz channel or all RB's in all sub-bands for wideband operation are fully allocated and all sub-bands are transmitted. Partial allocation A-MPR applies when one or more RB's in one or more sub-bands are not allocated or when not all transmitted sub-bands for wideband operation are transmitted.

NOTE 2: Applicable for 20 MHz channels centered at the nearest NR-ARFCN corresponding to 5180, 5200, 5220, 5280, 5300, 5320, 5500, 5520,

5540, 5560, 5580, 5600, 5620, 5640, 5660, 5680, 5745, 5765, 5785, and 5805 MHz.
 NOTE 3: Applicable for all valid channels and bandwidths other than those enumerated in NOTE 2.

6.2F.3.6 A-MPR for NS_53

When "NS_53" is indicated in the cell, the A-MPR is specified in Table 6.2F.3.6-1.

Table 6.2F.3.6-1: A-MPR for NS_53 power class 5

Pre-coding	Modulation	Channel bandwidth (Sub-band allocation) / RB Allocation							
		20 MHz		40 MHz		60 MHz		80 MHz	
		Full (dB)	Partial (dB)	Full (dB)	Partial (dB)	Full (dB)	Partial (dB)	Full (dB)	Partial (dB)
DFT-s-OFDM	QPSK	≤ 9.0	≤ 12.0	≤ 6.5	≤ 8.5	≤ 4.5	≤ 6.5	≤ 3.0	≤ 5.5
	16 QAM	≤ 9.0	≤ 12.0	≤ 6.5	≤ 8.5	≤ 4.5	≤ 6.5	≤ 3.0	≤ 5.5
	64 QAM	≤ 9.0	≤ 12.0	≤ 6.5	≤ 8.5	≤ 4.5	≤ 6.5	≤ 4.0	≤ 5.5
	256 QAM	≤ 9.0	≤ 12.0	≤ 6.5	≤ 8.5	≤ 5.0	≤ 7.0	≤ 5.0	≤ 5.5
CP-OFDM	QPSK	≤ 9.0	≤ 12.0	≤ 6.5	≤ 8.5	≤ 4.5	≤ 6.5	≤ 4.0	≤ 5.5
	16 QAM	≤ 9.0	≤ 12.0	≤ 6.5	≤ 8.5	≤ 4.5	≤ 6.5	≤ 4.0	≤ 5.5
	64 QAM	≤ 9.0	≤ 12.0	≤ 6.5	≤ 8.5	≤ 5.5	≤ 6.5	≤ 5.5	≤ 5.5
	256 QAM	≤ 9.0	≤ 12.0	≤ 7.0	≤ 8.5	≤ 7.0	≤ 7.0	≤ 7.0	≤ 7.0

NOTE 1: Full allocation A-MPR applies when all RB's in a 20 MHz channel or all RB's in all sub-bands for wideband operation are fully allocated and all sub-bands are transmitted. Partial allocation A-MPR applies when one or more RB's in one or more sub-bands are not allocated but when all sub-bands within the channel are transmitted. When not all sub-bands within the channel are transmitted, the A-MPR associated with the channel bandwidth according to the bandwidth of the contiguously transmitted sub-bands and according to the allocation type applies.

6.2F.3.7 A-MPR for NS_54

When "NS_54" is indicated in the cell, the A-MPR is specified in Table 6.2F.3.7-1.

Table 6.2F.3.7-1: A-MPR for NS_54 power class 5

Pre-coding	Modulation	RB Allocation (Note 2)	RB Allocation (Note 3)	
		Full/Partial	Full (dB)	Partial (dB)
DFT-s-OFDM	QPSK	See Table 6.2F.2-1	≤ 2.5	≤ 5.0
	16 QAM		≤ 3.0	≤ 5.0
	64 QAM		≤ 3.5	≤ 5.0
	256 QAM		≤ 5.0	≤ 6.0
CP-OFDM	QPSK		≤ 4.5	≤ 6.0
	16 QAM		≤ 4.5	≤ 6.0
	64 QAM		≤ 5.5	≤ 6.0
	256 QAM		≤ 7.0	≤ 7.0

NOTE 1: Full allocation A-MPR applies when all RB's in a 20 MHz channel or all RB's in all sub-bands for wideband operation are fully allocated and all sub-bands are transmitted. Partial allocation A-MPR applies when one or more RB's in one or more sub-bands are not allocated or when not all transmitted sub-bands for wideband operation are transmitted.
 NOTE 2: Applicable for all valid channels and bandwidths other than those enumerated in NOTE 3.
 NOTE 3: Applicable for 40 MHz channels centered at the nearest NR-ARFCN corresponding to [5965 MHz], 60 MHz channels centered at the nearest NR-ARFCN corresponding to [5975 and 5995 MHz], and 80 MHz channels centered at the nearest NR-ARFCN corresponding to [5985 MHz].

6.2F.3A UE additional maximum output power reduction for CA

6.2F.3A.1 UE additional maximum output power reduction for inter-band CA

For inter-band carrier aggregation with uplink assigned to two bands, the requirements in clause 6.2.3 apply for the NR uplink carrier and clause 6.2F.3 for the carrier operating with shared spectrum access.

6.2F.4 Configured transmitted power

The requirements for configured maximum output power in clause 6.2.4 apply.

6.3 Output power dynamics

6.3.1 Minimum output power

The minimum controlled output power of the UE is defined as the power in the channel bandwidth for all transmit bandwidth configurations (resource blocks), when the power is set to a minimum value.

The minimum output power is defined as the mean power in at least one sub-frame 1 ms. The minimum output power shall not exceed the values specified in Table 6.3.1-1. For UE power class 1.5 the minimum output power is defined as the sum of the minimum output power from both UE antenna connectors.

Table 6.3.1-1: Minimum output power

Channel bandwidth (MHz)	Minimum output power (dBm)	Measurement bandwidth (MHz)
5	-40	4.515
10	-40	9.375
15	-40	14.235
20	-40	19.095
25	-39	23.955
30	-38.2	28.815
40	-37	38.895
50	-36	48.615
60	-35.2	58.35
70	-34.6	68.07
80	-34	78.15
90	-33.5	88.23
100	-33	98.31

6.3.2 Transmit OFF power

Transmit OFF power is defined as the mean power in the channel bandwidth when the transmitter is OFF. The transmitter is considered OFF when the UE is not allowed to transmit on any of its ports..

The transmit OFF power is defined as the mean power in a duration of at least one sub-frame (1 ms) excluding any transient periods. The transmit OFF power shall not exceed the values specified in Table 6.3.2-1.

Table 6.3.2-1: Transmit OFF power

Channel bandwidth (MHz)	Transmit OFF power (dBm)	Measurement bandwidth (MHz)
5	-50	4.515
10	-50	9.375
15	-50	14.235
20	-50	19.095
25	-50	23.955
30	-50	28.815
40	-50	38.895
50	-50	48.615

60	-50	58.35
70	-50	68.07
80	-50	78.15
90	-50	88.23
100	-50	98.31

6.3.3 Transmit ON/OFF time mask

6.3.3.1 General

The transmit power time mask defines the transient period(s) allowed

- between transmit OFF power as defined in clause 6.3.2 and transmit ON power symbols (transmit ON/OFF)
- between continuous ON-power transmissions with power change or RB hopping is applied. When a UE signals the transient period capability, the transient period value (tp) can be 2, 4, or 7 μ s. If no capability is signalled, the default transient period value of 10 μ s applies.

In case of RB hopping, and in following figures where tp_{start} is specified, the transient period is shared symmetrically when the transient period is 10 μ sec. If the UE signals a transient period (tp) of 2, 4 or 7 μ s, the transient period start position is given by tp_{start} in Table 6.3.3.1-1.

Table 6.3.3.1-1: tp_{start} values

tp (μ s)	tp_{start} (μ s)
2	-0.5
4	-1
7	-2.7

NOTE 1: Negative values mean that the transient period starts before the symbol boundary

Unless otherwise stated the requirements in clause 6.5 apply also in transient periods.

In the following clauses, following definitions apply:

- A slot or long subslot transmission is a transmission with more than 2 symbols.
- A short subslot transmission is a transmission with 1 or 2 symbols.

6.3.3.2 General ON/OFF time mask

The general ON/OFF time mask defines the observation period between transmit OFF and ON power and between transmit ON and OFF power for each SCS. ON/OFF scenarios include: contiguous, and non-contiguous transmission, etc

The OFF power measurement period is defined in a duration of at least one slot excluding any transient periods. The ON power is defined as the mean power over one slot excluding any transient period.



Figure 6.3.3.2-1: General ON/OFF time mask for NR UL transmission in FR1

6.3.3.3 Transmit power time mask for slot and short or long subslot boundaries

The transmit power time mask for slot and a long subslot transmission boundaries defines the transient periods allowed between slot and long subslot PUSCH transmissions. For PUSCH-PUCCH and PUSCH-SRS transitions and multiplexing the time masks in clause 6.3.3.7 apply.

The transmit power time mask for slot or long subslot and short subslot transmission boundaries defines the transient periods allowed between slot or long subslot and short subslot transmissions. The time masks in clause 6.3.3.8 apply.

The transmit power time mask for short subslot transmission boundaries defines the transient periods allowed between short subslot transmissions. The time masks in clause 6.3.3.9 apply.

6.3.3.4 PRACH time mask

The PRACH ON power is specified as the mean power over the PRACH measurement period excluding any transient periods as shown in Figure 6.3.3.4-1. The measurement period for different PRACH preamble format is specified in Table 6.3.3.4-1.

Table 6.3.3.4-1: PRACH ON power measurement period

PRACH preamble format	SCS (kHz)	Measurement period (ms)
0	1.25	0.903125
1	1.25	2.284375
2	1.25	3.352604
3	5	0.903125
A1	15	0.142708
	30	0.071354
A2	15	0.285417
	30	0.142708
A3	15	0.428125
	30	0.2140625
B1	15	0.140365
	30	0.070182
B4	15	0.83046875
	30	0.415234375
A1/B1	15	0.142708 ms for first six occasion 0.140365 ms for the last occasion
	30	0.071354 ms for first six occasion 0.070182 ms for the last occasion
A2/B2	15	0.285417 ms for first two occasion 0.278385 ms for the third occasion
	30	0.142708 ms for first two occasion

		0.1391925 ms for the third occasion
A3/B3	15	0.428125 ms for the first occasion 0.41640625 ms for the second occasion
	30	0.2140625 ms for the first occasion 0.208203125 ms for the second occasion
C0	15	0.10703125
	30	0.053515625
C2	15	0.333333
	30	0.166667
NOTE: For PRACH on PRACH occasion start from the beginning of 0.5 ms or span the boundary of 0.5 ms of the subframe, the measurement period will plus 0.032552 μ s		

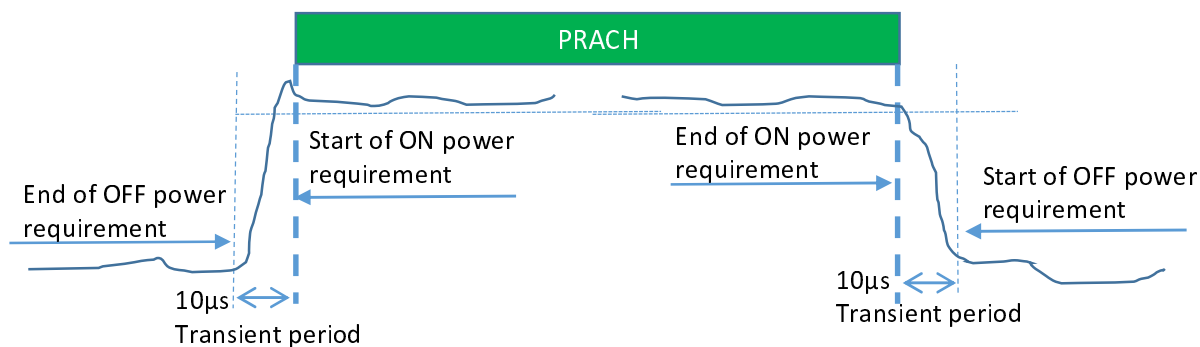

Figure 6.3.3.4-1: PRACH ON/OFF time mask

6.3.3.5 Void

6.3.3.6 SRS time mask

For SRS transmission mapped to one OFDM symbol, the ON power is defined as the mean power over the symbol duration excluding any transient period; See Figure 6.3.3.6-1

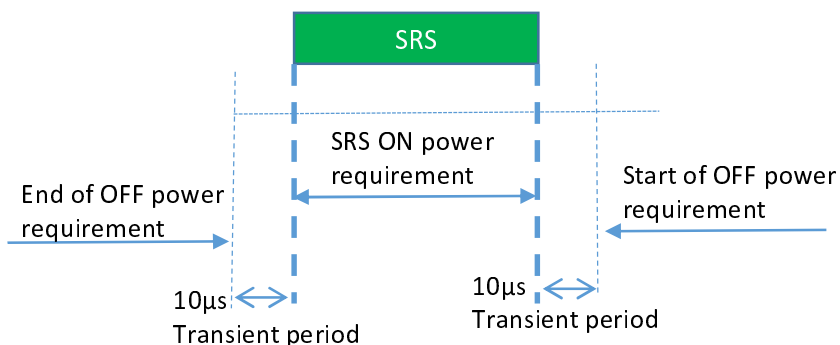

Figure 6.3.3.6-1: Single SRS time mask for NR UL transmission

For SRS transmission mapped to two or more OFDM symbols the ON power is defined as the mean power for each symbol duration excluding any transient period. For consecutive SRS transmissions without power change, Figure 6.3.3.6-2 applies.

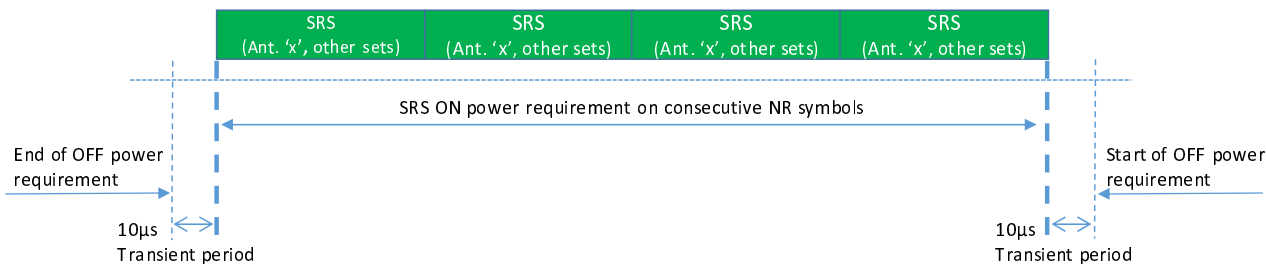

Figure 6.3.3.6-2: Consecutive SRS time mask for the case when no power change is required with SRS usage other than antenna switching.

When power change between consecutive SRS transmissions is required, then Figure 6.3.3.6-3 and Figure 6.3.3.6-4 apply.

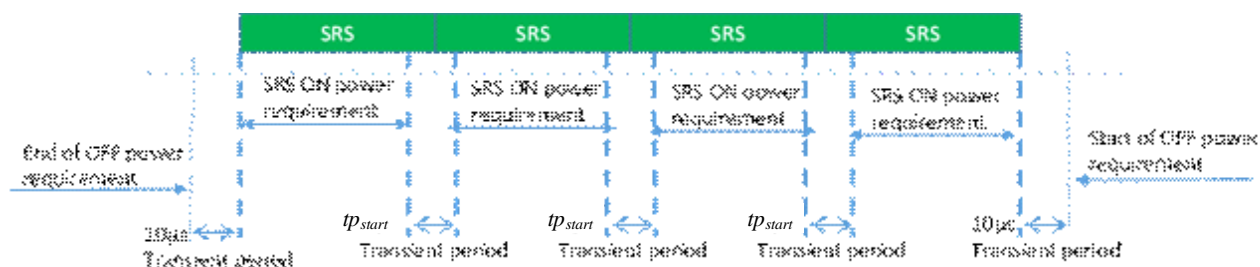

Figure 6.3.3.6-3: Consecutive SRS time mask for the case when power change is required and when 15 kHz and 30 kHz SCS is used in FR1 with SRS usage other than antenna switching.

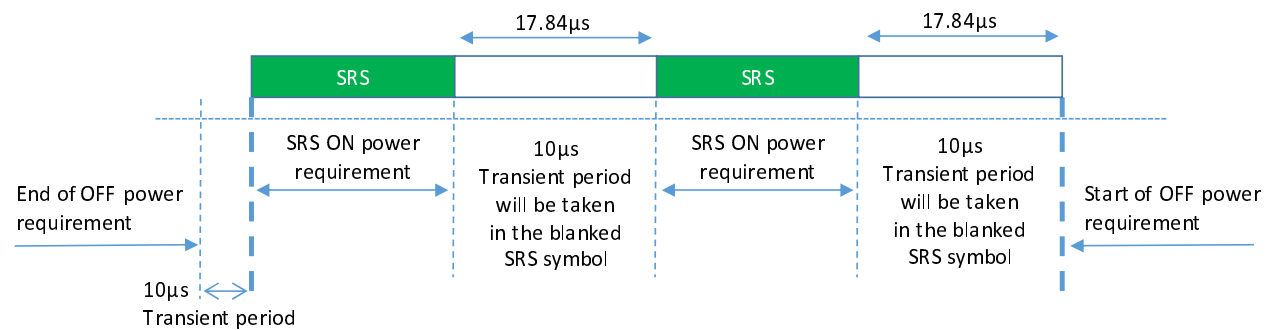

Figure 6.3.3.6-4: Consecutive SRS time mask for the case when power change is required and when 60 kHz SCS is used in FR1, when the transient period is 10 µs

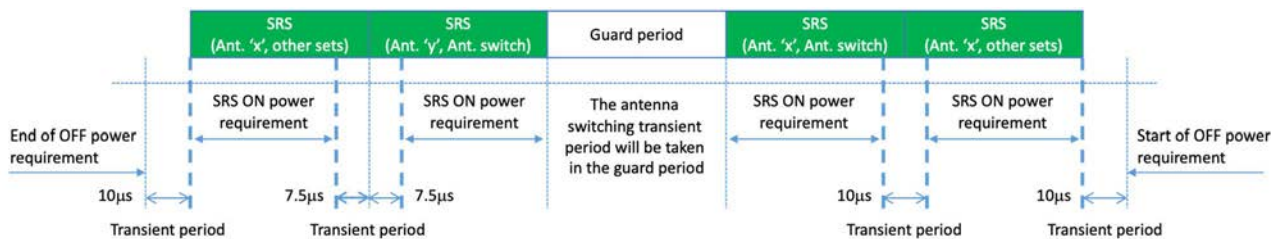

Figure 6.3.3.6-5: FR1 Time mask for 15 kHz and 30 kHz SCS for the case when consecutive SRS switching usage is between antenna switching & other sets

where "other sets" belongs to a "usage set" other than the set for antenna switching. The usage sets for SRS switching are defined in clause 6.2.1 of TS 38.214 [10].

NOTE: Guard period of one symbol is defined between two SRS resources of an SRS resource set for antenna switching for 15kHz, 30kHz and 60kHz SCS in Table 6.2.1.2-1 of TS 38.214 [10].

The above transient period applies to all the transmit CCs in CA with the CC sounding SRS. UE RF requirements do not apply during this transient period.

6.3.3.7 PUSCH-PUCCH and PUSCH-SRS time masks

The PUCCH/PUSCH/SRS time mask defines the observation period between sounding reference symbol (SRS) and an adjacent PUSCH/PUCCH symbol and subsequent UL transmissions. The time masks apply for all types of frame structures and their allowed PUCCH/PUSCH/SRS transmissions unless otherwise stated.

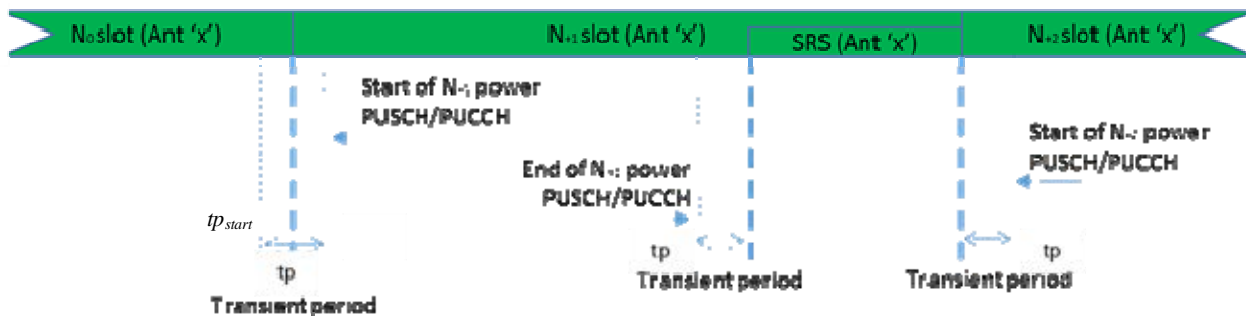

Figure 6.3.3.7-1: PUCCH/PUSCH/SRS time mask when there is a transmission before or after or both before and after SRS, when sounded on the same antenna (Ant 'x')

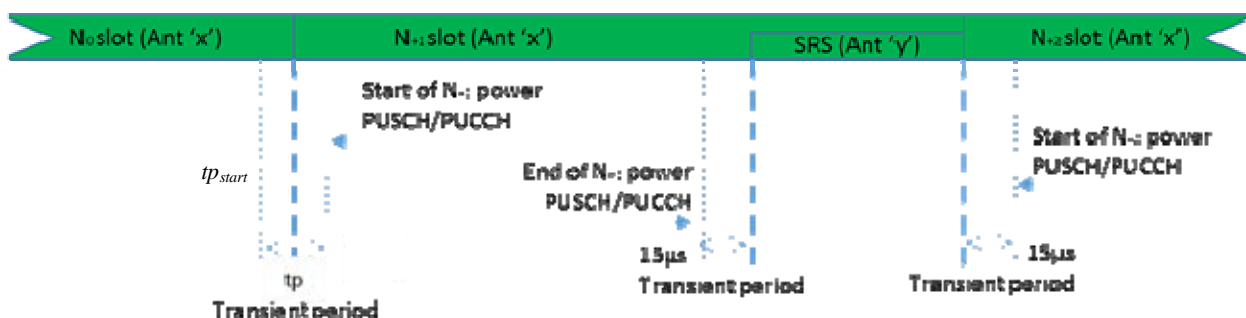

Figure 6.3.3.7-2: PUCCH/PUSCH/SRS time mask when there is a transmission before or after or both before and after SRS, when sounded on a different antenna (Ant 'x' and Ant 'y' are different antenna ports)

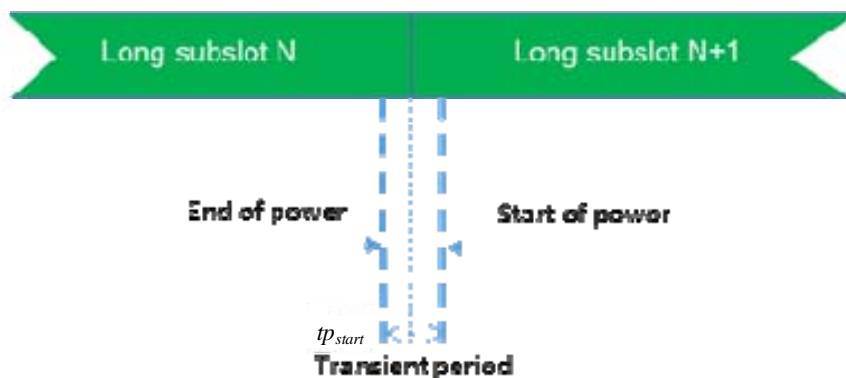

Figure 6.3.3.7-3: Consecutive long subslot transmission and long subslot transmission time mask

This transient period of 15 μ sec applies before and after SRS transmission to all the transmit CCs in CA with the CC sounding SRS. UE RF requirements do not apply during this transient period.

When there is no transmission preceding SRS transmission or succeeding SRS transmission, then the same time mask applies as shown in Figure 6.3.3.7-1.

6.3.3.8 Transmit power time mask for consecutive slot or long subslot transmission and short subslot transmission boundaries

The transmit power time mask for consecutive slot or long subslot transmission and short slot transmission boundaries defines the transient periods allowed between such transmissions.

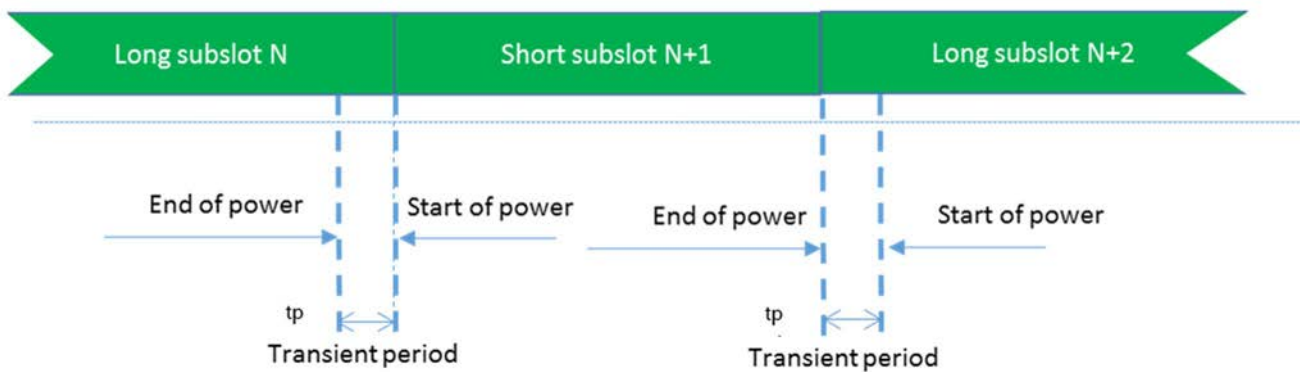

Figure 6.3.3.8-1: Consecutive slot or long subslot transmission and short subslot transmission time mask

6.3.3.9 Transmit power time mask for consecutive short subslot transmissions boundaries

The transmit power time mask for consecutive short subslot transmission boundaries defines the transient periods allowed between short subslot transmissions.

The transient period shall be equally shared as shown on Figure 6.3.3.9-2.

Figure 6.3.3.9-1: Void

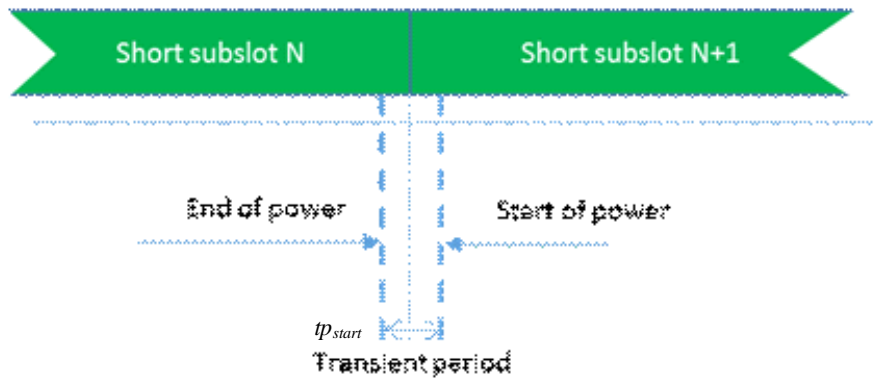

Figure 6.3.3.9-2: Consecutive short subslot transmissions time mask

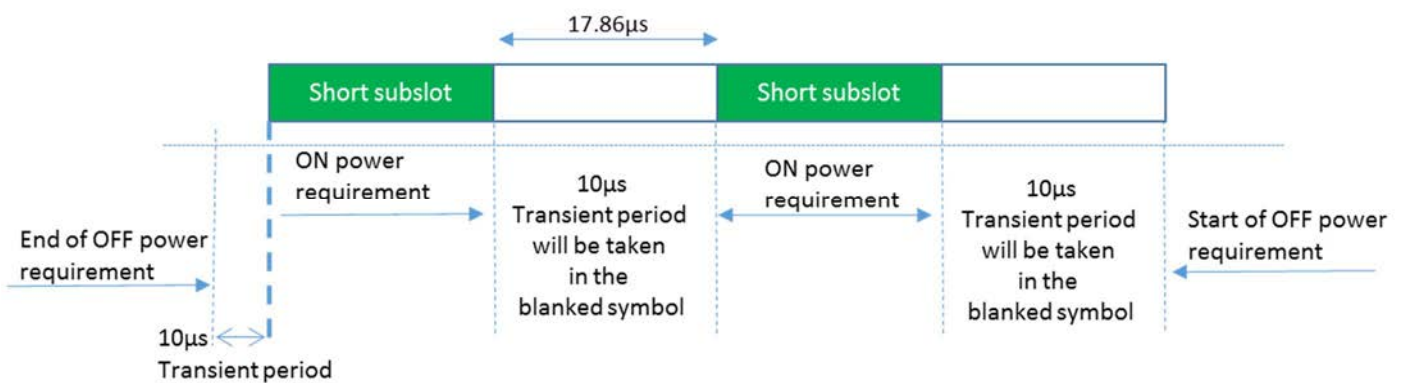

Figure 6.3.3.9-3: Consecutive short subslot (1 symbol gap) time mask for the case when transient period is required on both sides of the symbol and when 60 kHz SCS is used in FR1, when the transient period is 10 µs.

6.3.4 Power control

6.3.4.1 General

The requirements on power control accuracy apply under normal conditions. For UE power class 1.5 the power control accuracy requirements apply for the sum of the output power from both UE antenna connectors.

6.3.4.2 Absolute power tolerance

The absolute power tolerance is the ability of the UE transmitter to set its initial output power to a specific value for the first sub-frame (1 ms) at the start of a contiguous transmission or non-contiguous transmission with a transmission gap larger than 20 ms. The tolerance includes the channel estimation error.

The minimum requirement specified in Table 6.3.4.2-1 apply in the power range bounded by the minimum output power as specified in clause 6.3.1 and the maximum output power as specified in clause 6.2.1.

Table 6.3.4.2-1: Absolute power tolerance

Conditions	Tolerance
Normal	± 9.0 dB

6.3.4.3 Relative power tolerance

The relative power tolerance is the ability of the UE transmitter to set its output power in a target sub-frame (1 ms) relatively to the power of the most recently transmitted reference sub-frame (1 ms) if the transmission gap between these sub-frames is less than or equal to 20 ms.

The minimum requirements specified in Table 6.3.4.3-1 apply when the power of the target and reference sub-frames are within the power range bounded by the minimum output power as defined in clause 6.3.1 and the measured P_{UMAX} as defined in clause 6.2.4.

To account for RF Power amplifier mode changes, 2 exceptions are allowed for each of two test patterns. The test patterns are a monotonically increasing power sweep and a monotonically decreasing power sweep over a range bounded by the requirements of minimum power and maximum power specified in clauses 6.3.1 and 6.2.1, respectively. For those exceptions, the power tolerance limit is a maximum of ± 6.0 dB in Table 6.3.4.3-1.

Table 6.3.4.3-1: Relative power tolerance

Power step ΔP (Up or down) (dB)	All combinations of PUSCH and PUCCH transitions (dB)	All combinations of PUSCH/PUCCH and SRS transitions between sub- frames (dB)	PRACH (dB)
$\Delta P < 2$	± 2.0 (NOTE)	± 2.5	± 2.0
$2 \leq \Delta P < 3$	± 2.5	± 3.5	± 2.5
$3 \leq \Delta P < 4$	± 3.0	± 4.5	± 3.0
$4 \leq \Delta P < 10$	± 3.5	± 5.5	± 3.5
$10 \leq \Delta P < 15$	± 4.0	± 7.0	± 4.0
$15 \leq \Delta P$	± 5.0	± 8.0	± 5.0
NOTE: For PUSCH to PUSCH transitions with the allocated resource blocks fixed in frequency and no transmission gaps other than those generated by downlink subframes, DwPTS fields or Guard Periods: for a power step $\Delta P \leq 1$ dB, the relative power tolerance for transmission is ± 0.7 dB.			

6.3.4.4 Aggregate power tolerance

The aggregate power control tolerance is the ability of the UE transmitter to maintain its power in a sub-frame (1 ms) during non-contiguous transmissions within 21 ms in response to 0 dB commands with respect to the first UE transmission and all other power control parameters as specified in TS 38.213 [8] kept constant.

The minimum requirement specified in Table 6.3.4.4-1 apply in the power range bounded by the minimum output power as specified in clause 6.3.1 and the maximum output power as specified in clause 6.2.1.

Table 6.3.4.4-1: Aggregate power tolerance

TPC command	UL channel	Aggregate power tolerance within 21 ms
0 dB	PUCCH	± 2.5 dB
0 dB	PUSCH	± 3.5 dB

6.3A Output power dynamics for CA

6.3A.1 Minimum output power for CA

6.3A.1.1 Minimum output power for intra-band contiguous CA

For intra-band contiguous carrier aggregation, the minimum output power is defined per carrier and the requirement is specified in clause 6.3.1.

6.3A.1.2 Minimum output power for intra-band non-contiguous CA

For intra-band non-contiguous carrier aggregation, the minimum output power is defined per carrier and the requirement is specified in clause 6.3.1.

6.3A.1.3 Minimum output power for inter-band CA

For inter-band carrier aggregation with one uplink carrier assigned to one NR band, the minimum output power requirements in clause 6.3.1 apply.

For inter-band carrier aggregation with two uplink contiguous carrier assigned to one NR band, the minimum output power requirements in subclause 6.3A.1.1 apply for those carriers.

For inter-band carrier aggregation with uplink assigned to two NR bands, the minimum output power is defined per carrier and the requirement is specified in clause 6.3.1.

6.3A.1.4 Void

6.3A.2 Transmit OFF power for CA

6.3A.2.1 Transmit OFF power for intra-band contiguous CA

For intra-band contiguous carrier aggregation, the transmit OFF power specified in clause 6.3.2 is applicable for each component carrier when the transmitter is OFF on all component carriers. The transmitter is considered to be OFF when the UE is not allowed to transmit on any of its ports.

6.3A.2.2 Transmit OFF power for intra-band non-contiguous CA

For intra-band non-contiguous carrier aggregation, the transmit OFF power specified in clause 6.3.2 is applicable for each component carrier when the transmitter is OFF on all component carriers. The transmitter is considered to be OFF when the UE is not allowed to transmit on any of its ports.

6.3A.2.3 Transmit OFF power for inter-band CA

For inter-band carrier aggregation with one uplink carrier assigned to one NR band, the transmit OFF power requirements in subclause 6.3.2 apply.

For inter-band carrier aggregation with two contiguous carriers assigned to one NR band, the transmit OFF power requirements in subclause 6.3A.2.1 apply for those carriers.

For inter-band carrier aggregation with uplink assigned to two NR bands, the transmit OFF power specified in clause 6.3.2 is applicable for each component carrier when the transmitter is OFF on all component carriers. The transmitter is considered to be OFF when the UE is not allowed to transmit on any of its ports.

6.3A.2.4 Void

6.3A.3 Transmit ON/OFF time mask for CA

6.3A.3.1 Transmit ON/OFF time mask for intra-band contiguous CA

For a intra-band contiguous carrier aggregation, the general output power ON/OFF time mask specified in clause 6.3.3.1 is applicable for each component carrier during the ON power period and the transient periods. The OFF period as specified in clause 6.3.3.1 shall only be applicable for each component carrier when all the component carriers are OFF.

6.3A.3.2 Transmit ON/OFF time mask for intra-band non-contiguous CA

For a intra-band non-contiguous carrier aggregation, the general output power ON/OFF time mask specified in clause 6.3.3.1 is applicable for each component carrier during the ON power period and the transient periods. The OFF period as specified in clause 6.3.3.1 shall only be applicable for each component carrier when all the component carriers are OFF.

6.3A.3.3 Transmit ON/OFF time mask for inter-band CA

6.3A.3.3.1 General

For inter-band carrier aggregation with one uplink carrier assigned to one NR band, the transmit ON/OFF time mask requirements in subclause 6.3.3 apply.

For inter-band carrier aggregation with two contiguous carriers assigned to one NR band, the transmit ON/OFF time mask requirements in subclause 6.3A.3.1 apply for those carriers.

For inter-band carrier aggregation with uplink assigned to two NR bands, the general output power ON/OFF time mask specified in clause 6.3.3.1 is applicable for each component carrier during the ON power period and the transient periods. The OFF period as specified in clause 6.3.3.1 shall only be applicable for each component carrier when all the component carriers are OFF.

Time masks for Tx switching due to switching period are defined in clauses 6.3A.3.3.2 for both single TAG and dual-TAG scenarios. When a UE is configured with dual-TAG with at least two cells corresponding to two TAGs involved in one switching event, the timing advance difference should be considered in the time masks in sub-clauses 6.3A.3.3.2 for two uplink carriers. The UE may omit uplink transmission on OFDM symbols that partially or fully overlap with the configured switching period for any timing advance difference.

When the location of the switching period by *uplinkTxSwitchingPeriodLocation* is ignored by the UE, the length and location of allowed transient periods for dual TAG are as specified in 6.3A.3.3.2 with the UE scheduled or configured with uplink transmissions that do not result in

- simultaneous transmission on two antenna ports on one uplink carrier on one band, and any transmission on another uplink carrier on another band
- transmission of any of the carriers for a duration of at least the uplink switching gap indicated by UE capability

for any timing difference between uplink carriers in different bands up to the MTTD specified for UL CA in clause 7.5.4 of [7] in case of dual TAG.

Carriers within the same band belong to the same TAG in all cases.

6.3A.3.3.2 Time mask for switching between two uplink carriers

In addition to the requirements in 6.3A.3.3.1 and the maximum output power requirement specified in Table 6.2A.1.3-1 with uplink assigned to two NR bands, the switching time mask specified in this sub-clause is applicable for an uplink band pair of a inter-band UL CA configuration when the capability *uplinkTxSwitchingPeriod* is present, and is only applicable for uplink switching mechanisms specified in sub-clause 6.1.6 of TS 38.214 [10], where NR UL carrier 1 is capable of one transmit antenna connector and NR UL carrier 2 is capable of two transmit antenna connectors with 3dB boosting on the maximum output power when the capability *uplinkTxSwitching-PowerBoosting* is present and the IE *uplinkTxSwitchingPowerBoosting* is enabled, and the two uplink carriers are in different bands with different carrier frequencies. The UE shall support the switch between single layer transmission with one antenna port and two-layer transmission with two antenna ports on the two uplink carriers following the scheduling commands and rank adaptation, i.e., both single layer and two-layer transmission with 2 antenna ports, and single layer transmission with 1 antenna port shall be supported on NR UL carrier 2 as specified in [38.306].

The switching periods described in Figure 6.3A.3.3.2-1a and Figure 6.3A.3.3.2-1b are located in either NR carrier 1 or carrier 2 as indicated in RRC signalling *uplinkTxSwitchingPeriodLocation* [7], and the length of uplink switching period X is less than the value indicated by UE capability *uplinkTxSwitchingPeriod*.

When switching from one carrier to another, if there is no uplink transmission scheduled or configured on the switch-from carrier for at least the duration of the switching period ($X \mu\text{s}$) before the point in time the UE is scheduled or configured to start the transmission on the switch-to carrier, the switching period is fully contained in the time period

between the end of the transmission on the switch-from carrier and the start of the transmission on the switch-to carrier. In addition, the RRC signalling *uplinkTxSwitchingPeriodLocation* is ignored by the UE and does not take effect in this case.

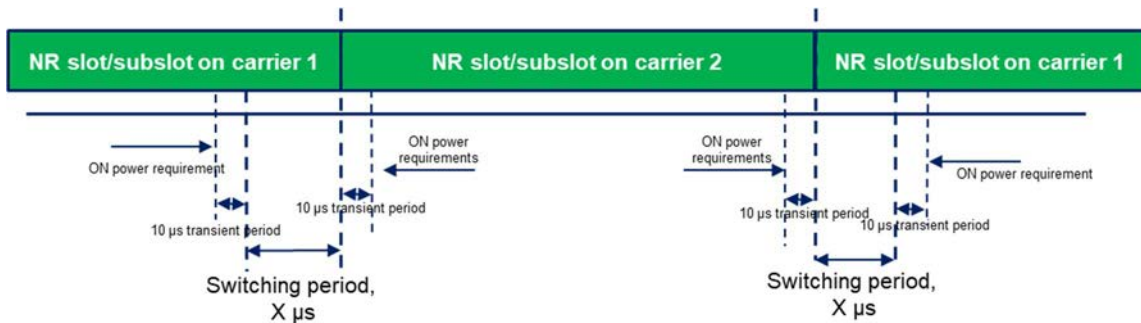

Figure 6.3A.3.3.2-1a: Time mask for switching between UL carrier 1 and UL Carrier 2, where the switching period is located in carrier 1

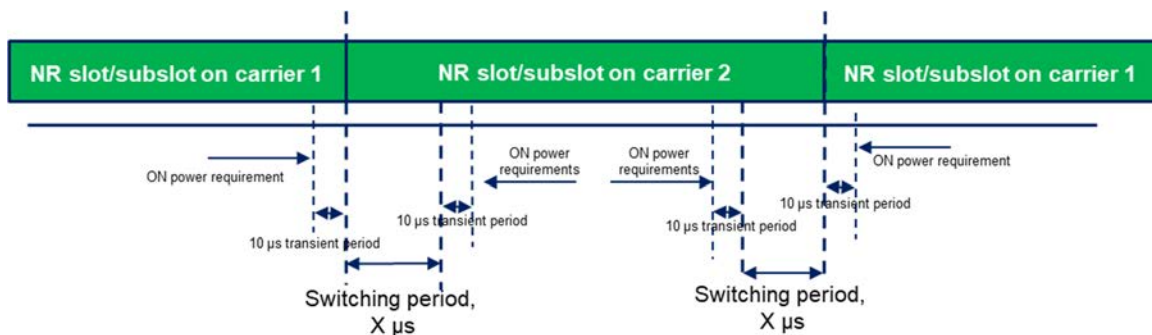

Figure 6.3A.3.3.2-1b: Time mask for switching between UL carrier 1 and UL Carrier 2, where the switching period is located in carrier 2

The following applies for the uplink switching cases specified in clause 6.1.6.2 of [10] with *uplinkTxSwitchingOption* set to either *switchedUL* or *dualUL* when the configuration of the location of the switching period by *uplinkTxSwitchingPeriodLocation* is ignored by the UE:

- if an uplink switching is triggered for an uplink transmission starting at T_0 based on higher layer configuration(s) or DCI(s) received before $T_0 - T_{offset}$ as specified in [10] and the UE is not configured or scheduled with uplink transmissions for a duration of at least the uplink switching gap indicated by *uplinkTxSwitchingPeriod* on any of the carriers before T_0 , transient periods of $10 \mu s$ are located at the end of the last symbol(s) configured or scheduled on the carriers before T_0 and at the start of the first symbol(s) configured or scheduled at T_0 on the switch-to carrier.

The requirements apply for the case of both non-colocated and co-located and synchronized network deployment for the two uplink carriers.

The time mask is applicable to uplink transmissions when configured with *switchedUL* or *dualUL*.

6.3A.3.4 Void

6.3A.4 Power control for CA

6.3A.4.1 Power control for intra-band contiguous CA

6.3A.4.1.1 Absolute power tolerance

The absolute power tolerance is the ability of the UE transmitter to set its initial output power to a specific value for the first sub-frame at the start of a contiguous transmission or non-contiguous transmission with a transmission gap on each active component carriers larger than 20ms. The requirement can be tested by time aligning any transmission gaps on the component carriers.

6.3A.4.1.1.1 Minimum requirements

For intra-band contiguous carrier aggregation the absolute power control tolerance per component carrier is given in Table 6.3.4.2-1.

6.3A.4.1.2 Relative power tolerance

6.3A.4.1.2.1 Minimum requirements

For intra-band contiguous carrier aggregation, the requirements apply when the power of the target and reference sub-frames on each component carrier exceed the minimum output power as defined in clause 6.3A.1 and the total power is limited by P_{UMAX} as defined in clause 6.2A.4. The UE shall meet the following requirements for transmission on both assigned component carriers when the average transmit power per PRB is aligned across both assigned carriers in the reference sub-frame:

- a) for all possible combinations of PUSCH and PUCCH transitions per component carrier, the corresponding requirements given in Table 6.3.4.3-1;
- b) for SRS transitions on each component carrier, the requirements for combinations of PUSCH/PUCCH and SRS transitions given in Table 6.3.4.2-1 with simultaneous SRS of constant SRS bandwidth allocated in the target and reference subframes;
- c) for RACH on the primary component carrier, the requirements given in Table 6.3.4.3-1 for PRACH.

For a) and b) above, the power step ΔP between the reference and target subframes shall be set by a TPC command and/or an uplink scheduling grant transmitted by means of an appropriate DCI Format.

6.3A.4.1.3 Aggregate power control tolerance

For intra-band contiguous carrier aggregation, the aggregate power tolerance per component carrier is given in Table 6.3.4.4-1. The average power per PRB shall be aligned across both assigned carriers before the start of the test. The requirement can be tested with the transmission gaps time aligned between component carriers.

6.3A.4.2 Power control for intra-band non-contiguous CA

6.3A.4.2.1 Absolute power tolerance

The absolute power tolerance is the ability of the UE transmitter to set its initial output power to a specific value for the first sub-frame at the start of a contiguous transmission or non-contiguous transmission with a transmission gap on each active component carriers larger than 20ms. The requirement can be tested by time aligning any transmission gaps on the component carriers.

6.3A.4.2.1.1 Minimum requirements

For intra-band non-contiguous carrier aggregation the absolute power control tolerance per component carrier is given in Table 6.3.4.2-1.

6.3A.4.2.2 Relative power tolerance

6.3A.4.2.2.1 Minimum requirements

For intra-band non-contiguous carrier aggregation, the requirements apply when the power of the target and reference sub-frames on each component carrier exceed the minimum output power as defined in subclause 6.3A.1 and the total power is limited by P_{UMAX} as defined in subclause 6.2A.4. The UE shall meet the following requirements for transmission on both assigned component carriers when the average transmit power per PRB is aligned across both assigned carriers in the reference sub-frame:

- a) for all possible combinations of PUSCH and PUCCH transitions per component carrier, the corresponding requirements given in Table 6.3.4.3-1;
- b) for SRS transitions on each component carrier, the requirements for combinations of PUSCH/PUCCH and SRS transitions given in Table 6.3.4.3-1 with simultaneous SRS of constant SRS bandwidth allocated in the target and reference subframes;
- c) for RACH on the primary component carrier, the requirements given in Table 6.3.4.3-1 for PRACH.

For a) and b) above, the power step ΔP between the reference and target subframes shall be set by a TPC command and/or an uplink scheduling grant transmitted by means of an appropriate DCI Format.

6.3A.4.2.3 Aggregate power control tolerance

For intra-band non-contiguous carrier aggregation, the aggregate power tolerance per component carrier is given in Table 6.3.4.4-1. The average power per PRB shall be aligned across both assigned carriers before the start of the test. The requirement can be tested with the transmission gaps time aligned between component carriers.

6.3A.4.3 Power control for inter-band CA

No requirements unique to CA operation are defined.

6.3A.4.4 Void

6.3B Output power dynamics for NR-DC

For inter-band NR-DC with one uplink carrier assigned per NR band, the output power dynamics for the corresponding inter-band CA configuration as specified in subclause 6.3A applies.

6.3C Output power dynamics for SUL

6.3C.1 Void

6.3C.2 Void

6.3C.3 Transmit ON/OFF time mask for SUL

6.3C.3.1 Time mask for switching between two uplink carriers

The switching time mask specified in this sub-clause is applicable for an uplink band pair of a SUL configuration when the capability *uplinkTxSwitchingPeriod* is present, is only applicable for uplink switching mechanisms specified in sub-clause 6.1.6 of TS 38.214 [10], where NR SUL carrier 1 is capable of one transmit antenna connector and NR UL carrier 2 is capable of two transmit antenna connectors, and the two uplink carriers are in different bands with different carrier frequencies. The UE shall support the switch between single layer transmission with one antenna port and two-layer transmission with two antenna ports on the two uplink carriers following the scheduling commands and rank

adaptation, i.e., both single layer and two-layer transmission with 2 antenna ports, and single layer transmission with 1 antenna port shall be supported on NR UL carrier 2.

The switching periods described in Figure 6.3C.3.1-1a and Figure 6.3C.3.1-1b are located in either NR carrier 1 or carrier 2 as indicated in RRC signalling *uplinkTxSwitchingPeriodLocation* [7], and the length of uplink switching period X is less than the value indicated by UE capability *uplinkTxSwitchingPeriod*.

When switching from one carrier to another, if there is no uplink transmission scheduled or configured on the switch-from carrier for at least the duration of the switching period ($X \mu\text{s}$) before the point in time the UE is scheduled or configured to start the transmission on the switch-to carrier, the switching period is fully contained in the time period between the end of the transmission on the switch-from carrier and the start of the transmission on the switch-to carrier. In addition, the RRC signalling *uplinkTxSwitchingPeriodLocation* does not take effect in this case.

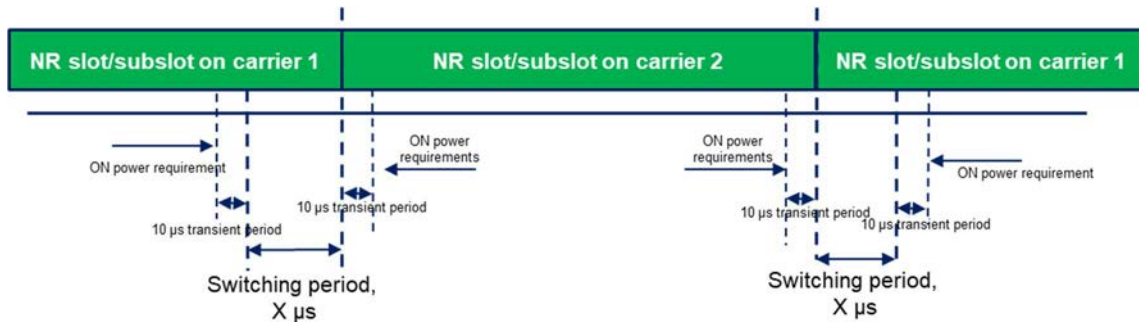

Figure 6.3C.3.1-1a: Time mask for switching between SUL carrier 1 and UL Carrier 2, where the switching period is located in carrier 1

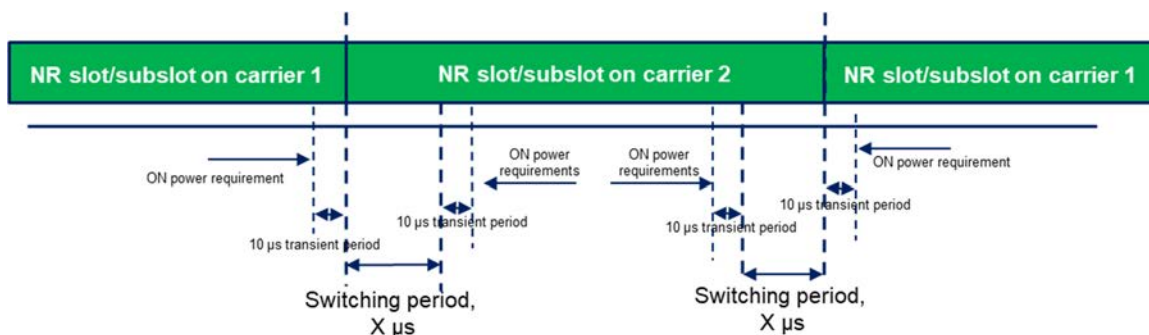

Figure 6.3C.3.1-1b: Time mask for switching between SUL carrier 1 and UL Carrier 2, where the switching period is located in carrier 2

The following applies for the uplink switching case specified in clause 6.1.6.3 of [10] when the configuration of the location of the switching period by *uplinkTxSwitchingPeriodLocation* is ignored by the UE:

- if an uplink switching is triggered for an uplink transmission starting at T_0 based on higher layer configuration(s) or DCI(s) received before $T_0 - T_{offset}$ as specified in [10] and the UE is not configured or scheduled with uplink transmissions for a duration of at least the uplink switching gap indicated by *uplinkTxSwitchingPeriod* on any of the carriers before T_0 , transient periods of $10 \mu\text{s}$ are located at the end of the last symbol(s) scheduled on the carriers before T_0 and at the start of the first symbol(s) configured or scheduled at T_0 .

The requirements apply for the case of co-located and synchronized network deployment for the two uplink carriers.

The requirements apply for the case of single TAG for the two uplink carriers, i.e., the same uplink timing for the two carriers as described in clause 4.2 of TS 38.213 [8].

6.3D Output power dynamics for UL MIMO

6.3D.1 Minimum output power for UL MIMO

For UE with two transmit antenna connectors in closed-loop spatial multiplexing scheme, the minimum output power is defined as the sum of the mean power from both transmit connector in one sub-frame (1 ms). The minimum output power shall not exceed the values specified in Table 6.3.1-1.

If UE is scheduled for single antenna-port PUSCH transmission by DCI format 0_0 or by DCI format 0_1 for single antenna port codebook based transmission, the requirements in clause 6.3.1 apply.

6.3D.2 Transmit OFF power for UL MIMO

The transmit OFF power is defined as the mean power at each transmit antenna connector in a duration of at least one sub-frame (1 ms) excluding any transient periods.

The transmit OFF power at each transmit antenna connector shall not exceed the values specified in Table 6.3.2-1.

6.3D.3 Transmit ON/OFF time mask for UL MIMO

For UE supporting UL MIMO, the ON/OFF time mask requirements in clause 6.3.3 apply at each transmit antenna connector.

For UE with two transmit antenna connectors in closed-loop spatial multiplexing scheme, the general ON/OFF time mask requirements specified in clause 6.3.3.1 apply to each transmit antenna connector. The requirements shall be met with the UL MIMO configurations described in clause 6.2D.1.

If UE is scheduled for single antenna-port PUSCH transmission by DCI format 0_0 or by DCI format 0_1 for single antenna port codebook based transmission, the requirements in clause 6.3.3 apply.

6.3D.4 Power control for UL MIMO

For UE supporting UL MIMO, the power control tolerance applies to the sum of output powers from both transmit antenna connector.

The power control requirements specified in clause 6.3.4 apply to UE with two transmit antenna connectors in closed-loop spatial multiplexing scheme. The requirements shall be met with UL MIMO configurations described in clause 6.2D.1.

If UE is scheduled for single antenna-port PUSCH transmission by DCI format 0_0 or by DCI format 0_1 for single antenna port codebook based transmission, the requirements in clause 6.3.4 apply.

6.3E Output power dynamics for V2X

6.3E.1 Minimum output power for V2X

6.3E.1.1 General

When UE is configured for NR V2X sidelink transmissions non-concurrent with NR uplink transmissions for NR V2X operating bands in Table 5.2E.1-1, the minimum output power is specified in Table 6.3E.1.1-1. The minimum output power is defined as the mean power in at least one sub-frame 1 ms.

Table 6.3E.1.1-1: Minimum output power

Channel bandwidth (MHz)	Minimum output power (dBm)	Measurement bandwidth (MHz)
10	-30	9.375
20	-30	19.095
30	-28.2	28.815

40	-27	38.895
----	-----	--------

For NR V2X UE with two transmit antenna connectors, the minimum output power is defined as the sum of the mean power at each transmit connector in one sub-frame (1 ms). The minimum output power shall not exceed the values specified for single carrier.

If the UE transmits on one antenna connector at a time, the requirements specified for single carrier shall apply to the active antenna connector.

6.3E.1.2 Minimum output power for V2X concurrent operation

For the inter-band con-current NR V2X operation, the requirements specified in clause 6.3.1 shall apply for the uplink in licensed band and the requirements specified in clause 6.3E.1.1 shall apply for the sidelink in licensed band or Band n47.

6.3E.2 Transmit OFF power for V2X

6.3E.2.1 General

When UE is configured for NR V2X sidelink transmissions non-concurrent with NR uplink transmissions for NR V2X operating bands in Table 5.2E.1-1, the requirements specified in current clause apply.

Table 6.3E.2.1-1: Transmit OFF power

Channel bandwidth (MHz)	Transmit OFF power (dBm)	Measurement bandwidth (MHz)
10	-50	9.375
20	-50	19.095
30	-50	28.815
40	-50	38.895

For NR V2X UE supporting SL MIMO, the transmit OFF power at each transmit antenna connector shall not exceed the values specified in Table 6.3E.2.1-1 for single carrier. Transmit off power is defined as the mean power in at least one sub-frame 1 ms.

6.3E.2.2 Transmit OFF power for V2X concurrent operation

For the inter-band con-current NR V2X operation, the requirements specified in clause 6.3.2 shall apply for the uplink in licensed band and the requirements specified in clause 6.3E.2.1 shall apply for the sidelink in licensed band or Band n47.

6.3E.3 Transmit ON/OFF time mask for V2X

6.3E.3.1 General

For NR V2X UE, additional requirements on ON/OFF time masks for V2X physical channels and signals are specified in this clause.

6.3E.3.2 General time mask

The General ON/OFF time mask defines the observation period between the Transmit OFF and ON power and between Transmit ON and OFF power for PSCCH, and PSSCH transmissions in a slot wherein the last symbol is punctured to create a guard period.

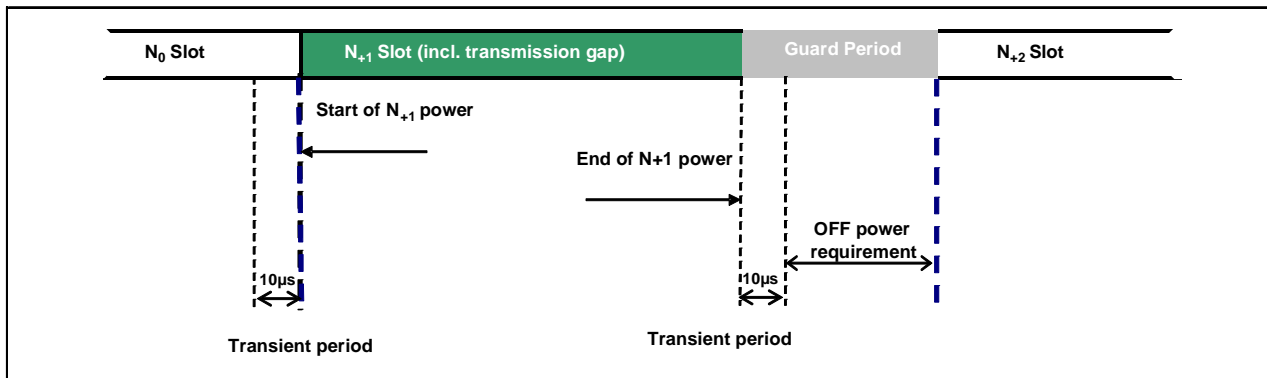

Figure 6.3E.3.2-1: General PSCCH/PSSCH time mask for NR V2X UE

For NR V2X UE supporting SL MIMO, the ON/OFF time mask requirements apply at each transmit antenna connector.

For UE with two transmit antenna connectors, the general ON/OFF time mask requirements specified in current subclause apply to each transmit antenna connector. The requirements shall be met with the SL MIMO configurations described in subclause 6.2D.1.

If the UE transmits on one antenna connector at a time, the general ON/OFF time mask requirements apply to the active antenna connector.

6.3E.3.3 S-SSB time mask

The S-PSS/S-SSS/PSBCH time mask for NR V2X UE defines the observation period between transmit OFF and ON S-PSS power and between transmit ON PSBCH and OFF power in a slot wherein the last symbol is punctured to create a guard period.

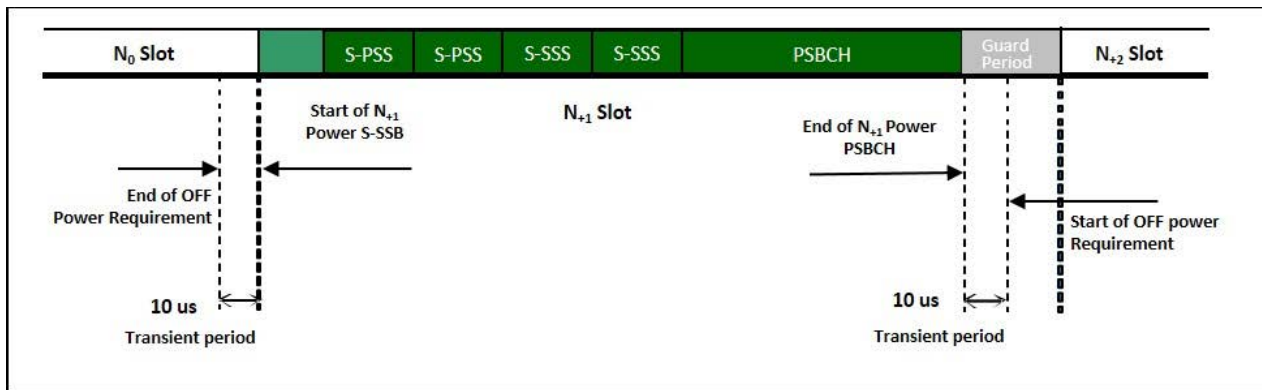

Figure 6.3E.3.3-1: S-SSB time mask for NR V2X UE

For NR V2X UE supporting SL MIMO, the ON/OFF time mask requirements apply at each transmit antenna connector.

For UE with two transmit antenna connectors, the S-SSB ON/OFF time mask requirements specified in current subclause apply to each transmit antenna connector. The requirements shall be met with the SL MIMO configurations described in subclause 6.2D.1.

If the UE transmits on one antenna connector at a time, the S-SSB ON/OFF time mask requirements apply to the active antenna connector.

6.3E.3.4 Transmit ON/OFF time mask for V2X concurrent operation

For the inter-band concurrent NR V2X operation, the requirements specified in clause 6.3.3 shall apply for the uplink in licensed band and the requirements specified in clause 6.3E.3.2 and 6.3E.3.3 shall apply for the sidelink in licensed band or Band n47.

6.3E.4 Power control for V2X

6.3E.4.1 General

When UE is configured for NR V2X sidelink transmissions non-concurrent with NR uplink transmissions for NR V2X operating bands in Table 5.2E.1-1, the following requirements are applied for NR V2X sidelink transmission.

For NR V2X UE supporting SL MIMO, the power control tolerance for single carrier shall apply to the sum of output power at each transmit antenna connector.

If the UE transmits on one antenna connector at a time, the requirements for single carrier shall apply to the active antenna connector.

6.3E.4.2 Absolute power tolerance

The requirements in clause 6.3.4.2 shall apply for NR V2X transmission.

6.3E.4.3 Power control for V2X concurrent operation

For the inter-band con-current NR V2X operation, the requirements specified in clause 6.3.4 shall apply for the uplink in licensed band and the requirements specified in clause 6.3E.4.1 and 6.3E.4.2 shall apply for the sidelink in licensed band or Band n47.

6.3F Output power dynamics for shared spectrum channel access

6.3F.1 Minimum output power

The requirements for minimum output power in clause 6.3.1 apply.

6.3F.2 Transmit OFF power

The requirements for Transmit OFF power in clause 6.3.2 apply.

6.3F.3 Transmit ON/OFF time mask

6.3F.3.1 General

The transmit power time mask defines the transient period(s) allowed between transmit OFF power as defined in clause 6.3F.2 and transmit ON power symbols (transmit ON/OFF). The transmit power ON/OFF time mask specified in clause 6.3F.3.2 supercedes the ON/OFF masks specified in clause 6.3.3; however, between continuous ON-power transmissions the requirements in clause 6.3.3 apply. Unless otherwise stated the requirements in clause 6.5F apply also in transient periods.

6.3F.3.2 General ON/OFF time mask

The general ON/OFF time mask defines the observation period between transmit OFF and ON power and between transmit ON and OFF power for each SCS as illustrated below in Figure 6.3F.3.2-1. ON/OFF scenarios include: contiguous, and non-contiguous transmission, etc.

The OFF power measurement period is defined in a duration of at least one slot excluding any transient periods. The ON power is defined as the mean power over the duration of at least one slot excluding any transient period and non-transmitted symbols. The leading transient period starts 5 μ s before the beginning of the first symbol of transmission and extends 10 μ s into the transmission including the CP extension if applicable. The trailing transient period starts 5 μ s before the end of transmission and extends 5 μ s beyond the end of transmission.

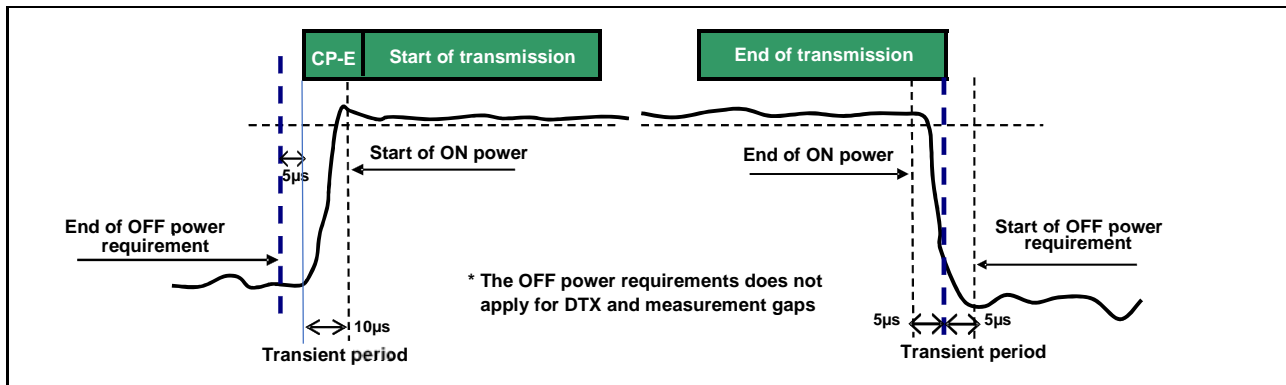

Figure 6.3F.3.2-1: General ON/OFF time mask for shared spectrum channel access

6.3F.3A General ON/OFF mask for CA

6.3F.3A.1 General ON/OFF mask for inter-band CA

For inter-band carrier aggregation with uplink assigned to two bands, the general output power ON/OFF time mask specified in clause 6.3.3.1 is applicable for the NR uplink carrier while the general output power ON/OFF time mask specified in clause 6.3F.3 is applicable for the carrier operating with shared spectrum access. The OFF period as specified in clause 6.3.3.1 and clause 6.3F.3 shall only be applicable for each component carrier when all the component carriers are OFF.

6.3F.4 Power control

6.3F.4.1 General

The requirements on power control accuracy apply under normal conditions.

6.3F.4.2 Absolute power tolerance

The absolute power tolerance requirements of clause 6.3.4.2 apply at the start of a contiguous transmission or non-contiguous transmission with a transmission gap larger than 40 ms.

6.3F.4.3 Relative power tolerance

The relative power tolerance requirements of clause 6.3.4.3 apply if the transmission gap between the target sub-frame and the reference sub-frame is less than or equal to 40 ms.

6.3F.4.4 Aggregate power tolerance

The aggregate power tolerance requirements of clause 6.3.4.4 apply during non-contiguous transmissions within 41ms with respect to the first UE transmission.

6.4 Transmit signal quality

6.4.1 Frequency error

The UE basic measurement interval of modulated carrier frequency is 1 UL slot. The mean value of basic measurements of UE modulated carrier frequency shall be accurate to within ± 0.1 PPM observed over a period of 1 ms of cumulated measurement intervals compared to the carrier frequency received from the NR Node B.

6.4.2 Transmit modulation quality

6.4.2.0 General

Transmit modulation quality defines the modulation quality for expected in-channel RF transmissions from the UE. The transmit modulation quality is specified in terms of:

- Error Vector Magnitude (EVM) for the allocated resource blocks (RBs)
- EVM equalizer spectrum flatness derived from the equalizer coefficients generated by the EVM measurement process
- Carrier leakage
- In-band emissions for the non-allocated RB

All the parameters defined in clause 6.4.2 are defined using the measurement methodology specified in Annex F.

In case the parameter 3300 or 3301 is reported from UE via the parameter *txDirectCurrentLocation* in *UplinkTxDirectCurrentList* IE (as defined in TS 38.331 [7]), carrier leakage measurement requirement in clause 6.4.2.2 and 6.4.2.3 shall be waived, and the RF correction with regard to the carrier leakage and IQ image shall be omitted during the calculation of transmit modulation quality.

6.4.2.1 Error Vector Magnitude

The Error Vector Magnitude is a measure of the difference between the reference waveform and the measured waveform. This difference is called the error vector. Before calculating the EVM the measured waveform is corrected by the sample timing offset and RF frequency offset. Then the carrier leakage shall be removed from the measured waveform before calculating the EVM.

The measured waveform is further equalised using the channel estimates subjected to the EVM equaliser spectrum flatness requirement specified in clause 6.4.2.4. For DFT-s-OFDM waveforms, the EVM result is defined after the front-end FFT and IDFT as the square root of the ratio of the mean error vector power to the mean reference power expressed as a %. For CP-OFDM waveforms, the EVM result is defined after the front-end FFT as the square root of the ratio of the mean error vector power to the mean reference power expressed as a %.

The basic EVM measurement interval in the time domain is one preamble sequence for the PRACH and one slot for PUCCH and PUSCH in the time domain. The EVM measurement interval is reduced by any symbols that contains an allowable power transient in the measurement interval, as defined in clause 6.3.3.

The RMS average of the basic EVM measurements over 10 subframes for the average EVM case, and over 60 subframes for the reference signal EVM case, for the different modulation schemes shall not exceed the values specified in Table 6.4.2.1-1 for the parameters defined in Table 6.4.2.1-2. For EVM evaluation purposes, all 13 PRACH preamble formats and all 5 PUCCH formats are considered to have the same EVM requirement as QPSK modulated.

For UE power class 1.5 the EVM is first measured per UE antenna connector and then evaluated according to the measurement method applicable for UEs indicating *txDiversity-r16*.

Table 6.4.2.1-1: Requirements for Error Vector Magnitude

Parameter	Unit	Average EVM Level
Pi/2-BPSK	%	30
QPSK	%	17.5
16 QAM	%	12.5
64 QAM	%	8
256 QAM	%	3.5

Table 6.4.2.1-2: Parameters for Error Vector Magnitude

Parameter	Unit	Level
UE Output Power	dBm	≥ Table 6.3.1-1

UE Output Power for 256 QAM	dBm	≥ Table 6.3.1-1 + 10 dB
Operating conditions		Normal conditions

6.4.2.1a Error Vector Magnitude including symbols with transient period

In 6.4.2.1, EVM has been defined by excluding the symbols which have a transient period. In this section, measurement interval is defined for the symbols with a transient period to include these symbols in the RMS average EVM computation when the UE reports a transient period capability other than the default. Before calculating the EVM, the measured waveform is corrected for sample timing offset and RF frequency offset. Then the carrier leakage shall be removed from the measured waveform before calculating the EVM. The symbols with transient period should not be used for equalization. Only CP-OFDM waveform is used for conformance testing.

In the case of PUSCH or PUCCH transmissions when the mean power, modulation or RB allocation across slot or subslot boundaries is expected to change the EVM result over the symbols where the transient occurs is calculated according to Table 6.4.2.1a-1.

Table 6.4.2.1a-1: EVM definition for reported transient period

Reported transient capability (us)	EVM definition	tp_{start} (μs)	SCS ⁴
2	$EVM_{after} = \max(\overline{EVM_{l,tp}}, \overline{EVM_h})$ $EVM_{before} = \max(\overline{EVM_l}, \overline{EVM_{h,tp}})$	-0.5	15kHz or 30kHz ⁵
4	$EVM_{after} = \max(\overline{EVM_{l,tp}}, \overline{EVM_h})$ $EVM_{before} = \max(\overline{EVM_l}, \overline{EVM_{h,tp}})$	-1	15kHz
7	$EVM_{after} = \min(\overline{EVM_{l,tp}}, \overline{EVM_h})$ $EVM_{before} = \max(\overline{EVM_l}, \overline{EVM_{h,tp}})$	-2.7	15kHz

NOTE 1: $\overline{EVM_l}$, $\overline{EVM_h}$, $\overline{EVM_{l,tp}}$, and $\overline{EVM_{h,tp}}$ are defined in Annex F
 NOTE 2: EVM_{after} is the EVM for a symbol right after a transition; EVM_{before} is the EVM for a symbol right before a transition
 NOTE 3: tp_{start} denotes the start position of the EVM exclusion window as shown in Annex F.4
 NOTE 4: SCS denotes the SCS that can be used in the conformance test
 NOTE 5: 30kHz shall be used in the conformance test unless the UE signals in *supportedSubCarrierSpacingUL* in *FeatureSetPerCC* that it only supports 15kHz in the corresponding band

The RMS average of the basic EVM measurements over 108 subframes calculated only on the symbols where the transient occurs for the different modulation schemes shall not exceed the values specified in Table 6.4.2.1a-2 for the parameters defined in Table 6.4.2.1a-3. This requirement can be verified with 64 QAM and 256 QAM modulation.

Table 6.4.2.1a-2: Requirements for Error Vector Magnitude

Parameter	Unit	Average EVM Level
64 QAM	%	10
256 QAM	%	8

Table 6.4.2.1a-3: Parameters for Error Vector Magnitude

Parameter	Unit	Level
UE Output Power	dBm	≥ Table 6.3.1-1
UE Output Power for 256 QAM	dBm	≥ Table 6.3.1-1 + 10 dB
Operating conditions		Normal conditions

6.4.2.2 Carrier leakage

Carrier leakage is an additive sinusoid waveform whose frequency is the same as the modulated waveform carrier frequency. The measurement interval is one slot in the time domain.

In the case that uplink sharing, the carrier leakage may have 7.5 kHz shift with the carrier frequency.

The relative carrier leakage power is a power ratio of the additive sinusoid waveform and the modulated waveform. The relative carrier leakage power shall not exceed the values specified in Table 6.4.2.2-1.

Table 6.4.2.2-1: Requirements for Carrier Leakage

Parameter	Relative Limit (dBc)
Output power > 10 dBm	-28
0 dBm ≤ Output power ≤ 10 dBm	-25
-30 dBm ≤ Output power < 0 dBm	-20
-40 dBm ≤ Output power < -30 dBm	-10

6.4.2.3 In-band emissions

The in-band emission is defined as the average emission across 12 sub-carriers and as a function of the RB offset from the edge of the allocated UL transmission bandwidth. The in-band emission is measured as the ratio of the UE output power in a non-allocated RB to the UE output power in an allocated RB.

The basic in-band emissions measurement interval is defined over one slot in the time domain; however, the minimum requirement applies when the in-band emission measurement is averaged over 10 sub-frames. When the PUSCH or PUCCH transmission slot is shortened due to multiplexing with SRS, the in-band emissions measurement interval is reduced by one or more symbols, accordingly.

The average of the basic in-band emission measurement over 10 sub-frames shall not exceed the values specified in Table 6.4.2.3-1.

Table 6.4.2.3-1: Requirements for in-band emissions

Parameter description	Unit	Limit (NOTE 1)		Applicable Frequencies
General	dB	$\max \left\{ -25 - 10 \cdot \log_{10} (N_{RB} / L_{CRB}), \right.$ $20 \cdot \log_{10} EVM - 3 - 5 \cdot (\Delta_{RB} - 1) / L_{CRB},$ $\left. -57 \text{ dBm} + 10 \log_{10} (SCS / 15 \text{ kHz}) - \overline{P_{RB}} \right\}$		Any non-allocated (NOTE 2)
IQ Image	dB	-28	Image frequencies when output power > 10 dBm	Image frequencies (NOTES 2, 3)
		-25	Image frequencies when output power ≤ 10 dBm	
Carrier leakage	dBc	-28	Output power > 10 dBm	Carrier leakage frequency (NOTES 4, 5)
		-25	0 dBm ≤ Output power ≤ 10 dBm	
		-20	-30 dBm ≤ Output power < 0 dBm	
		-10	-40 dBm ≤ Output power < -30 dBm	

NOTE 1: An in-band emissions combined limit is evaluated in each non-allocated RB. For each such RB, the minimum requirement is calculated as the higher of $\overline{P_{RB}} - 30$ dB and the power sum of all limit values (General, IQ Image or Carrier leakage) that apply. $\overline{P_{RB}}$ is defined in NOTE 10.

NOTE 2: The measurement bandwidth is 1 RB and the limit is expressed as a ratio of measured power in one non-allocated RB to the measured average power per allocated RB, where the averaging is done across all allocated RBs. For pi/2 BPSK with Spectrum Shaping, the limit is expressed as a ratio of measured power in one non-allocated RB to the measured power in the allocated RB with highest PSD.

NOTE 3: The applicable frequencies for this limit are those that are enclosed in the reflection of the allocated bandwidth, based on symmetry with respect to the carrier leakage frequency, but excluding any allocated RBs.

NOTE 4: The measurement bandwidth is 1 RB and the limit is expressed as a ratio of measured power in one non-allocated RB to the measured total power in all allocated RBs.

NOTE 5: The applicable frequencies for this limit depend on the parameter *txDirectCurrentLocation* in *UplinkTxDirectCurrent* IE, and are those that are enclosed either in the RB containing the carrier leakage frequency, or in the two RBs immediately adjacent to the carrier leakage frequency but excluding any allocated RB.

NOTE 6: L_{CRB} is the Transmission Bandwidth (see clause 5.3).

NOTE 7: N_{RB} is the Transmission Bandwidth Configuration (see clause 5.3).

NOTE 8: EVM is the limit specified in Table 6.4.2.1-1 for the modulation format used in the allocated RBs.

- NOTE 9: Δ_{RB} is the starting frequency offset between the allocated RB and the measured non-allocated RB (e.g. $\Delta_{RB} = 1$ or $\Delta_{RB} = -1$ for the first adjacent RB outside of the allocated bandwidth).
- NOTE 10: \overline{P}_{RB} is an average of the transmitted power over 10 sub-frames normalized by the number of allocated RBs, measured in dBm.
- NOTE 11: For almost contiguous allocations defined in clause 6.2.2, $L_{CRB} = N_{RB_alloc} + N_{RB_gap}$ with no in-gap emission requirement.

6.4.2.4 EVM equalizer spectrum flatness

The zero-forcing equalizer correction applied in the EVM measurement process (as described in Annex F) must meet a spectral flatness requirement for the EVM measurement to be valid. The EVM equalizer spectrum flatness is defined in terms of the maximum peak-to-peak ripple of the equalizer coefficients (dB) across the allocated uplink block. The basic measurement interval is the same as for EVM.

The peak-to-peak variation of the EVM equalizer coefficients contained within the frequency range of the uplink allocation shall not exceed the maximum ripple specified in Table 6.4.2.4-1 for normal conditions. For uplink allocations contained within both Range 1 and Range 2, the coefficients evaluated within each of these frequency ranges shall meet the corresponding ripple requirement and the following additional requirement: the relative difference between the maximum coefficient in Range 1 and the minimum coefficient in Range 2 must not be larger than 5 dB, and the relative difference between the maximum coefficient in Range 2 and the minimum coefficient in Range 1 must not be larger than 7 dB (see Figure 6.4.2.4-1).

The EVM equalizer spectral flatness shall not exceed the values specified in Table 6.4.2.4-2 for extreme conditions. For uplink allocations contained within both Range 1 and Range 2, the coefficients evaluated within each of these frequency ranges shall meet the corresponding ripple requirement and the following additional requirement: the relative difference between the maximum coefficient in Range 1 and the minimum coefficient in Range 2 must not be larger than 6 dB, and the relative difference between the maximum coefficient in Range 2 and the minimum coefficient in Range 1 must not be larger than 10 dB (see Figure 6.4.2.4-1).

For UE power class 1.5 the EVM equalizer spectrum flatness is measured according to the measurement method applicable for UEs indicating *txDiversity-r16*.

Table 6.4.2.4-1: Requirements for EVM equalizer spectrum flatness (normal conditions)

Frequency range	Maximum ripple (dB)
$F_{UL_Meas} - F_{UL_Low} \geq 3 \text{ MHz}$ and $F_{UL_High} - F_{UL_Meas} \geq 3 \text{ MHz}$ (Range 1)	4 (p-p)
$F_{UL_Meas} - F_{UL_Low} < 3 \text{ MHz}$ or $F_{UL_High} - F_{UL_Meas} < 3 \text{ MHz}$ (Range 2)	8 (p-p)
NOTE 1: F_{UL_Meas} refers to the sub-carrier frequency for which the equalizer coefficient is evaluated	
NOTE 2: F_{UL_Low} and F_{UL_High} refer to each NR frequency band specified in Table 5.2-1	

Table 6.4.2.4-2: Minimum requirements for EVM equalizer spectrum flatness (extreme conditions)

Frequency range	Maximum Ripple (dB)
$F_{UL_Meas} - F_{UL_Low} \geq 5 \text{ MHz}$ and $F_{UL_High} - F_{UL_Meas} \geq 5 \text{ MHz}$ (Range 1)	4 (p-p)
$F_{UL_Meas} - F_{UL_Low} < 5 \text{ MHz}$ or $F_{UL_High} - F_{UL_Meas} < 5 \text{ MHz}$ (Range 2)	12 (p-p)
NOTE 1: F_{UL_Meas} refers to the sub-carrier frequency for which the equalizer coefficient is evaluated	
NOTE 2: F_{UL_Low} and F_{UL_High} refer to each NR frequency band specified in Table 5.2-1	

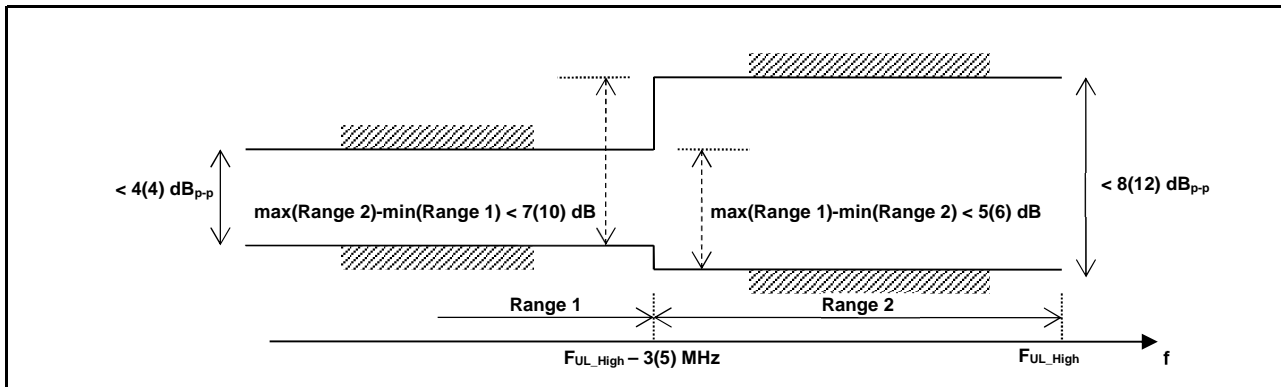

Figure 6.4.2.4-1: The limits for EVM equalizer spectral flatness with the maximum allowed variation of the coefficients indicated (the ETC minimum requirement are within brackets).

6.4.2.4.1 Requirements for Pi/2 BPSK modulation

These requirements apply if the IE *powerBoostPi2BPSK* is set to 1 for power class 3 UE operating in TDD bands n40, n41, n77, n78 and n79 with Pi/2 BPSK modulation and UE indicates support for UE capability *powerBoosting-pi2BPSK* and 40 % or less slots in radio frame are used for UL transmission. These requirements also apply if the IE *dmrs-UplinkTransformPrecoding-r16* is configured and UE indicates support for UE capability *lowPAPR-DMRS-PUSCHwithPrecoding-r16*. Otherwise the requirements for EVM equalizer spectrum flatness defined in clause 6.4.2.4 apply.

The EVM equalizer coefficients across the allocated uplink block shall be modified to fit inside the mask specified in Table 6.4.2.4.1-1 for normal conditions, prior to the calculation of EVM. The limiting mask shall be placed to minimize the change in equalizer coefficients in a sum of squares sense.

Table 6.4.2.4.1-1: Mask for EVM equalizer coefficients for Pi/2 BPSK, normal conditions

Frequency range	Parameter	Maximum ripple (dB)
$ F_{UL_Meas} - F_{center} \leq X \text{ MHz}$ (Range 1)	X1	6 (p-p)
$ F_{UL_Meas} - F_{center} > X \text{ MHz}$ (Range 2)	X2	14 (p-p)

NOTE 1: F_{UL_Meas} refers to the sub-carrier frequency for which the equalizer coefficient is evaluated
 NOTE 2: F_{center} refers to the center frequency of an allocated block of PRBs
 NOTE 3: X, in MHz, is equal to 25% of the bandwidth of the PRB allocation
 NOTE 4: See Figure 6.4.2.4.1-1 for description of X1, X2

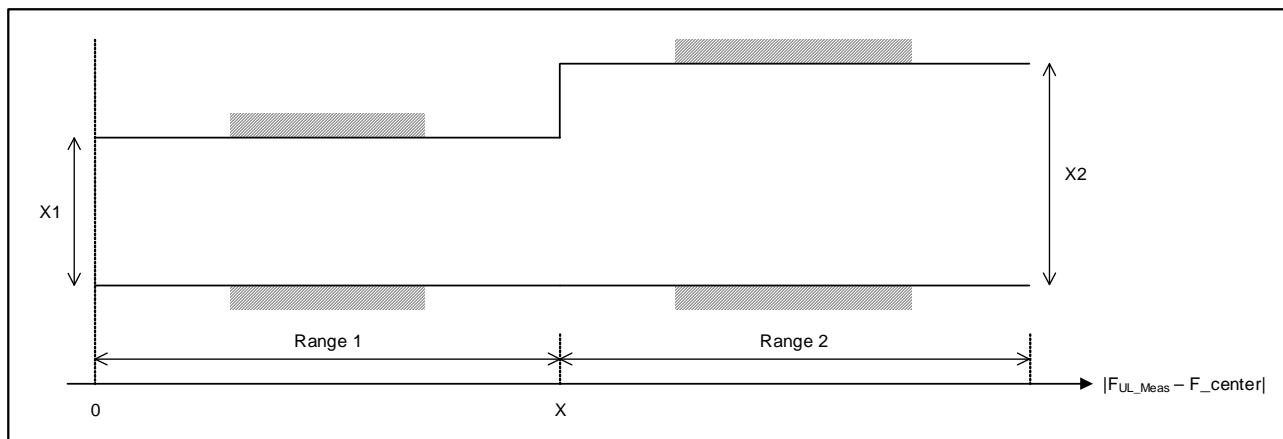

Figure 6.4.2.4.1-1: The limits for EVM equalizer spectral flatness with the maximum allowed variation.

For Pi/2 BPSK modulation the UE shall be allowed to employ spectral shaping and the shaping filter shall be restricted so that the impulse response of the shaping filter itself shall meet

$$\begin{aligned} |\tilde{a}_i(t,0)| &\geq |\tilde{a}_i(t,\tau)| \quad \forall \tau \neq 0 \\ 20\log_{10} |\tilde{a}_i(t,\tau)| &< -15 \text{ dB} \quad 1 < \tau < M - 1, \end{aligned}$$

where $|\tilde{a}_i(t,\tau)| = \text{IDFT}\{|\tilde{a}_i(t,f)| e^{j\varphi(t,f)}\}$, f is the frequency of the M allocated subcarriers, $\tilde{a}_i(t,f)$ and $\varphi(t,f)$ are the amplitude and phase response.

0 dB reference is defined as $20\log_{10} |\tilde{a}_i(t,0)|$.

6.4A Transmit signal quality for CA

6.4A.1 Frequency error for CA

6.4A.1.1 Frequency error for intra-band contiguous CA

For intra-band contiguous carrier aggregation the UE modulated carrier frequencies per band shall be accurate to within ± 0.1 PPM observed over a period of 1 ms of cumulated measurement intervals compared to the carrier frequency of primary component carrier received in the corresponding band

6.4A.1.2 Frequency error for intra-band non-contiguous CA

For intra-band non-contiguous carrier aggregation the requirements in Section 6.4.1 applies per component carrier.

6.4A.1.3 Frequency error for inter-band CA

For inter-band carrier aggregation with one uplink carrier assigned to one NR band, the frequency error requirements in subclause 6.4.1 apply.

For inter-band carrier aggregation with two contiguous carriers assigned to one NR band, the frequency error requirements in subclause 6.4A.1.1 apply for those carriers.

For inter-band carrier aggregation with uplink assigned to two NR bands, the frequency error requirements defined in clause 6.4.1 shall apply on each component carrier with all component carriers active.

6.4A.1.4 Void

6.4A.2 Transmit modulation quality for CA

6.4A.2.1 Transmit modulation quality for intra-band contiguous CA

6.4A.2.1.0 General

For intra-band contiguous carrier aggregation, the requirements in clauses 6.4A.2.1.1, 6.4A.2.1.2 and 6.4A.2.1.3 applies.

The requirements in this clause apply with PCC and SCC in the UL configured and activated: PCC with PRB allocation and SCC without PRB allocation and without CSI reporting and SRS configured.

In case the parameter 3300 or 3301 is reported from UE via *txDirectCurrentLocation-r16* or *txDirectCurrentLocation* (as defined in TS 38.331 [7]) or UE does not indicate the DC location parameters, carrier leakage measurement requirement in clause 6.4A.2.1.2 and 6.4A.2.1.3 shall be waived, and the RF correction with regard to the carrier leakage and IQ image shall be omitted during the calculation of transmit modulation quality.

6.4A.2.1.1 Error Vector Magnitude

For the intra-band contiguous carrier aggregation, the Error Vector Magnitude requirement should be defined for each component carrier. Requirements only apply with PRB allocation in one of the component carriers. Similar transmitter impairment removal procedures are applied for CA waveform before EVM calculation as is specified for non-CA waveform in sub-clause 6.4.2.1.

When a single component carrier is configured Table 6.4.2.1-1 apply.

The EVM requirements are according to Table 6.4A.2.1.1-1 if CA is configured in uplink with the parameters defined in Table 6.4.2.1-2.

Table 6.4A.2.1.1-1: Minimum requirements for Error Vector Magnitude

Parameter	Unit	Average EVM Level per CC
Pi/2-BPSK	%	30
QPSK	%	17.5
16 QAM	%	12.5
64 QAM	%	8
256 QAM	%	3.5

6.4A.2.1.2 In-band emissions

For intra-band contiguous carrier aggregation, the requirements in Table 6.4A.2.1.2-1 and 6.4A.2.1.2-2 apply within the aggregated transmission bandwidth configuration with both component carrier (s) active and one single contiguous PRB allocation of bandwidth L_{CRB} at the edge of the aggregated transmission bandwidth configuration.

The inband emission is defined as the interference falling into the non allocated resource blocks for all component carriers. The measurement method for the inband emissions in the component carrier with PRB allocation is specified in annex F.3. For a non allocated component carrier a spectral measurement is specified.

Table 6.4A.2.1.2-1: Minimum requirements for in-band emissions (allocated component carrier)

Parameter	Unit	Limit	Applicable Frequencies
General	dB	$\max \left\{ -25 - 10 \cdot \log_{10} (N_{RB} / L_{CRB}), \right.$ $20 \cdot \log_{10} EVM - 3 - 5 \cdot (\Delta_{RB} - 1) / L_{CRB},$ $\left. -57 \text{ dBm} + 10 \log_{10} (SCS / 15 \text{ kHz}) - \overline{P_{RB}} \right\}$	Any non-allocated (NOTE 2)
IQ Image	dB	-28	Output power > 10 dBm
		-25	$0 \leq \text{Output power} \leq 10 \text{ dBm}$
Carrier leakage	dBc	-28	Output power > 10 dBm
		-25	$0 \text{ dBm} \leq \text{Output power} \leq 10 \text{ dBm}$
		-20	$-30 \text{ dBm} \leq \text{Output power} \leq 0 \text{ dBm}$
		-10	$-40 \text{ dBm} \leq \text{Output power} < -30 \text{ dBm}$

NOTE 1: An in-band emissions combined limit is evaluated in each non-allocated RB. For each such RB, the minimum requirement is calculated as the higher of $\overline{P_{RB}} - 30 \text{ dB}$ and the power sum of all limit values (General, IQ Image or Carrier leakage) that apply. $\overline{P_{RB}}$ is defined in NOTE 10. The limit is evaluated in each non-allocated RB.

NOTE 2: The measurement bandwidth is 1 RB and the limit is expressed as a ratio of measured power in one non-allocated RB to the measured average power per allocated RB, where the averaging is done across all allocated RBs

NOTE 3: The applicable frequencies for this limit are those that are enclosed in the reflection of the allocated bandwidth, based on symmetry with respect to the carrier leakage frequency, but excluding any allocated RBs.

NOTE 4: Exceptions to the general limit are allowed for up to two contiguous non-allocated RBs. The measurement bandwidth is 1 RB and the limit is expressed as a ratio of measured power in the non-allocated RB to the measured total power in all allocated RBs.

NOTE 5: The applicable frequencies for this limit depend on the parameter *txDirectCurrentLocation-r16* in *UplinkTxDirectCurrentTwoCarrierList* IE indicated in active uplink carrier(s). For band combinations with supporting additional DC location reporting for intra-band CA, the applicable LO leakage frequency depend

on the *txDirectCurrentLocation-r16* indicated in the additional reporting IE, and are those that are enclosed either in the RB containing the carrier leakage frequency, or in the two RBs immediately adjacent to the carrier leakage frequency but excluding any allocated RB. Otherwise, the applicable frequencies for this limit depend on the parameter *txDirectCurrentLocation* in *UplinkTxDirectCurrent* IE. For only one uplink carrier is activated, the applicable LO leakage frequency follow definition in clause 6.4.2.

NOTE 6: L_{CRB} is the Transmission Bandwidth (see clause 5.3) not exceeding $\lfloor N_{RB} / 2 - 1 \rfloor$.

NOTE 7: N_{RB} is the Transmission Bandwidth Configuration (see clause 5.3) of the component carrier with RBs allocated.

NOTE 8: EVM is the limit specified in Table 6.4.2.1-1 for the modulation format used in the allocated RBs.

NOTE 9: Δ_{RB} is the starting frequency offset between the allocated RB and the measured non-allocated RB (e.g. $\Delta_{RB} = 1$ or $\Delta_{RB} = -1$ for the first adjacent RB outside of the allocated bandwidth).

NOTE 10: $\overline{P_{RB}}$ is an average of the transmitted power over 10 sub-frames normalized by the number of allocated RBs, measured in dBm.

Table 6.4A.2.1.2-2: Minimum requirements for in-band emissions (not allocated component carrier)

Parameter	Unit	Meas BW NOTE 1	Limit	remark	Applicable Frequencies	
General	dB	BW of 1 RB	$\max \left\{ -25 - 10 \cdot \log_{10} (N_{RB} / L_{CRB}), \right.$ $20 \cdot \log_{10} EVM - 3 - 5 \cdot (\Delta_{RB} - 1) / L_{CRB},$ $\left. -57 \text{ dBm} + 10 \log_{10} (SCS / 15 \text{ kHz}) - \overline{P_{RB}} \right\}$	The reference value is the average power per allocated RB in the allocated component carrier	Any RB in the non allocated component carrier. The frequency raster of the RBs is derived when this component carrier is allocated with RBs	
IQ Image	dB	BW of 1 RB	NOTE 2	The reference value is the average power per allocated RB in the allocated component carrier	The frequencies of the L_{CRB} contiguous non-allocated RBs are unknown. The frequency raster of the RBs is derived when this component carrier is allocated with RBs	
			-28			Output power > 10 dBm
			-25			0 ≤ Output power ≤ 10 dBm
Carrier leakage	dBc	BW of 1 RB	NOTE 3	The reference value is the total power of the allocated RBs in the allocated component carrier	The frequencies of the up to 2 non-allocated RBs are unknown. The frequency raster of the RBs is derived when this component carrier is allocated with RBs	
			-28			Output power > 10 dBm

			-25	0 dBm ≤ Output power ≤ 10 dBm	
			-20	-30 dBm ≤ Output power ≤ 0 dBm	
			-10	-40 dBm ≤ Output power < -30 dBm	
NOTE 1: Resolution BWs smaller than the measurement BW may be integrated to achieve the measurement bandwidth.					
NOTE 2: Exceptions to the general limit is are allowed for up to $L_{CRB} + 1$ RBs within a contiguous width of $L_{CRB} + 1$ non-allocated RBs.					
NOTE 3: Two Exceptions to the general limit are allowed for up to two contiguous non-allocated RBs					
NOTE 4: NOTES 1, 5, 6, 7, 8, 9 from Table 6.4A.2.1.1-1 apply for Table 6.4A.2.1.2-2 as well.					
NOTE 5: Δ_{RB} for measured non-allocated RB in the non allocated component carrier may take non-integer values when the carrier spacing between the CCs is not a multiple of RB.					

6.4A.2.1.3 Carrier leakage

Carrier leakage is an additive sinusoid waveform that is confined within the aggregated transmission bandwidth configuration. For intra-band contiguous CA, the carrier leakage requirement is defined with applicable frequencies dependent on parameter *txDirectCurrentLocation-r16* or *txDirectCurrentLocation* (as defined in TS 38.331 [7]). For only one uplink carrier is activated, the applicable LO leakage frequency follow definition in clause 6.4.2. The measurement interval is one slot in the time domain.

The relative carrier leakage power is a power ratio of the additive sinusoid waveform and the modulated waveform. The relative carrier leakage power shall not exceed the values specified in Table 6.4A.2.1.3-1. Carrier leakage frequencies are those that are enclosed either in the RB containing the carrier leakage frequency, or in the two RBs immediately adjacent to the carrier leakage frequency but excluding any allocated RB.

Table 6.4A.2.1.3-1: Minimum requirements for Relative Carrier Leakage Power

Parameters	Relative Limit (dBc)
Output power > 10 dBm	-28
0 dBm ≤ Output power ≤ 10 dBm	-25
-30 dBm ≤ Output power < 0 dBm	-20
-40 dBm ≤ Output power < -30 dBm	-10

6.4A.2.2 Transmit modulation quality for intra-band non-contiguous CA

6.4A.2.2.0 General

For intra-band non-contiguous carrier aggregation, the requirements in subclauses 6.4A.2.2.1, 6.4A.2.2.2 applies.

The requirements in this clause apply with PCC and SCC in the UL configured and activated: PCC with PRB allocation and SCC without PRB allocation and without CSI reporting and SRS configured.

In case the parameter 3300 or 3301 is reported from UE via *txDirectCurrentLocation-r16* or *txDirectCurrentLocation* (as defined in TS 38.331 [7]), or UE does not indicate the DC location parameters, carrier leakage measurement requirement in subclause 6.4A.2.2.2 shall be waived, and the RF correction with regard to the carrier leakage and IQ image shall be omitted during the calculation of transmit modulation quality.

6.4A.2.2.1 Error Vector Magnitude

For the intra-band non-contiguous carrier aggregation, the Error Vector Magnitude requirement should be defined for each component carrier. Requirements only apply with PRB allocation in one of the component carriers. Similar transmitter impairment removal procedures are applied for CA waveform before EVM calculation as is specified for non-CA waveform in sub-section 6.4.2.1.

When a single component carrier is configured Table 6.4.2.1-1 apply.

The EVM requirements are according to Table 6.4A.2.2.1-1 if CA is configured in uplink with the parameters defined in Table 6.4.2.1-2.

Table 6.4A.2.2.1-1: Minimum requirements for Error Vector Magnitude

Parameter	Unit	Average EVM Level per CC
Pi/2-BPSK	%	30
QPSK	%	17.5
16 QAM	%	12.5
64 QAM	%	8
256 QAM	%	3.5

6.4A.2.2.2 In-band emissions

For intra-band non-contiguous carrier aggregation the requirements for in-band emissions are defined for each component carrier. Requirements defined in clause 6.4A.2.1.2 only apply with PRB allocation in one of the component carriers.

When signalling for dualPA-Architecture IE is absent, carrier leakage or I/Q image may land inside the gap spectrum between 2 UL CCs.

For intra-band non-contiguous CA, the IQ image requirement is defined with the applicable frequencies based on symmetry with respect to the carrier leakage frequency, but excluding any allocated RBs.

6.4A.2.2.3 Carrier leakage

For intra-band non-contiguous CA, if UE indicates *uplinkTxDC-TwoCarrierReport-r16*, the carrier leakage requirement is defined with applicable frequencies dependent on parameter *txDirectCurrentLocation-r16* in *UplinkTxDirectCurrentTwoCarrierList* IE indicated in activated uplink carrier(s), otherwise, the carrier leakage requirement is defined with applicable frequencies dependent on parameter *txDirectCurrentLocation* in *UplinkTxDirectCurrent* IE. The relative carrier leakage power is a power ratio of the additive sinusoid waveform and the modulated waveform. The relative carrier leakage power shall not exceed the values specified in Table 6.4A.2.1.3-1. Carrier leakage frequencies are those that are enclosed either in the RB containing the carrier leakage frequency, or in the two RBs immediately adjacent to the carrier leakage frequency but excluding any allocated RB.

6.4A.2.3 Transmit modulation quality for inter-band CA

For inter-band carrier aggregation with one uplink carrier assigned to one NR band, the transmit modulation quality requirements in subclause 6.4.2 apply.

For inter-band carrier aggregation with two contiguous carriers assigned to one NR band, the transmit modulation quality requirements in subclause 6.4A.2.1 apply for those carriers.

For inter-band carrier aggregation with uplink assigned to two NR bands, the transmit modulation quality requirements shall apply on each component carrier as defined in clause 6.4.2 with all component carriers active: PCC with PRB allocation and SCC without PRB allocation and without CSI reporting and SRS configured.

6.4A.2.4 Void

6.4B Transmit signal quality for NR-DC

For inter-band NR-DC with one uplink carrier assigned per NR band, the transmit signal quality for the corresponding inter-band CA configuration as specified in clause 6.4A applies.

6.4D Transmit signal quality for UL MIMO

6.4D.0 General

For a UE supporting UL MIMO, the requirements in this section are defined per layer or as the sum of emissions from both antennas to account for the UL MIMO scheme.

Alternatively, when applicable, requirements may be verified per antenna connector using an UL MIMO transmission

with codebook of $\frac{1}{\sqrt{2}} \begin{bmatrix} 1 & 0 \\ 0 & 1 \end{bmatrix}$ and a configuration defined in Table 6.4D.0-1.

Table 6.4D.0-1: UL MIMO configuration for per connector measurements

Transmission scheme	DCI format	Codebook Index
Codebook based uplink	DCI format 0_1	Codebook index 0

6.4D.1 Frequency error for UL MIMO

For UE(s) supporting UL MIMO, the basic measurement interval of modulated carrier frequency is 1 UL slot. The mean value of basic measurements of UE modulated carrier frequency at each transmit antenna connector shall be accurate to within ± 0.1 PPM observed over a period of 1 ms of cumulated measurement intervals compared to the carrier frequency received from the NR Node B.

6.4D.2 Transmit modulation quality for UL MIMO

6.4D.2.0 General

For UE supporting UL MIMO, the transmit modulation quality requirements are specified based on measurements made at each transmit antenna connector.

If UE is scheduled for single antenna-port PUSCH transmission by DCI format 0_0 or by DCI format 0_1 for single antenna port codebook based transmission, the requirements in clause 6.4.2 apply.

The transmit modulation quality is specified in terms of:

- Error Vector Magnitude (EVM) for the allocated resource blocks (RBs)
- EVM equalizer spectrum flatness derived from the equalizer coefficients generated by the EVM measurement process
- Carrier leakage (caused by IQ offset)
- In-band emissions for the non-allocated RB

In case the parameter 3300 or 3301 is reported from UE via the parameter *txDirectCurrentLocation* in *UplinkTxDirectCurrentList* IE (as defined in TS 38.331 [7]), carrier leakage measurement requirement in clause 6.4D.2.2 and 6.4D.2.3 shall be waived, and the RF correction with regard to the carrier leakage and IQ image shall be omitted during the calculation of transmit modulation quality.

6.4D.2.1 Error Vector Magnitude

For UE with two transmit antenna connectors in closed-loop spatial multiplexing scheme, the Error Vector Magnitude requirements specified in clause 6.4.2.1 apply per layer. The requirements shall be met with the UL MIMO configurations specified in Table 6.2D.1-2

6.4D.2.2 Carrier leakage

For UE with two transmit antenna connectors in closed-loop spatial multiplexing scheme, the Relative Carrier Leakage Power requirements specified in Table 6.4.2.2-1 which is defined in clause 6.4.2.2 apply per layer. The requirements shall be met with the UL MIMO configurations specified in Table 6.2D.1-2

6.4D.2.3 In-band emissions

For UE with two transmit antenna connectors in closed-loop spatial multiplexing scheme, the In-band Emission requirements specified in Table 6.4.2.3-1 which is defined in clause 6.4.2.3 apply at each transmit antenna connector. The requirements shall be met with the uplink MIMO configurations specified in Table 6.2D.1-2

6.4D.2.4 EVM equalizer spectrum flatness for UL MIMO

For UE with two transmit antenna connectors in closed-loop spatial multiplexing scheme, the EVM Equalizer Spectrum Flatness requirements specified in clause 6.4.2.4 apply per layer. The requirements shall be met with the UL MIMO configurations specified in Table 6.2D.1-2

6.4D.3 Time alignment error for UL MIMO

For UE(s) with multiple transmit antenna connectors supporting UL MIMO, this requirement applies to frame timing differences between transmissions on multiple transmit antenna connectors in the closed-loop spatial multiplexing scheme.

The time alignment error (TAE) is defined as the average frame timing difference between any two transmissions on different transmit antenna connectors.

For UE(s) with multiple transmit antenna connectors, the Time Alignment Error (TAE) shall not exceed 130 ns.

6.4D.4 Requirements for coherent UL MIMO

For coherent UL MIMO, Table 6.4D.4-1 lists the maximum allowable difference between the measured relative power and phase errors between different antenna connectors in any slot within the specified time window from the last transmitted SRS on the same antenna connectors, for the purpose of uplink transmission (codebook or non-codebook usage) and those measured at that last SRS. The requirements in Table 6.4D.4-1 apply when the UL transmission power at each antenna connector is larger than 0 dBm for SRS transmission and for the duration of time window.

Table 6.4D.4-1: Maximum allowable difference of relative phase and power errors in a given slot compared to those measured at last SRS transmitted

Difference of relative phase error	Difference of relative power error	Time window
40 degrees	4 dB	20 msec

The above requirements when all the following conditions are met within the specified time window:

- UE is not signaled with a change in number of SRS ports in SRS-config, or a change in PUSCH-config
- UE remains in DRX active time (UE does not enter DRX OFF time)
- No measurement gap occurs
- No instance of SRS transmission with the usage antenna switching occurs
- Active BWP remains the same
- EN-DC and CA configuration is not changed for the UE (UE is not configured or de-configured with PSCell or SCell(s))
- When UE is not configured with uplink switching with parameter *uplinkTxSwitching-r16*; or when UE is configured with uplink switching with parameter *uplinkTxSwitching-r16*, and the capability *uplinkTxSwitching-PUSCH-TransCoherence* is absent or indicated as 'fullCoherent'; or when UE is configured with uplink switching with parameter *uplinkTxSwitching-r16*, the capability *uplinkTxSwitching-PUSCH-TransCoherence* is

indicated as 'nonCoherent', and uplink switching is not triggered by the switching mechanisms specified in sub-clause 6.1.6 of TS 38.214 [10] between last transmitted SRS and scheduled transmission.

6.4E Transmit signal quality for V2X

6.4E.1 Frequency error for V2X

6.4E.1.1 General

The UE modulated carrier frequency for NR V2X sidelink transmissions in Table 5.2E.1-1, shall be accurate to within ± 0.1 PPM observed over a period of 1 ms compared to the absolute frequency in case of using GNSS synchronization source. The same requirements applied over a period of 1 ms compared to the carrier frequency received from the gNB or V2X synchronization reference UE in case of using the gNB or V2X synchronization reference UE sidelink synchronization signals.

For NR V2X UE supporting SL MIMO, the UE modulated carrier frequency at each transmit antenna connector shall be accurate to within ± 0.1 PPM observed over a period of 1 ms in case of using GNSS synchronization source. The same requirements apply over a period of 1 ms compared to the relative frequency in case of using the NR gNode B or V2X synchronization reference UE sidelink synchronization signals.

If the UE transmits on one antenna connector at a time, the requirements for single carrier shall apply to the active antenna connector.

6.4E.1.2 Frequency error for V2X concurrent operation

For the inter-band con-current NR V2X operation, the requirements specified in clause 6.4.1 shall apply for the uplink in licensed band and the requirements specified in clause 6.4E.1.1 shall apply for the sidelink in licensed band or Band n47.

6.4E.2 Transmit modulation quality for V2X

6.4E.2.1 General

The transmit modulation quality requirements in this clause apply to V2X sidelink transmissions.

For NR V2X UE supporting SL MIMO, the transmit modulation quality requirements for single carrier shall apply to each transmit antenna connector.

If V2X UE transmits on one antenna connector at a time, the requirements specified for single carrier apply to the active antenna connector.

6.4E.2.2 Error Vector Magnitude for V2X

For V2X sidelink physical channels PSCCH and PSSCH, the Error Vector Magnitude requirements shall be as specified for PUSCH in Table 6.4.2.1-1 except $\pi/2$ -BPSK for NR V2X operating bands in Table 5.2E.1-1. When sidelink transmissions are shortened due to transmission gap of one symbol at the end of the slot, the EVM measurement interval is reduced by one symbol, accordingly.

6.4E.2.3 Carrier leakage for V2X

Carrier leakage of NR V2X sidelink transmission, the requirements for NR PUSCH in Table 6.4.2.2-1 shall be applied.

6.4E.2.4 In-band emissions for V2X

For V2X sidelink physical channels PSCCH, PSSCH and PSBCH, the In-band emissions requirements shall be as specified for PUSCH in subclause 6.4.2.3 for the corresponding modulation and transmission bandwidth. When V2X transmissions are shortened due to transmission gap of one symbol at the end of the subframe, the In-band emissions measurement interval is reduced by one symbol, accordingly.

6.4E.2.5 EVM equalizer spectrum flatness for V2X

For V2X sidelink physical channels PSCCH, PSSCH and PSBCH, the EVM equalizer spectrum flatness requirements shall be as specified for PUSCH in clause 6.4.2.4 for the corresponding modulation and transmission bandwidth.

6.4E.2.6 Transmit modulation quality for V2X concurrent operation

For the inter-band con-current NR V2X operation, the requirements specified in clause 6.4.2 shall apply for the uplink in licensed band and the requirements specified in clause 6.4E.2.1 through 6.4E.2.5 shall apply for the sidelink in licensed band or Band n47.

6.4F Transmit signal quality for shared spectrum channel access

6.4F.1 Frequency error

The requirements for frequency error in clause 6.4.1 apply.

6.4F.2 Transmit modulation quality

6.4F.2.0 General

Transmit modulation quality defines the modulation quality for expected in-channel RF transmissions from the UE. The transmit modulation quality is specified in terms of:

- Error Vector Magnitude (EVM) for the allocated resource blocks (RBs)
- EVM equalizer spectrum flatness derived from the equalizer coefficients generated by the EVM measurement process
- Carrier leakage
- In-band emissions for the non-allocated RB

All the parameters defined in clause 6.4.2 are defined using the measurement methodology specified in Annex F.

In case the parameter 3300 or 3301 is reported from UE via *txDirectCurrentLocation* IE (as defined in TS 38.331 [7]), carrier leakage measurement requirement in clause 6.4F.2.2 and 6.4F.2.3 shall be waived, and the RF correction with regard to the carrier leakage and IQ image shall be omitted during the calculation of transmit modulation quality.

6.4F.2.1 Error Vector Magnitude

The requirements for Error Vector Magnitude in clause 6.4.2.1 apply.

6.4F.2.2 Carrier leakage

The requirements for carrier leakage in clause 6.4.2.2 apply.

6.4F.2.3 In-band emissions

The in-band emission is defined as the average emission across 12 sub-carriers and as a function of the RB offset from the edge of the allocated UL transmission bandwidth. The in-band emission is measured as the ratio of the UE output power in a non-allocated RB to the UE output power in an allocated RB.

The basic in-band emissions measurement interval is defined over one slot in the time domain; however, the minimum requirement applies when the in-band emission measurement is averaged over 10 sub-frames. When the PUSCH or PUCCH transmission slot is shortened, the in-band emissions measurement interval is reduced by one or more symbols, accordingly. The requirement applies for power class 5 UE for 20 MHz channel bandwidth and 15 kHz SCS,

Instead of the general requirement in clause 6.4.2.3, the average of the basic in-band emission measurement over 10 sub-frames shall not exceed the values specified in Table 6.4F.2.3-1.

Table 6.4F.2.3-1: Minimum requirements for in-band emissions

Parameter description	Unit	Limit (NOTE 1)		Applicable Frequencies
General	dB	$\max \left\{ \begin{array}{l} -10 - 6(\Delta_{RB} - 1), \\ -57 \frac{dBm}{180} kHz - P_{RB} \end{array} \right\}$		Any non-allocated (NOTE 2)
IQ Image	dB	-28	Image frequencies when output power > 10 dBm	Image frequencies (NOTES 2, 3)
		-25	Image frequencies when output power ≤ 10 dBm	
Carrier leakage	dBc	-28	Output power > 10 dBm	Carrier frequency (NOTES 4, 5)
		-25	0 dBm ≤ Output power ≤ 10 dBm	
		-20	-30 dBm ≤ Output power ≤ 0 dBm	
		-10	-40 dBm ≤ Output power < -30 dBm	
<p>NOTE 1: An in-band emissions combined limit is evaluated in each non-allocated RB. For each such RB, the minimum requirement is calculated as the higher of P_{RB}- 30 dB and the power sum of all limit values (General, IQ Image or Carrier leakage) that apply. P_{RB} is defined in NOTE 10.</p> <p>NOTE 2: The measurement bandwidth is 1 RB and the limit is expressed as a ratio of measured power in one non-allocated RB to the measured average power per allocated RB, where the averaging is done across all allocated RBs. The requirement applies with $\Delta_{RB} \leq 5$ for any non-allocated RB with $RIV=1$ and $RIV=5$ in the uplink scheduling grant where RIV is specified in [10].</p> <p>NOTE 3: [The applicable frequencies for this limit are those that are enclosed in the reflection of the allocated RBs, based on symmetry with respect to the reported carrier frequency location in <i>txDirectCurrentLocation</i> field of the <i>UplinkTxDirectCurrentBWP</i>, but excluding any allocated RBs. If <i>txDirectCurrentLocation</i> is not available or is reported with value 3300 or 3301, applicable frequencies shall be calculated with an assumed carrier frequency location at the center of the channel.]</p> <p>NOTE 4: [The measurement bandwidth is 1 RB and the limit is expressed as a ratio of measured power in one non-allocated RB to the measured total power in all allocated RBs with $RIV=1$ and $RIV=5$ in the uplink scheduling grant.]</p> <p>NOTE 5: [The applicable frequencies for this limit are those that are enclosed in the RBs containing the DC frequency if N_{RB} is odd, or in the two RBs immediately adjacent to the DC frequency if N_{RB} is even, but excluding any allocated RB. The location of the DC frequency is given by <i>txDirectCurrentLocation</i> field of the <i>UplinkTxDirectCurrentBWP</i>. If <i>txDirectCurrentLocation</i> is not available or is reported with value 3300 or 3301, applicable frequencies shall be those that are enclosed in the RB(s) in the center of the channel.]</p> <p>NOTE 6: N_{RB} is the Transmission Bandwidth Configuration (see Figure 5.6-1).</p> <p>NOTE 7: Δ_{RB} is the starting frequency offset between the allocated RB and the measured non-allocated RB (e.g. $\Delta_{RB} = 1$ or $\Delta_{RB} = -1$ for the first adjacent RB outside of the allocated bandwidth).</p> <p>NOTE 10: P_{RB} is the transmitted power per $180 \cdot 2^{\mu}$ kHz in allocated RBs, measured in dBm.</p>				

6.4F.2.4 EVM equalizer spectrum flatness

The requirements for EVM equalizer spectrum flatness in clause 6.4.2.4 apply.

6.4F.2A Transmit modulation quality for CA

6.4F.2A.1 Transmit modulation quality for inter-band CA

For inter-band carrier aggregation with uplink assigned to two bands, the transmit modulation quality requirements shall apply on the NR carrier as defined in clause 6.4.2 and on the carrier operating with shared spectrum access as defined in clause 6.4F.2. The requirements apply with all component carrier active: PCC with PRB allocation and SCC without PRB allocation and without CSI reporting and SRS configured.

6.5 Output RF spectrum emissions

6.5.1 Occupied bandwidth

Occupied bandwidth is defined as the bandwidth containing 99 % of the total integrated mean power of the transmitted spectrum on the assigned channel. The occupied bandwidth for all transmission bandwidth configurations (Resources Blocks) shall be less than the channel bandwidth specified in Table 6.5.1-1. For UE power class 1.5 the occupied bandwidth requirements apply to the sum of the power from both UE antenna connectors.

Table 6.5.1-1: Occupied channel bandwidth

	NR channel bandwidth												
	5 MHz	10 MHz	15 MHz	20 MHz	25 MHz	30 MHz	40 MHz	50 MHz	60 MHz	70 MHz	80 MHz	90 MHz	100 MHz
Occupied channel bandwidth (MHz)	5	10	15	20	25	30	40	50	60	70	80	90	100

6.5.2 Out of band emission

6.5.2.1 General

The Out of band emissions are unwanted emissions immediately outside the assigned channel bandwidth resulting from the modulation process and non-linearity in the transmitter but excluding spurious emissions. This out of band emission limit is specified in terms of a spectrum emission mask and an adjacent channel leakage power ratio. For UE power class 1.5 the out-of-band emission limits apply to the sum of the power of the out-of-band emission from both UE antenna connectors.

To improve measurement accuracy, sensitivity and efficiency, the resolution bandwidth may be smaller than the measurement bandwidth. When the resolution bandwidth is smaller than the measurement bandwidth, the result should be integrated over the measurement bandwidth in order to obtain the equivalent noise bandwidth of the measurement bandwidth.

6.5.2.2 Spectrum emission mask

The spectrum emission mask of the UE applies to frequencies (Δf_{OoB}) starting from the \pm edge of the assigned NR channel bandwidth. For frequencies offset greater than Δf_{OoB} , the spurious requirements in clause 6.5.3 are applicable.

NOTE: For measurement conditions at the edge of each frequency range, the lowest frequency of the measurement position in each frequency range should be set at the lowest boundary of the frequency range plus MBW/2. The highest frequency of the measurement position in each frequency range should be set at the highest boundary of the frequency range minus MBW/2. MBW denotes the measurement bandwidth defined for the protected band.

The power of any UE emission shall not exceed the levels specified in Table 6.5.2.2-1 for the specified channel bandwidth.

Table 6.5.2.2-1: General NR spectrum emission mask

Spectrum emission limit (dBm) / Channel bandwidth														
Δf_{OoB} (MHz)	5 MHz	10 MHz	15 MHz	20 MHz	25 MHz	30 MHz	40 MHz	50 MHz	60 MHz	70 MHz	80 MHz	90 MHz	100 MHz	Measurement bandwidth
$\pm 0-1$	-13	-13	-13	-13	-13	-13	-13							1 % channel bandwidth
$\pm 0-1$								-24	-24	-24	-24	-24	-24	30 kHz
$\pm 1-5$	-10	-10	-10	-10	-10	-10	-10	-10	-10	-10	-10	-10	-10	1 MHz
$\pm 5-6$	-13	-13	-13	-13	-13	-13	-13	-13	-13	-13	-13	-13		
$\pm 6-10$	-25													
$\pm 10-15$		-25												

contained within the 26 dB emission bandwidth is used for determining the applicable SEM indicated by NS_04 as specified in Table 6.5.2.3.2-1 and Table 6.5.2.3.2-2.

Table 6.5.2.3.2-1: transmission bandwidth determining the NS_04 SEM for CP-OFDM

SCS (kHz)	Channel bandwidth (MHz) / Maximum transmission bandwidth (MHz)									
	10	15	20	30	40	50	60	80	90	100
15	9.36	14.22	19.08	28.80	38.88	48.6	N/A	N/A	N/A	N/A
30	8.64	13.68	18.36	28.08	38.16	47.88	58.32	78.12	88.02	98.28
60	7.92	12.96	17.28	27.36	36.72	46.8	56.88	77.04	87.12	97.20

Table 6.5.2.3.2-2: transmission bandwidth determining the NS_04 SEM for DFT-S-OFDM

SCS (kHz)	Channel bandwidth (MHz) / Maximum transmission bandwidth (MHz)									
	10	15	20	30	40	50	60	80	90	100
15	9.00	13.50	18.00	28.80	38.88	48.60	N/A	N/A	N/A	N/A
30	8.64	12.96	18.00	27.00	36.00	46.08	58.32	77.76	87.48	97.20
60	7.20	12.96	17.28	25.92	36.00	46.08	54.00	72.00	86.40	97.20

When "NS_04" is indicated in the cell, the power of any UE emission shall not exceed the levels specified in Table 6.5.2.3.2-3.

Table 6.5.2.3.2-3: n41 SEM with "NS_04"

Δf_{OoB} MHz	Channel bandwidth (MHz) / Spectrum emission limit (dBm)										Measurement bandwidth
	10	15	20	30	40	50	60	80	90	100	
$\pm 0 - 1$	-10	-10	-10	-10	-10						2 % channel bandwidth
								-10			1 MHz
$\pm 1 - 5$	-10										1 MHz
$\pm 5 - X$	-13										
$\pm X - (\text{BW}_{\text{Channel}} + 5 \text{ MHz})$	-25										

NOTE: X is defined in Table 6.5.2.3.2-1 for CP-OFDM and 6.5.2.3.2-2 for DFT-S-OFDM

6.5.2.3.3 Requirements for network signalling values "NS_03", "NS_03U", and "NS_21"

Additional spectrum emission requirements are signalled by the network to indicate that the UE shall meet an additional requirement for a specific deployment scenario as part of the cell handover/broadcast message.

When "NS_03", "NS_03U", or "NS_21" is indicated in the cell, the power of any UE emission shall not exceed the levels specified in Table 6.5.2.3.3-1.

Table 6.5.2.3.3-1: Additional requirements for "NS_03", "NS_03U", and "NS_21"

Δf_{OoB} MHz	Channel bandwidth (MHz) / Spectrum emission limit (dBm)							Measurement bandwidth
	5	10	15	20	25	30	40	
$\pm 0-1$	-13	-13	-13	-13	-13	-13	-13	1 % of channel BW
$\pm 1-6$	-13	-13	-13	-13	-13	-13	-13	1 MHz
$\pm 6-10$	-25	-13	-13	-13	-13	-13	-13	1 MHz
$\pm 10-15$		-25	-13	-13	-13	-13	-13	1 MHz
$\pm 15-20$			-25	-13	-13	-13	-13	1 MHz
$\pm 20-25$				-25	-13	-13	-13	1 MHz
$\pm 25-30$					-25	-13	-13	1 MHz
$\pm 30-35$						-25	-13	1 MHz
$\pm 35-40$							-13	1 MHz
$\pm 40-45$							-25	1 MHz

NOTE: As a general rule, the resolution bandwidth of the measuring equipment should be equal to the measurement bandwidth. However, to improve measurement accuracy, sensitivity and efficiency, the resolution bandwidth may be smaller than the measurement bandwidth. When the resolution bandwidth is smaller than the measurement bandwidth, the result should be integrated over the measurement bandwidth in order to obtain the equivalent noise bandwidth of the measurement bandwidth.

Table 6.5.2.3.3-2: Void

6.5.2.3.4 Requirements for network signalling value "NS_06"

Additional spectrum emission requirements are signalled by the network to indicate that the UE shall meet an additional requirement for a specific deployment scenario as part of the cell handover/broadcast message.

When "NS_06" is indicated in the cell, the power of any UE emission shall not exceed the levels specified in Table 6.5.2.3.4-1.

Table 6.5.2.3.4-1: Additional requirements for "NS_06"

Δf_{OoB} (MHz)	Channel bandwidth (MHz) / Spectrum emission limit (dBm)			Measurement bandwidth
	5	10	15	
$\pm 0 - 0.1$	-15	-18	-20	30 kHz
$\pm 0.1 - 1$	-13	-13	-13	100 kHz
$\pm 1 - 6$	-13	-13	-13	1 MHz
$\pm 6 - 10$	-25			
$\pm 10 - 15$		-25		
$\pm 15 - 20$			-25	

NOTE: As a general rule, the resolution bandwidth of the measuring equipment should be equal to the measurement bandwidth. However, to improve measurement accuracy, sensitivity and efficiency, the resolution bandwidth may be smaller than the measurement bandwidth. When the resolution bandwidth is smaller than the measurement bandwidth, the result should be integrated over the measurement bandwidth in order to obtain the equivalent noise bandwidth of the measurement bandwidth.

6.5.2.3.5 Void

6.5.2.3.6 Void

6.5.2.3.7 Void

6.5.2.3.8 Requirements for network signalling value "NS_27"

Additional spectrum emission requirements are signalled by the network to indicate that the UE shall meet an additional requirement for a specific deployment scenario as part of the cell handover/broadcast message.

When "NS_27" is indicated in the cell, the power of any UE emission shall not exceed the levels specified in Table 6.5.2.3.8-1.

Table 6.5.2.3.8-1: Additional requirements for "NS_27"

Δf_{OoB} MHz	Channel bandwidth (MHz) / Spectrum emission limit (dBm)	Measurement bandwidth
--------------------------------	---------------------------------------------------------	-----------------------

	5	10	15	20	40	
$\pm 0 - 1$	-13					1 % channel bandwidth
$\pm 1 - X$	-13					1 MHz
$< - X$ or $> X$	-25					
NOTE 1: X is occupied channel bandwidth as defined in Table 6.5.1-1.						
NOTE 2: The requirements apply only at the frequency range from 3540 MHz to 3710 MHz.						

NOTE: As a general rule, the resolution bandwidth of the measuring equipment should be equal to the measurement bandwidth. However, to improve measurement accuracy, sensitivity and efficiency, the resolution bandwidth may be smaller than the measurement bandwidth. When the resolution bandwidth is smaller than the measurement bandwidth, the result should be integrated over the measurement bandwidth in order to obtain the equivalent noise bandwidth of the measurement bandwidth.

6.5.2.4 Adjacent channel leakage ratio

Adjacent Channel Leakage power Ratio (ACLR) is the ratio of the filtered mean power centred on the assigned channel frequency to the filtered mean power centred on an adjacent channel frequency.

To improve measurement accuracy, sensitivity and efficiency, the resolution bandwidth may be smaller than the measurement bandwidth. When the resolution bandwidth is smaller than the measurement bandwidth, the result should be integrated over the measurement bandwidth in order to obtain the equivalent noise bandwidth of the measurement bandwidth.

6.5.2.4.1 NR ACLR

NR Adjacent Channel Leakage power Ratio (NR_{ACLR}) is the ratio of the filtered mean power centred on the assigned NR channel frequency to the filtered mean power centred on an adjacent NR channel frequency at nominal channel spacing.

The assigned NR channel power and adjacent NR channel power are measured with rectangular filters with measurement bandwidths specified in Table 6.5.2.4.1-1.

If the measured adjacent channel power is greater than -50 dBm then the NR_{ACLR} shall be higher than the value specified in Table 6.5.2.4.1-2.

Table 6.5.2.4.1-1: NR ACLR measurement bandwidth

NR channel bandwidth / NR ACLR measurement bandwidth													
	5 MHz	10 MHz	15 MHz	20 MHz	25 MHz	30 MHz	40 MHz	50 MHz	60 MHz	70 MHz	80 MHz	90 MHz	100 MHz
NR ACLR measurement bandwidth (MHz)	4.515	9.375	14.235	19.095	23.955	28.815	38.895	48.615	58.35	68.07	78.15	88.23	98.31

Table 6.5.2.4.1-2: NR ACLR requirement

	Power class 1 ¹	Power class 1.5	Power class 2	Power class 3
NR ACLR	37 dB ¹	31 dB	31 dB	30 dB
NOTE 1: Applicable for power class 1 UE operating in Band n14.				

6.5.2.4.2 UTRA ACLR

UTRA adjacent channel leakage power ratio ($UTRA_{ACLR}$) is the ratio of the filtered mean power centred on the assigned NR channel frequency to the filtered mean power centred on an adjacent(s) UTRA channel frequency.

$UTRA_{ACLR}$ is specified for the first adjacent UTRA channel ($UTRA_{ACLR1}$) which center frequency is ± 2.5 MHz from NR channel edge and for the 2nd adjacent UTRA channel ($UTRA_{ACLR2}$) which center frequency is ± 7.5 MHz from NR channel edge.

The UTRA channel power is measured with a RRC filter with roll-off factor $\alpha = 0.22$ and bandwidth of 3.84 MHz. The assigned NR channel power is measured with a rectangular filter with measurement bandwidth specified in Table 6.5.2.4.1-1.

If the measured adjacent channel power is greater than -50 dBm then the $UTRA_{ACLR1}$ and $UTRA_{ACLR2}$ shall be higher than the value specified in Table 6.5.2.4.2-1.

Table 6.5.2.4.2-1: UTRA ACLR requirement

	Power class 3
$UTRA_{ACLR1}$	33 dB
$UTRA_{ACLR2}$	36 dB

UTRA ACLR requirement is applicable when the network signalling value NS_03U, NS_05U, NS_43U or NS_100 is signalled by the network in the field *additionalSpectrumEmission*.

6.5.3 Spurious emissions

6.5.3.0 General

Spurious emissions are emissions which are caused by unwanted transmitter effects such as harmonics emission, parasitic emissions, intermodulation products and frequency conversion products, but exclude out of band emissions unless otherwise stated. The spurious emission limits are specified in terms of general requirements in line with SM.329 [9] and NR operating band requirement to address UE co-existence. For UE power class 1.5 the spurious emission limits apply to the sum of the power of the spurious emission from both UE antenna connectors.

To improve measurement accuracy, sensitivity and efficiency, the resolution bandwidth may be smaller than the measurement bandwidth. When the resolution bandwidth is smaller than the measurement bandwidth, the result should be integrated over the measurement bandwidth in order to obtain the equivalent noise bandwidth of the measurement bandwidth.

NOTE: For measurement conditions at the edge of each frequency range, the lowest frequency of the measurement position in each frequency range should be set at the lowest boundary of the frequency range plus MBW/2. The highest frequency of the measurement position in each frequency range should be set at the highest boundary of the frequency range minus MBW/2. MBW denotes the measurement bandwidth defined for the protected band.

6.5.3.1 General spurious emissions

Unless otherwise stated, the spurious emission limits apply for the frequency ranges that are more than F_{OOB} (MHz) in Table 6.5.3.1-1 from the edge of the channel bandwidth. The spurious emission limits in Table 6.5.3.1-2 apply for all transmitter band configurations (N_{RB}) and channel bandwidths.

Table 6.5.3.1-1: Boundary between NR out of band and general spurious emission domain

Channel bandwidth	OOB boundary F_{OOB} (MHz)
$BW_{Channel}$	$BW_{Channel} + 5$

Table 6.5.3.1-2: Requirement for general spurious emissions limits

Frequency Range	Maximum Level	Measurement bandwidth	NOTE
$9 \text{ kHz} \leq f < 150 \text{ kHz}$	-36 dBm	1 kHz	
$150 \text{ kHz} \leq f < 30 \text{ MHz}$	-36 dBm	10 kHz	
$30 \text{ MHz} \leq f < 1000 \text{ MHz}$	-36 dBm	100 kHz	
$1 \text{ GHz} \leq f < 12.75 \text{ GHz}$	-30 dBm	1 MHz	4
	-25 dBm	1 MHz	3
$12.75 \text{ GHz} \leq f < 5^{\text{th}}$ harmonic of the upper frequency edge of the	-30 dBm	1 MHz	1

UL operating band in GHz			
12.75 GHz < f < 26 GHz	-30 dBm	1 MHz	2
NOTE 1: Applies for Band for which the upper frequency edge of the UL Band is greater than 2.55 GHz and less than or equal to 5.2 GHz			
NOTE 2: Applies for Band that the upper frequency edge of the UL Band more than 5.2 GHz			
NOTE 3: Applies for Band n41, CA configurations including Band n41, and EN-DC configurations that include n41 specified in clause 5.2B of TS 38.101-3 [3] when NS_04 is signalled.			
NOTE 4: Does not apply for Band n41, CA configurations including Band n41, and EN-DC configurations that include n41 specified in subclause 5.2B of TS 38.101-3 [3] when NS_04 is signalled.			

6.5.3.2 Spurious emissions for UE co-existence

This clause specifies the requirements for NR bands for coexistence with protected bands.

Table 6.5.3.2-1: Requirements for spurious emissions for UE co-existence

NR Band	Spurious emission for UE co-existence						
	Protected band	Frequency range (MHz)			Maximum Level (dBm)	MBW (MHz)	NOTE
n1, n84	E-UTRA Band 1, 5, 7, 8, 11, 18, 19, 20, 21, 22, 26, 27, 28, 31, 32, 38, 40, 41, 42, 43, 44, 45, 50, 51, 52, 65, 67, 68, 69, 72, 73, 74, 75, 76, NR Band n78, n79	F _{DL_low}	-	F _{DL_high}	-50	1	
	NR Band n77	F _{DL_low}	-	F _{DL_high}	-50	1	2
	E-UTRA Band 3,	F _{DL_low}	-	F _{DL_high}	-50	1	15
	E-UTRA Band 34	F _{DL_low}	-	F _{DL_high}	-50	1	15, 47
	Frequency range	1880	-	1895	-40	1	15, 27
	Frequency range	1895	-	1915	-15.5	5	15, 26, 27
	Frequency range	1915	-	1920	+1.6	5	15, 26, 27
n2	E-UTRA Band 4, 5, 12, 13, 14, 17, 24, 26, 27, 28, 29, 30, 41, 42, 50, 51, 53, 66, 70, 71, 74, 85	F _{DL_low}	-	F _{DL_high}	-50	1	
	E-UTRA Band 2, 25	F _{DL_low}	-	F _{DL_high}	-50	1	15
	E-UTRA Band 43, 48 NR Band n77	F _{DL_low}	-	F _{DL_high}	-50	1	2
n3, n80	E-UTRA Band 1, 5, 7, 8, 20, 26, 27, 28, 31, 32, 33, 34, 38, 39, 40, 41, 43, 44, 45, 50, 51, 65, 67, 68, 69, 72, 73, 74, 75, 76. NR Band n79	F _{DL_low}	-	F _{DL_high}	-50	1	
	E-UTRA Band 3	F _{DL_low}	-	F _{DL_high}	-50	1	15
	E-UTRA Band 11, 18, 19, 21	F _{DL_low}	-	F _{DL_high}	-50	1	
	E-UTRA Band 22, 42, 52, NR Band n77, n78	F _{DL_low}	-	F _{DL_high}	-50	1	2
	Frequency range	1884.5	-	1915.7	-41	0.3	8
n5, n89	E-UTRA Band 1, 2, 3, 4, 5, 7, 8, 12, 13, 14, 17, 18, 19, 24, 25, 26, 28, 29, 30, 31, 34, 38, 40, 42, 43, 45, 48, 50, 51, 65, 66, 70, 71, 73, 74, 85 NR Band n79	F _{DL_low}	-	F _{DL_high}	-50	1	
	E-UTRA Band 41, 52, 53 NR Band n77, n78	F _{DL_low}	-	F _{DL_high}	-50	1	2
	E-UTRA Band 11, 21	F _{DL_low}	-	F _{DL_high}	-50	1	
	Frequency range	1884.5	-	1915.7	-41	0.3	8

NR Band	Spurious emission for UE co-existence						
	Protected band	Frequency range (MHz)			Maximum Level (dBm)	MBW (MHz)	NOTE
n7	E-UTRA Band 1, 2, 3, 4, 5, 7, 8, 12, 13, 14, 17, 20, 22, 26, 27, 28, 29, 30, 31, 32, 33, 34, 40, 42, 43, 50, 51, 52, 65, 66, 67, 68, 72, 74, 75, 76, 85, NR Band n77, n78	F _{DL_low}	-	F _{DL_high}	-50	1	
	NR Band n79	F _{DL_low}	-	F _{DL_high}	-50	1	2
	Frequency range	2570	-	2575	+1.6	5	15, 21, 26
	Frequency range	2575	-	2595	-15.5	5	15, 21, 26
	Frequency range	2595	-	2620	-40	1	15, 21
n8, n81, n93, n94	E-UTRA Band 1, 20, 28, 31, 32, 33, 34, 38, 39, 40, 45, 50, 51, 65, 67, 68, 69, 72, 73, 74, 75, 76	F _{DL_low}	-	F _{DL_high}	-50	1	
	E-UTRA band 3, 7, 22, 41, 42, 43, 52, NR Band n77, n78, n79	F _{DL_low}	-	F _{DL_high}	-50	1	2
	E-UTRA 8	F _{DL_low}	-	F _{DL_high}	-50	1	15
	E-UTRA Band 11, 21	F _{DL_low}	-	F _{DL_high}	-50	1	
	Frequency range	1884.5	-	1915.7	-41	0.3	8
n12	E-UTRA Band 2, 5, 13, 14, 17, 24, 25, 26, 27, 30, 41, 53, 70, 71, 74	F _{DL_low}	-	F _{DL_high}	-50	1	
	E-UTRA Band 4, 48, 50, 51, 66 NR Band n77	F _{DL_low}	-	F _{DL_high}	-50	1	2
	E-UTRA Band 12, 85	F _{DL_low}	-	F _{DL_high}	-50	1	15
n14	E-UTRA Band 2, 4, 5, 12, 13, 14, 17, 23, 24, 25, 26, 27, 29, 30, 41, 48, 53, 66, 70, 71, 85	F _{DL_low}	-	F _{DL_high}	-50	1	
	NR Band n77	F _{DL_low}	-	F _{DL_high}	-50	1	2
	Frequency range	769	-	775	-35	0.00625	12, 15
	Frequency range	799	-	805	-35	0.00625	11, 12, 15
n18	E-UTRA Band 1, 3, 11, 21, 34, 40, 42, 65 NR Band n79	F _{DL_low}	-	F _{DL_high}	-50	1	
	NR Band n77, n78	F _{DL_low}	-	F _{DL_high}	-50	1	2
	Frequency range	758	-	799	-50	1	
	Frequency range	799	-	803	-40	1	
	Frequency range	860	-	890	-40	1	
	Frequency range	945	-	960	-50	1	
	Frequency range	1884.5	-	1915.7	-41	0.3	8
	Frequency range	2545	-	2575	-50	1	
n20, n82, n91, n92	E-UTRA Band 1, 3, 7, 8, 22, 31, 32, 33, 34, 40, 43, 50, 51, 65, 67, 68, 72, 74, 75, 76	F _{DL_low}	-	F _{DL_high}	-50	1	
	E-UTRA Band 20	F _{DL_low}	-	F _{DL_high}	-50	1	15
	E-UTRA Band 38, 42, 52, 69, NR Band n77, n78	F _{DL_low}	-	F _{DL_high}	-50	1	2
	Frequency range	758	-	788	-50	1	
n25	E-UTRA Band 4, 5, 12, 13, 14, 17, 24, 26, 27, 28, 29, 30, 41, 42, 53, 66, 70, 71, 85	F _{DL_low}	-	F _{DL_high}	-50	1	
	E-UTRA Band 2	F _{DL_low}	-	F _{DL_high}	-50	1	15
	E-UTRA Band 25	F _{DL_low}	-	F _{DL_high}	-50	1	15
	E-UTRA Band 43, 48 NR Band n77	F _{DL_low}	-	F _{DL_high}	-50	1	2

NR Band	Spurious emission for UE co-existence						
	Protected band	Frequency range (MHz)			Maximum Level (dBm)	MBW (MHz)	NOTE
n26	E-UTRA Band 1, 2, 3, 4, 5, 11, 12, 13, 14, 17, 18,19, 21, 24, 25, 26, 29, 30, 31, 34, 39, 40, 42, 43, 48, 50, 51, 65, 66, 70, 71, 73,74, 85	F _{DL_low}	-	F _{DL_high}	-50	1	
	E-UTRA Band 41, 53 NR Band n77, n78, n79	F _{DL_low}	-	F _{DL_high}	-50	1	2
	Frequency range	703	-	799	-50	1	
	Frequency range	799	-	803	-40	1	15
	Frequency range	945	-	960	-50	1	
	Frequency range	1884.5	-	1915.7	-41	0.3	8
n28, n83	E-UTRA Band 1, 4, 22, 32, 42, 43, 50, 51, 65, 66, 74, 75, 76, NR Band n77, n78	F _{DL_low}	-	F _{DL_high}	-50	1	2
	E-UTRA Band 1	F _{DL_low}	-	F _{DL_high}	-50	1	19, 25
	E-UTRA Band 2, 3, 5, 7, 8, 18, 19, 20, 25, 26, 27, 31, 34, 38, 39, 40, 41, 52, 72, 73 NR Band n79	F _{DL_low}	-	F _{DL_high}	-50	1	
	E-UTRA Band 11, 21	F _{DL_low}	-	F _{DL_high}	-50	1	19, 24
	Frequency range	470	-	694	-42	8	15, 35
	Frequency range	470	-	710	-26.2	6	34
	Frequency range	662	-	694	-26.2	6	15
	Frequency range	758	-	773	-32	1	15
	Frequency range	773	-	803	-50	1	
	Frequency range	1884.5	-	1915.7	-41	0.3	8, 19
n30	E-UTRA Band 2, 4, 5, 7, 12, 13, 14, 17, 24, 25, 26, 27, 29, 30, 38, 41, 48, 53, 66, 70, 71, 85, NR Band n77	F _{DL_low}	-	F _{DL_high}	-50	1	
n34	E-UTRA Band 1, 3, 7, 8, 11, 18, 19, 20, 21, 22, 26, 28, 31, 32, 33, 38,39, 40, 41, 42, 43, 44, 45, 50, 51, 52, 65, 67, 69, 72, 74, 75, 76, NR Band n78, n79	F _{DL_low}	-	F _{DL_high}	-50	1	5
	NR Band n77	F _{DL_low}	-	F _{DL_high}	-50	1	2
	Frequency range	1884.5	-	1915.7	-41	0.3	8
n38	E-UTRA Band 1, 2, 3, 4, 5, 8, 12, 13, 14, 17, 20, 22, 27, 28, 29, 30, 31, 32, 33, 34, 40, 42, 43, 50, 51, 52, 65, 66, 67, 68, 72, 74, 75, 76, 85	F _{DL_low}	-	F _{DL_high}	-50	1	
	NR Band n77, n78, n79	F _{DL_low}	-	F _{DL_high}	-50	1	
	Frequency range	2620	-	2645	-15.5	5	15, 22, 26
	Frequency range	2645	-	2690	-40	1	15, 22
n39	E-UTRA Band 1, 8, 22, 26, 28, 34, 40, 41, 42, 44, 45, 50, 51, 52, 74, NR Band n79	F _{DL_low}	-	F _{DL_high}	-50	1	
	NR Band n77, n78	F _{DL_low}	-	F _{DL_high}	-50	1	2
	Frequency range	1805	-	1855	-40	1	33
	Frequency range	1855	-	1880	-15.5	5	15, 26, 33
n40	E-UTRA Band 1, 3, 5, 7, 8, 11, 18, 19, 20, 21, 22, 26, 27, 28, 31, 32, 33, 34, 38, 39, 41, 42, 43, 44, 45, 50, 51, 52, 65, 67, 68, 69, 72, 74, 75, 76,	F _{DL_low}	-	F _{DL_high}	-50	1	44

NR Band	Spurious emission for UE co-existence						
	Protected band	Frequency range (MHz)			Maximum Level (dBm)	MBW (MHz)	NOTE
	NR Band n77, n78						
	NR Band n79	F _{DL_low}	-	F _{DL_high}	-50	1	2
	Frequency range	1884.5		1915.7	-41	0.3	8
n41	E-UTRA Band 1, 2, 3, 4, 5, 8, 12, 13, 14, 17, 24, 25, 26, 27, 28, 29, 30, 34, 39, 42, 44, 45, 48, 50, 51, 52, 65, 66, 70, 71, 73, 74, 85, NR Band n77, n78	F _{DL_low}	-	F _{DL_high}	-50	1	
	E-UTRA Band 40	F _{DL_low}	-	F _{DL_high}	-40	1	
	NR Band n79	F _{DL_low}	-	F _{DL_high}	-50	1	2
	E-UTRA Band 11, 18, 19, 21	F _{DL_low}	-	F _{DL_high}	-50	1	
	Frequency range	1884.5		1915.7	-41	0.3	8
	Frequency range	2530	-	2535	-25	1	48
	Frequency range	2505	-	2530	-30	1	48
n47	E-UTRA Band 1, 3, 5, 7, 8, 22, 26, 28, 34, 39, 40, 41, 42, 44, 45, 65, 68, 72, 73	F _{DL_low}	-	F _{DL_high}	-50	1	
	NR Band n71, n77, n78, n79	F _{DL_low}	-	F _{DL_high}	-50	1	
n48	E-UTRA Band 2, 4, 5, 12, 13, 14, 17, 24, 25, 26, 29, 30, 41, 50, 51, 66, 70, 71, 74, 85	F _{DL_low}	-	F _{DL_high}	-50	1	
n50	E-UTRA Band 1, 2, 3, 4, 5, 7, 8, 12, 13, 17, 20, 26, 28, 29, 31, 34, 38, 39, 40, 41, 42, 43, 48, 65, 66, 67, 68	F _{DL_low}	-	F _{DL_high}	-50	1	
n51	E-UTRA Band 1, 2, 3, 4, 5, 7, 8, 12, 13, 17, 20, 26, 28, 29, 31, 34, 38, 39, 40, 41, 42, 43, 48, 52, 65, 66, 67, 68, 85	F _{DL_low}	-	F _{DL_high}	-50	1	
n53	E-UTRA Band 2, 4, 5, 12, 13, 14, 17, 24, 25, 26, 29, 30, 48, 66, 70, 71, 85, NR Band n77	F _{DL_low}	-	F _{DL_high}	-50	1	
n65	E-UTRA Band 1, 3, 5, 7, 8, 11, 18, 19, 20, 21, 22, 26, 27, 28, 31, 32, 38, 40, 41, 42, 43, 50, 51, 65, 68, 69, 72, 74, 75, 76, NR Band n78, n79	F _{DL_low}	-	F _{DL_high}	-50	1	
	NR Band n77	F _{DL_low}	-	F _{DL_high}	-50	1	2
	E-UTRA Band 34	F _{DL_low}	-	F _{DL_high}	-50	1	43
	Frequency range	1900	-	1915	-15.5	5	15, 26, 27
	Frequency range	1915	-	1920	+1.6	5	15, 26, 27
n66, n86	E-UTRA Band 2, 4, 5, 7, 12, 13, 14, 17, 25, 26, 27, 28, 29, 30, 38, 41, 43, 50, 51, 53, 66, 70, 71, 74, 85	F _{DL_low}	-	F _{DL_high}	-50	1	
	E-UTRA Band 42, 48, NR Band n77	F _{DL_low}	-	F _{DL_high}	-50	1	2
n70	E-UTRA Band 2, 4, 5, 12, 13, 14, 17, 24, 25, 26, 29, 30, 41, 48, 66, 70, 71, 85	F _{DL_low}	-	F _{DL_high}	-50	1	
	NR Band n47, n77	F _{DL_low}	-	F _{DL_high}	-50	1	2
n71	E-UTRA Band 4, 5, 12, 13, 14, 17, 24, 26, 30, 48, 53, 66, 85	F _{DL_low}	-	F _{DL_high}	-50	1	
	E-UTRA Band 2, 25, 41, 70, NR Band n77	F _{DL_low}	-	F _{DL_high}	-50	1	2
	E-UTRA Band 29	F _{DL_low}	-	F _{DL_high}	-38	1	15
	E-UTRA Band 71	F _{DL_low}	-	F _{DL_high}	-50	1	15

NR Band	Spurious emission for UE co-existence						
	Protected band	Frequency range (MHz)			Maximum Level (dBm)	MBW (MHz)	NOTE
n74	E-UTRA Band 1, 2, 3, 4, 5, 7, 8, 12, 13, 17, 18, 19, 20, 26, 28, 29, 31, 34, 38, 39, 40, 41, 42, 43, 48, 52, 65, 66, 67, 68, 85 NR Band n77, n78	F _{DL_low}	-	F _{DL_high}	-50	1	
	NR Band n79	F _{DL_low}	-	F _{DL_high}	-50	1	2
	Frequency range	1884.5	-	1915.7	-41	0.3	8
	Frequency range	1400	-	1427	-32	27	15, 41
	Frequency range	1475	-	1488	-28	1	15, 42
	Frequency range	1475	-	1488	-50	1	15, 45
	Frequency range	1475.9	-	1510.9	-35	1	15, 46
n77	E-UTRA Band 1, 2, 3, 4, 5, 7, 8, 11, 12, 13, 14, 17, 18, 19, 20, 21, 24, 25, 26, 27, 28, 29, 30, 34, 39, 40, 41, 53, 65, 66, 70, 71, 74, 85	F _{DL_low}	-	F _{DL_high}	-50	1	
	Frequency range	1884.5	-	1915.7	-41	0.3	8
n78	E-UTRA Band 1, 3, 5, 7, 8, 11, 18, 19, 20, 21, 26, 28, 32, 34, 39, 40, 41, 65, 75, 76	F _{DL_low}	-	F _{DL_high}	-50	1	
	Frequency range	1884.5	-	1915.7	-41	0.3	8
n79	E-UTRA Band 1, 3, 5, 7, 8, 11, 18, 19, 21, 28, 34, 39, 40, 41, 42, 65, 74	F _{DL_low}	-	F _{DL_high}	-50	1	
	Frequency range	1884.5	-	1915.7	-41	0.3	8
n95	E-UTRA Band 1, 3, 5, 8, 28, 39, 40, 41, NR Band n78, n79	F _{DL_low}	-	F _{DL_high}	-50	1	5
	NR Band n77	F _{DL_low}	-	F _{DL_high}	-50	1	2
	Frequency range	1884.5	-	1915.7	-41	0.3	8
NOTE 1: F _{DL_low} and F _{DL_high} refer to each frequency band specified in Table 5.2-1 in TS 38.101-1 or Table 5.5-1 in TS 36.101							
NOTE 2: As exceptions, measurements with a level up to the applicable requirements defined in Table 6.5.3.1-2 are permitted for each assigned NR carrier used in the measurement due to 2nd, 3rd, 4th or 5th harmonic spurious emissions. Due to spreading of the harmonic emission the exception is also allowed for the first 1 MHz frequency range immediately outside the harmonic emission on both sides of the harmonic emission. This results in an overall exception interval centred at the harmonic emission of (2 MHz + N x L _{CRB} x RB _{size} kHz), where N is 2, 3, 4, 5 for the 2nd, 3rd, 4th or 5th harmonic respectively. The exception is allowed if the measurement bandwidth (MBW) totally or partially overlaps the overall exception interval.							
NOTE 3: 15 kHz SCS is assumed when RB is mentioned in the note when channel bandwidth is less than or equal to 50 MHz, lowest SCS is assumed when channel bandwidth is larger than 50 MHz. The transmission bandwidth in terms of RB position and range is not limited to 15 kHz SCS and shall scale with SCS accordingly.							
NOTE 4: Void							
NOTE 5: For non-synchronised TDD operation to meet these requirements some restriction will be needed for either the operating band or protected band							
NOTE 6: N/A							
NOTE 7: Void							
NOTE 8: Applicable when co-existence with PHS system operating in 1884.5 - 1915.7 MHz.							
NOTE 9: Void							
NOTE 10: Void							
NOTE 11: Void							
NOTE 12: The emissions measurement shall be sufficiently power averaged to ensure a standard deviation < 0.5 dB							
NOTE 13: Void							
NOTE 14: Void							
NOTE 15: These requirements also apply for the frequency ranges that are less than F _{OOB} (MHz) in Table 6.5.3.1-1 from the edge of the channel bandwidth.							
NOTE 16: Void							

NR Band	Spurious emission for UE co-existence				
	Protected band	Frequency range (MHz)	Maximum Level (dBm)	MBW (MHz)	NOTE
					<p>NOTE 17: Void</p> <p>NOTE 18: Void</p> <p>NOTE 19: Applicable when the assigned NR carrier is confined within 718 MHz and 748 MHz and when the channel bandwidth used is 5 or 10 MHz.</p> <p>NOTE 20: Void</p> <p>NOTE 21: This requirement is applicable for any channel bandwidths up to 20MHz within the range 2500 - 2570 MHz with the following restriction: for carriers of 15 MHz bandwidth when carrier centre frequency is within the range 2560.5 - 2562.5 MHz and for carriers of 20 MHz bandwidth when carrier centre frequency is within the range 2552 - 2560 MHz the requirement is applicable only for an uplink transmission bandwidth less than or equal to 54 RB.</p> <p>NOTE 22: This requirement is applicable for power class 3 UE for any channel bandwidths up to 20 MHz. For channel bandwidth within the range 2570 - 2615 MHz with the following restriction: for carriers of 15 MHz bandwidth when the carrier centre frequency is within the range 2605.5 - 2607.5 MHz and for carriers of 20 MHz bandwidth when the carrier centre frequency is within the range 2597 - 2605 MHz the requirement is applicable only for an uplink transmission bandwidth less than or equal to 54 RB. . For carriers overlapping the frequency range 2615 - 2620 MHz the requirement applies with the maximum output power configured to +19 dBm in the IE P-Max.</p> <p>NOTE 23: Void</p> <p>NOTE 24: As exceptions, measurements with a level up to the applicable requirement of -38 dBm/MHz is permitted for each assigned NR carrier used in the measurement due to 2nd harmonic spurious emissions. An exception is allowed if there is at least one individual RB within the transmission bandwidth (see Figure 5.3.1-1) for which the 2nd harmonic totally or partially overlaps the measurement bandwidth (MBW).</p> <p>NOTE 25: As exceptions, measurements with a level up to the applicable requirement of -36 dBm/MHz is permitted for each assigned NR carrier used in the measurement due to 3rd harmonic spurious emissions. An exception is allowed if there is at least one individual RB within the transmission bandwidth (see Figure 5.3.1-1) for which the 3rd harmonic totally or partially overlaps the measurement bandwidth (MBW).</p> <p>NOTE 26: For these adjacent bands, the emission limit could imply risk of harmful interference to UE(s) operating in the protected operating band.</p> <p>NOTE 27: This requirement is applicable for power class 3 and channel bandwidths up to 20 MHz within the range 1920 - 1980 MHz with the following restriction: for carriers of 15 MHz bandwidth when the carrier centre frequency is within the range 1927.5 - 1929.5 MHz and for carriers of 20 MHz bandwidth when the carrier centre frequency is within the range 1930 - 1938 MHz the requirement is applicable only for an uplink transmission bandwidth less than or equal to 54 RB.</p> <p>NOTE 28: Void</p> <p>NOTE 29: Void</p> <p>NOTE 30: Void</p> <p>NOTE 31: Void</p> <p>NOTE 32: Void</p> <p>NOTE 33: This requirement is only applicable for carriers with bandwidth up to 20MHz and confined within 1885-1920 MHz (requirement for carriers with at least 1RB confined within 1880 - 1885 MHz is not specified). This requirement applies for an uplink transmission bandwidth less than or equal to 54 RB for carriers of 15 MHz bandwidth when carrier center frequency is within the range 1892.5 - 1894.5 MHz and for carriers of 20 MHz bandwidth when carrier center frequency is within the range 1895 - 1903 MHz.</p> <p>NOTE 34: This requirement is applicable for 5 and 10 MHz NR channel bandwidth allocated within 718-728 MHz. For carriers of 10 MHz bandwidth, this requirement applies for an uplink transmission bandwidth less than or equal to 30 RB with $RB_{start} > 1$ and $RB_{start} < 48$.</p> <p>NOTE 35: This requirement is applicable in the case of a 10 MHz NR carrier confined within 703 MHz and 733 MHz, otherwise the requirement of -25 dBm with a measurement bandwidth of 8 MHz applies.</p> <p>NOTE 36: Void</p> <p>NOTE 37: Void</p> <p>NOTE 38: Void</p> <p>NOTE 39: Void</p> <p>NOTE 40: Void</p> <p>NOTE 41: Applicable for cases and when the lower edge of the assigned NR UL channel bandwidth frequency is greater than or equal to 1427 MHz + the channel BW assigned for 5 and 10 MHz bandwidth, and when the lower edge of the assigned NR UL channel bandwidth frequency is greater than or equal to 1440 MHz for 15 and 20 MHz bandwidth. This requirement shall be verified with UE transmission power configured as high as possible but no higher than 15 dBm.</p> <p>NOTE 42: Applicable when upper edge of the assigned NR UL channel bandwidth frequency is more than 1460MHz and less than or equal to 1470MHz for 5 MHz bandwidth, and when the upper edge of</p>

NR Band	Spurious emission for UE co-existence				
	Protected band	Frequency range (MHz)	Maximum Level (dBm)	MBW (MHz)	NOTE
the assigned NR UL channel bandwidth frequency is more than 1460MHz and less than or equal to 1465 MHz for 10 MHz bandwidth. NOTE 43: This requirement is applicable for UE which is operating in power class 3 and NR channel bandwidths up to 20MHz within frequency range 1920-1980 MHz. NOTE 44: As exceptions, for 90 and 100 MHz channel bandwidth, -40 dBm/MHz is applicable in the frequency range of 2496 – 2505 MHz. NOTE 45: Applicable when upper edge of the assigned NR UL channel bandwidth frequency is equal to or less than 1460MHz. NOTE 46: Applicable for 5MHz bandwidth and when the NR carrier is within 1447.9 – 1462.9 MHz. NOTE 47: This requirement is applicable for power class 3 and channel bandwidths up to 20MHz. NOTE 48: Applicable when contained within 2545 – 2575 MHz in Japan. Channel bandwidth shall be confined so that there is at least $BW_{Channel}$ separation between 2535 MHz and lower $BW_{Channel}$ edge in the current release. With this $BW_{Channel}$ placement the requirement is covered by general SEM and the spurious emission limits.					

NOTE: To simplify Table 6.5.3.2-1, E-UTRA band numbers are listed for bands which are specified only for E-UTRA operation or both E-UTRA and NR operation. NR band numbers are listed for bands which are specified only for NR operation.

6.5.3.3 Additional spurious emissions

These requirements are specified in terms of an additional spectrum emission requirement. Additional spurious emission requirements are signalled by the network to indicate that the UE shall meet an additional requirement for a specific deployment scenario as part of the cell handover/broadcast message.

6.5.3.3.1 Requirement for network signalling value "NS_04"

When "NS_04" is indicated in the cell, the power of any UE emission shall not exceed the levels specified in Table 6.5.3.3.1-1. This requirement also applies for the frequency ranges that are less than F_{OOB} (MHz) in Table 6.5.3.1-1 from the edge of the channel bandwidth.

Table 6.5.3.3.1-1: Additional requirements for "NS_04"

Frequency range (MHz)	Channel bandwidth (MHz) / Spectrum emission limit (dBm)	Measurement bandwidth
	10, 15, 20, 30, 40, 50, 60, 80, 90, 100 MHz	
$2495 \leq f < 2496$	-13	1 % of Channel BW
$2490.5 \leq f < 2495$	-13	1 MHz
$0.009 < f < 2490.5$	-25	1 MHz

6.5.3.3.2 Requirement for network signalling value "NS_17"

When "NS_17" is indicated in the cell, the power of any UE emission shall not exceed the levels specified in Table 6.5.3.3.2-1. This requirement also applies for the frequency ranges that are less than F_{OOB} (MHz) in Table 6.5.3.1-1 from the edge of the channel bandwidth.

Table 6.5.3.3.2-1: Additional requirements for "NS_17"

Frequency range (MHz)	Channel bandwidth (MHz) / Spectrum emission limit (dBm)	Measurement bandwidth	NOTE
	5, 10		
$470 \leq f \leq 710$	-26.2	6 MHz	1
NOTE 1: Applicable when the assigned NR carrier is confined within 718 MHz and 748 MHz and when the channel bandwidth used is 5 or 10 MHz.			

6.5.3.3.3 Requirement for network signalling value "NS_18"

When "NS_18" is indicated in the cell, the power of any UE emission shall not exceed the levels specified in Table 6.5.3.3.3-1. This requirement also applies for the frequency ranges that are less than F_{OOB} (MHz) in Table 6.5.3.1-1 from the edge of the channel bandwidth.

Table 6.5.3.3.3-1: Additional requirements for "NS_18"

Frequency range (MHz)	Channel bandwidth (MHz) / Spectrum emission limit (dBm)	Measurement bandwidth	
	5, 10, 15, 20, 30		
692-698	-26.2	6 MHz	

6.5.3.3.4 Requirement for network signalling values "NS_05" and "NS_05U"

When "NS_05" or "NS_05U" is indicated in the cell, the power of any UE emission shall not exceed the levels specified in Table 6.5.3.3.4-1. This requirement also applies for the frequency ranges that are less than F_{OOB} (MHz) in Table 6.5.3.1-1 from the edge of the channel bandwidth.

Table 6.5.3.3.4-1: Additional requirements for "NS_05" and "NS_05U"

Frequency range (MHz)	Channel bandwidth (MHz) / Spectrum emission limit (dBm)	Measurement bandwidth	
	5, 10, 15, 20		
$1884.5 \leq f \leq 1915.7$	-41	300 kHz	

6.5.3.3.5 Requirement for network signalling values "NS_43" and "NS_43U"

When "NS_43" or "NS_43U" is indicated in the cell, the power of any UE emission shall not exceed the levels specified in Table 6.5.3.3.5-1. This requirement also applies for the frequency ranges that are less than F_{OOB} (MHz) in Table 6.5.3.1-1 from the edge of the channel bandwidth.

Table 6.5.3.3.5-1: Additional requirements for "NS_43" and "NS_43U"

Frequency range (MHz)	Channel bandwidth (MHz) / Spectrum emission limit (dBm)	Measurement bandwidth	
	5, 10, 15		
$860 \leq f \leq 890$	-40	1 MHz	
NOTE 1: Applicable for 5 MHz and 15 MHz channel BW confined between 900 MHz and 915 MHz and for 10 MHz channel BW confined between 905 MHz and 915 MHz			

6.5.3.3.6 Requirement for network signalling value "NS_37"

When "NS_37" is indicated in the cell, the power of any UE emission shall not exceed the levels specified in Table 6.5.3.3.6-1. This requirement also applies for the frequency ranges that are less than F_{OOB} (MHz) in Table 6.5.3.1-1 from the edge of the channel bandwidth.

Table 6.5.3.3.6-1: Additional requirement for "NS_37"

Frequency range (MHz)	Channel bandwidth (MHz) / Spectrum emission limit (dBm)	Measurement bandwidth	
	5, 10, 15		
$1475.9 \leq f \leq 1510.9$	-35	1 MHz	

6.5.3.3.7 Requirement for network signalling value "NS_38"

When "NS_38" is indicated in the cell, the power of any UE emission shall not exceed the levels specified in Table 6.5.3.3.7-1. This requirement also applies for the frequency ranges that are less than F_{OOB} (MHz) in Table 6.5.3.1-1 from the edge of the channel bandwidth.

Table 6.5.3.3.7-1: Additional requirements for NR channels assigned within 1430-1452MHz for "NS_38"

Frequency range (MHz)	Channel bandwidth (MHz) / Spectrum emission limit (dBm)	Measurement bandwidth
	5, 10, 15, 20	
$1400 \leq f \leq 1427$	-32	27 MHz
NOTE 1: This requirement shall be verified with UE transmission power configured as high as possible but no higher than 15 dBm.		

6.5.3.3.8 Requirement for network signalling value "NS_39"

When "NS_39" is indicated in the cell, the power of any UE emission shall not exceed the levels specified in Table 6.5.3.3.8-1. This requirement also applies for the frequency ranges that are less than F_{OOB} (MHz) in Table 6.5.3.1-1 from the edge of the channel bandwidth.

Table 6.5.3.3.8-1: Additional requirements for "NS_39"

Frequency range (MHz)	Channel bandwidth (MHz) / Spectrum emission limit (dBm)	Measurement bandwidth
	5, 10, 15, 20	
$1475 \leq f \leq 1488$	-28	1 MHz

6.5.3.3.9 Requirement for network signalling value "NS_40"

When "NS_40" is indicated in the cell, the power of any UE emission shall not exceed the levels specified in Table 6.5.3.3.9-1. This requirement also applies for the frequency ranges that are less than F_{OOB} (MHz) in Table 6.5.3.1-1 from the edge of the channel bandwidth.

Table 6.5.3.3.9-1: Additional requirements for NR channels assigned within 1427-1432MHz for "NS_40"

Frequency range (MHz)	Channel bandwidth (MHz) / Spectrum emission limit (dBm)	Measurement bandwidth
	5	
$1400 \leq f \leq 1427$	-32	27 MHz
NOTE 1: This requirement shall be verified with UE transmission power configured as high as possible but no higher than 15 dBm.		

6.5.3.3.10 Requirement for network signalling value "NS_41"

When "NS_41" is indicated in the cell, the power of any UE emission shall not exceed the levels specified in Table 6.5.3.3.10-1. This requirement also applies for the frequency ranges that are less than F_{OOB} (MHz) in Table 6.5.3.1-1 from the edge of the channel bandwidth.

Table 6.5.3.3.10-1: Additional requirements for NR channels assigned within 1432-1517 MHz for "NS_41"

Frequency range (MHz)	Channel bandwidth (MHz) / Spectrum emission limit (dBm)	Measurement bandwidth
-----------------------	---------------------------------------------------------	-----------------------

	5, 10, 15, 20, 40, 50, 60	
$1400 \leq f \leq 1427$	-32	27 MHz
NOTE 1: This requirement shall be verified with UE transmission power configured as high as possible but no higher than 15 dBm.		

6.5.3.3.11 Requirement for network signalling value "NS_42"

When "NS_42" is indicated in the cell, the power of any UE emission shall not exceed the levels specified in Table 6.5.3.3.11-1. This requirement also applies for the frequency ranges that are less than F_{OoB} (MHz) in Table 6.5.3.1-1 from the edge of the channel bandwidth.

Table 6.5.3.3.11-1: Additional requirements for NR channels assigned within 1432-1517 MHz for "NS_42"

Frequency range (MHz)	Channel bandwidth (MHz) / Spectrum emission limit (dBm)	Measurement bandwidth
	5, 10, 15, 20, 40, 50, 60 MHz	
$1518 \leq f \leq 1520$	-0.8	1 MHz
$1520 < f \leq 1559$	-30	1 MHz

6.5.3.3.12 Requirement for network signalling value "NS_21"

When "NS_21" is indicated in the cell, the power of any UE emission shall not exceed the levels specified in Table 6.5.3.3.12-1. These requirements also apply for the frequency ranges that are less than F_{OoB} (MHz) in Table 6.5.3.1-1 from the edge of the channel bandwidth.

Table 6.5.3.3.12-1: Additional requirements for "NS_21"

Frequency range (MHz)	Channel bandwidth (MHz) / Spectrum emission limit (dBm)	Measurement bandwidth
	5, 10	
$2200 \leq f < 2288$	-40	1 MHz
$2288 \leq f < 2292$	-37	1 MHz
$2292 \leq f < 2296$	-31	1 MHz
$2296 \leq f < 2300$	-25	1 MHz
$2320 \leq f < 2324$	-25	1 MHz
$2324 \leq f < 2328$	-31	1 MHz
$2328 \leq f < 2332$	-37	1 MHz
$2332 \leq f \leq 2395$	-40	1 MHz

6.5.3.3.13 Requirement for network signalling value "NS_24"

When "NS_24" is indicated in the cell, the power of any UE emission shall not exceed the levels specified in Table 6.5.3.3.13-1. This requirement also applies for the frequency ranges that are less than F_{OoB} (MHz) in Table 6.5.3.1-1 from the edge of the channel bandwidth.

Table 6.5.3.3.13-1: Additional requirements for "NS_24"

Frequency range (MHz)	Channel bandwidth (MHz) / Spectrum emission limit (dBm)	Measurement bandwidth
	5 MHz, 10 MHz, 15 MHz, 20 MHz	
$2010 \leq f \leq 2025$	-50	1 MHz
NOTE 1: This requirement applies at a frequency offset equal or larger than 5 MHz from the upper edge of the channel bandwidth, whenever these frequencies overlap with the specified frequency band.		

6.5.3.3.14 Requirement for network signalling value "NS_27"

When "NS_27" is indicated in the cell, the power of any UE emission shall not exceed the levels specified in Table 6.5.3.3.14-1. This requirement also applies for the frequency ranges that are less than F_{OOB} (MHz) in Table 6.5.3.1-1 from the edge of the channel bandwidth.

Table 6.5.3.3.14-1: Additional requirements for "NS_27"

Frequency range (MHz)	Channel bandwidth (MHz) / Spectrum emission limit (dBm)	Measurement bandwidth
	5, 10, 15, 20, 40	
9 kHz – 3530 MHz	-40	1 MHz
3530 MHz – 3540 MHz	-25	
3710 MHz – 3720 MHz	-25	
3720 MHz – 12.75 GHz	-40	

6.5.3.3.15 Requirement for network signalling value "NS_47"

When "NS_47" is indicated in the cell, the power of any UE emission shall not exceed the levels specified in Table 6.5.3.3.15-1. This requirement also applies for the frequency ranges that are less than F_{OOB} (MHz) in Table 6.5.3.1-1 from the edge of the channel bandwidth.

Table 6.5.3.3.15-1: Additional requirements for NR channels assigned within 2545 - 2575 MHz for "NS_47"

Frequency range (MHz)	Channel bandwidth (MHz) / Spectrum emission limit (dBm)	Measurement bandwidth
	30	
$2530 \leq f \leq 2535$	-25	1 MHz
$2505 \leq f \leq 2530$	-30	1 MHz

6.5.3.3.16 Requirement for network signalling value "NS_50"

When "NS_50" is indicated in the cell, the power of any UE emission shall not exceed the levels specified in Table 6.5.3.3.16-1. This requirement also applies for the frequency ranges that are less than F_{OOB} (MHz) in Table 6.5.3.1-1 from the edge of the channel bandwidth.

Table 6.5.3.3.16-1: Additional requirements for "NS_50"

Protected band	Frequency range (MHz)			Maximum Level (dBm)	MBW (MHz)	NOTE
Frequency range	1805	-	1855	-40	1	1
Frequency range	1855	-	1880	-15.5	5	1, 2, 3
NOTE 1: This requirement is applicable for carriers with aggregated channel bandwidths confined in 1885-1920 MHz for 25MHz and 30MHz channel BWs and confined in 1880-1920 MHz for 40MHz channel BW.						
NOTE 2: The requirement also applies for the frequency ranges that are less than F_{OOB} (MHz) in Table 6.5.3.1-1 and Table 6.5A.3.1-1 from the edge of the channel bandwidth.						
NOTE 3: For these adjacent bands, the emission limit could imply risk of harmful interference to UE(s) operating in the protected operating band.						

6.5.3.3.17 Requirement for network signalling value "NS_12"

When "NS_12" is indicated in the cell, the power of any UE emission shall not exceed the levels specified in Table 6.5.3.3.17-1. This requirement also applies for the frequency ranges that are less than F_{OOB} (MHz) in Table 6.5.3.1-1 from the edge of the channel bandwidth.

Table 6.5.3.3.17-1: Additional requirements "NS_12"

Frequency range (MHz)	Channel bandwidth / Spectrum emission limit	Measurement bandwidth
-----------------------	---------------------------------------------	-----------------------

	(dBm)	
	5 MHz, 10 MHz	
$806 \leq f \leq 813.5$	-42	6.25 kHz
NOTE 1: The requirement applies for NR carriers with lower channel edge at or above 814 MHz NOTE 2: The emissions measurement shall be sufficiently power averaged to ensure a standard deviation < 0.5 dB.		

6.5.3.3.18 Requirement for network signalling value "NS_13"

When "NS_13" is indicated in the cell, the power of any UE emission shall not exceed the levels specified in Table 6.5.3.3.18-1. This requirement also applies for the frequency ranges that are less than F_{OOB} (MHz) in Table 6.5.3.1-1 from the edge of the channel bandwidth.

Table 6.5.3.3.18-1: Additional requirements "NS_13"

Frequency range (MHz)	Channel bandwidth / Spectrum emission limit (dBm)	Measurement bandwidth
	5 MHz	
$806 \leq f \leq 816$	-42	6.25 kHz
NOTE 1: The requirement applies for NR carriers with lower channel edge at or above 817 MHz. NOTE 2: The emissions measurement shall be sufficiently power averaged to ensure a standard deviation < 0.5 dB.		

6.5.3.3.19 Requirement for network signalling value "NS_14"

When "NS_14" is indicated in the cell, the power of any UE emission shall not exceed the levels specified in Table 6.5.3.3.19-1. This requirement also applies for the frequency ranges that are less than F_{OOB} (MHz) in Table 6.5.3.1-1 from the edge of the channel bandwidth.

Table 6.5.3.3.19-1: Additional requirements "NS_14"

Frequency range (MHz)	Channel bandwidth / Spectrum emission limit (dBm)	Measurement bandwidth
	10 MHz, 15 MHz, 20MHz	
$806 \leq f \leq 816$	-42	6.25 kHz
NOTE 1: The requirement applies for NR carriers with lower channel edge at or above 824 MHz. NOTE 2: The emissions measurement shall be sufficiently power averaged to ensure a standard deviation < 0.5 dB.		

6.5.3.3.20 Requirement for network signalling value "NS_15"

When "NS_15" is indicated in the cell, the power of any UE emission shall not exceed the levels specified in Table 6.5.3.3.20-1. This requirement also applies for the frequency ranges that are less than F_{OOB} (MHz) in Table 6.5.3.1-1 from the edge of the channel bandwidth.

Table 6.5.3.3.20-1: Additional requirements "NS_15"

Frequency range (MHz)	Channel bandwidth / Spectrum emission limit (dBm)	Measurement bandwidth
	5 MHz, 10 MHz, 15 MHz, 20 MHz	
$851 \leq f \leq 859$	-53	6.25 kHz
NOTE 1: The emissions measurement shall be sufficiently power averaged to ensure a standard deviation < 0.5 dB.		

6.5.3.3.21 Requirement for network signalling value "NS_45"

When "NS_45" is indicated in the cell, the power of any UE emission shall not exceed the levels specified in Table 6.5.3.3.21-1. This requirement also applies for the frequency ranges that are less than F_{OOB} (MHz) in Table 6.5.3.1-1 from the edge of the channel bandwidth.

Table 6.5.3.3.21-1: Additional requirements "NS_45"

Frequency range (MHz)	Channel bandwidth / Spectrum emission limit (dBm)		Measurement bandwidth
	5 MHz	10 MHz	
$0.009 < f \leq 2473.5$	-25	-25	1 MHz
$2473.5 < f \leq 2477.5$	-25	-13	1 MHz
$2477.5 < f \leq 2478.5$	-13	-13	1 MHz
$2478.5 < f \leq 2483.5$	-10	-10	1 MHz
$2495 \leq f < 2496$	-13	-13	1% of Channel Bandwidth
$2496 \leq f < 2501$	-13	-13	1 MHz
$2501 < f \leq 2505$	-25	-13	1 MHz
$2505 \leq f \leq 5^{\text{th}}$ harmonic of the upper frequency edge of the UL operating band	-25	-25	1 MHz

6.5.3.3.22 Requirement for network signalling values "NS_48" and "NS_51"

When "NS_48" or "NS_51" is indicated in the cell, the power of any UE emission shall not exceed the levels specified in Table 6.5.3.3.22-1. This requirement also applies for the frequency ranges that are less than F_{OOB} (MHz) in Table 6.5.3.1-1 from the edge of the channel bandwidth.

Table 6.5.3.3.22-1: Additional requirements for "NS_48" and "NS_51"

Protected band	Frequency range (MHz)			Maximum Level (dBm)	MBW (MHz)	NOTE
E-UTRA band 34 – NR band n34	F_{DL_low}	-	F_{DL_high}	-50	1	
Frequency range	1900	-	1915	-15.5	5	1
Frequency range	1915	-	1920	+1.6	5	1
NOTE 1: For these adjacent bands, the emission limit could imply risk of harmful interference to UE(s) operating in the protected operating band.						

6.5.3.3.23 Requirement for network signalling value "NS_49"

When "NS_49" is indicated in the cell, the power of any UE emission shall not exceed the levels specified in Table 6.5.3.3.23-1. This requirement also applies for the frequency ranges that are less than F_{OOB} (MHz) in Table 6.5.3.1-1 from the edge of the channel bandwidth.

Table 6.5.3.3.23-1: Additional requirements for "NS_49"

Protected band	Frequency range (MHz)			Maximum Level (dBm)	MBW (MHz)	NOTE
E-UTRA band 34 - NR band n34	F_{DL_low}	-	F_{DL_high}	-50	1	
Frequency range	1880	-	1895	-40	1	
Frequency range	1895	-	1915	-15.5	5	1
Frequency range	1915	-	1920	1.6	5	1
NOTE 1: For these adjacent bands, the emission limit could imply risk of harmful interference to UE(s) operating in the protected operating band.						

6.5.3.3.24 Requirement for network signalling value "NS_44"

When "NS_44" is indicated in the cell, the power of any UE emission shall not exceed the levels specified in Table 6.5.3.3.24-1. This requirement also applies for the frequency ranges that are less than F_{OOB} (MHz) in Table 6.5.3.1-1 from the edge of the channel bandwidth.

Table 6.5.3.3.24-1: Additional requirements for "NS_44"

Protected band	Frequency range (MHz)			Maximum Level (dBm)	MBW (MHz)	NOTE
Frequency range	2620	-	2645	-15.5	5	1, 2
Frequency range	2645	-	2690	-40	1	1
NOTE 1: This requirement is applicable for carriers confined in 2570-2615 MHz.						
NOTE 2: For these adjacent bands, the emission limit could imply risk of harmful interference to UE(s) operating in the protected operating band.						

6.5.3.3.25 Requirement for network signalling value "NS_46"

When "NS_46" is indicated in the cell, the power of any UE emission shall not exceed the levels specified in Table 6.5.3.3.25-1. This requirement also applies for the frequency ranges that are less than F_{OOB} (MHz) in Table 6.5.3.1-1 from the edge of the channel bandwidth.

Table 6.5.3.3.25-1: Additional requirements for "NS_46"

Protected band	Frequency range (MHz)			Maximum Level (dBm)	MBW (MHz)	NOTE
Frequency range	2570	-	2575	+1.6	5	1, 2
Frequency range	2575	-	2595	-15.5	5	1, 2
Frequency range	2595	-	2620	-40	1	1
NOTE 1: This requirement is applicable for all carriers confined in 2500-2570 MHz. Special restrictions apply for channel bandwidths up to 20MHz: For carriers of 15 MHz bandwidth when carrier centre frequency is within the range 2560.5 - 2562.5 MHz and for carriers of 20 MHz bandwidth when carrier centre frequency is within the range 2552 - 2560 MHz the requirement is applicable only for an uplink transmission bandwidth less than or equal to 54 RB with the minimum supported SCS of 15KHz.						
NOTE 2: For these adjacent bands, the emission limit could imply risk of harmful interference to UE(s) operating in the protected operating band.						

6.5.4 Transmit intermodulation

The transmit intermodulation performance is a measure of the capability of the transmitter to inhibit the generation of signals in its non linear elements caused by presence of the wanted signal and an interfering signal reaching the transmitter via the antenna.

UE transmit intermodulation is defined by the ratio of the mean power of the wanted signal to the mean power of the intermodulation product when an interfering CW signal is added at a level below the wanted signal at each transmitter antenna port with the other antenna port(s) if any terminated. Both the wanted signal power and the intermodulation product power are measured through NR rectangular filter with measurement bandwidth shown in Table 6.5.4-1. For UE power class 1.5 the transmit intermodulation requirement is specified at each antenna connector with the wanted signal measured as the sum of the output power from both UE antenna connectors.

The requirement of transmit intermodulation is specified in Table 6.5.4-1.

Table 6.5.4-1: Transmit Intermodulation

Wanted signal channel bandwidth	$BW_{Channel}$	
Interference signal frequency offset from channel center	$BW_{Channel}$	$2 \cdot BW_{Channel}$
Interference CW signal level	-40 dBc	
Intermodulation product	< -29 dBc	< -35 dBc
Measurement bandwidth	The maximum transmission bandwidth configuration among the different SCS's for the channel BW as defined in Table 6.5.2.4.1-1	

Measurement offset from channel center	BW_{Channel} and $2 \cdot BW_{\text{Channel}}$	$2 \cdot BW_{\text{Channel}}$ and $4 \cdot BW_{\text{Channel}}$
----------------------------------------	---------------------------------------------------------	-----------------------------------------------------------------

6.5A Output RF spectrum emissions for CA

6.5A.0 General

For inter-band carrier aggregation with one uplink carrier assigned to one NR band, the output RF spectrum emissions requirements in clause 6.5 apply.

6.5A.1 Occupied bandwidth for CA

6.5A.1.1 Void

6.5A.1.1a Occupied bandwidth for Intra-band contiguous CA

For intra-band contiguous carrier aggregation the occupied bandwidth is a measure of the bandwidth containing 99 % of the total integrated power of the transmitted spectrum. The occupied bandwidth shall be less than the aggregated channel bandwidth defined in clause 5.3A.3.

6.5A.1.2 Occupied bandwidth for Intra-band non-contiguous CA

For intra-band non-contiguous carrier aggregation, the OBW requirement is met when the ratio of the transmitted power in all sub-blocks of the uplink CA configuration to the total integrated power of the transmitted spectrum is greater than 99%.

6.5A.1.3 Occupied bandwidth for Inter-band CA

For inter-band carrier aggregation with two contiguous carriers assigned to one NR band, the occupied bandwidth requirements in subclause 6.5A.1.1a apply for that band.

For inter-band carrier aggregation with uplink assigned to two NR bands, the occupied bandwidth is defined per component carrier. Occupied bandwidth is the bandwidth containing 99 % of the total integrated mean power of the transmitted spectrum on assigned channel bandwidth on the component carrier. The occupied bandwidth shall be less than the channel bandwidth specified in Table 6.5.1-1.

6.5A.2 Out of band emission for CA

6.5A.2.1 General

This clause contains requirements for out of band emissions for UE configured of carrier aggregation.

6.5A.2.2 Spectrum emission mask

6.5A.2.2.1 Spectrum emission mask for intra-band contiguous CA

For intra-band contiguous carrier aggregation the spectrum emission mask of the UE applies to frequencies (Δf_{OOB}) starting from the \pm edge of the aggregated channel bandwidth. For intra-band contiguous carrier aggregation, the power of any UE emission shall not exceed the levels specified in Table 6.5A.2.2.1-1 for the specified channel bandwidth.

Table 6.5A.2.2.1-1: General NR CA spectrum emission mask

Δf_{OOB} (MHz)	Spectrum emission limit(dBm)	MBW(MHz)
$\pm 0 - 1$	-13	$\text{Min}(0.01 \cdot BW_{\text{channel_CA}}, 0.4)$
$\pm 1 - 5$	-10	1MHz

$\pm 5 - BW_{\text{channel_CA}}$	-13	1MHz
$\pm BW_{\text{channel_CA}} - BW_{\text{channel_CA}+5}$	-25	1MHz

6.5A.2.2.2 Spectrum emission mask for intra-band non-contiguous CA

For intra-band non-contiguous carrier aggregation the spectrum emission mask requirement is defined as a composite spectrum emissions mask. Composite spectrum emission mask applies to frequencies up to Δf_{OOB} starting from the edges of the sub-blocks. Composite spectrum emission mask is defined as follows

- Composite spectrum emission mask is a combination of individual sub-block spectrum emissions masks
- In case the sub-block consist of one component carrier the sub-block general spectrum emission mask is defined in subclause 6.5.2.1
- If for some frequency sub-block spectrum emission masks overlap then spectrum emission mask allowing higher power spectral density applies for that frequency
- If for some frequency a sub-block spectrum emission mask overlaps with the sub-block bandwidth of another sub-block, then the emission mask does not apply for that frequency.

6.5A.2.2.3 Spectrum emission mask for Inter-band CA

For inter-band carrier aggregation with two contiguous carriers assigned to one NR band, the spectrum emission mask requirements in subclause 6.5A.2.2.1 apply for that band.

For inter-band carrier aggregation with uplink assigned to two NR bands, the spectrum emission mask of the UE is defined per component carrier while both component carriers are active and the requirements are specified in clauses 6.5.2.1 and 6.5.2.2. If for some frequency spectrum emission masks of component carriers overlap then spectrum emission mask allowing higher power spectral density applies for that frequency. If for some frequency a component carrier spectrum emission mask overlaps with the channel bandwidth of another component carrier, then the emission mask does not apply for that frequency.

6.5.A.2.2.4 Void

6.5A.2.3 Additional spectrum emission mask for CA

6.5A.2.3.1 Additional spectrum emission mask for intra-band contiguous CA

6.5A.2.3.1.1 Requirements for network signalling value "CA_NS_04"

When "CA_NS_04" is indicated in the cell, the power of any UE emission shall not exceed the levels specified in Table 6.5A.2.3.1.1-1.

Table 6.5A.2.3.1.1-1: Additional requirements for "CA_NS_04"

Δf_{OOB} MHz	BWChannel_CA (MHz) / Spectrum emission limit (dBm)		Measurement bandwidth
	≤ 50	> 50	
$\pm 0 - 1$	-10	-10	2 % of BW _{Channel_CA}
		-10	1 MHz
$\pm 1 - 5$	-10		1 MHz
$\pm 5 - X$	-13		
$\pm X - (BW_{\text{Channel_CA}} + 5 \text{ MHz})$	-25		
NOTE: X is aggregated bandwidth			

6.5A.2.3.1.2 Requirements for network signalling value "CA_NS_27"

When "CA_NS_27" is indicated in the cell, the power of any UE emission shall not exceed the levels specified in Table 6.2A.2.3.2.1-1.

Table 6.2A.2.3.2.1-1: Additional requirements for "CA_NS_27"

Spectrum emission limit (dBm) / measurement bandwidth for each aggregated channel bandwidth		
Δf_{OoB} MHz	Aggregated channel bandwidth of max 40 MHz	Measurement bandwidth
$\pm 0 - 1$	-13	1 % of X
$\pm 1 - X$	-13	1 MHz
$< -X$ or $> X$	-25	
NOTE 1: X is the aggregated channel bandwidth		
NOTE 2: The requirements apply only at the frequency range from 3540 MHz to 3710 MHz.		

NOTE: As a general rule, the resolution bandwidth of the measuring equipment should be equal to the measurement bandwidth. However, to improve measurement accuracy, sensitivity and efficiency, the resolution bandwidth may be smaller than the measurement bandwidth. When the resolution bandwidth is smaller than the measurement bandwidth, the result should be integrated over the measurement bandwidth in order to obtain the equivalent noise bandwidth of the measurement bandwidth.

6.5A.2.3.1 Void

6.5A.2.3.2 Additional spectrum emission mask for Intra-band non-contiguous CA

6.5A.2.3.2.1 Minimum requirement (network signalling value "CA_NC_NS_04")

For intra-band non-cotiguous CA_{n41(2A)}, the additional SEM requirements in subclause 6.5.2.3.2 (indicated by NS_04) applies in each uplink CC.

6.5A.2.3.3 Additional spectrum emission mask for Inter-band CA

6.5A.2.4 Adjacent channel leakage ratio

6.5A.2.4.1 NR ACLR

6.5A.2.4.1.1 NR ACLR for intra-band contiguous CA

For intra-band contiguous carrier aggregation the carrier aggregation the Adjacent Channel Leakage power Ratio is the ratio of the filtered mean power centred on the aggregated channel bandwidth to the filtered mean power centred on an adjacent aggregated channel bandwidth at nominal channel spacing. The assigned aggregated channel bandwidth power and adjacent aggregated channel bandwidth power are measured with rectangular filters with measurement bandwidths specified in Table 6.5A.2.4.1.1-1. If the measured adjacent channel power is greater than -50dBm then the NR_{ACLR} shall be higher than the value specified in Table 6.5A.2.4.1.1-1.

Table 6.5A.2.4.1.1-1: General requirements for intra-band contiguous CA ACLR

	ACLR / Measurement bandwidth
CA ACLR	30 dB
CA Measurement bandwidth (NOTE 1)	Nominal channel space+ $MBW_{\text{ACLR,low}}/2$ + $MBW_{\text{ACLR,high}}/2$
Adjacent channel centre frequency offset (in MHz)	$+ BW_{\text{Channel_CA}}$ / $- BW_{\text{Channel_CA}}$
Difference between ACLR MBW center and $F_{c,low}$	$MBW_{\text{shift}} = (MBW_{\text{ACLR_CA}} - MBW_{\text{ACLR,low}}) / 2$

NOTE 1: $MBW_{ACLR,low}$ and $MBW_{ACLR,high}$ are the single-channel ACLR measurement bandwidths specified for channel bandwidths $BW_{channel(low)}$ and $BW_{channel(high)}$ in 6.5.2.4.1, respectively.

6.5A.2.4.1.2 NR ACLR for intra-band non-contiguous CA

For intra-band non-contiguous carrier aggregation, CA Adjacent Channel Leakage power Ratio (CA_{ACLR}) is the ratio of the sum of the filtered mean power centred on each assigned channel frequency to the filtered mean power centred on an adjacent NR channel frequency at nominal channel spacing. In case the gap bandwidth W_{gap} between 2 uplink CCs is smaller than maximum of the 2 uplink channel bandwidths then no CA_{ACLR} requirement is set for the gap. Each assigned NR channel power and adjacent NR channel power are measured with rectangular filters with measurement bandwidths specified in Table 6.5.2.4.1-1. If the measured adjacent channel power is greater than -50dBm then the ACLR shall be higher than the value specified in Table 6.5A.2.4.1.2-1.

Table 6.5A.2.4.1.2-1: General requirements for intra-band non-contiguous CA ACLR

	ACLR / Measurement bandwidth
CA ACLR	30 dB
CA Measurement bandwidth for each sub block (NOTE 1)	MBW_{ACLR}
Adjacent channel centre frequency offset (in MHz)	+ $BW_{Channel}$ / - $BW_{Channel}$
NOTE 1: MBW_{ACLR} is the single-channel ACLR measurement bandwidths specified in 6.5.2.4.1.	

When the signalling is absent for dualPA-Architecture IE, carrier leakage or I/Q image may land inside the gap spectrum between 2 UL CCs when UL CCs are synchronized with frequencies in the gap.

6.5A.2.4.1.3 NR ACLR for Inter-band CA

For inter-band carrier aggregation with two contiguous carriers assigned to one NR band, the NR Adjacent Channel Leakage power Ratio (NRACLR) requirements in subclause 6.5A.2.4.1.1 apply for that band.

For inter-band carrier aggregation with uplink assigned to two NR bands, the NR Adjacent Channel Leakage power Ratio (NRACLR) is defined per component carrier while both component carriers are active and the requirement is specified in clause 6.5.2.4.1.

6.5A.2.4.1.4 Void

6.5A.2.4.2 UTRA ACLR

6.5A.2.4.2.1 Void

6.5A.2.4.2.2 Void

6.5A.2.4.2.3 UTRA ACLR for Inter-band CA

For inter-band carrier aggregation with uplink assigned to two NR bands, the UTRA Adjacent Channel Leakage power Ratio (UTRAACLR) is defined per component carrier while both component carrier are active and the requirement is specified in clause 6.5.2.4.2.

6.5A.3 Spurious emission for CA

6.5A.3.1 General spurious emissions

For inter-band carrier aggregation with uplink assigned to two NR bands, the spurious emission requirement Table 6.5.3.1-2 apply for the frequency ranges that are more than F_{OOB} as defined in Table 6.5.3.1-1 away from edges of the assigned channel bandwidth on a component carrier. If for some frequency a spurious emission requirement of

individual component carrier overlaps with the spectrum emission mask or channel bandwidth of another component carrier then it does not apply.

NOTE: For inter-band carrier aggregation with uplink assigned to two NR bands the requirements in Table 6.5.3.1-2 could be verified by measuring spurious emissions at the specific frequencies where second and third order intermodulation products generated by the two transmitted carriers can occur; in that case, the requirements for remaining applicable frequencies in Table 6.5.3.1-2 would be considered to be verified by the measurements verifying the one uplink inter-band CA spurious emission requirement.

For intra-band contiguous carrier aggregation the spurious emission limits apply for the frequency ranges that are more than FOOB (MHz) in Table 6.5A.3.1-1 from the edge of the aggregated channel bandwidth. For frequencies Δf_{OOB} greater than FOOB as specified in Table 6.5A.3.1-1 the spurious emission requirements in Table 6.5.3.1-2 are applicable.

Table 6.5A.3.1-1: Boundary between out of band and spurious emission domain for intra-band contiguous carrier aggregation

Aggregated Channel bandwidth	OOB boundary F_{OOB} (MHz)
$BW_{Channel_CA}$	$BW_{Channel_CA} + 5$

For intra-band non-contiguous carrier aggregation transmission the spurious emission requirement is defined as a composite spurious emission requirement. Composite spurious emission requirement applies to frequency ranges that are more than FOOB away from the edges of each carrier in the gap and out of the gap. Composite spurious emission requirement is defined as follows

- a) Composite spurious emission requirement is a combination of individual sub-block spurious emission requirements
- b) In case the sub-block consist of one component carrier the sub-lock spurious emission requirement and FOOB are defined in subclause 6.5.3.1
- c) If for some frequency an individual sub-block spurious emission requirement overlaps with the general spectrum emission mask or the sub-block bandwidth of another sub-block then it does not apply

6.5A.3.2 Spurious emissions for UE co-existence

6.5A.3.2.1 Spurious emissions for UE co-existence for intra-band contiguous CA

This clause specifies the requirements for the specified intra-band contiguous carrier aggregation configurations for coexistence with protected bands, the requirements in Table 6.5A.3.2.1-1 apply.

NOTE: For measurement conditions at the edge of each frequency range, the lowest frequency of the measurement position in each frequency range should be set at the lowest boundary of the frequency range plus $MBW/2$. The highest frequency of the measurement position in each frequency range should be set at the highest boundary of the frequency range minus $MBW/2$. MBW denotes the measurement bandwidth defined for the protected band.

Table 6.5A.3.2.1-1: Requirements for uplink intra-band contiguous carrier aggregation

NR CA combination	Spurious emission						
	Protected Band	Frequency range (MHz)			Maximum Level (dBm)	MBW (MHz)	NOTE
CA_n7	E-UTRA Band 1, 2, 3, 4, 5, 7, 8, 12, 13, 14, 17, 20, 22, 26, 27, 28, 29, 30, 31, 32, 33, 34, 40, 42, 43, 50, 51, 52, 65, 66, 67, 68, 72, 74, 75, 76, 85, NR Band n77, n78	F_{DL_low}	-	F_{DL_high}	-50	1	

CA_n41	E-UTRA Band 1, 2, 3, 4, 5, 8, 12, 13, 14, 17, 24, 25, 26, 27, 28, 29, 30, 34, 39, 42, 44, 45, 48, 50, 51, 52, 65, 66, 70, 71, 73, 74, 85, NR Band n77, n78	F _{DL_low}	-	F _{DL_high}	-50	1	
	NR Band n79	F _{DL_low}	-	F _{DL_high}	-50	1	2, 4
	E-UTRA Band 9, 11, 18, 19, 21	F _{DL_low}	-	F _{DL_high}	-50	1	6
	E-UTRA Band 40	F _{DL_low}	-	F _{DL_high}	-40	1	
	Frequency range	1884.5		1915.7	-41	0.3	5, 6
CA_n48	E-UTRA Band 2, 4, 5, 12, 13, 14, 17, 24, 25, 26, 29, 30, 41, 50, 51, 66, 70, 71, 74, 85	F _{DL_low}	-	F _{DL_high}	-50	1	
CA_n77	E-UTRA Band 1, 3, 5, 7, 8, 11, 18, 19, 20, 21, 26, 28, 34, 39, 40, 41, 65	F _{DL_low}	-	F _{DL_high}	-50	1	
	Frequency range	1884.5	-	1915.7	-41	0.3	5
CA_n78	E-UTRA Band 1, 3, 5, 7, 8, 11, 18, 19, 20, 21, 26, 28, 34, 39, 40, 41, 65	F _{DL_low}	-	F _{DL_high}	-50	1	
	Frequency range	1884.5	-	1915.7	-41	0.3	5
CA_n79	E-UTRA Band 1, 3, 5, 8, 11, 18, 19, 21, 28, 34, 39, 40, 41, 42, 65	F _{DL_low}	-	F _{DL_high}	-50	1	
	Frequency range	1884.5	-	1915.7	-41	0.3	5
<p>NOTE 1: Void NOTE 2: Void NOTE 3: Void NOTE 4: As exceptions, measurements with a level up to the applicable requirements defined in Table 6.5.3.1-2 are permitted for each assigned NR carrier used in the measurement due to 2nd, 3rd, 4th or 5th harmonic spurious emissions. Due to spreading of the harmonic emission the exception is also allowed for the first 1 MHz frequency range immediately outside the harmonic emission on both sides of the harmonic emission. This results in an overall exception interval centred at the harmonic emission of (2 MHz + N x L_{CRB} x R_{Bsize} kHz), where N is 2, 3, 4, 5 for the 2nd, 3rd, 4th or 5th harmonic respectively. The exception is allowed if the measurement bandwidth (MBW) totally or partially overlaps the overall exception interval. NOTE 5: Applicable when co-existence with PHS system operating in 1884.5 - 1915.7 MHz. NOTE 6: This requirement applies when the NR carrier is confined within 2545 – 2575 MHz or 2595 – 2645 MHz and the channel bandwidth is 10 or 20 MHz</p>							

6.5A.3.2.2 Spurious emissions for UE co-existence for intra-band non-contiguous CA

This clause specifies the requirements for the specified intra-band non-contiguous carrier aggregation configurations for coexistence with protected bands, the requirements in Table 6.5A.3.2.2-1 apply.

NOTE: For measurement conditions at the edge of each frequency range, the lowest frequency of the measurement position in each frequency range should be set at the lowest boundary of the frequency range plus MBW/2. The highest frequency of the measurement position in each frequency range should be set at the highest boundary of the frequency range minus MBW/2. MBW denotes the measurement bandwidth defined for the protected band.

Table 6.5A.3.2.2-1: Requirements for uplink intra-band non-contiguous carrier aggregation

NR CA combination	Spurious emission						
	Protected Band	Frequency range (MHz)			Maximum Level (dBm)	MBW (MHz)	NOTE
CA_n41	E-UTRA Band 1, 2, 3, 4, 5, 8, 10, 12, 13, 14, 17, 24, 25, 26, 27, 28, 29, 30, 34, 39, 42, 44, 45, 48, 50, 51, 52, 65, 66, 70, 71, 73, 74, 85,	F _{DL_low}	-	F _{DL_high}	-50	1	

	NR Band n77, n78						
	NR Band n79	F _{DL_low}	-	F _{DL_high}	-50	1	1, 2
	E-UTRA Band 40	F _{DL_low}	-	F _{DL_high}	-40	1	
	E-UTRA Band 9, 11, 18, 19, 21	F _{DL_low}	-	F _{DL_high}	-50	1	2
CA_n77	E-UTRA Band 1, 3, 5, 7, 8, 11, 18, 19, 20, 21, 26, 28, 34, 39, 40, 41, 65	F _{DL_low}	-	F _{DL_high}	-50	1	
CA_n78	E-UTRA Band 1, 3, 5, 7, 8, 11, 18, 19, 20, 21, 26, 28, 34, 39, 40, 41, 65	F _{DL_low}	-	F _{DL_high}	-50	1	

NOTE 1: As exceptions, measurements with a level up to the applicable requirements defined in Table 6.5.3.1-2 are permitted for each assigned NR carrier used in the measurement due to 2nd, 3rd, 4th or 5th harmonic spurious emissions. Due to spreading of the harmonic emission the exception is also allowed for the first 1 MHz frequency range immediately outside the harmonic emission on both sides of the harmonic emission. This results in an overall exception interval centred at the harmonic emission of (2 MHz + N x L_{CRB} x R_{Bsize} kHz), where N is 2, 3, 4, 5 for the 2nd, 3rd, 4th or 5th harmonic respectively. The exception is allowed if the measurement bandwidth (MBW) totally or partially overlaps the overall exception interval.

NOTE 2: This requirement applies when the NR carrier is confined within 2545 – 2575 MHz or 2595 – 2645 MHz and the channel bandwidth is 10 or 20 MHz

6.5A.3.2.3 Spurious emissions for UE co-existence for Inter-band CA

This clause specifies the additional requirements for inter-band uplink carrier aggregation configurations with the single CC uplink assigned to two NR bands for coexistence with protected bands for the specified uplink carrier aggregation configurations in Table 6.5A.3.2.3-1. The intersection of the requirements for the individual bands specified in clause 6.5.3.2 shall also apply for the specified uplink carrier aggregation configurations. Intersection of a requirement means that both UL constituent bands have the same protected band requirement specified and if one or both protected bands have note(s) associated those note(s) also apply

For inter-band carrier aggregation with two contiguous carriers assigned to one NR band, the requirements in subclause 6.5A.3.2.1 apply for that band.

For inter-band carrier aggregation with the uplink assigned to two NR bands, the requirements in Table 6.5A.3.2.3-1 apply on each component carrier with all component carriers are active.

NOTE: For inter-band carrier aggregation with uplink assigned to two NR bands the requirements in Table 6.5A.3.2.3-1 could be verified by measuring spurious emissions at the specific frequencies where second and third order intermodulation products generated by the two transmitted carriers can occur; in that case, the requirements for remaining applicable frequencies in Table 6.5A.3.2.3-1 and in clause 6.5.3.2 would be considered to be verified by the measurements verifying the one uplink inter-band CA UE to UE co-existence requirements.

Table 6.5A.3.2.3-1: Requirements for uplink inter-band carrier aggregation (two bands)

NR CA combination	Spurious emission						
	Protected Band	Frequency range (MHz)			Maximum Level (dBm)	MBW (MHz)	NOTE
CA_n1-n28	Frequency range	470	-	694	-42	8	4, 14
	Frequency range	470	-	710	-26.2	6	15
	Frequency range	758	-	773	-30	1	4
	Frequency range	773	-	803	-50	1	
	Frequency range	662	-	694	-26.2	6	4
CA_n1-n40	Frequency range	1884.5	-	1915.7	-41	0.3	3
CA_n3-n28	Frequency range	470	-	694	-42	8	4, 14
	Frequency range	470	-	710	-26.2	6	15
	Frequency range	758	-	773	-30	1	4
	Frequency range	773	-	803	-50	1	
	Frequency range	662	-	694	-26.2	6	4
	Frequency range	1839.9	-	1879.9	-50	1	4
	Frequency range	1884.5	-	1915.7	-41	0.3	3, 11

CA_n5-n66	Frequency range	1884.5	-	1915.7	-41	0.3	3
CA_n5-n77	Frequency range	1884.5	-	1915.7	-41	0.3	3
CA_n3-n40	Frequency range	1884.5	-	1915.7	-41	0.3	3
CA_n3-n41	Frequency range	1884.5	-	1915.7	-41	0.3	3
CA_n3-n77	Frequency range	1884.5	-	1915.7	-41	0.3	3
CA_n3-n78	Frequency range	1884.5	-	1915.7	-41	0.3	3
CA_n3-n79	Frequency range	1884.5	-	1915.7	-41	0.3	3
CA_n5-n78	Frequency range	945	-	960	-50	1	
	Frequency range	1884.5	-	1915.7	-41	0.3	3
	Frequency range	2545	-	2575	-50	1	2
	Frequency range	2595	-	2645	-50	1	
CA_n5-n79	Frequency range	1884.5	-	1915.7	-41	0.3	3
CA_n7-n28	Frequency range	758	-	773	-32	1	4
	Frequency range	773	-	803	-50	1	
CA_n8-n40	Frequency range	1884.5	-	1915.7	-41	0.3	3
CA_n8-n41	Frequency range	1884.5	-	1915.7	-41	0.3	3
CA_n8-n78	Frequency range	1884.5	-	1915.7	-41	0.3	3
CA_n8-n79	Frequency range	1884.5	-	1915.7	-41	0.3	3
CA_n20-n28	Frequency range	758	-	773	-32	1	4
	Frequency range	773	-	803	-50	1	
CA_n28-n40	Frequency range	758	-	773	-32	1	4
	Frequency range	773	-	803	-50	1	
	Frequency range	1884.5	-	1915.7	-41	0.3	3
CA_n28-n41	Frequency range	470	-	694	-42	8	4, 14
	Frequency range	470	-	710	-26.2	6	13
	Frequency range	662	-	694	-26.2	6	4
	Frequency range	758	-	773	-32	1	4
	Frequency range	773	-	803	-50	1	
CA_n28-n50	Frequency range	1884.5	-	1915.7	-41	0.3	3, 11
	Frequency range	470	-	694	-42	8	4, 14
	Frequency range	470	-	710	-26.2	6	13
	Frequency range	662	-	694	-26.2	6	4
	Frequency range	758	-	773	-32	1	4
	Frequency range	773	-	803	-50	1	
CA_n28-n77	Frequency range	1884.5	-	1915.7	-41	0.3	3, 11
	Frequency range	758	-	773	-32	1	
	Frequency range	773	-	803	-50	1	
CA_n28-n78	Frequency range	1884.5	-	1915.7	-41	0.3	3, 11
	Frequency range	758	-	773	-32	1	
	Frequency range	773	-	803	-50	1	
CA_n40-n41	Frequency range	1884.5	-	1915.7	-41	0.3	3
CA_n40-n78	Frequency range	1884.5	-	1915.7	-41	0.3	3
CA_n40-n79	Frequency range	1884.5	-	1915.7	-41	0.3	3
CA_n41-n78	Frequency range	1884.5	-	1915.7	-41	0.3	3
CA_n41-n79	Frequency range	1884.5	-	1915.7	-41	0.3	3

NOTE 1: Void

NOTE 2: As exceptions, measurements with a level up to the applicable requirements defined in Table 6.5.3.1-2 are permitted for each assigned NR carrier used in the measurement due to 2nd, 3rd, 4th or 5th harmonic spurious emissions. Due to spreading of the harmonic emission the exception is also allowed for the first 1 MHz frequency range immediately outside the harmonic emission on both sides of the harmonic emission. This results in an overall exception interval centred at the harmonic emission of $(2 \text{ MHz} + N \times L_{\text{CRB}} \times 180\text{kHz})$, where N is 2, 3, 4, 5 for the 2nd, 3rd, 4th or 5th harmonic respectively. The exception is allowed if the measurement bandwidth (MBW) totally or partially overlaps the overall exception interval.

NOTE 3: Applicable when co-existence with PHS system operating in 1884.5 -1915.7 MHz

NOTE 4: These requirements also apply for the frequency ranges that are less than F_{OoB} (MHz) in Table 6.5.3.1-1 from the edge of the channel bandwidth.

NOTE 5: Void.

NOTE 6: Void.

NOTE 7: Void.

NOTE 8: Void.

NOTE 9: Void.

NOTE 10: Void.

NOTE 11: Applicable when the assigned NR carrier is confined within 718 MHz and 748 MHz and when the channel bandwidth used is 5 or 10 MHz.

NOTE 12: Void.

NOTE 13: This requirement is applicable for 5 and 10 MHz NR channel bandwidth allocated within 718 - 728 MHz. For carriers of 10 MHz bandwidth, this requirement applies for an uplink transmission bandwidth less than or equal to 30 RB with RBstart > 1 and RBstart < 48.

NOTE 14: This requirement is applicable in the case of a 10 MHz NR carrier confined within 703 MHz and 733 MHz, otherwise the requirement of -25 dBm with a measurement bandwidth of 8 MHz applies.

NOTE 15: As exceptions, measurements with a level up to the applicable requirement of -36 dBm/MHz is permitted for each assigned E-UTRA carrier used in the measurement due to 3rd harmonic spurious emissions. An exception is allowed if there is at least one individual RB within the transmission bandwidth (see Figure 5.6-1) for which the 3rd harmonic totally or partially overlaps the measurement bandwidth (MBW).

NOTE 17: Void.

NOTE 18: Void.

NOTE 19: Void.

6.5A.3.2.4 Void

6.5A.3.2.5 Void

6.5A.3.2.6 Void

6.5A.3.3 Additional spurious emissions for CA

6.5A.3.3.1 Additional spurious emissions for intra-band contiguous CA

6.5A.3.3.1.1 Requirement for network signalling value "CA_NS_04"

When "CA_NS04" is indicated in the cell, the power of any UE emission shall not exceed the levels specified in Table 6.5A.3.3.1.1-1. This requirement also applies for the frequency ranges that are less than F_{OOB} (MHz) in Table 6.5A.3.1-1 from the edge of the aggregated channel bandwidth.

Table 6.5A.3.3.1.1-1: Additional requirements for "CA_NS_04"

Frequency range (MHz)	BWChannel_CA (MHz) / Spectrum emission limit (dBm)	Measurement bandwidth
	20 to 190 MHz	
$2495 \leq f < 2496$	-13	Max(1 % of BW _{Channel_CA} , 1 MHz)
$2490.5 \leq f < 2495$	-13	1 MHz
$0.009 < f < 2490.5$	-25	1 MHz

6.5A.3.3.1.2 Requirement for network signalling value "CA_NS_27"

When "CA_NS 27" is indicated in the cell, the power of any UE emission shall not exceed the levels specified in Table 6.5A.3.3.1.2-1. This requirement also applies for the frequency ranges that are less than F_{OOB} (MHz) in Table 6.5A.3.1-1 from the edge of the aggregated channel bandwidth.

Table 6.5A.3.3.1.2-1: Additional requirements for "CA_NS_27"

Frequency range (MHz)	Spectrum emission limit (dBm) for aggregated channel bandwidth of max 40 MHz	Measurement bandwidth
9 kHz – 3530 MHz	-40	1 MHz
3530 MHz – 3540 MHz	-25	
3710 MHz – 3720 MHz	-25	
3720 MHz – 12.75 GHz	-40	

6.5A.3.3.1.3 Requirement for network signalling value "CA_NS_46"

When "CA_NS_46" is indicated in the cell, the power of any UE emission shall not exceed the levels specified in Table 6.5A.3.3.1.3-1. This requirement also applies for the frequency ranges that are less than F_{OOB} (MHz) in Table 6.5A.3.1-1 from the edge of the aggregated channel bandwidth.

Table 6.5A.3.3.1.3-1: Additional requirements for "CA_NS_46"

Protected band	Frequency range (MHz)			Maximum Level (dBm)	MBW (MHz)	NOTE
Frequency range	2570	-	2575	+1.6	5	1, 2
Frequency range	2575	-	2595	-15.5	5	1, 2
Frequency range	2595	-	2620	-40	1	1
NOTE 1: This requirement is applicable for carriers confined in 2500-2570 MHz.						
NOTE 2: For these adjacent bands, the emission limit could imply risk of harmful interference to UE(s) operating in the protected operating band.						

6.5A.3.3.2 Additional spurious emissions for intra-band non-contiguous CA

6.5A.3.3.2.1 Requirement for network signalling value "CA_NC_NS_04"

For intra-band non-contiguous CA_{n41(2A)}, the spurious emission requirements in subclause 6.5.3.3.1 (indicated by NS_04) applies in each uplink CC.

6.5A.4 Transmit intermodulation for CA

6.5A.4.2.1 Transmit intermodulation for intra-band contiguous CA

For intra-band contiguous carrier aggregation the requirement of transmitting intermodulation is specified in Table 6.5A.4.2.1-1.

Table 6.5A.4.2.1-1: Transmit Intermodulation

CA bandwidth class(UL)	B and C	
Interference Signal Frequency Offset	$BW_{Channel_CA}$	$2 \cdot BW_{Channel_CA}$
Interference CW Signal Level	-40dBc	
Intermodulation Product	-29dBc	-35dBc
Measurement bandwidth (NOTE1)	Nominal channel space+ $MBW_{ACLR,low}/2$ + $MBW_{ACLR,high}/2$	
Measurement offset from channel center	$BW_{Channel_CA}$ and $2 \cdot BW_{Channel_CA}$	$2 \cdot BW_{Channel_CA}$ and $4 \cdot BW_{Channel_CA}$
NOTE 1: $MBW_{ACLR,low}$ and $MBW_{ACLR,high}$ are the single-channel ACLR measurement bandwidths specified for channel bandwidths $BW_{channel(low)}$ and $BW_{channel(high)}$ in 6.5.2.4.1, respectively.		

6.5A.4.2.2 Void

6.5A.4.2.3 Transmit intermodulation for Inter-band CA

For inter-band carrier aggregation with two contiguous carriers assigned to one NR band, the transmit intermodulation requirements in subclause 6.5A.4.2.1 apply for that band.

For inter-band carrier aggregation with uplink assigned to two NR bands, the transmit intermodulation requirement is specified in Table 6.5.4-1 which shall apply on each component carrier with both component carriers active.

6.5B Output RF spectrum emissions for NR-DC

For inter-band NR-DC with one uplink carrier assigned per NR band, the output RF spectrum emissions for the corresponding inter-band CA configuration as specified in clause 6.5A applies.

6.5D Output RF spectrum emissions for UL MIMO

6.5D.1 Occupied bandwidth for UL MIMO

For UE supporting UL MIMO, the requirements for occupied bandwidth apply to the sum of the powers from both UE transmit antenna connectors. The occupied bandwidth is defined as the bandwidth containing 99 % of the total integrated mean power of the transmitted spectrum on the assigned channel at each transmit antenna connector.

For UE with two transmit antenna connectors in closed-loop spatial multiplexing scheme, the occupied bandwidth shall be less than the channel bandwidth specified in table 6.5.1-1. The requirements shall be met with UL MIMO configurations described in clause 6.2D.1.

If UE is scheduled for single antenna-port PUSCH transmission by DCI format 0_0 or by DCI format 0_1 for single antenna port codebook based transmission, the requirements in clause 6.5.1 apply.

6.5D.2 Out of band emission for UL MIMO

For UE supporting UL MIMO, the requirements for Out of band emissions resulting from the modulation process and non-linearity in the transmitters is defined as the sum of the emissions from both UE transmit antenna connectors.

For UEs with two transmit antenna connectors in closed-loop spatial multiplexing scheme, the requirements in subclause 6.5.2 apply. The requirements shall be met with UL MIMO configurations described in clause 6.2D.1.

For UE support uplink full power transmission (ULFPTx) for UL MIMO, the requirements in clause 6.5.2 shall apply. The requirements shall be met with the PUSCH configurations specified in Table 6.2D.1-3, based upon UE's support of uplink full power transmission mode.

If UE is scheduled for single antenna-port PUSCH transmission by DCI format 0_0 or by DCI format 0_1 for single antenna port codebook based transmission, the requirements in clause 6.5.2 apply.

6.5D.3 Spurious emission for UL MIMO

For UE supporting UL MIMO, the requirements for Spurious emissions which are caused by unwanted transmitter effects such as harmonics emission, parasitic emissions, intermodulation products and frequency conversion products is defined as the sum of the emissions from both UE transmit antenna connectors.

For UEs with two transmit antenna connectors in closed-loop spatial multiplexing scheme, the requirements specified in subclause 6.5.3 apply. The requirements shall be met with the UL MIMO configurations described in clause 6.2D.1.

For UE support uplink full power transmission (ULFPTx) for UL MIMO, the requirements in clause 6.5.3 shall apply. The requirements shall be met with the PUSCH configurations specified in Table 6.2D.1-3, based upon UE's support of uplink full power transmission mode.

If UE is scheduled for single antenna-port PUSCH transmission by DCI format 0_0 or by DCI format 0_1 for single antenna port codebook based transmission, the requirements in clause 6.5.3 apply.

6.5D.4 Transmit intermodulation for UL MIMO

For UE supporting UL MIMO, the transmit intermodulation requirements are specified at each transmit antenna connector and the wanted signal is defined as the sum of output powers from both UE transmit antenna connectors.

For UEs with two transmit antenna connectors in closed-loop spatial multiplexing scheme, the requirements specified in clause 6.5.4 apply to each transmit antenna connector. The requirements shall be met with the UL MIMO configurations described in clause 6.2D.1.

If UE is scheduled for single antenna-port PUSCH transmission by DCI format 0_0 or by DCI format 0_1 for single antenna port codebook based transmission, the requirements in clause 6.5.4 apply.

6.5E Output RF spectrum emissions for V2X

6.5E.1 Occupied bandwidth for V2X

6.5E.1.1 General

When UE is configured for NR V2X sidelink transmissions non-concurrent with NR uplink transmissions for NR V2X operating bands specified in Table 5.2E.1-1, the requirements in clause 6.5.1 shall apply for NR V2X sidelink transmission.

For NR V2X UE with two transmit antenna connectors, the occupied bandwidth at each transmitter antenna shall be less than the channel bandwidth specified in Table 6.5.1-1. The requirements shall be met with SL MIMO configurations described in clause 6.2D.1.

If V2X UE transmits on one antenna connector at a time, the requirements specified for single carrier shall apply to the active antenna connector.

6.5E.1.2 Occupied bandwidth for V2X concurrent operation

For the inter-band con-current NR V2X operation, the requirements specified in clause 6.5.1 shall apply for the uplink in licensed band and the requirements specified in clause 6.5E.1.1 shall apply for the sidelink in licensed band or Band n47.

6.5E.2 Out of band emission for V2X

6.5E.2.1 General

When UE is configured for NR V2X sidelink transmissions non-concurrent with NR uplink transmissions for NR V2X operating bands specified in Table 5.2E.1-1, the requirements in clause 6.5E.2.2.1, 6.5E.2.3 and 6.5E.2.4.1 apply for NR V2X sidelink transmission.

For NR V2X UE with two transmit antenna connectors, the requirements specified for single carrier shall apply to each transmit antenna connector. The requirements shall be met with SL MIMO configurations described in clause 6.2D.1.

6.5E.2.2 Spectrum emission mask

6.5E.2.2.1 General

For NR V2X UE, the existing NR general spectrum emission mask in subclause 6.5.2.2 applies for all supporting NR V2X channel bandwidths. The spectrum emission mask of the UE applies to frequencies (Δf_{OOB}) starting from the \pm edge of the assigned NR channel bandwidth. For frequencies greater than (Δf_{OOB}), the power of any UE emission shall not exceed the levels specified in Table 6.5.2.2-1 for the specified channel bandwidth for NR V2X operating bands in Table 5.2E.1-1.

6.5E.2.2.2 Spectrum emission mask for V2X concurrent operation

For the inter-band con-current NR V2X operation, the general/additional SEM requirements specified in clause 6.5.2 shall apply for the uplink in licensed band and the general/additional SEM requirements specified in clause 6.5E.2.2.1 shall apply for the sidelink in licensed band or Band n47.

6.5E.2.3 Additional Spectrum emission mask

6.5E.2.3.1 Requirements for network signalling value "NS_33"

The additional spectrum mask in Table 6.5E.2.3.1-1 applies for NR V2X UE within 5 855 MHz to 5 950 MHz according to ETSI EN 302 571. Additional spectrum emission requirements are signalled by the network to indicate that the UE shall meet an additional requirement for a specific deployment scenario as part of the cell handover/broadcast message.

When "NS_33" is indicated in the cell or pre-configured radio parameters, the power of any V2X UE emission shall not exceed the levels specified in Table 6.5E.2.3.1-1.

Table 6.5E.2.3.1-1: Additional spectrum mask requirements for 10MHz channel bandwidth

Spectrum emission limit (dBm EIRP)/ Channel bandwidth		
Δf_{OoB} (MHz)	10 MHz	Measurement bandwidth
$\pm 0-0.5$	$[-13 - 12 \left(\frac{ \Delta f_{\text{OoB}} }{\text{MHz}} \right)]$	100 kHz
$\pm 0.5-5$	$[-19 - \frac{16}{9} \left(\frac{ \Delta f_{\text{OoB}} }{\text{MHz}} - 0.5 \right)]$	100 kHz
$\pm 5-10$	$[-27 - 2 \left(\frac{ \Delta f_{\text{OoB}} }{\text{MHz}} - 5.0 \right)]$	100 kHz

NOTE 1: As a general rule, the resolution bandwidth of the measuring equipment should be equal to the measurement bandwidth. However, to improve measurement accuracy, sensitivity and efficiency, the resolution bandwidth may be smaller than the measurement bandwidth. When the resolution bandwidth is smaller than the measurement bandwidth, the result should be integrated over the measurement bandwidth in order to obtain the equivalent noise bandwidth of the measurement bandwidth.

NOTE 2: Additional SEM for NR V2X overrides any other requirements in frequency range 5855-5950MHz.

NOTE 3: The EIRP requirement is converted to conducted requirement depend on the supported post antenna connector gain $G_{\text{post connector}}$ declared by the UE following the principle described in annex I in [11].

6.5E.2.3.2 Requirements for network signalling value "NS_52"

The additional spectrum mask in Table 6.5E.2.3.2-1 applies for NR V2X UE within 5 765 MHz to 6 005 MHz according to FCC regulation. Additional spectrum emission requirements are signalled by the network to indicate that the UE shall meet an additional requirement for a specific deployment scenario as part of the cell handover/broadcast message.

When "NS_52" is indicated in the cell or pre-configured radio parameters, the power of any V2X UE emission shall not exceed the levels specified in Table 6.5E.2.3.2-1.

Table 6.5E.2.3.2-1: Additional spectrum mask requirements for 40MHz channel bandwidth (fc = 5885MHz)

Δf_{OoB} (MHz)	Emission Limit (dBm)	Measurement Bandwidth
$\pm 0-2$	-32	100kHz
$\pm 2-10$	-36	100kHz
$\pm 10-20$	-38	100kHz
$\pm 20-40$	-43	100kHz
$\pm 40-100$	-50	100kHz

NOTE: The ASE requirements for NS_52 will not be verified until the corresponding regulation release a formal rule for C-V2X emission limits.

6.5E.2.4 Adjacent channel leakage ratio

6.5E.2.4.1 General

Adjacent Channel Leakage power Ratio (ACLR) is the ratio of the filtered mean power centred on the assigned channel frequency to the filtered mean power centred on an adjacent channel frequency.

For NR V2X UE, the existing ACLR requirement for NR uplink transmission in clause 6.5.2.4 are applied for NR V2X UE for NR V2X operating bands in 5.2E.1-1.

For NR V2X UE with two transmit antenna connectors, the requirements specified for single carrier shall apply to each transmit antenna connector. The requirements shall be met with SL MIMO configurations described in clause 6.2D.1.

If V2X UE transmits on one antenna connector at a time, the requirements specified for single carrier shall apply to the active antenna connector.

6.5E.2.4.2 ACLR for V2X concurrent operation

For the inter-band con-current NR V2X operation, the ACLR requirement specified in clause 6.5.2.4 shall apply for the uplink in licensed band and the ACLR requirement specified in clause 6.5E.2.4.1 shall apply for the sidelink in licensed band or Band n47.

6.5E.3 Spurious emissions for V2X

6.5E.3.1 General spurious emissions

When UE is configured for NR V2X sidelink transmissions non-concurrent with NR uplink transmissions for NR V2X operating bands specified in Table 5.2E.1-1, the general spurious emission requirements in clause 6.5.3.1 shall apply for NR V2X sidelink transmission.

For NR V2X UE with two transmit antenna connectors, the requirements specified for single carrier shall apply to each transmit antenna connector. The requirements shall be met with the SL MIMO configurations described in clause 6.2D.1.

6.5E.3.2 Spurious emissions for UE co-existence

When UE is configured for NR V2X sidelink transmissions non-concurrent with NR uplink transmissions for NR V2X operating bands specified in Table 5.2E.1-1, the requirements in clause 6.5.3.2 shall apply for NR V2X sidelink transmission.

For NR V2X UE with two transmit antenna connectors, the requirements specified for single carrier shall apply to each transmit antenna connector. The requirements shall be met with the SL MIMO configurations described in clause 6.2D.1.

6.5E.3.3 Spurious emissions for UE co-existence for V2X concurrent operation

This clause specifies the additional requirements for inter-band concurrent V2X operation with the single CC uplink assigned to two NR bands for coexistence with protected bands for the specified simultaneous transmission of the inter-band concurrent V2X configurations in Table 6.5E.3.3-1. The intersection of the requirements for the individual bands specified in clause 6.5.3.2 shall also apply for the specified simultaneous transmission of the inter-band concurrent V2X. Intersection of a requirement means that both UL or sidelink transmission constituent bands have the same protected band requirement specified and if one or both protected bands have note(s) associated those note(s) also apply.

For the inter-band concurrent NR V2X operation, the UE-coexistence requirements in Table 6.5E.3.3.1-1 apply for the corresponding inter-band concurrent operation with transmission assigned to both uplink in licensed band and sidelink in Band n47.

NOTE: For inter-band concurrent V2X operation with uplink assigned to NR band and sidelink transmission assigned to NR V2X operating bands, the requirements in Table 6.5E.3.3-1 could be verified by measuring spurious emissions at the specific frequencies where second and third order intermodulation products generated by the two transmitted carriers can occur; in that case, the requirements for remaining applicable frequencies in Table 6.5E.3.3-1

and in clause 6.5.3.2 would be considered to be verified by the measurements verifying the one uplink inter-band concurrent UE to UE co-existence requirements.

Table 6.5E.3.3-1: Requirements for inter-band con-current V2X operation

V2X concurrent operating band configuration	Spurious emission						
	Protected band	Frequency range (MHz)			Maximum Level (dBm)	MBW (MHz)	NOTE
V2X_n71A-n47A	Frequency range	5925	-	5950	-30	1	3, 4
	Frequency range	5815	-	5855	-30	1	3

NOTE 1: Void.
NOTE 2: Void.
NOTE 3: Applicable when NS_33 is configured by the pre-configured radio parameters for power class 3 V2X UE.
NOTE 4: In the frequency range x-5950MHz, SE requirement of -30dBm/MHz should be applied; where x = max (5925, fc + 15), where fc is the channel centre frequency.

6.5E.3.4 Additional spurious emissions requirements for V2X

6.5E.3.4.1 General

This clause specifies additional spurious emission requirements for V2X operation

6.5E.3.4.2 Requirements for network signalling value "NS_33"

Table 6.5E.3.4.2-1: Additional requirements for "NS_33"

Protected band	Frequency range (MHz)			Maximum Level (EIRP ²)	MBW (MHz)	NOTE
Frequency range	5925	-	5950	-30	1	1
Frequency range	5815	-	5855	-30	1	3

NOTE 1: In the frequency range x-5950MHz, SE requirement of -30dBm/MHz should be applied; where x = max (5925, fc + 15), where fc is the channel centre frequency.
NOTE 2: The EIRP requirement is converted to conducted requirement depend on the supported post antenna connector gain $G_{\text{post connector}}$ declared by the UE following the principle described in annex I in [11].
NOTE 3: Resolution BW is 10% of the measurement BW and the result should be integrated to achieve the measurement bandwidth. The sweep time shall be set larger than (symbol length)*(number of points in sweep) to improve the measurement accuracy.

When "NS_33" is configured from pre-configured radio parameters or the cell, and the indication from upper layers has indicated that the UE is within the protection zone of CEN DSRC devices or HDR DSRC devices, the power of any NR V2X UE emission shall fulfil either one of the two sets of conditions.

Table 6.5E.3.4.2-2: Requirements for spurious emissions to protect CEN DSRC for V2X UE

	Maximum Transmission Power (dBm EIRP ¹)	Emission Limit in Frequency Range 5795-5815 (dBm/MHz EIRP ¹)
Condition 1	10	-65
Condition 2	10	-45

NOTE 1: The EIRP requirement is converted to conducted requirement depend on the supported post antenna connector gain $G_{\text{post connector}}$ declared by the UE following the principle described in annex I in [11].

6.5E.3.4.3 Void

6.5E.4 Transmit intermodulation

6.5E.4.1 General

When UE is configured for NR V2X sidelink transmissions non-concurrent with NR uplink transmissions for NR V2X operating bands specified in Table 5.2E.1-1, the requirements in clause 6.5.4 apply for NR V2X sidelink transmission.

For NR V2X UE with two transmit antenna connectors, the requirements specified for single carrier shall apply to each transmit antenna connector. The requirements shall be met with the SL MIMO configurations described in clause 6.2D.1.

6.5E.4.2 Transmit intermodulation for V2X concurrent operation

For the inter-band con-current NR V2X operation, the requirements specified in clause 6.5.4 shall apply for the uplink in licensed band and the requirements specified in clause 6.5E.4.1 shall apply for the sidelink in licensed band or Band n47.

6.5F Output RF spectrum emissions

6.5F.1 Occupied bandwidth

The requirements for occupied bandwidth in clause 6.5.1 apply for the specified NR-U channel bandwidths in Table 5.3.5-1.

6.5F.2 Out of band emission

6.5F.2.1 General

The Out of band emissions are unwanted emissions immediately outside the assigned channel bandwidth resulting from the modulation process and non-linearity in the transmitter but excluding spurious emissions. This out of band emission limit is specified in terms of a spectrum emission mask and an adjacent channel leakage power ratio.

To improve measurement accuracy, sensitivity and efficiency, the resolution bandwidth may be smaller than the measurement bandwidth. When the resolution bandwidth is smaller than the measurement bandwidth, the result should be integrated over the measurement bandwidth in order to obtain the equivalent noise bandwidth of the measurement bandwidth.

6.5F.2.2 Spectrum emission mask for operation with shared spectrum channel access

6.5F.2.2.0 General

Instead of the general spectrum emission mask requirement in clause 6.5.2.2, when operating with shared spectrum channel access the relative power of any UE emission shall not exceed the levels specified in Table 6.5F.2.2-1 for the specified channel bandwidth or -30 dBm/MHz whichever is the greatest. The spectrum emission mask for operation with shared spectrum channel access is defined relative to the maximum power density in a 1 MHz measurement bandwidth within the channel bandwidth.

The spectrum emission mask for operation with shared spectrum channel access applies to frequencies (Δf_{OOB}) starting from the \pm edge of the assigned channel bandwidth. For frequencies offset greater than Δf_{OOB} , the spurious requirements in clause 6.5.3 are applicable.

Table 6.5F.2.2-1: Spectrum emission mask for operation with shared spectrum channel access

Spectrum emission limit (dBr) / Channel bandwidth

Δf_{OOB} (MHz)	10 MHz	20 MHz	40 MHz	60 MHz	80 MHz	Measurement bandwidth (MBW)
$\pm 0-1$	$-20 \Delta f_{OOB} $					$[100\text{kHz}]^3$
$\pm 1-5$	NOTE 1	NOTE 1	NOTE 1	NOTE 1	NOTE 1	1 MHz
$\pm 5-10$	NOTE 2					
$\pm 10-20$	-40	NOTE 2	NOTE 2	NOTE 2		
$\pm 20-30$	-40					
$\pm 30-40$		NOTE 2	NOTE 2	NOTE 2		
$\pm 40-50$						
$\pm 50-60$						
$\pm 60-70$			-40			
$\pm 70-80$						
$\pm 80-100$					-40	
<p>NOTE 1: Given as: $-20 - (8/A) \Delta f_{OOB} - 1$ where $A = (\text{Channel Bandwidth}/2) - 1$</p> <p>NOTE 2: Given as: $-16 - (12/B) \Delta f_{OOB}$ where $B = (\text{Channel Bandwidth}/2)$</p> <p>NOTE 3: The measured value shall be scaled by a factor equal to the ratio of the reference bandwidth (1 MHz) to the measurement bandwidth before the emission limit (dBr) is applied.</p> <p>NOTE 4: The carrier leakage exceptions from Table 6.4F.2.3-1 apply and carrier leakage contribution shall be removed prior to setting the 0dBr level of the mask, the reported carrier frequency location in <i>txDirectCurrentLocation</i> field of the <i>UplinkTxDirectCurrentBWP</i> can be used to cancel the carrier leakage contribution. If <i>txDirectCurrentLocation</i> is not available or is reported with value 3300 or 3301, a carrier frequency location at the center of the channel shall be assumed.</p>						

For measurement conditions at the edge of each frequency range, the lowest frequency of the measurement position in each frequency range should be set at the lowest boundary of the frequency range plus MBW/2. The highest frequency of the measurement position in each frequency range should be set at the highest boundary of the frequency range minus MBW/2.

6.5F.2.2.1 Spectrum emission mask for non-transmitted channels

In the case of non-transmitted 20 MHz channel(s) on the edges of an assigned channel bandwidth the spectrum emission mask for operation with shared spectrum channel access, specified in Table 6.5F.2.2-1, is applied by using the total bandwidth of the remaining transmitted channels. The spectrum emission mask for non-transmitted channels is floored at -28dBr.

The relative power of any UE emission shall not exceed the most stringent levels given by the spectrum emission mask for operation with shared spectrum channel access with full channel bandwidth and the spectrum emission mask for non-transmitted channels with the channel bandwidth of the transmitted channels in the case of non-transmitted channels at the edge of an assigned channel bandwidth.

An exception to the spectrum emission mask for non-transmitted channels allows a single [2] MHz bandwidth to extend to [-28] dBc relative to total transmit power, or [-20] dBm, whichever is the greatest.

6.5F.2.3 Additional spectrum emission mask

There are no additional spectrum emission mask requirements in this version of the specification.

6.5F.2.4 Adjacent channel leakage ratio

6.5F.2.4.0 General

Adjacent Channel Leakage power Ratio (ACLR) is the ratio of the filtered mean power centred on the assigned channel frequency to the filtered mean power centred on an adjacent channel frequency.

To improve measurement accuracy, sensitivity and efficiency, the resolution bandwidth may be smaller than the measurement bandwidth. When the resolution bandwidth is smaller than the measurement bandwidth, the result should be integrated over the measurement bandwidth in order to obtain the equivalent noise bandwidth of the measurement bandwidth.

6.5F.2.4.1 Shared spectrum channel access ACLR

The Adjacent Channel Leakage power Ratio is the ratio of the filtered mean power centred on the assigned channel frequency to the filtered mean power centred on an adjacent channel frequency at nominal channel spacing. The assigned channel power and adjacent channel power are measured with rectangular filters with measurement bandwidths specified in Table 6.5.2.4.1-1.

Instead of the general ACLR requirement in clause 6.5.2.4, if the measured adjacent channel power is greater than -47 dBm then the ACLR shall be higher than the value specified in Table 6.5F.2.4.1-1.

Table 6.5F.2.4.1-1: Shared spectrum channel access ACLR requirement

	Power class 5
ACLR	27 dB

6.5F.2.4.2 Additional requirement for network signaled value "NS_29"

When "NS_29" is indicated in the cell, the UE emission shall meet the additional requirements specified in Table 6.5F.2.4.2-1 for shared spectrum channels assigned within 5150 – 5350 MHz and 5470 – 5730 MHz.

Table 6.5F.2.4.2-1: ACLR2 requirement for "NS_29"

Power class 5	20 MHz	40 MHz	60, 80 MHz
ACLR2	40 dB	40 dB	N/A
Measurement bandwidth	20 MHz	40 MHz	N/A
Adjacent channel center frequency offset (MHz)	+40 / -40	+80 / -80	N/A

6.5F.3 Spurious emissions

6.5F.3.0 General

Spurious emissions are emissions which are caused by unwanted transmitter effects such as harmonics emission, parasitic emissions, intermodulation products and frequency conversion products, but exclude out of band emissions unless otherwise stated. The spurious emission limits are specified in terms of general requirements in line with SM.329 [9] and NR operating band requirement to address UE co-existence.

To improve measurement accuracy, sensitivity and efficiency, the resolution bandwidth may be smaller than the measurement bandwidth. When the resolution bandwidth is smaller than the measurement bandwidth, the result should be integrated over the measurement bandwidth in order to obtain the equivalent noise bandwidth of the measurement bandwidth.

NOTE: For measurement conditions at the edge of each frequency range, the lowest frequency of the measurement position in each frequency range should be set at the lowest boundary of the frequency range plus MBW/2. The highest frequency of the measurement position in each frequency range should be set at the highest boundary of the frequency range minus MBW/2. MBW denotes the measurement bandwidth defined for the protected band.

6.5F.3.1 General spurious emissions

The requirements for general spurious emission requirements in clause 6.5.3.1 apply.

6.5F.3.2 Spurious emissions for UE co-existence

Spurious emissions requirements for UE coexistence are not applicable to bands restricted to stand-alone operation with shared spectrum channel access as identified in Table 5.2-1.

6.5F.3.3 Additional spurious emissions

6.5F.3.3.0 General

These requirements are specified in terms of an additional spectrum emission requirement. Additional spurious emission requirements are signalled by the network to indicate that the UE shall meet an additional requirement for a specific deployment scenario as part of the cell handover/broadcast message.

6.5F.3.3.1 Requirement for network signalling value "NS_28"

When "NS_28" is indicated in the cell, the power of any UE emission for channels assigned within 5150-5350 and 5470-5725 MHz shall not exceed the levels specified in Table 6.5F.3.3.1-1. This requirement also applies for the frequency ranges that are less than F_{OOB} (MHz) in Table 6.5.3.1-1 from the edge of the channel bandwidth.

Table 6.5F.3.3.1-1: Additional requirements

Frequency band (MHz)	Channel bandwidth / Spectrum emission limit (dBm)	Measurement bandwidth
	20, 40, 60, 80, [100] MHz	
$47 \leq f \leq 74$	-54	100 kHz
$87.5 \leq f \leq 118$	-54	100 kHz
$174 \leq f \leq 230$	-54	100 kHz
$470 \leq f \leq 862$	-54	100 kHz
$1000 \leq f \leq 5150$	-30	1 MHz
$5350 \leq f \leq 5470$	-30	1 MHz
$5725 \leq f \leq 26000$	-30	1 MHz

6.5F.3.3.2 Requirement for network signalling value "NS_29"

When "NS_29" is indicated in the cell, the power of any UE emission for channels assigned within 5150-5350 and 5470-5730 MHz shall not exceed the levels specified in Table 6.5F.3.3.2-1, Table 6.5F.3.3.2-2, and Table 6.F.3.3.2-3. This requirement also applies for the frequency ranges that are less than F_{OOB} (MHz) in Table 6.5.3.1-1 from the edge of the channel bandwidth.

Table 6.5F.3.3.2-1: Additional requirements for 20 MHz channel bandwidth

Center Frequency F_c [MHz]	Protected range [MHz]	Minimum requirement [dBm]	Measurement bandwidth
$5179.98 \leq F_c \leq 5239.98$	$5135 \leq f \leq 5142$	-26	1 MHz
	$5142 < f \leq 5150$	-18	
	$5250 \leq f < 5250.2$	3 to -2	
	$5250.2 \leq f < 5251$	-2 to -10	
	$5251 \leq f < 5260$	-10 to -18	
	$5260 \leq f < 5266.7$	-18 to -26	
	$5266.7 \leq f \leq 5365$	-26	
$5260.02 \leq F_c \leq 5320.02$	$5135 \leq f \leq 5233.3$	-26	1 MHz
	$5233.3 < f \leq 5240$	-26 to -18	
	$5240 < f \leq 5249$	-18 to -10	
	$5249 < f \leq 5249.8$	-10 to -2	
	$5249.8 < f \leq 5250$	-2 to 3	
	$5350 \leq f \leq 5365$	-26	
$5500.02 \leq F_c \leq 5719.98$	$5420 \leq f \leq 5460$	-26	1 MHz
	$5460 < f \leq 5470$	-19	
	$5745 \leq f < 5765$	-19	
	$5765 \leq f \leq 5800$	-26	
NOTE: The minimum requirement when specified as a range denotes the emission requirement at the end points of the protected range. The requirement within the			

protected range is obtained by linear interpolation between the requirements at the end points.

Table 6.5F.3.3.2-2: Additional requirements for 40 MHz channel bandwidth

Center Frequency F_c [MHz]	Protected range [MHz]	Minimum requirement [dBm]	Measurement bandwidth
$5190 \leq F_c \leq 5230.02$	$5100 \leq f \leq 5141.6$	-26	1 MHz
	$5141.6 < f \leq 5150$	-18	
	$5250 \leq f < 5251$	-3 to -13	
	$5251 \leq f < 5270$	-13 to -21	
	$5270 \leq f < 5278.4$	-21 to -26	
$5278.4 \leq f \leq 5400$	-26		
$5269.98 \leq F_c \leq 5310$	$5210 < f \leq 5221.6$	-26	
	$5221.6 < f \leq 5230$	-26 to -21	
	$5230 < f \leq 5249$	-21 to -13	
	$5249 \leq f \leq 5250$	-13 to -3	
	$5350 \leq f \leq 5358.4$	-18	
$5509.98 \leq F_c \leq 5670$	$5358.4 < f \leq 5400$	-26	
	$5420 \leq f \leq 5460$	-19	
	$5460 < f \leq 5470$	-13	
	$5770 \leq f \leq 5800$	-19	
NOTE: The minimum requirement when specified as a range denotes the emission requirement at the end points of the protected range. The requirement within the protected range is obtained by linear interpolation between the requirements at the end points.			

Table 6.5F.3.3.2-3: Additional requirements for 60 and 80 MHz channel bandwidth

Center Frequency F_c [MHz]	Protected range [MHz]	Minimum requirement [dBm]	Measurement bandwidth
$5200.02 \leq F_c \leq 5220$	$5020 \leq f \leq 5123.2$	-26	1 MHz
	$5123.2 < f \leq 5150$	-18	
	$5250 \leq f < 5251$	-6 to -16	
	$5251 \leq f < 5290$	-16 to -24	
	$5290 \leq f < 5296.7$	-24 to -26	
$5280 \leq F_c \leq 5299.98$	$5296.7 \leq f \leq 5480$	-26	
	$5020 \leq f \leq 5203.3$	-26	
	$5203.3 < f \leq 5210$	-26 to -24	
	$5210 < f \leq 5249$	-24 to -16	
	$5249 < f \leq 5250$	-16 to -6	
$5520 \leq F_c \leq 5689.98$	$5350 \leq f < 5376.8$	-18	
	$5376.8 \leq f \leq 5480$	-26	
	$5340 \leq f \leq 5460$	-19	
	$5460 < f \leq 5469.5$	-13	
	$5469.5 < f \leq 5470$	-13	
	$5770 \leq f \leq 5800$	-19	
NOTE: The minimum requirement when specified as a range denotes the emission requirement at the end points of the protected range. The requirement within the protected range is obtained by linear interpolation between the requirements at the end points.			

6.5F.3.3.3 Requirement for network signalling value "NS_30"

When "NS_30" is indicated in the cell, the power of any UE emission for channels assigned within 5150-5350 MHz, 5470-5725 MHz and 5725-5850 MHz shall not exceed the levels specified in Table 6.5F.3.3.3-1-1, Table 6.5F.3.3.3-1-2 and Table 6.5F.3.3.3-1-3, respectively. These requirements also apply for the frequency ranges that are less than F_{OOB} (MHz) in Table 6.5.3.1-1 from the edge of the channel bandwidth.

Table 6.5F.3.3.3-1: Additional requirements for shared access channels assigned within 5150-5350 MHz

Protected range (MHz)	Channel bandwidth / Spectrum emission limit (dBm)	Measurement bandwidth
	20, 40, 60, 80 MHz	
$4500 \leq f \leq 5150$	-41	1 MHz
$5350 \leq f \leq 5460$	-41	

Table 6.5F.3.3.3-2: Additional requirements for shared access channels assigned within 5470-5725 MHz

Protected range (MHz)	Channel bandwidth / Spectrum emission limit (dBm)	Measurement bandwidth
	20, 40, 60, 80 MHz	
$4500 \leq f \leq 5150$	-41	1 MHz
$5350 \leq f \leq 5460$	-41	
$5460 < f \leq 5470$	-27	
$5725 \leq f$	-27	

Table 6.5F.3.3.3-3: Additional requirements for shared access channels assigned within 5725-5850 MHz

Protected range (MHz)	Channel bandwidth / Spectrum emission limit (dBm)	Measurement bandwidth
	20, 40, 60, 80, [100] MHz	
$f < 5650$	-27	1 MHz
$5650 \leq f < 5700$	-27 to 10	
$5700 \leq f < 5720$	10 to 15.6	
$5720 < f \leq 5725$	15.6 to 27	
$5850 \leq f \leq 5855$	27 to 15.6	
$5855 < f \leq 5875$	15.6 to 10	
$5875 < f \leq 5925$	10 to -27	
$5925 < f$	-27	
NOTE: The minimum requirement when specified as a range denotes the emission requirement at the end points of the protected range. The requirement within the protected range is obtained by linear interpolation between the requirements at the end points.		

6.5F.3.3.4 Requirement for network signalling value "NS_31"

When "NS_31" is indicated in the cell, the power of any UE emission for channels assigned within 5150-5250 MHz, 5250-5350 MHz, 5470-5725 MHz and 5725-5850 MHz shall not exceed the levels specified in Table 6.5F.3.3.4-1, Table 6.5F.3.3.4-2, Table 6.5F.3.3.4-3 and Table 6.5F.3.3.4-4, respectively. These requirements also apply for the frequency ranges that are less than F_{OOB} (MHz) in Table 6.5.3.1-1 from the edge of the channel bandwidth.

Table 6.5F.3.3.4-1: Additional requirements for NR-U channels assigned within 5150-5250 MHz

Frequency band (MHz)	Channel bandwidth / Spectrum emission limit (dBm)	Measurement bandwidth
----------------------	---------------------------------------------------	-----------------------

	20, 40, 60, 80 MHz	
$f \leq 5150$	-27	1 MHz
$f \geq 5250$	-27	

Table 6.5F.3.3.4-2: Additional requirements for NR-U channels assigned within 5250-5350 MHz

Frequency band (MHz)	Channel bandwidth / Spectrum emission limit (dBm)	Measurement bandwidth
	20, 40, 60, 80 MHz	
$f \leq 5250$	-27	1 MHz
$f \geq 5350$	-27	

Table 6.5F.3.3.4-3: Additional requirements for NR-U channels assigned within 5470-5725 MHz

Frequency band (MHz)	Channel bandwidth / Spectrum emission limit (dBm)	Measurement bandwidth
	20, 40, 60, 80 MHz	
$f \leq 5470$	-27	1 MHz
$f \geq 5725$	-27	

Table 6.5F.3.3.4-4: Additional requirements for NR-U channels assigned within 5725-5850 MHz

Frequency band (MHz)	Channel bandwidth / Spectrum emission limit (dBm)	Measurement bandwidth
	20, 40, 60, 80 MHz	
$f \leq 5725$	-27	1 MHz
$f \geq 5850$	-27	

6.5F.3.3.5 Requirements for network signalling value "NS_53" or "NS_54"

When "NS_53" or "NS_54" is indicated in the cell, the power of any UE emission shall not exceed the levels specified in Table 6.5F.3.3.5-1. These requirements also apply for the frequency ranges that are less than F_{OOB} (MHz) in Table 6.5.3.1-1 from the edge of the channel bandwidth.

Table 6.5F.3.3.5-1: Additional requirements

Frequency band (MHz)	Spectrum emission limit (dBm)	Measurement bandwidth
$f \leq 5925$	-27	1 MHz
$f \geq 7125$	-27	

6.5F.4 Transmit intermodulation

The requirements for transmit intermodulation in clause 6.5F.4 apply.

6.6 Void

6.6E Time alignment error

For V2X UE(s) with two transmit antenna connectors in SL MIMO, this requirement applies to slot timing differences between transmissions on two transmit antenna connectors. The Time Alignment Error (TAE) shall not exceed 260 ns.

7 Receiver characteristics

7.1 General

Unless otherwise stated the receiver characteristics are specified at the antenna connector(s) of the UE. For UE(s) with an integral antenna only, a reference antenna(s) with a gain of 0 dBi is assumed for each antenna port(s). UE with an integral antenna(s) may be taken into account by converting these power levels into field strength requirements, assuming a 0 dBi gain antenna. For UEs with more than one receiver antenna connector, identical interfering signals shall be applied to each receiver antenna port if more than one of these is used (diversity).

The levels of the test signal applied to each of the antenna connectors shall be as defined in the respective clauses below.

The applicability of receiver requirements for Band n90 is in accordance with that for Band n41; a UE supporting Band n90 shall meet the minimum requirements for Band n41.

With the exception of clause 7.3, the requirements shall be verified with the network signalling value NS_01 configured (Table 6.2.3-1).

All the parameters in clause 7 are defined using the UL reference measurement channels specified in Annexes A.2.2, the DL reference measurement channels specified in Annex A.3.2 and using the set-up specified in Annex C.3.1.

The minimum requirements specified in clauses 7.5, 7.6, 7.7 and 7.8 for NR band n48 refer to the minimum requirements for NR bands < 2.7 GHz.

For the additional requirements for intra-band non-contiguous carrier aggregation of two or more sub-blocks, an in-gap test refers to the case when the interfering signal is located at a negative offset with respect to the assigned lowest channel frequency of the highest sub-block and located at a positive offset with respect to the assigned highest channel frequency of the lowest sub-block.

For the additional requirements for intra-band non-contiguous carrier aggregation of two or more sub-blocks, an out-of-gap test refers to the case when the interfering signal(s) is (are) located at a positive offset with respect to the assigned channel frequency of the highest carrier frequency, or located at a negative offset with respect to the assigned channel frequency of the lowest carrier frequency.

For the additional requirements for intra-band non-contiguous carrier aggregation of two or more sub-blocks with channel bandwidth larger than or equal to 5 MHz, the existing adjacent channel selectivity requirements, in-band blocking requirements (for each case), and narrow band blocking requirements apply for in-gap tests only if the corresponding interferer frequency offsets with respect to the two measured carriers satisfy the following condition in relation to the sub-block gap size W_{gap} for at least one of these carriers $j = 1, 2$, so that the interferer frequency position does not change the nature of the core requirement tested:

$$W_{\text{gap}} \geq 2 \cdot |F_{\text{Interferer (offset)}_j} - BW_{\text{Channel}(j)}|$$

where $F_{\text{Interferer (offset)}_j}$ for a sub-block with a single component carrier is the interferer frequency offset with respect to carrier j as specified in clause 7.5, clause 7.6.2 and clause 7.6.4 for the respective requirement and $BW_{\text{Channel}(j)}$ the channel bandwidth of carrier j . $F_{\text{Interferer (offset)}_j}$ for a sub-block with two or more contiguous component carriers is the interference frequency offset with respect to the carrier adjacent to the gap as specified in clause 7.5A, 7.6A.2 and 7.6A.3. The interferer frequency offsets for adjacent channel selectivity, each in-band blocking case and narrow-band blocking shall be tested separately with a single in-gap interferer at a time.

For the additional requirements for operation with shared spectrum channel access, the receiver requirements apply under the assumption that all 20 MHz sub-bands and all RB's of each sub-band within the downlink channel are allocated with intra-cell guard bands configured to zero.

7.1A General

The minimum requirements for band combinations including Band n41 also apply for the corresponding band combinations with Band n90 replacing Band n41 but with otherwise identical parameters. For brevity the said band combinations with Band n90 are not listed in the tables below but are covered by this specification.

The minimum requirements specified in clauses 7.5A, 7.6A, 7.7A and 7.8A for NR band n48 refer to the minimum requirements for NR bands < 2.7 GHz.

The minimum requirements specified in clauses 7.5A, 7.6A, 7.7A and 7.8A for NR band n48 refer to the minimum requirements for NR bands < 2.7 GHz.

7.1F General

For wideband operations, the minimum requirements for the receiver characteristics are specified when zero width intra-cell guardbands are configured and with all RB set(s) within the channel scheduled and with all RB sets available for DL transmissions according to the channel access procedures in [14].

7.2 Diversity characteristics

The UE is required to be equipped with a minimum of two Rx antenna ports in all operating bands except for the bands n7, n38, n41, n48, n77, n78, n79 where the UE is required to be equipped with a minimum of four Rx antenna ports. This requirement applies when the band is used as a standalone band or as part of a band combination.

For the single carrier REFSSENS requirements in Clause 7, the UE shall be verified with two Rx antenna ports in all supported frequency bands, additional requirements for four Rx ports shall be verified in operating bands where the UE is equipped with four Rx antenna ports.

For Rx requirements other than single carrier REFSSENS in Clause 7, the UE shall be verified with four Rx antenna ports and skip two Rx antenna ports requirements in operating bands where the UE is equipped with four Rx antenna ports, otherwise, the UE shall be verified with two Rx antenna ports.

The above rules apply for all clauses with the exception of clause 7.9.

7.3 Reference sensitivity

7.3.1 General

The reference sensitivity power level REFSSENS is the minimum mean power applied to each one of the UE antenna ports for all UE categories, at which the throughput shall meet or exceed the requirements for the specified reference measurement channel.

In later clauses of Clause 7 where the value of REFSSENS is used as a reference to set the corresponding requirement:

when the UE is verified with 2 Rx antenna ports, it shall be verified against those requirements by applying the REFSSENS value in Table 7.3.2-1 with 2 Rx antenna ports tested;

when the UE is verified with 4 Rx antenna ports, it shall be verified against those requirements by applying the resulting REFSSENS value derived from the requirement in Table 7.3.2-2 with 4 Rx antenna ports tested.

7.3.2 Reference sensitivity power level

The throughput shall be ≥ 95 % of the maximum throughput of the reference measurement channels as specified in Annexes A.2.2.2, A.3.2 and A.3.3 (with one sided dynamic OCNG Pattern OP.1 FDD/TDD for the DL-signal as described in Annex A.5.1.1/A.5.2.1) with parameters specified in Table 7.3.2-1 and Table 7.3.2-2.

Table 7.3.2-1: Two antenna port reference sensitivity QPSK PREFSENS

Operating Band	Operating band / SCS / Channel bandwidth / Duplex-mode														Duplex Mode
	SCS kHz	5 MHz (dBm)	10 MHz (dBm)	15 MHz (dBm)	20 MHz (dBm)	25 MHz (dBm)	30 MHz (dBm)	40 MHz (dBm)	50 MHz (dBm)	60 MHz (dBm)	70 MHz (dBm)	80 MHz (dBm)	90 MHz (dBm)	100 MHz (dBm)	
n1	15	-100.0	-96.8	-95.0	-93.8	-92.7	-91.9	-90.6	-89.6						FDD
	30		-97.1	-95.1	-94.0	-92.8	-92.0	-90.7	-89.7						
	60		-97.5	-95.4	-94.2	-93.0	-92.1	-90.9	-89.7						
n2	15	-98.0	-94.8	-93.0	-91.8										FDD
	30		-95.1	-93.1	-92.0										
	60		-95.5	-93.4	-92.2										
n3	15	-97.0	-93.8	-92.0	-90.8	-89.7	-88.9	-82.3							FDD
	30		-94.1	-92.1	-91.0	-89.8	-89.0	-82.4							
	60		-94.5	-92.4	-91.2	-90.0	-89.1	-82.6							
n5	15	-98.0	-94.8	-93.0	-86.8										FDD
	30		-95.1	-93.1	-88.6										
	60														
n7 ¹	15	-98.0	-94.8	-93.0	-91.8	-90.7	-89.9	-88.6	-81.5						FDD
	30		-95.1	-93.1	-92.0	-90.8	-90.0	-88.7	-81.5						
	60		-95.5	-93.4	-92.2	-91.0	-90.1	-88.9	-81.5						
n8	15	-97.0	-93.8	-91.4	-85.8										FDD
	30		-94.1	-91.7	-87.2										
	60														
n12	15	-97.0	-93.8	-84.0											FDD
	30		-94.1	-84.1											
	60														
n14	15	-97.0	-93.8												FDD
	30		-94.1												
	60														
n18	15	-100.0	-96.8	-95.0											FDD
	30		-97.1	-95.1											
	60														
n20	15	-97.0	-93.8	-91.0	-89.8										FDD
	30		-94.1	-91.1	-90.0										
	60														
n25	15	-96.5	-93.3	-91.5	-90.3	-89.3	-82.2	-79.5							FDD
	30		-93.6	-91.6	-90.5	-89.4	-82.3	-79.6							
	60		-94.0	-91.9	-90.7	-89.6	-82.4	-79.7							
n26	15	-97.5 ⁶	-94.5 ⁶	-92.7 ⁶	-87.6										FDD
	30		-94.8 ⁶	-92.7 ⁶	-87.7										
n28	15	-98.5	-95.5	-93.5	-90.8		-78.5								FDD

Operating Band	Operating band / SCS / Channel bandwidth / Duplex-mode														Duplex Mode
	SCS kHz	5 MHz (dBm)	10 MHz (dBm)	15 MHz (dBm)	20 MHz (dBm)	25 MHz (dBm)	30 MHz (dBm)	40 MHz (dBm)	50 MHz (dBm)	60 MHz (dBm)	70 MHz (dBm)	80 MHz (dBm)	90 MHz (dBm)	100 MHz (dBm)	
	30		-95.6	-93.6	-91.0		-78.6								
	60														
n29*	15	-97.0	-93.8												SDL
	30		-94.1												
n30	15	-99.0	-95.8												FDD
	30		-96.1												
n34	15	-100.0	-96.8	-95.0											TDD
	30		-97.1	-95.1											
n38 ¹	15	-100.0	-96.8	-95.0	-93.8	-92.7	-91.9	-90.6							TDD
	30		-97.1	-95.1	-94.0	-92.8	-92.0	-90.7							
n39	15	-100.0	-96.8	-95.0	-93.8	-92.7	-91.9	-90.6							TDD
	30		-97.1	-95.1	-94.0	-92.8	-92.0	-90.7							
n40	15	-100.0	-96.8	-95.0	-93.8	-92.7	-91.9	-90.6	-89.6						TDD
	30		-97.1	-95.1	-94.0	-92.8	-92.0	-90.7	-89.7	-88.9	-87.6				
n41 ¹	15		-94.8	-93.0	-91.8		-89.9	-88.6	-87.6						TDD
	30		-95.1	-93.1	-92.0		-90.0	-88.7	-87.7	-86.9	-85.6	-85.1	-84.7		
n48 ¹	15	-99	-95.8	-94.0	-92.7			-89.6	-88.6 ⁵						TDD
	30		-96.1	-94.1	-92.9			-89.7	-88.7 ⁵	-87.9 ⁵	-86.6 ⁵	-86.1 ⁵	-85.6 ⁵		
n50	15	-100.0	-96.8	-95.0	-93.8		-91.9	-90.6	-89.6						TDD
	30		-97.1	-95.1	-94.0		-92.0	-90.7	-89.7	-88.9	-87.6				
n51	15	-100.0													TDD
	30														
n53	15	-100.0	-96.8												TDD
	30		-97.1												
n65	15	-99.5	-96.3	-94.5	-93.3				-89.2						FDD
	30		-96.6	-94.6	-93.5				-89.3						
n66	15	-99.5	-96.3	-94.5	-93.3	-92.2	-91.4	-90.1							FDD
	30		-96.6	-94.6	-93.5	-92.3	-91.5	-90.2							

Operating band / SCS / Channel bandwidth / Duplex-mode															
Operating Band	SCS kHz	5 MHz (dBm)	10 MHz (dBm)	15 MHz (dBm)	20 MHz (dBm)	25 MHz (dBm)	30 MHz (dBm)	40 MHz (dBm)	50 MHz (dBm)	60 MHz (dBm)	70 MHz (dBm)	80 MHz (dBm)	90 MHz (dBm)	100 MHz (dBm)	Duplex Mode
n70	60		-97.0	-94.9	-93.7	-92.5	-91.6	-90.4							FDD
	15	-100.0	-96.8	-95.0	-93.8	-92.7									
	30		-97.1	-95.1	-94.0	-92.8									
n71	60		-97.5	-95.4	-94.2	-93.0									FDD
	15	-97.2	-94.0	-91.6	-86.0										
	30		-94.3	-91.9	-87.4										
n74	60														FDD
	15	-99.5 ³	-96.3 ³	-94.5 ³	-89.3 ³										
	30		-96.6 ³	-94.6 ³	-89.5 ³										
n75 ⁷	60		-97.0 ³	-94.9 ³	-89.6 ³										SDL
	15	-100	-96.8	-95.0	-93.8	-92.7	-91.9	-90.6	-89.6						
	30		-97.1	-95.1	-94.0	-92.8	-92.0	-90.7	-89.7						
n76 ⁷	60		-97.5	-95.4	-94.2	-93.0	-92.1	-90.9	-89.8						SDL
	15	-100													
	30														
n77 ^{1,4}	60														TDD
	15		-95.3	-93.5	-92.2	-91.2	-90.4	-89.1	-88.1						
	30		-95.6	-93.6	-92.4	-91.3	-90.5	-89.2	-88.2	-87.4	-86.7	-86.1	-85.6	-85.1	
n78 ¹	60		-96.0	-93.9	-92.6	-91.5	-90.6	-89.4	-88.3	-87.5	-86.8	-86.2	-85.7	-85.2	TDD
	15		-95.8	-94.0	-92.7	-91.7	-90.9	-89.6	-88.6						
	30		-96.1	-94.1	-92.9	-91.8	-91	-89.7	-88.7	-87.9	-87.2	-86.6	-86.1	-85.6	
n79 ¹	60		-96.5	-94.4	-93.1	-92	-91.1	-89.9	-88.8	-88.0	-87.3	-86.7	-86.2	-85.7	TDD
	15							-89.6	-88.6						
	30							-89.7	-88.7	-87.9		-86.6		-85.6	
n91	60							-89.9	-88.8	-88.0		-86.7		-85.7	FDD
	15	-100													
	30														
n92	60														FDD
	15	-100	-96.8	-95.0	-93.8										
	30		-97.1	-95.1	-94.0										
n93	60														FDD
	15	-100													
	30														
n94	60														FDD
	15	-100	-96.8	-95.0	-93.8										
	30		-97.1	-95.1	-94.0										

NOTE 1: Four Rx antenna ports shall be the baseline for this operating band except for two Rx vehicular UE.

NOTE 2: The transmitter shall be set to P_{UMAX} as defined in clause 6.2.4

NOTE 3: The requirement is modified by -0.5 dB when the assigned NR channel bandwidth is confined within 1475.9 - 1510.9 MHz.

Operating band / SCS / Channel bandwidth / Duplex-mode															
Operating Band	SCS kHz	5 MHz (dBm)	10 MHz (dBm)	15 MHz (dBm)	20 MHz (dBm)	25 MHz (dBm)	30 MHz (dBm)	40 MHz (dBm)	50 MHz (dBm)	60 MHz (dBm)	70 MHz (dBm)	80 MHz (dBm)	90 MHz (dBm)	100 MHz (dBm)	Duplex Mode
NOTE 4: The requirement is modified by -0.5 dB when the assigned UE channel bandwidth is confined within 3300 - 3800 MHz.															
NOTE 5: For these bandwidths, the minimum requirements are restricted to operation when carrier is configured as a downlink carrier part of CA configuration.															
NOTE 6: Values are modified by -0.5dB when carrier channel BW is between 865MHz and 894MHz.															
NOTE 7: For SDL bands, the reference sensitivity requirements shall be verified by inter-band CA combinations with SDL band, which are supported by UE.															

For UE(s) equipped with 4 Rx antenna ports, reference sensitivity for 2Rx antenna ports in Table 7.3.2-1 shall be modified by the amount given in $\Delta R_{IB,4R}$ in Table 7.3.2-2 for the applicable operating bands.

Table 7.3.2-2: Four antenna port reference sensitivity allowance $\Delta R_{IB,4R}$

Operating band	$\Delta R_{IB,4R}$ (dB)
n28, n71	-2.7 ¹
n1, n2, n3, n30, n40, n7, n34, n38, n39, n41, n66, n70	-2.7
n48, n77, n78, n79	-2.2
NOTE 1: 4 Rx operation is targeted for FWA form factor	

The reference receive sensitivity (REFSENS) requirement specified in Table 7.3.2-1 and Table 7.3.2-2 shall be met with uplink transmission bandwidth less than or equal to that specified in Table 7.3.2-3.

Table 7.3.2-3: Uplink configuration for reference sensitivity

Operating band / SCS / Channel bandwidth / Duplex mode															
Operating Band	SCS kHz	5 MHz	10 MHz	15 MHz	20 MHz	25 MHz	30 MHz	40 MHz	50 MHz	60 MHz	70 MHz	80 MHz	90 MHz	100 MHz	Duplex Mode
n1	15	25	50 ¹	75 ¹	100 ¹	128 ¹	128 ¹	128 ¹	128 ¹						FDD
	30		24	36 ¹	50 ¹	64 ¹	64 ¹	64 ¹	64 ¹						
	60		10 ¹	18	24	30 ¹	30 ¹	30 ¹	30 ¹						
n2	15	25	50 ¹	50 ¹	50 ¹										FDD
	30	10 ¹	24	24 ¹	24 ¹										
	60		10 ¹	10 ¹	10 ¹										
n3	15	25	50 ¹	50 ¹	50 ¹	50 ¹	50 ¹	50 ¹							FDD
	30		24	24 ¹	24 ¹	24 ¹	24 ¹	24 ¹							
	60		10 ¹	10 ¹	10 ¹	10 ¹	10 ¹	10 ¹							
n5	15	25	25 ¹	20 ¹	20 ¹										FDD
	30		12 ¹	10 ¹	10 ¹										
	60														
n7	15	25	50 ¹	75 ¹	75 ¹	72 ¹	64 ¹	45 ¹	45 ¹						FDD
	30		24	36 ¹	36 ¹	36 ¹	32 ¹	20 ¹	20 ¹						
	60		10 ¹	18	18 ¹	18 ¹	16 ¹	10 ¹	10 ¹						
n8	15	25	25 ¹	20 ¹	20 ¹										FDD
	30		12 ¹	10 ¹	10 ¹										
	60														
n12	15	20 ¹	20 ¹	20 ¹											FDD
	30		10 ¹	10 ¹											
	60														
n14	15	20 ¹	20 ¹												FDD
	30		10 ¹												
	60														
n18	15	25	25 ¹	25 ¹											FDD
	30		10 ¹	10 ¹											
	60														
n20	15	25	20 ¹	20 ²	20 ²										FDD
	30		10 ¹	10 ²	10 ²										
	60														
n25	15	25	50 ¹	50 ¹	50 ¹	50 ¹	48 ¹	40 ¹							FDD
	30		24	24 ¹	24 ¹	24 ¹	24 ¹	20 ¹							
	60		10 ¹	10 ¹	10 ¹	10 ¹	10 ¹	10 ¹							
n26	15	25	25 ¹	25 ¹	25 ¹										FDD
	30		12 ¹	12 ¹	12 ¹										
n28	15	25	25 ¹	25 ¹	25 ¹		25 ¹								FDD
	30		10 ¹	10 ¹	10 ¹		10 ¹								
	60														
n30	15	20 ¹	20 ¹												FDD
	30		10 ¹												
	60														
n34	15	25	50	75											TDD

Operating band / SCS / Channel bandwidth / Duplex mode															
Operating Band	SCS kHz	5 MHz	10 MHz	15 MHz	20 MHz	25 MHz	30 MHz	40 MHz	50 MHz	60 MHz	70 MHz	80 MHz	90 MHz	100 MHz	Duplex Mode
	30		24	36											
	60		10	18											
n38	15	25	50	75	100	128	160	216							TDD
	30		24	36	50	64	75	100							
	60		10	18	24	30	36	50							
n39	15	25	50	75	100	128	160	216							TDD
	30		24	36	50	64	75	100							
	60		10	18	24	30	36	50							
n40	15	25	50	75	100	128	160	216	270						TDD
	30		24	36	50	64	75	100	128	162		216			
	60		10	18	24	30	36	50	64	75		100			
n41	15		50	75	100		160	216	270						TDD
	30		24	36	50		75	100	128	162		216	243	270	
	60		10	18	24		36	50	64	75		100	120	135	
n48	15	25	50	75	100			216							TDD
	30		24	36	50			100							
	60		10	18	24			50							
n50	15	25	50	75	100		160	216	270						TDD
	30		24	36	50		75	100	128	162		NOTE 3			
	60		10	18	24		36	50	64	75		NOTE 3			
n51	15	25													TDD
	30														
	60														
n53	15	25	50												TDD
	30		24												
	60		10												
n65	15	25	50 ¹	75 ¹	100 ¹				128 ¹						FDD
	30		24	36 ¹	50 ¹				64 ¹						
	60		10 ¹	18	24				30 ¹						
n66	15	25	50 ¹	75 ¹	100 ¹	128 ¹	160	216							FDD
	30		24	36 ¹	50 ¹	64 ¹	75 ¹	100 ¹							
	60		10 ¹	18	24	30 ¹	36 ¹	50 ¹							
n70	15	25	50 ¹	75 ¹	NOTE 3	NOTE 3									FDD
	30		24	36 ¹	NOTE 3	NOTE 3									
	60		10 ¹	18	NOTE 3	NOTE 3									
n71	15	25	25 ¹	20 ¹	20 ¹										FDD
	30		12 ¹	10 ¹	10 ¹										
	60														
n74	15	25	25 ¹	25 ¹	25 ¹										FDD
	30		10 ¹	10 ¹	10 ¹										
	60		5 ¹	5 ¹	5 ¹										
n77	15		50	75	100	128	160	216	270						TDD
	30		24	36	50	64	75	100	128	162	180	216	243	270	
	60		10	18	24	30	36	50	64	75	90	100	120	135	
n78	15		50	75	100	128	160	216	270						TDD
	30		24	36	50	64	75	100	128	162	180	216	243	270	
	60		10	18	24	30	36	50	64	75	90	100	120	135	
n79	15							216	270						TDD
	30							100	128	162		216		270	
	60							50	64	75		100		135	
n91	15	25 ⁴	20 ^{1,4}												FDD
	30														
	60														
n92	15	25	20 ¹	20 ¹	20 ¹										FDD
	30		10 ¹	10 ¹	10 ¹										
	60														
n93	15	25 ⁴	25 ^{1,4}												FDD
	30														

Operating band / SCS / Channel bandwidth / Duplex mode															
Operating Band	SCS kHz	5 MHz	10 MHz	15 MHz	20 MHz	25 MHz	30 MHz	40 MHz	50 MHz	60 MHz	70 MHz	80 MHz	90 MHz	100 MHz	Duplex Mode
n94	60														FDD
	15	25	25 ¹	20 ¹	20 ¹										
	30		12 ¹	10 ¹	10 ¹										
	60														

NOTE 1: UL resource blocks shall be located as close as possible to the downlink operating band but confined within the transmission bandwidth configuration for the channel bandwidth (Table 5.3.2-1).

NOTE 2: For band n20; for 15 kHz SCS, in the case of 15 MHz channel bandwidth, the UL resource blocks shall be located at RB_{start} 11 and in the case of 20 MHz channel bandwidth, the UL resource blocks shall be located at RB_{start} 16; for 30 kHz SCS, in the case of 15 MHz channel bandwidth, the UL resource blocks shall be located at RB_{start} 6 and in the case of 20 MHz channel bandwidth, the UL resource blocks shall be located at RB_{start} 8; for 60 kHz SCS;

NOTE 3: For DL channel bandwidths that do not have symmetric UL channel bandwidth, highest valid UL configuration with lowest TX-RX separation (Table 5.4.4-1) shall be used.

NOTE 4: For band n91 and n93, largest supported UL bandwidth configuration shall be used.

Unless given by Table 7.3.2-4, the minimum requirements specified in Tables 7.3.2-1 and 7.3.2-2 shall be verified with the network signalling value NS_01 (Table 6.2.3-1) configured.

Table 7.3.2-4: Network signaling value for reference sensitivity

Operating band	Network Signalling value
n2	NS_03
n12	NS_06
n14	NS_06
n25	NS_03
n30	NS_21
n48	NS_27
n53	NS_45
n66	NS_03
n70	NS_03
n71	NS_35

7.3.3 $\Delta R_{IB,c}$

For a UE supporting CA, SUL or DC band combination, the minimum requirement for reference sensitivity in Table 7.3.2-1 shall be increased by the amount given by $\Delta R_{IB,c}$ defined in clause 7.3A, 7.3B, 7.3C in this specification and 7.3A, 7.3B in TS 38.101-3 [3] for the applicable operating bands.

In case the UE supports more than one of band combinations for CA, SUL or DC, and an operating band belongs to more than one band combinations then

- When the operating band frequency range is ≤ 1 GHz, the applicable additional $\Delta R_{IB,c}$ shall be the average value for all band combinations defined in clause 7.3A, 7.3B, 7.3C in this specification and 7.3A, 7.3B in TS 38.101-3 [3], truncated to one decimal place that apply for that operating band among the supported band combinations. In case there is a harmonic relation between low band UL and high band DL, then the maximum $\Delta R_{IB,c}$ among the different supported band combinations involving such band shall be applied
- When the operating band frequency range is > 1 GHz, the applicable additional $\Delta R_{IB,c}$ shall be the maximum value for all band combinations defined in clause 7.3A, 7.3B, 7.3C in this specification and 7.3A, 7.3B in TS 38.101-3 [3] for the applicable operating bands.

7.3A Reference sensitivity for CA

7.3A.1 General

The reference sensitivity power level REFSENS is the minimum mean power applied to each one of the UE antenna ports for all UE categories, at which the throughput shall meet or exceed the requirements for the specified reference

measurement channel. For operations with 4 Rx antenna ports, the MSD in the applicable bands shall be increased by the absolute value of $\Delta R_{IB,4R}$ in Table 7.3.2-2 when $MSD > 0$.

For reference sensitivity exception test points where the specified carrier frequency does not correspond to a valid NR-ARFCN, the closest NR-ARFCN as specified in clause 5.4.2 applies.

7.3A.2 Reference sensitivity power level for CA

7.3A.2.1 Reference sensitivity power level for Intra-band contiguous CA

For intra-band contiguous carrier aggregation, the throughput of each component carrier shall be $\geq 95\%$ of the maximum throughput of the reference measurement channels as specified in Annexes A.2.2.2, A.3.2, and A.3.3 (with one sided dynamic OCNG Pattern OP.1 FDD/TDD for the DL-signal as described in Annex A.5.1.1/A.5.2.1) with parameters specified in Table 7.3.2-1, Table 7.3.2-2, and Table 7.3.2-3.

For UE(s) supporting one uplink carrier, the uplink configuration of the PCC shall be in accordance with Table 7.3.2-3 and the downlink PCC carrier center frequency shall be configured closer to uplink operating band than any of the downlink SCC center frequency.

For aggregation of two or more downlink FDD carriers with two uplink carriers, the reference sensitivity is defined only for the specific uplink and downlink test points which are specified in Table 7.3A.2.1-1 and the reference sensitivity power level increased by ΔR_{IBC} . The requirements apply with all downlink carriers active. Unless given by Table 7.3.2-4, the reference sensitivity requirements shall be verified with the network signaling value NS_01 (Table 6.2.3.1-1) configured.

Table 7.3A.2.1-1: Intra-band contiguous CA uplink configuration for reference sensitivity

CA configuration	SCS (PCC/SCC) (kHz)	Aggregated channel bandwidth (PCC+SCC)	UL PCC allocation (L _{CRB})	UL SCC allocation (L _{CRB})	PCC ΔR_{IBNC} (dB)	SCC ΔR_{IBNC} (dB)	Duplex mode
CA _{n7B}	15/15	10MHz + 40MHz	9 (RB _{start} = 26)	36 (RB _{start} = 180)	34	25	FDD
		40MHz + 10MHz	64 (RB _{start} = 152)	0	5.5	8.5	
		30MHz + 20MHz	64 (RB _{start} = 96)	0	4	8.5	
		30MHz + 15MHz	64 (RB _{start} = 96)	0	0	8	

NOTE 1: All combinations of channel bandwidths defined in Table 5.5A.1-1.

NOTE 2: The carrier centre frequency of SCC in the UL operating band is configured closer to the DL operating band.

NOTE 3: The transmitted power over both PCC and SCC shall be set to P_{UMAX} as defined in subclause 6.2A.4.

NOTE 4: The PCC allocation is same as Transmission bandwidth configuration N_{RB} as defined in Table 5.3.2-1.

7.3A.2.2 Reference sensitivity power level for Intra-band non-contiguous CA

For intra-band non-contiguous carrier aggregation with one uplink carrier and two or more downlink sub-blocks, throughput of each downlink component carrier shall be $\geq 95\%$ of the maximum throughput of the reference measurement channels as specified in Annexes A.2.2 and A.3.2 (with one sided dynamic OCNG Pattern OP.1 FDD/TDD for the DL-signal as described in Annex A.5.1.1/A.5.2.1) and parameters specified in Table 7.3.2-1, Table 7.3.2-2, and Table 7.3A.2.2-1 with the reference sensitivity power level increased by ΔR_{IBNC} given in Table 7.3A.2.2-1 for the SCC(s).

For aggregation of two or more downlink FDD carriers with one uplink carrier the reference sensitivity is defined only for the specific uplink and downlink test points which are specified in Table 7.3A.2.2-1. The requirements apply with all downlink carriers active. Unless given by Table 7.3.2-4, the reference sensitivity requirements shall be verified with the network signalling value NS_01 (Table 6.2.3.1-1) configured.

Table 7.3A.2.2-1: Intra-band non-contiguous CA with one uplink configuration for reference sensitivity in FDD bands.

CA configuration	SCS (PCC/SCC) (kHz)	Aggregated channel bandwidth (PCC+SCC)	W_{gap} / [MHz]	UL PCC allocation (L _{CRB})	ΔR_{IBNC} (dB)	Duplex mode
------------------	---------------------	----------------------------------------	-------------------	---------------------------------------	------------------------	-------------

CA_n3(2A)	15/15	5MHz + 5MHz	$W_{\text{gap}} = 65.0$	12^5	4.7	FDD
			$W_{\text{gap}} = 45.0$	25^5	0.0	
CA_n7(2A)	15/15	10MHz + 5MHz	$W_{\text{gap}} = 55$	32^5	0.0	FDD
			$W_{\text{gap}} = 30$	50^5	0.0	
CA_n25(2A)	15/15	5MHz + 5MHz	$W_{\text{gap}} = 55.0$	10^5	5.0	FDD
			$W_{\text{gap}} = 30.0$	25	0.0	
CA_n66(2A)	N/A	NOTE 1	NOTE 2	NOTE 3, NOTE 4	0.0	FDD

NOTE 1: All combinations of channel bandwidths defined in Table 5.5A.2-1.
NOTE 2: All applicable sub-block gap sizes.
NOTE 3: The PCC allocation is same as Transmission bandwidth configuration N_{RB} as defined in Table 5.3.2-1.
NOTE 4: The carrier center frequency of PCC in the DL operating band is configured closer to the UL operating band.
NOTE 5: Refers to the UL resource blocks shall be located as close as possible to the downlink operating band but confined within the transmission.
NOTE 6: W_{gap} is the sub-block gap between the two sub-blocks.
NOTE 7: The carrier centre frequency of SCC in the DL operating band is configured closer to the UL operating band.

7.3A.2.3 Reference sensitivity power level for Inter-band CA

For inter-band carrier aggregation with one component carrier per operating band and the uplink assigned to one NR band the throughput shall be ≥ 95 % of the maximum throughput of the reference measurement channels as specified in Annexes A.2.2.2, A.3.2, and A.3.3 (with one sided dynamic OCNG Pattern OP.1 FDD/TDD for the DL-signal as described in Annex A.5.1.1/A.5.2.1 with parameters specified in Table 7.3.2-1, Table 7.3.2-2 and Table 7.3.2-3 modified in accordance with clause 7.3A.3.2. The reference sensitivity is defined to be met with all downlink component carriers active and one of the uplink carriers active. Exceptions to reference sensitivity are allowed in accordance with clause 7.3A.4, 7.3A.5 and 7.3A.6.

For the combination of intra-band and inter-band carrier aggregation, the intra-band CA relaxation, ΔR_{IBC} and ΔR_{IBNC} , are also applied according to the clause 7.3A.2.1 and 7.3A.2.2.

7.3A.2.4 Void

clause

7.3A.3 $\Delta R_{\text{IB,c}}$ for CA

7.3A.3.1 General

For a UE supporting a CA configuration, the $\Delta R_{\text{IB,c}}$ applies for both SC and CA operation.

7.3A.3.2 $\Delta R_{\text{IB,c}}$ for Inter-band CA

For the UE which supports inter-band carrier aggregation, the minimum requirement for reference sensitivity in clause 7.3A.2 shall be increased by the amount given by $\Delta R_{\text{IB,c}}$ defined in clause 7.3A.3.2 for the applicable operating bands. Unless otherwise stated, $\Delta R_{\text{IB,c}}$ is set to zero.

In case the UE supports more than one of band combinations for CA, SUL or DC, and an operating band belongs to more than one band combinations then

- When the operating band frequency range is ≤ 1 GHz, the applicable additional $\Delta R_{\text{IB,c}}$ shall be the average value for all band combinations defined in clause 7.3A, 7.3B, 7.3C in this specification and 7.3A, 7.3B in TS 38.101-3 [3], truncated to one decimal place that apply for that operating band among the supported band combinations. In case there is a harmonic relation between low band UL and high band DL, then the maximum $\Delta R_{\text{IB,c}}$ among the different supported band combinations involving such band shall be applied

- When the operating band frequency range is > 1 GHz, the applicable additional $\Delta R_{IB,c}$ shall be the maximum value for all band combinations defined in clause 7.3A, 7.3B, 7.3C in this specification and 7.3A, 7.3B in TS 38.101-3 [3] for the applicable operating bands.

7.3A.3.2.1 $\Delta R_{IB,c}$ for two bands

Table 7.3A.3.2.1-1: $\Delta R_{IB,c}$ due to CA (two bands)

Inter-band CA combination	NR Band	$\Delta R_{IB,c}$ (dB)
CA_n1-n28	n28	0.2
CA_n1-n77	n1	0.2
	n77	0.5
CA_n1-n78	n78	0.5
CA_n2-n48	n2	0.2
	n48	0.5
CA_n2-n66	n2	0.3
	n66	0.3
CA_n2-n77	n2	0.2
	n77	0.5
CA_n2-n78	n2	0.2
	n78	0.5
CA_n3-n41	n41	0 ⁴
		0.5 ⁵
CA_n3-n77	n3	0.2
	n77	0.5
CA_n3-n78	n3	0.2
	n78	0.5
CA_n3-n79	n79	0.5
CA_n5-n77	n5	0.2
	n77	0.5
CA_n5-n78	n5	0.2
	n78	0.5
CA_n7-n66	n7	0.5
	n66	0.5
CA_n7-n78	n7	0.5
	n78	0.5
CA_n8-n78	n8	0.2
	n78	0.5
CA_n8-n79	n79	0.5
CA_n20-n78	n78	0.5
CA_n25-n66	n25	0.3
	n66	0.3
CA_n25-n71	n71	0.3
CA_n25-n78	n25	0.2
	n78	0.5
CA_n28-n75	n28	0.2
CA_n28-n77	n28	0.2
	n77	0.5
CA_n28-n78	n28	0.2
	n78	0.5
CA_n38-n66	n38	0.5
	n66	0.5
CA_n38-n78	n38	0.4
	n78	0.5
CA_n39-n40	n39	0.3
	n40	0.3
CA_n39-n41	n39	0.2 ²
	n41	0.2 ²
	n39	0.2 ³
	n41	0.2 ³
CA_n39-n79	n79	0.5
CA_n40-n78	n40	0.4
	n78	0.5
CA_n40-n79	n79	0.5

CA_n41-n66	n41	0.5 ⁶
		1 ⁷
	n66	0.5
CA_n41-n71	n71	0.2
CA_n41-n78 ¹	n78	0.5
CA_n41-n79	n41	0.5
	n79	0.5
CA_n48-n66	n48	0.5
	n66	0.2
CA_n50-n78	n50	0.2 ²
	n78	0.2 ²
	n50	0.2 ³
	n78	0.2 ³
CA_n66-n77	n66	0.2
	n77	0.5
CA_n66-n78	n66	0.2
	n78	0.5
CA_n75-n78	n78	0.5
CA_n76-n78	n78	0.5
CA_n78-n92	n78	0.5
<p>NOTE 1: The requirements only apply when the sub-frame and Tx-Rx timings are synchronized between the component carriers. In the absence of synchronization, the requirements are not within scope of these specifications.</p> <p>NOTE 2: Only applicable for UE supporting inter-band carrier aggregation with uplink in one NR band and without simultaneous Rx/Tx.</p> <p>NOTE 3: Applicable for UE supporting inter-band carrier aggregation without simultaneous Rx/Tx.</p> <p>NOTE 4: The requirement is applied for UE transmitting on the frequency range of 2515 – 2690 MHz.</p> <p>NOTE 5: The requirement is applied for UE transmitting on the frequency range of 2496 – 2515 MHz.</p> <p>NOTE 6: The requirement is applied for UE transmitting on the frequency range of 2545-2690 MHz.</p> <p>NOTE 7: The requirement is applied for UE transmitting on the frequency range of 2496-2545 MHz</p>		

Table 7.3A.3.2.1-2: void

7.3A.3.2.2 Void

7.3A.3.2.3 $\Delta R_{IB,c}$ for three bands

Table 7.3A.3.2.3-1: $\Delta R_{IB,c}$ due to CA (three bands)

Inter-band CA combination	NR Band	$\Delta R_{IB,c}$ (dB)
CA_n1-n3-n28	n28	0.2
CA_n1-n3-n41	n41	0 ¹
		0.5 ²
CA_n1-n3-n78	n1	0.2
	n3	0.2
	n78	0.5
CA_n1-n7-n28	n28	0.2
CA_n1-n7-n78	n1	0.2
	n7	0.2
	n78	0.5
CA_n1-n8-n78	n8	0.2
	n78	0.5
CA_n1-n28-n78	n28	0.2
	n78	0.5
CA_n1-n40-n78	n78	0.5
CA_n3-n7-n78	n3	0.2

	n7	0.2
	n78	0.5
CA_n3-n8-n78	n3	0.2
	n8	0.2
	n78	0.5
CA_n3-n28-n77	n3	0.2
	n28	0.2
	n77	0.5
CA_n3-n28-n78	n28	0.2
	n78	0.5
CA_n3-n40-n41	n41	0 ^{1,3}
		0.5 ^{2,3}
CA_n3-n41-n79	n41	0.5
	n79	0.5
CA_n5-n66-n78	n5	0.5
	n66	0.2
	n78	0.5
CA_n7-n25-n66	n7	0.5
	n25	0.3
	n66	0.5
CA_n7-n28-n78	n78	0.5
CA_n7-n66-n78	n7	0.5
	n66	0.5
	n78	0.5
CA_n8-n39-n41	n39	0.2 ⁴
	n41	0.2 ⁴
CA_n8-n41-n79	n41	0.5
	n79	0.5
CA_n20-n28-n78	n28	0.2
	n78	0.5
CA_n25-n41-n66	n25	0.3
	n41	0.5 ⁵
		1 ⁶
	n66	0.3
CA_n25-n41-n71	n71	0.2
CA_n25-n66-n71	n25	0.3
	n66	0.3
	n71	0.3
CA_n25-n66-n78	n25	0.3
	n66	0.3
	n78	0.5
CA_n28-n40-n78	n78	0.5
CA_n28-n41-n78	n28	0.2
	n78	0.5
CA_n39-n41-n79	n39	0.3 ⁴
	n41	0.3 ⁴
	n79	0.8
CA_n40-n41-n79	n40	0 ³
	n41	0.5 ³
	n79	0.5
CA_n41-n66-n71	n41	0.5 ⁵
		1 ⁶
	n66	0.5
<p>NOTE 1: Applicable for the frequency range of 2515-2690 MHz. NOTE 2: Applicable for the frequency range of 2496-2515 MHz. NOTE 3: Only applicable for UE supporting inter-band carrier aggregation without simultaneous Rx/Tx among band 40 and 41. NOTE 4: Applicable for UE supporting inter-band carrier aggregation without simultaneous Rx/Tx between n39 and n41. NOTE 5: The requirement is applied for UE transmitting on the frequency range of 2545 - 2690 MHz. NOTE 6: The requirement is applied for UE transmitting on the frequency range of 2496 - 2545 MHz. NOTE 7: Void. NOTE 8: Void.</p>		

7.3A.3.2.4 $\Delta R_{IB,c}$ for four bands

Table 7.3A.3.2.4-1: $\Delta R_{IB,c}$ due to CA (four bands)

Inter-band CA combination	NR Band	$\Delta R_{IB,c}$ (dB)
CA_n1-n3-n7-n28	n28	0.2
CA_n1-n3-n7-n78	n1	0.3
	n3	0.3
	n7	0.3
	n78	0.5
CA_n1-n3-n8-n78	n1	0.2
	n3	0.2
	n8	0.2
	n78	0.5
CA_n1-n3-n28-n78	n1	0.2
	n3	0.2
	n28	0.2
	n78	0.5
CA_n3-n7-n28-n78	n3	0.2
	n7	0.2
	n28	0.2
	n78	0.5
CA_n7-n25-n66-n78	n7	0.5
	n25	0.6
	n66	0.6
	n78	0.8

7.3A.4 Reference sensitivity exceptions due to UL harmonic interference for CA

Sensitivity degradation is allowed for a band in frequency range 1 if it is impacted by UL harmonic interference from another band in frequency range 1 of the same CA configuration. Reference sensitivity exceptions are specified in Table 7.3A.4-1 with uplink configuration specified in Table 7.3A.4-2.

Table 7.3A.4-1: Reference sensitivity exceptions due to UL harmonic for NR CA FR1

UL band	DL band	MSD due to harmonic exception for the DL band												
		5 MH	10 MH	15 MH	20 MH	25 MH	30 MH	40 MH	50 MHz	60 MHz	70 MH	80 MHz	90 MHz	100 MHz
		z	z	z	z	z	z	z	dB	dB	z	dB	dB	dB
n1	n77 ^{1,2}		23.9	22.1	20.9			17.9	16.8	16.0		14.8	14.3	13.8
	n77 ³		1.1	0.8	0.3									
n2	n48 ^{1,2}	27.1	23.9	22.1	20.9			17.9	16.9 ¹ ₂	16.1 ¹ ₂		14.8 ¹ ₂	14.3 ¹ ₂	13.8 ¹ ₂
	n48 ³	1.9	1.1	0.8	0.3									
n2	n77 ^{1,2}		23.9	22.1	20.9	19.8	19.0	17.9	16.8	16.0	15.5	14.8	14.3	13.8
	n77 ³		1.1	0.8	0.3	0.1								
2	n78 ^{1,2}		23.9	22.1	20.9	19.8	19.0	17.9	16.8	16.0		14.8	14.3	13.8
	n78 ³		1.1	0.8	0.3									
n3	n77 ^{1,2}		23.9	22.1	20.9			17.9	16.9	16.1		14.8	14.3	13.8
	n77 ³		1.1	0.8	0.3									
	n78 ^{1,2}		23.9	22.1	20.9			17.9	16.9	16.1		14.8	14.3	13.8
	n78 ³		1.1	0.8	0.3									
n5	n77 ^{4,5,13}		10.5	8.9	7.8	7.2	6.5	5.1	4.2	3.5	2.8	2.3	2.1	1.4
n5	n77 ^{6,7,13}		10.4	8.9	6.7	6.0	6.5	4.7	3.7	3	2.3	1.7	1.2	0.7
n5	n78 ^{4,5}		10.5	8.9	7.8			5.4	4.2	3.5		2.3	2.1	1.4

n8	n3 ¹¹	N/A	N/A	N/A	N/A	N/A	N/A							
	n41 ^{8,9}		13.0	11.3	10.1			7.0	6.1	5.5		4.3	3.9	3.5
	n78 ^{4,5}		10.8	9.1	8.0			5.1	4.2	3.5		2.3	2.1	1.4
	n79 ^{6,7}							6.8	6.2	5.6		4.9		4.4
n20	n78 ^{4,5}		10.8	9.1	8			6	4.0	3.2		2.0	1.5	1.0
25	n78 ^{1,2}		23.9	22.1	20.9			17.9	16.8	16.0		14.8	14.3	13.8
	n78 ³		1.1	0.8	0.3									
n28	n1 ^{8,9}	10.2	7.6	6.2	5.3									
	n50 ^{1,2}		19.8	18.0	16.8			13.8	12.8	12.0		10.8		
	n75 ^{1,2}	28.1	25.3	24.0	22.8	21.8	21.0	19.7	18.7					
	n77 ^{6,7}		10.4	8.9	7.8			4.7	3.7	3		1.7	1.2	0.7
	n78 ^{6,7}		10.4	8.9	7.8			4.7	3.7	3		1.7	1.2	0.7
n66	n48 ^{1,2}	27.1	23.9	22.1	20.9			17.9	16.9 ¹ ₂	16.1 ¹ ₂		14.8 ¹ ₂	14.3 ¹ ₂	13.8 ¹ ₂
	n48 ³	1.9	1.1	0.8	0.3									
n66	n77 ^{1,2}		23.9	22.1	20.9	19.8	19.0	17.9	16.8	16.0	15.3	14.8	14.3	13.8
	n77 ³		1.1	0.8	0.3	0.1								
n66	n78 ^{1,2}		23.9	22.1	20.9			17.9	16.8	16.0		14.8	14.3	13.8
	n78 ³		1.1	0.8	0.3									
n71	n25 ¹⁰	10	7.5	6	5.1									
	n41 ^{4,5}		10.8	9.1	8.0			5.1	4.2	3.5		2.3	2.1	1.4
	n70 ^{8,9}	9.9	7.1	6.7	4.9	4.1								
n92	n78 ^{4,5}		10.8	9.1	8			6	4.0	3.2		2.0	1.5	1.0

- NOTE 1: These requirements apply when there is at least one individual RE within the uplink transmission bandwidth of the aggressor (lower) band for which the 2nd transmitter harmonic is within the downlink transmission bandwidth of a victim (higher) band and a range ΔF_{HD} above and below the edge of this downlink transmission bandwidth. The value ΔF_{HD} depends on the band combination: $\Delta F_{HD} = 10$ MHz for CA_n1-n77, CA_n2-n78, CA_n3-n77, CA_n3-n78, CA_n2-n48, CA_n25-n78, CA_n48-n66, CA_n66-n78.
- NOTE 2: The requirements should be verified for UL NR-ARFCN of the aggressor (lower) band (superscript LB) such that $f_{UL}^{LB} = \lfloor f_{DL}^{HB} / 0.2 \rfloor \cdot 0.1$ in MHz and $F_{UL_low}^{LB} + BW_{Channel}^{LB} / 2 \leq f_{UL}^{LB} \leq F_{UL_high}^{LB} - BW_{Channel}^{LB} / 2$ with f_{DL}^{HB} carrier frequency in the victim (higher) band in MHz and $BW_{Channel}^{LB}$ the channel bandwidth configured in the lower band.
- NOTE 3: The requirements are only applicable to channel bandwidths no larger than 20 MHz and with a carrier frequency at $\pm (20 + BW_{Channel}^{HB} / 2)$ MHz offset from f_{UL}^{LB} in the victim (higher band) with $F_{UL_low}^{LB} + BW_{Channel}^{LB} / 2 \leq f_{UL}^{LB} \leq F_{UL_high}^{LB} - BW_{Channel}^{LB} / 2$, where $BW_{Channel}^{LB}$ and $BW_{Channel}^{HB}$ are the channel bandwidths configured in the aggressor (lower) and victim (higher) bands in MHz, respectively.
- NOTE 4: These requirements apply when there is at least one individual RE within the uplink transmission bandwidth of a low band for which the 4th transmitter harmonic is within the downlink transmission bandwidth of a high band.
- NOTE 5: The requirements should be verified for UL NR-ARFCN of a low band (superscript LB) such that $f_{UL}^{LB} = \lfloor f_{DL}^{HB} / 0.4 \rfloor \cdot 0.1$ in MHz and $F_{UL_low}^{LB} + BW_{Channel}^{LB} / 2 \leq f_{UL}^{LB} \leq F_{UL_high}^{LB} - BW_{Channel}^{LB} / 2$ with f_{DL}^{HB} the carrier frequency of a high band in MHz and $BW_{Channel}^{LB}$ the channel bandwidth configured in the low band.
- NOTE 6: These requirements apply when there is at least one individual RE within the uplink transmission bandwidth of a low band for which the 5th transmitter harmonic is within the downlink transmission bandwidth of a high band.
- NOTE 7: The requirements should be verified for UL NR-ARFCN of a low band (superscript LB) such that $f_{UL}^{LB} = \lfloor f_{DL}^{HB} / 0.5 \rfloor \cdot 0.1$ in MHz and $F_{UL_low}^{LB} + BW_{Channel}^{LB} / 2 \leq f_{UL}^{LB} \leq F_{UL_high}^{LB} - BW_{Channel}^{LB} / 2$ with f_{DL}^{HB} the carrier frequency of a high band in MHz and $BW_{Channel}^{LB}$ the channel bandwidth configured in the low band.
- NOTE 8: These requirements apply when there is at least one individual RE within the uplink transmission bandwidth of the aggressor (lower) band for which the 3rd transmitter harmonic is within the downlink transmission bandwidth of a victim (higher) band.
- NOTE 9: The requirements should be verified for UL NR-ARFCN of the aggressor (lower) band (superscript LB) such that $f_{UL}^{LB} = \lfloor f_{DL}^{HB} / 0.3 \rfloor \cdot 0.1$ in MHz and $F_{UL_low}^{LB} + BW_{Channel}^{LB} / 2 \leq f_{UL}^{LB} \leq F_{UL_high}^{LB} - BW_{Channel}^{LB} / 2$ with f_{DL}^{HB} carrier frequency in the victim (higher) band in MHz and $BW_{Channel}^{LB}$ the channel bandwidth configured in the lower band.
- NOTE 10: These requirements apply when the lower edge frequency of the 10 MHz, 15 MHz, or 20 MHz uplink channel in Band 71 is located at or below 668 MHz and the downlink channel in Band n25 is located with its upper edge at 1995 MHz.
- NOTE 11: No requirements apply when there is at least one individual RE within the uplink transmission bandwidth of the low band for which the 2nd transmitter harmonic is within the downlink transmission bandwidth of the high band. The reference sensitivity for all active downlink component carriers is only verified when this is not the case (the requirements specified in clause 7.3.2 apply unless otherwise specified).

NOTE 12: For these bandwidths, the minimum requirements are restricted to operation when carrier is configured as a downlink carrier part of CA configuration.
 NOTE 13: For a UE which supports this band combination only when the Band n77 frequency range restriction defined in NOTE 12 of Table 5.2-1 applies, the MSD test point(s) cannot be verified for the band combination and the test point(s) can be skipped.

Table 7.3A.4-2: Uplink configuration for reference sensitivity exceptions due to UL harmonic interference for NR CA, FR1

UL band	DL band	NR Band / Channel bandwidth of the high band												
		5 MHz	10 MHz	15 MHz	20 MHz	25 MHz	30 MHz	40 MHz	50 MHz	60 MHz	70 MHz	80 MHz	90 MHz	100 MHz
n1	n77		25	36	50			100	100	100		100	100	100
n2	n48	25	50	50	50			50	50	50		50	50	50
n2	n77		25	36	50	50	50	50	50	50	50	50	50	50
n2	n78		25	36	50	50	50	50	50	50		50	50	50
n3	n77		25	36	50			50	50	50		50	50	50
n3	n78		25	36	50			50	50	50		50	50	50
n5	n77		16	25	25	25	25	25	25	25	25	25	25	25
n5	n78		16	25	25			25	25	25		25	25	25
n8	n41		16	25	25			25	25	25		25	25	25
n8	n78		16	25	25			25	25	25		25	25	25
n8	n79							25	25	25		25		25
n20	n78		16	25	25			25	25	25		25	25	25
n25	n78		25	36	50			50	50	50		50	50	50
n28	n1	8	16	25	25									
n28	n50		25	25	25			25	25	25		25		
n28	n75	12	25	36	50	50	50	50	50					
n28	n77		10	15	20			25	25	25		25	25	25
n28	n78		10	15	20			25	25	25		25	25	25
n66	n48	12	25	36	50			100	128	160		200	200	200
n66	n77		25	36	50	64	80	100	100	100	100	100	100	100
n66	n78		25	36	50			100	100	100		100	100	100
n71	n25	8 ⁴	8 ⁴	8 ⁴	8 ⁴									
n71	n41		16	25	25			25	25	25		25	25	25
n71	n70	8	16	20	20	20								
n92	n78		16	25	25			25	25	25		25	25	25
		NOTE 1: 15 kHz SCS is assumed for UL band. NOTE 2: The UL configuration applies regardless of the channel bandwidth of the low band unless the UL resource blocks exceed that specified in Table 7.3.2-3 for the uplink bandwidth in which case the allocation according to Table 7.3.2-3 applies. NOTE 3: Unless stated otherwise, UL resource blocks shall be centred within the transmission bandwidth configuration for the channel bandwidth. NOTE 4: These requirements apply when the lower edge frequency of the uplink channel in Band n71 is located at or below 668 MHz and the downlink channel in Band n25 is located with its upper edge at 1990 MHz.												

Table 7.3A.4-3: Void

Table 7.3A.4-3a: Void

Sensitivity degradation is allowed for a band if it is impacted by receiver harmonic mixing due to another band part of the same CA configuration. Reference sensitivity exceptions are specified in Table 7.3A.4-4 with uplink configuration specified in Table 7.3A.4-4a. Sensitivity degradation is not required for receiver even order harmonic mixing with aggressor 3rd order and above harmonic interference.

Table 7.3A.4-4: Reference sensitivity exceptions due to harmonic mixing for CA in NR FR1

UL band	DL band	NR Band / Channel bandwidth of the affected DL band												
		5 MHz (dB)	10 MHz (dB)	15 MHz (dB)	20 MHz (dB)	25 MHz (dB)	30 MHz (dB)	40 MHz (dB)	50 MHz (dB)	60 MHz (dB)	70 MHz (dB)	80 MHz (dB)	90 MHz (dB)	100 MHz (dB)
n25	n71 ^{3,4}	26.5	23.3	20.9	15.3									

n40	n28 ⁴	37.8	34.8	33	30.3										
n77	n2	6.7	5.0	4.0	3.7										
n77	n5	5.7	4.0	3.0	2.7										
n78	n28 ⁵	31	28	26.2	25										
n78	n40 ²	10.4	10.4	10.4	10.4			7.2	6.2	5.5			4.5		
n78	n41 ²		10.4	10.4	10.4			8.2	7.6	7.3			6.6	6.4	6.3
n79	n8 ⁵	25	21.8	19.4	13.8										

NOTE 1: Void.

NOTE 2: The requirements should be verified for DL NR-ARFCN of the Victim (lower) band (superscript LB) such that $f_{DL}^{LB} = \lfloor f_{UL}^{HB} / 0.15 \rfloor 0.1$ and $F_{UL_low}^{HB} + BW_{Channel}^{HB} / 2 \leq f_{UL}^{HB} \leq F_{UL_high}^{HB} - BW_{Channel}^{HB} / 2$ with f_{UL}^{HB} the UL carrier frequency and $BW_{Channel}^{HB}$ the channel bandwidth configured in the higher band, both in MHz.

NOTE 3: These requirements apply when there is at least one individual RE within the downlink transmission bandwidth of the victim (lower) band for which the 3rd harmonic is within the uplink transmission bandwidth or the uplink adjacent channel's transmission bandwidth of an aggressor (higher) band.

NOTE 4: The requirements should be verified for UL NR-ARFCN of the aggressor (higher) band (superscript HB) such that $f_{DL}^{LB} = \lfloor f_{UL}^{HB} / 0.3 \rfloor 0.1$ in MHz and $F_{UL_low}^{HB} + BW_{Channel}^{HB} / 2 \leq f_{UL}^{HB} \leq F_{UL_high}^{HB} - BW_{Channel}^{HB} / 2$ with f_{DL}^{LB} the carrier frequency in the victim (lower) band and $BW_{Channel}^{HB}$ the channel bandwidth configured in the higher band.

NOTE 5: The requirements should be verified for DL EARFCN of the victim (lower) band (superscript LB) such that $f_{DL}^{LB} = \lfloor f_{UL}^{HB} / 0.5 \rfloor 0.1$ and $F_{UL_low}^{HB} + BW_{Channel}^{HB} / 2 \leq f_{UL}^{HB} \leq F_{UL_high}^{HB} - BW_{Channel}^{HB} / 2$ with f_{UL}^{HB} the UL carrier frequency and $BW_{Channel}^{HB}$ the channel bandwidth configured in the higher band, both in MHz.

Table 7.3A.4-4a: Uplink configuration for reference sensitivity exceptions due to receiver harmonic mixing for CA in NR FR1

NR Band / SCS / Channel bandwidth of the affected DL band															
UL band	DL band	SC S (kHz)	5 MHz	10 MHz	15 MHz	20 MHz	25 MHz	30 MHz	40 MHz	50 MHz	60 MHz	70 MHz	80 MHz	90 MHz	100 MHz
n25	n71	15	25	50	75	100									
n40	n28	15	25	50	75	100									
n77	n2	15	25	50	75	100									
n77	n5	25	25	20	20										
n78	n28	15	25	25	25	25									
n78	n40	30	50	50	50	50			50	50	50		50		
n78	n41	30		50	50	50		50	50	50	50		50	50	50
n79	n8	15	25	50	75	100									

NOTE 1: The UL configuration applies regardless of the channel bandwidth of the UL band unless the UL resource blocks exceed that specified in Table 7.3.2-3 for the uplink bandwidth in which case the allocation according to Table 7.3.2-3 applies.

7.3A.5 Reference sensitivity exceptions due to intermodulation interference due to 2UL CA

For inter-band carrier aggregation with uplink assigned to two NR bands given in Table 7.3A.5-1 and Table 7.3A.5-2 the reference sensitivity is defined only for the specific uplink and downlink test points specified in Table 7.3A.5-1 and Table 7.3A.5-2. For these test points the reference sensitivity requirement specified in Table 7.3.2-1 and Table 7.3.2-2 are relaxed by the amount of the corresponding parameter MSD given in Table 7.3A.5-1 and Table 7.3A.5-2.

Table 7.3A.5-1: 2DL/2UL inter-band Reference sensitivity QPSK P_{REFSENS} and uplink/downlink configurations

Band / Channel bandwidth / N _{RB} / Duplex mode								Source of IMD
NR CA band combination	NR band	UL F _c (MHz)	UL/DL BW (MHz)	UL L _{CRB}	DL F _c (MHz)	MSD (dB)	Duplex mode	

CA_n1-n3	n1	1950	5	25	2140	23	FDD	IMD3
	n3	1760	5	25	1855	N/A	TDD	N/A
CA_n1-n8	n1	1965	5	25	2155	6.0	FDD	IMD4
	n8	887.5	5	25	932.5	N/A	FDD	N/A
CA_n1-n78	n1	1950	5	25	2140	8.0	FDD	IMD4
	n78	3710	10	50	3710	N/A	TDD	N/A
CA_n2-n48	n2	1852.5	5	25	1932.5	12	FDD	IMD4
	n48	3625	20	100	3625	N/A	TDD	N/A
CA_n2-n77	n2	1855	5	25	1935	26	FDD	IMD2
	n77	3790	10	50	3790	N/A	TDD	N/A
	n2	1900	5	25	1980	8.0	FDD	IMD4
	n77	3720	10	50	3720	N/A	TDD	N/A
	n2	1885	5	25	1965	5	FDD	IMD5
	n77	3810	10	50	3810	N/A	TDD	N/A
CA_n2-n78	n2	1855	5	25	1935	26	FDD	IMD2 ⁴
	n78	3790	10	50	3790	N/A	TDD	N/A
CA_n3-n7	n3	1730	5	25	1825	N/A	FDD	N/A
	n7	2535	10	50	2655	10.2	FDD	IMD4
CA_n3-n8	n3	1755	10	50	1850	N/A	FDD	N/A
	n8	900	5	25	945	8	FDD	IMD4 ⁴
	n3	1747.5	10	50	1842.5	6.4	FDD	IMD5
	n8	897.5	5	25	942.5	N/A	FDD	N/A
CA_n3-n38	n3	1713	5	25	1808	8.2	FDD	IMD4
	n38	2617	5	25	2617	N/A	TDD	N/A
CA_n3-n41	n3	1740	5	25	1835	8.2	FDD	IMD4
	n41	2657.5	10	50	2657.5	N/A	TDD	N/A
CA_n3-n77	n3	1740	5	25	1835	26	FDD	IMD2 ⁴
	n77	3575	10	50	3575	N/A	TDD	N/A
	n3	1765	5	25	1860	8.0	FDD	IMD4 ⁴
	n77	3435	10	50	3435	N/A	TDD	N/A
CA_n3-n78	n3	1740	5	25	1835	26	FDD	IMD2 ⁴
	n78	3575	10	25	3575	N/A	TDD	N/A
	n3	1765	5	25	1860	8.0	FDD	IMD4 ⁴
	n78	3435	10	25	3435	N/A	TDD	N/A
CA_n5-n66	n5	838	5	25	883	30	FDD	IMD2 ⁴
	n66	1721	5	25	2121	N/A	FDD	N/A
CA_n5-n77 ⁶	n5	844	5	25	889	8.3	FDD	IMD4
	n77	3421	10	50	3421	N/A	TDD	N/A
	n5	829	5	25	874	5.5	FDD	IMD5
	n77	4190	10	50	4190	N/A	TDD	N/A
CA_n5-n78	n5	844	5	25	889	8.3	FDD	IMD4
	n78	3421	10	50	3421	N/A	TDD	N/A
CA_n7-n66	n7	2535	10	50	2655	15	FDD	IMD4
	n66	1730	5	25	2130	N/A	FDD	N/A
CA_n8-n41	n8	882.5	5	25	927.5	12.1	FDD	IMD3 ⁴
	n41	2685	10	50	2685	N/A	TDD	N/A
CA_n8-n78	n8	897.5	5	25	942.5	8.3	FDD	IMD4
	n78	3635	10	50	3635	N/A	TDD	N/A
CA_n8-n79	n8	897.5	5	25	942.5	4.8	FDD	IMD5
	n79	4532.5	40	216	4532.5	N/A	TDD	N/A
CA_n20-n78	n20	850	5	25	809	11	FDD	IMD4
	n78	3359	10	50	3359	N/A	TDD	N/A
CA_n25-n66	n66	1775	5	25	2175	N/A	FDD	N/A
	n25	1855	5	25	1935	20	FDD	IMD3
	n66	1712.5	5	25	2112.5	23	FDD	IMD3
	n25	1912.5	5	25	1992.5	N/A	FDD	N/A
	n66	1750	5	25	2150	4	FDD	IMD5

CA_n25-n78	n25	1883.3	5	25	1963.3	N/A	FDD	N/A
	n25	1855	5	25	1935	26	FDD	IMD2 ⁴
	n78	3790	10	50	3790	N/A	TDD	N/A
CA_n28-n50	n28	730	10	50	775	15.3	FDD	IMD2
	n50	1500	10	50	1500	N/A	TDD	N/A
	n28	740	10	50	785	6.0	FDD	IMD4 ⁴
	n50	1500	10	50	1500	N/A	TDD	N/A
CA_n28-n77	n28	705.5	5	25	760.5	5.5	FDD	IMD5
	n77/n78	3582.5	10	50	3582.5	N/A	TDD	N/A
CA_n41-n71	n41	2614	5	25	2614	N/A	TDD	N/A
	n71	665	5	25	619	11	FDD	IMD4
CA_n48-n66	n48	3660	5	25	3660	N/A	TDD	N/A
	n66	1730	5	25	2130	5.0	FDD	IMD5
CA_n66-n71	n66	1750	5	25	2150	5	FDD	IMD4
	n71	675	5	25	629	N/A	FDD	N/A
CA_n66-n77	n66	1775	5	25	2175	31	FDD	IMD2
	n77	3950	10	50	3950	N/A	TDD	N/A
	n66	1760	5	25	2160	5.0	FDD	IMD5
	n77	3720	10	50	3720	N/A	TDD	N/A
CA_n66-n78	n66	1730	5	25	2130	5.0	FDD	IMD5
	n78	3660	10	50	3660	N/A	TDD	N/A
CA_n70-n71	n70	1697.5	5	25	1997.5	5	FDD	IMD4
	n71	695.5	5	25	649.5	N/A	FDD	N/A

NOTE 1: Both of the transmitters shall be set min(+20 dBm, P_{C_{MAX}L,f,c}) as defined in clause 6.2A.4
 NOTE 2: RB_{START} = 0, 15 kHz SCS is assumed.
 NOTE 3: No requirements apply when there is at least one individual RE within the intermodulation generated by the dual uplink is within the downlink transmission bandwidth of the FDD band. The reference sensitivity should only be verified when this is not the case (the requirements specified in clause 7.3 apply).
 NOTE 4: This band is subject to IMD5 also which MSD is not specified.
 NOTE 5: Void.
 NOTE 6: For a UE which supports this band combination only when the Band n77 frequency range restriction defined in NOTE 12 of Table 5.2-1 applies, the MSD test point(s) cannot be verified for the band combination and the test point(s) can be skipped.

Table 7.3A.5-2: 3DL/2UL interband Reference sensitivity QPSK P_{REFSENS} and uplink/downlink configurations

Band / Channel bandwidth / N _{RB} / Duplex mode								Source of IMD
NR CA band combination	NR band	UL F _c (MHz)	UL/DL BW (MHz)	UL L _{CRB}	DL F _c (MHz)	MSD (dB)	Duplex mode	
CA_n1-n3-n41	n1	1977.5	5	25	2167.5	N/A	FDD	N/A
	n3	1712.5	5	25	1807.5	N/A	FDD	N/A
	n41	2507.5	10	25	2507.5	5.0	TDD	IMD5
CA_n1-n3-n78	n1	1950	5	25	2140	N/A	FDD	N/A
	n3	1750	5	25	1845	N/A		N/A
	n78	3700	10	52	3700	28.4	TDD	IMD2
	n1	1950	5	25	2140	N/A	FDD	N/A
	n3	1770	5	25	1865	N/A		N/A
	n78	3360	10	52	3360	11.2	TDD	IMD4
	n1	1950	5	25	2140	N/A	FDD	N/A
	n3	1735	5	25	1830	27.9		IMD2
n78	3780	10	52	3780	N/A	TDD	N/A	
CA_n1-n7-n28	n1	1935	5	25	2125	N/A	FDD	N/A
	n7	2533	10	50	2653	30.0	FDD	IMD2
	n28	718	5	25	773	N/A	FDD	N/A
	n1	1935	5	25	2125	N/A	FDD	N/A
	n7	2510	10	50	2630	N/A	FDD	N/A
	n28	730	10	50	785	4.5	FDD	IMD5
CA_n1-n7-n78	n1	1977.5	5	25	2167.5	N/A	FDD	N/A
	n7	2507.5	5	25	2627.5	9.1	FDD	IMD4
	n78	3305	10	50	3305	N/A	TDD	N/A
	n1	1950	5	25	2140	8.7	FDD	IMD4
	n7	2510	10	50	2630	N/A	FDD	N/A

	n78	3580	10	50	3580	N/A	TDD	N/A
	n1	1970	5	25	2160	N/A	FDD	N/A
	n7	2520	5	25	2640	N/A	FDD	N/A
	n78	3390	10	50	3390	10.1	TDD	IMD4
CA_n3-n8-n78	n3	1730	5	25	1825	N/A	FDD	N/A
	n8	910	5	25	955	N/A	FDD	N/A
	n78	3550	10	50	3550	16.1	TDD	IMD3
	n3	1730	5	25	1825	N/A	FDD	N/A
	n8	910	5	25	955	N/A	FDD	N/A
	n78	3370	10	50	3370	4.5	TDD	IMD5
	n3	1725	5	25	1820	15.7	FDD	IMD3
	n8	910	5	25	955	N/A	FDD	N/A
	n78	3640	10	50	3640	N/A	TDD	N/A
	CA_n3-n28-n77	n3	1720	5	25	1815	N/A	FDD
n28		733	5	25	788	N/A	FDD	N/A
n77		4173	10	50	4173	15.9	TDD	IMD3
n28		735	5	25	790	N/A	FDD	N/A
n77		3320	10	50	3320	N/A	TDD	N/A
n3		1755	5	25	1850	17.0	FDD	IMD3
n3		1712.5	5	25	1807.5	N/A	FDD	N/A
n77		4195	10	50	4195	N/A	TDD	N/A
n28		715	5	25	770	15.3	FDD	IMD3
CA_n3-n28-n78		n28	735	5	25	790	N/A	FDD
	n78	3320	10	50	3320	N/A	TDD	IMD3
	n3	1755	5	25	1850	17.3	FDD	N/A
	n3	1750	5	25	1845	N/A	FDD	N/A
	n28	743	5	25	798	N/A	FDD	N/A
	n78	3764	10	50	3764	4.5	TDD	IMD5
CA_n3-40-n41	n3	1747.5	5	25	1842.5	1.0	FDD	IMD5
	n40	2347.5	5	25	2347.5	N/A	TDD	N/A
	n41	2600	10	50	2600	N/A	TDD	N/A
CA_n5-n66-n78	n5	830	5	25	875	N/A	FDD	N/A
	n66	1720	5	25	2120	N/A	FDD	N/A
	n78	3380	10	50	3380	16.1	TDD	IMD3
	n5	830	5	25	875	N/A	FDD	N/A
	n66	1720	5	25	2120	13.2	FDD	IMD3
	n78	3780	10	50	3780	N/A	TDD	N/A
CA_n7-n66-n78	n7	2560	5	25	2680	N/A	FDD	N/A
	n66	1730	5	25	2130	N/A	FDD	N/A
	n78	3390	10	50	3390	16.1	TDD	IMD3
CA_n7-n66-n78	n7	2550	5	25	2670	N/A	FDD	N/A
	n66	1750	5	25	2150	8.7	FDD	IMD4
	n78	3625	10	50	3625	N/A	TDD	N/A
CA_n25-n66-n78	n25	1880	5	25	1960	N/A	FDD	N/A
	n66	1740	5	25	2140	N/A	FDD	N/A
	n78	3620	10	50	3620	29.4	TDD	IMD2
CA_n28-n41-n78	n28	738	5	25	793	N/A	FDD	N/A
	n78	3380	10	50	3380	N/A	TDD	N/A
	n41	2642	5	25	2642	29.5	TDD	IMD2
	n41	2642	5	25	2642	N/A	TDD	N/A
	n78	3440	10	50	3440	N/A	TDD	N/A
	n28	743	5	25	798	30.8	FDD	IMD2 ¹
	n41	2565	5	25	2565	N/A	TDD	N/A
	n28	745	5	25	800	N/A	FDD	N/A
	n78	3310	10	50	3310	29.7	TDD	IMD2 ²
CA_n40-n41-n79	n40	2340	5	25	2340	N/A	TDD	N/A
	n41	2600	10	50	2600	N/A	TDD	N/A
	n79	4940	40	216	4940	30.5	TDD	IMD2

NOTE 1: This band is subject to IMD5 also which MSD is not specified.

NOTE 2: This band is subject to IMD4 also which MSD is not specified.

NOTE 3: Both of the transmitters shall be set $\min(+20 \text{ dBm}, P_{\text{CMAX},L(f,c)})$ as defined in clause 6.2A.4

7.3A.6 Reference sensitivity exceptions due to cross band isolation for CA

Sensitivity degradation is allowed for a band if it is impacted by UL of another band part of the same NR CA configuration due to cross band isolation issues. Reference sensitivity exceptions for the victim band are specified in Table 7.3A.6-1 with uplink configuration of the aggressor band specified in Table 7.3A.6-2.

Table 7.3A.6-1: Reference sensitivity exceptions (MSD) due to cross band isolation for NR CA FR1

NR Band / Channel bandwidth of the affected DL band														
UL band	DL band	5 MHz (dB)	10 MHz (dB)	15 MHz (dB)	20 MHz (dB)	25 MHz (dB)	30 MHz (dB)	40 MHz (dB)	50 MHz (dB)	60 MHz (dB)	70 MHz (dB)	80 MHz (dB)	90 MHz (dB)	100 MHz (dB)
n1	n3	3	2.2	1.9	1.7	1.6	1.5							
n1	n40	6.6	6.6	6.6	6.6	6.6	6.6	6.6	6.6	6.6		6.6		
n1	n41		6.1	6.1	6.1			6.1	6.1	6.1		6.1	6.1	6.1
n3	n41		0.7	0.7	0.7			0.7	0.7	0.7		0.7	0.7	0.7
n38	n78		8.3	8.3	8.3	7.3	6.5	6.3	5.3	4.5		4.0	3.9	3.8
n40	n1	8.3	8.3	8.3	8.3									
n41	n1	9.1	9.1	9.1	9.1									
n41	n3	0.6	0.6	0.6	0.6	0.6	0.6							
n41	n25	0.6	0.6	0.6	0.6									
n41 ¹	n66	3.5	3.5	3.5	3.5			3.5						
n41	n78		8.3	8.3	8.3	7.3	6.5	6.3	5.3	4.5	4.3	4.0	3.9	3.8
n66	n2	1.2	1.2	1.2	1.2									
n66	n25	1.2	1.2	1.2	1.2	1.2	1.2	1.2						
n78	n7 ¹	4.5	4.5	4.5	4.5	4.5	4.5	4.5	4.5					
n78	n38	3.3	3.3	3.3	3.3									
n78	n40 ¹	4.5	4.5	4.5	4.5	4.5	4.5	4.5	4.5	4.5		4.5		
n78	n41 ¹		4.5	4.5	4.5		4.5	4.5	4.5	4.5		4.5	4.5	4.5
n78 ³	n79							2	2	2		2		2
n79	n78 ³		2.6	2.6	2.6			2.6	2.6	2.6		2.6	2.6	2.6

NOTE 1: Applicable only when harmonic mixing MSD for this combination is not applied.
 NOTE 2: Void
 NOTE 3: The requirements only apply for UEs supporting inter-band carrier aggregation with simultaneous Rx/Tx capability. Simultaneous Rx/Tx capability does not apply for UEs supporting band n78 with a n77 implementation.

Table 7.3A.6.2: Uplink configuration for reference sensitivity exceptions due to cross band isolation for NR CA FR1

NR Band / SCS / Channel bandwidth of the affected DL band															
UL band	DL band	SCS of UL band (kHz)	5 MHz	10 MHz	15 MHz	20 MHz	25 MHz	30 MHz	40 MHz	50 MHz	60 MHz	70 MHz	80 MHz	90 MHz	100 MHz
n1	n3	15	25	25	25	25	25	25							
n1	n40	15	25	50	75	100	100	100	100	100	100		100		
n1	n41	15		100	100	100			100	100	100		100	100	100
n3	n41	15		50	50	50			50	50	50		50	50	50
n38	n78	15		100	100	100	100	100	100	100	100		100	100	100
n40	n1	30	25	50	75	100									
n41	n1	30	128	128	128	128									
n41	n3	30	160	160	160	160	160	160							
n41	n25	15	160	160	160	160									
n41	n66	30	128	128	128	128			128						
n41	n78	15		100	100	100	100	100	100	100	100	100	100	100	100
n66	n2	15	216	216	216	216									
n66	n25	15	216	216	216	216	216	216	216						
n78	n7	30	270	270	270	270	270	270	270	270					
n78	n38	30	270	270	270	270									
n78	n40	30	270	270	270	270	270	270	270	270	270		270		
n78	n41	30		270	270	270		270	270	270	270		270	270	270
n78	n79	30						270 ³	270 ³	270 ³	270 ³		270 ³		270 ³
n79	n78	30		270 ³	270 ³	270 ³		270 ³	270 ³	270 ³	270 ³		270 ³	270 ³	270 ³

NOTE 1:	The UL configuration applies regardless of the channel bandwidth of the UL band unless the UL resource blocks exceed that specified in Table 7.3.2-3 for the uplink bandwidth in which case the allocation according to Table 7.3.2-3 applies.
NOTE 2:	Refers to the UL resource blocks shall be located as close as possible to the downlink operating band but confined within the transmission bandwidth configuration for the channel bandwidth in Table 5.3.2-1.
NOTE 3:	The requirements only apply for UEs supporting inter-band carrier aggregation with simultaneous Rx/Tx capability. Simultaneous Rx/Tx capability does not apply for UEs supporting band n78 with a n77 implementation.

7.3B Reference sensitivity for NR-DC

For inter-band NR-DC configurations, the reference sensitivity for the corresponding inter-band CA configuration as specified in clause 7.3A applies.

7.3C Reference sensitivity for SUL

7.3C.1 General

The reference sensitivity power level REFSSENS is the minimum mean power applied to each one of the UE antenna ports for all UE categories, at which the throughput shall meet or exceed the requirements for the specified reference measurement channel. For operations with 4 Rx antenna ports, the MSD in the applicable bands shall be increased by the absolute value of $\Delta R_{IB,4R}$ in Table 7.3.2-2 when $MSD > 0$.

7.3C.2 Reference sensitivity power level for SUL

For SUL operation, the reference receive sensitivity (REFSENS) requirement for downlink bands specified in Table 7.3.2-1 and Table 7.3.2-2 shall be met for an uplink transmission bandwidth less than or equal to that specified in Table 7.3.2-3 or supplementary uplink transmission bandwidth less than or equal to that specified in Table 7.3C.2-1 with reference measurement channels as specified in Annexes A.2.2.2, A.3.2, and A.3.3 (with one sided dynamic OCNG Pattern OP.1 FDD/TDD for the DL-signal as described in Annex A.5.1.1/A.5.2.1), unless sensitivity degradation is allowed in this clause of this specification. These exceptions also apply to any higher order CA or DC combination containing one of the exception combinations in this clause as subset.

For SUL operation with downlink CA, the reference receive sensitivity (REFSENS) requirement for downlink bands specified in clause 7.3A.2 shall be met for an uplink transmission bandwidth less than or equal to that specified in Table 7.3.2-3 or supplementary uplink transmission bandwidth less than or equal to that specified in Table 7.3C.2-1 with reference measurement channels as specified in Annexes A.2.2.2, A.3.2, and A.3.3 (with one sided dynamic OCNG Pattern OP.1 FDD/TDD for the DL-signal as described in Annex A.5.1.1/A.5.2.1), unless sensitivity degradation is allowed in this clause of this specification. These exceptions also apply to any higher order CA or DC combination containing one of the exception combinations in this clause as subset.

Table 7.3C.2-1: Supplementary uplink configuration for reference sensitivity

NR Band / SCS of SUL band / Channel bandwidth of the DL band / N_{RB}														
DL band	SUL band	SCS of SUL band (kHz)	5 MHz	10 MHz	15 MHz	20 MHz	25 MHz	30 MHz	40 MHz	50 MHz	60 MHz	80 MHz	90 MHz	100 MHz
n41	n80	15		160	160	160			160	160	160	160	160	160
n41	n81	15		100	100	100			100	100	100	100	100	100
n41	n95	15		75	75	75		75	75	75	75	75	75	75
n77	n80	15		160	160	160			160	160	160	160	160	160
n77	n84	15		100	100	100			100	100	100	100	100	100
n78	n80	15		160	160	160			160	160	160	160	160	160
n78	n81	15		100	100	100			100	100	100	100	100	100
n78	n82	15		100	100	100			100	100	100	100	100	100
n78	n83	15		100	100	100			100	100	100	100	100	100
n78	n84	15		100	100	100			100	100	100	100	100	100

n78	n86	15		216	216	216			216	216	216	216	216	216
n79	n80	15							160	160	160	160		160
n79	n81	15							100	100	100	100		100
n79	n84	15							100	100	100	100		100
n79	n95	15							75	75	75	75		75

For the UE that supports any of the SUL operation given in Table 7.3C.2-2, exceptions to the requirements specified in Table 7.3.2-1 are allowed when the uplink is active in a lower frequency band and is within a specified frequency range such that transmitter harmonics fall within the downlink transmission bandwidth assigned in a higher band as noted in Table 7.3C.2-2. For these exceptions, the UE shall meet the requirements specified in Table 7.3C.2-2 and Table 7.3C.2-3.

Table 7.3C.2-2: Reference sensitivity for SUL operation (exceptions due to harmonic issue)

NR Band / Channel bandwidth of the high band														
UL band	DL band	5 MHz	10 MHz	15 MHz	20 MHz	25 MHz	30 MHz	40 MHz	50 MHz	60 MHz	80 MHz	90 MHz	100 MHz	
		dB	dB	dB	dB	dB	dB	dB	dB	dB	dB	dB	dB	dB
n80	n77 ^{1,2}		23.9	22.1	20.9				17.9	16.8	16.0	14.8	14.3	13.8
	n77 ³		1.1	0.8	0.3									
n80	n78 ^{1,2}		23.9	22.1	20.9				17.9	16.8	16.0	14.8	14.3	13.8
	n78 ³		1.1	0.8	0.3									
n81	n41 ^{8,9}		13	11.3	10.1			7.0	6.1	5.5	4.3	3.9	3.5	
	n78 ^{4,5}		10.8	9.1	8			5.1	4.2	3.5	2.3	1.5	1.4	
	n79 ^{6,7}							6.8	6.2	5.6	4.9		4.4	
n82	n78 ^{4,5}		10.8	9.1	8			6	4.0	3.2	2.0	1.5	1.0	
n83	n78 ^{6,7}		10.4	8.9	7.8			4.7	3.7	3	1.7	1.2	0.7	
n84	n77 ^{1,2}		23.9	22.1	20.9				17.9	16.8	16.0	14.8	14.3	13.8
	n77 ³		1.1	0.8	0.3									
n86	n78 ^{1,2}		23.9	22.1	20.9				17.9	16.8	16.0	14.8	14.3	13.8
	n78 ³		1.1	0.8	0.3									

- NOTE 1: These requirements apply when there is at least one individual RE within the uplink transmission bandwidth of the aggressor (lower) band for which the 2nd transmitter harmonic is within the downlink transmission bandwidth of a victim (higher) band and a range ΔF_{HD} above and below the edge of this downlink transmission bandwidth. The value ΔF_{HD} depends on the band combination: $\Delta F_{HD} = 10$ MHz for SUL_n78-n80, SUL_n78-n86.
- NOTE 2: The requirements should be verified for UL EARFCN of the aggressor (lower) band (superscript LB) such that $f_{UL}^{LB} = \lfloor f_{DL}^{HB} / 0.2 \rfloor \cdot 0.1$ in MHz and $F_{UL,low}^{LB} + BW_{Channel}^{LB} / 2 \leq f_{UL}^{LB} \leq F_{UL,high}^{LB} - BW_{Channel}^{LB} / 2$ with f_{DL}^{HB} carrier frequency in the victim (higher) band in MHz and $BW_{Channel}^{LB}$ the channel bandwidth configured in the lower band.
- NOTE 3: The requirements are only applicable to channel bandwidths no larger than 20 MHz and with a carrier frequency at $\pm (20 + BW_{Channel}^{HB} / 2)$ MHz offset from $2 f_{UL}^{LB}$ in the victim (higher band) with $F_{UL,low}^{LB} + BW_{Channel}^{LB} / 2 \leq f_{UL}^{LB} \leq F_{UL,high}^{LB} - BW_{Channel}^{LB} / 2$, where $BW_{Channel}^{LB}$ and $BW_{Channel}^{HB}$ are the channel bandwidths configured in the aggressor (lower) and victim (higher) bands in MHz, respectively.
- NOTE 4: These requirements apply when there is at least one individual RE within the uplink transmission bandwidth of the aggressor (lower) band for which the 4th transmitter harmonic is within the downlink transmission bandwidth of a victim (higher) band.
- NOTE 5: The requirements should be verified for UL EARFCN of the aggressor (lower) band (superscript LB) such that $f_{UL}^{LB} = \lfloor f_{DL}^{HB} / 0.4 \rfloor \cdot 0.1$ in MHz and $F_{UL,low}^{LB} + BW_{Channel}^{LB} / 2 \leq f_{UL}^{LB} \leq F_{UL,high}^{LB} - BW_{Channel}^{LB} / 2$ with f_{DL}^{HB} carrier frequency in the victim (higher) band in MHz and $BW_{Channel}^{LB}$ the channel bandwidth configured in the lower band.
- NOTE 6: These requirements apply when there is at least one individual RE within the uplink transmission bandwidth of the aggressor (lower) band for which the 5th transmitter harmonic is within the downlink transmission bandwidth of a victim (higher) band.
- NOTE 7: The requirements should be verified for UL NR-ARFCN of the aggressor (lower) band (superscript LB) such that $f_{UL}^{LB} = \lfloor f_{DL}^{HB} / 0.5 \rfloor \cdot 0.1$ in MHz and $F_{UL,low}^{LB} + BW_{Channel}^{LB} / 2 \leq f_{UL}^{LB} \leq F_{UL,high}^{LB} - BW_{Channel}^{LB} / 2$ with f_{DL}^{HB} carrier frequency in the victim (higher) band in MHz and $BW_{Channel}^{LB}$ the channel bandwidth configured in the lower band.
- NOTE 8: These requirements apply when there is at least one individual RE within the uplink transmission bandwidth of the aggressor (lower) band for which the 3rd transmitter harmonic is within the downlink transmission bandwidth of a victim (higher) band.

NOTE 9 The requirements should be verified for UL EARFCN of the aggressor (lower) band (superscript LB) such that $f_{uL}^{LB} = \lfloor f_{uL}^{LB} / 0.3 \rfloor \cdot 0.1$ in MHz and $F_{uL}^{LB} + BW_{channel}^{LB} / 2 \leq f_{uL}^{LB} \leq F_{uL}^{LB} - BW_{channel}^{LB} / 2$ with the carrier frequency in the victim (higher) band in MHz and the channel bandwidth configured in the low band.

Table 7.3C.2-3: Supplementary uplink configuration (exceptions due to harmonic issue)

NR Band / Channel bandwidth of the high band													
UL band	DL band	5 MHz (NRB)	10 MHz (NRB)	15 MHz (NRB)	20 MHz (NRB)	25 MHz (NRB)	30 MHz (NRB)	40 MHz (NRB)	50 MHz (NRB)	60 MHz (NRB)	80 MHz (NRB)	90 MHz (NRB)	100 MHz (NRB)
n80	n77		25	36	50			50	50	50	50	50	50
n80	n78		25	36	50			50	50	50	50	50	50
n81	n41		16	25	25			25	25	25	25	25	25
n81	n78		16	25	25			25	25	25	25	25	25
n81	n79							25	25	25	25		25
n82	n78		16	20	20			20	20	20	20	20	20
n83	n78		10	15	20			25	25	25	25	25	25
n84	n77		25	36	50			100	100	100	100	100	100
n86	n78		25	36	50			100	100	100	100	100	100

NOTE 1: 15 kHz SCS is assumed for UL band.
 NOTE 2: The UL configuration applies regardless of the channel bandwidth of the low band
 NOTE 3: Unless stated otherwise, UL resource blocks shall be centered within the transmission bandwidth configuration for the channel bandwidth.

Sensitivity degradation is allowed for a band if it is impacted by UL of another band part of the same SUL configuration due to cross band isolation issues. Reference sensitivity exceptions are specified in Table 7.3C.2-4 with uplink configuration specified in Table 7.3C.2-5.

Table 7.3C.2-4: Reference sensitivity exceptions due to cross band isolation

UL band	DL band	5 MHz (dBm)	10 MHz (dBm)	15 MHz (dBm)	20 MHz (dBm)	25 MHz (dBm)	30 MHz (dBm)	40 MHz (dBm)	50 MHz (dBm)	60 MHz (dBm)	80 MHz (dBm)	90 MHz (dBm)	100 MHz (dBm)
n80	n41		4.3	4.0	3.9			3.9	3.5	3.3	3.2	3.1	3.0
n95	n41		6.1	6.1	6.1		6.1	6.1	6.1	6.1	6.1	6.1	6.1

NOTE 1: The B41 requirements are modified by -0.5dB when carrier frequency of the assigned E-UTRA channel bandwidth is within 2515 – 2690 MHz.

Table 7.3C.2-5: Uplink configuration for reference sensitivity exceptions due to cross band isolation

UL band	DL band	5 MHz (dBm)	10 MHz (dBm)	15 MHz (dBm)	20 MHz (dBm)	25 MHz (dBm)	30 MHz (dBm)	40 MHz (dBm)	50 MHz (dBm)	60 MHz (dBm)	80 MHz (dBm)	90 MHz (dBm)	100 MHz (dBm)
n80	n41		50	50	50			50	50	50	50	50	50
n95	n41		75	75	75		75	75	75	75	75	75	75

NOTE: 15 kHz SCS is assumed for UL band.

7.3C.3 $\Delta R_{IB,c}$ for SUL

7.3C.3.1 General

For a UE supporting a SUL configuration, the $\Delta R_{IB,c}$ applies for both SC and SUL operation.

7.3C.3.2 SUL band combination

For the UE which supports SUL band combination, the minimum requirement for reference sensitivity in clause 7.3C.2 shall be increased by the amount given in $\Delta R_{IB,c}$ defined in clause 7.3C.3.2 for the applicable operating bands. Unless otherwise stated, $\Delta R_{IB,c}$ is set to zero.

In case the UE supports more than one of band combinations for CA, SUL or DC, and an operating band belongs to more than one band combinations then

- When the operating band frequency range is ≤ 1 GHz, the applicable additional $\Delta R_{IB,c}$ shall be the average value for all band combinations defined in clause 7.3A, 7.3B, 7.3C in this specification and 7.3A, 7.3B in TS 38.101-3 [3], truncated to one decimal place that apply for that operating band among the supported band combinations. In case there is a harmonic relation between low band UL and high band DL, then the maximum $\Delta R_{IB,c}$ among the different supported band combinations involving such band shall be applied
- When the operating band frequency range is > 1 GHz, the applicable additional $\Delta R_{IB,c}$ shall be the maximum value for all band combinations defined in clause 7.3A, 7.3B, 7.3C in this specification and 7.3A, 7.3B in TS 38.101-3 [3] for the applicable operating bands.

7.3C.3.2.1 $\Delta R_{IB,c}$ for two bands

Table 7.3C.3.2.1-1: $\Delta R_{IB,c}$ due to SUL (two bands)

Band combination for SUL	NR Band	$\Delta R_{IB,c}$ (dB)
SUL_n41-n80	n41	0.5 (note)
SUL_n41-n95	n41	0.2
SUL_n77-n80	n77	0.5
SUL_n77-n84	n77	0.5
SUL_n78-n80	n78	0.5
SUL_n78-n81	n78	0.5
SUL_n78-n82	n78	0.5
SUL_n78-n83	n78	0.5
SUL_n78-n84	n78	0.5
SUL_n78-n86	n78	0.5

NOTE: The requirement is applied for UE transmitting on the frequency range of 2496 – 2515 MHz.

7.3D Reference sensitivity for UL MIMO

For UE with two transmitter antenna connectors in closed-loop spatial multiplexing scheme, the minimum requirements specified in clause 7.3 shall be met with the UL MIMO configurations described in clause 6.2D.1 and the reference measurement channels as specified in Annex A.2.2 for CP-OFDM waveforms shall apply. For UL MIMO, the parameter P_{UMAX} is the total transmitter power over the two transmits power over the two transmit antenna connectors.

7.3E Reference sensitivity for V2X

7.3E.1 General

The reference sensitivity power level $P_{REFSENS_V2X}$ is the minimum mean power applied to each one of the UE antenna port for V2X UE, at which the throughput shall meet or exceed the requirements for the specified reference measurement channel.

7.3E.2 Minimum requirements

When UE is configured for NR V2X reception non-concurrent with NR uplink transmissions for NR V2X operating bands specified in Table 5.2E.1-1, the throughput shall be $\geq 95\%$ of the maximum throughput of the reference measurement channels as specified in Annexes A.7.2 with parameters specified in Table 7.3E.2-1.

Table 7.3E.2-1: Reference sensitivity of NR V2X Bands (PC5)

NR V2X Band	SCS kHz	Channel bandwidth / $P_{REFSENS_V2X}$ (dBm)				Duplex Mode
		10 MHz	20 MHz	30 MHz	40 MHz	

n38	15	-96.5	-93.2	-91.4	-90.1	HD
	30	-96.1	-93.4	-91.7	-90.2	HD
	60	-96.9	-93.1	-91.9	-90.4	HD
n47	15	-92.5	-89.2	-87.4	-86.1	HD
	30	-92.1	-89.4	-87.7	-86.2	HD
	60	-92.9	-89.1	-87.9	-86.4	HD

NOTE 1: Reference measurement channel is defined in A.7.2.
 NOTE 2: The signal power is specified per antenna port.
 NOTE 3: Void.

Table 7.3E.2-2: Sidelink TX configuration for reference sensitivity of NR V2X Bands (PC5)

NR Band / SCS / Channel bandwidth / Duplex mode						
NR V2X Band	SCS kHz	10 MHz	20 MHz	30 MHz	40 MHz	Duplex Mode
n38	15	50	105	160	216	HD
	30	24	50	75	105	HD
	60	10 ²	24	36	50	HD
n47	15	50	105	160	216	HD
	30	24	50	75	105	HD
	60	10 ²	24	36	50	HD

NOTE 1: The sidelink allocated RB (L_{CRB}) size could be adjusted according to resource pool configuration in [7].
 NOTE 2: For the case, 11 RB is allowed for S-SSB Block.

When UE is configured for NR V2X reception on V2X carrier concurrent with NR uplink and downlink, NR V2X sidelink throughput for the carrier shall be $\geq 95\%$ of the maximum throughput of the reference measurement channels as specified in Annexes 7.2 with parameters specified in Table 7.3E.2-3. Also the NR downlink throughput shall be $\geq 95\%$ of the maximum throughput of the reference measurement channels as specified in Annexes A.3.

For the inter-band con-current NR V2X operation, and the UE also supports an NR downlink inter-band concurrent configuration in Table 7.3E.2-4, the minimum requirement for reference sensitivity shall be increased by the amount given in $\Delta R_{IB,V2X}$ in Table 7.3E.2-4 for the corresponding NR V2X inter-band combinations.

Table 7.3E.2-3: Reference sensitivity for V2X Communication QPSK $P_{REFSENS}$

Inter-band V2X reception		Channel bandwidth								
NR V2X Band	NR band	NR Band	SCS (kHz)	5 MHz (dBm)	10 MHz (dBm)	15 MHz (dBm)	20 MHz (dBm)	30 MHz (dBm)	40 MHz (dBm)	Duplex Mode
n47	n71	n71	15	-97.2	-94.0	-91.6	-86.0			FDD
			30		-94.3	-91.9	-87.4			
			60							
	n47	n47	15		-92.5		-89.2	-87.4	-86.1	HD
			30		-92.1		-89.4	-87.7	-86.2	
			60		-92.9		-89.1	-87.9	-86.4	

NOTE 1: Reference measurement channel is defined in A.7.2.
 NOTE 2: The signal power is specified per antenna port.
 NOTE 3: Void.

Table 7.3E.2-4: $\Delta R_{IB,V2X}$ (two bands)

V2X inter-band concurrent band Combination	NR Band	$\Delta R_{IB,V2X}$ [dB]
V2X_n71-n47	n71	0.0

The reference sensitivity is defined to be met with NR uplink assigned to one band (that differs from the V2X operating band) and all NR downlink carriers active. The NR uplink resource blocks shall be located as close as possible to NR V2X operating band but confined within the transmission bandwidth configuration for the channel. The uplink

configuration for the NR operating band is specified in Table 7.3E.2-5 and 7.3E.2-6. The REFSENS of Uu downlink and PC5 sidelink will be tested at the same time.

Table 7.3E.2-5: Uplink configuration for REFSENS of NR V2X Bands (PC5)

Inter-band NR V2X concurrent band configuration		NR UL band / SCS/ Channel BW / Duplex mode				
NR V2X band (PC5)	NR V2X band (Uu)	NR V2X UL band (Uu)	SCS (kHz)	Channel Bandwidth (MHz)	N _{RB}	Duplex Mode
n47	n71	n71	15	10	52	FDD
			30	10	24	
			60	10	11	

Table 7.3E.2-6: Sidelink TX configuration for REFSENS of NR V2X Bands (Uu)

Inter-band NR V2X concurrent band configuration		NR UL band / SCS/ Channel BW / Duplex mode				
NR V2X band (PC5)	NR V2X band (Uu)	NR V2X band (PC5)	SCS (kHz)	Channel Bandwidth (MHz)	N _{RB}	Duplex Mode
n47	n71	n47	15	10	50	HD
			30	10	24	
			60	10	10	

NOTE 1: The sidelink allocated RB (L_{CRB}) size could be adjusted according to resource pool configuration in [7].

7.3F Reference sensitivity for shared spectrum channel access

7.3F.1 General

The reference sensitivity power level REFSENS is the minimum mean power applied to each one of the UE antenna ports, at which the throughput shall meet or exceed the requirements for the specified reference measurement channel.

In later clauses of Clause 7 where the value of REFSENS is used as a reference to set the corresponding requirement, the UE shall be verified against those requirements by applying the REFSENS value in Table 7.3G.2-1 with 2 Rx antenna ports tested.

7.3F.2 Reference sensitivity power level

The throughput shall be ≥ 95 % of the maximum throughput of the reference measurement channels as specified in Annexes A.2.2.2, A.3.2 and A.3.3 (with one sided dynamic OCNG Pattern OP.1 FDD/TDD for the DL-signal as described in Annex A.5.1.1/A.5.2.1) with parameters specified in Table 7.3F.2-1, Table 7.3F.2-2, and Table 7.3F.2-3.

Table 7.3F.2-1: Two antenna port reference sensitivity QPSK PREFSENS

Operating Band	Operating band / SCS / Channel bandwidth				
	SCS kHz	20 MHz (dBm)	40 MHz (dBm)	60 MHz (dBm)	80 MHz (dBm)
n46	15	-89.7	-86.6		
	30	-89.9	-86.7	-84.8	-83.6
	60	-90.1	-86.9	-85.0	-83.6
n96	15	-89.2	-86.1		
	30	-89.4	-86.2	-84.3	-83.1
	60	-89.6	-86.4	-84.5	-83.1

For UE(s) equipped with 4 Rx antenna ports, reference sensitivity for 2Rx antenna ports in Table 7.3F.2-1 shall be modified by the amount given in $\Delta R_{IB,4R}$ in Table 7.3F.2-2 for the applicable operating bands.

Table 7.3F.2-2: Four antenna port reference sensitivity allowance $\Delta R_{IB,4R}$

Operating band	$\Delta R_{IB,4R}$ (dB)
n46, n96	-2.2

The reference receive sensitivity (REFSENS) requirement specified in Table 7.3F.2-1 and Table 7.3F.2-2 shall be met with uplink transmission bandwidth less than or equal to that specified in Table 7.3F.2-3.

Table 7.3F.2-3: Uplink configuration for reference sensitivity

Operating band / SCS / Channel bandwidth					
Operating Band	SCS kHz	20 MHz (dBm)	40 MHz (dBm)	60 MHz (dBm)	80 MHz (dBm)
n46	15	100	216		
	30	50	100	162	216
	60	24	50	75	100
n96	15	100	216		
	30	50	100	162	216
	60	24	50	75	100

Unless given by Table 7.3F.2-4, the minimum requirements specified in Tables 7.3F.2-1 and 7.3F.2-2 shall be verified with the network signalling value NS_01 (Table 6.2F.3.1-1) configured.

Table 7.3F.2-4: Network signaling value for reference sensitivity

Operating band	Network Signalling value
n46	NS_01
n96	NS_53

7.3F.3 $\Delta R_{IB,c}$

For a UE supporting CA or DC band combination, the minimum requirement for reference sensitivity in Table 7.3F.2-1 shall be increased by the amount given by $\Delta R_{IB,c}$ defined in Table 7.3F.3-1. Unless otherwise stated, $\Delta R_{IB,c}$ is set to zero.

Table 7.3F.3-1: $\Delta R_{IB,c}$ due to CA (two bands)

Inter-band CA combination	Operating Band	$\Delta R_{IB,c}$ (dB)
CA_n46-n48	n46	0
	n48	0.5

In case the UE supports more than one of band combinations for CA or DC, and an operating band belongs to more than one band combinations then the applicable additional $\Delta R_{IB,c}$ shall be the maximum value for all band combinations defined in clause 7.3A and 7.3F.3 in this specification and 7.3A, 7.3B in TS 38.101-3 [3] for the applicable operating bands.

7.3F.4 Intra-band contiguous shared spectrum channel access CA

For intra-band contiguous carrier aggregation, the throughput of each component carrier shall be $\geq 95\%$ of the maximum throughput of the reference measurement channels as specified in Annexes A.2.2.2, A.3.2, and A.3.3 (with one sided dynamic OCNG Pattern OP.1 FDD/TDD for the DL-signal as described in Annex A.5.1.1/A.5.2.1) with parameters specified in Table 7.3F.2-1, Table 7.3F.2-2, and Table 7.3F.2-3.

7.3F.5 Inter-band CA with shared spectrum channel access

For inter-band carrier aggregation with one component carrier per operating band and the uplink assigned to one NR band the throughput of the NR carrier shall be $\geq 95\%$ of the maximum throughput of the reference measurement channels as specified in Annexes A.2.2.2, A.3.2, and A.3.3 (with one sided dynamic OCNG Pattern OP.1 FDD/TDD for the DL-signal as described in Annex A.5.1.1/A.5.2.1 with parameters specified in Table 7.3.2-1, Table 7.3.2-2 and Table 7.3.2-3 modified in accordance with clause 7.3F.3. The throughput of the NR-U carrier shall be $\geq 95\%$ of the maximum throughput of the reference measurement channels as specified in Annexes A.2.2.2, A.3.2, and A.3.3 (with one sided dynamic OCNG Pattern OP.1 FDD/TDD for the DL-signal as described in Annex A.5.1.1/A.5.2.1) with parameters specified in Table 7.3F.2-1, Table 7.3F.2-2, and Table 7.3F.2-3 modified in accordance with clause 7.3F.3. The reference sensitivity is defined to be met with all downlink component carriers active and the PCell uplink carrier active. Exceptions to reference sensitivity are allowed in accordance with clause 7.3F.5.1 and clause 7.3F.5.2.

7.3F.5.1 Reference sensitivity exceptions due to UL harmonic interference

The reference sensitivity for the shared access band does not apply when there is at least one individual RE within the shared access downlink transmission bandwidth which falls into the reference sensitivity exclusion region as specified in Table 7.3F.5.1-1.

Table 7.3F.5.1-1: NR-U reference sensitivity measurement exclusion region in MHz.

NR Band / Harmonic order / Channel BW in UL						
Band	Harmonic order	5MHz	10MHz	15MHz	20 MHz	40MHz
n25	3	+/- 15	+/- 23	+/- 35	+/- 45	+/- 90
n66	3	+/- 15	+/- 23	+/- 35	+/- 45	+/- 90

NOTE 1: Even though UL harmonic does not fall directly into NR-U band the exclusion region still applies.
 NOTE 2: The center of the exclusion region is obtained by multiplying the UL channel center frequency by the harmonic order.

7.3F.5.2 Reference sensitivity exceptions due to receiver harmonic mixing

Sensitivity degradation is allowed for a band if it is impacted by receiver harmonic mixing due to another band part of the same CA configuration. Reference sensitivity exceptions are specified in Table 7.3F.5.2-1 with uplink configuration specified in Table 7.3F.5.2-2

Table 7.3F.5.2-1: Reference sensitivity exceptions due to harmonic mixing for CA in NR FR1

NR Band / Channel bandwidth of the affected DL band														
UL band	DL band	5 MHz (dB)	10 MHz (dB)	15 MHz (dB)	20 MHz (dB)	25 MHz (dB)	30 MHz (dB)	40 MHz (dB)	50 MHz (dB)	60 MHz (dB)	70 MHz (dB)	80 MHz (dB)	90 MHz (dB)	100 MHz (dB)
n46	n48 ¹	22.6	19.5	17.8	16.6			14	13.1	12.6	12	12	12	12

NOTE 1: The requirements should be verified for UL NR-ARFCN of the aggressor (high) band (superscript HB) such that $f_{UL}^{HB} = [15 * f_{DL}^{LB}]0.1$ in MHz and $F_{UL,low}^{HB} + BW_{Channel}^{HB}/2 \leq f_{UL}^{HB} \leq F_{UL,high}^{HB} - BW_{Channel}^{HB}/2$ with f_{UL}^{LB} carrier frequency in the victim (lower) band in MHz and the channel bandwidth configured in the higher band.

Table 7.3F.5.2-2: Reference sensitivity exceptions due to harmonic mixing for CA in NR FR1

Operating band / SCS / Channel bandwidth / Duplex-mode															
Operating Band	SCS kHz	5 MHz (dBm)	10 MHz (dBm)	15 MHz (dBm)	20 MHz (dBm)	25 MHz (dBm)	30 MHz (dBm)	40 MHz (dBm)	50 MHz (dBm)	60 MHz (dBm)	70 MHz (dBm)	80 MHz (dBm)	90 MHz (dBm)	100 MHz (dBm)	Duplex Mode
n46	15	12	25	36	50			100	100	100	100	100	100	100	FDD

7.3F.5.3 Reference sensitivity exceptions due to cross band isolation

For unsynchronized operation, Rx de-sensing in one band will be caused by another band due to lack of isolation in the band filters. Reference sensitivity exceptions for cross band are specified in Table 7.3F.5.3-1 with uplink configuration specified in Table 7.3F.5.3-2-2.

Table 7.3F.5.3-1: MSD for cross band isolation

CA Configuration	Operating Band / Channel bandwidth of the affected DL band													
	UL band	DL band	5 MHz (dB)	10 MHz (dB)	15 MHz (dB)	20 MHz (dB)	25 MHz (dB)	30 MHz (dB)	40 MHz (dB)	50 MHz (dB)	60 MHz (dB)	80 MHz (dB)	90 MHz (dB)	100 MHz (dB)
CA_n46A-n48A	n46	n48	13.3	10.4	8.8	7.8	-	-	7.8	7	6.5	5.7	5.4	5.1
	n48	n46	-	-	-	13.5	-	-	10.9	-	9.4	8.7	-	-

Table 7.3F.5.3-2: Uplink configuration for reference sensitivity exceptions due to cross band isolation

Operating Band / SCS / Channel bandwidth of the affected DL band														
UL band	DL band	SCS of UL band (kHz)	5 MHz	10 MHz	15 MHz	20 MHz	25 MHz	30 MHz	40 MHz	50 MHz	60 MHz	80 MHz	90 MHz	100 MHz
n46	n48	30	216	216	216	216			216	216	216	216	216	216
n48	n46	15				216			216		216	216		

NOTE 1: The UL configuration applies regardless of the channel bandwidth of the UL band unless the UL resource blocks exceed that specified in Table 7.3.2-3 for the uplink bandwidth in which case the allocation according to Table 7.3.2-3 applies.

NOTE 2: Refers to the UL resource blocks shall be located as close as possible to the downlink operating band but confined within the transmission bandwidth configuration for the channel bandwidth in Table 5.3.2-1.

7.4 Maximum input level

Maximum input level is defined as the maximum mean power received at the UE antenna port, at which the specified relative throughput shall meet or exceed the minimum requirements for the specified reference measurement channel. The throughput shall be $\geq 95\%$ of the maximum throughput of the reference measurement channels as specified in Annex A.3.2 and A.3.3 (with one sided dynamic OCNG Pattern OP.1 FDD/TDD as described in Annex A.5.1.1/A.5.2.1) with parameters specified in Table 7.4-1.

Table 7.4-1: Maximum input level

Rx Parameter	Units	Channel bandwidth													
		5 MHz	10 MHz	15 MHz	20 MHz	25 MHz	30 MHz	40 MHz	50 MHz	60 MHz	70 MHz	80 MHz	90 MHz	100 MHz	
Power in Transmission Bandwidth Configuration	dBm	-25 ²				-24 ²	-23 ²	-22 ²	-21 ²	-20 ²					
		-27 ³				-26 ³	-25 ³	-24 ³	-23 ³	-22 ³					

NOTE 1: The transmitter shall be set to 4 dB below $P_{CMAX_L,f,c}$ at the minimum uplink configuration specified in Table 7.3.2-3 with $P_{CMAX_L,f,c}$ as defined in clause 6.2.4.

NOTE 2: Reference measurement channel is A.3.2.3 or A.3.3.3 for 64 QAM.

NOTE 3: Reference measurement channel is A.3.2.4 or A.3.3.4 for 256 QAM.

7.4A Maximum input level for CA

7.4A.1 Maximum input level for Intra-band contiguous CA

For intra-band contiguous carrier aggregation maximum input level is defined as the maximum mean power received at the UE antenna port, over the Transmission bandwidth configuration of each CC.

The throughput shall be $\geq 95\%$ of the maximum throughput of the reference measurement channels as specified in Annex A.3.2 and A.3.3 (with one sided dynamic OCNG Pattern OP.1 FDD/TDD as described in Annex A.5.1.1/A.5.2.1) with parameters specified in Table 7.4A.1-1 for each component carrier.

Table 7.4A.1-1: Maximum input level for Intra-band contiguous CA

Rx Parameter	Units	NR CA Bandwidth Class			
		B	C	D	
Power in largest transmission bandwidth configuration CC, $P_{\text{largest BW}}$	dBm	-23 ²	-23 ²	-25 ²	
		-25 ³	-25 ³	-27 ³	
Power in each other CC	dBm	$P_{\text{largest BW}} + 10 \cdot \log\left\{\frac{N_{\text{RB},c} \cdot \text{SCS}_c}{N_{\text{RB},\text{largest BW}} \cdot \text{SCS}_{\text{largest BW}}}\right\}$			
NOTE 1: The transmitter shall be set to 4 dB below $P_{\text{CMAX}_L,f,c}$ at the minimum uplink configuration specified in Table 7.3.2-3 with $P_{\text{CMAX}_L,f,c}$ as defined in clause 6.2.4.					
NOTE 2: Reference measurement channel is A.3.2.3 or A.3.3.3 for 64 QAM.					
NOTE 3: Reference measurement channel is A.3.2.4 or A.3.3.4 for 256 QAM.					

7.4A.2 Maximum input level for Intra-band non-contiguous CA

For intra-band non-contiguous carrier aggregation with one uplink carrier and two or more downlink sub-blocks, each larger than or equal to 5 MHz, the maximum input level requirements are defined with the uplink configuration in accordance with 7.3A.2.2-1. For this uplink configuration, the UE shall meet the requirements for each sub-block as specified in Table 7.4-1 and Table 7.4A.1-1 for one component carrier and two component carriers per sub-block, respectively. The throughput of each downlink component carrier shall be $\geq 95\%$ of the maximum throughput of the specified reference measurement channel as specified in Annex A.3.2 and A.3.3 (with one sided dynamic OCNG Pattern OP.1 FDD/TDD as described in Annex A.5.1.1 and A.5.2.1). The requirements apply with all downlink carriers active.

7.4A.3 Maximum input level for Inter-band CA

For inter-band carrier aggregation with one component carrier per operating band and the uplink assigned to one NR band, the maximum input level is defined with the uplink active on the band(s) other than the band whose downlink is being tested. For NR CA configurations including an operating band without uplink band or an operating band with an unpaired DL part (as noted in Table 5.2-1), the requirements for all downlinks shall be met with the single uplink carrier active in each band capable of UL operation. The UE shall meet the requirements specified in clause 7.4 for each component carrier while all downlink carriers are active.

The throughput shall be $\geq 95\%$ of the maximum throughput of the reference measurement channels as specified in Annex A.3.2 and A.3.3 (with one sided dynamic OCNG Pattern OP.1 FDD/TDD as described in Annex A.5.1.1/A.5.2.1) for each component carrier.

7.4B Maximum input level for NR-DC

For inter-band NR-DC configurations, the maximum input level for the corresponding inter-band CA configuration as specified in clause 7.4A applies.

7.4D Maximum input level for UL MIMO

For UE with two transmitter antenna connectors in closed-loop spatial multiplexing, the minimum requirements specified in clause 7.4 shall be met with the UL MIMO configurations described in clause 6.2D.1. For UL MIMO, the parameter P_{CMAX_L} is defined as the total transmitter power over the two transmit antenna connectors.

7.4E Maximum input level for V2X

7.4E.1 General

Maximum input level is defined as the maximum mean power received at the UE antenna port, at which the specified relative throughput shall meet or exceed the minimum requirements for the specified reference measurement channel. The throughput shall be $\geq 95\%$ of the maximum throughput of the reference measurement channels as specified in Annexes A.7.3 and A.7.4 with parameters specified in Table 7.4E.1-1.

Table 7.4E.1-1: Maximum input level of NR V2X

Rx Parameter	Units	Channel bandwidth			
		10 MHz	20 MHz	30 MHz	40 MHz
Power in Transmission Bandwidth Configuration	dBm	-25 ¹	-25 ¹	-23 ¹	-22 ¹
		-27 ²	-27 ²	-25 ²	-24 ²
NOTE 1: Reference measurement channel is A.7.3 for 64 QAM.					
NOTE 2: Reference measurement channel is A.7.4 for 256 QAM.					

7.4E.2 Maximum input level for V2X concurrent operation

For the inter-band con-current NR V2X operation, the requirements specified in clause 7.4E.1 shall apply for the NR sidelink reception in the operating bands in Table 5.2E.2-1 and the requirements specified in clause 7.4 shall apply for the NR downlink reception in licensed band while all downlink carriers are active.

7.5 Adjacent channel selectivity

Adjacent channel selectivity (ACS) is a measure of a receiver's ability to receive an NR signal at its assigned channel frequency in the presence of an adjacent channel signal at a given frequency offset from the centre frequency of the assigned channel. ACS is the ratio of the receive filter attenuation on the assigned channel frequency to the receive filter attenuation on the adjacent channel(s).

The UE shall fulfil the minimum requirements specified in Table 7.5-1 for NR bands with $F_{\text{DL_high}} < 2700$ MHz and $F_{\text{UL_high}} < 2700$ MHz and the minimum requirements specified in Table 7.5-2 for NR bands with $F_{\text{DL_low}} \geq 3300$ MHz and $F_{\text{UL_low}} \geq 3300$ MHz. These requirements apply for all values of an adjacent channel interferer up to -25 dBm and for any SCS specified for the channel bandwidth of the wanted signal. However, it is not possible to directly measure the ACS; instead the lower and upper range of test parameters are chosen as in Table 7.5-3 and Table 7.5-4 for verification of the requirements specified in Table 7.5-1, and as in Table 7.5-5 and Table 7.5-6 for verification of the requirements specified in Table 7.5-2. For these test parameters, the throughput shall be $\geq 95\%$ of the maximum throughput of the reference measurement channels as specified in Annexes A.2.2, A.3.2, and A.3.3 (with one sided dynamic OCNG Pattern OP.1 FDD/TDD for the DL-signal as described in Annex A.5.1.1/A.5.2.1). For operating bands with an unpaired DL part (as noted in Table 5.2-1), the requirements only apply for carriers assigned in the paired part.

Table 7.5-1: ACS for NR bands with $F_{\text{DL_high}} < 2700$ MHz and $F_{\text{UL_high}} < 2700$ MHz

RX parameter	Units	Channel bandwidth				
		5 MHz	10 MHz	15 MHz	20 MHz	25 MHz
ACS	dB	33	33	30	27	26
RX parameter	Units	Channel bandwidth				
		30 MHz	40 MHz	50 MHz	60 MHz	80 MHz
ACS	dB	25.5	24	23	22.5	21
RX parameter	Units	Channel bandwidth				
		90 MHz	100 MHz			

ACS	dB	20.5	20			
-----	----	------	----	--	--	--

Table 7.5-2: ACS for NR bands with $F_{DL_low} \geq 3300$ MHz and $F_{UL_low} \geq 3300$ MHz

RX parameter	Units	Channel bandwidth				
		10 MHz	15 MHz	20 MHz	25 MHz	30 MHz
ACS	dB	33	33	33	33	33
RX parameter	Units	Channel bandwidth				
		40 MHz	50 MHz	60 MHz	70 MHz	80 MHz
ACS	dB	33	33	33	33	33
RX parameter	Units	Channel bandwidth				
		90 MHz	100 MHz			
ACS	dB	33	33			

Table 7.5-3: Test parameters for NR bands with $F_{DL_high} < 2700$ MHz and $F_{UL_high} < 2700$ MHz, case 1

RX parameter	Units	Channel bandwidth				
		5 MHz	10 MHz	15 MHz	20 MHz	25 MHz
Power in transmission bandwidth configuration	dBm	REFSENS + 14 dB				
$P_{interferer}$	dBm	REFSENS + 45.5 dB	REFSENS + 45.5 dB	REFSENS + 42.5 dB	REFSENS + 39.5 dB	REFSENS + 38.5 dB
$BW_{interferer}$	MHz	5	5	5	5	5
$F_{interferer}$ (offset)	MHz	5 / -5	7.5 / -7.5	10 / -10	12.5 / -12.5	15 / -15
RX parameter	Units	Channel bandwidth				
		30 MHz	40 MHz	50 MHz	60 MHz	80 MHz
Power in transmission bandwidth configuration	dBm	REFSENS + 14 dB				
$P_{interferer}$	dBm	REFSENS + 38 dB	REFSENS + 36.5 dB	REFSENS + 35.5 dB	REFSENS + 35 dB	REFSENS + 33.5 dB
$BW_{interferer}$	MHz	5	5	5	5	5
$F_{interferer}$ (offset)	MHz	17.5 / -17.5	22.5 / -22.5	27.5 / -27.5	32.5 / -32.5	42.5 / -42.5
RX parameter	Units	Channel bandwidth				
		90 MHz	100 MHz			
Power in transmission bandwidth configuration	dBm	REFSENS + 14 dB				
$P_{interferer}$	dBm	REFSENS + 33 dB	REFSENS + 32.5 dB			
$BW_{interferer}$	MHz	5	5			
$F_{interferer}$ (offset)	MHz	47.5 / -47.5	52.5 / -52.5			

NOTE 1: The transmitter shall be set to 4 dB below $P_{CMAX_L,f,c}$ at the minimum UL configuration specified in Table 7.3.2-3 with $P_{CMAX_L,f,c}$ defined in clause 6.2.4.

NOTE 2: The absolute value of the interferer offset $F_{interferer}$ (offset) shall be further adjusted to $\lceil \frac{|F_{interferer}|}{SCS} \rceil + 0.5 \cdot SCS$ MHz with SCS the sub-carrier spacing of the wanted signal in MHz. The interferer is an NR signal with 15 kHz SCS.

NOTE 3: The interferer consists of the NR interferer RMC specified in Annexes A.3.2.2 and A.3.3.2 with one sided dynamic OCNG Pattern OP.1 FDD/TDD for the DL-signal as described in Annex A.5.1.1/A.5.2.1.

Table 7.5-4: Test parameters for NR bands with $F_{DL_high} < 2700$ MHz and $F_{UL_high} < 2700$ MHz, case 2

RX parameter	Units	Channel bandwidth				
		5 MHz	10 MHz	15 MHz	20 MHz	25 MHz
Power in transmission bandwidth configuration	dBm	-56.5	-56.5	-53.5	-50.5	-49.5
$P_{interferer}$	dBm	-25				
$BW_{interferer}$	MHz	5	5	5	5	5
$F_{interferer}$ (offset)	MHz	5	7.5	10	12.5	15
		/	/	/	/	/
		-5	-7.5	-10	-12.5	-15
RX parameter	Units	Channel bandwidth				
		30 MHz	40 MHz	50 MHz	60 MHz	80 MHz
Power in transmission bandwidth configuration	dBm	-49	-47	-46.5	-46	-44.5
$P_{interferer}$	dBm	-25				
$BW_{interferer}$	MHz	5	5	5	5	5
$F_{interferer}$ (offset)	MHz	17.5	22.5	27.5	32.5	42.5
		/	/	/	/	/
		-17.5	-22.5	-27.5	-32.5	-42.5
RX parameter	Units	Channel bandwidth				
		90 MHz	100 MHz			
Power in transmission bandwidth configuration	dBm	-44	-43.5			
$P_{interferer}$	dBm	-25				
$BW_{interferer}$	MHz	5	5			
$F_{interferer}$ (offset)	MHz	47.5	52.5			
		/	/			
		-47.5	-52.5			
NOTE 1: The transmitter shall be set to 24 dB below $P_{CMAX_L,f,c}$ at the minimum UL configuration specified in Table 7.3.2-3 with $P_{CMAX_L,f,c}$ defined in clause 6.2.4.						
NOTE 2: The absolute value of the interferer offset $F_{interferer}$ (offset) shall be further adjusted to $(\lceil F_{interferer} / SCS \rceil + 0.5) \cdot SCS$ MHz with SCS the sub-carrier spacing of the wanted signal in MHz. The interferer is an NR signal with 15 kHz SCS.						
NOTE 3: The interferer consists of the RMC specified in Annexes A.3.2.2 and A.3.3.2 with one sided dynamic OCNG Pattern OP.1 FDD/TDD for the DL-signal as described in Annex A.5.1.1/A.5.2.1						

Table 7.5-5: Test parameters for NR bands with $F_{DL_low} \geq 3300$ MHz and $F_{UL_low} \geq 3300$ MHz, case 1

RX parameter	Units	Channel bandwidth				
		10 MHz	15 MHz	20 MHz	25 MHz	30 MHz
Power in transmission bandwidth configuration	dBm	REFSENS + 14 dB				
$P_{interferer}$	dBm	REFSENS + 45.5 dB				
$BW_{interferer}$	MHz	10	15	20	25	30
$F_{interferer}$ (offset)	MHz	10	15	20	25	30
		/	/	/	/	/
		-10	-15	-20	-25	-30
RX parameter	Units	Channel bandwidth				
		40 MHz	50 MHz	60 MHz	70 MHz	80 MHz
Power in transmission bandwidth configuration	dBm	REFSENS + 14 dB				
$P_{interferer}$	dBm	REFSENS + 45.5 dB	REFSENS + 45.5 dB	REFSENS + 45.5 dB	REFSENS + 45.5 dB	REFSENS + 45.5 dB
$BW_{interferer}$	MHz	40	50	60	70	80

$F_{\text{interferer}}$ (offset)	MHz	40 / -40	50 / -50	60 / -60	70 / -70	80 / -80
RX parameter	Units	Channel bandwidth				
		90 MHz	100 MHz			
Power in transmission bandwidth configuration	dBm	REFSENS + 14 dB				
$P_{\text{interferer}}$	dBm	REFSENS + 45.5 dB	REFSENS + 45.5 dB			
$BW_{\text{interferer}}$	MHz	90	100			
$F_{\text{interferer}}$ (offset)	MHz	100 / -90	100 / -100			
<p>NOTE 1: The transmitter shall be set to 4 dB below $P_{\text{CMAX_L,f,c}}$ at the minimum UL configuration specified in Table 7.3.2-3 with $P_{\text{CMAX_L,f,c}}$ defined in clause 6.2.4.</p> <p>NOTE 2: The absolute value of the interferer offset $F_{\text{interferer}}$ (offset) shall be further adjusted to $\lceil \frac{ F_{\text{interferer}} }{SCS} \rceil + 0.5 \cdot SCS$ MHz with SCS the sub-carrier spacing of the wanted signal in MHz. The interferer is an NR signal with an SCS equal to that of the wanted signal.</p> <p>NOTE 3: The interferer consists of the RMC specified in Annexes A.3.2.2 and A.3.3.2 with one sided dynamic OCNG Pattern OP.1 FDD/TDD for the DL-signal as described in Annex A.5.1.1/A.5.2.1.</p>						

Table 7.5-6: Test parameters for NR bands with $F_{\text{DL_low}} \geq 3300$ MHz and $F_{\text{UL_low}} \geq 3300$ MHz, case 2

RX parameter	Units	Channel bandwidth				
		10 MHz	15 MHz	20 MHz	25 MHz	30 MHz
Power in transmission bandwidth configuration	dBm	-56.5				
$P_{\text{interferer}}$	dBm	-25				
$BW_{\text{interferer}}$	MHz	10	15	20	25	30
$F_{\text{interferer}}$ (offset)	MHz	10 / -10	15 / -15	20 / -20	25 / -25	30 / -30
RX parameter	Units	Channel bandwidth				
		40 MHz	50 MHz	60 MHz	70 MHz	80 MHz
Power in transmission bandwidth configuration	dBm	-56.5				
$P_{\text{interferer}}$	dBm	-25	-25	-25	-25	-25
$BW_{\text{interferer}}$	MHz	40	50	60	70	80
$F_{\text{interferer}}$ (offset)	MHz	40 / -40	50 / -50	60 / -60	70 / -70	80 / -80
RX parameter	Units	Channel bandwidth				
		90 MHz	100 MHz			
Power in transmission bandwidth configuration	dBm	-56.5				
$P_{\text{interferer}}$	dBm	-25	-25			
$BW_{\text{interferer}}$	MHz	90	100			
$F_{\text{interferer}}$ (offset)	MHz	90 / -90	100 / -100			
<p>NOTE 1: The transmitter shall be set to 24 dB below $P_{\text{CMAX_L,f,c}}$ at the minimum UL configuration specified in Table 7.3.2-3 with $P_{\text{CMAX_L,f,c}}$ defined in clause 6.2.4.</p> <p>NOTE 2: The absolute value of the interferer offset $F_{\text{interferer}}$ (offset) shall be further adjusted to $\lceil \frac{ F_{\text{interferer}} }{SCS} \rceil + 0.5 \cdot SCS$ MHz with SCS the sub-carrier spacing of the wanted signal in MHz. The interferer is an NR signal with an SCS equal to that of the wanted signal.</p> <p>NOTE 3: The interferer consists of the RMC specified in Annexes A.3.2.2 and A.3.3.2 with one sided dynamic OCNG Pattern OP.1 FDD/TDD for the DL-signal as described in Annex A.5.1.1/A.5.2.1.</p>						

7.5A Adjacent channel selectivity for CA

7.5A.1 Adjacent channel selectivity for Intra-band contiguous CA

For intra-band contiguous carrier aggregation the downlink SCC(s) shall be configured at nominal channel spacing to the PCC. The UE shall fulfil the minimum requirement specified in Table 7.5A.1-1 and 7.5A.1-1a for an adjacent channel interferer on either side of the aggregated downlink signal at a specified frequency offset and for an interferer power up to -25 dBm.

The throughput of each carrier shall be $\geq 95\%$ of the maximum throughput of the reference measurement channels as specified in Annexes A.2.2, A.3.2, and A.3.3 (with one sided dynamic OCNG Pattern OP.1 FDD/TDD for the DL-signal as described in Annex A.5.1.1/A.5.2.1) with parameters specified in Tables 7.5A.1-2, 7.5A.1-2a, 7.5A.1-3 and 7.5A.1-3a.

Table 7.5A.1-1: ACS for intra-band contiguous CA with $F_{DL_low} \geq 3300$ MHz and $F_{UL_low} \geq 3300$ MHz

Rx Parameter	Units	NR CA bandwidth class		
		B	C	D
ACS	dB	26.0	33.0	25.2

Table 7.5A.1-1a: ACS for intra-band contiguous CA with $F_{DL_high} < 2700$ MHz and $F_{UL_high} < 2700$ MHz

Rx Parameter	Units	NR CA bandwidth class	
		B	C
ACS	dB	20.0	17.0

Table 7.5A.1-2: Test parameters for intra-band contiguous CA with $F_{DL_low} \geq 3300$ MHz and $F_{UL_low} \geq 3300$ MHz, case 1

Rx Parameter	Units	NR CA bandwidth class		
		B	C	D
Pw in Transmission Bandwidth Configuration, per CC	dBm	REFSENS + 14 dB	REFSENS + 14 dB	REFSENS + 14 dB
$P_{Interferer}$	dBm	Aggregated power + 24.5 dB	Aggregated power + 31.5 dB	Aggregated power + 23.7 dB
$BW_{Interferer}$	MHz	20	$BW_{channel\ CA}$	50
$F_{Interferer}$ (offset)	MHz	10 + F _{offset} / -10 - F _{offset}	$BW_{channel\ CA}/2 + F_{offset}$ / $-BW_{channel\ CA}/2 + F_{offset}$	25 + F _{offset} / -25 - F _{offset}

NOTE 1: The transmitter shall be set to 4 dB below $P_{CMAX_L,f,c}$ at the minimum UL configuration specified in Table 7.3.2-3 with $P_{CMAX_L,f,c}$ defined in clause 6.2.4.

NOTE 2: The absolute value of the interferer offset $F_{interferer}$ (offset) shall be further adjusted to $\lceil \lceil F_{interferer} \rceil / SCS \rceil + 0.5 \rceil SCS$ MHz with SCS the sub-carrier spacing of the carrier closest to the interferer in MHz. The interferer is an NR signal with an SCS equal to that of the closest carrier.

NOTE 3: The interferer consists of the RMC specified in Annexes A.3.2.2 and A.3.3.2 with one sided dynamic OCNG Pattern OP.1 FDD/TDD for the DL-signal as described in Annex A.5.1.1/A.5.2.1.

Table 7.5A.1-2a: Test parameters for intra-band contiguous CA with $F_{DL_high} < 2700$ MHz and $F_{UL_high} < 2700$ MHz, case 1

Rx Parameter	Units	NR CA bandwidth class	
		B	C
Pw in Transmission Bandwidth Configuration, per CC	dBm	REFSENS + 14 dB	REFSENS + 14 dB
$P_{Interferer}$	dBm	Aggregated power + 18.5 dB	Aggregated power + 15.5 dB

$BW_{\text{Interferer}}$	MHz	5	5
$F_{\text{Interferer}} \text{ (offset)}$	MHz	$2.5 + F_{\text{offset}}$ / $-2.5 - F_{\text{offset}}$	$2.5 + F_{\text{offset}}$ / $-2.5 - F_{\text{offset}}$
<p>NOTE 1: The transmitter shall be set to 4 dB below $P_{\text{CMAX_L,f,c}}$ at the minimum UL configuration specified in Table 7.3.2-3 with $P_{\text{CMAX_L,f,c}}$ defined in clause 6.2.4 .</p> <p>NOTE 2: The absolute value of the interferer offset $F_{\text{Interferer}} \text{ (offset)}$ shall be further adjusted to $(\lfloor F_{\text{interferer}} / SCS \rfloor + 0.5) SCS$ MHz with SCS the sub-carrier spacing of the carrier closest to the interferer in MHz. The interferer is an NR signal with 15 kHz SCS.</p> <p>NOTE 3: The interferer consists of the RMC specified in Annexes A.3.2.2 and A.3.3.2 with one sided dynamic OCNG Pattern OP.1 FDD/TDD for the DL-signal as described in Annex A.5.1.1/A.5.2.1.</p>			

Table 7.5A.1-3: Test parameters for intra-band contiguous CA with $F_{\text{DL_low}} \geq 3300$ MHz and $F_{\text{UL_low}} \geq 3300$ MHz, case 2

Rx Parameter	Units	NR CA bandwidth class		
		B	C	D
Pw in Transmission Bandwidth Configuration, per CC	dBm	$-49.5 + 10\log(N_{\text{RB,c}}/N_{\text{RB_agg}})$	-56.5	$-48.7 + 10\log(N_{\text{RB,c}}/N_{\text{RB_agg}})$
$P_{\text{Interferer}}$	dBm	-25	-25	-25
$BW_{\text{Interferer}}$	MHz	20	$BW_{\text{channel CA}}$	50
$F_{\text{Interferer}} \text{ (offset)}$	MHz	$10 + F_{\text{offset}}$ / $-10 - F_{\text{offset}}$	$BW_{\text{channel CA}}/2 + F_{\text{offset}}$ / $-BW_{\text{channel CA}}/2 + F_{\text{offset}}$	$25 + F_{\text{offset}}$ / $-25 - F_{\text{offset}}$
<p>NOTE 1: The transmitter shall be set to 24 dB below $P_{\text{CMAX_L,f,c}}$ at the minimum UL configuration specified in Table 7.3.2-3 with $P_{\text{CMAX_L,f,c}}$ defined in clause 6.2.4.</p> <p>NOTE 2: The absolute value of the interferer offset $F_{\text{Interferer}} \text{ (offset)}$ shall be further adjusted to $(\lfloor F_{\text{interferer}} / SCS \rfloor + 0.5) SCS$ MHz with SCS the sub-carrier spacing of the carrier closest to the interferer in MHz. The interferer is an NR signal with an SCS equal to that of the closest carrier.</p> <p>NOTE 3: The interferer consists of the RMC specified in Annexes A.3.2.2 and A.3.3.2 with one sided dynamic OCNG Pattern OP.1 FDD/TDD for the DL-signal as described in Annex A.5.1.1/A.5.2.1.</p>				

Table 7.5A.1-3a: Test parameters for intra-band contiguous CA with $F_{\text{DL_high}} < 2700$ MHz and $F_{\text{UL_high}} < 2700$ MHz, case 2

Rx Parameter	Units	NR CA Bandwidth Class	
		B	C
Pw in Transmission Bandwidth Configuration, per CC	dBm	$-43.5 + 10\log(N_{\text{RB,c}}/N_{\text{RB_agg}})$	$-40.5 + 10\log(N_{\text{RB,c}}/N_{\text{RB_agg}})$
$P_{\text{Interferer}}$	dBm	-25	-25
$BW_{\text{Interferer}}$	MHz	5	5
$F_{\text{Interferer}} \text{ (offset)}$	MHz	$2.5 + F_{\text{offset}}$ / $-2.5 - F_{\text{offset}}$	$2.5 + F_{\text{offset}}$ / $-2.5 - F_{\text{offset}}$
<p>NOTE 1: The transmitter shall be set to 24 dB below $P_{\text{CMAX_L,f,c}}$ at the minimum UL configuration specified in Table 7.3.2-3 with $P_{\text{CMAX_L,f,c}}$ defined in clause 6.2.4.</p> <p>NOTE 2: The absolute value of the interferer offset $F_{\text{Interferer}} \text{ (offset)}$ shall be further adjusted to $(\lfloor F_{\text{interferer}} / SCS \rfloor + 0.5) SCS$ MHz with SCS the sub-carrier spacing of the carrier closest to the interferer in MHz. The interferer is an NR signal with 15 kHz SCS.</p> <p>NOTE 3: The interferer consists of the RMC specified in Annexes A.3.2.2 and A.3.3.2 with one sided dynamic OCNG Pattern OP.1 FDD/TDD for the DL-signal as described in Annex A.5.1.1/A.5.2.1.</p>			

7.5A.2 Adjacent channel selectivity Intra-band non-contiguous CA

For intra-band non-contiguous carrier aggregation with $F_{\text{DL_high}} < 2700$ MHz and $F_{\text{UL_high}} < 2700$ MHz with one uplink carrier and two or more downlink sub-blocks, each larger than or equal to 5 MHz, the adjacent channel selectivity requirements are defined with the uplink configuration in accordance with Table 7.3A.2.2-1. For this uplink configuration, the UE shall meet the requirements for each sub-block as specified in clauses 7.5 and 7.5A.1 for one

component carrier and two component carriers per sub-block, respectively. The UE shall fulfil the minimum requirements all values of a single adjacent channel interferer in-gap and out-of-gap up to a -25 dBm interferer power while all downlink carriers are active. For the lower range of test parameters (Case 1), the interferer power $P_{\text{interferer}}$ shall be set to the maximum of the levels given by the carriers of the respective sub-blocks as specified in Table 7.5-3 and Table 7.5A.1-2a for one component carrier and two component carriers per sub-block, respectively. The wanted signal power levels for the carriers of each sub-block shall then be adjusted relative to $P_{\text{interferer}}$ in accordance with the ACS requirement for each sub-block (Table 7.5-1 and Table 7.5A.1-1a). For the upper range of test parameters (Case 2) for which the interferer power $P_{\text{interferer}}$ is -25 dBm (Table 7.5-4 and Table 7.5A.1-3a) the wanted signal power levels for the carriers of each sub-block shall be adjusted relative to $P_{\text{interferer}}$ like for Case 1.

For intra-band non-contiguous carrier aggregation with $F_{\text{DL,low}} \geq 3300$ MHz and $F_{\text{UL,low}} \geq 3300$ MHz with one uplink carrier and two or more downlink sub-blocks, each larger than or equal to 5 MHz, the adjacent channel selectivity requirements are defined with the uplink configuration in accordance with Table 7.3A.2.2-1. For this uplink configuration, the UE shall meet the requirements for each sub-block as specified in clauses 7.5 and 7.5A.1 for one component carrier and two component carriers per sub-block, respectively. The UE shall fulfil the minimum requirements all values of a single adjacent channel interferer in-gap and out-of-gap up to a -25 dBm interferer power while all downlink carriers are active. For the lower range of test parameters (Case 1), the interferer power $P_{\text{interferer}}$ shall be set to the maximum of the levels given by the carriers of the respective sub-blocks as specified in Table 7.5-5 and Table 7.5A.1-2 for one component carrier and two component carriers per sub-block, respectively. The wanted signal power levels for the carriers of each sub-block shall then be adjusted relative to $P_{\text{interferer}}$ in accordance with the ACS requirement for each sub-block (Table 7.5-2 and Table 7.5A.1-1). For the upper range of test parameters (Case 2) for which the interferer power $P_{\text{interferer}}$ is -25 dBm (Table 7.5-6 and Table 7.5A.1-3) the wanted signal power levels for the carriers of each sub-block shall be adjusted relative to $P_{\text{interferer}}$ like for Case 1.

The throughput of each carrier shall be ≥ 95 % of the maximum throughput of the reference measurement channels as specified in Annexes A.2.2, A.3.2, and A.3.3 (with one sided dynamic OCNG Pattern OP.1 FDD/TDD for the DL-signal as described in Annex A.5.1.1/A.5.2.1).

7.5A.3 Adjacent channel selectivity Inter-band CA

For inter-band carrier aggregation with one component carrier per operating band and the uplink assigned to one NR band, the adjacent channel requirements are defined with the uplink active on the band(s) other than the band whose downlink is being tested. For NR CA configurations including an operating band without uplink operation or an operating band with an unpaired DL part (as noted in Table 5.2-1), the requirements for all downlinks shall be met with the single uplink carrier active in each band capable of UL operation. The UE shall meet the requirements specified in clause 7.5 for each component carrier while all downlink carriers are active.

The throughput of each carrier shall be ≥ 95 % of the maximum throughput of the reference measurement channels as specified in Annexes A.2.2, A.3.2, and A.3.3 (with one sided dynamic OCNG Pattern OP.1 FDD/TDD for the DL-signal as described in Annex A.5.1.1/A.5.2.1).

7.5B Adjacent channel selectivity for NR-DC

For inter-band NR-DC configurations, the adjacent channel selectivity for the corresponding inter-band CA configuration as specified in clause 7.5A applies.

7.5D Adjacent channel selectivity for UL MIMO

For UE(s) with two transmitter antenna connectors in closed-loop spatial multiplexing scheme, the minimum requirements specified in clause 7.5 shall be met with the UL MIMO configurations described in clause 6.2D.1. For UL MIMO, the parameter $P_{\text{CMAX,L}}$ is defined as the total transmitter power over the two transmit antenna connectors.

7.5E Adjacent channel selectivity for V2X

7.5E.1 General

Adjacent channel selectivity (ACS) is a measure of a receiver's ability to receive an NR signal at its assigned channel frequency in the presence of an adjacent channel signal at a given frequency offset from the centre frequency of the

assigned channel. ACS is the ratio of the receive filter attenuation on the assigned channel frequency to the receive filter attenuation on the adjacent channel(s).

The UE shall fulfil the minimum requirements specified in Table 7.5E.1-1 for NR V2X UE. These requirements apply for all values of an adjacent channel interferer up to -25 dBm and for any SCS specified for the channel bandwidth of the wanted signal. However, it is not possible to directly measure the ACS; instead the lower and upper range of test parameters are chosen as in Table 7.5E.1-2 and Table 7.5E.1-3 for verification of the requirements specified in Table 7.5E.1-1. For these test parameters, the throughput shall be $\geq 95\%$ of the maximum throughput of the reference measurement channels as specified in Annexes A.7.2.

In licensed band, the minimum requirements shall reuse the same ACS values with NR UE.

Table 7.5E.1-1: Adjacent channel selectivity for NR V2X

RX parameter	Units	Channel bandwidth			
		10 MHz	20 MHz	30 MHz	40 MHz
ACS	dB	33.0	27.0	25.5	24.0

Table 7.5E.1-2: Test parameters for Adjacent channel selectivity for V2X, Case 1

RX parameter	Units	Channel bandwidth			
		10 MHz	20 MHz	30 MHz	40 MHz
Power in transmission bandwidth configuration	dBm	$P_{\text{REFSENS_V2X}} + 14$ dB			
$P_{\text{interferer}}$	dBm	$P_{\text{REFSENS_V2X}} + 45.5$ dB	$P_{\text{REFSENS_V2X}} + 39.5$ dB	$P_{\text{REFSENS_V2X}} + 38.0$ dB	$P_{\text{REFSENS_V2X}} + 36.5$ dB
$BW_{\text{interferer}}$	MHz	10	10	10	10
$F_{\text{interferer}}$ (offset)	MHz	10 / -10	15 / -15	20 / -20	25 / -25
NOTE 1: The interferer is QPSK modulated PUSCH containing data and reference symbols. Normal cyclic prefix is used.					
NOTE 2: The absolute value of the interferer offset $F_{\text{interferer}}$ (offset) shall be further adjusted to $(\lceil F_{\text{interferer}} / \text{SCS} \rceil + 0.5) \text{SCS}$ MHz with SCS the sub-carrier spacing of the wanted signal in MHz. The interferer is an NR signal with 15 kHz SCS.					

Table 7.5E.1-3: Test parameters for Adjacent channel selectivity for V2X, Case 2

RX parameter	Units	Channel bandwidth			
		10 MHz	20 MHz	30 MHz	40 MHz
Power in transmission bandwidth configuration	dBm	-56.5	-50.5	-49.0	-47.5
$P_{\text{interferer}}$	dBm	-25			
$BW_{\text{interferer}}$	MHz	10	10	10	10
$F_{\text{interferer}}$ (offset)	MHz	10 / -10	15 / -15	20 / -20	25 / -25
NOTE 1: The interferer is QPSK modulated PUSCH containing data and reference symbols. Normal cyclic prefix is used.					
NOTE 2: The absolute value of the interferer offset $F_{\text{interferer}}$ (offset) shall be further adjusted to $(\lceil F_{\text{interferer}} / \text{SCS} \rceil + 0.5) \text{SCS}$ MHz with SCS the sub-carrier spacing of the wanted signal in MHz. The interferer is an NR signal with 15 kHz SCS.					

7.5E.2 Adjacent channel selectivity for V2X concurrent operation

For the inter-band con-current NR V2X operation, the requirements specified in clause 7.5E.1 shall apply for the NR sidelink reception in the operating bands in Table 5.2E.2-1 and the requirements specified in clause 7.5 shall apply for the NR downlink reception in licensed band while all downlink carriers are active.

7.5F Adjacent channel selectivity

7.5F.1 General

Adjacent channel selectivity (ACS) is a measure of a receiver's ability to receive an NR signal at its assigned channel frequency in the presence of an adjacent channel signal at a given frequency offset from the centre frequency of the assigned channel. ACS is the ratio of the receive filter attenuation on the assigned channel frequency to the receive filter attenuation on the adjacent channel(s).

Instead of the general ACS requirements specified in clause 7.5, the UE shall fulfil the minimum requirements specified in Table 7.5F.1-1. These requirements apply for any SCS specified for the channel bandwidth of the wanted signal. For the test parameters specified in Table 7.5F.1-2, the throughput shall be ≥ 95 % of the maximum throughput of the reference measurement channels as specified in Annexes A.2.2, A.3.2, and A.3.3 (with one sided dynamic OCNG Pattern OP.1 FDD/TDD for the DL-signal as described in Annex A.5.1.1/A.5.2.1).

Table 7.5F.1-1: ACS for shared spectrum channel access bands

RX parameter	Units	Channel bandwidth			
		20 MHz	40 MHz	60 MHz	80 MHz
ACS	dB	24	21	19.2	18

Table 7.5F.1-2: Test parameters for shared spectrum channel access bands

RX parameter	Units	Channel bandwidth			
		20 MHz	40 MHz	60 MHz	80 MHz
Power in transmission bandwidth configuration	dBm	REFSENS + 14 dB			
$P_{\text{interferer}}$	dBm	REFSENS + 36.5 dB	REFSENS + 33.5 dB	REFSENS + 31.7 dB	REFSENS + 30.5 dB
$BW_{\text{interferer}}$	MHz	20			
$F_{\text{interferer}}$ (offset)	MHz	20 / -20			
NOTE 1: The transmitter shall be set to 4 dB below $P_{\text{CMAX_L,f,c}}$ at the minimum UL configuration specified in Table 7.3.2-3 with $P_{\text{CMAX_L,f,c}}$ defined in clause 6.2.4.					
NOTE 2: The absolute value of the interferer offset $F_{\text{interferer}}$ (offset) shall be further adjusted to $(\lceil F_{\text{interferer}} / SCS \rceil + 0.5) \cdot SCS$ MHz with SCS the sub-carrier spacing of the wanted signal in MHz. The interferer is an NR signal with an SCS equal to that of the wanted signal.					
NOTE 3: The interferer consists of the RMC specified in Annexes A.3.2.2 and A.3.3.2 with one sided dynamic OCNG Pattern OP.1 FDD/TDD for the DL-signal as described in Annex A.5.1.1/A.5.2.1.					

7.5F.2 Intra-band contiguous shared spectrum channel access CA

ACS for intra-band contiguous shared access CA requirements are specified in Table 7.5F.2-1. These requirements apply for any SCS specified for the channel bandwidth of the wanted signal. For the test parameters specified in Table 7.5F.2-2, the throughput of each carrier shall be ≥ 95 % of the maximum throughput of the reference measurement channels as specified in Annexes A.2.2, A.3.2, and A.3.3 (with one sided dynamic OCNG Pattern OP.1 FDD/TDD for the DL-signal as described in Annex A.5.1.1/A.5.2.1).

Table 7.5F.2-1: ACS for intra-band contiguous shared access CA

Rx Parameter	Units	NR-U CA bandwidth class							
		B	C	D	E	I	M	N	O
ACS	dB	$24 - 10\log_{10}(BW_{\text{Channel_CA}}/20)$							

Table 7.5F.2-2: Test parameters for intra-band contiguous NR-U CA

Rx Parameter	Units	NR-U CA bandwidth class
		B, C, D, E, M, N, O
Pw in Transmission Bandwidth Configuration, per CC	dBm	REFSENS + 14 dB
$P_{\text{Interferer}}$	dBm	Aggregated power + 22.5 – 10log ₁₀ (BW _{Channel_CA} /20) dB
BW _{Interferer}	MHz	20
F _{Interferer} (offset)	MHz	10 + Foffset / -10 - Foffset
NOTE 1: The transmitter shall be set to 4 dB below P _{CMAX_L,f,c} at the minimum UL configuration specified in Table 7.3.2-3 with P _{CMAX_L,f,c} defined in clause 6.2.4 .		
NOTE 2: The absolute value of the interferer offset F _{Interferer} (offset) shall be further adjusted to $(\lceil F_{\text{interferer}} / SCS \rceil + 0.5) SCS$ MHz with SCS the sub-carrier spacing of the carrier closest to the interferer in MHz. The interferer is an NR signal with an SCS equal to that of the closest carrier.		
NOTE 3: The interferer consists of the RMC specified in Annexes A.3.2.2 and A.3.3.2 with one sided dynamic OCNB Pattern OP.1 FDD/TDD for the DL-signal as described in Annex A.5.1.1/A.5.2.1.		

7.6 Blocking characteristics

7.6.1 General

The blocking characteristic is a measure of the receiver's ability to receive a wanted signal at its assigned channel frequency in the presence of an unwanted interferer on frequencies other than those of the spurious response or the adjacent channels, without this unwanted input signal causing a degradation of the performance of the receiver beyond a specified limit. The blocking performance shall apply at all frequencies except those at which a spurious response occurs.

For shared spectrum channel access and band combinations with operating bands intended for shared spectrum channel access, the blocking characteristics is specified in clause 7.6F.

7.6.2 In-band blocking

For NR bands with F_{DL_high} < 2700 MHz and F_{UL_high} < 2700 MHz in-band blocking (IBB) is defined for an unwanted interfering signal falling into the UE receive band or into the first 15 MHz below or above the UE receive band. The throughput of the wanted signal shall be ≥ 95 % of the maximum throughput of the reference measurement channels as specified in Annexes A.2.2, A.3.2 and A.3.3 (with one sided dynamic OCNB Pattern OP.1 FDD/TDD for the DL-signal as described in Annex A.5.1.1/A.5.2.1) with parameters specified in Table 7.6.2-1 and Table 7.6.2-2. The relative throughput requirement shall be met for any SCS specified for the channel bandwidth of the wanted signal. For operating bands with an unpaired DL part (as noted in Table 5.2-1), the requirements only apply for carriers assigned in the paired part.

Table 7.6.2-1: In-band blocking parameters for NR bands with F_{DL_high} < 2700 MHz and F_{UL_high} < 2700 MHz

RX parameter	Units	Channel bandwidth				
		5 MHz	10 MHz	15 MHz	20 MHz	25 MHz
Power in transmission bandwidth configuration	dBm	REFSENS + channel bandwidth specific value below				
	dB	6	6	7	9	10
BW _{interferer}	MHz	5				
F _{offset, case 1}	MHz	7.5				
F _{offset, case 2}	MHz	12.5				
RX parameter	Units	Channel bandwidth				
		30 MHz	40 MHz	50 MHz	60 MHz	80 MHz
Power in transmission	dBm	REFSENS + channel bandwidth specific value below				

bandwidth configuration	dB	11	12	13	14	15
BW _{interferer}	MHz	5				
F _{offset, case 1}	MHz	7.5				
F _{offset, case 2}	MHz	12.5				
RX parameter	Units	Channel bandwidth				
		90 MHz	100 MHz			
Power in transmission bandwidth configuration	dBm	REFSENS + channel bandwidth specific value below				
	dB	15.5	16			
BW _{interferer}	MHz	5				
F _{offset, case 1}	MHz	7.5				
F _{offset, case 2}	MHz	12.5				
NOTE 1: The transmitter shall be set to 4 dB below P _{CMAX,L,f,c} at the minimum UL configuration specified in Table 7.3.2-3 with P _{CMAX,L,f,c} defined in clause 6.2.4.						
NOTE 2: The interferer consists of the RMC specified in Annexes A.3.2.2 and A.3.3.2 with one sided dynamic OCNG Pattern OP.1 FDD/TDD for the DL-signal as described in Annex A.5.1.1/A.5.2.1 and 15 kHz SCS.						

Table 7.6.2-2: In-band blocking for NR bands with F_{DL,high} < 2700 MHz and F_{UL,high} < 2700 MHz

NR band	Parameter	Unit	Case 1	Case 2	Case 3	Case 4
		P _{interferer}	dBm	-56	-44	-15
	F _{interferer (offset)}	MHz	-BW _{Channel/2} – F _{offset, case 1} and BW _{Channel/2} + F _{offset, case 1}	≤ -BW _{Channel/2} – F _{offset, case 2} and ≥ BW _{Channel/2} + F _{offset, case 2}		-BW _{Channel/2} -11
n1, n2, n3, n5, n7, n8, n12, n14, n18, n20, n25, n26, n28, n29, n34, n38, n39, n40, n41, n48 ³ , n50, n51, n53, n65, n66, n70, n74, n75, n76, n91, n92, n93, n94	F _{interferer}	MHz	NOTE 2	F _{DL,low} – 15 to F _{DL,high} + 15		
n30	F _{interferer}	MHz	NOTE 2	F _{DL,low} – 15 to F _{DL,high} + 15		F _{DL,low} – 11
n71	F _{interferer}	MHz	NOTE 2	F _{DL,low} – 12 to F _{DL,high} + 15	F _{DL,low} – 12	
NOTE 1: The absolute value of the interferer offset F _{interferer (offset)} shall be further adjusted to $(\lceil F_{interferer} - / SCS \rceil + 0.5) \cdot SCS$ MHz with SCS the sub-carrier spacing of the wanted signal in MHz. The interferer is an NR signal with 15 kHz SCS.						
NOTE 2: For each carrier frequency, the requirement applies for two interferer carrier frequencies: a: -BW _{Channel/2} – F _{offset, case 1} ; b: BW _{Channel/2} + F _{offset, case 1}						
NOTE 3: n48 follows the requirement in this frequency range according to the general requirement defined in Clause 7.1.						
NOTE 4: For SDL bands, requirements shall be applied only for CA band combination cases.						

For NR bands with F_{DL,low} ≥ 3300 MHz and F_{UL,low} ≥ 3300 MHz in-band blocking (IBB) is defined for an unwanted interfering signal falling into the UE receive band or into an immediately adjacent frequency range up to 3*BW_{Channel} below or above the UE receive band where BW_{Channel} is the bandwidth of the wanted signal. The throughput of the wanted signal shall be ≥ 95% of the maximum throughput of the reference measurement channels as specified in Annexes A.2.2, A.3.2 and A.3.3 (with one sided dynamic OCNG Pattern OP.1 FDD/TDD for the DL-signal as

described in Annex A.5.1.1/A.5.2.1)] with parameters specified in Table 7.6.2-3 and Table 7.6.2-4. The relative throughput requirement shall be met for any SCS specified for the channel bandwidth of the wanted signal.

Table 7.6.2-3: In-band blocking parameters for NR bands with $F_{DL_low} \geq 3300$ MHz and $F_{UL_low} \geq 3300$ MHz

RX parameter	Units	Channel bandwidth				
		10 MHz	15 MHz	20 MHz	25 MHz	30 MHz
Power in transmission bandwidth configuration	dBm	REFSENS + channel bandwidth specific value below				
	dB	6				
BW _{interferer}	MHz	10	15	20	25	30
F _{offset, case 1}	MHz	15	22.5	30	37.5	45
F _{offset, case 2}	MHz	25	37.5	50	62.5	75
RX parameter	Units	Channel bandwidth				
		40 MHz	50 MHz	60 MHz	70 MHz	80 MHz
Power in transmission bandwidth configuration	dBm	REFSENS + channel bandwidth specific value below				
	dB	6				
BW _{interferer}	MHz	40	50	60	70	80
F _{offset, case 1}	MHz	60	75	90	105	120
F _{offset, case 2}	MHz	100	125	150	175	200
RX parameter	Units	Channel bandwidth				
		90 MHz	100 MHz			
Power in transmission bandwidth configuration	dBm	REFSENS + channel bandwidth specific value below				
	dB	6				
BW _{interferer}	MHz	90	100			
F _{offset, case 1}	MHz	135	150			
F _{offset, case 2}	MHz	225	250			
NOTE 1: The transmitter shall be set to 4 dB below P _{C_{MAX}L,f,c} at the minimum UL configuration specified in Table 7.3.2-3 with P _{C_{MAX}L,f,c} defined in clause 6.2.4.						
NOTE 2: The interferer consists of the RMC specified in Annexes A.3.2.2 and A.3.3.2 with one sided dynamic OCN Pattern OP.1 FDD/TDD for the DL-signal as described in Annex A.5.1.1/A.5.2.1						

Table 7.6.2-4: In-band blocking for NR bands with $F_{DL_low} \geq 3300$ MHz and $F_{UL_low} \geq 3300$ MHz

NR band	Parameter	Unit	Case 1	Case 2
		P _{interferer}	dBm	-56
n77, n78, n79	F _{interferer (offset)}	MHz	-BW _{Channel} /2 - F _{offset, case 1} and BW _{Channel} /2 + F _{offset, case 1}	≤ -BW _{Channel} /2 - F _{offset, case 2} and ≥ BW _{Channel} /2 + F _{offset, case 2}
	F _{interferer}		NOTE 2	F _{DL_low} - 3*BW _{Channel} to F _{DL_high} + 3*BW _{Channel}
NOTE 1: The absolute value of the interferer offset F _{interferer (offset)} shall be further adjusted to $(\lceil F_{interferer} \rceil /_{SCS} \lceil + 0.5 \rceil)_{SCS}$ MHz with SCS the sub-carrier spacing of the wanted signal in MHz. The interferer is an NR signal with an SCS equal to that of the wanted signal.				
NOTE 2: For each carrier frequency, the requirement applies for two interferer carrier frequencies: a: -BW _{Channel} /2 - F _{offset, case 1} ; b: BW _{Channel} /2 + F _{offset, case 1}				
NOTE 3: BW _{Channel} denotes the channel bandwidth of the wanted signal				

7.6.3 Out-of-band blocking

For NR bands with $F_{DL_high} < 2700$ MHz and $F_{UL_high} < 2700$ MHz out-of-band band blocking is defined for an unwanted CW interfering signal falling outside a frequency range 15 MHz below or above the UE receive band. The throughput of the wanted signal shall be $\geq 95\%$ of the maximum throughput of the reference measurement channels as specified in Annexes A.2.2, A.3.2 and A.3.3 (with one sided dynamic OCNG Pattern OP.1 FDD/TDD for the DL-signal as described in Annex A.5.1.1/A.5.2.1) with parameters specified in Table 7.6.3-1 and Table 7.6.3-2. The relative throughput requirement shall be met for any SCS specified for the channel bandwidth of the wanted signal. For operating bands with an unpaired DL part (as noted in Table 5.2-1), the requirements only apply for carriers assigned in the paired part.

Table 7.6.3-1: Out-of-band blocking parameters for NR bands with $F_{DL_high} < 2700$ MHz and $F_{UL_high} < 2700$ MHz

Channel bandwidth	Power in transmission bandwidth configuration [dBm]
5 MHz	REFSENS + 6.0 dB
10 MHz	REFSENS + 6.0 dB
15 MHz	REFSENS + 7.0 dB
20 MHz	REFSENS + 9.0 dB
25 MHz	REFSENS + 10.0 dB
30 MHz	REFSENS + 11.0 dB
40 MHz	REFSENS + 12.0 dB
50 MHz	REFSENS + 13.0 dB
60 MHz	REFSENS + 14.0 dB
80 MHz	REFSENS + 15.0 dB
90 MHz	REFSENS + 15.5 dB
100 MHz	REFSENS + 16.0 dB
NOTE: The transmitter shall be set to 4 dB below $P_{CMAX_L,f,c}$ at the minimum UL configuration specified in Table 7.3.2-3 with $P_{CMAX_L,f,c}$ defined in clause 6.2.4.	

Table 7.6.3-2: Out of-band blocking for NR bands with $F_{DL_high} < 2700$ MHz and $F_{UL_high} < 2700$ MHz

NR band	Parameter	Unit	Range 1	Range 2	Range 3
n1, n2, n3, n5, n7, n8, n12, n14, n18, n20, n25, n26, n28, n29, n30, n34, n38, n39, n40, n41, n48 ⁵ , n50, n51, n53 ⁶ , n65, n66, n70, n71, n74, n75, n76, n91, n92, n93, n94	$P_{interferer}$	dBm	-44	-30	-15
	$F_{interferer}$ (CW)	MHz	-60 < f – F_{DL_low} < -15 or 15 < f – F_{DL_high} < 60	-85 < f – F_{DL_low} ≤ -60 or 60 ≤ f – F_{DL_high} < 85	1 ≤ f ≤ F_{DL_low} – 85 or F_{DL_high} + 85 ≤ f ≤ 12750
NOTE 1: The power level of the interferer ($P_{interferer}$) for Range 3 shall be modified to -20 dBm for $F_{interferer} > 6000$ MHz.					
NOTE 2: For band 51 the F_{DL_high} of band 50 is applied as F_{DL_high} for band 51. For band 50, the F_{DL_low} of band 51 is applied as F_{DL_low} for band 50.					
NOTE 3: For band 76 the F_{DL_high} of band 75 is applied as F_{DL_high} for band 76. For band 75, the F_{DL_low} of band 76 is applied as F_{DL_low} for band 75.					
NOTE 4: For UEs supporting both bands 38 and 41, the F_{DL_high} and F_{DL_low} of band 41 is applied as F_{DL_high} and F_{DL_low} for band 38.					
NOTE 5: n48 follows the requirement in this frequency range according to the general requirement defined in Clause 7.1. The power level of the interferer ($P_{interferer}$) for Range 3 shall be modified to -20 dBm for $F_{interferer} > 2700$ MHz and $F_{interferer} < 4800$ MHz.					

NOTE 6: The power level of the interferer ($P_{\text{Interferer}}$) for Range 3 shall be modified to -20 dBm for $F_{\text{Interferer}} > 2580$ MHz and $F_{\text{Interferer}} < 2775$ MHz.
 NOTE 7: For UE supporting both bands 25 and 70, the $F_{\text{DL_high}}$ of band 70 is applied as $F_{\text{DL_high}}$ for band 25, and the $F_{\text{DL_low}}$ of band 25 is applied as $F_{\text{DL_low}}$ for band 70.
 NOTE 8: For bands 91 and 93 the $F_{\text{DL_high}}$ of bands 92 and 94 are applied as $F_{\text{DL_high}}$ for bands 91 and 93. For bands 92 and 94, the $F_{\text{DL_low}}$ of bands 91 and 93 are applied as $F_{\text{DL_low}}$ for bands 92 and 94
 NOTE 9: For SDL bands, requirements shall be applied only for CA band combination cases.
 NOTE 10: For a UE supporting CA_20A-28A and higher order band combinations in which CA_20A-28A is a subset, the requirements for Band n20 and Band n28 apply with $F_{\text{DL_low}}$ given by the lower limit of the restricted operating frequency range in Band n28 and $F_{\text{DL_high}}$ by Band n20.

For interferer frequencies across ranges 1, 2 and 3 in Table 7.6.3-2, a maximum of

$$\lfloor \max \{ 24, 6 \cdot \lceil n \cdot N_{\text{RB}} / 6 \rceil \} / \min \{ \lfloor n \cdot N_{\text{RB}} / 10 \rfloor, 5 \} \rfloor$$

exceptions are allowed for spurious response frequencies in each assigned frequency channel when measured using a step size of $\min(BW_{\text{channel}}/2, 5)$ MHz with N_{RB} the number of resource blocks in the downlink transmission bandwidth configuration, BW_{Channel} the bandwidth of the frequency channel in MHz and $n = 1, 2, 3$ for SCS = 15, 30, 60 kHz, respectively. For these exceptions, the requirements in clause 7.7 apply.

For NR bands with $F_{\text{DL_low}} \geq 3300$ MHz and $F_{\text{UL_low}} \geq 3300$ MHz out-of-band band blocking is defined for an unwanted CW interfering signal falling outside a frequency range up to $3 \cdot BW_{\text{Channel}}$ below or from $3 \cdot BW_{\text{Channel}}$ above the UE receive band, where BW_{Channel} is the channel bandwidth. The throughput of the wanted signal shall be $\geq 95\%$ of the maximum throughput of the reference measurement channels as specified in Annexes A.2.2, A.3.2 and A.3.3 (with one sided dynamic OCNG Pattern OP.1 FDD/TDD for the DL-signal as described in Annex A.5.1.1/A.5.2.1) with parameters specified in Table 7.6.3-3 and Table 7.6.3-4. The relative throughput requirement shall be met for any SCS specified for the channel bandwidth of the wanted signal.

Table 7.6.3-3: Out-of-band blocking parameters for NR bands with $F_{\text{DL_low}} \geq 3300$ MHz and $F_{\text{UL_low}} \geq 3300$ MHz

RX parameter	Units	Channel bandwidth				
		10 MHz	15 MHz	20 MHz	25 MHz	30 MHz
Power in transmission bandwidth configuration	dBm	REFSENS + channel bandwidth specific value below				
	dB	6	7	9	9	9
RX parameter	Units	Channel bandwidth				
		40 MHz	50 MHz	60 MHz	70 MHz	80 MHz
Power in transmission bandwidth configuration	dBm	REFSENS + channel bandwidth specific value below				
	dB	9	9	9	9	9
RX parameter	Units	Channel bandwidth				
		90 MHz	100 MHz			
Power in transmission bandwidth configuration	dBm	REFSENS + channel bandwidth specific value below				
	dB	9	9			
NOTE: The transmitter shall be set to 4 dB below $P_{\text{CMAX_L,f,c}}$ at the minimum UL configuration specified in Table 7.3.2-3 with $P_{\text{CMAX_L,f,c}}$ defined in clause 6.2.4.						

Table 7.6.3-4: Out of-band blocking for NR bands with $F_{\text{DL_low}} \geq 3300$ MHz and $F_{\text{UL_low}} \geq 3300$ MHz

NR band	Parameter	Unit	Range1	Range 2	Range 3
n77, n78 (NOTE 3)	$P_{\text{interferer}}$	dBm	-44	-30	-15
	$F_{\text{interferer}}$ (CW)	MHz	$-60 < f - F_{\text{DL_low}} \leq -3 \cdot BW_{\text{Channel}}$ or	$-200 < f - F_{\text{DL_low}} \leq -$ $\text{MAX}(60, 3 \cdot BW_{\text{Channel}})$	$1 \leq f \leq F_{\text{DL_low}} - \text{MAX}(200, 3 \cdot BW_{\text{Channel}})$

			$3 \cdot BW_{\text{Channel}} \leq f - F_{\text{DL_high}} < 60$	or $\text{MAX}(60, 3 \cdot BW_{\text{Channel}}) \leq f - F_{\text{DL_high}} < 200$	or $F_{\text{DL_high}} + \text{MAX}(200, 3 \cdot BW_{\text{Channel}}) \leq f \leq 12750$
n79 (NOTE 4)	$F_{\text{interferer}}$ (CW)	MHz	N/A	$-150 < f - F_{\text{DL_low}} \leq \text{MAX}(60, 3 \cdot BW_{\text{Channel}})$ or $\text{MAX}(60, 3 \cdot BW_{\text{Channel}}) \leq f - F_{\text{DL_high}} < 150$	$1 \leq f \leq F_{\text{DL_low}} - \text{MAX}(150, 3 \cdot BW_{\text{Channel}})$ or $F_{\text{DL_high}} + \text{MAX}(150, 3 \cdot BW_{\text{Channel}}) \leq f \leq 12750$
<p>NOTE 1: The power level of the interferer ($P_{\text{Interferer}}$) for Range 3 shall be modified to -20 dBm for $F_{\text{Interferer}} > 6000$ MHz.</p> <p>NOTE 2: BW_{Channel} denotes the channel bandwidth of the wanted signal</p> <p>NOTE 3: The power level of the interferer ($P_{\text{Interferer}}$) for Range 3 shall be modified to -20 dBm, for $F_{\text{Interferer}} > 2700$ MHz and $F_{\text{Interferer}} < 4800$ MHz. For $BW_{\text{Channel}} > 15$ MHz, the requirement for Range 1 is not applicable and Range 2 applies from the frequency offset of $3 \cdot BW_{\text{Channel}}$ from the band edge. For $BW_{\text{Channel}} > 60$ MHz, the requirement for Range 2 is not applicable and Range 3 applies from the frequency offset of $3 \cdot BW_{\text{Channel}}$ from the band edge.</p> <p>NOTE 4: The power level of the interferer ($P_{\text{Interferer}}$) for Range 3 shall be modified to -20 dBm, for $F_{\text{Interferer}} > 3650$ MHz and $F_{\text{Interferer}} < 5750$ MHz. For $BW_{\text{Channel}} > 40$ MHz, the requirement for Range 2 is not applicable and Range 3 applies from the frequency offset of $3 \cdot BW_{\text{Channel}}$ from the band edge.</p>					

For interferer frequencies across ranges 1, 2 and 3 in Table 7.6.3-4, a maximum of

$$\lfloor \max \{ 24, 6 \cdot \lceil n \cdot N_{\text{RB}} / 6 \rceil \} / \min \{ \lfloor n \cdot N_{\text{RB}} / 10 \rfloor, 5 \} \rfloor$$

exceptions are allowed for spurious response frequencies in each assigned frequency channel when measured using a step size of $\min(BW_{\text{channel}}/2, 5)$ MHz with N_{RB} the number of resource blocks in the downlink transmission bandwidth configuration, BW_{Channel} the bandwidth of the frequency channel in MHz and $n = 1, 2, 3$ for SCS = 15, 30, 60 kHz, respectively. For these exceptions, the requirements in clause 7.7 apply.

7.6.4 Narrow band blocking

This requirement is measure of a receiver's ability to receive a NR signal at its assigned channel frequency in the presence of an unwanted narrow band CW interferer at a frequency, which is less than the nominal channel spacing.

The relative throughput shall be ≥ 95 % of the maximum throughput of the reference measurement channels as specified in Annexes A.2.2, A.3.2 and A.3.3 (with one sided dynamic OCN Pattern OP.1 FDD/TDD for the DL-signal as described in Annex A.5.1.1/A.5.2.1) with parameters specified in Table 7.6.4-1. For operating bands with an unpaired DL part (as noted in Table 5.2-1), the requirements only apply for carriers assigned in the paired part.

Table 7.6.4-1: Narrow Band Blocking

NR band	Parameter	Unit	Channel Bandwidth										
			5 MHz	10 MHz	15 MHz	20 MHz	25 MHz	30 MHz	40 MHz	50 MHz	60 MHz	80 MHz	90 MHz
n1, n2, n3, n5, n7, n8, n12, n14, n18, n20, n25, n26, n28, n29,	P_w	dBm	P _{REFSENS} + channel-bandwidth specific value below										

n30, n34, n38, n39, n40, n41, n48, n50, n51, n53, n65, n66, n70, n71, n74, n75, n76														
		dB	16	13	14	16	16	16	16	16	16	16	16	16
	P _{UW} (CW)	dBm	-55	-55	-55	-55	-55	-55	-55	-55	-55	-55	-55	-55
	F _{UW} (offset SCS= 15 kHz)	MHz	2.707 5	5.212 5	7.702 5	10.20 75	13.02 75	15.60 75	20.55 75	25.70 25	NA	NA	NA	NA
F _{UW} (offset SCS= 30 kHz)	MHz	NA	NA	NA	NA	NA	NA	NA	NA	30.85 5	40.93 5	45.91 5	50.86 5	
NOTE 1: The transmitter shall be set a 4 dB below P _{C_{MAX}L,f,c} at the minimum UL configuration specified in Table 7.3.2-3 with P _{C_{MAX}L,f,c} defined in clause 6.2.4														
NOTE 2: Reference measurement channel is specified in Annexes A.3.2 and A.3.3 with one sided dynamic OCNG Pattern OP.1 FDD/TDD as described in Annex A.5.1.1/A.5.2.1.														
NOTE 3: The P _{REFSENS} power level is specified in Table 7.3.2-1 and Table 7.3.2-2 for two and four antenna ports, respectively.														
NOTE 4: For SDL bands, requirements shall be applied only for CA band combination cases.														

7.6A Blocking characteristics for CA

7.6A.1 General

7.6A.2 In-band blocking for CA

7.6A.2.1 In-band blocking for Intra-band contiguous CA

For intra-band contiguous carrier aggregation the downlink SCC(s) shall be configured at nominal channel spacing to the PCC. The UE shall fulfil the minimum requirement specified in Table 7.6A.2.1-1 and 7.6A.2.1-a for an adjacent channel interferer on either side of the aggregated downlink signal at a specified frequency offset and for an interferer power up to -25 dBm. The throughput of each carrier shall be ≥ 95% of the maximum throughput of the reference measurement channels as specified in Annexes A.2.2, A.3.2, and A.3.3 (with one sided dynamic OCNG Pattern OP.1 FDD/TDD for the DL-signal as described in Annex A.5.1.1/A.5.2.1).

D/TDD for the DL-signal as described in Annex A.5.1.1/A.5.2.1).

Table 7.6A.2.1-1: In-band blocking parameters for intra-band contiguous CA with F_{DL_low} ≥ 3300 MHz and F_{UL_low} ≥ 3300 MHz

Rx Parameter	Units	NR CA bandwidth class			
		B	C	D	
P _w in Transmission Bandwidth Configuration, per CC	dBm	REFSENS + CA bandwidth class specific value below			
	dB	10.0	6	13.8	
BW _{interferer}	MHz	20	BW _{channel CA}	50	

$F_{\text{offset, case 1}}$	MHz	30	$BW_{\text{channel CA}} + BW_{\text{channel CA}/2}$	75	
$F_{\text{offset, case 2}}$	MHz	50	$BW_{\text{interferer}} + F_{\text{offset, case 1}}$	125	

NOTE 1: The transmitter shall be set to 4dB below $P_{\text{CMAX_L,f,c}}$ at the minimum UL configuration specified in Table 7.3.2-3 with $P_{\text{CMAX_L,f,c}}$ defined in clause 6.2.4.

NOTE 2: The interferer consists of the Reference measurement channel specified in Annexes A.3.2 and A.3.3 with one sided dynamic OCNG Pattern OP.1 FDD/TDD as described in Annex A.5.1.1/A.5.2.1 and set-up according to Annex C.3.1

Table 7.6A.2.1-1a: In-band blocking parameters for intra-band contiguous CA with $F_{\text{DL_low}} < 2700$ MHz and $F_{\text{UL_low}} < 2700$ MHz

Rx Parameter	Units	NR CA bandwidth class	
		B	C
Pw in Transmission Bandwidth Configuration, per CC	dBm	REFSENS + NR CA bandwidth class specific value below	
	dB	16.0	19.0
$BW_{\text{interferer}}$	MHz	5	5
$F_{\text{offset, case 1}}$	MHz	7.5	7.5
$F_{\text{offset, case 2}}$	MHz	12.5	12.5

NOTE 1: The transmitter shall be set to 4 dB below $P_{\text{CMAX_L,f,c}}$ at the minimum UL configuration specified in Table 7.3.2-3 with $P_{\text{CMAX_L,f,c}}$ defined in clause 6.2.4.

NOTE 2: The interferer consists of the Reference measurement channel specified in Annexes A.3.2 and A.3.3 with one sided dynamic OCNG Pattern OP.1 FDD/TDD as described in Annex A.5.1.1/A.5.2.1 and set-up according to Annex C.3.1

Table 7.6A.2.1-2: In-band blocking for intra-band contiguous CA with $F_{\text{DL_low}} \geq 3300$ MHz and $F_{\text{UL_low}} \geq 3300$ MHz

NR band	Parameter	Unit	Case 1	Case 2
	$P_{\text{interferer}}$	dBm	-56	-44
n77, n78, n79	$F_{\text{interferer}}$ (offset)	MHz	$-F_{\text{offset}} - F_{\text{offset, case 1}}$ and $F_{\text{offset}} + F_{\text{offset, case 1}}$	$\leq -F_{\text{offset}} - F_{\text{offset, case 2}}$ and $\geq F_{\text{offset}} + F_{\text{offset, case 2}}$
	$F_{\text{interferer}}$	MHz	NOTE 2	$F_{\text{DL_low}} - 3BW_{\text{channel CA}}$ to $F_{\text{DL_high}} + 3BW_{\text{channel CA}}$

NOTE 1: The absolute value of the interferer offset $F_{\text{interferer}}$ (offset) shall be further adjusted to $(\lceil |F_{\text{interferer}}| / SCS \rceil + 0.5) SCS$ MHz with SCS the sub-carrier spacing of the carrier closest to the interferer in MHz. The interferer is an NR signal with an SCS equal to that of the closest carrier.

NOTE 2: For each carrier frequency, the requirement applies for two interferer carrier frequencies: a: $-F_{\text{offset}} - F_{\text{offset, case 1}}$; b: $F_{\text{offset}} + F_{\text{offset, case 1}}$

NOTE 3: $BW_{\text{channel CA}}$ denotes the aggregated channel bandwidth of the wanted signal

Table 7.6A.2.1-2a: In-band blocking for intra-band contiguous CA with $F_{\text{DL_low}} < 2700$ MHz and $F_{\text{UL_low}} < 2700$ MHz

NR band	Parameter	Unit	Case 1	Case 2	Case 3
	$P_{\text{interferer}}$	dBm	-56	-44	
n41, n66, n48 ⁴ , n40	$F_{\text{interferer}}$ (offset)	MHz	$-F_{\text{offset}} - F_{\text{offset, case 1}}$ and $F_{\text{offset}} + F_{\text{offset, case 1}}$	$\leq -F_{\text{offset}} - F_{\text{offset, case 2}}$ and $\geq F_{\text{offset}} + F_{\text{offset, case 2}}$	
	$F_{\text{interferer}}$	MHz	NOTE 2	$F_{\text{DL_low}} - 15$ to $F_{\text{DL_high}} + 15$	
n71	$F_{\text{interferer}}$	MHz	NOTE 2	$F_{\text{DL_low}} - 12$ to $F_{\text{DL_high}} + 15$	$F_{\text{DL_low}} - 12$

NOTE 1: The absolute value of the interferer offset $F_{\text{interferer}}$ (offset) shall be further adjusted to $(\lceil |F_{\text{interferer}}| / SCS \rceil + 0.5) SCS$ MHz with SCS the sub-carrier spacing of the carrier closest to the interferer in MHz. The interferer is an NR signal with 15 kHz SCS.

NOTE 2: For each carrier frequency, the requirement applies for two interferer carrier frequencies: a: $-F_{\text{offset}} - F_{\text{offset}}$, case 1; b: $F_{\text{offset}} + F_{\text{offset}}$, case 1
 NOTE 3: $BW_{\text{channel CA}}$ denotes the aggregated channel bandwidth of the wanted signal
 NOTE 4: n48 follows the requirement in this frequency range according to the general requirement defined in Clause 7.1A.

7.6A.2.2 In-band blocking for Intra-band non-contiguous CA

For intra-band non-contiguous carrier aggregation with one uplink carrier and two or more downlink sub-blocks, each larger than or equal to 5 MHz, the in-band blocking requirements are defined with the uplink configuration in accordance with Table 7.3A.2.2-1. For this uplink configuration, the UE shall meet the requirements for each sub-block as specified in clause 7.6.2 and 7.6A.2.1 for one component carrier and two component carriers per sub-block, respectively. The requirements apply for in-gap and out-of-gap interferers while all downlink carriers are active.

The throughput of each carrier shall be $\geq 95\%$ of the maximum throughput of the reference measurement channels as specified in Annexes A.2.2, A.3.2, and A.3.3 (with one sided dynamic OCNG Pattern OP.1 FDD/TDD for the DL-signal as described in Annex A.5.1.1/A.5.2.1).

7.6A.2.3 In-band blocking for Inter-band CA

For inter-band carrier aggregation with one component carrier per operating band and the uplink assigned to one NR band, the in-band blocking requirements are defined with the uplink active on the band(s) other than the band whose downlink is being tested. The UE shall meet the requirements specified in clause 7.6.2 for each component carrier while all downlink carriers are active.

For the UE which supports inter-band CA configuration in Table 7.3A.3.2, $P_{\text{interferer}}$ power defined in Table 7.6.2-2 and 7.6.2-4 is increased by the amount given by $\Delta R_{\text{IB,c}}$ in Table 7.3A.3.2.

For NR CA configurations including an operating band without uplink operation or an operating band with an unpaired DL part (as noted in Table 5.2-1), the requirements for all downlinks shall be met with the single uplink carrier active in each band capable of UL operation. The requirements for the component carrier configured in the operating band without uplink operation are specified in clause 7.6.2 while all downlink carriers are active.

Table 7.6A.2.3-1: Void

The throughput of each carrier shall be $\geq 95\%$ of the maximum throughput of the reference measurement channels as specified in Annexes A.2.2, A.3.2, and A.3.3 (with one sided dynamic OCNG Pattern OP.1 FDD/TDD for the DL-signal as described in Annex A.5.1.1/A.5.2.1).

7.6A.3 Out-of-band blocking for CA

7.6A.3.1 Out-of-band blocking for Intra-band contiguous CA

For intra-band contiguous carrier aggregation the downlink SCC(s) shall be configured at nominal channel spacing to the PCC. For FDD, the PCC shall be configured closest to the uplink band. All downlink carriers shall be active throughout the test.

The UE shall fulfil the minimum requirement in presence of an interfering signal specified in Table 7.6A.3-1 and Table 7.6A.3-2 being on either side of the aggregated signal. The throughput of each carrier shall be $\geq 95\%$ of the maximum throughput of the reference measurement channels as specified in Annexes A.2.2, A.3.2, and A.3.3 (with one sided dynamic OCNG Pattern OP.1 FDD/TDD for the DL-signal as described in Annex A.5.1.1/A.5.2.1).

Table 7.6A.3-1: Out-of-band blocking parameters for intra-band contiguous CA

RX parameter	Units	CA bandwidth class		
		B	C	D
Power in transmission bandwidth configuration	dBm	REFSENS + CA bandwidth class specific value below		
	dB	9	9	9

NOTE 1: The transmitter shall be set to 4 dB below $P_{\text{CMAX_L,f,c}}$ at the minimum UL configuration specified in Table 7.3.2-3 with $P_{\text{CMAX_L,f,c}}$ defined in clause 6.2.4.

Table 7.6A.3-1a: Void

Table 7.6A.3-2: Out of-band blocking for intra-band contiguous CA

NR band	Parameter	Unit	Range 1	Range 2	Range 3
	$P_{\text{interferer}}$	dBm	-45	-30	-15
n41,n66,n71,n48 ⁵ ,n40	$F_{\text{interferer}}$ (CW)	MHz	$-60 < f - F_{\text{DL_low}} < -15$ or $15 < f - F_{\text{DL_high}} < 60$	$-85 < f - F_{\text{DL_low}} \leq -60$ or $60 \leq f - F_{\text{DL_high}} < 85$	$1 \leq f \leq F_{\text{DL_low}} - 85$ or $F_{\text{DL_high}} + 85 \leq f \leq 12750$
n77, n78 (NOTE 3)	$F_{\text{interferer}}$ (CW)	MHz	N/A	N/A	$1 \leq f \leq F_{\text{DL_low}} - \text{MAX}(200, 3 \cdot \text{BW}_{\text{Channel_CA}})$ or $F_{\text{DL_high}} + \text{MAX}(200, 3 \cdot \text{BW}_{\text{Channel_CA}}) \leq f \leq 12750$
n79 (NOTE 4)	$F_{\text{interferer}}$ (CW)	MHz	N/A	N/A	$1 \leq f \leq F_{\text{DL_low}} - \text{MAX}(150, 3 \cdot \text{BW}_{\text{Channel_CA}})$ or $F_{\text{DL_high}} + \text{MAX}(150, 3 \cdot \text{BW}_{\text{Channel_CA}}) \leq f \leq 12750$
NOTE 1: The power level of the interferer ($P_{\text{interferer}}$) for Range 3 shall be modified to -20 dBm for $F_{\text{interferer}} > 6000$ MHz.					
NOTE 2: $\text{BW}_{\text{Channel_CA}}$ denotes the aggregated channel bandwidth of the wanted signal					
NOTE 3: The power level of the interferer ($P_{\text{interferer}}$) for Range 3 shall be modified to -20 dBm, for $F_{\text{interferer}} > 2700$ MHz and $F_{\text{interferer}} < 4800$ MHz. For $\text{BW}_{\text{Channel_CA}} > 15$ MHz, the requirement for Range 1 is not applicable and Range 2 applies from the frequency offset of $3 \cdot \text{BW}_{\text{Channel_CA}}$ from the band edge. For $\text{BW}_{\text{Channel_CA}} > 60$ MHz, the requirement for Range 2 is not applicable and Range 3 applies from the frequency offset of $3 \cdot \text{BW}_{\text{Channel_CA}}$ from the band edge.					
NOTE 4: The power level of the interferer ($P_{\text{interferer}}$) for Range 3 shall be modified to -20 dBm, for $F_{\text{interferer}} > 3650$ MHz and $F_{\text{interferer}} < 5750$ MHz. For $\text{BW}_{\text{Channel_CA}} > 40$ MHz, the requirement for Range 2 is not applicable and Range 3 applies from the frequency offset of $3 \cdot \text{BW}_{\text{Channel_CA}}$ from the band edge.					
NOTE 5: The power level of the interferer ($P_{\text{interferer}}$) for Range 3 shall be modified to -20 dBm for $F_{\text{interferer}} > 2700$ MHz and $F_{\text{interferer}} < 4800$ MHz					

Table 7.6A.3-2a: Void

For interferer frequencies across ranges 1, 2 and 3 in Table 7.6A.3-2, a maximum of

$$\lfloor \max \{24, 6 \cdot \lceil n \cdot N_{\text{RB}} / 6 \rceil \} / \min \{ \lfloor n \cdot N_{\text{RB}} / 10 \rfloor, 5 \} \rfloor$$

exceptions are allowed for spurious response frequencies in each assigned frequency channel when measured using a step size of $\min \lfloor \frac{\text{BW}_{\text{channel}}}{2}, 5 \rfloor$ MHz with N_{RB} the number of resource blocks in the downlink transmission bandwidth configuration, $\text{BW}_{\text{Channel}}$ is the bandwidth of the frequency channel in MHz and $n = 1, 2, 3$ for SCS = 15, 30, 60 kHz, respectively. For these exceptions, the requirements in subclause 7.7A.1 apply.

7.6A.3.2 Out-of-band blocking for Intra-band non-contiguous CA

For intra-band non-contiguous carrier aggregation with one uplink carrier and two or more downlink sub-blocks, the out-of-band blocking requirements are defined with the uplink configuration in accordance with table 7.3A.2.2-1. For this uplink configuration, the UE shall meet the requirements for each sub-block as specified in clauses 7.6.3 and 7.6A.3.1 for one component carrier and two component carriers per sub-block, respectively. The requirements apply with all downlink carriers active.

The throughput of each carrier shall be $\geq 95\%$ of the maximum throughput of the reference measurement channels as specified in Annexes A.2.2, A.3.2, and A.3.3 (with one sided dynamic OCN Pattern OP.1 FDD/TDD for the DL-signal as described in Annex A.5.1.1/A.5.2.1).

7.6A.3.3 Out-of-band blocking for Inter-band CA

For inter-band carrier aggregation with one component carrier per operating band and the uplink assigned to one NR band, the out-of-band blocking requirements are defined with the uplink active on the band(s) other than the band whose downlink is being tested. For NR CA configurations including an operating band without uplink band or an operating band with an unpaired DL part (as noted in Table 5.2-1), the requirements for all downlinks shall be met with the single uplink carrier active in each band capable of UL operation. The UE shall meet the requirements specified in clause 7.6.3 for each component carrier while all downlink carriers are active.

For inter-band carrier aggregation with component carriers in operating bands $< 2.7\text{GHz}$ including n48, and for $F_{DL_Low(j)} - 15\text{ MHz} \leq f \leq F_{DL_High(j)} + 15\text{ MHz}$, the appropriate adjacent channel selectivity and in-band blocking requirements in the respective clauses 7.5 and 7.6.2 shall be applied for carrier j . For inter-band carrier aggregation with component carriers in operating bands $> 2.7\text{GHz}$ excluding n48, and for $F_{DL_Low(j)} - 3 * BW_{channel} \leq f \leq F_{DL_High(j)} + 3 * BW_{channel}$, the appropriate adjacent channel selectivity and in-band blocking requirements in the respective clauses 7.5 and 7.6.2 shall be applied for carrier j . $F_{DL_Low(j)}$ and $F_{DL_High(j)}$ denote the respective lower and upper frequency limits of the operating band containing carrier j , $j = 1, \dots, X$, with carriers numbered in increasing order of carrier frequency and X the number of component carriers in the band combination. $BW_{channel}$ denotes the channel bandwidth of the wanted signal component carrier j . If CW interferer falls in a gap between $F_{DL_High(j)}$ and $F_{DL_Low(j+1)}$ where the corresponding OOB ranges 1 and 2 overlap, then the lower level interferer limit of the overlapping OOB ranges applies.

If F_{DL_high} of the lower NR band is greater than or equal to the F_{DL_low} of the another upper NR band as in overlapping RX frequency ranges, then the OOB range shall start from the F_{DL_low} of the lower NR band, and from the F_{DL_high} of the upper NR band.

For inter-band carrier aggregation with uplink assigned to two NR bands, the out-of-band blocking requirements specified in clause 7.6.3 shall be met with the transmitter power for the uplink set to 7 dB below $P_{CMAX_L,f,c}$ for each serving cell c .

For the UE which supports inter-band CA configuration in Table 7.3A.3.2.1-1, $P_{interferer}$ power defined in Table 7.6.3-2 and 7.6.3-4 is increased by the amount given by $\Delta R_{IB,c}$ in Table 7.3A.3.2.1-1.

For inter-band CA combination listed in Table 7.6A.3.3-1, exceptions to the requirement specified in Table 7.6A.3.3-2 are allowed when the second order intermodulation product of the lower frequency band UL carrier and the CW interfering signal fully or partially overlaps with the higher frequency band DL carrier.

Table 7.6A.3.3-1: CA band combination with exceptions allowed

CA band combination
CA_n5-n77
CA_n5-n78
CA_n5-n79
CA_n8-n78
CA_n8-n79
CA_n20-n78
CA_n28-n77
CA_n28-n78
CA_n78-n92

Table 7.6A.3.3-2: Requirement for out-of-band blocking exceptions

Parameter	Unit	Level
$P_{interferer}$ (CW)	dBm	-44 ¹
NOTE 1: The requirement applies when $ f_{interferer} \pm f_{UL}^{LB} - f_{DL}^{HB} \leq (BW_{UL}^{LB} + BW_{DL}^{HB})/2$, where f_{UL}^{LB} and f_{DL}^{HB} are the carrier frequencies for lower frequency band UL and higher frequency band DL, respectively. BW_{UL}^{LB} and BW_{DL}^{HB} are the channel bandwidths configured for lower frequency band UL carrier and higher frequency band DL carrier in MHz, respectively.		

For all interferer frequency ranges specified in clause 7.6.3 a maximum of

$$\lfloor \max \{24, 6 \cdot \lceil n \cdot N_{RB} / 6 \rceil \} / \min \{ \lfloor n \cdot N_{RB} / 10 \rfloor, 5 \} \rfloor$$

exceptions are allowed for spurious response frequencies in each assigned frequency channel when measured using a step size of $\min(BW_{channel}/2, 5)$ MHz with N_{RB} the number of resource blocks in the downlink transmission bandwidth configuration, $BW_{channel}$ the bandwidth of the frequency channel in MHz and $n = 1, 2, 3$ for SCS = 15, 30, 60 kHz, respectively. For these exceptions, the requirements in clause 7.7 apply.

The throughput of each carrier shall be $\geq 95\%$ of the maximum throughput of the reference measurement channels as specified in Annexes A.2.2, A.3.2, and A.3.3 (with one sided dynamic OCNG Pattern OP.1 FDD/TDD for the DL-signal as described in Annex A.5.1.1/A.5.2.1).

7.6A.4 Narrow band blocking for CA

7.6A.4.1 Narrow band blocking for Intra-band contiguous CA

For intra-band contiguous carrier aggregation, the downlink SCC(s) shall be configured at nominal channel spacing to the PCC. For FDD, the PCC shall be configured closest to the uplink band. All downlink carriers shall be active throughout the test. The uplink output power shall be set as specified in Table 7.6A.4.1-1 with the uplink configuration. For UE(s) supporting one uplink, the uplink configuration of the PCC shall be in accordance with Table 7.3.2-3. The UE shall fulfil the minimum requirement in presence of an interfering signal specified in Table 7.6A.4.1-1 being on either side of the aggregated signal. The throughput of each carrier shall be $\geq 95\%$ of the maximum throughput of the reference measurement channels as specified in Annexes A.2.2, A.3.2 and A.3.3 (with one sided dynamic OCNG Pattern OP.1 FDD/TDD for the DL-signal as described in Annex A.5.1.1/A.5.2.1) with parameters specified in Table 7.6A.4.1-1.

Table 7.6A.4.1-1: Narrow-band blocking for intra-band contiguous CA

NR band	Parameter	Unit	NR CA bandwidth class	
			B	C
n1, n41, n66, n71, n48, n40	P _w in Transmission Bandwidth Configuration, per CC	dBm	REFSENS + NR CA Bandwidth Class specific value below	
		dB	16	16
	P _{uw} (CW)	dBm	-55	-55
	F _{uw} (offset for Δf = 15 kHz, 30 kHz)	MHz	- F _{offset} - 0.2 / + F _{offset} + 0.2	- F _{offset} - 0.2 / + F _{offset} + 0.2
NOTE 1: The transmitter shall be set a 4 dB below P _{C_{MAX}_L,f,c} at the minimum UL configuration specified in Table 7.3.2-3 with P _{C_{MAX}_L,f,c} defined in clause 6.2.4. NOTE 2: Reference measurement channel is specified in Annexes A.3.2 and A3.2 with one sided dynamic OCNG Pattern OP.1 FDD/TDD as described in Annex A.5.1.1/A.5.2.1. NOTE 3: The PREFSENS power level is specified in Table 7.3.2-1 and Table 7.3.2-2 for two and four antenna ports, respectively. NOTE 4: The F _{uw} (offset) is the frequency separation of the center frequency of the carrier closest to the interferer and the center frequency of the interferer and shall be further adjusted to $\lfloor F_{interferer} / SCS + 0.5 \rfloor SCS + 0.5 SCS$ MHz to be offset from the sub-carrier raster.				

7.6A.4.2 Narrow band blocking for Intra-band non-contiguous CA

For intra-band non-contiguous carrier aggregation with $F_{DL_low} < 2700$ MHz and $F_{UL_low} < 2700$ MHz with one uplink carrier and two or more downlink sub-blocks, the narrow band blocking requirements are defined with the uplink configuration in accordance with Table 7.3A.2.2-1. For this uplink configuration, the UE shall meet the requirements for each sub-block as specified in clauses 7.6.4 and 7.6A.4.1 for one component carrier and two component carriers per sub-block, respectively. The requirements apply for in-gap and out-of-gap interferers while all downlink carriers are active.

The throughput of each carrier shall be $\geq 95\%$ of the maximum throughput of the reference measurement channels as specified in Annexes A.2.2, A.3.2, and A.3.3 (with one sided dynamic OCNG Pattern OP.1 FDD/TDD for the DL-signal as described in Annex A.5.1.1/A.5.2.1).

7.6A.4.3 Narrow band blocking for Inter-band CA

For inter-band carrier aggregation with one component carrier per operating band and the uplink assigned to one NR band, the narrow band blocking requirements are defined with the uplink active on the band(s) other than the band whose downlink is being tested. For NR CA configurations including an operating band without uplink band or an operating band with an unpaired DL part (as noted in Table 5.2-1), the requirements for all downlinks shall be met with the single uplink carrier active in each band capable of UL operation. The UE shall meet the requirements specified in clause 7.6.4 for each component carrier while all downlink carriers are active.

For the UE which supports inter-band CA configuration in Table 7.3A.3.2.1-1, P_{UW} power defined in Table 7.6.4-1 is increased by the amount given by $\Delta R_{IB,c}$ in Table 7.3A.3.2.1-1.

The throughput of each carrier shall be $\geq 95\%$ of the maximum throughput of the reference measurement channels as specified in Annexes A.2.2, A.3.2, and A.3.3 (with one sided dynamic OCNG Pattern OP.1 FDD/TDD for the DL-signal as described in Annex A.5.1.1/A.5.2.1).

7.6B Blocking characteristics for NR-DC

For inter-band NR-DC configurations, the blocking characteristics for the corresponding inter-band CA configuration as specified in clause 7.6A applies.

7.6C Blocking characteristics for SUL

7.6C.1 General

7.6C.2 In-band blocking for SUL

For SUL operation, the in-band blocking requirement for downlink bands specified in clause 7.6.2 shall be met.

For SUL operation with downlink CA, the in-band blocking requirement for downlink bands specified in clause 7.6A.2 shall be met.

7.6C.3 Out-of-band blocking for SUL

For SUL operation, the out-of-band blocking requirement for downlink bands specified in clause 7.6.3 shall be met. For SUL operation with downlink CA, the out-of-band blocking requirement for downlink bands specified in clause 7.6A.3 shall be met. For operation band combination listed in Table 7.6C.3-1, exceptions to the requirement specified in Table 7.6C.3-2 are allowed when the second order intermodulation product of the SUL carrier and the CW interfering signal fully or partially overlaps with the DL carrier.

Table 7.6C.3-1: SUL operating band combination with exceptions allowed

NR Band combination for SUL
SUL_n78-n81
SUL_n78-n82
SUL_n78-n83
SUL_n79-n81

Table 7.6C.3-2: Requirement for out-of-band blocking exceptions

Parameter	Unit	Level
$P_{\text{Interferer (CW)}}$	dBm	-44 ¹

NOTE 1: The requirement applies when $|f_{Interferer} \pm f_{SUL} - f_{DL}| \leq (BW_{SUL} + BW_{DL})/2$, where BW_{SUL} and BW_{DL} are the channel bandwidths configured for SUL and DL (victim) bands in MHz, respectively.

For all interferer frequency ranges specified in clause 7.6.3 a maximum of

$$\lfloor \max \{24, 6 \cdot \lceil n \cdot N_{RB} / 6 \rceil \} / \min \{ \lfloor n \cdot N_{RB} / 10 \rfloor, 5 \} \rfloor$$

exceptions are allowed for spurious response frequencies in each assigned frequency channel when measured using a step size of $\min(BW_{channel}/2, 5)$ MHz with N_{RB} the number of resource blocks in the downlink transmission bandwidth configuration, $BW_{channel}$ the bandwidth of the frequency channel in MHz and $n = 1, 2, 3$ for SCS = 15, 30, 60 kHz, respectively. For these exceptions, the requirements in clause 7.7 apply.

7.6C.4 Narrow band blocking for SUL

Narrow band blocking is not specified for SUL band combination.

7.6D Blocking characteristics for UL MIMO

For UE with two transmitter antenna connectors in closed-loop spatial multiplexing scheme, the minimum requirements specified in clause 7.6 shall be met with the UL MIMO configurations described in clause 6.2D.1. For UL MIMO, the parameter P_{CMAX_L} is defined as the total transmitter power over the two transmit antenna connectors.

7.6E Blocking characteristics for V2X

7.6E.1 General

The blocking characteristic is a measure of the receiver's ability to receive a wanted signal at its assigned channel frequency in the presence of an unwanted interferer on frequencies other than those of the spurious response or the adjacent channels, without this unwanted input signal causing a degradation of the performance of the receiver beyond a specified limit. The blocking performance shall apply at all frequencies except those at which a spurious response occurs.

7.6E.2 In-band blocking

7.6E.2.1 General

The throughput of the wanted signal shall be $\geq 95\%$ of the maximum throughput of the reference measurement channels as specified in Annex A.7.2 with parameters specified in Table 7.6E.2.1-1 and Table 7.6E.2.1-2. The relative throughput requirement shall be met for any SCS specified for the channel bandwidth of the wanted signal.

Table 7.6E.2.1-1: In-band blocking parameters for NR V2X

RX parameter	Units	Channel bandwidth			
		10 MHz	20 MHz	30 MHz	40 MHz
Power in transmission bandwidth configuration	dBm	P _{REFSENS_V2X} + channel bandwidth specific value below			
	dB	6	9	11	12
BW _{interferer}	MHz	10			
F _{offset, case 1}	MHz	15			
F _{offset, case 2}	MHz	25			
NOTE 1: The interferer is QPSK modulated PUSCH containing data and reference symbols. Normal cyclic prefix is used.					

Table 7.6E.2.1-2: In-band blocking for NR V2X

NR band	Parameter	Unit	Case 1	Case 2
n38, n47	$P_{interferer}$	dBm	-44	-44
	$F_{interferer}$ (offset)	MHz	$-BW/2 - F_{offset, case 1}$ and $BW/2 + F_{offset, case 1}$	$\leq -BW/2 - F_{offset, case 2}$ and $\geq BW/2 + F_{offset, case 2}$
	$F_{interferer}$	MHz	NOTE 2	$F_{DL_low} - 30$ to $F_{DL_high} + 30$
NOTE 1: For certain bands, the unwanted modulated interfering signal may not fall inside the UE receive band, but within the first 15 MHz below or above the UE receive band.				
NOTE 2: For each carrier frequency the requirement is valid for two frequencies: a. the carrier frequency $-BW/2 - F_{offset, case 1}$ and b. the carrier frequency $+BW/2 + F_{offset, case 1}$				
NOTE 3: $F_{interferer}$ range values for unwanted modulated interfering signal are interferer center frequencies				
NOTE 4: The absolute value of the interferer offset $F_{interferer}$ (offset) shall be further adjusted to $(\lceil F_{interferer} / SCS \rceil + 0.5) SCS$ MHz with SCS the sub-carrier spacing of the wanted signal in MHz. The interferer is an NR signal with 15 kHz SCS.				

7.6E.2.2 In-band blocking for V2X concurrent operation

For the inter-band con-current NR V2X operation, the requirements specified in clause 7.6E.2.1 shall apply for the NR sidelink reception in the operating bands in Table 5.2E.2-1 and the requirements specified in clause 7.6.2 shall apply for the NR downlink reception in licensed band while all downlink carriers are active.

7.6E.3 Out-of-band blocking

7.6E.3.1 General

For NR V2X bands out-of-band band blocking is defined for an unwanted CW interfering signal falling outside a frequency range 30 MHz below or above the UE receive band. The throughput of the wanted signal shall be $\geq 95\%$ of the maximum throughput of the reference measurement channels as specified in Annexes A.7.2 with parameters specified in Table 7.6E.3.1-1 and Table 7.6E.3.1-2. The relative throughput requirement shall be met for any SCS specified for the channel bandwidth of the wanted signal.

Table 7.6E.3.1-1: Out-of-band blocking parameters for NR V2X

RX parameter	Units	Channel bandwidth			
		10 MHz	20 MHz	30 MHz	40 MHz
Power in transmission bandwidth configuration	dBm	P _{REFSENS_V2X} + channel bandwidth specific value below			
	dB	6	9	11	12
NOTE: Reference measurement channel is A.7.2.					

Table 7.6E.3.1-2: Out of-band blocking for NR V2X

NR band	Parameter	Units	Range 1	Range 2	Range 3
n47	$P_{interferer}$	dBm	-44	-30	-15
	$F_{interferer}$ (CW)	MHz	$F_{DL_low} - 30$ to $F_{DL_low} - 60$	$F_{DL_low} - 60$ to $F_{DL_low} - 85$	$F_{DL_low} - 85$ to 1 MHz
			$F_{DL_high} + 30$ to $F_{DL_high} + 60$	$F_{DL_high} + 60$ to $F_{DL_high} + 85$	$F_{DL_high} + 85$ to +12750 MHz
n38	$P_{interferer}$	dBm	-44	-30	-15
	$F_{interferer}$ (CW)	MHz	$F_{DL_low} - 30$ to $F_{DL_low} - 60$	$F_{DL_low} - 60$ to $F_{DL_low} - 85$	$F_{DL_low} - 85$ to 1 MHz
NOTE 1: The power level of the interferer ($P_{interferer}$) for Range 3 shall be modified to -20 dBm for $F_{interferer} > 4400$ MHz.					

7.6E.3.2 Out-of-band blocking for V2X concurrent operation

For the inter-band con-current NR V2X operation, the requirements specified in clause 7.6E.3.1 shall apply for the NR sidelink reception in Band n47 and the requirements specified in clause 7.6.3 shall apply for the NR downlink reception in licensed band while all downlink carriers are active.

7.6F Blocking characteristics

7.6F.1 General

The blocking characteristic is a measure of the receiver's ability to receive a wanted signal at its assigned channel frequency in the presence of an unwanted interferer on frequencies other than those of the spurious response or the adjacent channels, without this unwanted input signal causing a degradation of the performance of the receiver beyond a specified limit. The blocking performance shall apply at all frequencies except those at which a spurious response occurs.

7.6F.2 In-band blocking

7.6F.2.1 General

In-band blocking (IBB) is defined for an unwanted interfering signal falling into the UE receive band or into the first 60 MHz below or above the UE receive band. The throughput of the wanted signal shall be $\geq 95\%$ of the maximum throughput of the reference measurement channels as specified in Annexes A.2.2, A.3.2 and A.3.3 (with one sided dynamic OCNG Pattern OP.1 FDD/TDD for the DL-signal as described in Annex A.5.1.1/A.5.2.1) with parameters specified in Table 7.6F.2.1-1 and Table 7.6F.2.1-2. The relative throughput requirement shall be met for any SCS specified for the channel bandwidth of the wanted signal.

Table 7.6F.2.1-1: In-band blocking parameters for shared access bands

RX parameter	Units	Channel bandwidth			
		20 MHz	40 MHz	60 MHz	80 MHz
Power in transmission bandwidth configuration	dBm	REFSENS + channel bandwidth specific value below			
	dB	9	12	13.8	15
$BW_{interferer}$	MHz	20			
$F_{offset, case 1}$	MHz	30			
$F_{offset, case 2}$	MHz	≥ 50			

Table 7.6F.2.1-2: In-band blocking for shared access bands

Operating band	Parameter	Unit	Case 1	Case 2
	$P_{interferer}$	dBm	-56	-44
	$F_{interferer}$ (offset)	MHz	$-CBW/2 - F_{offset, case 1}$ and $CBW/2 + F_{offset, case 1}$	$\leq -CBW/2 - F_{offset, case 2}$ and $\geq CBW/2 + F_{offset, case 2}$
n46, n96	$F_{interferer}$		NOTE 2	$F_{DL_low} - 3*CBW$ to $F_{DL_high} + 3*CBW$, NOTE 4
<p>NOTE 1: The absolute value of the interferer offset $F_{interferer}$ (offset) shall be further adjusted to $(\lceil F_{interferer} / SCS \rceil + 0.5) SCS$ MHz with SCS the sub-carrier spacing of the wanted signal in MHz. The interferer is an NR signal with an SCS equal to that of the wanted signal.</p> <p>NOTE 2: For each carrier frequency, the requirement applies for two interferer carrier frequencies: a: $-CBW/2 - F_{offset, case 1}$; b: $CBW/2 + F_{offset, case 1}$</p>				

NOTE 3: CBW denotes the channel bandwidth of the wanted signal
 NOTE 4: Interferer carrier frequencies in the frequency range for Case 2 shall be located at discrete frequencies in integer multiples of 20 MHz offset from $-CBW/2 - F_{\text{offset, case 2}}$ and $CBW/2 + F_{\text{offset, case 2}}$

7.6F.2.2 Intra-band contiguous shared spectrum channel access CA

In-band blocking for intra-band contiguous shared access CA requirements are specified in Table 7.6F.2.2-1. These requirements apply for any SCS specified for the channel bandwidth of the wanted signal. For the test parameters specified in Table 7.6F.2.2-2, the throughput of each carrier shall be $\geq 95\%$ of the maximum throughput of the reference measurement channels as specified in Annexes A.2.2, A.3.2, and A.3.3 (with one sided dynamic OCNG Pattern OP.1 FDD/TDD for the DL-signal as described in Annex A.5.1.1/A.5.2.1).

Table 7.6F.2.2-1: In-band blocking parameters for intra-band contiguous shared access CA

Rx Parameter	Units	Shared access CA bandwidth class
		B, C, D, E, M, N, O
Pw in Transmission Bandwidth Configuration, per CC	dBm	REFSENS + aggregated channel bandwidth value below
	dB	$9 + 10\log_{10}(BW_{\text{Channel_CA}}/20)$
BW _{Interferer}	MHz	20
F _{offset, case 1}	MHz	30
F _{offset, case 2}	MHz	≥ 50
NOTE 1: The transmitter shall be set to 4dB below P _{C_{MAX}L_{f,c}} at the minimum UL configuration specified in Table 7.3.2-3 with P _{C_{MAX}L_{f,c}} defined in clause 6.2.4.		
NOTE 2: The interferer consists of the Reference measurement channel specified in Annexes A.3.2 and A.3.3 with one sided dynamic OCNG Pattern OP.1 FDD/TDD as described in Annex A.5.1.1/A.5.2.1 and set-up according to Annex C.3.1		

Table 7.6F.2.2-2: In-band blocking for intra-band contiguous shared access CA

Operating band	Parameter	Unit	Case 1	Case 2
	P _{interferer}	dBm	-56	-44
	F _{interferer (offset)}	MHz	$-BW_{\text{channel CA}}/2 - F_{\text{offset, case 1}}$ and $BW_{\text{channel CA}}/2 + F_{\text{offset, case 1}}$	$\leq -BW_{\text{channel CA}}/2 - F_{\text{offset, case 2}}$ and $\geq BW_{\text{channel CA}}/2 + F_{\text{offset, case 2}}$
n46	F _{interferer}	MHz	NOTE 2	$F_{\text{DL_low}} - 3 * BW_{\text{channel CA}}$ to $F_{\text{DL_high}} + 3 * BW_{\text{channel CA}}$ NOTE 4
NOTE 1: The absolute value of the interferer offset F _{interferer (offset)} shall be further adjusted to $(\lceil F_{\text{interferer}} / SCS \rceil + 0.5) SCS$ MHz with SCS the sub-carrier spacing of the carrier closest to the interferer in MHz. The interferer is an NR signal with an SCS equal to that of the closest carrier.				
NOTE 2: For each carrier frequency, the requirement applies for two interferer carrier frequencies: a: $-BW_{\text{channel CA}}/2 - F_{\text{offset, case 1}}$; b: $BW_{\text{channel CA}}/2 + F_{\text{offset, case 1}}$				
NOTE 3: BW _{channel CA} denotes the aggregated channel bandwidth of the wanted signal				
NOTE 4: Interferer carrier frequencies in the frequency range for Case 2 shall be located at discrete frequencies in integer multiples of 20 MHz offset from $-BW_{\text{channel CA}}/2 - F_{\text{offset, case 2}}$ and $BW_{\text{channel CA}}/2 + F_{\text{offset, case 2}}$				

7.6F.3 Out-of-band blocking

7.6F.3.1 General

Out-of-band blocking is defined for an unwanted CW interfering signal falling outside a frequency range 60 MHz or greater below or above the UE receive band. The throughput of the wanted signal shall be $\geq 95\%$ of the maximum throughput of the reference measurement channels as specified in Annexes A.2.2, A.3.2 and A.3.3 (with one sided

dynamic OCNG Pattern OP.1 FDD/TDD for the DL-signal as described in Annex A.5.1.1/A.5.2.1) with parameters specified in Table 7.6F.3.1-1 and Table 7.6F.3.1-2. The relative throughput requirement shall be met for any SCS specified for the channel bandwidth of the wanted signal.

Table 7.6F.3.1-1: Out-of-band blocking parameters for shared access bands

RX parameter	Units	Channel bandwidth			
		20 MHz	40 MHz	60 MHz	80 MHz
Power in transmission bandwidth configuration	dBm	REFSENS + channel bandwidth specific value below			
	dB	9			
NOTE 1: The transmitter shall be set to 4 dB below P _{C_{MAX}L,f,c} at the minimum UL configuration specified in Table 7.3.2-3 with P _{C_{MAX}L,f,c} defined in clause 6.2.4.					

Table 7.6F.3.1-2: Out of-band blocking for shared access bands

Operating band	Parameter	Unit	Range1	Range 2	Range 3
	P _{interferer}	dBm	-44	-30	-15
n46, n96	F _{interferer} (CW)	MHz	N/A	-200 < f - F _{DL_low} ≤ -3*CBW or 3*CBW ≤ f - F _{DL_high} < 200	1 ≤ f ≤ F _{DL_low} - MAX(200,3*CBW) or F _{DL_high} + MAX(200,3*CBW) ≤ f ≤ 12750
NOTE 1: The power level of the interferer (P _{interferer}) for Range 3 shall be modified to -20 dBm for F _{interferer} > 4200 MHz.					
NOTE 2: CBW denotes the channel bandwidth of the wanted signal					

For interferer frequencies across ranges 1, 2 and 3 in Table 7.6F.3-2, a maximum of

$$\lfloor \max \{ 24 \cdot 6 \cdot \lceil n \cdot N_{RB} / 6 \rceil \} / \min \{ \lfloor n \cdot N_{RB} / 10 \rfloor, 5 \} \rfloor$$

exceptions are allowed for spurious response frequencies in each assigned frequency channel when measured using a step size of $\min(\lfloor CBW / 2 \rfloor, 5)$ MHz with N_{RB} the number of resource blocks in the downlink transmission bandwidth configuration, CBW the bandwidth of the frequency channel in MHz and $n = 1, 2, 3$ for SCS = 15, 30, 60 kHz, respectively. For these exceptions, the requirements in clause 7.7F apply.

7.6F.3.2 Intra-band contiguous shared spectrum channel access CA

Out-of-band blocking for intra-band contiguous shared access CA requirements are specified in Table 7.6F.3.2-1. These requirements apply for any SCS specified for the channel bandwidth of the wanted signal. For the test parameters specified in Table 7.6F.3.2-2, the throughput of each carrier shall be ≥ 95 % of the maximum throughput of the reference measurement channels as specified in Annexes A.2.2, A.3.2, and A.3.3 (with one sided dynamic OCNG Pattern OP.1 FDD/TDD for the DL-signal as described in Annex A.5.1.1/A.5.2.1).

Table 7.6F.3.2-1: Out-of-band blocking parameters for intra-band contiguous shared access CA

Rx Parameter	Units	Shared access CA bandwidth class
		B, C, D, E, M, N, O
Pw in Transmission Bandwidth Configuration, per CC	dBm	REFSENS + CA bandwidth class specific value below
	dB	9
NOTE 1: The transmitter shall be set to 4dB below P _{C_{MAX}L,f,c} at the minimum UL configuration specified in Table 7.3.2-3 with P _{C_{MAX}L,f,c} defined in clause 6.2.4.		

Table 7.6F.3.2-2: Out of-band blocking for intra-band contiguous CA

Operating band	Parameter	Unit	Range 1	Range 2	Range 3
		$P_{interferer}$	dBm	-45	-30
n46	Finterferer (CW)	MHz	N/A	$-200 < f - F_{DL_low} \leq -3 * BW_{Channel_CA}$ or $3 * BW_{Channel_CA} \leq f - F_{DL_high} < 200$	$1 \leq f \leq F_{DL_low} - \text{MAX}(200, 3 * BW_{Channel_CA})$ or $F_{DL_high} + \text{MAX}(200, 3 * BW_{Channel_CA}) \leq f \leq 12750$
NOTE 1: The power level of the interferer ($P_{interferer}$) for Range 3 shall be modified to -20 dBm, for $F_{interferer} > 4200$ MHz.					

7.7 Spurious response

Spurious response is a measure of the ability of the receiver to receive a wanted signal on its assigned channel frequency without exceeding a given degradation due to the presence of an unwanted CW interfering signal at any other frequency for which a response is obtained, i.e. for which the out-of-band blocking limit as specified in clause 7.6.3 is not met.

The throughput shall be $\geq 95\%$ of the maximum throughput of the reference measurement channels as specified in Annexes A.2.2, A.3.2 and A.3.3 (with one sided dynamic OCNG Pattern OP.1 FDD/TDD for the DL-signal as described in Annex A.5.1.1/A.5.2.1) with parameters for the wanted signal as specified in Table 7.7-1 for NR bands with $F_{DL_high} < 2700$ MHz and $F_{UL_high} < 2700$ MHz and in Table 7.7-1a for NR bands with $F_{DL_high} \geq 3300$ MHz and $F_{UL_high} \geq 3300$ MHz and for the interferer as specified in Table 7.7-2. The relative throughput requirement shall be met for any SCS specified for the channel bandwidth of the wanted signal. For operating bands with an unpaired DL part (as noted in Table 5.2-1), the requirements only apply for carriers assigned in the paired part.

Table 7.7-1: Spurious response parameters for NR bands with $F_{DL_high} < 2700$ MHz and $F_{UL_high} < 2700$ MHz

RX parameter	Units	Channel bandwidth				
		5 MHz	10 MHz	15 MHz	20 MHz	25 MHz
Power in transmission bandwidth configuration	dBm	REFSENS + channel bandwidth specific value below				
	dB	6	6	7	9	10
RX parameter	Units	Channel bandwidth				
		30 MHz	40 MHz	50 MHz	60 MHz	80 MHz
Power in transmission bandwidth configuration	dBm	REFSENS + channel bandwidth specific value below				
	dB	11	12	13	14	15
RX parameter	Units	Channel bandwidth				
		90 MHz	100 MHz			
Power in transmission bandwidth configuration	dBm	REFSENS + channel bandwidth specific value below				
	dB	15.5	16			
NOTE 1: The transmitter shall be set to 4 dB below $P_{CMAX_L,f,c}$ at the minimum UL configuration specified in Table 7.3.2-3 with $P_{CMAX_L,f,c}$ defined in clause 6.2.4.						

Table 7.7.1-1a: Spurious response parameters for NR bands with $F_{DL_low} \geq 3300$ MHz and $F_{UL_low} \geq 3300$ MHz

RX parameter	Units	Channel bandwidth				
		10 MHz	15 MHz	20 MHz	25 MHz	30 MHz

Power in transmission bandwidth configuration	dBm	REFSENS + channel bandwidth specific value below				
	dB	6	7	9	9	9
RX parameter	Units	Channel bandwidth				
		40 MHz	50 MHz	60 MHz	70 MHz	80 MHz
Power in transmission bandwidth configuration	dBm	REFSENS + channel bandwidth specific value below				
	dB	9	9	9	9	9
RX parameter	Units	Channel bandwidth				
		90 MHz	100 MHz			
Power in transmission bandwidth configuration	dBm	REFSENS + channel bandwidth specific value below				
	dB	9	9			
NOTE 1: The transmitter shall be set to 4 dB below $P_{\text{CMAX_L,f,c}}$ at the minimum UL configuration specified in Table 7.3.2-3 with $P_{\text{CMAX_L,f,c}}$ defined in clause 6.2.4.						

Table 7.7-2: Spurious response

Parameter	Unit	Level
$P_{\text{Interferer}}$ (CW)	dBm	-44
$F_{\text{Interferer}}$	MHz	Spurious response frequencies

7.7A Spurious response for CA

7.7A.1 Spurious response for Intra-band contiguous CA

Table 7.7A-1: Spurious response parameters for intra-band contiguous CA

RX parameter	Units	NR CA bandwidth class			
		B	C	D	
Power in transmission bandwidth configuration	dBm	REFSENS + CA bandwidth class specific value below			
	dB	9	9	9	
NOTE 1: The transmitter shall be set to 4 dB below $P_{\text{CMAX_L,f,c}}$ at the minimum UL configuration specified in Table 7.3.2-3 with $P_{\text{CMAX_L,f,c}}$ defined in clause 6.2.4.					

Table 7.7A-2: Spurious response for CA

Parameter	Unit	Level
$P_{\text{Interferer}}$ (CW)	dBm	-44
$F_{\text{Interferer}}$	MHz	Spurious response frequencies

Table 7.7A-3: Void

Table 7.7A-4: void

7.7A.2 Spurious response for Intra-band non-contiguous CA

For intra-band non-contiguous carrier aggregation with one uplink carrier and two or more downlink sub-blocks, the spurious response requirements are defined with the uplink configuration in accordance with Table 7.3A.2.2-1. For this uplink configuration, the UE shall meet the requirements for each sub-block as specified in clauses 7.7 and 7.7A.1 for one component carrier and two component carriers per sub-block, respectively. The requirements apply with all downlink carriers active.

The throughput of each carrier shall be ≥ 95 % of the maximum throughput of the reference measurement channels as specified in Annexes A.2.2, A.3.2, and A.3.3 (with one sided dynamic OCNG Pattern OP.1 FDD/TDD for the DL-signal as described in Annex A.5.1.1/A.5.2.1).

7.7A.3 Spurious response for Inter-band CA

For inter-band carrier aggregation with one component carrier per operating band and the uplink assigned to one NR band, the spurious response are defined with the uplink active on the band(s) other than the band whose downlink is being tested. The UE shall meet the requirements specified in clause 7.7 for each component carrier while all downlink carriers are active.

For the UE which supports inter-band CA configuration in Table 7.3A.3.2.1-1, $P_{\text{interferer}}$ power defined in Table 7.7-2 is increased by the amount given by $\Delta R_{\text{IB,c}}$ in Table 7.3A.3.2.1-1.

The throughput of each carrier shall be ≥ 95 % of the maximum throughput of the reference measurement channels as specified in Annexes A.2.2, A.3.2, and A.3.3 (with one sided dynamic OCNG Pattern OP.1 FDD/TDD for the DL-signal as described in Annex A.5.1.1/A.5.2.1).

7.7B Spurious response for NR-DC

For inter-band NR-DC configurations, the spurious response for the corresponding inter-band CA configuration as specified in clause 7.7A applies.

7.7D Spurious response for UL MIMO

For UE with two transmitter antenna connectors in closed-loop spatial multiplexing scheme, the minimum requirements specified in clause 7.7 shall be met with the UL MIMO configurations described in clause 6.2D.1. For UL MIMO, the parameter $P_{\text{CMAX,L}}$ is defined as the total transmitter power over the two transmit antenna connectors.

7.7E Spurious response for V2X

7.7E.1 General

Spurious response is a measure of the receiver's ability to receive a wanted signal on its assigned channel frequency without exceeding a given degradation due to the presence of an unwanted CW interfering signal at any other frequency for which a response is obtained, i.e. for which the out-of-band blocking limit as specified in clause 7.6E.3.1 is not met.

The throughput shall be ≥ 95 % of the maximum throughput of the reference measurement channels as specified in Annexes A.7.2 with parameters for the wanted signal as specified in Table 7.7E.1-1 and Table 7.7E.1-2 for NR V2X bands. The relative throughput requirement shall be met for any SCS specified for the channel bandwidth of the wanted signal.

Table 7.7E.1-1: Spurious response parameters for NR V2X

RX parameter	Units	Channel bandwidth			
		10 MHz	20 MHz	30 MHz	40 MHz
Power in transmission bandwidth configuration	dBm	$P_{\text{REFSENS_V2X}}$ + channel bandwidth specific value below			
	dB	6	9	11	12

NOTE 1: Reference measurement channel is A.7.2

Table 7.7E.1-2: Spurious response for NR V2X

Parameter	Unit	Level
$P_{\text{Interferer}} \text{ (CW)}$	dBm	-44
$F_{\text{Interferer}}$	MHz	Spurious response frequencies

7.7E.2 Spurious response for V2X concurrent operation

For the inter-band con-current NR V2X operation, the requirements specified in clause 7.7E.1 shall apply for the NR sidelink reception in the operating bands in Table 5.2E.2-1 and the requirements specified in clause 7.7 shall apply for the NR downlink reception in licensed band while all downlink carriers are active.

7.7F Spurious response for shared spectrum channel access

7.7F.1 General

For spurious responses, the throughput of the wanted signal shall be $\geq 95\%$ of the maximum throughput of the reference measurement channels as specified in Annexes A.2.2, A.3.2 and A.3.3 (with one sided dynamic OCNNG Pattern OP.1 FDD/TDD for the DL-signal as described in Annex A.5.1.1/A.5.2.1) with parameters specified in Table 7.7F.1-1 and Table 7.7F.1-2. The relative throughput requirement shall be met for any SCS at any other frequency at which a response is obtained i.e. for which the limit as specified in clause 7.6F.3.1 is not met.

Table 7.7F.1-1: Spurious response parameters for shared access bands

RX parameter	Units	Channel bandwidth			
		20 MHz	40 MHz	60 MHz	80 MHz
Power in transmission bandwidth configuration	dBm	REFSENS + channel bandwidth specific value below			
	dB	9			
NOTE 1: The transmitter shall be set to 4 dB below $P_{\text{CMAX_L,f,c}}$ at the minimum UL configuration specified in Table 7.3.2-3 with $P_{\text{CMAX_L,f,c}}$ defined in clause 6.2.4.					

Table 7.7F.1-2: Spurious response for shared spectrum channel access

Parameter	Unit	Level
$P_{\text{Interferer}} \text{ (CW)}$	dBm	-44
$F_{\text{Interferer}}$	MHz	Spurious response frequencies

7.7F.2 Intra-band contiguous shared spectrum channel access CA

For spurious responses, the throughput of each carrier shall be $\geq 95\%$ of the maximum throughput of the reference measurement channels as specified in Annexes A.2.2, A.3.2, and A.3.3 (with one sided dynamic OCNNG Pattern OP.1 FDD/TDD for the DL-signal as described in Annex A.5.1.1/A.5.2.1) with parameters specified in Table 7.7F.2-1 and Table 7.7F.2-2. The relative throughput requirement shall be met for any SCS at any other frequency at which a response is obtained i.e. for which the limit as specified in clause 7.6F.3.2 is not met.

Table 7.7F.2-1: Spurious response parameters for intra-band contiguous shared access CA

Rx Parameter	Units	Shared access CA bandwidth class
		B, C, D, E, I, M, N, O
Pw in Transmission Bandwidth Configuration, per CC	dBm	REFSENS + CA bandwidth class specific value below
	dB	9

NOTE 1: The transmitter shall be set to 4dB below $P_{C_{MAX_L,f,c}}$ at the minimum UL configuration specified in Table 7.3.2-3 with $P_{C_{MAX_L,f,c}}$ defined in clause 6.2.4.

Table 7.7F.2-2: Spurious response for intra-band contiguous shared access CA

Parameter	Unit	Level
$P_{Interferer}$ (CW)	dBm	-44
$F_{Interferer}$	MHz	Spurious response frequencies

7.8 Intermodulation characteristics

7.8.1 General

Intermodulation response rejection is a measure of the capability of the receiver to receive a wanted signal on its assigned channel frequency in the presence of two or more interfering signals which have a specific frequency relationship to the wanted signal

7.8.2 Wide band Intermodulation

The wide band intermodulation requirement is defined using a CW carrier and modulated NR signal as interferer 1 and interferer 2 respectively.

The throughput shall be $\geq 95\%$ of the maximum throughput of the reference measurement channels as specified in Annexes A.2.2, A.3.2 and A.3.3 (with one sided dynamic OCNG Pattern OP.1 FDD/TDD for the DL-signal as described in Annex A.5.1.1/A.5.2.1) with parameters specified in Table 7.8.2-1 for NR bands with $F_{DL_high} < 2700$ MHz and $F_{UL_high} < 2700$ MHz and Table 7.8.2-2 for NR bands with $F_{DL_low} \geq 3300$ MHz and $F_{UL_low} \geq 3300$ MHz. The relative throughput requirement shall be met for any SCS specified for the channel bandwidth of the wanted signal. For operating bands with an unpaired DL part (as noted in Table 5.2-1), the requirements only apply for carriers assigned in the paired part.

Table 7.8.2-1: Wide band intermodulation parameters for NR bands with $F_{DL_high} < 2700$ MHz and $F_{UL_high} < 2700$ MHz

Rx parameter	Units	Channel bandwidth											
		5 MHz	10 MHz	15 MHz	20 MHz	25 MHz	30 MHz	40 MHz	50 MHz	60 MHz	80 MHz	90 MHz	100 MHz
P_w in Transmission Bandwidth Configuration, per CC	dBm	REFSENS + channel bandwidth specific value below											
	dB	6	6	7	9	10	11	12	13	14	15	15	16
$P_{Interferer\ 1}$ (CW)	dBm	-46											
$P_{Interferer\ 2}$ (Modulated)	dBm	-46											
$BW_{Interferer\ 2}$	MHz	5											
$F_{Interferer\ 1}$ (Offset)	MHz	$-BW_{Channel}/2 - 7.5$											
		$+BW_{Channel}/2 + 7.5$											
$F_{Interferer\ 2}$ (Offset)	MHz	$2 * F_{Interferer\ 1}$											
NOTE 1: The transmitter shall be set to 4 dB below $P_{C_{MAX_L,f,c}}$ at the minimum UL configuration specified in Table 7.3.2-3 with $P_{C_{MAX_L,f,c}}$ defined in clause 6.2.4.													
NOTE 2: Reference measurement channel is specified in Annexes A.2.2, A.2.3, A.3.2, and A.3.3 (with one sided dynamic OCNG Pattern OP.1 FDD/TDD for the DL-signal as described in Annex A.5.1.1/A.5.2.1).													
NOTE 3: The modulated interferer consists of the Reference measurement channel specified in Annexes A.3.2.2 and A.3.3.2 with one sided dynamic OCNG Pattern OP.1 FDD/TDD for the DL-signal as described in Annex A.5.1.1/A.5.2.1 and 15 kHz SCS.													

NOTE 4: The $F_{\text{interferer 1}}$ (offset) is the frequency separation of the center frequency of the carrier closest to the interferer and the center frequency of the CW interferer and $F_{\text{interferer 2}}$ (offset) is the frequency separation of the center frequency of the carrier closest to the interferer and the center frequency of the modulated interferer.

Table 7.8.2-2: Wide band intermodulation parameters for NR bands with $F_{\text{DL_low}} \geq 3300$ MHz and $F_{\text{UL_low}} \geq 3300$ MHz

Rx parameter	Units	Channel bandwidth							
		10 MHz	20 MHz	40 MHz	50 MHz	60 MHz	80 MHz	90 MHz	100 MHz
P_w in Transmission Bandwidth Configuration, per CC	dBm	REFSENS + 6 dB							
$P_{\text{Interferer 1}}$ (CW)	dBm	-46							
$P_{\text{Interferer 2}}$ (Modulated)	dBm	-46							
$BW_{\text{Interferer 2}}$	MHz	BW_{Channel}							
$F_{\text{Interferer 1}}$ (Offset)	MHz	- $2BW_{\text{Channel}}$ / $+2BW_{\text{Channel}}$							
$F_{\text{Interferer 2}}$ (Offset)	MHz	$2 * F_{\text{Interferer 1}}$							

NOTE 1: The transmitter shall be set to 4dB below $P_{\text{CMAX_L,f,c}}$ at the minimum UL configuration specified in Table 7.3.2-3 with $P_{\text{CMAX_L,f,c}}$ defined in clause 6.2.4.
 NOTE 2: Reference measurement channel is specified in Annexes A.2.2, A.3.2, and A.3.3 (with one sided dynamic OCNG Pattern OP.1 FDD/TDD for the DL-signal as described in Annex A.5.1.1/A.5.2.1).
 NOTE 3: The modulated interferer consists of the Reference measurement channel specified in Annexes A.3.2.2 and A.3.3.2 with one sided dynamic OCNG Pattern OP.1 FDD/TDD for the DL-signal as described in Annex A.5.1.1/A.5.2.1 and the same SCS as the wanted signal.
 NOTE 4: The $F_{\text{interferer 1}}$ (offset) is the frequency separation of the center frequency of the carrier closest to the interferer and the center frequency of the CW interferer and $F_{\text{interferer 2}}$ (offset) is the frequency separation of the center frequency of the carrier closest to the interferer and the center frequency of the modulated interferer.

7.8A Intermodulation characteristics for CA

7.8A.1 General

7.8A.2 Wide band intermodulation for CA

7.8A.2.1 Wide band intermodulation for Intra-band contiguous CA

Table 7.8A.2.1-1: Wide band intermodulation parameters for intra-band contiguous CA with $F_{\text{DL_low}} \geq 3300$ MHz and $F_{\text{UL_low}} \geq 3300$ MHz

Rx parameter	Units	NR CA bandwidth class			
		B	C	D	
P_w in Transmission Bandwidth Configuration, per CC	dBm	REFSENS + 10 dB	REFSENS + 6 dB	REFSENS + 13.8 dB	
$P_{\text{Interferer 1}}$ (CW)	dBm	-46			
$P_{\text{Interferer 2}}$ (Modulated)	dBm	-46			
$BW_{\text{Interferer 2}}$	MHz	20	$BW_{\text{Channel_CA}}$	50	
$F_{\text{Interferer 1}}$ (Offset)	MHz	- $F_{\text{offset}}-30$ / $F_{\text{offset}}+30$	- $2BW_{\text{Channel_CA}}$ / $+2BW_{\text{Channel_CA}}$	- $F_{\text{offset}}-75$ / $F_{\text{offset}}+75$	

$F_{\text{Interferer 2}}$ (Offset)	MHz		$2 \cdot F_{\text{Interferer 1}}$
<p>NOTE 1: The transmitter shall be set to 4 dB below $P_{\text{CMAX_L,f,c}}$ at the minimum UL configuration specified in Table 7.3.2-3 with $P_{\text{CMAX_L,f,c}}$ defined in clause 6.2.4.</p> <p>NOTE 2: Reference measurement channel is specified in Annexes A.2.2, A.3.2, and A.3.3 (with one sided dynamic OCNG Pattern OP.1 FDD/TDD for the DL-signal as described in Annex A.5.1.1/A.5.2.1).</p> <p>NOTE 3: The modulated interferer consists of the Reference measurement channel specified in Annexes A.3.2.2 and A.3.3.2 with one sided dynamic OCNG Pattern OP.1 FDD/TDD for the DL-signal as described in Annex A.5.1.1/A.5.2.1 and the same SCS as the closest carrier.</p> <p>NOTE 4: The $F_{\text{Interferer 1}}$ (offset) is the frequency separation of the center frequency of the carrier closest to the interferer and the center frequency of the CW interferer and $F_{\text{Interferer 2}}$ (offset) is the frequency separation of the center frequency of the carrier closest to the interferer and the center frequency of the modulated interferer.</p>			

Table 7.8A.2.1-2: Wide band intermodulation parameters for intra-band contiguous CA with $F_{\text{DL_low}} < 2700$ MHz and $F_{\text{UL_low}} < 2700$ MHz

Rx parameter	Units	NR CA bandwidth class	
		B	C
P_w in Transmission Bandwidth Configuration, per CC	dBm	REFSENS + 16 dB	REFSENS + 19 dB
$P_{\text{Interferer 1}}$ (CW)	dBm	-46	-46
$P_{\text{Interferer 2}}$ (Modulated)	dBm	-46	-46
$BW_{\text{Interferer 2}}$	MHz	5	5
$F_{\text{Interferer 1}}$ (Offset)	MHz	$-F_{\text{offset}} - 7.5$ / $F_{\text{offset}} + 7.5$	$-F_{\text{offset}} - 7.5$ / $F_{\text{offset}} + 7.5$
$F_{\text{Interferer 2}}$ (Offset)	MHz	$2 \cdot F_{\text{Interferer 1}}$	$2 \cdot F_{\text{Interferer 1}}$
<p>NOTE 1: The transmitter shall be set to 4 dB below $P_{\text{CMAX_L,f,c}}$ at the minimum UL configuration specified in Table 7.3.2-3 with $P_{\text{CMAX_L,f,c}}$ defined in clause 6.2.4.</p> <p>NOTE 2: Reference measurement channel is specified in Annexes A.2.2, A.3.2, and A.3.3 (with one sided dynamic OCNG Pattern OP.1 FDD/TDD for the DL-signal as described in Annex A.5.1.1/A.5.2.1).</p> <p>NOTE 3: The modulated interferer consists of the Reference measurement channel specified in Annexes A.3.2.2 and A.3.3.2 with one sided dynamic OCNG Pattern OP.1 FDD/TDD for the DL-signal as described in Annex A.5.1.1/A.5.2.1 and the same SCS as the 15 kHz SCS.</p> <p>NOTE 4: The $F_{\text{Interferer 1}}$ (offset) is the frequency separation of the center frequency of the carrier closest to the interferer and the center frequency of the CW interferer and $F_{\text{Interferer 2}}$ (offset) is the frequency separation of the center frequency of the carrier closest to the interferer and the center frequency of the modulated interferer.</p>			

7.8A.2.2 Wide band intermodulation for Intra-band non-contiguous CA

For intra-band non-contiguous carrier aggregation with one uplink carrier and two or more downlink sub-blocks, the wide band intermodulation requirements are defined with the uplink configuration in accordance with Table 7.3A.2.2-1. For this uplink configuration, the UE shall meet the requirements for each sub-block as specified in clause 7.8.2 and 7.8A.2.1 for one component carrier and two component carriers per sub-block, respectively. The requirements apply for out-of-gap interferers while all downlink carriers are active.

The throughput of each carrier shall be ≥ 95 % of the maximum throughput of the reference measurement channels as specified in Annexes A.2.2, A.3.2, and A.3.3 (with one sided dynamic OCNG Pattern OP.1 FDD/TDD for the DL-signal as described in Annex A.5.1.1/A.5.2.1).

7.8A.2.3 Wide band intermodulation for Inter-band CA

For inter-band carrier aggregation with one component carrier per operating band and the uplink assigned to one NR band, the wide band intermodulation requirements are defined with the uplink active on the band(s) other than the band whose downlink is being tested. The UE shall meet the requirements specified in clause 7.8 for each component carrier while all downlink carriers are active.

For the UE which supports inter-band CA configuration in Table 7.3A.3.2.1-1, $P_{\text{interferer}}$ power defined in Table 7.8.2-1 and 7.8.2-2 is increased by the amount given by $\Delta R_{\text{IB,c}}$ in Table 7.3A.3.2.1-1.

The throughput of each carrier shall be $\geq 95\%$ of the maximum throughput of the reference measurement channels as specified in Annexes A.2.2, A.3.2, and A.3.3 (with one sided dynamic OCNG Pattern OP.1 FDD/TDD for the DL-signal as described in Annex A.5.1.1/A.5.2.1).

7.8B Intermodulation characteristics for NR-DC

For inter-band NR-DC configurations, the intermodulation characteristics for the corresponding inter-band CA configuration as specified in clause 7.8A applies.

7.8D Intermodulation characteristics for UL MIMO

For UE(s) with two transmitter antenna connectors in closed-loop spatial multiplexing scheme, the minimum requirements in clause 7.8 shall be met with the UL MIMO configurations described in clause 6.2D.1. For UL MIMO, the parameter $P_{\text{CMAX,L}}$ is defined as the total transmitter power over the two transmit antenna connectors.

7.8E Intermodulation characteristics for V2X

7.8E.1 General

Intermodulation response rejection is a measure of the capability of the receiver to receive a wanted signal on its assigned channel frequency in the presence of two or more interfering signals which have a specific frequency relationship to the wanted signal.

7.8E.2 Wide band Intermodulation

7.8E.2.1 General

The wide band intermodulation requirement is defined using modulated NR carrier and a CW signal as interferer 1 and interferer 2 respectively. The throughput shall be $\geq 95\%$ of the maximum throughput of the reference measurement channels as specified in Annexes A.7.2 with parameters specified in Table 7.8E.2-1 for NR V2X bands. The relative throughput requirement shall be met for any SCS specified for the channel bandwidth of the wanted signal.

Table 7.8E.2-1: Wide band intermodulation parameters for NR V2X

NR band	Rx parameter	Units	Channel bandwidth			
			10 MHz	20 MHz	30 MHz	40 MHz
n38, n47	Power in Transmission	dBm	$P_{\text{REFSENS_V2X}}$ + channel bandwidth specific value below			
	Bandwidth Configuration	dB	6	9	11	12
	$P_{\text{Interferer 1 (CW)}}$	dBm	-46			
	$P_{\text{Interferer 2 (Modulated)}}$	dBm	-46			
	$BW_{\text{Interferer 2}}$	MHz	10			
	$F_{\text{Interferer 1 (Offset)}}$	MHz	-BW/2 – 15 / +BW/2 + 15			
	$F_{\text{Interferer 2 (Offset)}}$	MHz	$2 * F_{\text{Interferer 1}}$			
NOTE 1: Reference measurement channel is A.7.2						
NOTE 2: The interferer is QPSK modulated PUSCH containing data and reference symbols. Normal cyclic prefix is used.						

7.8E.2.2 Wide band Intermodulation for V2X concurrent operation

For the inter-band con-current NR V2X operation, the requirements specified in clause 7.8E.2.1 shall apply for the NR sidelink reception in the operating bands in Table 5.2E.2-1 and the requirements specified in clause 7.8 shall apply for the NR downlink reception in licensed band while all downlink carriers are active.

7.8F Intermodulation characteristics for shared spectrum channel access

7.8F.1 General

Intermodulation response rejection is a measure of the capability of the receiver to receive a wanted signal on its assigned channel frequency in the presence of two or more interfering signals which have a specific frequency relationship to the wanted signal

7.8F.2 Wide band Intermodulation

The wide band intermodulation requirement is defined using a CW carrier and modulated NR signal as interferer 1 and interferer 2 respectively.

Instead of the general wideband intermodulation requirements specified in clause 7.8.2, the throughput shall be $\geq 95\%$ of the maximum throughput of the reference measurement channels as specified in Annexes A.2.2, A.3.2 and A.3.3 (with one sided dynamic OCNG Pattern OP.1 FDD/TDD for the DL-signal as described in Annex A.5.1.1/A.5.2.1) with parameters specified in Table 7.8F.2-1. The relative throughput requirement shall be met for any SCS specified for the channel bandwidth of the wanted signal.

Table 7.8F.2-1: Wide band intermodulation parameters for shared spectrum channel access

Rx parameter	Units	Channel bandwidth			
		20 MHz	40 MHz	60 MHz	80 MHz
P _w in Transmission Bandwidth Configuration, per CC	dBm	REFSENS + channel bandwidth specific value below			
	dB	9	12	13.8	15
P _{Interferer 1} (CW)	dBm	-46			
P _{Interferer 2} (Modulated)	dBm	-46			
BW _{Interferer 2}	MHz	20			
F _{Interferer 1} (Offset)	MHz	-BW/2 - 30 / +BW/2 + 30			
F _{Interferer 2} (Offset)	MHz	2 * F _{Interferer 1}			
NOTE 1: The transmitter shall be set to 4dB below P _{C_{MAX}L,f,c} at the minimum UL configuration specified in Table 7.3.2-3 with P _{C_{MAX}L,f,c} defined in clause 6.2.4.					
NOTE 2: Reference measurement channel is specified in Annexes A.2.2, A.3.2, and A.3.3 (with one sided dynamic OCNG Pattern OP.1 FDD/TDD for the DL-signal as described in Annex A.5.1.1/A.5.2.1).					
NOTE 3: The modulated interferer consists of the Reference measurement channel specified in Annexes A.3.2.2 and A.3.3.2 with one sided dynamic OCNG Pattern OP.1 FDD/TDD for the DL-signal as described in Annex A.5.1.1/A.5.2.1 and the same SCS as the wanted signal.					
NOTE 4: The F _{Interferer 1} (offset) is the frequency separation of the center frequency of the carrier closest to the interferer and the center frequency of the CW interferer and F _{Interferer 2} (offset) is the frequency separation of the center frequency of the carrier closest to the interferer and the center frequency of the modulated interferer.					

7.9 Spurious emissions

The spurious emissions power is the power of emissions generated or amplified in a receiver that appear at the UE antenna connector.

The power of any narrow band CW spurious emission shall not exceed the maximum level specified in Table 7.9-1

Table 7.9-1: General receiver spurious emission requirements

Frequency range	Measurement bandwidth	Maximum level	NOTE
$30 \text{ MHz} \leq f < 1 \text{ GHz}$	100 kHz	-57 dBm	
$1 \text{ GHz} \leq f \leq 12.75 \text{ GHz}$	1 MHz	-47 dBm	
$12.75 \text{ GHz} \leq f \leq 5^{\text{th}}$ harmonic of the upper frequency edge of the DL operating band in GHz	1 MHz	-47 dBm	2
12.75 GHz – 26 GHz	1 MHz	-47 dBm	3
NOTE 1: Unused PDCCH resources are padded with resource element groups with power level given by PDCCH as defined in Annex C.3.1.			
NOTE 2: Applies for Band that the upper frequency edge of the DL Band more than 2.69 GHz.			
NOTE 3: Applies for Band that the upper frequency edge of the DL Band more than 5.2 GHz.			

7.9A Spurious emissions for CA

7.9A.1 Void

7.9A.2 Void

7.9A.3 Spurious emissions for Inter-band CA

For inter-band carrier aggregation including an operating band without uplink band, the UE shall meet the Rx spurious emissions requirements specified in clause 7.9 for each component carrier while all downlink carriers are active.

7.9B Spurious emissions for NR-DC

For inter-band NR-DC configurations, the spurious emissions for the corresponding inter-band CA configuration as specified in clause 7.9A applies.

Annex A (normative): Measurement channels

A.1 General

The throughput values defined in the measurement channels specified in Annex A, are calculated and are valid per datastream (codeword). For multi-stream (more than one codeword) transmissions, the throughput referenced in the minimum requirements is the sum of throughputs of all datastreams (codewords).

The UE category entry in the definition of the reference measurement channel in Annex A is only informative and reveals the UE categories, which can support the corresponding measurement channel. Whether the measurement channel is used for testing a certain UE category or not is specified in the individual minimum requirements.

A.2 UL reference measurement channels

A.2.1 General

The measurement channels in the following clauses are defined to derive the requirements in clause 6 (Transmitter Characteristics) and clause 7 (Receiver Characteristics). The measurement channels represent example configurations of physical channels for different data rates.

The measurement channels in the following clauses are applicable to both FDD and TDD.

The active uplink slots for TDD configurations are specified in table A.2.1-1. TDD slot patterns defined for reference sensitivity tests will be used for TDD UL RMCs. The active uplink slots configuration specified in Table A.2.1-2 and the additional TDD pattern in Table A.2.1-3 are used for shorter transient period capability EVM tests at 15 kHz SCS.

Table A.2.1-1: TDD active uplink slots

SCS	Active Uplink slots
15 kHz	4, 9
30 kHz	8, 9, 18, 19
60 kHz	16, 17, 18, 19, 36, 37, 38, 39

Table A.2.1-2: TDD active uplink slots for shorter transient period capability

SCS	Active Uplink slots
15 kHz	3,4

Table A.2.1-3: Additional TDD pattern for shorter transient period capability

Parameter		Value
		SCS 15 kHz (μ 0)
TDD Slot Configuration pattern (Note 1)		2DS2U
Special Slot Configuration (Note 2)		10D+2G+2U
referenceSubcarrierSpacing		15 kHz
UL-DL configuration	<i>dl-UL-TransmissionPeriodicity</i>	5 ms
	<i>nrofDownlinkSlots</i>	2
	<i>nrofDownlinkSymbols</i>	10
	<i>nrofUplinkSlot</i>	2

<i>nrofUplinkSymbols</i>	2
NOTE 1: D denotes a slot with all DL symbols; S denotes a slot with a mix of DL, UL and guard symbols; U denotes a slot with all UL symbols. The field is for information.	
NOTE 2: D, G, U denote DL, guard and UL symbols, respectively. The field is for information.	

A.2.2 Reference measurement channels

A.2.2.1 DFT-s-OFDM Pi/2-BPSK

Table A.2.2.1-1: Reference Channels for DFT-s-OFDM Pi/2-BPSK

Parameter	Allocated resource blocks (L _{CRB})	DFT-s-OFDM Symbols per slot (Note 1)	Modulation	MCS Index (Note 2)	Payload size	Transport block CRC	LDPC Base Graph	Number of code blocks per slot (Note 3)	Total number of bits per slot	Total modulated symbols per slot
Unit					Bits	Bits			Bits	
	1	11	pi/2 BPSK	0	24	16	2	1	132	132
	5	11	pi/2 BPSK	0	160	16	2	1	660	660
	9	11	pi/2 BPSK	0	288	16	2	1	1188	1188
	10	11	pi/2 BPSK	0	320	16	2	1	1320	1320
	12	11	pi/2 BPSK	0	384	16	2	1	1584	1584
	15	11	pi/2 BPSK	0	480	16	2	1	1980	1980
	18	11	pi/2 BPSK	0	576	16	2	1	2376	2376
	24	11	pi/2 BPSK	0	768	16	2	1	3168	3168
	25	11	pi/2 BPSK	0	808	16	2	1	3300	3300
	30	11	pi/2 BPSK	0	984	16	2	1	3960	3960
	32	11	pi/2 BPSK	0	1032	16	2	1	4224	4224
	36	11	pi/2 BPSK	0	1128	16	2	1	4752	4752
	45	11	pi/2 BPSK	0	1416	16	2	1	5940	5940
	50	11	pi/2 BPSK	0	1544	16	2	1	6600	6600
	60	11	pi/2 BPSK	0	1864	16	2	1	7920	7920
	64	11	pi/2 BPSK	0	2024	16	2	1	8448	8448
	75	11	pi/2 BPSK	0	2408	16	2	1	9900	9900
	80	11	pi/2 BPSK	0	2472	16	2	1	10560	10560
	81	11	pi/2 BPSK	0	2536	16	2	1	10692	10692
	90	11	pi/2 BPSK	0	2792	16	2	1	11880	11880
	100	11	pi/2 BPSK	0	3104	16	2	1	13200	13200
	108	11	pi/2 BPSK	0	3368	16	2	1	14256	14256
	120	11	pi/2 BPSK	0	3752	16	2	1	15840	15840
	128	11	pi/2 BPSK	0	3976	24	2	2	16896	16896
	135	11	pi/2 BPSK	0	4104	24	2	2	17820	17820
	160	11	pi/2 BPSK	0	4872	24	2	2	21120	21120
	162	11	pi/2 BPSK	0	5000	24	2	2	21384	21384
	180	11	pi/2 BPSK	0	5512	24	2	2	23760	23760
	216	11	pi/2 BPSK	0	6664	24	2	2	28512	28512
	243	11	pi/2 BPSK	0	7560	24	2	2	32076	32076
	270	11	pi/2 BPSK	0	8448	24	2	3	35640	35640

NOTE 1: PUSCH mapping Type-A and single-symbol DM-RS configuration Type-1 with 2 additional DM-RS symbols, such that the DM-RS positions are set to symbols 2, 7, 11. DMRS is [TDM'ed] with PUSCH data. DM-RS symbols are not counted.

NOTE 2: MCS Index is based on MCS table 6.1.4.1-1 defined in TS 38.214 [10].

NOTE 3: If more than one Code Block is present, an additional CRC sequence of L = 24 Bits is attached to each Code Block (otherwise L = 0 Bit)

NOTE 4: The RMCs apply to all channel bandwidth where L_{CRB} ≤ N_{RB}.

Table A.2.2.1-2: Void

Table A.2.2.1-3: Void

A.2.2.2 DFT-s-OFDM QPSK

Table A.2.2.2-1: Reference Channels for DFT-s-OFDM QPSK

Parameter	Allocated resource blocks (L _{CRB})	DFT-s-OFDM Symbols per slot (Note 1)	Modulation	MCS Index (Note 2)	Payload size	Transport block CRC	LDPC Base Graph	Number of code blocks per slot (Note 3)	Total number of bits per slot	Total modulated symbols per slot
Unit					Bits	Bits			Bits	
	1	11	QPSK	2	48	16	2	1	264	132
	5	11	QPSK	2	256	16	2	1	1320	660
	9	11	QPSK	2	456	16	2	1	2376	1188
	10	11	QPSK	2	504	16	2	1	2640	1320
	12	11	QPSK	2	608	16	2	1	3168	1584
	15	11	QPSK	2	768	16	2	1	3960	1980
	18	11	QPSK	2	928	16	2	1	4752	2376
	20	11	QPSK	2	1032	16	2	1	5280	2640
	24	11	QPSK	2	1192	16	2	1	6336	3168
	25	11	QPSK	2	1256	16	2	1	6600	3300
	30	11	QPSK	2	1544	16	2	1	7920	3960
	32	11	QPSK	2	1608	16	2	1	8448	4224
	36	11	QPSK	2	1800	16	2	1	9504	4752
	45	11	QPKS	2	2208	16	2	1	11880	5940
	50	11	QPSK	2	2472	16	2	1	13200	6600
	60	11	QPSK	2	3104	16	2	1	15840	7920
	64	11	QPSK	2	3240	16	2	1	16896	8448
	75	11	QPSK	2	3752	16	2	1	19800	9900
	80	11	QPSK	2	3976	24	2	2	21120	10560
	81	11	QPSK	2	4040	24	2	2	21384	10692
	90	11	QPSK	2	4488	24	2	2	23760	11880
	100	11	QPSK	2	5000	24	2	2	26400	13200
	108	11	QPSK	2	5384	24	2	2	28512	14256
	120	11	QPSK	2	5896	24	2	2	31680	15840
	128	11	QPSK	2	6408	24	2	2	33792	16896
	135	11	QPSK	2	6664	24	2	2	35640	17820
	160	11	QPSK	2	7944	24	2	3	42240	21120
	162	11	QPSK	2	8064	24	2	3	42768	21384
	180	11	QPSK	2	8976	24	2	3	47520	23760
	216	11	QPSK	2	10752	24	2	3	57024	28512
	243	11	QPSK	2	12040	24	2	4	64152	32076
	270	11	QPSK	2	13320	24	2	4	71280	35640

NOTE 1: PUSCH mapping Type-A and single-symbol DM-RS configuration Type-1 with 2 additional DM-RS symbols, such that the DM-RS positions are set to symbols 2, 7, 11. DMRS is [TDM'ed] with PUSCH data. DM-RS symbols are not counted.

NOTE 2: MCS Index is based on MCS table 6.1.4.1-1 defined in TS 38.214 [10].

NOTE 3: If more than one Code Block is present, an additional CRC sequence of L = 24 Bits is attached to each Code Block (otherwise L = 0 Bit)

NOTE 4: The RMCs apply to all channel bandwidth where L_{CRB} ≤ N_{RB}.

Table A.2.2.2-2: Void

Table A.2.2.2-3: Void

A.2.2.3 DFT-s-OFDM 16QAM

Table A.2.2.3-1: Reference Channels for DFT-s-OFDM 16QAM

Parameter	Allocated resource blocks (L _{CRB})	DFT-s-OFDM Symbols per slot (Note 1)	Modulation	MCS Index (Note 2)	Payload size	Transport block CRC	LDPC Base Graph	Number of code blocks per slot (Note 3)	Total number of bits per slot	Total modulated symbols per slot
Unit					Bits	Bits			Bits	
	1	11	16QAM	10	176	16	2	1	528	132
	5	11	16QAM	10	888	16	2	1	2640	660
	9	11	16QAM	10	1608	16	2	1	4752	1188
	10	11	16QAM	10	1800	16	2	1	5280	1320
	12	11	16QAM	10	2088	16	2	1	6336	1584
	15	11	16QAM	10	2664	16	2	1	7920	1980
	18	11	16QAM	10	3240	16	2	1	9504	2376
	24	11	16QAM	10	4224	24	1	1	12672	3168
	25	11	16QAM	10	4352	24	1	1	13200	3300
	30	11	16QAM	10	5248	24	1	1	15840	3960
	32	11	16QAM	10	5632	24	1	1	16896	4224
	36	11	16QAM	10	6272	24	1	1	19008	4752
	45	11	16QAM	10	7808	24	1	1	23760	5940
	50	11	16QAM	10	8712	24	1	2	26400	6600
	60	11	16QAM	10	10504	24	1	2	31680	7920
	64	11	16QAM	10	11272	24	1	2	33792	8448
	75	11	16QAM	10	13064	24	1	2	39600	9900
	80	11	16QAM	10	14088	24	1	2	42240	10560
	81	11	16QAM	10	14088	24	1	2	42768	10692
	100	11	16QAM	10	17424	24	1	3	52800	13200
	108	11	16QAM	10	18960	24	1	3	57024	14256
	120	11	16QAM	10	21000	24	1	3	63360	15840
	128	11	16QAM	10	22536	24	1	3	67584	16896
	135	11	16QAM	10	23568	24	1	3	71280	17820
	160	11	16QAM	10	28168	24	1	4	84480	21120
	162	11	16QAM	10	28168	24	1	4	85536	21384
	216	11	16QAM	10	37896	24	1	5	114048	28512
	243	11	16QAM	10	43032	24	1	6	128304	32076
	270	11	16QAM	10	47112	24	1	6	142560	35640

NOTE 1: PUSCH mapping Type-A and single-symbol DM-RS configuration Type-1 with 2 additional DM-RS symbols, such that the DM-RS positions are set to symbols 2, 7, 11. DMRS is [TDM'ed] with PUSCH data. DM-RS symbols are not counted.

NOTE 2: MCS Index is based on MCS table 6.1.4.1-1 defined in TS 38.214 [10].

NOTE 3: If more than one Code Block is present, an additional CRC sequence of L = 24 Bits is attached to each Code Block (otherwise L = 0 Bit)

NOTE 4: The RMCs apply to all channel bandwidth where L_{CRB} ≤ N_{RB}.

Table A.2.2.3-2: Void

Table A.2.2.3-3: Void

A.2.2.4 DFT-s-OFDM 64QAM

Table A.2.2.4-1: Reference Channels for DFT-s-OFDM 64QAM

Parameter	Allocated resource blocks (L _{CRB})	DFT-s-OFDM Symbols per slot (Note 1)	Modulation	MCS Index (Note 2)	Payload size	Transport block CRC	LDPC Base Graph	Number of code blocks per slot (Note 3)	Total number of bits per slot	Total modulated symbols per slot
Unit					Bits	Bits			Bits	
	1	11	64QAM	18	408	16	2	1	792	132
	5	11	64QAM	18	2024	16	2	1	3960	660
	9	11	64QAM	18	3624	16	2	1	7128	1188
	10	11	64QAM	18	3968	24	1	1	7920	1320
	12	11	64QAM	18	4736	24	1	1	9504	1584
	15	11	64QAM	18	6016	24	1	1	11880	1980
	18	11	64QAM	18	7168	24	1	1	14256	2376
	24	11	64QAM	18	9480	24	1	2	19008	3168
	25	11	64QAM	18	9992	24	1	2	19800	3300
	30	11	64QAM	18	12040	24	1	2	23760	3960
	32	11	64QAM	18	12808	24	1	2	25344	4224
	36	11	64QAM	18	14344	24	1	2	28512	4752
	45	11	64QAM	18	17928	24	1	3	35640	5940
	50	11	64QAM	18	19968	24	1	3	39600	6600
	60	11	64QAM	18	24072	24	1	3	47520	7920
	64	11	64QAM	18	25608	24	1	4	50688	8448
	75	11	64QAM	18	30216	24	1	4	59400	9900
	80	11	64QAM	18	31752	24	1	4	63360	10560
	81	11	64QAM	18	32264	24	1	4	64152	10692
	90	11	64QAM	18	35856	24	1	5	71280	11880
	100	11	64QAM	18	39936	24	1	5	79200	13200
	108	11	64QAM	18	43032	24	1	6	85536	14256
	120	11	64QAM	18	48168	24	1	6	95040	15840
	128	11	64QAM	18	51216	24	1	7	101376	16896
	135	11	64QAM	18	54296	24	1	7	106920	17820
	160	11	64QAM	18	63528	24	1	8	126720	21120
	162	11	64QAM	18	64552	24	1	8	128304	21384
	180	11	64QAM	18	71688	24	1	9	142560	23760
	216	11	64QAM	18	86040	24	1	11	171072	28512
	243	11	64QAM	18	96264	24	1	12	192456	32076
	270	11	64QAM	18	108552	24	1	13	213840	35640

NOTE 1: PUSCH mapping Type-A and single-symbol DM-RS configuration Type-1 with 2 additional DM-RS symbols, such that the DM-RS positions are set to symbols 2, 7, 11. DMRS is [TDM'ed] with PUSCH data. DM-RS symbols are not counted.

NOTE 2: MCS Index is based on MCS table 6.1.4.1-1 defined in TS 38.214 [10].

NOTE 3: If more than one Code Block is present, an additional CRC sequence of L = 24 Bits is attached to each Code Block (otherwise L = 0 Bit)

NOTE 4: The RMCs apply to all channel bandwidth where L_{CRB} ≤ N_{RB}.

Table A.2.2.4-2: Void

Table A.2.2.4-3: Void

A.2.2.5 DFT-s-OFDM 256QAM

Table A.2.2.5-1: Reference Channels for DFT-s-OFDM 256QAM

Parameter	Allocated resource blocks (L _{CRB})	DFT-s-OFDM Symbols per slot (Note 1)	Modulation	MCS Index (Note 2)	Payload size	Transport block CRC	LDPC Base Graph	Number of code blocks per slot (Note 3)	Total number of bits per slot	Total modulated symbols per slot
Unit					Bits	Bits			Bits	
	1	11	256QAM	20	704	16	2	1	1056	132
	5	11	256QAM	20	3496	16	2	1	5280	660
	9	11	256QAM	20	6272	24	1	1	9504	1188
	10	11	256QAM	20	7040	24	1	1	10560	1320
	12	11	256QAM	20	8456	24	1	2	12672	1584
	15	11	256QAM	20	10504	24	1	2	15840	1980
	18	11	256QAM	20	12552	24	1	2	19008	2376
	24	11	256QAM	20	16896	24	1	3	25344	3168
	25	11	256QAM	20	17424	24	1	3	26400	3300
	30	11	256QAM	20	21000	24	1	3	31680	3960
	32	11	256QAM	20	22536	24	1	3	33792	4224
	36	11	256QAM	20	25104	24	1	3	38016	4752
	45	11	256QAM	20	31752	24	1	4	47520	5940
	50	11	256QAM	20	34816	24	1	5	52800	6600
	60	11	256QAM	20	42016	24	1	5	63360	7920
	64	11	256QAM	20	45096	24	1	6	67584	8448
	75	11	256QAM	20	53288	24	1	7	79200	9900
	80	11	256QAM	20	56368	24	1	7	84480	10560
	81	11	256QAM	20	57376	24	1	7	85536	10692
	90	11	256QAM	20	63528	24	1	8	95040	11880
	100	11	256QAM	20	69672	24	1	9	105600	13200
	108	11	256QAM	20	75792	24	1	9	114048	14256
	120	11	256QAM	20	83976	24	1	10	126720	15840
	128	11	256QAM	20	90176	24	1	11	135168	16896
	135	11	256QAM	20	94248	24	1	12	142560	17820
	160	11	256QAM	20	112648	24	1	14	168960	21120
	162	11	256QAM	20	114776	24	1	14	171072	21384
	180	11	256QAM	20	127080	24	1	16	190080	23760
	216	11	256QAM	20	151608	24	1	18	228096	28512
	243	11	256QAM	20	172176	24	1	21	256608	32076
	270	11	256QAM	20	188576	24	1	23	285120	35640

NOTE 1: PUSCH mapping Type-A and single-symbol DM-RS configuration Type-1 with 2 additional DM-RS symbols, such that the DM-RS positions are set to symbols 2, 7, 11. DMRS is [TDM'ed] with PUSCH data. DM-RS symbols are not counted.

NOTE 2: MCS Index is based on MCS table 5.1.3.1-2 defined in TS 38.214 [10].

NOTE 3: If more than one Code Block is present, an additional CRC sequence of L = 24 Bits is attached to each Code Block (otherwise L = 0 Bit)

NOTE 4: The RMCs apply to all channel bandwidth where L_{CRB} ≤ N_{RB}.

Table A.2.2.5-2: Void

Table A.2.2.5-3: Void

A.2.2.6 CP-OFDM QPSK

Table A.2.2.6-1: Reference Channels for CP-OFDM QPSK

Parameter	Allocated resource blocks (L _{CRB})	CP-OFDM Symbols per slot (Note 1)	Modulation	MCS Index (Note 2)	Payload size	Transport block CRC	LDPC Base Graph	Number of code blocks per slot (Note 3)	Total number of bits per slot	Total modulated symbols per slot
Unit					Bits	Bits			Bits	
	1	11	QPSK	2	48	16	2	1	264	132
	5	11	QPSK	2	256	16	2	1	1320	660
	6	11	QPSK	2	304	16	2	1	1584	792
	9	11	QPSK	2	456	16	2	1	2376	1188
	10	11	QPSK	2	504	16	2	1	2640	1320
	11	11	QPSK	2	552	16	2	1	2904	1452
	12	11	QPSK	2	608	16	2	1	3168	1584
	13	11	QPSK	2	672	16	2	1	3432	1716
	15	11	QPSK	2	768	16	2	1	3960	1980
	16	11	QPSK	2	808	16	2	1	4224	2112
	18	11	QPSK	2	928	16	2	1	4752	2376
	19	11	QPSK	2	984	16	2	1	5016	2508
	24	11	QPSK	2	1192	16	2	1	6336	3168
	25	11	QPSK	2	1256	16	2	1	6600	3300
	26	11	QPSK	2	1288	16	2	1	6864	3432
	31	11	QPSK	2	1544	16	2	1	8184	4092
	33	11	QPSK	2	1672	16	2	1	8712	4356
	38	11	QPSK	2	1928	16	2	1	10032	5016
	39	11	QPSK	2	2024	16	2	1	10296	5148
	40	11	QPSK	2	2024	16	2	1	10560	5280
	47	11	QPSK	2	2408	16	2	1	12408	6204
	51	11	QPSK	2	2536	16	2	1	13464	6732
	52	11	QPSK	2	2600	16	2	1	13728	6864
	53	11	QPSK	2	2664	16	2	1	13992	6996
	54	11	QPSK	2	2664	16	2	1	14256	7128
	61	11	QPSK	2	3104	16	2	1	16104	8052
	65	11	QPSK	2	3240	16	2	1	17160	8580
	67	11	QPSK	2	3368	16	2	1	17688	8844
	68	11	QPSK	2	3368	16	2	1	17952	8976
	78	11	QPSK	2	3848	24	2	2	20592	10296
	79	11	QPSK	2	3912	24	2	2	20856	10428
	80	11	QPSK	2	3976	24	2	2	21120	10560
	81	11	QPSK	2	4040	24	2	2	21384	10692
	93	11	QPSK	2	4616	24	2	2	24552	12276
	95	11	QPSK	2	4744	24	2	2	25080	12540
	106	11	QPSK	2	5256	24	2	2	27984	13992
	107	11	QPSK	2	5256	24	2	2	28248	14124
	108	11	QPSK	2	5384	24	2	2	28512	14256
	109	11	QPSK	2	5384	24	2	2	28776	14388
	121	11	QPSK	2	6024	24	2	2	31944	15972
	123	11	QPSK	2	6152	24	2	2	32472	16236
	133	11	QPSK	2	6664	24	2	2	35112	17556
	135	11	QPSK	2	6664	24	2	2	35640	17820
	137	11	QPSK	2	6792	24	2	2	36168	18084
	160	11	QPSK	2	7944	24	2	3	42240	21120
	162	11	QPSK	2	8064	24	2	3	42768	21384
	189	11	QPSK	2	9480	24	2	3	49896	24948
	216	11	QPSK	2	10752	24	2	3	57024	28512
	217	11	QPSK	2	10752	24	2	3	57288	28644
	245	11	QPSK	2	12296	24	2	4	64680	32340
	270	11	QPSK	2	13320	24	2	4	71280	35640
	273	11	QPSK	2	13576	24	2	4	72072	36036

NOTE 1: PUSCH mapping Type-A and single-symbol DM-RS configuration Type-1 with 2 additional DM-RS symbols, such that the DM-RS positions are set to symbols 2, 7, 11. DM-RS is [TDM'ed] with PUSCH data. DM-RS symbols are not counted.

NOTE 2: MCS Index is based on MCS table 5.1.3.1-1 defined in TS 38.214 [10].

NOTE 3: If more than one Code Block is present, an additional CRC sequence of $L = 24$ Bits is attached to each Code Block (otherwise $L = 0$ Bit)

NOTE 4: The RMCs apply to all channel bandwidth where $L_{CRB} \leq N_{RB}$.

Table A.2.2.6-2: Void

Table A.2.2.6-3: Void

A.2.2.7 CP-OFDM 16QAM

Table A.2.2.7-1: Reference Channels for CP-OFDM 16QAM

Parameter	Allocated resource blocks (L _{CRB})	CP-OFDM Symbols per slot (Note 1)	Modulation	MCS Index (Note 2)	Payload size	Transport block CRC	LDPC Base Graph	Number of code blocks per slot (Note 3)	Total number of bits per slot	Total modulated symbols per slot
Unit					Bits	Bits			Bits	
	1	11	16QAM	10	176	16	2	1	528	132
	5	11	16QAM	10	888	16	2	1	2640	660
	6	11	16QAM	10	1064	16	2	1	3168	792
	9	11	16QAM	10	1608	16	2	1	4752	1188
	10	11	16QAM	10	1800	16	2	1	5280	1320
	11	11	16QAM	10	1928	16	2	1	5808	1452
	12	11	16QAM	10	2088	16	2	1	6336	1584
	13	11	16QAM	10	2280	16	2	1	6864	1716
	15	11	16QAM	10	2664	16	2	1	7920	1980
	16	11	16QAM	10	2792	16	2	1	8448	2112
	18	11	16QAM	10	3240	16	2	1	9504	2376
	19	11	16QAM	10	3368	16	2	1	10032	2508
	24	11	16QAM	10	4224	24	1	1	12672	3168
	25	11	16QAM	10	4352	24	1	1	13200	3300
	26	11	16QAM	10	4480	24	1	1	13728	3432
	31	11	16QAM	10	5376	24	1	1	16368	4092
	33	11	16QAM	10	5760	24	1	1	17424	4356
	38	11	16QAM	10	6656	24	1	1	20064	5016
	39	11	16QAM	10	6784	24	1	1	20592	5148
	40	11	16QAM	10	7040	24	1	1	21120	5280
	47	11	16QAM	10	8192	24	1	1	24816	6204
	51	11	16QAM	10	8968	24	1	2	26928	6732
	52	11	16QAM	10	9224	24	1	2	27456	6864
	53	11	16QAM	10	9224	24	1	2	27984	6996
	54	11	16QAM	10	9480	24	1	2	28512	7128
	61	11	16QAM	10	10760	24	1	2	32208	8052
	65	11	16QAM	10	11272	24	1	2	34320	8580
	67	11	16QAM	10	11784	24	1	2	35376	8844
	68	11	16QAM	10	11784	24	1	2	35904	8976
	78	11	16QAM	10	13576	24	1	2	41184	10296
	79	11	16QAM	10	13832	24	1	2	41712	10428
	80	11	16QAM	10	14088	24	1	2	42240	10560
	81	11	16QAM	10	14088	24	1	2	42768	10692
	93	11	16QAM	10	16392	24	1	2	49404	12276
	95	11	16QMA	10	16392	24	1	2	50160	12540
	106	11	16QAM	10	18432	24	1	3	55968	13992
	107	11	16QAM	10	18960	24	1	3	56496	14124
	108	11	16QAM	10	18960	24	1	3	57024	14256
	109	11	16QAM	10	18960	24	1	3	57552	14388
	121	11	16QAM	10	21000	24	1	3	63888	15972
	123	11	16QAM	10	21504	24	1	3	64944	16236
	133	11	16QAM	10	23040	24	1	3	70224	17556
	135	11	16QAM	10	23568	24	1	3	71280	17820
	137	11	16QAM	10	24072	24	1	3	72336	18084
	160	11	16QAM	10	28168	24	1	4	84480	21120
	162	11	16QAM	10	28168	24	1	4	85536	21384
	189	11	16QAM	10	32776	24	1	4	99792	24948
	216	11	16QAM	10	37896	24	1	5	114048	28512
	217	11	16QAM	10	37896	24	1	5	114576	28644
	245	11	16QAM	10	43032	24	1	6	129360	32340
	270	11	16QAM	10	47112	24	1	6	142560	35640
	273	11	16QAM	10	48168	24	1	6	144144	36036

NOTE 1: PUSCH mapping Type-A and single-symbol DM-RS configuration Type-1 with 2 additional DM-RS symbols, such that the DM-RS positions are set to symbols 2, 7, 11. DM-RS is [TDM'ed] with PUSCH data. DM-RS symbols are not counted.

NOTE 2: MCS Index is based on MCS table 5.1.3.1-1 defined in TS 38.214 [10].

NOTE 3: If more than one Code Block is present, an additional CRC sequence of $L = 24$ Bits is attached to each Code Block (otherwise $L = 0$ Bit)

NOTE 4: The RMCs apply to all channel bandwidth where $L_{CRB} \leq N_{RB}$.

Table A.2.2.7-2: Void

Table A.2.2.7-3: Void

A.2.2.8 CP-OFDM 64QAM

Table A.2.2.8-1: Reference Channels for CP-OFDM 64QAM

Parameter	Allocated resource blocks (L _{CRB})	CP-OFDM Symbols per slot (Note 1)	Modulation	MCS Index (Note 2)	Payload size	Transport block CRC	LDPC Base Graph	Number of code blocks per slot (Note 3)	Total number of bits per slot	Total modulated symbols per slot
Unit					Bits	Bits			Bits	
	1	11	64QAM	19	408	16	2	1	792	132
	5	11	64QAM	19	2024	16	2	1	3960	660
	9	11	64QAM	19	3624	16	2	1	7128	1188
	10	11	64QAM	19	3968	24	1	1	7920	1320
	11	11	64QAM	19	4352	24	1	1	8712	1452
	12	11	64QAM	19	4736	24	1	1	9504	1584
	13	11	64QAM	19	5120	24	1	1	10296	1716
	15	11	64QAM	19	6016	24	1	1	11880	1980
	18	11	64QAM	19	7168	24	1	1	14256	2376
	19	11	64QAM	19	7552	24	1	1	15048	2508
	24	11	64QAM	19	9480	24	1	2	19008	3168
	25	11	64QAM	19	9992	24	1	2	19800	3300
	26	11	64QAM	19	10504	24	1	2	20592	3432
	31	11	64QAM	19	12296	24	1	2	24552	4092
	33	11	64QAM	19	13064	24	1	2	26136	4356
	38	11	64QAM	19	15112	24	1	2	30096	5016
	39	11	64QAM	19	15624	24	1	2	30888	5148
	47	11	64QAM	19	18960	24	1	3	37224	6204
	51	11	64QAM	19	20496	24	1	3	40392	6732
	52	11	64QAM	19	21000	24	1	3	41184	6864
	53	11	64QAM	19	21000	24	1	3	41976	6996
	61	11	64QAM	19	24567	24	1	3	48312	8052
	65	11	64QAM	19	26120	24	1	4	51480	8580
	67	11	64QAM	19	26632	24	1	4	53064	8844
	78	11	64QAM	19	31240	24	1	4	61776	10296
	79	11	64QAM	19	31752	24	1	4	62568	10428
	80	11	64QAM	19	31752	24	1	4	63360	10560
	81	11	64QAM	19	32264	24	1	4	64152	10692
	93	11	64QAM	19	36896	24	1	5	73656	12276
	95	11	64QAM	19	37896	24	1	5	75240	12540
	93	11	64QAM	19	36896	24	1	5	73656	12276
	106	11	64QAM	19	42016	24	1	5	83952	13992
	107	11	64QAM	19	43032	24	1	6	84744	14124
	108	11	64QAM	19	43032	24	1	6	85536	14256
	109	11	64QAM	19	44040	24	1	6	86328	14388
	121	11	64QAM	19	48168	24	1	6	95832	15972
	123	11	64QAM	19	49176	24	1	6	97416	16236
	133	11	64QAM	19	53288	24	1	7	105336	17556
	135	11	64QAM	19	54296	24	1	7	106920	17820
	137	11	64QAM	19	54296	24	1	7	108504	18084
	160	11	64QAM	19	63528	24	1	8	126720	21120
	162	11	64QAM	19	64552	24	1	8	128304	21384
	189	11	64QAM	19	75792	24	1	9	149688	24948
	216	11	64QAM	19	86040	24	1	11	171072	28512
	217	11	64QAM	19	86040	24	1	11	171864	28644
	245	11	64QAM	19	98376	24	1	12	194040	32340
	270	11	64QAM	19	108552	24	1	13	213840	35640
	273	11	64QAM	19	108552	24	1	13	216216	36036

NOTE 1: PUSCH mapping Type-A and single-symbol DM-RS configuration Type-1 with 2 additional DM-RS symbols, such that the DM-RS positions are set to symbols 2, 7, 11. DMRS is [TDM'ed] with PUSCH data. DM-RS symbols are not counted.

NOTE 2: MCS Index is based on MCS table 5.1.3.1-1 defined in TS 38.214 [10].

NOTE 3: If more than one Code Block is present, an additional CRC sequence of L = 24 Bits is attached to each Code Block (otherwise L = 0 Bit)

NOTE 4: The RMCs apply to all channel bandwidth where $L_{CRB} \leq N_{RB}$.

Table A.2.2.8-2: Void

Table A.2.2.8-3: Void

A.2.2.9 CP-OFDM 256QAM

Table A.2.2.9-1: Reference Channels for CP-OFDM 256QAM

Parameter	Allocated resource blocks (L _{CRB})	CP-OFDM Symbols per slot (Note 1)	Modulation	MCS Index (Note 2)	Payload size	Transport block CRC	LDPC Base Graph	Number of code blocks per slot (Note 3)	Total number of bits per slot	Total modulated symbols per slot
Unit					Bits	Bits			Bits	
	1	11	256QAM	20	704	16	2	1	1056	132
	5	11	256QAM	20	3496	16	2	1	5280	660
	9	11	256QAM	20	6272	24	1	1	9504	1188
	10	11	256QAM	20	7040	24	1	1	10560	1320
	11	11	256QAM	20	7680	24	1	1	11616	1452
	12	11	256QAM	20	8456	24	1	2	12672	1584
	13	11	256QAM	20	9224	24	1	2	13728	1716
	15	11	256QAM	20	10504	24	1	2	15840	1980
	18	11	256QAM	20	12552	24	1	2	19008	2376
	19	11	256QAM	20	13320	24	1	2	20064	2508
	24	11	256QAM	20	16896	24	1	3	25344	3168
	25	11	256QAM	20	17424	24	1	3	26400	3300
	26	11	256QAM	20	18432	24	1	3	27456	3432
	31	11	256QAM	20	22032	24	1	3	32736	4092
	33	11	256QAM	20	23040	24	1	3	34848	4356
	38	11	256QAM	20	26632	24	1	4	40128	5016
	39	11	256QAM	20	27656	24	1	4	41184	5148
	47	11	256QAM	20	32776	24	1	4	49632	6204
	51	11	256QAM	20	35856	24	1	5	53856	6732
	52	11	256QAM	20	36896	24	1	5	54912	6864
	53	11	256QAM	20	36896	24	1	5	55968	6996
	61	11	256QAM	20	43032	24	1	6	64416	8052
	65	11	256QAM	20	46104	24	1	6	68640	8580
	67	11	256QAM	20	47112	24	1	6	70752	8844
	78	11	256QAM	20	55304	24	1	7	82368	10296
	79	11	256QAM	20	55304	24	1	7	83424	10428
	80	11	256QAM	20	56368	24	1	7	84480	10560
	81	11	256QAM	20	57376	24	1	7	85536	10692
	93	11	256QAM	20	65576	24	1	8	98208	12276
	95	11	256QAM	20	67584	24	1	8	100320	12540
	106	11	256QAM	20	73776	24	1	9	111936	13992
	107	11	256QAM	20	75792	24	1	9	112992	14124
	108	11	256QAM	20	75792	24	1	9	114048	14256
	109	11	256QAM	20	75792	24	1	9	115104	14388
	121	11	256QAM	20	86040	24	1	11	127776	15972
	123	11	256QAM	20	86040	24	1	11	129888	16236
	133	11	256QAM	20	94248	24	1	12	140448	17556
	135	11	256QAM	20	94248	24	1	12	142560	17820
	137	11	256QAM	20	96264	24	1	12	144672	18084
	160	11	256QAM	20	112648	24	1	14	168960	21120
	162	11	256QAM	20	114776	24	1	14	171072	21384
	189	11	256QAM	20	131176	24	1	16	199584	24948
	216	11	256QAM	20	151608	24	1	18	228096	28512
	217	11	256QAM	20	151608	24	1	18	229152	28644
	245	11	256QAM	20	172176	24	1	21	258720	32340
	270	11	256QAM	20	188576	24	1	23	285120	35640
	273	11	256QAM	20	192624	24	1	23	288288	36036

NOTE 1: PUSCH mapping Type-A and single-symbol DM-RS configuration Type-1 with 2 additional DM-RS symbols, such that the DM-RS positions are set to symbols 2, 7, 11. DMRS is [TDM'ed] with PUSCH data. DM-RS symbols are not counted.

NOTE 2: MCS Index is based on MCS table 5.1.3.1-2 defined in TS 38.214 [10].

NOTE 3: If more than one Code Block is present, an additional CRC sequence of L = 24 Bits is attached to each Code Block (otherwise L = 0 Bit)

NOTE 4: The RMCs apply to all channel bandwidth where L_{CRB} ≤ N_{RB}.

Table A.2.2.9-2: Void

Table A.2.2.9-3: Void

A.2.3 Reference measurement channels for TDD

The TDD UL RMCs are defined in clause A.2.2 with the active UL slots specified in table A.2.1-1 and TDD slot patterns as defined for reference sensitivity tests.

A.2.3.1 DFT-s-OFDM Pi/2-BPSK

Table A.2.3.1-1: Void

Table A.2.3.1-2: Void

Table A.2.3.1-3: Void

A.2.3.2 DFT-s-OFDM QPSK

Table A.2.3.2-1: Void

Table A.2.3.2-2: Void

Table A.2.3.2-3: Void

A.2.3.3 DFT-s-OFDM 16QAM

Table A.2.3.3-1: Void

Table A.2.3.3-2: Void

Table A.2.3.3-3: Void

A.2.3.4 DFT-s-OFDM 64QAM

Table A.2.3.4-1: Void

Table A.2.3.4-2: Void

Table A.2.3.4-3: Void

A.2.3.5 DFT-s-OFDM 256QAM

Table A.2.3.5-1: Void

Table A.2.3.5-2: Void

Table A.2.3.5-3: Void

A.2.3.6 CP-OFDM QPSK

Table A.2.3.6-1: Void

Table A.2.3.6-2: Void

Table A.2.3.6-3: Void

A.2.3.7 CP-OFDM 16QAM

Table A.2.3.7-1: Void

Table A.2.3.7-2: Void

Table A.2.3.7-3: Void

A.2.3.8 CP-OFDM 64QAM

Table A.2.3.8-1: Void

Table A.2.3.8-2: Void

Table A.2.3.8-3: Void

A.2.3.9 CP-OFDM 256QAM

Table A.2.3.9-1: Void

Table A.2.3.9-2: Void

Table A.2.3.9-3: Void

A.3 DL reference measurement channels

A.3.1 General

Unless otherwise stated, Tables A.3.2.2-1, A.3.2.2-2, A.3.2.2-3, A.3.3.2-1, A.3.3.2-2 and A.3.3.2-3 are applicable for measurements of the Receiver Characteristics (clause 7) with the exception of clauses 7.4 (Maximum input level).

Unless otherwise stated, Tables A.3.2.3-1, A.3.2.3-2, A.3.2.3-3, A.3.3.3-1, A.3.3.3-2 and A.3.3.3-3 are applicable for clauses 7.4 (Maximum input level) and for UE not supporting PDSCH 256QAM,

Unless otherwise stated, Tables A.3.2.4-1, A.3.2.4-2, A.3.2.4-3, A.3.3.4-1, A.3.3.4-2 and A.3.3.4-3 are applicable for clauses 7.4 (Maximum input level) and for UE supporting PDSCH 256QAM,

Unless otherwise stated, Tables A.3.2.2-1, A.3.2.2-2, A.3.2.2-3, A.3.3.2-1, A.3.3.2-2 and A.3.3.2-3 also apply for the modulated interferer used in Clauses 7.5, 7.6 and 7.8 with test specific bandwidths.

In case of carrier aggregation scenarios, the k_1 values and number of HARQ processes of the Reference Measurement Channels specified in Annex A.3 shall be adapted as specified in table A.3.1-2 and A.3.1-3.

Table A.3.1-1: Common reference channel parameters

Parameter		Unit	Value
CORESET frequency domain allocation			Full BW
CORESET time domain allocation			2 OFDM symbols at the begin of each slot
PDSCH mapping type			Type A
PDSCH start symbol index (S)			2
Number of consecutive PDSCH symbols (L)			12
PDSCH PRB bundling		PRBs	2
Dynamic PRB bundling			false
Overhead value for TBS determination			0
First DMRS position for Type A PDSCH mapping			2
DMRS type			Type 1
Number of additional DMRS			2
FDM between DMRS and PDSCH			Disable
CSI-RS for tracking	First subcarrier index in the PRB used for CSI-RS (k_0)		0 for CSI-RS resource 1,2,3,4
	OFDM symbols in the PRB used for CSI-RS		$l_0 = 6$ for CSI-RS resource 1 and 3 $l_0 = 10$ for CSI-RS resource 2 and 4
	Number of CSI-RS ports		1 for CSI-RS resource 1,2,3,4
	CDM Type		'No CDM' for CSI-RS resource 1,2,3,4
	Density (ρ)		3 for CSI-RS resource 1,2,3,4
	CSI-RS periodicity	Slots	15 kHz SCS: 20 for CSI-RS resource 1,2,3,4 30 kHz SCS: 40 for CSI-RS resource 1,2,3,4 60 kHz SCS: 80 for CSI-RS resource 1,2,3,4
	CSI-RS offset	Slots	15 kHz SCS: 0 for CSI-RS resource 1 and 2 1 for CSI-RS resource 3 and 4 30 kHz SCS: 1 for CSI-RS resource 1 and 2 2 for CSI-RS resource 3 and 4 60 kHz SCS: 2 for CSI-RS resource 1 and 2 3 for CSI-RS resource 3 and 4
	Frequency Occupation		Start PRB 0 Number of PRB = BWP size
QCL info			TCI state #0
PTRS configuration			PTRS is not configured

Table A.3.1-2: Carrier aggregation test parameters for K1 values

The number of slots between PDSCH and corresponding HARQ-ACK information		CCs with the same duplex mode and SCS with Pcell	CCs with different duplex mode and/or SCS with Pcell
FDD 15 kHz + FDD 15 kHz CA	FDD PCell	{2}	N/A
FDD 15 kHz + FDD 30 kHz CA	15kHz PCell	{2}	{3}
	30kHz PCell	{2}	{2}
FDD 15 kHz + TDD 15 kHz CA	FDD PCell	{2}	{2}
	TDD PCell	{4,3,2}	{4,3,2,6,5}
FDD 15 kHz + TDD 30 kHz CA	FDD PCell	{2}	{3}
	TDD PCell	{8,7,6,5,4,3,2}	{8,6,4,2,10}
TDD 15 kHz + TDD 15 kHz CA	TDD PCell	{4,3,2}	N/A
TDD 15 kHz + TDD 30 kHz CA	15kHz PCell	{4,3,2}	{4,4,3,3,2,7,6}
	30kHz PCell	{8,7,6,5,4,3,2}	{7,5,4}
FDD 30 kHz + FDD 30 kHz CA	FDD PCell	{2}	N/A
FDD 30 kHz + TDD 15 kHz CA	FDD PCell	{2}	{2}
	TDD PCell	{4,3,2}	{4,4,3,3,7,7,6,6,5,5}
FDD 30 kHz + TDD 30 kHz CA	FDD PCell	{2}	{2}
	TDD PCell	{8,7,6,5,4,3,2}	{8,7,6,5,4,3,2,2,10,-} {NOTE 1}
TDD 30 kHz + TDD 30 kHz CA	TDD PCell	{8,7,6,5,4,3,2}	N/A

NOTE 1: No PDSCH shall be scheduled in slots 9 and 19 to avoid HARQ conflicts and maximize Throughput. Hence no K1 value is applicable for them.

Table A.3.1-3: Carrier Aggregation test parameters for number of HARQ processes

HARQ process number		CCs with the same duplex mode and SCS with Pcell	CCs with different duplex mode and/or SCS with Pcell
FDD 15 kHz + FDD 15 kHz CA	FDD PCell	4	N/A
FDD 15 kHz + FDD 30 kHz CA	15kHz PCell	8	8
	30kHz PCell	8	8
FDD 15 kHz + TDD 15 kHz CA	FDD PCell	4	8
	TDD PCell	8	8
FDD 15 kHz + TDD 30 kHz CA	FDD PCell	4	8
	TDD PCell	10	8
TDD 15 kHz + TDD 15 kHz CA	TDD PCell	8	N/A
TDD 15 kHz + TDD 30 kHz CA	15kHz PCell	8	12
	30kHz PCell	8	8
FDD 30 kHz + FDD 30 kHz CA	FDD PCell	8	N/A
FDD 30 kHz + TDD 15 kHz CA	FDD PCell	8	8
	TDD PCell	8	16

FDD 30 kHz + TDD 30 kHz CA	FDD PCell	8	8
	TDD PCell	8	16
TDD 30 kHz + TDD 30 kHz CA	TDD PCell	8	N/A

A.3.2 DL reference measurement channels for FDD

A.3.2.1 General

Table A.3.2.1-1 Additional reference channels parameters for FDD

Parameter	Unit	Value
Number of HARQ Processes		4
K1 value		2 for all slots

A.3.2.2 FRC for receiver requirements for QPSK

Table A.3.2.2-1 Fixed reference channel for receiver requirements (SCS 15 kHz, FDD, QPSK 1/3)

Parameter	Unit	Value							
		5	10	15	20	25	30	40	50
Channel bandwidth	MHz	5	10	15	20	25	30	40	50
Subcarrier spacing	kHz	15	15	15	15	15	15	15	15
Subcarrier spacing configuration μ		0	0	0	0	0	0	0	0
Allocated resource blocks		25	52	79	106	133	160	216	270
Subcarriers per resource block		12	12	12	12	12	12	12	12
Allocated slots per Frame		8	8	8	8	8	8	8	8
MCS Index		4	4	4	4	4	4	4	4
MCS Table for TBS determination		64QAM							
Modulation		QPSK	QPSK	QPSK	QPSK	QPSK	QPSK	QPSK	QPSK
Target Coding Rate		1/3	1/3	1/3	1/3	1/3	1/3	1/3	1/3
Maximum number of HARQ transmissions		1	1	1	1	1	1	1	1
Information Bit Payload per Slot									
For Slots 0,1	Bits	N/A	N/A	N/A	N/A	N/A	N/A	N/A	N/A
For Slots 2,3,4,5,6,7,8,9	Bits	1672	3368	5120	6912	8712	10504	14088	17424
Transport block CRC	Bits	16	16	24	24	24	24	24	24
LDPC base graph		2	2	1	1	1	1	1	1
Number of Code Blocks per Slot									
For Slots 0,1	CBs	N/A	N/A	N/A	N/A	N/A	N/A	N/A	N/A
For Slots 2,3,4,5,6,7,8,9	CBs	1	1	1	1	2	2	2	3
Binary Channel Bits per Slot									
For Slots 0,1	Bits	N/A	N/A	N/A	N/A	N/A	N/A	N/A	N/A
For Slots 2,3,4,5,6,7,8,9	Bits	5400	11232	17064	22896	28728	34560	46656	58320
Max. Throughput averaged over 1 frame	Mbps	1.338	2.694	4.096	5.530	6.970	8.403	11.27 0	13.93 92
NOTE 1: Additional parameters are specified in Table A.3.1-1 and Table A.3.2.1-1.									
NOTE 2: If more than one Code Block is present, an additional CRC sequence of L = 24 Bits is attached to each Code Block (otherwise L = 0 Bit).									
NOTE 3: SS/PBCH block is transmitted in slot #0 of each frame									
NOTE 4: Slot i is slot index per frame									

Table A.3.2.2-2 Fixed reference channel for receiver requirements (SCS 30 kHz, FDD, QPSK 1/3)

Parameter	Unit	Value										
		10	15	20	25	30	40	50	60	80	90	100
Channel bandwidth	MHz											
Subcarrier spacing configuration μ		1	1	1	1	1	1	1	1	1	1	1
Allocated resource blocks		24	38	51	65	78	106	133	162	217	245	273
Subcarriers per resource block		12	12	12	12	12	12	12	12	12	12	12
Allocated slots per Frame		17	17	17	17	17	17	17	17	17	17	17
MCS Index		4	4	4	4	4	4	4	4	4	4	4
MCS Table for TBS determination		64QAM										
Modulation		QPSK	QPSK	QPSK	QPSK	QPSK	QPSK	QPSK	QPSK	QPSK	QPSK	QPSK
Target Coding Rate		1/3	1/3	1/3	1/3	1/3	1/3	1/3	1/3	1/3	1/3	1/3
Maximum number of HARQ transmissions		1	1	1	1	1	1	1	1	1	1	1
Information Bit Payload per Slot												
For Slots 0,1,2	Bits	N/A	N/A	N/A	N/A	N/A	N/A	N/A	N/A	N/A	N/A	N/A
For Slots 3,...,19	Bits	1608	2472	3368	4224	4992	6912	8712	10504	14088	15880	17928
Transport block CRC	Bits	16	16	16	24	24	24	24	24	24	24	24
LDPC base graph		2	2	2	1	1	1	1	1	1	1	1
Number of Code Blocks per Slot												
For Slots 0,1,2	CBs	N/A	N/A	N/A	N/A	N/A	N/A	N/A	N/A	N/A	N/A	N/A
For Slots 3,...,19	CBs	1	1	1	1	1	1	2	2	2	2	3
Binary Channel Bits per Slot												
For Slots 0,1,2	Bits	N/A	N/A	N/A	N/A	N/A	N/A	N/A	N/A	N/A	N/A	N/A
For Slots 3,...,19	Bits	5184	8208	11016	14040	16848	22896	28728	34992	46872	52920	58968
Max. Throughput averaged over 1 frame	Mbps	2.734	4.202	5.726	7.181	8.486	11.750	14.810	17.857	23.950	26.996	30.478
NOTE 1: Additional parameters are specified in Table A.3.1-1 and Table A.3.2.1-1.												
NOTE 2: If more than one Code Block is present, an additional CRC sequence of L = 24 Bits is attached to each Code Block (otherwise L = 0 Bit).												
NOTE 3: SS/PBCH block is transmitted in slot #0 of each frame												
NOTE 4: Slot i is slot index per frame												

A.3.2.3 FRC for maximum input level for 64QAM

Table A.3.2.3-1 Fixed reference channel for maximum input level receiver requirements (SCS 15 kHz, FDD, 64QAM)

Parameter	Unit	Value							
		5	10	15	20	25	30	40	50
Channel bandwidth	MHz	5	10	15	20	25	30	40	50
Subcarrier spacing	kHz	15	15	15	15	15	15	15	15
Subcarrier spacing configuration μ		0	0	0	0	0	0	0	0
Allocated resource blocks		25	52	79	106	133	160	216	270
Subcarriers per resource block		12	12	12	12	12	12	12	12
Allocated slots per Frame		8	8	8	8	8	8	8	8
MCS Index		24	24	24	24	24	24	24	24
MCS Table for TBS determination		64QAM							
Modulation		64 QAM	64 QAM	64 QAM	64 QAM	64 QAM	64 QAM	64 QAM	64 QAM
Target Coding Rate		3/4	3/4	3/4	3/4	3/4	3/4	3/4	3/4
Maximum number of HARQ transmissions		1	1	1	1	1	1	1	1
Information Bit Payload per Slot									
For Slots 0,1	Bits	N/A	N/A	N/A	N/A	N/A	N/A	N/A	N/A
For Slots 2,3,4,5,6,7,8,9	Bits	12296	25608	38936	52224	64552	77896	106576	131176
Transport block CRC	Bits	24	24	24	24	24	24	24	24
LDPC base graph		1	1	1	1	1	1	1	1
Number of Code Blocks per Slot									
For Slot 0,1	CBs	N/A	N/A	N/A	N/A	N/A	N/A	N/A	N/A
For Slots 2,3,4,5,6,7,8,9	CBs	2	4	5	7	8	10	13	16
Binary Channel Bits per Slot									
For Slot 0,1	Bits	N/A	N/A	N/A	N/A	N/A	N/A	N/A	N/A
For Slots 2,3,4,5,6,7,8,9	Bits	16200	33696	51192	68688	86184	103680	139968	174960
Max. Throughput averaged over 1 frame	Mbps	9.837	20.486	31.149	41.779	51.642	62.317	85.261	104.941
NOTE 1: Additional parameters are specified in Table A.3.1-1 and Table A.3.2.1-1.									
NOTE 2: If more than one Code Block is present, an additional CRC sequence of L = 24 Bits is attached to each Code Block (otherwise L = 0 Bit).									
NOTE 3: SS/PBCH block is transmitted in slot 0 of each frame									
NOTE 4: Slot i is slot index per frame									

Table A.3.2.3-2 Fixed reference channel for maximum input level receiver requirements (SCS 30 kHz, FDD, 64QAM)

Parameter	Unit	Value										
		10	15	20	25	30	40	50	60	80	100	
Channel bandwidth	MHz											
Subcarrier spacing configuration μ		1	1	1	1	1	1	1	1	1	1	
Allocated resource blocks		24	38	51	65	78	106	133	162	217	273	
Subcarriers per resource block		12	12	12	12	12	12	12	12	12	12	
Allocated slots per Frame		17	17	17	17	17	17	17	17	17	17	
MCS Index		24	24	24	24	24	24	24	24	24	24	
MCS Table for TBS determination		64QAM										
Modulation		64 QAM	64 QAM	64 QAM	64 QAM	64 QAM	64 QAM	64 QAM	64 QAM	64 QAM	64 QAM	
Target Coding Rate		3/4	3/4	3/4	3/4	3/4	3/4	3/4	3/4	3/4	3/4	
Maximum number of HARQ transmissions		1	1	1	1	1	1	1	1	1	1	
Information Bit Payload per Slot												
For Slots 0,1,2	Bits	N/A	N/A	N/A	N/A	N/A	N/A	N/A	N/A	N/A	N/A	
For Slots 3,...,19	Bits	11784	18432	25104	31752	37896	52224	64552	79896	106576	135296	
Transport block CRC	Bits	24	24	24	24	24	24	24	24	24	24	
LDPC base graph		1	1	1	1	1	1	1	1	1	1	
Number of Code Blocks per Slot												
For Slot2 0,1,2	CBs	N/A	N/A	N/A	N/A	N/A	N/A	N/A	N/A	N/A	N/A	
For Slots 3,...,19	CBs	2	3	3	4	5	7	8	10	13	17	
Binary Channel Bits per Slot												
For Slots 0,1,2	Bits	N/A	N/A	N/A	N/A	N/A	N/A	N/A	N/A	N/A	N/A	
For Slots 3,...,19	Bits	15552	24624	33048	42120	50544	68688	86184	104976	140616	176904	
Max. Throughput averaged over 1 frame	Mbps	20.033	31.334	42.677	53.978	64.423	88.781	109.73 8	135.82 3	181.17 9	230.00 3	
NOTE 1: Additional parameters are specified in Table A.3.1-1 and Table A.3.2.1-1.												
NOTE 2: If more than one Code Block is present, an additional CRC sequence of L = 24 Bits is attached to each Code Block (otherwise L = 0 Bit).												
NOTE 3: SS/PBCH block is transmitted in slot 0 of each frame												
NOTE 4: Slot i is slot index per frame												

Table A.3.2.3-3 Fixed Reference Channel for Maximum input level receiver requirements (SCS 60 kHz, FDD, 64QAM)

Parameter	Unit	Value										
		10	15	20	25	30	40	50	60	80	100	
Channel bandwidth	MHz											
Subcarrier spacing configuration μ		2	2	2	2	2	2	2	2	2	2	
Allocated resource blocks		11	18	24	31	38	51	65	79	107	135	
Subcarriers per resource block		12	12	12	12	12	12	12	12	12	12	
Allocated slots per Frame		36	36	36	36	36	36	36	36	36	36	
MCS Index		24	24	24	24	24	24	24	24	24	24	
MCS Table for TBS determination		64QAM										
Modulation		64 QAM	64 QAM	64 QAM	64 QAM	64 QAM	64 QAM	64 QAM	64 QAM	64 QAM	64 QAM	
Target Coding Rate		3/4	3/4	3/4	3/4	3/4	3/4	3/4	3/4	3/4	3/4	
Maximum number of HARQ transmissions		1	1	1	1	1	1	1	1	1	1	
Information Bit Payload per Slot												
For Slots 0,1,2,3	Bits	N/A	N/A	N/A	N/A	N/A	N/A	N/A	N/A	N/A	N/A	
For Slots 4,...,39	Bits	5376	8712	11784	15112	18432	25104	31752	38936	52224	65576	
Transport block CRC	Bits	24	24	24	24	24	24	24	24	24	24	
LDPC base graph		1	1	1	1	1	1	1	1	1	1	
Number of Code Blocks per Slot												
For Slots 0,1,2,3	CBs	N/A	N/A	N/A	N/A	N/A	N/A	N/A	N/A	N/A	N/A	
For Slots 4,...,39	CBs	1	2	2	2	3	3	4	5	7	8	
Binary Channel Bits per Slot												
For Slots 0,1,2,3	Bits	N/A	N/A	N/A	N/A	N/A	N/A	N/A	N/A	N/A	N/A	
For Slots 4,...,39	Bits	7128	11664	15552	20088	24624	33048	42120	51192	69336	87480	
Max. Throughput averaged over 1 frame	Mbps	19.354	31.363	42.422	54.403	66.355	90.374	114.307	140.170	188.006	236.074	
NOTE 1: Additional parameters are specified in Table A.3.1-1 and Table A.3.2.1-1.												
NOTE 2: If more than one Code Block is present, an additional CRC sequence of L = 24 Bits is attached to each Code Block (otherwise L = 0 Bit).												
NOTE 3: SS/PBCH block is transmitted in slot #0 of each frame												
NOTE 4: Slot i is slot index per frame												

A.3.2.4 FRC for maximum input level for 256 QAM

Table A.3.2.4-1 Fixed reference channel for maximum input level receiver requirements (SCS 15 kHz, FDD, 256QAM)

Parameter	Unit	Value							
		5	10	15	20	25	30	40	50
Channel bandwidth	MHz	5	10	15	20	25	30	40	50
Subcarrier spacing	kHz	15	15	15	15	15	15	15	15
Subcarrier spacing configuration μ		0	0	0	0	0	0	0	0
Allocated resource blocks		25	52	79	106	133	160	216	270
Subcarriers per resource block		12	12	12	12	12	12	12	12
Allocated slots per Frame		8	8	8	8	8	8	8	8
MCS Index		23	23	23	23	23	23	23	23
MCS Table for TBS determination		256QAM							
Modulation		256 QAM	256 QAM	256 QAM	256 QAM	256 QAM	256 QAM	256 QAM	256 QAM
Target Coding Rate		4/5	4/5	4/5	4/5	4/5	4/5	4/5	4/5
Maximum number of HARQ transmissions		1	1	1	1	1	1	1	1
Information Bit Payload per Slot									
For Slots 0,1	Bits	N/A	N/A	N/A	N/A	N/A	N/A	N/A	N/A
For Slots 2,3,4,5,6,7,8,9	Bits	16896	34816	53288	71688	90176	108552	143400	180376
Transport block CRC	Bits	24	24	24	24	24	24	24	24
LDPC base graph		1	1	1	1	1	1	1	1
Number of Code Blocks per Slot									
For Slot 0,1	CBs	N/A	N/A	N/A	N/A	N/A	N/A	N/A	N/A
For Slots 2,3,4,5,6,7,8,9	CBs	3	5	7	9	11	13	18	22
Binary Channel Bits per Slot									
For Slots 0,1	Bits	N/A	N/A	N/A	N/A	N/A	N/A	N/A	N/A
For Slots 2,3,4,5,6,7,8,9	Bits	21600	44928	68256	91584	114912	138240	186624	233280
Max. Throughput averaged over 1 frame	Mbps	13.517	27.853	42.630	57.350	72.141	86.842	114.720	144.301
NOTE 1: Additional parameters are specified in Table A.3.1-1 and Table A.3.2.1-1.									
NOTE 2: If more than one Code Block is present, an additional CRC sequence of L = 24 Bits is attached to each Code Block (otherwise L = 0 Bit).									
NOTE 3: SS/PBCH block is transmitted in slot 0 of each frame									
NOTE 4: Slot i is slot index per frame									

Table A.3.2.4-2 Fixed reference channel for maximum input level receiver requirements (SCS 30 kHz, FDD, 256QAM)

Parameter	Unit	Value									
		10	15	20	25	30	40	50	60	80	100
Channel bandwidth	MHz										
Subcarrier spacing configuration μ		1	1	1	1	1	1	1	1	1	1
Allocated resource blocks		24	38	51	65	78	106	133	162	217	273
Subcarriers per resource block		12	12	12	12	12	12	12	12	12	12
Allocated slots per Frame		17	17	17	17	17	17	17	17	17	17
MCS Index		23	23	23	23	23	23	23	23	23	23
MCS Table for TBS determination		256QAM									
Modulation		256 QAM	256 QAM	256 QAM	256 QAM	256 QAM	256 QAM	256 QAM	256 QAM	256 QAM	256 QAM
Target Coding Rate		4/5	4/5	4/5	4/5	4/5	4/5	4/5	4/5	4/5	4/5
Maximum number of HARQ transmissions		1	1	1	1	1	1	1	1	1	1
Information Bit Payload per Slot											
For Slots 0,1,2	Bits	N/A	N/A	N/A	N/A	N/A	N/A	N/A	N/A	N/A	N/A
For Slots 3,...,19	Bits	16136	25608	33816	44040	52224	71688	90176	108552	147576	184424
Transport block CRC	Bits	24	24	24	24	24	24	24	24	24	24
LDPC base graph		1	1	1	1	1	1	1	1	1	1
Number of Code Blocks per Slot											
For Slots 0,1,2	CBs	N/A	N/A	N/A	N/A	N/A	N/A	N/A	N/A	N/A	N/A
For Slots 3,...,19	CBs	2	4	5	6	7	9	11	13	18	22
Binary Channel Bits per Slot											
For Slots 0,1,2	Bits	N/A	N/A	N/A	N/A	N/A	N/A	N/A	N/A	N/A	N/A
For Slots 3,...,19	Bits	20736	32832	44064	56160	67392	91584	114912	139968	187488	235872
Max. Throughput averaged over 1 frame	Mbps	27.431	43.534	57.487	74.868	88.781	121.87 0	153.29 9	184.53 8	250.87 9	313.52 1
NOTE 1: Additional parameters are specified in Table A.3.1-1 and Table A.3.2.1-1.											
NOTE 2: If more than one Code Block is present, an additional CRC sequence of L = 24 Bits is attached to each Code Block (otherwise L = 0 Bit).											
NOTE 3: SS/PBCH block is transmitted in slot 0 of each frame											
NOTE 4: Slot i is slot index per frame											

Table A.3.2.4-3 Fixed reference channel for maximum input level receiver requirements (SCS 60 kHz, FDD, 256QAM)

Parameter	Unit	Value									
		10	15	20	25	30	40	50	60	80	100
Channel bandwidth	MHz										
Subcarrier spacing configuration μ		2	2	2	2	2	2	2	2	2	2
Allocated resource blocks		11	18	24	31	38	51	65	79	107	135
Subcarriers per resource block		12	12	12	12	12	12	12	12	12	12

Allocated slots per Frame		36	36	36	36	36	36	36	36	36	36
MCS Index		23	23	23	23	23	23	23	23	23	23
MCS Table for TBS determination		256QAM									
Modulation		256 QAM	256 QAM	256 QAM	256 QAM	256 QAM	256 QAM	256 QAM	256 QAM	256 QAM	256 QAM
Target Coding Rate		4/5	4/5	4/5	4/5	4/5	4/5	4/5	4/5	4/5	4/5
Maximum number of HARQ transmissions		1	1	1	1	1	1	1	1	1	1
Information Bit Payload per Slot											
For Slots 0,1,2,3	Bits	N/A	N/A	N/A	N/A	N/A	N/A	N/A	N/A	N/A	N/A
For Slots 4,...,39	Bits	7424	12040	16136	21000	25608	33816	44040	53288	71688	90176
Transport block CRC	Bits	24	24	24	24	24	24	24	24	24	24
LDPC base graph		1	1	1	1	1	1	1	1	1	1
Number of Code Blocks per Slot											
For Slots 0,1,2,3	CBs	N/A	N/A	N/A	N/A	N/A	N/A	N/A	N/A	N/A	N/A
For Slots 4,...,39	CBs	1	2	2	3	4	5	6	7	9	11
Binary Channel Bits per Slot											
For Slot 0,1,2,3	Bits	N/A	N/A	N/A	N/A	N/A	N/A	N/A	N/A	N/A	N/A
For Slots 4,...,39	Bits	9504	15552	20736	26784	32832	44064	56160	68256	92448	116640
Max. Throughput averaged over 1 frame	Mbps	26.726	43.344	58.090	75.600	92.189	121.73 8	158.54 4	191.83 7	258.07 7	324.63 4
NOTE 1: Additional parameters are specified in Table A.3.1-1 and Table A.3.2.1-1.											
NOTE 2: If more than one Code Block is present, an additional CRC sequence of L = 24 Bits is attached to each Code Block (otherwise L = 0 Bit).											
NOTE 3: SS/PBCH block is transmitted in slot #0 of each frame											
NOTE 4: Slot i is slot index per frame											

A.3.3 DL reference measurement channels for TDD

A.3.3.1 General

Table A.3.3.1-1 Additional reference channels parameters for TDD

Parameter		Value		
		SCS 15 kHz ($\mu=0$)	SCS 30 kHz ($\mu=1$)	SCS 60 kHz ($\mu=2$)
TDD Slot Configuration pattern (Note 1)		DDDSU	7DS2U	14DS ₁ S ₂ 4U
Special Slot Configuration (Note 2)		10D+2G+2U	6D+4G+4U	$S_1=12D+2G$, $S_2=6G+8U$
referenceSubcarrierSpacing		15 kHz	30 kHz	60 kHz
UL-DL configuration	<i>dl-UL-TransmissionPeriodicity</i>	5 ms	5 ms	5 ms
	<i>nrofDownlinkSlots</i>	3	7	14
	<i>nrofDownlinkSymbols</i>	10	6	12
	<i>nrofUplinkSlots</i>	1	2	4
	<i>nrofUplinkSymbols</i>	2	4	8
Number of HARQ Processes		8	8	16
The number of slots between PDSCH and corresponding HARQ-ACK information (Note 3)		K1 = 4 if mod(i,5) = 0 K1 = 3 if mod(i,5) = 1 K1 = 2 if mod(i,5) = 2 where i is slot index per frame; i = {0,...,9}	K1 = 8 if mod(i,10) = 0 K1 = 7 if mod(i,10) = 1 K1 = 6 if mod(i,10) = 2 K1 = 5 if mod(i,10) = 3 K1 = 4 if mod(i,10) = 4 K1 = 3 if mod(i,10) = 5 K1 = 2 if mod(i,10) = 6 where i is slot index per frame; i = {0,...,19}	K1 = 13 if mod(i,20) = 2 K1 = 12 if mod(i,20) = 3 K1 = 11 if mod(i,20) = 4 K1 = 10 if mod(i,20) = 5 K1 = 9 if mod(i,20) = 6 K1 = 8 if mod(i,20) = 7 K1 = 7 if mod(i,20) = 8 K1 = 6 if mod(i,20) = 9 K1 = 6 if mod(i,20) = 10 K1 = 6 if mod(i,20) = 11 K1 = 6 if mod(i,20) = 12 K1 = 6 if mod(i,20) = 13 where i is slot index per frame; i = {0,...,39}
NOTE 1: D denotes a slot with all DL symbols; S denotes a slot with a mix of DL, UL and guard symbols; U denotes a slot with all UL symbols. The field is for information.				
NOTE 2: D, G, U denote DL, guard and UL symbols, respectively. The field is for information.				
NOTE 3: i is the slot index per frame.				
NOTE 4: A -2ms or +3ms time offset to the NR configuration pattern relative to the E-UTRA UL-DL configuration must be apply in the TDD intra-band EN-DC.				

A.3.3.2 FRC for receiver requirements for QPSK

Table A.3.3.2-1 Fixed reference channel for receiver requirements (SCS 15 kHz, TDD, QPSK 1/3)

Parameter	Unit	Value							
		5	10	15	20	25	30	40	50
Channel bandwidth	MHz	5	10	15	20	25	30	40	50
Subcarrier spacing	kHz	15	15	15	15	15	15	15	15
Subcarrier spacing configuration μ		0	0	0	0	0	0	0	0
Allocated resource blocks		25	52	79	106	133	160	216	270
Subcarriers per resource block		12	12	12	12	12	12	12	12
Allocated slots per Frame		4	4	4	4	4	4	4	4
MCS Index		4	4	4	4	4	4	4	4
MCS Table for TBS determination		64QAM							
Modulation		QPSK	QPSK	QPSK	QPSK	QPSK	QPSK	QPSK	QPSK
Target Coding Rate		1/3	1/3	1/3	1/3	1/3	1/3	1/3	1/3
Maximum number of HARQ transmissions		1	1	1	1	1	1	1	1

Information Bit Payload per Slot									
For Slots 0,1,3,4,8,9	Bits	N/A	N/A	N/A	N/A	N/A	N/A	N/A	N/A
For Slots 2,5,6,7	Bits	1672	3368	5120	6912	8712	10504	14088	17424
Transport block CRC	Bits	16	16	24	24	24	24	24	24
LDPC base graph		2	2	1	1	1	1	1	1
Number of Code Blocks per Slot									
For Slots 0,1,3,4,8,9	CBs	N/A	N/A	N/A	N/A	N/A	N/A	N/A	N/A
For Slots 2,5,6,7	CBs	1	1	1	1	2	2	2	3
Binary Channel Bits per Slot									
For Slots 0,1,3,4,8,9	Bits	N/A	N/A	N/A	N/A	N/A	N/A	N/A	N/A
For Slots 2,5,6,7	Bits	5400	11232	17064	22896	28728	34560	46656	58320
Max. Throughput averaged over 1 frame	Mbps	0.669	1.347	2.048	2.765	3.485	4.202	5.635	6.970
NOTE 1: Additional parameters are specified in Table A.3.1-1 and Table A.3.3.1-1.									
NOTE 2: If more than one Code Block is present, an additional CRC sequence of L = 24 Bits is attached to each Code Block (otherwise L = 0 Bit).									
NOTE 3: SS/PBCH block is transmitted in slot 0 of each frame									
NOTE 4: Slot i is slot index per frame									

Table A.3.3.2-2 Fixed reference channel for receiver requirements (SCS 30 kHz, TDD, QPSK 1/3)

Parameter	Unit	Value										
		10	15	20	25	30	40	50	60	70	80	100
Channel bandwidth	MHz	10	15	20	25	30	40	50	60	70	80	100
Subcarrier spacing configuration μ		1	1	1	1	1	1	1	1	1	1	1
Allocated resource blocks		24	38	51	65	78	106	133	162	162	217	273
Subcarriers per resource block		12	12	12	12	12	12	12	12	12	12	12
Allocated slots per Frame		11	11	11	11	11	11	11	11	13	11	11
MCS Index		4	4	4	4	4	4	4	4	4	4	4
MCS Table for TBS determination		64QAM										
Modulation		QPSK	QPSK	QPSK	QPSK	QPSK	QPSK	QPSK	QPSK	QPSK	QPSK	QPSK
Target Coding Rate		1/3	1/3	1/3	1/3	1/3	1/3	1/3	1/3	1/3	1/3	1/3
Maximum number of HARQ transmissions		1	1	1	1	1	1	1	1	1	1	1
Information Bit Payload per Slot												
For Slots 0,1,2 and Slot i, if $\text{mod}(i, 10) = \{7,8,9\}$ for i from $\{0, \dots, 19\}$	Bits	N/A	N/A	N/A	N/A	N/A	N/A	N/A	N/A	N/A	N/A	N/A
For Slot i, if $\text{mod}(i, 10) = \{0,1,2,3,4,5,6\}$ for i from $\{3, \dots, 19\}$	Bits	1608	2472	3368	4224	4992	6912	8712	10504	12296	14088	17928
Transport block CRC	Bits	16	16	16	24	24	24	24	24	24	24	24
LDPC base graph		2	2	2	1	1	1	1	1	1	1	1
Number of Code Blocks per Slot												
For Slots 0,1,2 and Slot i, if $\text{mod}(i, 10) = \{7,8,9\}$ for i from $\{0, \dots, 19\}$	CBs	N/A	N/A	N/A	N/A	N/A	N/A	N/A	N/A	N/A	N/A	N/A
For Slot i, if $\text{mod}(i, 10) = \{0,1,2,3,4,5,6\}$ for i from $\{3, \dots, 19\}$	CBs	1	1	1	1	1	1	2	2	2	2	3
Binary Channel Bits per Slot												
For Slots 0,1,2 and Slot i, if $\text{mod}(i, 10) = \{7,8,9\}$ for i from $\{0, \dots, 19\}$	Bits	N/A	N/A	N/A	N/A	N/A	N/A	N/A	N/A	N/A	N/A	N/A
For Slot i, if $\text{mod}(i, 10) = \{0,1,2,3,4,5,6\}$ for i from $\{3, \dots, 19\}$	Bits	5184	8208	11016	14040	16848	22896	28728	34992	40824	46872	58968
Max. Throughput averaged over 1 frame	Mbps	2.1.769	2.719	3.705	4.646	5.491	7.603	9.583	11.554	13.526	15.497	19.721
NOTE 1: Additional parameters are specified in Table A.3.1-1 and Table A.3.3.1-1.												
NOTE 2: If more than one Code Block is present, an additional CRC sequence of L = 24 Bits is attached to each Code Block (otherwise L = 0 Bit).												
NOTE 3: SS/PBCH block is transmitted in slot #0 of each frame												
NOTE 4: Slot i is slot index per frame												

Table A.3.3.2-3 Fixed reference channel for receiver requirements (SCS 60 kHz, TDD, QPSK 1/3)

Parameter	Unit	Value										
		10	15	20	25	30	40	50	60	70	80	100
Channel bandwidth	MHz	10	15	20	25	30	40	50	60	70	80	100
Subcarrier spacing configuration μ		2	2	2	2	2	2	2	2	2	2	2
Allocated resource blocks		11	18	24	31	38	51	65	79	93	107	135
Subcarriers per resource block		12	12	12	12	12	12	12	12	12	12	12
Allocated slots per Frame		24	24	24	24	24	24	24	24	26	24	24
MCS Index		4	4	4	4	4	4	4	4	4	4	4
MCS Table for TBS determination		64QAM										
Modulation		QPSK	QPSK	QPSK	QPSK	QPSK	QPSK	QPSK	QPSK	QPSK	QPSK	QPSK
Target Coding Rate		1/3	1/3	1/3	1/3	1/3	1/3	1/3	1/3	1/3	1/3	1/3
Maximum number of HARQ transmissions		1	1	1	1	1	1	1	1	1	1	1
Information Bit Payload per Slot												
For Slots 0,1,2,3 and Slot i, if $\text{mod}(i, 20) = \{14,15,16,17,18,19\}$ for i from $\{0,\dots,39\}$	Bits	N/A	N/A	N/A	N/A	N/A	N/A	N/A	N/A	N/A	N/A	N/A
For Slot i, if $\text{mod}(i, 20) = \{0,\dots, 13\}$ for i from $\{4,\dots,39\}$	Bits	736	1192	1608	2024	2472	3368	4224	5120	6016	6912	8712
Transport block CRC	Bits	16	16	16	16	16	16	24	24	24	24	24
LDPC base graph		2	2	2	2	2	2	1	1	1	1	1
Number of Code Blocks per Slot												
For Slots 0,1,2,3 and Slot i, if $\text{mod}(i, 20) = \{14,15,16,17,18,19\}$ for i from $\{0,\dots,39\}$	CBs	N/A	N/A	N/A	N/A	N/A	N/A	N/A	N/A	N/A	N/A	N/A
For Slot i, if $\text{mod}(i, 20) = \{0,\dots, 13\}$ for i from $\{4,\dots,39\}$	CBs	1	1	1	1	1	1	1	1	1	1	2
Binary Channel Bits per Slot												
For Slots 0,1,2,3 and Slot i, if $\text{mod}(i, 20) = \{14,15,16,17,18,19\}$ for i from $\{0,\dots,39\}$	Bits	N/A	N/A	N/A	N/A	N/A	N/A	N/A	N/A	N/A	N/A	N/A
For Slot i, if $\text{mod}(i, 20) = \{0,\dots,13\}$ for i from $\{4,\dots,39\}$	Bits	2376	3888	5184	6696	8208	11016	14040	17064	20088	23112	29160
Max. Throughput averaged over 1 frame	Mbps	1.766	2.861	3.859	4.858	5.933	8.083	10.138	12.288	14.438	16.589	20.909
NOTE 1: Additional parameters are specified in Table A.3.1-1 and Table A.3.3.1-1.												
NOTE 2: If more than one Code Block is present, an additional CRC sequence of L = 24 Bits is attached to each Code Block (otherwise L = 0 Bit).												
NOTE 3: SS/PBCH block is transmitted in slot #0 of each frame												
NOTE 4: Slot i is slot index per frame												

A.3.3.3 FRC for maximum input level for 64QAM

Table A.3.3.3-1 Fixed reference channel for maximum input level receiver requirements (SCS 15 kHz, TDD, 64QAM)

Parameter	Unit	Value							
		5	10	15	20	25	30	40	50
Channel bandwidth	MHz	5	10	15	20	25	30	40	50
Subcarrier spacing	kHz	15	15	15	15	15	15	15	15
Subcarrier spacing configuration μ		0	0	0	0	0	0	0	0
Allocated resource blocks		25	52	79	106	133	160	216	270
Subcarriers per resource block		12	12	12	12	12	12	12	12
Allocated slots per Frame		4	4	4	4	4	4	4	4
MCS Index		24	24	24	24	24	24	24	24
MCS Table for TBS determination		64QAM							
Modulation		64 QAM	64 QAM	64 QAM	64 QAM	64 QAM	64 QAM	64 QAM	64 QAM
Target Coding Rate		3/4	3/4	3/4	3/4	3/4	3/4	3/4	3/4
Maximum number of HARQ transmissions		1	1	1	1	1	1	1	1
Information Bit Payload per Slot									
For Slots 0,1,3,4,8,9	Bits	N/A	N/A	N/A	N/A	N/A	N/A	N/A	N/A
For Slots 2,5,6,7	Bits	12296	25608	38936	52224	64552	77896	106576	131176
Transport block CRC	Bits	24	24	24	24	24	24	24	24
LDPC base graph		1	1	1	1	1	1	1	1
Number of Code Blocks per Slot									
For Slots 0,1,3,4,8,9	CBs	N/A	N/A	N/A	N/A	N/A	N/A	N/A	N/A
For Slots 2,5,6,7	CBs	2	4	5	7	8	10	13	16
Binary Channel Bits per Slot									
For Slots 0,1,3,4,8,9	Bits	N/A	N/A	N/A	N/A	N/A	N/A	N/A	N/A
For Slots 2,5,6,7	Bits	16200	33696	51192	68688	86184	103680	139968	174960
Max. Throughput averaged over 1 frame	Mbps	4.918	10.243	15.574	20.890	20.890	31.158	42.630	52.470
NOTE 1: Additional parameters are specified in Table A.3.1-1 and Table A.3.3.1-1.									
NOTE 2: If more than one Code Block is present, an additional CRC sequence of L = 24 Bits is attached to each Code Block (otherwise L = 0 Bit).									
NOTE 3: SS/PBCH block is transmitted in slot 0 of each frame									
NOTE 4: Slot i is slot index per frame									

Table A.3.3.3-2 Fixed reference channel for maximum input level receiver requirements (SCS 30 kHz, TDD, 64QAM)

Parameter	Unit	Value										
		10	15	20	25	30	40	50	60	70	80	100
Channel bandwidth	MHz	1	1	1	1	1	1	1	1	1	1	1
Subcarrier spacing configuration μ		1	1	1	1	1	1	1	1	1	1	1
Allocated resource blocks		24	38	51	65	78	106	133	162	189	217	273
Subcarriers per resource block		12	12	12	12	12	12	12	12	12	12	12
Allocated slots per Frame		11	11	11	11	11	11	11	11	13	11	11
MCS Index		24	24	24	24	24	24	24	24	24	24	24
MCS Table for TBS determination		64QAM										
Modulation		64 QAM	64 QAM	64 QAM	64 QAM	64 QAM	64 QAM	64 QAM	64 QAM	64 QAM	64 QAM	64 QAM
Target Coding Rate		3/4	3/4	3/4	3/4	3/4	3/4	3/4	3/4	3/4	3/4	3/4
Maximum number of HARQ transmissions		1	1	1	1	1	1	1	1	1	1	1
Information Bit Payload per Slot												
For Slots 0,1,2 and Slot i, if $\text{mod}(i, 10) = \{7,8,9\}$ for i from $\{0, \dots, 19\}$	Bits	N/A	N/A	N/A	N/A	N/A	N/A	N/A	N/A	N/A	N/A	N/A
For Slot i, if $\text{mod}(i, 10) = \{0,1,2,3,4,5,6\}$ for i from $\{3, \dots, 19\}$	Bits	11784	18432	25104	31752	37896	52224	64552	79896	92200	106576	135296
Transport block CRC	Bits	24	24	24	24	24	24	24	24	24	24	24
LDPC base graph		1	1	1	1	1	1	1	1	1	1	1
Number of Code Blocks per Slot												
For Slots 0,1,2 and Slot i, if $\text{mod}(i, 10) = \{7,8,9\}$ for i from $\{0, \dots, 19\}$	CBs	N/A	N/A	N/A	N/A	N/A	N/A	N/A	N/A	N/A	N/A	N/A
For Slot i, if $\text{mod}(i, 10) = \{0,1,2,3,4,5,6\}$ for i from $\{3, \dots, 19\}$	CBs	2	3	3	4	5	7	8	10	11	13	17
Binary Channel Bits per Slot												
For Slots 0,1,2 and Slot i, if $\text{mod}(i, 10) = \{7,8,9\}$ for i from $\{0, \dots, 19\}$	Bits	N/A	N/A	N/A	N/A	N/A	N/A	N/A	N/A	N/A	N/A	N/A
For Slot i, if $\text{mod}(i, 10) = \{0,1,2,3,4,5,6\}$ for i from $\{3, \dots, 19\}$	Bits	15552	24624	33048	42120	50544	68688	86184	104976	122472	140616	176904
Max. Throughput averaged over 1 frame	Mbps	12.962	20.275	27.614	34.927	41.686	57.446	71.007	87.886	101.42	117.23 4	148.82 6
NOTE 1: Additional parameters are specified in Table A.3.1-1 and Table A.3.3.1-1.												
NOTE 2: If more than one Code Block is present, an additional CRC sequence of L = 24 Bits is attached to each Code Block (otherwise L = 0 Bit).												
NOTE 3: SS/PBCH block is transmitted in slot #0 of each frame												
NOTE 4: Slot i is slot index per frame												

Table A.3.3.3-3. Fixed reference channel for maximum input level receiver requirements (SCS 60 kHz, TDD, 64QAM)

Parameter	Unit	Value										
		10	15	20	25	30	40	50	60	70	80	100
Channel bandwidth	MHz	10	15	20	25	30	40	50	60	70	80	100
Subcarrier spacing configuration μ		2	2	2	2	2	2	2	2	2	2	2
Allocated resource blocks		11	18	24	31	38	51	65	79	93	107	135
Subcarriers per resource block		12	12	12	12	12	12	12	12	12	12	12
Allocated slots per Frame		24	24	24	24	24	24	24	24	26	24	24
MCS Index		24	24	24	24	24	24	24	24	24	24	24
MCS Table for TBS determination		64QAM										
Modulation		64 QAM	64 QAM	64 QAM	64 QAM	64 QAM	64 QAM	64 QAM	64 QAM	64 QAM	64 QAM	64 QAM
Target Coding Rate		3/4	3/4	3/4	3/4	3/4	3/4	3/4	3/4	3/4	3/4	3/4
Maximum number of HARQ transmissions		1	1	1	1	1	1	1	1	1	1	1
Information Bit Payload per Slot												
For Slots 0,1,2,3 and Slot i, if mod(i, 20) = {14,15,16,17,18,19} for i from {0,...,39}	Bits	N/A	N/A	N/A	N/A	N/A	N/A	N/A	N/A	N/A	N/A	N/A
For Slot i, if mod(i, 20) = {0,..., 13} for i from {4,...,39}	Bits	5376	8712	11784	15112	18432	25104	31752	38936	45096	52224	65576
Transport block CRC	Bits	24	24	24	24	24	24	24	24	24	24	24
LDPC base graph		1	1	1	1	1	1	1	1	1	1	1
Number of Code Blocks per Slot												
For Slots 0,1,2,3 and Slot i, if mod(i, 20) = {14,15,16,17,18,19} for i from {0,...,39}	CBs	N/A	N/A	N/A	N/A	N/A	N/A	N/A	N/A	N/A	N/A	N/A
For Slot i, if mod(i, 20) = {0,..., 13} for i from {4,...,39}	CBs	1	2	2	2	3	3	4	5	6	7	8
Binary Channel Bits per Slot												
For Slots 0,1,2,3 and Slot i, if mod(i, 20) = {14,15,16,17,18,19} for i from {0,...,39}	Bits	N/A	N/A	N/A	N/A	N/A	N/A	N/A	N/A	N/A	N/A	N/A
For Slot i, if mod(i, 20) = {0,..., 13} for i from {4,...,39}	Bits	7128	11664	15552	20088	24624	33048	42120	51192	60264	69336	87480
Max. Throughput averaged over 1 frame	Mbps	12.902	20.909	28.282	36.269	44.237	60.250	76.205	93.446	108.23	125.33 8	157.38 2
NOTE 1: Additional parameters are specified in Table A.3.1-1 and Table A.3.3.1-1.												
NOTE 2: If more than one Code Block is present, an additional CRC sequence of L = 24 Bits is attached to each Code Block (otherwise L = 0 Bit).												
NOTE 3: SS/PBCH block is transmitted in slot #0 of each frame												
NOTE 4: Slot i is slot index per frame												

A.3.3.4 FRC for maximum input level for 256 QAM

Table A.3.3.4-1 Fixed reference channel for maximum input level receiver requirements (SCS 15 kHz, TDD, 256QAM)

Parameter	Unit	Value							
		5	10	15	20	25	30	40	50
Channel bandwidth	MHz	5	10	15	20	25	30	40	50
Subcarrier spacing	kHz	15	15	15	15	15	15	15	15
Subcarrier spacing configuration μ		0	0	0	0	0	0	0	0
Allocated resource blocks		25	52	79	106	133	160	216	270
Subcarriers per resource block		12	12	12	12	12	12	12	12
Allocated slots per Frame		4	4	4	4	4	4	4	4
MCS Index		23	23	23	23	23	23	23	23
MCS table for TBS determination		256QAM							
Modulation		256 QAM	256 QAM	256 QAM	256 QAM	256 QAM	256 QAM	256 QAM	256 QAM
Target Coding Rate		4/5	4/5	4/5	4/5	4/5	4/5	4/5	4/5
Maximum number of HARQ transmissions		1	1	1	1	1	1	1	1
Information Bit Payload per Slot									
For Slots 0,1,3,4,8,9	Bits	N/A	N/A	N/A	N/A	N/A	N/A	N/A	N/A
For Slots 2,5,6,7	Bits	16896	34816	53288	71688	90176	108552	143400	180376
Transport block CRC	Bits	24	24	24	24	24	24	24	24
LDPC base graph		1	1	1	1	1	1	1	1
Number of Code Blocks per Slot									
For Slots 0,1,3,4,8,9	CBs	N/A	N/A	N/A	N/A	N/A	N/A	N/A	N/A
For Slots 2,5,6,7	CBs	3	5	7	9	12	14	18	23
Binary Channel Bits per Slot									
For Slots 0,1,3,4,8,9	Bits	N/A	N/A	N/A	N/A	N/A	N/A	N/A	N/A
For Slots 2,5,6,7	Bits	21600	44928	68256	91584	114912	138240	186624	233280
Max. Throughput averaged over 1 frame	Mbps	6.758	13.926	21.315	28.675	36.070	43.421	57.360	72.150
NOTE 1: Additional parameters are specified in Table A.3.1-1 and Table A.3.3.1-1.									
NOTE 2: If more than one Code Block is present, an additional CRC sequence of L = 24 Bits is attached to each Code Block (otherwise L = 0 Bit).									
NOTE 3: SS/PBCH block is transmitted in slot 0 of each frame									
NOTE 4: Slot i is slot index per frame									

Table A.3.3.4-2 Fixed Reference channel for maximum input level receiver requirements (SCS 30 kHz, TDD, 256QAM)

Parameter	Unit	Value										
		10	15	20	25	30	40	50	60	70	80	100
Channel bandwidth	MHz	1	1	1	1	1	1	1	1	1	1	1
Subcarrier spacing configuration μ		1	1	1	1	1	1	1	1	1	1	1
Allocated resource blocks		24	38	51	65	78	106	133	162	189	217	273
Subcarriers per resource block		12	12	12	12	12	12	12	12	12	12	12
Allocated slots per Frame		11	11	11	11	11	11	11	11	13	11	11
MCS Index		23	23	23	23	23	23	23	23	23	23	23
MCS Table for TBS determination		256QAM										
Modulation		256 QAM	256 QAM	256 QAM	256 QAM	256 QAM	256 QAM	256 QAM	256 QAM	256 QAM	256 QAM	256 QAM
Target Coding Rate		4/5	4/5	4/5	4/5	4/5	4/5	4/5	4/5	4/5	4/5	4/5
Maximum number of HARQ transmissions		1	1	1	1	1	1	1	1	1	1	1
Information Bit Payload per Slot												
For Slots 0,1,2 and Slot i, if mod(i, 10) = {7,8,9} for i from {0,...,19}	Bits	N/A	N/A	N/A	N/A	N/A	N/A	N/A	N/A	N/A	N/A	N/A
For Slot i, if mod(i, 10) = {0,1,2,3,4,5,6} for i from {3,...,19}	Bits	16136	25608	33816	44040	52224	71688	90176	108552	127080	147576	184424
Transport block CRC	Bits	24	24	24	24	24	24	24	24	24	24	24
LDPC base graph		1	1	1	1	1	1	1	1	1	1	1
Number of Code Blocks per Slot												
For Slots 0,1,2 and Slot i, if mod(i, 10) = {7,8,9} for i from {0,...,19}	CBs	N/A	N/A	N/A	N/A	N/A	N/A	N/A	N/A	N/A	N/A	N/A
For Slot i, if mod(i, 10) = {0,1,2,3,4,5,6} for i from {3,...,19}	CBs	1	1	1	1	1	1	2	2	2	2	3
Binary Channel Bits per Slot												
For Slots 0,1,2 and Slot i, if mod(i, 10) = {7,8,9} for i from {0,...,19}	Bits	N/A	N/A	N/A	N/A	N/A	N/A	N/A	N/A	N/A	N/A	N/A
For Slot i, if mod(i, 10) = {0,1,2,3,4,5,6} for i from {3,...,19}	Bits	20736	32832	44064	56160	67392	91584	114912	139968	163296	187488	235872
Max. Throughput averaged over 1 frame	Mbps	17.750	28.169	37.198	48.444	57.446	78.857	99.194	119.407	139.788	162.334	202.866
NOTE 1: Additional parameters are specified in Table A.3.1-1 and Table A.3.3.1-1.												
NOTE 2: If more than one Code Block is present, an additional CRC sequence of L = 24 Bits is attached to each Code Block (otherwise L = 0 Bit).												
NOTE 3: SS/PBCH block is transmitted in slot #0 of each frame												
NOTE 4: Slot i is slot index per frame												

Table A.3.3.4-3 Fixed reference channel for maximum input level receiver requirements (SCS 60 kHz, TDD, 256QAM)

Parameter	Unit	Value										
		10	15	20	25	30	40	50	60	70	80	100
Channel bandwidth	MHz	10	15	20	25	30	40	50	60	70	80	100
Subcarrier spacing configuration μ		2	2	2	2	2	2	2	2	2	2	2
Allocated resource blocks		11	18	24	31	38	51	65	79	93	107	135
Subcarriers per resource block		12	12	12	12	12	12	12	12	12	12	12
Allocated slots per Frame		24	24	24	24	24	24	24	24	26	24	24
MCS Index		23	23	23	23	23	23	23	23	23	23	23
MCS Table for TBS determination		256QAM										
Modulation		256 QAM	256 QAM	256 QAM	256 QAM	256 QAM	256 QAM	256 QAM	256 QAM	256 QAM	256 QAM	256 QAM
Target Coding Rate		4/5	4/5	4/5	4/5	4/5	4/5	4/5	4/5	4/5	4/5	4/5
Maximum number of HARQ transmissions		1	1	1	1	1	1	1	1	1	1	1
Information Bit Payload per Slot												
For Slots 0,1,2,3 and Slot i, if mod(i, 20) = {14,15,16,17,18,19} for i from {0,...,39}	Bits	N/A	N/A	N/A	N/A	N/A	N/A	N/A	N/A	N/A	N/A	N/A
For Slot i, if mod(i, 20) = {0,..., 13} for i from {4,...,39}	Bits	7424	12040	16136	21000	25608	33816	44040	53288	62504	71688	90176
Transport block CRC	Bits	24	24	24	24	24	24	24	24	24	24	24
LDPC base graph		1	1	1	1	1	1	1	1	1	1	1
Number of Code Blocks per Slot												
For Slots 0,1,2,3 and Slot i, if mod(i, 20) = {14,15,16,17,18,19} for i from {0,...,39}	CBs	N/A	N/A	N/A	N/A	N/A	N/A	N/A	N/A	N/A	N/A	N/A
For Slot i, if mod(i, 20) = {0,..., 13} for i from {4,...,39}	CBs	1	2	3	3	4	5	6	7	8	9	12
Binary Channel Bits per Slot												
For Slots 0,1,2,3 and Slot i, if mod(i, 20) = {14,15,16,17,18,19} for i from {0,...,39}	Bits	N/A	N/A	N/A	N/A	N/A	N/A	N/A	N/A	N/A	N/A	N/A
For Slot i, if mod(i, 20) = {0,..., 13} for i from {4,...,39}	Bits	9504	15552	20736	26784	32832	44064	56160	68256	80352	92448	116640
Max. Throughput averaged over 1 frame	Mbps	17.818	28.896	38.726	50.400	61.459	81.158	105.69 6	127.89 1	150.01 0	172.05 1	216.42 2
NOTE 1: Additional parameters are specified in Table A.3.1-1 and Table A.3.3.1-1.												
NOTE 2: If more than one Code Block is present, an additional CRC sequence of L = 24 Bits is attached to each Code Block (otherwise L = 0 Bit).												
NOTE 3: SS/PBCH block is transmitted in slot #0 of each frame												
NOTE 4: Slot i is slot index per frame												

A.4 CSI reference measurement channels

A.5 OFDMA Channel Noise Generator (OCNG)

A.5.1 OCNG Patterns for FDD

A.5.1.1 OCNG FDD pattern 1: Generic OCNG FDD Pattern for all unused REs

Table A.5.1.1-1: OP.1 FDD: Generic OCNG FDD Pattern for all unused REs

OCNG Parameters	OCNG Appliance	Control Region (Core Set)	Data Region
Resources allocated		All unused REs (Note 1)	All unused REs (Note 2)
Structure		PDCCH	PDSCH
Content		Uncorrelated pseudo random QPSK modulated data	Uncorrelated pseudo random QPSK modulated data
Transmission scheme for multiple antennas ports transmission		Single Tx port transmission	Spatial multiplexing using any precoding matrix with dimensions same as the precoding matrix for PDSCH
Subcarrier Spacing		Same as for RMC PDCCH in the active BWP	Same as for RMC PDSCH in the active BWP
Power Level		Same as for RMC PDCCH	Same as for RMC PDSCH
NOTE 1: All unused REs in the active CORESETS appointed by the search spaces in use.			
NOTE 2: Unused available REs refer to REs in PRBs not allocated for any physical channels, CORESETS, synchronization signals or reference signals in channel bandwidth.			

A.5.2 OCNG Patterns for TDD

A.5.2.1 OCNG TDD pattern 1: Generic OCNG TDD Pattern for all unused REs

Table A.5.2.1-1: OP.1 TDD: Generic OCNG TDD Pattern for all unused REs

OCNG Parameters	OCNG Appliance	Control Region (Core Set)	Data Region
Resources allocated		All unused REs (Note 1)	All unused REs (Note 2)
Structure		PDCCH	PDSCH
Content		Uncorrelated pseudo random QPSK modulated data	Uncorrelated pseudo random QPSK modulated data
Transmission scheme for multiple antennas ports transmission		Single Tx port transmission	Spatial multiplexing using any precoding matrix with dimensions same as the precoding matrix for PDSCH
Subcarrier Spacing		Same as for RMC PDCCH in the active BWP	Same as for RMC PDSCH in the active BWP
Power Level		Same as for RMC PDCCH	Same as for RMC PDSCH
NOTE 1: All unused REs in the active CORESETS appointed by the search spaces in use.			
NOTE 2: Unused available REs refer to REs in PRBs not allocated for any physical channels, CORESETS, synchronization signals or reference signals in channel bandwidth.			

A.6 Void

A.7 V2X reference measurement channels

A.7.1 General

The algorithm for determining the payload size A is as follows; given a desired coding rate R and radio block allocation NRB

1. Calculate the RE number of 2nd stage SCI Q_SCI2^A that can be transmitted in a given sub-frame, where in order to make sure that the code-rate of 2-A is approximate to SCI 1-A, a beta offset is selected based on MCS, and vacant resource elements γ value is determined based on NRB and DMRS frequency density.
2. Transport Block Size is determined according to clause 8.1.3.2 of TS 38.214 [13] based on Table A.7.1-1.
3. Calculate Binary Channel Bits per Slot for PSSCH as below

Binary Channel Bits per Slot = $(NRB * \text{Subcarriers per resource block} * \text{CP-OFDM symbols per slot} - \text{DMRS resource REs} - \text{PSCCH resource Res} - Q_SCI2^A) * Q_m$

Where Q_m is the modulation order corresponding to MCS.

In Table A.7.1-1 Common reference channel parameters are listed the Sidelink reference measurement channels specified in annexes A.7.2 to A.7.6.

Table A.7.1-1: Common reference channel parameters

Parameter	Value	remark
Number of HARQ Processes	1	
Channel state	AWGN	
Subcarriers per resource block	12	
sl-PSSCH-DMRS-TimePatternList	2	symbol4 and symbol 10 in each slot FDMed with PSSCH within DMRS symbol Frequency density is $\frac{1}{2}$
CP-OFDM symbols per slot (Note1)	12 for all slots	Excluding the first OFDM symbol in one SL slot used for AGC
PSCCH resource	10 PRBs, 3 symbols in time domain	
Slot number in 10ms	$10 * 2^\mu$	$\mu = 0,1,2$ for 15kHz, 30kHz, 60kHz
PT-RS	disable	
CSI-RS	disable	
x-overhead	0	
PSFCH period	0	
2 nd stage SCI payload size	59	35bits SCI-2A + 24bits CRC
Redundancy Version	RV0	For channel coding
Alpha value for SCI-2	1	

A.7.2 FRC for V2X receiver requirements for QPSK

For V2X transmission over PC5, Table A.7.2-1, Table A.7.2-2 and Table A.7.2-3 are applicable for measurements on the Receiver Characteristics with the exception of Maximum input level.

Table A.7.2-1: Fixed reference channel for V2X receiver requirements (SCS 15 kHz, QPSK)

Parameter	Unit	Value			
		10	20	30	40
Channel bandwidth	MHz	10	20	30	40
Subcarrier spacing	kHz	15	15	15	15

Subchannel size		10	15	10	12
Allocated resource blocks		50	105	160	216
MCS Index		4	4	4	4
MCS Table for TBS determination		64QAM			
Modulation		QPSK	QPSK	QPSK	QPSK
Transport Block Size		3624	7936	12296	16896
Transport block CRC	Bits	16	24	24	24
LDPC base graph		2	1	1	1
Number of Code Blocks per Slot		1	1	2	3
Beta offset for 2nd stage SCI		2.25	2.25	2.25	2.25
γ value when 2nd stage SCI rate match		1	1	1	1
Binary Channel Bits per Slot		12036	26556	41076	55860
Max. Throughput averaged over 100ms	Mbps	0.3624	0.7936	1.2296	1.6896
NOTE 1: If more than one Code Block is present, an additional CRC sequence of L = 24 Bits is attached to each Code Block (otherwise L = 0 Bit).					
NOTE 2: γ is the number of vacant resource elements in the resource block to which the last coded symbol of the 2 nd -stage SCI belongs.					

Table A.7.2-2: Fixed reference channel for V2X receiver requirements (SCS 30 kHz, QPSK)

Parameter	Unit	Value			
		10	20	30	40
Channel bandwidth	MHz	10	20	30	40
Subcarrier spacing	kHz	30	30	30	30
Subchannel size		12	10	15	15
Allocated resource blocks		24	50	75	105
MCS Index		4	4	4	4
MCS Table for TBS determination		64QAM			
Modulation		QPSK	QPSK	QPSK	QPSK
Transport Block Size		1608	3624	5632	7936
Transport block CRC	Bits	16	16	24	24
LDPC base graph		2	2	1	1
Number of Code Blocks per Slot		1	1	1	1
Beta offset for 2nd stage SCI		2.25	2.25	2.25	2.25
γ value when 2nd stage SCI rate match		7	1	1	1
Binary Channel Bits per Slot		5160	12036	18636	26556
Max. Throughput averaged over 100ms	Mbps	0.3216	0.7248	1.1264	1.5872
NOTE 1: If more than one Code Block is present, an additional CRC sequence of L = 24 Bits is attached to each Code Block (otherwise L = 0 Bit).					
NOTE 2: γ is the number of vacant resource elements in the resource block to which the last coded symbol of the 2 nd -stage SCI belongs.					

Table A.7.2-3: Fixed reference channel for V2X receiver requirements (SCS 60 kHz, QPSK)

Parameter	Unit	Value			
		10	20	30	40
Channel bandwidth	MHz	10	20	30	40
Subcarrier spacing	kHz	60	60	60	60
Subchannel size		10	12	12	10
Allocated resource blocks		10	24	36	50
MCS Index		4	4	4	4
MCS Table for TBS determination		64QAM			
Modulation		QPSK	QPSK	QPSK	QPSK
Transport Block Size		456	1608	2536	3624
Transport block CRC	Bits	16	16	16	16
LDPC base graph		2	2	2	2
Number of Code Blocks per Slot		1	1	1	1
Beta offset for 2nd stage SCI		2.25	2.25	2.25	2.25
γ value when 2nd stage SCI rate match		7	7	7	1
Binary Channel Bits per Slot		1464	5160	8328	12036
Max. Throughput averaged over 100ms	Mbps	0.1824	0.6432	1.0144	1.4496
NOTE 1: If more than one Code Block is present, an additional CRC sequence of L = 24 Bits is attached to each Code Block (otherwise L = 0 Bit).					
NOTE 2: γ is the number of vacant resource elements in the resource block to which the last coded symbol of the 2 nd -stage SCI belongs.					

A.7.3 FRC for maximum input level for 64QAM

For V2X transmission over PC5, Table A.7.3-1, Table A.7.3-2 and TableA.7.3-3 are applicable for Maximum input level when the maximum modulation order is 64QAM.

Table A.7.3-1: Fixed reference channel for V2X receiver requirements (SCS 15 kHz, 64QAM)

Parameter	Unit	Value			
		10	20	30	40
Channel bandwidth	MHz	10	20	30	40
Subcarrier spacing	kHz	15	15	15	15
Subchannel size		10	15	10	12
Allocated resource blocks		50	105	160	216
MCS Index		24	24	24	24
MCS Table for TBS determination		64QAM			
Modulation		64QAM	64QAM	64QAM	64QAM
Transport Block Size		27144	60456	92200	127080
Transport block CRC	Bits	24	24	24	24
LDPC base graph		1	1	1	1
Number of Code Blocks per Slot		4	8	11	16
Beta offset for 2nd stage SCI		6.25	6.25	6.25	6.25
γ value when 2nd stage SCI rate match		1	1	1	1
Binary Channel Bits per Slot		35964	79524	123084	167436
Max. Throughput averaged over 100ms	Mbps	2.7144	6.0456	9.22	12.708
NOTE 1: If more than one Code Block is present, an additional CRC sequence of L = 24 Bits is attached to each Code Block (otherwise L = 0 Bit).					
NOTE 2: γ is the number of vacant resource elements in the resource block to which the last coded symbol of the 2 nd -stage SCI belongs.					

Table A.7.3-2: Fixed reference channel for V2X receiver requirements (SCS 30 kHz, 64QAM)

Parameter	Unit	Value			
		10	20	30	40
Channel bandwidth	MHz	10	20	30	40
Subcarrier spacing	kHz	30	30	30	30
Subchannel size		12	10	15	15
Allocated resource blocks		24	50	75	105
MCS Index		24	24	24	24
MCS Table for TBS determination		64QAM			
Modulation		64QAM	64QAM	64QAM	64QAM
Transport Block Size		11528	27144	42016	60456
Transport block CRC	Bits	24	24	24	24
LDPC base graph		1	1	1	1
Number of Code Blocks per Slot		2	4	5	8
Beta offset for 2nd stage SCI		6.25	6.25	6.25	6.25
γ value when 2nd stage SCI rate match		7	1	1	1
Binary Channel Bits per Slot		15336	35964	55764	79524
Max. Throughput averaged over 100ms	Mbps	2.3056	5.4288	8.4032	12.091
NOTE 1: If more than one Code Block is present, an additional CRC sequence of L = 24 Bits is attached to each Code Block (otherwise L = 0 Bit).					
NOTE 2: γ is the number of vacant resource elements in the resource block to which the last coded symbol of the 2 nd -stage SCI belongs.					

TableA.7.3-3: Fixed reference channel for V2X receiver requirements (SCS 60 kHz, 64QAM)

Parameter	Unit	Value			
		10	20	30	40
Channel bandwidth	MHz	10	20	30	40
Subcarrier spacing	kHz	60	60	60	60
Subchannel size		10	12	12	10
Allocated resource blocks		10	24	36	50
MCS Index		24	24	24	24
MCS Table for TBS determination		64QAM			

Modulation		64QAM	64QAM	64QAM	64QAM
Transport Block Size		3240	11528	18960	27144
Transport block CRC	Bits	16	24	24	24
LDPC base graph		2	1	1	1
Number of Code Blocks per Slot		1	2	3	4
Beta offset for 2nd stage SCI		6.25	6.25	6.25	6.25
γ value when 2nd stage SCI rate match		7	7	7	1
Binary Channel Bits per Slot		4248	15336	24840	35964
Max. Throughput averaged over 100ms	Mbps	1.296	4.6112	7.584	10.858
NOTE 1: If more than one Code Block is present, an additional CRC sequence of L = 24 Bits is attached to each Code Block (otherwise L = 0 Bit).					
NOTE 2: γ is the number of vacant resource elements in the resource block to which the last coded symbol of the 2 nd -stage SCI belongs.					

A.7.4 FRC for maximum input level for 256QAM

For V2X transmission over PC5, Table A.7.4-1, Table A.7.4-2 and Table A.7.4-3 are applicable for Maximum input level when the 256QAM is supported.

Table A.7.4-1: Fixed reference channel for V2X receiver requirements (SCS 15 kHz, 256QAM)

Parameter	Unit	Value			
		10	20	30	40
Channel bandwidth	MHz	10	20	30	40
Subcarrier spacing	kHz	15	15	15	15
Subchannel size		10	15	10	12
Allocated resource blocks		50	105	160	216
MCS Index		23	23	23	23
MCS Table for TBS determination		256QAM			
Modulation		256QAM	256QAM	256QAM	256QAM
Transport Block Size		36896	81976	127080	172176
Transport block CRC	Bits	24	24	24	24
LDPC base graph		1	1	1	1
Number of Code Blocks per Slot		5	10	16	21
Beta offset for 2nd stage SCI		6.25	6.25	6.25	6.25
γ value when 2nd stage SCI rate match		3	3	3	3
Binary Channel Bits per Slot		48000	106080	164160	223296
Max. Throughput averaged over 100ms	Mbps	3.6896	8.1976	12.708	17.218
NOTE 1: If more than one Code Block is present, an additional CRC sequence of L = 24 Bits is attached to each Code Block (otherwise L = 0 Bit).					
NOTE 2: γ is the number of vacant resource elements in the resource block to which the last coded symbol of the 2 nd -stage SCI belongs.					

Table A.7.4-2: Fixed reference channel for V2X receiver requirements (SCS 30 kHz, 256QAM)

Parameter	Unit	Value			
		10	20	30	40
Channel bandwidth	MHz	10	20	30	40
Subcarrier spacing	kHz	30	30	30	30
Subchannel size		12	10	15	15
Allocated resource blocks		24	50	75	105
MCS Index		23	23	23	23
MCS Table for TBS determination		256QAM			
Modulation		256QAM	256QAM	256QAM	256QAM
Transport Block Size		15880	36896	58384	81976
Transport block CRC	Bits	24	24	24	24
LDPC base graph		1	1	1	1
Number of Code Blocks per Slot		2	5	7	10
Beta offset for 2nd stage SCI		6.25	6.25	6.25	6.25
γ value when 2nd stage SCI rate match		3	3	3	3
Binary Channel Bits per Slot		20544	48000	74400	106080
Max. Throughput averaged over 100ms	Mbps	3.176	7.3792	11.677	16.395
NOTE 1: If more than one Code Block is present, an additional CRC sequence of L = 24 Bits is attached to each Code Block (otherwise L = 0 Bit).					

NOTE 2: γ is the number of vacant resource elements in the resource block to which the last coded symbol of the 2nd-stage SCI belongs.

Table A.7.4-3: Fixed reference channel for V2X receiver requirements (SCS 60kHz, 256QAM)

Parameter	Unit	Value			
Channel bandwidth	MHz	10	20	30	40
Subcarrier spacing	kHz	60	60	60	60
Subchannel size		10	12	12	10
Allocated resource blocks		10	24	36	50
MCS Index		23	23	23	23
MCS Table for TBS determination		256QAM			
Modulation		256QAM	256QAM	256QAM	256QAM
Transport Block Size		4480	15880	25608	36896
Transport block CRC	Bits	24	24	24	24
LDPC base graph		1	1	1	1
Number of Code Blocks per Slot		1	2	4	5
Beta offset for 2nd stage SCI		6.25	6.25	6.25	6.25
γ value when 2nd stage SCI rate match		3	3	3	3
Binary Channel Bits per Slot		5760	20544	33216	48000
Max. Throughput averaged over 100ms	Mbps	1.792	6.352	10.243	14.758
NOTE 1: If more than one Code Block is present, an additional CRC sequence of L = 24 Bits is attached to each Code Block (otherwise L = 0 Bit).					
NOTE 2: γ is the number of vacant resource elements in the resource block to which the last coded symbol of the 2 nd -stage SCI belongs.					

Annex B (informative): Void

Annex C (informative): Downlink physical channels

C.1 General

The following clauses, describes the downlink Physical Channels that are transmitted during a connection i.e., when measurements are done.

C.2 Setup

Table C.2-1 describes the downlink Physical Channels that are required for connection set up.

Table C.2-1: Downlink Physical Channels required for connection set-up

Physical Channel
PBCH
SSS
PSS
PDCCH
PDSCH
PBCH DMRS
PDCCH DMRS
PDSCH DMRS
CSI-RS

C.3 Connection

C.3.1 Measurement of Receiver Characteristics

Unless otherwise stated, Table C.3.1-1 is applicable for measurements on the Receiver Characteristics (clause 7).

Table C.3.1-1: Downlink Physical Channels transmitted during a connection (FDD and TDD)

Parameter	Unit	Value
SSS transmit power	W	Test specific
EPRE ratio of PSS to SSS	dB	0
EPRE ratio of PBCH to SSS	dB	0
EPRE ratio of PBCH to PBCH DMRS	dB	0
EPRE ratio of PDCCH to SSS	dB	0
EPRE ratio of PDCCH to PDCCH DMRS	dB	0
EPRE ratio of PDSCH to SSS	dB	0
EPRE ratio of PDSCH to PDSCH DMRS (Note 1)	dB	-3
EPRE ratio of CSI-RS to SSS	dB	0
EPRE ratio of PTRS to PDSCH	dB	Test specific
EPRE ratio of OCNG DMRS to SSS	dB	0
EPRE ratio of OCNG to OCNG DMRS (Note 1)	dB	0
NOTE 1: No boosting is applied to any of the channels except PDSCH DMRS. For PDSCH DMRS, 3 dB power boosting is applied assuming DMRS Type 1 configuration when DMRS and PDSCH are TDM'ed and only half of the DMRS REs are occupied.		
NOTE 2: Number of DMRS CDM groups without data for PDSCH DMRS configuration for OCNG is set to 1.		

Annex D (normative): Characteristics of the interfering signal

D.1 General

Some RF performance requirements for the NR UE receiver are defined with interfering signals present in addition to the wanted signal.

For NR bands with $F_{DL_high} < 2700$ MHz and $F_{UL_high} < 2700$ MHz, a modulated 5 MHz full bandwidth NR down link signal, and in some cases an additional CW signal, are used as interfering signal. For intra-band contiguous CA bandwidth class B and C, a modulated 5 MHz NR downlink signal is used. And for some cases an additional CW signal is used.

For NR bands with $F_{DL_low} \geq 3300$ MHz and $F_{UL_low} \geq 3300$ MHz, a modulated NR downlink signal which equals to channel bandwidth of the wanted signal for single carrier and inter-band CA cases is used as interfering signal. For intra-band contiguous CA bandwidth Class C, a modulated NR downlink signal which equals to the aggregated channel bandwidth of the wanted signal is used. For intra-band contiguous CA bandwidth class D and E cases, a modulated 50 MHz NR downlink signal is used. And for some cases an additional CW signal is used.

D.2 Interference signals

Table D.2-1 and Table D.2-4 describes the modulated interferer for different channel bandwidth options for NR band lower than 2700MHz.

Table D.2-1: Description of modulated NR interferer for NR bands with $F_{DL_high} < 2700$ MHz and $F_{UL_high} < 2700$ MHz

	Channel bandwidth					
	5 MHz	10MHz	15 MHz	20 MHz	25 MHz	30 MHz
RB	NOTE 1					
$BW_{Interferer}$	5 MHz					
	Channel bandwidth					
	40 MHz	50 MHz	60 MHz	80 MHz	90 MHz	100 MHz
RB	NOTE 1					
$BW_{Interferer}$	5 MHz					
NOTE 1: The RB configured for interfering signal is the same as maximum RB number defined in Table 5.3.2-1 for each sub-carrier spacing.						

Table D.2-2 and Table D.2-3 describe the modulated interferer for different channel bandwidth options for NR band higher than 3300MHz.

Table D.2-2: Description of modulated NR interferer for NR bands with $F_{DL_low} \geq 3300$ MHz and $F_{UL_low} \geq 3300$ MHz

	Channel bandwidth								
	10 MHz	15 MHz	20 MHz	40 MHz	50 MHz	60 MHz	80 MHz	90 MHz	100 MHz
RB	NOTE 1								
$BW_{Interferer}$	10 MHz	15 MHz	20 MHz	40 MHz	50 MHz	60 MHz	80 MHz	90 MHz	100 MHz
NOTE 1: The RB configured for interfering signal is the same as maximum RB number defined in Table 5.3.2-1 for each sub-carrier spacing.									

Table D.2-3: Description of modulated NR interferer for NR bands with $F_{DL_low} \geq 3300$ MHz and $F_{UL_low} \geq 3300$ MHz for Intra-band contiguous CA

	Aggregated Channel bandwidth of Bandwidth Class C								Bandwidth Class D/E
	110 MHz	120 MHz	130 MHz	140 MHz	150 MHz	160 MHz	180 MHz	200 MHz	
RB(SCS=30 kHz)	NOTE 1								133
RB(SCS=60 kHz)	NOTE 1								65
$BW_{interferer}$	110 MHz	120 MHz	130 MHz	140 MHz	150 MHz	160 MHz	180 MHz	200 MHz	50MHz
NOTE 1: The interfering signal shall be configured in the same way as the aggregated bandwidth of the wanted signal. The RB configurations for each component carrier are defined in Table 5.3.2-1 for each sub-carrier spacing.									

Table D.2-4: Description of modulated NR interferer for NR bands with $F_{DL_low} < 2700$ MHz and $F_{UL_low} < 2700$ MHz for Intra-band contiguous CA

	Bandwidth Class B	Bandwidth Class C
RB	NOTE 1	NOTE 1
$BW_{interferer}$	5 MHz	5 MHz
NOTE 1: The RB configured for interfering signal is the same as maximum RB number defined in Table 5.3.2-1 for each sub-carrier spacing.		

Annex E (normative): Environmental conditions

E.1 General

This normative annex specifies the environmental requirements of the UE. Within these limits the requirements of the present documents shall be fulfilled.

E.2 Environmental

The requirements in this clause apply to all types of UE(s).

E.2.1 Temperature

The UE shall fulfil all the requirements in the full temperature range of:

Table E.2.1-1: Temperature conditions

+15°C to +35°C	For normal conditions (with relative humidity up to 75 %)
-10°C to +55°C	For extreme conditions (see IEC publications 68-2-1 and 68-2-2)

Outside this temperature range the UE, if powered on, shall not make ineffective use of the radio frequency spectrum. In no case shall the UE exceed the transmitted levels as defined in clause 6.2 for extreme operation.

E.2.2 Voltage

The UE shall fulfil all the requirements in the full voltage range, i.e. the voltage range between the extreme voltages.

The manufacturer shall declare the lower and higher extreme voltages and the approximate shutdown voltage. For the equipment that can be operated from one or more of the power sources listed below, the lower extreme voltage shall not be higher, and the higher extreme voltage shall not be lower than that specified below.

Table E.2.2-1: Voltage conditions

Power source	Lower extreme voltage	Higher extreme voltage	Normal conditions voltage
AC mains	0,9 * nominal	1,1 * nominal	nominal
Regulated lead acid battery	0,9 * nominal	1,3 * nominal	1,1 * nominal
Non regulated batteries:			
Leclanché	0,85 * nominal	Nominal	Nominal
Lithium	0,95 * nominal	1,1 * Nominal	1,1 * Nominal
Mercury/nickel & cadmium	0,90 * nominal		Nominal

Outside this voltage range the UE if powered on, shall not make ineffective use of the radio frequency spectrum. In no case shall the UE exceed the transmitted levels as defined in clause 6.2 for extreme operation. In particular, the UE shall inhibit all RF transmissions when the power supply voltage is below the manufacturer declared shutdown voltage.

E.2.3 Vibration

The UE shall fulfil all the requirements when vibrated at the following frequency/amplitudes.

Table E.2.3-1: Vibration conditions

Frequency	ASD (Acceleration Spectral Density) random vibration
5 Hz to 20 Hz	0.96 m ² /s ³
20 Hz to 500 Hz	0.96 m ² /s ³ at 20 Hz, thereafter -3 dB/Octave

Outside the specified frequency range the UE, if powered on, shall not make ineffective use of the radio frequency spectrum. In no case shall the UE exceed the transmitted levels as defined in TS 38.101-1 for extreme operation.

Annex F (normative): Transmit modulation

F.0 General

While measuring the transmit modulation quality of carriers, an existence of the carrier leakage needs to be taken into account indicated by the parameter *txDirectCurrentLocation* in *UplinkTxDirectCurrent* IE.

F.1 Measurement Point

Figure F.1-1 shows the measurement point for the unwanted emission falling into non-allocated RB(s) and the EVM for the allocated RB(s).

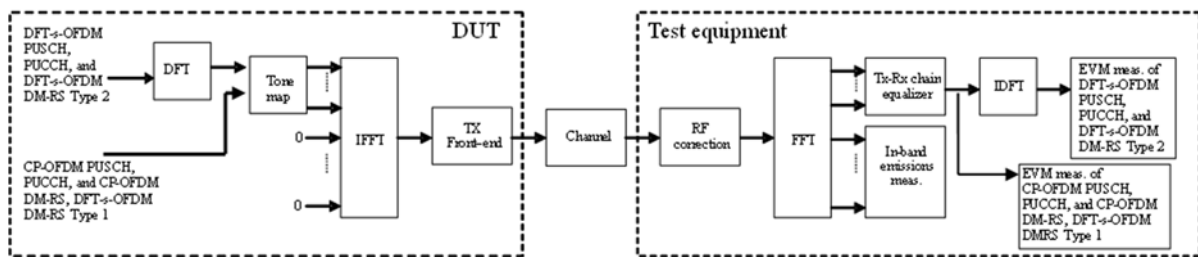

Figure F.1-1: EVM measurement points

F.2 Basic Error Vector Magnitude measurement

The EVM is the difference between the ideal waveform and the measured waveform for the allocated RB(s)

$$EVM = \sqrt{\frac{\sum_{v \in T_m} |z'(v) - i(v)|^2}{|T_m| \cdot P_0}}$$

where

T_m is a set of $|T_m|$ modulation symbols with the considered modulation scheme being active within the measurement period,

$z'(v)$ are the samples of the signal evaluated for the EVM,

$i(v)$ is the ideal signal reconstructed by the measurement equipment, and

P_0 is the average power of the ideal signal. For normalized modulation symbols P_0 is equal to 1.

The basic EVM measurement interval is defined over one slot in the time domain for PUCCH and PUSCH and over one preamble sequence for the PRACH.

F.3 Basic in-band emissions measurement

The in-band emissions are a measure of the interference falling into the non-allocated resources blocks. The in-band emission requirement is evaluated for PUCCH and PUSCH transmissions. The in-band emission requirement is not evaluated for PRACH transmissions.

The in-band emissions are measured as follows

$$Emissions_{absolute}(\Delta_{RB}) = \begin{cases} \frac{1}{|T_s|} \sum_{t \in T_s} \sum_{f_l + (12 \cdot \Delta_{RB} + 1) \cdot \Delta f}^{f_l + (12 \cdot \Delta_{RB} + 11) \cdot \Delta f} |Y(t, f)|^2, \Delta_{RB} < 0 \\ \frac{1}{|T_s|} \sum_{t \in T_s} \sum_{f_h + (12 \cdot \Delta_{RB} - 11) \cdot \Delta f}^{\min(f_{\max}, f_h + 12 \cdot \Delta_{RB} \cdot \Delta f)} |Y(t, f)|^2, \Delta_{RB} > 0 \end{cases},$$

where

T_s is a set of $|T_s|$ OFDM symbols with the considered modulation scheme being active within the measurement period,

Δ_{RB} is the starting frequency offset between the allocated RB and the measured non-allocated RB (e.g. $\Delta_{RB} = 1$ or $\Delta_{RB} = -1$ for the first adjacent RB),

f_{\min} (resp. f_{\max}) is the lower (resp. upper) edge of the UL UE channel bandwidth,

f_l and f_h are the lower and upper edge of the allocated BW, and

$Y(t, f)$ is the frequency domain signal evaluated for in-band emissions as defined in the clause (ii)

The relative in-band emissions are, given by

$$Emissions_{relative}(\Delta_{RB}) = \frac{Emissions_{absolute}(\Delta_{RB})}{\frac{1}{|T_s| \cdot N_{RB}} \sum_{t \in T_s} \sum_{f_l}^{f_l + (12 \cdot N_{RB} - 1) \cdot \Delta f} |Y(t, f)|^2}$$

where

N_{RB} is the number of allocated RBs

The basic in-band emissions measurement interval is defined over one slot in the time domain. When the PUSCH or PUCCH transmission slot is shortened due to multiplexing with SRS, the in-band emissions measurement interval is reduced by one OFDM symbol, accordingly.

In the evaluation of in-band emissions, the timing is set according to $\tilde{\Delta}_f = \tilde{\Delta}_c$, where sample time offsets $\tilde{\Delta}_f$ and $\tilde{\Delta}_c$ are defined in clause F.4.

F.4 Modified signal under test

Implicit in the definition of EVM is an assumption that the receiver is able to compensate a number of transmitter impairments.

The DFT-s-OFDM modulated signals or PRACH signal under test is modified and, in the case of DFT-s-OFDM modulated signals, decoded according to:

$$Z'(t, f) = IDFT \left\{ \frac{FFT \left\{ z(v - \Delta\tilde{t}) \cdot e^{-j2\pi\Delta\tilde{f}v} \right\} e^{j2\pi f \Delta\tilde{t}}}{\tilde{a}(t, f) \cdot e^{j\tilde{\varphi}(t, f)}} \right\}$$

where

$z(v)$ is the time domain samples of the signal under test.

The CP-OFDM modulated signals or PUSCH demodulation reference signal or PUCCH data signal under test is equalised and, in the case of CP-OFDM modulated signals decoded according to:

$$Z'(t, f) = \frac{FFT \left\{ z(v - \Delta\tilde{t}) \cdot e^{-j2\pi\Delta\tilde{f}v} \right\} e^{j2\pi f \Delta\tilde{t}}}{\tilde{a}(t, f) \cdot e^{j\tilde{\varphi}(t, f)}}$$

where

$z(v)$ is the time domain samples of the signal under test.

To minimize the error, the signal under test should be modified with respect to a set of parameters following the procedure explained below.

Notation:

$\Delta\tilde{t}$ is the sample timing difference between the FFT processing window in relation to nominal timing of the ideal signal.

$\Delta\tilde{f}$ is the RF frequency offset.

$\tilde{\varphi}(t, f)$ is the phase response of the TX chain.

$\tilde{a}(t, f)$ is the amplitude response of the TX chain.

In the following $\Delta\tilde{c}$ represents the middle sample of the EVM window of length w (defined in the next clauses) or the last sample of the first window half if w is even.

The EVM analyser shall

- detect the start of each slot and estimate $\Delta\tilde{t}$ and $\Delta\tilde{f}$,
- determine $\Delta\tilde{c}$ so that the EVM window of length w is centred
 - on the time interval determined by the measured cyclic prefix minus 16κ samples of the considered OFDM symbol for symbol 1 for subcarrier spacing configuration μ in a subframe, with $l = 0$ or $l = 7 \cdot 2^\mu$ for normal CP, i.e. the first 16κ samples of the CP should not be taken into account for this step. In the determination of the number of excluded samples, a sampling rate of $1/T_c$ is assumed. If a different sampling rate is used, the number of excluded samples is scaled linearly.
 - on the measured cyclic prefix of the considered OFDM symbol for all other symbols for normal CP and for symbol 0 to 11 for extended CP.

- on the measured preamble cyclic prefix for the PRACH

To determine the other parameters a sample timing offset equal to $\Delta\tilde{\tau}$ is corrected from the signal under test. The EVM analyser shall then

- correct the RF frequency offset $\hat{\Delta f}$ for each time slot, and
- apply an FFT of appropriate size. The chosen FFT size shall ensure that in the case of an ideal signal under test, there is no measured inter-subcarrier interference.

The carrier leakage shall be removed from the evaluated signal before calculating the EVM and the in-band emissions; however, the removed relative carrier leakage power also has to satisfy the applicable requirement.

At this stage the allocated RBs shall be separated from the non-allocated RBs. In the case of PUCCH and PUSCH EVM, the signal on the non-allocated RB(s), $y(t, f)$, is used to evaluate the in-band emissions.

Moreover, the following procedure applies only to the signal on the allocated RB(s).

- In the case of PUCCH and PUSCH, the UL EVM analyzer shall estimate the TX chain equalizer coefficients $\tilde{a}(t, f)$ and $\tilde{\varphi}(t, f)$ used by the ZF equalizer for all subcarriers by time averaging at each signal subcarrier of the amplitude and phase of the reference and data symbols. The time-averaging length is 1 slot. This process creates an average amplitude and phase for each signal subcarrier used by the ZF equalizer. The knowledge of data modulation symbols may be required in this step because the determination of symbols by demodulation is not reliable before signal equalization.
- In the case of PRACH, the UL EVM analyzer shall estimate the TX chain coefficients $\tilde{a}(t)$ and $\tilde{\varphi}(t)$ used for phase and amplitude correction and are selected so as to minimize the resulting EVM. The TX chain coefficients are not dependent on frequency, i.e. $\tilde{a}(t, f) = \tilde{a}(t)$ and $\tilde{\varphi}(t, f) = \tilde{\varphi}(t)$. The TX chain coefficients are chosen independently for each preamble transmission and for each $\Delta\tilde{\tau}$.

At this stage estimates of $\hat{\Delta f}$, $\tilde{a}(t, f)$, $\tilde{\varphi}(t, f)$ and $\Delta\tilde{\tau}$ are available. $\Delta\tilde{\tau}$ is one of the extremities of the window W , i.e. $\Delta\tilde{\tau}$ can be $\Delta\tilde{\tau} + \alpha - \left\lfloor \frac{W}{2} \right\rfloor$ or $\Delta\tilde{\tau} + \left\lfloor \frac{W}{2} \right\rfloor$, where $\alpha = 0$ if W is odd and $\alpha = 1$ if W is even. The EVM analyser shall then

- calculate EVM_l with $\Delta\tilde{\tau}$ set to $\Delta\tilde{\tau} + \alpha - \left\lfloor \frac{W}{2} \right\rfloor$,
- calculate EVM_h with $\Delta\tilde{\tau}$ set to $\Delta\tilde{\tau} + \left\lfloor \frac{W}{2} \right\rfloor$.

For the EVM calculation on the symbols with a transient period when the UE signals a transient period capability (tp) of 2, 4 or 7usec, $\Delta\tilde{\tau}$ is given below.

- calculate $\text{EVM}_{l, tp}$ with $\Delta\tilde{\tau}$ set to $\left\lfloor \frac{tp + tp_{start}}{T_c} \right\rfloor + 1$, where $1/T_c$ is the sampling rate
- calculate $\text{EVM}_{h, tp}$ with $\Delta\tilde{\tau}$ set to $\left\lfloor \frac{CP + tp_{start}}{T_c} \right\rfloor - 1$, where $1/T_c$ is the sampling rate and the CP is the cyclic prefix of the symbol on which EVM is calculated (e.g. long CP for the first symbol of the slot) in seconds

A pictorial representation of the EVM measurement windows is given in Figure F.4-1.

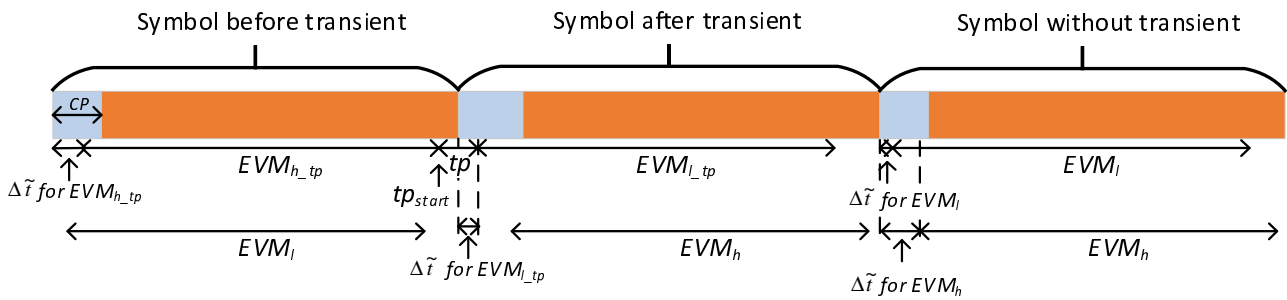

Figure F.4-1: EVM measurement window

F.5 Window length

F.5.1 Timing offset

As a result of using a cyclic prefix, there is a range of $\Delta\tilde{\tau}$, which, at least in the case of perfect Tx signal quality, would give close to minimum error vector magnitude. As a first order approximation, that range should be equal to the length of the cyclic prefix. Any time domain windowing or FIR pulse shaping applied by the transmitter reduces the $\Delta\tilde{\tau}$ range within which the error vector is close to its minimum.

F.5.2 Window length

The window length W affects the measured EVM and is expressed as a function of the configured cyclic prefix length. In the case where equalization is present, as with frequency domain EVM computation, the effect of FIR is reduced. This is because the equalization can correct most of the linear distortion introduced by the FIR. However, the time domain windowing effect can't be removed.

F.5.3 Window length for normal CP

Table F.5.3-1, F.5.3-2, F.5.3-3 below specify the EVM window length (W) for normal CP.

Table F.5.3-1: EVM window length for normal CP for NR, FR1, 15 kHz SCS

Channel Bandwidth (MHz)	FFT size	Cyclic prefix length for symbols 1-6 and 8-13 in FFT samples	EVM window length W	Ratio of W to total CP length for symbols 1-6 and 8-13 ¹ (%)
5	512	36	18	50
10	1024	72	36	50
15	1536	108	54	50
20	2048	144	72	50
25	2048	144	72	50
30	3072	216	108	50
40	4096	288	144	50
50	4096	288	144	50

NOTE 1: These percentages are informative and apply to a slot's symbols 1 to 6 and 8 to 13. Symbols 0 and 7 have a longer CP and therefore a lower percentage.

Table F.5.3-2: EVM window length for normal CP for NR, FR1, 30 kHz SCS

Channel Bandwidth (MHz)	FFT size	Cyclic prefix length for symbols 1-13 in FFT samples	EVM window length W	Ratio of W to total CP length for symbols 1-13 ¹ (%)
5	256	18	9	50
10	512	36	18	50
15	768	54	27	50
20	1024	72	36	50
25	1024	72	36	50
30	1536	108	54	50
40	2048	144	72	50
50	2048	144	72	50
60	3072	216	108	50
70	3072	216	108	50
80	4096	288	144	50
90	4096	288	144	50
100	4096	288	144	50

NOTE 1: These percentages are informative and apply to a slot's symbols 1 through 13. Symbol 0 has a longer CP and therefore a lower percentage.

Table F.5.3-3: EVM window length for normal CP for NR (60 kHz SCS)

Channel Bandwidth (MHz)	FFT size	Cyclic prefix length for symbols in FFT samples	EVM window length W	Ratio of W to total CP length ¹ (%)
10	256	18	9	50
15	384	27	14	50
20	512	36	18	50
25	512	36	18	50
30	768	54	27	50
40	1024	72	36	50
50	1024	72	36	50
60	1536	108	54	50
70	1536	108	54	50
80	2048	144	72	50
90	2048	144	72	50
100	2048	144	72	50

NOTE 1: These percentages are informative and apply to all OFDM symbols within subframe except for symbol 0 of slot 0 and slot 2. Symbol 0 of slot 0 and slot 2 may have a longer CP and therefore a lower percentage.

F.5.4 Window length for Extended CP

Table F.5.4-1 below specifies the EVM window length (W) for extended CP. The number of CP samples excluded from the EVM window is the same as for normal CP length.

Table F.5.4-1: EVM window length for extended CP for NR, FR1, 60 kHz SCS

Channel Bandwidth (MHz)	FFT size	Cyclic prefix length in FFT samples	EVM window length W	Ratio of W to total CP length ¹ (%)
10	256	64	54	84.4

15	384	96	80	83.3
20	512	128	106	82.8
25	512	128	110	85.9
30	768	192	164	85.4
40	1024	256	220	85.9
50	1024	256	220	85.9
60	1536	384	330	85.9
70	1536	384	330	85.9
80	2048	512	440	85.9
90	2048	512	440	85.9
100	2048	512	440	85.9
NOTE 1: These percentages are informative.				

F.5.5 Window length for PRACH

The table below specifies the EVM window length for PRACH preamble formats for $L_{RA}=839$ and $\Delta f^{RA} \in \{1.25, .5\}$ kHz

Table F.5.5-1 EVM window length for PRACH formats for $L_{RA}=839$

Preamble format	Cyclic prefix length N_{CP}	Nominal FFT size ¹	EVM window length W in FFT samples	Ratio of W to CP^2
0	3168	24576	2307	72.8%
1	21024	24576	20163	95.9%
2	4688	24576	3827	81.6%
3	3168	6144	2952	93.2%
NOTE 1: The use of other FFT sizes is possible as long as appropriate scaling of the window length is applied				
NOTE 2: These percentages are informative				

The table below specifies the EVM window length for PRACH preamble formats for $L_{RA}=139$ and $\Delta f^{RA} = 15 \cdot 2^{-\mu}$ kHz where $\mu \in \{0, 1, 2\}$.

Table F.5.5-2 EVM window length for PRACH formats for $L_{RA}=139$

Preamble format	Cyclic prefix length N_{CP}	Nominal FFT size ¹	EVM window length W in FFT samples	Ratio of W to CP^2
A1	$288 \cdot 2^{-\mu}$	$2048 \cdot 2^{-\mu}$	$144 \cdot 2^{-\mu}$	50.0%
A2	$576 \cdot 2^{-\mu}$	$2048 \cdot 2^{-\mu}$	$432 \cdot 2^{-\mu}$	75.0%
A3	$864 \cdot 2^{-\mu}$	$2048 \cdot 2^{-\mu}$	$720 \cdot 2^{-\mu}$	83.3%
B1	$216 \cdot 2^{-\mu}$	$2048 \cdot 2^{-\mu}$	$72 \cdot 2^{-\mu}$	33.3%
B2	$360 \cdot 2^{-\mu}$	$2048 \cdot 2^{-\mu}$	$216 \cdot 2^{-\mu}$	60.0%
B3	$504 \cdot 2^{-\mu}$	$2048 \cdot 2^{-\mu}$	$360 \cdot 2^{-\mu}$	71.4%
B4	$936 \cdot 2^{-\mu}$	$2048 \cdot 2^{-\mu}$	$792 \cdot 2^{-\mu}$	84.6%
C0	$1240 \cdot 2^{-\mu}$	$2048 \cdot 2^{-\mu}$	$1096 \cdot 2^{-\mu}$	88.4%
C2	$2048 \cdot 2^{-\mu}$	$2048 \cdot 2^{-\mu}$	$1904 \cdot 2^{-\mu}$	93.0%
NOTE 1: The use of other FFT sizes is possible as long as appropriate scaling of the window length is applied				
NOTE 2: These percentages are informative				

F.6 Averaged EVM

The general EVM is averaged over basic EVM measurements for n slots in the time domain.

$$\overline{EVM} = \sqrt{\frac{1}{n} \sum_{i=1}^n EVM_i^2},$$

where n is

$$n = \begin{cases} 10, & \text{for 15 kHz SCS} \\ 20, & \text{for 30 kHz SCS} \\ 40, & \text{for 60 kHz SCS} \end{cases}$$

for PUCCH, PUSCH.

The EVM requirements shall be tested against the maximum of the RMS average at the window W extremities of the EVM measurements:

Thus \overline{EVM}_l is calculated using $\Delta \tilde{\tau} = \Delta \tilde{\tau}_l$ in the expressions above and \overline{EVM}_h is calculated using $\Delta \tilde{\tau} = \Delta \tilde{\tau}_h$.

Thus we get:

$$EVM = \max(\overline{EVM}_l, \overline{EVM}_h)$$

The calculation of the EVM for the demodulation reference signal, EVM_{DMRS} , follows the same procedure as calculating the general EVM, with the exception that the modulation symbol set T_m defined in clause F.2 is restricted to symbols containing uplink demodulation reference signals.

The basic EVM_{DMRS} measurements are first averaged over n slots in the time domain to obtain an intermediate average \overline{EVM}_{DMRS} .

$$\overline{EVM}_{DMRS} = \sqrt{\frac{1}{n} \sum_{i=1}^n EVM_{DMRS,i}^2}$$

In the determination of each $EVM_{DMRS,i}$, the timing is set to $\Delta \tilde{\tau} = \Delta \tilde{\tau}_l$ if $\overline{EVM}_l > \overline{EVM}_h$, and it is set to $\Delta \tilde{\tau} = \Delta \tilde{\tau}_h$ otherwise, where \overline{EVM}_l and \overline{EVM}_h are the general average EVM values calculated in the same n slots over which the intermediate average \overline{EVM}_{DMRS} is calculated. Note that in some cases, the general average EVM may be calculated only for the purpose of timing selection for the demodulation reference signal EVM.

Then the results are further averaged to get the EVM for the demodulation reference signal, EVM_{DMRS} ,

$$EVM_{DMRS} = \sqrt{\frac{1}{6} \sum_{j=1}^6 \overline{EVM}_{DMRS,j}^2}$$

The PRACH EVM, EVM_{PRACH} , is averaged over 2 preamble sequence measurements for long preamble formats as defined in table 6.3.3.1-1 in [6] and averaged over 10 preamble sequence measurements for short preamble formats as defined in table 6.3.3.1-2 in [6].

The EVM requirements shall be tested against the maximum of the RMS average at the window W extremities of the EVM measurements:

Thus $\overline{EVM}_{PRACH,l}$ is calculated using $\Delta \tilde{\tau} = \Delta \tilde{\tau}_l$ and $\overline{EVM}_{PRACH,h}$ is calculated using $\Delta \tilde{\tau} = \Delta \tilde{\tau}_h$.

Thus we get:

$$EVM_{PRACH} = \max(\overline{EVM}_{PRACH,l}, \overline{EVM}_{PRACH,h})$$

F.7 Spectrum Flatness

The data shall be taken from FFT coded data symbols and the demodulation reference symbols of the allocated resource block.

F.8

F.9

F.10 EVM for UL MIMO

F10.1 General

EVM for UL MIMO is measured per layer. A zero-forcing (ZF) MIMO receiver architecture is used so that dual layer transmissions by the UE can be demodulated by the test equipment receiver.

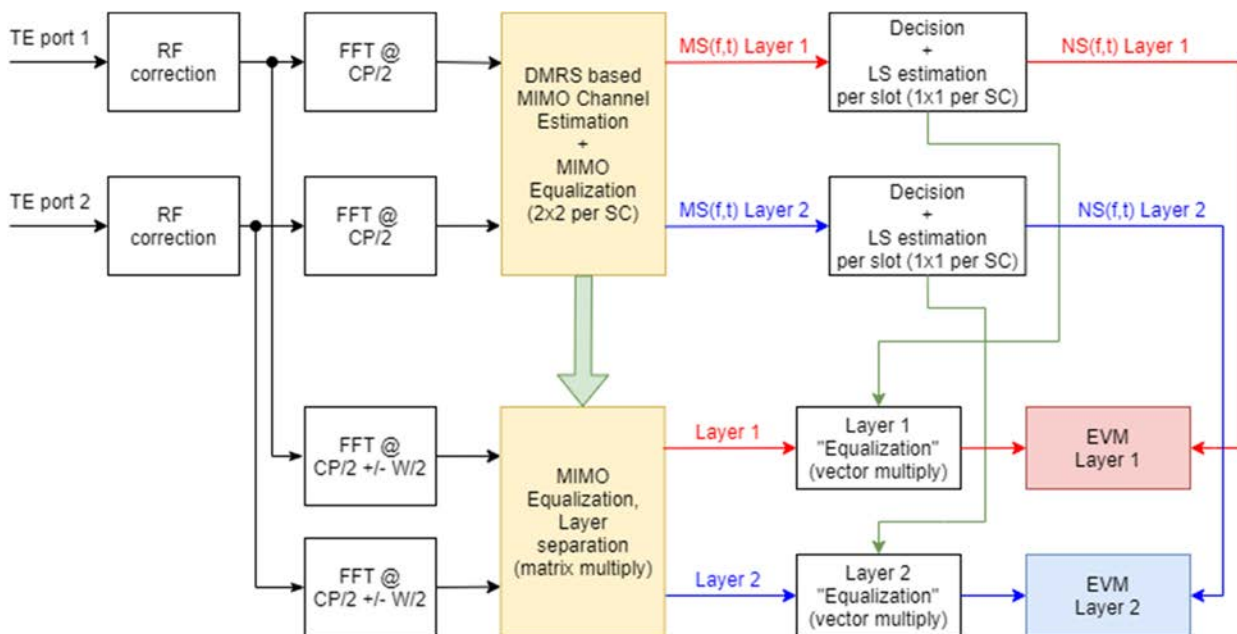

Figure F.10.1-1: EVM calculation block diagram for 2-Layer UL MIMO

The TE receives signals from 2 different ports which are connected to two antenna connectors in the test system.

For UL MIMO measurements a MIMO equalization step as described in section F.10.2 is performed to separate the layers.

Each layer is then processed as described in section F.10.3 to receive the measurement results for each individual layer.

F10.2 MIMO Equalization

The MIMO equalization is based only on reference signals (DMRS) without using any data symbols. For the equalization process all available DMRS symbols shall be used.

The effective 2x2 channel matrix is estimated using reference signals of different subcarriers, e.g. in case of DMRS antenna ports 0 and 2. In case that same subcarriers are used, e.g. DMRS antenna ports 0 and 1, a channel decomposition is necessary taking advantage of the orthogonal codes w_f and w_t and assuming identical channel coefficients for adjacent subcarriers of same CDM group.

Effective channel including the precoding matrix P is:

$$\tilde{H} = HP = \begin{bmatrix} \tilde{h}_{0,0} & \tilde{h}_{0,1} \\ \tilde{h}_{1,0} & \tilde{h}_{1,1} \end{bmatrix}$$

with

$$\tilde{h}_{n,v} = \frac{y_n r_v^*}{|r_v|^2}$$

where y denotes the received symbol on port index n and r the reference signal for layer index v .

Since reference signals of a specific layer are transmitted only on subcarriers of one CDM group channel, interpolation is needed in order to obtain channel coefficients for all subcarriers. Channel interpolation is done using the channel coefficients of active CDM group in all other CDM groups.

The channel coefficients used to calculate the equalizer coefficients are obtained after channel smoothing in frequency domain by computing the moving average of interpolated channel coefficients. The moving average window size is 7. For subcarriers at or near the edge of allocation the window size is reduced accordingly.

The ZF equalizer coefficients are calculated as the inverse of the effective channel matrix, in general:

$$G_{ZF} = \tilde{H}^{-1}$$

F10.3 Layer processing

After performing the MIMO equalization as described in section F.10.2 each layer is processed using the existing procedure as defined in Annex E of TS 38.521-1 [4].

Since the channel estimation is calculated only on the DMRS symbols, an averaging including all 14 symbols of one slot, i.e. data and reference signals, is needed in order to minimize EVM. The averaging is achieved by the least square (LS) equalization method described for single layer in Annex E.3. of TS 38.521-1 [4].

$MS(f,t)$ and $NS(f,t)$ are processed with a LS estimator, to derive one equalizer coefficient per time slot and per allocated subcarrier. $EC(f)$ is defined for each layer as:

$$EC_v(f) = \frac{\sum_{t=0}^{13} NS_v(f,t)^* NS_v(f,t)}{\sum_{t=0}^{13} MS_v(f,t)^* NS_v(f,t)}$$

With $*$ denoting complex conjugation. $EC(f)$ are used to equalize layer data symbols.

EVM equalizer spectral flatness is derived from equalizer coefficients for each layer as follows:

$$c_v = |EC_v(f)| \sqrt{|g_{v,0}|^2 + |g_{v,1}|^2}$$

Annex G (normative):

Difference of relative phase and power errors

G.0 General

This annex gives further information needed for understanding and implementing 6.4D.4. The following terms should be understood as follows:

Relative phase error: refers to the phase difference between signals at different antenna connectors, which should be ideally 0. It should be understood as for a slot i.e. (slot) relative phase. It is calculated based on DMRS symbols of that slot or on SRS symbols.

Difference of relative phase error: refers to the difference between the relative phase error determined per slot and the relative phase error determined based on the SRS transmitted.

G.1 Measurement Point

Figure G.1-1 shows the measurement point for the difference of relative phase and power errors.

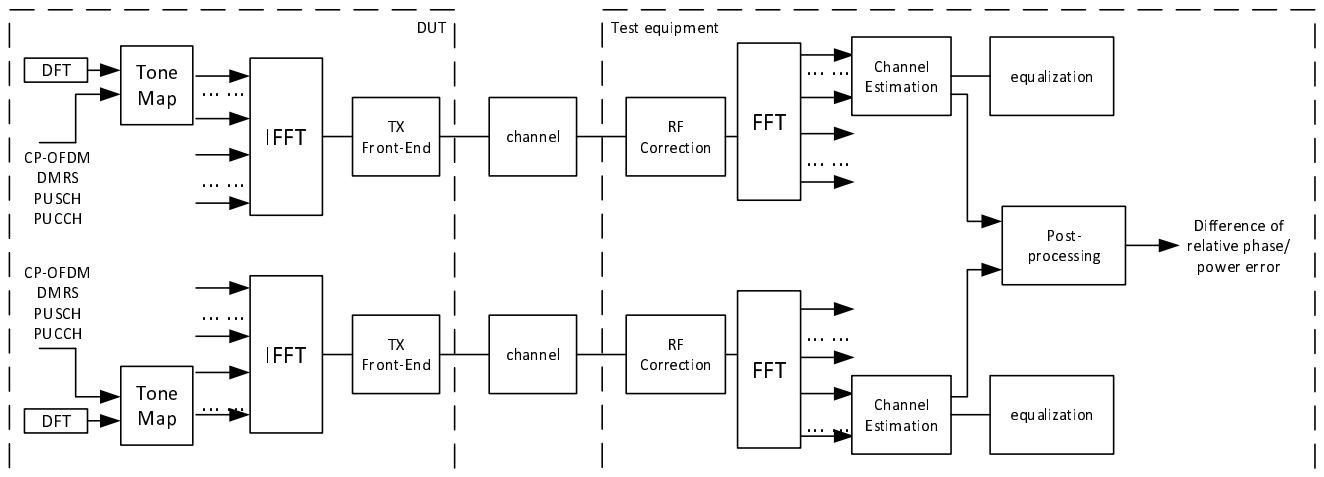

Figure G.1-1 - Measurement point for difference of relative phase/power error for UL coherent MIMO

G.2 Relative Phase Error Measurement

Here are listed the different aspects that may lead to different interpretations.

G.2.1 Symbols and subcarriers used

Phase error is determined based on DMRS REs (DMRS mapping type A with 3 DMRS symbols per slot, the REs corresponding to the odd subcarriers and DMRS symbols are non-allocated for data or DMRS.) and SRS REs (with 4 SRS symbols in the SRS slot, same SRS resource mapping is used for non-codebook-based and codebook-based precoding).

For the DMRS and SRS to occupy identical SCs and maximize their frequency density, DMRS configuration type 1 and SRS comb2 configuration are used.

UL RMC described in Annex A.2 is used.

G.2.2 CFO (carrier frequency offset) correction

The TE performs a CFO correction on a slot-by-slot basis using a common frequency correction at the two uplink antenna connectors.

G.2.3 Steps of the measurement method

Below are detailed the steps necessary to obtain the maximum difference of relative phase error during the 20ms time window.

- 1 Determination for each subcarrier and at each antenna, the SRS relative phase error based on the last SRS transmitted on Ant1 and Ant2, that relative phase error serves as a reference for the calculation of the difference of relative phase error for each slot inside the 20 ms time window.

The output is the “SRS relative phase error” vector for the last SRS transmitted: $[1 \times \textit{number_of_subcarriers}]$.

- 2 Calculation for the last SRS transmitted, for each RB of the SRS relative phase errors based on the arithmetic mean of the subcarrier SRS relative phase errors determined in previous step.

The output is the “SRS relative phase error” vector for the last SRS transmitted: $[1 \times \textit{number_of_RBs}]$.

- 3 CFO correction on slot-by-slot basis using a common frequency correction for both antenna outputs. 4 Determination for each subcarrier and at each antenna, the phase over the slot being analyzed. The phase is extracted from the channel estimate derived from the 3 DMRS symbols of the slot using the LSE technique.

The output is one vector of dimension $[1 \times \textit{number_of_subcarriers}]$ for each antenna.

- 5 Calculation for a slot for each subcarrier of the relative phase error (difference between the vectors determined in the previous step).

The output is subcarrier relative phase errors of a slot: $[1 \times \textit{number_of_subcarriers}]$.

- 6 Calculation for a slot, for each RB of the relative phase errors based on the arithmetic mean of the subcarrier relative phase errors determined in previous step.

The output is a “slot relative phase error” vector for a slot: $[1 \times \textit{number_of_RBs}]$.

- 7 Calculation for a slot of the difference of relative phase errors based on the “SRS relative phase error” (reference) determined in step 2 and the “slot relative phase error” determined in previous step.

The output is a “difference of relative phase error” vector for a slot: $[1 \times \textit{number_of_RBs}]$.

- 8 Calculation for a slot of the arithmetic mean value of the “difference of relative phase error” vector determined in previous step, this value corresponds to an RB.

The output is a “difference of relative phase error” value for a slot: $[1 \times 1]$.

- 9 Perform for each slot of the 20ms time window, steps 3 to 8.

The output is a “difference of relative phase error” vector: $[1 \times \textit{number_of_slots}]$.

- 10 Calculation of the maximum value of the “difference of relative phase error”.

The output is the “difference of relative phase error” that should be verified as complying with the 40° maximum allowable difference of relative phase error requirement: $[1 \times 1]$.

Annex H (informative): Void

Annex I (informative): Void

Annex J (informative): Void

Annex K (informative): Void

Annex L (normative): ModifiedMPR-Behavior

L.1 Indication of modified MPR behavior

This annex contains the definitions of the bits in the field *modifiedMPR-Behavior* indicated per supported NR band in the IE *RF-Parameters* [7] by a UE supporting an MPR or A-MPR modified in a given version of this specification. A modified MPR or A-MPR behaviour can apply to a supported NR band in stand-alone operation (including CA and NN-DC operation) or in non-standalone operation with the said NR band as part of an EN-DC or NE-DC band combination.

NOTE 1: In the present release, the *modifiedMPR-Behavior* is indicated [7] by an 8-bit bitmap per supported NR band.

Table L.1-1: Definitions of the bits in the field *modifiedMPR-Behavior*

NR Band	Index of field (bit number)	Definition (description of the supported functionality if indicator set to one)	Notes
n41	0 (leftmost bit)	- EN-DC contiguous intraband MPR as defined in clause 6.2B.2.1 of 38.101-3 v15.5.0	- This bit shall be set to 1 by a UE supporting DC_(n)41AA UE EN-DC
	1	- EN-DC non-contiguous intraband MPR as defined in clause 6.2B.2.2 of 38.101-3 v15.5.0	- This bit shall be set to 1 by a UE supporting DC_41A_n41A EN-DC
	2	- EN-DC contiguous and non-contiguous intraband MPR and A-MPR as defined in 38.101-3 v16.4.0. If this bit is not set the UE uses Rel-15 MPR or A-MPR for EN-DC contiguous and non-contiguous intraband MPR and A-MPR	-This bit may be set to 1 by a UE supporting DC_(n)41AA or DC_41A_n41A EN-DC
n71	0 (leftmost bit)	- EN-DC contiguous intraband MPR as defined in clause 6.2B.2.1 of 38.101-3 v15.5.0	- This bit shall be set to 1 by a UE supporting DC_(n)71AA UE EN-DC

Annex M (informative): Change history

Change history							
Date	Meeting	TDoc	CR	Rev	Cat	Subject/Comment	New version
2017-08	RAN4#84	R4-1708909				Initial Skeleton	0.0.1
2017-10	RAN4#84 Bis	R4-1709958				Added approved TPs in RAN4-NR-AH#3 R4-1709948, TP for TS 38.101-1: minimum output power, Huawei R4-1709454, TP for TS 38.101-1:UE Tx spurious emission for range 1, ZTE Corporation	0.1.0
2017-10	RAN4#84 Bis	R4-1711978				Embedded approved TPs in RAN4#84Bis R4-1711556, "TP to TS 38.101: Draft CR to Transmitter power clause", Nokia R4-1710962, "TP to TS 38.101-1: Draft CR to Output RF spectrum emissions" Nokia R4-1711608, "TP for TS38.101-1 on conducted UE transmitter intermodulation for FR1(section 6.5)" ZTE Corporation Number of TPs by editors	0.2.0
2017-12	RAN4#85	R4-1713805				Approved TPs in RAN4#85 R4-1713204, TP on general parts for 38.101-1 NR FR1, Ericsson R4-1714047, WF on MPR for sub6GHz, NTT DOCOMO, INC. R4-1714052, TP for TS 38.101-1 introduction of band n71 for transmitter characteristics, T-Mobile USA Inc. R4-1714162, TP to 38.101-1: ACS, Ericsson R4-1714163, TP to 36.101-1: In-band blocking, Ericsson R4-1714446, TP to 36.101-1: Out-of-band blocking and exceptions for spurious response, Ericsson R4-1714369, TP for NBB requirement for FR1, Intel Corporation R4-1714529, TP on introducing operating bands for NR-LTE DC including SUL band combinations in 38.101-1, Huawei R4-1714097, TP for TS 38.101-1: UE RF requirements for standalone SUL, Huawei R4-1714536, TP for TS 38.101-1: Channel Bandwidth Definition, Qualcomm Incorporated (Note, this TP was further discussed and edited in the reflector) R4-1714114, TP for TS 38.101-1: Channel Arrangement, Qualcomm Incorporated (Note, this TP was further discussed and edited in the reflector) R4-1714029, Sub6 Reference Sensitivity, Qualcomm Incorporated R4-1714329, TP to TR 38.101-01 v0.2.0: ON/OFF mask design for NR UE transmissions for FR1, Ericsson Band list according to R4-1714542, List of bands and band combinations to be introduced into RAN4 NR core requirements by December 2017, RAN4 Chairmen Input from: R4-1714479, TP for TR 38.817-01 NR channel bandwidth, Huawei, HiSilicon	0.3.0
2017-12	RAN4#85	R4-1714569				Further corrections and alignments with 38.104 after email review	0.4.0
2017-12	RAN#78	RP-172475				v1.0.0 submitted for plenary approval. Contents same as 0.4.0	1.0.0
2017-12	RAN#78					Approved by plenary – Rel-15 spec under change control	15.0.0
2018-03	RAN#79	RP-180264	0003		F	Implementation of endorsed CRs to 38.101-1 Endorsed draft CRs F: R4-1800400, Editorial corrections for 38.101-1, Qualcomm B: R4-1801102, Draft CR for 30 MHz CBW support, Huawei F: R4-1800032, 38.101-1 n71 draft CR for section 6.2.3 - UE A-MPR - NS values, T-Mobile USA Inc. B: R4-1801121, Draft pCR for TS 38.101-1 version 15.0.0: Remaining ON/OFF masks for FR1 NR UE transmissions, Ericsson F: R4-1800417, Correction of NR SEM table and additional requirements table, vivo F: R4-1800033, 38.101-1 n71 draft CR for section 6.5.3.2 Spurious emissions for UE co-existence, T-Mobile USA Inc. F: R4-1801114, Proposal on protected band numbering in UE specs, Sprint Corporation	15.1.0

					<p>F: R4-1800407, Draft CR for TS 38.101-1: Mandatory 4Rx antenna performance for NR UE, Vodafone Group Plc F: R4-1800451 Draft CR for TS 38.101-1: Clarification of 4Rx NR bands, Huawei, HiSilicon F: R4-1801136, Draft CR for TS 38.101-1: REFSENS for NR bands, Huawei, HiSilicon F: R4-1801137, Draft CR: n71 REFSENS, Dish Network F: R4-1800395, Draft CR to 38.101-1: corrections to ACS and in-band blocking, Ericsson F: R4-1800396, Draft CR to 38.101-1: corrections to out-of-band blocking, Ericsson F: R4-1800397, Draft CR to 38.101-1: corrections to spurious response, Ericsson F: R4-1800305, Draft CR for NR FR1 wide band intermodulation requirements, MediaTek Inc. F: R4-1800320, Draft CR to 38.101-1: Rx Spurious emission for NR FR1 (section 7.9), ZTE Corporation F: R4-1800473, Draft CR on UE RF requirements for SUL in TS 38.101-1, Huawei F: R4-1800965, Draft CR to TS 38.101-1: Asymmetric CH BW operation, Dish Network F: R4-1800882, Draft CR for correction of UE channel bandwidth for Bands n77 and n78 for TS 38.101-1, Orange UK F: R4-1801012, Draft CR to 38.101-1: Clarifications to UE spectrum utilization section 5.3, Ericsson F: R4-1800030, 38.101-1 n71 draft CR for section 5.4.4 - TX-RX frequency separation, T-Mobile USA Inc F: R4-1801228, Draft CR to 38.101-1: Channel spacing for CA for NR FR1(section 5.4.1.2), ZTE Corporation F: R4-1801231, Correction CR for channel spacing:38.101-1, Samsung F: R4-1801235, Draft CR to TS 38.101-1: Corrections on channel raster calculation in section 5.4.2, ZTE Corporation F: R4-1801318, Draft CR on synchronization raster, Huawei</p> <p>RAN4#86: R4-1803053, Draft CR for new spec structure of 38.101-1, Ericsson R4-1801479, Draft CR to 38.101-1: Default Tx-RX frequency separation for NR FR1(section 5.4.4), ZTE R4-1801581, Draft CR for TS 38.101-1 update of 4Rx bands, Huawei Technologies France R4-1802211, draft CR TS 38.101-1 Uplink configuration for FR1 NR REFSENS, Skyworks Solutions Inc. R4-1802342, Draft CR for NR FR1 ACS case 2 transmitter power setting correction (Note 1), MediaTek Inc. R4-1802509, Draft CR on 38.101-1 v15.0.0: Remaining ON/OFF masks for FR1 NR UE transmissions, Ericsson R4-1802566, Draft CR to TS 38.101-1: Clarification of mixed numerology guardband size, Ericsson R4-1802978, Draft CR to TS 38.101-1: Corrections on channel raster in Section 5.4.2.3, Intel Corporation R4-1803064, Draft CR for 38.101-1: Correction of errors, Sprint Corporation R4-1803065, Draft CR for 38.101-1 Introduction of n41requirements, Sprint Corporation R4-1803242, Draft CR to 38.101-1: Corrections to n66, Dish Network R4-1803285, Draft CR to 38.101-1: Correction to CH BWs without symmetric uplink Dish Network, Skyworks Solutions Inc. R4-1803436, Introduction of UL subcarrier alignment for additional bands, AT&T R4-1803456, Draft CR for 38.101-1: Spurious Emissions for UE Coexistence, Sprint Corporation R4-1803461, CR on configured transmitted power for TS 38.101-1, Huawei R4-1803452, draft CR for introduction of completed band combinations from 37.865-01-01 into 38.101-1, Ericsson R4-1803567, Draft CR for TS 38.101-1: Sync raster offset in re-farming bands (5.4.3), Ericsson R4-1803365, CR to introduce MPR for PC2 and PC3 and A-MPR for UTRA protection, Nokia</p>	
2018-06	RAN#80	RP-181262	0011	F	<p>CR to TS 38.101-1: Implementation of endorsed draft CRs from RAN4 #86bis and RAN4 #87</p> <p>R4-1803900, Draft CR into TS 38.101-1 Introduction of band combinations for SUL, Huawei</p>	15.2.0

					<p>R4-1804021 CR for clarifications for NR FR1 CA BW Classes Nokia, Nokia Shanghai Bell</p> <p>R4-1804140 CR for Narrow Band Blocking requirement for FR1 Intel Corporation</p> <p>R4-1804219 Draft CR for 38.101-1: n41 SEM and additional spurious emissions SPRINT Corporation</p> <p>R4-1804266 Draft CR to 38.101-1 MPR channel bandwidth criteria Skyworks Solutions Inc.</p> <p>R4-1804267 Draft CR to 38.101-1 n3,n5,n8 REFSENS levels Skyworks Solutions Inc.</p> <p>R4-1804268 Draft CR to 38.101-1: Correction to n41 uplink configuration for reference sensitivity Skyworks Solutions Inc.</p> <p>R4-1804370 Draft CR to add missing NR inter-band DL CA in FR1 for TS 38.101-1 NTT DOCOMO, INC.</p> <p>R4-1804581 Draft CR to 38.101-1: On EVM Wording Qualcomm, Inc.</p> <p>R4-1804948 Corrections to 5.3.3 in TS 38.101-1 Nokia, Nokia Shanghai Bell</p> <p>R4-1804877 draft CR introduction completed band combinations 37.865-01-01 -> 38.101-1 Ericsson</p> <p>R4-1805444 Draft CR to TS 38.101-1: Asymmetric CH BW operation Dish Network</p> <p>R4-1805447 draft CR for including SRS antenna switching in configured output power Qualcomm Incorporated</p> <p>R4-1805462 Editorial corrections to UE RF requirements in 38.101-1 Qualcomm Incorporated</p> <p>R4-1805659 Draft CR for CBW for n50 for 38.101-1 Huawei</p> <p>R4-1805664 Draft CR to 38.101-1: Addition of Annex F Rohde & Schwarz</p> <p>R4-1805665 Correction to inner and outer definitions for MPR Qualcomm Incorporated</p> <p>R4-1805684 Draft CR to TS38.101-1: Channel Raster to Resource Element Mapping (Section 5.4.2.2) and RB alignment with different numerologies (Section 5.3.4) ZTE Corporation</p> <p>R4-1805698 Draft CR for 38.101-1 for Rx(Ch7) of Band n77, n78 and n79 RF requirements CMCC</p> <p>R4-1805699 Draft CR to 38.101-1:introduction of Tx/Rx requirements for inter-band CA ZTE Corporation</p> <p>R4-1805751 Draft CR on UE-to-UE coexistence requirements to protect band 29 from NR band 71 LG Electronics France</p> <p>R4-1805783 Draft CR for 38.101-1 for Tx(Ch6) of Band n77, n78 and n79 RF requirements CMCC</p> <p>R4-1805902 Draft CR into TS 38.101-1 Correction on SUL_n78-n80Huawei, HiSilicon</p> <p>R4-1805904 Draft CR into TS 38.101-1 Introduction of new band combinations for SUL Huawei, HiSilicon</p> <p>R4-1805921 Draft CR on NR UE REFSENS SNR FRC for FR1 Intel Corporation</p> <p>R4-1805981 Draft CR for TS38.101-1:Sync raster Samsung</p> <p>R4-1804548 Draft CR for CA BW class for FR1 NTT DOCOMO, INC.</p> <p>R4-1806170 Draft CR on frequency error for TS 38.101-1 ZTE Corporation</p> <p>R4-1806481 Draft CR for Environmental conditions in TS 38.101-1 Annex NTT DOCOMO, INC.</p> <p>R4-1806657 Draft CR to 38.101-1: Measurement BW for min and off power Skyworks Solutions Inc.</p> <p>R4-1806669 Draft CR to TS38.101-1_introduction of completed band combinations for inter-band 2UL CA ZTE Corporation</p> <p>R4-1806673 Draft CR to TS38.101-1_Remove brackets from Tx and Rx spurious emission table ZTE Corporation</p> <p>R4-1806677 Draft CR on including CA bandwidth class and band combinations for intra-band CA LG Electronics France</p> <p>R4-1806719 Introduction of 7.5 kHz frequency shift for Band n71 Ericsson, T-Mobile</p> <p>R4-1806844 Draft CR for 38.101-1 for Tx(Ch6): missing maximum power requirements for n1 and n8 SoftBank Corp.</p> <p>R4-1806945 Draft CR for TS 38.101-1: Channel raster and NR-ARFCN clarification (5.4.2) Ericsson</p> <p>R4-1807039 Intra-band CA terminology for UE ZTE Corporation</p> <p>R4-1807178 Corrections to n70 TX/RX frequency separation Dish Network</p> <p>R4-1807181 Corrections to spurious emissions UE co-existence table Dish Network</p> <p>R4-1807234 Draft CR into TS 38.101-1 Some Corrections for SUL Huawei, HiSilicon</p>	
--	--	--	--	--	----------------------------------------------------------------------------------------------------------------------------------------------------------------------------------------------------------------------------------------------------------------------------------------------------------------------------------------------------------------------------------------------------------------------------------------------------------------------------------------------------------------------------------------------------------------------------------------------------------------------------------------------------------------------------------------------------------------------------------------------------------------------------------------------------------------------------------------------------------------------------------------------------------------------------------------------------------------------------------------------------------------------------------------------------------------------------------------------------------------------------------------------------------------------------------------------------------------------------------------------------------------------------------------------------------------------------------------------------------------------------------------------------------------------------------------------------------------------------------------------------------------------------------------------------------------------------------------------------------------------------------------------------------------------------------------------------------------------------------------------------------------------------------------------------------------------------------------------------------------------------------------------------------------------------------------------------------------------------------------------------------------------------------------------------------------------------------------------------------------------------------------------------------------------------------------------------------------------------------------------------------------------------------------------------------------------------------------------------------------------------------------------------------------------------------------------------------------------------------------------------------------------------------------------------------------------------------------------------------------------------------------------------------------------------------------------------------------------------------------------------------------------------------------------------------------------------------------------------------------------------------------------------------------------------------------------------------------------------------------------------------------------------------------------------------------------------------------------------------------------------------------------------------------------------------------------------------------------------------------------------------------------------------------------------------------------------------------------------------------------------------------------------------------------------------------------------------------------------------------------------------------------------------------------------------------------------------------------------------------------------------------------------------------------------------------------------------------------------------------------------------------------------------------------------------------------------------------------------------------------------------------	--

					<p>R4-1807269 Corrections to Wide band intermodulation table <2700MHz Dish Network</p> <p>R4-1807392 to remove the brackets for SU in 38.101-1 Huawei, HiSilicon</p> <p>R4-1807647 Draft CR to TS 38.101-1: Correction to Asymmetric CH BW operation Dish Network</p> <p>R4-1807680 Draft CR on 38.101-1 on channel raster to achieve alignment of data and SSB subcarrier grids Nokia, Nokia Shanghai Bell, Ericsson</p> <p>R4-1807705 CR for TS 38.101-1 A-MPR for n51 Huawei, Hisilicon</p> <p>R4-1807814 Draft CR for 38.101-1: SEM correction for n41 Sprint Corporation</p> <p>R4-1807851 Draft CR for 38.101-1: UE spurious emission protection requirements for n5 Sprint Corporation</p> <p>R4-1807920 General requirements for downlink inter-band CA Qualcomm Incorporated</p> <p>R4-1807923 Resolution bandwidth for ACLR Qualcomm Incorporated</p> <p>R4-1808084 Introduction of n12 into TS 38.101-1 Nokia</p> <p>R4-1808087 Draft CR 38.101-1: Introduction of n2, n25, n66 and n70 Sprint Corporation, Dishnetwork</p> <p>R4-1808090 Draft CR to TS 38.101-1: Inclusion of Simultaneous RxTx UE capability for some band combinations Ericsson, Vodafone, Orange</p> <p>R4-1808107 Draft CR to TS38.101-1_corrections on UE coexistence ZTE Corporation</p> <p>R4-1808111 TP to TS38.101-1 - UE ON/OFF masks Ericsson</p> <p>R4-1808116 Draft CR to 38.101-1: introduction of Band n34,n39 and n40 RF requirements ZTE Corporation,CMCC</p> <p>R4-1808136 Draft CR to 38.101-1: FR1 UE Power Control Qualcomm Incorporated</p> <p>R4-1808141 Correction to MPR for PC2 and spectrum emission mask measurement bandwidth Qualcomm Incorporated</p> <p>R4-1808142 Draft CR for 38.101-1 n41 A-MPR Sprint Corporation, Nokia, Nokia Shanghai Bell, Ericsson</p> <p>R4-1808143 Draft CR for TS 38.101-1 A-MPR for n20 Huawei, HiSilicon</p> <p>R4-1808155 Draft CR for TS 38.101-1: to correct requirements for n71 Samsung</p> <p>R4-1808178 Addition parameters about n50 & n51 in TS 38.101-1 Huawei, Hisilicon, Etisalat (editors note: n50 not implemented per chairmans agreement)</p> <p>R4-1808182 Draft CR for TS 38.101-1 A-MPR for n28 Huawei, HiSilicon</p> <p>R4-1808187 CR for RF requirements for Coherent UL MIMO for FR1 Qualcomm Austria RFFE GmbH</p> <p>R4-1808207 Draft CR to 38.101-1: On EVM Averaging Length, Wording , Qualcomm</p> <p>R4-1808209 Draft CR for 38.101-1 for Tx (Ch6) of HPUE Qualcomm</p> <p>R4-1808466 Draft CR on UL RMC and OCNG pattern for FDD REFSENS tests RD session</p> <p>R4-1808493 Draft CR for TS 38.101-1: Channel and sync raster corrections (5.4) Ericsson</p> <p>R4-1808507 Draft CR for TS38.101-1 on addition of new 90MHz UE CBW for n41/n78 LG Electronics Inc., LG Uplus, Samsung</p> <p>R4-1808176, Draft CR for 38.101-1 : Introduction of A-MPR for n8, SoftBank</p> <p>R4-1808201, Draft CR for 38.101-1 : Introduction of A-MPR for n1, SoftBank</p> <p>R4-1807101, draft CR introduction completed band combinations 37.865-01-01 -> 38.101-1, Ericsson</p>	
2018-09	RAN#81	RP-181896	0025	F	<p>Big CR for 38.101-1</p> <p>Endorced draft CRs from RAN4#NR-AH-1807</p> <p>R4-1809335, Draft CR on UL RMC for FR1 RF tests, Qualcomm Incorporated</p> <p>R4-1809337, Draft CR on NR UE REFSENS SNR FRC for FR1, Intel Corporation</p> <p>R4-1809339, Draft CR on measurement of receiver characteristics for FR1 RF Tests, Qualcomm Incorporated</p> <p>R4-1809396, Draft CR on NR UE maximum input level FRC for FR1, Intel</p> <p>R4-1809567, Draft CR on OCNG pattern for FR1 REFSENS tests, Qualcomm Incorporated, Rohde & Schwarz</p>	15.3.0

					<p>Endorced draft CRs from RAN4#88</p> <p>R4-1809714, Draft CR to correct in-band blocking parameters for FR1, Anritsu Corporation</p> <p>R4-1809784, Draft CR to 38.101-1: Corrections on CA bandwidth classes for FR1, ZTE Corporation</p> <p>R4-1809785, Draft CR to TS 38.101-1 for Corrections on UE transmitter power, ZTE Corporation</p> <p>R4-1809793, Draft CR to 38.101-1: Corrections on additional spectrum emission mask, ZTE Corporation</p> <p>R4-1809919, Correction on UE receiver requirement for FR1, CATT</p> <p>R4-1810091, Draft CR TS 38.101-1 - UE ON-OFF mask clean up, Ericsson</p> <p>R4-1810210, Draft CR for TS 38.101-1: MPR inner and outer RB allocations formula correction, MediaTek, Inc.</p> <p>R4-1810229, Draft CR for TS 38.101-1: Spurious emission for UE coexistence table corrections, MediaTek, Inc.</p> <p>R4-1810230, Draft CR for TS38.101-1 to correct 90MHz UE CBW, LG Electronics, Inc.</p> <p>R4-1810232, Draft CR for TS 38.101-1: Table 7.3.2-1 n77 reference sensitivity corrections, MediaTek, Inc.</p> <p>R4-1810369, Draft CR to 38.101-1: Corrections on symbols and abbreviations in section 3, ZTE Corporation</p> <p>R4-1810376, Draft CR: General corrections to n71 requirements, Dish Network</p> <p>R4-1810428, Draft CR on TS38.101-1 for UE maximum output power for UL MIMO, OPPO</p> <p>R4-1810552, Correction of reference tables, OPPO</p> <p>R4-1810729, Draft CR for introduction of Band n74 for TS 38.101-1, NTT DOCOMO, Inc.</p> <p>R4-1810862, Draft CR to 38.101-1: Updates to Transmit Modulation Annex, Rohde & Schwarz</p> <p>R4-1810892, CR to update Table 6.2D.1-2 for FR1, Qualcomm Incorporated</p> <p>R4-1810961, CR on ACS minimum requirement, Intel Corporation</p> <p>R4-1810965, CR on Out-of-Band Blocking minimum requirement, Intel Corporation</p> <p>R4-1810967, CR on Rx Intermodulation characteristics for CA, Intel Corporation</p> <p>R4-1810974, Annex lettering change for 38.101-1, Qualcomm Incorporated</p> <p>R4-1811189, CR to add more details to Coherent UL MIMO spec for FR1, Qualcomm Incorporated</p> <p>R4-1811280, Corrections of NR receiver characteristics titles, Vivo</p> <p>R4-1811455, Draft CR on DL Physical Channel for FR1 RF tests, Qualcomm Europe Inc. (Spain)</p> <p>R4-1811457, NS numbering, Qualcomm Incorporated</p> <p>R4-1811459, Correction on UE transmitter requirement for FR1, CATT</p> <p>R4-1811463, Draft CR for 38.101-1: Addition of missing NR CA configurations n8-n75 and n28-n75, VodafoneItalia SpA</p> <p>R4-1811472, Addition parameters about n51 in TS 38.101-1, Huawei, Hisilicon, Etisalat</p> <p>R4-1811474, CR CP- OFDM almost contiguous allocation, Nokia, Nokia Shanghai Bell</p> <p>R4-1811477, Draft CR to 38.101-1: FR1 Power Control, Qualcomm Incorporated</p> <p>R4-1811478, A-MPR correction for n20 and n28, Huawei, HiSilicon</p> <p>R4-1811490, Draft CR to 38.101-1: Addition of Carrier Leakage table, Rohde & Schwarz</p> <p>R4-1811491, Draft CR for TS38.101-1 on transmit signal quality, OPPO</p> <p>R4-1811493, CR to TS 38.101-1: pi/2 BPSK with Spectrum Shaping, Indian Institute of Tech (M), Indian Institute of Tech (H), CEWiT, Nokia</p> <p>R4-1811513, A proposal on 2UL co-ex table modification, SoftBank Corp.</p> <p>R4-1811514, Draft CR to TS 38.101-1: Clarification on OCNG, Keysight Technologies UK Ltd</p> <p>R4-1811516, Draft CR on NR DL FRCs for FR1 UE RF requirements, Intel Corporation</p> <p>R4-1811550, Draft CR to TS 38.101-1 on channel bandwidth and spacing descriptions, Ericsson</p> <p>R4-1811553, Draft CR to 38.101-1: Corrections on description of channel raster entries, ZTE Corporation</p> <p>R4-1811783, Measurement period of PRACH time mask, CATT</p>	
--	--	--	--	--	--------------------------------------------------------------------------------------------------------------------------------------------------------------------------------------------------------------------------------------------------------------------------------------------------------------------------------------------------------------------------------------------------------------------------------------------------------------------------------------------------------------------------------------------------------------------------------------------------------------------------------------------------------------------------------------------------------------------------------------------------------------------------------------------------------------------------------------------------------------------------------------------------------------------------------------------------------------------------------------------------------------------------------------------------------------------------------------------------------------------------------------------------------------------------------------------------------------------------------------------------------------------------------------------------------------------------------------------------------------------------------------------------------------------------------------------------------------------------------------------------------------------------------------------------------------------------------------------------------------------------------------------------------------------------------------------------------------------------------------------------------------------------------------------------------------------------------------------------------------------------------------------------------------------------------------------------------------------------------------------------------------------------------------------------------------------------------------------------------------------------------------------------------------------------------------------------------------------------------------------------------------------------------------------------------------------------------------------------------------------------------------------------------------------------------------------------------------------------------------------------------------------------------------------------------------------------------------------------------------------------------------------------------------------------------------------------------------------------------------------------------------------------------------------------------------------------------------------------------------------------------------------------------------------------------------------------------------------------------------------------------------------------------------------------------------------------------------------------------------------------------------------------------------------------------------------------------------------------------------------------------------------------------------------------------------------------------------------------------------------------------------------------------------------------------------------------------------------------------------------------------------------------------------------------------------------------------------------------------------------------------------------------------------------------------------------------------------------------------------------------------------------------------------------------------	--

						<p>R4-1811792, Draft CR for A-MPR revision for n1, NTT DOCOMO, INC.</p> <p>R4-1811798, Draft CR for Pcmx for FR1, Qualcomm Incorporated</p> <p>R4-1811799, Pcmx for inter-band NR CA FR1 draft CR, InterDigital, Inc.</p> <p>R4-1811812, Draft CR to 38.101-1: On FR1 AMPR Band n41 NS_04, Qualcomm Incorporated</p> <p>R4-1811816, CR to update the definition of Long and Short subslot for FR1, Qualcomm</p> <p>R4-1811894, Addition parameters about n50 in TS 38.101-1, Huawei</p> <p>R4-1811896, Draft CR for TS 38.101-1: n41 GSCN range modification, MediaTek Inc.</p> <p>R4-1811285, Draft CR TS 38.101-1: NS_04 A-MPR' and spurious emisison corrections, Sprint</p>	
2018-12	RAN#82	RP-182836	0029	1	F	<p>Endorced draft CRs from RAN4#88Bis:</p> <p>R4-1812050, CR Simplification of NR NS_08, Nokia</p> <p>R4-1812054, Correction for Inter-band CA operating bands table in TS 38.101-1, Nokia.</p> <p>R4-1812079, draft CR to introduce asymmetric UL DL channel BW combinations for n71, T-Mobile USA Inc.</p> <p>R4-1812121, Draft CR on Note1 Corrections in 38.101 RX tests, Qualcomm</p> <p>R4-1812128, draftCR on 256QAM UL power requirement, Intel Corporation</p> <p>R4-1812200, Draft CR to TS 38.101-1 Add clarification note to PC3 MPR table, Intel Corporation</p> <p>R4-1812217, Draft CR to 38.101-1: Corrections on the descriptions of UE channel bandwidth for CA, ZTE Corporation</p> <p>R4-1812319, Draft CR for TS 38.101-1: REFSENS UL configuration corrections, MediaTek Inc.</p> <p>R4-1812320, Draft CR for TS 38.101-1: Out-of-band blocking exceptions for CA, MediaTek Inc.</p> <p>R4-1812322, Draft CR for TS 38.101-1: Blocking characteristics for SUL, MediaTek Inc.</p> <p>R4-1812397, Clarification for almost contiguous CP-OFDM, Qualcomm Incorporated</p> <p>R4-1812508, Draft CR to 38.101-1: Corrections on channel raster & SS raster for operating bands, ZTE Corporation</p> <p>R4-1812611, Draft CR to 38.101-1: Some corrections for inter-band CA combinations, ZTE Corporation</p> <p>R4-1813459, Draft CR for TS 38.101-1: Support 4Rx for n38, Huawei</p> <p>R4-1813469, draftCR on applicability of TDD configuratiin for CA in TS 38.101-1, Huawei</p> <p>R4-1813521, Addition of ?TC,c for single carrier Pcmx for FR1, vivo</p> <p>R4-1813798, Draft CR to 38.101-1: Corrections on UE additional maximum output power reduction, ZTE Corporation</p> <p>R4-1813811, Draft CR to 38.101-1: Correction to n12 reference sensitivity power levels, Skyworks Solutions Inc.</p> <p>R4-1813812, Band n41 spurious emission limits, Qualcomm Incorporated</p> <p>R4-1813813, Draft CR for TS 38.101-1: P-Max for 5G NR HPUE, CMCC</p> <p>R4-1814158, CR on Spurious emissions for UE co-existence, Intel Corporation</p> <p>R4-1814159, Draft CR for CA ACS/IBB for Bandwidth class C, Qualcomm</p> <p>R4-1813843, Draft CR to 38.101-1: Update of Annex F, Rohde & Schwarz</p> <p>R4-1813845, Correction for PI/2 PBSK requiriements, Nokia</p> <p>Endorsed draft CR's from RAN4#89</p> <p>R4-1815950, dCR on TS38.101-1 merging draft CRs from RAN4#88Bis, Qualcomm Incorporated</p> <p>R4-1814752, DraftCR to TS 38.101-1 pi/2 BPSK in n41, CMCC</p> <p>R4-1814824, n50 A-MPR, Qualcomm Incorporated</p> <p>R4-1814959, Changes to Max input power UL and DL configuratgions in FR1, OPPO</p> <p>R4-1814970, NR FR1 relative power tolerance CR, Nokia</p> <p>R4-1814972, A-MPR for NS_03 and NS_03U and re-formulation of NS_100, Nokia</p> <p>R4-1815060, draft CR for adding note about the fallback of NR CA in FR1 for TS 38.101-1, NTT DOCOMO, INC.</p> <p>R4-1815392, Draft CR to 38.101-1: Update to NS_04 requirements, Rohde & Schwarz</p>	15.4.0

						<p>R4-1815563, Draft CR to 38.101-1 on Clarification on 7.5 KHz raster shift in NR re-farmed bands, Ericsson</p> <p>R4-1815863, Draft CR for 38.101-1: Nominal carrier spacing for 30 kHz raster, SPRINT Corporation</p> <p>R4-1815898, draft CR on CA configuration on bandwidth class F, Huawei</p> <p>R4-1815917, draftCR on DL RMC for TS 38.101-1, Huawei</p> <p>R4-1816162, Draft CR on introduction of SRS switch IL in FR1, OPPO</p> <p>R4-1816199, Draft CR on FR1-FR2 UE-to-UE coexistence for TS38.101-1, LG Electronics France</p> <p>R4-1816200, Draft CR to 38.101-1 on intra-band contiguous CA configurations for FR1, ZTE Corporation</p> <p>R4-1816240, Transient period for SRS Antenna Switching for FR1, Qualcomm</p> <p>R4-1816243, Draft CR to TS38.101-1 _Clarifications on MSD and UL configuration tables for inter-band CA, ZTE Corporation</p> <p>R4-1816466, Draft CR on some changes for SUL band combinations to TS 38.101-1, Huawei</p> <p>R4-1816468, Support of 7.5 kHz carrier shift for additional operating bands, Ericsson</p> <p>R4-1816604, TDD configuration for UE Tx test in FR1, Ericsson</p> <p>R4-1816663, Draft CR to 38.101-1 (5.3.4) RB alignment, Huawei</p> <p>R4-1816755, CR to 38.101-1: ACS and IBB intra-band contiguous CA, Intel Corporation</p> <p>Further changes in RAN#82 - 7.5 kHz frequency shift is specified for all FDD bands in clause 5.4.2.1</p>	
2018-12	RAN#82	RP-182814	0030	2	F	Company CR on 2Rx exception for NR vehicular UE at FR1	15.4.0
2019-03	RAN#83	RP-190403	0034		F	<p>CR to TS 38.101-1: Implementation of endorsed draft CRs from RAN4#90</p> <p>Endorced draft CR from Ran4#90</p> <p>R4-1900032, Editorial corrections for 38.101-1, Qualcomm Incorporated</p> <p>R4-1900031, draftCR on SRS IL for CA, Qualcomm Incorporated</p> <p>R4-1900161, CR on Relative power tolerance, Intel Corporation</p> <p>R4-1900162, CR on Minimum output power, Intel Corporation</p> <p>R4-1900274, Draft CR to TS 38.101-1 on NR general spectrum emission mask, ZTE Corporation</p> <p>R4-1900275, Draft CR to TS 38.101-1 on spurious emission for network signalled value NS_40, NS_41 and NS_42, ZTE Corporation</p> <p>R4-1900424, Correction of table references and other typos, Ericsson</p> <p>R4-1900508, Draft CR to TS 38.101-1 on UE transmitter power and some other editorial corrections, ZTE Corporation</p> <p>R4-1900723, Draft CR on editorial error of TS38.101-1, LG Electronics Inc.</p> <p>R4-1900727, Update to PRACH EVM window length for FR1, Rohde & Schwarz</p> <p>R4-1900840, Draft CR for 38.101-1 modification of Transmit intermodulation requirement, Huawei</p> <p>R4-1900848, [RAN5 LS]Draft CR for 38.101-1: adding note for inter-band CA spurious emissions, Huawei</p> <p>R4-1901033, Alignment of Foob related description for 38.101-1, vivo</p> <p>R4-1901273, Correction of HARQ-ACK transmission timing for DL RMC for FR1 TDD SCS=60kHz, Ericsson</p> <p>R4-1901766, draft_CR TS 38.101-1 Correction to UL configuration for reference sensitivity, Skyworks Solutions Inc.</p> <p>R4-1901823, draft CR on spurious requirment for TS 38.101-1, Huawei, HiSilicon</p> <p>R4-1901835, draftCR on MSD for CA_n41-n78 for TS 38.101-1, Huawei</p> <p>R4-1901847, Draft CR for 38.101-1: Addition of default power class, Sprint Corporation</p> <p>R4-1901873, Receiver requirement RMC references, Qualcomm Incorporated</p> <p>R4-1901925, Draft CR to 38.101-1 to update and clarify Rx wide band intermod and spurious requirments for BW class C, D, E, Qualcomm Incorporated</p> <p>R4-1901992, Draft CR to 38.101-1. Correct FR1 NS_41 AMPR for n50, Huawei</p> <p>R4-1902001, Draft CR to 38.101-1 on n41 – B40 coexistence, Qualcomm Incorporated</p>	15.5.0

					<p>R4-1902150, Draft CR to TS38.101-1 _Clarifications on MSD and UL configuration tables for inter-band CA, ZTE Corporation</p> <p>R4-1902166, Tx ON/OFF time mask for FR1, Qualcomm Inc</p> <p>R4-1902174, Draft CR to 38.101-1: On FR1 A-MPR NS_08 for n8, Qualcomm Incorporated</p> <p>R4-1902175, Draft CR on AMPR requirements for NS_05U and NS_08U to TS 38.101-1, Huawei</p> <p>R4-1902194, [41 DL]Draft CR for 38.101-1 adding DL intra-band CA requirements for frequency less than 2700MHz, Huawei</p> <p>R4-1902196, Draft CR for 7.9A Spurious emissions for CA, CMCC</p> <p>R4-1902223, UE optional bandwidth for FR1, Nokia</p> <p>R4-1902225, CR to 38.101-1 on CA BW Classes fallback groups, Intel Corporation</p> <p>R4-1902233, Draft CR to 38.101-1: SUL clarifications, Nokia</p> <p>R4-1902339, Draft CR to TS 38.101-1 on FR1 extension, Ericsson</p> <p>R4-1902455, Completion of the Pcmx specification: additional P-max and P_Nr, Ericsson</p> <p>R4-1902468, Draft CR: Introduction of Annex on Characteristics of the Interfering Signal, Samsung</p> <p>R4-1902479, Draft CR on some errors to TS 38.101-1, Huawei</p> <p>R4-1902480, Draft CR for 38.101-1 modification of requirements for network signalled value NS_04, Huawei</p> <p>R4-1902655, CR to 38.101-1 on NR Uplink RBs location, Intel Corporation</p> <p>R4-1901610, Draft CR for 38.101-1 REFSENS for UL MIMO, Huawei</p> <p>Editorial changes after RAN#83</p> <p>To align the annex numbering with other specifications (TS 38.101-x series), annexes J and K were added and Change history was numbered as annex L.</p>	
2019-06	RAN#84	RP-191240	0047	F	<p>CR to TS 38.101-1: Implementation of endorsed draft CRs from RAN4#90bis and RAN4#91</p> <p>Endorced draft CRs from RAN4#90Bis</p> <p>R4-1902826, Draft CR for 38.101-1 modification of ACS test parameters case 2 for intra-band contiguous CA, Huawei</p> <p>R4-1902926, Draft CR to TS 38.101-1 Correction to Pcmx, Intel Corporation</p> <p>R4-1902975, Draft CR on PRACH and PUCCH format description for EVM in FR1, Anritsu corporation</p> <p>R4-1903032, Draft CR on editorial error of TS38.101-1, LG Electronics France</p> <p>R4-1903120, Draft CR on DL power allocation for TS 38.101-1, Intel Corporation</p> <p>R4-1903124, Draft CR on b41-n40 coexistence, Intel Corporation</p> <p>R4-1903151, Draft CR to TS38.101-1_removing DC sections, ZTE Corporation</p> <p>R4-1903195, Draft CR for 38.101-1: remove the bracket of UE capability "powerBoosting-pi2BPSK", Huawei</p> <p>R4-1903392, Draft CR for TS 38.101-1: Corrections to EVM equalizer spectrum flatness requirements, MediaTek Inc.</p> <p>R4-1903473, Draft CR on FREF,Shift, CMCC</p> <p>R4-1903508, Draft CR to TS 38.101-1 on spurious emissions for UE co-existence, ZTE Corporation</p> <p>R4-1904335, DraftCR TS 38.101 Corrections to NS_100 UTRA ACLR frequency band list, Skyworks Solutions Inc.</p> <p>R4-1904460, Draft CR for 38.101-1 CA Pcmx, Huawei</p> <p>R4-1904537, Draft CR for TR 38.101-1 correction of A-MPR for NS_04, Huawei</p> <p>R4-1904554, Draft CR to 38.101-1: FR1 power dynamics DTX removal, Qualcomm Incorporated</p> <p>R4-1904927, Draft CR to clarify frequency of carrier leakage in RBs for FR1, Anritsu corporation</p> <p>R4-1904928, Draft CR to TS 38.101-1 on description of UE additional output power reduction, ZTE Corporation</p> <p>R4-1904929, draft Rel-15 CR for editorial corrections in 38.101-1, Ericsson</p> <p>R4-1904941, draft CR to 38.101-1 Correction to Pi/2 BPSK power boosting, Intel Corporation</p> <p>R4-1904957, Draft CR for TR38.101-1 – Update to EVM averaging, Rohde & Schwarz</p> <p>R4-1904958, Draft CR for TR38.101-1 – Update to spectrum flatness, Rohde & Schwarz</p> <p>R4-1904967, Draft CR for 38.101-1 definition of Maximum input level for intra-band contiguous CA, Huawei</p> <p>R4-1904969, Draft CR for 38.101-1: editorial correction, Huawei</p> <p>R4-1904987, Draft CR for correction on TS38.101-1, CATT</p>	15.6.0

						<p>Endorced draft CRs from RAN4#91</p> <p>R4-1905339 removal of A-MPR brackets in FR1 Nokia</p> <p>R4-1905503 Change description 4.2(d) in Applicability of minimum requirements for TS 38.101-1 vivo</p> <p>R4-1905524 [Rx]Draft CR for 38.101-1 Removing the brackets in Rx requirements Huawei</p> <p>R4-1905526 [Rx]Draft CR for 38.101-1 defining NBB requirements<2.7GHz Huawei</p> <p>R4-1905772 Draft CR to TS38.101-1 Almost contiguous MPR Intel Corporation</p> <p>R4-1905795 Correction to a description of PRB for in-band emission in FR1 Anritsu Corporation</p> <p>R4-1905797 Correction to power control in FR1 Anritsu Corporation</p> <p>R4-1906140 draft CR for TS 38.101-1 Rx requirement for CA Huawei</p> <p>R4-1906153 Draft CR for TS 38.101-1: Editorial corrections to intra-band contiguous CA ACS and in-band blocking requirements MediaTek Inc.</p> <p>R4-1906154 Draft CR for TS 38.101-1: Adding symbol definitions for intra-band contiguous CA Rx maximum input level and ACS requirements MediaTek Inc.</p> <p>R4-1906871 Draft CR for TS 38.101-1 UE optional bandwidth for FR1 Huawei</p> <p>R4-1907131 Draft CR to 38.101-1. Clarification to FR1 NS_43 AMPR frequency ranges Qualcomm Incorporated</p> <p>R4-1907135 Draft CR to 38.101-1 rel. 15 to fix missing Exceptions for Out-of-band Blocking Apple</p> <p>R4-1907419 Draft CR for TS 38.101-1: Editorial improvement to EVM equalizer spectrum flatness requirements for Pi/2 BPSK MediaTek Inc.</p> <p>R4-1907429 Draft CR to TS38.101-1 A-MPR for Inter-band CA Intel Corporation</p> <p>R4-1907434 [Rx]Draft CR for 38.101-1 modifying characteristics of the interfering signal in Annex D Huawei</p> <p>R4-1907435 Draft CR to TS38.101-1_introduction of n41C and corrections on Rx requirements for NR intra-band contiguous CA ZTE Corporation</p> <p>R4-1907439 Draft CR to TS 38.101-1 on CA bandwidth class description ZTE Corporation</p> <p>R4-1907471 Draft CR to 38.101-1. Clarify all RB reference so transmission BW applies for all SCS Qualcomm Incorporated</p> <p>R4-1907474 Draft CR for TS 38.101-1 Correction of channel bandwidth set for NR CA Huawei</p> <p>R4-1907477 Draft CR to TS 38.101-1 on maximum aggregated bandwidth for NR CA configurations ZTE Corporation</p> <p>R4-1907481 Correction of RefSens exceptions due to UL harmonic interference for NR CA in 38.101-1 vivo</p> <p>R4-1907687 Correction to CA carrier spacing Ericsson</p>	
2019-06	RAN#84	RP-191248	0037	1	B	Introduction of n48 in to TS 38.101-1	16.0.0
2019-06	RAN#84	RP-191241	0040		B	CR to REL-16 TS 38.101-1: Implementation of endorsed draft CRs on NR combinations and dual Connectivity combinations	16.0.0
2019-06	RAN#84	RP-191242	0041	1	B	CR to TS 38.101-1: Introduction of band n14 – Endorsed R4-1904008 in RAN4#90b	16.0.0
2019-06	RAN#84	RP-191246	0042	1	B	CR to TS 38.101-1: Introduction of band n30 + editorial in table 7.6.2-2	16.0.0
2019-06	RAN#84	RP-191244	0043	1	B	CR to introduce n18 to TS 38.101-1	16.0.0
2019-06	RAN#84	RP-191250	0044	1	B	n65 introduction to 38.101-1	16.0.0
2019-06	RAN#84	RP-191251	0045		B	Addition channel bandwidth of 30MHz for n50 in TS 38.101-1	16.0.0
2019-06	RAN#84	RP-191252	0046	1	B	Introduction of a new NR band for LTE/NR spectrum sharing in Band 41/n41	16.0.0
2019-06	RAN#84	RP-191241	0048		B	CR on introducing NR inter-band CA of 3DL Bands and 1UL band	16.0.0
2019-06	RAN#84	RP-191241	0049		B	CR to reflect the completed NR inter-band CA/DC combinations into Rel16 TS38.101-1	16.0.0
2019-06	RAN#84	RP-191241	0050		B	CR to reflect the completed NR inter-band CA/DC combinations for 3 bands DL with 2 bands UL into Rel16 TS38.101-1	16.0.0
2019-06	RAN#84	RP-191241	0051		B	CR introduction completed band combinations 38.716-01-01 -> 38.101-1	16.0.0
2019-09	RAN#85	RP-192038	0052		F	Correction to FR1 ASEM NS_27	16.1.0
2019-09	RAN#85	RP-192032	0053		B	Addition of NS information on 30MHz support for n41	16.1.0
2019-09	RAN#85	RP-192031	0054	1	B	Addition of new channel bandwidths for n7 into TS 38.101-1	16.1.0
2019-09	RAN#85	RP-192027	0055		B	CR on introducing NR intra-band CA for 3DL Bands and 1UL band	16.1.0
2019-09	RAN#85	RP-192027	0057	1	F	Minor corrections of intra-band non-contiguous CA operating bands in TS 38.101-1	16.1.0
2019-09	RAN#85	RP-192027	0058	1	F	Adding DeltaFHD for CA_n1-n77 refersense requirments	16.1.0

2019-09	RAN#85	RP-192032	0060		B	CR to introduce 30MHz bandwidth of n41 into TS 38.101-1	16.1.0
2019-09	RAN#85	RP-192026	0061	1	B	Characteristics of Interfering signal for Contiguous Intra-band CA Class B	16.1.0
2019-09	RAN#85	RP-192027	0062	1	F	Correction Inter-band CA configurations	16.1.0
2019-09	RAN#85	RP-192027	0063	1	F	Finalizing Generic Intra-band Contiguous CA Class B requirements	16.1.0
2019-09	RAN#85	RP-192034	0064	1	B	n29 introduction to 38.101	16.1.0
2019-09	RAN#85	RP-192027	0065		F	[SUL] CR on SUL band combinations into Rel-16 TS 38.101-1	16.1.0
2019-09	RAN#85	RP-192029	0066		B	CR on Introduction of SUL band n89 into Rel-16 TS 38.101-1	16.1.0
2019-09	RAN#85	RP-192046	0068	2	F	Correction to Band n66	16.1.0
2019-09	RAN#85	RP-192026	0070	1	F	CR to 38.101-1. Revamp CA ACS and IBB tables to differentiate by band numbers and not frequency	16.1.0
2019-09	RAN#85	RP-192038	0071		F	CR to 38.101-1. Add missing AMPR to NS27	16.1.0
2019-09	RAN#85	RP-192026	0072		B	CR for 38.101-1 Rx requirement for NR intra-band non-contiguous CA	16.1.0
2019-09	RAN#85	RP-192036	0073		F	CR for 38.101-1: Correction to the Spurious Emission for UE Coexistence table for n14	16.1.0
2019-09	RAN#85	RP-192037	0074		F	CR for 38.101-1: Correction to the Spurious Emission for UE Coexistence table for n30	16.1.0
2019-09	RAN#85	RP-192027	0075		B	CR introduction completed band combinations 38.716-01-01 -> 38.101-1	16.1.0
2019-09	RAN#85	RP-192027	0076		B	CR to reflect the completed NR inter band CA DC combinations for 2 bands DL with up to 2 bands UL into Rel16 TS 38.101-1	16.1.0
2019-09	RAN#85	RP-192027	0077		B	CR to reflect the completed NR inter band CA DC combinations for 3 bands DL with 2 bands UL into Rel16 TS 38.101-1	16.1.0
2019-09	RAN#85	RP-192049	0079		A	CR to TS 38.101-1: Implementation of endorsed draft CRs from RAN#92 (Rel-16) - Mirrors changes in R4-1910350 (of RAN#92) for Rel-15 TS 38.101-1	16.1.0
2019-12	RAN#86	RP-193022	0097		F	CR to align NS27 AMPR to CA_NS_10 AMPR for 40MHz BW at the center of band 48.	16.2.0
2019-12	RAN#86	RP-193028	0099		A	CR for 38.101- RX Out-of-Band Blocking for B38 and B41	16.2.0
2019-12	RAN#86	RP-193028	0103		A	CR for 38.101-1 n39 AMPR	16.2.0
2019-12	RAN#86	RP-193013	0105	1	B	Introduction of 2010-2025MHz SUL band into Rel-16 TS 38.101-1	16.2.0
2019-12	RAN#86	RP-193015	0110		B	Addition of 25, 30 and 40 MHz to NR band n25 in TS 38.101-1	16.2.0
2019-12	RAN#86	RP-193028	0112		A	Sync raster to SSB resource element mapping	16.2.0
2019-12	RAN#86	RP-193028	0114		A	CR to TS 38.101-1 Almost contiguous A-MPR (R16)	16.2.0
2019-12	RAN#86	RP-193028	0118		A	CR to 38.101-1 (Rel-16) to clarify measurement interval and observation window on frequency error	16.2.0
2019-12	RAN#86	RP-193020	0119		D	Format misalignment on NS_47 protection requirement table	16.2.0
2019-12	RAN#86	RP-193028	0121		A	CR to TS 38.101-1: Replace CBW with symbols defined in the specification	16.2.0
2019-12	RAN#86	RP-193012	0124		B	CR to reflect the completed NR inter band CA DC combinations for 2 bands DL with up to 2 bands UL into Rel16 TS 38.101-1	16.2.0
2019-12	RAN#86	RP-193012	0125		B	CR to reflect the completed NR inter band CA DC combinations for 3 bands DL with 2 bands UL into Rel16 TS 38.101-1	16.2.0
2019-12	RAN#86	RP-193012	0126		F	CR to remove square brackets for n90 in TS38.101-1	16.2.0
2019-12	RAN#86	RP-193028	0128		A	CR for TS38.101-1, Clarification and Editorial corrections	16.2.0
2019-12	RAN#86	RP-193012	0132		B	Introducing NR inter-band CA for 3DL Bands and 1UL band for 38.101-1	16.2.0
2019-12	RAN#86	RP-193029	0133		B	Adding band n71 and n28 to 4 Rx antenna ports support in 38.101-1	16.2.0
2019-12	RAN#86	RP-193028	0137		A	CR for TS 38.101-1: Editorial correction for n2 uplink configuration note index in Table 7.3.2-3	16.2.0
2019-12	RAN#86	RP-193028	0138		A	CR to TS 38.101-1 on A-MPR table cleanup (Rel-16)	16.2.0
2019-12	RAN#86	RP-193029	0140		A	CR for TS 38.101-1: Removing CA configurations for CA_n77D/E, CA_n78D/E, and CA_n79D/E	16.2.0
2019-12	RAN#86	RP-193029	0144		A	CR for TS 38.101-1: Fix out-of-band blocking issue for n50 and n75	16.2.0
2019-12	RAN#86	RP-193029	0146		A	CR to TS 38.101-1 on corrections to channel raster entries for NR band (Rel-16)	16.2.0
2019-12	RAN#86	RP-193029	0150		A	CR to transmit modulation quality in FR1	16.2.0
2019-12	RAN#86	RP-193012	0151		F	Corrections Intra-band CA simultaneous TX/RX requirements	16.2.0
2019-12	RAN#86	RP-193029	0153		F	Removal of brackets from receiver requirements in 38.101-1 REL-16	16.2.0
2019-12	RAN#86	RP-193012	0155		B	Extension of CA BW class B	16.2.0
2019-12	RAN#86	RP-193029	0157		A	CR to 38.101-1: Editorial correction of UL RMCs	16.2.0
2019-12	RAN#86	RP-193012	0164		B	CR for 38.101-1 introduce SUL band combination CA_n78(2A)_SUL_n78A-n86A	16.2.0
2019-12	RAN#86	RP-193010	0165		F	CR for 38.101-1: add BCS1 configurations for CA_n78(2A)	16.2.0
2019-12	RAN#86	RP-193017	0166		B	CR to 38.101-1 - Band n75 - wider CBW	16.2.0
2019-12	RAN#86	RP-193018	0167		B	CR for TS 38.101: adding wider channel bandwidths	16.2.0
2019-12	RAN#86	RP-193016	0168		B	CR to 38.101-1: Addition of channel bandwidth for band n38	16.2.0
2019-12	RAN#86	RP-193012	0169		B	CR introduction completed band combinations 38.716-01-01 -> 38.101-1	16.2.0
2019-12	RAN#86	RP-193012	0170		B	CR introduction completed band combinations 38.716-04-01 -> 38.101-1	16.2.0

2019-12	RAN#86	RP-193021	0171		C	CR for 38.101-1: Making 90 MHz channel bandwidth mandatory for n41, n78 and n90	16.2.0
2019-12	RAN#86	RP-193020	0172		B	CR for 38.101-1: adding 30 MHz CHBW to NS_04 for n41	16.2.0
2019-12	RAN#86	RP-193029	0174		A	CR to 38.101-1-g10 Corrections to Transient Time Masks	16.2.0
2019-12	RAN#86	RP-193010	0176	1	F	CR for intra-band DL contiguous CA RF requirements	16.2.0
2019-12	RAN#86	RP-193010	0179		B	Introduction of almost contiguous MPR for PC2	16.2.0
2019-12	RAN#86	RP-193029	0180		A	CR for asynchronous operation for NR CA n78-n79	16.2.0
2019-12	RAN#86	RP-193028	0182		A	CR to 38.101-1: DMRS Exceptions	16.2.0
2020-03	RAN#87	RP-200408	0191		F	Corrections to n65	16.3.0
2020-03	RAN#87	RP-200377	0201	1	F	CR for 38.101-1 to introduce BCS1 for CA_n77C and CA_n78C	16.3.0
2020-03	RAN#87	RP-200394	0203		A	CR to TS 38.101-1 on corrections to network signalling value (Rel-16)	16.3.0
2020-03	RAN#87	RP-200484	0208		A	CR for 38.101- n39 NS flag change due to conflict	16.3.0
2020-03	RAN#87	RP-200394	0210		A	Mirror CR for 38.101-1: n41 and n25 corrections	16.3.0
2020-03	RAN#87	RP-200380	0211	2	F	CR for 38.101-1: Corrections to intra-band CA tables	16.3.0
2020-03	RAN#87	RP-200387	0212		F	CR for 38.101-1: Missing 70 MHz for NS_01	16.3.0
2020-03	RAN#87	RP-200381	0215		B	CR for 38.101-1: Introduction of n26	16.3.0
2020-03	RAN#87	RP-200380	0216		F	CR to TS 38.101-1: Corrections on MSD tables for CA_n20-n78 and CA_n66-n78	16.3.0
2020-03	RAN#87	RP-200394	0218		A	CR to TS 38.101-1: corrections on ACS for intra-band contiguous CA	16.3.0
2020-03	RAN#87	RP-200380	0219	1	F	CR to TS 38.101-1: Improvement on NR 3DL inter-band CA combination	16.3.0
2020-03	RAN#87	RP-200394	0221		A	CR to TS 38.101-1: Replace CBW with symbols defined in the specification. NOTE: The CR is based on something else than the latest version of the specification and therefore it is not implemented, e.g. Tables 6.2.3.1-1, 7.6.2-2 and Table 7.6.2-4 in CR0221 are different compared to those in 38.101-1 v16.2.0.	16.3.0
2020-03	RAN#87	RP-200380	0222		B	CR to reflect the completed NR inter band CA DC combinations for 2 bands DL with up to 2 bands UL into Rel16 TS 38.101-1	16.3.0
2020-03	RAN#87	RP-200380	0223		B	CR to reflect the completed NR inter band CA DC combinations for 3 bands DL with 2 bands UL into Rel16 TS 38.101-1	16.3.0
2020-03	RAN#87	RP-200394	0224	1	B	Introduction of n53 into TS 38.101-1	16.3.0
2020-03	RAN#87	RP-200394	0229		A	CR for TS38.101-1, Remove notes for UE channel bandwidth	16.3.0
2020-03	RAN#87	RP-200394	0231		A	CR for TS38.101-1, Correction of IE RF-Parameters name of maxUplinkDutyCycle	16.3.0
2020-03	RAN#87	RP-200380	0234	1	B	Introducing NR inter-band CA for 3DL Bands and 1UL band for 38.101-1	16.3.0
2020-03	RAN#87	RP-200377	0239	1	F	CR for TS 38.101-1: Corrections for n48 receiver requirements	16.3.0
2020-03	RAN#87	RP-200386	0240	1	B	CR for TS 38.101: adding wider channel bandwidths for n66	16.3.0
2020-03	RAN#87	RP-200392	0241	1	F	Maintenance on the UE BW for n92 and n94	16.3.0
2020-03	RAN#87	RP-200392	0242		F	Maintenance on the Rx-Tx separation terms	16.3.0
2020-03	RAN#87	RP-200394	0244		A	CR for 38.101-1: to remove fallback group 1 in table 5.5A.1-1	16.3.0
2020-03	RAN#87	RP-200389	0247		F	CR for 38.101-1: to correct CA_n8A-n75A REFSSENS	16.3.0
2020-03	RAN#87	RP-200384	0249	1	B	CR for 38.101-1: to introduce UE RF requirements for adding wider channel bandwidth in band n28	16.3.0
2020-03	RAN#87	RP-200383	0250	1	B	CR to 38.101-1 Band n1 - wider CBW - Additional Channel BW	16.3.0
2020-03	RAN#87	RP-200385	0252	1	B	CR to 38.101-1 Band n38 - wider CBW - Additional Channel BW	16.3.0
2020-03	RAN#87	RP-200380	0260	1	F	Editorial corrections	16.3.0
2020-03	RAN#87	RP-200377	0263		F	CR for almost contiguous allocation applicability	16.3.0
2020-03	RAN#87	RP-200394	0265	1	A	CR for inter-band CA Tx requirement	16.3.0
2020-03	RAN#87	RP-200377	0266	1	F	CR for intra-band CA configuration and DL RF requirements	16.3.0
2020-03	RAN#87	RP-200391	0273		F	CR for 38.101-1: Mandatory support for n41 by UEs that support n90	16.3.0
2020-03	RAN#87	RP-200394	0275		A	CR for [agreed] asynchronous operation for NR CA n78-n79 NOTE: The CR is based on something else than the latest version of the specification and therefore it is not implemented, e.g. Tables 6.2A.4.2.3-1, Table 7.3A.6-1, 7.3A.6.2 and table notes are different compared to those in 38.101-1 v16.2.0.	16.3.0
2020-03	RAN#87	RP-200380	0280		F	CR for 38.101-1: delta Tib corrections	16.3.0
2020-03	RAN#87	RP-200394	0281		A	Removal of unnecessary definition of offset _{max,IMD3} from Table 6.2.3.2-1	16.3.0
2020-06	RAN#88	RP-201338	0293	4	B	CR to TS 38.101-1: Switching time mask between two uplink carriers in UL CA and SUL	16.4.0
2020-06	RAN#88	RP-200959	0294		F	Corrections to CA n48	16.4.0
2020-06	RAN#88	RP-200985	0300		A	CR to asymmetric CBW operation in FR1	16.4.0
2020-06	RAN#88	RP-200985	0302		A	CR on ACLR MBW definition in FR1	16.4.0

2020-06	RAN#88	RP-200959	0305		B	Introducing NR inter-band CA for 3DL Bands and 1UL band for 38.101-1	16.4.0
2020-06	RAN#88	RP-200959	0307		F	CR Coexistence cleanup for 38101-1 Rel16	16.4.0
2020-06	RAN#88	RP-200985	0310		A	CR to TS 38.101-1 R16: corrections on ACS for intra-band contiguous CA	16.4.0
2020-06	RAN#88	RP-200966	0311		F	CR for TS 38.101-1: UL harmonic MSD and OOB exception	16.4.0
2020-06	RAN#88	RP-200981	0315		F	Update 4Rx Requirement for Band n30	16.4.0
2020-06	RAN#88	RP-200958	0317		B	CR on NR V2X UE RF requirements for single carrier in TS38.101-1	16.4.0
2020-06	RAN#88	RP-200985	0327		A	Maintenance CR to 38101-1 on relative power tolerance R16	16.4.0
2020-06	RAN#88	RP-200974	0329		F	Endorsed CR on default AMPR signaling for n91 n92 n93 and n94	16.4.0
2020-06	RAN#88	RP-200985	0331		A	Update of CSI-RS definition for FR1 DL RMCs	16.4.0
2020-06	RAN#88	RP-200985	0335		A	Correction to FR1 QPSK UL RMC	16.4.0
2020-06	RAN#88	RP-200966	0336		B	CR to TS38.101-1: Introduction of NR DC(Clauses 3	16.4.0
2020-06	RAN#88	RP-200985	0338		A	CR to TS 38.101-1: Correction on the CA nominal channel spacing	16.4.0
2020-06	RAN#88	RP-200985	0340		A	CR to TS 38.101-1: Replace CBW with symbols defined in the specification.	16.4.0
2020-06	RAN#88	RP-200959	0341		B	CR to reflect the completed NR inter band CA DC combinations for 2 bands DL with up to 2 bands UL into Rel16 TS 38.101-1	16.4.0
2020-06	RAN#88	RP-200985	0345		A	30k SSB SCS for n50	16.4.0
2020-06	RAN#88	RP-200985	0347		A	Addition of 30k SSB SCS for Band n38	16.4.0
2020-06	RAN#88	RP-200985	0354		A	IBE measurements for Pi/2 BPSK with spectrum shaping	16.4.0
2020-06	RAN#88	RP-200959	0357		B	CR to reflect the completed NR inter band CA DC combinations for 3 bands DL with 2 bands UL into Rel16 TS 38.101-1	16.4.0
2020-06	RAN#88	RP-200959	0360		B	CR introduction completed band combinations 38.716-01-01 -	16.4.0
2020-06	RAN#88	RP-200959	0361		B	CR introduction completed band combinations 38.716-04-01 -	16.4.0
2020-06	RAN#88	RP-200959	0364		B	CR on Introduction of completed SUL band combinations into TS 38.101-1	16.4.0
2020-06	RAN#88	RP-201045	0365		F	CR for 38.101-1 to introduce BCS2 for CA_n78(2A).	16.4.0
2020-06	RAN#88	RP-200985	0367		A	CR for 38.101-1 to remove the NR CA configuration for REFSSENS exception due to cross band isolation for CA (mirror CR)	16.4.0
2020-06	RAN#88	RP-200985	0369		A	CR for 38.101-1 to add the REFSSENS exception for inter band CA with SDL (mirror CR)	16.4.0
2020-06	RAN#88	RP-200979	0373		F	CR on introduce delta-MPR for inter-band CA in band n28 and review value with brackets	16.4.0
2020-06	RAN#88	RP-200985	0379		A	IBE requirement for almost contiguous allocations	16.4.0
2020-06	RAN#88	RP-200985	0385		A	OOB blocking for n70 adjacent to n25	16.4.0
2020-06	RAN#88	RP-200985	0394		F	CR for TS 38.101-1 UE co-existence correction (R16)	16.4.0
2020-06	RAN#88	RP-200985	0396		F	CR for 38.101-1 RFC corrections (R16)	16.4.0
2020-06	RAN#88	RP-200985	0400		A	TS38.101-1 CR on 30KHz SSB SCS for n40(Rel-16)	16.4.0
2020-06	RAN#88	RP-200959	0318	1	F	CR to add simultaneous RXTX capability for CA_n41-n79	16.4.0
2020-06	RAN#88	RP-200985	0404		A	CR for 38.101-1: to add some missing sub-clause title for NR inter-band CA	16.4.0
2020-06	RAN#88	RP-200985	0343	1	A	CR for [agreed] asynchronous operation for NR CA n78-n79	16.4.0
2020-06	RAN#88	RP-201045	0387	1	B	CR on FR1 UL contiguous CA requirement	16.4.0
2020-06	RAN#88	RP-200974	0325	1	F	CR on blocking requirements for n91 n92 n93 and n94	16.4.0
2020-06	RAN#88	RP-201045	0380	1	B	Addition of mutual UE coexistence between US bands and NR Band n77	16.4.0
2020-06	RAN#88	RP-200977	0356	1	B	CR for TS 38.101: adding 50 MHz CBW for n1	16.4.0
2020-06	RAN#88	RP-200980	0358	1	B	CR to TS 38.101-1 - Add 40 MHz CBW in band n3	16.4.0
2020-06	RAN#88	RP-200982	0359	1	B	CR to TS 38.101-1 - Add 50 MHz CBW in band n65	16.4.0
2020-06	RAN#88	RP-200985	0405		F	Corrections of UE co-ex tables for Japan-related bands (R16)	16.4.0
2020-06	RAN#88	RP-201045	0320	2	B	CR to 38.101-1: Introduce an operating band list and NR bands to UL MIMO	16.4.0
2020-06	RAN#88	RP-200966	0362	1	B	CR to 38.101-1 for Introduction of requirements for NR-DC	16.4.0
2020-09	RAN#89	RP-201495	0407	1	F	Correction to FR1 UL contiguous CA MPR regions	16.5.0
2020-09	RAN#89	RP-201506	0409		F	CR for n26 AMPR for 256QAM	16.5.0
2020-09	RAN#89	RP-201512	0411		A	OOB blocking for Inter-band CA	16.5.0
2020-09	RAN#89	RP-201512	0416	1	F	Correction to ASEM for NS_27	16.5.0
2020-09	RAN#89	RP-201507	0419		F	Introduction of UE PC2 for NR band n40	16.5.0
2020-09	RAN#89	RP-201502	0422	1	B	Introduction of LTE/NR spectrum sharing in band 48/n48 frequency range	16.5.0
2020-09	RAN#89	RP-201507	0423		F	Coexistence cleanup for 38101-1 Rel16	16.5.0
2020-09	RAN#89	RP-201506	0424		D	CR Editorial cleanup of band combination tables for 38101-1 Rel16	16.5.0
2020-09	RAN#89	RP-201512	0426		A	CR to TS 38.101-1: corrections on narrow band blocking for intra-band contiguous CA	16.5.0
2020-09	RAN#89	RP-201492	0428	1	F	CR for TS 38.101-1: Removal of table 6.5E.3.4.3-1 and table 6.5E.3.4.3-2	16.5.0
2020-09	RAN#89	RP-201503	0432	1	B	CR for 38.101-1: Introduction of Power Class 1.5	16.5.0
2020-09	RAN#89	RP-201488	0433	1	B	CR to TS38.101-1 on introduction of Uplink Full Power Transmission	16.5.0
2020-09	RAN#89	RP-201512	0435		A	Corrections of Japan-related CA co-ex tables for REL-15 combo	16.5.0
2020-09	RAN#89	RP-201492	0437	1	F	Correction on 5G V2X UE RF requirements in rel-16	16.5.0
2020-09	RAN#89	RP-201495	0438	2	B	A-MPR definition for CA_n48B, CA_n41B and CA_n41C	16.5.0

2020-09	RAN#89	RP-201495	0439		F	CR Restoring the clause structure of NR FR1 uplink contiguous intraband CA	16.5.0
2020-09	RAN#89	RP-201492	0440	1	F	CR on TS38.101-1 for NR V2X	16.5.0
2020-09	RAN#89	RP-201512	0442		A	30k SSB SCS for Band n34 and n39	16.5.0
2020-09	RAN#89	RP-201512	0444		F	Correction for 5 MHz channel bandwidth for n50 and introduction of Annex H	16.5.0
2020-09	RAN#89	RP-201512	0458		A	CR for 38.101-1 FRC corrections (R16)	16.5.0
2020-09	RAN#89	RP-201506	0459	1	F	CR for 38.101-1 to remove PHS system and 860~890 protection for NR CA band combination with band n1 and band n8	16.5.0
2020-09	RAN#89	RP-201506	0460	1	F	CR for 38.101-1 to add the missing region for NS_18 and maintenance the ?mprc	16.5.0
2020-09	RAN#89	RP-201512	0462		A	CR for 38.101-1 to add the missing MSD for CA_n41A-n78A	16.5.0
2020-09	RAN#89	RP-201512	0465		A	Correction to configured power with allowance for SRS switching	16.5.0
2020-09	RAN#89	RP-202117	0466		B	Introduce UE NR-U requirements to 38.101-1 including Band n46 (5 GHz) and Band n96 (6 GHz)	16.5.0
2020-09	RAN#89	RP-201495	0468	1	F	CR for intra-band UL CA non-contiguous CA requirement	16.5.0
2020-09	RAN#89	RP-201495	0469	1	F	CR for correction on intra-band UL CA contiguous CA requirement	16.5.0
2020-09	RAN#89	RP-201495	0470	1	F	CR for intra-band UL contiguous CA DC location	16.5.0
2020-09	RAN#89	RP-201495	0471	1	B	CR for intra-band UL CA non-contiguous CA requirement	16.5.0
2020-09	RAN#89	RP-201507	0480	1	F	CR to 38.101-1 - Correction to CA BCS and cross band isolation MSD tables	16.5.0
2020-09	RAN#89	RP-201512	0483		A	Correction of applicability of 2Rx requirements	16.5.0
2020-09	RAN#89	RP-201488	0486	2	B	CR to add PC3 Pi/2 BPSK DMRS for IE powerBoostPi2BPSK = 0	16.5.0
2020-09	RAN#89	RP-202098	0499	1	C	7.5 kHz UL shift for LTE/NR spectrum sharing in Band 38/n38	16.5.0
2020-12	RAN#90	RP-202440	0492	1	F	CR CatF n7 NS_46 AMPR and coexistence	16.6.0
2020-12	RAN#90	RP-202427	0498	1	F	Correction on 5G V2X UE RF requirements in TS38.101-1 in rel-16	16.6.0
2020-12	RAN#90	RP-202438	0506		F	n53 bracket removal	16.6.0
2020-12	RAN#90	RP-202442	0507	2	F	A-MPR definition for CA_n7B, CA_n48B, CA_n41B and CA_n41C	16.6.0
2020-12	RAN#90	RP-202485	0512		A	CR to TS38.101-1 on DC location correction	16.6.0
2020-12	RAN#90	RP-202509	0518		F	Coexistence cleanup for 38.101-1 Rel16	16.6.0
2020-12	RAN#90	RP-202509	0524	1	F	CR to TS 38.101-1 on simplification for inter-band CA configuration	16.6.0
2020-12	RAN#90	RP-202427	0525		F	CR on TS38.101-1 for NR V2X	16.6.0
2020-12	RAN#90	RP-202485	0527		A	CR to TS 38.101-1[R16]: Clarification of non-simultaneous Rx/Tx operation for CA_n77-n79 and CA_n78-n79 in TS 38.101-1.	16.6.0
2020-12	RAN#90	RP-202442	0533	1	F	CR to 38.101-1 Add requirement on the UL CA configurations with no DL interruption	16.6.0
2020-12	RAN#90	RP-202509	0534		F	Editorial correction on section 5.2C to 38.101-1 R16	16.6.0
2020-12	RAN#90	RP-202427	0535	1	F	CR on V2X bands reference table	16.6.0
2020-12	RAN#90	RP-202509	0536	1	F	CR on sum of power for multiple transmit connectors	16.6.0
2020-12	RAN#90	RP-202428	0540		F	CR for 38.101-1 to correct the notation of SUL band combinations in order to be aligned with 38.101-3	16.6.0
2020-12	RAN#90	RP-202485	0542		A	CR for 38.101-1 to adjust the structure of NR CA REFSSENS (Rel-16)	16.6.0
2020-12	RAN#90	RP-202509	0544		F	Reference measurement channels for 70 MHz CBW	16.6.0
2020-12	RAN#90	RP-202428	0547		F	Correction to supported channel bandwidths per SUL_n41A-n81A	16.6.0
2020-12	RAN#90	RP-202414	0550	3	F	Correction to the intra-cell guard band definition for wideband operation	16.6.0
2020-12	RAN#90	RP-202414	0552	1	F	Correction to receiver requirements for shared spectrum channel access	16.6.0
2020-12	RAN#90	RP-202442	0556		F	CR Correction to NS_27 and Band 10 protection 38101-1 Rel16	16.6.0
2020-12	RAN#90	RP-202428	0557	1	F	CR for editorial corrections 38.101-1	16.6.0
2020-12	RAN#90	RP-202414	0558	2	F	Removal of square brackets for 38.101-1 NR-U	16.6.0
2020-12	RAN#90	RP-202509	0562		F	CR to for 38.101-1: CA uplink power clarification	16.6.0
2020-12	RAN#90	RP-202509	0563		D	CR for 38.101-1: Editorial corrections	16.6.0
2020-12	RAN#90	RP-202427	0566	1	F	CR for 38.101-1 NR V2X FRC	16.6.0
2020-12	RAN#90	RP-202485	0571		A	CR for TS 38.101-1: correction of delta Tib for UE supporting multiple band combinations (R16)	16.6.0
2020-12	RAN#90	RP-202442	0574	1	B	CR for intra-band UL CA non-contiguous CA requirement	16.6.0
2020-12	RAN#90	RP-202485	0581		A	CR for 38.101-1 on corrections for AMPR-Rel-16	16.6.0
2020-12	RAN#90	RP-202485	0584		A	CR to DMRS position in UL RMC for FR1	16.6.0
2021-03	RAN#91	RP-210190	0588	2	F	PC1 and PC3 Updates for Band n14	16.7.0
2021-03	RAN#91	RP-210117	0593	1	F	38.101 Void clean up R16	16.7.0
2021-03	RAN#91	RP-210082	0600		F	CA_n7B_REFSSENS_CatF_CR	16.7.0
2021-03	RAN#91	RP-210072	0605	1	F	CR on editorial correction on V2X operation in TS38.101-1 in Rel-16	16.7.0
2021-03	RAN#91	RP-210117	0611		A	CR for TS38 101-1 Rel-16 Correction for definition of P-MPR	16.7.0
2021-03	RAN#91	RP-210117	0613	2	F	CR for TS38 101-1 Rel-16 Correction of condition for MPR and delta MPR	16.7.0
2021-03	RAN#91	RP-210082	0629		F	CR for TS 38.101-1: Correction on 1Tx-2Tx switching between two uplink carriers (Rel-16)	16.7.0
2021-03	RAN#91	RP-210091	0632		F	CR for 38.101-1: Update of missing fallback NR-DC combinations Rel-16	16.7.0
2021-03	RAN#91	RP-210117	0637	1	F	CR for 38.101-1 Rel16 corrections on exception requirements on out-of-band blocking for inter-band CA	16.7.0

2021-03	RAN#91	RP-210091	0641	1	B	CR on introduction of shorter Transient Period Capability	16.7.0
2021-03	RAN#91	RP-210091	0659		F	CR for 38.101-1 to add missing spurious emissions for band n38 UE co-existence (Rel-16)	16.7.0
2021-03	RAN#91	RP-210084	0662	1	F	CR to TS 38.101-1: system parameters maintenance for NR-U	16.7.0
2021-03	RAN#91	RP-210117	0664		A	Simplification of n70	16.7.0
2021-03	RAN#91	RP-210074	0668		F	CR for 38.101-1: Add CA_n25A-n41(2A)-n71A which was missing in the CR implementation	16.7.0
2021-03	RAN#91	RP-210117	0673		A	CR to TS38.101-1: Correction on applicability of minimum requirements	16.7.0
2021-03	RAN#91	RP-210117	0676		A	CR to TS38.101-1: Correction on the Aggregated Channel Bandwidth	16.7.0
2021-03	RAN#91	RP-210117	0678		F	CR to TS38.101-1: Correction on configured transmitted power requirement	16.7.0
2021-03	RAN#91	RP-210117	0689	1	D	Missing parent clause for NR-DC PCMAX	16.7.0
2021-03	RAN#91	RP-210117	0691	1	F	Corrections to PCMAX for UL CA	16.7.0
2021-03	RAN#91	RP-210117	0698		A	CR for TS 38.101-1: Correction to FR1 time mask for SRS antenna switching	16.7.0
2021-03	RAN#91	RP-210082	0700	1	F	CR for TS 38.101-1: Corrections to intra-band UL NC CA requirements	16.7.0
2021-03	RAN#91	RP-210091	0702		F	CR for TS 38.101-1: Cleanup for spurious emissions for UE co-existence table	16.7.0
2021-03	RAN#91	RP-210091	0710		F	CR on TS 38.101-1 NS_49	16.7.0
2021-06	RAN#92	RP-211084	0735		A	Update of FR1 UL RMC tables	16.8.0
2021-06	RAN#92	RP-211104	0737		F	CR Removal of square brackets from n48 NS_27 R16 CAT F	16.8.0
2021-06	RAN#92	RP-211114	0739	1	F	CR TDD Intraband CA REFSENS requirement issue R16	16.8.0
2021-06	RAN#92	RP-211118	0744	1	F	CR on PC1.5 HPUE SAR issue into Rel-16 TS 38.101-1	16.8.0
2021-06	RAN#92	RP-211102	0749	1	F	CR on spurious emission between n40 and n41 into Rel-16 TS 38.101-1	16.8.0
2021-06	RAN#92	RP-211080	0759	1	F	Correction of an improper usage of band edge relaxation for MOP	16.8.0
2021-06	RAN#92	RP-211085	0764		A	CR to TS38.101-1[R16]: Addition of UE co-existence requirements for n40	16.8.0
2021-06	RAN#92	RP-211115	0767		F	Correction on supported channel bandwidth for CA_n39-n41-n79	16.8.0
2021-06	RAN#92	RP-211114	0774	1	F	CR for correction of Rel-16 NR inter-band CA DC configuration for 2DL with up to 2 bands UL	16.8.0
2021-06	RAN#92	RP-211077	0778	1	F	Cleanup for UE co-existence 38.101-1 Rel-16	16.8.0
2021-06	RAN#92	RP-211105	0782		F	UL MIMO coherence for Tx switching between two carriers (Rel-16)	16.8.0
2021-06	RAN#92	RP-211077	0785		F	CR to 38.101-1 for missing MSD due to receiver harmonic mixing for combos with n46	16.8.0
2021-06	RAN#92	RP-211077	0791	1	F	CR for updating the note of mandatory simultaneous Rx/Tx capability for FR1 NR-CA combinations	16.8.0
2021-06	RAN#92	RP-211077	0799	1	F	Correction to MPR for serving cells of intra-band UL CA	16.8.0
2021-06	RAN#92	RP-211095	0801	1	F	Corrections to BCS for n46	16.8.0
2021-06	RAN#92	RP-211095	0803	1	F	Applicability of minimum requirements for shared spectrum access	16.8.0
2021-06	RAN#92	RP-211095	0810		F	CR to 38.101-1 with correction of NR-U 60 MHz and 80 MHz channels	16.8.0
2021-06	RAN#92	RP-211086	0813		F	CR for Rel-16 38.101-1 to correct some errors in Delta TIB and Delta RIB table	16.8.0
2021-06	RAN#92	RP-211086	0815		F	CR for 38.101-1 Rel16 corrections on power tolerance for intra-band contiguous CA	16.8.0
2021-06	RAN#92	RP-211101	0820	1	F	CR for 38.101-1 to correct AMPR value for NR V2X NS_52(Rel-16)	16.8.0
2021-06	RAN#92	RP-211107	0822		F	CR to TS38.101-1: Correction on configured transmitted power for NR non-contiguous CA	16.8.0
2021-06	RAN#92	RP-211115	0824		F	CR to TS38.101-1: Add missing CA_n1A-n3A-n78A	16.8.0
2021-06	RAN#92	RP-211095	0835		F	Applicability of requirements for intra-band contiguous CA	16.8.0
2021-06	RAN#92	RP-211102	0837	1	F	Correction to Band n48 reference sensitivity	16.8.0
2021-06	RAN#92	RP-211114	0846	1	F	Rel-16 CR 38101-1-g70 corrections	16.8.0
2021-06	RAN#92	RP-211101	0863	2	F	CR for TS 38.101-1 update configured transmitted power for V2X (R16)	16.8.0
2021-06	RAN#92	RP-211080	0867	1	F	CR for 38.101-1-g70: Corrections to intra-band non-contiguous CA REFSENS	16.8.0
2021-06	RAN#92	RP-211116	0869		F	CR for 38.101-1-g70: Corrections to NS_12, NS_13, NS_14, NS_15	16.8.0
2021-09	RAN#93	RP-211910	0910	1	B	Introduction of the UL 7.5kHz shift for NR TDD band n34 and n39	16.9.0
2021-09	RAN#93	RP-211921	0920		F	Big CR for TS 38.101-1 Maintenance part1 (Rel-16)	16.9.0
2021-09	RAN#93	RP-211907	0922		F	Big CR for TS 38.101-1 Maintenance part2 (Rel-16)	16.9.0
2021-09	RAN#93	RP-212599	0926	2	C	Introduction of NS value for distinguishing support of extended n77	16.9.0
2021-12	RAN#94	RP-212847	0976		F	CR to remove LO exceptions	16.10.0
2021-12	RAN#94	RP-212853	0982		F	Big CR for TS 38.101-1 Maintenance (Rel-16)	16.10.0
2022-03	RAN#95	RP-220337	1036		F	Big CR for TS 38.101-1 Maintenance Part-1 (Rel-16)	16.11.0
2022-03	RAN#95	RP-220337	1038		F	Big CR for TS 38.101-1 Maintenance Part-2 (Rel-16)	16.11.0
2022-06	RAN#96	RP-221666	1052		F	CR for 38.101-1-gb0: Correction for n7 A-MPR (NS_46)	16.12.0
2022-06	RAN#96	RP-221668	1056		F	CR for 38.101-1 Rel16 Minor AMPR Corrections for n65 to account for SCS	16.12.0
2022-06	RAN#96	RP-221661	1115	1	F	CR to R16 TS38.101-1 on transient period capability	16.12.0

2022-06	RAN#96	RP-221655	1120		F	Big CR for TS 38.101-1 Maintenance Part-1 (Rel-16)	16.12.0
2022-06	RAN#96	RP-221066	1125		F	CR for updating the note of mandatory simultaneous Rx/Tx capability for FR1 NR-CA combinations	16.12.1
2022-09	RAN#97	RP-222035	1189		F	CR for TS 38.101-1, Correction of configured transmitted power for V2X	16.13.0
2022-09	RAN#97	RP-222023	1191		F	Big CR for 38.101-1 maintenance part1 (Rel-16)	16.13.0
2022-09	RAN#97	RP-222023	1193		F	Big CR for 38.101-1 maintenance part2 (Rel-16)	16.13.0
2022-09	RAN#97	RP-222682	1195	2	C	Extension of operation in the n77 frequency range in US [n77 US]	16.13.0
2022-12	RAN#98-e	RP-223290	1209		A	Addition of FR1 UL MIMO EVM measurement description	16.14.0
2022-12	RAN#98-e	RP-223290	1212		A	Addition of FR2 UL MIMO EVM measurement description Note: The CR was not implementable and therefore was not implemented in the specification.	16.14.0
2022-12	RAN#98-e	RP-223295	1219	2	F	Addition of CA_n77-n78 to CA Band table R16	16.14.0
2022-12	RAN#98-e	RP-223297	1221		F	Correction to n91,n92,n93 and n94 co-ex R16	16.14.0
2022-12	RAN#98-e	RP-223296	1224		F	CR for TS 38.101-1 Rel-16: Correcting critical error with co-existence for band CA_n8-n40	16.14.0
2022-12	RAN#98-e	RP-223296	1243		F	CR to R16 TS38.101-1 maintenance for UE co-ex requirements for UL CA	16.14.0
2022-12	RAN#98-e	RP-223296	1252	2	F	CR to 38.101-1 on removing ambiguity in CA MPR definition	16.14.0
2022-12	RAN#98-e	RP-223291	1266		A	CR on 'Annex G Difference of relative phase and power errors' for FR1 UL coherent MIMO	16.14.0
2022-12	RAN#98-e	RP-223291	1269		A	CR on TDD RMC for Intra-band EN-DC - TS 38.101-1	16.14.0
2022-12	RAN#98-e	RP-223480	1277	2	F	Clarification of the CA_NS indication the values for n77 in the US [n77 US]	16.14.0
2023-03	RAN#99	RP-230501	1303		F	CR for TS 38.101-1 Rel-16: Correction for wrong reference in NS_50	16.15.0
2023-03	RAN#99	RP-230502	1322		A	Addition of configuration for carrier aggregation RMCs	16.15.0
2023-03	RAN#99	RP-230504	1353	1	F	Rel16 Cat F CR Correct the wrong table and clause that clause 6.2A.3.1.1 refer to	16.15.0
2023-03	RAN#99	RP-230507	1371		F	Correct the scaling number for MPR/A-MPR and NS_04 SEM requirement	16.15.0
2023-03	RAN#99	RP-230502	1379		A	CR on Harmonic mixing MSD for CA_n8A-n79A (R16 CAT-A)	16.15.0
2023-03	RAN#99	RP-230507	1391	1	F	Clarification on Time mask for Tx switching for SA (Rel-16)	16.15.0
2023-03	RAN#99	RP-230504	1398	1	F	CR for Rel-16 38.101-1 to correct the configurations for CA_n46M/N/O	16.15.0
2023-03	RAN#99	RP-230507	1402		F	CR to 38.101-1: Corrections on reference section for A-MPR for CA_NC_NS_04	16.15.0
2023-03	RAN#99	RP-230503	1409		A	CR for TS 38.101-1 to clarify the inner outer condition for almost contiguous RB allocation (R16)	16.15.0
2023-03	RAN#99	RP-230501	1412		F	CR for TS 38.101-1 to clarify band n34 protection for band n1 and n65	16.15.0
2023-03	RAN#99	RP-230501	1415		F	CR for TS 38.101-1 to clarify Out-of-band blocking exception for band n20 and n28 (R16)	16.15.0
2023-03	RAN#99	RP-230503	1434		A	CR to TS 38.101-1 on humidity condition for normal temperature	16.15.0
2023-03	RAN#99	RP-230507	1452	1	F	CR to return the Eq1 for intra-band UL CA contiguous	16.15.0
2023-03	RAN#99	RP-230504	1453	1	F	CR to clarify duplex mode of SDL bands	16.15.0
2023-03	RAN#99	RP-230501	1455		F	CR to add band n29 to blocking requirements	16.15.0
2023-03	RAN#99	RP-230504	1457		A	Output power for NS_38, NS_40, and NS_41	16.15.0
2023-03	RAN#99	RP-230501	1463		F	CR to TS 38.101-1 Rel-16 4Rx for SUL	16.15.0
2023-03	RAN#99	RP-230504	1466	1	F	CR to TS 38.101-1 Rel-16 Minimum guardband and missing ULCA power class	16.15.0
2023-06	RAN#100	RP-231355	1482		A	CR to K1 and PdschNumOfHargProcess for DL-CA	16.16.0
2023-06	RAN#100	RP-231355	1486		A	FR1 OOB requirements correction	16.16.0
2023-06	RAN#100	RP-231351	1492		F	CR TS 38.101-1: Correction on NR V2X requirements in Rel-16	16.16.0
2023-06	RAN#100	RP-231354	1532	1	F	NR interband 2UL CA co-ex simplification R16	16.16.0
2023-06	RAN#100	RP-231355	1541		A	CR for TS 38.101-1 on corrections to the minimum guardband calculation (R16_CAT_A)	16.16.0
2023-06	RAN#100	RP-231351	1544	2	F	Rel-16 CR to 38 101-1 for Clarification of UL Tx Switching	16.16.0
2023-06	RAN#100	RP-231356	1555	2	F	CR to TS38.101-1: Correction on terms for NR DC Pcmx	16.16.0
2023-06	RAN#100	RP-231351	1586		F	CR for TS 38.101-1: Adding missing requirements for NR-U Rel-16 CAT-F	16.16.0
2023-06	RAN#100	RP-231352	1593		F	CR for 38.101-1: Single SUL CA combination notation modifications	16.16.0
2023-06	RAN#100	RP-231356	1597		A	Update of FR1 UL MIMO EVM measurement description	16.16.0
2023-06	RAN#100	RP-231356	1603		A	CR to 38.101-1 Rel-16 Cat A, FRC correction	16.16.0
2023-09	RAN#101	RP-232505	1648	1	F	CR to TS 38.101-1 Rel-16 Introduction of TDD uplink RMC for shorter transients	16.17.0
2023-09	RAN#101	RP-232487	1657		A	CR for TS 38.101-1 Rel-16 CAT-A: Introducing modification for NS_43 A-MPR region	16.17.0
2023-09	RAN#101	RP-232504	1664		A	CR to clarify pi2BPSK note	16.17.0
2023-09	RAN#101	RP-232500	1676		F	[TEI16] CR 38.101-1: Various maintenance issues R16	16.17.0
2023-09	RAN#101	RP-232487	1690		A	CR for 38101-1: Almost contiguous NBC change reversal	16.17.0
2023-09	RAN#101	RP-232505	1708		A	CR to TS 38.101-1: correction of Pcmx tolerance for 2Tx (Rel-16)	16.17.0

2023-09	RAN#101	RP-232489	1724		F	CR for TS 38.101-1 [NR_CADC_R16_3BDL_2BUL-Core] Removal of the constituent bands for the delta RIB values for inter-band CA configurations	16.17.0
2023-09	RAN#101	RP-232502	1733		A	[NR_newRAT-Core]Editorial modification CR for TS 38.101-1_V2	16.17.0
2023-09	RAN#101	RP-232503	1748		A	[NR_newRAT-Perf] CR: Correction of FRC for maximum input level for 256QAM	16.17.0
2023-09	RAN#101	RP-232489	1751		F	CR to 38.101-1: add the missing Tx requirement for CA_n25-n71	16.17.0
2023-09	RAN#101	RP-232501	1756	1	A	[NR_newRAT-Core] CR for TS 38.101-1 to modify MSD due to harmonic mixing interference (R16)	16.17.0
2023-09	RAN#101	RP-232486	1761		F	CR to TS38.101-1 on corrections for A-MPR requirements_R16 NOTE: CR was not implemented as A-MPR requirements for NS_59 for Rel-16 does ot exist.	16.17.0
2023-09	RAN#101	RP-232503	1766	1	F	[NR_RF_FR1-Core] Editorial correction to 6.2A.4 (Rel-16)	16.17.0
2023-09	RAN#101	RP-232501	1787		A	[NR_newRAT-Core] Correction of intraband contiguous CA ACS requirements	16.17.0
2023-09	RAN#101	RP-232498	1790		F	[NR_RF_FR1] Correction of intraband non-contiguous CA ACS requirements	16.17.0
2023-09	RAN#101	RP-232498	1805	1	F	CR for 38.101-1: CA_NS_27 and CA_NS_46 fix	16.17.0
2023-12	RAN#102	RP-233331	1813		A	Fc terminology update	16.18.0
2023-12	RAN#102	RP-233336	1830		F	CR on TS38.101-1 for simplification of NR V2X UE coexistence in Rel-16	16.18.0
2023-12	RAN#102	RP-233337	1840		F	CR for 38.101-1 UE to UE coex R16	16.18.0
2023-12	RAN#102	RP-233331	1853		A	[NR_newRAT-Core] CR for TS 38.101-1 Rel-16: Introducing missing MSD for harmonic mixing	16.18.0
2023-12	RAN#102	RP-233332	1873		A	[NR_newRAT] CR for clarification on applicability of Rx antenna number for Rx requirements for TS 38.101-1	16.18.0
2023-12	RAN#102	RP-233339	1878		F	Addition of 30 kHz SCS for Sync Raster for Band n53	16.18.0
2023-12	RAN#102	RP-233339	1884		F	[NR_n41_BW-Core] Support of PC1.5 for n41 30MHz in Japan (R16)	16.18.0
2023-12	RAN#102	RP-233332	1901	1	A	[NR_newRAT-Core] CR to remove the word capable in power class 3 capable UE - TS38.101-1, Rel-16, Cat-A	16.18.0
2023-12	RAN#102	RP-233340	1904	1	F	[NR_RF_FR1-Core] CR concerning the RMS average used in EVM measurement with transient period - TS38.101-1, Rel-16, Cat-F	16.18.0
2023-12	RAN#102	RP-233339	1911		F	[NR_n38_BW2] Clarify A-MPR values for NS_44 - Rel16	16.18.0
2023-12	RAN#102	RP-233337	1915		F	[NR_CADC_R16_2BDL_xBUL] CR for TS 38.101-1 to correct inter-band NR DC configuration table (R16)	16.18.0
2023-12	RAN#102	RP-233332	1927	1	F	[NR_newRAT-Core] CR for 38.101-1 to clarify the applicable bands for additional UTRA ACLR requirements. (R16)	16.18.0
2023-12	RAN#102	RP-233331	1957		A	[NR_newRAT] CR to 38.101-1 on FRC correction	16.18.0
2023-12	RAN#102	RP-233331	1961		A	[NR_newRAT] CR to 38.101-1 on FRC deletion for 5MHz 30 KHz	16.18.0
2023-12	RAN#102	RP-233340	1970		A	Correction of ?T_RxSRS for SRS resource set consisting of two SRS ports	16.18.0
2023-12	RAN#102	RP-233340	1974	1	F	CR for Intra-band UL CA MPR clarification	16.18.0
2023-12	RAN#102	RP-233332	1975		F	CR to TS 38.101-1 Rel-16 Corrections to UE co-existence requirements	16.18.0
2024-03	RAN#103	RP-240576	2009		F	CR to TS38.101-1 Rel-16 CAT-F: On corrections for NR-U R16 A-MPR requirements	16.19.0
2024-03	RAN#103	RP-240574	2016		F	(NR_RF_FR1) Introduction of missing DMRS configuration restriction for intra-ULCA in FR1	16.19.0
2024-03	RAN#103	RP-240552	2037		F	(TEI16) CR for 38.101-1 corrections for UL CA onigurations R16	16.19.0
2024-03	RAN#103	RP-240552	2041	2	F	(TEI16) almost contiguous A-MPR for PC2	16.19.0
2024-03	RAN#103	RP-240574	2046		F	(NR_RF_FR1-Core) CA MPR correction	16.19.0
2024-03	RAN#103	RP-240566	2080		F	(NR_newRAT-Core) Correct the equation in the NOTE for harmonic mixing MSD	16.19.0
2024-03	RAN#103	RP-240561	2098		F	(NR_n48-Core) CR to correct or add note applicable for specific channel bandwidths for CA including band n48 - TS38.101-1, Rel-16, Cat-F	16.19.0
2024-03	RAN#103	RP-240566	2104	1	A	(NR_newRAT-Core) CR to correct "Supplement" to "Supplementary" in the definition of the suffix used for SUL - TS38.101-1, Rel-16, Cat-F	16.19.0
2024-03	RAN#103	RP-240564	2117		A	(NR_newRAT-Core) CR for TS 38.101-1 to correct the Finterferer (offset) for intra-band CA ACS and IBB requirements (R16)	16.19.0
2024-03	RAN#103	RP-240552	2125		B	Minimum requirements for uplink TX switching with dual TAG [UL TX switching]	16.19.0
2024-03	RAN#103	RP-240574	2141	1	F	(NR_RF_FR1) CR to TS 38.101-1: Channel raster to resource element mapping	16.19.0
2024-03	RAN#103	RP-240564	2148		A	(NR_newRAT-Core) CR to remove the word capable in power class related requirements	16.19.0
2024-03	RAN#103	RP-240564	2152		A	(NR_newRAT-Core) CR to TS38.101-1: Correction of band number in uplink configuration for reference sensitivity table	16.19.0
2024-06	RAN#104	RP-241393	2212		F	CR to align NR carrier centre frequencies with LTE for NS_24	16.20.0
2024-06	RAN#104	RP-241389	2271	1	F	(5G_V2X_NRSL) CR to TS 38.101-1: correction of Pmax tolerance for sidelink (Rel-16)	16.20.0

2024-06	RAN#104	RP-241391	2274	1	F	(LTE_NR_DC_CA_enh) CR to TS 38.101-1: correction of P _{cm} tolerance for NR DC (Rel-16)	16.20.0
2024-06	RAN#104	RP-241394	2279	1	F	(NR_CA_R16_intra-Core) CR to add notes for SCS restrictions on CBWs in CA configurations - TS38.101-1, Rel-16	16.20.0
2024-06	RAN#104	RP-241382	2285		A	(NR_newRAT-Core) Correct the P _{cm} tolerance for inter-band CA	16.20.0
2024-06	RAN#104	RP-241492	2291		F	Cat F CR to TS 38.101-1 Rel-16 NR-U Nominal channel spacing	16.20.0
2024-06	RAN#104	RP-241402	2318		F	[NR_RF_FR1-Core] CR to TS 38.101-1: Almost contiguous RB allocations	16.20.0
2024-06	RAN#104	RP-241395	2327		F	Adding missing MSD for CA_n2A-n66A and for CA_n25A-n66A PC3	16.20.0
2024-06	RAN#104	RP-241382	2346		A	(NR_newRAT-Core) CR for TS 38.101-1 on UE additional spurious emissions (R16_CAT_A)	16.20.0
2024-09	RAN#105	RP-242173	2389		A	CR for TS 38.101-1 Rel-16 correction on the terminology of emission bandwidth for NS_04	16.21.0
2024-09	RAN#105	RP-242171	2408		F	(NR_n28_BW-Core) Apply ?MPR to the total MOP reduction	16.21.0
2024-09	RAN#105	RP-242190	2416		F	CR on typo for A-MPR of NR unlicensed band	16.21.0
2024-09	RAN#105	RP-242174	2434		A	(NR_newRAT-core) CR for TS 38.101-1 R16 correction on AMPR for NS_10	16.21.0
2024-09	RAN#105	RP-242149	2440		F	(5G_V2X_NRSL-Core) CR to correct the name of the feature "V2X con-current operation" to "V2X concurrent operation" - TS38.101-1	16.21.0
2024-09	RAN#105	RP-242191	2445		F	(TEI16) CR to correct (typo) of the definitions of the symbols Nrb_agg - TS38.101-1	16.21.0
2024-09	RAN#105	RP-242186	2450	1	F	Correction for value B for non-contiguous uplink carrier aggregation	16.21.0
2024-09	RAN#105	RP-242191	2468		A	Cat A CR to TS 38.101-1 Rel-16 REFSENS Corrections	16.21.0
2024-09	RAN#105	RP-242191	2474		A	Cat A CR to TS 38.101-1 Rel-16 Power Class 4 clean-up	16.21.0
2024-09	RAN#105	RP-242171	2479	2	F	(NR_n41_BW-Core) CR to TS 38.101-1: NS_47 correction	16.21.0
2024-09	RAN#105	RP-242191	2487		A	(TEI) On missing BCS set definition for asymmetric TDD	16.21.0
2024-09	RAN#105	RP-242171	2494	1	F	(NR_n14-Core, TEI16) Correction of notes for UE output power	16.21.0
2024-09	RAN#105	RP-242173	2501	1	A	CR to 38.101-1 Rel-16: Corrections of NR operating bands clause in FR1	16.21.0

History

Document history		
V16.4.0	July 2020	Publication
V16.5.0	November 2020	Publication
V16.6.0	January 2021	Publication
V16.7.0	May 2021	Publication
V16.8.0	September 2021	Publication
V16.9.0	October 2021	Publication
V16.10.0	April 2022	Publication
V16.11.0	May 2022	Publication
V16.12.1	July 2022	Publication
V16.13.0	October 2022	Publication
V16.14.0	January 2023	Publication
V16.15.0	May 2023	Publication
V16.16.0	July 2023	Publication
V16.17.0	October 2023	Publication
V16.18.0	February 2024	Publication
V16.19.0	June 2024	Publication
V16.20.0	August 2024	Publication
V16.21.0	October 2024	Publication