

ETSI TS 138 101-2 V16.13.0 (2022-10)



**5G;
NR;
User Equipment (UE) radio transmission and reception;
Part 2: Range 2 Standalone
(3GPP TS 38.101-2 version 16.13.0 Release 16)**



Reference

RTS/TSGR-0438101-2v0d0

Keywords

5G

ETSI

650 Route des Lucioles
F-06921 Sophia Antipolis Cedex - FRANCE

Tel.: +33 4 92 94 42 00 Fax: +33 4 93 65 47 16

Siret N° 348 623 562 00017 - APE 7112B
Association à but non lucratif enregistrée à la
Sous-Préfecture de Grasse (06) N° w061004871

Important notice

The present document can be downloaded from:

<http://www.etsi.org/standards-search>

The present document may be made available in electronic versions and/or in print. The content of any electronic and/or print versions of the present document shall not be modified without the prior written authorization of ETSI. In case of any existing or perceived difference in contents between such versions and/or in print, the prevailing version of an ETSI deliverable is the one made publicly available in PDF format at www.etsi.org/deliver.

Users of the present document should be aware that the document may be subject to revision or change of status.

Information on the current status of this and other ETSI documents is available at

<https://portal.etsi.org/TB/ETSIDeliverableStatus.aspx>

If you find errors in the present document, please send your comment to one of the following services:

<https://portal.etsi.org/People/CommitteeSupportStaff.aspx>

If you find a security vulnerability in the present document, please report it through our
Coordinated Vulnerability Disclosure Program:

<https://www.etsi.org/standards/coordinated-vulnerability-disclosure>

Notice of disclaimer & limitation of liability

The information provided in the present deliverable is directed solely to professionals who have the appropriate degree of experience to understand and interpret its content in accordance with generally accepted engineering or other professional standard and applicable regulations.

No recommendation as to products and services or vendors is made or should be implied.

No representation or warranty is made that this deliverable is technically accurate or sufficient or conforms to any law and/or governmental rule and/or regulation and further, no representation or warranty is made of merchantability or fitness for any particular purpose or against infringement of intellectual property rights.

In no event shall ETSI be held liable for loss of profits or any other incidental or consequential damages.

Any software contained in this deliverable is provided "AS IS" with no warranties, express or implied, including but not limited to, the warranties of merchantability, fitness for a particular purpose and non-infringement of intellectual property rights and ETSI shall not be held liable in any event for any damages whatsoever (including, without limitation, damages for loss of profits, business interruption, loss of information, or any other pecuniary loss) arising out of or related to the use of or inability to use the software.

Copyright Notification

No part may be reproduced or utilized in any form or by any means, electronic or mechanical, including photocopying and microfilm except as authorized by written permission of ETSI.

The content of the PDF version shall not be modified without the written authorization of ETSI.

The copyright and the foregoing restriction extend to reproduction in all media.

© ETSI 2022.
All rights reserved.

Intellectual Property Rights

Essential patents

IPRs essential or potentially essential to normative deliverables may have been declared to ETSI. The declarations pertaining to these essential IPRs, if any, are publicly available for **ETSI members and non-members**, and can be found in ETSI SR 000 314: "*Intellectual Property Rights (IPRs); Essential, or potentially Essential, IPRs notified to ETSI in respect of ETSI standards*", which is available from the ETSI Secretariat. Latest updates are available on the ETSI Web server (<https://ipr.etsi.org/>).

Pursuant to the ETSI Directives including the ETSI IPR Policy, no investigation regarding the essentiality of IPRs, including IPR searches, has been carried out by ETSI. No guarantee can be given as to the existence of other IPRs not referenced in ETSI SR 000 314 (or the updates on the ETSI Web server) which are, or may be, or may become, essential to the present document.

Trademarks

The present document may include trademarks and/or tradenames which are asserted and/or registered by their owners. ETSI claims no ownership of these except for any which are indicated as being the property of ETSI, and conveys no right to use or reproduce any trademark and/or tradename. Mention of those trademarks in the present document does not constitute an endorsement by ETSI of products, services or organizations associated with those trademarks.

DECT™, **PLUGTESTS™**, **UMTS™** and the ETSI logo are trademarks of ETSI registered for the benefit of its Members. **3GPP™** and **LTE™** are trademarks of ETSI registered for the benefit of its Members and of the 3GPP Organizational Partners. **oneM2M™** logo is a trademark of ETSI registered for the benefit of its Members and of the oneM2M Partners. **GSM®** and the GSM logo are trademarks registered and owned by the GSM Association.

Legal Notice

This Technical Specification (TS) has been produced by ETSI 3rd Generation Partnership Project (3GPP).

The present document may refer to technical specifications or reports using their 3GPP identities. These shall be interpreted as being references to the corresponding ETSI deliverables.

The cross reference between 3GPP and ETSI identities can be found under <http://webapp.etsi.org/key/queryform.asp>.

Modal verbs terminology

In the present document "**shall**", "**shall not**", "**should**", "**should not**", "**may**", "**need not**", "**will**", "**will not**", "**can**" and "**cannot**" are to be interpreted as described in clause 3.2 of the [ETSI Drafting Rules](#) (Verbal forms for the expression of provisions).

"**must**" and "**must not**" are **NOT** allowed in ETSI deliverables except when used in direct citation.

Contents

| | |
|---|----|
| Intellectual Property Rights | 2 |
| Legal Notice | 2 |
| Modal verbs terminology..... | 2 |
| Foreword..... | 11 |
| 1 Scope | 13 |
| 2 References | 13 |
| 3 Definitions, symbols and abbreviations | 14 |
| 3.1 Definitions | 14 |
| 3.2 Symbols..... | 15 |
| 3.3 Abbreviations | 17 |
| 4 General | 19 |
| 4.1 Relationship between minimum requirements and test requirements | 19 |
| 4.2 Applicability of minimum requirements | 19 |
| 4.3 Specification suffix information..... | 19 |
| 5 Operating bands and channel arrangement..... | 21 |
| 5.1 General | 21 |
| 5.2 Operating bands..... | 21 |
| 5.2A Operating bands for CA | 21 |
| 5.2A.1 Intra-band CA | 21 |
| 5.2A.2 Inter-band CA | 22 |
| 5.2D Operating bands for UL MIMO | 22 |
| 5.3 UE Channel bandwidth | 22 |
| 5.3.1 General..... | 22 |
| 5.3.2 Maximum transmission bandwidth configuration | 23 |
| 5.3.3 Minimum guardband and transmission bandwidth configuration..... | 23 |
| 5.3.4 RB alignment | 24 |
| 5.3A UE channel bandwidth for CA | 25 |
| 5.3A.1 General..... | 25 |
| 5.3A.2 Minimum guardband and transmission bandwidth configuration for CA | 25 |
| 5.3A.3 RB alignment with different numerologies for CA..... | 27 |
| 5.3A.4 UE channel bandwidth per operating band for CA..... | 27 |
| 5.3D Channel bandwidth for UL MIMO..... | 28 |
| 5.4 Channel arrangement..... | 29 |
| 5.4.1 Channel spacing..... | 29 |
| 5.4.1.1 Channel spacing for adjacent NR carriers | 29 |
| 5.4.2 Channel raster | 29 |
| 5.4.2.1 NR-ARFCN and channel raster..... | 29 |
| 5.4.2.2 Channel raster to resource element mapping..... | 29 |
| 5.4.2.3 Channel raster entries for each operating band | 30 |
| 5.4.3 Synchronization raster | 30 |
| 5.4.3.1 Synchronization raster and numbering..... | 30 |
| 5.4.3.2 Synchronization raster to synchronization block resource element mapping..... | 31 |
| 5.4.3.3 Synchronization raster entries for each operating band..... | 31 |
| 5.4A Channel arrangement for CA..... | 31 |
| 5.4A.1 Channel spacing for CA..... | 31 |
| 5.5 Configurations | 33 |
| 5.5A Configurations for CA..... | 33 |
| 5.5A.1 Configurations for intra-band contiguous CA..... | 33 |
| 5.5A.2 Configurations for intra-band non-contiguous CA | 38 |
| 5.5A.3 Configurations for inter-band CA | 50 |
| 5.5D Configurations for UL MIMO..... | 50 |
| 6 Transmitter characteristics | 51 |

| | | |
|------------|--|----|
| 6.1 | General | 51 |
| 6.2 | Transmitter power | 51 |
| 6.2.1 | UE maximum output power | 51 |
| 6.2.1.0 | General | 51 |
| 6.2.1.1 | UE maximum output power for power class 1 | 51 |
| 6.2.1.2 | UE maximum output power for power class 2 | 52 |
| 6.2.1.3 | UE maximum output power for power class 3 | 53 |
| 6.2.1.4 | UE maximum output power for power class 4 | 54 |
| 6.2.2 | UE maximum output power reduction | 55 |
| 6.2.2.0 | General | 55 |
| 6.2.2.1 | UE maximum output power reduction for power class 1 | 55 |
| 6.2.2.2 | UE maximum output power reduction for power class 2 | 56 |
| 6.2.2.3 | UE maximum output power reduction for power class 3 | 57 |
| 6.2.2.4 | UE maximum output power reduction for power class 4 | 58 |
| 6.2.3 | UE maximum output power with additional requirements | 58 |
| 6.2.3.1 | General | 58 |
| 6.2.3.2 | Void | 59 |
| 6.2.3.2.1 | Void | 59 |
| 6.2.3.2.2 | Void | 59 |
| 6.2.3.2.3 | Void | 59 |
| 6.2.3.2.4 | Void | 59 |
| 6.2.3.3 | A-MPR for NS_202 | 59 |
| 6.2.3.3.1 | A-MPR for NS_202 for power class 1 | 59 |
| 6.2.3.3.2 | A-MPR for NS_202 for power class 2 | 60 |
| 6.2.3.3.3 | A-MPR for NS_202 for power class 3 | 60 |
| 6.2.3.3.4 | A-MPR for NS_202 for power class 4 | 60 |
| 6.2.3.4 | A-MPR for NS_203 | 60 |
| 6.2.3.4.1 | A-MPR for NS_203 for power class 1 | 60 |
| 6.2.3.4.2 | A-MPR for NS_203 for power class 2 | 60 |
| 6.2.3.4.3 | A-MPR for NS_203 for power class 3 | 60 |
| 6.2.3.4.4 | A-MPR for NS_203 for power class 4 | 60 |
| 6.2.4 | Configured transmitted power | 60 |
| 6.2A | Transmitter power for CA | 61 |
| 6.2A.1 | UE maximum output power for CA | 61 |
| 6.2A.2 | UE maximum output power reduction for CA | 61 |
| 6.2A.2.1 | General | 61 |
| 6.2A.2.2 | Maximum output power reduction for power class 1 | 62 |
| 6.2A.2.2.1 | Maximum output power reduction for power class 1 intra-band contiguous UL CA | 62 |
| 6.2A.2.2.2 | Maximum output power reduction for power class 1 intra-band non-contiguous UL CA | 63 |
| 6.2A.2.3 | Maximum output power reduction for power class 2 | 63 |
| 6.2A.2.4 | Maximum output power reduction for power class 3 | 64 |
| 6.2A.2.4.1 | Maximum output power reduction for power class 3 intra-band contiguous CA | 64 |
| 6.2A.2.4.2 | Maximum output power reduction for power class 3 intra-band non-contiguous CA | 65 |
| 6.2A.2.5 | Maximum output power reduction for power class 4 | 65 |
| 6.2A.3 | UE maximum output power with additional requirements for CA | 65 |
| 6.2A.3.1 | General | 65 |
| 6.2A.3.2 | Void | 66 |
| 6.2A.3.2.1 | Void | 66 |
| 6.2A.3.2.2 | Void | 66 |
| 6.2A.3.2.3 | Void | 66 |
| 6.2A.3.2.4 | Void | 66 |
| 6.2A.3.3 | A-MPR for CA_NS_202 | 66 |
| 6.2A.3.3.1 | A-MPR for CA_NS_202 for power class 1 | 66 |
| 6.2A.3.3.2 | A-MPR for CA_NS_202 for power class 2 | 66 |
| 6.2A.3.3.3 | A-MPR for CA_NS_202 for power class 3 | 66 |
| 6.2A.3.3.4 | A-MPR for CA_NS_202 for power class 4 | 66 |
| 6.2A.3.4 | A-MPR for CA_NS_203 | 66 |
| 6.2A.3.4.1 | A-MPR for CA_NS_203 for power class 1 | 66 |
| 6.2A.3.4.2 | A-MPR for CA_NS_203 for power class 2 | 67 |
| 6.2A.3.4.3 | A-MPR for CA_NS_203 for power class 3 | 67 |
| 6.2A.3.4.4 | A-MPR for CA_NS_203 for power class 4 | 67 |
| 6.2A.4 | Configured transmitted power for CA | 67 |

| | | |
|----------|--|----|
| 6.2D | Transmitter power for UL MIMO | 68 |
| 6.2D.1 | UE maximum output power for UL MIMO..... | 68 |
| 6.2D.1.0 | General | 68 |
| 6.2D.1.1 | UE maximum output power for UL MIMO for power class 1..... | 68 |
| 6.2D.1.2 | UE maximum output power for UL MIMO for power class 2..... | 69 |
| 6.2D.1.3 | UE maximum output power for UL MIMO for power class 3..... | 70 |
| 6.2D.1.4 | UE maximum output power for UL MIMO for power class 4..... | 71 |
| 6.2D.2 | UE maximum output power reduction for modulation / channel bandwidth for UL MIMO..... | 72 |
| 6.2D.2.1 | UE maximum output power reduction for modulation / channel bandwidth for UL MIMO for power class 1 | 72 |
| 6.2D.2.2 | UE maximum output power reduction for modulation / channel bandwidth for UL MIMO for power class 2..... | 72 |
| 6.2D.2.3 | UE maximum output power reduction for modulation / channel bandwidth for UL MIMO for power class 3..... | 72 |
| 6.2D.2.4 | UE maximum output power reduction for modulation / channel bandwidth for UL MIMO for power class 4..... | 73 |
| 6.2D.3 | UE maximum output power reduction with additional requirements for UL MIMO | 73 |
| 6.2D.3.1 | UE maximum output power reduction with additional requirements for UL MIMO for power class 1..... | 73 |
| 6.2D.3.2 | UE maximum output power reduction with additional requirements for UL MIMO for power class 2..... | 73 |
| 6.2D.3.3 | UE maximum output power reduction with additional requirements for UL MIMO for power class 3..... | 73 |
| 6.2D.3.4 | UE maximum output power reduction with additional requirements for UL MIMO for power class 4..... | 73 |
| 6.2D.4 | Configured transmitted power for UL MIMO | 73 |
| 6.3 | Output power dynamics..... | 74 |
| 6.3.1 | Minimum output power | 74 |
| 6.3.1.0 | General | 74 |
| 6.3.1.1 | Minimum output power for power class 1 | 74 |
| 6.3.1.2 | Minimum output power for power class 2, 3, and 4..... | 74 |
| 6.3.2 | Transmit OFF power..... | 74 |
| 6.3.3 | Transmit ON/OFF time mask | 75 |
| 6.3.3.1 | General | 75 |
| 6.3.3.2 | General ON/OFF time mask | 75 |
| 6.3.3.3 | Transmit power time mask for slot and short or long subslot boundaries..... | 75 |
| 6.3.3.4 | PRACH time mask..... | 76 |
| 6.3.3.5 | Void..... | 77 |
| 6.3.3.6 | SRS time mask | 77 |
| 6.3.3.7 | PUSCH-PUCCH and PUSCH-SRS time masks | 78 |
| 6.3.3.8 | Transmit power time mask for consecutive slot or long subslot transmission and short subslot transmission boundaries | 78 |
| 6.3.3.9 | Transmit power time mask for consecutive short subslot transmissions boundaries | 79 |
| 6.3.4 | Power control..... | 79 |
| 6.3.4.1 | General | 79 |
| 6.3.4.2 | Absolute power tolerance..... | 79 |
| 6.3.4.3 | Relative power tolerance | 80 |
| 6.3.4.4 | Aggregate power tolerance..... | 81 |
| 6.3A | Output power dynamics for CA | 81 |
| 6.3A.1 | Minimum output power for CA | 81 |
| 6.3A.1.0 | General | 81 |
| 6.3A.1.1 | Minimum output power for power class 1 | 82 |
| 6.3A.1.2 | Minimum output power for power class 2, 3, and 4..... | 82 |
| 6.3A.2 | Transmit OFF power for CA..... | 82 |
| 6.3A.3 | Transmit ON/OFF time mask for CA | 82 |
| 6.3A.4 | Power control for CA..... | 83 |
| 6.3A.4.1 | General | 83 |
| 6.3D | Output power dynamics for UL MIMO | 84 |
| 6.3D.0 | General..... | 84 |
| 6.3D.1 | Minimum output power for UL MIMO | 84 |
| 6.3D.1.1 | Minimum output power for UL MIMO for power class 1 | 84 |
| 6.3D.1.2 | Minimum output power for UL MIMO for power class 2, 3 and 4..... | 84 |

| | | |
|------------|--|-----|
| 6.3D.2 | Transmit OFF power for UL MIMO..... | 84 |
| 6.3D.3 | Transmit ON/OFF time mask for UL MIMO | 84 |
| 6.4 | Transmit signal quality | 84 |
| 6.4.1 | Frequency Error | 84 |
| 6.4.2 | Transmit modulation quality..... | 84 |
| 6.4.2.0 | General | 84 |
| 6.4.2.1 | Error vector magnitude | 85 |
| 6.4.2.2 | Carrier leakage | 86 |
| 6.4.2.2.1 | General | 86 |
| 6.4.2.2.2 | Carrier leakage for power class 1 | 86 |
| 6.4.2.2.3 | Carrier leakage for power class 2 | 86 |
| 6.4.2.2.4 | Carrier leakage for power class 3 | 86 |
| 6.4.2.2.5 | Carrier leakage for power class 4 | 86 |
| 6.4.2.3 | In-band emissions | 87 |
| 6.4.2.3.1 | General | 87 |
| 6.4.2.3.2 | In-band emissions for power class 1..... | 87 |
| 6.4.2.3.3 | In-band emissions for power class 2..... | 88 |
| 6.4.2.3.4 | In-band emissions for power class 3..... | 89 |
| 6.4.2.3.5 | In-band emissions for power class 4..... | 90 |
| 6.4.2.4 | EVM equalizer spectrum flatness | 91 |
| 6.4.2.5 | EVM spectral flatness for Pi/2 BPSK modulation | 92 |
| 6.4A | Transmit signal quality for CA..... | 93 |
| 6.4A.0 | General..... | 93 |
| 6.4A.1 | Frequency error..... | 93 |
| 6.4A.2 | Transmit modulation quality..... | 93 |
| 6.4A.2.0 | General | 93 |
| 6.4A.2.1 | Error Vector magnitude..... | 94 |
| 6.4A.2.2 | Carrier leakage | 94 |
| 6.4A.2.2.1 | General | 94 |
| 6.4A.2.2.2 | Carrier leakage for power class 1 | 94 |
| 6.4A.2.2.3 | Carrier leakage for power class 2 | 94 |
| 6.4A.2.2.4 | Carrier leakage for power class 3 | 94 |
| 6.4A.2.2.5 | Carrier leakage for power class 4 | 95 |
| 6.4A.2.3 | Inband emissions..... | 95 |
| 6.4A.2.3.1 | General | 95 |
| 6.4A.2.3.2 | Inband emissions for power class 1 | 95 |
| 6.4A.2.3.3 | Inband emissions for power class 2..... | 96 |
| 6.4A.2.3.4 | Inband emissions for power class 3..... | 97 |
| 6.4A.2.3.5 | Inband emissions for power class 4..... | 98 |
| 6.4A.2.4 | EVM equalizer spectrum flatness | 99 |
| 6.4D | Transmit signal quality for UL MIMO..... | 99 |
| 6.4D.0 | General..... | 99 |
| 6.4D.1 | Frequency error for UL MIMO..... | 99 |
| 6.4D.2 | Transmit modulation quality for UL MIMO..... | 99 |
| 6.4D.3 | Time alignment error for UL MIMO | 100 |
| 6.4D.4 | Requirements for coherent UL MIMO | 100 |
| 6.5 | Output RF spectrum emissions..... | 101 |
| 6.5.1 | Occupied bandwidth | 101 |
| 6.5.2 | Out of band emissions..... | 101 |
| 6.5.2.0 | General | 101 |
| 6.5.2.1 | Spectrum emission mask | 101 |
| 6.5.2.2 | Void..... | 102 |
| 6.5.2.3 | Adjacent channel leakage ratio | 102 |
| 6.5.3 | Spurious emissions | 102 |
| 6.5.3.1 | Spurious emission band UE co-existence | 103 |
| 6.5.3.2 | Additional spurious emissions | 103 |
| 6.5.3.2.1 | General | 103 |
| 6.5.3.2.2 | Void..... | 103 |
| 6.5.3.2.3 | Additional spurious emission requirements for NS_202 | 103 |
| 6.5.3.2.4 | Additional spurious emission requirements for NS_203 | 104 |
| 6.5A | Output RF spectrum emissions for CA..... | 104 |
| 6.5A.1 | Occupied bandwidth for CA | 104 |

| | | |
|------------|---|-----|
| 6.5A.1.0 | General | 104 |
| 6.5A.1.1 | Occupied bandwidth for intra-band contiguous UL CA | 104 |
| 6.5A.1.2 | Occupied bandwidth for intra-band non-contiguous UL CA | 104 |
| 6.5A.2 | Out of band emissions..... | 104 |
| 6.5A.2.1 | Spectrum emission mask for CA..... | 104 |
| 6.5A.2.1.0 | General | 104 |
| 6.5A.2.1.1 | Spectrum emission mask for intra-band contiguous UL CA | 105 |
| 6.5A.2.1.2 | Spectrum emission mask for intra-band non-contiguous UL CA..... | 105 |
| 6.5A.2.3 | Adjacent channel leakage ratio for CA | 105 |
| 6.5A.2.3.1 | Adjacent channel leakage ratio for CA intra-band contiguous UL CA | 105 |
| 6.5A.2.3.2 | Adjacent channel leakage ratio for CA intra-band non-contiguous UL CA | 106 |
| 6.5A.3 | Spurious emissions for CA | 106 |
| 6.5A.3.0 | General spurious emissions for CA..... | 106 |
| 6.5A.3.0.0 | General | 106 |
| 6.5A.3.0.1 | Spurious emissions for intra-band contiguous UL CA..... | 107 |
| 6.5A.3.0.2 | Spurious emissions for intra-band non-contiguous UL CA..... | 107 |
| 6.5A.3.1 | Spurious emission band UE co-existence for UL CA | 107 |
| 6.5A.3.2 | Additional spurious emissions | 107 |
| 6.5A.3.2.1 | General | 107 |
| 6.5A.3.2.2 | Void..... | 108 |
| 6.5A.3.2.3 | Additional spurious emission requirements for CA_NS_202 | 108 |
| 6.5A.3.2.4 | Additional spurious emission requirements for CA_NS_203 | 108 |
| 6.5D | Output RF spectrum emissions for UL MIMO..... | 108 |
| 6.5D.1 | Occupied bandwidth for UL MIMO | 108 |
| 6.5D.2 | Out of band emissions for UL MIMO | 108 |
| 6.5D.3 | Spurious emissions for UL MIMO | 108 |
| 6.6 | Beam correspondence..... | 108 |
| 6.6.1 | General..... | 108 |
| 6.6.2 | Void..... | 108 |
| 6.6.3 | Void..... | 108 |
| 6.6.4 | Beam correspondence for power class 3..... | 108 |
| 6.6.4.1 | General | 108 |
| 6.6.4.2 | Beam correspondence tolerance for power class 3..... | 109 |
| 6.6.4.3 | Side Conditions | 110 |
| 6.6.4.3.1 | Side Condition for beam correspondence based on SSB and CSI-RS..... | 110 |
| 6.6.4.3.2 | Side Condition for SSB based enhanced Beam Correspondence requirements..... | 111 |
| 6.6.4.3.3 | Side Condition for CSI-RS based enhanced Beam Correspondence requirements | 111 |
| 6.6.4.4 | Applicability..... | 111 |
| 6.6.5 | Void..... | 112 |
| 6.6A | Beam correspondence for CA | 112 |
| 7 | Receiver characteristics | 113 |
| 7.1 | General | 113 |
| 7.2 | Diversity characteristics | 113 |
| 7.3 | Reference sensitivity | 113 |
| 7.3.1 | General..... | 113 |
| 7.3.2 | Reference sensitivity power level..... | 113 |
| 7.3.2.1 | Reference sensitivity power level for power class 1 | 113 |
| 7.3.2.2 | Reference sensitivity power level for power class 2 | 114 |
| 7.3.2.3 | Reference sensitivity power level for power class 3 | 114 |
| 7.3.2.4 | Reference sensitivity power level for power class 4 | 115 |
| 7.3.3 | Void | 115 |
| 7.3.4 | EIS spherical coverage..... | 115 |
| 7.3.4.3 | EIS spherical coverage for power class 3..... | 116 |
| 7.3A | Reference sensitivity for DL CA..... | 117 |
| 7.3A.1 | General..... | 117 |
| 7.3A.2 | Reference sensitivity power level for CA | 117 |
| 7.3A.2.1 | Intra-band contiguous CA | 117 |
| 7.3A.2.3 | Inter-band CA | 118 |
| 7.3A.3 | EIS spherical coverage for DL CA | 118 |
| 7.3A.3.1 | Void..... | 118 |
| 7.3A.3.2 | Void..... | 118 |

| | | |
|---|---|------------|
| 7.3A.3.3 | EIS spherical coverage for inter-band CA | 118 |
| 7.3D | Void..... | 119 |
| 7.4 | Maximum input level | 119 |
| 7.4A | Maximum input level for DL CA..... | 119 |
| 7.4A.1 | Maximum input level for Intra-band contiguous CA..... | 119 |
| 7.4A.2 | Maximum input level for Intra-band non-contiguous CA | 120 |
| 7.4A.3 | Maximum input level for Inter-band CA | 120 |
| 7.4D | Void..... | 120 |
| 7.5 | Adjacent channel selectivity..... | 120 |
| 7.5A | Adjacent channel selectivity for DL CA | 122 |
| 7.5A.1 | Adjacent channel selectivity for Intra-band contiguous CA | 122 |
| 7.5A.2 | Adjacent channel selectivity for Intra-band non-contiguous CA..... | 123 |
| 7.5A.3 | Adjacent channel selectivity for Inter-band CA..... | 123 |
| 7.5D | Void..... | 124 |
| 7.6 | Blocking characteristics | 124 |
| 7.6.1 | General..... | 124 |
| 7.6.2 | In-band blocking | 124 |
| 7.6.3 | Void | 125 |
| 7.6A | Blocking characteristics for DL CA | 125 |
| 7.6A.1 | General..... | 125 |
| 7.6A.2 | In-band blocking..... | 125 |
| 7.6A.2.2 | In-band blocking for Intra-band non-contiguous CA | 126 |
| 7.6A.2.3 | In-band blocking for Inter-band CA..... | 126 |
| 7.6D | Void..... | 126 |
| 7.7 | Void..... | 126 |
| 7.8 | Void..... | 126 |
| 7.9 | Spurious emissions | 126 |
| 7.10 | Void..... | 127 |
| Annex A (normative): Measurement channels..... | | 128 |
| A.1 | General | 128 |
| A.2 | UL reference measurement channels | 128 |
| A.2.1 | General | 128 |
| A.2.2 | Void..... | 128 |
| A.2.3 | Reference measurement channels for TDD..... | 129 |
| A.2.3.1 | DFT-s-OFDM Pi/2-BPSK | 129 |
| A.2.3.2 | DFT-s-OFDM QPSK..... | 130 |
| A.2.3.3 | DFT-s-OFDM 16QAM..... | 130 |
| A.2.3.4 | DFT-s-OFDM 64QAM..... | 131 |
| A.2.3.5 | CP-OFDM QPSK | 131 |
| A.2.3.6 | CP-OFDM 16QAM | 132 |
| A.2.3.7 | CP-OFDM 64QAM | 132 |
| A.3 | DL reference measurement channels | 133 |
| A.3.1 | General | 133 |
| A.3.2 | Void..... | 136 |
| A.3.3 | DL reference measurement channels for TDD..... | 136 |
| A.3.3.1 | General | 136 |
| A.3.3.2 | FRC for receiver requirements for QPSK | 137 |
| A.3.3.3 | FRC for receiver requirements for 16QAM | 138 |
| A.3.3.4 | FRC for receiver requirements for 64QAM | 139 |
| A.3.3.5 | FRC for receiver requirements for 256QAM | 141 |
| A.4 | Void..... | 143 |
| A.5 | OFDMA Channel Noise Generator (OCNG) | 143 |
| A.5.1 | OCNG Patterns for FDD..... | 143 |
| A.5.2 | OCNG Patterns for TDD | 143 |
| A.5.2.1 | OCNG TDD pattern 1: Generic OCNG TDD Pattern for all unused REs | 143 |
| Annex B (informative): Void | | 144 |
| Annex C (normative): Downlink physical channels..... | | 145 |

| | | |
|--|--|------------|
| C.1 | General | 145 |
| C.2 | Setup..... | 145 |
| C.3 | Connection | 145 |
| C.3.1 | Measurement of Receiver Characteristics | 145 |
| Annex D (normative): Characteristics of the interfering signal..... | | 146 |
| D.1 | General | 146 |
| D.2 | Interference signals..... | 146 |
| Annex E (normative): Environmental conditions | | 147 |
| E.1 | General | 147 |
| E.2 | Environmental | 147 |
| E.2.1 | Temperature | 147 |
| E.2.2 | Voltage | 147 |
| E.2.3 | Void..... | 148 |
| Annex F (normative): Transmit modulation..... | | 149 |
| F.1 | Measurement Point..... | 149 |
| F.2 | Basic Error Vector Magnitude measurement | 149 |
| F.3 | Basic in-band emissions measurement..... | 150 |
| F.4 | Modified signal under test..... | 150 |
| F.5 | Window length | 152 |
| F.5.1 | Timing offset..... | 152 |
| F.5.2 | Window length | 152 |
| F.5.3 | Window length for normal CP | 153 |
| F.5.4 | Window length for Extended CP..... | 153 |
| F.5.5 | Window length for PRACH | 153 |
| F.6 | Averaged EVM | 154 |
| F.7 | Spectrum Flatness | 155 |
| Annex G (normative):..... | | 156 |
| G.0 | General | 156 |
| G.1 | Measurement Point..... | 156 |
| G.2 | Relative Phase Error Measurement | 156 |
| G.2.1 | Symbols used..... | 156 |
| G.2.2 | CFO (carrier frequency offset) correction..... | 157 |
| G.2.3 | Steps of the measurement method..... | 157 |
| Annex H (Normative): Modified MPR behavior..... | | 158 |
| H.1 | Indication of modified MPR behavior..... | 158 |
| Annex I (informative): Void | | 159 |
| Annex J (normative): UE coordinate system | | 160 |
| J.1 | Reference coordinate system..... | 160 |
| J.2 | Test conditions and angle definitions..... | 161 |
| J.3 | DUT positioning guidelines | 165 |
| Annex K (informative): Void | | 167 |
| Annex L (informative): Change history | | 168 |

History178

Foreword

This Technical Specification has been produced by the 3rd Generation Partnership Project (3GPP).

The contents of the present document are subject to continuing work within the TSG and may change following formal TSG approval. Should the TSG modify the contents of the present document, it will be re-released by the TSG with an identifying change of release date and an increase in version number as follows:

Version x.y.z

where:

- x the first digit:
 - 1 presented to TSG for information;
 - 2 presented to TSG for approval;
 - 3 or greater indicates TSG approved document under change control.
- y the second digit is incremented for all changes of substance, i.e. technical enhancements, corrections, updates, etc.
- z the third digit is incremented when editorial only changes have been incorporated in the document.

In the present document, modal verbs have the following meanings:

- shall** indicates a mandatory requirement to do something
- shall not** indicates an interdiction (prohibition) to do something

The constructions "shall" and "shall not" are confined to the context of normative provisions, and do not appear in Technical Reports.

The constructions "must" and "must not" are not used as substitutes for "shall" and "shall not". Their use is avoided insofar as possible, and they are not used in a normative context except in a direct citation from an external, referenced, non-3GPP document, or so as to maintain continuity of style when extending or modifying the provisions of such a referenced document.

- should** indicates a recommendation to do something
- should not** indicates a recommendation not to do something
- may** indicates permission to do something
- need not** indicates permission not to do something

The construction "may not" is ambiguous and is not used in normative elements. The unambiguous constructions "might not" or "shall not" are used instead, depending upon the meaning intended.

- can** indicates that something is possible
- cannot** indicates that something is impossible

The constructions "can" and "cannot" are not substitutes for "may" and "need not".

- will** indicates that something is certain or expected to happen as a result of action taken by an agency the behaviour of which is outside the scope of the present document
- will not** indicates that something is certain or expected not to happen as a result of action taken by an agency the behaviour of which is outside the scope of the present document
- might** indicates a likelihood that something will happen as a result of action taken by some agency the behaviour of which is outside the scope of the present document

might not indicates a likelihood that something will not happen as a result of action taken by some agency the behaviour of which is outside the scope of the present document

In addition:

is (or any other verb in the indicative mood) indicates a statement of fact

is not (or any other negative verb in the indicative mood) indicates a statement of fact

The constructions "is" and "is not" do not indicate requirements.

1 Scope

The present document establishes the minimum RF requirements for NR User Equipment (UE) operating on frequency Range 2.

2 References

The following documents contain provisions which, through reference in this text, constitute provisions of the present document.

- References are either specific (identified by date of publication, edition number, version number, etc.) or non-specific.
- For a specific reference, subsequent revisions do not apply.
- For a non-specific reference, the latest version applies. In the case of a reference to a 3GPP document (including a GSM document), a non-specific reference implicitly refers to the latest version of that document *in the same Release as the present document*.

- [1] 3GPP TR 21.905: "Vocabulary for 3GPP Specifications".
- [2] 3GPP TS 38.101-1: "NR; User Equipment (UE) radio transmission and reception; Part 1: Range 1 Standalone"
- [3] 3GPP TS 38.101-3: "NR; User Equipment (UE) radio transmission and reception; Part 3: Range 1 and Range 2 Interworking operation with other radios"
- [4] Void
- [5] 3GPP TS 38.521-2: "NR; User Equipment (UE) conformance specification; Radio transmission and reception; Part 2: Range 2 Standalone"
- [6] Recommendation ITU-R M.1545: "Measurement uncertainty as it applies to test limits for the terrestrial component of International Mobile Telecommunications-2000"
- [7] ITU-R Recommendation SM.329-10, "Unwanted emissions in the spurious domain"
- [8] 47 CFR Part 30, "UPPER MICROWAVE FLEXIBLE USE SERVICE, §30.202 Power limits", FCC.
- [9] 3GPP TS 38.211: "NR; Physical channels and modulation".
- [10] 3GPP TS 38.213: "NR; Physical layer procedures for control".
- [11] 3GPP TS 38.215: "NR; Physical layer measurements".
- [12] 3GPP TS 38.133: "NR; Requirements for support of radio resource management".
- [13] 3GPP TS 38.331: "NR; Radio Resource Control (RRC); Protocol specification".
- [14] 3GPP TS 38.306: "NR; User Equipment (UE) radio access capabilities".
- [15] IEEE Std 149: "IEEE Standard Test Procedures for Antennas", IEEE.

3 Definitions, symbols and abbreviations

3.1 Definitions

For the purposes of the present document, the terms and definitions given in 3GPP TR 21.905 [1] and the following apply. A term defined in the present document takes precedence over the definition of the same term, if any, in 3GPP TR 21.905 [1].

Aggregated Channel Bandwidth: The RF bandwidth in which a UE is configured to transmit and receive multiple contiguously aggregated carriers.

Bidirectional spectrum: UL/DL common spectrum in which the UE supports the configuration of uplink or downlink CCs.

Beam correspondence: the ability of the UE to select a suitable beam for UL transmission based on DL measurements with or without relying on UL beam sweeping.

Carrier aggregation: Aggregation of two or more component carriers in order to support wider transmission bandwidths.

Carrier aggregation band: A set of one or more operating bands across which multiple carriers are aggregated with a specific set of technical requirements.

Carrier aggregation bandwidth class: A class defined by the aggregated transmission bandwidth configuration and maximum number of component carriers supported by a UE.

Carrier aggregation configuration: A combination of CA operating band(s) and CA bandwidth class(es) supported by a UE.

NOTE: Carriers aggregated in each band can be contiguous or non-contiguous.

Cumulative aggregated channel bandwidth: The cumulative aggregated channel bandwidth is defined as the frequency band from the lowest edge of the lowest CC to the upper edge of the highest CC of all UL and DL configured CCs inside the bidirectional spectrum of the UE.

EIRP(Link=Link angle, Meas=Link angle): measurement of the UE such that the link angle is aligned with the measurement angle. EIRP (indicator to be measured) can be replaced by EIS, Frequency, EVM, carrier Leakage, In-band emission and OBW.

EIRP(Link=TX beam peak direction, Meas=Link angle): measurement of the EIRP of the UE such that the measurement angle is aligned with the beam peak direction within an acceptable measurement error uncertainty. EIRP (indicator to be measured) can be replaced by Frequency, EVM, carrier Leakage, In-band emission and OBW

EIRP(Link=Spherical coverage grid, Meas=Link angle): measurement of the EIRP spherical coverage of the UE such that the EIRP link and measurement angles are aligned with the directions along the spherical coverage grid within an acceptable measurement error uncertainty. Alternatively, the spherical coverage grid can be replaced by the beam peak search grid as the results from the beam peak search can be re-used for spherical coverage.

EIS (effective isotropic sensitivity): sensitivity for an isotropic directivity device equivalent to the sensitivity of the discussed device exposed to an incoming wave from a defined AoA

EIS(Link=RX beam peak direction, Meas=Link angle): measurement of the EIS of the UE such that the measurement angle is aligned with the RX beam peak direction within an acceptable measurement error uncertainty.

NOTE 1: The sensitivity is the minimum received power level at which specific requirement is met.

NOTE 2: Isotropic directivity is equal in all directions (i.e. 0 dBi).

Fallback group: Group of carrier aggregation bandwidth classes for which it is mandatory for a UE to be able to fallback to lower order CA bandwidth class configuration. It is not mandatory for a UE to be able to fallback to lower order CA bandwidth class configuration that belong to a different fallback group.

IBM(Independent Beam Management): A UE that supports inter-band CA with IBM selects its DL Rx beam(s) for all CCs in each configured band based on DL reference signals measurements made in that band.

Inter-band carrier aggregation: Carrier aggregation of component carriers in different operating bands.

NOTE: Carriers aggregated in each band can be contiguous or non-contiguous.

Intra-band contiguous carrier aggregation: Contiguous carriers aggregated in the same operating band.

Intra-band non-contiguous carrier aggregation: Non-contiguous carriers aggregated in the same operating band.

Link angle: a DL-signal AoA from the view point of the UE, as described in Annex J. If the beam lock function is used to lock the UE beam(s), the link angle can become any arbitrary AoA once the beam lock has been activated.

Measurement angle: the angle of measurement of the desired metric from the view point of the UE, as described in Annex J

radiated interface boundary: operating band specific radiated requirements reference point where the radiated requirements apply

radiated requirements reference point: for the RF measurement setup, the radiated requirements reference point is located at the centre of the quiet zone. From the UE perspective the reference point is the input of the UE antenna array

RX beam peak direction: direction where the maximum total component of RSRP and thus best total component of EIS is found

Sub-block: This is one contiguous allocated block of spectrum for transmission and reception by the same UE. There may be multiple instances of sub-blocks within an RF bandwidth.

TX beam peak direction: direction where the maximum total component of EIRP is found

TRP(Link=TX beam peak direction, Meas=TRP grid): measurement of the TRP of the UE such that the measurement angles are aligned with the directions of the TRP grid points within an acceptable measurement uncertainty while the link angle is aligned with the TX beam peak direction

NOTE: For requirements based on EIRP/EIS, the radiated interface boundary is associated to the far-field region

UE transmission bandwidth configuration: Set of resource blocks located within the UE channel bandwidth which may be used for transmitting or receiving by the UE.

Vehicular UE: A UE embedded in a vehicle

3.2 Symbols

For the purposes of the present document, the following symbols apply:

| | |
|---------------------|---|
| $\Delta EIRP_{BC}$ | The beam correspondence tolerance, where $\Delta EIRP_{BC} = EIRP_2 - EIRP_1$ |
| ΔF_{Global} | Granularity of the global frequency raster |
| ΔF_{Raster} | Band dependent channel raster granularity |
| Δf_{OOB} | Δ Frequency of Out Of Band emission |
| Δ_{RB} | The starting frequency offset between the allocated RB and the measured non-allocated RB |
| ΔR_{IB} | Allowed reference sensitivity relaxation due to support for inter-band CA operation |
| ΔR_{IBC} | Allowed reference sensitivity relaxation due to support for intra-band contiguous CA operation |
| ΔR_{IBNC} | Allowed reference sensitivity relaxation due to support for intra-band non-contiguous CA operation |
| $\Delta R_{IB,P,n}$ | Allowed relaxation to each, minimum peak EIRP and reference sensitivity due to support for inter-band CA operation, per band in a combination of supported bands |
| $\Delta R_{IB,S,n}$ | Allowed relaxation to each, EIRP spherical coverage and EIS spherical coverage due to support for inter-band CA operation, per band in a combination of supported bands |
| $\Delta MB_{P,n}$ | Allowed relaxation to minimum peak EIRP and reference sensitivity due to support for multi-band operation, per supported band in a combination |
| $\Delta MB_{S,n}$ | Allowed relaxation to EIRP spherical coverage and EIS spherical coverage due to support for multi-band operation, per supported band in a combination |

| | |
|--------------------------|--|
| $\sum MB_p$ | Total allowed relaxation to minimum peak EIRP and reference sensitivity due to support for multi-band operation, for all supported bands in a combination |
| $\sum MB_s$ | Total allowed relaxation to each, EIRP spherical coverage and EIS spherical coverage due to support for multi-band operation, for all supported bands in a combination |
| $BW_{Channel}$ | Channel bandwidth |
| $BW_{Channel_CA}$ | Aggregated channel bandwidth, expressed in MHz |
| BW_{GB} | $\max(BW_{GB,Channel(k)})$ |
| $BW_{GB,Channel(k)}$ | Minimum guard band defined in sub-clause 5.3A.2 of carrier k |
| $BW_{interferer}$ | Bandwidth of the interferer |
| $Ceil(x)$ | Rounding upwards; $ceil(x)$ is the smallest integer such that $ceil(x) \geq x$ |
| $EIRP_1$ | The measured total EIRP based on the beam the UE chooses autonomously (corresponding beam) to transmit in the direction of the incoming DL signal, which is based on beam correspondence without relying on UL beam sweeping |
| $EIRP_2$ | The measured total EIRP based on the beam yielding highest EIRP in a given direction, which is based on beam correspondence with relying on UL beam sweeping |
| $EIRP_{max}$ | The applicable maximum EIRP as specified in sub-clause 6.2.1 |
| $Floor(x)$ | Rounding downwards; $floor(x)$ is the greatest integer such that $floor(x) \leq x$ |
| F_{center} | The center frequency of an allocated block of PRBs |
| F_C | <i>RF reference frequency</i> for the carrier center on the channel raster, given in table 5.4.2.2-1 |
| $F_{C,block,high}$ | Fc of the highest transmitted/received carrier in a sub-block. |
| $F_{C,block,low}$ | Fc of the lowest transmitted/received carrier in a sub-block. |
| $F_{C,low}$ | The Fc of the lowest carrier, expressed in MHz. |
| $F_{C,high}$ | The Fc of the highest carrier, expressed in MHz. |
| F_{DL_low} | The lowest frequency of the downlink <i>operating band</i> |
| F_{DL_high} | The highest frequency of the downlink <i>operating band</i> |
| $F_{edge,block,low}$ | The lower sub-block edge, where $F_{edge,block,low} = F_{C,block,low} - F_{offset,low}$. |
| $F_{edge,block,high}$ | The upper sub-block edge, where $F_{edge,block,high} = F_{C,block,high} + F_{offset,high}$. |
| $F_{edge,low}$ | The lower edge of <i>Aggregated Channel Bandwidth</i> , expressed in MHz. $F_{edge,low} = F_{C,low} - F_{offset,low}$. |
| $F_{edge,high}$ | The upper edge of <i>Aggregated Channel Bandwidth</i> , expressed in MHz. $F_{edge,high} = F_{C,high} + F_{offset,high}$. |
| $F_{interferer}$ | Frequency of the interferer |
| $F_{interferer}(offset)$ | Frequency offset of the interferer (between the center frequency of the interferer and the carrier frequency of the carrier measured) |
| F_{offset} | Frequency offset of the interferer (between the center frequency of the interferer and the closest edge of the carrier measured) |
| $Floor(x)$ | Rounding downwards; $floor(x)$ is the greatest integer such that $floor(x) \leq x$ |
| F_{OOB} | The boundary between the NR out of band emission and spurious emission domains |
| F_{REF} | RF reference frequency |
| $F_{REF-Offs}$ | Offset used for calculating F_{REF} |
| F_{UL_low} | The lowest frequency of the uplink <i>operating band</i> |
| F_{UL_high} | The highest frequency of the uplink <i>operating band</i> |
| F_{UL_Meas} | The sub-carrier frequency for which the equalizer coefficient is evaluated |
| $GB_{Channel}$ | Minimum guard band defined in sub-clause 5.3.3 |
| L_{CRB} | Transmission bandwidth which represents the length of a contiguous resource block allocation expressed in units of resources blocks |
| $L_{CRB,Max}$ | Maximum number of RB for a given Channel bandwidth and sub-carrier spacing |
| $Max()$ | The largest of given numbers |
| $Min()$ | The smallest of given numbers |
| $MPR_{f,c}$ | Maximum output power reduction for carrier f of serving cell c |
| MPR_{narrow} | Maximum output power reduction due to narrow PRB allocation |
| MPR_{WT} | Maximum power reduction due to modulation orders, transmit bandwidth configurations, waveform types |
| n_{PRB} | Physical resource block number |
| NR_{ACLR} | NR ACLR |
| N_{RB} | Transmission bandwidth configuration, expressed in units of resource blocks |
| $N_{RB,low}$ | Transmission bandwidth configurations according to Table 5.3.2-1 for the lowest assigned component carrier in clause 5.3A.1 |
| $N_{RB,high}$ | Transmission bandwidth configurations according to Table 5.3.2-1 for the highest assigned component carrier in clause 5.3A.1 |
| N_{REF} | NR Absolute Radio Frequency Channel Number (NR-ARFCN) |
| $N_{REF-Offs}$ | Offset used for calculating N_{REF} |
| P_{CMAX} | The configured maximum UE output power |

| | |
|----------------------------|---|
| $P_{\text{CMAX},f,c}$ | The configured maximum UE output power for carrier f of serving cell c |
| P_{int} | The intermediate power point as defined in table 6.3.4.2-2 |
| $P_{\text{Interferer}}$ | Modulated mean power of the interferer |
| P_{max} | The maximum UE output power as specified in sub-clause 6.2.1 |
| P_{min} | The minimum UE output power as specified in sub-clause 6.3.1 |
| $P\text{-MPR}_{f,c}$ | The Power Management UE Maximum Power Reduction for carrier f of serving cell c |
| $P_{\text{PowerClass}}$ | Nominal UE power class (i.e., no tolerance) as specified in sub-clause 6.2.1 |
| P_{RB} | The transmitted power per allocated RB, measured in dBm |
| $P_{\text{TMAX},f,c}$ | The measured total radiated power for carrier f of serving cell c |
| P_{UMAX} | The measured configured maximum UE output power |
| P_{w} | Power of a wanted DL signal |
| RB_{start} | Indicates the lowest RB index of transmitted resource blocks |
| SCS_{low} | SCS for the lowest assigned component carrier in clause 5.3A.1 |
| SCS_{high} | SCS for the highest assigned component carrier in clause 5.3A.1 |
| SS_{REF} | SS block reference frequency position |
| $T(\Delta P)$ | The tolerance $T(\Delta P)$ for applicable values of ΔP (values in dB) |
| TRP_{max} | The maximum TRP for the UE power class as specified in sub-clause 6.2.1 |

3.3 Abbreviations

For the purposes of the present document, the abbreviations given in 3GPP TR 21.905 [1] and the following apply. An abbreviation defined in the present document takes precedence over the definition of the same abbreviation, if any, in 3GPP TR 21.905 [1].

| | |
|------------|--|
| ACLR | Adjacent Channel Leakage Ratio |
| ACS | Adjacent Channel Selectivity |
| A-MPR | Additional Maximum Power Reduction |
| AoA | Angle of Arrival |
| BCS | Bandwidth Combination Set |
| BPSK | Binary Phase-Shift Keying |
| BS | Base Station |
| BW | Bandwidth |
| BWP | Bandwidth Part |
| CA | Carrier aggregation |
| CABW | Cumulative Aggregated Channel Bandwidth |
| CA_nX-nY | Inter-band CA of component carrier(s) in one sub-block within Band X and component carrier(s) in one sub-block within Band Y where X and Y are the applicable NR <i>operating band</i> |
| CC | Component carrier |
| CDF | Cumulative Distribution Function |
| CP-OFDM | Cyclic Prefix-OFDM |
| CW | Continuous Wave |
| DFT-s-OFDM | Discrete Fourier Transform-spread-OFDM |
| DM-RS | Demodulation Reference Signal |
| DTX | Discontinuous Transmission |
| EIRP | Effective Isotropic Radiated Power |
| EIS | Effective Isotropic Sensitivity |
| EVM | Error Vector Magnitude |
| FR | Frequency Range |
| FWA | Fixed Wireless Access |
| GSCN | Global Synchronization Channel Number |
| IBB | In-band Blocking |
| IBM | Independent Beam Management |
| IDFT | Inverse Discrete Fourier Transformation |
| ITU-R | Radiocommunication Sector of the International Telecommunication Union |
| MBW | Measurement bandwidth defined for the protected band |
| MPR | Allowed maximum power reduction |
| NR | New Radio |
| NR-ARFCN | NR Absolute Radio Frequency Channel Number |
| OCNG | OFDMA Channel Noise Generator |
| OOB | Out-of-band |
| OTA | Over The Air |

| | |
|---------|--|
| P-MPR | Power Management Maximum Power Reduction |
| PRB | Physical Resource Block |
| QAM | Quadrature Amplitude Modulation |
| RF | Radio Frequency |
| REFSENS | Reference Sensitivity |
| RIB | Radiated Interface Boundary |
| RMS | Root Mean Square (value) |
| RSRP | Reference Signal Receiving Power |
| Rx | Receiver |
| SCS | Subcarrier spacing |
| SEM | Spectrum Emission Mask |
| SRS | Sounding Reference Symbol |
| SS | Synchronization Symbol |
| TPC | Transmission Power Control |
| TRP | Total Radiated Power |
| Tx | Transmitter |
| UE | User Equipment |
| UL MIMO | Uplink Multiple Antenna transmission |
| ULFPTx | Uplink Full Power Transmission |

4 General

4.1 Relationship between minimum requirements and test requirements

The present document is a Single-RAT specification for NR UE, covering RF characteristics and minimum performance requirements. Conformance to the present specification is demonstrated by fulfilling the test requirements specified in the conformance specification 3GPP TS 38.521-2 [5].

The Minimum Requirements given in this specification make no allowance for measurement uncertainty. The test specification TS 38.521-2 [5] defines test tolerances. These test tolerances are individually calculated for each test. The test tolerances are used to relax the minimum requirements in this specification to create test requirements. For some requirements, including regulatory requirements, the test tolerance is set to zero.

The measurement results returned by the test system are compared - without any modification - against the test requirements as defined in 3GPP TS 38.521-2 [5].

4.2 Applicability of minimum requirements

- a) In this specification the Minimum Requirements are specified as general requirements and additional requirements. Where the Requirement is specified as a general requirement, the requirement is mandated to be met in all scenarios
- b) For specific scenarios for which an additional requirement is specified, in addition to meeting the general requirement, the UE is mandated to meet the additional requirements.
- c) The spurious emissions power requirements are for the long-term average of the power. For the purpose of reducing measurement uncertainty it is acceptable to average the measured power over a period of time sufficient to reduce the uncertainty due to the statistical nature of the signal
- d) All the requirements for intra-band contiguous and non-contiguous CA apply under the assumption of the same slot format indicated by *TDD-UL-DL-ConfigurationCommon* and *TDD-UL-DL-ConfigurationDedicated* in the PCell and SCells for NR SA.

For FR2 intra-band CA configurations with multiple FR2 sub-blocks, where at least one of the sub-blocks is a contiguous CA configuration:

- if the field *partialFR2-FallbackRX-Req* is not present, the UE shall meet all applicable UE RF requirements for the highest order CA configuration and all associated fallback CA configurations;
- if the field *partialFR2-FallbackRX-Req* is present, for each FR2 intra-band CA configuration with multiple sub-blocks that the UE indicates support for explicitly in UE capability signalling: the in-gap UE RF requirements in clauses 7.5A, 7.5D, 7.6A, 7.6D apply as the equivalent requirements for the associated fallback CA configurations with the same number of sub-blocks, where at least one of the sub-blocks consists of a contiguous CA configuration. The UE shall meet all applicable UE RF requirements for fallback CA configurations with a lesser number of sub-blocks;
- regardless of the field *partialFR2-FallbackRX-Req*, the UE shall meet all DL out-of-gap requirements for all lower order fallback CA configurations.

4.3 Specification suffix information

Unless stated otherwise the following suffixes are used for indicating at 2nd level clause, shown in Table 4.3-1.

Table 4.3-1: Definition of suffixes

| Clause suffix | Variant |
|----------------------|---|
| None | Single Carrier |
| A | Carrier Aggregation (CA) |
| B | Dual-Connectivity (DC) |
| C | Supplement Uplink (SUL) |
| D | UL MIMO |
| NOTE: | Suffix D in this specification represents either polarized UL MIMO or spatial UL MIMO. RF requirements are same. If UE supports both kinds of UL MIMO, then RF requirements only need to be verified under either polarized or spatial UL MIMO. |

5 Operating bands and channel arrangement

5.1 General

The channel arrangements presented in this clause are based on the operating bands and channel bandwidths defined in the present release of specifications.

NOTE: Other operating bands and channel bandwidths may be considered in future releases.

Requirements throughout the RF specifications are in many cases defined separately for different frequency ranges (FR). The frequency ranges in which NR can operate according to this version of the specification are identified as described in Table 5.1-1.

Table 5.1-1: Definition of frequency ranges

| Frequency range designation | Corresponding frequency range |
|-----------------------------|-------------------------------|
| FR1 | 410 MHz – 7125 MHz |
| FR2 | 24250 MHz – 52600 MHz |

The present specification covers FR2 operating bands.

5.2 Operating bands

NR is designed to operate in the FR2 operating bands defined in Table 5.2-1.

Table 5.2-1: NR operating bands in FR2

| Operating Band | Uplink (UL) operating band BS receive UE transmit | Downlink (DL) operating band BS transmit UE receive | Duplex Mode |
|----------------|---|---|-------------|
| | F_{UL_low} – F_{UL_high} | F_{DL_low} – F_{DL_high} | |
| n257 | 26500 MHz – 29500 MHz | 26500 MHz – 29500 MHz | TDD |
| n258 | 24250 MHz – 27500 MHz | 24250 MHz – 27500 MHz | TDD |
| n259 | 39500 MHz – 43500 MHz | 39500 MHz – 43500 MHz | TDD |
| n260 | 37000 MHz – 40000 MHz | 37000 MHz – 40000 MHz | TDD |
| n261 | 27500 MHz – 28350 MHz | 27500 MHz – 28350 MHz | TDD |

5.2A Operating bands for CA

5.2A.1 Intra-band CA

NR intra-band contiguous and non-contiguous carrier aggregation is designed to operate in the operating bands defined in Table 5.2A.1-1, where all operating bands are within FR2.

Table 5.2A.1-1: Intra-band contiguous and non-contiguous CA operating bands in FR2

| NR CA Band | NR Band (Table 5.2-1) |
|------------|--------------------------|
| CA_n257 | n257 |
| CA_n258 | n258 |
| CA_n259 | n259 |
| CA_n260 | n260 |
| CA_n261 | n261 |

5.2A.2 Inter-band CA

NR inter-band carrier aggregation is designed to operate in the operating bands defined in Table 5.2A.2-1, where all operating bands are within FR2.

Beam management type is according to UE capability declaration *IE beamManagementType-r16*. The requirements in the following clauses are only applicable to inter-band CA with IBM type.

Table 5.2A.2-1: Inter-band CA operating bands in FR2

| NR CA Band | NR Band (Table 5.2-1) |
|---|--------------------------|
| CA_n260-n261 | n260, n261 |
| NOTE 1: The minimum requirements apply only when there is non-simultaneous Rx/Tx operation between inter-band NR carriers in the current version of this specification. | |

5.2D Operating bands for UL MIMO

NR UL MIMO is designed to operate in the operating bands defined in Table 5.2D-1.

Table 5.2D-1: NR UL MIMO operating bands

| UL MIMO operating band (Table 5.2-1) |
|---|
| n257 |
| n258 |
| n259 |
| n260 |
| n261 |

5.3 UE Channel bandwidth

5.3.1 General

The UE channel bandwidth supports a single NR RF carrier in the uplink or downlink at the UE. From a BS perspective, different UE channel bandwidths may be supported within the same spectrum for transmitting to and receiving from UEs connected to the BS. Transmission of multiple carriers to the same UE (CA) or multiple carriers to different UEs within the BS channel bandwidth can be supported.

From a UE perspective, the UE is configured with one or more BWP / carriers, each with its own UE channel bandwidth. The UE does not need to be aware of the BS channel bandwidth or how the BS allocates bandwidth to different UEs.

The placement of the UE channel bandwidth for each UE carrier is flexible but can only be completely within the BS channel bandwidth.

The relationship between the channel bandwidth, the guardband and the transmission bandwidth configuration is shown in Figure 5.3.1-1.

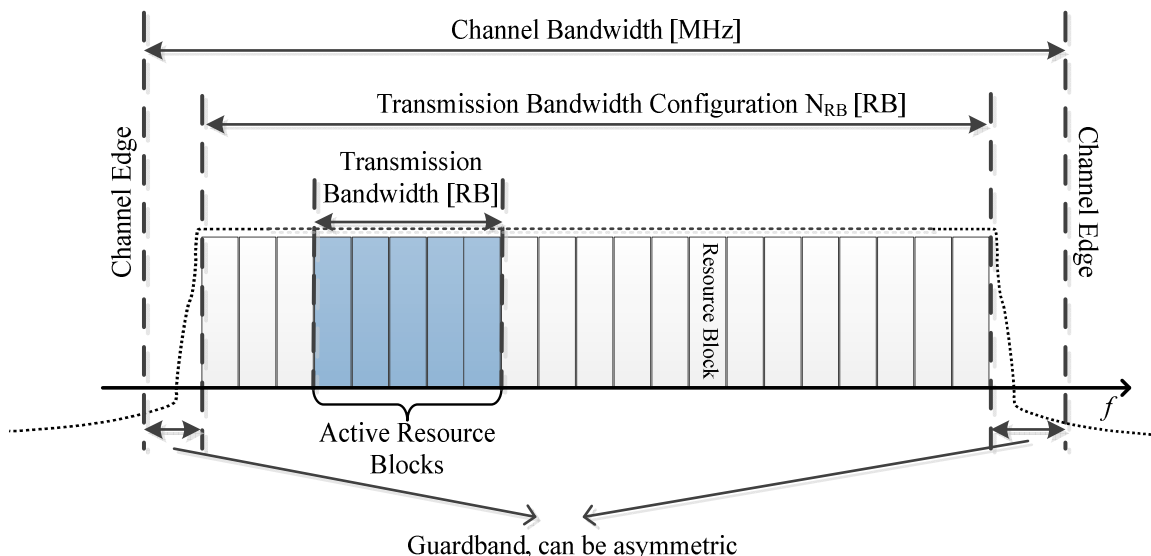

Figure 5.3.1-1: Definition of channel bandwidth and transmission bandwidth configuration for one NR channel

5.3.2 Maximum transmission bandwidth configuration

The maximum transmission bandwidth configuration N_{RB} for each UE channel bandwidth and subcarrier spacing is specified in Table 5.3.2-1

Table 5.3.2-1: Maximum transmission bandwidth configuration N_{RB}

| SCS (kHz) | 50 MHz | 100 MHz | 200 MHz | 400 MHz |
|-----------|----------|----------|----------|----------|
| | N_{RB} | N_{RB} | N_{RB} | N_{RB} |
| 60 | 66 | 132 | 264 | N.A |
| 120 | 32 | 66 | 132 | 264 |

5.3.3 Minimum guardband and transmission bandwidth configuration

The minimum guardband for each UE channel bandwidth and SCS is specified in Table 5.3.3-1

Table 5.3.3-1: Minimum guardband for each UE channel bandwidth and SCS (kHz)

| SCS (kHz) | 50 MHz | 100 MHz | 200 MHz | 400 MHz |
|-----------|--------|---------|---------|---------|
| 60 | 1210 | 2450 | 4930 | N. A |
| 120 | 1900 | 2420 | 4900 | 9860 |

NOTE: The minimum guardbands have been calculated using the following equation: $(BW_{Channel} \times 1000 \text{ (kHz)} - N_{RB} \times SCS \times 12) / 2 - SCS/2$, where N_{RB} are from Table 5.3.2-1.

The minimum guardband of receiving BS SCS 240 kHz SS/PBCH block for each UE channel bandwidth is specified in table 5.3.3-2 for FR2.

Table: 5.3.3-2: Minimum guardband (kHz) of SCS 240 kHz SS/PBCH block

| SCS (kHz) | 100 MHz | 200 MHz | 400 MHz |
|-----------|---------|---------|---------|
| 240 | 3800 | 7720 | 15560 |

NOTE: The minimum guardband in Table 5.3.3-2 is applicable only when the SCS 240 kHz SS/PBCH block is received adjacent to the edge of the UE channel bandwidth within which the SS/PBCH block is located.

Figure 5.3.3-1: Void

The number of RBs configured in any channel bandwidth shall ensure that the minimum guardband specified in this clause is met.

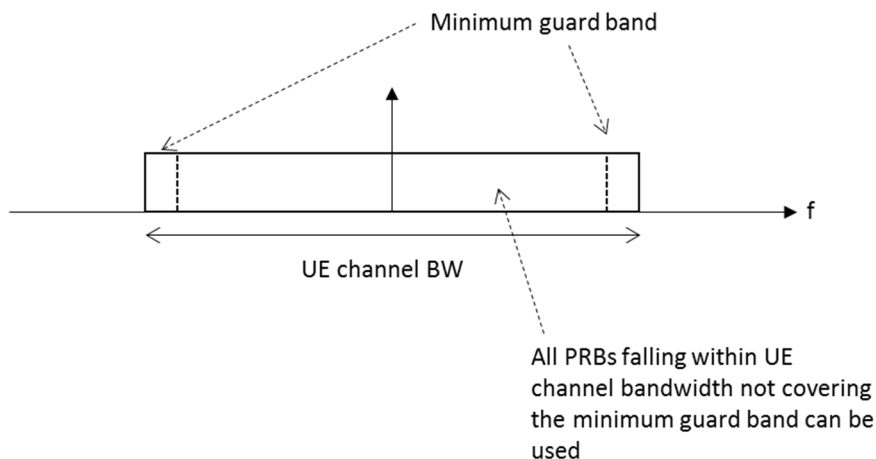

Figure 5.3.3-2 UE PRB utilization

In the case that multiple numerologies are multiplexed in the same symbol due to BS transmission of SSB, the minimum guardband on each side of the carrier is the guardband applied at the configured channel bandwidth for the numerology that is transmitted immediately adjacent to the guard band.

If multiple numerologies are multiplexed in the same symbol and the UE channel bandwidth is > 200 MHz, the minimum guardband applied adjacent to 60 kHz SCS shall be the same as the minimum guardband defined for 120 kHz SCS for the same UE channel bandwidth.

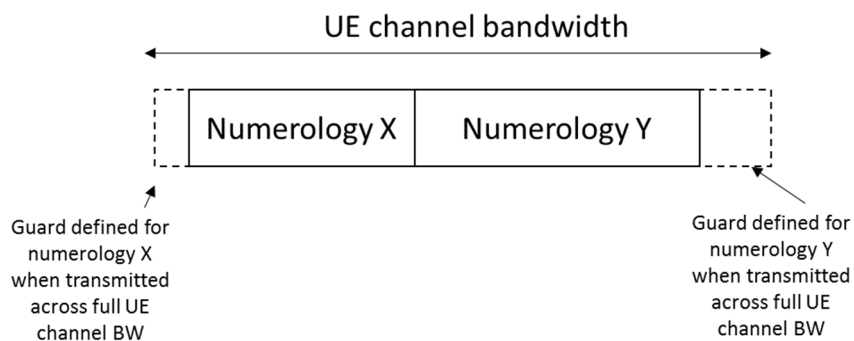

Figure 5.3.3-3 Guard band definition when transmitting multiple numerologies

Note: Figure 5.3.3-3 is not intended to imply the size of any guard between the two numerologies. Inter-numerology guard band within the carrier is implementation dependent.

5.3.4 RB alignment

For each numerology, its common resource blocks are specified in Clause 4.4.4.3 in [9], and the starting point of its transmission bandwidth configuration on the common resource block grid for a given channel bandwidth is indicated by an offset to "Reference point A" in the unit of the numerology. The *UE transmission bandwidth configuration* is indicated by the higher layer parameter *carrierBandwidth* [13] and will fulfil the minimum UE guardband requirement specified in Clause 5.3.3.

5.3.5 Channel bandwidth per operating band

The requirements in this specification apply to the combination of channel bandwidths, SCS and operating bands shown in Table 5.3.5-1. The transmission bandwidth configuration in Table 5.3.2-1 shall be supported for each of the specified channel bandwidths. The channel bandwidths are specified for both the Tx and Rx path.

Table 5.3.5-1: Channel bandwidths for each NR band

| Operating band / SCS / UE channel bandwidth | | | | | |
|---|---------|--------|---------|---------|----------------------|
| Operating band | SCS kHz | 50 MHz | 100 MHz | 200 MHz | 400 ¹ MHz |
| n257 | 60 | Yes | Yes | Yes | |
| | 120 | Yes | Yes | Yes | Yes |
| n258 | 60 | Yes | Yes | Yes | |
| | 120 | Yes | Yes | Yes | Yes |
| n259 | 60 | Yes | Yes | Yes | |
| | 120 | Yes | Yes | Yes | Yes |
| n260 | 60 | Yes | Yes | Yes | |
| | 120 | Yes | Yes | Yes | Yes |
| n261 | 60 | Yes | Yes | Yes | |
| | 120 | Yes | Yes | Yes | Yes |

NOTE 1: This UE channel bandwidth is optional in this release of the specification.

5.3A UE channel bandwidth for CA

5.3A.1 General

5.3A.2 Minimum guardband and transmission bandwidth configuration for CA

For intra-band contiguous carrier aggregation, *Aggregated Channel Bandwidth* and *Guard Bands* are defined as follows, see Figure 5.3A.2-1.

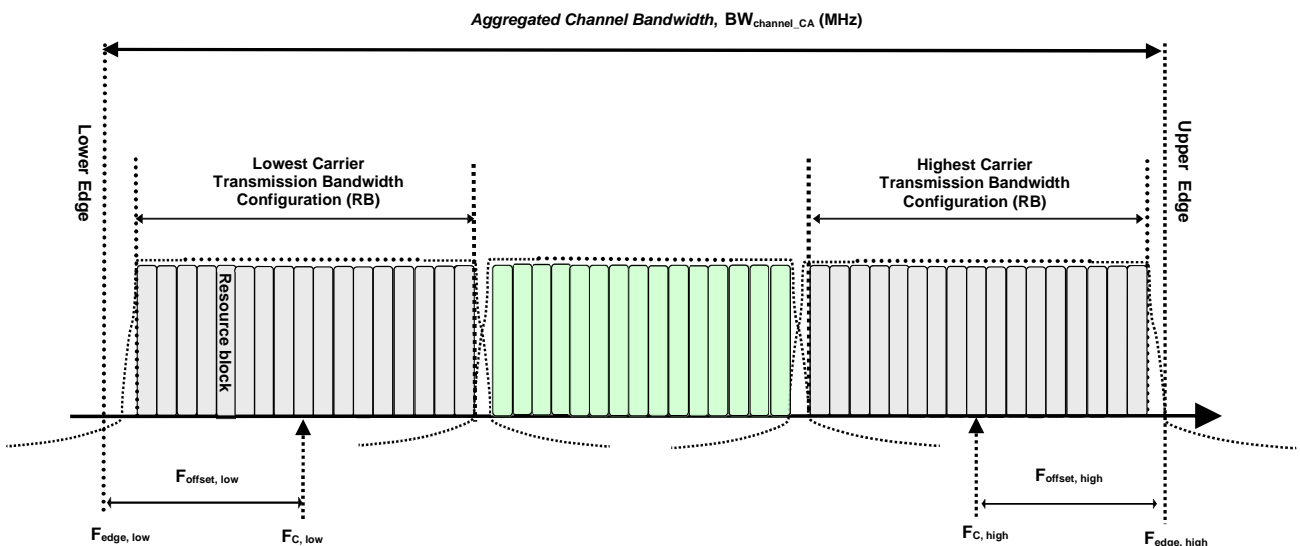

Figure 5.3A.2-1: Definition of *Aggregated Channel Bandwidth* for intra-band carrier aggregation

The *aggregated channel bandwidth*, $BW_{Channel_CA}$, is defined as

$$BW_{Channel_CA} = F_{edge,high} - F_{edge,low} \text{ (MHz)}.$$

The lower bandwidth edge $F_{edge,low}$ and the upper bandwidth edge $F_{edge,high}$ of the aggregated channel bandwidth are used as frequency reference points for transmitter and receiver requirements and are defined by

$$F_{edge,low} = F_{C,low} - F_{offset,low}$$

$$F_{edge,high} = F_{C,high} + F_{offset,high}$$

The lower and upper frequency offsets depend on the transmission bandwidth configurations of the lowest and highest assigned edge component carrier and are defined as

$$F_{offset,low} = (N_{RB,low} * 12 + 1) * SCS_{low} / 2 + BW_{GB} \text{ (MHz)}$$

$$F_{offset,high} = (N_{RB,high} * 12 - 1) * SCS_{high} / 2 + BW_{GB} \text{ (MHz)}$$

$$BW_{GB} = \max(BW_{GB,Channel(k)})$$

$N_{RB,low}$ and $N_{RB,high}$ are the transmission bandwidth configurations according to Table 5.3.2-1 for the lowest and highest assigned component carrier, SCS_{low} and SCS_{high} are the sub-carrier spacing for the lowest and highest assigned component carrier respectively. SCS_{low} , SCS_{high} , $N_{RB,low}$, $N_{RB,high}$, and $BW_{GB,Channel(k)}$ use the largest μ value among the subcarrier spacing configurations supported in the operating band for both of the channel bandwidths according to Table 5.3.5-1 and $BW_{GB,Channel(k)}$ is the minimum guard band for carrier k according to Table 5.3.3-1 for the said μ value.

For intra-band non-contiguous carrier aggregation *Sub-block Bandwidth* and *Sub-block edges* are defined as follows, see Figure 5.3A.2-2.

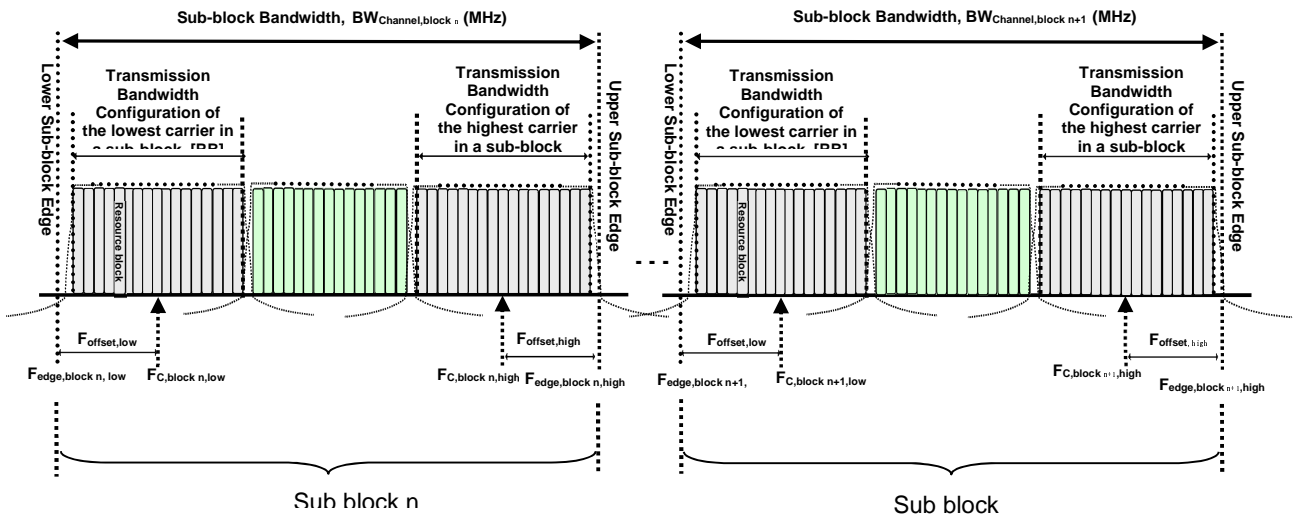

Figure 5.3A.2-2: Definition of sub-block bandwidth for intra-band non-contiguous spectrum

The lower sub-block edge of the Sub-block Bandwidth ($BW_{Channel,block}$) is defined as

$$F_{edge,block,low} = F_{C,block,low} - F_{offset,low}$$

The upper sub-block edge of the Sub-block Bandwidth is defined as

$$F_{edge,block,high} = F_{C,block,high} + F_{offset,high}$$

The Sub-block Bandwidth, $BW_{Channel,block}$, is defined as follows:

$$BW_{Channel,block} = F_{edge,block,high} - F_{edge,block,low} \text{ (MHz)}$$

The lower and upper frequency offsets $F_{offset,block,low}$ and $F_{offset,block,high}$ depend on the transmission bandwidth configurations of the lowest and highest assigned edge component carriers within a sub-block and are defined as

$$F_{offset,block,low} = (N_{RB,low} * 12 + 1) * SCS_{low} / 2 + BW_{GB} \text{ (MHz)}$$

$$F_{offset,block,high} = (N_{RB,high} * 12 - 1) * SCS_{high} / 2 + BW_{GB} \text{ (MHz)}$$

$$BW_{GB} = \max(BW_{GB,Channel(k)})$$

where $N_{RB,low}$ and $N_{RB,high}$ are the transmission bandwidth configurations according to Table 5.3.2-1 for the lowest and highest assigned component carrier within a sub-block, respectively. SCS_{low} and SCS_{high} are the sub-carrier spacing for the lowest and highest assigned component carrier within a sub-block, respectively. SCS_{low} , SCS_{high} , $N_{RB,low}$, $N_{RB,high}$, and $BW_{GB,Channel(k)}$ use the largest μ value among the subcarrier spacing configurations supported in the operating band for both of the channel bandwidths according to Table 5.3.5-1 and $BW_{GB,Channel(k)}$ is the minimum guard band for carrier k according to Table 5.3.3-1 for the said μ value.

The sub-block gap size between two consecutive sub-blocks W_{gap} is defined as

$$W_{gap} = F_{edge,block\ n+1,low} - F_{edge,block\ n,high} \text{ (MHz)}$$

5.3A.3 RB alignment with different numerologies for CA

5.3A.4 UE channel bandwidth per operating band for CA

For intra-band contiguous carrier aggregation, a carrier aggregation configuration is a single operating band supporting a carrier aggregation bandwidth class with associated bandwidth combination sets specified in clause 5.5A.1. For each carrier aggregation configuration, requirements are specified for all aggregated channel bandwidths contained in a bandwidth combination set, UE can indicate support of several bandwidth combination sets per carrier aggregation configuration. The requirements are applicable only when Uplink CCs are configured within the frequency range between lower edge of lowest downlink component carrier and upper edge of highest downlink component carrier.

For intra-band non-contiguous carrier aggregation, a carrier aggregation configuration is a single operating band supporting two or more sub-blocks, each supporting a carrier aggregation bandwidth class. The requirements are applicable only when Uplink CCs in each UL sub-block are configured within the frequency range between lower edge of lowest downlink component carrier and upper edge of highest downlink component carrier of a DL sub-block.

Frequency separation class (F_s) specified in Table 5.3A.4-2 indicates the maximum frequency span between lower edge of lowest component carrier and upper edge of highest component carrier that UE can support per band in downlink or uplink (DL F_s or UL F_s) respectively in non-contiguous intra-band operation within the bidirectional spectrum.

The DL-only frequency spectrum is the width of UE frequency spectrum available to network to configure DL CCs only, and it extends on one-side of the bidirectional spectrum in contiguous manner with no frequency gap between the two. Frequency separation class for DL-only spectrum (F_{sd}) specified in Table 5.3A.4-3 and is declared per band. The frequency separation class for DL-only spectrum (F_{sd}) can be equal but not larger than the frequency separation (DL F_s). The combined downlink spectrum (DL $F_s + F_{sd}$) cannot exceed 2400 MHz. A UE may configure DL-only spectrum only if the combined downlink spectrum (DL $F_s + F_{sd}$) exceeds 1400 MHz. When a UE configures DL-only spectrum, it shall not expect a CC to be configured across the boundary between bidirectional spectrum and DL-only spectrum UE can support respectively.

For inter-band carrier aggregation, a carrier aggregation configuration is a combination of operating bands, each supporting a carrier aggregation bandwidth class.

Table 5.3A.4-1: CA bandwidth classes

| NR CA bandwidth class | Aggregated channel bandwidth | Number of contiguous CC | Fallback group |
|-----------------------|---|-------------------------|----------------|
| A | $BW_{\text{Channel}} \leq 400$ MHz | 1 | 1,2,3,4 |
| B | $400 \text{ MHz} < BW_{\text{Channel_CA}} \leq 800$ MHz | 2 | 1 |
| C | $800 \text{ MHz} < BW_{\text{Channel_CA}} \leq 1200$ MHz | 3 | |
| D | $200 \text{ MHz} < BW_{\text{Channel_CA}} \leq 400$ MHz | 2 | |
| E | $400 \text{ MHz} < BW_{\text{Channel_CA}} \leq 600$ MHz | 3 | 2 |
| F | $600 \text{ MHz} < BW_{\text{Channel_CA}} \leq 800$ MHz | 4 | |
| G | $100 \text{ MHz} < BW_{\text{Channel_CA}} \leq 200$ MHz | 2 | |
| H | $200 \text{ MHz} < BW_{\text{Channel_CA}} \leq 300$ MHz | 3 | 3 |
| I | $300 \text{ MHz} < BW_{\text{Channel_CA}} \leq 400$ MHz | 4 | |
| J | $400 \text{ MHz} < BW_{\text{Channel_CA}} \leq 500$ MHz | 5 | |
| K | $500 \text{ MHz} < BW_{\text{Channel_CA}} \leq 600$ MHz | 6 | |
| L | $600 \text{ MHz} < BW_{\text{Channel_CA}} \leq 700$ MHz | 7 | |
| M | $700 \text{ MHz} < BW_{\text{Channel_CA}} \leq 800$ MHz | 8 | 4 |
| O | $100 \text{ MHz} \leq BW_{\text{Channel_CA}} \leq 200$ MHz | 2 | |
| P | $150 \text{ MHz} \leq BW_{\text{Channel_CA}} \leq 300$ MHz | 3 | |
| Q | $200 \text{ MHz} \leq BW_{\text{Channel_CA}} \leq 400$ MHz | 4 | |

NOTE 1: Maximum supported component carrier bandwidths for fallback groups 1, 2, 3 and 4 are 400 MHz, 200 MHz, 100 MHz and 100 MHz respectively except for CA bandwidth class A.

NOTE 2: It is mandatory for a UE to be able to fallback to lower order CA bandwidth class configuration within a fallback group. It is not mandatory for a UE to be able to fallback to lower order CA bandwidth class configuration that belong to a different fallback group.

Table 5.3A.4-2: Frequency separation classes for non-contiguous intra-band operation

| Frequency separation class | Max. allowed frequency separation (Fs) |
|----------------------------|--|
| I | 800 MHz |
| II | 1200 MHz |
| III | 1400 MHz |
| IV | 1000 MHz |
| V | 1600 MHz |
| VI | 1800 MHz |
| VII | 2000 MHz |
| VIII | 2200 MHz |
| IX | 2400 MHz |
| X | 400 MHz |
| XI | 600 MHz |

NOTE 1: Fs values larger than 1400 MHz apply only to downlink frequency separation.

Table 5.3A.4-3: Frequency separation classes for DL-only spectrum

| Frequency separation class | Max. allowed frequency separation (Fsd) |
|----------------------------|---|
| I | 200 MHz |
| II | 400 MHz |
| III | 600 MHz |
| IV | 800 MHz |
| V | 1000 MHz |
| VI | 1200 MHz |

5.3D Channel bandwidth for UL MIMO

The requirements specified in clause 5.3 are applicable to UE supporting UL MIMO.

5.4 Channel arrangement

5.4.1 Channel spacing

5.4.1.1 Channel spacing for adjacent NR carriers

The spacing between carriers will depend on the deployment scenario, the size of the frequency block available and the channel bandwidths. The nominal channel spacing between two adjacent NR carriers is defined as following:

For NR operating bands with 60 kHz channel raster,

$$\text{Nominal Channel spacing} = (\text{BW}_{\text{Channel}(1)} + \text{BW}_{\text{Channel}(2)})/2 + \{-20 \text{ kHz}, 0 \text{ kHz}, 20 \text{ kHz}\} \text{ for } \Delta F_{\text{Raster}} \text{ equals to } 60 \text{ kHz}$$

$$\text{Nominal Channel spacing} = (\text{BW}_{\text{Channel}(1)} + \text{BW}_{\text{Channel}(2)})/2 + \{-40 \text{ kHz}, 0 \text{ kHz}, 40 \text{ kHz}\} \text{ for } \Delta F_{\text{Raster}} \text{ equals to } 120 \text{ kHz}$$

where $\text{BW}_{\text{Channel}(1)}$ and $\text{BW}_{\text{Channel}(2)}$ are the channel bandwidths of the two respective NR carriers. The channel spacing can be adjusted depending on the channel raster to optimize performance in a particular deployment scenario.

5.4.2 Channel raster

5.4.2.1 NR-ARFCN and channel raster

The global frequency raster defines a set of RF reference frequencies F_{REF} . The RF reference frequency is used in signalling to identify the position of RF channels, SS blocks and other elements.

The global frequency raster is defined for all frequencies from 0 to 100 GHz. The granularity of the global frequency raster is ΔF_{Global} .

RF reference frequency is designated by an NR Absolute Radio Frequency Channel Number (NR-ARFCN) in the range [2016667...3279165] on the global frequency raster. The relation between the NR-ARFCN and the RF reference frequency F_{REF} in MHz is given by the following equation, where $F_{\text{REF-Offs}}$ and $N_{\text{Ref-Offs}}$ are given in table 5.4.2.1-1 and N_{REF} is the NR-ARFCN

$$F_{\text{REF}} = F_{\text{REF-Offs}} + \Delta F_{\text{Global}} (N_{\text{REF}} - N_{\text{REF-Offs}})$$

Table 5.4.2.1-1: NR-ARFCN parameters for the global frequency raster

| Frequency range (MHz) | ΔF_{Global} (kHz) | $F_{\text{REF-Offs}}$ [MHz] | $N_{\text{REF-Offs}}$ | Range of N_{REF} |
|-----------------------|----------------------------------|-----------------------------|-----------------------|---------------------------|
| 24250 – 100000 | 60 | 24250.08 | 2016667 | 2016667 – 3279165 |

The *channel raster* defines a subset of *RF reference frequencies* that can be used to identify the RF channel position in the uplink and downlink. The *RF reference frequency* for an RF channel maps to a resource element on the carrier. For each operating band, a subset of frequencies from the global frequency raster are applicable for that band and forms a channel raster with a granularity ΔF_{Raster} , which may be equal to or larger than ΔF_{Global} .

The mapping between the channel raster and corresponding resource element is given in Clause 5.4.2.2. The applicable entries for each operating band are defined in clause 5.4.2.3

5.4.2.2 Channel raster to resource element mapping

The mapping between the RF reference frequency on channel raster and the corresponding resource element is given in Table 5.4.2.2-1 and can be used to identify the RF channel position. The mapping depends on the total number of RBs that are allocated in the channel and applies to both UL and DL. The mapping must apply to at least one numerology supported by the UE.

Table 5.4.2.2-1: Channel raster to resource element mapping

| Resource element index k | $N_{RB} \bmod 2 = 0$ | $N_{RB} \bmod 2 = 1$ |
|--|---|---|
| Physical resource block number n_{PRB} | 0 | 6 |
| | $n_{PRB} = \left\lfloor \frac{N_{RB}}{2} \right\rfloor$ | $n_{PRB} = \left\lfloor \frac{N_{RB}}{2} \right\rfloor$ |

k , n_{RB} , N_{RB} are as defined in TS 38.211 [9].

5.4.2.3 Channel raster entries for each operating band

The RF channel positions on the channel raster in each NR operating band are given through the applicable NR-ARFCN in Table 5.4.2.3-1, using the channel raster to resource element mapping in clause 5.4.2.2.

- For NR operating bands with 60 kHz channel raster above 24 GHz, $\Delta F_{\text{Raster}} = I \times \Delta F_{\text{Global}}$, where $I \in \{1,2\}$. Every I^{th} NR-ARFCN within the operating band are applicable for the channel raster within the operating band and the step size for the channel raster in table 5.4.2.3-1 is given as $\langle I \rangle$.
- In frequency bands with two ΔF_{Raster} , the higher ΔF_{Raster} applies to channels using only the SCS that equals the higher ΔF_{Raster} and the SSB SCS that is equal to or larger than the higher ΔF_{Raster} .

Table 5.4.2.3-1: Applicable NR-ARFCN per operating band

| Operating Band | ΔF_{Raster} (kHz) | Uplink and Downlink Range of N_{REF} (First – $\langle \text{Step size} \rangle$ – Last) |
|----------------|----------------------------------|---|
| n257 | 60 | 2054166 – $\langle 1 \rangle$ – 2104165 |
| | 120 | 2054167 – $\langle 2 \rangle$ – 2104165 |
| n258 | 60 | 2016667 – $\langle 1 \rangle$ – 2070832 |
| | 120 | 2016667 – $\langle 2 \rangle$ – 2070831 |
| n259 | 60 | 2270833 – $\langle 1 \rangle$ – 2337499 |
| | 120 | 2270833 – $\langle 2 \rangle$ – 2337499 |
| n260 | 60 | 2229166 – $\langle 1 \rangle$ – 2279165 |
| | 120 | 2229167 – $\langle 2 \rangle$ – 2279165 |
| n261 | 60 | 2070833 – $\langle 1 \rangle$ – 2084999 |
| | 120 | 2070833 – $\langle 2 \rangle$ – 2084999 |

5.4.3 Synchronization raster

5.4.3.1 Synchronization raster and numbering

The synchronization raster indicates the frequency positions of the synchronization block that can be used by the UE for system acquisition when explicit signalling of the synchronization block position is not present.

A global synchronization raster is defined for all frequencies. The frequency position of the SS block is defined as SS_{REF} with corresponding number GSCN. The parameters defining the SS_{REF} and GSCN for all the frequency ranges are in Table 5.4.3.1-1.

The resource element corresponding to the SS block reference frequency SS_{REF} is given in clause 5.4.3.2. The synchronization raster and the subcarrier spacing of the synchronization block is defined separately for each band.

Table 5.4.3.1-1: GSCN parameters for the global frequency raster

| Frequency range | SS block frequency position SS_{REF} | GSCN | Range of GSCN |
|--------------------|---|-----------|---------------|
| 24250 – 100000 MHz | 24250.08 MHz + N * 17.28 MHz, N = 0:4383 | 22256 + N | 22256 – 26639 |

5.4.3.2 Synchronization raster to synchronization block resource element mapping

The mapping between the synchronization raster and the corresponding resource element of the SS block is given in Table 5.4.3.2-1.

Table 5.4.3.2-1: Synchronization raster to SS block resource element mapping

| | |
|----------------------------|-----|
| Resource element index k | 120 |
| | |

k is the subcarrier number of SS/PBCH block defined in TS 38.211 clause 7.4.3.1 [9].

5.4.3.3 Synchronization raster entries for each operating band

The synchronization raster for each band is given in Table 5.4.3.3-1. The distance between applicable GSCN entries is given by the <Step size> indicated in Table 5.4.3.3-1.

Table 5.4.3.3-1: Applicable SS raster entries per operating band

| NR Operating Band | SS Block SCS | SS Block pattern ¹ | Range of GSCN (First – <Step size> – Last) |
|-------------------|--------------|-------------------------------|---|
| n257 | 120 kHz | Case D | 22388 - <1> - 22558 |
| | 240 kHz | Case E | 22390 - <2> - 22556 |
| n258 | 120 kHz | Case D | 22257 - <1> - 22443 |
| | 240 kHz | Case E | 22258 - <2> - 22442 |
| n259 | 120 kHz | Case D | 23140 - <1> - 23369 |
| | 240 kHz | Case E | 23142 - <2> - 23368 |
| n260 | 120 kHz | Case D | 22995 - <1> - 23166 |
| | 240 kHz | Case E | 22996 - <2> - 23164 |
| n261 | 120 kHz | Case D | 22446 - <1> - 22492 |
| | 240 kHz | Case E | 22446 - <2> - 22490 |

NOTE 1: SS Block pattern is defined in clause 4.1 in TS 38.213 [10].

5.4A Channel arrangement for CA

5.4A.1 Channel spacing for CA

For intra-band contiguous carrier aggregation with two or more component carriers, the nominal channel spacing between two adjacent NR component carriers is defined as the following unless stated otherwise:

For NR operating bands with 60kHz channel raster:

$$\text{Nominal channel spacing} = \left\lfloor \frac{BW_{\text{Channel}(1)} + BW_{\text{Channel}(2)} - 2|GB_{\text{Channel}(1)} - GB_{\text{Channel}(2)}|}{0.06 * 2^{n+1}} \right\rfloor 0.06 * 2^n \text{ [MHz]}$$

with

$$n = \mu_0 - 2$$

where $BW_{\text{Channel}(1)}$ and $BW_{\text{Channel}(2)}$ are the channel bandwidths of the two respective NR component carriers according to Table 5.3.2-1 with values in MHz, μ_0 is the largest μ value among the subcarrier spacing configurations supported in the operating band for both of the channel bandwidths according to Table 5.3.5-1, and $GB_{\text{Channel}(i)}$ is the minimum guard band for channel bandwidth i according to Table 5.3.3-1 for the said μ value, with μ as defined in TS 38.211 [9].

The channel spacing for intra-band contiguous carrier aggregation can be adjusted to any multiple of least common multiple of channel raster and sub-carrier spacing less than the nominal channel spacing to optimize performance in a particular deployment scenario.

For intra-band non-contiguous carrier aggregation, the channel spacing between two NR component carriers in different sub-blocks shall be larger than the nominal channel spacing defined in this clause.

5.5 Configurations

5.5A Configurations for CA

5.5A.1 Configurations for intra-band contiguous CA

Table 5.5A.1-1: NR CA configurations, bandwidth combination sets, and fallback group defined for intra-band contiguous CA

| NR CA configuration / Bandwidth combination set / Fallback group | | | | | | | | | | | | | |
|--|--|-----------------------------|-----------------------------|-----------------------------|-----------------------------|-----------------------------|-----------------------------|-----------------------------|-----------------------------|-----------------------------|-----------------------------|-----|----------------|
| NR CA configuration | Uplink CA configurations | BW _{Channel} (MHz) | BW _{Channel} (MHz) | BW _{Channel} (MHz) | BW _{Channel} (MHz) | BW _{Channel} (MHz) | BW _{Channel} (MHz) | BW _{Channel} (MHz) | BW _{Channel} (MHz) | BW _{Channel} (MHz) | Maximum aggregated BW (MHz) | BCS | Fallback group |
| CA_n257B | CA_n257B | 50, 100, 200, 400 | 400 | | | | | | | | 800 | 0 | 1 |
| CA_n257C | CA_n257B | 50, 100, 200, 400 | 400 | 400 | | | | | | | 1200 | 0 | |
| CA_n257D | CA_n257D | 50, 100, 200 | 200 | | | | | | | | 400 | 0 | 2 |
| CA_n257E | CA_n257D CA_n257E | 50, 100, 200 | 200 | 200 | | | | | | | 600 | 0 | |
| CA_n257F | CA_n257D CA_n257E CA_n257F | 50, 100, 200 | 200 | 200 | 200 | | | | | | 800 | 0 | |
| CA_n257G | CA_n257G | 50, 100 | 100 | | | | | | | | 200 | 0 | 3 |
| CA_n257H | CA_n257G CA_n257H | 50, 100 | 100 | 100 | | | | | | | 300 | 0 | |
| CA_n257I | CA_n257G CA_n257H CA_n257I | 50, 100 | 100 | 100 | 100 | | | | | | 400 | 0 | |
| CA_n257J | CA_n257G CA_n257H CA_n257I CA_n257J | 50, 100 | 100 | 100 | 100 | 100 | | | | | 500 | 0 | |
| CA_n257K | CA_n257G CA_n257H CA_n257I CA_n257J CA_n257K | 50, 100 | 100 | 100 | 100 | 100 | 100 | | | | 600 | 0 | |
| CA_n257L | CA_n257G CA_n257H CA_n257I CA_n257J CA_n257K CA_n257L | 50, 100 | 100 | 100 | 100 | 100 | 100 | 100 | | | 700 | 0 | |
| CA_n257M | CA_n257G CA_n257H CA_n257I CA_n257J CA_n257K CA_n257L CA_n257M | 50, 100 | 100 | 100 | 100 | 100 | 100 | 100 | 100 | | 800 | 0 | |
| CA_n258B | CA_n258B | 50, 100, 200, 400 | 400 | | | | | | | | 800 | 0 | 1 |

| NR CA configuration / Bandwidth combination set / Fallback group | | | | | | | | | | | | | |
|--|--|-----------------------------|-----------------------------|-----------------------------|-----------------------------|-----------------------------|-----------------------------|-----------------------------|-----------------------------|-----------------------------|-----------------------------|-----|----------------|
| NR CA configuration | Uplink CA configurations | BW _{Channel} (MHz) | BW _{Channel} (MHz) | BW _{Channel} (MHz) | BW _{Channel} (MHz) | BW _{Channel} (MHz) | BW _{Channel} (MHz) | BW _{Channel} (MHz) | BW _{Channel} (MHz) | BW _{Channel} (MHz) | Maximum aggregated BW (MHz) | BCS | Fallback group |
| CA_n258C | CA_n258B CA_n258C | 50, 100, 200, 400 | 400 | 400 | | | | | | | 1200 | 0 | |
| CA_n258D | CA_n258D | 50, 100, 200 | 200 | | | | | | | | 400 | 0 | 2 |
| CA_n258E | CA_n258D CA_n258E | 50, 100, 200 | 200 | 200 | | | | | | | 600 | 0 | |
| CA_n258F | CA_n258D CA_n258E CA_n258F | 50, 100, 200 | 200 | 200 | 200 | | | | | | 800 | 0 | |
| CA_n258G | CA_n258G | 50, 100 | 100 | | | | | | | | 200 | 0 | 3 |
| CA_n258H | CA_n258G CA_n258H | 50, 100 | 100 | 100 | | | | | | | 300 | 0 | |
| CA_n258I | CA_n258G CA_n258H CA_n258I | 50, 100 | 100 | 100 | 100 | | | | | | 400 | 0 | |
| CA_n258J | CA_n258G CA_n258H CA_n258I CA_n258J | 50, 100 | 100 | 100 | 100 | 100 | | | | | 500 | 0 | |
| CA_n258K | CA_n258G CA_n258H CA_n258I CA_n258J CA_n258K | 50, 100 | 100 | 100 | 100 | 100 | 100 | | | | 600 | 0 | |
| CA_n258L | CA_n258G CA_n258H CA_n258I CA_n258J CA_n258K CA_n258L | 50, 100 | 100 | 100 | 100 | 100 | 100 | 100 | | | 700 | 0 | |
| CA_n258M | CA_n258G CA_n258H CA_n258I CA_n258J CA_n258K CA_n258L CA_n258M | 50, 100 | 100 | 100 | 100 | 100 | 100 | 100 | 100 | | 800 | 0 | |
| CA_n259B | CA_n259B | 50, 100, 200, 400 | 400 | | | | | | | | 800 | 0 | 1 |
| CA_n259C | CA_n259B | 50, 100, 200, 400 | 400 | 400 | | | | | | | 1200 | 0 | |
| CA_n259G | CA_n259G | 50, 100 | 100 | | | | | | | | 200 | 0 | 3 |

| NR CA configuration / Bandwidth combination set / Fallback group | | | | | | | | | | | | | |
|--|--|-----------------------------|-----------------------------|-----------------------------|-----------------------------|-----------------------------|-----------------------------|-----------------------------|-----------------------------|-----------------------------|-----------------------------|-----|----------------|
| NR CA configuration | Uplink CA configurations | BW _{Channel} (MHz) | BW _{Channel} (MHz) | BW _{Channel} (MHz) | BW _{Channel} (MHz) | BW _{Channel} (MHz) | BW _{Channel} (MHz) | BW _{Channel} (MHz) | BW _{Channel} (MHz) | BW _{Channel} (MHz) | Maximum aggregated BW (MHz) | BCS | Fallback group |
| CA_n259H | CA_n259G CA_n259H | 50, 100 | 100 | 100 | | | | | | | 300 | 0 | |
| CA_n259I | CA_n259G CA_n259H CA_n259I | 50, 100 | 100 | 100 | 100 | | | | | | 400 | 0 | |
| CA_n259J | CA_n259G CA_n259H CA_n259I CA_n259J | 50, 100 | 100 | 100 | 100 | 100 | | | | | 500 | 0 | |
| CA_n259K | CA_n259G CA_n259H CA_n259I CA_n259J CA_n259K | 50, 100 | 100 | 100 | 100 | 100 | 100 | | | | 600 | 0 | |
| CA_n259L | CA_n259G CA_n259H CA_n259I CA_n259J CA_n259K CA_n259L | 50, 100 | 100 | 100 | 100 | 100 | 100 | 100 | | | 700 | 0 | |
| CA_n259M | CA_n259G CA_n259H CA_n259I CA_n259J CA_n259K CA_n259L CA_n259M | 50, 100 | 100 | 100 | 100 | 100 | 100 | 100 | 100 | | 800 | 0 | |
| CA_n260B | CA_n260B | 50, 100, 200, 400 | 400 | | | | | | | | 800 | 0 | 1 |
| CA_n260C | CA_n260B | 50, 100, 200, 400 | 400 | 400 | | | | | | | 1200 | 0 | |
| CA_n260D | CA_n260D | 50, 100, 200 | 200 | | | | | | | | 400 | 0 | 2 |
| CA_n260E | CA_n260D CA_n260E | 50, 100, 200 | 200 | 200 | | | | | | | 600 | 0 | |
| CA_n260F | CA_n260D CA_n260E CA_n260F | 50, 100, 200 | 200 | 200 | 200 | | | | | | 800 | 0 | |
| CA_n260G | CA_n260G | 50, 100 | 100 | | | | | | | | 200 | 0 | 3 |
| CA_n260H | CA_n260G CA_n260H | 50, 100 | 100 | 100 | | | | | | | 300 | 0 | |

| NR CA configuration / Bandwidth combination set / Fallback group | | | | | | | | | | | | | |
|--|--|-----------------------------|-----------------------------|-----------------------------|-----------------------------|-----------------------------|-----------------------------|-----------------------------|-----------------------------|-----------------------------|-----------------------------|-----|----------------|
| NR CA configuration | Uplink CA configurations | BW _{Channel} (MHz) | BW _{Channel} (MHz) | BW _{Channel} (MHz) | BW _{Channel} (MHz) | BW _{Channel} (MHz) | BW _{Channel} (MHz) | BW _{Channel} (MHz) | BW _{Channel} (MHz) | BW _{Channel} (MHz) | Maximum aggregated BW (MHz) | BCS | Fallback group |
| CA_n260I | CA_n260G CA_n260H CA_n260I | 50, 100 | 100 | 100 | 100 | | | | | | 400 | 0 | |
| CA_n260J | CA_n260G CA_n260H CA_n260I CA_n260J | 50, 100 | 100 | 100 | 100 | 100 | | | | | 500 | 0 | |
| CA_n260K | CA_n260G CA_n260H CA_n260I CA_n260J CA_n260K | 50, 100 | 100 | 100 | 100 | 100 | 100 | | | | 600 | 0 | |
| CA_n260L | CA_n260G CA_n260H CA_n260I CA_n260J CA_n260K CA_n260L | 50, 100 | 100 | 100 | 100 | 100 | 100 | 100 | | | 700 | 0 | |
| CA_n260M | CA_n260G CA_n260H CA_n260I CA_n260J CA_n260K CA_n260L CA_n260M | 50, 100 | 100 | 100 | 100 | 100 | 100 | 100 | 100 | | 800 | 0 | |
| CA_n260O | CA_n260O | 50, 100 | 50, 100 | | | | | | | | 200 | 0 | 4 |
| CA_n260P | CA_n260O CA_n260P | 50, 100 | 50, 100 | 50, 100 | | | | | | | 300 | 0 | |
| CA_n260Q | CA_n260O CA_n260P CA_n260Q | 50, 100 | 50, 100 | 50, 100 | 50, 100 | | | | | | 400 | 0 | |
| CA_n261B | CA_n261B | 50, 100, 200, 400 | 400 | | | | | | | | 800 | 0 | 1 |
| CA_n261C | CA_n261B | 50 | 400 | 400 | | | | | | | 850 | 0 | |
| CA_n261D | CA_n261D | 50, 100, 200 | 200 | | | | | | | | 400 | 0 | 2 |
| CA_n261E | CA_n261D CA_n261E | 50, 100, 200 | 200 | 200 | | | | | | | 600 | 0 | |
| CA_n261F | CA_n261D CA_n261E CA_n261F | 50, 100, 200 | 200 | 200 | 200 | | | | | | 800 | 0 | |
| CA_n261G | CA_n261G | 50, 100 | 100 | | | | | | | | 200 | 0 | 3 |

| NR CA configuration / Bandwidth combination set / Fallback group | | | | | | | | | | | | | |
|--|--|-----------------------------|-----------------------------|-----------------------------|-----------------------------|-----------------------------|-----------------------------|-----------------------------|-----------------------------|-----------------------------|-----------------------------|-----|----------------|
| NR CA configuration | Uplink CA configurations | BW _{Channel} (MHz) | BW _{Channel} (MHz) | BW _{Channel} (MHz) | BW _{Channel} (MHz) | BW _{Channel} (MHz) | BW _{Channel} (MHz) | BW _{Channel} (MHz) | BW _{Channel} (MHz) | BW _{Channel} (MHz) | Maximum aggregated BW (MHz) | BCS | Fallback group |
| CA_n261H | CA_n261G CA_n261H | 50, 100 | 100 | 100 | | | | | | | 300 | 0 | |
| CA_n261I | CA_n261G CA_n261H CA_n261I | 50, 100 | 100 | 100 | 100 | | | | | | 400 | 0 | |
| CA_n261J | CA_n261G CA_n261H CA_n261I CA_n261J | 50, 100 | 100 | 100 | 100 | 100 | | | | | 500 | 0 | |
| CA_n261K | CA_n261G CA_n261H CA_n261I CA_n261J CA_n261K | 50, 100 | 100 | 100 | 100 | 100 | 100 | | | | 600 | 0 | |
| CA_n261L | CA_n261G CA_n261H CA_n261I CA_n261J CA_n261K CA_n261L | 50, 100 | 100 | 100 | 100 | 100 | 100 | 100 | | | 700 | 0 | |
| CA_n261M | CA_n261G CA_n261H CA_n261I CA_n261J CA_n261K CA_n261L CA_n261M | 50, 100 | 100 | 100 | 100 | 100 | 100 | 100 | 100 | | 800 | 0 | |
| CA_n261O | CA_n261O | 50, 100 | 50, 100 | | | | | | | | 200 | 0 | 4 |
| CA_n261P | CA_n261O CA_n261P | 50, 100 | 50, 100 | 50, 100 | | | | | | | 300 | 0 | |
| CA_n261Q | CA_n261O CA_n261P CA_n261Q | 50, 100 | 50, 100 | 50, 100 | 50, 100 | | | | | | 400 | 0 | |
| NOTE 1: Void | | | | | | | | | | | | | |
| NOTE 2: For the NR CA configuration with more than two component carries, the bandwidths in a BCS which may introduce combinations more than requested unintentionally should be listed in a row separately. | | | | | | | | | | | | | |

5.5A.2 Configurations for intra-band non-contiguous CA

Configurations listed in this clause apply to downlink carrier aggregation only.

NOTE: Sub-blocks belonging to a CA configuration can be in any order. In other words certain CA configuration acronym includes all sub-block arrangements which have exactly the same sub-block set. As an example, CA_n260(2G-3O) denotes CA_n260(2O-2G-O), CA_n260(G-3O-G) etc. but these are not listed in tables separately.

Table 5.5A.2-1: NR CA configurations with single CA bandwidth class defined for intra-band non-contiguous CA

| NR CA configuration / Bandwidth combination set | | | | | | | | | | | | | | | | | |
|---|--------------------------|-----------|-----------|-----------|-----------|-----------|-----------|-----------|-----------|-----------|-----------|-----------|-----------|-----------|-----------|------------------------------------|-----|
| NR configuration | Uplink CA configurations | Sub-block | Sub-block | Sub-block | Sub-block | Sub-block | Sub-block | Sub-block | Sub-block | Sub-block | Sub-block | Sub-block | Sub-block | Sub-block | Sub-block | $\Sigma(BW_{Channel,block})$ (MHz) | BCS |

| | | | | | | | | | | | | | | | | | |
|--------------|----------------------|----------|----------|----------|----------|-------|-------|-------|-------|-------|-------|--|--|--|--|------|---|
| CA_n257(2A) | - | n257A | n257A | | | | | | | | | | | | | 800 | 0 |
| CA_n258(2A) | - | n258A | n258A | | | | | | | | | | | | | 800 | 0 |
| CA_n258(3A) | - | n258A | n258A | n258A | | | | | | | | | | | | 1200 | 0 |
| CA_n258(4A) | - | n258A | n258A | n258A | n258A | | | | | | | | | | | 1600 | 0 |
| CA_n258(5A) | - | n258A | n258A | n258A | n258A | n258A | | | | | | | | | | 2000 | 0 |
| CA_n260(2A) | CA_n260(2A) | n260A | n260A | | | | | | | | | | | | | 800 | 0 |
| CA_n260(3A) | CA_n260(3A) | n260A | n260A | n260A | | | | | | | | | | | | 1200 | 0 |
| CA_n260(4A) | - | n260A | n260A | n260A | n260A | | | | | | | | | | | 1600 | 0 |
| CA_n260(5A) | - | n260A | n260A | n260A | n260A | n260A | | | | | | | | | | 2000 | 0 |
| CA_n260(6A) | - | n260A | n260A | n260A | n260A | n260A | n260A | | | | | | | | | 2400 | 0 |
| CA_n260(7A) | - | n260A | n260A | n260A | n260A | n260A | n260A | n260A | | | | | | | | 2800 | 0 |
| CA_n260(8A) | - | n260A | n260A | n260A | n260A | n260A | n260A | n260A | n260A | | | | | | | 2900 | 0 |
| CA_n260(9A) | - | n260A | n260A | n260A | n260A | n260A | n260A | n260A | n260A | n260A | | | | | | 2950 | 0 |
| CA_n260(10A) | - | n260A | n260A | n260A | n260A | n260A | n260A | n260A | n260A | n260A | n260A | | | | | 2950 | 0 |
| CA_n260(2D) | - | CA_n260D | CA_n260D | | | | | | | | | | | | | 800 | 0 |
| CA_n260(2G) | CA_n260G | CA_n260G | CA_n260G | | | | | | | | | | | | | 400 | 0 |
| CA_n260(3G) | - | CA_n260G | CA_n260G | CA_n260G | | | | | | | | | | | | 600 | 0 |
| CA_n260(4G) | - | CA_n260G | CA_n260G | CA_n260G | CA_n260G | | | | | | | | | | | 800 | 0 |
| CA_n260(2H) | CA_n260H CA_n260H | CA_n260H | CA_n260H | | | | | | | | | | | | | 600 | 0 |
| CA_n260(2O) | - | CA_n260O | CA_n260O | | | | | | | | | | | | | 400 | 0 |
| CA_n260(3O) | - | CA_n260O | CA_n260O | CA_n260O | | | | | | | | | | | | 600 | 0 |
| CA_n260(4O) | - | CA_n260O | CA_n260O | CA_n260O | CA_n260O | | | | | | | | | | | 800 | 0 |
| CA_n260(2P) | - | CA_n260P | CA_n260P | | | | | | | | | | | | | 600 | 0 |
| CA_n260(3P) | - | CA_n260P | CA_n260P | CA_n260P | | | | | | | | | | | | 900 | 0 |
| CA_n260(4P) | - | CA_n260P | CA_n260P | CA_n260P | CA_n260P | | | | | | | | | | | 1200 | 0 |
| CA_n260(2Q) | - | CA_n260Q | CA_n260Q | | | | | | | | | | | | | 800 | 0 |
| CA_n261(2A) | - | n261A | n261A | | | | | | | | | | | | | 800 | 0 |
| CA_n261(3A) | - | n261A | n261A | n261A | | | | | | | | | | | | 800 | 0 |
| CA_n261(4A) | - | n261A | n261A | n261A | n261A | | | | | | | | | | | 800 | 0 |
| CA_n261(2D) | - | CA_n261D | CA_n261D | | | | | | | | | | | | | 800 | 0 |

| | | | | | | | | | | | | | | | | | | | |
|-------------|----------------------------------|--------------|--------------|--------------|--------------|--------------|--------------|--------------|--|--|--|--|--|--|--|--|--|-----|---|
| CA_n261(2G) | CA_n261G | CA_n26 1G | CA_n26 1G | | | | | | | | | | | | | | | 400 | 0 |
| CA_n261(3G) | - | CA_n26 1G | CA_n26 1G | CA_n26 1G | | | | | | | | | | | | | | 600 | 0 |
| CA_n261(4G) | - | CA_n26 1G | CA_n26 1G | CA_n26 1G | CA_n26 1G | | | | | | | | | | | | | 800 | 0 |
| CA_n261(2H) | CA_n261G CA_n261H | CA_n26 1H | CA_n26 1H | | | | | | | | | | | | | | | 600 | 0 |
| CA_n261(2I) | CA_n261G CA_n261H CA_n261I | CA_n26 1I | CA_n26 1I | | | | | | | | | | | | | | | 800 | 0 |
| CA_n261(2O) | - | CA_n26 1O | CA_n26 1O | | | | | | | | | | | | | | | 400 | 0 |
| CA_n261(3O) | - | CA_n26 1O | CA_n26 1O | CA_n26 1O | | | | | | | | | | | | | | 600 | 0 |
| CA_n261(4O) | - | CA_n26 1O | CA_n26 1O | CA_n26 1O | CA_n26 1O | | | | | | | | | | | | | 800 | 0 |
| CA_n261(5O) | - | CA_n26 1O | CA_n26 1O | CA_n26 1O | CA_n26 1O | CA_n26 1O | | | | | | | | | | | | 800 | 0 |
| CA_n261(6O) | - | CA_n26 1O | CA_n26 1O | CA_n26 1O | CA_n26 1O | CA_n26 1O | CA_n26 1O | | | | | | | | | | | 800 | 0 |
| CA_n261(7O) | - | CA_n26 1O | CA_n26 1O | CA_n26 1O | CA_n26 1O | CA_n26 1O | CA_n26 1O | CA_n2 61O | | | | | | | | | | 800 | 0 |
| CA_n261(2P) | - | CA_n26 1P | CA_n26 1P | | | | | | | | | | | | | | | 600 | 0 |
| CA_n261(2Q) | - | CA_n26 1Q | CA_n26 1Q | | | | | | | | | | | | | | | 800 | 0 |

NOTE 1: Void
 NOTE 2: Void
 NOTE 3: Void
 NOTE 4: Void
 NOTE 5: Channel bandwidth per operating band defined in Table 5.3.5-1
 NOTE 6: Unless otherwise stated, BCS0 is referred in each constituent CA configuration
 NOTE 7: $\Sigma(BW_{\text{Channel,block}})$ denotes the maximum total bandwidth from the summation of the sub-block bandwidths and shall be less than the bandwidth of the operating band.

Table 5.5A.2-2: NR CA configurations with multiple CA bandwidth classes defined for intra-band non-contiguous CA

| NR CA configuration / Bandwidth combination set | | | | | | | | | | | | | | | |
|---|--------------------------|-------------|-------------|-------------|-------------|-------------|-----------|-----------|-----------|-----------|-----------|-----------|-----------|--|-----|
| CA configuration | Uplink CA configurations | Sub-block | Sub-block | Sub-block | Sub-block | Sub-block | Sub-block | Sub-block | Sub-block | Sub-block | Sub-block | Sub-block | Sub-block | $\Sigma(BW_{\text{Chann el,block}})$ (MHz) | BCS |
| CA_n260(A-D) | - | n260A | CA_n260D | | | | | | | | | | | 800 | 0 |
| CA_n260(2A-D) | - | CA_n260(2A) | | CA_n260D | | | | | | | | | | 1200 | 0 |
| CA_n260(A-2D) | - | n260A | CA_n260(2D) | | | | | | | | | | | 1200 | 0 |
| CA_n260(2A-2D) | - | CA_n260(2A) | | CA_n260(2D) | | | | | | | | | | 1600 | 0 |
| CA_n260(A-D-O) | - | n260A | CA_n260D | CA_n260O | | | | | | | | | | 1000 | 0 |
| CA_n260(2A-D-O) | - | CA_n260(2A) | | CA_n260D | CA_n260O | | | | | | | | | 1400 | 0 |
| CA_n260(A-D-2O) | - | n260A | CA_n260D | CA_n260(2O) | | | | | | | | | | 1200 | 0 |
| CA_n260(2A-D-2O) | - | CA_n260(2A) | | CA_n260D | CA_n260(2O) | | | | | | | | | 1600 | 0 |
| CA_n260(A-G) | CA_n260G | n260A | CA_n260G | | | | | | | | | | | 600 | 0 |
| CA_n260(2A-G) | CA_n260G | CA_n260(2A) | | CA_n260G | | | | | | | | | | 1000 | 0 |
| CA_n260(A-2G) | CA_n260G | n260A | CA_n260(2G) | | | | | | | | | | | 800 | 0 |
| CA_n260(2A-2G) | CA_n260G | CA_n260(2A) | | CA_n260(2G) | | | | | | | | | | 1200 | 0 |
| CA_n260(2A-2G-O) | - | CA_n260(2A) | | CA_n260(2G) | | CA_n260O | | | | | | | | 1400 | 0 |
| CA_n260(2A-2G-2O) | - | CA_n260(2A) | | CA_n260(2G) | | CA_n260(2O) | | | | | | | | 1600 | 0 |
| CA_n260(3A-2G) | - | CA_n260(3A) | | | CA_n260(2G) | | | | | | | | | 1600 | 0 |
| CA_n260(4A-G) | - | CA_n260(4A) | | | | CA_n260G | | | | | | | | 1800 | 0 |
| CA_n260(4A-2G) | - | CA_n260(4A) | | | | CA_n260(2G) | | | | | | | | 2000 | 0 |
| CA_n260(A-2G-2O) | - | n260A | CA_n260(2G) | | CA_n260(2O) | | | | | | | | | 1200 | 0 |
| CA_n260(2A-G-2O) | - | CA_n260(2A) | | CA_n260G | CA_n260(2O) | | | | | | | | | 1400 | 0 |
| CA_n260(3A-G) | CA_n260G | CA_n260(3A) | | | CA_n260G | | | | | | | | | 1400 | 0 |
| CA_n260(A-2H) | - | n260A | CA_n260(2H) | | | | | | | | | | | 1000 | 0 |
| CA_n260(2A-H) | - | CA_n260(2A) | | CA_n260H | | | | | | | | | | 1100 | 0 |
| CA_n260(2A-2H) | - | CA_n260(2A) | | CA_n260(2H) | | | | | | | | | | 1400 | 0 |
| CA_n260(A-H) | CA_n260G CA_n260H | n260A | CA_n260H | | | | | | | | | | | 700 | 0 |
| CA_n260(A-O) | - | n260A | CA_n260O | | | | | | | | | | | 600 | 0 |

| | | | | | | | | | | | | | | |
|-------------------|---|-------------|-------------|-------------|-------------|-------------|----------|----------|--|--|--|--|------|---|
| CA_n260(A-O-P) | - | n260A | CA_n260O | CA_n260P | | | | | | | | | 900 | 0 |
| CA_n260(A-O-2P) | - | n260A | CA_n260O | CA_n260(2P) | | | | | | | | | 1200 | 0 |
| CA_n260(2A-O-P) | - | CA_n260(2A) | | CA_n260O | CA_n260P | | | | | | | | 1300 | 0 |
| CA_n260(2A-O-2P) | - | CA_n260(2A) | | CA_n260O | CA_n260(2P) | | | | | | | | 1600 | 0 |
| CA_n260(2A-2O-P) | - | CA_n260(2A) | | CA_n260(2O) | | CA_n260P | | | | | | | 1500 | 0 |
| CA_n260(A-O-Q) | - | n260A | CA_n260O | CA_n260Q | | | | | | | | | 1000 | 0 |
| CA_n260(A-O-2Q) | - | n260A | CA_n260O | CA_n260(2Q) | | | | | | | | | 1400 | 0 |
| CA_n260(2A-O-Q) | - | CA_n260(2A) | | CA_n260O | CA_n260Q | | | | | | | | 1400 | 0 |
| CA_n260(2A-O-2Q) | - | CA_n260(2A) | | CA_n260O | CA_n260(2Q) | | | | | | | | 1800 | 0 |
| CA_n260(2A-2O-Q) | - | CA_n260(2A) | | CA_n260(2O) | | CA_n260Q | | | | | | | 1600 | 0 |
| CA_n260(2A-O) | - | CA_n260(2A) | | CA_n260O | | | | | | | | | 1000 | 0 |
| CA_n260(A-2O) | - | n260A | CA_n260(2O) | | | | | | | | | | 800 | 0 |
| CA_n260(A-2O-P) | - | n260A | CA_n260(2O) | | CA_n260P | | | | | | | | 1100 | 0 |
| CA_n260(A-2O-2P) | - | n260A | CA_n260(2O) | | CA_n260(2P) | | | | | | | | 1400 | 0 |
| CA_n260(A-2O-Q) | - | n260A | CA_n260(2O) | | CA_n260Q | | | | | | | | 1200 | 0 |
| CA_n260(A-2O-2Q) | - | n260A | CA_n260(2O) | | CA_n260(2Q) | | | | | | | | 1600 | 0 |
| CA_n260(2A-2O) | - | CA_n260(2A) | | CA_n260(2O) | | | | | | | | | 1200 | 0 |
| CA_n260(2A-2O-2P) | - | CA_n260(2A) | | CA_n260(2O) | | CA_n260(2P) | | | | | | | 1800 | 0 |
| CA_n260(2A-2O-2Q) | - | CA_n260(2A) | | CA_n260(2O) | | CA_n260(2Q) | | | | | | | 2000 | 0 |
| CA_n260(2A-3O) | - | CA_n260(2A) | | CA_n260(3O) | | | | | | | | | 1400 | 0 |
| CA_n260(3A-2O) | - | CA_n260(3A) | | | CA_n260(2O) | | | | | | | | 1600 | 0 |
| CA_n260(4A-O) | - | CA_n260(4A) | | | | CA_n260O | | | | | | | 1800 | 0 |
| CA_n260(4A-3O) | - | CA_n260(4A) | | | | CA_n260(3O) | | | | | | | 2200 | 0 |
| CA_n260(5A-O) | - | CA_n260(5A) | | | | | CA_n260O | | | | | | 2200 | 0 |
| CA_n260(6A-O) | - | CA_n260(6A) | | | | | | CA_n260O | | | | | 2600 | 0 |

| | | | | | | | | | | | | |
|-----------------|----------------------|-------------|-------------|-------------|-------------|----------|--|--|--|--|------|---|
| CA_n260(7A-O) | - | CA_n260(7A) | | | | CA_n260O | | | | | 2950 | 0 |
| CA_n260(8A-O) | - | CA_n260(8A) | | | | CA_n260O | | | | | 2950 | 0 |
| CA_n260(4A-2O) | - | CA_n260(4A) | | CA_n260(2O) | | | | | | | 2000 | 0 |
| CA_n260(4A-2Q) | - | CA_n260(4A) | | CA_n260(2Q) | | | | | | | 2400 | 0 |
| CA_n260(3A-3O) | - | CA_n260(3A) | | CA_n260(3O) | | | | | | | 1800 | 0 |
| CA_n260(A-G-O) | - | n260A | CA_n260G | CA_n260O | | | | | | | 800 | 0 |
| CA_n260(A-G-2O) | - | n260A | CA_n260G | CA_n260(2O) | | | | | | | 1000 | 0 |
| CA_n260(2A-G-O) | - | CA_n260(2A) | | CA_n260G | CA_n260O | | | | | | 1200 | 0 |
| CA_n260(A-2G-O) | - | n260A | CA_n260(2G) | | CA_n260O | | | | | | 1000 | 0 |
| CA_n260(A-3O) | - | n260A | CA_n260(3O) | | | | | | | | 1000 | 0 |
| CA_n260(3A-O) | - | CA_n260(3A) | | | CA_n260O | | | | | | 1400 | 0 |
| CA_n260(3A-O-P) | CA_n260O CA_n260P | CA_n260(3A) | | | CA_n260O | CA_n260P | | | | | 1700 | 0 |
| CA_n260(A-4O) | - | n260A | CA_n260(4O) | | | | | | | | 1200 | 0 |
| CA_n260(2A-4O) | - | CA_n260(2A) | | CA_n260(4O) | | | | | | | 1600 | 0 |
| CA_n260(3A-4O) | - | CA_n260(3A) | | CA_n260(4O) | | | | | | | 2000 | 0 |
| CA_n260(4A-4O) | - | CA_n260(4A) | | | CA_n260(4O) | | | | | | 2400 | 0 |
| CA_n260(5A-4O) | - | CA_n260(5A) | | | CA_n260(4O) | | | | | | 2800 | 0 |
| CA_n260(A-P) | - | n260A | CA_n260P | | | | | | | | 700 | 0 |
| CA_n260(A-3P) | - | n260A | CA_n260(3P) | | | | | | | | 1300 | 0 |
| CA_n260(A-4P) | - | n260A | CA_n260(4P) | | | | | | | | 1600 | 0 |
| CA_n260(A-P-Q) | CA_n260P CA_n260Q | n260A | CA_n260P | CA_n260Q | | | | | | | 1100 | 0 |
| CA_n260(2A-P) | - | CA_n260(2A) | | CA_n260P | | | | | | | 1100 | 0 |
| CA_n260(3A-P) | - | CA_n260(3A) | | | CA_n260P | | | | | | 1500 | 0 |
| CA_n260(4A-P) | - | CA_n260(4A) | | | CA_n260P | | | | | | 1900 | 0 |
| CA_n260(5A-P) | - | CA_n260(5A) | | | CA_n260P | | | | | | 2300 | 0 |
| CA_n260(6A-P) | - | CA_n260(6A) | | | | CA_n260P | | | | | 2700 | 0 |
| CA_n260(A-2P) | - | n260A | CA_n260(2P) | | | | | | | | 1000 | 0 |
| CA_n260(2A-2P) | - | CA_n260(2A) | | CA_n260(2P) | | | | | | | 1400 | 0 |
| CA_n260(2A-3P) | - | CA_n260(2A) | | CA_n260(3P) | | | | | | | 1700 | 0 |
| CA_n260(2A-4P) | - | CA_n260(2A) | | CA_n260(4P) | | | | | | | 2000 | 0 |
| CA_n260(3A-2P) | - | CA_n260(3A) | | | CA_n260(2P) | | | | | | 1800 | 0 |

| | | | | | | | | | | | | | | |
|----------------|----------------------|-------------|-------------|-------------|-------------|-------------|--|--|-------------|--|--|--|------|---|
| CA_n260(4A-2P) | - | CA_n260(4A) | | CA_n260(2P) | | | | | | | | | 2200 | 0 |
| CA_n260(5A-2P) | - | CA_n260(5A) | | | CA_n260(2P) | | | | | | | | 2600 | 0 |
| CA_n260(5A-2O) | - | CA_n260(5A) | | | CA_n260(2O) | | | | | | | | 2400 | 0 |
| CA_n260(6A-2O) | - | CA_n260(6A) | | | CA_n260(2O) | | | | | | | | 2800 | 0 |
| CA_n260(5A-3O) | - | CA_n260(5A) | | | CA_n260(3O) | | | | | | | | 2600 | 0 |
| CA_n260(6A-3O) | - | CA_n260(6A) | | | CA_n260(3O) | | | | | | | | 2950 | 0 |
| CA_n260(7A-2O) | - | CA_n260(7A) | | | | CA_n260(2O) | | | | | | | 2950 | 0 |
| CA_n260(7A-3O) | - | CA_n260(7A) | | | | CA_n260(3O) | | | | | | | 2950 | 0 |
| CA_n260(6A-2P) | - | CA_n260(6A) | | | CA_n260(2P) | | | | | | | | 2950 | 0 |
| CA_n260(8A-2O) | - | CA_n260(8A) | | | | | | | CA_n260(2O) | | | | 2550 | 0 |
| CA_n260(A-Q) | - | n260A | CA_n260Q | | | | | | | | | | 800 | 0 |
| CA_n260(A-2Q) | - | n260A | CA_n260(2Q) | | | | | | | | | | 1200 | 0 |
| CA_n260(2A-Q) | - | CA_n260(2A) | | CA_n260Q | | | | | | | | | 1200 | 0 |
| CA_n260(2A-2Q) | - | CA_n260(2A) | | CA_n260(2Q) | | | | | | | | | 1600 | 0 |
| CA_n260(3A-Q) | - | CA_n260(3A) | | | CA_n260Q | | | | | | | | 1600 | 0 |
| CA_n260(3A-2Q) | - | CA_n260(3A) | | | CA_n260(2Q) | | | | | | | | 2000 | 0 |
| CA_n260(4A-Q) | - | CA_n260(4A) | | | CA_n260Q | | | | | | | | 2000 | 0 |
| CA_n260(D-2G) | - | CA_n260D | CA_n260(2G) | | | | | | | | | | 800 | 0 |
| CA_n260(2D-O) | - | CA_n260(2D) | | CA_n260O | | | | | | | | | 1000 | 0 |
| CA_n260(D-2O) | - | CA_n260D | CA_n260(2O) | | | | | | | | | | 800 | 0 |
| CA_n260(A-I) | CA_n260I | n260A | CA_n260I | | | | | | | | | | 800 | 0 |
| CA_n260(D-G) | CA_n260D CA_n260G | CA_n260D | CA_n260G | | | | | | | | | | 600 | 0 |
| CA_n260(D-H) | CA_n260D CA_n260H | CA_n260D | CA_n260H | | | | | | | | | | 700 | 0 |
| CA_n260(D-I) | CA_n260D CA_n260I | CA_n260D | CA_n260I | | | | | | | | | | 800 | 0 |
| CA_n260(D-O) | CA_n260D CA_n260O | CA_n260D | CA_n260O | | | | | | | | | | 600 | 0 |
| CA_n260(D-P) | CA_n260D CA_n260P | CA_n260D | CA_n260P | | | | | | | | | | 700 | 0 |
| CA_n260(D-Q) | CA_n260D CA_n260Q | CA_n260D | CA_n260Q | | | | | | | | | | 800 | 0 |
| CA_n260(E-O) | CA_n260E CA_n260O | CA_n260O | CA_n260E | | | | | | | | | | 800 | 0 |
| CA_n260(E-P) | | CA_n260E | | | | | | | | | | | 800 | 0 |

| | | | | | | | | | | | | | | | | |
|------------------|----------------------------------|-------|--------------|--------------|--------------|--------------|--|--|--|--|--|--|--|--|-----|---|
| CA_n261(A-2D) | - | n261A | CA_n261(2D) | | | | | | | | | | | | 800 | 0 |
| CA_n261(A-D-H) | - | n261A | CA_n2 61D | CA_n261 H | | | | | | | | | | | 800 | 0 |
| CA_n261(A-D-O) | - | n261A | CA_n2 61D | CA_n261 O | | | | | | | | | | | 800 | 0 |
| CA_n261(A-D-2O) | - | n261A | CA_n2 61D | CA_n261(2O) | | | | | | | | | | | 800 | 0 |
| CA_n261(A-G) | CA_n261G | n261A | CA_n2 61G | | | | | | | | | | | | 600 | 0 |
| CA_n261(A-G-H) | CA_n261G CA_n261H | n261A | CA_n2 61G | CA_n261 H | | | | | | | | | | | 800 | 0 |
| CA_n261(A-G-I) | CA_n261G CA_n261H CA_n261I | n261A | CA_n2 61G | CA_n261I | | | | | | | | | | | 800 | 0 |
| CA_n261(A-G-O) | - | n261A | CA_n2 61G | CA_n261 O | | | | | | | | | | | 800 | 0 |
| CA_n261(A-G-2O) | - | n261A | CA_n2 61G | CA_n261(2O) | | | | | | | | | | | 800 | 0 |
| CA_n261(A-2G-O) | - | n261A | CA_n261(2G) | | CA_n26 1O | | | | | | | | | | 800 | 0 |
| CA_n261(A-2G-2O) | - | n261A | CA_n261(2G) | | CA_n261(2O) | | | | | | | | | | 800 | 0 |
| CA_n261(A-3G) | - | n261A | CA_n261(3G) | | | | | | | | | | | | 800 | 0 |
| CA_n261(A-3G-O) | - | n261A | CA_n261(3G) | | | CA_n261 O | | | | | | | | | 800 | 0 |
| CA_n261(A-2G) | CA_n261G | n261A | CA_n261(2G) | | | | | | | | | | | | 800 | |
| CA_n261(A-4G) | - | n261A | CA_n261(4G) | | | | | | | | | | | | 800 | 0 |
| CA_n261(A-H) | CA_n261G CA_n261H | n261A | CA_n2 61H | | | | | | | | | | | | 700 | 0 |
| CA_n261(A-2H) | - | n261A | CA_n261(2H) | | | | | | | | | | | | 800 | 0 |
| CA_n261(A-H-I) | - | n261A | CA_n2 61H | CA_n261I | | | | | | | | | | | 800 | 0 |
| CA_n261(A-I) | CA_n261G CA_n261H CA_n261I | n261A | CA_n2 61I | | | | | | | | | | | | 800 | 0 |
| CA_n261(A-2I) | - | n261A | CA_n261(2I) | | | | | | | | | | | | 800 | 0 |
| CA_n261(A-J) | CA_n261G CA_n261H CA_n261I | n261A | CA_n2 61J | | | | | | | | | | | | 700 | 0 |
| CA_n261(A-K) | CA_n261G CA_n261H CA_n261I | n261A | CA_n2 61K | | | | | | | | | | | | 800 | 0 |
| CA_n261(A-O) | - | n261A | CA_n2 61O | | | | | | | | | | | | 600 | 0 |
| CA_n261(A-2O) | - | n261A | CA_n261(2O) | | | | | | | | | | | | 800 | 0 |
| CA_n261(A-3O) | - | n261A | CA_n261(3O) | | | | | | | | | | | | 800 | 0 |

| | | | | | | | | | | | | | |
|---------------|----------------------------------|--------------|--------------|--------------|--------------|--|--|--|--|--|-----|-----|---|
| CA_n261(A-4O) | - | n261A | CA_n261(4O) | | | | | | | | | 800 | 0 |
| CA_n261(A-5O) | - | n261A | CA_n261(5O) | | | | | | | | | 800 | 0 |
| CA_n261(A-6O) | - | n261A | CA_n261(6O) | | | | | | | | | 800 | 0 |
| CA_n261(A-7O) | - | n261A | CA_n261(7O) | | | | | | | | | 800 | 0 |
| CA_n261(A-P) | - | n261A | CA_n2 61P | | | | | | | | 700 | 0 | |
| CA_n261(A-2P) | - | n261A | CA_n261(2P) | | | | | | | | | 800 | 0 |
| CA_n261(A-Q) | - | n261A | CA_n2 61Q | | | | | | | | 800 | 0 | |
| CA_n261(A-2Q) | - | n261A | CA_n261(2Q) | | | | | | | | | 800 | 0 |
| CA_n261(2A-G) | CA_n261G | CA_n261(2A) | | CA_n261 G | | | | | | | 800 | 0 | |
| CA_n261(2A-H) | CA_n261G CA_n261H | CA_n261(2A) | | CA_n261 H | | | | | | | 800 | 0 | |
| CA_n261(2A-I) | CA_n261G CA_n261H CA_n261I | CA_n261(2A) | | CA_n261I | | | | | | | 800 | 0 | |
| CA_n261(3A-G) | CA_n261G | CA_n261(3A) | | | CA_n26 1G | | | | | | 800 | 0 | |
| CA_n261(D-G) | CA_n261D CA_n261G | CA_n261 D | CA_n2 61G | | | | | | | | 600 | 0 | |
| CA_n261(D-H) | CA_n261D CA_n261H | CA_n261 D | CA_n2 61H | | | | | | | | 700 | 0 | |
| CA_n261(D-I) | CA_n261D CA_n261I | CA_n261 D | CA_n2 61I | | | | | | | | 800 | 0 | |
| CA_n261(D-O) | CA_n261D CA_n261O | CA_n261 D | CA_n2 61O | | | | | | | | 600 | 0 | |
| CA_n261(D-2O) | - | CA_n261 D | CA_n261(2O) | | | | | | | | | 800 | 0 |
| CA_n261(D-P) | CA_n261D CA_n261P | CA_n261 D | CA_n2 61P | | | | | | | | 700 | 0 | |
| CA_n261(D-Q) | CA_n261D CA_n261Q | CA_n261 D | CA_n2 61Q | | | | | | | | 800 | 0 | |
| CA_n261(E-O) | CA_n261E CA_n261O | CA_n261E | CA_n2 61O | | | | | | | | 800 | 0 | |
| CA_n261(E-P) | CA_n261E CA_n261P | CA_n261E | CA_n2 61P | | | | | | | | 800 | 0 | |
| CA_n261(E-Q) | CA_n261E CA_n261Q | CA_n261E | CA_n2 61Q | | | | | | | | 800 | 0 | |
| CA_n261(G-I) | CA_n261G CA_n261H CA_n261I | CA_n261 G | CA_n2 61I | | | | | | | | 600 | 0 | |
| CA_n261(G-H) | CA_n261G CA_n261H | CA_n261 G | CA_n2 61H | | | | | | | | 500 | 0 | |

| | | | | | | | | | | | | | | | |
|----------------|----------------------------------|--------------|--------------|--------------|--------------|--|--|--|--|--|--|--|--|-----|---|
| CA_n261(2G-2O) | - | CA_n261(2G) | | CA_n261(2O) | | | | | | | | | | 800 | 0 |
| CA_n261(G-O) | - | CA_n261 G | CA_n2 61O | | | | | | | | | | | 400 | 0 |
| CA_n261(G-2O) | - | CA_n261 G | CA_n261(2O) | | | | | | | | | | | 600 | 0 |
| CA_n261(2G-O) | - | CA_n261(2G) | | CA_n261 O | | | | | | | | | | 600 | 0 |
| CA_n261(3G-O) | - | CA_n261(3G) | | | CA_n26 1O | | | | | | | | | 800 | 0 |
| CA_n261(H-I) | CA_n261G CA_n261H CA_n261I | CA_n261 H | CA_n2 61I | | | | | | | | | | | 700 | 0 |

NOTE 1: Void
 NOTE 2: Void
 NOTE 3: Channel bandwidth per operating band defined in Table 5.3.5-1
 NOTE 4: Configurations for intra-band contiguous CA defined in Table 5.5A.1-1
 NOTE 5: Configurations for intra-band non-contiguous CA defined in Table 5.5A.2-1
 NOTE 6: Void
 NOTE 7: Unless otherwise stated, BCS0 is referred in each constituent CA configuration.
 NOTE 8: $\Sigma(BW_{Channel,block})$ denotes the maximum total bandwidth from the summation of the sub-block bandwidths and shall be less than the bandwidth of the operating band.

5.5A.3 Configurations for inter-band CA

Table 5.5A.3-1: NR CA configurations for inter-band CA

| NR CA configuration | Uplink CA configuration | NR Band | Channel bandwidth (MHz) (NOTE 1) | | | | Bandwidth combination set |
|---------------------|-------------------------|---------|----------------------------------|-----|-----|-----|---------------------------|
| | | | 50 | 100 | 200 | 400 | |
| CA_n260A-n261A | - | n260 | 50 | 100 | 200 | 400 | 0 |
| | | n261 | 50 | 100 | 200 | 400 | |

NOTE 1: The SCS of each channel bandwidth for NR band refers to Table 5.3.5-1.

5.5D Configurations for UL MIMO

The requirements specified in clause 5.5 are applicable to UE supporting UL MIMO.

6 Transmitter characteristics

6.1 General

Unless otherwise stated, the transmitter characteristics are specified over the air (OTA) with a single or multiple transmit chains.

Unless otherwise stated, for power class 3 UEs, the beam correspondence side condition for SSB and CSI-RS specified in clause 6.6.4 shall apply to the transmission tests.

Transmitter requirements for CA operation apply only when the DMRS initialization parameters (including the case when the UE applies cell ID as DMRS scrambling ID) are different across all CCs. The UE may use higher MPR values outside this limitation.

For a UE that supports 'UL full power transmission' and is configured to transmit a single layer with $nrofSRS\text{-}Ports = 2$, the requirements for UL MIMO operation apply only when it is configured for any of its declared full power modes in IE *FullPowerTransmission-r16* (as defined in TS 38.331[13]).

For a UE configured to transmit 2 layers, transmitter requirements for UL MIMO operation apply when the UE transmits on 2 ports on the same CDM group. The UE may use higher MPR values outside this limitation.

6.2 Transmitter power

6.2.1 UE maximum output power

6.2.1.0 General

NOTE: Power class 1, 2, 3, and 4 are specified based on the assumption of certain UE types with specific device architectures. The UE types can be found in Table 6.2.1.0-1.

Table 6.2.1.0-1: Assumption of UE Types

| UE Power class | UE type |
|----------------|--------------------------------|
| 1 | Fixed wireless access (FWA) UE |
| 2 | Vehicular UE |
| 3 | Handheld UE |
| 4 | High power non-handheld UE |

Power class 3 is default power class.

6.2.1.1 UE maximum output power for power class 1

The following requirements define the maximum output power radiated by the UE for any transmission bandwidth within the channel bandwidth for non-CA configuration, unless otherwise stated. The period of measurement shall be at least one sub frame (1ms). The minimum output power values for EIRP are found in Table 6.2.1.1-1. The requirement is verified with the test metric of EIRP (Link=TX beam peak direction, Meas=Link angle).

Table 6.2.1.1-1: UE minimum peak EIRP for power class 1

| Operating band | Min peak EIRP (dBm) |
|----------------|---------------------|
| n257 | 40.0 |
| n258 | 40.0 |
| n260 | 38.0 |
| n261 | 40.0 |

NOTE 1: Minimum peak EIRP is defined as the lower limit without tolerance

The maximum output power values for TRP and EIRP are found in Table 6.2.1.1-2 below. The maximum allowed EIRP is derived from regulatory requirements [8]. The requirements are verified with the test metrics of TRP (Link=TX beam peak direction, Meas=TRP grid) in beam locked mode and EIRP (Link=TX beam peak direction, Meas=Link angle).

Table 6.2.1.1-2: UE maximum output power limits for power class 1

| Operating band | Max TRP (dBm) | Max EIRP (dBm) |
|----------------|---------------|----------------|
| n257 | 35 | 55 |
| n258 | 35 | 55 |
| n260 | 35 | 55 |
| n261 | 35 | 55 |

The minimum EIRP at the 85th percentile of the distribution of radiated power measured over the full sphere around the UE is defined as the spherical coverage requirement and is found in Table 6.2.1.1-3 below. The requirement is verified with the test metric of EIRP (Link=Spherical coverage grid, Meas=Link angle).

Table 6.2.1.1-3: UE spherical coverage for power class 1

| Operating band | Min EIRP at 85 %-tile CDF (dBm) |
|----------------|---------------------------------|
| n257 | 32.0 |
| n258 | 32.0 |
| n260 | 30.0 |
| n261 | 32.0 |

NOTE 1: Minimum EIRP at 85 %-tile CDF is defined as the lower limit without tolerance
NOTE 2: The requirements in this table are verified only under normal temperature conditions as defined in Annex E.2.1.

6.2.1.2 UE maximum output power for power class 2

The following requirements define the maximum output power radiated by the UE for any transmission bandwidth within the channel bandwidth for non-CA configuration, unless otherwise stated. The period of measurement shall be at least one sub frame (1ms). The minimum output power values for EIRP are found in Table 6.2.1.2-1. The requirement is verified with the test metric of EIRP (Link=TX beam peak direction, Meas=Link angle).

Table 6.2.1.2-1: UE minimum peak EIRP for power class 2

| Operating band | Min peak EIRP (dBm) |
|----------------|---------------------|
| n257 | 29 |
| n258 | 29 |
| n261 | 29 |

NOTE 1: Minimum peak EIRP is defined as the lower limit without tolerance

The maximum output power values for TRP and EIRP are found in Table 6.2.1.2-2 below. The maximum allowed EIRP is derived from regulatory requirements [8]. The requirements are verified with the test metrics of TRP (Link=TX beam peak direction, Meas=TRP grid) in beam locked mode and EIRP (Link=TX beam peak direction, Meas=Link angle).

Table 6.2.1.2-2: UE maximum output power limits for power class 2

| Operating band | Max TRP (dBm) | Max EIRP (dBm) |
|----------------|---------------|----------------|
| n257 | 23 | 43 |
| n258 | 23 | 43 |
| n261 | 23 | 43 |

The minimum EIRP at the 60th percentile of the distribution of radiated power measured over the full sphere around the UE is defined as the spherical coverage requirement and is found in Table 6.2.1.2-3 below. The requirement is verified with the test metric of EIRP (Link=Spherical coverage grid, Meas=Link angle).

Table 6.2.1.2-3: UE spherical coverage for power class 2

| Operating band | Min EIRP at 60 %-tile CDF (dBm) |
|---|---------------------------------|
| n257 | 18.0 |
| n258 | 18.0 |
| n261 | 18.0 |
| NOTE 1: Minimum EIRP at 60 %-tile CDF is defined as the lower limit without tolerance | |
| NOTE 2: The requirements in this table are verified only under normal temperature conditions as defined in Annex E.2.1. | |

6.2.1.3 UE maximum output power for power class 3

The following requirements define the maximum output power radiated by the UE for any transmission bandwidth within the channel bandwidth for non-CA configuration, unless otherwise stated. The period of measurement shall be at least one sub frame (1ms). The minimum output power values for EIRP are found in Table 6.2.1.3-1. The requirement is verified with the test metric of total component of EIRP (Link=TX beam peak direction, Meas=Link angle). The requirement for the UE which supports a single FR2 band is specified in Table 6.2.1.3-1. The requirement for the UE which supports multiple FR2 bands is specified in both Table 6.2.1.3-1 and Table 6.2.1.3-4.

Table 6.2.1.3-1: UE minimum peak EIRP for power class 3

| Operating band | Min peak EIRP (dBm) |
|---|---------------------|
| n257 | 22.4 |
| n258 | 22.4 |
| n259 | 18.7 |
| n260 | 20.6 |
| n261 | 22.4 |
| NOTE 1: Minimum peak EIRP is defined as the lower limit without tolerance | |
| NOTE 2: Void | |

The maximum output power values for TRP and EIRP are found on the Table 6.2.1.3-2. The max allowed EIRP is derived from regulatory requirements [8]. The requirements are verified with the test metrics of TRP (Link=TX beam peak direction, Meas=TRP grid) in beam locked mode and the total component of EIRP (Link=TX beam peak direction, Meas=Link angle).

Table 6.2.1.3-2: UE maximum output power limits for power class 3

| Operating band | Max TRP (dBm) | Max EIRP (dBm) |
|----------------|---------------|----------------|
| n257 | 23 | 43 |
| n258 | 23 | 43 |
| n259 | 23 | 43 |
| n260 | 23 | 43 |
| n261 | 23 | 43 |

The minimum EIRP at the 50th percentile of the distribution of radiated power measured over the full sphere around the UE is defined as the spherical coverage requirement and is found in Table 6.2.1.3-3 below. The requirement is verified with the test metric of the total component of EIRP (Link=Beam peak search grids, Meas=Link angle). The requirement for the UE which supports a single FR2 band is specified in Table 6.2.1.3-3. The requirement for the UE which supports multiple FR2 bands is specified in both Table 6.2.1.3-3 and Table 6.2.1.3-4.

Table 6.2.1.3-3: UE spherical coverage for power class 3

| Operating band | Min EIRP at 50 %-tile CDF (dBm) |
|---|---------------------------------|
| n257 | 11.5 |
| n258 | 11.5 |
| n259 | 5.8 |
| n260 | 8 |
| n261 | 11.5 |
| NOTE 1: Minimum EIRP at 50 %-tile CDF is defined as the lower limit without tolerance | |
| NOTE 2: Void | |
| NOTE 3: The requirements in this table are verified only under normal temperature conditions as defined in Annex E.2.1. | |

For the UEs that support multiple FR2 bands, minimum requirement for peak EIRP and EIRP spherical coverage in Tables 6.2.1.3-1 and 6.2.1.3-3 shall be decreased per band, respectively, by the peak EIRP relaxation parameter $\Delta MB_{P,n}$ and EIRP spherical coverage relaxation parameter $\Delta MB_{S,n}$, as defined in Table 6.2.1.3-4..

Table 6.2.1.3-4: UE multi-band relaxation factors for power class 3

| Band | $\Delta MB_{P,n}$ (dB) | $\Delta MB_{S,n}$ (dB) |
|---|------------------------|------------------------|
| n257 | 0.7 ³ | 0.7 ³ |
| n258 | 0.6 | 0.7 |
| n259 | 0.5 | 0.4 |
| n260 | 0.5 ¹ | 0.4 ¹ |
| n261 | 0.5 ^{2,4} | 0.7 ⁴ |
| Note 1: n260 peak and spherical relaxations are 0 dB for UE that exclusively supports n261+n260 | | |
| Note 2: n261 peak relaxation is 0 dB for UE that exclusively supports n261+n260 | | |
| Note 3: n257 peak and spherical relaxations are 0 dB for UE that exclusively supports n261+n257 | | |
| Note 4: n261 peak and spherical relaxations are 0 dB for UE that exclusively supports n261+n257 | | |

6.2.1.4 UE maximum output power for power class 4

The following requirements define the maximum output power radiated by the UE for any transmission bandwidth within the channel bandwidth for non-CA configuration, unless otherwise stated. The period of measurement shall be at least one sub frame (1ms). The minimum output power values for EIRP are found in Table 6.2.1.4-1. The requirement is verified with the test metric of EIRP (Link=TX beam peak direction, Meas=Link angle).

Table 6.2.1.4-1: UE minimum peak EIRP for power class 4

| Operating band | Min peak EIRP (dBm) |
|---|---------------------|
| n257 | 34 |
| n258 | 34 |
| n260 | 31 |
| n261 | 34 |
| NOTE 1: Minimum peak EIRP is defined as the lower limit without tolerance | |

The maximum output power values for TRP and EIRP are found in Table 6.2.1.4-2 below. The maximum allowed EIRP is derived from regulatory requirements [8]. The requirements are verified with the test metrics of TRP (Link=TX beam peak direction, Meas=TRP grid) in beam locked mode and EIRP (Link=TX beam peak direction, Meas=Link angle).

Table 6.2.1.4-2: UE maximum output power limits for power class 4

| Operating band | Max TRP (dBm) | Max EIRP (dBm) |
|----------------|---------------|----------------|
| n257 | 23 | 43 |
| n258 | 23 | 43 |
| n260 | 23 | 43 |
| n261 | 23 | 43 |

The minimum EIRP at the 20th percentile of the distribution of radiated power measured over the full sphere around the UE is defined as the spherical coverage requirement and is found in Table 6.2.1.4-3 below. The requirement is verified with the test metric of EIRP (Link=Spherical coverage grid, Meas=Link angle).

Table 6.2.1.4-3: UE spherical coverage for power class 4

| Operating band | Min EIRP at 20 %-tile CDF (dBm) |
|----------------|---------------------------------|
| n257 | 25 |
| n258 | 25 |
| n260 | 19 |
| n261 | 25 |

NOTE 1: Minimum EIRP at 20 %-tile CDF is defined as the lower limit without tolerance
NOTE 2: The requirements in this table are verified only under normal temperature conditions as defined in Annex E.2.1.

6.2.2 UE maximum output power reduction

6.2.2.0 General

The requirements in clause 6.2.2 only apply when both UL and DL of a UE are configured for single CC operation, and they are of the same bandwidth. A UE may reduce its maximum output power due to modulation orders, transmit bandwidth configurations, waveform types and narrow allocations. This Maximum Power Reduction (MPR) is defined in clauses below. The allowed MPR for SRS, PUCCH formats 0, 1, 3 and 4, and PRACH shall be as specified for QPSK modulated DFT-s-OFDM of equivalent RB allocation. The allowed MPR for PUCCH format 2 shall be as specified for QPSK modulated CP-OFDM of equivalent RB allocation. When the maximum output power of a UE is modified by MPR, the power limits specified in clause 6.2.4 apply.

For a UE that is configured for single CC operation with different channel bandwidths in UL and DL, the requirements in clause 6.2A.2 apply.

For all power classes, the waveform defined by BW = 100 MHz, SCS = 120 kHz, DFT-S-OFDM QPSK, 20RB23 is the reference waveform with 0 dB MPR and is used for the power class definition.

6.2.2.1 UE maximum output power reduction for power class 1

For power class 1, MPR for contiguous allocations is defined as:

$$\text{MPR} = \max(\text{MPR}_{\text{WT}}, \text{MPR}_{\text{narrow}})$$

Where,

$\text{MPR}_{\text{narrow}} = 14.4$ dB, when $\text{BW}_{\text{alloc, RB}} \leq 1.44$ MHz, $\text{MPR}_{\text{narrow}} = 10$ dB, when 1.44 MHz $< \text{BW}_{\text{alloc, RB}} \leq 10.8$ MHz, where $\text{BW}_{\text{alloc, RB}}$ is the bandwidth of the RB allocation size.

MPR_{WT} is the maximum power reduction due to modulation orders, transmission bandwidth configurations listed in table 5.3.2-1, and waveform types. MPR_{WT} is defined in Tables 6.2.2.1-1 and 6.2.2.1-2.

Table 6.2.2.1-1 MPR_{WT} for power class 1, BW_{channel} ≤ 200 MHz

| Modulation | | MPR _{WT} (dB), BW _{channel} ≤ 200 MHz | | |
|------------|-----------|---|----------------------|----------|
| | | Outer RB allocations | Inner RB allocations | |
| | | | Region 1 | Region 2 |
| DFT-s-OFDM | Pi/2 BPSK | ≤ 5.5 | 0.0 | ≤ 3.0 |
| | QPSK | ≤ 6.5 | 0.0 | ≤ 3.0 |
| | 16 QAM | ≤ 6.5 | ≤ 4.0 | ≤ 4.0 |
| | 64 QAM | ≤ 6.5 | ≤ 5.0 | ≤ 5.0 |
| CP-OFDM | QPSK | ≤ 7.0 | ≤ 4.5 | ≤ 4.5 |
| | 16 QAM | ≤ 7.0 | ≤ 5.5 | ≤ 5.5 |
| | 64 QAM | ≤ 7.5 | ≤ 7.5 | ≤ 7.5 |

Table 6.2.2.1-2 MPR_{WT} for power class 1, BW_{channel} = 400 MHz

| Modulation | | MPR _{WT} (dB), BW _{channel} = 400 MHz | | |
|------------|-----------|---|----------------------|----------|
| | | Outer RB allocations | Inner RB allocations | |
| | | | Region 1 | Region 2 |
| DFT-s-OFDM | Pi/2 BPSK | ≤ 5.5 | 0.0 | ≤ 3.0 |
| | QPSK | ≤ 6.5 | 0.0 | ≤ 3.5 |
| | 16 QAM | ≤ 6.5 | ≤ 4.5 | ≤ 4.5 |
| | 64 QAM | ≤ 6.5 | ≤ 6.5 | ≤ 6.5 |
| CP-OFDM | QPSK | ≤ 7.0 | ≤ 5.0 | ≤ 5.0 |
| | 16 QAM | ≤ 7.0 | ≤ 6.5 | ≤ 6.5 |
| | 64 QAM | ≤ 9.0 | ≤ 9.0 | ≤ 9.0 |

Where the following parameters are defined to specify valid RB allocation ranges for the RB allocations regions in Tables 6.2.2.1-1 and 6.2.2.1-2:

N_{RB} is the maximum number of RBs for a given Channel bandwidth and sub-carrier spacing defined in Table 5.3.2-1.

$$RB_{end} = RB_{start} + L_{CRB} - 1$$

$$RB_{start,Low} = \text{Max}(1, \text{Floor}(L_{CRB}/2))$$

$$RB_{start,High} = N_{RB} - RB_{start,Low} - L_{CRB}$$

An RB allocation is an Outer RB allocation if

$$RB_{start} < RB_{start,Low} \text{ OR } RB_{start} > RB_{start,High} \text{ OR } L_{CRB} > \text{Ceil}(N_{RB}/2)$$

An RB allocation belonging to table 6.2.2.1-1 is a Region 1 inner RB allocation if

$$RB_{start} \geq \text{Ceil}(1/3 N_{RB}) \text{ AND } RB_{end} < \text{Ceil}(2/3 N_{RB})$$

An RB allocation belonging to table 6.2.2.1-2 is a Region 1 inner RB allocation if

$$RB_{start} \geq \text{Ceil}(1/4 N_{RB}) \text{ AND } RB_{end} < \text{Ceil}(3/4 N_{RB}) \text{ AND } L_{CRB} \leq \text{Ceil}(1/4 N_{RB})$$

An RB allocation is a Region 2 inner allocation if it is NOT an Outer allocation AND NOT a Region 1 inner allocation

For the UE maximum output power modified by MPR, the power limits specified in clause 6.2.4 apply.

6.2.2.2 UE maximum output power reduction for power class 2

For power class 2, MPR specified in clause 6.2.2.3 applies.

Table 6.2.2.2-1: Void

6.2.2.3 UE maximum output power reduction for power class 3

For power class 3, MPR for contiguous allocations is defined as:

$$\text{MPR} = \max(\text{MPR}_{\text{WT}}, \text{MPR}_{\text{narrow}})$$

For transmission bandwidth configuration less than or equal to 200MHz, and $0 \leq \text{RB}_{\text{start}} < \text{Ceil}(1/3 N_{\text{RB}})$ or $\text{Ceil}((2/3N_{\text{RB}}) - L_{\text{CRB}}) < \text{RB}_{\text{start}} \leq N_{\text{RB}} - L_{\text{CRB}}$:

- $\text{MPR}_{\text{narrow}} = 2.5$ dB, when $\text{BW}_{\text{alloc, RB}}$ is less than or equal to 1.44 MHz,
- $\text{MPR}_{\text{narrow}} = 2.0$ dB, when $1.44 \text{ MHz} < \text{BW}_{\text{alloc, RB}} \leq 4.32 \text{ MHz}$,
- otherwise $\text{MPR}_{\text{narrow}} = 0$ dB.

MPR_{WT} is the maximum power reduction due to modulation orders, transmission bandwidth configurations listed in Table 5.3.2-1, and waveform types. MPR_{WT} is defined in Table 6.2.2.3-1.

Table 6.2.2.3-1 MPR_{WT} for power class 3, $\text{BW}_{\text{channel}} \leq 200$ MHz

| Modulation | | $\text{MPR}_{\text{WT}}, \text{BW}_{\text{channel}} \leq 200$ MHz | |
|------------|-----------|---|---------------------|
| | | Inner RB allocations, Region 1 | Edge RB allocations |
| DFT-s-OFDM | Pi/2 BPSK | 0.0 | ≤ 2.0 |
| | QPSK | 0.0 | ≤ 2.0 |
| | 16 QAM | ≤ 3.0 | ≤ 3.5 |
| | 64 QAM | ≤ 5.0 | ≤ 5.5 |
| CP-OFDM | QPSK | ≤ 3.5 | ≤ 4.0 |
| | 16 QAM | ≤ 5.0 | ≤ 5.0 |
| | 64 QAM | ≤ 7.5 | ≤ 7.5 |

Where the following parameters are defined to specify valid RB allocation ranges for RB allocations in Table 6.2.2.3-1:

- $\text{RB}_{\text{Start, Low}} = \max(1, L_{\text{CRB}})$, where $\max()$ indicates the largest value of all arguments.
- $\text{RB}_{\text{Start, High}} = N_{\text{RB}} - \text{RB}_{\text{Start, Low}} - L_{\text{CRB}}$.

An RB allocation belonging to table 6.2.2.3-1 is a Region 1 inner RB allocation if:

- $\text{RB}_{\text{Start, Low}} \leq \text{RB}_{\text{Start}} \leq \text{RB}_{\text{Start, High}}$, and $L_{\text{CRB}} \leq \text{ceil}(N_{\text{RB}}/3)$, where $\text{ceil}(x)$ is the smallest integer greater than or equal to x .

For transmission bandwidth configuration equal to 400MHz,

$\text{MPR}_{\text{narrow}} = 2.5$ dB, when $\text{BW}_{\text{alloc, RB}}$ is less than or equal to 1.44 MHz, and $0 \leq \text{RB}_{\text{start}} < \text{Ceil}(1/3 N_{\text{RB}})$ or $\text{Ceil}(2/3N_{\text{RB}}) \leq \text{RB}_{\text{start}} \leq N_{\text{RB}} - L_{\text{CRB}}$, where $\text{BW}_{\text{alloc, RB}}$ is the bandwidth of the RB allocation size.

MPR_{WT} is the maximum power reduction due to modulation orders, transmission bandwidth configurations listed in Table 5.3.2-1, and waveform types. MPR_{WT} is defined in Table 6.2.2.3-2.

Table 6.2.2.3-2 MPR_{WT} for power class 3, BW_{channel} = 400 MHz

| Modulation | | MPR _{WT} , BW _{channel} = 400 MHz | |
|------------|-----------|---|---------------------|
| | | Inner RB allocations, Region 1 | Edge RB allocations |
| DFT-s-OFDM | Pi/2 BPSK | 0.0 | ≤ 3.0 |
| | QPSK | 0.0 | ≤ 3.0 |
| | 16 QAM | ≤ 4.5 | ≤ 4.5 |
| | 64 QAM | ≤ 6.5 | ≤ 6.5 |
| CP-OFDM | QPSK | ≤ 5.0 | ≤ 5.0 |
| | 16 QAM | ≤ 6.5 | ≤ 6.5 |
| | 64 QAM | ≤ 9.0 | ≤ 9.0 |

Where the following parameters are defined to specify valid RB allocation ranges for RB allocations in Table 6.2.2.3-2:

N_{RB} is the maximum number of RBs for a given Channel bandwidth and sub-carrier spacing defined in Table 5.3.2-1.

$$RB_{end} = RB_{start} + L_{CRB} - 1$$

An RB allocation belonging to table 6.2.2.3-2 is a Region 1 inner RB allocation if

$$RB_{start} \geq \text{Ceil}(1/4 N_{RB}) \text{ AND } RB_{end} < \text{Ceil}(3/4 N_{RB}) \text{ AND } L_{CRB} \leq \text{Ceil}(1/4 N_{RB})$$

For all transmission bandwidth configurations, an RB allocation is an Edge allocation if it is NOT a Region 1 inner allocation.

6.2.2.4 UE maximum output power reduction for power class 4

For power class 4, MPR specified in sub-clause 6.2.2.3 applies.

Table 6.2.2.4-1: Void

6.2.3 UE maximum output power with additional requirements

6.2.3.1 General

Additional emission requirements can be signalled by the network. Each additional emission requirement is associated with a unique network signalling (NS) value indicated in RRC signalling by an NR frequency band number of the applicable operating band and an associated value in the field *additionalSpectrumEmission*. Throughout this specification, the notion of indication or signalling of an NS value refers to the corresponding indication of an NR frequency band number of the applicable operating band (the IE field *freqBandIndicatorNR*) and an associated value of *additionalSpectrumEmission* in the relevant RRC information elements.

To meet these additional requirements, additional maximum power reduction (A-MPR) is allowed for the maximum output power as specified in clause 6.2.1. Unless stated otherwise, an A-MPR of 0 dB shall be used.

Table 6.2.3.1-1 specifies the additional requirements with their associated network signalling values and the allowed A-MPR and applicable operating band(s) for each NS value. The mapping of NR frequency band numbers and values of the *additionalSpectrumEmission* to network signalling labels is specified in Table 6.2.3.1-2. Unless otherwise stated, the allowed total back off is maximum of A-MPR and MPR specified in clause 6.2.2.

Table 6.2.3.1-1: Additional maximum power reduction (A-MPR)

| Network Signalling label | Requirements (clause) | NR Band | Channel bandwidth (MHz) | Resources Blocks (N_{RB}) | A-MPR (dB) |
|--|-----------------------|------------|-------------------------|-------------------------------|------------|
| NS_200 | | | | | N/A |
| NS_201 (NOTE 1) | 6.5.3.2.2 | n258 | | | 6.2.3.2 |
| NS_202 | 6.5.3.2.3 | n257, n258 | 50, 100, 200, 400 | Table 5.3.2-1 | 6.2.3.3 |
| NS_203 | 6.5.3.2.4 | n258 | 50, 100, 200, 400 | Table 5.3.2-1 | 6.2.3.4 |
| NOTE 1: NS_201 is obsolete, the associated additional spurious emission requirements are not applicable. | | | | | |

Table 6.2.3.1-2: Mapping of Network Signalling label

| NR Band | Value of <i>additionalSpectrumEmission</i> (NOTE 1) | | | | | | | |
|---|---|-----------------|--------|--------|---|---|---|---|
| | 0 | 1 | 2 | 3 | 4 | 5 | 6 | 7 |
| n257 | NS_200 | NS_202 | | | | | | |
| n258 | NS_200 | NS_201 (NOTE 2) | NS_202 | NS_203 | | | | |
| n259 | NS_200 | | | | | | | |
| n260 | NS_200 | | | | | | | |
| n261 | NS_200 | | | | | | | |
| NOTE 1: <i>additionalSpectrumEmission</i> corresponds to an information element of the same name defined in sub-clause 6.3.2 of TS 38.331 [13]. | | | | | | | | |
| NOTE 2: NS_201 is obsolete, the associated additional spurious emission requirements are not applicable. | | | | | | | | |

6.2.3.2 Void

6.2.3.2.1 Void

Table 6.2.3.2.1-1: (Void)

6.2.3.2.2 Void

Table 6.2.3.2.2-1: (Void)

6.2.3.2.3 Void

Table 6.2.3.2.3-1: (Void)

6.2.3.2.4 Void

6.2.3.3 A-MPR for NS_202

6.2.3.3.1 A-MPR for NS_202 for power class 1

For power class 1, A-MPR for NS_202 shall be 11.0 dB.

6.2.3.3.2 A-MPR for NS_202 for power class 2

For power class 2, A-MPR for NS_202 specified in clause 6.2.3.3.3 applies.

6.2.3.3.3 A-MPR for NS_202 for power class 3

For power class 3, A-MPR for NS_202 shall be 1.0 dB.

6.2.3.3.4 A-MPR for NS_202 for power class 4

For power class 4, A-MPR for NS_202 specified in clause 6.2.3.3.3 applies.

6.2.3.4 A-MPR for NS_203

6.2.3.4.1 A-MPR for NS_203 for power class 1

For power class 1, A-MPR for NS_203 shall be 3.0 dB if Offset frequency $< BW_{\text{channel}}$, 0.0 dB otherwise. The Offset frequency is defined as the frequency from 24.25 GHz to the lower edge of the channel bandwidth.

6.2.3.4.2 A-MPR for NS_203 for power class 2

For power class 2, A-MPR for NS_203 specified in subclause 6.2.3.4.3 applies.

6.2.3.4.3 A-MPR for NS_203 for power class 3

For power class 3, A-MPR for NS_203 shall be 0 dB.

6.2.3.4.4 A-MPR for NS_203 for power class 4

For power class 4, A-MPR for NS_203 specified in subclause 6.2.3.4.3 applies.

6.2.4 Configured transmitted power

The UE can configure its maximum output power. The configured UE maximum output power $P_{\text{CMAX},f,c}$ for carrier f of a serving cell c is defined as that available to the reference point of a given transmitter branch that corresponds to the reference point of the higher-layer filtered RSRP measurement as specified in TS 38.215 [11].

The configured UE maximum output power $P_{\text{CMAX},f,c}$ for carrier f of a serving cell c shall be set such that the corresponding measured peak EIRP $P_{\text{UMAX},f,c}$ is within the following bounds

$$P_{\text{Powerclass}} + \Delta P_{\text{IBE}} - \text{MAX}(\text{MAX}(\text{MPR}_{f,c}, \text{A-MPR}_{f,c}) + \Delta \text{MB}_{P,n}, \text{P-MPR}_{f,c}) - \text{MAX}\{\text{T}(\text{MAX}(\text{MPR}_{f,c}, \text{A-MPR}_{f,c})), \text{T}(\text{P-MPR}_{f,c})\} \leq P_{\text{UMAX},f,c} \leq \text{EIRP}_{\text{max}}$$

while the corresponding measured total radiated power $P_{\text{TMAX},f,c}$ is bounded by

$$P_{\text{TMAX},f,c} \leq \text{TRP}_{\text{max}}$$

with $P_{\text{Powerclass}}$ the UE minimum peak EIRP as specified in sub-clause 6.2.1, EIRP_{max} the applicable maximum EIRP as specified in sub-clause 6.2.1, $\text{MPR}_{f,c}$ as specified in sub-clause 6.2.2, $\text{A-MPR}_{f,c}$ as specified in sub-clause 6.2.3, $\Delta \text{MB}_{P,n}$ the peak EIRP relaxation as specified in clause 6.2.1 and TRP_{max} the maximum TRP for the UE power class as specified in sub-clause 6.2.1. ΔP_{IBE} is 1.0 dB if UE declares support for *mpr-PowerBoost-FR2-r16*, UL transmission is QPSK, $\text{MPR}_{f,c} = 0$ and when NS_200 applies and the network configures the UE to operate with *mpr-PowerBoost-FR2-r16* otherwise ΔP_{IBE} is 0.0 dB. The requirement is verified in beam peak direction.

maxUplinkDutyCycle-FR2, as defined in TS 38.306 [14], is a UE capability to facilitate electromagnetic power density exposure requirements. This UE capability is applicable to all FR2 power classes.

If the field of UE capability *maxUplinkDutyCycle-FR2* is present and the percentage of uplink symbols transmitted within any 1 s evaluation period is larger than *maxUplinkDutyCycle-FR2*, the UE follows the uplink scheduling and can apply P-MPR_{f,c}.

If the field of UE capability *maxUplinkDutyCycle-FR2* is absent, the compliance to electromagnetic power density exposure requirements are ensured by means of scaling down the power density or by other means.

P-MPR_{f,c} is the power management maximum output power reduction. The UE shall apply P-MPR_{f,c} for carrier f of serving cell c only for the cases described below. For UE conformance testing P-MPR_{f,c} shall be 0 dB.

- a) ensuring compliance with applicable electromagnetic power density exposure requirements and addressing unwanted emissions / self desense requirements in case of simultaneous transmissions on multiple RAT(s) for scenarios not in scope of 3GPP RAN specifications;
- b) ensuring compliance with applicable electromagnetic power density exposure requirements in case of proximity detection is used to address such requirements that require a lower maximum output power.

NOTE 1: P-MPR_{f,c} was introduced in the P_{C_{MAX,f,c}} equation such that the UE can report to the gNB the available maximum output transmit power. This information can be used by the gNB for scheduling decisions.

NOTE 2: P-MPR_{f,c} and *maxUplinkDutyCycle-FR2* may impact the maximum uplink performance for the selected UL transmission path.

NOTE 3: MPE P-MPR Reporting capability *tdd-MPE-P-MPR-Reporting-r16*, as defined in TS 38.306 [14], is used to report P-MPR_{f,c} when the reporting conditions configured by gNB are met. This UE capability is applicable to all FR2 power classes.

The tolerance T(Δ P) for applicable values of Δ P (values in dB) is specified in Table 6.2.4-1.

Table 6.2.4-1: P_{UMAX,f,c} tolerance

| Operating Band | Δ P (dB) | Tolerance T(Δ P) (dB) |
|--|---------------------------|-------------------------------|
| n257, n258, n259, n260, n261 | Δ P = 0 | 0 |
| | $0 < \Delta$ P \leq 2 | 1.5 |
| | $2 < \Delta$ P \leq 3 | 2.0 |
| | $3 < \Delta$ P \leq 4 | 3.0 |
| | $4 < \Delta$ P \leq 5 | 4.0 |
| | $5 < \Delta$ P \leq 10 | 5.0 |
| | $10 < \Delta$ P \leq 15 | 7.0 |
| | $15 < \Delta$ P \leq X | 8.0 |
| NOTE: X is the value such that P _{umax,f,c} lower bound, P _{Powerclass} - Δ P - T(Δ P) = minimum output power specified in clause 6.3.1 | | |

6.2A Transmitter power for CA

6.2A.1 UE maximum output power for CA

For downlink intra-band contiguous and non-contiguous carrier aggregation with a single uplink component carrier configured in the NR band, the maximum output power is specified in clause 6.2.1.

For uplink intra-band contiguous and non-contiguous carrier aggregation for any CA bandwidth class, the maximum output power is specified in clause 6.2.1.

Power class 3 is default power class.

6.2A.2 UE maximum output power reduction for CA

6.2A.2.1 General

The UE is defined to be configured for CA operation when it has at least one of UL or DL configured for CA. In CA operation, the UE may reduce its maximum output power due to higher order modulations and transmit bandwidth

configurations. This Maximum Power Reduction (MPR) is defined in clauses below. The allowed MPR for SRS, PUCCH formats 0, 1, 3 and 4, shall be as specified for QPSK modulated DFT-s-OFDM of equivalent RB allocation. The allowed MPR for PUCCH format 2, shall be as specified for QPSK modulated CP-OFDM of equivalent RB allocation.

When the maximum output power of a UE is modified by MPR, the power limits specified in clause 6.2A.4 apply.

The requirements in the following clauses are applicable to the following CA configurations:

- intra-band contiguous uplink CA, with the aggregated channel bandwidth no greater than 800 MHz.
- intra-band non-contiguous uplink CA with UL frequency separation no greater than 1400 MHz, and no more than 3 sub-blocks. A sub-block may consist of single CC or multiple contiguous CCs.
- In case the CA configuration consists of a single UL CC, MPR for contiguous UL CA applies and where necessary, $BW_{channel}$ shall be used as $BW_{channel_CA}$.

6.2A.2.2 Maximum output power reduction for power class 1

6.2A.2.2.1 Maximum output power reduction for power class 1 intra-band contiguous UL CA

For power class 1, MPR for intra-band contiguous UL CA with contiguous allocations within the cumulative aggregated bandwidth is defined as:

$$MPR_{C_CA} = \max(MPR_{WT_C_CA}, MPR_{narrow})$$

Where,

$MPR_{narrow} = 14.4$ dB, when $BW_{alloc, RB}$ is less than or equal to 1.44 MHz, $MPR_{narrow} = 10$ dB, when $1.44 \text{ MHz} < BW_{alloc, RB} \leq 10.8$ MHz, where $BW_{alloc, RB}$ is the bandwidth of the RB allocation size.

$MPR_{WT_C_CA}$ is the maximum power reduction due to modulation orders, transmit bandwidth configurations, and waveform types. $MPR_{WT_C_CA}$ is defined in Table 6.2A.2.2-1.

Table 6.2A.2.2-1: Maximum power reduction ($MPR_{WT_C_CA}$) for UE power class 1

| Waveform Type | | Cumulative aggregated channel bandwidth | | | |
|---------------|-----------|---|---------------------------------|---------------------------------------|-----------------------------------|
| | | < 400 MHz | ≥ 400 MHz and < 800 MHz | ≥ 800 MHz and ≤ 1400 MHz | > 1400 MHz and ≤ 2400 MHz |
| DFT-s-OFDM | Pi/2 BPSK | $\leq 5.5^1$ | 7.7^1 | 8.2 | ≤ 8.7 |
| | QPSK | $\leq 6.5^1$ | 8.7^1 | 9.7 | ≤ 9.7 |
| | 16 QAM | ≤ 6.5 | 8.7 | 9.2 | ≤ 9.7 |
| | 64 QAM | ≤ 9.0 | 10.7 | 11.2 | ≤ 11.7 |
| CP-OFDM | QPSK | ≤ 6.5 | 8.7 | 8.7 | ≤ 9.7 |
| | 16 QAM | ≤ 6.5 | 8.7 | 8.7 | ≤ 9.7 |
| | 64 QAM | ≤ 9.0 | 10.7 | 11.2 | ≤ 11.7 |

NOTE 1: (Void)

In case of a contiguous RB, DFT-s-BPSK or DFT-s-QPSK UL allocation in a single CC of a CA configuration with contiguous CCs, and whose cumulative aggregated BW ≤ 400 MHz, $MPR_{WT_C_CA}$ shall be derived instead as $\max(MPR_1, MPR_2)$, where:

MPR_1 shall be determined from Table 6.2.2.1-1 if CABW ≤ 200 MHz, from Table 6.2.2.1-2 if CABW > 200 MHz.

MPR_2 shall be determined from Table 6.2.2.1-1 if UL $BW_{channel_CA} \leq 200$ MHz, from Table 6.2.2.1-2 if UL $BW_{channel_CA} > 200$ MHz.

and assume all UL CCs use the same SCS for the purpose of determination of inner and outer RB allocations in Table 6.2.2.1-1 and Table 6.2.2.1-2:

N_{RB} shall be chosen as the sum of N_{RB} of all constituent UL CCs in the CA configuration.

L_{CRB} shall be chosen as $BW_{alloc, RB}$

RB_{start} shall be derived as: $RB_{start_allocatedCC} + N_{RB_unallocatedCC_low}$

$RB_{start_allocatedCC}$ is the index of the first allocated RB in the CC with allocation

$N_{RB_unallocatedCC_low}$ is the sum of N_{RB} in all UL CCs lower in frequency compared to the CC with allocation

When different waveform types exist across CCs, the requirement is set by the waveform type used in the configuration with the largest MPR_{C_CA} .

For intra-band contiguous UL CA with non-contiguous RB allocations, the following rule for MPR applies:

$$MPR = \max(MPR_{C_CA}, -10 \cdot A + 14.4)$$

Where:

$$A = N_{RB_alloc} / N_{RB_agg_C}$$

N_{RB_alloc} is the total number of allocated UL RBs

$N_{RB_agg_C}$ is the number of the aggregated RBs within the fully allocated cumulative aggregated channel bandwidth assuming lowest SCS among all configured CCs

6.2A.2.2.2 Maximum output power reduction for power class 1 intra-band non-contiguous UL CA

For intra-band non-contiguous UL CA, the following rule for MPR applies:

$$MPR = \max(MPR_{NC_CA}, -10 \cdot A + 14.4)$$

Where:

MPR_{NC_CA} is derived from table 6.2A.2.2.2-1

Table 6.2A.2.2.2-1: MPR_{NC_CA} for UE power class 1

| Waveform Type | | Cumulative aggregated channel bandwidth (CABW) | | | |
|---------------|-----------|--|-------------------------|--------------------------|---------------------------|
| | | < 400 MHz | ≥ 400 MHz and < 800 MHz | ≥ 800 MHz and ≤ 1400 MHz | > 1400 MHz and ≤ 2400 MHz |
| DFT-s-OFDM | Pi/2 BPSK | ≤ 6 | ≤ 7.7 | ≤ 8.2 | ≤ 8.7 |
| | QPSK | ≤ 7 | ≤ 8.7 | ≤ 9.2 | ≤ 9.7 |
| | 16 QAM | ≤ 7 | ≤ 8.7 | ≤ 9.2 | ≤ 9.7 |
| | 64 QAM | ≤ 9.0 | ≤ 10.7 | ≤ 11.2 | ≤ 11.7 |
| CP-OFDM | QPSK | ≤ 7 | ≤ 8.7 | ≤ 9.2 | ≤ 9.7 |
| | 16 QAM | ≤ 7 | ≤ 8.7 | ≤ 9.2 | ≤ 9.7 |
| | 64 QAM | ≤ 9.0 | ≤ 10.7 | ≤ 11.2 | ≤ 11.7 |

6.2A.2.3 Maximum output power reduction for power class 2

For power class 2, MPR specified in sub-clause 6.2A.2.4.1 applies for intra-band contiguous UL CA and sub-clause 6.2A.2.4.2 applies for intra-band non-contiguous UL CA.

Table 6.2A.2.3-1: (Void)

6.2A.2.4 Maximum output power reduction for power class 3

6.2A.2.4.1 Maximum output power reduction for power class 3 intra-band contiguous CA

For power class 3, MPR for intra-band contiguous UL CA with contiguous allocations within the cumulative aggregated bandwidth is denoted as MPR_{C_CA} and is defined in Table 6.2A.2.4-1.

Table 6.2A.2.4-1: Maximum power reduction (MPR_{C_CA}) for UE power class 3

| | | Cumulative aggregated channel bandwidth (CABW) | | | |
|-----------------|-----------|--|-----------------------------|------------------------------------|----------------------------------|
| | | ≤ 400 MHz | > 400 MHz and < 800 MHz | ≥ 800 MHz and ≤ 1400 MHz | > 1400 MHz and ≤ 2400 MHz |
| DFT-s-OFDM | Pi/2 BPSK | $\leq 5.0^1$ | $\leq 7.7^1$ | ≤ 8.2 | ≤ 8.7 |
| | QPSK | $\leq 5.0^1$ | $\leq 7.7^1$ | ≤ 8.2 | ≤ 9.7 |
| | 16 QAM | ≤ 6.5 | ≤ 8.7 | ≤ 9.3 | ≤ 9.7 |
| | 64 QAM | ≤ 9.0 | ≤ 10.7 | ≤ 11.2 | ≤ 11.7 |
| CP-OFDM | QPSK | ≤ 5.0 | ≤ 7.5 | ≤ 8.0 | ≤ 9.7 |
| | 16 QAM | ≤ 6.5 | ≤ 8.7 | ≤ 9.2 | ≤ 9.7 |
| | 64 QAM | ≤ 9.0 | ≤ 10.7 | ≤ 11.2 | ≤ 11.7 |
| NOTE 1: (Void). | | | | | |

In case of a contiguous RB, DFT-s-BPSK or DFT-s-QPSK UL allocation in a single CC of a CA configuration with contiguous CCs, and whose cumulative aggregated BW ≤ 400 MHz, MPR_{C_CA} shall be derived instead as $\text{MAX}(MPR_1, MPR_2)$, where:

MPR_1 shall be determined from Table 6.2.2.3-1 if CABW ≤ 200 MHz, from Table 6.2.2.3-2 if CABW > 200 MHz.

MPR_2 shall be determined from Table 6.2.2.3-1 if UL $BW_{\text{channel_CA}} \leq 200$ MHz, from Table 6.2.2.3-2 if UL $BW_{\text{channel_CA}} > 200$ MHz.

and assume all UL CCs use the same SCS for the purpose of determination of inner and outer RB allocations in Table 6.2.2.3-1 and Table 6.2.2.3-2:

N_{RB} shall be chosen as the sum of N_{RB} of all constituent UL CCs in the CA configuration.

L_{CRB} shall be chosen as $BW_{\text{alloc, RB}}$

RB_{start} shall be derived as: $RB_{\text{start_allocatedCC}} + N_{RB_unallocatedCC_low}$

$RB_{\text{start_allocatedCC}}$ is the index of the first allocated RB in the CC with allocation

$N_{RB_unallocatedCC_low}$ is the sum of N_{RB} in all UL CCs lower in frequency compared to the CC with allocation

When different waveform types exist across CCs, the requirement is set by the waveform type used in the configuration with the highest contiguous MPR.

For intra-band contiguous UL CA with non-contiguous RB allocations, the following rule for MPR applies:

$$MPR = \max(MPR_{C_CA}, -10 \cdot A + 7.0)$$

Where:

$$A = N_{RB_alloc} / N_{RB_agg_C}$$

N_{RB_alloc} is the total number of allocated UL RBs

$N_{RB_agg_C}$ is the number of the aggregated RBs within the fully allocated cumulative aggregated channel bandwidth assuming lowest SCS among all configured CCs

6.2A.2.4.2 Maximum output power reduction for power class 3 intra-band non-contiguous CA

For intra-band non-contiguous UL CA, the following rule for MPR applies:

$$\text{MPR} = \max(\text{MPR}_{\text{NC_CA}}, -8 \cdot A + 10.0)$$

Where:

$\text{MPR}_{\text{NC_CA}}$ is derived from table 6.2A.2.4.2-1

Table 6.2A.2.4.2-1: $\text{MPR}_{\text{NC_CA}}$ for UE power class 3

| | | Cumulative aggregated channel bandwidth (CABW) | | | |
|------------|-----------|--|-------------------------|--------------------------|---------------------------|
| | | ≤ 400 MHz | > 400 MHz and < 800 MHz | ≥ 800 MHz and ≤ 1400 MHz | > 1400 MHz and ≤ 2400 MHz |
| DFT-s-OFDM | Pi/2 BPSK | ≤ 5.5 | ≤ 7.7 | ≤ 8.2 | ≤ 8.7 |
| | QPSK | ≤ 6 | ≤ 7.7 | ≤ 8.2 | ≤ 8.7 |
| | 16 QAM | ≤ 7 | ≤ 8.7 | ≤ 9.3 | ≤ 9.8 |
| | 64 QAM | ≤ 9.0 | ≤ 10.7 | ≤ 11.2 | ≤ 11.7 |
| CP-OFDM | QPSK | ≤ 6 | ≤ 7.5 | ≤ 8.0 | ≤ 8.5 |
| | 16 QAM | ≤ 7 | ≤ 8.7 | ≤ 9.2 | ≤ 9.7 |
| | 64 QAM | ≤ 9.0 | ≤ 10.7 | ≤ 11.2 | ≤ 11.7 |

6.2A.2.5 Maximum output power reduction for power class 4

For power class 4, MPR specified in sub-clause 6.2A.2.4.1 applies for intra-band contiguous UL CA and sub-clause 6.2A.2.4.2 applies for intra-band non-contiguous UL CA.

6.2A.3 UE maximum output power with additional requirements for CA

6.2A.3.1 General

Additional emission requirements can be signalled by the network with network signalling value indicated by the field *additionalSpectrumEmission*. To meet these additional requirements, additional maximum power reduction (A-MPR) is allowed for the maximum output power as specified in clause 6.2A.1. Unless stated otherwise, an A-MPR of 0 dB shall be used. Unless otherwise stated, the allowed total back off is maximum of A-MPR and MPR specified in clause 6.2A.2.

For intra-band contiguous aggregation with the UE configured for transmissions on two serving cells, the maximum output power reduction specified in Table 6.2A.3.1-1 is allowed for all serving cells of the applicable uplink contiguous CA configurations according to the CA network signalling value indicated by the field *additionalSpectrumEmissionSCell*.

Table 6.2A.3.1-1 specifies the additional requirements and allowed A-MPR with corresponding network signalling label and operating band. The mapping between network signalling labels and the *additionalSpectrumEmission* IE defined in TS 38.331 [13] is specified in Table 6.2A.3.1-2. Unless otherwise stated, the allowed total back off is maximum of A-MPR and MPR specified in clause 6.2A.2.

Table 6.2A.3.1-1: Additional maximum power reduction (A-MPR)

| Network Signalling value | Requirements (clause) | NR Band | Channel bandwidth (MHz) | Resources Blocks (N_{RB}) | A-MPR (dB) |
|---|-----------------------|------------|-------------------------|--------------------------------------|------------|
| CA_NS_200 | | | | | N/A |
| CA_NS_201 | 6.5.3.2.2 | n258 | | | 6.2A.3.2 |
| CA_NS_202 | 6.5.3.2.3 | n257, n258 | | | 6.2A.3.3 |
| CA_NS_203 | 6.5.3.2.4 | n258 | | | 6.2A.3.4 |
| NOTE: CA_NS_201 is obsolete, the associated additional spurious emission requirements are not applicable. | | | | | |

Table 6.2A.3.1-2: Value of additionalSpectrumEmission

| NR Band | Value of additionalSpectrumEmission / NS number | | | | | | | |
|---------|---|-----------|-----------|-----------|---|---|---|---|
| | 0 | 1 | 2 | 3 | 4 | 5 | 6 | 7 |
| n257 | CA_NS_200 | CA_NS_202 | | | | | | |
| n258 | CA_NS_200 | CA_NS_201 | CA_NS_202 | CA_NS_203 | | | | |
| n259 | CA_NS_200 | | | | | | | |
| n260 | CA_NS_200 | | | | | | | |
| n261 | CA_NS_200 | | | | | | | |

NOTE 1: additionalSpectrumEmission corresponds to an information element of the same name defined in clause 6.3.2 of TS 38.331 [13].
 NOTE 2: CA_NS_201 is obsolete, the associated additional spurious emission requirements are not applicable.

6.2A.3.2 Void

6.2A.3.2.1 Void

Table 6.2A.3.2.1-1: (Void)

6.2A.3.2.2 Void

Table 6.2A.3.2.2-1: (Void)

6.2A.3.2.3 Void

Table 6.2A.3.2.3-1: Void

6.2A.3.2.4 Void

6.2A.3.3 A-MPR for CA_NS_202

6.2A.3.3.1 A-MPR for CA_NS_202 for power class 1

For intra-band contiguous CA, A-MPR for CA_NS_202 shall be 11.0 dB.

6.2A.3.3.2 A-MPR for CA_NS_202 for power class 2

For intra-band contiguous CA, A-MPR for CA_NS_202 specified in sub-clause 6.2A.3.3.3 applies.

6.2A.3.3.3 A-MPR for CA_NS_202 for power class 3

For intra-band contiguous CA, A-MPR for CA_NS_202 shall be 2.0 dB.

6.2A.3.3.4 A-MPR for CA_NS_202 for power class 4

For intra-band contiguous CA, A-MPR for CA_NS_202 specified in sub-clause 6.2A.3.3.3 applies.

6.2A.3.4 A-MPR for CA_NS_203

6.2A.3.4.1 A-MPR for CA_NS_203 for power class 1

For intra-band contiguous CA, A-MPR for CA_NS_203 shall be 6.5 dB, if Offset frequency < BW_{Channel_CA} of the UL CA configuration, 0.0 dB, otherwise

The Offset frequency is defined as the frequency from 24.25 GHz to the lower edge of the lowest CC among the configured UL CA.

6.2A.3.4.2 A-MPR for CA_NS_203 for power class 2

For intra-band contiguous CA, AMPR specified in sub-clause 6.2A.3.4.3 applies.

6.2A.3.4.3 A-MPR for CA_NS_203 for power class 3

For intra-band contiguous CA, A-MPR for CA_NS_203 shall be 2.5 dB, if Offset frequency $< BW_{\text{Channel_CA}}$ of the UL CA configuration, 0.0 dB otherwise.

The Offset frequency is defined as the frequency from 24.25 GHz to to the lower edge of the lowest CC among the configured UL CA.

6.2A.3.4.4 A-MPR for CA_NS_203 for power class 4

For intra-band contiguous CA, AMPR specified in sub-clause 6.2A.3.4.3 applies.

6.2A.4 Configured transmitted power for CA

A UE configured with carrier aggregation can configure its maximum output power for each uplink activated serving cell c and its total configured maximum output power P_{CMAX} . The definition of the configured UE maximum output power $P_{\text{CMAX},f,c}$ for each carrier f of a serving cell c is used for power headroom reporting for carrier f of serving cell c only and is in accordance with that specified in clause 6.2.4 with parameters MPR, A-MPR and P-MPR replaced with those specified in subclause 6.2A.2, 6.2A.3 and 6.2.4, respectively. The UE maximum configured power P_{CMAX} in a transmission occasion is determined by the UL grants for carriers f of all serving cells c with non-zero granted power in the respective reference point.

For uplink intra-band contiguous carrier aggregation, MPR is specified in clause 6.2A.2. P_{CMAX} is calculated under the assumption that power spectral density for each RB in each component carrier is same.

The configured UE maximum output power P_{CMAX} shall be set such that the corresponding measured total peak EIRP P_{UMAX} is within the following bounds

$$P_{\text{Powerclass}} - \text{MAX}(\text{MAX}(\text{MPR}, \text{A-MPR}) + \Delta\text{MB}_{\text{P,n}}, \text{P-MPR}) - \text{MAX}\{\text{T}(\text{MAX}(\text{MPR}, \text{A-MPR})), \text{T}(\text{P-MPR})\} \leq P_{\text{UMAX}} \leq \text{EIRP}_{\text{max}}$$

with $P_{\text{Powerclass}}$ the UE minimum peak EIRP as specified in sub-clause 6.2A.1, EIRP_{max} the applicable maximum EIRP as specified in sub-clause 6.2A.1, MPR as specified in sub-clause 6.2A.2, A-MPR as specified in sub-clause 6.2A.3, $\Delta\text{MB}_{\text{P,n}}$ the peak EIRP relaxation as specified in clause 6.2.1, P-MPR the power management term for the UE as described in 6.2.4.

The measured configured power P_{UMAX} for carrier aggregation is defined as

$$P_{\text{UMAX}} = 10 \log_{10} \sum_{c,f(c)} p_{\text{UMAX},f,c}$$

where $p_{\text{UMAX},f,c}$ is the linear value of the measured power $P_{\text{UMAX},f,c}$ for carrier $f=f(c)$ of serving cell c . The measured total radiated power P_{TMAX} for carrier aggregation is defined as

$$P_{\text{TMAX}} = 10 \log_{10} \sum_{c,f(c)} p_{\text{TMAX},f,c}$$

where $p_{\text{TMAX},f,c}$ is the linear value of the measured total radiated power $P_{\text{TMAX},f,c}$ for carrier $f=f(c)$ of serving cell c . The total radiated power P_{TMAX} is bounded by

$$P_{\text{TMAX}} \leq \text{TRP}_{\text{max}}$$

where TRP_{max} the maximum TRP for the UE power class as specified in sub-clause 6.2A.1.

The tolerance $\text{T}(\Delta\text{P})$ for applicable values of ΔP (values in dB) is specified in Table 6.2A.4-1.

Table 6.2A.4-1: P_{UMAX} tolerance

| Operating Band | ΔP (dB) | Tolerance T(ΔP) (dB) |
|--|-------------------------|--------------------------------|
| n257, n258, n259, n260, n261 | $\Delta P = 0$ | 0 |
| | $0 < \Delta P \leq 2$ | 1.5 |
| | $2 < \Delta P \leq 3$ | 2.0 |
| | $3 < \Delta P \leq 4$ | 3.0 |
| | $4 < \Delta P \leq 5$ | 4.0 |
| | $5 < \Delta P \leq 10$ | 5.0 |
| | $10 < \Delta P \leq 15$ | 7.0 |
| | $15 < \Delta P \leq X$ | 8.0 |
| NOTE: X is the value such that P _{umax} lower bound, P _{Powerclass} - ΔP - T(ΔP) = minimum output power specified in clause 6.3A.1 | | |

6.2D Transmitter power for UL MIMO

6.2D.1 UE maximum output power for UL MIMO

6.2D.1.0 General

The requirements in the following clauses define the maximum output power radiated by the UE with *nrofSRS-Ports* set to 2, for any transmission bandwidth within the channel bandwidth for non-CA configuration, unless otherwise stated. MPR shall be applied as specified in clause 6.2D.2

For the maximum output power requirement for 2-layer UL MIMO operation, a UE shall be configured for 2-layer UL MIMO transmission as specified in Table 6.2D.1.0-1.

Table 6.2D.1.0-1: UL MIMO configuration

| Transmission scheme | DCI format | Number of layers | TPMI index |
|-----------------------|----------------|------------------|------------|
| Codebook based uplink | DCI format 0_1 | 2 | 0 |

The maximum output power requirement for single layer transmission shall apply to a UE that supports ULFPTx feature and is configured for single layer transmission in its declared full power mode [10, TS 38.213] as specified in Table 6.2D.1.0-2.

Table 6.2D.1.0-2: PUSCH Configuration for uplink full power transmission (ULFPTx)

| ULFPTx Mode | Transmission scheme | DCI format | Modulation | Number of layers | TPMI index |
|--|-----------------------|----------------|----------------------------------|------------------|---------------------|
| Mode-1 | Codebook based uplink | DCI format 0_1 | DFT-s-OFDM, CP-OFDM ¹ | 1 | 2 |
| Mode-2 | Codebook based uplink | DCI format 0_1 | DFT-s-OFDM, CP-OFDM | 1 | 0 or 1 ² |
| Mode-full power | Codebook based uplink | DCI format 0_1 | DFT-s-OFDM, CP-OFDM | 1 | 0,1 |
| NOTE 1: For PUSCH configured with ULFPTxModes set to Mode-1, all requirements for 1-layer CP-OFDM based modulation in subsection 6.2D are assumed to be met if the requirement for 2-layer UL MIMO has been validated. | | | | | |
| NOTE 2: TPMI index selected shall be based upon the full power TPMI reported by the UE [10, TS 38.213]. | | | | | |

6.2D.1.1 UE maximum output power for UL MIMO for power class 1

The following requirements define the maximum output power radiated by the PC1 UE. Requirements apply to UEs when configured for 2-layer transmission as well as when configured for single layer uplink full power transmission (ULFPTx), with configuration per clause 6.2D.1.0.

The minimum peak EIRP requirements are found in Table 6.2D.1.1-1 below. The period of measurement shall be at least one sub frame (1ms). The requirement is verified with the test metric of EIRP (Link=TX beam peak direction, Meas=Link angle). Power class 1 UE is used for fixed wireless access (FWA).

Table 6.2D.1.1-1: UE minimum peak EIRP for UL MIMO for power class 1

| Operating band | Min peak EIRP (dBm) |
|---|---------------------|
| n257 | 40.0 |
| n258 | 40.0 |
| n260 | 38.0 |
| n261 | 40.0 |
| NOTE 1: Minimum peak EIRP is defined as the lower limit without tolerance | |

Table 6.2D.1.1-2: (void)

The maximum output power values for TRP and EIRP are found in Table 6.2D.1.1-3 below for UE with UL MIMO. The maximum allowed EIRP is derived from regulatory requirements [8]. The requirements are verified with the test metrics of TRP (Link=TX beam peak direction, Meas=TRP grid) in beam locked mode and EIRP (Link=TX beam peak direction, Meas=Link angle).

Table 6.2D.1.1-3: UE maximum output power limits for UL MIMO for power class 1

| Operating band | Max TRP (dBm) | Max EIRP (dBm) |
|----------------|---------------|----------------|
| n257 | 35 | 55 |
| n258 | 35 | 55 |
| n260 | 35 | 55 |
| n261 | 35 | 55 |

The minimum EIRP at the 85th percentile of the distribution of radiated power measured over the full sphere around the UE with UL MIMO is defined as the spherical coverage requirement and is found in Table 6.2D.1.1-4 below. The requirement is verified with the test metric of EIRP (Link=Spherical coverage grid, Meas=Link angle).

Table 6.2D.1.1-4: UE spherical coverage for UL MIMO for power class 1

| Operating band | Min EIRP at 85 %-tile CDF (dBm) |
|---|---------------------------------|
| n257 | 32.0 |
| n258 | 32.0 |
| n260 | 30.0 |
| n261 | 32.0 |
| NOTE 1: Minimum EIRP at 85 %-tile CDF is defined as the lower limit without tolerance | |

6.2D.1.2 UE maximum output power for UL MIMO for power class 2

The following requirements define the maximum output power radiated by the PC2 UE. Requirements apply to UEs when configured for 2-layer transmission as well as when configured for single layer uplink full power transmission (ULFPTx), with configuration per clause 6.2D.1.0.

The minimum peak EIRP requirements are found in Table 6.2D.1.2-1 below. The period of measurement shall be at least one sub frame (1ms). The requirement is verified with the test metric of EIRP (Link=TX beam peak direction, Meas=Link angle).

Table 6.2D.1.2-1: UE minimum peak EIRP for UL MIMO for power class 2

| Operating band | Min peak EIRP (dBm) |
|--|---------------------|
| n257 | 29 |
| n258 | 29 |
| n261 | 29 |
| NOTE 1: Minimum peak EIRP is defined as the lower limit without tolerance. | |
| NOTE 2: Min Peak EIRP refers to the total EIRP for the UL beams peaks. | |

The maximum output power values for TRP and EIRP are found in Table 6.2D.1.2-2 below. The maximum allowed EIRP is derived from regulatory requirements [8]. The requirements are verified with the test metrics of TRP (Link=TX beam peak direction, Meas=TRP grid) in beam locked mode and EIRP (Link=TX beam peak direction, Meas=Link angle).

Table 6.2D.1.2-2: UE maximum output power limits for UL MIMO for power class 2

| Operating band | Max TRP (dBm) | Max EIRP (dBm) |
|----------------|---------------|----------------|
| n257 | 23 | 43 |
| n258 | 23 | 43 |
| n261 | 23 | 43 |

Table 6.2D.1.2-3: (void)

The minimum EIRP at the 60th percentile of the distribution of radiated power measured over the full sphere around the UE is defined as the spherical coverage requirement and is found in Table 6.2D.1.2-4 below. The requirement is verified with the test metric of EIRP (Link=Spherical coverage grid, Meas=Link angle).

Table 6.2D.1.2-4: UE spherical coverage for UL MIMO for power class 2

| Operating band | Min EIRP at 60 %-tile CDF (dBm) |
|---|---------------------------------|
| n257 | 18.0 |
| n258 | 18.0 |
| n261 | 18.0 |
| NOTE 1: Minimum EIRP at 60 %-tile CDF is defined as the lower limit without tolerance | |

6.2D.1.3 UE maximum output power for UL MIMO for power class 3

The following requirements define the maximum output power radiated by the PC3 UE.. Requirements apply to UEs when configured for 2-layer transmission as well as when configured for single layer uplink full power transmission (ULFPTx), with configuration per clause 6.2D.1.0.

The minimum peak EIRP requirements are found in Table 6.2D.1.3-1 below. The period of measurement shall be at least one sub frame (1 ms). The requirement is verified with the test metric of EIRP (Link=TX beam peak direction, Meas=Link angle).

Table 6.2D.1.3-1: UE minimum peak EIRP for UL MIMO for power class 3

| Operating band | Min peak EIRP (dBm) |
|--|---------------------|
| n257 | 22.4 |
| n258 | 22.4 |
| n259 | 18.7 |
| n260 | 20.6 |
| n261 | 22.4 |
| NOTE 1: Minimum peak EIRP is defined as the lower limit without tolerance. | |
| NOTE 2: Min Peak EIRP refers to the total EIRP for the UL beams peaks. | |

The maximum output power values for TRP and EIRP are found in Table 6.2D.1.3-2 below. The maximum allowed EIRP is derived from regulatory requirements [8]. The requirements are verified with the test metrics of TRP (Link=TX beam peak direction, Meas=TRP grid) in beam locked mode and EIRP (Link=TX beam peak direction, Meas=Link angle).

Table 6.2D.1.3-2: UE maximum output power limits for UL MIMO for power class 3

| Operating band | Max TRP (dBm) | Max EIRP (dBm) |
|----------------|---------------|----------------|
| n257 | 23 | 43 |
| n258 | 23 | 43 |
| n259 | 23 | 43 |
| n260 | 23 | 43 |
| n261 | 23 | 43 |

Table 6.2D.1.3-3: (void)

The minimum EIRP at the 50th percentile of the distribution of radiated power measured over the full sphere around the UE is defined as the spherical coverage requirement and is found in Table 6.2D.1.3-4 below. The requirement is verified with the test metric of EIRP (Link=spherical coverage grid, Meas=Link angle).

Table 6.2D.1.3-4: UE spherical coverage for UL MIMO for power class 3

| Operating band | Min EIRP at 50 %-tile CDF (dBm) |
|---|---------------------------------|
| n257 | 11.5 |
| n258 | 11.5 |
| n259 | 5.8 |
| n260 | 8 |
| n261 | 11.5 |
| NOTE 1: Minimum EIRP at 50 %-tile CDF is defined as the lower limit without tolerance | |
| NOTE 2: The requirements in this table are only applicable for UE which supports single band in FR2 | |

6.2D.1.4 UE maximum output power for UL MIMO for power class 4

The following requirements define the maximum output power radiated by the PC4 UE. Requirements apply to UEs configured for 2-layer transmission as well as UEs configured for single layer uplink full power transmission (ULFPTx), with configuration per clause 6.2D.1.0.

The minimum peak EIRP requirements are found in Table 6.2D.1.4-1 below. The period of measurement shall be at least one sub frame (1ms). The requirement is verified with the test metric of EIRP (Link=TX beam peak direction, Meas=Link angle).

Table 6.2D.1.4-1: UE minimum peak EIRP for UL MIMO for power class 4

| Operating band | Min peak EIRP (dBm) |
|--|---------------------|
| n257 | 34 |
| n258 | 34 |
| n260 | 31 |
| n261 | 34 |
| NOTE 1: Minimum peak EIRP is defined as the lower limit without tolerance. | |
| NOTE 2: Min Peak EIRP refers to the total EIRP for the UL beams peaks. | |

The maximum output power values for TRP and EIRP are found in Table 6.2D.1.4-2 below. The maximum allowed EIRP is derived from regulatory requirements [8]. The requirements are verified with the test metrics of TRP (Link=TX beam peak direction, Meas=TRP grid) in beam locked mode and EIRP (Link=TX beam peak direction, Meas=Link angle).

Table 6.2D.1.4-2: UE maximum output power limits for UL MIMO for power class 4

| Operating band | Max TRP (dBm) | Max EIRP (dBm) |
|----------------|---------------|----------------|
| n257 | 23 | 43 |
| n258 | 23 | 43 |
| n260 | 23 | 43 |
| n261 | 23 | 43 |

Table 6.2D.1.4-3: (void)

The minimum EIRP at the 20th percentile of the distribution of radiated power measured over the full sphere around the UE is defined as the spherical coverage requirement and is found in Table 6.2D.1.4-4 below. The requirement is verified with the test metric of EIRP (Link=Spherical coverage grid, Meas=Link angle).

Table 6.2D.1.4-4: UE spherical coverage for UL MIMO for power class 4

| Operating band | Min EIRP at 20 %-tile CDF (dBm) |
|---|---------------------------------|
| n257 | 25 |
| n258 | 25 |
| n260 | 19 |
| n261 | 25 |
| NOTE 1: Minimum EIRP at 20 %-tile CDF is defined as the lower limit without tolerance | |

6.2D.2 UE maximum output power reduction for modulation / channel bandwidth for UL MIMO

6.2D.2.1 UE maximum output power reduction for modulation / channel bandwidth for UL MIMO for power class 1

For UEs configured for 2-layer transmission as well as UEs configured for single layer uplink full power transmission (ULFPTx), the allowed Maximum Power Reduction (MPR) for the maximum output power in Table 6.2D.1.1-1 is specified in sub-clause 6.2.2.1. The requirements shall be met with configurations specified in sub-clause 6.2D.1.0.

For the UE maximum output power modified by MPR, the power limits specified in clause 6.2D.4 apply.

6.2D.2.2 UE maximum output power reduction for modulation / channel bandwidth for UL MIMO for power class 2

For UEs configured for 2-layer transmission as well as UEs configured for single layer uplink full power transmission (ULFPTx), the allowed Maximum Power Reduction (MPR) for the maximum output power in Table 6.2D.1.2-1 is specified in sub-clause 6.2.2.2. The requirements shall be met with configurations specified in sub-clause 6.2D.1.0.

For the UE maximum output power modified by MPR, the power limits specified in clause 6.2D.4 apply.

6.2D.2.3 UE maximum output power reduction for modulation / channel bandwidth for UL MIMO for power class 3

For UEs configured for 2-layer transmission as well as UEs configured for single layer uplink full power transmission (ULFPTx), the allowed Maximum Power Reduction (MPR) for the maximum output power in Table 6.2D.1.3-1 is specified in sub-clause 6.2.2.3. The requirements shall be met with configurations specified in sub-clause 6.2D.1.0.

For the UE maximum output power modified by MPR, the power limits specified in clause 6.2D.4 apply.

6.2D.2.4 UE maximum output power reduction for modulation / channel bandwidth for UL MIMO for power class 4

For UEs configured for 2-layer transmission as well as UEs configured for single layer uplink full power transmission (ULFPTx), the allowed Maximum Power Reduction (MPR) for the maximum output power in Table 6.2D.1.4-1 is specified in sub-clause 6.2.2.4. The requirements shall be met with configurations specified in sub-clause 6.2D.1.0.

For the UE maximum output power modified by MPR, the power limits specified in clause 6.2D.4 apply.

6.2D.3 UE maximum output power reduction with additional requirements for UL MIMO

6.2D.3.1 UE maximum output power reduction with additional requirements for UL MIMO for power class 1

For UEs configured for 2-layer transmission as well as UEs configured for single layer uplink full power transmission (ULFPTx), the A-MPR values specified in clause 6.2.3 shall apply to the maximum output power specified in Table 6.2D.1.1-1. The requirements shall be met with the configurations specified in sub-clause 6.2D.1.0.

For the UE maximum output power modified by A-MPR, the power limits specified in clause 6.2D.4 apply.

6.2D.3.2 UE maximum output power reduction with additional requirements for UL MIMO for power class 2

For UEs configured for 2-layer transmission as well as UEs configured for single layer uplink full power transmission (ULFPTx), the A-MPR values specified in clause 6.2.3 shall apply to the maximum output power specified in Table 6.2D.1.2-1. The requirements shall be met with the configurations specified in clause 6.2D.1.0.

For the UE maximum output power modified by A-MPR, the power limits specified in clause 6.2D.4 apply.

6.2D.3.3 UE maximum output power reduction with additional requirements for UL MIMO for power class 3

For UEs configured for 2-layer transmission as well as UEs configured for single layer uplink full power transmission (ULFPTx), the A-MPR values specified in clause 6.2.3 shall apply to the maximum output power specified in Table 6.2D.1.3-1. The requirements shall be met with the configurations specified in clause 6.2D.1.0.

For the UE maximum output power modified by A-MPR, the power limits specified in clause 6.2D.4 apply.

6.2D.3.4 UE maximum output power reduction with additional requirements for UL MIMO for power class 4

For UEs configured for 2-layer transmission as well as UEs configured for single layer uplink full power transmission (ULFPTx), the A-MPR values specified in clause 6.2.3 shall apply to the maximum output power specified in Table 6.2D.1.4-1. The requirements shall be met with the configurations specified in clause 6.2D.1.0.

6.2D.4 Configured transmitted power for UL MIMO

For UEs configured for 2-layer transmission as well as UEs configured for single layer uplink full power transmission (ULFPTx), the configured maximum output power $P_{\text{CMAX},c}$ for serving cell c is defined as sum of all streams and is bound by limits set in clause 6.2.4.

6.3 Output power dynamics

6.3.1 Minimum output power

6.3.1.0 General

The minimum controlled output power of the UE is defined as the EIRP in the channel bandwidth for all transmit bandwidth configurations (resource blocks) when the power is set to a minimum value.

The minimum output power is defined as the mean power in at least one sub frame (1ms).

6.3.1.1 Minimum output power for power class 1

For power class 1 UE, the minimum output power shall not exceed the values specified in Table 6.3.1.1-1 for each operating band supported. The minimum power is verified in beam locked mode with the test metric of EIRP (Link=TX beam peak direction, Meas=Link angle).

Table 6.3.1.1-1: Minimum output power for power class 1

| Operating band | Channel bandwidth (MHz) | Minimum output power (dBm) | Measurement bandwidth (MHz) |
|------------------------|-------------------------|----------------------------|-----------------------------|
| n257, n258, n260, n261 | 50 | 4 | 47.58 |
| | 100 | 4 | 95.16 |
| | 200 | 4 | 190.20 |
| | 400 | 4 | 380.28 |

6.3.1.2 Minimum output power for power class 2, 3, and 4

The minimum output power shall not exceed the values specified in Table 6.3.1.2-1 for each operating band supported. The minimum power is verified in beam locked mode with the test metric of EIRP (Link=TX beam peak direction, Meas=Link angle).

Table 6.3.1.2-1: Minimum output power for power class 2, 3, and 4

| Operating band | Channel bandwidth (MHz) | Minimum output power (dBm) | Measurement bandwidth (MHz) |
|--|-------------------------|----------------------------|-----------------------------|
| n257, n258, n259, n260, n261 | 50 | -13 | 47.58 |
| | 100 | -13 | 95.16 |
| | 200 | -13 | 190.20 |
| | 400 | -13 | 380.28 |
| NOTE 1: n260 is not applied for power class 2. | | | |
| NOTE 2: n259 is not applied for power class 2 and 4. | | | |

6.3.2 Transmit OFF power

The transmit OFF power is defined as the TRP in the channel bandwidth when the transmitter is OFF. The transmitter is considered OFF when the UE is not allowed to transmit on any of its ports.

The transmit OFF power shall not exceed the values specified in Table 6.3.2-1 for each operating band supported. The requirement is verified with the test metric of TRP (Link=TX beam peak direction, Meas=TRP grid).

Table 6.3.2-1: Transmit OFF power

| Operating band | Channel bandwidth / Transmit OFF power (dBm) / measurement bandwidth | | | |
|------------------------------|--|-----------|------------|------------|
| | 50 MHz | 100 MHz | 200 MHz | 400 MHz |
| n257, n258, n259, n260, n261 | -35 | -35 | -35 | -35 |
| | 47.58 MHz | 95.16 MHz | 190.20 MHz | 380.28 MHz |

6.3.3 Transmit ON/OFF time mask

6.3.3.1 General

The transmit ON/OFF time mask defines the transient period(s) allowed

- between transmit OFF power and transmit ON power symbols (transmit ON/OFF)
- between continuous ON-power transmissions when power change or RB hopping is applied.

In case of RB hopping, transition period is shared symmetrically.

Unless otherwise stated the minimum requirements in clause 6.5 apply also in transient periods.

The transmit ON/OFF time mask is defined as a directional requirement. The requirement is verified in beam locked mode at beam peak direction. The maximum allowed EIRP OFF power level is -30dBm at beam peak direction. The requirement is verified with the test metric of EIRP (Link=TX beam peak direction, Meas=Link angle).

In the following sub-clauses, following definitions apply:

- A slot transmission is a Type A transmission.
- A long subslot transmission is a Type B transmission with more than 2 symbols.
- A short subslot transmission is a Type B transmission with 1 or 2 symbols.

6.3.3.2 General ON/OFF time mask

The general ON/OFF time mask defines the observation period allowed between transmit OFF and ON power. ON/OFF scenarios include: contiguous, and non-contiguous transmission, etc

The OFF power measurement period is defined in a duration of at least one slot excluding any transient periods. The ON power is defined as the mean power over one slot excluding any transient period.



Figure 6.3.3.2-1: General ON/OFF time mask for NR UL transmission in FR2

6.3.3.3 Transmit power time mask for slot and short or long subslot boundaries

The transmit power time mask for slot and a long subslot transmission boundaries defines the transient periods allowed between slot and long subslot PUSCH transmissions. For PUSCH-PUCCH and PUSCH-SRS transitions and multiplexing the time masks in sub-clause 6.3.3.7 apply.

The transmit power time mask for slot or long subslot and short subslot transmission boundaries defines the transient periods allowed between slot or long subslot and short subslot transmissions. The time masks in sub-clause 6.3.3.8 apply.

The transmit power time mask for short subslot transmission boundaries defines the transient periods allowed between short subslot transmissions. The time masks in sub-clause 6.3.3.9 apply.

6.3.3.4 PRACH time mask

The PRACH ON power is specified as the mean power over the PRACH measurement period excluding any transient periods as shown in Figure 6.3.3.4-1. The measurement period for different PRACH preamble format is specified in Table 6.3.3.4-1.

Table 6.3.3.4-1: PRACH ON power measurement period

| Format | SCS | Measurement period |
|--------------------------------|---------|--|
| A ₁ | 60 kHz | 0.035677 ms |
| | 120 kHz | 0.017839 ms |
| A ₂ | 60 kHz | 0.071354 ms |
| | 120 kHz | 0.035677 ms |
| A ₃ | 60 kHz | 0.107031 ms |
| | 120 kHz | 0.053516 ms |
| B ₁ | 60 kHz | 0.035091 ms |
| | 120 kHz | 0.0175455 ms |
| B ₄ | 60 kHz | 0.207617 ms |
| | 120 kHz | 0.103809 ms |
| A ₁ /B ₁ | 60 kHz | 0.035677 ms for front X1 occasion 0.035091 ms for last occasion X1 = [2,5] |
| | 120 kHz | 0.017839 ms for front X1 occasion 0.017546 ms for last occasion X1 = [2,5] |
| A ₂ /B ₂ | 60 kHz | 0.071354 ms for front X2 occasion 0.069596 ms for last occasion X2 = [1,2] |
| | 120 kHz | 0.035677 ms for front X2 occasion 0.034798 ms for last occasion X2 = [1,2] |
| A ₃ /B ₃ | 60 kHz | 0.107031 ms for first occasion 0.104101 ms for second occasion |
| | 120 kHz | 0.053515 ms for first occasion 0.052050 ms for second occasion |
| C ₀ | 60 kHz | 0.026758 ms |
| | 120 kHz | 0.013379 ms |
| C ₂ | 60 kHz | 0.083333 ms |
| | 120 kHz | 0.0416667 ms |

NOTE: For PRACH on PRACH occasion start from begin of 0ms or 0.5 ms boundary, the measurement period will plus 0.032552 μs

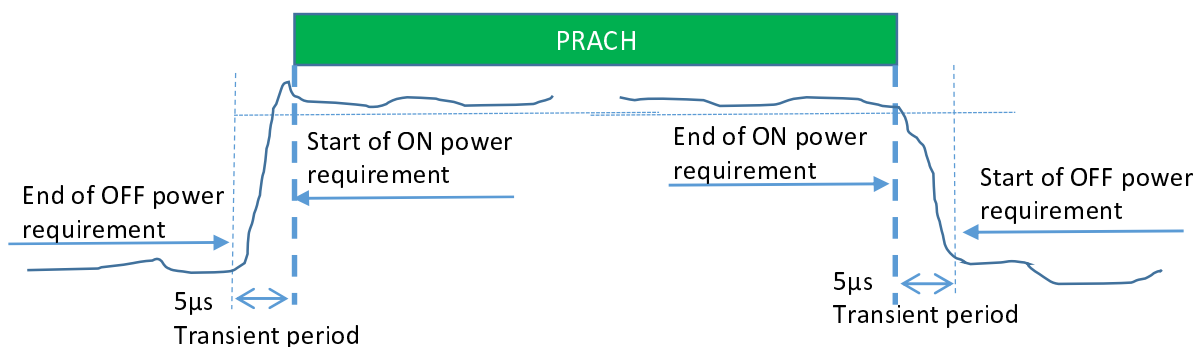

Figure 6.3.3.4-1: PRACH ON/OFF time mask

6.3.3.5 Void

6.3.3.6 SRS time mask

In the case a single SRS transmission, the ON power is defined as the mean power over the symbol duration excluding any transient period; Figure 6.3.3.6-1.

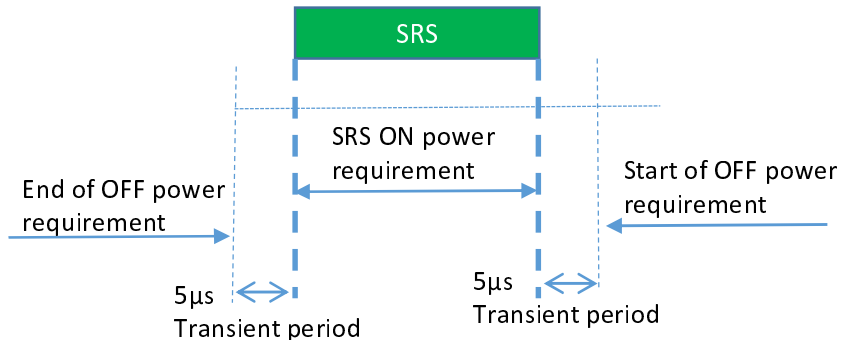

Figure 6.3.3.6-1: Single SRS time mask for NR UL transmission

In the case multiple consecutive SRS transmission, the ON power is defined as the mean power for each symbol duration excluding any transient period. See Figure 7.7.4-2

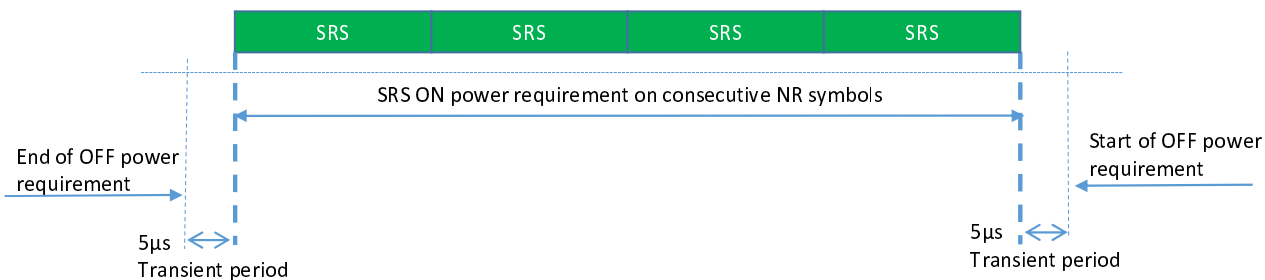

Figure 6.3.3.6-2: Consecutive SRS time mask for the case when no power change is required

When power change between consecutive SRS transmissions is required, then Figure 6.3.3.6-3 and Figure 6.3.3.6-4 apply.

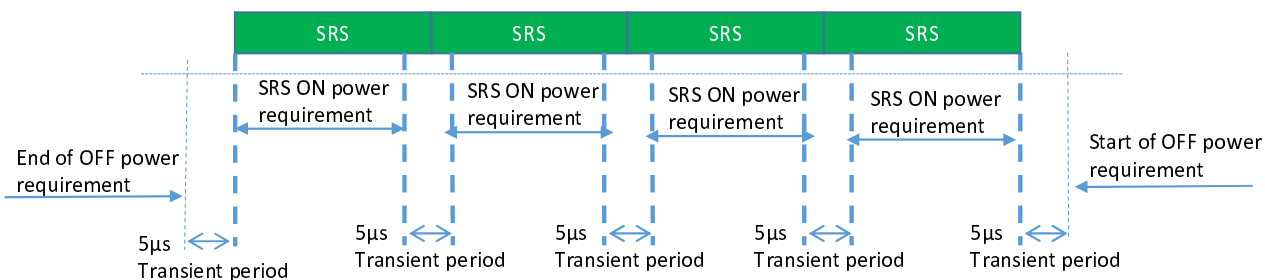

Figure 6.3.3.6-3: Consecutive SRS time mask for the case when power change is required and when 60kHz SCS is used in FR2

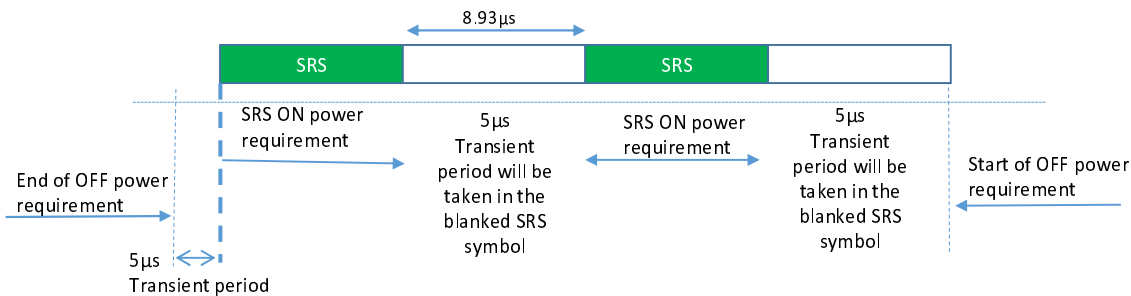

Figure 6.3.3.6-4: Consecutive SRS time mask for the case when power change is required and when 120kHz SCS is used in FR2

6.3.3.7 PUSCH-PUCCH and PUSCH-SRS time masks

The PUCCH/PUSCH/SRS time mask defines the observation period between sounding reference symbol (SRS) and an adjacent PUSCH/PUCCH symbol and subsequent UL transmissions. The time masks apply for all types of frame structures and their allowed PUCCH/PUSCH/SRS transmissions unless otherwise stated.

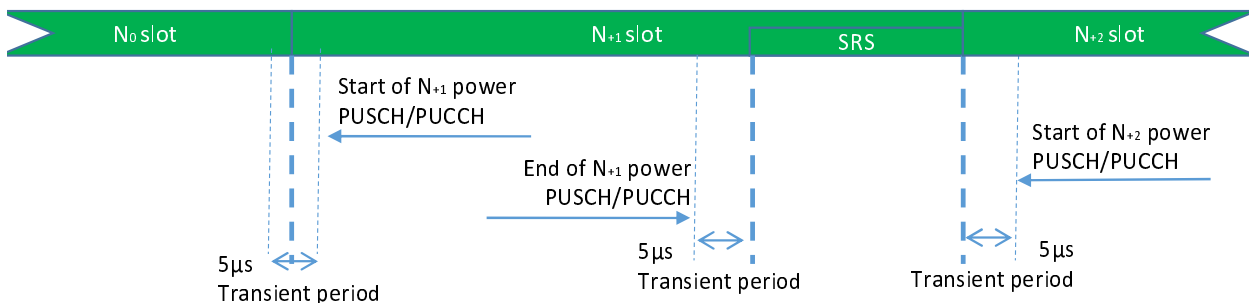

Figure 6.3.3.7-1: PUCCH/PUSCH/SRS time mask when there is a transmission before or after or both before and after SRS

When there is no transmission preceding SRS transmission or succeeding SRS transmission, then the same time mask applies as shown in Figure 6.3.3.7-1.

6.3.3.8 Transmit power time mask for consecutive slot or long subslot transmission and short subslot transmission boundaries

The transmit power time mask for consecutive slot or long subslot transmission and short subslot transmission boundaries defines the transient periods allowed between such transmissions.

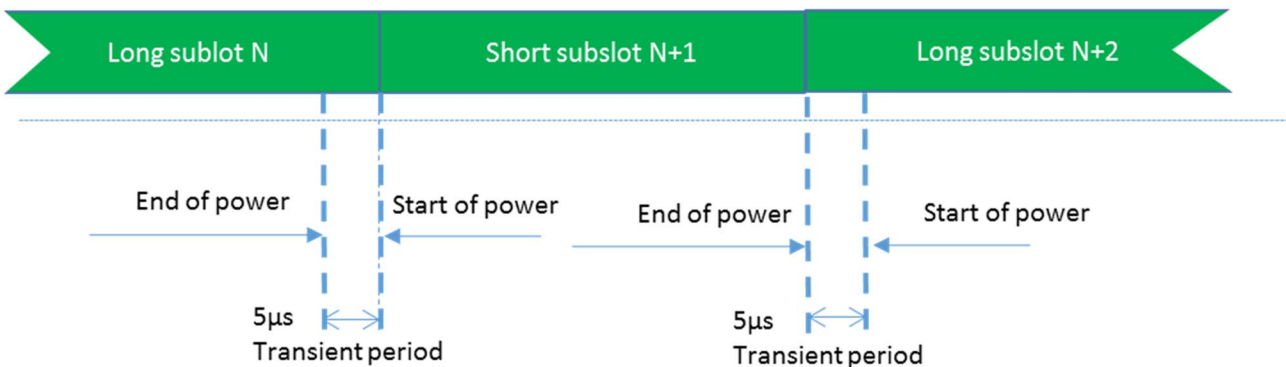

Figure 6.3.3.8-1: Consecutive slot or long subslot transmission and short subslot transmission time mask

6.3.3.9 Transmit power time mask for consecutive short subslot transmissions boundaries

The transmit power time mask for consecutive short subslot transmission boundaries defines the transient periods allowed between short subslot transmissions.

The transient period shall be equally shared as shown on Figure 6.3.3.9-2.

Figure 6.3.3.9-1: Void

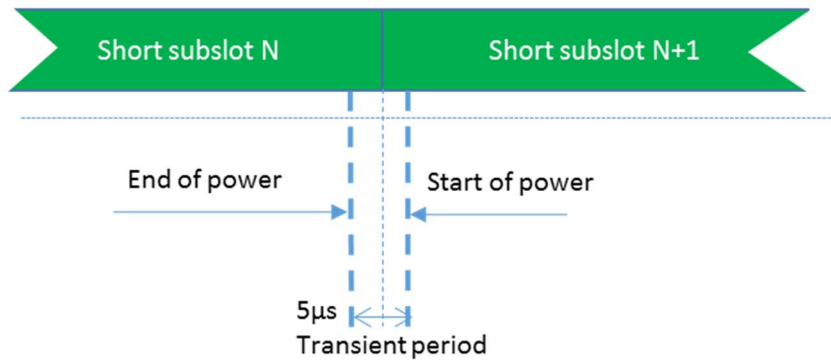

Figure 6.3.3.9-2: Consecutive short subslot transmissions time mask where DMRS is not the first symbol in the adjacent short subslot transmission

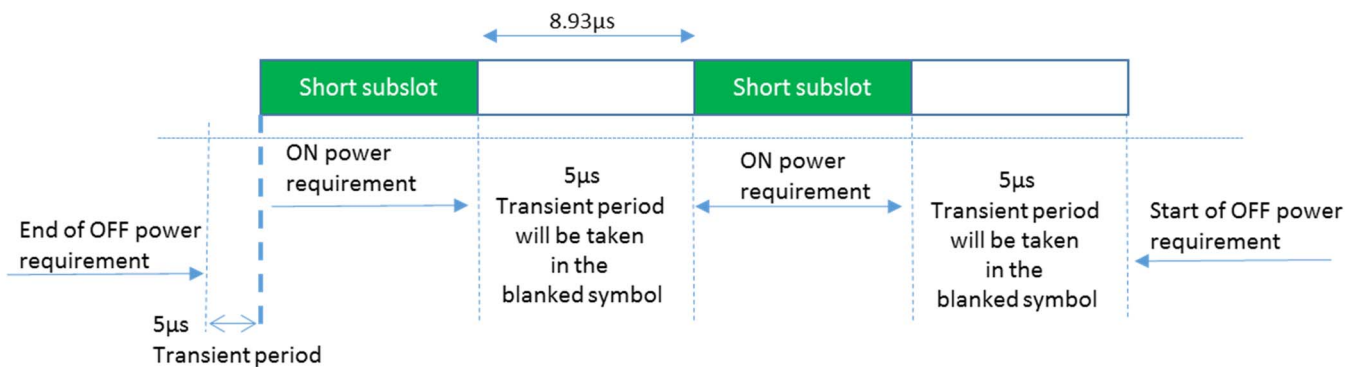

Figure 6.3.3.9-3: Consecutive short subslot (1 symbol gap) time mask for the case when transient period is required on both sides of the symbol and when 120 kHz SCS is used in FR2

6.3.4 Power control

6.3.4.1 General

The requirements on power control accuracy apply under normal conditions and are defined as a directional requirement. The requirements are verified in beam locked mode on beam peak direction.

6.3.4.2 Absolute power tolerance

The absolute power tolerance is the ability of the UE transmitter to set its initial output power to a specific value for the first sub-frame (1 ms) at the start of a contiguous transmission or non-contiguous transmission with a transmission gap larger than 20 ms. The tolerance includes the channel estimation error RSRP estimate.

The minimum requirements specified in Table 6.3.4.2-1 apply in the power range bounded by the minimum output power as specified in sub-clause 6.3.1 ('P_{min}') and the maximum output power as specified in sub-clause 6.2.1 as minimum peak EIRP ('P_{max}'). The intermediate power point 'P_{int}' is defined in table 6.3.4.2-2

Table 6.3.4.2-1: Absolute power tolerance

| Power Range | Tolerance |
|---|---------------|
| $P_{\text{int}} \geq P \geq P_{\text{min}}$ | ± 14.0 dB |
| $P_{\text{max}} \geq P > P_{\text{int}}$ | ± 12.0 dB |

Table 6.3.4.2-2: Intermediate power point

| Power Parameter | Value |
|------------------|----------------------------|
| P_{int} | $P_{\text{max}} - 12.0$ dB |

6.3.4.3 Relative power tolerance

The relative power tolerance is the ability of the UE transmitter to set its output power in a target sub-frame (1 ms) relatively to the power of the most recently transmitted reference sub-frame (1 ms) if the transmission gap between these sub-frames is less than or equal to 20 ms.

The minimum requirements specified in Table 6.3.4.3-1 apply when the power of the target and reference sub-frames are within the power range bounded by the minimum output power as defined in sub-clause 6.3.1 and P_{int} as defined in sub-clause 6.3.4.2. The minimum requirements specified in Table 6.3.4.3-2 apply when the power of the target and reference sub-frames are within the power range bounded by P_{int} as defined in sub-clause 6.3.4.2 and the measured P_{UMAX} as defined in sub-clause 6.2.4.

For a test pattern that is either a monotonically increasing or monotonically decreasing power sweep over the range specified for Tables 6.3.4.3-1 and 6.3.4.3-2, 3 exceptions are allowed for each of the test patterns. For these exceptions, the power tolerance limit is a maximum of ± 11.0 dB.

Table 6.3.4.3-1: Relative power tolerance, $P_{\text{int}} \geq P \geq P_{\text{min}}$

| Power step ΔP (Up or down) (dB) | All combinations of PUSCH and PUCCH, PUSCH/PUCCH and SRS transitions between sub-frames, PRACH (dB) |
|---|---|
| $\Delta P < 2$ | ± 5.0 |
| $2 \leq \Delta P < 3$ | ± 6.0 |
| $3 \leq \Delta P < 4$ | ± 7.0 |
| $4 \leq \Delta P < 10$ | ± 8.0 |
| $10 \leq \Delta P < 15$ | ± 10.0 |
| $15 \leq \Delta P$ | ± 11.0 |
| NOTE: The requirements apply with <i>ue-BeamLockFunction</i> enabled. | |

Table 6.3.4.3-2: Relative power tolerance, $P_{UMAX} \geq P > P_{int}$

| Power step ΔP (Up or down) (dB) | All combinations of PUSCH and PUCCH, PUSCH/PUCCH and SRS transitions between sub-frames, PRACH (dB) |
|---|---|
| $\Delta P < 2$ | ± 3.0 |
| $2 \leq \Delta P < 3$ | ± 4.0 |
| $3 \leq \Delta P < 4$ | ± 5.0 |
| $4 \leq \Delta P < 10$ | ± 6.0 |
| $10 \leq \Delta P < 15$ | ± 8.0 |
| $15 \leq \Delta P$ | ± 9.0 |
| NOTE 1: The requirements apply with <i>ue-BeamLockFunction</i> enabled. | |
| NOTE 2: For PUSCH to PUSCH transitions with the allocated resource blocks fixed in frequency and no transmission gaps other than those generated by downlink subframes, guard periods: for a power step $\Delta P = 1$ dB, the relative power tolerance for transmission is ± 1.0 dB. | |

6.3.4.4 Aggregate power tolerance

The aggregate power control tolerance is the ability of the UE transmitter to maintain its power in a sub-frame (1 ms) during non-contiguous transmissions within 21ms in response to 0 dB TPC commands with respect to the first UE transmission and all other power control parameters as specified in 38.213 kept constant.

The minimum requirements specified in Table 6.3.4.4-1 apply when the power of the target and reference sub-frames are within the power range bounded by the minimum output power as defined in sub-clause 6.3.1 and P_{int} as defined in sub-clause 6.3.4.2. The minimum requirements specified in Table 6.3.4.4-2 apply when the power of the target and reference sub-frames are within the power range bounded by P_{int} as defined in sub-clause 6.3.4.2 and the maximum output power as specified in sub-clause 6.2.1.

Table 6.3.4.4-1: Aggregate power tolerance, $P_{int} \geq P \geq P_{min}$

| TPC command | UL channel | Aggregate power tolerance within 21 ms |
|-------------|------------|--|
| 0 dB | PUCCH | ± 5.5 dB |
| 0 dB | PUSCH | ± 5.5 dB |

Table 6.3.4.4-2: Aggregate power tolerance, $P_{max} \geq P > P_{int}$

| TPC command | UL channel | Aggregate power tolerance within 21 ms |
|-------------|------------|--|
| 0 dB | PUCCH | ± 3.5 dB |
| 0 dB | PUSCH | ± 3.5 dB |

6.3A Output power dynamics for CA

6.3A.1 Minimum output power for CA

Table 6.3A.1-1: Void

6.3A.1.0 General

For intra-band contiguous and non-contiguous carrier aggregation, the minimum controlled output power of the UE is defined as the transmit power of the UE per component carrier, i.e., EIRP in the channel bandwidth of each component carrier for all transmit bandwidth configurations (resource blocks), when the power on both component carriers are set to a minimum value.

The minimum output power is defined as the mean power in at least one sub frame (1ms).

6.3A.1.1 Minimum output power for power class 1

The minimum output power shall not exceed the values specified in Table 6.3A.1.1-1 for each operating band supported. The minimum power is verified in beam locked mode with the test metric of EIRP (Link=TX beam peak direction, Meas=Link angle).

Table 6.3A.1.1-1: Minimum output power for power class 1

| Operating band | Channel bandwidth (MHz) | Minimum output power (dBm) | Measurement bandwidth (MHz) |
|------------------------|-------------------------|----------------------------|-----------------------------|
| n257, n258, n260, n261 | 50 | 4 | 47.58 |
| | 100 | 4 | 95.16 |
| | 200 | 4 | 190.20 |
| | 400 | 4 | 380.28 |

6.3A.1.2 Minimum output power for power class 2, 3, and 4

The minimum output power shall not exceed the values specified in Table 6.3A.1.2-1 for each operating band supported. The minimum power is verified in beam locked mode with the test metric of EIRP (Link=TX beam peak direction, Meas=Link angle).

Table 6.3A.1.2-1: Minimum output power for CA for power class 2, 3, and 4

| Operating band | Channel bandwidth (MHz) | Minimum output power (dBm) | Measurement bandwidth (MHz) |
|--|-------------------------|----------------------------|-----------------------------|
| n257, n258, n259, n260, n261 | 50 | -13 | 47.58 |
| | 100 | -13 | 95.16 |
| | 200 | -13 | 190.20 |
| | 400 | -13 | 380.28 |
| NOTE 1: n260 is not applied for power class 2. | | | |
| NOTE 2: n259 is not applied for power class 2 and 4. | | | |

6.3A.2 Transmit OFF power for CA

For intra-band contiguous and non-contiguous carrier aggregation, the transmit OFF power is defined as the TRP in the channel bandwidth per component carrier when the transmitter is OFF. The transmitter is considered OFF when the UE is not allowed to transmit on any of it sports.

The transmit OFF power shall not exceed the values specified in Table 6.3A.2-1 for each operating band supported.

Table 6.3A.2-1: Transmit OFF power for CA

| Operating band | Channel bandwidth / Transmit OFF power (dBm) / measurement bandwidth | | | |
|------------------------------|--|-----------|------------|------------|
| | 50 MHz | 100 MHz | 200 MHz | 400 MHz |
| n257, n258, n259, n260, n261 | -35 | -35 | -35 | -35 |
| | 47.58 MHz | 95.16 MHz | 190.20 MHz | 380.28 MHz |

6.3A.3 Transmit ON/OFF time mask for CA

For intra-band contiguous and non-contiguous UL carrier aggregation, the general output power ON/OFF time mask specified in clause 6.3.3.2 is applicable for each component carrier during the ON power period and the transient periods. The OFF period as specified in clause 6.3.3.2 shall only be applicable for each component carrier when all the component carriers are OFF.

6.3A.4 Power control for CA

6.3A.4.1 General

The requirements in this clause apply to a UE when it has at least one of UL or DL configured for CA operation. The requirements on power control accuracy in CA operation apply under normal conditions and are defined as a directional requirement. The requirements are verified in beam locked mode on beam peak direction. The requirements apply for one single PUCCH, PUSCH or SRS transmission of contiguous PRB allocation per configured UL CC with power setting in accordance with Clause 7.1 of [10]

6.3A.4.2 Absolute power tolerance

For intra-band contiguous and non-contiguous UL carrier aggregation, the absolute power tolerance is the ability of the UE transmitter to set its initial output power to a specific value for the first sub-frame at the start of a contiguous transmission or non-contiguous transmission with a transmission gap on each active component carriers larger than 20 ms. For SRS switching, the absolute power tolerance is the ability of the UE transmitter to set its initial output power to a specific value for the first sub-frame at the start of a contiguous transmission or non-contiguous transmission with a transmission gap on component carriers (to which SRS switching occurs) larger than 20 ms. The requirement can be tested by time aligning any transmission gaps on the component carriers. For intra-band contiguous CA, the absolute power control tolerance per configured UL CC is given in Tables 6.3.4.2-1 and 6.3.4.2-2.

6.3A.4.3 Relative power tolerance

For intra-band contiguous and non-contiguous UL carrier aggregation, the relative power tolerance is the ability of the UE transmitter to set its output power in a target sub-frame relative to the power of the most recently transmitted reference sub-frame if the transmission gap between these sub-frames is less than or equal to 20ms.

For intra-band contiguous CA, the requirements apply when the power of the target and reference sub-frames on each component carrier exceed the minimum output power as defined in clause 6.3A.1 and the total power is limited by P_{UMAX} as defined in clause 6.2A.4. For the purpose of these requirements, the power in each component carrier is specified over only the transmitted resource blocks. The UE shall meet the requirements in tables 6.3.4.3-1 and 6.3.4.3-2 for transmission on each assigned component carrier, when the average PSDs over each CC are aligned with each other in the reference sub-frame. The requirements apply per component carrier to:

- a. All possible combinations of PUSCH and PUCCH transitions
- b. SRS and PUSCH/PUCCH transitions, only with simultaneous SRS of constant SRS bandwidth allocated in the target and reference subframes
- c. RACH, primary component carrier

When applicable, the power step ΔP between the reference and target subframes shall be set by a TPC command and/or an uplink scheduling grant transmitted by means of an appropriate DCI Format.

6.3A.4.4 Aggregate power tolerance

For intra-band contiguous and non-contiguous UL carrier aggregation, the aggregate power control tolerance is the ability of the UE transmitter to maintain its power during non-contiguous transmissions within 21 ms in response to 0 dB TPC commands with respect to the first UE transmission and all other power control parameters as specified in [10] kept constant.

For intra-band contiguous CA, the aggregate power tolerance per CC is given in Tables 6.3.4.4.1-1 and 6.3.4.4.1-2, with simultaneous PUSCH configured. The average PSDs over each assigned CC shall be aligned before the start of the test. The requirement can be tested with the transmission gaps time aligned between component carriers.

6.3D Output power dynamics for UL MIMO

6.3D.0 General

The requirements in subclause 6.3D shall be met with configurations specified in sub-clause 6.2D.1.x, where 'x' depends on power class. Unless otherwise specified, the requirements shall be verified in beam locked mode with the test metric of EIRP (Link=TX beam peak direction, Meas=Link angle).

6.3D.1 Minimum output power for UL MIMO

6.3D.1.0 General

The minimum output power is defined as the mean power in at least one sub frame (1ms). The minimum controlled output power is defined as the EIRP, i.e. the sum of the power in the channel bandwidth for all transmit bandwidth configurations (resource blocks), when the UE power is set to a minimum value.

6.3D.1.1 Minimum output power for UL MIMO for power class 1

For UE supporting UL MIMO, the minimum output power shall not exceed the sum of the values specified in Table 6.3.1.1-1 and the quantity $10 \cdot \log_{10}(\text{Number of Layers})$. The minimum power is verified in beam locked mode with the test metric of EIRP (Link=TX beam peak direction, Meas=Link angle).

6.3D.1.2 Minimum output power for UL MIMO for power class 2, 3 and 4

For UE supporting UL MIMO, the minimum output power shall not exceed the sum of the values specified in Table 6.3.1.2-1 and the quantity $10 \cdot \log_{10}(\text{Number of Layers})$.

6.3D.2 Transmit OFF power for UL MIMO

For UE supporting UL MIMO, the transmit OFF power is defined as the TRP in the channel bandwidth when the transmitter is OFF. The transmitter is considered OFF when the UE is not allowed to transmit on any of its ports. During DTX and measurements gaps, the transmitter is not considered OFF. The minimum output power shall not exceed the values specified in Table 6.3.2-1. The requirement is verified with the test metric of TRP (Link=TX beam peak direction, Meas=TRP grid).

6.3D.3 Transmit ON/OFF time mask for UL MIMO

For UE supporting UL MIMO, the ON/OFF time mask requirements in clause 6.3.3 apply.

6.4 Transmit signal quality

6.4.1 Frequency Error

The UE basic measurement interval of modulated carrier frequency is 1 UL slot. The mean value of basic measurements of UE modulated carrier frequency shall be accurate to within ± 0.1 PPM observed over a period of 1 msec of cumulated measurement intervals compared to the carrier frequency received from the NR gNB.

The frequency error is defined as a directional requirement. The requirement is verified in beam locked mode with the test metric of Frequency (Link=TX beam peak direction, Meas=Link angle).

6.4.2 Transmit modulation quality

6.4.2.0 General

Transmit modulation quality defines the modulation quality for expected in-channel RF transmissions from the UE. The transmit modulation quality is specified in terms of:

- Error Vector Magnitude (EVM) for the allocated resource blocks (RBs)
- EVM equalizer spectrum flatness derived from the equalizer coefficients generated by the EVM measurement process
- Carrier leakage
- In-band emissions for the non-allocated RB

All the parameters defined in clause 6.4.2 are defined using the measurement methodology specified in Annex F.

All the requirements in 6.4.2 are defined as directional requirement. The requirements are verified in beam locked mode on beam peak direction, with parameter *maxRank* (as defined in TS 38.331 [13]) set to 1. The requirements are applicable to UL transmission from each configurable antenna port (as defined in TS 38.331 [13]) of UE, enabled one at a time.

In case the parameter 3300 or 3301 is reported from UE via the parameter *txDirectCurrentLocation* in *UplinkTxDirectCurrentList* IE (as defined in TS 38.331 [13]), carrier leakage measurement requirement in clause 6.4.2.2 and 6.4.2.3 shall be waived, and the RF correction with regard to the carrier leakage and IQ image shall be omitted during the calculation of transmit modulation quality.

6.4.2.1 Error vector magnitude

The Error Vector Magnitude is a measure of the difference between the reference waveform and the measured waveform. This difference is called the error vector. Before calculating the EVM, the measured waveform is corrected by the sample timing offset and RF frequency offset. Then the carrier leakage shall be removed from the measured waveform before calculating the EVM.

The measured waveform is further equalised using the channel estimates subjected to the EVM equaliser spectrum flatness requirement specified in sub-clauses 6.4.2.4 and 6.4.2.5. For DFT-s-OFDM waveforms, the EVM result is defined after the front-end FFT and IDFT as the square root of the ratio of the mean error vector power to the mean reference power expressed as a %. For CP-OFDM waveforms, the EVM result is defined after the front-end FFT as the square root of the ratio of the mean error vector power to the mean reference power expressed as a %.

The basic EVM measurement interval in the time domain is one preamble sequence for the PRACH and one slot for PUCCH and PUSCH in the time domain. The EVM measurement interval is reduced by any symbols that contains an allowable power transient in the measurement interval as defined in clause 6.3.3.

The RMS average of the basic EVM measurements over 10 subframes for the average EVM case, and over 60 subframes for the reference signal EVM case, for the different modulation schemes shall not exceed the values specified in Table 6.4.2.1-1 for the parameters defined in Table 6.4.2.1-2 or 6.4.2.1-3, depending on UE power class. For EVM evaluation purposes, all 13 PRACH preamble formats and all 5 PUCCH formats are considered to have the same EVM requirement as QPSK modulated.

The requirement is verified with the test metric of EVM (Link=TX beam peak direction, Meas=Link angle).

Table 6.4.2.1-1: Minimum requirements for error vector magnitude

| Parameter | Unit | Average EVM level | Reference signal EVM level |
|-----------|------|-------------------|----------------------------|
| Pi/2 BPSK | % | 30.0 | 30.0 |
| QPSK | % | 17.5 | 17.5 |
| 16 QAM | % | 12.5 | 12.5 |
| 64 QAM | % | 8.0 | 8.0 |

Table 6.4.2.1-2: Parameters for Error Vector Magnitude for power class 1

| Parameter | Unit | Level |
|-----------------------|------|-------------------|
| UE EIRP | dBm | ≥ 4 |
| UE EIRP for UL 16 QAM | dBm | ≥ 7 |
| UE EIRP for UL 64 QAM | dBm | ≥ 11 |
| Operating conditions | | Normal conditions |

Table 6.4.2.1-3: Parameters for Error Vector Magnitude for power class 2, 3, and 4

| Parameter | Unit | Level |
|-----------------------|------|-------------------|
| UE EIRP | dBm | ≥ -13 |
| UE EIRP for UL 16 QAM | dBm | ≥ -10 |
| UE EIRP for UL 64 QAM | dBm | ≥ -6 |
| Operating conditions | | Normal conditions |

6.4.2.2 Carrier leakage

6.4.2.2.1 General

Carrier leakage is an additive sinusoid waveform. The carrier leakage requirement is defined for each component carrier. The measurement interval is one slot in the time domain. The relative carrier leakage power is a power ratio of the additive sinusoid waveform to the power in the modulated waveform.

The requirement is verified with the test metric of Carrier Leakage (Link=TX beam peak direction, Meas=Link angle).

6.4.2.2.2 Carrier leakage for power class 1

When carrier leakage is contained inside the spectrum confined within the configured UL and DL CCs, the relative carrier leakage power shall not exceed the values specified in Table 6.4.2.2.2-1 for power class 1 UEs.

Table 6.4.2.2.2-1: Minimum requirements for relative carrier leakage power for power class 1

| Parameters | Relative Limit (dBc) |
|---------------------------------|----------------------|
| EIRP > 17 dBm | -25 |
| 4 dBm \leq EIRP \leq 17 dBm | -20 |

6.4.2.2.3 Carrier leakage for power class 2

When carrier leakage is contained inside the spectrum occupied by the configured UL CCs and DL CCs, the relative carrier leakage power shall not exceed the values specified in Table 6.4.2.2.3-1 for power class 2.

Table 6.4.2.2.3-1: Minimum requirements for relative carrier leakage power for power class 2

| Parameters | Relative Limit (dBc) |
|----------------------------------|----------------------|
| EIRP > 6 dBm | -25 |
| -13 dBm \leq EIRP \leq 6 dBm | -20 |

6.4.2.2.4 Carrier leakage for power class 3

When carrier leakage is contained inside the spectrum occupied by the configured UL CCs and DL CCs, the relative carrier leakage power shall not exceed the values specified in Table 6.4.2.2.4-1 for power class 3 UEs.

Table 6.4.2.2.4-1: Minimum requirements for relative carrier leakage power for power class 3

| Parameters | Relative Limit (dBc) |
|----------------------------------|----------------------|
| EIRP > 0 dBm | -25 |
| -13 dBm \leq EIRP \leq 0 dBm | -20 |

6.4.2.2.5 Carrier leakage for power class 4

When carrier leakage is contained inside the spectrum occupied by the configured UL CCs and DL CCs, the relative carrier leakage power shall not exceed the values specified in Table 6.4.2.2.5-1 for power class 4.

Table 6.4.2.2.5-1: Minimum requirements for relative carrier leakage power for power class 4

| Parameters | Relative Limit (dBc) |
|-------------------------|----------------------|
| EIRP > 11 dBm | -25 |
| -13 dBm ≤ EIRP ≤ 11 dBm | -20 |

6.4.2.3 In-band emissions

6.4.2.3.1 General

The in-band emission is defined as the average across 12 sub-carriers and as a function of the RB offset from the edge of the allocated UL transmission bandwidth. The in-band emission is measured as the ratio of the UE output power in a non-allocated RB to the UE output power in an allocated RB. The IBE requirement does not apply if UE declares support for *mpr-PowerBoost-FR2-r16*, UL transmission is QPSK, $MPR_{f,c} = 0$ and when NS_200 applies, and the network configures the UE to operate with *mpr-PowerBoost-FR2-r16*.

The basic in-band emissions measurement interval is identical to that of the EVM test.

The requirement is verified with the test metric of In-band emission (Link=TX beam peak direction, Meas=Link angle).

6.4.2.3.2 In-band emissions for power class 1

The average of the in-band emission measurement over 10 sub-frames shall not exceed the values specified in Table 6.4.2.3.2-1 for power class 1 UEs.

Table 6.4.2.3.2-1: Requirements for in-band emissions for power class 1

| Parameter description | Unit | Limit (NOTE 1) | | Applicable Frequencies |
|-----------------------|------|--|-------------------------------|--------------------------------|
| General | dB | $\max \left[\begin{array}{l} -25 - 10 \cdot \log_{10} \left(\frac{N_{RB}}{L_{CRB}} \right), \\ 20 \cdot \log_{10}(\text{EVM}) - 5 \cdot \frac{(\Delta_{RB} - 1)}{L_{CRB}}, \\ -55.1 \text{ dBm} - \overline{P_{RB}} \end{array} \right]$ | | Any non-allocated (NOTE 2) |
| IQ Image | dB | -25 | Output power > 27 dBm | Image frequencies (NOTES 2, 3) |
| | | -20 | Output power ≤ 27 dBm | |
| Carrier leakage | dBc | -25 | Output power > 17 dBm | Carrier frequency (NOTES 4, 5) |
| | | -20 | 4 dBm ≤ Output power ≤ 17 dBm | |

- NOTE 1: An in-band emissions combined limit is evaluated in each non-allocated RB. For each such RB, the minimum requirement is calculated as the higher of ($\overline{P_{RB}} - 25$ dB) and the power sum of all limit values (General, IQ Image or Carrier leakage) that apply. $\overline{P_{RB}}$ is defined in NOTE 10.
- NOTE 2: The measurement bandwidth is 1 RB and the limit is expressed as a ratio of measured power in one non-allocated RB to the measured average power per allocated RB, where the averaging is done across all allocated RBs. For pi/2 BPSK with Spectrum Shaping, the limit is expressed as a ratio of measured power in one non-allocated RB to the measured power in the allocated RB with highest PSD
- NOTE 3: The applicable frequencies for this limit are those that are enclosed in the reflection of the allocated bandwidth, based on symmetry with respect to the carrier frequency, but excluding any allocated RBs.
- NOTE 4: The measurement bandwidth is 1 RB and the limit is expressed as a ratio of measured power in one non-allocated RB to the measured total power in all allocated RBs.
- NOTE 5: The applicable frequencies for this limit depend on the parameter *txDirectCurrentLocation* in *UplinkTxDirectCurrent* IE, and are those that are enclosed in the RBs containing the DC frequency but excluding any allocated RB.
- NOTE 6: L_{CRB} is the Transmission Bandwidth (see Clause 5.3).
- NOTE 7: N_{RB} is the Transmission Bandwidth Configuration (see Clause 5.3).
- NOTE 8: EVM is the limit for the modulation format used in the allocated RBs.
- NOTE 9: Δ_{RB} is the starting frequency offset between the allocated RB and the measured non-allocated RB (e.g. $\Delta_{RB} = 1$ or $\Delta_{RB} = -1$ for the first adjacent RB outside of the allocated bandwidth).
- NOTE 10: $\overline{P_{RB}}$ is an average of the transmitted power over 10 sub-frames normalized by the number of allocated RBs, measured in dBm.
- NOTE 11: All powers are EIRP in beam peak direction.

6.4.2.3.3 In-band emissions for power class 2

The average of the in-band emission measurement over 10 sub-frames shall not exceed the values specified in Table 6.4.2.3.3-1 for power class 2.

Table 6.4.2.3.3-1: Requirements for in-band emissions for power class 2

| Parameter description | Unit | Limit (NOTE 1) | | Applicable Frequencies |
|--|------|--|--------------------------------|--------------------------------|
| General | dB | $\max \left[\begin{array}{l} -25 - 10 \cdot \log_{10} \left(\frac{N_{RB}}{L_{CRB}} \right), \\ 20 \cdot \log_{10}(\text{EVM}) - 5 \cdot \frac{(\Delta_{RB} - 1)}{L_{CRB}}, \\ -55.1 \text{ dBm} - \overline{P_{RB}} \end{array} \right]$ | | Any non-allocated (NOTE 2) |
| IQ Image | dB | -25 | Output power > 16 dBm | Image frequencies (NOTES 2, 3) |
| | | -20 | Output power ≤ 16 dBm | |
| Carrier leakage | dBc | -25 | Output power > 6 dBm | Carrier frequency (NOTES 4, 5) |
| | | -20 | -13 dBm ≤ Output power ≤ 6 dBm | |
| <p>NOTE 1: An in-band emissions combined limit is evaluated in each non-allocated RB. For each such RB, the minimum requirement is calculated as the higher of ($\overline{P_{RB}} - 25$ dB) and the power sum of all limit values (General, IQ Image or Carrier leakage) that apply. $\overline{P_{RB}}$ is defined in NOTE 10.</p> <p>NOTE 2: The measurement bandwidth is 1 RB and the limit is expressed as a ratio of measured power in one non-allocated RB to the measured average power per allocated RB, where the averaging is done across all allocated RBs. For Pi/2 BPSK with Spectrum Shaping, the limit is expressed as a ratio of measured power in one non-allocated RB to the measured power in the allocated RB with highest PSD</p> <p>NOTE 3: The applicable frequencies for this limit are those that are enclosed in the reflection of the allocated bandwidth, based on symmetry with respect to the carrier frequency, but excluding any allocated RBs.</p> <p>NOTE 4: The measurement bandwidth is 1 RB and the limit is expressed as a ratio of measured power in one non-allocated RB to the measured total power in all allocated RBs.</p> <p>NOTE 5: The applicable frequencies for this limit depend on the parameter <i>txDirectCurrentLocation</i> in <i>UplinkTxDirectCurrent</i> IE, and are those that are enclosed in the RBs containing the DC frequency but excluding any allocated RB.</p> <p>NOTE 6: L_{CRB} is the Transmission Bandwidth (see Clause 5.3).</p> <p>NOTE 7: N_{RB} is the Transmission Bandwidth Configuration (see Clause 5.3).</p> <p>NOTE 8: EVM is the limit for the modulation format used in the allocated RBs.</p> <p>NOTE 9: Δ_{RB} is the starting frequency offset between the allocated RB and the measured non-allocated RB (e.g. $\Delta_{RB} = 1$ or $\Delta_{RB} = -1$ for the first adjacent RB outside of the allocated bandwidth).</p> <p>NOTE 10: $\overline{P_{RB}}$ is an average of the transmitted power over 10 sub-frames normalized by the number of allocated RBs, measured in dBm.</p> <p>NOTE 11: All powers are EIRP in beam peak direction.</p> | | | | |

6.4.2.3.4 In-band emissions for power class 3

The average of the in-band emission measurement over 10 sub-frames shall not exceed the values specified in Table 6.4.2.3.4-1 for power class 3 UEs.

Table 6.4.2.3.4-1: Requirements for in-band emissions for power class 3

| Parameter description | Unit | Limit (NOTE 1) | | Applicable Frequencies |
|--|------|--|--------------------------------|--------------------------------|
| General | dB | $\max \left[\begin{array}{l} -25 - 10 \cdot \log_{10} \left(\frac{N_{RB}}{L_{CRB}} \right), \\ 20 \cdot \log_{10}(\text{EVM}) - 5 \cdot \frac{(\Delta_{RB} - 1)}{L_{CRB}}, \\ -55.1 \text{ dBm} - \overline{P_{RB}} \end{array} \right]$ | | Any non-allocated (NOTE 2) |
| IQ Image | dB | -25 | Output power > 10 dBm | Image frequencies (NOTES 2, 3) |
| | | -20 | Output power ≤ 10 dBm | |
| Carrier leakage | dBc | -25 | Output power > 0 dBm | Carrier frequency (NOTES 4, 5) |
| | | -20 | -13 dBm ≤ Output power ≤ 0 dBm | |
| <p>NOTE 1: An in-band emissions combined limit is evaluated in each non-allocated RB. For each such RB, the minimum requirement is calculated as the higher of ($\overline{P_{RB}} - 25$ dB) and the power sum of all limit values (General, IQ Image or Carrier leakage) that apply. $\overline{P_{RB}}$ is defined in NOTE 10.</p> <p>NOTE 2: The measurement bandwidth is 1 RB and the limit is expressed as a ratio of measured power in one non-allocated RB to the measured average power per allocated RB, where the averaging is done across all allocated RBs. For Pi/2 BPSK with Spectrum Shaping, the limit is expressed as a ratio of measured power in one non-allocated RB to the measured power in the allocated RB with highest PSD</p> <p>NOTE 3: The applicable frequencies for this limit are those that are enclosed in the reflection of the allocated bandwidth, based on symmetry with respect to the carrier frequency, but excluding any allocated RBs.</p> <p>NOTE 4: The measurement bandwidth is 1 RB and the limit is expressed as a ratio of measured power in one non-allocated RB to the measured total power in all allocated RBs.</p> <p>NOTE 5: The applicable frequencies for this limit depend on the parameter <i>txDirectCurrentLocation</i> in <i>UplinkTxDirectCurrent</i> IE, and are those that are enclosed in the RBs containing the DC frequency but excluding any allocated RB.</p> <p>NOTE 6: L_{CRB} is the Transmission Bandwidth (see Clause 5.3).</p> <p>NOTE 7: N_{RB} is the Transmission Bandwidth Configuration (see Clause 5.3).</p> <p>NOTE 8: EVM is the limit for the modulation format used in the allocated RBs.</p> <p>NOTE 9: Δ_{RB} is the starting frequency offset between the allocated RB and the measured non-allocated RB (e.g. $\Delta_{RB} = 1$ or $\Delta_{RB} = -1$ for the first adjacent RB outside of the allocated bandwidth).</p> <p>NOTE 10: $\overline{P_{RB}}$ is an average of the transmitted power over 10 sub-frames normalized by the number of allocated RBs, measured in dBm.</p> <p>NOTE 11: All powers are EIRP in beam peak direction.</p> | | | | |

6.4.2.3.5 In-band emissions for power class 4

The average of the in-band emission measurement over 10 sub-frames shall not exceed the values specified in Table 6.4.2.3.5-1 for power class 4 UEs.

Table 6.4.2.3.5-1: Requirements for in-band emissions for power class 4

| Parameter description | Unit | Limit (NOTE 1) | | Applicable Frequencies |
|--|------|--|---------------------------------|--------------------------------|
| General | dB | $\max \left[\begin{array}{l} -25 - 10 \cdot \log_{10} \left(\frac{N_{RB}}{L_{CRB}} \right), \\ 20 \cdot \log_{10}(\text{EVM}) - 5 \cdot \frac{(\Delta_{RB} - 1)}{L_{CRB}}, \\ -55.1 \text{ dBm} - \overline{P_{RB}} \end{array} \right]$ | | Any non-allocated (NOTE 2) |
| IQ Image | dB | -25 | Output power > 21 dBm | Image frequencies (NOTES 2, 3) |
| | | -20 | Output power ≤ 21 dBm | |
| Carrier leakage | dBc | -25 | Output power > 11 dBm | Carrier frequency (NOTES 4, 5) |
| | | -20 | -13 dBm ≤ Output power ≤ 11 dBm | |
| <p>NOTE 1: An in-band emissions combined limit is evaluated in each non-allocated RB. For each such RB, the minimum requirement is calculated as the higher of ($\overline{P_{RB}}$ - 25 dB) and the power sum of all limit values (General, IQ Image or Carrier leakage) that apply. $\overline{P_{RB}}$ is defined in NOTE 10.</p> <p>NOTE 2: The measurement bandwidth is 1 RB and the limit is expressed as a ratio of measured power in one non-allocated RB to the measured average power per allocated RB, where the averaging is done across all allocated RBs. For Pi/2 BPSK with Spectrum Shaping, the limit is expressed as a ratio of measured power in one non-allocated RB to the measured power in the allocated RB with highest PSD</p> <p>NOTE 3: The applicable frequencies for this limit are those that are enclosed in the reflection of the allocated bandwidth, based on symmetry with respect to the carrier frequency, but excluding any allocated RBs.</p> <p>NOTE 4: The measurement bandwidth is 1 RB and the limit is expressed as a ratio of measured power in one non-allocated RB to the measured total power in all allocated RBs.</p> <p>NOTE 5: The applicable frequencies for this limit depend on the parameter <i>txDirectCurrentLocation</i> in <i>UplinkTxDirectCurrent</i> IE, and are those that are enclosed in the RBs containing the DC frequency but excluding any allocated RB.</p> <p>NOTE 6: L_{CRB} is the Transmission Bandwidth (see Clause 5.3).</p> <p>NOTE 7: N_{RB} is the Transmission Bandwidth Configuration (see Clause 5.3).</p> <p>NOTE 8: EVM is the limit for the modulation format used in the allocated RBs.</p> <p>NOTE 9: Δ_{RB} is the starting frequency offset between the allocated RB and the measured non-allocated RB (e.g. $\Delta_{RB} = 1$ or $\Delta_{RB} = -1$ for the first adjacent RB outside of the allocated bandwidth).</p> <p>NOTE 10: $\overline{P_{RB}}$ is an average of the transmitted power over 10 sub-frames normalized by the number of allocated RBs, measured in dBm.</p> <p>NOTE 11: All powers are EIRP in beam peak direction.</p> | | | | |

6.4.2.4 EVM equalizer spectrum flatness

The EVM measurement process (as described in Annex F) entails generation of a zero-forcing equalizer. The EVM equalizer spectrum flatness is defined in terms of the maximum peak-to-peak ripple of the equalizer coefficients (dB) across the allocated uplink block. The basic measurement interval is the same as for EVM.

For Pi/2 BPSK modulation, the minimum requirements are defined in Clause 6.4.2.5.

The peak-to-peak variation of the EVM equalizer coefficients contained within the frequency range of the uplink allocation shall not exceed the maximum ripple specified in Table 6.4.2.4-1 for normal conditions. For uplink allocations contained within both Range 1 and Range 2, the coefficients evaluated within each of these frequency ranges shall meet the corresponding ripple requirement and the following additional requirements: the relative difference between the maximum coefficient in Range 1 and the minimum coefficient in Range 2 (Table 6.4.2.4-1) must not be larger than 7 dB, and the relative difference between the maximum coefficient in Range 2 and the minimum coefficient in Range 1 must not be larger than 8 dB (see Figure 6.4.2.4-1).

The requirement is verified with the test metric of EVM SF (Link=TX beam peak direction, Meas=Link angle).

Table 6.4.2.4-1: Minimum requirements for EVM equalizer spectrum flatness (normal conditions)

| Frequency range | Maximum ripple (dB) |
|---|---------------------|
| $ F_{UL_Meas} - F_{center} \leq X$ MHz (Range 1) | 6 (p-p) |
| $ F_{UL_Meas} - F_{center} > X$ MHz (Range 2) | 9 (p-p) |

NOTE 1: F_{UL_Meas} refers to the sub-carrier frequency for which the equalizer coefficient is evaluated
 NOTE 2: F_{center} refers to the center frequency of the CC
 NOTE 3: X, in MHz, is equal to 30 % of the CC bandwidth

Table 6.4.2.4-2: (Void)

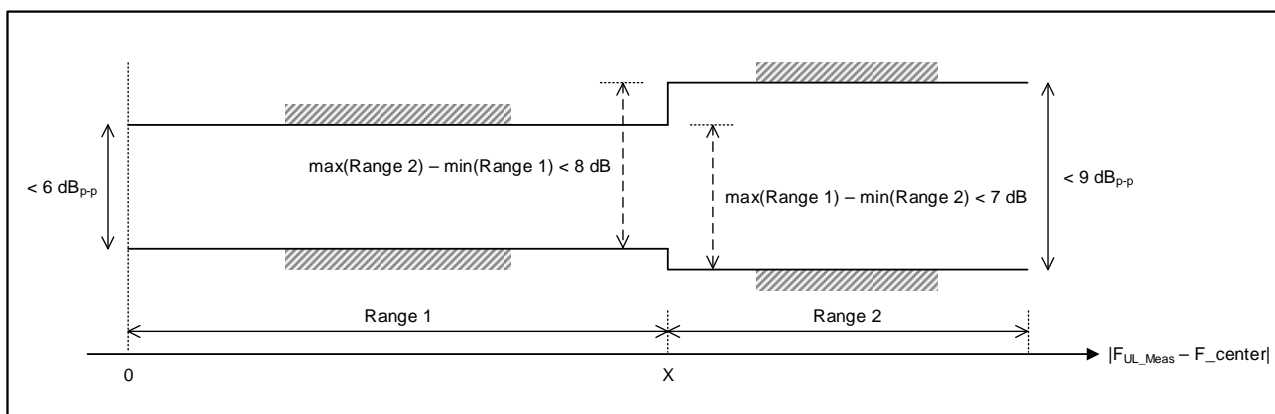

Figure 6.4.2.4-1: The limits for EVM equalizer spectral flatness with the maximum allowed variation of the coefficients indicated under normal conditions

6.4.2.5 EVM spectral flatness for Pi/2 BPSK modulation

These requirements are defined for Pi/2 BPSK modulation. The EVM equalizer coefficients across the allocated uplink block shall be modified to fit inside the mask specified in Table 6.4.2.5-1 for normal conditions, prior to the calculation of EVM. The limiting mask shall be placed to minimize the change in equalizer coefficients in a sum of squares sense.

Table 6.4.2.5-1: Mask for EVM equalizer coefficients for pi/2 BPSK (normal conditions)

| Frequency range | Parameter | Maximum ripple (dB) |
|---|-----------|---------------------|
| $ F_{UL_Meas} - F_{center} \leq X$ MHz (Range 1) | X1 | 6 (p-p) |
| $ F_{UL_Meas} - F_{center} > X$ MHz (Range 2) | X2 | 14 (p-p) |

NOTE 1: F_{UL_Meas} refers to the sub-carrier frequency for which the equalizer coefficient is evaluated
 NOTE 2: F_{center} refers to the center frequency of an allocated block of PRBs
 NOTE 3: X, in MHz, is equal to 25% of the bandwidth of the PRB allocation
 NOTE 4: See Figure 6.4.2.5-1 for description of X1, X2 and X3

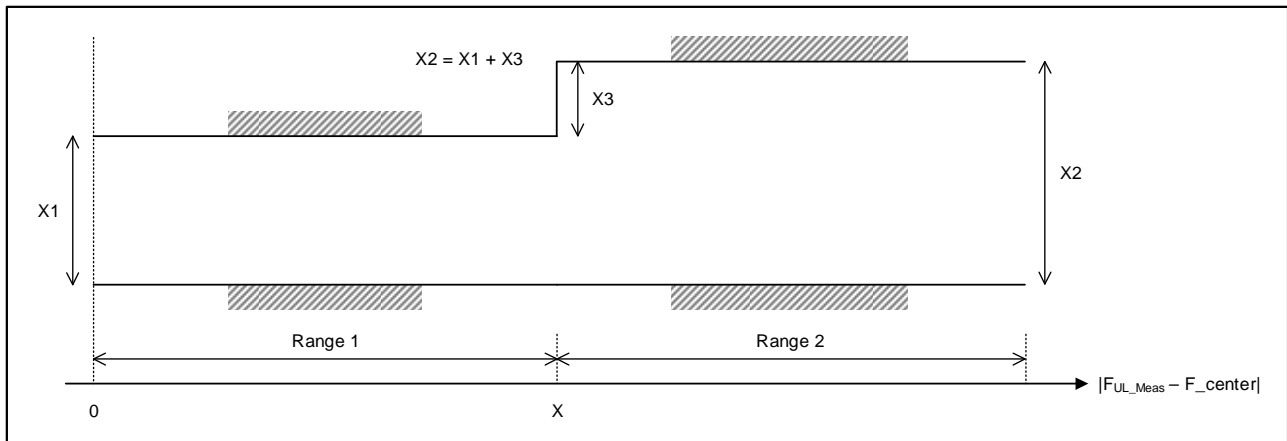

Figure 6.4.2.5-1: The limits for EVM equalizer spectral flatness with the maximum allowed variation. F_{center} denotes the center frequency of the allocated block of PRBs.

This requirement does not apply to other modulation types. The UE shall be allowed to employ spectral shaping for Pi/2 BPSK. The shaping filter shall be restricted so that the impulse response of the transmit chain shall meet

$$|\tilde{a}_i(t,0)| \geq |\tilde{a}_i(t,\tau)| \quad \forall \tau \neq 0$$

$$20\log_{10} |\tilde{a}_i(t,\tau)| < -15 \text{ dB} \quad 1 < \tau < M - 1,$$

Where:

$$|\tilde{a}_i(t,\tau)| = \text{IDFT}\{ |\tilde{a}_i(t,f)| e^{j\phi(t,f)} \},$$

f is the frequency of the M allocated subcarriers,

$\tilde{a}_i(t,f)$ and $\phi(t,f)$ are the amplitude and phase response, respectively of the transmit chain

0dB reference is defined as $20\log_{10} |\tilde{a}_i(t,0)|$

6.4A Transmit signal quality for CA

6.4A.0 General

The requirements in this clause apply if the UE has at least one of UL or DL configured for CA.

6.4A.1 Frequency error

The requirements in this clause apply to UEs of all power classes.

For intra-band contiguous and non-contiguous carrier aggregation, the UE basic measurement interval of modulated carrier frequency is 1 UL slot. The mean value of basic measurements of UE modulated carrier frequencies per band shall be accurate to within ± 0.1 PPM observed over a period of 1ms of cumulated measurement intervals compared to the carrier frequency of primary component carrier received from the gNB.

The frequency error is defined as a directional requirement. The requirement is verified in beam locked mode on beam peak direction.

6.4A.2 Transmit modulation quality

6.4A.2.0 General

For intra-band contiguous and non-contiguous carrier aggregation, the requirements in clauses 6.4A.2.1, 6.4A.2.2, and 6.4A.2.3.

All the parameters defined in clause 6.4A.2 are defined using the measurement methodology specified in Annex F.

All the requirements in 6.4A.2 are defined as directional requirement. The requirements are verified in beam locked mode on beam peak direction, with both UL polarizations active.

In case the parameter 3300 or 3301 is reported from UE via the parameter *txDirectCurrentLocation* in *UplinkTxDirectCurrentList* IE (as defined in TS 38.331 [13]), carrier leakage measurement requirement in clause 6.4A.2.2 and 6.4A.2.3 shall be waived, and the RF correction with regard to the carrier leakage and IQ image shall be omitted during the calculation of transmit modulation quality.

The UE is defined to be configured for CA operation when it has at least one of UL or DL configured for CA.

6.4A.2.1 Error Vector magnitude

The requirements in this clause apply to UEs of all power classes. For intra-band contiguous and non-contiguous carrier aggregation, the Error Vector Magnitude requirement of clause 6.4.2.2 is defined for each component carrier. Requirements only apply with PRB allocation in one of the component carriers. Similar transmitter impairment removal procedures are applied for CA waveform before EVM calculation as is specified for non-CA waveform.

6.4A.2.2 Carrier leakage

6.4A.2.2.1 General

Carrier leakage is an additive sinusoid waveform. The carrier leakage requirement is defined for each component carrier and is measured on the component carrier with PRBs allocated. The measurement interval is one slot in the time domain.

Note: When UE has DL configured for non-contiguous CA, carrier leakage may land outside the spectrum occupied by all configured UL and DL CC.

The relative carrier leakage power is a power ratio of the additive sinusoid waveform and the modulated waveform. The requirement is verified with the test metric of Carrier Leakage (Link=TX beam peak direction, Meas=Link angle).

6.4A.2.2.2 Carrier leakage for power class 1

When carrier leakage is contained inside the spectrum occupied by all configured UL and DL CCs, the relative carrier leakage power shall not exceed the values specified in Table 6.4A.2.2.2-1 for power class 1 UEs.

Table 6.4A.2.2.2-1: Minimum requirements for relative carrier leakage for power class 1

| Parameters | Relative Limit (dBc) |
|-----------------------|----------------------|
| EIRP > 17 dBm | -25 |
| 4 dBm ≤ EIRP ≤ 17 dBm | -20 |

6.4A.2.2.3 Carrier leakage for power class 2

When carrier leakage is contained inside the spectrum occupied by all configured UL and DL CCs, the relative carrier leakage power shall not exceed the values specified in Table 6.4A.2.2.3-1 for power class 2.

Table 6.4A.2.2.3-1: Minimum requirements for relative carrier leakage power class 2

| Parameters | Relative limit (dBc) |
|------------------------|----------------------|
| EIRP > 6 dBm | -25 |
| -13 dBm ≤ EIRP ≤ 6 dBm | -20 |

6.4A.2.2.4 Carrier leakage for power class 3

When carrier leakage is contained inside the spectrum occupied by all configured UL and DL CCs, the relative carrier leakage power shall not exceed the values specified in Table 6.4A.2.2.4-1 for power class 3 UEs.

Table 6.4A.2.2.4-1: Minimum requirements for relative carrier leakage power class 3

| Parameters | Relative limit (dBc) |
|-------------------------------------|----------------------|
| Output power > 0 dBm | -25 |
| -13 dBm ≤ Output power EIRP ≤ 0 dBm | -20 |

6.4A.2.2.5 Carrier leakage for power class 4

When carrier leakage is contained inside the spectrum occupied by all configured UL and DL CCs, the relative carrier leakage power shall not exceed the values specified in Table 6.4A.2.2.5-1 for power class 4 UEs.

Table 6.4A.2.2.5-1: Minimum requirements for relative carrier leakage power class 4

| Parameters | Relative limit (dBc) |
|--------------------------------------|----------------------|
| Output power > 11 dBm | -25 |
| -13 dBm ≤ Output power EIRP ≤ 11 dBm | -20 |

6.4A.2.3 Inband emissions

6.4A.2.3.1 General

Inband emission requirement is defined over the spectrum occupied by all configured UL and DL CCs. The measurement interval is as defined in clause 6.4.2.4. The requirement is verified with the test metric of In-band emission (Link=TX beam peak direction, Meas=Link angle).

For intra-band contiguous and non-contiguous carrier aggregation, the requirements in this clause apply with all component carriers active and with one single contiguous PRB allocation in one of uplink component carriers. The inband emission is defined as the interference falling into the non-allocated resource blocks for all component carriers.

6.4A.2.3.2 Inband emissions for power class 1

The average of the in-band emission measurement over 10 sub-frames shall not exceed the values specified in Table 6.4A.2.3.2-1 for power class 1 UEs.

Table 6.4A.2.3.2-1: Requirements for in-band emissions for power class 1

| Parameter description | Unit | Limit (NOTE 1) | | Applicable Frequencies |
|-----------------------|------|---|-------------------------------|---|
| General | dB | $\max \left[\begin{array}{l} -25 - 10 \cdot \log_{10} \left(\frac{N_{RB}}{L_{CRB}} \right), \\ 20 \cdot \log_{10}(\text{EVM}) - 5 \cdot \frac{(\Delta_{RB} - 1)}{L_{CRB}}, \\ -55.1 \text{ dBm} - \frac{P_{RB}}{P_{max}} \end{array} \right]$ | | Any non-allocated RB in allocated component carrier and not allocated component carriers (NOTE 2) |
| IQ Image | dB | -25 | Output power > 27 dBm | Image frequencies (NOTES 2, 3) |
| | | -20 | Output power ≤ 27 dBm | |
| Carrier leakage | dBc | -25 | Output power > 17 dBm | Carrier frequency (NOTES 4, 5) |
| | | -20 | 4 dBm ≤ Output power ≤ 17 dBm | |

NOTE 1: An in-band emissions combined limit is evaluated in each non-allocated RB. For each such RB, the minimum requirement is calculated as the higher of ($\overline{P_{RB}} - 25$ dB) and the power sum of all limit values (General, IQ Image or Carrier leakage) that apply. $\overline{P_{RB}}$ is defined in NOTE 9.

NOTE 2: The measurement bandwidth is 1 RB and the limit is expressed as a ratio of measured power in one non-allocated RB to the measured average power per allocated RB, where the averaging is done across all allocated RBs. For Pi/2 BPSK with Spectrum Shaping, the limit is expressed as a ratio of measured power in one non-allocated RB to the measured power in the allocated RB with highest PSD.

NOTE 3: Image frequencies for UL CA are specified in relation to either UL or DL carrier frequency. The applicable frequencies for this limit are those that are enclosed in the reflection of the allocated bandwidth, based on symmetry with respect to the carrier frequency reported DC location position, but excluding any allocated RBs.

NOTE 4: The measurement bandwidth is 1 RB and the limit is expressed as a ratio of measured power in one non-allocated RB to the measured total power in all allocated RBs.

NOTE 5: The applicable frequencies for this limit are those that are enclosed in the RBs containing the DC frequency, or in the two RBs immediately adjacent to the DC frequency but excluding any allocated RB.

NOTE 6: L_{CRB} is the Transmission Bandwidth for kth allocated component carrier (see Figure 5.3.3-1).

NOTE 7: EVM is the limit for the modulation format used in the allocated RBs.

NOTE 8: Δ_{RB} is the starting frequency offset between the allocated RB and the measured non-allocated RB (e.g. $\Delta_{RB} = 1$ or $\Delta_{RB} = -1$ for the first adjacent RB outside of the allocated bandwidth), and may take non-integer values when the carrier spacing between the CCs is not a multiple of RB.

NOTE 9: $\overline{P_{RB}}$ is an average of the transmitted power over 10 sub-frames normalized by the number of allocated RBs, measured in dBm.

NOTE 10: All powers are EIRP in beam peak direction.

6.4A.2.3.3 Inband emissions for power class 2

The average of the in-band emission measurement over 10 sub-frames shall not exceed the values specified in Table 6.4A.2.3.3-1 for power class 2.

Table 6.4A.2.3.3-1: Requirements for in-band emissions for power class 2

| Parameter description | Unit | Limit (NOTE 1) | | Applicable Frequencies |
|-----------------------|------|--|--------------------------------|---|
| General | dB | $\max \left[\begin{array}{l} -25 - 10 \cdot \log_{10} \left(\frac{N_{RB}}{L_{CRB}} \right), \\ 20 \cdot \log_{10}(\text{EVM}) - 5 \cdot \frac{(\Delta_{RB} - 1)}{L_{CRB}}, \\ -55.1 \text{ dBm} - \overline{P_{RB}} \end{array} \right]$ | | Any non-allocated RB in allocated component carrier and not allocated component carriers (NOTE 2) |
| IQ Image | dB | -25 | Output power > 16 dBm | Image frequencies (NOTES 2, 3) |
| | | -20 | Output power ≤ 16 dBm | |
| Carrier leakage | dBc | -25 | Output power > 6 dBm | Carrier frequency (NOTES 4, 5) |
| | | -20 | -13 dBm ≤ Output power ≤ 6 dBm | |

NOTE 1: An in-band emissions combined limit is evaluated in each non-allocated RB. For each such RB, the minimum requirement is calculated as the higher of ($\overline{P_{RB}} - 25$ dB) and the power sum of all limit values (General, IQ Image or Carrier leakage) that apply. $\overline{P_{RB}}$ is defined in NOTE 9.

NOTE 2: The measurement bandwidth is 1 RB and the limit is expressed as a ratio of measured power in one non-allocated RB to the measured average power per allocated RB, where the averaging is done across all allocated RBs. For Pi/2 BPSK with Spectrum Shaping, the limit is expressed as a ratio of measured power in one non-allocated RB to the measured power in the allocated RB with highest PSD.

NOTE 3: Image frequencies for UL CA are specified in relation to either UL or DL carrier frequency. The applicable frequencies for this limit are those that are enclosed in the reflection of the allocated bandwidth, based on symmetry with respect to the reported DC location position, but excluding any allocated RBs.

NOTE 4: The measurement bandwidth is 1 RB and the limit is expressed as a ratio of measured power in one non-allocated RB to the measured total power in all allocated RBs.

NOTE 5: The applicable frequencies for this limit are those that are enclosed in the RBs containing the DC frequency, or in the two RBs immediately adjacent to the DC frequency but excluding any allocated RB.

NOTE 6: L_{CRB} is the Transmission Bandwidth for kth allocated component carrier (see Figure 5.3.3-1).

NOTE 7: EVM is the limit for the modulation format used in the allocated RBs.

NOTE 8: Δ_{RB} is the starting frequency offset between the allocated RB and the measured non-allocated RB (e.g. $\Delta_{RB} = 1$ or $\Delta_{RB} = -1$ for the first adjacent RB outside of the allocated bandwidth), and may take non-integer values when the carrier spacing between the CCs is not a multiple of RB.

NOTE 9: $\overline{P_{RB}}$ is an average of the transmitted power over 10 sub-frames normalized by the number of allocated RBs, measured in dBm.

NOTE 10: All powers are EIRP in beam peak direction.

6.4A.2.3.4 Inband emissions for power class 3

The average of the in-band emission measurement over 10 sub-frames shall not exceed the values specified in Table 6.4A.2.3.4-1 for power class 3 UEs.

Table 6.4A.2.3.4-1: Requirements for in-band emissions for power class 3

| Parameter description | Unit | Limit (NOTE 1) | | Applicable Frequencies |
|-----------------------|------|--|--------------------------------|---|
| General | dB | $\max \left[\begin{array}{l} -25 - 10 \cdot \log_{10} \left(\frac{N_{RB}}{L_{CRB}} \right), \\ 20 \cdot \log_{10}(\text{EVM}) - 5 \cdot \frac{(\Delta_{RB} - 1)}{L_{CRB}}, \\ -55.1 \text{ dBm} - \overline{P_{RB}} \end{array} \right]$ | | Any non-allocated RB in allocated component carrier and not allocated component carriers (NOTE 2) |
| IQ Image | dB | -25 | Output power > 10 dBm | Image frequencies (NOTES 2, 3) |
| | | -20 | Output power ≤ 10 dBm | |
| Carrier leakage | dBc | -25 | Output power > 0 dBm | Carrier frequency (NOTES 4, 5) |
| | | -20 | -13 dBm ≤ Output power ≤ 0 dBm | |

NOTE 1: An in-band emissions combined limit is evaluated in each non-allocated RB. For each such RB, the minimum requirement is calculated as the higher of ($\overline{P_{RB}} - 25$ dB) and the power sum of all limit values (General, IQ Image or Carrier leakage) that apply. $\overline{P_{RB}}$ is defined in NOTE 9.

NOTE 2: The measurement bandwidth is 1 RB and the limit is expressed as a ratio of measured power in one non-allocated RB to the measured average power per allocated RB, where the averaging is done across all allocated RBs. For Pi/2 BPSK with Spectrum Shaping, the limit is expressed as a ratio of measured power in one non-allocated RB to the measured power in the allocated RB with highest PSD.

NOTE 3: Image frequencies for UL CA are specified in relation to either UL or DL carrier frequency. The applicable frequencies for this limit are those that are enclosed in the reflection of the allocated bandwidth, based on symmetry with respect to the reported DC location position, but excluding any allocated RBs.

NOTE 4: The measurement bandwidth is 1 RB and the limit is expressed as a ratio of measured power in one non-allocated RB to the measured total power in all allocated RBs.

NOTE 5: The applicable frequencies for this limit are those that are enclosed in the RBs containing the DC frequency, or in the two RBs immediately adjacent to the DC frequency but excluding any allocated RB.

NOTE 6: L_{CRB} is the Transmission Bandwidth for kth allocated component carrier (see Figure 5.3.3-1).

NOTE 7: EVM is the limit for the modulation format used in the allocated RBs.

NOTE 8: Δ_{RB} is the starting frequency offset between the allocated RB and the measured non-allocated RB (e.g. $\Delta_{RB} = 1$ or $\Delta_{RB} = -1$ for the first adjacent RB outside of the allocated bandwidth), and may take non-integer values when the carrier spacing between the CCs is not a multiple of RB.

NOTE 9: $\overline{P_{RB}}$ is an average of the transmitted power over 10 sub-frames normalized by the number of allocated RBs, measured in dBm.

NOTE 10: All powers are EIRP in beam peak direction.

6.4A.2.3.5 Inband emissions for power class 4

The average of the in-band emission measurement over 10 sub-frames shall not exceed the values specified in Table 6.4A.2.3.5-1 for power class 4 UEs.

Table 6.4A.2.3.5-1: Requirements for in-band emissions for power class 4

| Parameter description | Unit | Limit (NOTE 1) | | Applicable Frequencies |
|-----------------------|------|--|---------------------------------|---|
| General | dB | $\max \left[\begin{array}{l} -25 - 10 \cdot \log_{10} \left(\frac{N_{RB}}{L_{CRB}} \right), \\ 20 \cdot \log_{10}(\text{EVM}) - 5 \cdot \frac{(\Delta_{RB} - 1)}{L_{CRB}}, \\ -55.1 \text{ dBm} - \overline{P_{RB}} \end{array} \right]$ | | Any non-allocated RB in allocated component carrier and not allocated component carriers (NOTE 2) |
| IQ Image | dB | -25 | Output power > 21 dBm | Image frequencies (NOTES 2, 3) |
| | | -20 | Output power ≤ 21 dBm | |
| Carrier leakage | dBc | -25 | Output power > 11 dBm | Carrier frequency (NOTES 4, 5) |
| | | -20 | -13 dBm ≤ Output power ≤ 11 dBm | |

- NOTE 1: An in-band emissions combined limit is evaluated in each non-allocated RB. For each such RB, the minimum requirement is calculated as the higher of ($\overline{P_{RB}} - 25$ dB) and the power sum of all limit values (General, IQ Image or Carrier leakage) that apply. $\overline{P_{RB}}$ is defined in NOTE 9.
- NOTE 2: The measurement bandwidth is 1 RB and the limit is expressed as a ratio of measured power in one non-allocated RB to the measured average power per allocated RB, where the averaging is done across all allocated RBs. For pi/2 BPSK with Spectrum Shaping, the limit is expressed as a ratio of measured power in one non-allocated RB to the measured power in the allocated RB with highest PSD.
- NOTE 3: Image frequencies for UL CA are specified in relation to either UL or DL carrier frequency. The applicable frequencies for this limit are those that are enclosed in the reflection of the allocated bandwidth, based on symmetry with respect to the reported DC location position, but excluding any allocated RBs.
- NOTE 4: The measurement bandwidth is 1 RB and the limit is expressed as a ratio of measured power in one non-allocated RB to the measured total power in all allocated RBs.
- NOTE 5: The applicable frequencies for this limit are those that are enclosed in the RBs containing the DC frequency, or in the two RBs immediately adjacent to the DC frequency but excluding any allocated RB.
- NOTE 6: L_{CRB} is the Transmission Bandwidth for kth allocated component carrier (see Figure 5.3.3-1).
- NOTE 7: EVM is the limit for the modulation format used in the allocated RBs.
- NOTE 8: Δ_{RB} is the starting frequency offset between the allocated RB and the measured non-allocated RB (e.g. $\Delta_{RB} = 1$ or $\Delta_{RB} = -1$ for the first adjacent RB outside of the allocated bandwidth), and may take non-integer values when the carrier spacing between the CCs is not a multiple of RB.
- NOTE 9: $\overline{P_{RB}}$ is an average of the transmitted power over 10 sub-frames normalized by the number of allocated RBs, measured in dBm.
- NOTE 10: All powers are EIRP in beam peak direction.

6.4A.2.4 EVM equalizer spectrum flatness

6.4D Transmit signal quality for UL MIMO

6.4D.0 General

For a UE supporting UL MIMO, the transmit modulation quality requirements in clause 6.4 apply but with all references to sub-clauses 6.3.1.x in clause 6.4 redirected to sub-clauses 6.3D.1.x, where 'x' depends on power class. The requirements apply when the UE is configured for 2-layer UL MIMO transmission as specified in Table 6.2D.1.0-1.

The requirement may alternatively be verified in each of the single layer UL MIMO configurations as specified in Table 6.4D.0-1. In this case, the transmit modulation quality requirements in clause 6.4 apply without modification.

Table 6.4D.0-1: Alternative UL MIMO configuration for transmit signal quality tests

| Transmission scheme | DCI format | TPMI Index |
|-----------------------|----------------|------------|
| Codebook based uplink | DCI format 0_1 | 0 |
| Codebook based uplink | DCI format 0_1 | 1 |

6.4D.1 Frequency error for UL MIMO

For a UE supporting UL MIMO, the UE basic measurement interval of modulated carrier frequency is 1 UL slot. The mean value of basic measurements of UE modulated carrier frequency at each layer shall be accurate to within ± 0.1 PPM observed over a period of 1ms of cumulated measurement intervals compared to the carrier frequency received from the NR Node B.

6.4D.2 Transmit modulation quality for UL MIMO

For UE supporting UL MIMO, the transmit modulation quality requirements are specified per layer in terms of:

Error Vector Magnitude (EVM) for the allocated resource blocks (RBs)

EVM equalizer spectrum flatness derived from the equalizer coefficients generated by the EVM measurement process

Carrier leakage (caused by IQ offset)

For UE supporting UL MIMO, the transmit modulation quality requirements are specified as the total component of EIRP in terms of: In-band emissions for the non-allocated RB

The requirements are defined as directional requirements. The requirements are verified in beam locked mode in the TX beam peak direction (Link=TX beam peak direction, Meas=Link angle).

In case the parameter 3300 or 3301 is reported from UE via the parameter *txDirectCurrentLocation* in *UplinkTxDirectCurrentList* IE (as defined in TS 38.331 [13]), carrier leakage measurement requirement in clause 6.4D.2.2 and 6.4D.2.3 shall be waived, and the RF correction with regard to the carrier leakage and IQ image shall be omitted during the calculation of transmit modulation quality.

6.4D.3 Time alignment error for UL MIMO

For a UE with multiple physical antenna ports supporting UL MIMO, this requirement applies to frame timing differences between transmissions on multiple physical antenna ports in the codebook transmission scheme.

The time alignment error (TAE) is defined as the average frame timing difference between any two transmissions on different physical antenna ports.

For a UE with multiple physical antenna ports, the Time Alignment Error (TAE) shall not exceed 130 ns.

6.4D.4 Requirements for coherent UL MIMO

For coherent UL MIMO, Table 6.4D.4-1 lists the maximum allowable difference between the measured relative power and phase errors between different physical antenna ports in any slot within the specified time window from the last transmitted SRS on the same antenna ports, for the purpose of uplink transmission (codebook or non-codebook usage) and those measured at that last SRS. The requirements in Table 6.4D.4-1 apply when the UL transmission power at each physical antenna port is larger than 0 dBm for SRS transmission and for the duration of time window. The requirement is verified with the test metric of EIRP (Link=TX Beam peak direction, Meas=Link angle).

Table 6.4D.4-1: Maximum allowable difference of relative phase and power errors in a given slot compared to those measured at last SRS transmitted

| Difference of relative phase error | Difference of relative power error | Time window |
|------------------------------------|------------------------------------|-------------|
| 40 degrees | 4 dB | 20 msec |

The above requirements apply when all of the following conditions are met within the specified time window:

- UE is not signaled with a change in number of SRS ports in *SRS-config*, or a change in *PUSCH-config*
- UE remains in DRX active time (UE does not enter DRX OFF time)
- No measurement gap occurs
- No instance of SRS transmission with the usage antenna switching occurs
- Active BWP remains the same
- EN-DC and CA configuration is not changed for the UE (UE is not configured or de-configured with PSCell or SCell(s))

6.5 Output RF spectrum emissions

6.5.1 Occupied bandwidth

Occupied bandwidth is defined as the bandwidth containing 99 % of the total integrated mean power of the transmitted spectrum on the assigned channel. The occupied bandwidth for all transmission bandwidth configurations (Resources Blocks) shall be less than the channel bandwidth specified in Table 6.5.1-1.

The occupied bandwidth is defined as a directional requirement. The requirement is verified in beam locked mode with the test metric of OBW (Link=TX beam peak direction, Meas=Link angle).

Table 6.5.1-1: Occupied channel bandwidth

| | Occupied channel bandwidth / Channel bandwidth | | | |
|-------------------------|--|---------|---------|---------|
| | 50 MHz | 100 MHz | 200 MHz | 400 MHz |
| Channel bandwidth (MHz) | 50 | 100 | 200 | 400 |

6.5.2 Out of band emissions

6.5.2.0 General

The Out of band emissions are unwanted emissions immediately outside the assigned channel bandwidth resulting from the modulation process and non-linearity in the transmitter but excluding spurious emissions. This out of band emission limit is specified in terms of a spectrum emission mask and an adjacent channel leakage power ratio. Additional requirements to protect specific bands are also considered.

The requirements in clause 6.5.2.1 only apply when both UL and DL of a UE are configured for single CC operation, and they are of the same bandwidth. For a UE that is configured for single CC operation with different channel bandwidths in UL and DL, the requirements in clause 6.5A.2.1 apply.

All out of band emissions for frequency range 2 are TRP.

6.5.2.1 Spectrum emission mask

The spectrum emission mask of the UE applies to frequencies (Δf_{OOB}) starting from the \pm edge of the assigned NR channel bandwidth. For frequencies offset greater than F_{OOB} as specified in Table 6.5.2.1-1 the spurious requirements in clause 6.5.3 are applicable.

The power of any UE emission shall not exceed the levels specified in Table 6.5.2.1-1 for the specified channel bandwidth. The requirement is verified in beam locked mode with the test metric of TRP (Link=TX beam peak direction, Meas=TRP grid).

Table 6.5.2.1-1: General NR spectrum emission mask for frequency range 2.

| Spectrum emission limit (dBm) / Channel bandwidth | | | | | |
|---|--------|---------|---------|---------|-----------------------|
| Δf_{OOB} (MHz) | 50 MHz | 100 MHz | 200 MHz | 400 MHz | Measurement bandwidth |
| $\pm 0-5$ | -5 | -5 | -5 | -5 | 1 MHz |
| $\pm 5-10$ | -13 | -5 | -5 | -5 | 1 MHz |
| $\pm 10-20$ | -13 | -13 | -5 | -5 | 1 MHz |
| $\pm 20-40$ | -13 | -13 | -13 | -5 | 1 MHz |
| $\pm 40-100$ | -13 | -13 | -13 | -13 | 1 MHz |
| $\pm 100-200$ | | -13 | -13 | -13 | 1 MHz |
| $\pm 200-400$ | | | -13 | -13 | 1 MHz |
| $\pm 400-800$ | | | | -13 | 1 MHz |
| NOTE 1: Void | | | | | |

6.5.2.2 Void

6.5.2.3 Adjacent channel leakage ratio

Adjacent Channel Leakage power Ratio (ACLR) is the ratio of the filtered mean power centred on the assigned channel frequency to the filtered mean power centred on an adjacent channel frequency. ACLR requirement is specified for a scenario in which adjacent carrier is another NR channel.

NR Adjacent Channel Leakage power Ratio (NR_{ACLR}) is the ratio of the filtered mean power centred on the assigned channel frequency to the filtered mean power centred on an adjacent channel frequency at nominal channel spacing. The assigned NR channel power and adjacent NR channel power are measured with rectangular filters with measurement bandwidths specified in Table 6.5.2.3-1.

If the measured adjacent channel power is greater than -35 dBm then the NR_{ACLR} shall be higher than the value specified in Table 6.5.2.3-1. The requirement is verified in beam locked mode with the test metric of TRP (Link=TX beam peak direction, Meas=TRP grid).

Table 6.5.2.3-1: General requirements for NR_{ACLR}

| | Channel bandwidth / NR_{ACLR} / Measurement bandwidth | | | |
|--|---|-------------------|-------------------|-------------------|
| | 50 MHz | 100 MHz | 200 MHz | 400 MHz |
| NR_{ACLR} for band n257, n258, n261 | 17 dB | 17 dB | 17 dB | 17 dB |
| NR_{ACLR} for band n259, n260 | 16 dB | 16 dB | 16 dB | 16 dB |
| NR channel measurement bandwidth (MHz) | 47.58 | 95.16 | 190.20 | 380.28 |
| Adjacent channel centre frequency offset (MHz) | +50 / -50 | +100 / -100 | +200 / -200 | +400 / -400 |

6.5.3 Spurious emissions

Spurious emissions are emissions which are caused by unwanted transmitter effects such as harmonics emission, parasitic emissions, intermodulation products and frequency conversion products, but exclude out of band emissions unless otherwise stated. The spurious emission limits are specified in terms of general requirements in line with SM.329 [7] and NR operating band requirement to address UE co-existence. Spurious emissions are measured as TRP.

To improve measurement accuracy, sensitivity and efficiency, the resolution bandwidth may be smaller than the measurement bandwidth. When the resolution bandwidth is smaller than the measurement bandwidth, the result should be integrated over the measurement bandwidth in order to obtain the equivalent noise bandwidth of the measurement bandwidth.

Unless otherwise stated, the spurious emission limits apply for the frequency ranges that are more than F_{OOB} (MHz) in Table 6.5.3-1 starting from the edge of the assigned NR channel bandwidth. The spurious emission limits in Table 6.5.3-2 apply for all transmitter band configurations (NRB) and channel bandwidths. The requirement is verified in beam locked mode with the test metric of TRP (Link=TX beam peak direction, Meas=TRP grid).

NOTE: For measurement conditions at the edge of each frequency range, the lowest frequency of the measurement position in each frequency range should be set at the lowest boundary of the frequency range plus $MBW/2$. The highest frequency of the measurement position in each frequency range should be set at the highest boundary of the frequency range minus $MBW/2$. MBW denotes the measurement bandwidth defined for the protected band.

Table 6.5.3-1: Boundary between NR out of band and spurious emission domain

| Channel bandwidth | 50 MHz | 100 MHz | 200 MHz | 400 MHz |
|------------------------------|--------|---------|---------|---------|
| OOB boundary F_{OOB} (MHz) | 100 | 200 | 400 | 800 |

Table 6.5.3-2: Spurious emissions limits

| Frequency Range | Maximum Level | Measurement bandwidth |
|--|---------------|-----------------------|
| $30 \text{ MHz} \leq f < 1000 \text{ MHz}$ | -36 dBm | 100 kHz |
| $1 \text{ GHz} \leq f < 12.75 \text{ GHz}$ | -30 dBm | 1 MHz |
| $12.75 \text{ GHz} \leq f \leq 2^{\text{nd}}$ harmonic of the upper frequency edge of the UL operating band in GHz | -13 dBm | 1 MHz |

6.5.3.1 Spurious emission band UE co-existence

This clause specifies the requirements for the specified NR band, for coexistence with protected bands.

NOTE: For measurement conditions at the edge of each frequency range, the lowest frequency of the measurement position in each frequency range should be set at the lowest boundary of the frequency range plus MBW/2. The highest frequency of the measurement position in each frequency range should be set at the highest boundary of the frequency range minus MBW/2. MBW denotes the measurement bandwidth defined for the protected band.

Table 6.5.3.1-1: Requirements

| NR Band | Spurious emission | | | | | |
|---------|--------------------------------|-----------------------|---|---------------------|-----------|------|
| | Protected band/frequency range | Frequency range (MHz) | | Maximum Level (dBm) | MBW (MHz) | NOTE |
| n257 | NR Band n260 | F_{DL_low} | - | F_{DL_high} | -2 | |
| | Frequency range | 57000 | - | 66000 | 2 | |
| | Frequency range | 23600 | - | 24000 | 1 | 3 |
| n258 | Frequency range | 57000 | - | 66000 | 2 | 100 |
| n259 | NR Band 257 | F_{DL_low} | - | F_{DL_high} | -5 | 100 |
| | NR Band 261 | F_{DL_low} | - | F_{DL_high} | -5 | 100 |
| | Frequency range | 36000 | - | 37000 | 7 | 1000 |
| | Frequency range | 57000 | - | 66000 | 2 | 100 |
| n260 | NR Band 257 | F_{DL_low} | - | F_{DL_high} | -5 | 100 |
| | NR Band 261 | F_{DL_low} | - | F_{DL_high} | -5 | 100 |
| | Frequency range | 57000 | - | 66000 | 2 | 100 |
| n261 | NR Band 260 | F_{DL_low} | - | F_{DL_high} | -2 | 100 |
| | Frequency range | 57000 | - | 66000 | 2 | 100 |

NOTE 1: F_{DL_low} and F_{DL_high} refer to each NR frequency band specified in Table 5.2-1
NOTE 2: Void
NOTE 3: The protection of frequency range 23600-24000 MHz is meant for protection of satellite passive services.

6.5.3.2 Additional spurious emissions

6.5.3.2.1 General

These requirements are specified in terms of an additional spectrum emission requirement. Additional spurious emission requirements are signalled by the network to indicate that the UE shall meet an additional requirement for a specific deployment scenario as part of the cell handover/broadcast message.

6.5.3.2.2 Void

Table 6.5.3.2.2-1: (Void)

6.5.3.2.3 Additional spurious emission requirements for NS_202

When "NS_202" is indicated in the cell, the power of any UE emission shall not exceed the levels specified in Table 6.5.3.2.3-1.

Table 6.5.3.2.3-1: Additional requirements (NS_202)

| Frequency Range | Maximum Level | Measurement bandwidth | NOTE |
|--|---------------|-----------------------|------|
| $7.25 \text{ GHz} \leq f \leq 2^{\text{nd}}$ harmonic of the upper frequency edge of the UL operating band | -10 dBm | 100 MHz | |
| $23.6 \text{ GHz} \leq f \leq 24.0$ GHz | +1 dBm | 200 MHz | 1 |
| NOTE 1: This requirement also applies for the frequency ranges that are less than F_{OOB} (MHz) in Table 6.5.3-1 from the edge of the channel bandwidth. The protection of frequency range 23600 - 24000 MHz is meant for protection of satellite passive services. | | | |

6.5.3.2.4 Additional spurious emission requirements for NS_203

When "NS_203" is indicated in the cell, the power of any UE emission shall not exceed the levels specified in Table 6.5.3.2.4-1. This requirement also applies for the frequency ranges that are less than F_{OOB} (MHz) in Table 6.5.3-1 from the edge of the channel bandwidth.

Table 6.5.3.2.4-1: Additional requirements (NS_203)

| Frequency band (GHz) | Spectrum emission limit (dBm) | Measurement bandwidth |
|-------------------------|-------------------------------|-----------------------|
| $23.6 \leq f \leq 24.0$ | +1 | 200 MHz |

6.5A Output RF spectrum emissions for CA

6.5A.1 Occupied bandwidth for CA

6.5A.1.0 General

The occupied bandwidth for UL CA is defined as a directional requirement. The requirement is verified in beam locked mode on beam peak direction. In case the CA configuration consists of a single UL CC, the occupied bandwidth requirement defined in subclause 6.5.1 applies.

6.5A.1.1 Occupied bandwidth for intra-band contiguous UL CA

For intra-band contiguous UL carrier aggregation, the occupied bandwidth is a measure of the bandwidth containing 99 % of the total integrated power of the transmitted spectrum. The occupied bandwidth for UL CA shall be less than the UL aggregated channel bandwidth defined in clause 5.3A.

6.5A.1.2 Occupied bandwidth for intra-band non-contiguous UL CA

For intra-band non-contiguous UL carrier aggregation, the occupied bandwidth requirement is met when the ratio of the transmitted power in all sub-blocks of the UL CA configuration to the total integrated power of the transmitted spectrum is greater than 99%.

6.5A.2 Out of band emissions

6.5A.2.1 Spectrum emission mask for CA

6.5A.2.1.0 General

The requirements specified in this clause shall apply if the UE has at least one of UL or DL configured for CA or if the UE is configured for single CC operation with different channel bandwidths in UL and DL carriers. In case the CA

configuration consists of a single UL CC, spectrum emission mask defined in subclause 6.5.2.1 applies. Spectral emission mask requirements do not apply at any frequency where IBE requirements of clause 6.4A.2.3 apply.

The requirement is verified in beam locked mode with the test metric of TRP (Link=TX beam peak direction).

6.5A.2.1.1 Spectrum emission mask for intra-band contiguous UL CA

For intra-band contiguous UL carrier aggregation, the spectrum emission mask of the UE applies to frequencies (Δf_{OoB}) starting from the \pm edge of the UL aggregated channel bandwidth (Table 5.3A.5-1). For any bandwidth class defined in Table 5.3A.5-1, the UE emission shall not exceed the levels specified in Table 6.5A.2.1-1.

Table 6.5A.2.1.1-1: General NR spectrum emission mask for intra-band contiguous CA in frequency range 2

| Δf_{OoB} (MHz) | Any carrier aggregation bandwidth class | Measurement bandwidth |
|---|--|--------------------------|
| $\pm 0-0.1 \cdot BW_{\text{Channel_CA}}$ | -5 | 1 MHz |
| $\pm 0.1 \cdot BW_{\text{Channel_CA}} - 2 \cdot BW_{\text{Channel_CA}}$ | -13 | 1 MHz |
| NOTE 1: (void) | | |

6.5A.2.1.2 Spectrum emission mask for intra-band non-contiguous UL CA

For intra-band non-contiguous UL carrier aggregation, the spectrum emission mask requirement is defined as a composite spectrum emissions mask. Composite spectrum emission mask applies to frequencies up to $\pm \Delta f_{\text{OoB}}$ starting from the edge of each UL sub-block. Composite spectrum emission mask is defined as follows:

- Composite spectrum emission mask is a combination of individual spectrum emissions masks defined for each sub-block. If for some frequency, spectrum emission masks from multiple sub-blocks overlap, the spectrum emission mask allowing the highest power spectral density applies for that frequency
- In case a sub-block comprises of multiple component carriers, the spectrum emissions mask is defined in subclause 6.5A.2.1.1 or in case of a single component carrier, the sub-block spectrum emission mask is defined in subclause 6.5.2.1
- If for some frequency the spectrum emission mask of one sub-block overlaps another sub-block, the emission mask does not apply for that frequency.
- If carrier leakage or I/Q image lands inside the spectrum occupied by the configured UL and DL CCs, exception to the general spectrum emission mask limit applies. For carrier leakage the requirements specified in section 6.4A.2.2 shall apply. For I/Q image the requirements specified in section 6.4A.2.3 shall apply.

6.5A.2.3 Adjacent channel leakage ratio for CA

6.5A.2.3.1 Adjacent channel leakage ratio for CA intra-band contiguous UL CA

In case the CA configuration consists of a single UL CC, the adjacent channel leakage ratio defined in subclause 6.5.2.3 applies. For intra-band contiguous UL carrier aggregation, the carrier aggregation NR adjacent channel leakage power ratio (CA NR_{ACLR}) is the ratio of the filtered mean power centred on the UL aggregated channel bandwidth to the filtered mean power centred on an adjacent UL aggregated channel bandwidth at spacing equal to the UL aggregated channel bandwidth. The assigned UL aggregated channel bandwidth power and adjacent UL aggregated channel bandwidth power are measured with rectangular filters with measurement bandwidths specified in Table 6.5A.2.3.1-1. If the measured adjacent channel power is greater than -35 dBm then the CA NR_{ACLR} shall be higher than the value specified in Table 6.5A.2.3.1-1.

Table 6.5A.2.3.1-1: General requirements for contiguous UL CA NR_{ACLR}

| | CA bandwidth class / CA NR _{ACLR} / Measurement bandwidth |
|---|--|
| | Any CA bandwidth class |
| CA NR _{ACLR} for band n257, n258, n261 | 17 dB |
| CA NR _{ACLR} for band n259, n260 | 16 dB |
| NR channel measurement bandwidth ¹ | $BW_{\text{Channel_CA}} - 2 \cdot BW_{\text{GB}}$ |
| Adjacent channel centre frequency offset (in MHz) | $+ BW_{\text{Channel_CA}}$ / $- BW_{\text{Channel_CA}}$ |
| NOTE 1: BW_{GB} is defined in clause 5.3A.2. | |

6.5A.2.3.2 Adjacent channel leakage ratio for CA intra-band non-contiguous UL CA

For intra-band non-contiguous carrier aggregation, adjacent channel leakage power ratio (CA NR_{ACLR}) is the ratio of the sum of the filtered mean powers centred on each sub-block bandwidth to the filtered mean power centred on an adjacent sub-block frequency at nominal spacing equal to the sub-block bandwidth. The power in the configured UL CCs and power in the sub-block bandwidth adjacent to each sub-block of configured UL CCs are measured with rectangular filters with measurement bandwidths specified in Table 6.5A.2.3.1-2. In case a sub-block consists of a single component carrier, the measurement bandwidths and adjacent frequency offset from subclause 6.5.2.3 shall be used. If the measured adjacent sub-block power is greater than -35 dBm then the CA NR_{ACLR} shall be higher than the value specified in Table 6.5A.2.3.1-2.

No requirement applies in the gap between neighbouring sub-blocks if the frequency span between the lowest edge of the upper sub-block and the highest edge of the lower sub-block is smaller than the bandwidth of either sub-block.

Table 6.5A.2.3.1-2: General requirements for NC UL CA NR_{ACLR}

| | CA bandwidth class / CA NR _{ACLR} / Measurement bandwidth |
|---|---|
| | Any CA bandwidth class |
| CA NR _{ACLR} for band n257, n258, n261 | 17 dB |
| CA NR _{ACLR} for band n260 | 16 dB |
| NR channel measurement bandwidth ¹ | $\Sigma(BW_{\text{Channel_block}})$ |
| Adjacent sub-block centre frequency offset (in MHz) | $+ BW_{\text{Channel_block}}$ / $- BW_{\text{Channel_block}}$ |
| NOTE 1: $BW_{\text{Channel_block}}$ is defined in clause 5.3A.2. | |
| NOTE 2: 'Adjacent sub-block centre frequency offset' is defined for each sub-block in the UL CA configuration | |

6.5A.3 Spurious emissions for CA

6.5A.3.0 General spurious emissions for CA

6.5A.3.0.0 General

This clause specifies the spurious emission requirements for carrier aggregation. The requirement is verified in beam locked mode with the test metric of TRP (Link=TX beam peak direction).

In case the CA configuration consists of a single UL CC, spurious emissions requirements defined in subclause 6.5.3 apply. Spurious emissions requirements do not apply at any frequency where IBE requirements of clause 6.4A.2.3 apply.

NOTE: For measurement conditions at the edge of each frequency range, the lowest frequency of the measurement position in each frequency range should be set at the lowest boundary of the frequency range plus MBW/2. The highest frequency of the measurement position in each frequency range should be set at the highest boundary of the frequency range minus MBW/2. MBW denotes the measurement bandwidth defined for the protected band.

6.5A.3.0.1 Spurious emissions for intra-band contiguous UL CA

For intra-band contiguous UL carrier aggregation, the spurious emission limits apply for the frequency ranges that are more than F_{OOB} (MHz) from the edge of the UL aggregated channel bandwidth, where F_{OOB} is defined as the twice the UL aggregated channel bandwidth. For frequencies Δf_{OOB} greater than F_{OOB} , the spurious emission requirements in Table 6.5.3-2 are applicable.

6.5A.3.0.2 Spurious emissions for intra-band non-contiguous UL CA

For intra-band non-contiguous UL carrier aggregation, the spurious emission requirement is defined as a composite spurious emission requirement which is a combination of individual spurious emission requirements defined for each UL sub-block. The limits in Table 6.5.3-2 apply for the frequency ranges that are more than F_{OOB} (MHz) from the edge of each UL sub-block but excludes frequency ranges that coincide with another UL sub-block. No spurious emission limit applies in the gap between neighbouring UL sub-blocks if the frequency span between the lowest edge of the upper sub-block and the highest edge of the lower sub-block is smaller than $F_{OOB_L} + F_{OOB_H}$.

6.5A.3.1 Spurious emission band UE co-existence for UL CA

This clause specifies the requirements for the specified contiguous or non-contiguous UL carrier aggregation configurations for coexistence with protected bands.

NOTE: For measurement conditions at the edge of each frequency range, the lowest frequency of the measurement position in each frequency range should be set at the lowest boundary of the frequency range plus $MBW/2$. The highest frequency of the measurement position in each frequency range should be set at the highest boundary of the frequency range minus $MBW/2$. MBW denotes the measurement bandwidth defined for the protected band.

For intra-band contiguous and non-contiguous carrier aggregation, the requirements in Table 6.5A.3-1 apply.

Table 6.5A.3.1-1: Requirements for CA

| CA band | Spurious emission | | | | | | |
|---------|----------------------------------|-----------------------|---|----------------|---------------------|-----------|------|
| | Protected band / frequency range | Frequency range (MHz) | | | Maximum Level (dBm) | MBW (MHz) | NOTE |
| CA_n257 | NR Band n260 | F_{DL_low} | - | F_{DL_high} | -2 | 100 | |
| | Frequency range | 57000 | - | 66000 | 2 | 100 | |
| | Frequency range | 23600 | - | 24000 | 1 | 200 | 2 |
| CA_n258 | Frequency range | 57000 | - | 66000 | 2 | 100 | |
| CA_n259 | NR Band 257 | F_{DL_low} | - | F_{DL_high} | -5 | 100 | |
| | NR Band 261 | F_{DL_low} | - | F_{DL_high} | -5 | 100 | |
| | Frequency range | 36000 | - | 37000 | 7 | 1000 | |
| | Frequency range | 57000 | - | 66000 | 2 | 100 | |
| CA_n260 | NR Band 257 | F_{DL_low} | - | F_{DL_high} | -5 | 100 | |
| | NR Band 261 | F_{DL_low} | - | F_{DL_high} | -5 | 100 | |
| | Frequency range | 57000 | - | 66000 | 2 | 100 | |
| CA_n261 | NR Band 260 | F_{DL_low} | - | F_{DL_high} | -2 | 100 | |
| | Frequency range | 57000 | - | 66000 | 2 | 100 | |

NOTE 1: F_{DL_low} and F_{DL_high} refer to each NR frequency band specified in Table 5.2-1
NOTE 2: The protection of frequency range 23600-24000 MHz is meant for protection of satellite passive services.

6.5A.3.2 Additional spurious emissions

6.5A.3.2.1 General

These requirements are specified in terms of an additional spectrum emission requirement. Additional spurious emission requirements are signalled by the network to indicate that the UE shall meet an additional requirement for a specific deployment scenario as part of the cell handover/broadcast message.

6.5A.3.2.2 Void

6.5A.3.2.3 Additional spurious emission requirements for CA_NS_202

When "CA_NS_202" is indicated in the cell, the power of any UE emission shall not exceed the levels specified in Table 6.5.3.2.3-1.

6.5A.3.2.4 Additional spurious emission requirements for CA_NS_203

When "CA_NS_203" is indicated in the cell, the power of any UE emission shall not exceed the levels specified in Table 6.5.3.2.4-1. This requirement also applies for the frequency ranges that are less than F_{OOB} (MHz) as defined in section 6.5A.3.

6.5D Output RF spectrum emissions for UL MIMO

6.5D.1 Occupied bandwidth for UL MIMO

For UE(s) supporting UL MIMO, the occupied bandwidth requirement in clause 6.5.1 apply. The requirements shall be met with the UL MIMO configurations specified in Table 6.2D.1.0-1.

6.5D.2 Out of band emissions for UL MIMO

For UE(s) supporting UL MIMO, the out of band emissions requirements in clause 6.5.2 apply. The requirements shall be met with the UL MIMO configurations specified in Table 6.2D.1.0-1.

6.5D.3 Spurious emissions for UL MIMO

For UE(s) supporting UL MIMO, the spurious emissions requirements in clause 6.5.3 apply. The requirements shall be met with the UL MIMO configurations specified in Table 6.2D.1.0-1.

6.6 Beam correspondence

6.6.1 General

Beam correspondence is the ability of the UE to select a suitable beam for UL transmission based on DL measurements with or without relying on UL beam sweeping. Unless explicitly addressed in subclauses below, the beam correspondence requirement is fulfilled if the UE meets the corresponding minimum peak EIRP requirement and spherical coverage requirement for that power class with its autonomously chosen UL beams and without uplink beam sweeping.

6.6.2 Void

6.6.3 Void

6.6.4 Beam correspondence for power class 3

6.6.4.1 General

The beam correspondence requirement for power class 3 UEs consists of three components: UE minimum peak EIRP (as defined in Clause 6.2.1.3), UE spherical coverage (as defined in Clause 6.2.1.3), and beam correspondence tolerance (as defined in Clause 6.6.4.2). The beam correspondence requirement is fulfilled if the UE satisfies one of the following conditions, depending on the UE's beam correspondence capability IE *beamCorrespondenceWithoutUL-BeamSweeping*, as defined in TS 38.306 [14]:

- If *beamCorrespondenceWithoutUL-BeamSweeping* is supported, the UE shall meet the minimum peak EIRP requirement according to Table 6.2.1.3-1 and spherical coverage requirement according to Table 6.2.1.3-3 with its autonomously chosen UL beams and without uplink beam sweeping. Such a UE is considered to have met the beam correspondence tolerance requirement.
- If *beamCorrespondenceWithoutUL-BeamSweeping* and *beamCorrespondenceSSB-based-r16* are supported, the UE shall meet the minimum peak EIRP requirement according to Table 6.2.1.3-1 and spherical coverage requirement according to Table 6.2.1.3-3 using the side conditions for SSB based enhanced beam correspondence requirements as defined in Clause 6.6.4.3.2.
- If *beamCorrespondenceWithoutUL-BeamSweeping* and *beamCorrespondenceCSI-RS-based-r16* are supported, the UE shall meet the minimum peak EIRP requirement according to Table 6.2.1.3-1 and spherical coverage requirement according to Table 6.2.1.3-3 using the side conditions for CSI-RS based enhanced beam correspondence requirements as defined in Clause 6.6.4.3.3.
- If *beamCorrespondenceWithoutUL-BeamSweeping* is not present, the UE shall meet the minimum peak EIRP requirement according to Table 6.2.1.3-1 and spherical coverage requirement according to Table 6.2.1.3-3 with uplink beam sweeping. Such a UE shall meet the beam correspondence tolerance requirement defined in Clause 6.6.4.2 and shall support uplink beam management, as defined in TS 38.306 [14].
- If *beamCorrespondenceWithoutUL-BeamSweeping* is not present and *beamCorrespondenceSSB-based-r16* is supported, the UE shall meet the minimum peak EIRP requirement according to Table 6.2.1.3-1 and spherical coverage requirement according to Table 6.2.1.3-3 with uplink beam sweeping using the side conditions for SSB based enhanced beam correspondence requirements as defined in Clause 6.6.4.3.2. Such a UE shall meet the beam correspondence tolerance requirement defined in Clause 6.6.4.2 and shall support uplink beam management, as defined in TS 38.306 [14].
- If *beamCorrespondenceWithoutUL-BeamSweeping* is not present and *beamCorrespondenceCSI-RS-based-r16* is supported, the UE shall meet the minimum peak EIRP requirement according to Table 6.2.1.3-1 and spherical coverage requirement according to Table 6.2.1.3-3 with uplink beam sweeping using the side conditions for CSI-RS based enhanced beam correspondence requirements as defined in Clause 6.6.4.3.3. Such a UE shall meet the beam correspondence tolerance requirement defined in Clause 6.6.4.2 and shall support uplink beam management, as defined in TS 38.306 [14].

6.6.4.2 Beam correspondence tolerance for power class 3

The beam correspondence tolerance requirement $\Delta\text{EIRP}_{\text{BC}}$ for power class 3 UEs is defined based on a percentile of the distribution of $\Delta\text{EIRP}_{\text{BC}}$, defined as $\Delta\text{EIRP}_{\text{BC}} = \text{EIRP}_2 - \text{EIRP}_1$ over the link angles spanning a subset of the spherical coverage grid points, such that

- EIRP_1 is the total EIRP in dBm calculated based on the beam the UE chooses autonomously (corresponding beam) to transmit in the direction of the incoming DL signal, which is based on beam correspondence without relying on UL beam sweeping.
- EIRP_2 is the best total EIRP (beam yielding highest EIRP in a given direction) in dBm which is based on beam correspondence with relying on UL beam sweeping.
- The link angles are the ones corresponding to the top N^{th} percentile of the EIRP_2 measurement over the whole sphere, where the value of N is according to the test point of EIRP spherical coverage requirement for power class 3, i.e. $N = 50$.

For power class 3 UEs, the requirement is fulfilled if the UE's corresponding UL beams satisfy the maximum limit in Table 6.6.4.2-1.

Table 6.6.4.2-1: UE beam correspondence tolerance for power class 3

| Operating band | Max $\Delta\text{EIRP}_{\text{BC}}$ at 85 th %-tile $\Delta\text{EIRP}_{\text{BC}}$ CDF (dB) |
|--|--|
| n257 | 3.0 |
| n258 | 3.0 |
| n259 | 3.2 |
| n260 | 3.2 |
| n261 | 3.0 |
| NOTE: The requirements in this table are verified only under normal temperature conditions as defined in Annex E.2.1 | |

6.6.4.3 Side Conditions

6.6.4.3.1 Side Condition for beam correspondence based on SSB and CSI-RS

The beam correspondence requirements are only applied under the following side conditions:

- The downlink reference signals including both SSB and CSI-RS are provided and Type D QCL shall be maintained between SSB and CSI-RS.
- The reference measurement channel for beam correspondence is fulfilled according to the CSI-RS configuration in Annex A.3.
- For beam correspondence, conditions for L1-RSRP measurements are fulfilled according to Table 6.6.4.3.1-1 and Table 6.6.4.3.1-2.

Table 6.6.4.3.1-1: Conditions for SSB based L1-RSRP measurements for beam correspondence

| Angle of arrival | NR operating bands | Minimum SSB_RP ^{Note 2} | | SSB $\hat{\text{E}}_{\text{s/lot}}$ dB |
|--|--------------------|---|--|---|
| | | dBm / SCS_{SSB} | | |
| | | $\text{SCS}_{\text{SSB}} = 120 \text{ kHz}$ | | |
| All angles ^{Note 1} | n257 | -92.2 | | ≥ 6 |
| | n258 | -96.2 | | |
| | n259 | -90.7 | | |
| | n260 | -91.9 | | |
| | n261 | -96.2 | | |
| NOTE 1: For UEs that support multiple FR2 bands, the Minimum SSB_RP values for all angles are increased by $\Delta\text{MB}_{\text{s,n}}$, the UE multi-band relaxation factor in dB specified in clause 6.2.1. | | | | |
| NOTE 2: Values specified at the radiated requirements reference point to give minimum SSB $\hat{\text{E}}_{\text{s/lot}}$, with no applied noise. | | | | |

Table 6.6.4.3.1-2: Conditions for CSI-RS based L1-RSRP measurements for beam correspondence

| Angle of arrival | NR operating bands | Minimum CSI-RS_RP ^{Note 2} | | CSI-RS $\hat{\text{E}}_{\text{s/lot}}$ dB |
|--|--------------------|--|--|--|
| | | dBm / $\text{SCS}_{\text{CSI-RS}}$ | | |
| | | $\text{SCS}_{\text{CSI-RS}} = 120 \text{ kHz}$ | | |
| All angles ^{Note 1} | n257 | -96.2 | | ≥ 6 |
| | n258 | -96.2 | | |
| | n259 | -90.7 | | |
| | n260 | -91.9 | | |
| | n261 | -96.2 | | |
| NOTE 1: For UEs that support multiple FR2 bands, the Minimum CSI-RS_RP values are increased by $\Delta\text{MB}_{\text{s,n}}$, the UE multi-band relaxation factor in dB specified in clause 6.2.1. | | | | |
| NOTE 2: Values specified at the radiated requirements reference point to give minimum CSI-RS $\hat{\text{E}}_{\text{s/lot}}$, with no applied noise. | | | | |

6.6.4.3.2 Side Condition for SSB based enhanced Beam Correspondence requirements

The beam correspondence requirements for beam correspondence based on SSB are only applied under the following side conditions:

- The downlink reference signal SSB is provided and CSI-RS is not provided.
- For beam correspondence, conditions for L1-RSRP measurements are fulfilled according to Table 6.6.4.3.1-1.

6.6.4.3.3 Side Condition for CSI-RS based enhanced Beam Correspondence requirements

The beam correspondence requirements for beam correspondence based on CSI-RS are only applied under the following side conditions:

- The downlink reference signals including both SSB and CSI-RS are provided.
- The reference measurement channel for beam correspondence is fulfilled according to the CSI-RS configuration in Annex A.3.
- For beam correspondence, conditions for L1-RSRP measurements are fulfilled according to Table 6.6.4.3.1-2 and SSB signal is provided according to Table 6.6.4.3.3-1.

Table 6.6.4.3.3-1: SSB signal conditions for CSI-RS based beam correspondence requirements

| Angle of arrival | NR operating bands | Minimum SSB_RP ^{Note 2} | |
|---|--------------------|----------------------------------|--|
| | | dBm / SCS _{SSB} | |
| | | SCS _{SSB} = 120 kHz | |
| All angles ^{Note 1} | n257 | -101,4 | |
| | n258 | -101,4 | |
| | n259 | -97,1 | |
| | n260 | -97,1 | |
| | n261 | -101,4 | |
| NOTE 1: For UEs that support multiple FR2 bands, the Minimum SSB_RP values for all angles are increased by $\Delta MB_{s,n}$, the UE multi-band relaxation factor in dB specified in clause 6.2.1. | | | |
| NOTE 2: Values specified at the radiated requirements reference point to give minimum SSB \hat{E}_s/lot , with no applied noise. | | | |

6.6.4.4 Applicability

For UEs supporting more than one type of beam correspondence, the following applicability rules apply:

- If a UE meets enhanced beam correspondence requirements either based on SSB or based on CSI-RS, it is considered to have met the beam correspondence requirements based on SSB and CSI-RS.
- For a UE supporting either SSB based or CSI-RS based enhanced beam correspondence, the UE shall meet the supported enhanced beam correspondence requirements.
- For a UE supporting both SSB based and CSI-RS based enhanced beam correspondence, the UE shall meet both SSB based and CSI-RS based enhanced beam correspondence requirements and the following applicability rules for verifying the requirements apply:
 - The enhanced beam correspondence requirements shall be verified with the SSB based enhanced beam correspondence side conditions in clause 6.6.4.3.2. If the UE meets the SSB based enhanced beam correspondence requirements using the side conditions in clause 6.6.4.3.2 and meets the minimum peak EIRP requirement as defined in clause 6.2.1.3 using the CSI-RS based side conditions in clause 6.6.4.3.3, where the link direction is determined in the SSB based enhanced beam correspondence test, the UE is considered to have met both the SSB based and CSI-RS based enhanced beam correspondence requirements.
 - Otherwise, if UE does not meet the minimum peak EIRP requirement as defined in clause 6.2.1.3 using the CSI-RS based side conditions in clause 6.6.4.3.3, the enhanced beam correspondence requirements shall be further verified for the UE with the CSI-RS based enhanced beam correspondence side conditions in clause 6.6.4.3.3.

6.6.5 Void

6.6A Beam correspondence for CA

For intra-band CA in FR2, the same beam correspondence relationship for beam management is supported across CCs in this release of the specification and no requirement is specified. Beam correspondence performance for intra-band CA is fulfilled if the beam correspondence requirements defined in clause 6.6 is met for non-CA case.

7 Receiver characteristics

7.1 General

Unless otherwise stated, the receiver characteristics are specified over the air (OTA). The reference receive sensitivity (REFSENS) is defined assuming a 0 dBi reference antenna located at the center of the quiet zone.

7.2 Diversity characteristics

The minimum requirements on effective isotropic sensitivity (EIS) apply to two measurements, corresponding to DL signals in orthogonal polarizations.

7.3 Reference sensitivity

7.3.1 General

The reference sensitivity power level REFSENS is defined as the EIS level at the centre of the quiet zone in the RX beam peak direction, at which the throughput shall meet or exceed the requirements for the specified reference measurement channel.

7.3.2 Reference sensitivity power level

7.3.2.1 Reference sensitivity power level for power class 1

The throughput shall be ≥ 95 % of the maximum throughput of the reference measurement channels as specified in Annexes A.2.3.2 and A.3.3.2 (with one sided dynamic OCNG Pattern OP.1 TDD for the DL-signal as described in Annex A.5.2.1) with peak reference sensitivity specified in Table 7.3.2.1-1. The requirement is verified with the test metric of EIS (Link=RX beam peak direction, Meas=Link Angle).

Table 7.3.2.1-1: Reference sensitivity for power class 1

| Operating band | REFSENS (dBm) / Channel bandwidth | | | |
|----------------|-----------------------------------|---------|---------|---------|
| | 50 MHz | 100 MHz | 200 MHz | 400 MHz |
| n257 | -97.5 | -94.5 | -91.5 | -88.5 |
| n258 | -97.5 | -94.5 | -91.5 | -88.5 |
| n260 | -94.5 | -91.5 | -88.5 | -85.5 |
| n261 | -97.5 | -94.5 | -91.5 | -88.5 |

NOTE 1: The transmitter shall be set to P_{UMAX} as defined in clause 6.2.4

The REFSENS requirement shall be met for an uplink transmission using QPSK DFT-s-OFDM waveforms and for uplink transmission bandwidth less than or equal to that specified in Table 7.3.2.1-2.

Table 7.3.2.1-2: Uplink configuration for reference sensitivity

| Operating band | NR Band / Channel bandwidth / NRB / SCS / Duplex mode | | | | | |
|----------------|---|---------|---------|---------|---------|-------------|
| | 50 MHz | 100 MHz | 200 MHz | 400 MHz | SCS | Duplex Mode |
| n257 | 32 | 64 | 128 | 256 | 120 kHz | TDD |
| n258 | 32 | 64 | 128 | 256 | 120 kHz | TDD |
| n260 | 32 | 64 | 128 | 256 | 120 kHz | TDD |
| n261 | 32 | 64 | 128 | 256 | 120 kHz | TDD |

Unless given by Table 7.3.2.1-3, the minimum requirements for reference sensitivity shall be verified with the network signalling value NS_200 (Table 6.2.3-1) configured.

Table 7.3.2.1-3: Reserved

| Operating band | Network Signalling value |
|----------------|--------------------------|
| | |

7.3.2.2 Reference sensitivity power level for power class 2

The throughput shall be ≥ 95 % of the maximum throughput of the reference measurement channels as specified in Annexes A.2.3.2 and A.3.3.2 (with one sided dynamic OCNG Pattern OP.1 TDD for the DL-signal as described in Annex A.5.2.1) with peak reference sensitivity specified in Table 7.3.2.2-1. The requirement is verified with the test metric of EIS (Link=RX beam peak direction, Meas=Link Angle).

Table 7.3.2.2-1: Reference sensitivity for power class 2

| Operating band | REFSENS (dBm) / Channel bandwidth | | | |
|----------------|-----------------------------------|---------|---------|---------|
| | 50 MHz | 100 MHz | 200 MHz | 400 MHz |
| n257 | -92.0 | -89.0 | -86.0 | -83.0 |
| n258 | -92.0 | -89.0 | -86.0 | -83.0 |
| n261 | -92.0 | -89.0 | -86.0 | -83.0 |

NOTE 1: The transmitter shall be set to P_{UMAX} as defined in clause 6.2.4

The REFSENS requirement shall be met for an uplink transmission using QPSK DFT-s-OFDM waveforms and for uplink transmission bandwidth less than or equal to that specified in Table 7.3.2.1-2.

Unless given by Table 7.3.2.1-3, the minimum requirements for reference sensitivity shall be verified with the network signalling value NS_200 (Table 6.2.3-1) configured.

7.3.2.3 Reference sensitivity power level for power class 3

The throughput shall be ≥ 95 % of the maximum throughput of the reference measurement channels as specified in Annexes A.2.3.2 and A.3.3.2 (with one sided dynamic OCNG Pattern OP.1 TDD for the DL-signal as described in Annex A.5.2.1) with peak reference sensitivity specified in Table 7.3.2.3-1. The requirement is verified with the test metric of EIS (Link=RX beam peak direction, Meas=Link Angle).

For the UEs that support multiple FR2 bands, the minimum requirement for Reference sensitivity in Table 7.3.2.3-1 shall be increased per band, respectively, by the reference sensitivity relaxation parameter $\Delta MB_{P,n}$ as specified in clause 6.2.1.3. The requirement for the UE which supports a single FR2 band is specified in Table 7.3.2.3-1. The requirement for the UE which supports multiple FR2 bands is specified in both Table 7.3.2.3-1 and Table 6.2.1.3-4.

Table 7.3.2.3-1: Reference sensitivity

| Operating band | REFSENS (dBm) / Channel bandwidth | | | |
|----------------|-----------------------------------|---------|---------|---------|
| | 50 MHz | 100 MHz | 200 MHz | 400 MHz |
| n257 | -88.3 | -85.3 | -82.3 | -79.3 |
| n258 | -88.3 | -85.3 | -82.3 | -79.3 |
| n259 | -84.7 | -81.7 | -78.7 | -75.7 |
| n260 | -85.7 | -82.7 | -79.7 | -76.7 |
| n261 | -88.3 | -85.3 | -82.3 | -79.3 |

NOTE 1: The transmitter shall be set to P_{UMAX} as defined in clause 6.2.4

The REFSENS requirement shall be met for an uplink transmission using QPSK DFT-s-OFDM waveforms and for uplink transmission bandwidth less than or equal to that specified in Table 7.3.2.1-2.

Unless given by Table 7.3.2.1-3, the minimum requirements for reference sensitivity shall be verified with the network signalling value NS_200 (Table 6.2.3-1) configured.

7.3.2.4 Reference sensitivity power level for power class 4

The throughput shall be $\geq 95\%$ of the maximum throughput of the reference measurement channels as specified in Annexes A.2.3.2 and A.3.3.2 (with one sided dynamic OCN Pattern OP.1 TDD for the DL-signal as described in Annex A.5.2.1) with peak reference sensitivity specified in Table 7.3.2.4-1. The requirement is verified with the test metric of EIS (Link=RX beam peak direction, Meas=Link Angle).

Table 7.3.2.4-1: Reference sensitivity for power class 4

| Operating band | REFSENS (dBm) / Channel bandwidth | | | |
|----------------|-----------------------------------|---------|---------|---------|
| | 50 MHz | 100 MHz | 200 MHz | 400 MHz |
| n257 | -97.0 | -94.0 | -91.0 | -88.0 |
| n258 | -97.0 | -94.0 | -91.0 | -88.0 |
| n260 | -95.0 | -92.0 | -89.0 | -86.0 |
| n261 | -97.0 | -94.0 | -91.0 | -88.0 |

NOTE 1: The transmitter shall be set to P_{UMAX} as defined in clause 6.2.4

The REFSENS requirement shall be met for an uplink transmission using QPSK DFT-s-OFDM waveforms and for uplink transmission bandwidth less than or equal to that specified in Table 7.3.2.1-2.

Unless given by Table 7.3.2.1-3, the minimum requirements for reference sensitivity shall be verified with the network signalling value NS_200 (Table 6.2.3-1) configured.

7.3.3 Void

7.3.4 EIS spherical coverage

7.3.4.1 EIS spherical coverage for power class 1

The reference measurement channels and throughput criterion shall be as specified in clause 7.3.2.1

The maximum EIS at the 85th percentile of the CCDF of EIS measured over the full sphere around the UE is defined as the spherical coverage requirement and is found in Table 7.3.4.1-1 below. The requirement is verified with the test metric of EIS (Link=Spherical coverage grid, Meas=Link angle).

Table 7.3.4.1-1: EIS spherical coverage for power class 1

| Operating band | EIS at 85 th %-tile CCDF (dBm) / Channel bandwidth | | | |
|----------------|---|---------|---------|---------|
| | 50 MHz | 100 MHz | 200 MHz | 400 MHz |
| n257 | -89.5 | -86.5 | -83.5 | -80.5 |
| n258 | -89.5 | -86.5 | -83.5 | -80.5 |
| n260 | -86.5 | -83.5 | -80.5 | -77.5 |
| n261 | -89.5 | -86.5 | -83.5 | -80.5 |

NOTE 1: The transmitter shall be set to P_{UMAX} as defined in clause 6.2.4
NOTE 2: The EIS spherical coverage requirements are verified only under normal thermal conditions as defined in Annex E.2.1.

The requirement shall be met for an uplink transmission using QPSK DFT-s-OFDM waveforms and for uplink transmission bandwidth less than or equal to that specified in Table 7.3.2.1-2.

Unless given by Table 7.3.2.1-3, the minimum requirements for reference sensitivity shall be verified with the network signalling value NS_200 (Table 6.2.3-1) configured.

7.3.4.2 EIS spherical coverage for power class 2

The reference measurement channels and throughput criterion shall be as specified in clause 7.3.2.2

The maximum EIS at the 60th percentile of the CCDF of EIS measured over the full sphere around the UE is defined as the spherical coverage requirement and is found in Table 7.3.4.2-1 below. The requirement is verified with the test metric of EIS (Link=Spherical coverage grid, Meas=Link angle).

Table 7.3.4.2-1: EIS spherical coverage for power class 2

| Operating band | EIS at 60 th %-tile CCDF (dBm) / Channel bandwidth | | | |
|--|---|---------|---------|---------|
| | 50 MHz | 100 MHz | 200 MHz | 400 MHz |
| n257 | -81.0 | -78.0 | -75.0 | -72.0 |
| n258 | -81.0 | -78.0 | -75.0 | -72.0 |
| n261 | -81.0 | -78.0 | -75.0 | -72.0 |
| NOTE 1: The transmitter shall be set to P _{UMAX} as defined in clause 6.2.4 | | | | |
| NOTE 2: The EIS spherical coverage requirements are verified only under normal thermal conditions as defined in Annex E.2.1. | | | | |

The requirement shall be met for an uplink transmission using QPSK DFT-s-OFDM waveforms and for uplink transmission bandwidth less than or equal to that specified in Table 7.3.2.1-2.

Unless given by Table 7.3.2.1-3, the minimum requirements for reference sensitivity shall be verified with the network signalling value NS_200 (Table 6.2.3-1) configured.

7.3.4.3 EIS spherical coverage for power class 3

The reference measurement channels and throughput criterion shall be as specified in clause 7.3.2.3

The maximum EIS at the 50th percentile of the CCDF of EIS measured over the full sphere around the UE is defined as the spherical coverage requirement and is found in Table 7.3.4.3-1 below. The requirement is verified with the test metric of EIS (Link=Spherical coverage grid, Meas=Link angle).

For the UEs that support multiple FR2 bands, the minimum requirement for EIS spherical coverage in Table 7.3.4.3-1 shall be increased per band, respectively, by the EIS spherical coverage relaxation parameter $\Delta MB_{S,n}$ as specified in clause 6.2.1.3. The requirement for the UE which supports a single FR2 band is specified in Table 7.3.4.3-1. The requirement for the UE which supports multiple FR2 bands is specified in both Table 7.3.4.3-1 and Table 6.2.1.3-4.

Table 7.3.4.3-1: EIS spherical coverage for power class 3

| Operating band | EIS at 50 th %-tile CCDF (dBm) / Channel bandwidth | | | |
|--|---|---------|---------|---------|
| | 50 MHz | 100 MHz | 200 MHz | 400 MHz |
| n257 | -77.4 | -74.4 | -71.4 | -68.4 |
| n258 | -77.4 | -74.4 | -71.4 | -68.4 |
| n259 | -71.9 | -68.9 | -65.9 | -62.9 |
| n260 | -73.1 | -70.1 | -67.1 | -64.1 |
| n261 | -77.4 | -74.4 | -71.4 | -68.4 |
| NOTE 1: The transmitter shall be set to P _{UMAX} as defined in clause 6.2.4 | | | | |
| NOTE 2: The EIS spherical coverage requirements are verified only under normal thermal conditions as defined in Annex E.2.1. | | | | |

The requirement shall be met for an uplink transmission using QPSK DFT-s-OFDM waveforms and for uplink transmission bandwidth less than or equal to that specified in Table 7.3.2.1-2.

Unless given by Table 7.3.2.1-3, the minimum requirements for reference sensitivity shall be verified with the network signalling value NS_200 (Table 6.2.3-1) configured.

7.3.4.4 EIS spherical coverage for power class 4

The reference measurement channels and throughput criterion shall be as specified in clause 7.3.2.4

The maximum EIS at the 20th percentile of the CCDF of EIS measured over the full sphere around the UE is defined as the spherical coverage requirement and is found in Table 7.3.4.4-1 below. The requirement is verified with the test metric of EIS (Link=Spherical coverage grid, Meas=Link angle).

Table 7.3.4.4-1: EIS spherical coverage for power class 4

| Operating band | EIS at 20 th %-tile CCDF (dBm) / Channel bandwidth | | | |
|--|---|---------|---------|---------|
| | 50 MHz | 100 MHz | 200 MHz | 400 MHz |
| n257 | -88.0 | -85.0 | -82.0 | -79.0 |
| n258 | -88.0 | -85.0 | -82.0 | -79.0 |
| n260 | -83.0 | -80.0 | -77.0 | -74.0 |
| n261 | -88.0 | -85.0 | -82.0 | -79.0 |
| NOTE 1: The transmitter shall be set to P_{UMAX} as defined in clause 6.2.4 | | | | |
| NOTE 2: The EIS spherical coverage requirements are verified only under normal thermal conditions as defined in Annex E.2.1. | | | | |

The requirement shall be met for an uplink transmission using QPSK DFT-s-OFDM waveforms and for uplink transmission bandwidth less than or equal to that specified in Table 7.3.2.1-2.

Unless given by Table 7.3.2.1-3, the minimum requirements for reference sensitivity shall be verified with the network signalling value NS_200 (Table 6.2.3-1) configured.

7.3A Reference sensitivity for DL CA

7.3A.1 General

7.3A.2 Reference sensitivity power level for CA

7.3A.2.1 Intra-band contiguous CA

For each component carrier in the intra-band contiguous carrier aggregation, the throughput in QPSK $R = 1/3$ shall be $\geq 95\%$ of the maximum throughput of the reference measurement channels as specified in Annexes A.2.3.2 and A.3.3.2 (with one sided dynamic OCNG Pattern OP.1 TDD for the DL-signal as described in Annex A.5.2.1) with peak reference sensitivity values determined from clause 7.3.2, and relaxation applied to peak reference sensitivity requirement as specified in Table 7.3A.2.1-1.

Table 7.3A.2.1-1: ΔR_{IBC} EIS Relaxation for CA operation by aggregated channel bandwidth

| Aggregated Channel BW ' $BW_{Channel_CA}$ ' (MHz) | ΔR_{IBC} (dB) |
|--|-----------------------|
| $BW_{Channel_CA} \leq 800$ | 0.0 |
| $800 < BW_{Channel_CA} \leq 1200$ | 0.5 |

7.3A.2.2 Intra-band non-contiguous CA

For each component carrier in the intra-band non-contiguous carrier aggregation, the throughput shall be $\geq 95\%$ of the maximum throughput of the reference measurement channels as specified in Annexes A.2.3.2 and A.3.3.2 (with one sided dynamic OCNG Pattern OP.1 TDD for the DL-signal as described in Annex A.5.2.1) with peak reference sensitivity values determined from clause 7.3.2, and relaxation applied to peak reference sensitivity requirement as specified in Table 7.3A.2.2-1. The configured downlink spectrum is defined as the frequency band from the lowest edge of the lowest CC to the upper edge of the highest CC of all UL and DL configured CCs.

Table 7.3A.2.2-1: ΔR_{IBC} EIS Relaxation for CA operation

| Configured DL spectrum (MHz) | ΔR_{IBC} (dB) |
|------------------------------|-----------------------|
| ≤ 800 | 0.0 |
| > 800 and ≤ 1400 | 0.5 |
| > 1400 and ≤ 2400 | 1.5 |

7.3A.2.3 Inter-band CA

The inter-band requirement applies for all active component carriers. The throughput for each component carrier shall be $\geq 95\%$ of the maximum throughput of the reference measurement channels as specified in Annexes A.2.3.2 and A.3.3.2 (with one sided dynamic OCN Pattern OP.1 TDD for the DL-signal as described in Annex A.5.2.1) with peak reference sensitivity for each carrier specified in section 7.3.2, and relaxation $\Delta R_{IB,P,n}$ applied to peak reference sensitivity requirement. $\Delta R_{IB,P,n}$ is specified in Table 7.3A.2.3-1. The requirement on each component carrier shall be met when the power in the component carrier in the other band is set to its EIS spherical coverage requirement for inter-band CA specified in sub-clause 7.3A.3.3.

For the combination of intra-band and inter-band carrier aggregation, the intra-band CA relaxation, ΔR_{IBC} and ΔR_{IBNC} , are also applied according to the clause 7.3A.2.1 and 7.3A.2.2.

Table 7.3A.2.3-1: $\Delta R_{IB,P,n}$ reference sensitivity relaxation for inter-band CA for power class 3

| NR CA band combination | NR band | $\Delta R_{IB,P,n}$ (dB) |
|------------------------|---------|--------------------------|
| CA_n260-n261 | n260 | 3.5 |
| | n261 | 3.5 |

7.3A.3 EIS spherical coverage for DL CA

7.3A.3.1 Void

7.3A.3.2 Void

7.3A.3.3 EIS spherical coverage for inter-band CA

The inter-band CA requirement applies per operating band, for all active component carriers with UL assigned to one band and one DL component carrier per band. The requirement on each component carrier shall be met when the power in the component carrier in the other band is set to its EIS spherical coverage requirement for inter-band CA specified in this sub-clause.

The inter-band CA spherical coverage requirement for each power class will be satisfied if the intersection set of spherical coverage areas exceeds the common coverage requirement. Intersection set of spherical coverage areas is defined as a fraction of area of full sphere measured around the UE where both bands meet their defined individual EIS spherical coverage requirements for inter-band CA operation. The common coverage requirement is determined as $\langle 100\text{-percentile rank} \rangle \%$, where 'percentile rank' is the percentile value in the specification of spherical coverage for that power class from clause 7.3.4. The requirement is verified with the test metric of EIS (Link=Beam peak search grids, Meas=Link angle).

The reference measurement channels and throughput criterion shall be as specified in clause 7.3A.2.3. The requirement shall be met for an uplink transmission using QPSK DFT-s-OFDM waveforms and for uplink transmission bandwidth less than or equal to that specified in clause 7.3.2.

Unless otherwise specified, the minimum requirements for reference sensitivity shall be verified with the network signalling value NS_200 (Table 6.2.3.1-1) configured.

The required spherical coverage EIS for each band in inter-band CA operation is given in clause 7.3.4 and modified by $\Delta R_{IB,S,n}$. The value of $\Delta R_{IB,S,n}$ is defined in Table 7.3A.3.3-1.

Table 7.3A.3.3-1: $\Delta R_{IB,S,n}$ EIS spherical coverage requirement relaxation for inter-band CA for power class 3

| NR CA band combination | NR band | $\Delta R_{IB,S,n}$ (dB) |
|------------------------|---------|--------------------------|
| CA_n260-n261 | n260 | 3.5 |
| | n261 | 3.5 |

7.3D Void

7.4 Maximum input level

The maximum input level is defined as the maximum mean power, for which the throughput shall meet or exceed the minimum requirements for the specified reference measurement channel.

The maximum input level is defined as a directional requirement. The requirement is verified in beam locked mode in the direction where peak gain is achieved.

The throughput shall be $\geq 95\%$ of the maximum throughput of the reference measurement channels as specified in Annex A (with one sided dynamic OCNG Pattern OP.1 TDD for the DL-signal as described in Annex A.5.2.1) with parameters specified in Table 7.4-1. The requirement is verified with the test metric of EIS (Link=RX beam peak direction, Meas=Link angle).

Table 7.4-1: Maximum input level

| Rx Parameter | Units | Channel bandwidth | | | |
|---|-------|------------------------------|---------|---------|---------|
| | | 50 MHz | 100 MHz | 200 MHz | 400 MHz |
| Power in transmission bandwidth configuration | dBm | -25 (NOTE 2) -27 (NOTE 3) | | | |
| NOTE 1: The transmitter shall be set to 4 dB below the $P_{UMAX,f,c}$ as defined in clause 6.2.4, with uplink configuration specified in Table 7.3.2.1-2. | | | | | |
| NOTE 2: Reference measurement channel is specified in Annex A.3.3.2: QPSK, R=1/3 variant with one sided dynamic OCNG Pattern as described in Annex A. | | | | | |
| NOTE 3: Reference measurement channel is specified in Annex A.3.3.5: 256QAM, R=4/5 variant with one sided dynamic OCNG Pattern as described in Annex A. | | | | | |

Table 7.4-2: Void

7.4A Maximum input level for DL CA

Table 7.4A-1: Void

Table 7.4A-2: Void

7.4A.1 Maximum input level for Intra-band contiguous CA

For intra-band contiguous carrier aggregation the input level is defined as the cumulative received power, summed over the transmission bandwidth configurations of each active DL CC. All DL CCs shall be active throughout the test. The input power shall be distributed among the active DL CCs so their PSDs are aligned with each other. At the maximum input level, the specified relative throughput shall meet or exceed the minimum requirements for the specified reference measurement channel over each component carrier. The minimum requirement is specified in Table 7.4A-1.

The maximum input level is defined as a directional requirement. The requirement is verified in beam locked mode in the direction where peak gain is achieved. The requirement is verified with the test metric of EIS (Link=RX beam peak direction, Meas=Link angle).

Table 7.4A.1-1: Maximum input level for Intra-band contiguous CA

| Rx Parameter | Units | Level |
|--|-------|------------------------------|
| Power summed over transmission bandwidth configurations of all active DL CCs | dBm | -25 (NOTE 2) -27 (NOTE 3) |
| NOTE 1: The transmitter shall be set to 4 dB below the $P_{UMAX,f,c}$ as defined in clause 6.2.4, with uplink configuration specified in Table 7.3.2.1-2 | | |
| NOTE 2: Reference measurement channel in each CC is specified in Annex A.3.3.2: QPSK, R=1/3 variant with one sided dynamic OCNG Pattern as described in Annex A. | | |
| NOTE 3: Reference measurement channel is specified in Annex A.3.3.5: 256QAM, R=4/5 variant with one sided dynamic OCNG Pattern as described in Annex A. | | |

7.4A.2 Maximum input level for Intra-band non-contiguous CA

For intra-band non-contiguous carrier aggregation the requirement of section 7.4A.1 applies

7.4A.3 Maximum input level for Inter-band CA

For inter-band carrier aggregation with one component carrier per operating band and the uplink assigned to one NR band, the maximum input level is defined with the uplink active on the band other than the band whose downlink is being tested. The UE shall meet the requirements specified in clause 7.4 for each component carrier while all downlink carriers are active.

For the combination of intra-band and inter-band carrier aggregation and uplink carrier(s) assigned to one NR band, the requirement is defined with the uplink active on the band other than the band whose downlink is being tested. The UE shall meet the requirements specified in clause 7.4A.1 and 7.4A.2 for each band while all downlink carriers are active.

7.4D Void

7.5 Adjacent channel selectivity

Adjacent Channel Selectivity (ACS) is a measure of a receiver's ability to receive a NR signal at its assigned channel frequency in the presence of an adjacent channel signal at a given frequency offset from the centre frequency of the assigned channel. ACS is the ratio of the receive filter attenuation on the assigned channel frequency to the receive filter attenuation on the adjacent channel(s).

The requirement applies at the RIB when the AoA of the incident wave of the wanted signal and the interfering signal are both from the direction where peak gain is achieved.

The wanted and interfering signals apply to all supported polarizations, under the assumption of polarization match.

The UE shall fulfil the minimum requirement specified in Table 7.5-1 for all values of an adjacent channel interferer up to -25 dBm. However, it is not possible to directly measure the ACS, instead the lower and upper range of test parameters are chosen in Table 7.5-2 and Table 7.5-3 where the throughput shall be $\geq 95\%$ of the maximum throughput of the reference measurement channels as specified in Annexes A.2.3.2 and A.3.3.2, with one sided dynamic OCNG Pattern OP.1 TDD for the DL-signal as described in Annex A.5.2.1. The requirement is verified with the test metric of EIS (Link=RX beam peak direction, Meas=Link angle).

Table 7.5-1: Adjacent channel selectivity

| Operating band | Units | Adjacent channel selectivity / Channel bandwidth | | | |
|------------------|-------|--|---------|---------|---------|
| | | 50 MHz | 100 MHz | 200 MHz | 400 MHz |
| n257, n258, n261 | dB | 23 | 23 | 23 | 23 |
| n259, n260 | dB | 22 | 22 | 22 | 22 |

Table 7.5-2: Adjacent channel selectivity test parameters, Case 1

| Rx Parameter | Units | Channel bandwidth | | | |
|---|-------|--------------------------|----------------------------|----------------------------|----------------------------|
| | | 50 MHz | 100 MHz | 200 MHz | 400 MHz |
| Power in Transmission Bandwidth Configuration | dBm | REFSENS + 14 dB | | | |
| $P_{\text{Interferer}}$ for band n257, n258, n261 | dBm | REFSENS + 35.5 dB | REFSENS +35.5 dB | REFSENS +35.5 dB | REFSENS +35.5 dB |
| $P_{\text{Interferer}}$ for band n259, n260 | dBm | REFSENS + 34.5 dB | REFSENS +34.5 dB | REFSENS +34.5 dB | REFSENS +34.5 dB |
| $BW_{\text{Interferer}}$ | MHz | 50 | 100 | 200 | 400 |
| $F_{\text{Interferer}}$ (offset) | MHz | 50 / -50 NOTE 3 | 100 / -100 NOTE 3 | 200 / -200 NOTE 3 | 400 / -400 NOTE 3 |
| <p>NOTE 1: The interferer consists of the Reference measurement channel specified in Annex A.3.2 with one sided dynamic OCNG Pattern as described in Annex A.3.2 and set-up according to Annex C.</p> <p>NOTE 2: The REFSENS power level is specified in Clause 7.3.2, which are applicable to different UE power classes.</p> <p>NOTE 3: The absolute value of the interferer offset $F_{\text{Interferer}}$ (offset) shall be further adjusted to $(\text{CEIL}(F_{\text{Interferer}} /\text{SCS}) + 0.5) * \text{SCS}$ MHz with SCS the sub-carrier spacing of the wanted signal in MHz. Wanted and interferer signal have same SCS.</p> <p>NOTE 4: The transmitter shall be set to 4 dB below the $P_{\text{UMAX},f,c}$ as defined in clause 6.2.4, with uplink configuration specified in Table 7.3.2.1-2.</p> | | | | | |

Table 7.5-3: Adjacent channel selectivity test parameters, Case 2

| Rx Parameter | Units | Channel bandwidth | | | |
|--|-------|--------------------------|----------------------------|----------------------------|----------------------------|
| | | 50 MHz | 100 MHz | 200 MHz | 400 MHz |
| Power in Transmission Bandwidth Configuration for band n257, n258, n261 | dBm | -46.5 | -46.5 | -46.5 | -46.5 |
| Power in Transmission Bandwidth Configuration for band n259, n260 | dBm | -45.5 | -45.5 | -45.5 | -45.5 |
| $P_{\text{Interferer}}$ | dBm | -25 | | | |
| $BW_{\text{Interferer}}$ | MHz | 50 | 100 | 200 | 400 |
| $F_{\text{Interferer}}$ (offset) | MHz | 50 / -50 NOTE 2 | 100 / -100 NOTE 2 | 200 / -200 NOTE 2 | 400 / -400 NOTE 2 |
| <p>NOTE 1: The interferer consists of the Reference measurement channel specified in Annex 3.2 with one sided dynamic OCNG Pattern TDD as described in Annex A and set-up according to Annex C.</p> <p>NOTE 2: The absolute value of the interferer offset $F_{\text{Interferer}}$ (offset) shall be further adjusted to $(\text{CEIL}(F_{\text{Interferer}} /\text{SCS}) + 0.5) * \text{SCS}$ MHz with SCS the sub-carrier spacing of the wanted signal in MHz. Wanted and interferer signal have same SCS.</p> <p>NOTE 3: The transmitter shall be set to 4 dB below the $P_{\text{UMAX},f,c}$ as defined in clause 6.2.4, with uplink configuration specified in Table 7.3.2.1-2.</p> | | | | | |

7.5A Adjacent channel selectivity for DL CA

Table 7.5A-1: Void

Table 7.5A-2: Void

Table 7.5A-3: Void

7.5A.1 Adjacent channel selectivity for Intra-band contiguous CA

For intra-band contiguous carrier aggregation, the SCC(s) shall be configured at nominal channel spacing to the PCC. The input power shall be distributed among the active DL CCs so their PSDs are aligned with each other. The UE shall fulfil the minimum requirement specified in Table 7.5A.1-1 for an adjacent channel interferer on either side of the aggregated downlink signal at a specified frequency offset and for an interferer power up to -25 dBm.

The throughput of each carrier shall be $\geq 95\%$ of the maximum throughput of the reference measurement channels as specified in Annexes A.2.3.2 and A.3.3.2 (with one sided dynamic OCNG Pattern OP.1 TDD for the DL-signal as described in Annex A.5.2.1). The requirement is verified with the test metric of EIS (Link=RX beam peak direction, Meas=Link angle).

Table 7.5A.1-1: Adjacent channel selectivity for intra-band contiguous CA

| Operating band | Units | Adjacent channel selectivity / CA bandwidth class |
|------------------|-------|--|
| | | All CA bandwidth class |
| n257, n258, n261 | dB | 23 |
| n259, n260 | dB | 22 |

Table 7.5A.1-2: Adjacent channel selectivity test parameters for intra-band contiguous CA, Case 1

| Rx Parameter | Units | All CA bandwidth Classes |
|--|-------|---|
| P _w in Transmission Bandwidth Configuration, per CC | | REFSENS + 14 dB |
| P _{Interferer} for band n257, n258, n261 | dBm | Aggregated power + 21.5 |
| P _{Interferer} for band n259, n260 | dBm | Aggregated power + 20.5 |
| BW _{Interferer} | MHz | BW _{Channel_CA} |
| F _{Interferer} (offset) | MHz | + BW _{channel CA} / - BW _{channel CA} NOTE 3 |
| <p>NOTE 1: The interferer consists of the Reference measurement channel specified in Annex 3.2 with one sided dynamic OCNG Pattern as described in Annex A and set-up according to Annex C.</p> <p>NOTE 2: The F_{Interferer} (offset) is the frequency separation between the center of the aggregated CA bandwidth and the center frequency of the Interferer signal</p> <p>NOTE 3: The absolute value of the interferer offset F_{Interferer} (offset) shall be further adjusted to (CEIL(F_{Interferer} /SCS) + 0.5)*SCS MHz with SCS the sub-carrier spacing of the carrier closest to the interferer in MHz. The interfering signal has the same SCS as that of the closest carrier.</p> <p>NOTE 4: The transmitter shall be set to 4 dB below the P_{UMAX,f,c} as defined in clause 6.2.4, with uplink configuration specified in Table 7.3.2.1-2.</p> | | |

Table 7.5A.1-3: Adjacent channel selectivity test parameters for intra-band contiguous CA, Case 2

| Rx Parameter | Units | All CA bandwidth classes |
|--|-------|---|
| P _w in Transmission Bandwidth Configuration, aggregated power for band n257, n258, n261 | dBm | - 46.5 |
| P _w in Transmission Bandwidth Configuration, aggregated power for band n259, n260 | dBm | - 45.5 |
| P _{interferer} | dBm | - 25 |
| BW _{interferer} | MHz | BW _{Channel, CA} |
| F _{interferer} (offset) | MHz | + BW _{channel CA} / - BW _{channel CA} |
| NOTE 3 | | |
| NOTE 1: The interferer consists of the Reference measurement channel specified in Annex A.3.3.2 with one sided dynamic OCNB Pattern OP.1 TDD as described in Annex A.5.2.1 and set-up according to Annex C. | | |
| NOTE 2: The F _{interferer} (offset) is the frequency separation between the center of the aggregated CA bandwidth and the center frequency of the Interferer signal | | |
| NOTE 3: The absolute value of the interferer offset F _{interferer} (offset) shall be further adjusted to (CEIL(F _{interferer} /SCS) + 0.5)*SCS MHz with SCS the sub-carrier spacing of the carrier closest to the interferer in MHz. The interfering signal has the same SCS as that of the closest carrier. | | |
| NOTE 4: The transmitter shall be set to 4 dB below the P _{UMAX,f,c} as defined in clause 6.2.4, with uplink configuration specified in Table 7.3.2.1-2. | | |

7.5A.2 Adjacent channel selectivity for Intra-band non-contiguous CA

For intra-band non-contiguous carrier aggregation with two component carriers, two different requirements apply for out-of-gap and in-gap. For out-of-gap, the UE shall meet the requirements for each component carrier as specified in clauses 7.5. For in-gap, the requirement applies if the following minimum gap condition is met:

$$\Delta f_{ACS} \geq BW_1/2 + BW_2/2 + \max(BW_1, BW_2),$$

where Δf_{ACS} is the frequency separation between the center frequencies of the component carriers and BW_k are the channel bandwidths of carrier k , $k = 1, 2$.

If the minimum gap condition is met, the UE shall meet the requirements specified in clauses 7.5 for each component carrier considered. The respective channel bandwidth of the component carrier under test will be used in the parameter calculations of the requirement. In case of more than two component carriers, the minimum gap condition is computed for any pair of adjacent component carriers following the same approach as the two component carriers. The in-gap requirement for the corresponding pairs shall apply if the minimum gap condition is met.

For every component carrier to which the requirements apply, the UE shall meet the requirement with one active interferer signal (in-gap or out-of-gap) while all downlink carriers are active and the input power shall be distributed among the active DL CCs so their PSDs are aligned with each other.

7.5A.3 Adjacent channel selectivity for Inter-band CA

For inter-band carrier aggregation with one component carrier per operating band and the uplink assigned to one NR band, the adjacent channel requirements are defined with the uplink active on the band other than the band whose downlink is being tested. The UE shall meet the requirements specified in clause 7.5 for each component carrier while all downlink carriers are active.

For the combination of intra-band and inter-band carrier aggregation and uplink carrier(s) assigned to one NR band, the requirement is defined with the uplink active on the band other than the band whose downlink is being tested. The UE shall meet the requirements specified in clauses 7.5A.1 and 7.5A.2 for each band while all downlink carriers are active.

7.5D Void

7.6 Blocking characteristics

7.6.1 General

The blocking characteristic is a measure of the receiver's ability to receive a wanted signal at its assigned channel frequency in the presence of an unwanted interferer on frequencies other than those of the spurious response or the adjacent channels, without this unwanted input signal causing a degradation of the performance of the receiver beyond a specified limit. The blocking performance shall apply at all frequencies except those at which a spurious response occurs.

The requirement applies at the RIB when the AoA of the incident wave of the wanted signal and the interfering signal are both from the direction where peak gain is achieved.

The wanted and interfering signals apply to all supported polarizations, under the assumption of polarization match.

7.6.2 In-band blocking

In-band blocking is a measure of a receiver's ability to receive a NR signal at its assigned channel frequency in the presence of an interferer at a given frequency offset from the centre frequency of the assigned channel.

The throughput shall be $\geq 95\%$ of the maximum throughput of the reference measurement channels as specified in Annexes A.2.3.2 and A.3.3.2 (with one sided dynamic OCNG Pattern OP.1 TDD for the DL-signal as described in Annex A.5.2.1). The requirement is verified with the test metric of EIS (Link=RX beam peak direction, Meas=Link angle).

Table 7.6.2-1: In band blocking requirements

| Rx parameter | Units | Channel bandwidth | | | |
|--|-------|---|---|---|---|
| | | 50 MHz | 100 MHz | 200 MHz | 400 MHz |
| Power in Transmission Bandwidth Configuration | dBm | REFSENS + 14 dB | | | |
| $BW_{\text{Interferer}}$ | MHz | 50 | 100 | 200 | 400 |
| $P_{\text{Interferer}}$ for bands n257, n258, n261 | dBm | REFSENS + 35.5 dB | REFSENS + 35.5 dB | REFSENS + 35.5 dB | REFSENS + 35.5 dB |
| $P_{\text{Interferer}}$ for band n259, n260 | dBm | REFSENS + 34.5 dB | REFSENS + 34.5 dB | REFSENS + 34.5 dB | REFSENS + 34.5 dB |
| F_{offset} | MHz | ≤ -100 & ≥ 100 NOTE 5 | ≤ -200 & ≥ 200 NOTE 5 | ≤ -400 & ≥ 400 NOTE 5 | ≤ -800 & ≥ 800 NOTE 5 |
| $F_{\text{Interferer}}$ | MHz | $F_{\text{DL_low}} + 25$ to $F_{\text{DL_high}} - 25$ | $F_{\text{DL_low}} + 50$ to $F_{\text{DL_high}} - 50$ | $F_{\text{DL_low}} + 100$ to $F_{\text{DL_high}} - 100$ | $F_{\text{DL_low}} + 200$ to $F_{\text{DL_high}} - 200$ |
| NOTE 1: The interferer consists of the Reference measurement channel specified in Annex A.3.3.2 with one sided dynamic OCNG Pattern OP.1. TDD as described in Annex A.5.2.1 and set-up according to Annex C. | | | | | |
| NOTE2: The REFSENS power level is specified in Clause 7.3.2, which are applicable according to different UE power classes. | | | | | |
| NOTE 3: The wanted signal consists of the reference measurement channel specified in Annex A.3.3.2 with one sided dynamic OCNG pattern OP.1 TDD as described in Annex A.5.2.1 and set-up according to Annex C. | | | | | |
| NOTE 4: F_{offset} is the frequency separation between the center of the channel bandwidth and the center frequency of the Interferer signal. | | | | | |
| NOTE 5: The absolute value of the interferer offset F_{offset} shall be further adjusted $(\text{CEIL}(F_{\text{Interferer}} /\text{SCS}) + 0.5) * \text{SCS}$ MHz with SCS the sub-carrier spacing of the wanted signal in MHz. Wanted and interferer signal have same SCS. | | | | | |
| NOTE 6: $F_{\text{Interferer}}$ range values for unwanted modulated interfering signals are interferer center frequencies. | | | | | |
| NOTE 7: The transmitter shall be set to 4 dB below the $P_{\text{UMAX},f,c}$ as defined in clause 6.2.4, with uplink configuration specified in Table 7.3.2.1-2. | | | | | |

7.6.3 Void

7.6A Blocking characteristics for DL CA

7.6A.1 General

7.6A.2 In-band blocking

Table 7.6A.2-1: Void

Table 7.6A.2-2: Void

7.6A.2.1 In-band blocking for Intra-band contiguous CA For intra-band contiguous carrier aggregation, the SCC(s) shall be configured at nominal channel spacing to the PCC. The input power shall be distributed among the active DL CCs so their PSDs are aligned with each other. The UE shall fulfil the minimum requirement specified in Table 7.6A.2-1 for in the presence of an interferer at a given frequency offset from the centre frequency of the assigned channel and an interferer power shall not exceed -25 dBm. The throughput of each carrier shall be $\geq 95\%$ of the maximum throughput of the reference measurement channels as specified in Annexes A.2.3.2 and A.3.3.2 (with one sided dynamic OCNG Pattern OP.1 TDD for the DL-signal as described in Annex A.5.2.1). The requirement is verified with the test metric of EIS (Link=RX beam peak direction, Meas=Link angle).

Table 7.6A.2.1-1: In band blocking minimum requirements for intra-band contiguous CA

| Rx Parameter | Units | All CA bandwidth classes |
|--|-------|---|
| Power in Transmission Bandwidth Configuration, per CC | dBm | REFSENS + 14 dB |
| P _{interferer} for band n257, n258, n261 | dBm | Aggregated power + 21.5 dB |
| P _{interferer} for band n260 | dBm | Aggregated power + 20.5 dB |
| BW _{interferer} | MHz | BW _{Channel_CA} |
| F _{offset} | MHz | +2*BW _{Channel_CA} / -2*BW _{Channel_CA} NOTE 5 |
| F _{interferer} | MHz | F _{DL_low} + 0.5*BW _{Channel_CA} To F _{DL_high} - 0.5*BW _{Channel_CA} |
| <p>NOTE 1: The interferer consists of the Reference measurement channel specified in Annex A.3.3.2 with one sided dynamic OCNG Pattern OP.1 TDD as described in Annex A.5.2.1. and set-up according to Annex C.</p> <p>NOTE 2: The REFSENS power level is specified in Table 7.3.2-1.</p> <p>NOTE 3: The wanted signal consists of the reference measurement channel specified in Annex A.3.3.2 QPSK, R=1/3 with one sided dynamic OCNG pattern OP.1 TDD as described in Annex A.5.2.1 and set-up according to Annex C.</p> <p>NOTE 4: The F_{interferer} (offset) is the frequency separation between the center of the aggregated CA bandwidth and the center frequency of the Interferer signal.</p> <p>NOTE 5: The absolute value of the interferer offset F_{interferer} (offset) shall be further adjusted to (CEIL(F_{interferer} /SCS) + 0.5)*SCS MHz with SCS the sub-carrier spacing of the carrier closest to the interferer in MHz. The interfering signal has the same SCS as that of the closest carrier.</p> <p>NOTE 6: F_{interferer} range values for unwanted modulated interfering signals are interferer center frequencies.</p> <p>NOTE 7: The transmitter shall be set to 4 dB below the P_{UMAX,f,c} as defined in clause 6.2.4, with uplink configuration specified in Table 7.3.2.1-2.</p> | | |

7.6A.2.2 In-band blocking for Intra-band non-contiguous CA

For intra-band non-contiguous carrier aggregation with two component carriers, the requirement applies to out-of-gap and in-gap. For out-of-gap, the UE shall meet the requirements for each component carrier with parameters as specified in 7.6.2-1. The requirement associated to the maximum channel between across the component carriers is selected. For in-gap, the requirement shall apply if the following minimum gap condition is met:

$$\Delta f_{IBB} \geq 0.5(BW_1 + BW_2) + 2 \max(BW_1, BW_2),$$

where Δf_{IBB} is the frequency separation between the center frequencies of the component carriers and BW_k are the channel bandwidths of carrier k , $k = 1, 2$.

If the minimum gap condition is met, the UE shall meet the requirement specified in Table 7.6.2-1 for each component carrier. The respective channel bandwidth of the component carrier under test will be used in the parameter calculations of the requirement. In case of more than two component carriers, the minimum gap condition is computed for any pair of adjacent component carriers following the same approach as the two component carriers. The in-gap requirement for the corresponding pairs shall apply if the minimum gap condition is met. For every component carrier to which the requirements apply, the UE shall meet the requirement with one active interferer signal (in-gap or out-of-gap) while all downlink carriers are active and the input power shall be distributed among the active DL CCs so their PSDs are aligned with each other.

7.6A.2.3 In-band blocking for Inter-band CA

For inter-band carrier aggregation with one component carrier per operating band and the uplink assigned to one NR band, the in-band blocking requirements are defined with the uplink active on the band other than the band whose downlink is being tested. The UE shall meet the requirements specified in clause 7.6.2 for each component carrier while all downlink carriers are active.

For the combination of intra-band and inter-band carrier aggregation and uplink carrier(s) assigned to one NR band, the requirement is defined with the uplink active on the band other than the band whose downlink is being tested. The UE shall meet the requirements specified in clauses 7.6A.2.1 and 7.6A.2.2 for each band while all downlink carriers are active.

7.6D Void

7.7 Void

7.8 Void

7.9 Spurious emissions

The spurious emissions power is the power of emissions generated or amplified in a receiver. The spurious emissions power level is measured as TRP.

The power of any narrow band CW spurious emission shall not exceed the maximum level specified in Table 7.9-1. The requirement is verified in beam locked mode with the test metric of TRP (Link=TX beam peak direction, Meas=TRP grid).

Table 7.9-1: General receiver spurious emission requirements

| Frequency range | Measurement bandwidth | Maximum level | NOTE |
|---|-----------------------|---------------|------|
| $30\text{MHz} \leq f < 1\text{GHz}$ | 100 kHz | -57 dBm | 1 |
| $1\text{GHz} \leq f \leq 2^{\text{nd}}$ harmonic of the upper frequency edge of the DL operating band in GHz | 1 MHz | -47 dBm | |
| NOTE 1: Unused PDCCH resources are padded with resource element groups with power level given by PDCCH as defined in Annex C.3.1. | | | |

7.10 Void

Annex A (normative): Measurement channels

A.1 General

A.2 UL reference measurement channels

A.2.1 General

A.2.2 Void

A.2.3 Reference measurement channels for TDD

For UL RMCs defined below, TDD slot pattern defined in Table A.2.3-1 will be used for the requirements requiring at least one sub frame (1ms) for the measurement period. For other requirements, TDD slot patterns defined for reference sensitivity tests in Table A.3.3.1-1 will be used.

Table A.2.3-1: Additional reference channels parameters for TDD

| Parameter | | Value | |
|--|--------------------------------------|-----------------------------------|-----------------------------------|
| | | SCS 60 kHz ($\mu=2$) | SCS 120 kHz ($\mu=3$) |
| TDD Slot Configuration pattern (Note 1) | | DDDSUUUU | 7DS8U |
| Special Slot Configuration (Note 2) | | S=4D+6G+4U | S=12D+2G |
| referenceSubcarrierSpacing | | 60 kHz | 120 kHz |
| UL-DL configuration | <i>dl-UL-TransmissionPeriodicity</i> | 2 ms | 2 ms |
| | <i>nrofDownlinkSlots</i> | 3 | 7 |
| | <i>nrofDownlinkSymbols</i> | 4 | 12 |
| | <i>nrofUplinkSlot</i> | 4 | 8 |
| | <i>nrofUplinkSymbols</i> | 4 | 0 |
| Indexes of active UL slots | | mod(slot index, 40) = {36,...,39} | mod(slot index, 80) = {72,...,79} |
| NOTE 1: D denotes a slot with all DL symbols; S denotes a slot with a mix of DL, UL and guard symbols; U denotes a slot with all UL symbols. The field is for information. | | | |
| NOTE 2: D, G, U denote DL, guard and UL symbols, respectively. The field is for information. | | | |

A.2.3.1 DFT-s-OFDM Pi/2-BPSK

Table A.2.3.1-1: Reference Channels for DFT-s-OFDM pi/2-BPSK

| Parameter | Allocated resource blocks (L_{CRB}) | DFT-s-OFDM Symbols per slot (Note 1) | Modulation | MCS Index (Note 2) | Payload size | Transport block CRC | LDPC Base Graph | Number of code blocks per slot (Note 3) | Total number of bits per slot | Total modulated symbols per slot |
|---|---|--------------------------------------|------------|--------------------|--------------|---------------------|-----------------|---|-------------------------------|----------------------------------|
| Unit | | | | | Bits | Bits | | | Bits | |
| | 1 | 11 | pi/2 BPSK | 0 | 24 | 16 | 2 | 1 | 132 | 132 |
| | 16 | 11 | pi/2 BPSK | 0 | 504 | 16 | 2 | 1 | 2112 | 2112 |
| | 32 | 11 | pi/2 BPSK | 0 | 1032 | 16 | 2 | 1 | 4224 | 4224 |
| | 64 | 11 | pi/2 BPSK | 0 | 2024 | 16 | 2 | 1 | 8448 | 8448 |
| | 128 | 11 | pi/2 BPSK | 0 | 3976 | 24 | 2 | 2 | 16896 | 16896 |
| | 256 | 11 | pi/2 BPSK | 0 | 7944 | 24 | 2 | 3 | 33792 | 33792 |
| NOTE 1: PUSCH mapping Type-A and single-symbol DM-RS configuration Type-1 with 2 additional DM-RS symbols, such that the DM-RS positions are set to symbols 2, 7, 11. DMRS is [TDM'ed] with PUSCH data. DM-RS symbols are not counted. | | | | | | | | | | |
| NOTE 2: MCS Index is based on MCS table 6.1.4.1-1 defined in 38.214. | | | | | | | | | | |
| NOTE 3: If more than one Code Block is present, an additional CRC sequence of L = 24 Bits is attached to each Code Block (otherwise L = 0 Bit) | | | | | | | | | | |
| NOTE 4: Indexes of active UL slots are given by Table A.2.3-1 with TDD UL-DL configuration specified in A2.3 for the requirements requiring at least one sub frame (1ms) for the measurement period. For other requirements, indexes of active UL slots are given by the slots satisfying mod(slot index+1, 5) = 0 with TDD UL-DL configuration specified in A.3.3.1. | | | | | | | | | | |
| NOTE 5: The RMCs apply to all channel bandwidth where $L_{CRB} \leq N_{RB}$. | | | | | | | | | | |

Table A.2.3.1-2: Void

A.2.3.2 DFT-s-OFDM QPSK

Table A.2.3.2-1: Reference Channels for DFT-s-OFDM QPSK

| Parameter | Allocated resource blocks (L_{CRB}) | DFT-s-OFDM Symbols per slot (Note 1) | Modulation | MCS Index (Note 2) | Payload size | Transport block CRC | LDPC Base Graph | Number of code blocks per slot (Note 3) | Total number of bits per slot | Total modulated symbols per slot |
|-----------|---|--------------------------------------|------------|--------------------|--------------|---------------------|-----------------|---|-------------------------------|----------------------------------|
| Unit | | | | | Bits | Bits | | | Bits | |
| | 1 | 11 | QPSK | 2 | 48 | 16 | 2 | 1 | 264 | 132 |
| | 16 | 11 | QPSK | 2 | 808 | 16 | 2 | 1 | 4224 | 2112 |
| | 20 | 11 | QPSK | 2 | 1032 | 16 | 2 | 1 | 5280 | 2640 |
| | 32 | 11 | QPSK | 2 | 1608 | 16 | 2 | 1 | 8448 | 4224 |
| | 64 | 11 | QPSK | 2 | 3240 | 16 | 2 | 1 | 16896 | 8448 |
| | 128 | 11 | QPSK | 2 | 6408 | 24 | 2 | 2 | 33792 | 16896 |
| | 256 | 11 | QPSK | 2 | 12808 | 24 | 2 | 4 | 67584 | 33792 |

NOTE 1: PUSCH mapping Type-A and single-symbol DM-RS configuration Type-1 with 2 additional DM-RS symbols, such that the DM-RS positions are set to symbols 2, 7, 11. DMRS is [TDM'ed] with PUSCH data. DM-RS symbols are not counted.

NOTE 2: MCS Index is based on MCS table 6.1.4.1-1 defined in 38.214.

NOTE 3: If more than one Code Block is present, an additional CRC sequence of L = 24 Bits is attached to each Code Block (otherwise L = 0 Bit)

NOTE 4: Indexes of active UL slots are given by Table A.2.3-1 with TDD UL-DL configuration specified in A2.3 for the requirements requiring at least one sub frame (1ms) for the measurement period. For other requirements, indexes of active UL slots are given by the slots satisfying $\text{mod}(\text{slot index}+1, 5) = 0$ with TDD UL-DL configuration specified in A.3.3.1.

NOTE 5: The RMCs apply to all channel bandwidth where $L_{CRB} \leq N_{RB}$.

Table A.2.3.2-2: Void

A.2.3.3 DFT-s-OFDM 16QAM

Table A.2.3.3-1: Reference Channels for DFT-s-OFDM 16QAM

| Parameter | Allocated resource blocks (L_{CRB}) | DFT-s-OFDM Symbols per slot (Note 1) | Modulation | MCS Index (Note 2) | Payload size | Transport block CRC | LDPC Base Graph | Number of code blocks per slot (Note 3) | Total number of bits per slot | Total modulated symbols per slot |
|-----------|---|--------------------------------------|------------|--------------------|--------------|---------------------|-----------------|---|-------------------------------|----------------------------------|
| Unit | | | | | Bits | Bits | | | Bits | |
| | 1 | 11 | 16QAM | 10 | 176 | 16 | 2 | 1 | 528 | 132 |
| | 16 | 11 | 16QAM | 10 | 2792 | 16 | 2 | 1 | 8448 | 2112 |
| | 32 | 11 | 16QAM | 10 | 5632 | 24 | 1 | 1 | 16896 | 4224 |
| | 64 | 11 | 16QAM | 10 | 11272 | 24 | 1 | 2 | 33792 | 8448 |
| | 128 | 11 | 16QAM | 10 | 22536 | 24 | 1 | 3 | 67584 | 16896 |
| | 256 | 11 | 16QAM | 10 | 45096 | 24 | 1 | 6 | 135168 | 33792 |

NOTE 1: PUSCH mapping Type-A and single-symbol DM-RS configuration Type-1 with 2 additional DM-RS symbols, such that the DM-RS positions are set to symbols 2, 7, 11. DMRS is [TDM'ed] with PUSCH data. DM-RS symbols are not counted.

NOTE 2: MCS Index is based on MCS table 6.1.4.1-1 defined in 38.214.

NOTE 3: If more than one Code Block is present, an additional CRC sequence of L = 24 Bits is attached to each Code Block (otherwise L = 0 Bit)

NOTE 4: Indexes of active UL slots are given by Table A.2.3-1 with TDD UL-DL configuration specified in A2.3 for the requirements requiring at least one sub frame (1ms) for the measurement period. For other requirements, indexes of active UL slots are given by the slots satisfying $\text{mod}(\text{slot index}+1, 5) = 0$ with TDD UL-DL configuration specified in A.3.3.1.

NOTE 5: The RMCs apply to all channel bandwidth where $L_{CRB} \leq N_{RB}$.

Table A.2.3.3-2: Void

A.2.3.4 DFT-s-OFDM 64QAM

Table A.2.3.4-1: Reference Channels for DFT-s-OFDM 64QAM

| Parameter | Allocated resource blocks (L _{CRB}) | DFT-s-OFDM Symbols per slot (Note 1) | Modulation | MCS Index (Note 2) | Payload size | Transport block CRC | LDPC Base Graph | Number of code blocks per slot (Note 3) | Total number of bits per slot | Total modulated symbols per slot |
|-----------|---|--------------------------------------|------------|--------------------|--------------|---------------------|-----------------|---|-------------------------------|----------------------------------|
| Unit | | | | | Bits | Bits | | | Bits | |
| | 1 | 11 | 64QAM | 18 | 408 | 16 | 2 | 1 | 792 | 132 |
| | 16 | 11 | 64QAM | 18 | 6400 | 24 | 1 | 1 | 12672 | 2112 |
| | 32 | 11 | 64QAM | 18 | 12808 | 24 | 1 | 2 | 25344 | 4224 |
| | 64 | 11 | 64QAM | 18 | 25608 | 24 | 1 | 4 | 50688 | 8448 |
| | 128 | 11 | 64QAM | 18 | 51216 | 24 | 1 | 7 | 101376 | 16896 |
| | 256 | 11 | 64QAM | 18 | 102416 | 24 | 1 | 13 | 202752 | 33792 |

NOTE 1: PUSCH mapping Type-A and single-symbol DM-RS configuration Type-1 with 2 additional DM-RS symbols, such that the DM-RS positions are set to symbols 2, 7, 11. DMRS is [TDM'ed] with PUSCH data. DM-RS symbols are not counted.

NOTE 2: MCS Index is based on MCS table 6.1.4.1-1 defined in 38.214.

NOTE 3: If more than one Code Block is present, an additional CRC sequence of L = 24 Bits is attached to each Code Block (otherwise L = 0 Bit)

NOTE 4: Indexes of active UL slots are given by Table A.2.3-1 with TDD UL-DL configuration specified in A2.3 for the requirements requiring at least one sub frame (1ms) for the measurement period. For other requirements, indexes of active UL slots are given by the slots satisfying $\text{mod}(\text{slot index}+1, 5) = 0$ with TDD UL-DL configuration specified in A.3.3.1.

NOTE 5: The RMCs apply to all channel bandwidth where $L_{CRB} \leq N_{RB}$.

Table A.2.3.4-2: Void

A.2.3.5 CP-OFDM QPSK

Table A.2.3.5-1: Reference Channels for CP-OFDM QPSK

| Parameter | Allocated resource blocks (L _{CRB}) | DFT-s-OFDM Symbols per slot (Note 1) | Modulation | MCS Index (Note 2) | Payload size | Transport block CRC | LDPC Base Graph | Number of code blocks per slot (Note 3) | Total number of bits per slot | Total modulated symbols per slot |
|-----------|---|--------------------------------------|------------|--------------------|--------------|---------------------|-----------------|---|-------------------------------|----------------------------------|
| Unit | | | | | Bits | Bits | | | Bits | |
| | 1 | 11 | QPSK | 2 | 48 | 16 | 2 | 1 | 264 | 132 |
| | 16 | 11 | QPSK | 2 | 808 | 16 | 2 | 1 | 4224 | 2112 |
| | 32 | 11 | QPSK | 2 | 1608 | 16 | 2 | 1 | 8448 | 4224 |
| | 33 | 11 | QPSK | 2 | 1672 | 16 | 2 | 1 | 8712 | 4356 |
| | 66 | 11 | QPSK | 2 | 3368 | 16 | 2 | 1 | 17424 | 8712 |
| | 132 | 11 | QPSK | 2 | 6536 | 24 | 2 | 2 | 34848 | 17424 |
| | 264 | 11 | QPSK | 2 | 13064 | 24 | 2 | 4 | 69696 | 34848 |

NOTE 1: PUSCH mapping Type-A and single-symbol DM-RS configuration Type-1 with 2 additional DM-RS symbols, such that the DM-RS positions are set to symbols 2, 7, 11. DMRS is [TDM'ed] with PUSCH data. DM-RS symbols are not counted.

NOTE 2: MCS Index is based on MCS table 5.1.3.1-1 defined in 38.214.

NOTE 3: If more than one Code Block is present, an additional CRC sequence of L = 24 Bits is attached to each Code Block (otherwise L = 0 Bit)

NOTE 4: Indexes of active UL slots are given by Table A.2.3-1 with TDD UL-DL configuration specified in A2.3 for the requirements requiring at least one sub frame (1ms) for the measurement period. For other requirements, indexes of active UL slots are given by the slots satisfying $\text{mod}(\text{slot index}+1, 5) = 0$ with TDD UL-DL configuration specified in A.3.3.1.

NOTE 5: The RMCs apply to all channel bandwidth where $L_{CRB} \leq N_{RB}$.

Table A.2.3.5-2: Void

A.2.3.6 CP-OFDM 16QAM

Table A.2.3.6-1: Reference Channels for CP-OFDM 16QAM

| Parameter | Allocated resource blocks (L_{CRB}) | DFT-s-OFDM Symbols per slot (Note 1) | Modulation | MCS Index (Note 2) | Payload size | Transport block CRC | LDPC Base Graph | Number of code blocks per slot (Note 3) | Total number of bits per slot | Total modulated symbols per slot |
|-----------|---|--------------------------------------|------------|--------------------|--------------|---------------------|-----------------|---|-------------------------------|----------------------------------|
| Unit | | | | | Bits | Bits | | | Bits | |
| | 1 | 11 | 16QAM | 10 | 176 | 16 | 2 | 1 | 528 | 132 |
| | 16 | 11 | 16QAM | 10 | 2792 | 16 | 2 | 1 | 8448 | 2112 |
| | 32 | 11 | 16QAM | 10 | 5632 | 24 | 1 | 1 | 16896 | 4224 |
| | 33 | 11 | 16QAM | 10 | 5760 | 24 | 1 | 1 | 17424 | 4356 |
| | 66 | 11 | 16QAM | 10 | 11528 | 24 | 1 | 2 | 34848 | 8712 |
| | 132 | 11 | 16QAM | 10 | 23040 | 24 | 1 | 3 | 69696 | 17424 |
| | 264 | 11 | 16QAM | 10 | 46104 | 24 | 1 | 6 | 139392 | 34848 |

NOTE 1: PUSCH mapping Type-A and single-symbol DM-RS configuration Type-1 with 2 additional DM-RS symbols, such that the DM-RS positions are set to symbols 2, 7, 11. DMRS is [TDM'ed] with PUSCH data. DM-RS symbols are not counted.

NOTE 2: MCS Index is based on MCS table 5.1.3.1-1 defined in 38.214.

NOTE 3: If more than one Code Block is present, an additional CRC sequence of L = 24 Bits is attached to each Code Block (otherwise L = 0 Bit)

NOTE 4: Indexes of active UL slots are given by Table A.2.3-1 with TDD UL-DL configuration specified in A2.3 for the requirements requiring at least one sub frame (1ms) for the measurement period. For other requirements, indexes of active UL slots are given by the slots satisfying $\text{mod}(\text{slot index}+1, 5) = 0$ with TDD UL-DL configuration specified in A.3.3.1.

NOTE 5: The RMCs apply to all channel bandwidth where $L_{CRB} \leq N_{RB}$.

Table A.2.3.6-2: Void

A.2.3.7 CP-OFDM 64QAM

Table A.2.3.7-1: Reference Channels for CP-OFDM 64QAM

| Parameter | Allocated resource blocks (L_{CRB}) | DFT-s-OFDM Symbols per slot (Note 1) | Modulation | MCS Index (Note 2) | Payload size | Transport block CRC | LDPC Base Graph | Number of code blocks per slot (Note 3) | Total number of bits per slot | Total modulated symbols per slot |
|-----------|---|--------------------------------------|------------|--------------------|--------------|---------------------|-----------------|---|-------------------------------|----------------------------------|
| Unit | | | | | Bits | Bits | | | Bits | |
| | 1 | 11 | 64QAM | 19 | 408 | 16 | 2 | 1 | 792 | 132 |
| | 16 | 11 | 64QAM | 19 | 6400 | 24 | 1 | 1 | 12672 | 2112 |
| | 32 | 11 | 64QAM | 19 | 12808 | 24 | 1 | 2 | 25344 | 4224 |
| | 33 | 11 | 64QAM | 19 | 13064 | 24 | 1 | 2 | 26136 | 4356 |
| | 66 | 11 | 64QAM | 19 | 26120 | 24 | 1 | 4 | 52272 | 8712 |
| | 132 | 11 | 64QAM | 19 | 53288 | 24 | 1 | 7 | 104544 | 17424 |
| | 264 | 11 | 64QAM | 19 | 106576 | 24 | 1 | 13 | 209088 | 34848 |

NOTE 1: PUSCH mapping Type-A and single-symbol DM-RS configuration Type-1 with 2 additional DM-RS symbols, such that the DM-RS positions are set to symbols 2, 7, 11. DMRS is [TDM'ed] with PUSCH data. DM-RS symbols are not counted.

NOTE 2: MCS Index is based on MCS table 5.1.3.1-1 defined in 38.214.

NOTE 3: If more than one Code Block is present, an additional CRC sequence of L = 24 Bits is attached to each Code Block (otherwise L = 0 Bit)

NOTE 4: Indexes of active UL slots are given by Table A.2.3-1 with TDD UL-DL configuration specified in A2.3 for the requirements requiring at least one sub frame (1ms) for the measurement period. For other requirements, indexes of active UL slots are given by the slots satisfying $\text{mod}(\text{slot index}+1, 5) = 0$ with TDD UL-DL configuration specified in A.3.3.1.

NOTE 5: The RMCs apply to all channel bandwidth where $L_{CRB} \leq N_{RB}$.

Table A.2.3.7-2: Void

A.3 DL reference measurement channels

A.3.1 General

Unless otherwise stated, Tables A.3.3.2-1 and A.3.3.2-2 are applicable for measurements of the Receiver Characteristics (clause 7).

Unless otherwise stated, Tables A.3.3.2-1 and A.3.3.2-2 also apply for the modulated interferer used in Clauses 7.5 and 7.6 with test specific bandwidths.

CSI-RS configuration parameter defined in Table A.3.1-2 and Table A.3.1-3 are used for verifying the beam correspondence requirement, 2 slots of CSI-RS shall be provided at each test grid point. The DL channel shall be configured for zero power on all tones except those used by CSI-RS in slots containing CSI-RS for beam refinement, and the DL and UL channel sizes shall be the same during verification.

Table A.3.1-1: Test parameters

| Parameter | Unit | Value |
|--|---|---|
| CORESET frequency domain allocation | | Full BW |
| CORESET time domain allocation | | 2 OFDM symbols at the begin of each slot |
| PDSCH mapping type | | Type A |
| PDSCH start symbol index (S) | | 2 |
| Number of consecutive PDSCH symbols (L) | | 12 |
| PDSCH PRB bundling | PRBs | 2 |
| Dynamic PRB bundling | | false |
| MCS table for TBS determination | | 64QAM |
| Overhead value for TBS determination | | 0 |
| First DMRS position for Type A PDSCH mapping | | 2 |
| DMRS type | | Type 1 |
| Number of additional DMRS | | 2 |
| FDM between DMRS and PDSCH | | Disable |
| CSI-RS for tracking | First subcarrier index in the PRB used for CSI-RS (k_0) | 0 for CSI-RS resource 1,2 |
| | OFDM symbols in the PRB used for CSI-RS | $l_0 = 8$ for CSI-RS resource 1 $l_0 = 12$ for CSI-RS resource 2 |
| | Number of CSI-RS ports | 1 for CSI-RS resource 1,2 |
| | CDM Type | 'No CDM' for CSI-RS resource 1,2 |
| | Density (ρ) | 3 for CSI-RS resource 1,2 |
| | CSI-RS periodicity | Slots 60 kHz SCS: 80 for CSI-RS resources 1 and 2 120 kHz SCS: 160 for CSI-RS resources 1 and 2 |
| | CSI-RS offset | Slots 60 kHz SCS: 40 for CSI-RS resources 1 and 2 120kHz SCS: 80 for CSI-RS resources 1 and 2 |
| | Frequency Occupation | Start PRB 0 Number of PRB = BWP size |
| | QCL info | TCI state #0 |
| PTRS configuration | | PTRS is not configured |

Table A.3.1-2: CSI-RS parameters for beam correspondence based on SSB and CSI-RS

| Resource Type | aperiodic |
|-----------------------------|--|
| Resource Set Config | |
| repetition | on |
| aperiodicTriggeringOffset | Depending on UE capability |
| Resource Config | |
| nzp-CSI-RS-ResourceId | 30 for resource #0 |
| | 31 for resource #1 |
| | 32 for resource #2 |
| | 33 for resource #3 |
| | 34 for resource #4 |
| | 35 for resource #5 |
| | 36 for resource #6 |
| | 37 for resource #7 |
| powerControlOffset | 0 |
| powerControlOffsetSS | db0 |
| nrofPorts | 1 |
| firstOFDMSymbolInTimeDomain | 6 for resource #0 |
| | 7 for resource #1 |
| | 8 for resource #2 |
| | 9 for resource #3 |
| | 10 for resource #4 |
| | 11 for resource #5 |
| | 12 for resource #6 |
| | 13 for resource #7 |
| cdm-Type | noCDM |
| density | 3 |
| nrofRBs | 48 for channel bandwidth \geq 100MHz 32 for channel bandwidth=50MHz |
| qcl-info | Type D to SSB |

CSI-RS configuration parameter defined in Table A.3.1-3 is used for verifying the beam correspondence requirement, CSI-RS shall be provided once every 10msec.

Table A.3.1-3: CSI-RS parameters for CSI-RS based beam correspondence

| Resource Type | aperiodic |
|-----------------------------|--|
| Resource Set Config | |
| repetition | on |
| aperiodicTriggeringOffset | Depending on UE capability |
| Resource Config | |
| nzp-CSI-RS-ResourceId | 30 for resource #0 |
| | 31 for resource #1 |
| | 32 for resource #2 |
| | 33 for resource #3 |
| | ... |
| | ... |
| | 29+N for resource #(N-1), where N is <i>maxNumberRxBeam</i> in UE capability IE of <i>MIMO-ParametersPerBand</i> |
| powerControlOffset | 0 |
| powerControlOffsetSS | db0 |
| nrofPorts | 1 |
| firstOFDMSymbolInTimeDomain | 6 for resource #0 |
| | 7 for resource #1 |
| | 8 for resource #2 |
| | 9 for resource #3 |
| | ... |
| | ... |
| | 5+N for resource #(N-1), where N= <i>maxNumberRxBeam</i> -1 in UE capability IE of <i>MIMO-ParametersPerBand</i> |
| cdm-Type | noCDM |
| density | 3 |
| nrofRBs | 48 for channel bandwidth \geq 100MHz 32 for channel bandwidth=50MHz |
| qcl-info | Type D to SSB |

A.3.2 Void

A.3.3 DL reference measurement channels for TDD

A.3.3.1 General

Table A.3.3.1-1. Additional test parameters for TDD

| Parameter | | Value | |
|--|--------------------------------------|---|---|
| | | SCS 60 kHz ($\mu=2$) | SCS 120 kHz ($\mu=3$) |
| TDD Slot Configuration pattern (Note 1) | | DDDSU | DDDSU |
| Special Slot Configuration (Note 2) | | S=4D+6G+4U | S=10D+2G+2U |
| referenceSubcarrierSpacing | | 60 kHz | 120 kHz |
| UL-DL configuration | <i>dl-UL-TransmissionPeriodicity</i> | 1.25 ms | 0.625 ms |
| | <i>nrofDownlinkSlots</i> | 3 | 3 |
| | <i>nrofDownlinkSymbols</i> | 4 | 10 |
| | <i>nrofUplinkSlot</i> | 1 | 1 |
| | <i>nrofUplinkSymbols</i> | 4 | 2 |
| Number of HARQ Processes | | 8 | 8 |
| The number of slots between PDSCH and corresponding HARQ-ACK information (Note 3) | | K1 = 4 if $\text{mod}(i,5) = 0$ K1 = 3 if $\text{mod}(i,5) = 1$ K1 = 7 if $\text{mod}(i,5) = 2$ where i is slot index per frame; $i = \{0, \dots, 39\}$ | K1 = 4 if $\text{mod}(i,5) = 0$ K1 = 3 if $\text{mod}(i,5) = 1$ K1 = 7 if $\text{mod}(i,5) = 2$ where i is slot index per frame; $i = \{0, \dots, 79\}$ |
| NOTE 1: D denotes a slot with all DL symbols; S denotes a slot with a mix of DL, UL and guard symbols; U denotes a slot with all UL symbols. The field is for information. | | | |
| NOTE 2: D, G, U denote DL, guard and UL symbols, respectively. The field is for information. | | | |
| NOTE 3: i is the slot index per frame. | | | |

A.3.3.2 FRC for receiver requirements for QPSK

Table A.3.3.2-1 Fixed Reference Channel for Receiver Requirements (SCS 60 kHz, TDD)

| Parameter | Unit | Value | | |
|---|------|---------|---------|---------|
| Channel bandwidth | MHz | 50 | 100 | 200 |
| Subcarrier spacing configuration μ | | 2 | 2 | 2 |
| Allocated resource blocks | | 66 | 132 | 264 |
| Subcarriers per resource block | | 12 | 12 | 12 |
| Allocated slots per Frame (NOTE 7) | | 23 / 24 | 23 / 24 | 23 / 24 |
| MCS index | | 4 | 4 | 4 |
| Modulation | | QPSK | QPSK | QPSK |
| Target Coding Rate | | 1/3 | 1/3 | 1/3 |
| Maximum number of HARQ transmissions | | 1 | 1 | 1 |
| Information Bit Payload per Slot | | | | |
| For Slots 0 and Slot i, if $\text{mod}(i, 5) = \{3,4\}$ for i from $\{0, \dots, 79\}$ (NOTE 5) | Bits | N/A | N/A | N/A |
| For Slot i, if $\text{mod}(i, 5) = \{0,1,2\}$ for i from $\{1, \dots, 79\}$ (NOTE 6) | Bits | 4224 | 8456 | 16896 |
| Transport block CRC | Bits | 24 | 24 | 24 |
| LDPC base graph | | 1 | 1 | 1 |
| Number of Code Blocks per Slot | | | | |
| For Slots 0 and Slot i, if $\text{mod}(i, 5) = \{3,4\}$ for i from $\{0, \dots, 79\}$ (NOTE 5) | CBs | N/A | N/A | N/A |
| For Slot i, if $\text{mod}(i, 5) = \{0,1,2\}$ for i from $\{1, \dots, 79\}$ (NOTE 6) | CBs | 1 | 2 | 2 |
| Binary Channel Bits Per Slot | | | | |
| For Slots 0 and Slot i, if $\text{mod}(i, 5) = \{3,4\}$ for i from $\{0, \dots, 79\}$ (NOTE 5) | Bits | N/A | N/A | N/A |
| For Slot i, if $\text{mod}(i, 5) = \{0,1,2\}$ for i from $\{1, \dots, 79\}$ (NOTE 6) | Bits | 14256 | 28512 | 57024 |
| Max. Throughput averaged over 1 frame (NOTE 8) | Mbps | 10.138 | 20.294 | 40.550 |
| <p>NOTE 1: Additional parameters are specified in Table A.3.1-1 and Table A.3.3.1-1.</p> <p>NOTE 2: If more than one Code Block is present, an additional CRC sequence of L = 24 Bits is attached to each Code Block (otherwise L = 0 Bit).</p> <p>NOTE 3: SS/PBCH block is transmitted in slot 0 with periodicity 20 ms</p> <p>NOTE 4: Slot i is slot index per 2 frames</p> <p>NOTE 5: When this DL RMC used together with the UL RMC for the transmitter requirements requiring at least one sub frame (1ms) for the measurement period, Slot i, if $\text{mod}(i, 8) = \{3,4,5,6,7\}$ for i from $\{0, \dots, 79\}$ together with the TDD UL-DL configuration specified in A2.3.</p> <p>NOTE 6: When this DL RMC used together with the UL RMC for the transmitter requirements requiring at least one sub frame (1ms) for the measurement period, Slot i, if $\text{mod}(i, 8) = \{0,1,2\}$ for i from $\{0, \dots, 79\}$ together with the TDD UL-DL configuration specified in A2.3.</p> <p>NOTE 7: First number corresponds to the number slots allocated in the first frame of the RMC; second number corresponds to the number slots allocated in the second frame of the RMC.</p> <p>NOTE 8: Throughput is averaged over 2nd frame of RMC.</p> | | | | |

Table A.3.3.2-2 Fixed Reference Channel for Receiver Requirements (SCS 120 kHz, TDD)

| Parameter | Unit | Value | | | |
|--|------|---------|---------|---------|---------|
| | | 50 | 100 | 200 | 400 |
| Channel bandwidth | MHz | 50 | 100 | 200 | 400 |
| Subcarrier spacing configuration μ | | 3 | 3 | 3 | 3 |
| Allocated resource blocks | | 32 | 66 | 132 | 264 |
| Subcarriers per resource block | | 12 | 12 | 12 | 12 |
| Allocated slots per Frame (NOTE 7) | | 47 / 48 | 47 / 48 | 47 / 48 | 47 / 48 |
| MCS index | | 4 | 4 | 4 | 4 |
| Modulation | | QPSK | QPSK | QPSK | QPSK |
| Target Coding Rate | | 1/3 | 1/3 | 1/3 | 1/3 |
| Maximum number of HARQ transmissions | | 1 | 1 | 1 | 1 |
| Information Bit Payload per Slot | | | | | |
| For Slots 0 and Slot i, if $\text{mod}(i, 5) = \{3,4\}$ for i from $\{0, \dots, 159\}$ (NOTE 5) | Bits | N/A | N/A | N/A | N/A |
| For Slot i, if $\text{mod}(i, 5) = \{0,1,2\}$ for i from $\{1, \dots, 159\}$ (NOTE 6) | Bits | 2088 | 4224 | 8456 | 16896 |
| Transport block CRC | Bits | 16 | 24 | 24 | 24 |
| LDPC base graph | | 2 | 1 | 1 | 1 |
| Number of Code Blocks per Slot | | | | | |
| For Slots 0 and Slot i, if $\text{mod}(i, 5) = \{3,4\}$ for i from $\{0, \dots, 159\}$ (NOTE 5) | CBs | N/A | N/A | N/A | N/A |
| For Slot i, if $\text{mod}(i, 5) = \{0,1,2\}$ for i from $\{1, \dots, 159\}$ (NOTE 6) | CBs | 1 | 1 | 2 | 2 |
| Binary Channel Bits Per Slot | | | | | |
| For Slots 0 and Slot i, if $\text{mod}(i, 5) = \{3,4\}$ for i from $\{0, \dots, 159\}$ (NOTE 5) | Bits | N/A | N/A | N/A | N/A |
| For Slot i, if $\text{mod}(i, 5) = \{0,1,2\}$ for i from $\{1, \dots, 159\}$ (NOTE 6) | Bits | 6912 | 14256 | 28512 | 57024 |
| Max. Throughput averaged over 1 frame (NOTE 8) | Mbps | 10.022 | 20.275 | 40.589 | 81.101 |
| NOTE 1: Additional parameters are specified in Table A.3.1-1 and Table A.3.3.1-1. | | | | | |
| NOTE 2: If more than one Code Block is present, an additional CRC sequence of L = 24 Bits is attached to each Code Block (otherwise L = 0 Bit). | | | | | |
| NOTE 3: SS/PBCH block is transmitted in slot 0 with periodicity 20 ms | | | | | |
| NOTE 4: Slot i is slot index per 2 frames | | | | | |
| NOTE 5: When this DL RMC used together with the UL RMC for the transmitter requirements requiring at least one sub frame (1ms) for the measurement period, Slot i, if $\text{mod}(i, 16) = \{7, \dots, 15\}$ for i from $\{0, \dots, 159\}$ together with the TDD UL-DL configuration specified in A2.3. | | | | | |
| NOTE 6: When this DL RMC used together with the UL RMC for the transmitter requirements requiring at least one sub frame (1ms) for the measurement period, Slot i, if $\text{mod}(i, 16) = \{0, \dots, 6\}$ for i from $\{0, \dots, 159\}$ together with the TDD UL-DL configuration specified in A2.3. | | | | | |
| NOTE 7: First number corresponds to the number slots allocated in the first frame of the RMC; second number corresponds to the number slots allocated in the second frame of the RMC. | | | | | |
| NOTE 8: Throughput is averaged over 2nd frame of RMC. | | | | | |

A.3.3.3 FRC for receiver requirements for 16QAM

A.3.3.4 FRC for receiver requirements for 64QAM

Table A.3.3.4-1 Fixed Reference Channel for Receiver Requirements (SCS 60 kHz, TDD)

| Parameter | Unit | Value | | |
|---|------|---------|---------|---------|
| Channel bandwidth | MHz | 50 | 100 | 200 |
| Subcarrier spacing configuration μ | | 2 | 2 | 2 |
| Allocated resource blocks | | 66 | 132 | 264 |
| Subcarriers per resource block | | 12 | 12 | 12 |
| Allocated slots per Frame (NOTE 6) | | 23 / 24 | 23 / 24 | 23 / 24 |
| MCS index | | 19 | 19 | 19 |
| Modulation | | 64QAM | 64QAM | 64QAM |
| Target Coding Rate | | 1/2 | 1/2 | 1/2 |
| Maximum number of HARQ transmissions | | 1 | 1 | 1 |
| Information Bit Payload per Slot | | | | |
| For Slots 0 and Slot i, if $\text{mod}(i, 5) = \{3,4\}$ for i from $\{0, \dots, 79\}$ | Bits | N/A | N/A | N/A |
| For Slot i, if $\text{mod}(i, 5) = \{0,1,2\}$ for i from $\{1, \dots, 79\}$ | Bits | 20496 | 40976 | 81976 |
| Transport block CRC | Bits | 24 | 24 | 24 |
| LDPC base graph | | 1 | 1 | 1 |
| Number of Code Blocks per Slot | | | | |
| For Slot i, if $\text{mod}(i, 10) = \{0,1,2\}$ for i from $\{1, \dots, 79\}$ | CBs | N/A | N/A | N/A |
| For Slot i, if $\text{mod}(i, 5) = \{0,1,2\}$ for i from $\{1, \dots, 79\}$ | CBs | 3 | 5 | 10 |
| Binary Channel Bits Per Slot | | | | |
| For Slots 0 and Slot i, if $\text{mod}(i, 5) = \{3,4\}$ for i from $\{0, \dots, 79\}$ | Bits | N/A | N/A | N/A |
| For Slot i, if $\text{mod}(i, 5) = \{0,1,2\}$ for i from $\{1, \dots, 79\}$ | Bits | 40392 | 80784 | 161568 |
| Max. Throughput averaged over 1 frame (NOTE 7) | Mbps | 49.190 | 98.343 | 196.742 |
| NOTE 1: Additional parameters are specified in Table A.3.1-1 and Table A.3.3.1-1. | | | | |
| NOTE 2: If more than one Code Block is present, an additional CRC sequence of L = 24 Bits is attached to each Code Block (otherwise L = 0 Bit). | | | | |
| NOTE 3: SS/PBCH block is transmitted in slot 0 with periodicity 20 ms | | | | |
| NOTE 4: Slot i is slot index per 2 frames | | | | |
| NOTE 5: PTRS is configured on symbols containing PDSCH with 1 port, per 2PRB in frequency domain, per symbol in time domain. Overhead for TBS calculation is assumed to be 6. | | | | |
| NOTE 6: First number corresponds to the number slots allocated in the first frame of the RMC; second number corresponds to the number slots allocated in the second frame of the RMC. | | | | |
| NOTE 7: Throughput is averaged over 2nd frame of RMC | | | | |

Table A.3.3.4-2 Fixed Reference Channel for Receiver Requirements (SCS 120 kHz, TDD)

| Parameter | Unit | Value | | | |
|---|------|---------|---------|---------|---------|
| | | 50 | 100 | 200 | 400 |
| Channel bandwidth | MHz | 50 | 100 | 200 | 400 |
| Subcarrier spacing configuration μ | | 3 | 3 | 3 | 3 |
| Allocated resource blocks | | 32 | 66 | 132 | 264 |
| Subcarriers per resource block | | 12 | 12 | 12 | 12 |
| Allocated slots per Frame (NOTE 6) | | 47 / 48 | 47 / 48 | 47 / 48 | 47 / 48 |
| MCS index | | 19 | 19 | 19 | 19 |
| Modulation | | 64QAM | 64QAM | 64QAM | 64QAM |
| Target Coding Rate | | 1/2 | 1/2 | 1/2 | 1/2 |
| Maximum number of HARQ transmissions | | 1 | 1 | 1 | 1 |
| Information Bit Payload per Slot | | | | | |
| For Slots 0 and Slot i, if $\text{mod}(i, 5) = \{3,4\}$ for i from $\{0, \dots, 159\}$ | Bits | N/A | N/A | N/A | N/A |
| For Slot i, if $\text{mod}(i, 5) = \{0,1,2\}$ for i from $\{1, \dots, 159\}$ | Bits | 9992 | 20496 | 40976 | 81976 |
| Transport block CRC | Bits | 24 | 24 | 24 | 24 |
| LDPC base graph | | 1 | 1 | 1 | 1 |
| Number of Code Blocks per Slot | | | | | |
| For Slots 0 and Slot i, if $\text{mod}(i, 5) = \{3,4\}$ for i from $\{0, \dots, 159\}$ | CBs | N/A | N/A | N/A | N/A |
| For Slot i, if $\text{mod}(i, 5) = \{0,1,2\}$ for i from $\{1, \dots, 159\}$ | CBs | 2 | 3 | 5 | 10 |
| Binary Channel Bits Per Slot | | | | | |
| For Slots 0 and Slot i, if $\text{mod}(i, 5) = \{3,4\}$ for i from $\{0, \dots, 159\}$ | Bits | N/A | N/A | N/A | N/A |
| For Slot i, if $\text{mod}(i, 5) = \{0,1,2\}$ for i from $\{1, \dots, 159\}$ | Bits | 19584 | 40392 | 80784 | 161568 |
| Max. Throughput averaged over 1 frame (NOTE 7) | Mbps | 47.962 | 98.381 | 196.685 | 393.485 |
| NOTE 1: Additional parameters are specified in Table A.3.1-1 and Table A.3.3.1-1. | | | | | |
| NOTE 2: If more than one Code Block is present, an additional CRC sequence of L = 24 Bits is attached to each Code Block (otherwise L = 0 Bit). | | | | | |
| NOTE 3: SS/PBCH block is transmitted in slot 0 of each frame | | | | | |
| NOTE 4: Slot i is slot index per frame | | | | | |
| NOTE 5: PTRS is configured on symbols containing PDSCH with 1 port, per 2PRB in frequency domain, per symbol in time domain. Overhead for TBS calculation is assumed to be 6. | | | | | |
| NOTE 6: First number corresponds to the number slots allocated in the first frame of the RMC; second number corresponds to the number slots allocated in the second frame of the RMC. | | | | | |
| NOTE 7: Throughput is averaged over 2nd frame of RMC. | | | | | |

A.3.3.5 FRC for receiver requirements for 256QAM

Table A.3.3.5-1 Fixed Reference Channel for Receiver Requirements (SCS 60 kHz, TDD)

| Parameter | Unit | Value | | |
|---|------|---------|---------|---------|
| Channel bandwidth | MHz | 50 | 100 | 200 |
| Subcarrier spacing configuration μ | | 2 | 2 | 2 |
| Allocated resource blocks | | 66 | 132 | 264 |
| Subcarriers per resource block | | 12 | 12 | 12 |
| Allocated slots per Frame (NOTE 6) | | 23 / 24 | 23 / 24 | 23 / 24 |
| MCS index | | 24 | 24 | 24 |
| Modulation | | 256QAM | 256QAM | 256QAM |
| Target Coding Rate | | 4/5 | 4/5 | 4/5 |
| Maximum number of HARQ transmissions | | 1 | 1 | 1 |
| Information Bit Payload per Slot | | | | |
| For Slots 0 and Slot i, if $\text{mod}(i, 5) = \{3,4\}$ for i from $\{0, \dots, 79\}$ | Bits | N/A | N/A | N/A |
| For Slot i, if $\text{mod}(i, 5) = \{0,1,2\}$ for i from $\{1, \dots, 79\}$ | Bits | 44040 | 88064 | 176208 |
| Transport block CRC | Bits | 24 | 24 | 24 |
| LDPC base graph | | 1 | 1 | 1 |
| Number of Code Blocks per Slot | | | | |
| For Slots 0 and Slot i, if $\text{mod}(i, 5) = \{3,4\}$ for i from $\{0, \dots, 79\}$ | CBs | N/A | N/A | N/A |
| For Slot i, if $\text{mod}(i, 5) = \{0,1,2\}$ for i from $\{1, \dots, 79\}$ | CBs | 6 | 11 | 21 |
| Binary Channel Bits Per Slot | | | | |
| For Slots 0 and Slot i, if $\text{mod}(i, 5) = \{3,4\}$ for i from $\{0, \dots, 79\}$ | Bits | N/A | N/A | N/A |
| For Slot i, if $\text{mod}(i, 5) = \{0,1,2\}$ for i from $\{1, \dots, 79\}$ | Bits | 53856 | 107712 | 215424 |
| Max. Throughput averaged over 1 frame (NOTE 7) | Mbps | 105.696 | 211.354 | 422.899 |
| NOTE 1: Additional parameters are specified in Table A.3.1-1 and Table A.3.3.1-1. | | | | |
| NOTE 2: If more than one Code Block is present, an additional CRC sequence of L = 24 Bits is attached to each Code Block (otherwise L = 0 Bit). | | | | |
| NOTE 3: SS/PBCH block is transmitted in slot 0 of each frame | | | | |
| NOTE 4: Slot i is slot index per 2 frames | | | | |
| NOTE 5: PTRS is configured on symbols containing PDSCH with 1 port, per 2PRB in frequency domain, per symbol in time domain. Overhead for TBS calculation is assumed to be 6. | | | | |
| NOTE 6: First number corresponds to the number slots allocated in the first frame of the RMC; second number corresponds to the number slots allocated in the second frame of the RMC. | | | | |
| NOTE 7: Throughput is averaged over 2nd frame of RMC. | | | | |

Table A.3.3.5-2 Fixed Reference Channel for Receiver Requirements (SCS 120 kHz, TDD)

| Parameter | Unit | Value | | | |
|---|------|---------|---------|---------|---------|
| | | 50 | 100 | 200 | 400 |
| Channel bandwidth | MHz | 50 | 100 | 200 | 400 |
| Subcarrier spacing configuration μ | | 3 | 3 | 3 | 3 |
| Allocated resource blocks | | 32 | 66 | 132 | 264 |
| Subcarriers per resource block | | 12 | 12 | 12 | 12 |
| Allocated slots per Frame (NOTE 6) | | 47 / 48 | 47 / 48 | 47 / 48 | 47 / 48 |
| MCS index | | 24 | 24 | 24 | 24 |
| Modulation | | 256QAM | 256QAM | 256QAM | 256QAM |
| Target Coding Rate | | 4/5 | 4/5 | 4/5 | 4/5 |
| Maximum number of HARQ transmissions | | 1 | 1 | 1 | 1 |
| Information Bit Payload per Slot | | | | | |
| For Slots 0 and Slot i, if $\text{mod}(i, 5) = \{3,4\}$ for i from $\{0, \dots, 159\}$ | Bits | N/A | N/A | N/A | N/A |
| For Slot i, if $\text{mod}(i, 5) = \{0,1,2\}$ for i from $\{1, \dots, 159\}$ | Bits | 21504 | 44040 | 88064 | 176208 |
| Transport block CRC | Bits | 24 | 24 | 24 | 24 |
| LDPC base graph | | 1 | 1 | 1 | 1 |
| Number of Code Blocks per Slot | | | | | |
| For Slots 0 and Slot i, if $\text{mod}(i, 5) = \{3,4\}$ for i from $\{0, \dots, 159\}$ | CBs | N/A | N/A | N/A | N/A |
| For Slot i, if $\text{mod}(i, 5) = \{0,1,2\}$ for i from $\{1, \dots, 159\}$ | CBs | 3 | 6 | 11 | 21 |
| Binary Channel Bits Per Slot | | | | | |
| For Slots 0 and Slot i, if $\text{mod}(i, 5) = \{3,4\}$ for i from $\{0, \dots, 159\}$ | Bits | N/A | N/A | N/A | N/A |
| For Slot i, if $\text{mod}(i, 5) = \{0,1,2\}$ for i from $\{1, \dots, 159\}$ | Bits | 26112 | 53856 | 107712 | 215424 |
| Max. Throughput averaged over 1 frame (NOTE 7) | Mbps | 103.219 | 211.392 | 422.707 | 845.798 |
| NOTE 1: Additional parameters are specified in Table A.3.1-1 and Table A.3.3.1-1. | | | | | |
| NOTE 2: If more than one Code Block is present, an additional CRC sequence of L = 24 Bits is attached to each Code Block (otherwise L = 0 Bit). | | | | | |
| NOTE 3: SS/PBCH block is transmitted in slot 0 of each frame | | | | | |
| NOTE 4: Slot i is slot index per 2 frames | | | | | |
| NOTE 5: PTRS is configured on symbols containing PDSCH with 1 port, per 2PRB in frequency domain, per symbol in time domain. Overhead for TBS calculation is assumed to be 6. | | | | | |
| NOTE 6: First number corresponds to the number slots allocated in the first frame of the RMC; second number corresponds to the number slots allocated in the second frame of the RMC. | | | | | |
| NOTE 7: Throughput is averaged over 2nd frame of RMC. | | | | | |

A.4 Void

A.5 OFDMA Channel Noise Generator (OCNG)

A.5.1 OCNG Patterns for FDD

A.5.2 OCNG Patterns for TDD

A.5.2.1 OCNG TDD pattern 1: Generic OCNG TDD Pattern for all unused REs

Table A.5.2.1-1: OP.1 TDD: Generic OCNG TDD Pattern for all unused REs

| OCNG Appliance | Control Region (Core Set) | Data Region |
|---|--|--|
| OCNG Parameters | | |
| Resources allocated | All unused REs (Note 1) | All unused REs (Note 2) |
| Structure | PDCCH | PDSCH |
| Content | Uncorrelated pseudo random QPSK modulated data | Uncorrelated pseudo random QPSK modulated data |
| Transmission scheme for multiple antennas ports transmission | Single Tx port transmission | Spatial multiplexing using any precoding matrix with dimensions same as the precoding matrix for PDSCH |
| Subcarrier Spacing | Same as for RMC PDCCH in the active BWP | Same as for RMC PDSCH in the active BWP |
| Power Level | Same as for RMC PDCCH | Same as for RMC PDSCH |
| Note 1: All unused REs in the active CORESETS appointed by the search spaces in use. Note 2: Unused available REs refer to REs in PRBs not allocated for any physical channels, CORESETS, synchronization signals or reference signals in channel bandwidth. | | |

Annex B (informative): Void

Annex C (normative): Downlink physical channels

C.1 General

C.2 Setup

Table C.2-1 describes the downlink Physical Channels that are required for connection set up.

Table C.2-1: Downlink Physical Channels required for connection set-up

| Physical Channel |
|------------------|
| PBCH |
| SSS |
| PSS |
| PDCCH |
| PDSCH |
| PBCH DMRS |
| PDCCH DMRS |
| PDSCH DMRS |
| CSI-RS |
| PTRS |

C.3 Connection

C.3.1 Measurement of Receiver Characteristics

Unless otherwise stated, Table C.3.1-1 is applicable for measurements on the Receiver Characteristics (clause 7).

Table C.3.1-1: Downlink Physical Channels transmitted during a connection (TDD)

| Parameter | Unit | Value |
|--|---|----------------------|
| SSS transmit power | W | Test specific |
| EPRE ratio of PSS to SSS | dB | 0 |
| EPRE ratio of PBCH to SSS | dB | 0 |
| EPRE ratio of PBCH to PBCH DMRS | dB | 0 |
| EPRE ratio of PDCCH to SSS | dB | 0 |
| EPRE ratio of PDCCH to PDCCH DMRS | dB | 0 |
| EPRE ratio of PDSCH to SSS | dB | 0 |
| EPRE ratio of PDSCH to PDSCH DMRS (Note 1) | dB | -3 |
| EPRE ratio of CSI-RS to SSS | dB | 0 |
| EPRE ratio of PTRS to PDSCH | dB | Test specific |
| EPRE ratio of OCNB DMRS to SSS | dB | 0 |
| EPRE ratio of OCNB to OCNB DMRS (Note 1) | dB | 0 |
| Note 1: | No boosting is applied to any of the channels except PDSCH DMRS. For PDSCH DMRS, 3 dB power boosting is applied assuming DMRS Type 1 configuration when DMRS and PDSCH are TDM'ed and only half of the DMRS REs are occupied. | |
| Note 2: | Number of DMRS CDM groups without data for PDSCH DMRS configuration for OCNB is set to 1. | |

Annex D (normative): Characteristics of the interfering signal

D.1 General

Unless otherwise stated, a modulated full bandwidth NR downlink signal, which equals to channel bandwidth of the wanted signal for Single Carrier case is used as interfering signals when RF performance requirements for NR UE receiver are defined. For intra-band contiguous CA case, a modulated NR downlink signal which equals to the aggregated channel bandwidth of the wanted signal is used.

D.2 Interference signals

Table D.2-1 describes the modulated interferer for different channel bandwidth options.

Table D.2-1: Description of modulated NR interferer

| | Channel bandwidth for Single Carrier | | | | Intra band contiguous CA |
|--|--------------------------------------|---------|---------|---------|-----------------------------|
| | 50 MHz | 100 MHz | 200 MHz | 400 MHz | |
| $BW_{\text{Interferer}}$ | 50 MHz | 100 MHz | 200 MHz | 400MHz | $BW_{\text{Channel_CA}}$ |
| RB | NOTE1 | | | | |
| NOTE 1: The RB configured for interfering signal is the same as maximum RB number defined in Table 5.3.2-1 for each sub-carrier spacing. | | | | | |

Annex E (normative): Environmental conditions

E.1 General

This annex specifies the environmental requirements of the UE. Within these limits the requirements of the present documents shall be fulfilled.

E.2 Environmental

The requirements in this clause apply to all types of UE(s).

E.2.1 Temperature

All RF requirements for UEs operating in FR2 are defined over the air and can only be tested in an OTA chamber.

The UE shall fulfil all the requirements in the temperature range for extreme conditions, as defined in Table E.2.1-1, unless explicitly stated otherwise in any requirement.

Table E.2.1-1: Temperature conditions

| | |
|-----------------|---|
| + 25 °C ± 10 °C | For normal (room temperature) conditions with relative humidity of 25 % to 75 % |
| -10°C to +55°C | For extreme conditions |

Outside this temperature range the UE, if powered on, shall not make ineffective use of the radio frequency spectrum. In no case shall the UE exceed the transmitted levels as defined in clause 6.2 for extreme operation.

E.2.2 Voltage

Editor's note: This requirement is incomplete. The following aspects are either missing or not yet determined:

Methodology to control the voltage in a case which a power cable is not connected to DUT is FFS since it is not agreed whether we can connect the power cable to DUT at the OTA measurement situation yet.

The UE shall fulfil all the requirements in the full voltage range, i.e. the voltage range between the extreme voltages.

The manufacturer shall declare the lower and higher extreme voltages and the approximate shutdown voltage. For the equipment that can be operated from one or more of the power sources listed below, the lower extreme voltage shall not be higher, and the higher extreme voltage shall not be lower than that specified below.

Table E.2.2-1: Voltage conditions

| Power source | Lower extreme voltage | Higher extreme voltage | Normal conditions voltage |
|-----------------------------|-----------------------|------------------------|---------------------------|
| AC mains | 0,9 * nominal | 1,1 * nominal | nominal |
| Regulated lead acid battery | 0,9 * nominal | 1,3 * nominal | 1,1 * nominal |
| Nonregulated batteries: | | | |
| Leclanché | 0,85 * nominal | Nominal | Nominal |
| Lithium | 0,95 * nominal | 1,1 * Nominal | 1,1 * Nominal |
| Mercury/nickel & cadmium | 0,90 * nominal | | Nominal |

Outside this voltage range the UE if powered on, shall not make ineffective use of the radio frequency spectrum. In no case shall the UE exceed the transmitted levels as defined in clause 6.2 for extreme operation. In particular, the UE shall inhibit all RF transmissions when the power supply voltage is below the manufacturer declared shutdown voltage.

E.2.3 Void

Annex F (normative): Transmit modulation

F.1 Measurement Point

Figure F.1-1 shows the measurement point for the unwanted emission falling into non-allocated RB(s) and the EVM for the allocated RB(s).

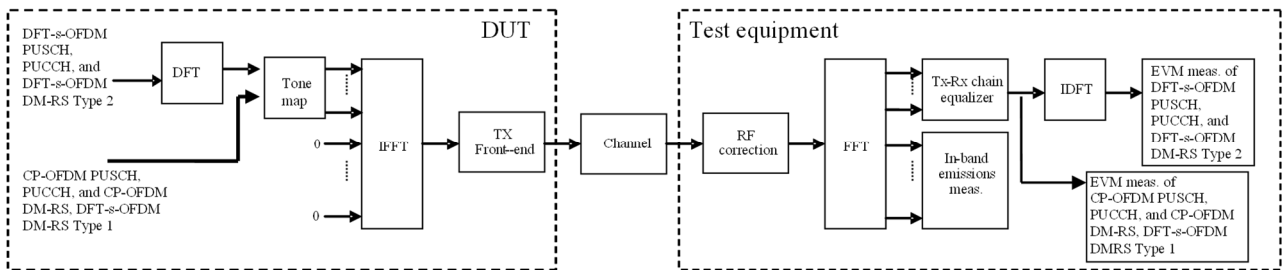

Figure F.1-1: EVM measurement points

F.2 Basic Error Vector Magnitude measurement

The EVM is the difference between the ideal waveform and the measured waveform for the allocated RB(s)

$$EVM = \sqrt{\frac{\sum_{v \in T_m} |z'(v) - i(v)|^2}{|T_m| \cdot P_0}}$$

where

T_m is a set of $|T_m|$ modulation symbols with the considered modulation scheme being active within the measurement period,

$z'(v)$ are the samples of the signal evaluated for the EVM,

$i(v)$ is the ideal signal reconstructed by the measurement equipment, and

P_0 is the average power of the ideal signal. For normalized modulation symbols P_0 is equal to 1.

The basic EVM measurement interval is defined over one slot in the time domain for PUCCH and PUSCH and over one preamble sequence for the PRACH.

F.3 Basic in-band emissions measurement

The in-band emissions are a measure of the interference falling into the non-allocated resources blocks. The in-band emission requirement is evaluated for PUCCH and PUSCH transmissions. The in-band emission requirement is not evaluated for PRACH transmissions.

The in-band emissions are measured as follows

$$Emissions_{absolute}(\Delta_{RB}) = \begin{cases} \frac{1}{|T_s|} \sum_{t \in T_s} \sum_{f_i + (12 \cdot \Delta_{RB} + 11) \cdot \Delta f}^{\max(f_{\min}, f_i + 12 \cdot \Delta_{RB} \cdot \Delta f)} |Y(t, f)|^2, \Delta_{RB} < 0 \\ \frac{1}{|T_s|} \sum_{t \in T_s} \sum_{f_h + (12 \cdot \Delta_{RB} - 11) \cdot \Delta f}^{\min(f_{\max}, f_h + 12 \cdot \Delta_{RB} \cdot \Delta f)} |Y(t, f)|^2, \Delta_{RB} > 0 \end{cases},$$

where

T_s is a set of $|T_s|$ OFDM symbols with the considered modulation scheme being active within the measurement period,

Δ_{RB} is the starting frequency offset between the allocated RB and the measured non-allocated RB (e.g. $\Delta_{RB} = 1$ or $\Delta_{RB} = -1$ for the first adjacent RB),

f_{\min} (resp. f_{\max}) is the lower (resp. upper) edge of the UL system BW,

f_l and f_h are the lower and upper edge of the allocated BW, and

$Y(t, f)$ is the frequency domain signal evaluated for in-band emissions as defined in the clause (ii)

The relative in-band emissions are, given by

$$Emissions_{relative}(\Delta_{RB}) = \frac{Emissions_{absolute}(\Delta_{RB})}{\frac{1}{|T_s| \cdot N_{RB}} \sum_{t \in T_s} \sum_{f_i}^{f_i + (12 \cdot N_{RB} - 1) \Delta f} |Y(t, f)|^2}$$

where

N_{RB} is the number of allocated RBs

The basic in-band emissions measurement interval is defined over one slot in the time domain. When the PUSCH or PUCCH transmission slot is shortened due to multiplexing with SRS, the in-band emissions measurement interval is reduced by one OFDM symbol, accordingly.

In the evaluation of in-band emissions, the timing is set according to $\Delta \tilde{t} = \Delta \tilde{c}$, where sample time offsets $\Delta \tilde{t}$ and $\Delta \tilde{c}$ are defined in clause F.4.

F.4 Modified signal under test

Implicit in the definition of EVM is an assumption that the receiver is able to compensate a number of transmitter impairments.

The DFT-s-OFDM modulated signals or PRACH signal under test is modified and, in the case of DFT-s-OFDM modulated signals, decoded according to:

$$Z'(t, f) = IDFT \left\{ \frac{FFT \left\{ z(v - \Delta \tilde{t}) \cdot e^{-j2\pi \Delta \tilde{f} v} \right\} e^{j2\pi f \Delta \tilde{t}}}{\tilde{a}(t, f) \cdot e^{j\tilde{\varphi}(t, f)}} \right\}$$

where

$z(v)$ is the time domain samples of the signal under test.

The CP-OFDM modulated signals or PUSCH demodulation reference signal or CP-OFDM modulated signals under test is equalised and, in the case of PUCCH data signal decoded according to:

$$Z'(t, f) = \frac{FFT \left\{ z(v - \Delta \tilde{t}) \cdot e^{-j2\pi \Delta \tilde{f} v} \right\} e^{j2\pi f \Delta \tilde{t}}}{\tilde{a}(t, f) \cdot e^{j\tilde{\varphi}(t, f)}}$$

where

$z(v)$ is the time domain samples of the signal under test.

To minimize the error, the signal under test should be modified with respect to a set of parameters following the procedure explained below.

Notation:

$\Delta \tilde{t}$ is the sample timing difference between the FFT processing window in relation to nominal timing of the ideal signal.

$\Delta \tilde{f}$ is the RF frequency offset.

$\tilde{\varphi}(t, f)$ is the phase response of the TX chain.

$\tilde{a}(t, f)$ is the amplitude response of the TX chain.

In the following $\Delta \tilde{c}$ represents the middle sample of the EVM window of length W (defined in the next clauses) or the last sample of the first window half if W is even.

The EVM analyser shall

- detect the start of each slot and estimate $\Delta \tilde{t}$ and $\Delta \tilde{f}$,
- determine $\Delta \tilde{c}$ so that the EVM window of length W is centred
 - on the time interval determined by the measured cyclic prefix minus 16κ samples of the considered OFDM symbol for symbol l for subcarrier spacing configuration μ in a subframe, with $l = 0$ or $l = 7 \cdot 2^\mu$ for normal CP, i.e. the first 16κ samples of the CP should not be taken into account for this step. In the determination of the number of excluded samples, a sampling rate of $1/T_c$ is assumed. If a different sampling rate is used, the number of excluded samples is scaled linearly.
 - on the measured cyclic prefix of the considered OFDM symbol for all other symbols for normal CP and for symbol 0 to 11 for extended CP.
 - on the measured preamble cyclic prefix for the PRACH

To determine the other parameters a sample timing offset equal to $\Delta \tilde{c}$ is corrected from the signal under test. The EVM analyser shall then

- correct the RF frequency offset $\Delta \tilde{f}$ for each time slot, and

- apply an FFT of appropriate size. The chosen FFT size shall ensure that in the case of an ideal signal under test, there is no measured inter-subcarrier interference.

The carrier leakage shall be removed from the evaluated signal before calculating the EVM and the in-band emissions; however, the removed relative carrier leakage power also has to satisfy the applicable requirement.

At this stage the allocated RBs shall be separated from the non-allocated RBs. In the case of PUCCH and PUSCH EVM, the signal on the non-allocated RB(s), $Y(t, f)$, is used to evaluate the in-band emissions.

Moreover, the following procedure applies only to the signal on the allocated RB(s).

- In the case of PUCCH and PUSCH, the UL EVM analyzer shall estimate the TX chain equalizer coefficients $\tilde{a}(t, f)$ and $\tilde{\varphi}(t, f)$ used by the ZF equalizer for all subcarriers by time averaging at each signal subcarrier of the amplitude and phase of the reference and data symbols. The time-averaging length is 1 slot. This process creates an average amplitude and phase for each signal subcarrier used by the ZF equalizer. The knowledge of data modulation symbols may be required in this step because the determination of symbols by demodulation is not reliable before signal equalization.
- In the case of PRACH, the UL EVM analyzer shall estimate the TX chain coefficients $\tilde{a}(t)$ and $\tilde{\varphi}(t)$ used for phase and amplitude correction and are selected so as to minimize the resulting EVM. The TX chain coefficients are not dependent on frequency, i.e. $\tilde{a}(t, f) = \tilde{a}(t)$ and $\tilde{\varphi}(t, f) = \tilde{\varphi}(t)$. The TX chain coefficients are chosen independently for each preamble transmission and for each $\Delta \tilde{t}$.

At this stage estimates of $\Delta \tilde{f}$, $\tilde{a}(t, f)$, $\tilde{\varphi}(t, f)$ and $\Delta \tilde{c}$ are available. $\Delta \tilde{t}$ is one of the extremities of the window W , i.e. $\Delta \tilde{t}$ can be $\Delta \tilde{c} + \alpha - \left\lfloor \frac{W}{2} \right\rfloor$ or $\Delta \tilde{c} + \left\lfloor \frac{W}{2} \right\rfloor$, where $\alpha = 0$ if W is odd and $\alpha = 1$ if W is even.

The EVM analyser shall then

- calculate EVM_l with $\Delta \tilde{t}$ set to $\Delta \tilde{c} + \alpha - \left\lfloor \frac{W}{2} \right\rfloor$,
- calculate EVM_h with $\Delta \tilde{t}$ set to $\Delta \tilde{c} + \left\lfloor \frac{W}{2} \right\rfloor$.

F.5 Window length

F.5.1 Timing offset

As a result of using a cyclic prefix, there is a range of $\Delta \tilde{t}$, which, at least in the case of perfect Tx signal quality, would give close to minimum error vector magnitude. As a first order approximation, that range should be equal to the length of the cyclic prefix. Any time domain windowing or FIR pulse shaping applied by the transmitter reduces the $\Delta \tilde{t}$ range within which the error vector is close to its minimum.

F.5.2 Window length

The window length W affects the measured EVM and is expressed as a function of the configured cyclic prefix length. In the case where equalization is present, as with frequency domain EVM computation, the effect of FIR is reduced. This is because the equalization can correct most of the linear distortion introduced by the FIR. However, the time domain windowing effect can't be removed.

F.5.3 Window length for normal CP

Table F.5.3-1 and Table F.5.3-2 below specify the EVM window length (W) for normal CP for FR2.

Table F.5.3-1: EVM window length for normal CP for 60 kHz SCS

| Channel Bandwidth (MHz) | FFT size | Cyclic prefix length in FFT samples | EVM window length W | Ratio of W to total CP length ¹ (%) |
|--|----------|-------------------------------------|-----------------------|--|
| 50 | 1024 | 72 | 36 | 50 |
| 100 | 2048 | 144 | 72 | 50 |
| 200 | 4096 | 288 | 144 | 50 |
| Note 1: These percentages are informative and apply to all OFDM symbols within subframe except for symbol 0 of slot 0 and slot 2. Symbol 0 of slot 0 and slot 2 may have a longer CP and therefore a lower percentage. | | | | |

Table F.5.3-2: EVM window length for normal CP for 120 kHz SCS

| Channel Bandwidth (MHz) | FFT size | Cyclic prefix length in FFT samples | EVM window length W | Ratio of W to total CP length ¹ (%) |
|--|----------|-------------------------------------|-----------------------|--|
| 50 | 512 | 36 | 18 | 50 |
| 100 | 1024 | 72 | 36 | 50 |
| 200 | 2048 | 144 | 72 | 50 |
| 400 | 4096 | 288 | 144 | 50 |
| Note 1: These percentages are informative and apply to all OFDM symbols within subframe except for symbol 0 of slot 0 and slot 4. Symbol 0 of slot 0 and slot 4 may have a longer CP and therefore a lower percentage. | | | | |

F.5.4 Window length for Extended CP

Table F.5.4-1 below specifies the EVM window length (W) for extended CP. The number of CP samples excluded from the EVM window is the same as for normal CP length.

Table F.5.4-1: EVM window length for extended CP for 60 kHz SCS

| Channel Bandwidth (MHz) | FFT size | Cyclic prefix length in FFT samples | EVM window length W | Ratio of W to total CP length ¹ (%) |
|--|----------|-------------------------------------|-----------------------|--|
| 50 | 1024 | 256 | 220 | 85.9 |
| 100 | 2048 | 512 | 440 | 85.9 |
| 200 | 4096 | 1024 | 880 | 85.9 |
| Note 1: These percentages are informative. | | | | |

F.5.5 Window length for PRACH

The table below specifies the EVM window length for PRACH preamble formats for $L_{RA} = 139$ and

$$\Delta f^{RA} = 15 \cdot 2^\mu \text{ kHz} \quad \text{where } \mu \in \{2,3\}.$$

Table F.5.5-1: EVM window length for PRACH formats for $L_{RA} = 139$

| Preamble format | Cyclic prefix length N_{cp} | Nominal FFT size ¹ | EVM window length W in FFT samples | Ratio of W to CP ² |
|-----------------|---|-------------------------------|--------------------------------------|---------------------------------|
| A1 | 1152·2 ^{-μ} | 8192·2 ^{-μ} | 576·2 ^{-μ} | 50.0% |
| A2 | 2304·2 ^{-μ} | 8192·2 ^{-μ} | 1728·2 ^{-μ} | 75.0% |
| A3 | 3456·2 ^{-μ} | 8192·2 ^{-μ} | 2880·2 ^{-μ} | 83.3% |
| B1 | 864·2 ^{-μ} | 8192·2 ^{-μ} | 288·2 ^{-μ} | 33.3% |
| B2 | 1440·2 ^{-μ} | 8192·2 ^{-μ} | 864·2 ^{-μ} | 60.0% |
| B3 | 2016·2 ^{-μ} | 8192·2 ^{-μ} | 1440·2 ^{-μ} | 71.4% |
| B4 | 3744·2 ^{-μ} | 8192·2 ^{-μ} | 3168·2 ^{-μ} | 84.6% |
| C0 | 4960·2 ^{-μ} | 8192·2 ^{-μ} | 4384·2 ^{-μ} | 88.4% |
| C2 | 8192·2 ^{-μ} | 8192·2 ^{-μ} | 7616·2 ^{-μ} | 93.0% |
| Note 1: | The use of other FFT sizes is possible as long as appropriate scaling of the window length is applied | | | |
| Note 2: | These percentages are informative | | | |

F.6 Averaged EVM

The general EVM is averaged over basic EVM measurements for n slots in the time domain.

$$\overline{EVM} = \sqrt{\frac{1}{n} \sum_{i=1}^n EVM_i^2},$$

where n is

$$n = \begin{cases} 40, & \text{for 60 kHz SCS} \\ 80, & \text{for 120 kHz SCS} \end{cases}$$

for PUCCH, PUSCH.

The EVM requirements shall be tested against the maximum of the RMS average at the window W extremities of the EVM measurements:

Thus \overline{EVM}_l is calculated using $\Delta\tilde{t} = \Delta\tilde{t}_l$ in the expressions above and \overline{EVM}_h is calculated using $\Delta\tilde{t} = \Delta\tilde{t}_h$.

Thus we get:

$$EVM = \max(\overline{EVM}_l, \overline{EVM}_h)$$

The calculation of the EVM for the demodulation reference signal, EVM_{DMRS} , follows the same procedure as calculating the general EVM, with the exception that the modulation symbol set T_m defined in clause F.2 is restricted to symbols containing uplink demodulation reference signals.

The basic EVM_{DMRS} measurements are first averaged over n slots in the time domain to obtain an intermediate average \overline{EVM}_{MR} .

$$\overline{EVM}_{DMRS} = \sqrt{\frac{1}{n} \sum_{i=1}^n EVM_{DMRS,i}^2}$$

In the determination of each $EVM_{DMRS,i}$, the timing is set to $\Delta\tilde{t} = \Delta\tilde{t}_l$ if $\overline{EVM} > \overline{EVM}_h$, and it is set to

$\Delta\tilde{t} = \Delta\tilde{t}_h$ otherwise, where \overline{EVM} and \overline{EVM}_h are the general average EVM values calculated in the same n slots

over which the intermediate average \overline{EVM}_{DMRS} is calculated. Note that in some cases, the general average EVM may be calculated only for the purpose of timing selection for the demodulation reference signal EVM.

Then the results are further averaged to get the EVM for the demodulation reference signal, EVM_{DMRS} ,

$$EVM_{DMRS} = \sqrt{\frac{1}{6} \sum_{j=1}^6 \overline{EVM}_{DMRS,j}^2}$$

The PRACH EVM, EVM_{PRACH} is averaged over 2 preamble sequence measurements for long preamble formats as defined in table 6.3.3.1-1 in [9] and averaged over 10 preamble sequence measurements for short preamble formats as defined in table 6.3.3.1-2 in [9].

The EVM requirements shall be tested against the maximum of the RMS average at the window W extremities of the EVM measurements:

Thus $\overline{EVM}_{PRACH,l}$ is calculated using $\Delta\tilde{t} = \Delta\tilde{t}_l$ and $\overline{EVM}_{PRACH,h}$ is calculated using $\Delta\tilde{t} = \Delta\tilde{t}_h$.

Thus we get:

$$EVM_{PRACH} = \max(\overline{EVM}_{PRACH,l}, \overline{EVM}_{PRACH,h})$$

F.7 Spectrum Flatness

The data shall be taken from FFT coded data symbols and the demodulation reference symbols of the allocated resource block.

Annex G (normative):

Difference of relative phase and power errors

G.0 General

This annex gives further information needed for understanding and implementing 6.4D.4. The following terms should be understood as follows:

- Relative phase error: refers to the phase difference between signals at different antenna ports, which should be ideally 0. It should be understood as for a slot i.e. (slot) relative phase. It is calculated based on DMRS symbols of that slot or on SRS symbols.
- Difference of relative phase error: refers to the difference between the relative phase error determined per slot and the relative phase error determined based on the SRS transmitted.

G.1 Measurement Point

Figure G.1-1 shows the measurement point for the difference of relative phase and power errors. To separate signals from the two transmitters, it is necessary for the test equipment to perform joint demodulation by inverting the 2x2 composite channel ('HGW') resulting from DUT precoding 'W' and antenna virtualization 'G' and OTA channel between DUT and test equipment 'H'.

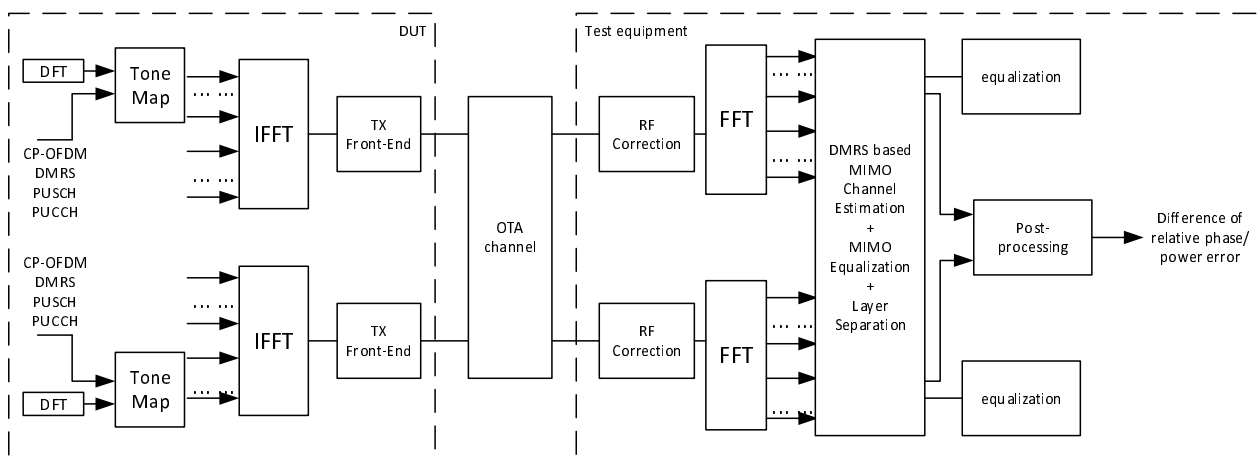

Figure G.1-1 - Measurement point for difference of relative phase/power error for UL coherent MIMO

G.2 Relative Phase Error Measurement

Here are listed the different aspects that may lead to different interpretations.

G.2.1 Symbols used

Phase error is determined based on DMRS REs (3 DMRS symbols per slot).

G.2.2 CFO (carrier frequency offset) correction

The TE performs a CFO correction on a slot-by-slot basis using a common frequency correction at the two uplink layers.

G.2.3 Steps of the measurement method

Below are detailed the steps necessary to obtain the maximum difference of relative phase error during the 20ms time window.

- 1 Determination for each subcarrier and at each antenna port, the SRS relative phase error based on the last SRS transmitted on Ant1 and Ant2, that relative phase error serves as a reference for the calculation of the difference of relative phase error for each slot inside the 20 ms time window.

The output is the “SRS relative phase error” vector for the last SRS transmitted: $[1 \times \textit{number_of_subcarriers}]$.

- 2 Calculation for the last SRS transmitted, for each RB of the SRS relative phase errors based on the arithmetic mean of the subcarrier SRS relative phase errors determined in previous step.

The output is the “SRS relative phase error” vector for the last SRS transmitted: $[1 \times \textit{number_of_RBs}]$.

- 3 CFO correction on slot-by-slot basis using a common frequency correction for both antenna ports.

- 4 Determination for each subcarrier and at each antenna port, the phase over the slot being analyzed. The phase is extracted from the channel estimate derived from the 3 DMRS symbols of the slot using the LSE technique.

The output is one vector of dimension $[1 \times \textit{number_of_subcarriers}]$ for each antenna port.

- 5 Calculation for a slot for each subcarrier of the relative phase error (difference between the vectors determined in the previous step).

The output is subcarrier relative phase errors of a slot: $[1 \times \textit{number_of_subcarriers}]$.

- 6 Calculation for a slot, for each RB of the relative phase errors based on the arithmetic mean of the subcarrier relative phase errors determined in previous step.

The output is a “slot relative phase error” vector for a slot: $[1 \times \textit{number_of_RBs}]$.

- 7 Calculation for a slot of the difference of relative phase errors based on the “SRS relative phase error” (reference) determined in step 2 and the “slot relative phase error” determined in previous step.

The output is a “difference of relative phase error” vector for a slot: $[1 \times \textit{number_of_RBs}]$.

- 8 Calculation for a slot of the arithmetic mean value of the “difference of relative phase error” vector determined in previous step, this value corresponds to an RB.

The output is a “difference of relative phase error” value for a slot: $[1 \times 1]$.

- 9 Perform for each slot of the 20ms time window, steps 3 to 8.

The output is a “difference of relative phase error” vector: $[1 \times \textit{number_of_slots}]$.

- 10 Calculation of the maximum value of the “difference of relative phase error”.

The output is the “difference of relative phase error” that should be verified as complying with the 40° maximum allowable difference of relative phase error requirement: $[1 \times 1]$.

Annex H (Normative): Modified MPR behavior

H.1 Indication of modified MPR behavior

This annex contains the definitions of the bits in the field *modifiedMPR-Behavior* indicated per supported NR band in the IE *RF-Parameters* [13] by a UE supporting an MPR or A-MPR modified in a given version of this specification. A modified MPR or A-MPR behaviour can apply to a supported NR band in stand-alone operation (including CA and NN-DC operation) or in non-standalone operation with the said NR band as part of an EN-DC or NE-DC band combination. Moreover, the bits in the field can explicitly indicate NS value(s) supported by a UE.

NOTE 1: In the present release, the *modifiedMPR-Behavior* is indicated [13] by an 8-bit bitmap per supported NR band.

Table H.1-1: Definitions of the bits in the field *modifiedMPRbehavior*

| NR Band | Index of field (bit number) | Definition (description of the supported functionality if indicator set to one) | Notes |
|---------|-----------------------------|---|---|
| n257 | 0 (leftmost bit) | - FR2 power class 3 MPR as defined in clause 6.2.2.3 of 38.101-2 v16.2.0 | - This bit may be set to 1 by a UE supporting n257 |
| n258 | 0 (leftmost bit) | - FR2 power class 3 MPR as defined in clause 6.2.2.3 of 38.101-2 v16.2.0 | - This bit may be set to 1 by a UE supporting n258 |
| | 1 | Void | |
| | 2 | - NS_203 as defined in clause 6.5.3.2.4 or both NS_203 and CA_NS_203 as defined in clause 6.5A.3.2.4 of 38.101-2 v15.11.0 | - This bit shall be set to 1 by a UE supporting n258 or both n258 and CA_n258 |
| n260 | 0 (leftmost bit) | - FR2 power class 3 MPR as defined in clause 6.2.2.3 of 38.101-2 v16.2.0 | - This bit may be set to 1 by a UE supporting n260 |
| n261 | 0 (leftmost bit) | - FR2 power class 3 MPR as defined in clause 6.2.2.3 of 38.101-2 v16.2.0 | - This bit may be set to 1 by a UE supporting n261 |

Annex I (informative): Void

Annex J (normative): UE coordinate system

J.1 Reference coordinate system

This annex defines the measurement coordinate system for the NR UE. The reference coordinate system as defined in IEEE Std 149 [15] is provided in Figure J.1-1 below while Figure J.1-2 shows the DUT in the default alignment, i.e., the DUT and the reference coordinate systems are aligned with $\alpha = 0^\circ$ and $\beta = 0^\circ$ and $\gamma = 0^\circ$ where α , β , and γ describe the relative angles between the two coordinate systems.

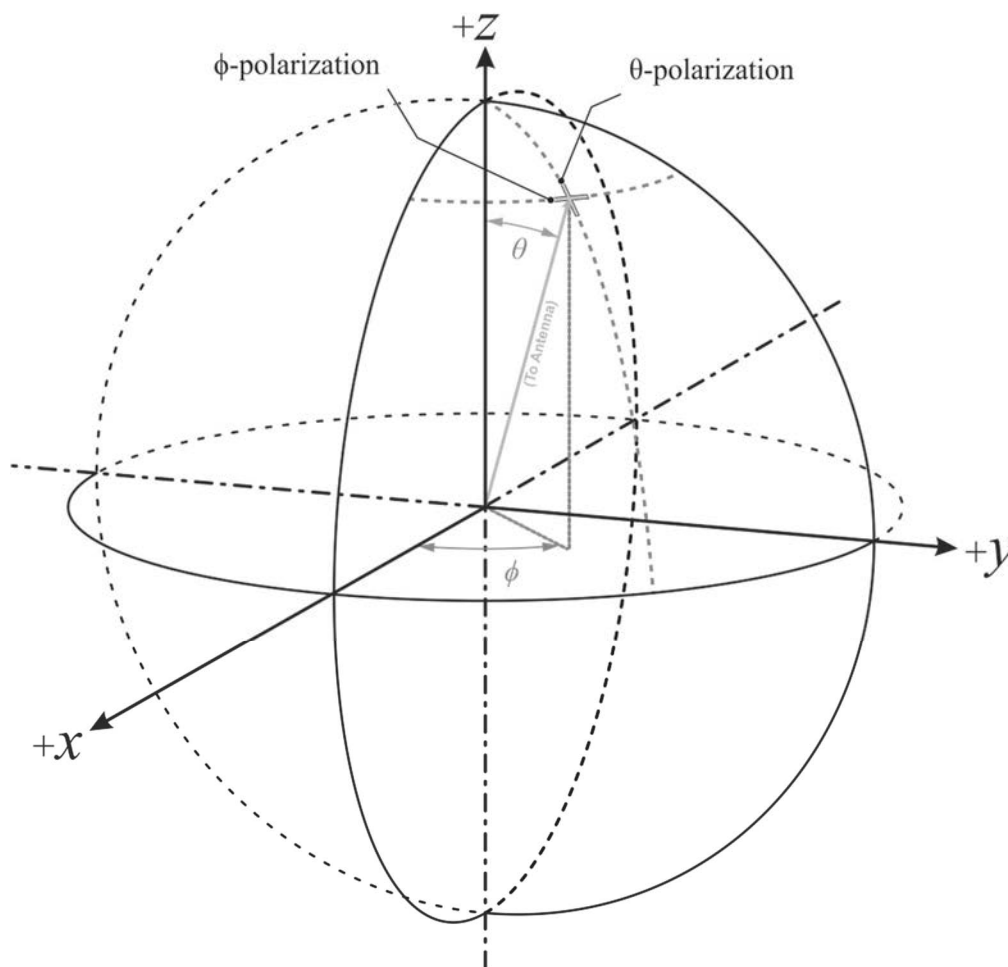

Figure J.1-1: Reference coordinate system

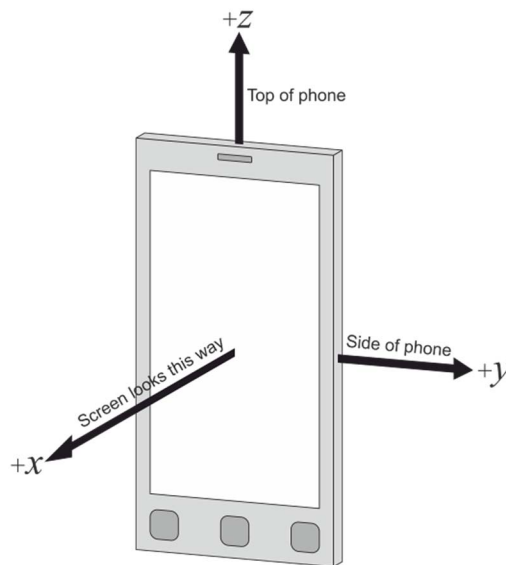

Figure J.1-2: DUT default alignment to coordinate system

The following aspects are necessary:

- A basic understanding of the top and bottom of the device is needed in order to define unambiguous DUT positioning requirements for the test, e.g., in the drawings used in this annex, the three buttons are on the bottom of the device (front) and the camera is on the top of the device (back).
- An understanding of the origin and alignment the coordinate system inside the test system i.e. the directions in which the x, y, z -axes points inside the test chamber is needed in order to define unambiguous DUT orientation, DUT beam, signal, interference, and measurement angles

J.2 Test conditions and angle definitions

Tables J.2-1 through J.2-3 below provides the test conditions and angle definitions for three permitted device alignment for the default test condition, DUT orientation 1, and two different options for each permitted device alignment to re-position the device for DUT Orientation 2 as outlined in Figures J.2-1 and J.2-3.

Table J.2-1: Test conditions and angle definitions for Alignment Option 1

| Test condition | DUT orientation | Link angle | Measurement angle | Diagram |
|--|---|---|---|---------|
| Free space DUT Orientation 1 (default) | $\alpha = 0^\circ$; $\beta = 0^\circ$; $\gamma = 0^\circ$ | θ_{Link} ; ϕ_{Link} with polarization reference $Pol_{Link} = \theta$ or ϕ | θ_{Meas} ; ϕ_{Meas} with polarization reference $Pol_{Meas} = \theta$ or ϕ | |
| Free space DUT Orientation 2 – Option 1 (based on re-positioning approach) | $\alpha = 180^\circ$; $\beta = 0^\circ$; $\gamma = 0^\circ$ | θ_{Link} ; ϕ_{Link} with polarization reference $Pol_{Link} = \theta$ or ϕ | θ_{Meas} ; ϕ_{Meas} with polarization reference $Pol_{Meas} = \theta$ or ϕ | |
| Free space DUT Orientation 2 – Option 2 (based on re-positioning approach) | $\alpha = 0^\circ$; $\beta = 180^\circ$; $\gamma = 0^\circ$ | θ_{Link} ; ϕ_{Link} with polarization reference $Pol_{Link} = \theta$ or ϕ | θ_{Meas} ; ϕ_{Meas} with polarization reference $Pol_{Meas} = \theta$ or ϕ | |

NOTE 1: A polarization reference, as defined in relation to the reference coordinate system in J.1-1, is maintained for each signal angle, link or interferer angle, and measurement angle.
NOTE 2: The combination of rotations is captured by matrix $M=R_z(\gamma)\cdot R_y(\beta)\cdot R_x(\alpha)$

Table J.2-2: Test conditions and angle definitions for Alignment Option 2

| Test condition | DUT orientation | Link angle | Measurement angle | Diagram |
|--|--|---|---|---------|
| Free space DUT Orientation 1 (default) | $\alpha = 0^\circ$; $\beta = -90^\circ$; $\gamma = 0^\circ$ | θ_{Link} ; ϕ_{Link} with polarization reference $\text{Pol}_{\text{Link}} = \theta$ or ϕ | θ_{Meas} ; ϕ_{Meas} with polarization reference $\text{Pol}_{\text{Meas}} = \theta$ or ϕ | |
| Free space DUT Orientation 2 – Option 1 (based on re-positioning approach) | $\alpha = 180^\circ$; $\beta = 90^\circ$; $\gamma = 0^\circ$ | θ_{Link} ; ϕ_{Link} with polarization reference $\text{Pol}_{\text{Link}} = \theta$ or ϕ | θ_{Meas} ; ϕ_{Meas} with polarization reference $\text{Pol}_{\text{Meas}} = \theta$ or ϕ | |
| Free space DUT Orientation 2 – Option 2 (based on re-positioning approach) | $\alpha = 0^\circ$; $\beta = 90^\circ$; $\gamma = 0^\circ$ | θ_{Link} ; ϕ_{Link} with polarization reference $\text{Pol}_{\text{Link}} = \theta$ or ϕ | θ_{Meas} ; ϕ_{Meas} with polarization reference $\text{Pol}_{\text{Meas}} = \theta$ or ϕ | |
| <p>NOTE 1: A polarization reference, as defined in relation to the reference coordinate system in J.1-1, is maintained for each signal angle, link or interferer angle, and measurement angle.</p> <p>NOTE 2: The combination of rotations is captured by matrix $M=R_z(\gamma)\cdot R_y(\beta)\cdot R_x(\alpha)$</p> | | | | |

Table J.2-3: Test conditions and angle definitions for Alignment Option 3

| Test condition | DUT orientation | Link angle | Measurement angle | Diagram |
|--|--|---|---|---------|
| Free space DUT Orientation 1 (default) | $\alpha = 90^\circ;$ $\beta = 0^\circ;$ $\gamma = 0^\circ$ | $\theta_{Link};$ ϕ_{Link} with polarization reference $Pol_{Link} = \theta$ or ϕ | $\theta_{Meas};$ ϕ_{Meas} with polarization reference $Pol_{Meas} = \theta$ or ϕ | |
| Free space DUT Orientation 2 – Option 1 (based on re-positioning approach) | $\alpha = -90^\circ;$ $\beta = 0^\circ;$ $\gamma = 0^\circ$ | $\theta_{Link};$ ϕ_{Link} with polarization reference $Pol_{Link} = \theta$ or ϕ | $\theta_{Meas};$ ϕ_{Meas} with polarization reference $Pol_{Meas} = \theta$ or ϕ | |
| Free space DUT Orientation 2 – Option 2 (based on re-positioning approach) | $\alpha = 90^\circ;$ $\beta = 180^\circ;$ $\gamma = 0^\circ$ | $\theta_{Link};$ ϕ_{Link} with polarization reference $Pol_{Link} = \theta$ or ϕ | $\theta_{Meas};$ ϕ_{Meas} with polarization reference $Pol_{Meas} = \theta$ or ϕ | |

NOTE 1: A polarization reference, as defined in relation to the reference coordinate system in J.1-1, is maintained for each signal angle, link or interferer angle, and measurement angle.
NOTE 2: The combination of rotations is captured by matrix $M=R_z(\gamma) \cdot R_y(\beta) \cdot R_x(\alpha)$

For each UE requirement and test case, each of the parameters in Table J.2-1 through J.2-3 need to be recorded, such that DUT positioning, DUT beam direction, and angles of the signal, link/interferer, and measurement are specified in terms of the fixed coordinate system.

Due to the non-commutative nature of rotations, the order of rotations is important and needs to be defined when multiple DUT orientations are tested.

The rotations around the x, y, and z axes can be defined with the following rotation matrices

$$R_x(\alpha) = \begin{bmatrix} 1 & 0 & 0 & 0 \\ 0 & \cos \alpha & -\sin \alpha & 0 \\ 0 & \sin \alpha & \cos \alpha & 0 \\ 0 & 0 & 0 & 1 \end{bmatrix}$$

$$R_y(\beta) = \begin{bmatrix} \cos \beta & 0 & \sin \beta & 0 \\ 0 & 1 & 0 & 0 \\ -\sin \beta & 0 & \cos \beta & 0 \\ 0 & 0 & 0 & 1 \end{bmatrix}$$

and

$$R_z(\gamma) = \begin{bmatrix} \cos \gamma & -\sin \gamma & 0 & 0 \\ \sin \gamma & \cos \gamma & 0 & 0 \\ 0 & 0 & 1 & 0 \\ 0 & 0 & 0 & 1 \end{bmatrix}$$

with the respective angles of rotation, α , β , γ , and

$$\begin{bmatrix} x' \\ y' \\ z' \\ 1 \end{bmatrix} = R \begin{bmatrix} x \\ y \\ z \\ 1 \end{bmatrix}$$

Additionally, any translation of the DUT can be defined with the translation matrix

$$T(t_x, t_y, t_z) = \begin{bmatrix} 1 & 0 & 0 & t_x \\ 0 & 1 & 0 & t_y \\ 0 & 0 & 1 & t_z \\ 0 & 0 & 0 & 1 \end{bmatrix}$$

with offsets t_x , t_y , t_z in x, y, and z, respectively and with

$$\begin{bmatrix} x' \\ y' \\ z' \\ 1 \end{bmatrix} = T \begin{bmatrix} x \\ y \\ z \\ 1 \end{bmatrix}$$

The combination of rotations and translation is captured by the multiplication of rotation and translation matrices.

For instance, the matrix M

$$M = T(t_x, t_y, t_z) \cdot R_z(\gamma) \cdot R_y(\beta) \cdot R_x(\alpha)$$

describes an initial rotation of the DUT around the x axis with angle α , a subsequent rotation around the y axis with angle β , and a final rotation around the z axis with angle γ . After those rotations, the DUT is translated by t_x , t_y , t_z in x, y, and z, respectively.

J.3 DUT positioning guidelines

The centre of the reference coordinate system shall be aligned with the geometric centre of the DUT in order to minimize the offset between antenna arrays integrated at any position of the UE and the centre of the quiet zone.

Near-field coupling effects between the antenna and the pedestals/positioners/fixtures generally cause increased signal ripples. Re-positioning the DUT by directing the beam peak away from those areas can reduce the effect of signal ripple on EIRP/EIS measurements. Figure J.3-1 and J.3-2 illustrate how to reposition the DUT in distributed axes and combined axes system, when the beam peak is directed to the DUTs upper hemisphere (DUT orientation 1) or the DUTs lower hemisphere (DUT orientation 2). While these figures are examples of different positioning systems and other implementations are not precluded, the relative orientation of the coordinate system with respect to the antennas/reflectors and the axes of rotation shall apply to any measurement setup.

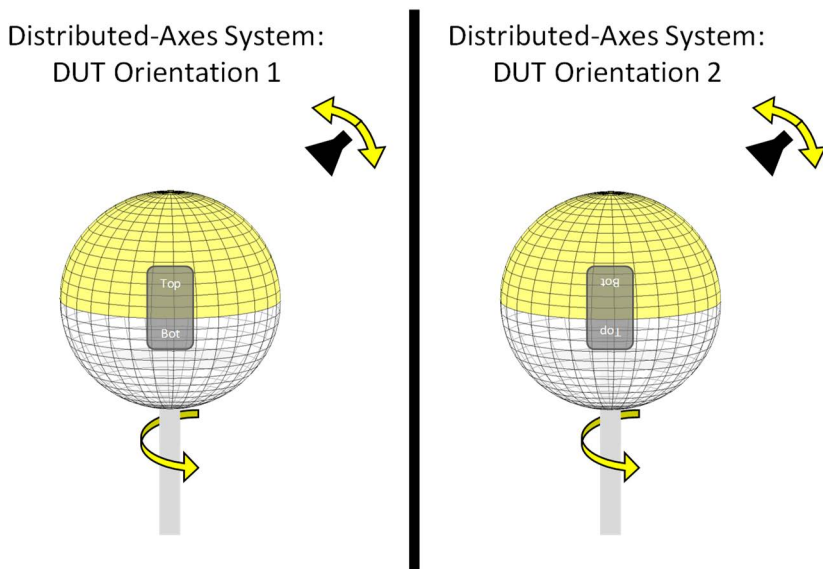

Figure J.3-1: DUT re-positioning for an example of distributed-axes system

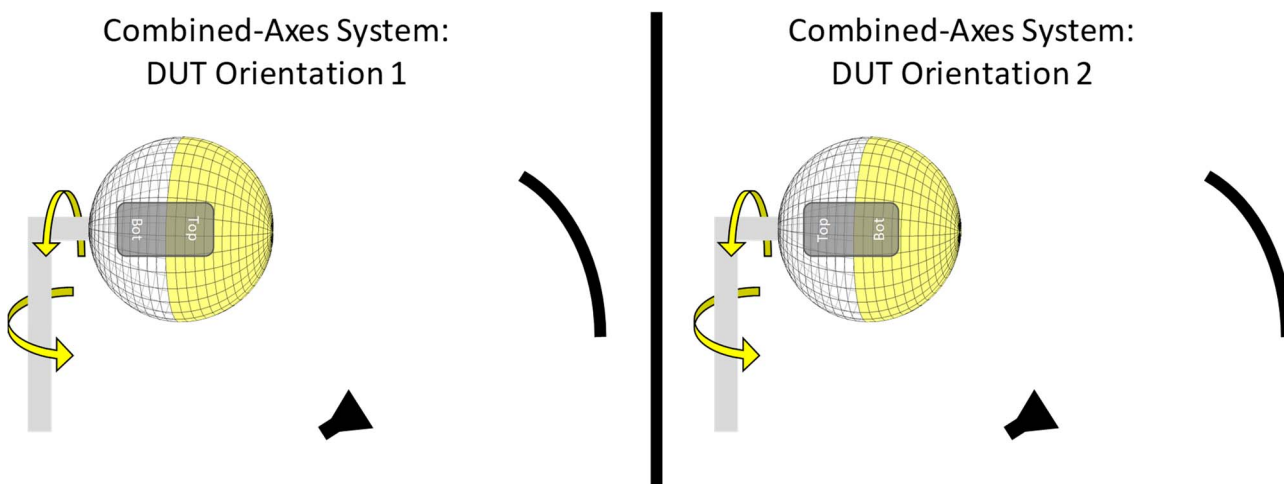

Figure J.3-2: DUT re-positioning for an example of combined-axes system

For EIRP/EIS measurements, re-positioning the DUT makes sure the pedestal is not obstructing the beam path and that the pedestal is not in closer proximity to the measurement antenna/reflector than the DUT. For TRP measurements, re-positioning the DUT makes sure that the beam peak direction is not obstructed by the pedestal and the pedestal is in the measurement path only when measuring the back-hemisphere. No re-positioning during the TRP measurement is required.

Annex K (informative): Void

Annex L (informative): Change history

| Change history | | | | | | | |
|----------------|-------------|------------|------|-----|-----|---|-------------|
| Date | Meeting | TDoc | CR | Rev | Cat | Subject/Comment | New version |
| 2017-08 | RAN4#84 | | | | | Initial Skeleton | 0.0.1 |
| 2017-10 | RAN4#84 Bis | R4-1711979 | | | | TPs from R4#84Bis by editors | 0.1.0 |
| 2017-12 | RAN4#85 | R4-1713806 | | | | <p>Approved TPs from R4#85</p> <p>R4-1714537, TP for TS 38.101-2: Channel Bandwidth Definition, Qualcomm Incorporated</p> <p>R4-1714115, TP for TS 38.101-2: Channel Arrangement, : Qualcomm Incorporated (Note: this TP was further discussed and edited in the reflector)</p> <p>R4-1713205, TP on general parts for 38.101-2 NR FR, : Ericsson</p> <p>R4-1712884, TP to TS38.101-2 on environmental conditions, Intel Corporation</p> <p>R4-1714018, TP to TS 38.101-2 for definition of UE RF terminologies, Anritsu Corporation</p> <p>R4-1714447, TP on UE power class for FR2, Intel Corporation</p> <p>R4-1714372, TP to TS38.101-2 on EVM equalizer spectrum flatness requirements, Intel Corporation</p> <p>R4-1714330, TP to TR 38.101-02 v0.1.0: ON/OFF mask design for NR UE transmissions for FR2, Ericsson</p> <p>R4-1714364, TP to TR 38.101: NR UE transmit OFF power for FR2, CATT</p> <p>R4-1714347, TP to TS38.101-2 on spurious emissions requirements for FR2, Intel Corporation (Note: this TP was further discussed and edited in the reflector)</p> <p>R4-1714456, TP on REFSENS for FR2, Intel Corporation</p> <p>R4-1714337 TP to TS 38.101-2 ACS requirement for mmW (section 7.5), Qualcomm Incorporated</p> <p>R4-1714338, TP to TS 38.101-2 IBB requirement for mmW (section 7.6.1), Qualcomm Incorporated</p> <p>R4-1714348, TP to TS38.101-2 on Rx spurious emissions for FR2, Intel Corporation</p> <p>Min power for EVM requirement according to R4-1711568, TP to TR 38.xxx - UE minimum transmit power for range 2, CATT</p> <p>Band list according to R4-1714542, List of bands and band combinations to be introduced into RAN4 NR core requirements by December 2017, RAN4 Chairmen</p> | 0.2.0 |
| 2017-12 | RAN4#85 | R4-1714570 | | | | Further corrections and alignments with 38.104 after email review | 0.3.0 |
| 2017-12 | RAN#78 | RP-172476 | | | | v1.0.0 submitted for plenary approval. Contents same as 0.3.0 | 1.0.0 |
| 2017-12 | RAN#78 | | | | | Approved by plenary – Rel-15 spec under change control | 15.0.0 |
| 2018-03 | RAN#79 | RP-180264 | 0004 | | F | <p>Implementation of endorsed CR on to 38.101-2</p> <p>Endorsed draft CRs in RAN4-NR-AH#1801</p> <p>F: R4-1800918, Draft CR to 38.101-2 on channel bandwidth corrections (5.3.5), Nokia</p> <p>F: R4-1801097, Modification for TS38.101-2, CATT</p> <p>F: R4-1801098 Draft CR for TS38.101-2: On requirement metrics. Sumitomo Elec. Industries, Ltd</p> <p>F: R4-1800401, Editorial corections to 38.101-2, Qualcomm</p> <p>F: R4-1801122: Draft pCR for TS 38.101-2 version 15.0.0: Remaining ON/OFF masks for FR2 NR UE transmissions, Ericsson</p> <p>F: R4-1800418, Correction of NR SEM for FR2 table, vivo</p> <p>F: R4-1800316 Draft CR to 38.101-2: Tx spurious emission for NR FR2 (section 6.5.3), ZTE Corporation</p> <p>F: R4-1800918 Draft CR to 38.101-2 on channel bandwidth corrections (5.3.5), Nokia</p> <p>F: R4-1801013, Draft CR to 38.101-2: Clarifications to UE spectrum utilization section 5.3, Ericsson</p> <p>F: R4-1801229, Draft CR to 38.101-2: Channel spacing for CA for NR FR2(section 5.4.1.2), ZTE Corporation</p> <p>F: R4-1801232, Correction CR for channel spacing:38.101-2, Samsung</p> | 15.1.0 |

| | | | | | | |
|---------|--------|-----------|------|---|---|--------|
| | | | | | <p>F: R4-1801325, Draft CR to TS 38.101-2: Corrections on channel raster calculation in section 5.4.2, ZTE Corporation F: R4-1800860, Corrections of GSCN, Nokia</p> <p>Endorsed draft CRs in RAN4#86</p> <p>R4-1803054, Draft CR for new spec structure of 38.101-2, Ericsson R4-1801446, Modification for NR UE time mask requirement for FR2, CATT R4-1801729, Draft CR to 38.101-2: Corrections to In-band blocking requirements, Rohde & Schwarz R4-1801967, CR on EVM spectrum flatness for FR2, Huawei R4-1802339, Draft CR to 38.101-2: Clarifications on peak directions and REFSENS, ROHDE & SCHWARZ R4-1802567, Draft CR to TS 38.101-2: Clarification of mixed numerology guardband size, Ericsson R4-1803238, Draft CR for TS 38.101-2: ACLR requirement clarification, Huawei R4-1803365, Draft CR to 38.101-2: Clarification on REFSENS Definition, ROHDE & SCHWARZ R4-1803453, draft CR for introduction of completed band combinations from 37.865-01-01 into 38.101-2, Ericsson R4-1803566, Draft CR for TS 38.101-2: Sync raster offset in re-farming bands (5.4.3), Ericsson</p> | |
| 2018-06 | RAN#80 | RP-181262 | 0010 | F | <p>CR to TS 38.101-2: Implementation of endorsed draft CRs from RAN4 #86bis and RAN4 #87</p> <p>Endorsed draft CRs from RAN4#86Bis</p> <p>R4-1803736, Draft CR on channel raster entry of band n258 for TS 38.101-2, ZTE Wistron Telecom AB R4-1804022, CR for modifications and clarifications for NR FR2 CA BW Classes, Nokia R4-1804585, Draft CR to 38.101-2: IBE Section Update, Qualcomm, Inc. R4-1804657, Introduction of UE to UE coexistence requirements requirements for FR2, Qualcomm Incorporated R4-1804949, Corrections to 5.3.3 in TS 38.101-2, Nokia R4-1805641, Corrections of BCS for n257 intraband contiguous CA in 38.101-2, Nokia R4-1805685, Draft CR to TS38.101-2: Channel Raster to Resource Element Mapping (Section 5.4.2.2) and RB alignment with different numerologies (Section 5.3.4), ZTE Corporation R4-1805704, Update of UE emission requirements for FR2, Qualcomm Incorporated R4-1805705, Draft CR to 38.101-2: Update of section 7.1, Rohde & Schwarz R4-1805757, Update of ACS requirement for FR2, Qualcomm Incorporated R4-1805771, Update of IBB requirement for FR2, Qualcomm Incorporated R4-1805775, draft CR for TS 38.101-2 on US 28 GHz band number, Qualcomm Incorporated R4-1805949, Draft CR on minimum guardband of SCS 240 kHz SSB for TS 38.101-2, ZTE Wistron Telecom AB R4-1805982, draft CR for 38.101-2: sync raster, Samsung R4-1804878, draft CR introduction completed band combinations 37.865-01-01 -> 38.101-2, Ericsson R4-1803628, pi/2 BPSK related CR, IITH</p> <p>Endorsed draft CRs from RAN#87</p> <p>R4-1806167, Draft CR on channel raster entry of band n261 for TS 38.101-2, ZTE Corporation R4-1806169, Draft CR on SSB clarification for TS 38.101-2, ZTE Corporation R4-1806383, Draft CR of clarifications on TRx RF test metrics for mmWave, Anritsu Corporation R4-1806946, Draft CR for TS 38.101-2: Channel raster and NR-ARFCN clarification (5.4.2), Ericsson R4-1807652, FR2 UE ACLR requirement for CA, Qualcomm R4-1807655, Further refinements for UE Rx requirements in FR2, Qualcomm R4-1807681, Draft CR on 38.101-2 on channel raster to achieve alignment of data and SSB subcarrier grids, Nokia R4-1807853, Draft CR to TS 38.101-2: UE maximum output power for UL CA, Nokia</p> | 15.2.0 |

| | | | | | | |
|---------|--------|-----------|------|---|---|--------|
| | | | | | <p>R4-1807855, Draft CR on 38.101-2: Transmit ON/OFF time mask for UL CA, Nokia</p> <p>R4-1807857, Draft CR on 38.101-2: Occupied BW for UL CA, Nokia</p> <p>R4-1808101, Draft CR to 38.101-2: On EVM Averaging Length, Wording, Qualcomm Incorporated</p> <p>R4-1808105, Configured maximum output power for FR2, Ericsson</p> <p>R4-1808124, draft CR on UE RF requirement for UE type 2 in FR2, LG Electronics</p> <p>R4-1808125, Draft CR to TS 38.101-2: Minimum output and OFF Power, Nokia</p> <p>R4-1808147, Draft CR for NR FR2 CA BW class modifications, MediaTek Inc.</p> <p>R4-1808148, EVM equaliser spectral flatness for FR2, Ericsson</p> <p>R4-1808149, UE Shaping Filter Requirement for pi/2 BPSK, Indian Institute of Tech (M)</p> <p>R4-1808152, Draft CR for Finalizing UE RF Requirement for FWA, Samsung</p> <p>R4-1808266, Draft CR for TS 38.101-2: Channel and sync raster corrections (5.4), Ericsson</p> <p>R4-1808545, Draft CR on UE RF requirement for UE type 3 in FR2, Verizon</p> <p>R4-1808546, Power class 3 Spherical coverage introduction and peak EIRP requirement update, Qualcomm</p> <p>R4-1808206, Draft CR to 38.101-2: FR2 Type 1 UE Power Control, Qualcomm</p> <p>R4-1808208, Draft CR to 38.101-2: FR2 Type 1 UE CA EIS update, Qualcomm</p> <p>R4-1808191, TP to TS38.101-2 - UE ON/OFF masks, Ericsson</p> <p>R4-1807102, draft CR introduction completed band combinations 37.865-01-01 -> 38.101-2, Ericsson</p> | |
| 2018-09 | RAN#81 | RP-181896 | 0015 | F | <p>Big CR for 38.101-2</p> <p>Endorced draft CRs from RAN4#NR-AH-1807</p> <p>R4-1809336, Draft CR on UL RMC for FR2 RF tests, Qualcomm Incorporated</p> <p>R4-1809338, Draft CR on NR UE REFSSENS SNR FRC for FR2, Intel Corporation</p> <p>R4-1809397, Draft CR on measurement of receiver characteristics for FR2 RF Tests, Qualcomm Incorporated</p> <p>R4-1809566, Draft CR on OCNG pattern for FR2 REFSSENS test, Qualcomm Incorporated</p> <p>Endorced draft CR s from RAN4#88</p> <p>R4-1809817, TP to TS 38.101-2 on ON/OFF time mask, Intel Corporation</p> <p>R4-1809976, Draft CR for TS 38.101-2: Channel raster corrections (5.4.2), Ericsson</p> <p>R4-1810092, Draft CR TS 38.101-2 - UE ON-OFF mask clean up, Ericsson</p> <p>R4-1810211, Draft CR for TS 38.101-2: MPR inner and outer RB allocations formula correction, MediaTek Inc.</p> <p>R4-1810228, draft CR on UL-MIMO requirement for Power Class 2 in FR2, LG Electronics Inc</p> <p>R4-1810373, Draft CR to 38.101-2: Corrections on symbols and abbreviations in section 3, ZTE Corporation</p> <p>R4-1810805, Draft CR to TS 38.101-2: Spurious emissions, Nokia</p> <p>R4-1810863, Draft CR to 38.101-2: Addition of Transmit Modulation Annex, Rohde & Schwarz</p> <p>R4-1811026, Draft CR to 38.101-2: FR2 UE CA Transmit Signal Quality update, Qualcomm Incorporated</p> <p>R4-1811104, Finalization of SEM requirements in FR2, Qualcomm Incorporated</p> <p>R4-1811140, FR2 ULMIMO Updates and enhancements, Qualcomm Incorporated</p> <p>R4-1811322, Draft CR to 38.101-2: REFSSENS of power class 1, Intel Corporation</p> <p>R4-1811456, Draft CR on DL Physical Channel for FR2 RF tests, Qualcomm Inc</p> <p>R4-1811460, Draft CR to 38.101-2: Correct both Table 5.5A.2-1 and Table 5.5A.2-2, Verizon</p> <p>R4-1811489, Draft CR to 38.101-2: FR2 Power Control, Qualcomm Incorporated</p> <p>R4-1811499, Implementation of additional requirement to protect passive EESS in 23.6-24GHz, Qualcomm Incorporated</p> <p>R4-1811515, Draft CR to TS 38.101-2: Clarification on OCNG, Keysight Technologies UK Ltd</p> | 15.3.0 |

| | | | | | | |
|---------|--------|-----------|------|---|---|--------|
| | | | | | <p>R4-1811517, Draft CR on NR DL FRCs for FR2 UE RF requirements, Intel Corporation R4-1811519, Draft CR to 38.101-2: On FR2 MPR for single CC PC1 and PC3, Qualcomm R4-1811520, Draft CR to 38.101-2: FR2 Max. Input Power, Qualcomm Incorporated R4-1811524, Clarification of UL MIMO for FR2, OPPO R4-1811551, Draft CR to TS 38.101-2 on channel bandwidth and spacing descriptions, Ericsson R4-1811554, Draft CR to 38.101-2: Corrections on description of channel raster entries, ZTE Corporation R4-1811802, Draft CR to TS 38.101-2 update the P_{max} tolerance table for configured transmitted power, Intel Corporation R4-1811807, Draft CR to 38.101-2: FR2 UE Transmit Signal Quality update, Qualcomm Incorporated R4-1811813, Correction on UE transmitter requirement for FR2, CATT R4-1811817, Updated ON/OFF mask for FR2, vivo R4-1811800, DRAFT CR for P_{max} FR2 correction, Qualcomm Incorporated</p> | |
| 2018-12 | RAN#82 | RP-182899 | 0016 | 2 | <p>F</p> <p>Endorsed draft CR s from RAN4#88Bis: R4-1812122, Draft CR for FR2 ACLR Measurement BW, Qualcomm R4-1812134, CR on Out of Band Blocking for FR2, Intel Corporation R4-1812426, draft CR of MPR for Power Class 2 in FR2, LG Electronics R4-1812428, draft CR of transmit signal quality for Power Class 2 in FR2, LG Electronics R4-1812453, Draft CR to TS 38.101-2 Adjust placement of 0dB MPR reference waveform, Intel Corporation R4-1812495, Draft CR to 38.101-2: Corrections on channel raster & SS raster, ZTE Corporation R4-1813470, draftCR on applicability of TDD configuratiin for CA in TS 38.101-2, Huawei R4-1813472, draftCR on CA spectrum Emission for TS 38.101-2, Huawei R4-1813473, draftCR on coherent UL MIMO for TS 38.101-2, Huawei R4-1813527, Correction to FR2 spurious emission requirement, Nokia R4-1813585, Draft CR to Specify UL Power for FR2 REFSSENS Test Cases, Keysight R4-1813815, Draft CR to 38.101-2: Corrections on configurations for intra-band non-contiguous CA, ZTE Corporation R4-1814149, Changes to FR2 UL MIMO, OPPO R4-1814180, Draft CR to TS 38.101-2 on channel arrangement descriptions, LG Electronics Inc. R4-1814181, Draft CR to 38.101-2: Corrections on the descriptions of UE channel bandwidth for CA, ZTE Corporation R4-1814163, draft CR of operating band for Power Class 2 in FR2, LG Electronics R4-1813834, Draft CR to 38.101-2: Update of Annex F, Rohde & Schwarz R4-1814164, draftCR on MPR for TS 38.101-2, Huawei R4-1814165, Draft CR to 38.101-2: FR2 Power Control for CA, Qualcomm Incorporated R4-1814170, Draft CR to 38.101-2: FR2 UL Config for EIS Testing, Qualcomm Incorporated</p> <p>Endorsed draft CR's from RAN4#89 R4-1815951, dCR on TS38.101-2 merging draft CRs from RAN4#89, Qualcomm Incorporated R4-1814497, Correction on UL MIMO requirement for PC1 UE, Samsung R4-1814585, Draft CR to TS 38.101-2 UL CA power control in FR2, Intel Corporation R4-1814698, Draft CR to TS38.101-2 updating references, Apple Inc. R4-1815623, Draft CR to 38.101-2: FR2 Max. Input Power UL Configuration, Qualcomm Incorporated R4-1815801, draft CR editorial correction in 38.101-2, Ericsson R4-1815810, draft Rel-15 CR to 38.101-2 to include n260 fallbacks needed, Ericsson R4-1815942, dCR on P-MPR for FR2, Qualcomm Incorporated R4-1815943, dCD Coherent UL MIMO parameters for FR2, Qualcomm Incorporated R4-1816205, Draft CR to TS38.101-2 correcting the P_{max} requirement, Apple Inc.</p> | 15.4.0 |

| | | | | | | |
|---------|--------|-----------|------|---|--|--------|
| | | | | | <p>R4-1816206, draft CR on P_{max} for ULCA and limitation on max aggregated ULCA BW, Qualcomm Incorporated</p> <p>R4-1816217, Draft CR to 38.101-2 on UE maximum output power with additional requirements, ZTE Corporation</p> <p>R4-1816218, Draft CR for Introducing missing requirement for power class 4 in FR2 for TS 38.101-2, NTT DOCOMO, INC.</p> <p>R4-1816219, draft CR of MPR for Power Class 2 in FR2, LG Electronics</p> <p>R4-1816220, Draft CR to 38.101-2: On FR2 CA MPR v2, Qualcomm Incorporated</p> <p>R4-1816239, Draft CR to 38.101-2: On FR2 EESS A-MPR for n258, Qualcomm Incorporated</p> <p>R4-1816245, Draft CR to 38.101-2: FR2 EIS DL Signal Polarization Clarification, Qualcomm Incorporated</p> <p>R4-1816257, Draft CR to TS38.101-2 to correct UL CA scope for FR2 in Rel-15, Apple Inc.</p> <p>R4-1816605, TDD configuration for UE Tx test in FR2, Ericsson</p> <p>R4-1816664, Draft CR to 38.101-2 (5.3.4) RB alignment, Huawei</p> <p>R4-1816751, Draft CR for RF exposure compliance in TS38.101-2, LG Electronics France</p> <p>R4-1816626, Draft CR to TS 38.101-2: Introducing multi-band applicability for PC3, Apple Inc.</p> <p>R4-1816634, Draft CR to 38.101-2: FR2 EIS Spherical Coverage Requirement, Qualcomm Incorporated</p> <p>R4-1816639, Verification of beam correspondence, Ericsson, Sony</p> <p>R4-1816633, draft CR on UE type for Power Class 2 in FR2, LG Electronics</p> <p>R4-1816644, Draft CR to TS 38.101-2: Temperature Condition for testing EIRP Spherical Coverage requirement, Apple Inc.</p> | |
| 2019-03 | RAN#83 | RP-190747 | 0018 | 1 | <p>F</p> <p>CR to TS 38.101-2: Implementation of endorsed draft CRs from RAN4#90 plus PC3 MPR changes to accommodate FR2 OBW</p> <p>Endorced draft CRs from RAN4#90</p> <p>R4-1900049, Draft CR on UL RMC for FR2 UE RF Tests, Qualcomm Incorporated</p> <p>R4-1900050, Draft CR on DL RMC for FR2 UE RF Tests, Qualcomm Incorporated</p> <p>R4-1900131, draft CR to 38101-2 Correction to EVM equalizer spectrum flatness for Pi2 BPSK, Intel Corporation</p> <p>R4-1900132, draft CR to 38101-2 FR2 transmit modulation quality for CA, Intel Corporation</p> <p>R4-1900254, Draft CR on clarification of maxUplinkDutyCycle in FR2, OPPO</p> <p>R4-1900301, Draft CR: Introduction of Annex on Characteristics of the Interfering Signal, Samsung</p> <p>R4-1900386, CR to 38.101-2 on CA BW Classes fallback groups, Intel Corporation</p> <p>R4-1900443, CR to chance Annex E2.1, Qualcomm Incorporated</p> <p>R4-1900509, Draft CR to TS 38.101-2 on BCS definition for intra-band non-contiguous CA, ZTE Corporation</p> <p>R4-1900531, draft CR on A-MPR for power class 2 in FR2, LG Electronics</p> <p>R4-1900533, draft CR on maximum output power reduction for CA for power class 2 in FR2, LG Electronics</p> <p>R4-1900535, draft CR on A-MPR for CA for power class 2 in FR2, LG Electronics</p> <p>R4-1900542, Draft CR on Measurement period of PRACH time mask, Qualcomm Incorporated</p> <p>R4-1900677, Draft CR to 38.101-2: FR2 ULMIMO max. output power, Qualcomm Incorporated</p> <p>R4-1900674, Draft CR to 38.101-2: UL config for DL NC CA, Qualcomm Incorporated</p> <p>R4-1900678, Draft CR to 38.101-2: EVM Requirement for PRACH, Qualcomm Incorporated</p> <p>R4-1900679, Draft CR to 38.101-2: IBB requirement update, Qualcomm Incorporated</p> <p>R4-1900680, Draft CR to 38.101-2: Complete P_{min} requirement for CA, Qualcomm Incorporated</p> <p>R4-1900728, Update to PRACH EVM window length for FR2, Rohde & Schwarz</p> <p>R4-1900736, Draft CR on editorial error of TS38.101-2, LG Electronics Inc.</p> <p>R4-1900755, Draft CR on spurious emission limit in 38.101-2, Qualcomm Incorporated</p> <p>R4-1902005, Draft CR to 38.101-2: Add annex for UE coordinate system, Qualcomm Incorporated</p> | 15.5.0 |

| | | | | | | |
|---------|--------|-----------|------|---|---|--------|
| | | | | | <p>R4-1902152, Editorial corrections for 38.101-2, Qualcomm Incorporated</p> <p>R4-1902180, Draft CR to 38.101-2: correction of the relationship between minimum requirements and test requirements, Apple Inc.</p> <p>R4-1902345, draft_CR TS 38.101-2 FR1 frequency range extension, Skyworks Solutions Inc.</p> <p>R4-1902474, Draft CR to 38.101-2: correction of multi-band aspects in REFSSENS for PC3, Apple Inc.</p> <p>R4-1902490, draftCR on maximum output power for TS 38.101-2, Huawei</p> <p>R4-1902491, Draft CR for Multi-band relaxation to TS 38.101-2, NTT DOCOMO, INC.</p> <p>R4-1902492, Draft CR on max input power in FR2, OPPO</p> <p>R4-1902590, Draft CR to TS 38.101-2: Introduction of the requirement on beam correspondence, Apple Inc</p> <p>Further changes in RAN#83: Changes in Section 6.2.2.0 to modify the MPR=0dB waveform and Section 6.2.2.3 to modify the MPR tables to accommodate the OBW requirements</p> | |
| 2019-06 | RAN#84 | RP-191240 | 0021 | F | <p>CR to TS 38.101-2: Implementation of endorsed draft CRs from RAN4#90bis and RAN4#91</p> <p>Endorsed draft CRs from RAN4#90Bis:</p> <p>R4-1902932: Draft CR to TS 38.101-2 Correction to P_{cm}, Intel Corporation</p> <p>R4-1902976 Draft CR on PRACH and PUCCH format description for EVM in FR2Anritsu corporation</p> <p>R4-1903121 Draft CR on DL power allocation for TS 38.101-2 Intel Corporation</p> <p>R4-1903242 Adding BCS definition in TS38.101-2 CATT</p> <p>R4-1903474 draft CR of in-band emission for FR2 PC2 LG Electronics</p> <p>R4-1903888 Draft CR: Alignment of FR2 DL scheduling of DL RMC with UL RMC Ericsson</p> <p>R4-1904001 Draft CR for TS 38.101-2 – UE coordinate system Rohde & Schwarz</p> <p>R4-1904411 draft Rel-15 CR for editorial corrections in 38.101-2 Ericsson</p> <p>R4-1904553 Draft CR to 38.101-2: FR2 power dynamics DTX removal Qualcomm Incorporated</p> <p>R4-1904930 Draft CR to 38.101-2: Updating MPR wording in ULMIMO section Qualcomm Incorporated</p> <p>R4-1904931 Draft CR to clarify frequency of carrier leakage in RBs for FR2 Anritsu corporation</p> <p>R4-1904932 Draft CR on editorial error of TS38.101-2 LG Electronics France</p> <p>R4-1904933 Draft CR on UE optional bandwidth for FR2 Huawei, HiSilicon</p> <p>R4-1904956 Draft CR for TS 38.101-2: Corrections to configurations for intra-band non-contiguous CA MediaTek Inc.</p> <p>R4-1904961 Draft CR for TR38.101-2 – Update to EVM averaging Rohde & Schwarz</p> <p>R4-1904962 Draft CR to 38.101-2: FR2 ULMIMO EVM Qualcomm Incorporated</p> <p>R4-1904966 Draft CR to TS 38.101-2 CA maximum input level Intel Corporation</p> <p>R4-1904986 Draft CR for TS 38.101-2: Corrections to EVM equalizer spectrum flatness requirements MediaTek Inc.</p> <p>R4-1904994 draft CR to 38.101-2 Correction to ACS and In-band Blocking notes Intel Corporation</p> <p>R4-1905003 Draft CR to 38.101-2: FR2 PC3 and PC1 MPR Qualcomm Incorporated</p> <p>R4-1905005 Draft CR for 38.101-2 frequency separation class Huawei, HiSilicon</p> <p>Endorsed draft CRs from RAN4#91:</p> <p>R4-1905504 Change description 4.2(d) in Applicability of minimum requirements for TS 38.101-2 vivo</p> <p>R4-1905685 Draft CR to 38.101-2: FR2 Sensitivity Qualcomm Incorporated</p> <p>R4-1905764 draft CR to 38.101-2 UE maximum output power reduction for UL-MIMO Intel Corporation</p> <p>R4-1905765 draft CR to 38.101-2 UE maximum output power for UL-MIMO Intel Corporation</p> | 15.6.0 |

| | | | | | | | |
|---------|--------|-----------|------|---|---|--|--------|
| | | | | | | <p>R4-1905796 Correction to a description of PRB for in-band emission in FR2 Anritsu Corporation</p> <p>R4-1905798 Correction to power control in FR2 Anritsu Corporation</p> <p>R4-1905821 draft CR of loosening EIS for FR2 PC2 LG Electronics Inc.</p> <p>R4-1907003 Draft CR for editorial corrections in TS 38.101-2 Google Inc.</p> <p>R4-1907420 draft CR of simple application for FR2 PC2 and 4 requirements with PC3 same requirements LG Electronics Inc.</p> <p>R4-1907423 Draft CR for TS 38.101-2 Correction of channel bandwidth set for NR CA Huawei, HiSilicon, CMCC</p> <p>R4-1907437 Draft CR to 38.101-2: Insert definitions Qualcomm Incorporated</p> <p>R4-1907443 Draft CR to TS38.101-2 Complete FR2 MPR/A-MPR Intel Corporation</p> <p>R4-1907444 Amendment of the relative power tolerance requirement Ericsson, Qualcomm Incorporated</p> <p>R4-1907446 Draft CR to 38.101-2: FR2 CA REFESNS Qualcomm Incorporated</p> <p>R4-1907447 Draft CR to 38.101-2 on UL RMC slot patterns Apple Inc.</p> <p>R4-1907466 Draft CR to 38.101-2: FR2 CA MPR enhancement Qualcomm Incorporated</p> <p>R4-1907468 Draft CR to 38.101-2: FR2 MPR Wording CleanUp Qualcomm Incorporated</p> <p>R4-1907473 Draft CR to TS38.101-2 on FR2 PC3 UE maxUplinkDutyCycle Nokia, Nokia Shanghai Bell</p> <p>R4-1907478 Draft CR to TS 38.101-2 on configurations for intra-band contiguous CA ZTE Corporation</p> <p>R4-1907493 Correction to P_{max} and P_{max} for CA Ericsson</p> <p>R4-1907611 Draft CR to TS38.101-2 on beam correspondence Samsung, Apple, Verizon</p> <p>R4-1907688 Correction to CA carrier spacing Ericsson</p> | |
| 2019-06 | RAN#84 | RP-191241 | 0020 | | B | CR to REL-16 TS 38.101-2: Implementation of endorsed draft CRs on NR combinations and dual Connectivity combinations | 16.0.0 |
| 2019-06 | RAN#84 | RP-191241 | 0022 | 1 | B | CR introduction completed band combinations 38.716-01-01 -> 38.101-2 | 16.0.0 |
| 2019-09 | RAN#85 | RP-192049 | 0028 | | A | <p>CR to TS 38.101-2: Implementation of endorsed draft CRs from RAN4#92 (Rel-16)</p> <p>- Mirrors changes in R4-1910352 for Rel-15 TS 38.101-2</p> <p>Endorsed draft CRs from RAN4#92</p> <p>R4-1907999 Draft CR for NR non-contiguous CA configuration Verizon, Nokia, Ericsson, Qualcomm</p> <p>R4-1908082 draft CR to TS 38.101-2 on channel spacing for CA Samsung, ZTE</p> <p>R4-1908137 Update to FR2 EVM definition ROHDE & SCHWARZ</p> <p>R4-1908153 dCR to 38.101-2: Editorial corrections for 38.101-2 Qualcomm Incorporated</p> <p>R4-1908573 Draft CR to TS 38.101-2: corrections on Rx requirements for intra-band CA ZTE Corporation</p> <p>R4-1908633 Draft CR to TS38.101-2: Corrections on EVM window length (Section F.5) ZTE Corporation</p> <p>R4-1908708 Draft CR to TS38.101-2: corrections on the receiver spurious emission (section 7.9) ZTE Corporation</p> <p>R4-1909117 Draft CR for 38.101-2 applicability for intra-band CA Huawei</p> <p>R4-1909316 Draft CR to TS 38.101-2 on symbols correction ZTE Corporation</p> <p>R4-1910235 Draft CR to TS38.101-2 for Rx RF requirements LG Electronics Finland</p> <p>R4-1910238 CR for Handling of fallbacks for combined contiguous and non-contiguous CA in FR2 Apple</p> <p>R4-1910241 Draft CR to TS 38.101-2 on NR CA configurations for FR2 ZTE Corporation</p> <p>R4-1910259 dCR to 38.101-2: Reference signal clarifications Qualcomm Incorporated</p> <p>R4-1910261 dCR to 38.101-2: FR2 AMPR updates, including ERC 74-01 changes Qualcomm Incorporated</p> <p>R4-1910287 dCR to 38.101-2: FR2 CA MPR refinement Qualcomm Incorporated</p> | 16.1.0 |

| | | | | | | | |
|---------|--------|-----------|------|---|---|---|--------|
| | | | | | | R4-1910328 Draft CR to TS 38.101-2: Corrections for UL and DL RMC for FR2 tests Intel Corporation R4-1910333 Draft CR for 38.101-2 reference measurement channel for beam correspondence Huawei R4-1910334 Draft CR for TS38.101-2, Editorial corrections CATT R4-1910412 Draft CR for 38.101-2 correction for channel raster Huawei R4-1910614 Draft CR for TS 38.101-2: Channel spacing for adjacent NR carriers ZTE Conditional agreements for BC for PC1/2/4 from R4-1902252 | |
| 2019-09 | RAN#85 | RP-192027 | 0025 | 1 | F | Minor corrections of intra-band non-contiguous CA operating bands in TS 38.101-2 | 16.1.0 |
| 2019-09 | RAN#85 | RP-192027 | 0026 | | D | Rel-16 CR for further simplification of 38.101-2 Table 5.5A.2-2 | 16.1.0 |
| 2019-12 | RAN#86 | RP-193030 | 0032 | | A | CR to 38.101-2: DMRS exceptions | 16.2.0 |
| 2019-12 | RAN#86 | RP-193030 | 0036 | | A | Sync raster to SSB resource element mapping | 16.2.0 |
| 2019-12 | RAN#86 | RP-193030 | 0039 | | A | CR to 38.101-2 (Rel-16) to clarify measurement interval and observation window on frequency error | 16.2.0 |
| 2019-12 | RAN#86 | RP-193031 | 0041 | | A | CR to TS 38.101-2 on beam correspondence side condition applicability | 16.2.0 |
| 2019-12 | RAN#86 | RP-193031 | 0044 | | A | CR to TS 38.101-2: Correctin on FInterferer (offset) for CA ACS | 16.2.0 |
| 2019-12 | RAN#86 | RP-193030 | 0048 | | A | CR for TS 38.101-2: Editorial correction on MPR for contiguous CA notation | 16.2.0 |
| 2019-12 | RAN#86 | RP-193031 | 0050 | | A | CR for TS 38.101-2: CA bandwidth class definition amendment | 16.2.0 |
| 2019-12 | RAN#86 | RP-193030 | 0052 | | A | CR to TS 38.101-2 on corrections to channel raster entries for NR band (Rel-16) | 16.2.0 |
| 2019-12 | RAN#86 | RP-193030 | 0056 | | A | CR to transmit modulation quality in FR2 | 16.2.0 |
| 2019-12 | RAN#86 | RP-193030 | 0058 | | A | Frequency separation class clarification REL-16 | 16.2.0 |
| 2019-12 | RAN#86 | RP-193012 | 0064 | | B | CR introduction completed band combinations 38.716-01-01 -> 38.101-2 | 16.2.0 |
| 2019-12 | RAN#86 | RP-193011 | 0065 | 1 | F | CR to 38.101-2-g10 Corrections to maximum output power reduction for power class 3 | 16.2.0 |
| 2019-12 | RAN#86 | RP-193030 | 0067 | | A | CR for TS 38.101-2: power classes and maxUplinkDutyCycle-FR2 | 16.2.0 |
| 2019-12 | RAN#86 | RP-193031 | 0074 | | A | CR for agreed MPR CA for FR2 intra-band contiguous | 16.2.0 |
| 2019-12 | RAN#86 | RP-193031 | 0075 | 1 | A | CR for 38.101-2 on NS_202 band defintion | 16.2.0 |
| 2019-12 | RAN#86 | RP-193031 | 0077 | | A | CR to TS 38.101-2: Correctin on CA NRACLR | 16.2.0 |
| 2020-03 | RAN#87 | RP-200395 | 0080 | | A | Correction of the FR2 RMC slot patterns for MOP test cases | 16.3.0 |
| 2020-03 | RAN#87 | RP-200395 | 0099 | | A | CR to 38.101-2 (Rel-16) MPR for CA | 16.3.0 |
| 2020-03 | RAN#87 | RP-200395 | 0106 | | F | CR FR2 CA tables REL16 | 16.3.0 |
| 2020-03 | RAN#87 | RP-200395 | 0108 | | A | CR to TS 38.101-2 on corrections to intra-band contiguous CA for FR2 bands (Rel-16) | 16.3.0 |
| 2020-03 | RAN#87 | RP-200395 | 0110 | | A | CR to 38.101-2: Align Rx CA requirements structure with TS38.101-1 | 16.3.0 |
| 2020-03 | RAN#87 | RP-200395 | 0114 | | A | CR for TS 38.101-2: Editorial addition of CBW and CABW definitions in Abbreviations section | 16.3.0 |
| 2020-03 | RAN#87 | RP-200395 | 0118 | | A | CR to TS 38.101-2: Correction on FRC table for FR2 DL 64QAM | 16.3.0 |
| 2020-03 | RAN#87 | RP-200469 | 0126 | 2 | A | CR for 38.101-2 side condition for BC_Rel16 | 16.3.0 |
| 2020-03 | RAN#87 | RP-200380 | 0132 | | F | Editorial corrections | 16.3.0 |
| 2020-03 | RAN#87 | RP-200378 | 0133 | | F | Correction of Inner Allocation Definition for Powerclass 3 | 16.3.0 |
| 2020-03 | RAN#87 | RP-200395 | 0136 | | A | R16 CR to 38.101-2: TRS and SSB configurations in FR2 | 16.3.0 |
| 2020-04 | | | 0147 | | A | Change history corrected | 16.3.1 |
| 2020-06 | RAN#88 | RP-200985 | 0148 | | F | CR on ACLR MBW definition in FR2 | 16.4.0 |
| 2020-06 | RAN#88 | RP-201046 | 0151 | | A | CR to 38.101-2: Revision to Multiband Relaxations | 16.4.0 |
| 2020-06 | RAN#88 | RP-200985 | 0164 | | A | CR to 38.101-2 on correction of reference point for beam correspondence side conditions R16 | 16.4.0 |
| 2020-06 | RAN#88 | RP-200985 | 0168 | | A | CR to 38.101-2 to correct Link and Meas Angles | 16.4.0 |
| 2020-06 | RAN#88 | RP-200985 | 0170 | | A | CR to 38.101-2: NS_202 update after changes to EU regulations | 16.4.0 |
| 2020-06 | RAN#88 | RP-200985 | 0172 | | A | CR for TS 38.101-2: Intra-band non-contiguous CA configuration clarifications | 16.4.0 |
| 2020-06 | RAN#88 | RP-200985 | 0174 | | A | CR for TS 38.101-2: Correction for configured transmitted power for CA | 16.4.0 |
| 2020-06 | RAN#88 | RP-200985 | 0175 | | F | CR for TS 38.101-2: Clarifications on transmitter power for receiver requirements | 16.4.0 |
| 2020-06 | RAN#88 | RP-200959 | 0181 | | A | CR for TS 38.101-2: Intra-band non-contiguous CA configuration clarifications | 16.4.0 |
| 2020-06 | RAN#88 | RP-200985 | 0183 | | A | Update of CSI-RS definition for FR2 DL RMCs | 16.4.0 |
| 2020-06 | RAN#88 | RP-200985 | 0184 | | F | Correction to FR2 QPSK UL RMC | 16.4.0 |
| 2020-06 | RAN#88 | RP-200985 | 0188 | | B | Correction of Rel-16 UL RMCs | 16.4.0 |
| 2020-06 | RAN#88 | RP-200972 | 0193 | | F | CR to TS 38.101-2: Introduction of FR2 DL 256QAM | 16.4.0 |
| 2020-06 | RAN#88 | RP-200985 | 0198 | | A | ACS requirement correction | 16.4.0 |
| 2020-06 | RAN#88 | RP-200985 | 0200 | | A | CR for intra-band CA DL Rx requirement-FR2_Rel-16 | 16.4.0 |
| 2020-06 | RAN#88 | RP-200985 | 0208 | | A | CR for modified MPR_Rel-16 | 16.4.0 |
| 2020-06 | RAN#88 | RP-200985 | 0162 | 1 | B | CR to TS38.101-2 on Rel-15 beam correspondence | 16.4.0 |

| | | | | | | | |
|---------|--------|-----------|------|---|---|---|---------|
| 2020-06 | RAN#88 | RP-200959 | 0209 | | A | CR to 38.101-2: Introduce mmWave intra-band uplink CA configurations | 16.4.0 |
| 2020-06 | RAN#88 | RP-200985 | 0161 | 1 | B | CR to K1 value in Annex A.3.3 of 38.101-2 | 16.4.0 |
| 2020-06 | RAN#88 | RP-201046 | 0211 | | A | CR to 38.101-2 on FR2 frequency separation class enhancement | 16.4.0 |
| 2020-06 | RAN#88 | RP-200985 | 0191 | 2 | B | CR on P _{cmx} correction for CA | 16.4.0 |
| 2020-06 | RAN#88 | RP-200978 | 0155 | 1 | B | CR to 38.101-2 for Introduction of band n259 | 16.4.0 |
| 2020-06 | RAN#88 | RP-201046 | 0147 | | A | FR2 new MPR and modifiedmpr | 16.4.0 |
| 2020-09 | RAN#89 | RP-201496 | 0216 | 1 | B | Introduction of MPE related P-MPR operation in sub-clause 6.2.4 | 16.5.0 |
| 2020-09 | RAN#89 | RP-201512 | 0218 | | A | CR on Minimum output power and Off power MBW definition in FR2 | 16.5.0 |
| 2020-09 | RAN#89 | RP-201496 | 0221 | 1 | B | CR to 38.101-2 (Rel-16) intra-band non-cont. DL CA | 16.5.0 |
| 2020-09 | RAN#89 | RP-201512 | 0224 | | A | CR for R16 38.101-2: Correction of in-band emission tables | 16.5.0 |
| 2020-09 | RAN#89 | RP-201512 | 0226 | 1 | F | Correction for REL16 FR2 contiguous intra-band CA configuration table | 16.5.0 |
| 2020-09 | RAN#89 | RP-201512 | 0230 | 1 | F | modifiedMPR correction for FR2 REL16 | 16.5.0 |
| 2020-09 | RAN#89 | RP-201496 | 0231 | 2 | B | Beam correspondence enhancement | 16.5.0 |
| 2020-09 | RAN#89 | RP-201512 | 0234 | | A | CR to TS 38.101-2 on corrections to operating bands for intra-band CA (Rel-16) | 16.5.0 |
| 2020-09 | RAN#89 | RP-201506 | 0235 | | F | Correction of ACS requiremet for n259 | 16.5.0 |
| 2020-09 | RAN#89 | RP-201496 | 0237 | 2 | F | Introduction of FR2 inter-band DL CA | 16.5.0 |
| 2020-09 | RAN#89 | RP-201512 | 0239 | | A | CR for introduction of EESS protection for n257 into general spurious emission | 16.5.0 |
| 2020-09 | RAN#89 | RP-201512 | 0241 | | A | CR to TS 38.101-2: Correction on the Aggregated Channel Bandwidth | 16.5.0 |
| 2020-09 | RAN#89 | RP-201512 | 0243 | | A | CR to TS 38.101-2: Correction on the PC3 MPR description | 16.5.0 |
| 2020-09 | RAN#89 | RP-201512 | 0246 | | A | FR2 Minimum output power measurement period definition | 16.5.0 |
| 2020-09 | RAN#89 | RP-201488 | 0249 | 2 | F | CR to TS38.101-2 on ULFP _{tx} and UE SRS port configuration clarification | 16.5.0 |
| 2020-09 | RAN#89 | RP-201496 | 0250 | 1 | F | CR to 38.101-2: DL CA BW Enhancement and CA REFSSENS | 16.5.0 |
| 2020-09 | RAN#89 | RP-201496 | 0251 | 1 | B | CR to 38.101-2: FR2 UE EIRP increase with IBE relaxation | 16.5.0 |
| 2020-09 | RAN#89 | RP-201496 | 0252 | 1 | B | FR2 intra-band non-contiguous UL CA feature | 16.5.0 |
| 2020-09 | RAN#89 | RP-201507 | 0259 | | F | Correction of corrupted table | 16.5.0 |
| 2020-12 | RAN#90 | RP-202485 | 0263 | | A | EESS protection related requirements for FR2 bands | 16.6.0 |
| 2020-12 | RAN#90 | RP-202485 | 0267 | | A | CR to 38.101-2: ULCA clarifications | 16.6.0 |
| 2020-12 | RAN#90 | RP-202485 | 0269 | | A | CR for TS38.101-2 Rel-16, Correction for definition of P-MPR | 16.6.0 |
| 2020-12 | RAN#90 | RP-202443 | 0270 | 1 | F | REL16 eBC capability alingment with 38.306 | 16.6.0 |
| 2020-12 | RAN#90 | RP-202443 | 0271 | 1 | F | CR to 38.101-2 (Rel-16) inter-band DL CA | 16.6.0 |
| 2020-12 | RAN#90 | RP-202443 | 0272 | 1 | F | Clarification of EIS spherical coverage for inter-band CA | 16.6.0 |
| 2020-12 | RAN#90 | RP-202485 | 0274 | | A | Transmission gap for relative power tolerance in FR2 | 16.6.0 |
| 2020-12 | RAN#90 | RP-202485 | 0276 | | A | CR to TS38.101-2 on DC location correction | 16.6.0 |
| 2020-12 | RAN#90 | RP-202485 | 0280 | | A | CR for TS 38.101-2: Clarification for NS_202 | 16.6.0 |
| 2020-12 | RAN#90 | RP-202509 | 0282 | 1 | F | CR to TS 38.101-2 on fallback group for intra-band contiguous CA (Rel-16) | 16.6.0 |
| 2020-12 | RAN#90 | RP-202509 | 0283 | 1 | F | CR to TS 38.101-2 on simplification for inter-band CA configuration | 16.6.0 |
| 2020-12 | RAN#90 | RP-202485 | 0289 | | A | Correction to P _{cmx} : total radiated power | 16.6.0 |
| 2020-12 | RAN#90 | RP-202485 | 0293 | | A | Correction to EIS definition | 16.6.0 |
| 2020-12 | RAN#90 | RP-202428 | 0297 | 1 | F | CR for editorial corrections 38.101-2 | 16.6.0 |
| 2020-12 | RAN#90 | RP-202485 | 0299 | | A | Mirror CR for 38.101-2: IBB and ACS corrections | 16.6.0 |
| 2020-12 | RAN#90 | RP-202485 | 0310 | | A | CR to DMRS position in UL RMC for FR2 | 16.6.0 |
| 2021-03 | RAN#91 | RP-210116 | 0314 | | A | CR for 38.141-2: BS demodulation synchronization in test setup | 16.7.0 |
| 2021-03 | RAN#91 | RP-210091 | 0318 | | F | CR to TS 38.101-2 on correction to intra-band non-contiguous CA configurations (Rel-16) | 16.7.0 |
| 2021-03 | RAN#91 | RP-210083 | 0323 | 1 | F | P _{cmx} P _{IBE} wording refinement and terminology improvement | 16.7.0 |
| 2021-03 | RAN#91 | RP-210117 | 0333 | | F | CR to 38.101-2: correction on UL MIMO | 16.7.0 |
| 2021-03 | RAN#91 | RP-210117 | 0336 | | A | CR to 38.101-2 on beam correspondence | 16.7.0 |
| 2021-03 | RAN#91 | RP-210191 | 0344 | 2 | F | CR on FR2 inter-band DL CA CBM and IBM | 16.7.0 |
| 2021-03 | RAN#91 | RP-210117 | 0345 | | A | CR on FR2 intra-band UL CA | 16.7.0 |
| 2021-06 | RAN#92 | RP-211083 | 0352 | | A | P _{cmx} fix for the CA applicability | 16.8.0 |
| 2021-06 | RAN#92 | RP-211084 | 0358 | | A | Update of FR2 UL RMC tables | 16.8.0 |
| 2021-06 | RAN#92 | RP-211104 | 0363 | | F | Removal of CA _{n260} (*) notation and IE fix R16 CATF | 16.8.0 |
| 2021-06 | RAN#92 | RP-211117 | 0365 | 1 | F | Correction of the channel raster of n259 for TS 38.101-2 | 16.8.0 |
| 2021-06 | RAN#92 | RP-211117 | 0383 | | F | CR to 38.101-2 on side conditions for beam correspondence based on SSB and CSI-RS for n259 (Rel-16) | 16.8.0 |
| 2021-06 | RAN#92 | RP-211080 | 0384 | 1 | F | CR for Rel-16 38.101-2 to correct some errors in Table 5.5A.2-2 | 16.8.0 |
| 2021-06 | RAN#92 | RP-211107 | 0386 | | F | CR to TS38.101-2: Some Corrections on for CA _{n260-n261} | 16.8.0 |
| 2021-06 | RAN#92 | RP-211091 | 0404 | | A | CR to 38.101-2: CABW definition addition | 16.8.0 |
| 2021-06 | RAN#92 | RP-211091 | 0407 | | F | CR for 38.101-2-g70: Removing ambiguity on MPR _{narrow} for PC3 MPR | 16.8.0 |
| 2021-09 | RAN#93 | RP-211921 | 0312 | 3 | A | CR to 38.101-2 on handling of fallbacks for FR2 CA | 16.9.0 |
| 2021-09 | RAN#93 | RP-211923 | 0422 | | F | Big CR for TS 38.101-2 Maintenance part1 (Rel-16) | 16.9.0 |
| 2021-12 | RAN#94 | RP-212845 | 0435 | | F | Big CR for TS 38.101-2 Maintenance (Rel-16) | 16.10.0 |
| 2022-03 | RAN#95 | RP-220337 | 0444 | | F | Big CR for TS 38.101-2 Maintenance (Rel-16) | 16.11.0 |
| 2022-06 | RAN#96 | RP-221661 | 0454 | | F | CR for 38.101-2-gb0: Correction for PC3 MPR _{narrow} | 16.12.0 |

| | | | | | | | |
|---------|--------|-----------|------|--|---|--|---------|
| 2022-06 | RAN#96 | RP-221661 | 0465 | | F | CR for TS 38.101-2: update of simultaneous RxTx capability for band combinations | 16.12.0 |
| 2022-06 | RAN#96 | RP-221655 | 0467 | | F | Big CR for TS 38.101-2 Maintenance (Rel-16) | 16.12.0 |
| 2022-09 | RAN#97 | RP-222026 | 0495 | | F | Big CR for 38.101-2 maintenance (Rel-16) | 16.13.0 |

History

| Document history | | |
|-------------------------|----------------|-------------|
| V16.4.0 | July 2020 | Publication |
| V16.5.0 | November 2020 | Publication |
| V16.6.0 | January 2021 | Publication |
| V16.7.0 | April 2021 | Publication |
| V16.8.0 | September 2021 | Publication |
| V16.9.0 | October 2021 | Publication |
| V16.10.1 | April 2022 | Publication |
| V16.11.0 | April 2022 | Publication |
| V16.12.0 | August 2022 | Publication |
| V16.13.0 | October 2022 | Publication |