

ETSI TS 138 101-2 V17.16.0 (2025-01)



**5G;  
NR;  
User Equipment (UE) radio transmission and reception;  
Part 2: Range 2 Standalone  
(3GPP TS 38.101-2 version 17.16.0 Release 17)**



---

Reference

RTS/TSGR-0438101-2vhg0

---

Keywords

5G

**ETSI**

650 Route des Lucioles  
F-06921 Sophia Antipolis Cedex - FRANCE

Tel.: +33 4 92 94 42 00 Fax: +33 4 93 65 47 16

Siret N° 348 623 562 00017 - APE 7112B  
Association à but non lucratif enregistrée à la  
Sous-Préfecture de Grasse (06) N° w061004871

---

**Important notice**

The present document can be downloaded from the  
[ETSI Search & Browse Standards application](#).

The present document may be made available in electronic versions and/or in print. The content of any electronic and/or print versions of the present document shall not be modified without the prior written authorization of ETSI. In case of any existing or perceived difference in contents between such versions and/or in print, the prevailing version of an ETSI deliverable is the one made publicly available in PDF format on [ETSI deliver repository](#).

Users should be aware that the present document may be revised or have its status changed, this information is available in the [Milestones listing](#).

If you find errors in the present document, please send your comments to the relevant service listed under [Committee Support Staff](#).

If you find a security vulnerability in the present document, please report it through our [Coordinated Vulnerability Disclosure \(CVD\)](#) program.

---

**Notice of disclaimer & limitation of liability**

The information provided in the present deliverable is directed solely to professionals who have the appropriate degree of experience to understand and interpret its content in accordance with generally accepted engineering or other professional standard and applicable regulations.

No recommendation as to products and services or vendors is made or should be implied.

No representation or warranty is made that this deliverable is technically accurate or sufficient or conforms to any law and/or governmental rule and/or regulation and further, no representation or warranty is made of merchantability or fitness for any particular purpose or against infringement of intellectual property rights.

In no event shall ETSI be held liable for loss of profits or any other incidental or consequential damages.

Any software contained in this deliverable is provided "AS IS" with no warranties, express or implied, including but not limited to, the warranties of merchantability, fitness for a particular purpose and non-infringement of intellectual property rights and ETSI shall not be held liable in any event for any damages whatsoever (including, without limitation, damages for loss of profits, business interruption, loss of information, or any other pecuniary loss) arising out of or related to the use of or inability to use the software.

---

**Copyright Notification**

No part may be reproduced or utilized in any form or by any means, electronic or mechanical, including photocopying and microfilm except as authorized by written permission of ETSI.

The content of the PDF version shall not be modified without the written authorization of ETSI.

The copyright and the foregoing restriction extend to reproduction in all media.

© ETSI 2025.  
All rights reserved.

---

# Intellectual Property Rights

## Essential patents

IPRs essential or potentially essential to normative deliverables may have been declared to ETSI. The declarations pertaining to these essential IPRs, if any, are publicly available for **ETSI members and non-members**, and can be found in ETSI SR 000 314: "*Intellectual Property Rights (IPRs); Essential, or potentially Essential, IPRs notified to ETSI in respect of ETSI standards*", which is available from the ETSI Secretariat. Latest updates are available on the [ETSI IPR online database](#).

Pursuant to the ETSI Directives including the ETSI IPR Policy, no investigation regarding the essentiality of IPRs, including IPR searches, has been carried out by ETSI. No guarantee can be given as to the existence of other IPRs not referenced in ETSI SR 000 314 (or the updates on the ETSI Web server) which are, or may be, or may become, essential to the present document.

## Trademarks

The present document may include trademarks and/or tradenames which are asserted and/or registered by their owners. ETSI claims no ownership of these except for any which are indicated as being the property of ETSI, and conveys no right to use or reproduce any trademark and/or tradename. Mention of those trademarks in the present document does not constitute an endorsement by ETSI of products, services or organizations associated with those trademarks.

**DECT™**, **PLUGTESTS™**, **UMTS™** and the ETSI logo are trademarks of ETSI registered for the benefit of its Members. **3GPP™**, **LTE™** and **5G™** logo are trademarks of ETSI registered for the benefit of its Members and of the 3GPP Organizational Partners. **oneM2M™** logo is a trademark of ETSI registered for the benefit of its Members and of the oneM2M Partners. **GSM®** and the GSM logo are trademarks registered and owned by the GSM Association.

---

# Legal Notice

This Technical Specification (TS) has been produced by ETSI 3rd Generation Partnership Project (3GPP).

The present document may refer to technical specifications or reports using their 3GPP identities. These shall be interpreted as being references to the corresponding ETSI deliverables.

The cross reference between 3GPP and ETSI identities can be found at [3GPP to ETSI numbering cross-referencing](#).

---

# Modal verbs terminology

In the present document "**shall**", "**shall not**", "**should**", "**should not**", "**may**", "**need not**", "**will**", "**will not**", "**can**" and "**cannot**" are to be interpreted as described in clause 3.2 of the [ETSI Drafting Rules](#) (Verbal forms for the expression of provisions).

"**must**" and "**must not**" are **NOT** allowed in ETSI deliverables except when used in direct citation.

# Contents

Intellectual Property Rights .....	2
Legal Notice .....	2
Modal verbs terminology.....	2
Foreword.....	12
1 Scope .....	14
2 References .....	14
3 Definitions, symbols and abbreviations .....	15
3.1 Definitions .....	15
3.2 Symbols.....	16
3.3 Abbreviations .....	18
4 General .....	20
4.1 Relationship between minimum requirements and test requirements .....	20
4.2 Applicability of minimum requirements .....	20
4.3 Specification suffix information.....	20
5 Operating bands and channel arrangement.....	22
5.1 General .....	22
5.2 Operating bands.....	22
5.2A Operating bands for CA .....	22
5.2A.1 Intra-band CA .....	22
5.2A.2 Inter-band CA .....	23
5.2D Operating bands for UL MIMO .....	23
5.3 UE Channel bandwidth .....	23
5.3.1 General.....	23
5.3.2 Maximum transmission bandwidth configuration .....	24
5.3.3 Minimum guardband and transmission bandwidth configuration.....	24
5.3.4 RB alignment .....	26
5.3A UE channel bandwidth for CA .....	27
5.3A.1 General.....	27
5.3A.2 Minimum guardband and transmission bandwidth configuration for CA .....	27
5.3A.3 RB alignment with different numerologies for CA.....	28
5.3A.4 UE channel bandwidth per operating band for CA.....	28
5.3D Channel bandwidth for UL MIMO.....	31
5.4 Channel arrangement.....	31
5.4.1 Channel spacing.....	31
5.4.1.1 Channel spacing for adjacent NR carriers .....	31
5.4.2 Channel raster .....	32
5.4.2.1 NR-ARFCN and channel raster.....	32
5.4.2.2 Channel raster to resource element mapping.....	32
5.4.2.3 Channel raster entries for each operating band .....	32
5.4.3 Synchronization raster .....	33
5.4.3.1 Synchronization raster and numbering.....	33
5.4.3.2 Synchronization raster to synchronization block resource element mapping.....	33
5.4.3.3 Synchronization raster entries for each operating band.....	34
5.4A Channel arrangement for CA.....	34
5.4A.1 Channel spacing for CA.....	34
5.5 Configurations .....	36
5.5A Configurations for CA.....	36
5.5A.1 Configurations for intra-band contiguous CA.....	36
5.5A.2 Configurations for intra-band non-contiguous CA .....	43
5.5A.3 Configurations for inter-band CA .....	52
5.5D Configurations for UL MIMO.....	56
6 Transmitter characteristics .....	57

6.1	General .....	57
6.2	Transmitter power .....	57
6.2.1	UE maximum output power .....	57
6.2.1.0	General .....	57
6.2.1.1	UE maximum output power for power class 1 .....	57
6.2.1.2	UE maximum output power for power class 2 .....	58
6.2.1.3	UE maximum output power for power class 3 .....	59
6.2.1.4	UE maximum output power for power class 4 .....	61
6.2.1.5	UE maximum output power for power class 5 .....	62
6.2.1.6	UE maximum output power for power class 6 .....	63
6.2.1.7	UE maximum output power for power class 7 .....	64
6.2.2	UE maximum output power reduction .....	65
6.2.2.0	General .....	65
6.2.2.1	UE maximum output power reduction for power class 1 .....	65
6.2.2.2	UE maximum output power reduction for power class 2 .....	67
6.2.2.3	UE maximum output power reduction for power class 3 .....	67
6.2.2.4	UE maximum output power reduction for power class 4 .....	69
6.2.2.5	UE maximum output power reduction for power class 5 .....	69
6.2.2.6	UE maximum output power reduction for power class 6 .....	69
6.2.2.7	UE maximum output power reduction for power class 7 .....	69
6.2.3	UE maximum output power with additional requirements .....	69
6.2.3.1	General .....	69
6.2.3.2	Void .....	71
6.2.3.2.1	Void .....	71
6.2.3.2.2	Void .....	71
6.2.3.2.3	Void .....	71
6.2.3.2.4	Void .....	71
6.2.3.2.5	Void .....	71
6.2.3.3	A-MPR for NS_202 .....	71
6.2.3.3.1	A-MPR for NS_202 for power class 1 .....	71
6.2.3.3.2	A-MPR for NS_202 for power class 2 .....	71
6.2.3.3.3	A-MPR for NS_202 for power class 3 .....	71
6.2.3.3.4	A-MPR for NS_202 for power class 4 .....	71
6.2.3.3.5	A-MPR for NS_202 for power class 5 .....	71
6.2.3.3.6	A-MPR for NS_202 for power class 6 .....	71
6.2.3.3.7	A-MPR for NS_202 for power class 7 .....	71
6.2.3.4	A-MPR for NS_203 .....	71
6.2.3.4.1	A-MPR for NS_203 for power class 1 .....	71
6.2.3.4.2	A-MPR for NS_203 for power class 2 .....	72
6.2.3.4.3	A-MPR for NS_203 for power class 3 .....	72
6.2.3.4.4	A-MPR for NS_203 for power class 4 .....	72
6.2.3.4.5	A-MPR for NS_203 for power class 5 .....	72
6.2.3.4.6	A-MPR for NS_203 for power class 6 .....	72
6.2.3.4.7	A-MPR for NS_203 for power class 7 .....	72
6.2.4	Configured transmitted power .....	72
6.2.5	Requirements for UL gap ( <i>ul-GapFR2-r17</i> ) for TX power management .....	73
6.2A	Transmitter power for CA .....	74
6.2A.1	UE maximum output power for CA .....	74
6.2A.2	UE maximum output power reduction for CA .....	75
6.2A.2.1	General .....	75
6.2A.2.2	Maximum output power reduction for power class 1 .....	75
6.2A.2.2.1	Maximum output power reduction for power class 1 intra-band contiguous UL CA .....	75
6.2A.2.2.2	Maximum output power reduction for power class 1 intra-band non-contiguous UL CA .....	77
6.2A.2.2.3	Maximum output power reduction for power class 1 inter-band CA .....	77
6.2A.2.3	Maximum output power reduction for power class 2 .....	78
6.2A.2.4	Maximum output power reduction for power class 3 .....	78
6.2A.2.4.1	Maximum output power reduction for power class 3 intra-band contiguous CA .....	78
6.2A.2.4.2	Maximum output power reduction for power class 3 intra-band non-contiguous CA .....	79
6.2A.2.4.3	Maximum output power reduction for power class 3 inter-band CA .....	80
6.2A.2.5	Maximum output power reduction for power class 4 .....	80
6.2A.2.6	Maximum output power reduction for power class 5 .....	80
6.2A.3	UE maximum output power with additional requirements for CA .....	81

6.2A.3.1	General .....	81
6.2A.3.2	Void.....	82
6.2A.3.2.1	Void .....	82
6.2A.3.2.2	Void .....	82
6.2A.3.2.3	Void .....	82
6.2A.3.2.4	Void .....	82
6.2A.3.2.5	Void .....	82
6.2A.3.3	A-MPR for CA_NS_202.....	82
6.2A.3.3.1	A-MPR for CA_NS_202 for power class 1 .....	82
6.2A.3.3.2	A-MPR for CA_NS_202 for power class 2.....	82
6.2A.3.3.3	A-MPR for CA_NS_202 for power class 3.....	82
6.2A.3.3.4	A-MPR for CA_NS_202 for power class 4.....	82
6.2A.3.3.5	A-MPR for CA_NS_202 for power class 5.....	82
6.2A.3.4	A-MPR for CA_NS_203.....	82
6.2A.3.4.1	A-MPR for CA_NS_203 for power class 1 .....	82
6.2A.3.4.2	A-MPR for CA_NS_203 for power class 2.....	82
6.2A.3.4.3	A-MPR for CA_NS_203 for power class 3.....	82
6.2A.3.4.4	A-MPR for CA_NS_203 for power class 4.....	83
6.2A.3.4.5	A-MPR for CA_NS_203 for power class 5.....	83
6.2A.4	Configured transmitted power for CA .....	83
6.2A.4.1	Configured transmitted power for intra-band UL CA.....	83
6.2A.4.2	Configured transmitted power for inter-band UL CA.....	84
6.2A.5	Requirements for UL gap ( <i>ul-GapFR2-r17</i> ) for TX power management in CA .....	85
6.2D	Transmitter power for UL MIMO .....	85
6.2D.1	UE maximum output power for UL MIMO.....	85
6.2D.1.0	General .....	85
6.2D.1.1	UE maximum output power for UL MIMO for power class 1.....	86
6.2D.1.2	UE maximum output power for UL MIMO for power class 2.....	87
6.2D.1.3	UE maximum output power for UL MIMO for power class 3.....	88
6.2D.1.4	UE maximum output power for UL MIMO for power class 4.....	89
6.2D.1.5	UE maximum output power for UL MIMO for power class 5.....	90
6.2D.1.6	UE maximum output power for UL MIMO for power class 6.....	90
6.2D.2	UE maximum output power reduction for modulation / channel bandwidth for UL MIMO.....	91
6.2D.2.1	UE maximum output power reduction for modulation / channel bandwidth for UL MIMO for power class 1 .....	91
6.2D.2.2	UE maximum output power reduction for modulation / channel bandwidth for UL MIMO for power class 2.....	92
6.2D.2.3	UE maximum output power reduction for modulation / channel bandwidth for UL MIMO for power class 3.....	92
6.2D.2.4	UE maximum output power reduction for modulation / channel bandwidth for UL MIMO for power class 4.....	92
6.2D.2.5	UE maximum output power reduction for modulation / channel bandwidth for UL MIMO for power class 5.....	92
6.2D.2.6	UE maximum output power reduction for modulation / channel bandwidth for UL MIMO for power class 6.....	92
6.2D.3	UE maximum output power reduction with additional requirements for UL MIMO .....	92
6.2D.3.1	UE maximum output power reduction with additional requirements for UL MIMO for power class 1.....	92
6.2D.3.2	UE maximum output power reduction with additional requirements for UL MIMO for power class 2.....	93
6.2D.3.3	UE maximum output power reduction with additional requirements for UL MIMO for power class 3.....	93
6.2D.3.4	UE maximum output power reduction with additional requirements for UL MIMO for power class 4.....	93
6.2D.3.5	UE maximum output power reduction with additional requirements for UL MIMO for power class 5.....	93
6.2D.3.6	UE maximum output power reduction with additional requirements for UL MIMO for power class 6.....	93
6.2D.4	Configured transmitted power for UL MIMO .....	93
6.3	Output power dynamics.....	93
6.3.1	Minimum output power .....	93
6.3.1.0	General .....	93

6.3.1.1	Minimum output power for power class 1 .....	94
6.3.1.2	Minimum output power for power class 2, 3, and 4.....	94
6.3.1.3	Minimum output power for power class 5 and 6.....	94
6.3.1.4	Minimum output power for power class 7 .....	95
6.3.2	Transmit OFF power.....	95
6.3.3	Transmit ON/OFF time mask .....	95
6.3.3.1	General .....	95
6.3.3.2	General ON/OFF time mask .....	96
6.3.3.3	Transmit power time mask for slot and short or long subslot boundaries.....	96
6.3.3.4	PRACH time mask.....	96
6.3.3.5	Void.....	98
6.3.3.6	SRS time mask .....	98
6.3.3.7	PUSCH-PUCCH and PUSCH-SRS time masks .....	99
6.3.3.8	Transmit power time mask for consecutive slot or long subslot transmission and short subslot transmission boundaries .....	99
6.3.3.9	Transmit power time mask for consecutive short subslot transmissions boundaries .....	100
6.3.4	Power control.....	101
6.3.4.1	General .....	101
6.3.4.2	Absolute power tolerance.....	101
6.3.4.3	Relative power tolerance .....	101
6.3.4.4	Aggregate power tolerance.....	102
6.3A	Output power dynamics for CA .....	102
6.3A.1	Minimum output power for CA .....	102
6.3A.1.0	General .....	102
6.3A.1.1	Minimum output power for power class 1 .....	103
6.3A.1.2	Minimum output power for power class 2, 3, and 4.....	103
6.3A.1.3	Minimum output power for power class 5 .....	104
6.3A.2	Transmit OFF power for CA.....	104
6.3A.3	Transmit ON/OFF time mask for CA .....	104
6.3A.4	Power control for CA.....	105
6.3A.4.1	General .....	105
6.3A.4.2	Absolute power tolerance.....	105
6.3A.4.3	Relative power tolerance .....	105
6.3A.4.4	Aggregate power tolerance.....	105
6.3D	Output power dynamics for UL MIMO .....	106
6.3D.0	General.....	106
6.3D.1	Minimum output power for UL MIMO .....	106
6.3D.1.1	Minimum output power for UL MIMO for power class 1 .....	106
6.3D.1.2	Minimum output power for UL MIMO for power class 2, 3 and 4.....	106
6.3D.1.3	Minimum output power for UL MIMO for power class 5 and 6.....	106
6.3D.2	Transmit OFF power for UL MIMO.....	106
6.3D.3	Transmit ON/OFF time mask for UL MIMO .....	106
6.4	Transmit signal quality .....	106
6.4.1	Frequency Error .....	106
6.4.2	Transmit modulation quality.....	107
6.4.2.0	General .....	107
6.4.2.1	Error vector magnitude .....	107
6.4.2.2	Carrier leakage .....	109
6.4.2.2.1	General .....	109
6.4.2.2.2	Carrier leakage for power class 1 .....	109
6.4.2.2.3	Carrier leakage for power class 2 .....	109
6.4.2.2.4	Carrier leakage for power class 3 .....	110
6.4.2.2.5	Carrier leakage for power class 4 .....	110
6.4.2.2.6	Carrier leakage for power class 5 .....	110
6.4.2.2.7	Carrier leakage for power class 6 .....	110
6.4.2.2.8	Carrier leakage for power class 7 .....	110
6.4.2.3	In-band emissions .....	111
6.4.2.3.1	General .....	111
6.4.2.3.2	In-band emissions for power class 1.....	111
6.4.2.3.3	In-band emissions for power class 2.....	112
6.4.2.3.4	In-band emissions for power class 3.....	112
6.4.2.3.5	In-band emissions for power class 4.....	113

6.4.2.3.6	In-band emissions for power class 5 .....	114
6.4.2.3.7	In-band emissions for power class 6 .....	115
6.4.2.3.8	In-band emissions for power class 7 .....	115
6.4.2.4	EVM equalizer spectrum flatness .....	115
6.4.2.5	EVM spectral flatness for Pi/2 BPSK modulation .....	116
6.4.2.6	Phase continuity requirements for DMRS bundling .....	117
6.4A	Transmit signal quality for CA .....	118
6.4A.0	General .....	118
6.4A.1	Frequency error .....	119
6.4A.2	Transmit modulation quality .....	119
6.4A.2.0	General .....	119
6.4A.2.1	Error Vector magnitude .....	119
6.4A.2.2	Carrier leakage .....	119
6.4A.2.2.1	General .....	119
6.4A.2.2.2	Carrier leakage for power class 1 .....	120
6.4A.2.2.3	Carrier leakage for power class 2 .....	120
6.4A.2.2.4	Carrier leakage for power class 3 .....	120
6.4A.2.2.5	Carrier leakage for power class 4 .....	121
6.4A.2.2.6	Carrier leakage for power class 5 .....	121
6.4A.2.3	Inband emissions .....	121
6.4A.2.3.1	General .....	121
6.4A.2.3.2	Inband emissions for power class 1 .....	122
6.4A.2.3.3	Inband emissions for power class 2 .....	122
6.4A.2.3.4	Inband emissions for power class 3 .....	123
6.4A.2.3.5	Inband emissions for power class 4 .....	124
6.4A.2.3.6	Inband emissions for power class 5 .....	125
6.4A.2.4	EVM equalizer spectrum flatness .....	126
6.4D	Transmit signal quality for UL MIMO .....	126
6.4D.0	General .....	126
6.4D.1	Frequency error for UL MIMO .....	126
6.4D.2	Transmit modulation quality for UL MIMO .....	126
6.4D.3	Time alignment error for UL MIMO .....	127
6.4D.4	Requirements for coherent UL MIMO .....	127
6.5	Output RF spectrum emissions .....	128
6.5.1	Occupied bandwidth .....	128
6.5.2	Out of band emissions .....	128
6.5.2.0	General .....	128
6.5.2.1	Spectrum emission mask .....	128
6.5.2.2	Void .....	129
6.5.2.3	Adjacent channel leakage ratio .....	129
6.5.3	Spurious emissions .....	130
6.5.3.1	Spurious emission band UE co-existence .....	130
6.5.3.2	Additional spurious emissions .....	131
6.5.3.2.1	General .....	131
6.5.3.2.2	Void .....	132
6.5.3.2.3	Additional spurious emission requirements for NS_202 .....	132
6.5.3.2.4	Additional spurious emission requirements for NS_203 .....	132
6.5.3.2.5	Additional spurious emission requirements for NS_204 .....	132
6.5A	Output RF spectrum emissions for CA .....	133
6.5A.1	Occupied bandwidth for CA .....	133
6.5A.1.0	General .....	133
6.5A.1.1	Occupied bandwidth for intra-band contiguous UL CA .....	133
6.5A.1.2	Occupied bandwidth for intra-band non-contiguous UL CA .....	133
6.5A.1.3	Occupied bandwidth for inter-band UL CA .....	133
6.5A.2	Out of band emissions .....	133
6.5A.2.1	Spectrum emission mask for CA .....	133
6.5A.2.1.0	General .....	133
6.5A.2.1.1	Spectrum emission mask for intra-band contiguous UL CA .....	133
6.5A.2.1.2	Spectrum emission mask for intra-band non-contiguous UL CA .....	134
6.5A.2.1.3	Spectrum emission mask for inter-band UL CA .....	134
6.5A.2.2	Void .....	134
6.5A.2.3	Adjacent channel leakage ratio for CA .....	134



6.5A.2.3.1	Adjacent channel leakage ratio for CA intra-band contiguous UL CA .....	134
6.5A.2.3.2	Adjacent channel leakage ratio for CA intra-band non-contiguous UL CA .....	135
6.5A.2.3.3	Adjacent channel leakage ratio for CA inter-band UL CA .....	135
6.5A.3	Spurious emissions for CA .....	135
6.5A.3.0	General spurious emissions for CA .....	135
6.5A.3.0.0	General .....	135
6.5A.3.0.1	Spurious emissions for intra-band contiguous UL CA .....	136
6.5A.3.0.2	Spurious emissions for intra-band non-contiguous UL CA .....	136
6.5A.3.0.3	Spurious emissions for inter-band UL CA .....	136
6.5A.3.1	Spurious emission band UE co-existence for UL CA .....	136
6.5A.3.2	Additional spurious emissions .....	137
6.5A.3.2.1	General .....	137
6.5A.3.2.2	Void .....	137
6.5A.3.2.3	Additional spurious emission requirements for CA_NS_202 .....	137
6.5A.3.2.4	Additional spurious emission requirements for CA_NS_203 .....	137
6.5D	Output RF spectrum emissions for UL MIMO .....	138
6.5D.1	Occupied bandwidth for UL MIMO .....	138
6.5D.2	Out of band emissions for UL MIMO .....	138
6.5D.3	Spurious emissions for UL MIMO .....	138
6.6	Beam correspondence .....	138
6.6.1	General .....	138
6.6.2	(Void) .....	138
6.6.3	(Void) .....	138
6.6.4	Beam correspondence for power class 3 .....	138
6.6.4.1	General .....	138
6.6.4.2	Beam correspondence tolerance for power class 3 .....	139
6.6.4.3	Side Conditions .....	139
6.6.4.3.1	Side Condition for beam correspondence based on SSB and CSI-RS .....	139
6.6.4.3.2	Side Condition for SSB based enhanced Beam Correspondence requirements .....	140
6.6.4.3.3	Side Condition for CSI-RS based enhanced Beam Correspondence requirements .....	140
6.6.4.4	Applicability .....	141
6.6.5	(Void) .....	141
6.6.6	Beam correspondence for power class 5 .....	141
6.6.6.1	General .....	141
6.6.6.2	(Reserved) .....	142
6.6.6.3	Side Conditions .....	142
6.6.6.3.1	Side Condition for beam correspondence based on SSB and CSI-RS .....	142
6.6.6.3.2	Side Condition for SSB based enhanced Beam Correspondence requirements .....	143
6.6.6.3.3	Side Condition for CSI-RS based enhanced Beam Correspondence requirements .....	143
6.6.6.4	Applicability .....	143
6.6.7	Beam correspondence for power class 6 .....	144
6.6.7.1	General .....	144
6.6.7.2	(Void) .....	144
6.6.7.3	Side Conditions .....	144
6.6.7.3.1	(Void) .....	144
6.6.7.3.2	Side Condition for SSB based enhanced Beam Correspondence requirements .....	144
6.6.7.3.3	Side Condition for CSI-RS based enhanced Beam Correspondence requirements .....	144
6.6.7.4	Applicability .....	145
6.6.8	Beam correspondence for power class 7 .....	146
6.6.8.1	General .....	146
6.6.8.2	Void .....	146
6.6.8.3	Side Conditions .....	146
6.6.8.3.1	Side Condition for beam correspondence based on SSB and CSI-RS .....	146
6.6.8.3.2	Side Condition for SSB based enhanced Beam Correspondence requirements .....	147
6.6.8.3.3	Side Condition for CSI-RS based enhanced Beam Correspondence requirements .....	147
6.6.8.4	Applicability .....	147
6.6A	Beam correspondence for CA .....	148
7	Receiver characteristics .....	149
7.1	General .....	149
7.2	Diversity characteristics .....	149
7.3	Reference sensitivity .....	149

7.3.1	General.....	149
7.3.2	Reference sensitivity power level .....	149
7.3.2.1	Reference sensitivity power level for power class 1 .....	149
7.3.2.2	Reference sensitivity power level for power class 2 .....	150
7.3.2.3	Reference sensitivity power level for power class 3 .....	150
7.3.2.4	Reference sensitivity power level for power class 4 .....	151
7.3.2.5	Reference sensitivity power level for power class 5 .....	151
7.3.2.6	Reference sensitivity power level for power class 6 .....	152
7.3.2.7	Reference sensitivity power level for power class 7 .....	152
7.3.3	Void .....	153
7.3.4	EIS spherical coverage.....	153
7.3.4.1	EIS spherical coverage for power class 1 .....	153
7.3.4.2	EIS spherical coverage for power class 2.....	153
7.3.4.3	EIS spherical coverage for power class 3.....	154
7.3.4.4	EIS spherical coverage for power class 4.....	154
7.3.4.5	EIS spherical coverage for power class 5.....	155
7.3.4.6	EIS spherical coverage for power class 6.....	155
7.3.4.7	EIS spherical coverage for power class 7.....	155
7.3A	Reference sensitivity for DL CA .....	156
7.3A.1	General.....	156
7.3A.2	Reference sensitivity power level for CA .....	156
7.3A.2.1	Intra-band contiguous CA .....	156
7.3A.2.3	Inter-band CA .....	157
7.3A.3	EIS spherical coverage for DL CA .....	157
7.3A.3.1	Void.....	157
7.3A.3.2	Void.....	157
7.3A.3.3	EIS spherical coverage for inter-band CA .....	157
7.3D	Void.....	158
7.4	Maximum input level .....	158
7.4A	Maximum input level for DL CA .....	159
7.4A.1	Maximum input level for Intra-band contiguous CA.....	159
7.4A.2	Maximum input level for Intra-band non-contiguous CA .....	159
7.4A.3	Maximum input level for Inter-band CA .....	159
7.4D	Void.....	159
7.5	Adjacent channel selectivity.....	159
7.5A	Adjacent channel selectivity for DL CA .....	161
7.5A.1	Adjacent channel selectivity for Intra-band contiguous CA .....	161
7.5A.2	Adjacent channel selectivity for Intra-band non-contiguous CA.....	163
7.5A.3	Adjacent channel selectivity for Inter-band CA.....	163
7.5D	Void.....	163
7.6	Blocking characteristics .....	163
7.6.1	General.....	163
7.6.2	In-band blocking.....	164
7.6.3	Void .....	165
7.6A	Blocking characteristics for DL CA .....	165
7.6A.1	General.....	165
7.6A.2	In-band blocking .....	165
7.6A.2.2	In-band blocking for Intra-band non-contiguous CA .....	165
7.6A.2.3	In-band blocking for Inter-band CA.....	166
7.6D	Void.....	166
7.7	Void.....	166
7.8	Void.....	166
7.9	Spurious emissions .....	166
7.10	Void.....	167
<b>Annex A (normative):</b>	<b>Measurement channels.....</b>	<b>168</b>
A.1	General .....	168
A.2	UL reference measurement channels .....	168
A.2.1	General .....	168
A.2.2	Void.....	168
A.2.3	Reference measurement channels for TDD.....	169

A.2.3.1	DFT-s-OFDM Pi/2-BPSK .....	169
A.2.3.2	DFT-s-OFDM QPSK .....	170
A.2.3.3	DFT-s-OFDM 16QAM .....	170
A.2.3.4	DFT-s-OFDM 64QAM .....	171
A.2.3.5	CP-OFDM QPSK .....	171
A.2.3.6	CP-OFDM 16QAM .....	172
A.2.3.7	CP-OFDM 64QAM .....	173
A.3	DL reference measurement channels .....	174
A.3.1	General .....	174
A.3.2	Void .....	177
A.3.3	DL reference measurement channels for TDD .....	177
A.3.3.1	General .....	177
A.3.3.2	FRC for receiver requirements for QPSK .....	178
A.3.3.3	FRC for receiver requirements for 16QAM .....	181
A.3.3.4	FRC for receiver requirements for 64QAM .....	182
A.3.3.5	FRC for receiver requirements for 256QAM .....	186
A.4	Void .....	190
A.5	OFDMA Channel Noise Generator (OCNG) .....	190
A.5.1	OCNG Patterns for FDD .....	190
A.5.2	OCNG Patterns for TDD .....	190
A.5.2.1	OCNG TDD pattern 1: Generic OCNG TDD Pattern for all unused REs .....	190
<b>Annex B (informative):</b>	<b>Void .....</b>	<b>191</b>
<b>Annex C (normative):</b>	<b>Downlink physical channels .....</b>	<b>192</b>
C.1	General .....	192
C.2	Setup .....	192
C.3	Connection .....	192
C.3.1	Measurement of Receiver Characteristics .....	192
<b>Annex D (normative):</b>	<b>Characteristics of the interfering signal .....</b>	<b>193</b>
D.1	General .....	193
D.2	Interference signals .....	193
<b>Annex E (normative): Environmental conditions .....</b>		<b>194</b>
E.1	General .....	194
E.2	Environmental .....	194
E.2.1	Temperature .....	194
E.2.2	Voltage .....	194
E.2.3	Void .....	195
<b>Annex F (normative):</b>	<b>Transmit modulation .....</b>	<b>196</b>
F.1	Measurement Point .....	196
F.2	Basic Error Vector Magnitude measurement .....	196
F.3	Basic in-band emissions measurement .....	197
F.4	Modified signal under test .....	197
F.5	Window length .....	199
F.5.1	Timing offset .....	199
F.5.2	Window length .....	199
F.5.3	Window length for normal CP .....	200
F.5.4	Window length for Extended CP .....	200
F.5.5	Window length for PRACH .....	200
F.6	Averaged EVM .....	201
F.7	Spectrum Flatness .....	202

F.8	Phase offset measurement for DMRS bundling .....	202
F.8.1	Measurement point .....	202
F.8.2	Symbols used.....	203
F.8.3	Modified test signal .....	203
F.8.4	Phase offset measurement .....	203
F.9	Reserved .....	203
F.10	EVM for dual transmit polarizations .....	203
F.10.1	General .....	203
F.10.2	MIMO Equalization (UL MIMO transmission) .....	204
F.10.3	Maximum Ratio combining (Tx diversity transmission).....	205
F.10.4	Layer processing .....	205
<b>Annex G (normative): Difference of relative phase and power errors .....</b>		<b>207</b>
G.0	General .....	207
G.1	Measurement Point.....	207
G.2	Relative Phase Error Measurement .....	207
G.2.1	Symbols and subcarriers used .....	208
G.2.2	CFO (carrier frequency offset) correction.....	208
G.2.3	Steps of the measurement method.....	208
<b>Annex H (Normative): Modified MPR behavior.....</b>		<b>210</b>
H.1	Indication of modified MPR behavior.....	210
<b>Annex I (informative): Void .....</b>		<b>211</b>
<b>Annex J (normative): UE coordinate system .....</b>		<b>212</b>
J.1	Reference coordinate system.....	212
J.2	Test conditions and angle definitions .....	213
J.3	DUT positioning guidelines .....	217
<b>Annex K (informative): Void .....</b>		<b>219</b>
<b>Annex L (informative): Change history .....</b>		<b>220</b>
History .....		231

---

# Foreword

This Technical Specification has been produced by the 3rd Generation Partnership Project (3GPP).

The contents of the present document are subject to continuing work within the TSG and may change following formal TSG approval. Should the TSG modify the contents of the present document, it will be re-released by the TSG with an identifying change of release date and an increase in version number as follows:

Version x.y.z

where:

- x the first digit:
  - 1 presented to TSG for information;
  - 2 presented to TSG for approval;
  - 3 or greater indicates TSG approved document under change control.
- y the second digit is incremented for all changes of substance, i.e. technical enhancements, corrections, updates, etc.
- z the third digit is incremented when editorial only changes have been incorporated in the document.

In the present document, modal verbs have the following meanings:

- shall** indicates a mandatory requirement to do something
- shall not** indicates an interdiction (prohibition) to do something

The constructions "shall" and "shall not" are confined to the context of normative provisions, and do not appear in Technical Reports.

The constructions "must" and "must not" are not used as substitutes for "shall" and "shall not". Their use is avoided insofar as possible, and they are not used in a normative context except in a direct citation from an external, referenced, non-3GPP document, or so as to maintain continuity of style when extending or modifying the provisions of such a referenced document.

- should** indicates a recommendation to do something
- should not** indicates a recommendation not to do something
- may** indicates permission to do something
- need not** indicates permission not to do something

The construction "may not" is ambiguous and is not used in normative elements. The unambiguous constructions "might not" or "shall not" are used instead, depending upon the meaning intended.

- can** indicates that something is possible
- cannot** indicates that something is impossible

The constructions "can" and "cannot" are not substitutes for "may" and "need not".

- will** indicates that something is certain or expected to happen as a result of action taken by an agency the behaviour of which is outside the scope of the present document
- will not** indicates that something is certain or expected not to happen as a result of action taken by an agency the behaviour of which is outside the scope of the present document
- might** indicates a likelihood that something will happen as a result of action taken by some agency the behaviour of which is outside the scope of the present document

**might not** indicates a likelihood that something will not happen as a result of action taken by some agency the behaviour of which is outside the scope of the present document

In addition:

**is** (or any other verb in the indicative mood) indicates a statement of fact

**is not** (or any other negative verb in the indicative mood) indicates a statement of fact

The constructions "is" and "is not" do not indicate requirements.

---

# 1 Scope

The present document establishes the minimum RF requirements for NR User Equipment (UE) operating on frequency Range 2.

---

# 2 References

The following documents contain provisions which, through reference in this text, constitute provisions of the present document.

- References are either specific (identified by date of publication, edition number, version number, etc.) or non-specific.
- For a specific reference, subsequent revisions do not apply.
- For a non-specific reference, the latest version applies. In the case of a reference to a 3GPP document (including a GSM document), a non-specific reference implicitly refers to the latest version of that document *in the same Release as the present document*.

- [1] 3GPP TR 21.905: "Vocabulary for 3GPP Specifications".
- [2] 3GPP TS 38.101-1: "NR; User Equipment (UE) radio transmission and reception; Part 1: Range 1 Standalone"
- [3] 3GPP TS 38.101-3: "NR; User Equipment (UE) radio transmission and reception; Part 3: Range 1 and Range 2 Interworking operation with other radios"
- [4] Void
- [5] 3GPP TS 38.521-2: "NR; User Equipment (UE) conformance specification; Radio transmission and reception; Part 2: Range 2 Standalone"
- [6] Recommendation ITU-R M.1545: "Measurement uncertainty as it applies to test limits for the terrestrial component of International Mobile Telecommunications-2000"
- [7] ITU-R Recommendation SM.329-10, "Unwanted emissions in the spurious domain"
- [8] 47 CFR Part 30, "UPPER MICROWAVE FLEXIBLE USE SERVICE, §30.202 Power limits", FCC.
- [9] 3GPP TS 38.211: "NR; Physical channels and modulation".
- [10] 3GPP TS 38.213: "NR; Physical layer procedures for control".
- [11] 3GPP TS 38.215: "NR; Physical layer measurements".
- [12] 3GPP TS 38.133: "NR; Requirements for support of radio resource management".
- [13] 3GPP TS 38.331: "NR; Radio Resource Control (RRC); Protocol specification".
- [14] 3GPP TS 38.306: "NR; User Equipment (UE) radio access capabilities".
- [15] IEEE Std 149: "IEEE Standard Test Procedures for Antennas", IEEE.

## 3 Definitions, symbols and abbreviations

### 3.1 Definitions

For the purposes of the present document, the terms and definitions given in 3GPP TR 21.905 [1] and the following apply. A term defined in the present document takes precedence over the definition of the same term, if any, in 3GPP TR 21.905 [1].

**Aggregated Channel Bandwidth:** The RF bandwidth in which a UE is configured to transmit and receive multiple contiguously aggregated carriers.

**Bidirectional spectrum:** UL/DL common spectrum in which the UE supports the configuration of uplink or downlink CCs.

**Beam correspondence:** the ability of the UE to select a suitable beam for UL transmission based on DL measurements with or without relying on UL beam sweeping.

**Carrier aggregation:** Aggregation of two or more component carriers in order to support wider transmission bandwidths.

**Carrier aggregation band:** A set of one or more operating bands across which multiple carriers are aggregated with a specific set of technical requirements.

**Carrier aggregation bandwidth class:** A class defined by the aggregated transmission bandwidth configuration and maximum number of component carriers supported by a UE.

**Carrier aggregation configuration:** A combination of CA operating band(s) and CA bandwidth class(es) supported by a UE.

NOTE: Carriers aggregated in each band can be contiguous or non-contiguous.

**Cumulative aggregated channel bandwidth:** The cumulative aggregated channel bandwidth is defined as the frequency band from the lowest edge of the lowest CC to the upper edge of the highest CC of all UL and DL configured CCs inside the bidirectional spectrum of the UE.

**EIRP(Link=Link angle, Meas=Link angle):** measurement of the UE such that the link angle is aligned with the measurement angle. EIRP (indicator to be measured) can be replaced by EIS, Frequency, EVM, carrier Leakage, In-band emission and OBW.

**EIRP(Link=TX beam peak direction, Meas=Link angle):** measurement of the EIRP of the UE such that the measurement angle is aligned with the beam peak direction within an acceptable measurement error uncertainty. EIRP (indicator to be measured) can be replaced by Frequency, EVM, carrier Leakage, In-band emission and OBW

**EIRP(Link=Spherical coverage grid, Meas=Link angle):** measurement of the EIRP spherical coverage of the UE such that the EIRP link and measurement angles are aligned with the directions along the spherical coverage grid within an acceptable measurement error uncertainty. Alternatively, the spherical coverage grid can be replaced by the beam peak search grid as the results from the Tx beam peak search can be re-used for spherical coverage.

**EIS (effective isotropic sensitivity):** sensitivity for an isotropic directivity device equivalent to the sensitivity of the discussed device exposed to an incoming wave from a defined AoA

**EIS(Link=RX beam peak direction, Meas=Link angle):** measurement of the EIS of the UE such that the measurement angle is aligned with the RX beam peak direction within an acceptable measurement error uncertainty.

NOTE 1: The sensitivity is the minimum received power level at which specific requirement is met.

NOTE 2: Isotropic directivity is equal in all directions (i.e. 0 dBi).

**EIS(Link=Spherical coverage grid, Meas=Link angle):** measurement of the EIS spherical coverage of the UE such that the EIS link and measurement angles are aligned with the directions along the spherical coverage grid within an acceptable measurement error uncertainty. Alternatively, the spherical coverage grid can be replaced by the Rx beam peak search grid as the results from the Rx beam peak search can be re-used for spherical coverage.



**Fallback group:** Group of carrier aggregation bandwidth classes for which it is mandatory for a UE to be able to fallback to lower order CA bandwidth class configuration. It is not mandatory for a UE to be able to fallback to lower order CA bandwidth class configuration that belong to a different fallback group.

**FWA UE:** A UE intended to be used in fixed wireless access scenario.

**Handheld UE:** A UE intended to be used in hand held scenario.

**IBM(Independent Beam Management):** A UE that supports inter-band CA with IBM selects its DL and UL beam(s) for all CCs in each configured band based on DL reference signals measurements made in that band.

**Inter-band carrier aggregation:** Carrier aggregation of component carriers in different operating bands.

NOTE: Carriers aggregated in each band can be contiguous or non-contiguous.

**Intra-band contiguous carrier aggregation:** Contiguous carriers aggregated in the same operating band.

**Intra-band non-contiguous carrier aggregation:** Non-contiguous carriers aggregated in the same operating band.

**Link angle:** a DL-signal AoA from the view point of the UE, as described in Annex J. If the beam lock function is used to lock the UE beam(s), the link angle can become any arbitrary AoA once the beam lock has been activated.

**Measurement angle:** the angle of measurement of the desired metric from the view point of the UE, as described in Annex J

**radiated interface boundary:** operating band specific radiated requirements reference point where the radiated requirements apply

**radiated requirements reference point:** for the RF measurement setup, the radiated requirements reference point is located at the centre of the quiet zone. From the UE perspective the reference point is the input of the UE antenna array

**RedCap UE:** The UE with reduced capabilities as defined in clause 4.2.21.1 from TS38.306 [14]

**RX beam peak direction:** direction where the maximum total component of RSRP and thus best total component of EIS is found

**Sub-block:** This is one contiguous allocated block of spectrum for transmission and reception by the same UE. There may be multiple instances of sub-blocks within an RF bandwidth.

**TX beam peak direction:** direction where the maximum total component of EIRP is found

**TRP(Link=TX beam peak direction, Meas=TRP grid):** measurement of the TRP of the UE such that the measurement angles are aligned with the directions of the TRP grid points within an acceptable measurement uncertainty while the link angle is aligned with the TX beam peak direction

NOTE: For requirements based on EIRP/EIS, the radiated interface boundary is associated to the far-field region

**UE transmission bandwidth configuration:** Set of resource blocks located within the UE channel bandwidth which may be used for transmitting or receiving by the UE.

**Vehicular UE:** A UE embedded in a vehicle

## 3.2 Symbols

For the purposes of the present document, the following symbols apply:

$\Delta\text{EIRP}_{\text{BC}}$	The beam correspondence tolerance, where $\Delta\text{EIRP}_{\text{BC}} = \text{EIRP}_2 - \text{EIRP}_1$
$\Delta\text{F}_{\text{Global}}$	Granularity of the global frequency raster
$\Delta\text{F}_{\text{Raster}}$	Band dependent channel raster granularity
$\Delta\text{f}_{\text{OOB}}$	$\Delta$ Frequency of Out Of Band emission
$\Delta_{\text{RB}}$	The starting frequency offset between the allocated RB and the measured non-allocated RB
$\Delta\text{R}_{\text{IB}}$	Allowed reference sensitivity relaxation due to support for inter-band CA operation
$\Delta\text{R}_{\text{IBC}}$	Allowed reference sensitivity relaxation due to support for intra-band contiguous CA operation
$\Delta\text{R}_{\text{IBNC}}$	Allowed reference sensitivity relaxation due to support for intra-band non-contiguous CA operation

$\Delta R_{IB,P,n}$	Allowed relaxation to reference sensitivity due to support for inter-band CA operation, per supported band in a combination.
$\Delta R_{IB,S,n}$	Allowed relaxation to EIS spherical coverage due to support for inter-band CA operation, per supported band in a combination.
$\Delta T_{IB}$	Allowed relaxation to EIRP requirements due to support for inter-band CA operation
$\Delta T_{IB,P,n}$	Allowed relaxation to peak EIRP requirements due to support for inter-band CA operation, per supported band in a combination.
$\Delta T_{IB,S,n}$	Allowed relaxation to EIRP spherical coverage due to support for inter-band CA operation, per supported band in a combination.
$\Delta MB_{P,n}$	Allowed relaxation to each, minimum peak EIRP and reference sensitivity due to support for multi-band operation, per supported band in a combination.
$\Delta MB_{S,n}$	Allowed relaxation to each, EIRP spherical coverage and EIS spherical coverage due to support for multi-band operation, per supported band in a combination.
$BW_{Channel}$	Channel bandwidth
$BW_{Channel\_CA}$	Aggregated channel bandwidth, expressed in MHz
$BW_{GB}$	$\max( BW_{GB,Channel(k)} )$
$BW_{GB,Channel(k)}$	Minimum guard band defined in sub-clause 5.3A.2 of carrier k
$BW_{interferer}$	Bandwidth of the interferer
$Ceil(x)$	Rounding upwards; $ceil(x)$ is the smallest integer such that $ceil(x) \geq x$
$EIRP_1$	The measured total EIRP based on the beam the UE chooses autonomously (corresponding beam) to transmit in the direction of the incoming DL signal, which is based on beam correspondence without relying on UL beam sweeping
$EIRP_2$	The measured total EIRP based on the beam yielding highest EIRP in a given direction, which is based on beam correspondence with relying on UL beam sweeping
$EIRP_{max}$	The applicable maximum EIRP as specified in sub-clause 6.2.1
$Floor(x)$	Rounding downwards; $floor(x)$ is the greatest integer such that $floor(x) \leq x$
$F_{center}$	The center frequency of an allocated block of PRBs
$F_C$	Center frequency of a carrier for a numerology defined by the <i>RF reference frequency</i> on the channel raster mapped to the carrier according to subclause 5.4.2.2
$F_{C,block,high}$	$F_C$ of the highest transmitted/received carrier in a sub-block.
$F_{C,block,low}$	$F_C$ of the lowest transmitted/received carrier in a sub-block.
$F_{C,low}$	The $F_C$ of the lowest carrier, expressed in MHz.
$F_{C,high}$	The $F_C$ of the highest carrier, expressed in MHz.
$F_{DL\_low}$	The lowest frequency of the downlink <i>operating band</i>
$F_{DL\_high}$	The highest frequency of the downlink <i>operating band</i>
$F_{edge,block,low}$	The lower sub-block edge, where $F_{edge,block,low} = F_{C,block,low} - F_{offset,low}$ .
$F_{edge,block,high}$	The upper sub-block edge, where $F_{edge,block,high} = F_{C,block,high} + F_{offset,high}$ .
$F_{edge,low}$	The lower edge of <i>Aggregated Channel Bandwidth</i> , expressed in MHz. $F_{edge,low} = F_{C,low} - F_{offset,low}$ .
$F_{edge,high}$	The upper edge of <i>Aggregated Channel Bandwidth</i> , expressed in MHz. $F_{edge,high} = F_{C,high} + F_{offset,high}$ .
$F_{interferer}$	Frequency of the interferer
$F_{interferer} (offset)$	Frequency offset of the interferer (between the center frequency of the interferer and the carrier frequency of the carrier measured)
$F_{ioffset}$	Frequency offset of the interferer (between the center frequency of the interferer and the closest edge of the carrier measured)
$Floor(x)$	Rounding downwards; $floor(x)$ is the greatest integer such that $floor(x) \leq x$
$F_{OOB}$	The boundary between the NR out of band emission and spurious emission domains
$F_{REF}$	RF reference frequency
$F_{REF-Offs}$	Offset used for calculating $F_{REF}$
$F_{UL\_low}$	The lowest frequency of the uplink <i>operating band</i>
$F_{UL\_high}$	The highest frequency of the uplink <i>operating band</i>
$F_{UL\_Meas}$	The sub-carrier frequency for which the equalizer coefficient is evaluated
$GB_{Channel}$	Minimum guard band defined in sub-clause 5.3.3, expressed in kHz
$L_{CRB}$	Transmission bandwidth which represents the length of a contiguous resource block allocation expressed in units of resources blocks
$L_{CRB,Max}$	Maximum number of RB for a given Channel bandwidth and sub-carrier spacing
$Max()$	The largest of given numbers
$Min()$	The smallest of given numbers
$MPR_{f,c}$	Maximum output power reduction for carrier $f$ of serving cell $c$
$MPR_{narrow}$	Maximum output power reduction due to narrow PRB allocation
$MPR_{WT}$	Maximum power reduction due to modulation orders, transmit bandwidth configurations, waveform types

$n_{\text{PRB}}$	Physical resource block number
$\text{NR}_{\text{ACLR}}$	NR ACLR
$\text{NR}_{\text{B}}$	Transmission bandwidth configuration, expressed in units of resource blocks
$\text{NR}_{\text{B,low}}$	Transmission bandwidth configurations according to Table 5.3.2-1 for the lowest assigned component carrier in clause 5.3A.1
$\text{NR}_{\text{B,high}}$	Transmission bandwidth configurations according to Table 5.3.2-1 for the highest assigned component carrier in clause 5.3A.1
$\text{N}_{\text{REF}}$	NR Absolute Radio Frequency Channel Number (NR-ARFCN)
$\text{N}_{\text{REF-Offs}}$	Offset used for calculating $\text{N}_{\text{REF}}$
$\text{P}_{\text{CMAX}}$	The configured maximum UE output power
$\text{P}_{\text{CMAX},f,c}$	The configured maximum UE output power for carrier $f$ of serving cell $c$
$\text{P}_{\text{int}}$	The intermediate power point as defined in table 6.3.4.2-2
$\text{P}_{\text{Interferer}}$	Modulated mean power of the interferer
$\text{P}_{\text{max}}$	The maximum UE output power as specified in sub-clause 6.2.1
$\text{P}_{\text{min}}$	The minimum UE output power as specified in sub-clause 6.3.1
$\text{P-MPR}_{f,c}$	The Power Management UE Maximum Power Reduction for carrier $f$ of serving cell $c$
$\text{P}_{\text{PowerClass}}$	Nominal UE power class (i.e., no tolerance) as specified in sub-clause 6.2.1
$\text{P}_{\text{RB}}$	The transmitted power per allocated RB, measured in dBm
$\text{P}_{\text{TMAX},f,c}$	The measured total radiated power for carrier $f$ of serving cell $c$
$\text{P}_{\text{UMAX}}$	The measured configured maximum UE output power
$\text{P}_w$	Power of a wanted DL signal
$\text{RB}_{\text{start}}$	Indicates the lowest RB index of transmitted resource blocks
$\text{SCS}_{\text{low}}$	SCS for the lowest assigned component carrier in clause 5.3A.1, expressed in kHz
$\text{SCS}_{\text{high}}$	SCS for the highest assigned component carrier in clause 5.3A.1, expressed in kHz
$\text{SS}_{\text{REF}}$	SS block reference frequency position
$\text{T}(\Delta\text{P})$	The tolerance $\text{T}(\Delta\text{P})$ for applicable values of $\Delta\text{P}$ (values in dB)
$\text{TRP}_{\text{max}}$	The maximum TRP for the UE power class as specified in sub-clause 6.2.1

### 3.3 Abbreviations

For the purposes of the present document, the abbreviations given in 3GPP TR 21.905 [1] and the following apply. An abbreviation defined in the present document takes precedence over the definition of the same abbreviation, if any, in 3GPP TR 21.905 [1].

ACLR	Adjacent Channel Leakage Ratio
ACS	Adjacent Channel Selectivity
A-MPR	Additional Maximum Power Reduction
AoA	Angle of Arrival
BCS	Bandwidth Combination Set
BPSK	Binary Phase-Shift Keying
BS	Base Station
BW	Bandwidth
BWP	Bandwidth Part
CA	Carrier aggregation
CABW	Cumulative Aggregated Channel Bandwidth
$\text{CA}_{nX-nY}$	Inter-band CA of component carrier(s) in one sub-block within Band X and component carrier(s) in one sub-block within Band Y where X and Y are the applicable NR <i>operating band</i>
CC	Component carrier
CDF	Cumulative Distribution Function
CP-OFDM	Cyclic Prefix-OFDM
CW	Continuous Wave
DFT-s-OFDM	Discrete Fourier Transform-spread-OFDM
DM-RS	Demodulation Reference Signal
DTX	Discontinuous Transmission
EIRP	Effective Isotropic Radiated Power
EIS	Effective Isotropic Sensitivity
EVM	Error Vector Magnitude
FR	Frequency Range
FWA	Fixed Wireless Access
GSCN	Global Synchronization Channel Number
IBB	In-band Blocking

IBM	Independent Beam Management
IDFT	Inverse Discrete Fourier Transformation
ITU-R	Radiocommunication Sector of the International Telecommunication Union
MBW	Measurement bandwidth defined for the protected band
MPR	Allowed maximum power reduction
NR	New Radio
NR-ARFCN	NR Absolute Radio Frequency Channel Number
OCNG	OFDMA Channel Noise Generator
OOB	Out-of-band
OTA	Over The Air
P-MPR	Power Management Maximum Power Reduction
PRB	Physical Resource Block
QAM	Quadrature Amplitude Modulation
RF	Radio Frequency
REFSENS	Reference Sensitivity
RedCap	Reduced Capability
RIB	Radiated Interface Boundary
RMS	Root Mean Square (value)
RSRP	Reference Signal Receiving Power
Rx	Receiver
SCS	Subcarrier spacing
SEM	Spectrum Emission Mask
SRS	Sounding Reference Symbol
SS	Synchronization Symbol
TPC	Transmission Power Control
TRP	Total Radiated Power
Tx	Transmitter
UE	User Equipment
UL MIMO	Uplink Multiple Antenna transmission
ULFPTx	Uplink Full Power Transmission

---

## 4 General

### 4.1 Relationship between minimum requirements and test requirements

The present document is a Single-RAT specification for NR UE, covering RF characteristics and minimum performance requirements. Conformance to the present specification is demonstrated by fulfilling the test requirements specified in the conformance specification 3GPP TS 38.521-2 [5].

The Minimum Requirements given in this specification make no allowance for measurement uncertainty. The test specification TS 38.521-2 [5] defines test tolerances. These test tolerances are individually calculated for each test. The test tolerances are used to relax the minimum requirements in this specification to create test requirements. For some requirements, including regulatory requirements, the test tolerance is set to zero.

The measurement results returned by the test system are compared - without any modification - against the test requirements as defined in 3GPP TS 38.521-2 [5].

### 4.2 Applicability of minimum requirements

- a) In this specification the Minimum Requirements are specified as general requirements and additional requirements. Where the Requirement is specified as a general requirement, the requirement is mandated to be met in all scenarios
- b) For specific scenarios for which an additional requirement is specified, in addition to meeting the general requirement, the UE is mandated to meet the additional requirements.
- c) The spurious emissions power requirements are for the long-term average of the power. For the purpose of reducing measurement uncertainty it is acceptable to average the measured power over a period of time sufficient to reduce the uncertainty due to the statistical nature of the signal
- d) All the requirements for intra-band contiguous and non-contiguous CA apply under the assumption of the same slot format indicated by *TDD-UL-DL-ConfigurationCommon* and *TDD-UL-DL-ConfigurationDedicated* in the PCell and SCells for NR SA.

For FR2 intra-band CA configurations with multiple FR2 sub-blocks, where at least one of the sub-blocks is a contiguous CA configuration:

- if the field *partialFR2-FallbackRX-Req* is not present, the UE shall meet all applicable UE RF requirements for the highest order CA configuration and all associated fallback CA configurations;
- if the field *partialFR2-FallbackRX-Req* is present, for each FR2 intra-band CA configuration with multiple sub-blocks that the UE indicates support for explicitly in UE capability signalling: the in-gap UE RF requirements in clauses 7.5A, 7.5D, 7.6A, 7.6D apply as the equivalent requirements for the associated fallback CA configurations with the same number of sub-blocks, where at least one of the sub-blocks consists of a contiguous CA configuration. The UE shall meet all applicable UE RF requirements for fallback CA configurations with a lesser number of sub-blocks;
- regardless of the field *partialFR2-FallbackRX-Req*, the UE shall meet all DL out-of-gap requirements for all lower order fallback CA configurations.

### 4.3 Specification suffix information

Unless stated otherwise the following suffixes are used for indicating at 2<sup>nd</sup> level clause, shown in Table 4.3-1.

**Table 4.3-1: Definition of suffixes**

<b>Clause suffix</b>	<b>Variant</b>
None	Single Carrier
A	Carrier Aggregation (CA)
B	Dual-Connectivity (DC)
C	Supplement Uplink (SUL)
D	UL MIMO
NOTE:	Suffix D in this specification represents either polarized UL MIMO or spatial UL MIMO. RF requirements are same. If UE supports both kinds of UL MIMO, then RF requirements only need to be verified under either polarized or spatial UL MIMO.

## 5 Operating bands and channel arrangement

### 5.1 General

The channel arrangements presented in this clause are based on the operating bands and channel bandwidths defined in the present release of specifications.

NOTE: Other operating bands and channel bandwidths may be considered in future releases.

Requirements throughout the RF specifications are in many cases defined separately for different frequency ranges (FR). The frequency ranges in which NR can operate according to this version of the specification are identified as described in Table 5.1-1. Whenever the FR2 is referred, both FR2-1 and FR2-2 frequency sub-ranges shall be considered, unless otherwise stated.

**Table 5.1-1: Definition of frequency ranges**

Frequency range designation		Corresponding frequency range
FR1		410 MHz – 7125 MHz
FR2	FR2-1	24250 MHz – 52600 MHz
	FR2-2	52600 MHz – 71000 MHz

The present specification covers FR2 operating bands.

### 5.2 Operating bands

NR is designed to operate in the FR2 operating bands defined in Table 5.2-1.

**Table 5.2-1: NR operating bands in FR2**

Operating Band	Uplink (UL) operating band BS receive UE transmit	Downlink (DL) operating band BS transmit UE receive	Duplex Mode
	F <sub>UL_low</sub> – F <sub>UL_high</sub>	F <sub>DL_low</sub> – F <sub>DL_high</sub>	
n257	26500 MHz – 29500 MHz	26500 MHz – 29500 MHz	TDD
n258	24250 MHz – 27500 MHz	24250 MHz – 27500 MHz	TDD
n259	39500 MHz – 43500 MHz	39500 MHz – 43500 MHz	TDD
n260	37000 MHz – 40000 MHz	37000 MHz – 40000 MHz	TDD
n261	27500 MHz – 28350 MHz	27500 MHz – 28350 MHz	TDD
n262	47200 MHz – 48200 MHz	47200 MHz – 48200 MHz	TDD
n263	57000 MHz – 71000 MHz	57000 MHz – 71000 MHz	TDD <sup>1</sup>
NOTE 1: This band is for unlicensed operation and subject to regional and/or country specific regulatory requirements.			

#### 5.2A Operating bands for CA

##### 5.2A.1 Intra-band CA

NR intra-band contiguous and non-contiguous carrier aggregation is designed to operate in the operating bands defined in Table 5.2A.1-1, where all operating bands are within FR2.

**Table 5.2A.1-1: Intra-band contiguous and non-contiguous CA operating bands in FR2**

NR CA Band	NR Band (Table 5.2-1)
CA_n257	n257
CA_n258	n258
CA_n259	n259
CA_n260	n260
CA_n261	n261
CA_n263 <sup>1</sup>	n263
NOTE 1: In this release of the specification, only contiguous CA is applicable for this operating band.	

## 5.2A.2 Inter-band CA

NR inter-band carrier aggregation is designed to operate in the operating bands defined in Table 5.2A.2-1, where all operating bands are within FR2.

Beam management type is according to UE capability declaration *IE beamManagementType-r16* or *beamManagementType-CBM-r17*. The requirements in the following clauses are only applicable to inter-band CA with IBM type.

**Table 5.2A.2-1: Inter-band CA operating bands in FR2**

NR CA Band	NR Band (Table 5.2-1)
CA_n257-n259 <sup>1</sup>	n257, n259
CA_n258-n260 <sup>1</sup>	n258, n260
CA_n258-n261 <sup>1</sup>	n258, n261
CA_n260-n261 <sup>1</sup>	n260, n261
NOTE 1: The minimum requirements apply only when there is non-simultaneous Rx/Tx operation between inter-band NR carriers in the current version of this specification.	

## 5.2D Operating bands for UL MIMO

NR UL MIMO is designed to operate in the operating bands defined in Table 5.2D-1.

**Table 5.2D-1: NR UL MIMO operating bands**

UL MIMO operating band (Table 5.2-1)
n257
n258
n259
n260
n261
n262

## 5.3 UE Channel bandwidth

### 5.3.1 General

The UE channel bandwidth supports a single NR RF carrier in the uplink or downlink at the UE. From a BS perspective, different UE channel bandwidths may be supported within the same spectrum for transmitting to and receiving from UEs connected to the BS. Transmission of multiple carriers to the same UE (CA) or multiple carriers to different UEs within the BS channel bandwidth can be supported.



From a UE perspective, the UE is configured with one or more BWP / carriers, each with its own UE channel bandwidth. The UE does not need to be aware of the BS channel bandwidth or how the BS allocates bandwidth to different UEs.

The placement of the UE channel bandwidth for each UE carrier is flexible but can only be completely within the BS channel bandwidth.

The relationship between the channel bandwidth, the guardband and the transmission bandwidth configuration is shown in Figure 5.3.1-1.

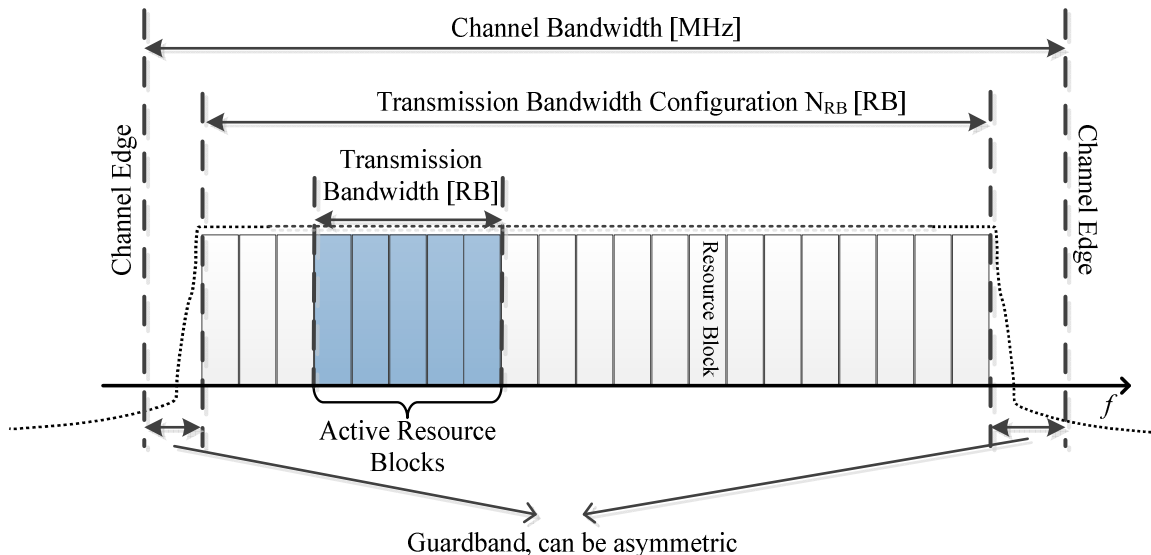


Figure 5.3.1-1: Definition of channel bandwidth and transmission bandwidth configuration for one NR channel

### 5.3.2 Maximum transmission bandwidth configuration

The maximum transmission bandwidth configuration  $N_{RB}$  for each UE channel bandwidth and subcarrier spacing is specified in Table 5.3.2-1

Table 5.3.2-1: Maximum transmission bandwidth configuration  $N_{RB}$

SCS (kHz)	50 MHz	100 MHz	200 MHz	400 MHz	800 MHz	1600 MHz	2000 MHz
	$N_{RB}$	$N_{RB}$	$N_{RB}$	$N_{RB}$	$N_{RB}$	$N_{RB}$	$N_{RB}$
60	66	132	264	N/A	N/A	N/A	N/A
120	32	66	132	264	N/A	N/A	N/A
480 <sup>1</sup>	N/A	N/A	N/A	66	124	248	N/A
960 <sup>1</sup>	N/A	N/A	N/A	33	62	124	148

Note 1: This SCS is optional in this release of the specification.

### 5.3.3 Minimum guardband and transmission bandwidth configuration

The minimum guardband for each UE channel bandwidth and SCS is specified in Table 5.3.3-1.

Table 5.3.3-1: Minimum guardband for each UE channel bandwidth and SCS (kHz)

SCS (kHz)	50 MHz	100 MHz	200 MHz	400 MHz	800 MHz	1600 MHz	2000 MHz
60	1210	2450	4930	N/A	N/A	N/A	N/A
120	1900	2420	4900	9860	N/A	N/A	N/A
480	N/A	N/A	N/A	9680	42640	85520	N/A
960	N/A	N/A	N/A	9440	42400	85280	147040

NOTE: The minimum guardbands have been calculated using the following equation:  $GB_{channel} = (BW_{Channel} \times 1000 \text{ (kHz)} - N_{RB} \times SCS \times 12) / 2 - SCS/2$ , where  $N_{RB}$  are from Table 5.3.2-1 and  $GB_{channel}$  expressed in kHz.

The minimum guardband of receiving BS SCS 240 kHz SS/PBCH block for each UE channel bandwidth is specified in table 5.3.3-2 for FR2.

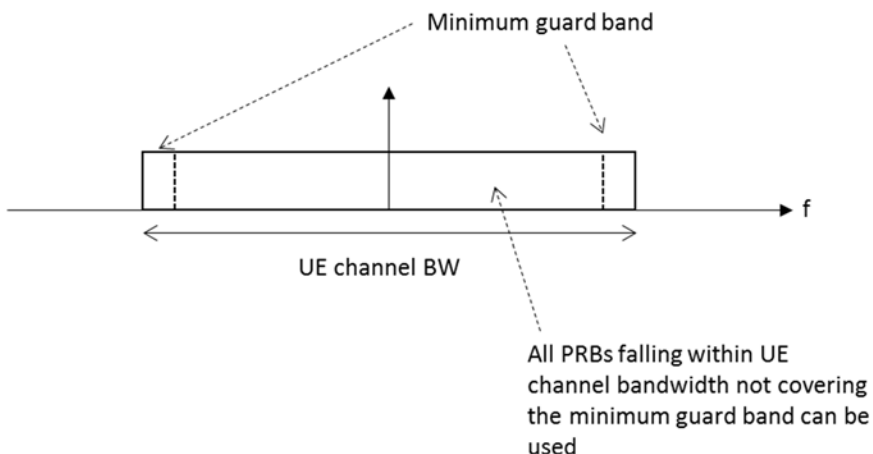
**Table: 5.3.3-2: Minimum guardband (kHz) of SCS 240 kHz SS/PBCH block in FR2-1**

SCS (kHz)	100 MHz	200 MHz	400 MHz
240	3800	7720	15560

NOTE: In FR2-1, the minimum guardband in Table 5.3.3-2 is applicable only when the SCS 240 kHz SS/PBCH block is received adjacent to the edge of the UE channel bandwidth within which the SS/PBCH block is located.

**Figure 5.3.3-1: Void**

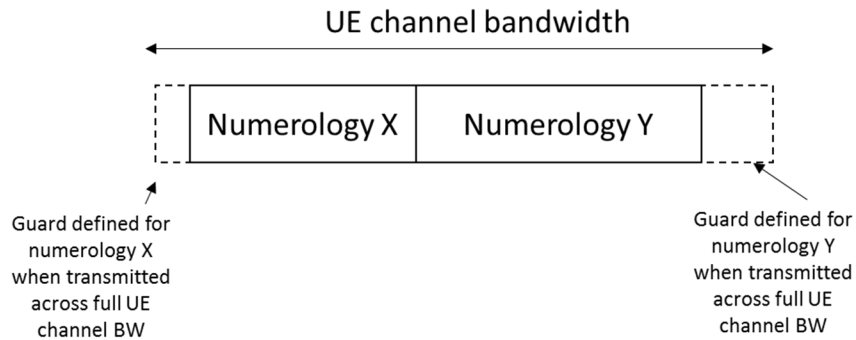
The number of RBs configured in any channel bandwidth shall ensure that the minimum guardband specified in this clause is met.



**Figure 5.3.3-2 UE PRB utilization**

In the case that multiple numerologies are multiplexed in the same symbol due to BS transmission of SSB, the minimum guardband on each side of the carrier is the guardband applied at the configured channel bandwidth for the numerology that is transmitted immediately adjacent to the guard band.

If multiple numerologies are multiplexed in the same symbol and the UE channel bandwidth is > 200 MHz, the minimum guardband applied adjacent to 60 kHz SCS shall be the same as the minimum guardband defined for 120 kHz SCS for the same UE channel bandwidth.



**Figure 5.3.3-3 Guard band definition when transmitting multiple numerologies**

Note: Figure 5.3.3-3 is not intended to imply the size of any guard between the two numerologies. Inter-numerology guard band within the carrier is implementation dependent.

### 5.3.4 RB alignment

For each numerology, its common resource blocks are specified in Clause 4.4.4.3 in [9], and the starting point of its transmission bandwidth configuration on the common resource block grid for a given channel bandwidth is indicated by an offset to "Reference point A" in the unit of the numerology. The *UE transmission bandwidth configuration* is indicated by the higher layer parameter *carrierBandwidth* [13] and will fulfil the minimum UE guardband requirement specified in Clause 5.3.3.

### 5.3.5 Channel bandwidth per operating band

The requirements in this specification apply to the combination of channel bandwidths, SCS and operating bands shown in Table 5.3.5-1. The transmission bandwidth configuration in Table 5.3.2-1 shall be supported for each of the specified channel bandwidths. The channel bandwidths are specified for both the Tx and Rx path.

**Table 5.3.5-1: Channel bandwidths for each NR band**

Operating band	SCS (kHz)	UE channel bandwidth (MHz)						
		50	100	200	400	800	1600	2000
n257	60	50	100	200				
	120	50	100	200	400 <sup>1</sup>			
n258	60	50	100	200				
	120	50	100	200	400 <sup>1</sup>			
n259	60	50	100	200				
	120	50	100	200	400 <sup>1</sup>			
n260	60	50	100	200				
	120	50	100	200	400 <sup>1</sup>			
n261	60	50	100	200				
	120	50	100	200	400 <sup>1</sup>			
n262	60	50	100	200				
	120	50	100	200	400 <sup>1</sup>			
n263	120		100		400			
	480 <sup>2</sup>				400	800 <sup>1</sup>	1600 <sup>1</sup>	
	960 <sup>2</sup>				400	800 <sup>1</sup>	1600 <sup>1</sup>	2000 <sup>1</sup>

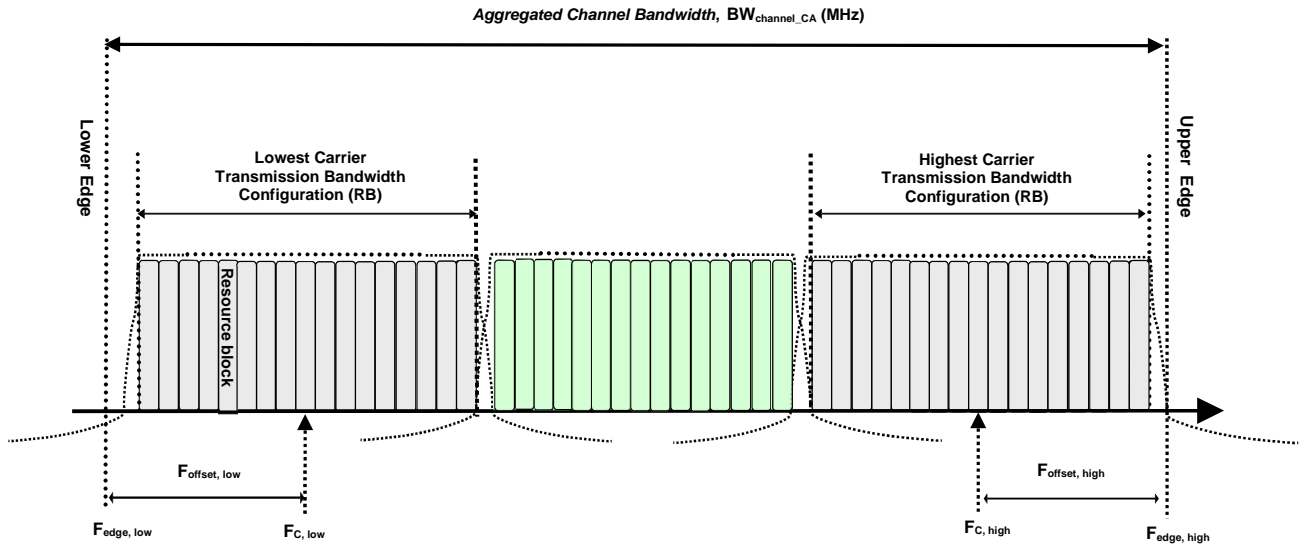
NOTE 1: This UE channel bandwidth is optional in this release of the specification.  
 NOTE 2: This SCS is optional in this release of the specification.

## 5.3A UE channel bandwidth for CA

### 5.3A.1 General

### 5.3A.2 Minimum guardband and transmission bandwidth configuration for CA

For intra-band contiguous carrier aggregation, *Aggregated Channel Bandwidth* and *Guard Bands* are defined as follows, see Figure 5.3A.2-1.



**Figure 5.3A.2-1: Definition of *Aggregated Channel Bandwidth* for intra-band carrier aggregation**

The *aggregated channel bandwidth*,  $BW_{\text{Channel\_CA}}$ , is defined as

$$BW_{\text{Channel\_CA}} = F_{\text{edge,high}} - F_{\text{edge,low}} \text{ (MHz)}.$$

The lower bandwidth edge  $F_{\text{edge,low}}$  and the upper bandwidth edge  $F_{\text{edge,high}}$  of the aggregated channel bandwidth are used as frequency reference points for transmitter and receiver requirements and are defined by

$$F_{\text{edge,low}} = F_{\text{c,low}} - F_{\text{offset,low}}$$

$$F_{\text{edge,high}} = F_{\text{c,high}} + F_{\text{offset,high}}$$

The lower and upper frequency offsets depend on the transmission bandwidth configurations of the lowest and highest assigned edge component carrier and are defined as

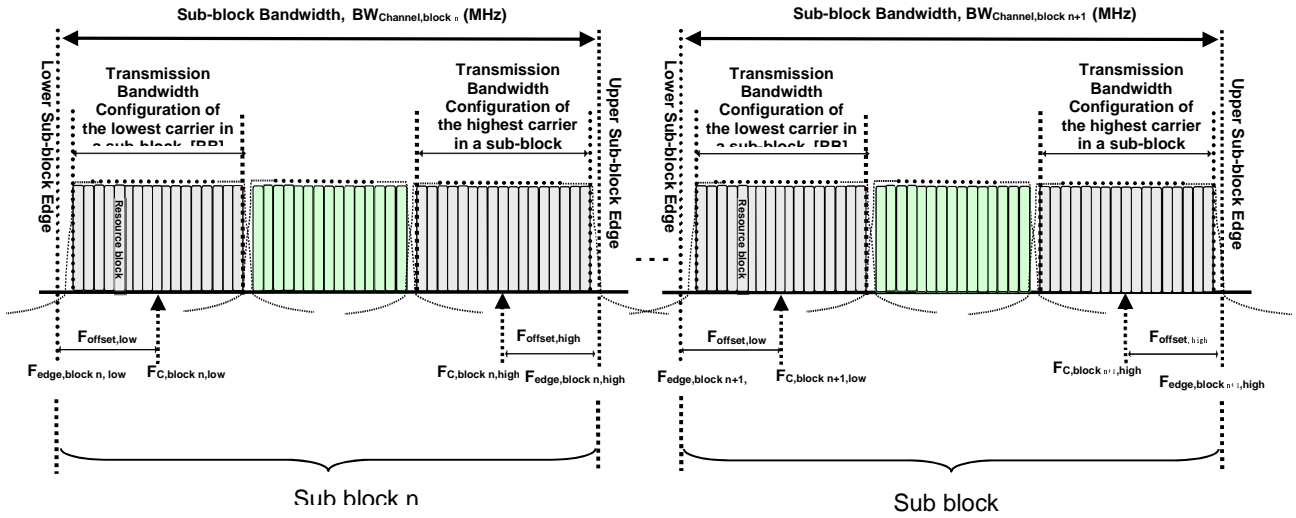
$$F_{\text{offset,low}} = (N_{\text{RB,low}} * 12 + 1) * SCS_{\text{low}} / 2 + BW_{\text{GB}} \text{ (MHz)}$$

$$F_{\text{offset,high}} = (N_{\text{RB,high}} * 12 - 1) * SCS_{\text{high}} / 2 + BW_{\text{GB}} \text{ (MHz)}$$

$$BW_{\text{GB}} = \max(BW_{\text{GB,Channel}(k)})$$

$N_{\text{RB,low}}$  and  $N_{\text{RB,high}}$  are the transmission bandwidth configurations according to Table 5.3.2-1 for the lowest and highest assigned component carrier,  $SCS_{\text{low}}$  and  $SCS_{\text{high}}$  are the sub-carrier spacing for the lowest and highest assigned component carrier respectively.  $SCS_{\text{low}}$ ,  $SCS_{\text{high}}$ ,  $N_{\text{RB,low}}$ ,  $N_{\text{RB,high}}$ , and  $BW_{\text{GB,Channel}(k)}$  use the largest  $\mu$  value among the subcarrier spacing configurations supported in the operating band for both of the channel bandwidths according to Table 5.3.5-1 and  $BW_{\text{GB,Channel}(k)}$  is the minimum guard band for carrier  $k$  according to Table 5.3.3-1 for the said  $\mu$  value.

For intra-band non-contiguous carrier aggregation *Sub-block Bandwidth* and *Sub-block edges* are defined as follows, see Figure 5.3A.2-2.



**Figure 5.3A.2-2: Definition of sub-block bandwidth for intra-band non-contiguous spectrum**

The lower sub-block edge of the Sub-block Bandwidth ( $BW_{\text{Channel,block}}$ ) is defined as

$$F_{\text{edge,block,low}} = F_{\text{C,block,low}} - F_{\text{offset,low}}$$

The upper sub-block edge of the Sub-block Bandwidth is defined as

$$F_{\text{edge,block,high}} = F_{\text{C,block,high}} + F_{\text{offset,high}}$$

The Sub-block Bandwidth,  $BW_{\text{Channel,block}}$ , is defined as follows:

$$BW_{\text{Channel,block}} = F_{\text{edge,block,high}} - F_{\text{edge,block,low}} \text{ (MHz)}$$

The lower and upper frequency offsets  $F_{\text{offset,block,low}}$  and  $F_{\text{offset,block,high}}$  depend on the transmission bandwidth configurations of the lowest and highest assigned edge component carriers within a sub-block and are defined as

$$F_{\text{offset,block,low}} = (N_{\text{RB,low}} * 12 + 1) * SCS_{\text{low}} / 2 + BW_{\text{GB}} \text{ (MHz)}$$

$$F_{\text{offset,block,high}} = (N_{\text{RB,high}} * 12 - 1) * SCS_{\text{high}} / 2 + BW_{\text{GB}} \text{ (MHz)}$$

$$BW_{\text{GB}} = \max(BW_{\text{GB,Channel}(k)})$$

where  $N_{\text{RB,low}}$  and  $N_{\text{RB,high}}$  are the transmission bandwidth configurations according to Table 5.3.2-1 for the lowest and highest assigned component carrier within a sub-block, respectively.  $SCS_{\text{low}}$  and  $SCS_{\text{high}}$  are the sub-carrier spacing for the lowest and highest assigned component carrier within a sub-block, respectively.  $SCS_{\text{low}}$ ,  $SCS_{\text{high}}$ ,  $N_{\text{RB,low}}$ ,  $N_{\text{RB,high}}$ , and  $BW_{\text{GB,Channel}(k)}$  use the largest  $\mu$  value among the subcarrier spacing configurations supported in the operating band for both of the channel bandwidths according to Table 5.3.5-1 and  $BW_{\text{GB,Channel}(k)}$  is the minimum guard band for carrier  $k$  according to Table 5.3.3-1 for the said  $\mu$  value.

The sub-block gap size between two consecutive sub-blocks  $W_{\text{gap}}$  is defined as

$$W_{\text{gap}} = F_{\text{edge,block } n+1,\text{low}} - F_{\text{edge,block } n,\text{high}} \text{ (MHz)}$$

### 5.3A.3 RB alignment with different numerologies for CA

### 5.3A.4 UE channel bandwidth per operating band for CA

For intra-band contiguous carrier aggregation, a carrier aggregation configuration is a single operating band supporting a carrier aggregation bandwidth class with associated bandwidth combination sets specified in clause 5.5A.1. For each carrier aggregation configuration, requirements are specified for all aggregated channel bandwidths contained in a bandwidth combination set, UE can indicate support of several bandwidth combination sets per carrier aggregation configuration. The requirements are applicable only when Uplink CCs are configured within the frequency range between lower edge of lowest downlink component carrier and upper edge of highest downlink component carrier.

For intra-band non-contiguous carrier aggregation, a carrier aggregation configuration is a single operating band supporting two or more sub-blocks, each supporting a carrier aggregation bandwidth class. The requirements are applicable only when Uplink CCs in each UL sub-block are configured within the frequency range between lower edge of lowest downlink component carrier and upper edge of highest downlink component carrier of a DL sub-block.

Frequency separation class (Fs) specified in Table 5.3A.4-2 indicates the maximum frequency span between lower edge of lowest component carrier and upper edge of highest component carrier that UE can support per band in downlink or uplink (DL Fs or UL Fs) respectively in non-contiguous intra-band operation within the bidirectional spectrum.

The DL-only frequency spectrum is the width of UE frequency spectrum available to network to configure DL CCs only, and it extends on one-side of the bidirectional spectrum in contiguous manner with no frequency gap between the two. Frequency separation class for DL-only spectrum (Fsd) specified in Table 5.3A.4-3 and is declared per band. The frequency separation class for DL-only spectrum (Fsd) can be equal but not larger than the frequency separation (DL Fs). The combined downlink spectrum (DL Fs + Fsd) cannot exceed 2400 MHz. A UE may configure DL-only spectrum only if the combined downlink spectrum (DL Fs + Fsd) exceeds 1400 MHz. When a UE configures DL-only spectrum, it shall not expect a CC to be configured across the boundary between bidirectional spectrum and DL-only spectrum UE can support respectively.

For inter-band carrier aggregation, a carrier aggregation configuration is a combination of operating bands, each supporting a carrier aggregation bandwidth class.

Table 5.3A.4-1: CA bandwidth classes

NR CA bandwidth class	Aggregated channel bandwidth	Number of contiguous CC	Fallback group
A	$BW_{\text{Channel}} \leq 400 \text{ MHz}$	1	1,2,3,4,5
B	$400 \text{ MHz} < BW_{\text{Channel\_CA}} \leq 800 \text{ MHz}$	2	1
C	$800 \text{ MHz} < BW_{\text{Channel\_CA}} \leq 1200 \text{ MHz}$	3	
V (Note 4)	$1200 \text{ MHz} < BW_{\text{Channel\_CA}} \leq 1600 \text{ MHz}$	4	
W (Note 4)	$1600 \text{ MHz} < BW_{\text{Channel\_CA}} \leq 2000 \text{ MHz}$	5	
D	$200 \text{ MHz} < BW_{\text{Channel\_CA}} \leq 400 \text{ MHz}$	2	2
E	$400 \text{ MHz} < BW_{\text{Channel\_CA}} \leq 600 \text{ MHz}$	3	
F	$600 \text{ MHz} < BW_{\text{Channel\_CA}} \leq 800 \text{ MHz}$	4	
R	$800 \text{ MHz} < BW_{\text{Channel\_CA}} \leq 1000 \text{ MHz}$	5	
S	$1000 \text{ MHz} < BW_{\text{Channel\_CA}} \leq 1200 \text{ MHz}$	6	
T	$1200 \text{ MHz} < BW_{\text{Channel\_CA}} \leq 1400 \text{ MHz}$	7	
U	$1400 \text{ MHz} < BW_{\text{Channel\_CA}} \leq 1600 \text{ MHz}$	8	
G	$100 \text{ MHz} < BW_{\text{Channel\_CA}} \leq 200 \text{ MHz}$	2	3
H	$200 \text{ MHz} < BW_{\text{Channel\_CA}} \leq 300 \text{ MHz}$	3	
I	$300 \text{ MHz} < BW_{\text{Channel\_CA}} \leq 400 \text{ MHz}$	4	
J	$400 \text{ MHz} < BW_{\text{Channel\_CA}} \leq 500 \text{ MHz}$	5	
K	$500 \text{ MHz} < BW_{\text{Channel\_CA}} \leq 600 \text{ MHz}$	6	
L	$600 \text{ MHz} < BW_{\text{Channel\_CA}} \leq 700 \text{ MHz}$	7	
M	$700 \text{ MHz} < BW_{\text{Channel\_CA}} \leq 800 \text{ MHz}$	8	
O	$100 \text{ MHz} \leq BW_{\text{Channel\_CA}} \leq 200 \text{ MHz}$	2	4
P	$150 \text{ MHz} \leq BW_{\text{Channel\_CA}} \leq 300 \text{ MHz}$	3	
Q	$200 \text{ MHz} \leq BW_{\text{Channel\_CA}} \leq 400 \text{ MHz}$	4	
R2	$200 \text{ MHz} \leq BW_{\text{Channel\_CA}} \leq 400 \text{ MHz}$	2	5
R3	$300 \text{ MHz} \leq BW_{\text{Channel\_CA}} \leq 600 \text{ MHz}$	3	
R4	$400 \text{ MHz} \leq BW_{\text{Channel\_CA}} \leq 800 \text{ MHz}$	4	
R5	$500 \text{ MHz} \leq BW_{\text{Channel\_CA}} \leq 1000 \text{ MHz}$	5	
R6	$600 \text{ MHz} \leq BW_{\text{Channel\_CA}} \leq 1200 \text{ MHz}$	6	
R7	$700 \text{ MHz} \leq BW_{\text{Channel\_CA}} \leq 1400 \text{ MHz}$	7	
R8	$800 \text{ MHz} \leq BW_{\text{Channel\_CA}} \leq 1600 \text{ MHz}$	8	
R9	$900 \text{ MHz} \leq BW_{\text{Channel\_CA}} \leq 1800 \text{ MHz}$	9	
R10	$1000 \text{ MHz} \leq BW_{\text{Channel\_CA}} \leq 2000 \text{ MHz}$	10	
R11	$1100 \text{ MHz} \leq BW_{\text{Channel\_CA}} \leq 2200 \text{ MHz}$	11	
R12	$1200 \text{ MHz} \leq BW_{\text{Channel\_CA}} \leq 2400 \text{ MHz}$	12	
<p>NOTE 1: Maximum supported component carrier bandwidths for fallback groups 1, 2, 3, 4 and 5 are 400 MHz, 200 MHz, 100 MHz, 100 MHz and 200 MHz respectively except for CA bandwidth class A. For CA bandwidth classes of fallback groups 1, 2, 3, 4 and 5, the minimum requirements apply for the cases in which each CA bandwidth class consists of up to two contiguous blocks of spectrum each with one or more contiguous component carriers of a single channel bandwidth.</p> <p>NOTE 2: It is mandatory for a UE to be able to fallback to lower order CA bandwidth class configuration within a fallback group. It is not mandatory for a UE to be able to fallback to lower order CA bandwidth class configuration that belong to a different fallback group.</p> <p>NOTE 3: In this release of the specification, the minimum requirements for intra-band contiguous CA configurations apply for aggregated channel bandwidths up to 1600 MHz for FR2-1 (this note is not relevant for UE capability parsing by the network).</p> <p>NOTE 4: This bandwidth class is applicable only for operating bands within FR2-2.</p>			

**Table 5.3A.4-2: Frequency separation classes for non-contiguous intra-band operation**

Frequency separation class	Max. allowed frequency separation (Fs)
I	800 MHz
II	1200 MHz
III	1400 MHz
IV	1000 MHz
V	1600 MHz
VI	1800 MHz
VII	2000 MHz
VIII	2200 MHz
IX	2400 MHz
X	400 MHz
XI	600 MHz
NOTE 1: Fs values larger than 1400 MHz apply only to downlink frequency separation.	

**Table 5.3A.4-3: Frequency separation classes for DL-only spectrum**

Frequency separation class	Max. allowed frequency separation (Fsd)
I	200 MHz
II	400 MHz
III	600 MHz
IV	800 MHz
V	1000 MHz
VI	1200 MHz

## 5.3D Channel bandwidth for UL MIMO

The requirements specified in clause 5.3 are applicable to UE supporting UL MIMO.

## 5.4 Channel arrangement

### 5.4.1 Channel spacing

#### 5.4.1.1 Channel spacing for adjacent NR carriers

The spacing between carriers will depend on the deployment scenario, the size of the frequency block available and the channel bandwidths. The nominal channel spacing between two adjacent NR carriers is defined as following:

For NR operating bands with 60 kHz channel raster,

$$\text{Nominal Channel spacing} = (\text{BW}_{\text{Channel}(1)} + \text{BW}_{\text{Channel}(2)})/2 + \{-20 \text{ kHz}, 0 \text{ kHz}, 20 \text{ kHz}\} \text{ for } \Delta F_{\text{Raster}} \text{ equals to } 60 \text{ kHz}$$

$$\text{Nominal Channel spacing} = (\text{BW}_{\text{Channel}(1)} + \text{BW}_{\text{Channel}(2)})/2 + \{-40 \text{ kHz}, 0 \text{ kHz}, 40 \text{ kHz}\} \text{ for } \Delta F_{\text{Raster}} \text{ equals to } 120 \text{ kHz}$$

For operating band n263,

$$\text{Nominal Channel spacing} = \text{ceil}((\text{BW}_{\text{Channel}(1)} + \text{BW}_{\text{Channel}(2)})/100.8) * 50.4 \text{ MHz},$$

where  $\text{BW}_{\text{Channel}(1)}$  and  $\text{BW}_{\text{Channel}(2)}$  are the channel bandwidths of the two respective NR carriers. The channel spacing can be adjusted depending on the channel raster to optimize performance in a particular deployment scenario.



## 5.4.2 Channel raster

### 5.4.2.1 NR-ARFCN and channel raster

The global frequency raster defines a set of RF reference frequencies  $F_{\text{REF}}$ . The RF reference frequency is used in signalling to identify the position of RF channels, SS blocks and other elements.

The global frequency raster is defined for all frequencies from 0 to 100 GHz. The granularity of the global frequency raster is  $\Delta F_{\text{Global}}$ .

RF reference frequency is designated by an NR Absolute Radio Frequency Channel Number (NR-ARFCN) in the range [2016667...3279165] on the global frequency raster. The relation between the NR-ARFCN and the RF reference frequency  $F_{\text{REF}}$  in MHz is given by the following equation, where  $F_{\text{REF-Offs}}$  and  $N_{\text{REF-Offs}}$  are given in table 5.4.2.1-1 and  $N_{\text{REF}}$  is the NR-ARFCN

$$F_{\text{REF}} = F_{\text{REF-Offs}} + \Delta F_{\text{Global}} (N_{\text{REF}} - N_{\text{REF-Offs}})$$

**Table 5.4.2.1-1: NR-ARFCN parameters for the global frequency raster**

Frequency range (MHz)	$\Delta F_{\text{Global}}$ (kHz)	$F_{\text{REF-Offs}}$ [MHz]	$N_{\text{REF-Offs}}$	Range of $N_{\text{REF}}$
24250 – 100000	60	24250.08	2016667	2016667 – 3279165

The *channel raster* defines a subset of RF reference frequencies that can be used to identify the RF channel position in the uplink and downlink. The RF reference frequency for an RF channel maps to a resource element on the carrier. For each operating band, a subset of frequencies from the global frequency raster are applicable for that band and forms a channel raster with a granularity  $\Delta F_{\text{Raster}}$ , which may be equal to or larger than  $\Delta F_{\text{Global}}$ .

The mapping between the channel raster and corresponding resource element is given in Clause 5.4.2.2. The applicable entries for each operating band are defined in clause 5.4.2.3

### 5.4.2.2 Channel raster to resource element mapping

The mapping between the RF reference frequency on channel raster and the corresponding resource element is given in Table 5.4.2.2-1 and can be used to identify the RF channel position. The mapping depends on the total number of RBs that are allocated in the channel and applies to both UL and DL. The mapping must apply to at least one numerology supported by the UE.

**Table 5.4.2.2-1: Channel raster to resource element mapping**

Resource element index $k$	$N_{\text{RB}} \bmod 2 = 0$	$N_{\text{RB}} \bmod 2 = 1$
Physical resource block number $n_{\text{PRB}}$	$n_{\text{PRB}} = \left\lfloor \frac{N_{\text{RB}}}{2} \right\rfloor$	$n_{\text{PRB}} = \left\lfloor \frac{N_{\text{RB}}}{2} \right\rfloor$

$k$ ,  $n_{\text{RB}}$ ,  $N_{\text{RB}}$  are as defined in TS 38.211 [9].

### 5.4.2.3 Channel raster entries for each operating band

The RF channel positions on the channel raster in each NR operating band are given through the applicable NR-ARFCN in Table 5.4.2.3-1, using the channel raster to resource element mapping in clause 5.4.2.2.

- For NR operating bands with 60 kHz channel raster above 24 GHz,  $\Delta F_{\text{Raster}} = I \times \Delta F_{\text{Global}}$ , where  $I \in \{1, 2\}$ . Every  $I^{\text{th}}$  NR-ARFCN within the operating band are applicable for the channel raster within the operating band and the step size for the channel raster in table 5.4.2.3-1 is given as  $\langle I \rangle$ .
- In frequency bands with two  $\Delta F_{\text{Raster}}$ , the higher  $\Delta F_{\text{Raster}}$  applies to channels using only the SCS that equals the higher  $\Delta F_{\text{Raster}}$  and the SSB SCS that is equal to or larger than the higher  $\Delta F_{\text{Raster}}$ .

**Table 5.4.2.3-1: Applicable NR-ARFCN per operating band**

Operating Band	$\Delta F_{\text{Raster}}$ (kHz)	Uplink and Downlink Range of $N_{\text{REF}}$ (First – <Step size> – Last)
n257	60	2054166 – <1> – 2104165
	120	2054167 – <2> – 2104165
n258	60	2016667 – <1> – 2070832
	120	2016667 – <2> – 2070831
n259	60	2270833 – <1> – 2337499
	120	2270833 – <2> – 2337499
n260	60	2229166 – <1> – 2279165
	120	2229167 – <2> – 2279165
n261	60	2070833 – <1> – 2084999
	120	2070833 – <2> – 2084999
n262	60	2399166 – <1> – 2415832
	120	2399167 – <2> – 2415831
n263	120	See Table 5.4.2.3-2
	480	
	960	

**Table 5.4.2.3-2: Applicable NR-ARFCN for operation in band n263**

Channel Bandwidth	Applicable NR-ARFCN
100 MHz	2564083 + 1680 * N, N = 0:137
400 MHz	2566603 + 6720 * N, N = 0:33
800 MHz	2569963 + 6720 * N, N = 0:32
1600 MHz	2576683 + 6720 * N, N = 0:30
2000 MHz	2580043 + 6720 * N, N = 0:29, 2585083, 2655643, 2692603, 2764843

## 5.4.3 Synchronization raster

### 5.4.3.1 Synchronization raster and numbering

The synchronization raster indicates the frequency positions of the synchronization block that can be used by the UE for system acquisition when explicit signalling of the synchronization block position is not present.

A global synchronization raster is defined for all frequencies. The frequency position of the SS block is defined as  $SS_{\text{REF}}$  with corresponding number GSCN. The parameters defining the  $SS_{\text{REF}}$  and GSCN for all the frequency ranges are in Table 5.4.3.1-1.

The resource element corresponding to the SS block reference frequency  $SS_{\text{REF}}$  is given in clause 5.4.3.2. The synchronization raster and the subcarrier spacing of the synchronization block is defined separately for each band.

**Table 5.4.3.1-1: GSCN parameters for the global frequency raster**

Frequency range	SS block frequency position $SS_{\text{REF}}$	GSCN	Range of GSCN
24250 – 100000 MHz	24250.08 MHz + N * 17.28 MHz, N = 0:4383	22256 + N	22256 – 26639

### 5.4.3.2 Synchronization raster to synchronization block resource element mapping

The mapping between the synchronization raster and the corresponding resource element of the SS block is given in Table 5.4.3.2-1.

**Table 5.4.3.2-1: Synchronization raster to SS block resource element mapping**

Resource element index $k$	120
----------------------------	-----

$k$  is the subcarrier number of SS/PBCH block defined in TS 38.211 clause 7.4.3.1 [9].

### 5.4.3.3 Synchronization raster entries for each operating band

The synchronization raster for each band is give in Table 5.4.3.3-1. The distance between applicable GSCN entries is given by the <Step size> indicated in Table 5.4.3.3-1.

**Table 5.4.3.3-1: Applicable SS raster entries per operating band**

NR Operating Band	SS Block SCS	SS Block pattern <sup>1</sup>	Range of GSCN (First – <Step size> – Last)
n257	120 kHz	Case D	22388 - <1> - 22558
	240 kHz	Case E	22390 - <2> - 22556
n258	120 kHz	Case D	22257 - <1> - 22443
	240 kHz	Case E	22258 - <2> - 22442
n259	120 kHz	Case D	23140 – <1> – 23369
	240 kHz	Case E	23142 – <2> – 23368
n260	120 kHz	Case D	22995 - <1> - 23166
	240 kHz	Case E	22996 - <2> - 23164
n261	120 kHz	Case D	22446 - <1> - 22492
	240 kHz	Case E	22446 - <2> - 22490
n262	120 kHz	Case D	23586 – <1> – 23641
	240 kHz	Case E	23588 – <2> – 23640
n263	120 kHz	Case D	Table 5.4.3.3-2
	480 kHz	Case F	
	960 kHz <sup>2</sup>	Case G	24162 – <6> – 24954

NOTE 1: SS Block pattern is defined in clause 4.1 in TS 38.213 [10].  
NOTE 2: SS Block SCS of 960 kHz is not used for initial access.

**Table 5.4.3.3-2: Allowed GSCN for operation in band n263 for 120 kHz and 480 kHz**

SS Block SCS	Range of GSCN
120 kHz	$24156 + 6 * N - 3 * \text{floor}((N+5)/18)$ , $N=0:137$
480 kHz	$24162 + 24 * N - 12 * \text{floor}((N+4)/18)$ , $N=0:33$

## 5.4A Channel arrangement for CA

### 5.4A.1 Channel spacing for CA

For intra-band contiguous carrier aggregation with two or more component carriers, the nominal channel spacing between two adjacent NR component carriers is defined as the following unless stated otherwise:

For NR operating bands with 60kHz channel raster:

$$\text{Nominal channel spacing} = \left\lceil \frac{BW_{\text{Channel (1)}} + BW_{\text{Channel (2)}} - 2|GB_{\text{Channel (1)}} - GB_{\text{Channel (2)}}|}{0.06 * 2^{n+1}} \right\rceil 0.06 * 2^n \text{ [MHz]}$$

with

$$n = \mu_0 - 2$$

and for operating band n263:

$$\text{Nominal Channel spacing} = \text{ceil}((BW_{\text{Channel(1)}} + BW_{\text{Channel(2)}})/100.8)*50.4 \text{ MHz.}$$

where  $BW_{\text{Channel}(1)}$  and  $BW_{\text{Channel}(2)}$  are the channel bandwidths of the two respective NR component carriers according to Table 5.3.2-1 with values in MHz,  $\mu_o$  is the largest  $\mu$  value among the subcarrier spacing configurations supported in the operating band for both of the channel bandwidths according to Table 5.3.5-1, and  $GB_{\text{Channel}(i)}$  is the minimum guard band for channel bandwidth  $i$  according to Table 5.3.3-1 for the said  $\mu$  value, with  $\mu$  as defined in TS 38.211 [9].

The channel spacing for intra-band contiguous carrier aggregation can be adjusted to any multiple of least common multiple of channel raster and sub-carrier spacing less than the nominal channel spacing to optimize performance in a particular deployment scenario.

For intra-band non-contiguous carrier aggregation, the channel spacing between two NR component carriers in different sub-blocks shall be larger than the nominal channel spacing defined in this clause.

## 5.5 Configurations

### 5.5A Configurations for CA

#### 5.5A.1 Configurations for intra-band contiguous CA

**Table 5.5A.1-1: NR CA configurations, bandwidth combination sets, and fallback group defined for intra-band contiguous CA**

NR CA configuration / Bandwidth combination set / Fallback group													
NR CA configuration	Uplink CA configurations	BW <sub>Channel</sub> (MHz)	BW <sub>Channel</sub> (MHz)	BW <sub>Channel</sub> (MHz)	BW <sub>Channel</sub> (MHz)	BW <sub>Channel</sub> (MHz)	BW <sub>Channel</sub> (MHz)	BW <sub>Channel</sub> (MHz)	BW <sub>Channel</sub> (MHz)	BW <sub>Channel</sub> (MHz)	Maximum aggregated BW (MHz)	BCS	Fallback group
CA_n257B	CA_n257B	50, 100, 200, 400	400								800	0	1
CA_n257C	CA_n257B	50, 100, 200, 400	400	400							1200	0	
CA_n257D	CA_n257D	50, 100, 200	200								400	0	2
CA_n257E	CA_n257D CA_n257E	50, 100, 200	200	200							600	0	
CA_n257F	CA_n257D CA_n257E CA_n257F	50, 100, 200	200	200	200						800	0	
CA_n257G	CA_n257G	50, 100	100								200	0	3
CA_n257H	CA_n257G CA_n257H	50, 100	100	100							300	0	
CA_n257I	CA_n257G CA_n257H CA_n257I	50, 100	100	100	100						400	0	
CA_n257J	CA_n257G CA_n257H CA_n257I CA_n257J	50, 100	100	100	100	100					500	0	
CA_n257K	CA_n257G CA_n257H CA_n257I CA_n257J CA_n257K	50, 100	100	100	100	100	100				600	0	
CA_n257L	CA_n257G CA_n257H CA_n257I CA_n257J CA_n257K CA_n257L	50, 100	100	100	100	100	100	100			700	0	
CA_n257M	CA_n257G CA_n257H CA_n257I CA_n257J CA_n257K CA_n257L CA_n257M	50, 100	100	100	100	100	100	100	100		800	0	
CA_n258B	CA_n258B	50, 100, 200, 400	400								800	0	1

NR CA configuration / Bandwidth combination set / Fallback group													
NR CA configuration	Uplink CA configurations	BW <sub>Channel</sub> (MHz)	BW <sub>Channel</sub> (MHz)	BW <sub>Channel</sub> (MHz)	BW <sub>Channel</sub> (MHz)	BW <sub>Channel</sub> (MHz)	BW <sub>Channel</sub> (MHz)	BW <sub>Channel</sub> (MHz)	BW <sub>Channel</sub> (MHz)	BW <sub>Channel</sub> (MHz)	Maximum aggregated BW (MHz)	BCS	Fallback group
CA_n258C	CA_n258B	50, 100, 200, 400	400	400							1200	0	
CA_n258D	CA_n258D	50, 100, 200	200								400	0	2
CA_n258E	CA_n258D CA_n258E	50, 100, 200	200	200							600	0	
CA_n258F	CA_n258D CA_n258E CA_n258F	50, 100, 200	200	200	200						800	0	
CA_n258G	CA_n258G	50, 100	100								200	0	3
CA_n258H	CA_n258G CA_n258H	50, 100	100	100							300	0	
CA_n258I	CA_n258G CA_n258H CA_n258I	50, 100	100	100	100						400	0	
CA_n258J	CA_n258G CA_n258H CA_n258I CA_n258J	50, 100	100	100	100	100					500	0	
CA_n258K	CA_n258G CA_n258H CA_n258I CA_n258J CA_n258K	50, 100	100	100	100	100	100				600	0	
CA_n258L	CA_n258G CA_n258H CA_n258I CA_n258J CA_n258K CA_n258L	50, 100	100	100	100	100	100	100			700	0	
CA_n258M	CA_n258G CA_n258H CA_n258I CA_n258J CA_n258K CA_n258L CA_n258M	50, 100	100	100	100	100	100	100	100		800	0	
CA_n258O	CA_n258O	50, 100	50, 100								200	0	4
CA_n258P	CA_n258O CA_n258P	50, 100	50, 100	50, 100							300	0	

NR CA configuration / Bandwidth combination set / Fallback group													
NR CA configuration	Uplink CA configurations	BW <sub>Channel</sub> (MHz)	BW <sub>Channel</sub> (MHz)	BW <sub>Channel</sub> (MHz)	BW <sub>Channel</sub> (MHz)	BW <sub>Channel</sub> (MHz)	BW <sub>Channel</sub> (MHz)	BW <sub>Channel</sub> (MHz)	BW <sub>Channel</sub> (MHz)	BW <sub>Channel</sub> (MHz)	Maximum aggregated BW (MHz)	BCS	Fallback group
CA_n258Q	CA_n258O CA_n258P CA_n258Q	50, 100	50, 100	50, 100	50, 100						400	0	
CA_n259B	CA_n259B	50, 100, 200, 400	400								800	0	1
CA_n259C	CA_n259B	50, 100, 200, 400	400	400							1200	0	
CA_n259G	CA_n259G	50, 100	100								200	0	3
CA_n259H	CA_n259G CA_n259H	50, 100	100	100							300	0	
CA_n259I	CA_n259G CA_n259H CA_n259I	50, 100	100	100	100						400	0	
CA_n259J	CA_n259G CA_n259H CA_n259I CA_n259J	50, 100	100	100	100	100					500	0	
CA_n259K	CA_n259G CA_n259H CA_n259I CA_n259J CA_n259K	50, 100	100	100	100	100	100				600	0	
CA_n259L	CA_n259G CA_n259H CA_n259I CA_n259J CA_n259K CA_n259L	50, 100	100	100	100	100	100	100			700	0	
CA_n259M	CA_n259G CA_n259H CA_n259I CA_n259J CA_n259K CA_n259L CA_n259M	50, 100	100	100	100	100	100	100	100		800	0	
CA_n260B	CA_n260B	50, 100, 200, 400	400								800	0	1
CA_n260C	CA_n260B	50, 100, 200, 400	400	400							1200	0	
CA_n260D	CA_n260D	50, 100, 200	200								400	0	2



NR CA configuration / Bandwidth combination set / Fallback group														
NR CA configuration	Uplink CA configurations	BW <sub>Channel</sub> (MHz)	BW <sub>Channel</sub> (MHz)	BW <sub>Channel</sub> (MHz)	BW <sub>Channel</sub> (MHz)	BW <sub>Channel</sub> (MHz)	BW <sub>Channel</sub> (MHz)	BW <sub>Channel</sub> (MHz)	BW <sub>Channel</sub> (MHz)	BW <sub>Channel</sub> (MHz)	Maximum aggregated BW (MHz)	BCS	Fallback group	
CA_n260E	CA_n260D CA_n260E	50, 100, 200	200	200							600	0		
CA_n260F	CA_n260D CA_n260E CA_n260F	50, 100, 200	200	200	200						800	0		
CA_n260G	CA_n260G	50, 100	100								200	0	3	
CA_n260H	CA_n260G CA_n260H	50, 100	100	100							300	0		
CA_n260I	CA_n260G CA_n260H CA_n260I	50, 100	100	100	100						400	0		
CA_n260J	CA_n260G CA_n260H CA_n260I CA_n260J	50, 100	100	100	100	100					500	0		
CA_n260K	CA_n260G CA_n260H CA_n260I CA_n260J CA_n260K	50, 100	100	100	100	100	100				600	0		
CA_n260L	CA_n260G CA_n260H CA_n260I CA_n260J CA_n260K CA_n260L	50, 100	100	100	100	100	100	100			700	0		
CA_n260M	CA_n260G CA_n260H CA_n260I CA_n260J CA_n260K CA_n260L CA_n260M	50, 100	100	100	100	100	100	100	100		800	0		
CA_n260O	CA_n260O	50, 100	50, 100								200	0		4
CA_n260P	CA_n260O CA_n260P	50, 100	50, 100	50, 100							300	0		
CA_n260Q	CA_n260O CA_n260P CA_n260Q	50, 100	50, 100	50, 100	50, 100						400	0		
CA_n261B	CA_n261B	50, 100, 200, 400	400								800	0	1	
CA_n261C	CA_n261B	50	400	400							850	0		

NR CA configuration / Bandwidth combination set / Fallback group													
NR CA configuration	Uplink CA configurations	BW <sub>Channel</sub> (MHz)	BW <sub>Channel</sub> (MHz)	BW <sub>Channel</sub> (MHz)	BW <sub>Channel</sub> (MHz)	BW <sub>Channel</sub> (MHz)	BW <sub>Channel</sub> (MHz)	BW <sub>Channel</sub> (MHz)	BW <sub>Channel</sub> (MHz)	BW <sub>Channel</sub> (MHz)	Maximum aggregated BW (MHz)	BCS	Fallback group
CA_n261D	CA_n261D	50, 100, 200	200								400	0	2
CA_n261E	CA_n261D CA_n261E	50, 100, 200	200	200							600	0	
CA_n261F	CA_n261D CA_n261E CA_n261F	50, 100, 200	200	200	200						800	0	
CA_n261G	CA_n261G	50, 100	100								200	0	3
CA_n261H	CA_n261G CA_n261H	50, 100	100	100							300	0	
CA_n261I	CA_n261G CA_n261H CA_n261I	50, 100	100	100	100						400	0	
CA_n261J	CA_n261G CA_n261H CA_n261I CA_n261J	50, 100	100	100	100	100					500	0	
CA_n261K	CA_n261G CA_n261H CA_n261I CA_n261J CA_n261K	50, 100	100	100	100	100	100				600	0	
CA_n261L	CA_n261G CA_n261H CA_n261I CA_n261J CA_n261K CA_n261L	50, 100	100	100	100	100	100	100			700	0	
CA_n261M	CA_n261G CA_n261H CA_n261I CA_n261J CA_n261K CA_n261L CA_n261M	50, 100	100	100	100	100	100	100	100		800	0	
CA_n261O	CA_n261O	50, 100	50, 100								200	0	4
CA_n261P	CA_n261O CA_n261P	50, 100	50, 100	50, 100							300	0	
CA_n261Q	CA_n261O CA_n261P CA_n261Q	50, 100	50, 100	50, 100	50, 100						400	0	
CA_n262G	CA_n262G	50, 100	100								200	0	3

NR CA configuration / Bandwidth combination set / Fallback group													
NR CA configuration	Uplink CA configurations	BW <sub>Channel</sub> (MHz)	BW <sub>Channel</sub> (MHz)	BW <sub>Channel</sub> (MHz)	BW <sub>Channel</sub> (MHz)	BW <sub>Channel</sub> (MHz)	BW <sub>Channel</sub> (MHz)	BW <sub>Channel</sub> (MHz)	BW <sub>Channel</sub> (MHz)	BW <sub>Channel</sub> (MHz)	Maximum aggregated BW (MHz)	BCS	Fallback group
CA_n262H	CA_n262G CA_n262H	50, 100	100	100							300	0	
CA_n262I	CA_n262G CA_n262H CA_n262I	50, 100	100	100	100						400	0	
CA_n262J	CA_n262G CA_n262H CA_n262I CA_n262J	50, 100	100	100	100	100					500	0	
CA_n262K	CA_n262G CA_n262H CA_n262I CA_n262J CA_n262K	50, 100	100	100	100	100	100				600	0	
CA_n262L	CA_n262G CA_n262H CA_n262I CA_n262J CA_n262K CA_n262L	50, 100	100	100	100	100	100	100			700	0	
CA_n262M	CA_n262G CA_n262H CA_n262I CA_n262J CA_n262K CA_n262L CA_n262M	50, 100	100	100	100	100	100	100	100	100	800	0	
CA_n263B	CA_n263A	400	400								800	0	1
CA_n263C	CA_n263A	400	400	400							1200	0	1
CA_n263G	CA_n263A	100	100								200	0	3
CA_n263H	CA_n263A	100	100	100							300	0	3
CA_n263I	CA_n263A	100	100	100	100						400	0	3
CA_n263J	CA_n263A	100	100	100	100	100					500	0	3
CA_n263K	CA_n263A	100	100	100	100	100	100				600	0	3
CA_n263L	CA_n263A	100	100	100	100	100	100	100			700	0	3
CA_n263M	CA_n263A	100	100	100	100	100	100	100	100	100	800	0	3
NOTE 1: Void													
NOTE 2: For the NR CA configuration with more than two component carries, the bandwidths in a BCS which may introduce combinations more than requested unintentionally should be listed in a row separately.													
NOTE 3: In this release of the specification, contiguous DL CA configurations within FR2-2 may only contain multiples of the same channel bandwidth.													

## 5.5A.2 Configurations for intra-band non-contiguous CA

Configurations listed in this clause apply to downlink carrier aggregation only.

NOTE: Sub-blocks belonging to a CA configuration can be in any order. In other words certain CA configuration acronym includes all sub-block arrangements which have exactly the same sub-block set. As an example, CA\_n260(2G-3O) denotes CA\_n260(2O-2G-O), CA\_n260(G-3O-G) etc. but these are not listed in tables separately.

**Table 5.5A.2-1: NR CA configurations with single CA bandwidth class defined for intra-band non-contiguous CA**

NR CA configuration / Bandwidth combination set			
NR configuration	Uplink CA configurations	$\Sigma(BW_{\text{Channel,block}})$ (MHz)	BCS

CA_n257(2A)	-	800	0
CA_n258(2A)	-	800	0
CA_n258(3A)	-	1200	0
CA_n258(4A)	-	1600	0
CA_n258(5A)	-	2000	0
CA_n258(2G)	CA_n258G	400	0
CA_n260(2A)	CA_n260(2A)	800	0
CA_n260(3A)	CA_n260(3A)	1200	0
CA_n260(4A)	-	1600	0
CA_n260(5A)	-	2000	0
CA_n260(6A)	-	2400	0
CA_n260(7A)	-	2800	0
CA_n260(8A)	-	2900	0
CA_n260(9A)	-	2950	0
CA_n260(10A)	-	2950	0
CA_n260(2D)	-	800	0
CA_n260(2G)	CA_n260G	400	0
CA_n260(3G)	-	600	0
CA_n260(4G)	-	800	0
CA_n260(2H)	CA_n260G CA_n260H	600	0
CA_n260(2O)	-	400	0
CA_n260(3O)	-	600	0
CA_n260(4O)	-	800	0
CA_n260(2P)	-	600	0
CA_n260(3P)	-	900	0
CA_n260(4P)	-	1200	0
CA_n260(2Q)	-	800	0
CA_n261(2A)	-	800	0
CA_n261(3A)	-	800	0
CA_n261(4A)	-	800	0
CA_n261(5A)	-	800	0
CA_n261(6A)	-	800	0
CA_n261(7A)	-	800	0
CA_n261(8A)	-	800	0
CA_n261(2D)	-	800	0
CA_n261(2G)	CA_n261G	400	0
CA_n261(3G)	-	600	0
CA_n261(4G)	-	800	0
CA_n261(2H)	CA_n261G CA_n261H	600	0
CA_n261(2I)	CA_n261G CA_n261H CA_n261I	800	0
CA_n261(2O)	-	400	0
CA_n261(3O)	-	600	0
CA_n261(4O)	-	800	0
CA_n261(5O)	-	800	0
CA_n261(6O)	-	800	0
CA_n261(7O)	-	800	0
CA_n261(2P)	-	600	0
CA_n261(2Q)	-	800	0

NOTE 1: Void

NOTE 2: Void

NOTE 3: Void

NOTE 4: Void

NOTE 5: Channel bandwidth per operating band defined in Table 5.3.5-1

NOTE 6: Unless otherwise stated, BCS0 is referred in each constituent CA configuration

NOTE 7:  $\Sigma(BW_{\text{Channel,block}})$  denotes the maximum total bandwidth from the summation of the sub-block bandwidths and shall be less than the bandwidth of the operating band.

**Table 5.5A.2-2: NR CA configurations with multiple CA bandwidth classes defined for intra-band non-contiguous CA**

NR CA configuration / Bandwidth combination set			
CA configuration	Uplink CA configurations	$\Sigma(BW_{\text{Channel,block}})$ (MHz)	BCS
CA_n258(A-G)	CA_n258G	600	0
CA_n258(A-H)	CA_n258G CA_n258H	700	0
CA_n258(G-H)	CA_n258G CA_n258H	500	0
CA_n260(A-D)	-	800	0
CA_n260(A-E)	-	1000	0
CA_n260(2A-D)	-	1200	0
CA_n260(3A-D)	-	1600	0
CA_n260(4A-D)	-	2000	0
CA_n260(A-2D)	-	1200	0
CA_n260(2A-2D)	-	1600	0
CA_n260(A-D-O)	-	1000	0
CA_n260(A-D-G)	-	1000	0
CA_n260(2A-D-O)	-	1400	0
CA_n260(3A-D-O)	-	1800	0
CA_n260(A-D-2O)	-	1200	0
CA_n260(2A-D-2O)	-	1600	0
CA_n260(A-G)	CA_n260G	600	0
CA_n260(A-G-H)	-	900	0
CA_n260(2A-G)	CA_n260G	1000	0
CA_n260(A-2G)	CA_n260G	800	0
CA_n260(A-3G)	-	1000	0
CA_n260(A-4G)	-	1200	0
CA_n260(2A-2G)	CA_n260G	1200	0
CA_n260(2A-3G)	-	1400	0
CA_n260(2A-2G-O)	-	1400	0
CA_n260(2A-2G-2O)	-	1600	0
CA_n260(3A-2G)	-	1600	0
CA_n260(3A-2G-O)	-	1800	0
CA_n260(4A-G)	-	1800	0
CA_n260(4A-G-O)	-	2000	0
CA_n260(4A-2G)	-	2000	0
CA_n260(5A-G)	-	2200	0
CA_n260(A-2G-2O)	-	1200	0
CA_n260(A-2G-3O)	-	1400	0
CA_n260(2A-G-H)	-	1300	0
CA_n260(2A-G-2O)	-	1400	0
CA_n260(2A-G-3O)	-	1600	0
CA_n260(3A-G)	CA_n260G	1400	0
CA_n260(3A-G-O)	-	1600	0
CA_n260(3A-G-2O)	-	1800	0
CA_n260(A-2H)	-	1000	0
CA_n260(2A-H)	-	1100	0
CA_n260(3A-H)	-	1500	0
CA_n260(2A-2H)	-	1400	0
CA_n260(A-H)	CA_n260G CA_n260H	700	0
CA_n260(A-H-O)	-	900	0
CA_n260(A-O)	-	600	0
CA_n260(A-O-P)	-	900	0
CA_n260(A-O-P-Q)	-	1300	0
CA_n260(A-O-2P)	-	1200	0
CA_n260(A-O-3P)	-	1500	0
CA_n260(2A-O-P)	-	1300	0
CA_n260(2A-O-P-Q)	-	1700	0
CA_n260(2A-O-2P)	-	1600	0
CA_n260(2A-O-3P)	-	1900	0
CA_n260(2A-2O-P)	-	1500	0
CA_n260(2A-2O-P-Q)	-	1900	0
CA_n260(A-O-Q)	-	1000	0
CA_n260(A-O-2Q)	-	1400	0

CA_n260(2A-O-Q)	-	1400	0
CA_n260(2A-O-2Q)	-	1800	0
CA_n260(2A-2O-Q)	-	1600	0
CA_n260(2A-O)	-	1000	0
CA_n260(A-2O)	-	800	0
CA_n260(A-2O-P)	-	1100	0
CA_n260(A-2O-P-Q)	-	1500	0
CA_n260(A-2O-2P)	-	1400	0
CA_n260(A-2O-Q)	-	1200	0
CA_n260(A-2O-2Q)	-	1600	0
CA_n260(A-3O-P)	-	1300	0
CA_n260(A-3O-Q)	-	1400	0
CA_n260(2A-2O)	-	1200	0
CA_n260(2A-2O-2P)	-	1800	0
CA_n260(2A-2O-2Q)	-	2000	0
CA_n260(2A-3O)	-	1400	0
CA_n260(2A-3O-P)	-	1700	0
CA_n260(2A-3O-Q)	-	1800	0
CA_n260(3A-2O)	-	1600	0
CA_n260(3A-2O-P)	-	1900	0
CA_n260(3A-2O-Q)	-	2000	0
CA_n260(4A-O)	-	1800	0
CA_n260(4A-O-P)	-	2100	0
CA_n260(4A-O-Q)	-	2200	0
CA_n260(5A-O-P)	-	2500	0
CA_n260(6A-O-P)	-	2900	0
CA_n260(4A-3O)	-	2200	0
CA_n260(5A-O)	-	2200	0
CA_n260(6A-O)	-	2600	0
CA_n260(7A-O)	-	2950	0
CA_n260(8A-O)	-	2950	0
CA_n260(4A-2O)	-	2000	0
CA_n260(4A-2Q)	-	2400	0
CA_n260(3A-3O)	-	1800	0
CA_n260(A-G-O)	-	800	0
CA_n260(A-G-2O)	-	1000	0
CA_n260(A-G-3O)	-	1200	0
CA_n260(A-G-4O)	-	1400	0
CA_n260(2A-G-O)	-	1200	0
CA_n260(A-2G-O)	-	1000	0
CA_n260(A-3G-O)	-	1200	0
CA_n260(A-3O)	-	1000	0
CA_n260(3A-O)	-	1400	0
CA_n260(3A-O-P)	CA_n260O CA_n260P	1700	0
CA_n260(3A-O-P-Q)	-	2100	0
CA_n260(3A-O-2P)	-	2000	0
CA_n260(3A-O-Q)	-	1800	0
CA_n260(3A-O-2Q)	-	2200	0
CA_n260(A-4O)	-	1200	0
CA_n260(2A-4O)	-	1600	0
CA_n260(3A-4O)	-	2000	0
CA_n260(4A-4O)	-	2400	0
CA_n260(5A-4O)	-	2800	0
CA_n260(A-P)	-	700	0
CA_n260(A-3P)	-	1300	0
CA_n260(A-4P)	-	1600	0
CA_n260(A-P-Q)	CA_n260O CA_n260P CA_n260Q	1100	0
CA_n260(2A-P)	-	1100	0
CA_n260(2A-P-Q)	-	1500	0
CA_n260(3A-P)	-	1500	0
CA_n260(3A-P-Q)	-	1900	0
CA_n260(4A-P)	-	1900	0



CA_n260(4A-P-Q)	-	2300	0
CA_n260(5A-P)	-	2300	0
CA_n260(6A-P)	-	2700	0
CA_n260(7A-P)	-	3000	0
CA_n260(A-2P)	-	1000	0
CA_n260(2A-2P)	-	1400	0
CA_n260(2A-3P)	-	1700	0
CA_n260(2A-4P)	-	2000	0
CA_n260(3A-2P)	-	1800	0
CA_n260(3A-3P)	-	2100	0
CA_n260(4A-2P)	-	2200	0
CA_n260(5A-2P)	-	2600	0
CA_n260(5A-2O)	-	2400	0
CA_n260(6A-2O)	-	2800	0
CA_n260(5A-3O)	-	2600	0
CA_n260(6A-3O)	-	2950	0
CA_n260(7A-2O)	-	2950	0
CA_n260(7A-3O)	-	2950	0
CA_n260(6A-2P)	-	2950	0
CA_n260(8A-2O)	-	2550	0
CA_n260(9A-O)	-	3000	0
CA_n260(A-Q)	-	800	0
CA_n260(A-2Q)	-	1200	0
CA_n260(2A-Q)	-	1200	0
CA_n260(2A-2Q)	-	1600	0
CA_n260(3A-Q)	-	1600	0
CA_n260(3A-2Q)	-	2000	0
CA_n260(4A-Q)	-	2000	0
CA_n260(5A-Q)	-	2400	0
CA_n260(D-2G)	-	800	0
CA_n260(2D-O)	-	1000	0
CA_n260(D-2O)	-	800	0
CA_n260(A-I)	CA_n260I	800	0
CA_n260(D-G)	CA_n260D CA_n260G	600	0
CA_n260(D-H)	CA_n260D CA_n260G CA_n260H	700	0
CA_n260(D-I)	CA_n260D CA_n260G CA_n260H CA_n260I	800	0
CA_n260(D-O)	CA_n260D CA_n260O	600	0
CA_n260(D-P)	CA_n260D CA_n260O CA_n260P	700	0
CA_n260(D-Q)	CA_n260D CA_n260O CA_n260P CA_n260Q	800	0
CA_n260(E-O)	CA_n260D CA_n260E CA_n260O	800	0
CA_n260(E-P)	CA_n260D CA_n260E CA_n260O CA_n260P	800	0
CA_n260(E-Q)	CA_n260D CA_n260E CA_n260O CA_n260P CA_n260Q	1000	0
CA_n260(G-H)	CA_n260G CA_n260H	500	0
CA_n260(G-H-O)	-	700	0

CA_n260(G-I)	CA_n260G CA_n260I	600	0
CA_n260(G-O)	-	400	0
CA_n260(G-2O)	-	600	0
CA_n260(2G-O)	-	600	0
CA_n260(2G-2O)	-	800	0
CA_n260(G-3O)	-	800	0
CA_n260(3G-O)	-	800	0
CA_n260(2G-3O)	-	1000	0
CA_n260(G-4O)	-	1000	0
CA_n260(2G-4O)	-	1200	0
CA_n260(4G-O)	-	1000	0
CA_n260(H-O)	-	500	0
CA_n260(2H-O)	-	800	0
CA_n260(O-2P)	-	800	0
CA_n260(O-3P)	-	1100	0
CA_n260(O-2Q)	-	1000	0
CA_n260(O-P)	-	500	0
CA_n260(O-P-Q)	-	900	0
CA_n260(2O-P)	-	700	0
CA_n260(2O-P-Q)	-	1100	0
CA_n260(2O-2P)	-	1000	0
CA_n260(3O-P)	-	900	0
CA_n260(3O-Q)	-	1000	0
CA_n260(O-Q)	-	600	0
CA_n260(2O-Q)	-	800	0
CA_n260(2O-2Q)	-	1200	0
CA_n260(P-Q)	-	700	0
CA_n261(A-D)	-	800	0
CA_n261(A-E)	-	800	0
CA_n261(2A-D)	-	800	0
CA_n261(2A-D-O)	-	800	0
CA_n261(A-2D)	-	800	0
CA_n261(A-D-G)	-	800	0
CA_n261(A-D-H)	-	800	0
CA_n261(A-D-O)	-	800	0
CA_n261(A-D-2O)	-	800	0
CA_n261(A-G)	CA_n261G	600	0
CA_n261(A-G-H)	CA_n261G CA_n261H	800	0
CA_n261(A-G-I)	CA_n261G CA_n261H CA_n261I	800	0
CA_n261(A-G-O)	-	800	0
CA_n261(2A-G-O)	-	800	0
CA_n261(A-G-2O)	-	800	0
CA_n261(2A-G-2O)	-	800	0
CA_n261(A-2G-O)	-	800	0
CA_n261(A-2G-2O)	-	800	0
CA_n261(A-3G)	-	800	0
CA_n261(A-3G-O)	-	800	0
CA_n261(A-2G)	CA_n261G	800	0
CA_n261(A-4G)	-	800	0
CA_n261(A-H)	CA_n261G CA_n261H	700	0
CA_n261(A-2H)	-	800	0
CA_n261(A-H-I)	-	800	0
CA_n261(A-I)	CA_n261G CA_n261H CA_n261I	800	0
CA_n261(A-2I)	-	800	0
CA_n261(A-J)	CA_n261G CA_n261H CA_n261I	700	0

CA_n261(A-K)	CA_n261G CA_n261H CA_n261I	800	0
CA_n261(A-L)	CA_n261A CA_n261G CA_n261H CA_n261I	800	0
CA_n261(A-O)	-	600	0
CA_n261(A-O-P)	-	800	0
CA_n261(A-O-Q)	-	800	0
CA_n261(2A-O)	-	800	0
CA_n261(A-2O)	-	800	0
CA_n261(A-3O)	-	800	0
CA_n261(A-4O)	-	800	0
CA_n261(A-5O)	-	800	0
CA_n261(A-6O)	-	800	0
CA_n261(A-7O)	-	800	0
CA_n261(A-P)	-	700	0
CA_n261(A-P-Q)	-	800	0
CA_n261(2A-P)	-	800	0
CA_n261(A-2P)	-	800	0
CA_n261(A-Q)	-	800	0
CA_n261(2A-Q)	-	800	0
CA_n261(A-2Q)	-	800	0
CA_n261(2A-G)	CA_n261G	800	0
CA_n261(2A-2G)	-	800	0
CA_n261(2A-2G-O)	-	800	0
CA_n261(2A-3G)	-	800	0
CA_n261(2A-2O)	-	800	0
CA_n261(2A-3O)	-	800	0
CA_n261(2A-4O)	-	800	0
CA_n261(2A-5O)	-	800	0
CA_n261(2A-6O)	-	800	0
CA_n261(2A-H)	CA_n261G CA_n261H	800	0
CA_n261(2A-I)	CA_n261G CA_n261H CA_n261I	800	0
CA_n261(3A-G)	CA_n261G	800	0
CA_n261(3A-G-O)	-	800	0
CA_n261(3A-2G)	-	800	0
CA_n261(3A-D)	-	800	0
CA_n261(3A-O)	-	800	0
CA_n261(3A-2O)	-	800	0
CA_n261(3A-3O)	-	800	0
CA_n261(3A-4O)	-	800	0
CA_n261(3A-5O)	-	800	0
CA_n261(4A-G)	-	800	0
CA_n261(4A-O)	-	800	0
CA_n261(4A-2O)	-	800	0
CA_n261(4A-3O)	-	800	0
CA_n261(4A-4O)	-	800	0
CA_n261(5A-O)	-	800	0
CA_n261(5A-2O)	-	800	0
CA_n261(5A-3O)	-	800	0
CA_n261(6A-O)	-	800	0
CA_n261(6A-2O)	-	800	0
CA_n261(7A-O)	-	800	0
CA_n261(D-G)	CA_n261D CA_n261G	600	0
CA_n261(D-H)	CA_n261D CA_n261G CA_n261H	700	0
CA_n261(D-I)		800	0

	CA_n261D CA_n261G CA_n261H CA_n261I		
CA_n261(D-O)	CA_n261D CA_n261O	600	0
CA_n261(D-2O)	-	800	0
CA_n261(D-P)	CA_n261D CA_n261P	700	0
CA_n261(D-Q)	CA_n261D CA_n261O CA_n261P CA_n261Q	800	0
CA_n261(E-O)	CA_n261D CA_n261E CA_n261O	800	0
CA_n261(E-P)	CA_n261D CA_n261E CA_n261O CA_n261P	800	0
CA_n261(E-Q)	CA_n261D CA_n261E CA_n261O CA_n261P CA_n261Q	800	0
CA_n261(G-I)	CA_n261G CA_n261H CA_n261I	600	0
CA_n261(G-H)	CA_n261G CA_n261H	500	0
CA_n261(G-J)	CA_n261A CA_n261G CA_n261H CA_n261I	700	0
CA_n261(2G-2O)	-	800	0
CA_n261(G-O)	-	400	0
CA_n261(G-2O)	-	600	0
CA_n261(2G-O)	-	600	0
CA_n261(3G-O)	-	800	0
CA_n261(H-I)	CA_n261G CA_n261H CA_n261I	700	0
CA_n261(O-P)	-	500	0
CA_n261(O-Q)	-	600	0
CA_n261(P-Q)	-	700	0

NOTE 1: Void

NOTE 2: Void

NOTE 3: Channel bandwidth per operating band defined in Table 5.3.5-1

NOTE 4: Configurations for intra-band contiguous CA defined in Table 5.5A.1-1

NOTE 5: Configurations for intra-band non-contiguous CA defined in Table 5.5A.2-1

NOTE 6: Void

NOTE 7: Unless otherwise stated, BCS0 is referred in each constituent CA configuration.

NOTE 8:  $\Sigma(BW_{\text{Channel,block}})$  denotes the maximum total bandwidth from the summation of the sub-block bandwidths and shall be less than the bandwidth of the operating band.

### 5.5A.3 Configurations for inter-band CA

**Table 5.5A.3-1: NR CA configurations for inter-band CA**

NR CA configuration	Uplink CA configuration	NR Band	Channel bandwidth (MHz) (NOTE 1)	Bandwidth combination set
CA_n257A-n259A	CA_n257A-n259A	n257	50, 100, 200, 400	0
		n259	50, 100, 200, 400	
CA_n257A-n259G	CA_n257A-n259A	n257	50, 100, 200, 400	0
		n259	CA_n259G	
CA_n257A-n259H	CA_n257A-n259A	n257	50, 100, 200, 400	0
		n259	CA_n259H	
CA_n257A-n259I	CA_n257A-n259A	n257	50, 100, 200, 400	0
		n259	CA_n259I	
CA_n257A-n259J	CA_n257A-n259A	n257	50, 100, 200, 400	0
		n259	CA_n259J	
CA_n257A-n259K	CA_n257A-n259A	n257	50, 100, 200, 400	0
		n259	CA_n259K	
CA_n257A-n259L	CA_n257A-n259A	n257	50, 100, 200, 400	0
		n259	CA_n259L	
CA_n257A-n259M	CA_n257A-n259A	n257	50, 100, 200, 400	0
		n259	CA_n259M	
CA_n257G-n259A	CA_n257A-n259A	n257	CA_n257G	0
		n259	50, 100, 200, 400	
CA_n257G-n259G	CA_n257A-n259A	n257	CA_n257G	0
		n259	CA_n259G	
CA_n257G-n259H	CA_n257A-n259A	n257	CA_n257G	0
		n259	CA_n259H	
CA_n257G-n259I	CA_n257A-n259A	n257	CA_n257G	0
		n259	CA_n259I	
CA_n257G-n259J	CA_n257A-n259A	n257	CA_n257G	0
		n259	CA_n259J	
CA_n257G-n259K	CA_n257A-n259A	n257	CA_n257G	0
		n259	CA_n259K	
CA_n257G-n259L	CA_n257A-n259A	n257	CA_n257G	0
		n259	CA_n259L	
CA_n257G-n259M	CA_n257A-n259A	n257	CA_n257G	0
		n259	CA_n259M	
CA_n257H-n259A	CA_n257A-n259A	n257	CA_n257H	0
		n259	50, 100, 200, 400	
CA_n257H-n259G	CA_n257A-n259A	n257	CA_n257H	0
		n259	CA_n259G	
CA_n257H-n259H	CA_n257A-n259A	n257	CA_n257H	0
		n259	CA_n259H	
CA_n257H-n259I	CA_n257A-n259A	n257	CA_n257H	0
		n259	CA_n259I	
CA_n257H-n259J	CA_n257A-n259A	n257	CA_n257H	0
		n259	CA_n259J	
CA_n257H-n259K	CA_n257A-n259A	n257	CA_n257H	0
		n259	CA_n259K	
CA_n257H-n259L	CA_n257A-n259A	n257	CA_n257H	0
		n259	CA_n259L	
CA_n257H-n259M	CA_n257A-n259A	n257	CA_n257H	0
		n259	CA_n259M	
CA_n257I-n259A	CA_n257A-n259A	n257	CA_n257I	0
		n259	50, 100, 200, 400	
CA_n257I-n259G	CA_n257A-n259A	n257	CA_n257I	0
		n259	CA_n259G	
CA_n257I-n259H	CA_n257A-n259A	n257	CA_n257I	0
		n259	CA_n259H	
CA_n257I-n259I	CA_n257A-n259A	n257	CA_n257I	0
		n259	CA_n259I	
CA_n257I-n259J	CA_n257A-n259A	n257	CA_n257I	0
		n259	CA_n259J	
CA_n257I-n259K	CA_n257A-n259A	n257	CA_n257I	0
		n259	CA_n259K	
CA_n257I-n259L	CA_n257A-n259A	n257	CA_n257I	0
		n259	CA_n259L	
CA_n257I-n259M	CA_n257A-n259A	n257	CA_n257I	0

		n259	CA_n259M	
CA_n258A-n260A	-	n258	50, 100, 200, 400	0
		n260	50, 100, 200, 400	
CA_n258A-n261A	-	n258	50, 100, 200, 400	0
		n261	50, 100, 200, 400	
CA_n260A-n261A	CA_n260A-n261A	n260	50, 100, 200, 400	0
		n261	50, 100, 200, 400	
CA_n260A-n261G	CA_n260A-n261A CA_n261G CA_n261H CA_n261I CA_n261J CA_n261K CA_n261L CA_n261M	n260	50, 100, 200, 400	0
CA_n260A-n261H		n261	CA_n261G	
		n260	50, 100, 200, 400	0
		n261	CA_n261H	
CA_n260A-n261I		n260	50, 100, 200, 400	0
		n261	CA_n261I	
CA_n260A-n261J		n260	50, 100, 200, 400	0
		n261	CA_n261J	
CA_n260A-n261K		n260	50, 100, 200, 400	0
		n261	CA_n261K	
CA_n260A-n261L		n260	50, 100, 200, 400	0
		n261	CA_n261L	
CA_n260A-n261M		n260	50, 100, 200, 400	0
		n261	CA_n261M	
CA_n260G-n261A	CA_n260A-n261A CA_n260G CA_n261G CA_n261H CA_n261I CA_n261J CA_n261K CA_n261L CA_n261M	n260	CA_n260G	0
		n261	50, 100, 200, 400	
CA_n260G-n261G		n260	CA_n260G	0
		n261	CA_n261G	
CA_n260G-n261H		n260	CA_n260G	0
		n261	CA_n261H	
CA_n260G-n261I		n260	CA_n260G	0
		n261	CA_n261I	
CA_n260G-n261J		n260	CA_n260G	0
		n261	CA_n261J	
CA_n260G-n261K		n260	CA_n260G	0
		n261	CA_n261K	
CA_n260G-n261L		n260	CA_n260G	0
		n261	CA_n261L	
CA_n260G-n261M	n260	CA_n260G	0	
	n261	CA_n261M		
CA_n260H-n261A	CA_n260A-n261A CA_n260G CA_n260H CA_n261G CA_n261H CA_n261I CA_n261J CA_n261K CA_n261L CA_n261M	n260	CA_n260H	0
		n261	50, 100, 200, 400	
CA_n260H-n261G		n260	CA_n260H	0
		n261	CA_n261G	
CA_n260H-n261H		n260	CA_n260H	0
		n261	CA_n261H	
CA_n260H-n261I		n260	CA_n260H	0
		n261	CA_n261I	
CA_n260H-n261J		n260	CA_n260H	0
		n261	CA_n261J	
CA_n260H-n261K		n260	CA_n260H	0
		n261	CA_n261K	
CA_n260H-n261L		n260	CA_n260H	0
		n261	CA_n261L	
CA_n260H-n261M	n260	CA_n260H	0	
	n261	CA_n261M		
CA_n260I-n261A	CA_n260A-n261A CA_n260G CA_n260H CA_n260I CA_n261G CA_n261H CA_n261I CA_n261J CA_n261K CA_n261L CA_n261M	n260	CA_n260I	0
		n261	50, 100, 200, 400	
CA_n260I-n261G		n260	CA_n260I	0
		n261	CA_n261G	
CA_n260I-n261H		n260	CA_n260I	0
		n261	CA_n261H	
CA_n260I-n261I		n260	CA_n260I	0
		n261	CA_n261I	
CA_n260I-n261J		n260	CA_n260I	0
		n261	CA_n261J	
CA_n260I-n261K	n260	CA_n260I	0	
	n261	CA_n261K		

CA_n260I-n261L		n260	CA_n260I	0
		n261	CA_n261L	
CA_n260I-n261M		n260	CA_n260I	0
		n261	CA_n261M	
CA_n260J-n261A		n260	CA_n260J	0
		n261	50, 100, 200, 400	
CA_n260J-n261G	CA_n260A-n261A	n260	CA_n260J	0
	CA_n260G	n261	CA_n261G	
CA_n260J-n261H	CA_n260H	n260	CA_n260J	0
	CA_n260I	n261	CA_n261H	
CA_n260J-n261I	CA_n260J	n260	CA_n260J	0
	CA_n261G	n261	CA_n261I	
CA_n260J-n261J	CA_n261H	n260	CA_n260J	0
	CA_n261I	n261	CA_n261J	
CA_n260J-n261K	CA_n261J	n260	CA_n260J	0
	CA_n261K	n261	CA_n261K	
CA_n260J-n261L	CA_n261L	n260	CA_n260J	0
	CA_n261M	n261	CA_n261L	
CA_n260J-n261M		n260	CA_n260J	0
		n261	CA_n261M	
CA_n260K-n261A		n260	CA_n260K	0
		n261	50, 100, 200, 400	
CA_n260K-n261G	CA_n260A-n261A	n260	CA_n260K	0
	CA_n260G	n261	CA_n261G	
CA_n260K-n261H	CA_n260H	n260	CA_n260K	0
	CA_n260I	n261	CA_n261H	
CA_n260K-n261I	CA_n260J	n260	CA_n260K	0
	CA_n260K	n261	CA_n261I	
CA_n260K-n261J	CA_n261G	n260	CA_n260K	0
	CA_n261H	n261	CA_n261J	
CA_n260K-n261K	CA_n261I	n260	CA_n260K	0
	CA_n261J	n261	CA_n261K	
CA_n260K-n261L	CA_n261K	n260	CA_n260K	0
	CA_n261L	n261	CA_n261L	
CA_n260K-n261M	CA_n261M	n260	CA_n260K	0
		n261	CA_n261M	
CA_n260L-n261A		n260	CA_n260L	0
		n261	50, 100, 200, 400	
CA_n260L-n261G	CA_n260A-n261A	n260	CA_n260L	0
	CA_n260G	n261	CA_n261G	
CA_n260L-n261H	CA_n260H	n260	CA_n260L	0
	CA_n260I	n261	CA_n261H	
CA_n260L-n261I	CA_n260J	n260	CA_n260L	0
	CA_n260K	n261	CA_n261I	
CA_n260L-n261J	CA_n260L	n260	CA_n260L	0
	CA_n261G	n261	CA_n261J	
CA_n260L-n261K	CA_n261H	n260	CA_n260L	0
	CA_n261I	n261	CA_n261K	
CA_n260L-n261L	CA_n261J	n260	CA_n260L	0
	CA_n261K	n261	CA_n261L	
CA_n260L-n261M	CA_n261L	n260	CA_n260L	0
	CA_n261M	n261	CA_n261M	
CA_n260M-n261A		n260	CA_n260M	0
		n261	50, 100, 200, 400	
CA_n260M-n261G		n260	CA_n260M	0
		n261	CA_n261G	
CA_n260M-n261H		n260	CA_n260M	0
		n261	CA_n261H	
CA_n260M-n261I		n260	CA_n260M	0
		n261	CA_n261I	
CA_n260M-n261J		n260	CA_n260M	0
		n261	CA_n261J	
CA_n260M-n261K		n260	CA_n260M	0
		n261	CA_n261K	
CA_n260M-n261L		n260	CA_n260M	0



CA_n260M-n261M	CA_n260A-n261A	n261	CA_n261L	0
	CA_n260G CA_n260H CA_n260I CA_n260J CA_n260K CA_n260L CA_n260M CA_n261G CA_n261H CA_n261I CA_n261J CA_n261K CA_n261L CA_n261M	n260	CA_n260M	
NOTE 1: The SCS of each channel bandwidth for NR band refers to Table 5.3.5-1. NOTE 2: Unless otherwise stated, BCS0 is referred in each constituent CA configuration NOTE 3: Void				

### 5.5D Configurations for UL MIMO

The requirements specified in clause 5.5 are applicable to UE supporting UL MIMO.

## 6 Transmitter characteristics

### 6.1 General

Unless otherwise stated, the transmitter characteristics are specified over the air (OTA) with a single or multiple transmit chains.

Unless otherwise stated, for power class 3 UEs, the beam correspondence side condition for SSB and CSI-RS specified in clause 6.6.4 shall apply to the transmission tests.

Unless otherwise stated, the UE min peak EIRP requirements and UE spherical coverage requirements specified in clause 6.2.1 does not apply to initial access and RRC\_INACTIVE.

Transmitter requirements for CA operation apply only when the DMRS initialization parameters (including the case when the UE applies cell ID as DMRS scrambling ID) are different across all CCs. The UE may use higher MPR values outside this limitation.

For a UE that supports 'UL full power transmission' and is configured to transmit a single layer with  $nrofSRS\text{-}Ports = 2$ , the requirements for UL MIMO operation apply only when it is configured for any of its declared full power modes in IE *FullPowerTransmission-r16* (as defined in TS 38.331[13]).

For a UE configured to transmit 2 layers, transmitter requirements for UL MIMO operation apply when the UE transmits on 2 ports on the same CDM group. The UE may use higher MPR values outside this limitation.

### 6.2 Transmitter power

#### 6.2.1 UE maximum output power

##### 6.2.1.0 General

NOTE: Power classes are specified based on the assumption of certain UE types with specific device architectures. The UE types can be found in Table 6.2.1.0-1.

**Table 6.2.1.0-1: Assumption of UE Types**

UE Power class	UE type
1	Fixed wireless access (FWA) UE
2	Vehicular UE
3	Handheld UE
4	High power non-handheld UE
5	Fixed wireless access (FWA) UE
6	High Speed Train Roof-Mounted UE
7	RedCap UE
Note: Any power class can be used for Redcap type devices as long as the device can meet the core requirements that are applicable to Redcap devices as defined in clause 4.2.21.1 from TS38.306 [14]	

Power class 3 is default power class.

##### 6.2.1.1 UE maximum output power for power class 1

The following requirements define the maximum output power radiated by the UE for any transmission bandwidth within the channel bandwidth for non-CA configuration, unless otherwise stated. The period of measurement shall be at least one sub frame (1ms). The minimum output power values for EIRP are found in Table 6.2.1.1-1. The requirement is verified with the test metric of EIRP (Link=TX beam peak direction, Meas=Link angle).

**Table 6.2.1.1-1: UE minimum peak EIRP for power class 1**

Operating band	Min peak EIRP (dBm)
n257	40.0
n258	40.0
n260	38.0
n261	40.0
n262	34.2
n263	30.6

NOTE 1: Minimum peak EIRP is defined as the lower limit without tolerance

The maximum output power values for TRP and EIRP are found in Table 6.2.1.1-2 below. The maximum allowed EIRP is derived from regulatory requirements [8]. The requirements are verified with the test metrics of TRP (Link=TX beam peak direction, Meas=TRP grid) in beam locked mode and EIRP (Link=TX beam peak direction, Meas=Link angle).

**Table 6.2.1.1-2: UE maximum output power limits for power class 1**

Operating band	Max TRP (dBm)	Max EIRP (dBm)
n257	35	55
n258	35	55
n260	35	55
n261	35	55
n262	35	55
n263	25	40

The minimum EIRP at the 85<sup>th</sup> percentile of the distribution of radiated power measured over the full sphere around the UE is defined as the spherical coverage requirement and is found in Table 6.2.1.1-3 below. The requirement is verified with the test metric of EIRP (Link=Spherical coverage grid, Meas=Link angle).

**Table 6.2.1.1-3: UE spherical coverage for power class 1**

Operating band	Min EIRP at 85 %-tile CDF (dBm)
n257	32.0
n258	32.0
n260	30.0
n261	32.0
n262	26.0
n263	19.1

NOTE 1: Minimum EIRP at 85 %-tile CDF is defined as the lower limit without tolerance

NOTE 2: The requirements in this table are verified only under normal temperature conditions as defined in Annex E.2.1.

## 6.2.1.2 UE maximum output power for power class 2

The following requirements define the maximum output power radiated by the UE for any transmission bandwidth within the channel bandwidth for non-CA configuration, unless otherwise stated. The period of measurement shall be at least one sub frame (1ms). The minimum output power values for EIRP are found in Table 6.2.1.2-1. The requirement is verified with the test metric of EIRP (Link=TX beam peak direction, Meas=Link angle).

**Table 6.2.1.2-1: UE minimum peak EIRP for power class 2**

Operating band	Min peak EIRP (dBm)
n257	29
n258	29
n259	25
n261	29
n262	22.9
n263	22.7
NOTE 1: Minimum peak EIRP is defined as the lower limit without tolerance	

The maximum output power values for TRP and EIRP are found in Table 6.2.1.2-2 below. The maximum allowed EIRP is derived from regulatory requirements [8]. The requirements are verified with the test metrics of TRP (Link=TX beam peak direction, Meas=TRP grid) in beam locked mode and EIRP (Link=TX beam peak direction, Meas=Link angle).

**Table 6.2.1.2-2: UE maximum output power limits for power class 2**

Operating band	Max TRP (dBm)	Max EIRP (dBm)
n257	23	43
n258	23	43
n259	23	43
n261	23	43
n262	23	43
n263	23	43

The minimum EIRP at the 60<sup>th</sup> percentile of the distribution of radiated power measured over the full sphere around the UE is defined as the spherical coverage requirement and is found in Table 6.2.1.2-3 below. The requirement is verified with the test metric of EIRP (Link=Spherical coverage grid, Meas=Link angle).

**Table 6.2.1.2-3: UE spherical coverage for power class 2**

Operating band	Min EIRP at 60 %-tile CDF (dBm)
n257	18.0
n258	18.0
n259	12.5
n261	18.0
n262	11.0
n263	7.6
NOTE 1: Minimum EIRP at 60 %-tile CDF is defined as the lower limit without tolerance	
NOTE 2: The requirements in this table are verified only under normal temperature conditions as defined in Annex E.2.1.	

### 6.2.1.3 UE maximum output power for power class 3

The following requirements define the maximum output power radiated by the UE for any transmission bandwidth within the channel bandwidth for non-CA configuration, unless otherwise stated. The period of measurement shall be at least one sub frame (1ms). The minimum output power values for EIRP are found in Table 6.2.1.3-1. The requirement is verified with the test metric of total component of EIRP (Link=TX beam peak direction, Meas=Link angle). The requirement for the UE which supports a single FR2 band is specified in Table 6.2.1.3-1. The requirement for the UE which supports multiple FR2 bands is specified in both Table 6.2.1.3-1 and Table 6.2.1.3-4.

**Table 6.2.1.3-1: UE minimum peak EIRP for power class 3**

Operating band	Min peak EIRP (dBm)
n257	22.4
n258	22.4
n259	18.7
n260	20.6
n261	22.4
n262	16.0
n263	14.1
NOTE 1: Minimum peak EIRP is defined as the lower limit without tolerance	
NOTE 2: Void	

The maximum output power values for TRP and EIRP are found on the Table 6.2.1.3-2. The max allowed EIRP is derived from regulatory requirements [8]. The requirements are verified with the test metrics of TRP (Link=TX beam peak direction, Meas=TRP grid) in beam locked mode and the total component of EIRP (Link=TX beam peak direction, Meas=Link angle).

**Table 6.2.1.3-2: UE maximum output power limits for power class 3**

Operating band	Max TRP (dBm)	Max EIRP (dBm)	Max EIRP (dBm/MHz)	Notes
n257	23	43		
n258	23	43		
n259	23	43		
n260	23	43		
n261	23	43		
n262	23	43		
n263	25	43		Default for "NS_200"
	25	40	23	Applies when "NS_204" is indicated in the cell

The minimum EIRP at the 50<sup>th</sup> percentile of the distribution of radiated power measured over the full sphere around the UE is defined as the spherical coverage requirement and is found in Table 6.2.1.3-3 below. The requirement is verified with the test metric of the total component of EIRP (Link=Beam peak search grids, Meas=Link angle). The requirement for the UE which supports a single FR2 band is specified in Table 6.2.1.3-3. The requirement for the UE which supports multiple FR2 bands is specified in both Table 6.2.1.3-3 and Table 6.2.1.3-4.

**Table 6.2.1.3-3: UE spherical coverage for power class 3**

Operating band	Min EIRP at 50 %-tile CDF (dBm)
n257	11.5
n258	11.5
n259	5.8
n260	8
n261	11.5
n262	2.9
n263	2.3
NOTE 1: Minimum EIRP at 50 %-tile CDF is defined as the lower limit without tolerance	
NOTE 2: Void	
NOTE 3: The requirements in this table are verified only under normal temperature conditions as defined in Annex E.2.1.	

For the UEs that support multiple FR2 bands, minimum requirement for peak EIRP and EIRP spherical coverage in Tables 6.2.1.3-1 and 6.2.1.3-3 shall be decreased per band, respectively, by the peak EIRP relaxation parameter  $\Delta MB_{P,n}$  and EIRP spherical coverage relaxation parameter  $\Delta MB_{S,n}$ , as defined in Table 6.2.1.3-4..

**Table 6.2.1.3-4: UE multi-band relaxation factors for power class 3**

Band	$\Delta MB_{P,n}$ (dB)	$\Delta MB_{S,n}$ (dB)
n257	0.7 <sup>3</sup>	0.7 <sup>3</sup>
n258	0.6	0.7
n259	0.5	0.4
n260	0.5 <sup>1</sup>	0.4 <sup>1</sup>
n261	0.5 <sup>2,4</sup>	0.7 <sup>4</sup>
n262	0.7	0.7
n263	1.0	1.0

Note 1: n260 peak and spherical relaxations are 0 dB for UE that exclusively supports n261+n260  
Note 2: n261 peak relaxation is 0 dB for UE that exclusively supports n261+n260  
Note 3: n257 peak and spherical relaxations are 0 dB for UE that exclusively supports n261+n257  
Note 4: n261 peak and spherical relaxations are 0 dB for UE that exclusively supports n261+n257

#### 6.2.1.4 UE maximum output power for power class 4

The following requirements define the maximum output power radiated by the UE for any transmission bandwidth within the channel bandwidth for non-CA configuration, unless otherwise stated. The period of measurement shall be at least one sub frame (1ms). The minimum output power values for EIRP are found in Table 6.2.1.4-1. The requirement is verified with the test metric of EIRP (Link=TX beam peak direction, Meas=Link angle).

**Table 6.2.1.4-1: UE minimum peak EIRP for power class 4**

Operating band	Min peak EIRP (dBm)
n257	34
n258	34
n260	31
n261	34
n262	28.3

NOTE 1: Minimum peak EIRP is defined as the lower limit without tolerance

The maximum output power values for TRP and EIRP are found in Table 6.2.1.4-2 below. The maximum allowed EIRP is derived from regulatory requirements [8]. The requirements are verified with the test metrics of TRP (Link=TX beam peak direction, Meas=TRP grid) in beam locked mode and EIRP (Link=TX beam peak direction, Meas=Link angle).

**Table 6.2.1.4-2: UE maximum output power limits for power class 4**

Operating band	Max TRP (dBm)	Max EIRP (dBm)
n257	23	43
n258	23	43
n260	23	43
n261	23	43
n262	23	43

The minimum EIRP at the 20<sup>th</sup> percentile of the distribution of radiated power measured over the full sphere around the UE is defined as the spherical coverage requirement and is found in Table 6.2.1.4-3 below. The requirement is verified with the test metric of EIRP (Link=Spherical coverage grid, Meas=Link angle).

**Table 6.2.1.4-3: UE spherical coverage for power class 4**

Operating band	Min EIRP at 20 %-tile CDF (dBm)
n257	25
n258	25
n260	19
n261	25
n262	16.2
NOTE 1: Minimum EIRP at 20 %-tile CDF is defined as the lower limit without tolerance	
NOTE 2: The requirements in this table are verified only under normal temperature conditions as defined in Annex E.2.1.	

### 6.2.1.5 UE maximum output power for power class 5

The following requirements define the maximum output power radiated by the UE for any transmission bandwidth within the channel bandwidth for non-CA configuration, unless otherwise stated. The period of measurement shall be at least one sub frame (1ms). The minimum output power values for EIRP are found in Table 6.2.1.5-1. The requirement is verified with the test metric of EIRP (Link=TX beam peak direction, Meas=Link angle).

**Table 6.2.1.5-1: UE minimum peak EIRP for power class 5**

Operating band	Min peak EIRP (dBm)
n257	30
n258	30.4
n259	27.7
NOTE 1: Minimum peak EIRP is defined as the lower limit without tolerance	

The maximum output power values for TRP and EIRP are found in Table 6.2.1.5-2 below. The maximum allowed EIRP is derived from regulatory requirements. The requirements are verified with the test metrics of TRP (Link=TX beam peak direction, Meas=TRP grid) in beam locked mode and EIRP (Link=TX beam peak direction, Meas=Link angle).

**Table 6.2.1.5-2: UE maximum output power limits for power class 5**

Operating band	Max TRP (dBm)	Max EIRP (dBm)
n257	23	43
n258	23	43
n259	23	43

The minimum EIRP at the 85<sup>th</sup> percentile of the distribution of radiated power measured over the full sphere around the UE is defined as the spherical coverage requirement and is found in Table 6.2.1.5-3 below. The requirement is verified with the test metric of EIRP (Link=Spherical coverage grid, Meas=Link angle).

**Table 6.2.1.4-3: UE spherical coverage for power class 5**

Operating band	Min EIRP at 85 %-tile CDF (dBm)
n257	22
n258	22.4
n259	19.7
NOTE 1: Minimum EIRP at 85 %-tile CDF is defined as the lower limit without tolerance	
NOTE 2: The requirements in this table are verified only under normal temperature conditions as defined in Annex E.2.1.	

For the UEs that support multiple FR2 bands, minimum requirement for peak EIRP and EIRP spherical coverage in Tables 6.2.1.5-1 and 6.2.1.5-3 shall be decreased per band, respectively, by the peak EIRP relaxation parameter  $\Delta MB_{P,n}$  and EIRP spherical coverage relaxation parameter  $\Delta MB_{S,n}$ , as defined in Table 6.2.1.5-4..

**Table 6.2.1.5-4: UE multi-band relaxation factors for power class 5**

Band	$\Delta MB_{P,n}$ (dB)	$\Delta MB_{S,n}$ (dB)
n257	0.7	0.7
n258	0.7	0.7
n259	0.5	0,5

### 6.2.1.6 UE maximum output power for power class 6

The following requirements define the maximum output power radiated by the UE for any transmission bandwidth within the channel bandwidth for non-CA configuration, unless otherwise stated. The period of measurement shall be at least one sub frame (1ms). The minimum output power values for EIRP are found in Table 6.2.1.6-1. The requirement is verified with the test metric of EIRP (Link=TX beam peak direction, Meas=Link angle).

**Table 6.2.1.6-1: UE minimum peak EIRP for power class 6**

Operating band	Min peak EIRP (dBm)
n257	30
n258	30.4
n261	30
NOTE 1: Minimum peak EIRP is defined as the lower limit without tolerance	

The maximum output power values for TRP and EIRP are found in Table 6.2.1.6-2 below. The maximum allowed EIRP is derived from regulatory requirements [8]. The requirements are verified with the test metrics of TRP (Link=TX beam peak direction, Meas=TRP grid) in beam locked mode and EIRP (Link=TX beam peak direction, Meas=Link angle).

**Table 6.2.1.6-2: UE maximum output power limits for power class 6**

Operating band	Max TRP (dBm)	Max EIRP (dBm)
n257	23	43
n258	23	43
n261	23	43

The minimum EIRP measured over the spherical coverage evaluation areas specified below is defined as the spherical coverage requirement and is found in Table 6.2.1.6-3 below. UE spherical coverage evaluation areas are found in Table 6.2.1.6-3a below, by consisting of Area-1 and Area-2, in the reference coordinate system in Annex J.1. The requirement is verified with the test metric of EIRP (Link= Spherical coverage grid, Meas=Link angle).

**Table 6.2.1.6-3: UE spherical coverage for power class 6**

Operating band	Min EIRP over UE spherical coverage evaluation areas (dBm)
n257	20
n258	20.4
n261	20
NOTE 1: Minimum EIRP over UE spherical coverage evaluation areas is defined as the lower limit without tolerance	
NOTE 2: The requirements in this table are verified only under normal temperature conditions as defined in Annex E.2.1.	
NOTE 3: The requirements in this table are applicable to FR2 PC6 UE with the network signalling <i>highSpeedMeasFlag-r17</i> configured as <i>set2</i> .	



**Table 6.2.1.6-3a: UE spherical coverage evaluation areas for power class 6**

	$\theta$ range (degree)	$\phi$ range (degree)
Area-1	90 to 60	- 37.5 to + 37.5
Area-2	90 to 60	142.5 to 217.5

NOTE 1: When testing power class 6 UEs, DUT orientation can be determined according to the UE spherical coverage evaluation areas, not necessarily following default alignment in Figure J.1-2 or positioning guidelines in clause J.3.

NOTE 2: High speed train deployment is expected to be w.r.t. the reference coordination system:  $\theta = 90$  (degree) corresponds to the ground plane the train is running on, and  $\phi = 0$  or  $180$  with  $\theta = 90$  are the train track directions.

For the UEs that support multiple FR2 bands, minimum requirement for peak EIRP and EIRP spherical coverage in Tables 6.2.1.6-1 and 6.2.1.6-3 shall be decreased per band, respectively, by the peak EIRP relaxation parameter  $\Delta MB_{P,n}$  and EIRP spherical coverage relaxation parameter  $\Delta MB_{S,n}$ , as defined in Table 6.2.1.6-4.

**Table 6.2.1.6-4: UE multi-band relaxation factors for power class 6**

Band	$\Delta MB_{P,n}$ (dB)	$\Delta MB_{S,n}$ (dB)
n257	0.7	0.7
n258	0.7	0.7
n261	0.7	0.7

### 6.2.1.7 UE maximum output power for power class 7

The following requirements define the maximum output power radiated by the UE for any transmission bandwidth within the channel bandwidth for non-CA configuration, unless otherwise stated. The period of measurement shall be at least one sub frame (1ms). The minimum output power values for EIRP are found in Table 6.2.1.7-1. The requirement is verified with the test metric of total component of EIRP (Link=TX beam peak direction, Meas=Link angle).

**Table 6.2.1.7-1: UE minimum peak EIRP for power class 7**

Operating band	Min peak EIRP (dBm)
n257	16.4
n258	16.4
n261	16.4

NOTE 1: Minimum peak EIRP is defined as the lower limit without tolerance

NOTE 2: Void

The maximum output power values for TRP and EIRP are found on the Table 6.2.1.7-2. The max allowed EIRP is derived from regulatory requirements [8]. The requirements are verified with the test metrics of TRP (Link=TX beam peak direction, Meas=TRP grid) in beam locked mode and the total component of EIRP (Link=TX beam peak direction, Meas=Link angle).

**Table 6.2.1.7-2: UE maximum output power limits for power class 7**

Operating band	Max TRP (dBm)	Max EIRP (dBm)
n257	23	43
n258	23	43
n261	23	43

The minimum EIRP at the 50<sup>th</sup> percentile of the distribution of radiated power measured over the full sphere around the UE is defined as the spherical coverage requirement and is found in Table 6.2.1.7-3 below. The requirement is verified with the test metric of the total component of EIRP (Link=Beam peak search grids, Meas=Link angle).

**Table 6.2.1.7-3: UE spherical coverage for power class 7**

Operating band	Min EIRP at 50 %-tile CDF (dBm)
n257	5.5
n258	5.5
n261	5.5
NOTE 1: Minimum EIRP at 50 %-tile CDF is defined as the lower limit without tolerance	
NOTE 2: The requirements in this table are verified only under normal temperature conditions as defined in Annex E.2.1.	

For power class 7 UEs that support multiple FR2 bands, minimum requirement for peak EIRP and EIRP spherical coverage in Tables 6.2.1.7-1 and 6.2.1.7-3 shall be decreased per band, respectively, by the peak EIRP relaxation parameter  $\Delta MB_{P,n}$  and EIRP spherical coverage relaxation parameter  $\Delta MB_{S,n}$ , as defined for power class 3 in Table 6.2.1.3-4.

## 6.2.2 UE maximum output power reduction

### 6.2.2.0 General

The requirements in clause 6.2.2 only apply when both UL and DL of a UE are configured for single CC operation, and they are of the same bandwidth. A UE may reduce its maximum output power due to modulation orders, transmit bandwidth configurations, waveform types and narrow allocations. This Maximum Power Reduction (MPR) is defined in clauses below. The allowed MPR for SRS, PUCCH formats 0, 1, 3 and 4 shall be as specified for QPSK modulated DFT-s-OFDM of equivalent RB allocation. The allowed MPR for PUCCH format 2 shall be as specified for QPSK modulated CP-OFDM of equivalent RB allocation. When the maximum output power of a UE is modified by MPR, the power limits specified in clause 6.2.4 apply.

For a UE that is configured for single CC operation with different channel bandwidths in UL and DL, the requirements in clause 6.2A.2 apply.

For all power classes, the waveform defined by  $BW = 100$  MHz,  $SCS = 120$  kHz, DFT-S-OFDM QPSK, 20RB23 is the reference waveform with 0 dB MPR and is used for the power class definition.

### 6.2.2.1 UE maximum output power reduction for power class 1

For power class 1, MPR for contiguous allocations is defined as:

$$MPR = \max(MPR_{WT}, MPR_{narrow})$$

Where,

$MPR_{narrow} = 14.4$  dB, when  $BW_{alloc, RB} \leq 1.44$  MHz,  $MPR_{narrow} = 10$  dB, when  $1.44$  MHz  $< BW_{alloc, RB} \leq 10.8$  MHz, where  $BW_{alloc, RB}$  is the bandwidth of the RB allocation size.

$MPR_{WT}$  is the maximum power reduction due to modulation orders, transmission bandwidth configurations listed in table 5.3.2-1, and waveform types.  $MPR_{WT}$  is defined in Tables 6.2.2.1-1 and 6.2.2.1-2 for FR2-1 and in Tables 6.2.2.1-3 and 6.2.2.1-4 for FR2-2.

**Table 6.2.2.1-1 MPR<sub>WT</sub> for power class 1, BW<sub>channel</sub> ≤ 200 MHz in FR2-1**

Modulation		MPR <sub>WT</sub> (dB), BW <sub>channel</sub> ≤ 200 MHz		
		Outer RB allocations	Inner RB allocations	
			Region 1	Region 2
DFT-s-OFDM	Pi/2 BPSK	≤ 5.5	0.0	≤ 3.0
	QPSK	≤ 6.5	0.0	≤ 3.0
	16 QAM	≤ 6.5	≤ 4.0	≤ 4.0
	64 QAM	≤ 6.5	≤ 5.0	≤ 5.0
CP-OFDM	QPSK	≤ 7.0	≤ 4.5	≤ 4.5
	16 QAM	≤ 7.0	≤ 5.5	≤ 5.5
	64 QAM	≤ 7.5	≤ 7.5	≤ 7.5

**Table 6.2.2.1-2 MPR<sub>WT</sub> for power class 1, BW<sub>channel</sub> = 400 MHz in FR2-1**

Modulation		MPR <sub>WT</sub> (dB), BW <sub>channel</sub> = 400 MHz		
		Outer RB allocations	Inner RB allocations	
			Region 1	Region 2
DFT-s-OFDM	Pi/2 BPSK	≤ 5.5	0.0	≤ 3.0
	QPSK	≤ 6.5	0.0	≤ 3.5
	16 QAM	≤ 6.5	≤ 4.5	≤ 4.5
	64 QAM	≤ 6.5	≤ 6.5	≤ 6.5
CP-OFDM	QPSK	≤ 7.0	≤ 5.0	≤ 5.0
	16 QAM	≤ 7.0	≤ 6.5	≤ 6.5
	64 QAM	≤ 9.0	≤ 9.0	≤ 9.0

**Table 6.2.2.1-3 MPR<sub>WT</sub> for power class 1, BW<sub>channel</sub> = 100 MHz in FR2-2**

Modulation		MPR <sub>WT</sub> (dB), BW <sub>channel</sub> = 100 MHz		
		Outer RB allocations	Inner RB allocations	
			Region 1	Region 2
DFT-s-OFDM	Pi/2 BPSK	≤ 5.5	0.0	≤ 3.5
	QPSK	≤ 6.5	0.0	≤ 3.5
	16 QAM	≤ 7.0	≤ 2.5	≤ 2.5
	64 QAM	≤ 8.0	≤ 8.0	≤ 8.0
CP-OFDM	QPSK	≤ 8.0	≤ 1.5	≤ 3.5
	16 QAM	≤ 8.0	≤ 3.5	≤ 4.0
	64 QAM	≤ 9.5	≤ 9.5	≤ 9.5

**Table 6.2.2.1-4 MPR<sub>WT</sub> for power class 1, BW<sub>channel</sub> ≥ 400 MHz in FR2-2**

Modulation		MPR <sub>WT</sub> (dB), BW <sub>channel</sub> = 400, 800, 1600, 2000 MHz		
		Outer RB allocations	Inner RB allocations	
			Region 1	Region 2
DFT-s-OFDM	Pi/2 BPSK	≤ 6.0	≤ 1.0	≤ 3.5
	QPSK	≤ 6.0	≤ 1.0	≤ 4.0
	16 QAM	≤ 4.5	≤ 3.0	≤ 3.0
	64 QAM	≤ 8.0	≤ 8.0	≤ 8.0
CP-OFDM	QPSK	≤ 6.0	≤ 1.5	≤ 3.5
	16 QAM	≤ 6.0	≤ 4.0	≤ 5.5
	64 QAM	≤ 10.0	≤ 10.0	≤ 10.0

Where the following parameters are defined to specify valid RB allocation ranges for the RB allocations regions in Tables 6.2.2.1-1, 6.2.2.1-2, 6.2.2.1-3, and 6.2.2.1-4:

$N_{RB}$  is the maximum number of RBs for a given Channel bandwidth and sub-carrier spacing defined in Table 5.3.2-1.

$$RB_{end} = RB_{start} + L_{CRB} - 1$$

$$RB_{start,Low} = \text{Max}(1, \text{Floor}(L_{CRB}/2))$$

$$RB_{start,High} = N_{RB} - RB_{start,Low} - L_{CRB}$$

An RB allocation is an Outer RB allocation if

$$RB_{Start} < RB_{Start,Low} \text{ OR } RB_{Start} > RB_{Start,High} \text{ OR } L_{CRB} > Ceil(N_{RB}/2)$$

An RB allocation belonging to table 6.2.2.1-1 and 6.2.2.1-3 is a Region 1 inner RB allocation if

$$RB_{start} \geq Ceil(1/3 N_{RB}) \text{ AND } RB_{end} < Ceil(2/3 N_{RB})$$

An RB allocation belonging to table 6.2.2.1-2 and 6.2.2.1-4 is a Region 1 inner RB allocation if

$$RB_{start} \geq Ceil(1/4 N_{RB}) \text{ AND } RB_{end} < Ceil(3/4 N_{RB}) \text{ AND } L_{CRB} \leq Ceil(1/4 N_{RB})$$

An RB allocation is a Region 2 inner allocation if it is NOT an Outer allocation AND NOT a Region 1 inner allocation

For the UE maximum output power modified by MPR, the power limits specified in clause 6.2.4 apply.

### 6.2.2.2 UE maximum output power reduction for power class 2

For power class 2, MPR for FR2-1 and FR2-2 as specified in clause 6.2.2.3 applies.

**Table 6.2.2.2-1: Void**

### 6.2.2.3 UE maximum output power reduction for power class 3

For power class 3, MPR for contiguous allocations is defined as:

$$MPR = \max(MPR_{WT}, MPR_{narrow})$$

For transmission bandwidth configuration less than or equal to 200MHz, and  $0 \leq RB_{start} < Ceil(1/3 N_{RB})$  or  $Ceil((2/3 N_{RB}) - L_{CRB}) < RB_{start} \leq N_{RB} - L_{CRB}$ :

- $MPR_{narrow} = 2.5$  dB, when  $BW_{alloc, RB}$  is less than or equal to 1.44 MHz,
- $MPR_{narrow} = 2.0$  dB, when  $1.44 \text{ MHz} < BW_{alloc, RB} \leq 4.32 \text{ MHz}$ ,
- otherwise  $MPR_{narrow} = 0$  dB.

$MPR_{WT}$  is the maximum power reduction due to modulation orders, transmission bandwidth configurations listed in Table 5.3.2-1, and waveform types.  $MPR_{WT}$  is defined for FR2-1 in Table 6.2.2.3-1.

**Table 6.2.2.3-1  $MPR_{WT}$  for power class 3,  $BW_{channel} \leq 200$  MHz, FR2-1**

Modulation		$MPR_{WT}, BW_{channel} \leq 200$ MHz	
		Inner RB allocations, Region 1	Edge RB allocations
DFT-s-OFDM	Pi/2 BPSK	0.0	$\leq 2.0$
	QPSK	0.0	$\leq 2.0$
	16 QAM	$\leq 3.0$	$\leq 3.5$
	64 QAM	$\leq 5.0$	$\leq 5.5$
CP-OFDM	QPSK	$\leq 3.5$	$\leq 4.0$
	16 QAM	$\leq 5.0$	$\leq 5.0$
	64 QAM	$\leq 7.5$	$\leq 7.5$

$MPR_{WT}$  is defined for FR2-2 in Table 6.2.2.3-1b.

**Table 6.2.2.3-1b MPR<sub>WT</sub> for power class 3, BW<sub>channel</sub> = 100 MHz, FR2-2**

Modulation		MPR <sub>WT</sub> , BW <sub>channel</sub> = 100 MHz	
		Inner RB allocations, Region 1	Edge RB allocations
DFT-s-OFDM	Pi/2 BPSK	0.0	≤ 0.5
	QPSK	0.0	≤ 0.5
	16 QAM	≤ 3.0	≤ 3.0
	64 QAM	≤ 8.5	≤ 8.5
CP-OFDM	QPSK	≤ 1.5	≤ 1.5
	16 QAM	≤ 4.0	≤ 4.0
	64 QAM	≤ 10.0	≤ 10.0

Where the following parameters are defined to specify valid RB allocation ranges for RB allocations in Table 6.2.2.3-1 and 6.2.2.3-1b:

- $RB_{Start,Low} = \max(1, L_{CRB})$ , where  $\max()$  indicates the largest value of all arguments.
- $RB_{Start,High} = N_{RB} - RB_{Start,Low} - L_{CRB}$ ,

An RB allocation belonging to table 6.2.2.3-1 and 6.2.2.3-1b is a Region 1 inner RB allocation if:

- $RB_{Start,Low} \leq RB_{Start} \leq RB_{Start,High}$ , and  $L_{CRB} \leq \text{ceil}(N_{RB}/3)$ , where  $\text{ceil}(x)$  is the smallest integer greater than or equal to  $x$ .

For transmission bandwidth configuration equal to 400MHz,

$MPR_{narrow} = 2.5$  dB, when  $BW_{alloc,RB}$  is less than or equal to 1.44 MHz, and  $0 \leq RB_{start} < \text{Ceil}(1/3 N_{RB})$  or  $\text{Ceil}(2/3 N_{RB}) \leq RB_{start} \leq N_{RB} - L_{CRB}$ , where  $BW_{alloc,RB}$  is the bandwidth of the RB allocation size.

$MPR_{WT}$  is the maximum power reduction due to modulation orders, transmission bandwidth configurations listed in Table 5.3.2-1, and waveform types.  $MPR_{WT}$  is defined for FR2-1 in Table 6.2.2.3-2.

**Table 6.2.2.3-2 MPR<sub>WT</sub> for power class 3, BW<sub>channel</sub> = 400 MHz, FR2-1**

Modulation		MPR <sub>WT</sub> , BW <sub>channel</sub> = 400 MHz	
		Inner RB allocations, Region 1	Edge RB allocations
DFT-s-OFDM	Pi/2 BPSK	0.0	≤ 3.0
	QPSK	0.0	≤ 3.0
	16 QAM	≤ 4.5	≤ 4.5
	64 QAM	≤ 6.5	≤ 6.5
CP-OFDM	QPSK	≤ 5.0	≤ 5.0
	16 QAM	≤ 6.5	≤ 6.5
	64 QAM	≤ 9.0	≤ 9.0

$MPR_{WT}$  is defined for FR2-2 in Table 6.2.2.3-2b and 6.2.2.3-2c.

**Table 6.2.2.3-2b MPR<sub>WT</sub> for power class 3, BW<sub>channel</sub> = 400 MHz, FR2-2**

Modulation		MPR <sub>WT</sub> , BW <sub>channel</sub> = 400 MHz	
		Inner RB allocations, Region 1	Edge RB allocations
DFT-s-OFDM	Pi/2 BPSK	≤ 1.0	≤ 3.0
	QPSK	≤ 1.0	≤ 3.0
	16 QAM	≤ 4.5	≤ 4.5
	64 QAM	≤ 9.5	≤ 9.0
CP-OFDM	QPSK	≤ 5.0	≤ 5.0
	16 QAM	≤ 6.5	≤ 6.5
	64 QAM	≤ 10.0	≤ 10.0

**Table 6.2.2.3-2c MPR<sub>WT</sub> for power class 3, BW<sub>channel</sub> ≥ 800 MHz, FR2-2**

Modulation		MPR <sub>WT</sub> , BW <sub>channel</sub> ≥ 800 MHz	
		Inner RB allocations, Region 1	Edge RB allocations
DFT-s-OFDM	Pi/2 BPSK	≤ 1.0	≤ 4.0
	QPSK	≤ 1.0	≤ 4.0
	16 QAM	≤ 6.0	≤ 6.0
	64 QAM	≤ 9.5	≤ 9.0
CP-OFDM	QPSK	≤ 6.5	≤ 6.5
	16 QAM	≤ 8.0	≤ 8.0
	64 QAM	≤ 10.5	≤ 10.5

Where the following parameters are defined to specify valid RB allocation ranges for RB allocations in Table 6.2.2.3-2, 6.2.2.3-2b and 6.2.2.3-2c:

$N_{RB}$  is the maximum number of RBs for a given Channel bandwidth and sub-carrier spacing defined in Table 5.3.2-1.

$$RB_{end} = RB_{start} + L_{CRB} - 1$$

An RB allocation belonging to table 6.2.2.3-2, 6.2.2.3-2b and 6.2.2.3-2c is a Region 1 inner RB allocation if

$$RB_{start} \geq \text{Ceil}(1/4 N_{RB}) \text{ AND } RB_{end} < \text{Ceil}(3/4 N_{RB}) \text{ AND } L_{CRB} \leq \text{Ceil}(1/4 N_{RB})$$

For all transmission bandwidth configurations, an RB allocation is an Edge allocation if it is NOT a Region 1 inner allocation.

#### 6.2.2.4 UE maximum output power reduction for power class 4

For power class 4, MPR specified in sub-clause 6.2.2.3 applies.

**Table 6.2.2.4-1: Void**

#### 6.2.2.5 UE maximum output power reduction for power class 5

For power class 5, MPR specified in sub-clause 6.2.2.3 applies.

#### 6.2.2.6 UE maximum output power reduction for power class 6

For power class 6, MPR specified in sub-clause 6.2.2.3 applies.

#### 6.2.2.7 UE maximum output power reduction for power class 7

For power class 7, MPR specified in table 6.2.2.3-1 applies.

### 6.2.3 UE maximum output power with additional requirements

#### 6.2.3.1 General

Additional emission requirements can be signalled by the network. Each additional emission requirement is associated with a unique network signalling (NS) value indicated in RRC signalling by an NR frequency band number of the applicable operating band and an associated value in the field *additionalSpectrumEmission*. Throughout this specification, the notion of indication or signalling of an NS value refers to the corresponding indication of an NR frequency band number of the applicable operating band (the IE field *freqBandIndicatorNR*) and an associated value of *additionalSpectrumEmission* in the relevant RRC information elements.

To meet these additional requirements, additional maximum power reduction (A-MPR) is allowed for the maximum output power as specified in clause 6.2.1. Unless stated otherwise, an A-MPR of 0 dB shall be used.

Table 6.2.3.1-1 specifies the additional requirements with their associated network signalling values and the allowed A-MPR and applicable operating band(s) for each NS value. The mapping of NR frequency band numbers and values of the *additionalSpectrumEmission* to network signalling labels is specified in Table 6.2.3.1-2. Unless otherwise stated, the allowed total back off is maximum of A-MPR and MPR specified in clause 6.2.2.

**Table 6.2.3.1-1: Additional maximum power reduction (A-MPR)**

Network Signalling label	Requirements (clause)	NR Band	Channel bandwidth (MHz)	Resources Blocks ( $N_{RB}$ )	A-MPR (dB)
NS_200					N/A
NS_201 (NOTE 1)	6.5.3.2.2	n258			6.2.3.2
NS_202	6.5.3.2.3	n257, n258	50, 100, 200, 400	Table 5.3.2-1	6.2.3.3
NS_203	6.5.3.2.4	n258	50, 100, 200, 400	Table 5.3.2-1	6.2.3.4
NOTE 1: NS_201 is obsolete, the associated additional spurious emission requirements are not applicable.					

**Table 6.2.3.1-2: Mapping of Network Signalling labe**

NR Band	Value of additionalSpectrumEmission							
	0	1	2	3	4	5	6	7
n257	NS_200	NS_202						
n258	NS_200	NS_201 (NOTE 2)	NS_202	NS_203				
n259	NS_200							
n260	NS_200							
n261	NS_200							
n263	NS_200	NS_204						
NOTE 1: <i>additionalSpectrumEmission</i> corresponds to an information element of the same name defined in sub-clause 6.3.2 of TS 38.331 [13].								
NOTE 2: NS_201 is obsolete, the associated additional spurious emission requirements are not applicable.								

6.2.3.2 Void

6.2.3.2.1 Void

**Table 6.2.3.2.1-1: (Void)**

6.2.3.2.2 Void

**Table 6.2.3.2.2-1: (Void)**

6.2.3.2.3 Void

**Table 6.2.3.2.3-1: (Void)**

6.2.3.2.4 Void

6.2.3.2.5 Void

6.2.3.3 A-MPR for NS<sub>202</sub>

6.2.3.3.1 A-MPR for NS<sub>202</sub> for power class 1

For power class 1, A-MPR for NS<sub>202</sub> shall be 11.0 dB.

6.2.3.3.2 A-MPR for NS<sub>202</sub> for power class 2

For power class 2, A-MPR for NS<sub>202</sub> specified in clause 6.2.3.3.3 applies.

6.2.3.3.3 A-MPR for NS<sub>202</sub> for power class 3

For power class 3, A-MPR for NS<sub>202</sub> shall be 1.0 dB.

6.2.3.3.4 A-MPR for NS<sub>202</sub> for power class 4

For power class 4, A-MPR for NS<sub>202</sub> specified in clause 6.2.3.3.3 applies.

6.2.3.3.5 A-MPR for NS<sub>202</sub> for power class 5

For power class 5, A-MPR for NS<sub>202</sub> specified in clause 6.2.3.3.3 applies.

6.2.3.3.6 A-MPR for NS<sub>202</sub> for power class 6

For power class 6, A-MPR for NS<sub>202</sub> specified in clause 6.2.3.3.3 applies.

6.2.3.3.7 A-MPR for NS<sub>202</sub> for power class 7

For power class 7, A-MPR for NS<sub>202</sub> specified in clause 6.2.3.3.3 applies.

6.2.3.4 A-MPR for NS<sub>203</sub>

6.2.3.4.1 A-MPR for NS<sub>203</sub> for power class 1

For power class 1, A-MPR for NS<sub>203</sub> shall be 3.0 dB if Offset frequency < BW<sub>channel</sub>, 0.0 dB otherwise.

The Offset frequency is defined as the frequency from 24.25 GHz to the lower edge of the channel bandwidth.



#### 6.2.3.4.2 A-MPR for NS\_203 for power class 2

For power class 2, A-MPR for NS\_203 specified in subclause 6.2.3.4.3 applies.

#### 6.2.3.4.3 A-MPR for NS\_203 for power class 3

For power class 3, A-MPR for NS\_203 shall be 0 dB.

#### 6.2.3.4.4 A-MPR for NS\_203 for power class 4

For power class 4, A-MPR for NS\_203 specified in subclause 6.2.3.4.3 applies.

#### 6.2.3.4.5 A-MPR for NS\_203 for power class 5

For power class 5, A-MPR for NS\_203 specified in subclause 6.2.3.4.3 applies.

#### 6.2.3.4.6 A-MPR for NS\_203 for power class 6

For power class 6, A-MPR for NS\_203 specified in subclause 6.2.3.4.3 applies.

#### 6.2.3.4.7 A-MPR for NS\_203 for power class 7

For power class 7, AMPR for NS\_203 specified in subclause 6.2.3.4.3 applies.

## 6.2.4 Configured transmitted power

The UE can configure its maximum output power. The configured UE maximum output power  $P_{\text{CMAX},f,c}$  for carrier  $f$  of a serving cell  $c$  is defined as that available to the reference point of a given transmitter branch that corresponds to the reference point of the higher-layer filtered RSRP measurement as specified in TS 38.215 [11].

The configured UE maximum output power  $P_{\text{CMAX},f,c}$  for carrier  $f$  of a serving cell  $c$  shall be set such that the corresponding measured peak EIRP  $P_{\text{UMAX},f,c}$  is within the following bounds

$$P_{\text{Powerclass}} + \Delta P_{\text{IBE}} - \text{MAX}(\text{MAX}(\text{MPR}_{f,c}, \text{A-MPR}_{f,c}) + \Delta \text{MB}_{P,n}, \text{P-MPR}_{f,c}) - \text{MAX}\{\text{T}(\text{MAX}(\text{MPR}_{f,c}, \text{A-MPR}_{f,c})), \text{T}(\text{P-MPR}_{f,c})\} \leq P_{\text{UMAX},f,c} \leq \text{EIRP}_{\text{max}}$$

while the corresponding measured total radiated power  $P_{\text{TMAX},f,c}$  is bounded by

$$P_{\text{TMAX},f,c} \leq \text{TRP}_{\text{max}}$$

with  $P_{\text{Powerclass}}$  the UE minimum peak EIRP as specified in sub-clause 6.2.1,  $\text{EIRP}_{\text{max}}$  the applicable maximum EIRP as specified in sub-clause 6.2.1,  $\text{MPR}_{f,c}$  as specified in sub-clause 6.2.2,  $\text{A-MPR}_{f,c}$  as specified in sub-clause 6.2.3,  $\Delta \text{MB}_{P,n}$  the peak EIRP relaxation as specified in clause 6.2.1 and  $\text{TRP}_{\text{max}}$  the maximum TRP for the UE power class as specified in sub-clause 6.2.1.  $\Delta P_{\text{IBE}}$  is 1.0 dB if UE declares support for *mpr-PowerBoost-FR2-r16*, UL transmission is QPSK,  $\text{MPR}_{f,c} = 0$  and when NS\_200 applies and the network configures the UE to operate with *mpr-PowerBoost-FR2-r16* otherwise  $\Delta P_{\text{IBE}}$  is 0.0 dB. The requirement is verified in beam peak direction.

*maxUplinkDutyCycle-FR2*, as defined in TS 38.306 [14], is a UE capability to facilitate electromagnetic power density exposure requirements. This UE capability is applicable to all FR2 power classes.

If the field of UE capability *maxUplinkDutyCycle-FR2* is present and the percentage of uplink symbols transmitted including any PRACH transmission within any 1 s evaluation period is larger than *maxUplinkDutyCycle-FR2*, the UE follows the uplink scheduling and can apply P-MPR<sub>f,c</sub>.

If the field of UE capability *maxUplinkDutyCycle-FR2* is absent, the compliance to electromagnetic power density exposure requirements are ensured by means of scaling down the power density or by other means.

P-MPR<sub>f,c</sub> is the power management maximum output power reduction. The UE shall apply P-MPR<sub>f,c</sub> for carrier  $f$  of serving cell  $c$  only for the cases described below. For UE conformance testing P-MPR<sub>f,c</sub> shall be 0 dB, except for the testing of UL gap for Tx power management, where P-MPR<sub>f,c</sub> may be non-zero dB.

- a) ensuring compliance with applicable electromagnetic power density exposure requirements and addressing unwanted emissions / self desense requirements in case of simultaneous transmissions on multiple RAT(s) for scenarios not in scope of 3GPP RAN specifications;
- b) ensuring compliance with applicable electromagnetic power density exposure requirements in case of proximity detection is used to address such requirements that require a lower maximum output power.

NOTE 1: P-MPR<sub>f,c</sub> was introduced in the P<sub>C<sub>MAX</sub>,f,c</sub> equation such that the UE can report to the gNB the available maximum output transmit power. This information can be used by the gNB for scheduling decisions.

NOTE 2: P-MPR<sub>f,c</sub> and *maxUplinkDutyCycle-FR2* may impact the maximum uplink performance for the selected UL transmission path.

NOTE 3: MPE P-MPR Reporting capability *tdd-MPE-P-MPR-Reporting-r16*, as defined in TS 38.306 [14], is used to report P-MPR<sub>f,c</sub> when the reporting conditions configured by gNB are met. This UE capability is applicable to all FR2 power classes.

The tolerance T( $\Delta$ P) for applicable values of  $\Delta$ P (values in dB) is specified in Tables 6.2.4-1 and 6.2.4-2.

**Table 6.2.4-1: P<sub>UMAX,f,c</sub> tolerance for FR2-1**

Operating Band	$\Delta$ P (dB)	Tolerance T( $\Delta$ P) (dB)
n257, n258, n259, n260, n261, n262	$\Delta$ P = 0	0
	$0 < \Delta$ P $\leq$ 2	1.5
	$2 < \Delta$ P $\leq$ 3	2.0
	$3 < \Delta$ P $\leq$ 4	3.0
	$4 < \Delta$ P $\leq$ 5	4.0
	$5 < \Delta$ P $\leq$ 10	5.0
	$10 < \Delta$ P $\leq$ 15	7.0
	$15 < \Delta$ P $\leq$ X	8.0
NOTE: X is the value such that P <sub>umax,f,c</sub> lower bound, P <sub>Powerclass</sub> - $\Delta$ P - T( $\Delta$ P) = minimum output power specified in clause 6.3.1		

**Table 6.2.4-2: P<sub>UMAX,f,c</sub> tolerance for FR2-2**

Operating Band	$\Delta$ P (dB)	Tolerance T( $\Delta$ P) (dB)
n263	$\Delta$ P = 0	[0]
	$0 < \Delta$ P $\leq$ 2	[1.5]
	$2 < \Delta$ P $\leq$ 3	[2.0]
	$3 < \Delta$ P $\leq$ 4	[3.0]
	$4 < \Delta$ P $\leq$ 5	[4.0]
	$5 < \Delta$ P $\leq$ 10	[5.0]
	$10 < \Delta$ P $\leq$ 15	[7.0]
	$15 < \Delta$ P $\leq$ X	[8.0]
NOTE: X is the value such that P <sub>umax,f,c</sub> lower bound, P <sub>Powerclass</sub> - $\Delta$ P - T( $\Delta$ P) = minimum output power specified in clause 6.3.1		

## 6.2.5 Requirements for UL gap (*ul-GapFR2-r17*) for TX power management

The difference of the measured peak EIRP P<sub>UMAX,f,c,GAP\_ON</sub> when UL gap for TX power management is configured and activated, and the measured peak EIRP P<sub>UMAX,f,c,GAP\_OFF</sub> when UL gap is not configured or de-activated, shall meet the following requirement:

$$P_{UMAX,f,c,GAP\_ON} - P_{UMAX,f,c,GAP\_OFF} \geq \max((EIRP_{meas\_peak} - 23) + 10 * \log_{10}(Z/20), 3)\text{dB}$$

where  $EIRP_{meas\_peak}$  is the measured UE peak EIRP with zero MPR/A-MPR/P-MPR as specified in clause 6.2.1 for the corresponding power class, and  $Z\%$  is duty cycle of the reference measurement channel.  $P_{UMAX,f,c\_GAP\_ON}$  shall be measured outside of the UL gap symbol(s). The period of measurement shall be at least 4 seconds. The requirement is verified with the test metric of EIRP (Link=TX beam peak direction, Meas=Link angle) and in the test  $Z$  is set to 20 when  $maxUplinkDutyCycle-FR2$  is less than 20 or not reported, and should be larger than  $maxUplinkDutyCycle-FR2$  when  $maxUplinkDutyCycle-FR2$  is equal to or greater than 20. The reference measurement channel is specified in Annex A.2.3.

When UL gap for Tx power management is configured and activated, the reported P-MPR<sub>f,c</sub> shall be less than 3dB. When UL gap for Tx power management is not configured and activated at the duty cycle percentage value  $Z$  of the reference measurement channel larger than  $maxUplinkDutyCycle-FR2$ , UE shall set the P bit in PHR to 1 in the test when PHR is configured. P-bit is defined in TS 38.321 clause 6.1.3.8 and 6.1.3.9.

## 6.2A Transmitter power for CA

### 6.2A.1 UE maximum output power for CA

For downlink intra-band contiguous and non-contiguous carrier aggregation with a single uplink component carrier configured in the NR band, the maximum output power is specified in clause 6.2.1.

For uplink intra-band contiguous and non-contiguous carrier aggregation for any CA bandwidth class, the maximum output power is specified in clause 6.2.1.

For inter-band uplink CA with two NR bands with each UL band configured with a single CC, the maximum power requirements are applicable per band, with both carriers active with non-zero power UL RB allocation. The maximum output power values for TRP and EIRP are applicable per carrier and are specified in tables 6.2.1.x-2. The minimum peak values for EIRP are defined in Tables 6.2.1.x-1 and further relaxed by  $\Delta T_{IB,P,n}$  specified in Table 6.2A.1-x. The peak EIRP requirements are verified with the test metric of EIRP (Link=TX beam peak direction, Meas=Link angle).

The inter-band ULCA spherical coverage requirement for each power class is met if the intersection set of spherical coverage areas exceeds the common coverage requirement for that power class. For inter-band ULCA, the spherical coverage area for each band is the region of the sphere measured around the UE where the measured EIRP exceeds the EIRP level specified in Tables 6.2.1.x-3 and further reduced by the parameter  $\Delta T_{IB,S,n}$  specified in Table 6.2A.1-x. The intersection set of spherical coverage areas is defined as a fraction of area of full sphere measured around the UE where both bands meet their individual EIRP spherical coverage requirements for inter-band CA operation. The common coverage requirement is determined as  $<100\text{-percentile rank}> \%$ , where 'percentile rank' is the percentile value in the specification of spherical coverage for that power class from Tables 6.2.1.x-3. The spherical coverage EIRP requirements are verified with the test metric of EIRP (Link=Spherical coverage grid, Meas=Link angle).

The  $\Delta T_{IB}$  parameters are specified in tables 6.2A.1-x.

**Table 6.2A.1-1:  $\Delta T_{IB}$  EIRP relaxations for inter-band UL CA for power class 1**

NR CA configuration	NR band	$\Delta T_{IB,P,n}$ (dB)	$\Delta T_{IB,S,n}$ (dB)
CA_n260A-n261A	n260	[1.5]	2.5
	n261	[1.5]	2.5

**Table 6.2A.1-2:  $\Delta T_{IB}$  EIRP relaxations for inter-band UL CA for power class 2**

NR CA configuration	NR band	$\Delta T_{IB,P,n}$ (dB)	$\Delta T_{IB,S,n}$ (dB)
CA_n257A-n259A	n257	2.5	2.5
	n259	2.5	2.5

**Table 6.2A.1-3:  $\Delta T_{IB}$  EIRP relaxations for inter-band UL CA for power class 3**

NR CA configuration	NR band	$\Delta T_{IB,P,n}$ (dB)	$\Delta T_{IB,S,n}$ (dB)
CA_n257A-n259A	n257	6.0	6.0
	n259	6.0	6.0
CA_n260A-n261A	n260	6.0	6.0
	n261	6.0	6.0

**Table 6.2A.1-4: reserved for future use****Table 6.2A.1-5:  $\Delta T_{IB}$  EIRP relaxations for inter-band UL CA for power class 5**

NR CA configuration	NR band	$\Delta T_{IB,P,n}$ (dB)	$\Delta T_{IB,S,n}$ (dB)
CA_n257A-n259A	n257	[1.5]	2.5
	n259	[1.5]	2.5

Power class 3 is default power class.

NOTE: UL carrier aggregation within FR2 is defined only within FR2-1 in this release of the specification.

## 6.2A.2 UE maximum output power reduction for CA

### 6.2A.2.1 General

The UE is defined to be configured for CA operation when it has at least one of UL or DL configured for CA. In CA operation, the UE may reduce its maximum output power due to higher order modulations and transmit bandwidth configurations. This Maximum Power Reduction (MPR) is defined in clauses below. The allowed MPR for SRS, PUCCH formats 0, 1, 3 and 4, shall be as specified for QPSK modulated DFT-s-OFDM of equivalent RB allocation. The allowed MPR for PUCCH format 2, shall be as specified for QPSK modulated CP-OFDM of equivalent RB allocation.

When the maximum output power of a UE is modified by MPR, the power limits specified in clause 6.2A.4 apply. The requirements in the following clauses are applicable to the following CA configurations:

- intra-band contiguous uplink CA, with the aggregated channel bandwidth no greater than 800 MHz.
- intra-band non-contiguous uplink CA with UL frequency separation no greater than 1400 MHz, and no more than 3 sub-blocks. A sub-block may consist of single CC or multiple contiguous CCs.
- inter-band uplink CA with two NR bands, and each UL band is configured with a single CC.
- In case the CA configuration consists of a single UL CC, MPR for contiguous UL CA applies and where necessary,  $BW_{channel}$  shall be used as  $BW_{channel\_CA}$ .

### 6.2A.2.2 Maximum output power reduction for power class 1

#### 6.2A.2.2.1 Maximum output power reduction for power class 1 intra-band contiguous UL CA

For power class 1, MPR for intra-band contiguous UL CA with contiguous allocations within the cumulative aggregated bandwidth is defined as:

$$MPR_{C\_CA} = \max(MPR_{WT\_C\_CA}, MPR_{narrow})$$

Where,

$MPR_{narrow} = 14.4$  dB, when  $BW_{alloc,RB}$  is less than or equal to 1.44 MHz,  $MPR_{narrow} = 10$  dB, when  $1.44$  MHz <  $BW_{alloc,RB} \leq 10.8$  MHz, where  $BW_{alloc,RB}$  is the bandwidth of the RB allocation size.

$MPR_{WT\_C\_CA}$  is the maximum power reduction due to modulation orders, transmit bandwidth configurations, and waveform types.  $MPR_{WT\_C\_CA}$  is defined in Tables 6.2A.2.2-1 and 6.2A.2.2-2.

**Table 6.2A.2.2-1: Maximum power reduction ( $MPR_{WT\_C\_CA}$ ) for UE power class 1 in FR2-1**

Waveform Type		Cumulative aggregated channel bandwidth			
		< 400 MHz	≥ 400 MHz and < 800 MHz	≥ 800 MHz and ≤ 1400 MHz	> 1400 MHz and ≤ 2400 MHz
DFT-s-OFDM	Pi/2 BPSK	≤ 5.5 <sup>1</sup>	≤ 7.7	≤ 8.2	≤ 8.7
	QPSK	≤ 6.5 <sup>1</sup>	≤ 8.7	≤ 9.7	≤ 9.7
	16 QAM	≤ 6.5	≤ 8.7	≤ 9.2	≤ 9.7
	64 QAM	≤ 9.0	≤ 10.7	≤ 11.2	≤ 11.7
CP-OFDM	QPSK	≤ 6.5	≤ 8.7	≤ 8.7	≤ 9.7
	16 QAM	≤ 6.5	≤ 8.7	≤ 8.7	≤ 9.7
	64 QAM	≤ 9.0	≤ 10.7	≤ 11.2	≤ 11.7

NOTE 1: (Void)

**Table 6.2A.2.2-2: Maximum power reduction ( $MPR_{WT\_C\_CA}$ ) for UE power class 1 in FR2-2**

Waveform Type	Cumulative aggregated channel bandwidth			
	< 400 MHz	≥ 400 MHz and < 800 MHz	≥ 800 MHz and ≤ 1400 MHz	> 1400 MHz and ≤ 2000 MHz
Pi/2 BPSK	≤ 7.0	≤ 5.0	≤ 2.0	≤ 2.0
QPSK	≤ 8.0	≤ 6.0	≤ 3.0	≤ 3.0
16 QAM	≤ 8.0	≤ 6.0	≤ 4.0	≤ 4.0
64 QAM	≤ 10.0	≤ 10.0	≤ 10.0	≤ 10.0

In case of a contiguous RB, DFT-s-BPSK or DFT-s-QPSK UL allocation in a single CC of a CA configuration with contiguous CCs, and whose cumulative aggregated BW ≤ 400 MHz,  $MPR_{WT\_C\_CA}$  shall be derived instead as  $\text{MAX}(MPR_1, MPR_2)$ , where:

$MPR_1$  shall be determined from Table 6.2.2.1-1 if CABW ≤ 200 MHz, from Table 6.2.2.1-2 if CABW > 200 MHz.

$MPR_2$  shall be determined from Table 6.2.2.1-1 if UL  $BW_{\text{channel\_CA}} \leq 200$  MHz, from Table 6.2.2.1-2 if UL  $BW_{\text{channel\_CA}} > 200$  MHz.

and assume all UL CCs use the same SCS for the purpose of determination of inner and outer RB allocations in Table 6.2.2.1-1 and Table 6.2.2.1-2:

$N_{RB}$  shall be chosen as the sum of  $N_{RB}$  of all constituent UL CCs in the CA configuration.

$L_{CRB}$  shall be chosen as  $BW_{\text{alloc, RB}}$

$RB_{\text{start}}$  shall be derived as:  $RB_{\text{start\_allocatedCC}} + N_{RB\_unallocatedCC\_low}$

$RB_{\text{start\_allocatedCC}}$  is the index of the first allocated RB in the CC with allocation

$N_{RB\_unallocatedCC\_low}$  is the sum of  $N_{RB}$  in all UL CCs lower in frequency compared to the CC with allocation

When different waveform types exist across CCs, the requirement is set by the waveform type used in the configuration with the largest  $MPR_{C\_CA}$ .

For intra-band contiguous UL CA with non-contiguous RB allocations, the following rule for MPR applies:

$$MPR = \max(MPR_{C\_CA}, -10 \cdot A + 14.4)$$

Where:

$$A = N_{RB\_alloc} / N_{RB\_agg\_C}$$

$N_{RB\_alloc}$  is the total number of allocated UL RBs

$N_{RB\_agg\_C}$  is the number of the aggregated RBs within the fully allocated cumulative aggregated channel bandwidth assuming lowest SCS among all configured CCs

**6.2A.2.2.2 Maximum output power reduction for power class 1 intra-band non-contiguous UL CA**

For intra-band non-contiguous UL CA, the following rule for MPR applies:

$$MPR = \max(MPR_{NC\_CA}, -10 \cdot A + 14.4)$$

Where:

$MPR_{NC\_CA}$  is derived from table 6.2A.2.2.2-1

$$A = N_{RB\_alloc} / N_{RB\_agg\_C}$$

$N_{RB\_alloc}$  is the total number of allocated UL RBs

$N_{RB\_agg\_C}$  is the number of the aggregated RBs within the fully allocated cumulative aggregated channel bandwidth assuming lowest SCS among all configured CCs

**Table 6.2A.2.2.2-1:  $MPR_{NC\_CA}$  for UE power class 1**

Waveform Type		Cumulative aggregated channel bandwidth (CABW)			
		< 400 MHz	≥ 400 MHz and < 800 MHz	≥ 800 MHz and ≤ 1400 MHz	> 1400 MHz and ≤ 2400 MHz
DFT-s-OFDM	Pi/2 BPSK	≤ 6	≤ 7.7	≤ 8.2	≤ 8.7
	QPSK	≤ 7	≤ 8.7	≤ 9.2	≤ 9.7
	16 QAM	≤ 7	≤ 8.7	≤ 9.2	≤ 9.7
	64 QAM	≤ 9.0	≤ 10.7	≤ 11.2	≤ 11.7
CP-OFDM	QPSK	≤ 7	≤ 8.7	≤ 9.2	≤ 9.7
	16 QAM	≤ 7	≤ 8.7	≤ 9.2	≤ 9.7
	64 QAM	≤ 9.0	≤ 10.7	≤ 11.2	≤ 11.7

When different waveform types exist across CCs, the requirement is set by the waveform type used in the configuration with the largest  $MPR_{NC\_CA}$ .

**6.2A.2.2.3 Maximum output power reduction for power class 1 inter-band CA**

For inter-band carrier aggregation with uplink assigned to two NR bands, the MPR for each configured UL band in the UL CA band combination is:

$$MPR_{inter-band\_CA} = \max(MPR_{SingleBand}, MPR_{PA-PA})$$

Where:

$MPR_{SingleBand}$  is the MPR specified in clause 6.2.2.1 for the allocation and modulation type in that band

$MPR_{PA-PA}$  is MAX( $MPR_1$ ,  $MPR_2$ ), where  $MPR_1$  and  $MPR_2$  are specified per band combination in Table 6.2A.2.2.3-1 and applies only when both bands have non-zero power UL RB allocations, 0 dB otherwise.

**Table 6.2A.2.2.3-1:  $MPR_{PA-PA}$  for Inter-band ULCA in FR2 for PC1**

NR CA Band	MPR	Value (dB)	Condition
CA_n260A-n261A	MPR1	Max(0, 10 - 10*log <sub>10</sub> (Max(1.0, L <sub>RB,min</sub> *12*SCS/1e6)))	L <sub>RB,min</sub> = Min (L <sub>RB,n260</sub> , L <sub>RB,n261</sub> ), where L <sub>RB,n</sub> is the number of non-zero power UL RBs in band 'n'
	MPR2	6.0 if condition satisfied, 0.0 otherwise	47.2 GHz ≤ 2*f <sub>n260</sub> - f <sub>n261</sub> ≤ 48.2 GHz Where f <sub>n</sub> is any frequency inside the UL allocation in band 'n'

6.2A.2.3 Maximum output power reduction for power class 2

For power class 2, MPR specified in sub-clause 6.2A.2.4.1 applies for intra-band contiguous UL CA and sub-clause 6.2A.2.4.2 applies for intra-band non-contiguous UL CA.

**Table 6.2A.2.3-1: (Void)**

For inter-band carrier aggregation with uplink assigned to two NR bands, the MPR for each configured UL band in the UL CA band combination is:

$$MPR_{inter-band\_CA} = \max(MPR_{SingleBand}, MPR_{PA-PA})$$

Where:

$MPR_{SingleBand}$  is the MPR specified in clause 6.2.2.2 for the allocation and modulation type in that band

$MPR_{PA-PA}$  is specified in Table 6.2A.2.3-2 and applies only when both bands have non-zero UL RB allocations, 0 dB otherwise.

**Table 6.2A.2.3-2:  $MPR_{PA-PA}$  for Inter-band ULCA in FR2 for PC2**

NR CA Band	Value (dB)	Condition
CA_n257A-n259A	$\text{Max}(0, 6 - 10 \cdot \log_{10}(\text{Max}(1.0, L_{RB,min} \cdot 12 \cdot \text{SCS}/1e6)))$	$L_{RB,min} = \text{Min}(L_{RB,n257}, L_{RB,n259})$ , where $L_{RB,n}$ is the number of non-zero power UL RBs in band 'n'

6.2A.2.4 Maximum output power reduction for power class 3

6.2A.2.4.1 Maximum output power reduction for power class 3 intra-band contiguous CA

For power class 3, MPR for intra-band contiguous UL CA with contiguous allocations within the cumulative aggregated bandwidth is denoted as  $MPR_{C\_CA}$  and is defined in Tables 6.2A.2.4-1 and 6.2A.2.4-2.

**Table 6.2A.2.4-1: Maximum power reduction ( $MPR_{C\_CA}$ ) for UE power class 3 in FR2-1**

		Cumulative aggregated channel bandwidth (CABW)			
		≤ 400 MHz	> 400 MHz and < 800 MHz	≥ 800 MHz and ≤ 1400 MHz	> 1400 MHz and ≤ 2400 MHz
DFT-s-OFDM	Pi/2 BPSK	≤ 5.0 <sup>1</sup>	≤ 7.7	≤ 8.2	≤ 8.7
	QPSK	≤ 5.0 <sup>1</sup>	≤ 7.7	≤ 8.2	≤ 9.7
	16 QAM	≤ 6.5	≤ 8.7	≤ 9.3	≤ 9.7
	64 QAM	≤ 9.0	≤ 10.7	≤ 11.2	≤ 11.7
CP-OFDM	QPSK	≤ 5.0	≤ 7.5	≤ 8.0	≤ 9.7
	16 QAM	≤ 6.5	≤ 8.7	≤ 9.2	≤ 9.7
	64 QAM	≤ 9.0	≤ 10.7	≤ 11.2	≤ 11.7

NOTE 1: (Void).

**Table 6.2A.2.4-2: Maximum power reduction ( $MPR_{WT\_C\_CA}$ ) for UE power class 3 in FR2-2**

Waveform Type	Cumulative aggregated channel bandwidth			
	< 400 MHz	≥ 400 MHz and < 800 MHz	≥ 800 MHz and ≤ 1400 MHz	> 1400 MHz and ≤ 2000 MHz
Pi/2 BPSK	≤ 1.0	≤ 1.0	≤ 1.0	≤ 1.0
QPSK	≤ 2.0	≤ 2.0	≤ 2.0	≤ 2.0
16 QAM	≤ 4.0	≤ 4.0	≤ 4.0	≤ 4.0
64 QAM	≤ 10.0	≤ 10.0	≤ 10.0	≤ 10.0

In case of a contiguous RB, DFT-s-BPSK or DFT-s-QPSK UL allocation in a single CC of a CA configuration with contiguous CCs, and whose cumulative aggregated BW ≤ 400 MHz,  $MPR_{C\_CA}$  shall be derived instead as  $\text{MAX}(MPR_1, MPR_2)$ , where:

$MPR_1$  shall be determined from Table 6.2.2.3-1 if  $CABW \leq 200$  MHz, from Table 6.2.2.3-2 if  $CABW > 200$  MHz.

$MPR_2$  shall be determined from Table 6.2.2.3-1 if  $UL\ BW_{channel\_CA} \leq 200$  MHz, from Table 6.2.2.3-2 if  $UL\ BW_{channel\_CA} > 200$  MHz.

and assume all UL CCs use the same SCS for the purpose of determination of inner and outer RB allocations in Table 6.2.2.3-1 and Table 6.2.2.3-2:

$N_{RB}$  shall be chosen as the sum of  $N_{RB}$  of all constituent UL CCs in the CA configuration.

$L_{CRB}$  shall be chosen as  $BW_{alloc,RB}$

$RB_{start}$  shall be derived as:  $RB_{start\_allocatedCC} + N_{RB\_unallocatedCC\_low}$

$RB_{start\_allocatedCC}$  is the index of the first allocated RB in the CC with allocation

$N_{RB\_unallocatedCC\_low}$  is the sum of  $N_{RB}$  in all UL CCs lower in frequency compared to the CC with allocation

When different waveform types exist across CCs, the requirement is set by the waveform type used in the configuration with the highest contiguous MPR.

For intra-band contiguous UL CA with non-contiguous RB allocations, the following rule for MPR applies:

$$MPR = \max(MPR_{C\_CA}, -10 \cdot A + 7.0)$$

Where:

$$A = N_{RB\_alloc} / N_{RB\_agg\_C}$$

$N_{RB\_alloc}$  is the total number of allocated UL RBs

$N_{RB\_agg\_C}$  is the number of the aggregated RBs within the fully allocated cumulative aggregated channel bandwidth assuming lowest SCS among all configured CCs

#### 6.2A.2.4.2 Maximum output power reduction for power class 3 intra-band non-contiguous CA

For intra-band non-contiguous UL CA, the following rule for MPR applies:

$$MPR = \max(MPR_{NC\_CA}, -8 \cdot A + 10.0)$$

Where:

$MPR_{NC\_CA}$  is derived from table 6.2A.2.4.2-1

$$A = N_{RB\_alloc} / N_{RB\_agg\_C}$$

$N_{RB\_alloc}$  is the total number of allocated UL RBs

$N_{RB\_agg\_C}$  is the number of the aggregated RBs within the fully allocated cumulative aggregated channel bandwidth assuming lowest SCS among all configured CCs



**Table 6.2A.2.4.2-1:  $MPR_{NC\_CA}$  for UE power class 3**

		Cumulative aggregated channel bandwidth (CABW)			
		$\leq 400$ MHz	$> 400$ MHz and $< 800$ MHz	$\geq 800$ MHz and $\leq 1400$ MHz	$> 1400$ MHz and $\leq 2400$ MHz
DFT-s-OFDM	Pi/2 BPSK	$\leq 5.5$	$\leq 7.7$	$\leq 8.2$	$\leq 8.7$
	QPSK	$\leq 6$	$\leq 7.7$	$\leq 8.2$	$\leq 8.7$
	16 QAM	$\leq 7$	$\leq 8.7$	$\leq 9.3$	$\leq 9.8$
	64 QAM	$\leq 9.0$	$\leq 10.7$	$\leq 11.2$	$\leq 11.7$
CP-OFDM	QPSK	$\leq 6$	$\leq 7.5$	$\leq 8.0$	$\leq 8.5$
	16 QAM	$\leq 7$	$\leq 8.7$	$\leq 9.2$	$\leq 9.7$
	64 QAM	$\leq 9.0$	$\leq 10.7$	$\leq 11.2$	$\leq 11.7$

When different waveform types exist across CCs, the requirement is set by the waveform type used in the configuration with the largest  $MPR_{NC\_CA}$ .

### 6.2A.2.4.3 Maximum output power reduction for power class 3 inter-band CA

For inter-band carrier aggregation with uplink assigned to two NR bands, the MPR for each configured UL band in the UL CA band combination is:

$$MPR_{inter-band\_CA} = \max(MPR_{SingleBand}, MPR_{PA-PA})$$

Where:

$MPR_{SingleBand}$  is the MPR specified in clause 6.2.2.3 for the allocation and modulation type in that band.

$MPR_{PA-PA}$  is  $\max(MPR1, MPR2)$ , where MPR1 and MPR2 are specified per band combination in Table 6.2A.2.4.3-1 and applies only when both bands have non-zero power UL RB allocations, 0 dB otherwise.

**Table 6.2A.2.4.3-1:  $MPR_{PA-PA}$  for Inter-band ULCA in FR2 for PC3**

NR CA Band	MPR	Value (dB)	Condition
CA_n257A-n259A	MPR1	$\max(0, 6 - 10 \cdot \log_{10}(\max(1.0, L_{RB,min} \cdot 12 \cdot SCS / 1e6)))$	$L_{RB,min} = \min(L_{RB,n257}, L_{RB,n259})$ , where $L_{RB,n}$ is the number of non-zero power UL RBs in band 'n'
	MPR2	0.0	-
CA_n260A-n261A	MPR1	$\max(0, 6 - 10 \cdot \log_{10}(\max(1.0, L_{RB,min} \cdot 12 \cdot SCS / 1e6)))$	$L_{RB,min} = \min(L_{RB,n260}, L_{RB,n261})$ , where $L_{RB,n}$ is the number of non-zero power UL RBs in band 'n'
	MPR2	2.0 if condition satisfied, 0.0 otherwise	$47.2 \text{ GHz} \leq 2 \cdot f_{n260} - f_{n261} \leq 48.2 \text{ GHz}$ Where $f_n$ is any frequency inside the UL allocation in band 'n'

### 6.2A.2.5 Maximum output power reduction for power class 4

For power class 4, MPR specified in sub-clause 6.2A.2.4.1 applies for intra-band contiguous UL CA and sub-clause 6.2A.2.4.2 applies for intra-band non-contiguous UL CA.

### 6.2A.2.6 Maximum output power reduction for power class 5

For power class 5, MPR specified in sub-clause 6.2A.2.4.1 applies for intra-band contiguous UL CA and sub-clause 6.2A.2.4.2 applies for intra-band non-contiguous UL CA.

For inter-band carrier aggregation with uplink assigned to two NR bands, MPR for each configured UL band in the UL CA band combination is:

$$MPR_{inter-band\_CA} = \max(MPR_{SingleBand}, MPR_{PA-PA})$$

Where:

$MPR_{SingleBand}$  is the MPR specified in clause 6.2.2.5 for the allocation and modulation type in that band

$MPR_{PA-PA}$  is the maximum of the MPR values specified per band combination in Table 6.2A.2.5-1 and applies only when both bands have non-zero UL RB allocations, 0 dB otherwise.

**Table 6.2A.2.5-1:  $MPR_{PA-PA}$  for Inter-band CA in FR2 for PC5**

NR CA Band	Value (dB)	Condition
CA_n257A-n259A	$\text{Max}(0, 6 - 10 \cdot \log_{10}(\text{Max}(1.0, L_{RB, \min} \cdot 12 \cdot \text{SCS} / 1e6)))$	$L_{RB, \min} = \text{Min}(L_{RB, n257}, L_{RB, n259})$ , where $L_{RB, n}$ is the number of non-zero power UL RBs in band 'n'

### 6.2A.3 UE maximum output power with additional requirements for CA

#### 6.2A.3.1 General

Additional emission requirements can be signalled by the network with network signalling value indicated by the field *additionalSpectrumEmission*. To meet these additional requirements, additional maximum power reduction (A-MPR) is allowed for the maximum output power as specified in clause 6.2A.1. Unless stated otherwise, an A-MPR of 0 dB shall be used. Unless otherwise stated, the allowed total back off is maximum of A-MPR and MPR specified in clause 6.2A.2.

For intra-band contiguous aggregation with the UE configured for transmissions on two serving cells, the maximum output power reduction specified in Table 6.2A.3.1-1 is allowed for all serving cells of the applicable uplink contiguous CA configurations.

Table 6.2A.3.1-1 specifies the additional requirements and allowed A-MPR with corresponding network signalling label and operating band. The mapping between network signalling labels and the *additionalSpectrumEmission* IE defined in TS 38.331 [13] is specified in Table 6.2A.3.1-2. Unless otherwise stated, the allowed total back off is maximum of A-MPR and MPR specified in clause 6.2A.2.

**Table 6.2A.3.1-1: Additional maximum power reduction (A-MPR)**

Network Signalling value	Requirements (clause)	NR Band	Channel bandwidth (MHz)	Resources Blocks ( $N_{RB}$ )	A-MPR (dB)
CA_NS_200					N/A
CA_NS_201	6.5A.3.2.2	n258			6.2A.3.2
CA_NS_202	6.5A.3.2.3	n257, n258			6.2A.3.3
CA_NS_203	6.5A.3.2.4	n258			6.2A.3.4
NOTE: CA_NS_201 is obsolete, the associated additional spurious emission requirements are not applicable.					

**Table 6.2A.3.1-2: Value of additionalSpectrumEmission**

NR Band	Value of additionalSpectrumEmission / NS number							
	0	1	2	3	4	5	6	7
n257	CA_NS_200	CA_NS_202						
n258	CA_NS_200	CA_NS_201	CA_NS_202	CA_NS_203				
n259	CA_NS_200							
n260	CA_NS_200							
n261	CA_NS_200							
NOTE 1: additionalSpectrumEmission corresponds to an information element of the same name defined in clause 6.3.2 of TS 38.331 [13].								
NOTE 2: CA_NS_201 is obsolete, the associated additional spurious emission requirements are not applicable.								

6.2A.3.2 Void

6.2A.3.2.1 Void

**Table 6.2A.3.2.1-1: (Void)**

6.2A.3.2.2 Void

**Table 6.2A.3.2.2-1: (Void)**

6.2A.3.2.3 Void

**Table 6.2A.3.2.3-1: Void**

6.2A.3.2.4 Void

6.2A.3.2.5 Void

6.2A.3.3 A-MPR for CA\_NS\_202

6.2A.3.3.1 A-MPR for CA\_NS\_202 for power class 1

For intra-band contiguous CA, A-MPR for CA\_NS\_202 shall be 11.0 dB.

6.2A.3.3.2 A-MPR for CA\_NS\_202 for power class 2

For intra-band contiguous CA, A-MPR for CA\_NS\_202 specified in sub-clause 6.2A.3.3.3 applies.

6.2A.3.3.3 A-MPR for CA\_NS\_202 for power class 3

For intra-band contiguous CA, A-MPR for CA\_NS\_202 shall be 2.0 dB.

6.2A.3.3.4 A-MPR for CA\_NS\_202 for power class 4

For intra-band contiguous CA, A-MPR for CA\_NS\_202 specified in sub-clause 6.2A.3.3.3 applies.

6.2A.3.3.5 A-MPR for CA\_NS\_202 for power class 5

For intra-band contiguous CA, A-MPR for CA\_NS\_202 specified in sub-clause 6.2A.3.3.3 applies.

6.2A.3.4 A-MPR for CA\_NS\_203

6.2A.3.4.1 A-MPR for CA\_NS\_203 for power class 1

For intra-band contiguous CA, A-MPR for CA\_NS\_203 shall be 6.5 dB, if Offset frequency  $< BW_{\text{Channel\_CA}}$  of the UL CA configuration, 0.0 dB, otherwise

The Offset frequency is defined as the frequency from 24.25 GHz to the lower edge of the lowest CC among the configured UL CA.

6.2A.3.4.2 A-MPR for CA\_NS\_203 for power class 2

For intra-band contiguous CA, AMPR specified in sub-clause 6.2A.3.4.3 applies.

6.2A.3.4.3 A-MPR for CA\_NS\_203 for power class 3

For intra-band contiguous CA, A-MPR for CA\_NS\_203 shall be 2.5 dB, if Offset frequency  $< BW_{\text{Channel\_CA}}$  of the UL CA configuration, 0.0 dB otherwise.

The Offset frequency is defined as the frequency from 24.25 GHz to to the lower edge of the lowest CC among the configured UL CA.

#### 6.2A.3.4.4 A-MPR for CA\_NS\_203 for power class 4

For intra-band contiguous CA, AMPR specified in sub-clause 6.2A.3.4.3 applies.

#### 6.2A.3.4.5 A-MPR for CA\_NS\_203 for power class 5

For intra-band contiguous CA, AMPR specified in sub-clause 6.2A.3.4.3 applies.

### 6.2A.4 Configured transmitted power for CA

#### 6.2A.4.1 Configured transmitted power for intra-band UL CA

A UE configured with carrier aggregation can configure its maximum output power for each uplink activated serving cell  $c$  and its total configured maximum output power  $P_{\text{CMAX}}$ . The definition of the configured UE maximum output power  $P_{\text{CMAX},f,c}$  for each carrier  $f$  of a serving cell  $c$  is used for power headroom reporting for carrier  $f$  of serving cell  $c$  only and is in accordance with that specified in clause 6.2.4 with parameters MPR, A-MPR and P-MPR replaced with those specified in subclause 6.2A.2, 6.2A.3 and 6.2.4, respectively. The UE maximum configured power  $P_{\text{CMAX}}$  in a transmission occasion is determined by the UL grants for carriers  $f$  of all serving cells  $c$  with non-zero granted power in the respective reference point.

For uplink intra-band contiguous carrier aggregation, MPR is specified in clause 6.2A.2.  $P_{\text{CMAX}}$  is calculated under the assumption that power spectral density for each RB in each component carrier is same.

The configured UE maximum output power  $P_{\text{CMAX}}$  shall be set such that the corresponding measured total peak EIRP  $P_{\text{UMAX}}$  is within the following bounds

$$P_{\text{Powerclass}} - \text{MAX}(\text{MAX}(\text{MPR}, \text{A-MPR}) + \Delta\text{MB}_{\text{P,n}}, \text{P-MPR}) - \text{MAX}\{\text{T}(\text{MAX}(\text{MPR}, \text{A-MPR})), \text{T}(\text{P-MPR})\} \leq P_{\text{UMAX}} \leq \text{EIRP}_{\text{max}}$$

with  $P_{\text{Powerclass}}$  the UE minimum peak EIRP as specified in sub-clause 6.2A.1,  $\text{EIRP}_{\text{max}}$  the applicable maximum EIRP as specified in sub-clause 6.2A.1, MPR as specified in sub-clause 6.2A.2, A-MPR as specified in sub-clause 6.2A.3,  $\Delta\text{MB}_{\text{P,n}}$  the peak EIRP relaxation as specified in clause 6.2.1, P-MPR the power management term for the UE as described in 6.2.4.

The measured configured power  $P_{\text{UMAX}}$  for carrier aggregation is defined as

$$P_{\text{UMAX}} = 10 \log_{10} \sum_{c,f(c)} p_{\text{UMAX},f,c}$$

where  $p_{\text{UMAX},f,c}$  is the linear value of the measured power  $P_{\text{UMAX},f,c}$  for carrier  $f=f(c)$  of serving cell  $c$ . The measured total radiated power  $P_{\text{TMAX}}$  for carrier aggregation is defined as

$$P_{\text{TMAX}} = 10 \log_{10} \sum_{c,f(c)} p_{\text{TMAX},f,c}$$

where  $p_{\text{TMAX},f,c}$  is the linear value of the measured total radiated power  $P_{\text{TMAX},f,c}$  for carrier  $f=f(c)$  of serving cell  $c$ . The total radiated power  $P_{\text{TMAX}}$  is bounded by

$$P_{\text{TMAX}} \leq \text{TRP}_{\text{max}}$$

where  $\text{TRP}_{\text{max}}$  the maximum TRP for the UE power class as specified in sub-clause 6.2A.1.

The tolerance  $\text{T}(\Delta\text{P})$  for applicable values of  $\Delta\text{P}$  (values in dB) is specified in Table 6.2A.4.1-1 and Table 6.2A.4.1-2.

Table 6.2A.4.1-1: P<sub>UMAX</sub> tolerance for FR2-1

Operating Band	$\Delta P$ (dB)	Tolerance T( $\Delta P$ ) (dB)
n257, n258, n259, n260, n261, n262	$\Delta P = 0$	0
	$0 < \Delta P \leq 2$	1.5
	$2 < \Delta P \leq 3$	2.0
	$3 < \Delta P \leq 4$	3.0
	$4 < \Delta P \leq 5$	4.0
	$5 < \Delta P \leq 10$	5.0
	$10 < \Delta P \leq 15$	7.0
	$15 < \Delta P \leq X$	8.0
NOTE: X is the value such that P <sub>umax</sub> lower bound, P <sub>Powerclass</sub> - $\Delta P$ - T( $\Delta P$ ) = minimum output power specified in clause 6.3A.1		

Table 6.2A.4.1-2: P<sub>UMAX</sub> tolerance for FR2-2

Operating Band	$\Delta P$ (dB)	Tolerance T( $\Delta P$ ) (dB)
n263	$\Delta P = 0$	[0]
	$0 < \Delta P \leq 2$	[1.5]
	$2 < \Delta P \leq 3$	[2.0]
	$3 < \Delta P \leq 4$	[3.0]
	$4 < \Delta P \leq 5$	[4.0]
	$5 < \Delta P \leq 10$	[5.0]
	$10 < \Delta P \leq 15$	[7.0]
	$15 < \Delta P \leq X$	[8.0]
NOTE: X is the value such that P <sub>umax</sub> lower bound, P <sub>Powerclass</sub> - $\Delta P$ - T( $\Delta P$ ) = minimum output power specified in clause 6.3A.1		

## 6.2A.4.2 Configured transmitted power for inter-band UL CA

A UE can configure its maximum output power for each uplink band when it is configured for inter-band UL carrier aggregation with two NR bands each with a single UL CC. For each uplink band  $n$ , the configured UE maximum output power P<sub>CMAX,f,c,n</sub> for carrier  $f$  of a serving cell  $c$  is defined as that available to the reference point of a given transmitter branch that corresponds to the reference point of the higher-layer filtered RSRP measurement as specified in TS 38.215 [11].

The configured UE maximum output power P<sub>CMAX,f,c,n</sub> for carrier  $f$  of a serving cell  $c$  in band  $n$  shall be set such that the corresponding measured peak EIRP P<sub>UMAX,f,c,n</sub> is within the following bounds

$$P_{\text{Powerclass}} + \Delta P_{\text{IBE}} - \text{MAX}(\text{MAX}(\text{MPR}_{f,c,n}, A - \text{MPR}_{f,c,n}) + \Delta T_{\text{IB,P,n}}, P - \text{MPR}_{f,c,n}) - \text{MAX}\{\text{T}(\text{MAX}(\text{MPR}_{f,c,n}, A - \text{MPR}_{f,c,n})), \text{T}(P - \text{MPR}_{f,c,n})\} \leq P_{\text{UMAX},f,c,n} \leq \text{EIRP}_{\text{max},n}$$

while the corresponding measured total radiated power in uplink band  $n$ , P<sub>TMAX,f,c,n</sub>, is bounded by

$$P_{\text{TMAX},f,c,n} \leq \text{TRP}_{\text{max},n}$$

with P<sub>Powerclass</sub> the UE minimum peak EIRP as specified in sub-clause 6.2A.1, EIRP<sub>max,n</sub> the applicable maximum EIRP as specified in sub-clause 6.2A.1 for uplink band  $n$  and TRP<sub>max,n</sub> the applicable maximum TRP as specified in sub-clause 6.2A.1 for uplink band  $n$ . MPR<sub>f,c,n</sub> as specified in sub-clause 6.2A.2 for uplink band  $n$ , A-MPR<sub>f,c,n</sub> as specified in sub-clause 6.2A.3 for uplink band  $n$ ,  $\Delta T_{\text{IB,P,n}}$  the peak EIRP relaxation as specified in clause 6.2A.1. The requirement is verified in beam peak direction.

$\Delta P_{\text{IBE}}$ , *mpr-PowerBoost-FR2-r16* and *maxUplinkDutyCycle-FR2* are described in clause 6.2.4.

P-MPR<sub>f,c,n</sub> is the power management maximum output power reduction P-MPR<sub>f,c</sub> in band  $n$ . P-MPR<sub>f,c</sub> is defined in clause 6.2.4.

The tolerance  $T(\Delta P)$  for applicable values of  $\Delta P$  (values in dB) in each band is specified in Table 6.2.4-1.

## 6.2A.5 Requirements for UL gap (*ul-GapFR2-r17*) for TX power management in CA

The difference of the measured peak EIRP  $P_{\text{UMAX\_GAP\_ON}}$  for CA when UL gap for TX power management is configured and activated, and the measured peak EIRP  $P_{\text{UMAX\_GAP\_OFF}}$  when UL gap is not configured or de-activated, shall meet the following requirement:

$$P_{\text{UMAX\_GAP\_ON}} - P_{\text{UMAX\_GAP\_OFF}} \geq \max((\text{EIRP}_{\text{meas\_peak}} - 23) + 10 * \log_{10}(Z/20), 3)\text{dB}$$

where  $\text{EIRP}_{\text{meas\_peak}}$  is the measured UE peak EIRP with zero MPR/A-MPR/P-MPR in clause 6.2A.1 for the corresponding power class, and  $Z\%$  is duty cycle of the reference measurement channel.  $P_{\text{UMAX,f,c\_GAP\_ON}}$  shall be measured outside of the UL gap symbol(s). The period of measurement shall be at least 4 seconds. The requirement is verified with the test metric of EIRP (Link=TX beam peak direction, Meas=Link angle) and in the test  $Z$  is set to 20 when *maxUplinkDutyCycle-FR2* is less than 20 or not reported, and should be larger than *maxUplinkDutyCycle-FR2* when *maxUplinkDutyCycle-FR2* is equal to or greater than 20, assuming all CCs share the same TX beam peak direction. The reference measurement channel is specified in Annex A.2.3.

When UL gap for Tx power management is configured and activated, the reported P-MPR<sub>f,c</sub> shall be less than 3dB. When UL gap for Tx power management is not configured and activated, UE shall set the P bit in PHR to 1 in the test when PHR is configured. P-bit is defined in TS 38.321 clause 6.1.3.8 and 6.1.3.9.

## 6.2D Transmitter power for UL MIMO

### 6.2D.1 UE maximum output power for UL MIMO

#### 6.2D.1.0 General

The requirements in the following clauses define the maximum output power radiated by the UE with *nrofSRS-Ports* set to 2, for any transmission bandwidth within the channel bandwidth for non-CA configuration, unless otherwise stated. MPR shall be applied as specified in clause 6.2D.2

For the maximum output power requirement for 2-layer UL MIMO operation, a UE shall be configured for 2-layer UL MIMO transmission as specified in Table 6.2D.1.0-1.

**Table 6.2D.1.0-1: UL MIMO configuration**

Transmission scheme	DCI format	Number of layers	TPMI index
Codebook based uplink	DCI format 0_1	2	0

The maximum output power requirement for single layer transmission shall apply to a UE that supports ULFPTx feature and is configured for single layer transmission in its declared full power mode [10, TS 38.213] as specified in Table 6.2D.1.0-2.

**Table 6.2D.1.0-2: PUSCH Configuration for uplink full power transmission (ULFPTx)**

ULFPTx Mode	Transmission scheme	DCI format	Modulation	Number of layers	TPMI index
Mode-1	Codebook based uplink	DCI format 0_1	DFT-s-OFDM, CP-OFDM <sup>1</sup>	1	2
Mode-2	Codebook based uplink	DCI format 0_1	DFT-s-OFDM, CP-OFDM	1	0 or 1 <sup>2</sup>
Mode-full power	Codebook based uplink	DCI format 0_1	DFT-s-OFDM, CP-OFDM	1	0,1
NOTE 1: For PUSCH configured with ULFPTxModes set to Mode-1, all requirements for 1-layer CP-OFDM based modulation in subsection 6.2D are assumed to be met if the requirement for 2-layer UL MIMO has been validated.					
NOTE 2: TPMI index selected shall be based upon the full power TPMI reported by the UE [10, TS 38.213].					

NOTE: UL MIMO for FR2 is defined only for FR2-1 in this release of the specification.

### 6.2D.1.1 UE maximum output power for UL MIMO for power class 1

The following requirements define the maximum output power radiated by the PC1 UE. Requirements apply to UEs when configured for 2-layer transmission as well as when configured for single layer uplink full power transmission (ULFPTx), with configuration per clause 6.2D.1.0.

The minimum peak EIRP requirements are found in Table 6.2D.1.1-1 below. The period of measurement shall be at least one sub frame (1ms). The requirement is verified with the test metric of EIRP (Link=TX beam peak direction, Meas=Link angle). Power class 1 UE is used for fixed wireless access (FWA).

**Table 6.2D.1.1-1: UE minimum peak EIRP for UL MIMO for power class 1**

Operating band	Min peak EIRP (dBm)
n257	40.0
n258	40.0
n260	38.0
n261	40.0
n262	34.2
NOTE 1: Minimum peak EIRP is defined as the lower limit without tolerance	

**Table 6.2D.1.1-2: (void)**

The maximum output power values for TRP and EIRP are found in Table 6.2D.1.1-3 below for UE with UL MIMO. The maximum allowed EIRP is derived from regulatory requirements [8]. The requirements are verified with the test metrics of TRP (Link=TX beam peak direction, Meas=TRP grid) in beam locked mode and EIRP (Link=TX beam peak direction, Meas=Link angle).

**Table 6.2D.1.1-3: UE maximum output power limits for UL MIMO for power class 1**

Operating band	Max TRP (dBm)	Max EIRP (dBm)
n257	35	55
n258	35	55
n260	35	55
n261	35	55
n262	35	55

The minimum EIRP at the 85<sup>th</sup> percentile of the distribution of radiated power measured over the full sphere around the UE with UL MIMO is defined as the spherical coverage requirement and is found in Table 6.2D.1.1-4 below. The requirement is verified with the test metric of EIRP (Link=Spherical coverage grid, Meas=Link angle).

**Table 6.2D.1.1-4: UE spherical coverage for UL MIMO for power class 1**

Operating band	Min EIRP at 85 %-tile CDF (dBm)
n257	32.0
n258	32.0
n260	30.0
n261	32.0
n262	26.0
NOTE 1: Minimum EIRP at 85 %-tile CDF is defined as the lower limit without tolerance	

### 6.2D.1.2 UE maximum output power for UL MIMO for power class 2

The following requirements define the maximum output power radiated by the PC2 UE. Requirements apply to UEs when configured for 2-layer transmission as well as when configured for single layer uplink full power transmission (ULFPTx), with configuration per clause 6.2D.1.0.

The minimum peak EIRP requirements are found in Table 6.2D.1.2-1 below. The period of measurement shall be at least one sub frame (1ms). The requirement is verified with the test metric of EIRP (Link=TX beam peak direction, Meas=Link angle).

**Table 6.2D.1.2-1: UE minimum peak EIRP for UL MIMO for power class 2**

Operating band	Min peak EIRP (dBm)
n257	29
n258	29
n261	29
n262	22.9
NOTE 1: Minimum peak EIRP is defined as the lower limit without tolerance.	
NOTE 2: Min Peak EIRP refers to the total EIRP for the UL beams peaks.	

The maximum output power values for TRP and EIRP are found in Table 6.2D.1.2-2 below. The maximum allowed EIRP is derived from regulatory requirements [8]. The requirements are verified with the test metrics of TRP (Link=TX beam peak direction, Meas=TRP grid) in beam locked mode and EIRP (Link=TX beam peak direction, Meas=Link angle).

**Table 6.2D.1.2-2: UE maximum output power limits for UL MIMO for power class 2**

Operating band	Max TRP (dBm)	Max EIRP (dBm)
n257	23	43
n258	23	43
n261	23	43
n262	23	43

**Table 6.2D.1.2-3: (void)**

The minimum EIRP at the 60<sup>th</sup> percentile of the distribution of radiated power measured over the full sphere around the UE is defined as the spherical coverage requirement and is found in Table 6.2D.1.2-4 below. The requirement is verified with the test metric of EIRP (Link=Spherical coverage grid, Meas=Link angle).



**Table 6.2D.1.2-4: UE spherical coverage for UL MIMO for power class 2**

Operating band	Min EIRP at 60 %-tile CDF (dBm)
n257	18.0
n258	18.0
n261	18.0
n262	11.0
NOTE 1: Minimum EIRP at 60 %-tile CDF is defined as the lower limit without tolerance	

### 6.2D.1.3 UE maximum output power for UL MIMO for power class 3

The following requirements define the maximum output power radiated by the PC3 UE.. Requirements apply to UEs when configured for 2-layer transmission as well as when configured for single layer uplink full power transmission (ULFPTx), with configuration per clause 6.2D.1.0.

The minimum peak EIRP requirements are found in Table 6.2D.1.3-1 below. The period of measurement shall be at least one sub frame (1 ms). The requirement is verified with the test metric of EIRP (Link=TX beam peak direction, Meas=Link angle).

**Table 6.2D.1.3-1: UE minimum peak EIRP for UL MIMO for power class 3**

Operating band	Min peak EIRP (dBm)
n257	22.4
n258	22.4
n259	18.7
n260	20.6
n261	22.4
n262	16.0
NOTE 1: Minimum peak EIRP is defined as the lower limit without tolerance.	
NOTE 2: Min Peak EIRP refers to the total EIRP for the UL beams peaks.	

The maximum output power values for TRP and EIRP are found in Table 6.2D.1.3-2 below. The maximum allowed EIRP is derived from regulatory requirements [8]. The requirements are verified with the test metrics of TRP (Link=TX beam peak direction, Meas=TRP grid) in beam locked mode and EIRP (Link=TX beam peak direction, Meas=Link angle).

**Table 6.2D.1.3-2: UE maximum output power limits for UL MIMO for power class 3**

Operating band	Max TRP (dBm)	Max EIRP (dBm)
n257	23	43
n258	23	43
n259	23	43
n260	23	43
n261	23	43
n262	23	43

**Table 6.2D.1.3-3: (void)**

The minimum EIRP at the 50<sup>th</sup> percentile of the distribution of radiated power measured over the full sphere around the UE is defined as the spherical coverage requirement and is found in Table 6.2D.1.3-4 below. The requirement is verified with the test metric of EIRP (Link=spherical coverage grid, Meas=Link angle).

**Table 6.2D.1.3-4: UE spherical coverage for UL MIMO for power class 3**

Operating band	Min EIRP at 50 %-tile CDF (dBm)
n257	11.5
n258	11.5
n259	5.8
n260	8
n261	11.5
NOTE 1: Minimum EIRP at 50 %-tile CDF is defined as the lower limit without tolerance	
NOTE 2: The requirements in this table are only applicable for UE which supports single band in FR2	

#### 6.2D.1.4 UE maximum output power for UL MIMO for power class 4

The following requirements define the maximum output power radiated by the PC4 UE. Requirements apply to UEs configured for 2-layer transmission as well as UEs configured for single layer uplink full power transmission (ULFPTx), with configuration per clause 6.2D.1.0.

The minimum peak EIRP requirements are found in Table 6.2D.1.4-1 below. The period of measurement shall be at least one sub frame (1ms). The requirement is verified with the test metric of EIRP (Link=TX beam peak direction, Meas=Link angle).

**Table 6.2D.1.4-1: UE minimum peak EIRP for UL MIMO for power class 4**

Operating band	Min peak EIRP (dBm)
n257	34
n258	34
n260	31
n261	34
n262	28.3
NOTE 1: Minimum peak EIRP is defined as the lower limit without tolerance.	
NOTE 2: Min Peak EIRP refers to the total EIRP for the UL beams peaks.	

The maximum output power values for TRP and EIRP are found in Table 6.2D.1.4-2 below. The maximum allowed EIRP is derived from regulatory requirements [8]. The requirements are verified with the test metrics of TRP (Link=TX beam peak direction, Meas=TRP grid) in beam locked mode and EIRP (Link=TX beam peak direction, Meas=Link angle).

**Table 6.2D.1.4-2: UE maximum output power limits for UL MIMO for power class 4**

Operating band	Max TRP (dBm)	Max EIRP (dBm)
n257	23	43
n258	23	43
n260	23	43
n261	23	43
n262	23	43

**Table 6.2D.1.4-3: (void)**

The minimum EIRP at the 20<sup>th</sup> percentile of the distribution of radiated power measured over the full sphere around the UE is defined as the spherical coverage requirement and is found in Table 6.2D.1.4-4 below. The requirement is verified with the test metric of EIRP (Link=Spherical coverage grid, Meas=Link angle).

**Table 6.2D.1.4-4: UE spherical coverage for UL MIMO for power class 4**

Operating band	Min EIRP at 20 %-tile CDF (dBm)
n257	25
n258	25
n260	19
n261	25
n262	16.2
NOTE 1: Minimum EIRP at 20 %-tile CDF is defined as the lower limit without tolerance	

### 6.2D.1.5 UE maximum output power for UL MIMO for power class 5

The following requirements define the maximum output power radiated by the PC4 UE. Requirements apply to UEs configured for 2-layer transmission as well as UEs configured for single layer uplink full power transmission (ULFPTx), with configuration per clause 6.2D.1.0.

The minimum peak EIRP requirements are found in Table 6.2D.1.5-1 below. The period of measurement shall be at least one sub frame (1ms). The requirement is verified with the test metric of EIRP (Link=TX beam peak direction, Meas=Link angle). Power class 5 UE is used for fixed wireless access (FWA).

**Table 6.2D.1.5-1: UE minimum peak EIRP for UL MIMO for power class 5**

Operating band	Min peak EIRP (dBm)
n257	30
n258	30.4
n259	27.7
NOTE 1: Minimum peak EIRP is defined as the lower limit without tolerance	

The maximum output power values for TRP and EIRP are found in Table 6.2D.1.5-3 below for UE with UL MIMO. The maximum allowed EIRP is derived from regulatory requirements. The requirements are verified with the test metrics of TRP (Link=TX beam peak direction, Meas=TRP grid) in beam locked mode and EIRP (Link=TX beam peak direction, Meas=Link angle).

**Table 6.2D.1.5-2: UE maximum output power limits for UL MIMO for power class 5**

Operating band	Max TRP (dBm)	Max EIRP (dBm)
n257	23	43
n258	23	43
n259	23	43

The minimum EIRP at the 85<sup>th</sup> percentile of the distribution of radiated power measured over the full sphere around the UE with UL MIMO is defined as the spherical coverage requirement and is found in Table 6.2D.1.5-3 below. The requirement is verified with the test metric of EIRP (Link=Spherical coverage grid, Meas=Link angle).

**Table 6.2D.1.5-3: UE spherical coverage for UL MIMO for power class 5**

Operating band	Min EIRP at 85 %-tile CDF (dBm)
n257	22
n258	22.4
n259	19.7
NOTE 1: Minimum EIRP at 85 %-tile CDF is defined as the lower limit without tolerance	

### 6.2D.1.6 UE maximum output power for UL MIMO for power class 6

The following requirements define the maximum output power radiated by the PC6 UE. Requirements apply to UEs configured for 2-layer transmission as well as UEs configured for single layer uplink full power transmission (ULFPTx), with configuration per clause 6.2D.1.0.

The minimum peak EIRP requirements are found in Table 6.2D.1.6-1 below. The period of measurement shall be at least one sub frame (1ms). The requirement is verified with the test metric of EIRP (Link=TX beam peak direction, Meas=Link angle).

**Table 6.2D.1.6-1: UE minimum peak EIRP for UL MIMO for power class 6**

Operating band	Min peak EIRP (dBm)
n257	30
n258	30.4
n261	30
NOTE 1: Minimum peak EIRP is defined as the lower limit without tolerance	

The maximum output power values for TRP and EIRP are found in Table 6.2D.1.5-2 below for UE with UL MIMO. The maximum allowed EIRP is derived from regulatory requirements [8]. The requirements are verified with the test metrics of TRP (Link=TX beam peak direction, Meas=TRP grid) in beam locked mode and EIRP (Link=TX beam peak direction, Meas=Link angle).

**Table 6.2D.1.6-2: UE maximum output power limits for UL MIMO for power class 6**

Operating band	Max TRP (dBm)	Max EIRP (dBm)
n257	23	43
n258	23	43
n261	23	43

The minimum EIRP measured over the spherical coverage evaluation areas is defined as the spherical coverage requirement and is found in Table 6.2D.1.6-3 below. UE spherical coverage evaluation areas are found in Table 6.2.1.6-3a in clause 6.2.1.6, by consisting of Area-1 and Area-2, in the reference coordinate system in Annex J.1. The requirement is verified with the test metric of EIRP (Link= Spherical coverage grid, Meas=Link angle).

**Table 6.2D.1.6-3: UE spherical coverage for UL MIMO for power class 6**

Operating band	Min EIRP over UE spherical coverage evaluation areas (dBm)
n257	20
n258	20.4
n261	20
NOTE 1: Minimum EIRP over UE spherical coverage evaluation areas is defined as the lower limit without tolerance	
NOTE 2: The requirements in this table are verified only under normal temperature conditions as defined in Annex E.2.1.	
NOTE 3: The requirements in this table are applicable to FR2 PC6 UE with the network signalling <i>highSpeedMeasFlag-r17</i> configured as <i>set2</i> .	

## 6.2D.2 UE maximum output power reduction for modulation / channel bandwidth for UL MIMO

### 6.2D.2.1 UE maximum output power reduction for modulation / channel bandwidth for UL MIMO for power class 1

For UEs configured for 2-layer transmission as well as UEs configured for single layer uplink full power transmission (ULFPTx), the allowed Maximum Power Reduction (MPR) for the maximum output power in Table 6.2D.1.1-1 is specified in sub-clause 6.2.2.1. The requirements shall be met with configurations specified in sub-clause 6.2D.1.0.

For the UE maximum output power modified by MPR, the power limits specified in clause 6.2D.4 apply.

### 6.2D.2.2 UE maximum output power reduction for modulation / channel bandwidth for UL MIMO for power class 2

For UEs configured for 2-layer transmission as well as UEs configured for single layer uplink full power transmission (ULFPTx), the allowed Maximum Power Reduction (MPR) for the maximum output power in Table 6.2D.1.2-1 is specified in sub-clause 6.2.2.2. The requirements shall be met with configurations specified in sub-clause 6.2D.1.0.

For the UE maximum output power modified by MPR, the power limits specified in clause 6.2D.4 apply.

### 6.2D.2.3 UE maximum output power reduction for modulation / channel bandwidth for UL MIMO for power class 3

For UEs configured for 2-layer transmission as well as UEs configured for single layer uplink full power transmission (ULFPTx), the allowed Maximum Power Reduction (MPR) for the maximum output power in Table 6.2D.1.3-1 is specified in sub-clause 6.2.2.3. The requirements shall be met with configurations specified in sub-clause 6.2D.1.0.

For the UE maximum output power modified by MPR, the power limits specified in clause 6.2D.4 apply.

### 6.2D.2.4 UE maximum output power reduction for modulation / channel bandwidth for UL MIMO for power class 4

For UEs configured for 2-layer transmission as well as UEs configured for single layer uplink full power transmission (ULFPTx), the allowed Maximum Power Reduction (MPR) for the maximum output power in Table 6.2D.1.4-1 is specified in sub-clause 6.2.2.4. The requirements shall be met with configurations specified in sub-clause 6.2D.1.0.

For the UE maximum output power modified by MPR, the power limits specified in clause 6.2D.4 apply.

### 6.2D.2.5 UE maximum output power reduction for modulation / channel bandwidth for UL MIMO for power class 5

For UEs configured for 2-layer transmission as well as UEs configured for single layer uplink full power transmission (ULFPTx), the allowed Maximum Power Reduction (MPR) for the maximum output power in Table 6.2D.1.5-1 is specified in sub-clause 6.2.2.5. The requirements shall be met with configurations specified in sub-clause 6.2D.1.0.

For the UE maximum output power modified by MPR, the power limits specified in clause 6.2D.4 apply.

### 6.2D.2.6 UE maximum output power reduction for modulation / channel bandwidth for UL MIMO for power class 6

For UEs configured for 2-layer transmission as well as UEs configured for single layer uplink full power transmission (ULFPTx), the allowed Maximum Power Reduction (MPR) for the maximum output power in Table 6.2D.1.6-1 is specified in sub-clause 6.2.2.6. The requirements shall be met with configurations specified in sub-clause 6.2D.1.0.

For the UE maximum output power modified by MPR, the power limits specified in clause 6.2D.6 apply.

## 6.2D.3 UE maximum output power reduction with additional requirements for UL MIMO

### 6.2D.3.1 UE maximum output power reduction with additional requirements for UL MIMO for power class 1

For UEs configured for 2-layer transmission as well as UEs configured for single layer uplink full power transmission (ULFPTx), the A-MPR values specified in clause 6.2.3 shall apply to the maximum output power specified in Table 6.2D.1.1-1. The requirements shall be met with the configurations specified in sub-clause 6.2D.1.0.

For the UE maximum output power modified by A-MPR, the power limits specified in clause 6.2D.4 apply.

### 6.2D.3.2 UE maximum output power reduction with additional requirements for UL MIMO for power class 2

For UEs configured for 2-layer transmission as well as UEs configured for single layer uplink full power transmission (ULFPTx), the A-MPR values specified in clause 6.2.3 shall apply to the maximum output power specified in Table 6.2D.1.2-1. The requirements shall be met with the configurations specified in clause 6.2D.1.0.

For the UE maximum output power modified by A-MPR, the power limits specified in clause 6.2D.4 apply.

### 6.2D.3.3 UE maximum output power reduction with additional requirements for UL MIMO for power class 3

For UEs configured for 2-layer transmission as well as UEs configured for single layer uplink full power transmission (ULFPTx), the A-MPR values specified in clause 6.2.3 shall apply to the maximum output power specified in Table 6.2D.1.3-1. The requirements shall be met with the configurations specified in clause 6.2D.1.0.

For the UE maximum output power modified by A-MPR, the power limits specified in clause 6.2D.4 apply.

### 6.2D.3.4 UE maximum output power reduction with additional requirements for UL MIMO for power class 4

For UEs configured for 2-layer transmission as well as UEs configured for single layer uplink full power transmission (ULFPTx), the A-MPR values specified in clause 6.2.3 shall apply to the maximum output power specified in Table 6.2D.1.4-1. The requirements shall be met with the configurations specified in clause 6.2D.1.0.

### 6.2D.3.5 UE maximum output power reduction with additional requirements for UL MIMO for power class 5

For UEs configured for 2-layer transmission as well as UEs configured for single layer uplink full power transmission (ULFPTx), the A-MPR values specified in clause 6.2.3 shall apply to the maximum output power specified in Table 6.2D.1.5-1. The requirements shall be met with the configurations specified in clause 6.2D.1.0.

### 6.2D.3.6 UE maximum output power reduction with additional requirements for UL MIMO for power class 6

For UEs configured for 2-layer transmission as well as UEs configured for single layer uplink full power transmission (ULFPTx), the A-MPR values specified in clause 6.2.3 shall apply to the maximum output power specified in Table 6.2D.1.6-1. The requirements shall be met with the configurations specified in clause 6.2D.1.0.

## 6.2D.4 Configured transmitted power for UL MIMO

For UEs configured for 2-layer transmission as well as UEs configured for single layer uplink full power transmission (ULFPTx), the configured maximum output power  $P_{\text{CMAX},c}$  for serving cell  $c$  is defined as sum of all streams and is bound by limits set in clause 6.2.4.

## 6.3 Output power dynamics

### 6.3.1 Minimum output power

#### 6.3.1.0 General

The minimum controlled output power of the UE is defined as the EIRP in the channel bandwidth for all transmit bandwidth configurations (resource blocks) when the power is set to a minimum value.

The minimum output power is defined as the mean power in at least one sub frame (1ms).

### 6.3.1.1 Minimum output power for power class 1

For power class 1 UE, the minimum output power shall not exceed the values specified in Table 6.3.1.1-1 for each operating band supported. The minimum power is verified in beam locked mode with the test metric of EIRP (Link=TX beam peak direction, Meas=Link angle).

**Table 6.3.1.1-1: Minimum output power for power class 1**

Operating band	Channel bandwidth (MHz)	Minimum output power (dBm)	Measurement bandwidth (MHz)
n257, n258, n260, n261, n262	50	4	47.58
	100	4	95.16
	200	4	190.20
	400	4	380.28
n263	100	4	95.16
	400	4	381.12
	800	4	715.20
	1600	4	1429.44
	2000	4	1705.92

### 6.3.1.2 Minimum output power for power class 2, 3, and 4

The minimum output power shall not exceed the values specified in Table 6.3.1.2-1 for each operating band supported. The minimum power is verified in beam locked mode with the test metric of EIRP (Link=TX beam peak direction, Meas=Link angle).

**Table 6.3.1.2-1: Minimum output power for power class 2, 3, and 4**

Operating band	Channel bandwidth (MHz)	Minimum output power (dBm)	Measurement bandwidth (MHz)
n257, n258, n259, n260, n261, n262	50	-13	47.58
	100	-13	95.16
	200	-13	190.20
	400	-13	380.28
n263	100	-13	95.16
	400	-13	381.12
	800	-13	715.20
	1600	-13	1429.44
	2000	-13	1705.92
NOTE 1: n260 is not applied for power class 2.			
NOTE 2: n259 is not applied for power class 4.			
NOTE 3: power class 4 is not applicable to n263			

### 6.3.1.3 Minimum output power for power class 5 and 6

The minimum output power shall not exceed the values specified in Table 6.3.1.3-1 for each operating band supported. The minimum power is verified in beam locked mode with the test metric of EIRP (Link=TX beam peak direction, Meas=Link angle).

**Table 6.3.1.3-1: Minimum output power for power class 5 and 6**

Operating band	Channel bandwidth (MHz)	Minimum output power (dBm)	Measurement bandwidth (MHz)
n257, n258, n259, n261	50	-6	47.58
	100	-6	95.16
	200	-6	190.20
	400	-6	380.28

### 6.3.1.4 Minimum output power for power class 7

The minimum output power shall not exceed the values specified in Table 6.3.1.4-1 for each operating band supported. The minimum power is verified in beam locked mode with the test metric of EIRP (Link=TX beam peak direction, Meas=Link angle).

**Table 6.3.1.4-1: Minimum output power for power class 7**

Operating band	Channel bandwidth (MHz)	Minimum output power (dBm)	Measurement bandwidth (MHz)
n257, n258, n261	50	-13	47.58
	100	-13	95.16

### 6.3.2 Transmit OFF power

The transmit OFF power is defined as the TRP in the channel bandwidth when the transmitter is OFF. The transmitter is considered OFF when the UE is not allowed to transmit on any of its ports.

The transmit OFF power shall not exceed the values specified in Tables 6.3.2-1 and 6.3.2-2 for each operating band supported. The requirement is verified with the test metric of TRP (Link=TX beam peak direction, Meas=TRP grid).

**Table 6.3.2-1: Transmit OFF power for FR2-1**

Operating band	Channel bandwidth / Transmit OFF power (dBm) / measurement bandwidth			
	50 MHz	100 MHz	200 MHz	400 MHz
n257, n258, n259, n260, n261, n262	-35	-35	-35	-35
	47.58 MHz	95.16 MHz	190.20 MHz	380.28 MHz

**Table 6.3.2-2: Transmit OFF power for FR2-2**

Operating band	Channel bandwidth / Transmit OFF power (dBm) / measurement bandwidth				
	100 MHz	400 MHz	800 MHz	1600 MHz	2000 MHz
n263	-35	-35	-35	-35	-35
	95.16 MHz	381.12 MHz	715.20	1429.44	1705.92

For UE indicating *ul-GapFR2-r17*, UE shall meet OFF power requirement defined in this clause for the band for which UL transmission is stopped in the activated UL gap.

### 6.3.3 Transmit ON/OFF time mask

#### 6.3.3.1 General

The transmit ON/OFF time mask defines the transient period(s) allowed

- between transmit OFF power and transmit ON power symbols (transmit ON/OFF)
- between continuous ON-power transmissions when power change or RB hopping is applied.

In case of RB hopping, transition period is shared symmetrically.

Unless otherwise stated the minimum requirements in clause 6.5 apply also in transient periods.



The transmit ON/OFF time mask is defined as a directional requirement. The requirement is verified in beam locked mode at beam peak direction. The maximum allowed EIRP OFF power level is -30dBm at beam peak direction. The requirement is verified with the test metric of EIRP (Link=TX beam peak direction, Meas=Link angle).

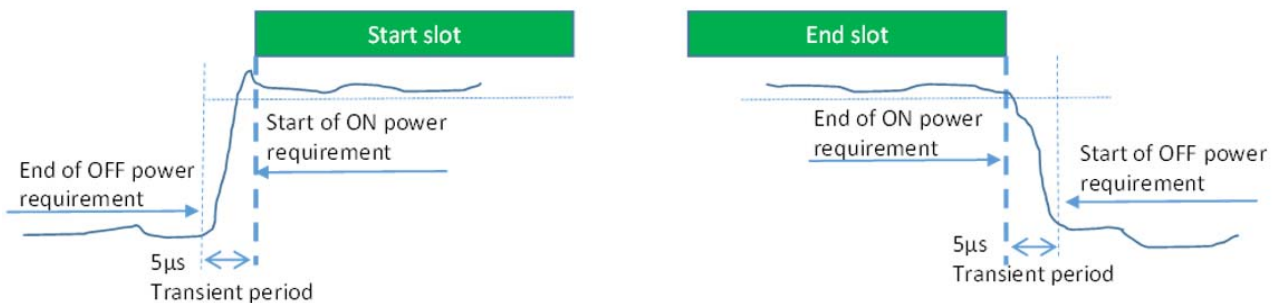
In the following sub-clauses, following definitions apply:

- A slot transmission is a Type A transmission.
- A long subslot transmission is a Type B transmission with more than 2 symbols.
- A short subslot transmission is a Type B transmission with 1 or 2 symbols.

### 6.3.3.2 General ON/OFF time mask

The general ON/OFF time mask defines the observation period allowed between transmit OFF and ON power. ON/OFF scenarios include: contiguous, and non-contiguous transmission, etc

The OFF power measurement period is defined in a duration of at least one slot excluding any transient periods. The ON power is defined as the mean power over one slot excluding any transient period.



**Figure 6.3.3.2-1: General ON/OFF time mask for NR UL transmission in FR2**

### 6.3.3.3 Transmit power time mask for slot and short or long subslot boundaries

The transmit power time mask for slot and a long subslot transmission boundaries defines the transient periods allowed between slot and long subslot PUSCH transmissions. For PUSCH-PUCCH and PUSCH-SRS transitions and multiplexing the time masks in sub-clause 6.3.3.7 apply.

The transmit power time mask for slot or long subslot and short subslot transmission boundaries defines the transient periods allowed between slot or long subslot and short subslot transmissions. The time masks in sub-clause 6.3.3.8 apply.

The transmit power time mask for short subslot transmission boundaries defines the transient periods allowed between short subslot transmissions. The time masks in sub-clause 6.3.3.9 apply.

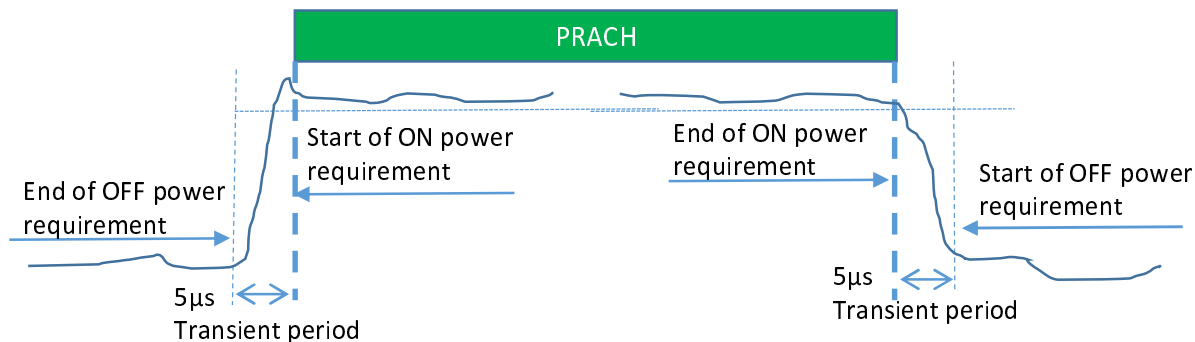
### 6.3.3.4 PRACH time mask

The PRACH ON power is specified as the mean power over the PRACH measurement period excluding any transient periods as shown in Figure 6.3.3.4-1. The measurement period for different PRACH preamble format is specified in Table 6.3.3.4-1.

Table 6.3.3.4-1: PRACH ON power measurement period

Format	SCS	Measurement period	Note
A <sub>1</sub>	60 kHz	0.035677 ms	
	120 kHz	0.017839 ms	
	480 kHz	0.004460 ms	
	960 kHz	0.002230 ms	
A <sub>2</sub>	60 kHz	0.071354 ms	
	120 kHz	0.035677 ms	
	480 kHz	0.008919 ms	
	960 kHz	0.004460 ms	
A <sub>3</sub>	60 kHz	0.107031 ms	
	120 kHz	0.053516 ms	
	480 kHz	0.013379 ms	
	960 kHz	0.006690 ms	
B <sub>1</sub>	60 kHz	0.035091 ms	
	120 kHz	0.0175455 ms	
	480 kHz	0.004386 ms	
	960 kHz	0.002193 ms	
B <sub>4</sub>	60 kHz	0.207617 ms	
	120 kHz	0.103809 ms	
	480 kHz	0.025952 ms	
	960 kHz	0.012976 ms	
A <sub>1</sub> /B <sub>1</sub>	60 kHz	0.035677 ms for front X1 occasion 0.035091 ms for last occasion	X1 = [2,5]
	120 kHz	0.017839 ms for front X1 occasion 0.017546 ms for last occasion	
	480 kHz	0.004460 ms for front X1 occasion 0.004386 ms for last occasion	
	960 kHz	0.002230 ms for front X1 occasion 0.002193 ms for last occasion	
A <sub>2</sub> /B <sub>2</sub>	60 kHz	0.071354 ms for front X2 occasion 0.069596 ms for last occasion	X2 = [1,2]
	120 kHz	0.035677 ms for front X2 occasion 0.034798 ms for last occasion	
	480 kHz	0.008919 ms for front X2 occasion 0.008700 ms for last occasion	
	960 kHz	0.004460 ms for front X2 occasion 0.004350 ms for last occasion	
A <sub>3</sub> /B <sub>3</sub>	60 kHz	0.107031 ms for first occasion 0.104101 ms for second occasion	
	120 kHz	0.053515 ms for first occasion 0.052050 ms for second occasion	
	480 kHz	0.013379 ms for first occasion 0.013013 ms for second occasion	
	960 kHz	0.006690 ms for first occasion 0.006506 ms for second occasion	
C <sub>0</sub>	60 kHz	0.026758 ms	
	120 kHz	0.013379 ms	
	480 kHz	0.003345 ms	
	960 kHz	0.001672 ms	
C <sub>2</sub>	60 kHz	0.083333 ms	
	120 kHz	0.0416667 ms	
	480 kHz	0.010417 ms	
	960 kHz	0.005208 ms	

NOTE: For PRACH on PRACH occasion start from begin of 0ms or 0.5 ms boundary, the measurement period will plus 0.032552 μs

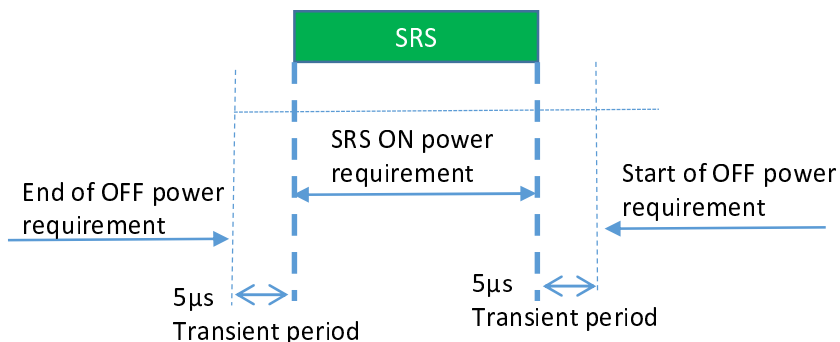


**Figure 6.3.3.4-1: PRACH ON/OFF time mask**

6.3.3.5 Void

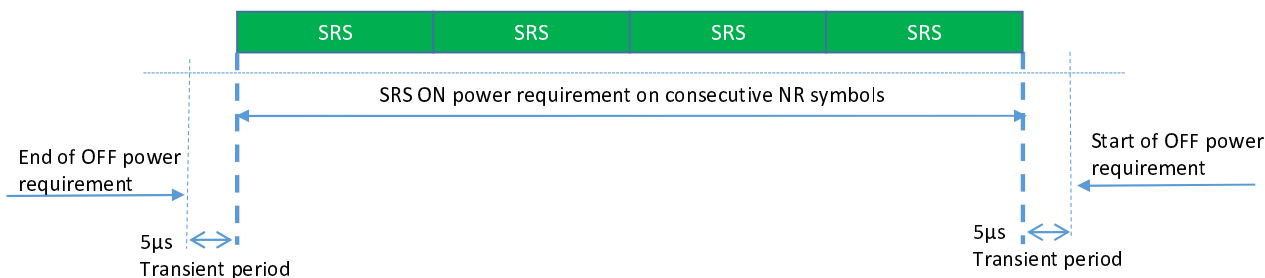
6.3.3.6 SRS time mask

In the case a single SRS transmission, the ON power is defined as the mean power over the symbol duration excluding any transient period; Figure 6.3.3.6-1.



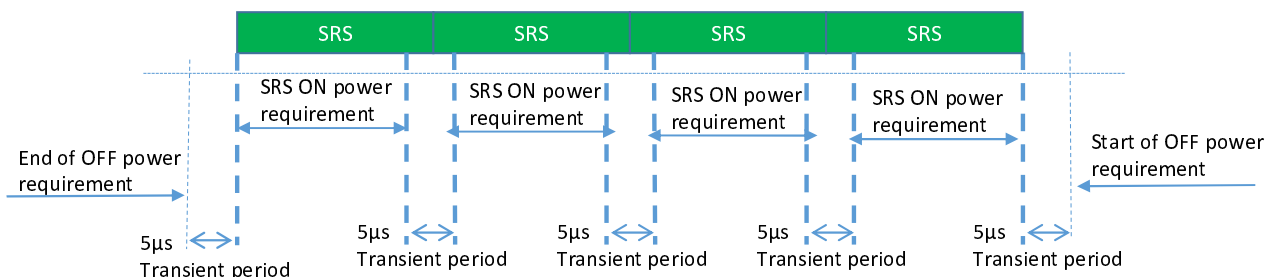
**Figure 6.3.3.6-1: Single SRS time mask for NR UL transmission**

In the case multiple consecutive SRS transmission, the ON power is defined as the mean power for each symbol duration excluding any transient period. See Figure 7.7.4-2

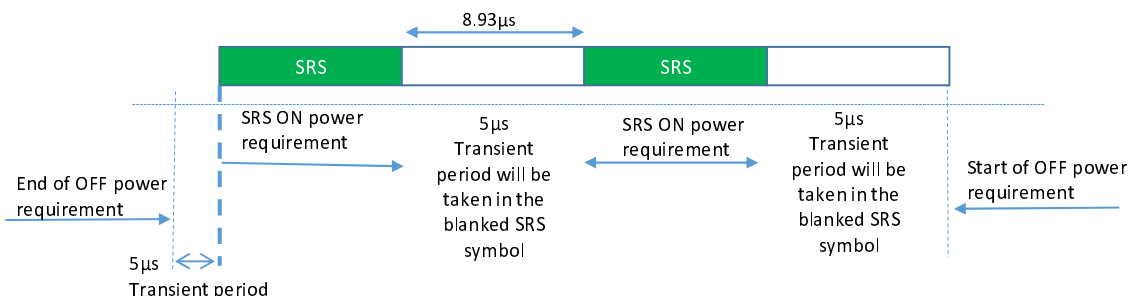


**Figure 6.3.3.6-2: Consecutive SRS time mask for the case when no power change is required**

When power change between consecutive SRS transmissions is required, then Figure 6.3.3.6-3 and Figure 6.3.3.6-4 apply.



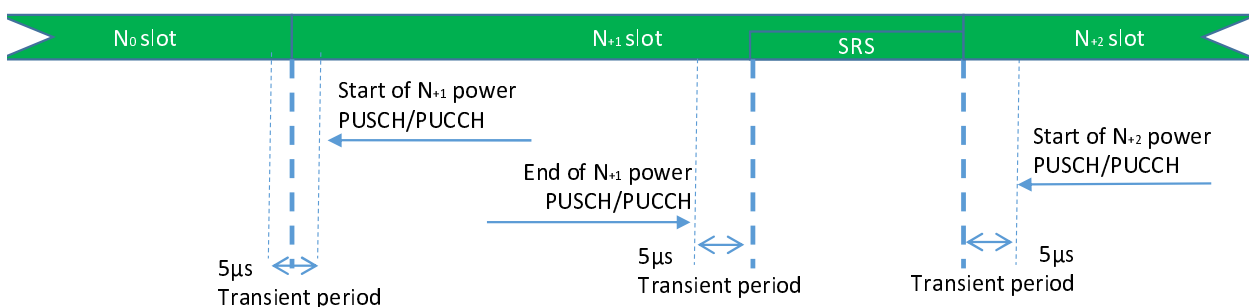
**Figure 6.3.3.6-3: Consecutive SRS time mask for the case when power change is required and when 60kHz SCS is used in FR2**



**Figure 6.3.3.6-4: Consecutive SRS time mask for the case when power change is required and when 120kHz SCS is used in FR2**

6.3.3.7 PUSCH-PUCCH and PUSCH-SRS time masks

The PUCCH/PUSCH/SRS time mask defines the observation period between sounding reference symbol (SRS) and an adjacent PUSCH/PUCCH symbol and subsequent UL transmissions. The time masks apply for all types of frame structures and their allowed PUCCH/PUSCH/SRS transmissions unless otherwise stated.

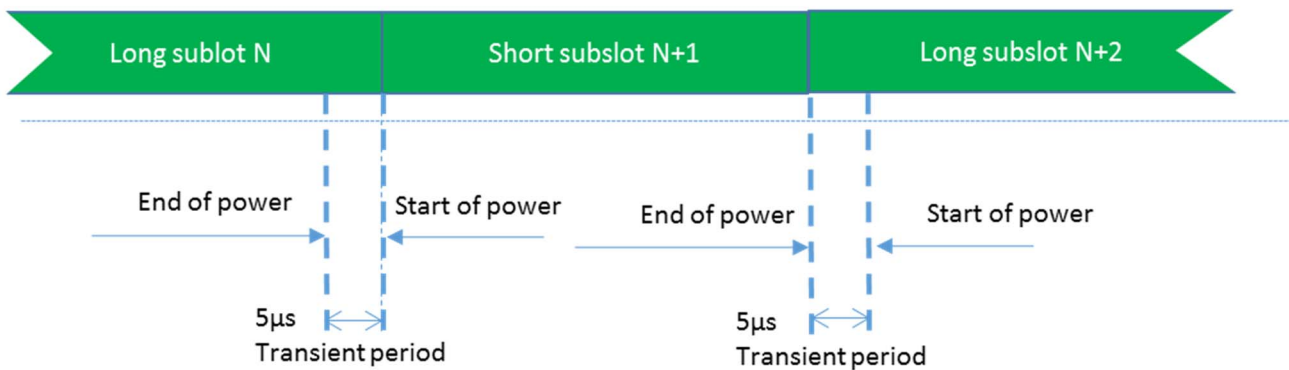


**Figure 6.3.3.7-1: PUCCH/PUSCH/SRS time mask when there is a transmission before or after or both before and after SRS**

When there is no transmission preceding SRS transmission or succeeding SRS transmission, then the same time mask applies as shown in Figure 6.3.3.7-1.

6.3.3.8 Transmit power time mask for consecutive slot or long subslot transmission and short subslot transmission boundaries

The transmit power time mask for consecutive slot or long subslot transmission and short subslot transmission boundaries defines the transient periods allowed between such transmissions.



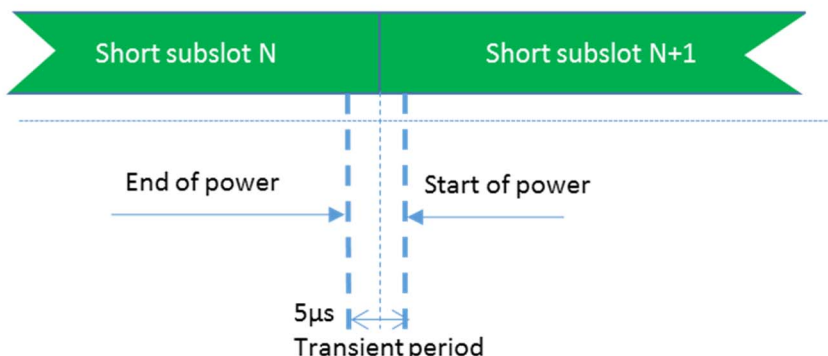
**Figure 6.3.3.8-1: Consecutive slot or long subslot transmission and short subslot transmission time mask**

**6.3.3.9 Transmit power time mask for consecutive short subslot transmissions boundaries**

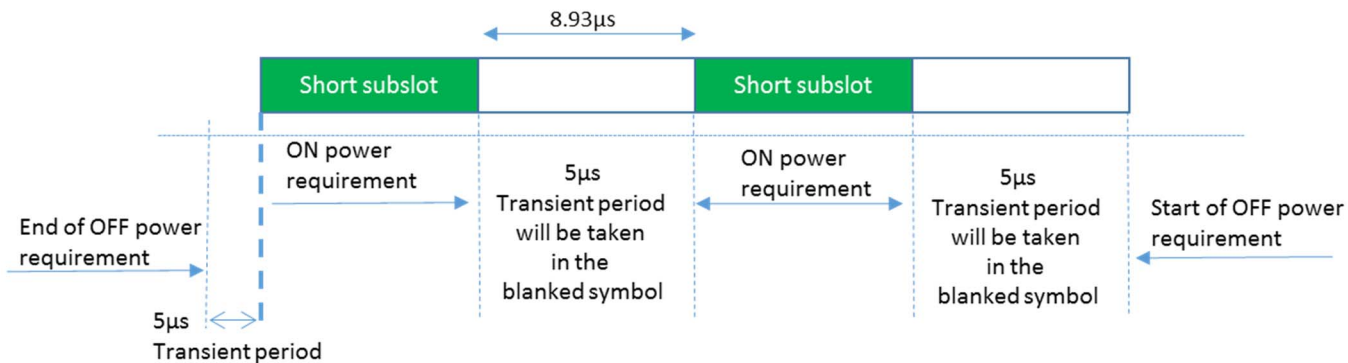
The transmit power time mask for consecutive short subslot transmission boundaries defines the transient periods allowed between short subslot transmissions.

The transient period shall be equally shared as shown on Figure 6.3.3.9-2.

**Figure 6.3.3.9-1: Void**



**Figure 6.3.3.9-2: Consecutive short subslot transmissions time mask where DMRS is not the first symbol in the adjacent short subslot transmission**



**Figure 6.3.3.9-3: Consecutive short subslot (1 symbol gap) time mask for the case when transient period is required on both sides of the symbol and when 120 kHz SCS is used in FR2**

## 6.3.4 Power control

### 6.3.4.1 General

The requirements on power control accuracy apply under normal conditions and are defined as a directional requirement. The requirements are verified in beam locked mode on beam peak direction.

### 6.3.4.2 Absolute power tolerance

The absolute power tolerance is the ability of the UE transmitter to set its initial output power to a specific value for the first sub-frame (1 ms) at the start of a contiguous transmission or non-contiguous transmission with a transmission gap larger than 20 ms. The tolerance includes the channel estimation error RSRP estimate.

The minimum requirements specified in Table 6.3.4.2-1 apply in the power range bounded by the minimum output power as specified in sub-clause 6.3.1 ( $P_{\min}$ ) and the maximum output power as specified in sub-clause 6.2.1 as minimum peak EIRP ( $P_{\max}$ ). The intermediate power point ' $P_{\text{int}}$ ' is defined in table 6.3.4.2-2

**Table 6.3.4.2-1: Absolute power tolerance**

Power Range	Tolerance
$P_{\text{int}} \geq P \geq P_{\min}$	$\pm 14.0$ dB
$P_{\max} \geq P > P_{\text{int}}$	$\pm 12.0$ dB

**Table 6.3.4.2-2: Intermediate power point**

Power Parameter	Value
$P_{\text{int}}$	$P_{\max} - 12.0$ dB

### 6.3.4.3 Relative power tolerance

The relative power tolerance is the ability of the UE transmitter to set its output power in a target sub-frame (1 ms) relatively to the power of the most recently transmitted reference sub-frame (1 ms) if the transmission gap between these sub-frames is less than or equal to 20 ms.

The minimum requirements specified in Table 6.3.4.3-1 apply when the power of the target and reference sub-frames are within the power range bounded by the minimum output power as defined in sub-clause 6.3.1 and  $P_{\text{int}}$  as defined in sub-clause 6.3.4.2. The minimum requirements specified in Table 6.3.4.3-2 apply when the power of the target and reference sub-frames are within the power range bounded by  $P_{\text{int}}$  as defined in sub-clause 6.3.4.2 and the measured  $P_{\text{UMAX}}$  as defined in sub-clause 6.2.4.

For a test pattern that is either a monotonically increasing or monotonically decreasing power sweep over the range specified for Tables 6.3.4.3-1 and 6.3.4.3-2, 3 exceptions are allowed for each of the test patterns. For these exceptions, the power tolerance limit is a maximum of  $\pm 11.0$  dB.

**Table 6.3.4.3-1: Relative power tolerance,  $P_{\text{int}} \geq P \geq P_{\min}$**

Power step $\Delta P$ (Up or down) (dB)	All combinations of PUSCH and PUCCH, PUSCH/PUCCH and SRS transitions between sub-frames, PRACH (dB)
$\Delta P < 2$	$\pm 5.0$
$2 \leq \Delta P < 3$	$\pm 6.0$
$3 \leq \Delta P < 4$	$\pm 7.0$
$4 \leq \Delta P < 10$	$\pm 8.0$
$10 \leq \Delta P < 15$	$\pm 10.0$
$15 \leq \Delta P$	$\pm 11.0$
NOTE: The requirements apply with <i>ue-BeamLockFunction</i> enabled.	

**Table 6.3.4.3-2: Relative power tolerance,  $P_{UMAX} \geq P > P_{int}$** 

Power step $\Delta P$ (Up or down) (dB)	All combinations of PUSCH and PUCCH, PUSCH/PUCCH and SRS transitions between sub-frames, PRACH (dB)
$\Delta P < 2$	$\pm 3.0$
$2 \leq \Delta P < 3$	$\pm 4.0$
$3 \leq \Delta P < 4$	$\pm 5.0$
$4 \leq \Delta P < 10$	$\pm 6.0$
$10 \leq \Delta P < 15$	$\pm 8.0$
$15 \leq \Delta P$	$\pm 9.0$
NOTE 1: The requirements apply with <i>ue-BeamLockFunction</i> enabled.	
NOTE 2: For PUSCH to PUSCH transitions with the allocated resource blocks fixed in frequency and no transmission gaps other than those generated by downlink subframes, guard periods: for a power step $\Delta P = 1$ dB, the relative power tolerance for transmission is $\pm 1.0$ dB.	

#### 6.3.4.4 Aggregate power tolerance

The aggregate power control tolerance is the ability of the UE transmitter to maintain its power in a sub-frame (1 ms) during non-contiguous transmissions within 21ms in response to 0 dB TPC commands with respect to the first UE transmission and all other power control parameters as specified in 38.213 kept constant.

The minimum requirements specified in Table 6.3.4.4-1 apply when the power of the target and reference sub-frames are within the power range bounded by the minimum output power as defined in sub-clause 6.3.1 and  $P_{int}$  as defined in sub-clause 6.3.4.2. The minimum requirements specified in Table 6.3.4.4-2 apply when the power of the target and reference sub-frames are within the power range bounded by  $P_{int}$  as defined in sub-clause 6.3.4.2 and the maximum output power as specified in sub-clause 6.2.1.

**Table 6.3.4.4-1: Aggregate power tolerance,  $P_{int} \geq P \geq P_{min}$** 

TPC command	UL channel	Aggregate power tolerance within 21 ms
0 dB	PUCCH	$\pm 5.5$ dB
0 dB	PUSCH	$\pm 5.5$ dB

**Table 6.3.4.4-2: Aggregate power tolerance,  $P_{max} \geq P > P_{int}$** 

TPC command	UL channel	Aggregate power tolerance within 21 ms
0 dB	PUCCH	$\pm 3.5$ dB
0 dB	PUSCH	$\pm 3.5$ dB

### 6.3A Output power dynamics for CA

#### 6.3A.1 Minimum output power for CA

**Table 6.3A.1-1: Void**

##### 6.3A.1.0 General

For intra-band contiguous and non-contiguous carrier aggregation, the minimum controlled output power of the UE is defined as the transmit power of the UE per component carrier, i.e., EIRP in the channel bandwidth of each component carrier for all transmit bandwidth configurations (resource blocks), when the power on both component carriers are set to a minimum value.

The minimum output power is defined as the mean power in at least one sub frame (1ms).

### 6.3A.1.1 Minimum output power for power class 1

For intra-band contiguous and non-contiguous carrier aggregation, the minimum output power shall not exceed the values specified in Table 6.3A.1.1-1 for each operating band supported. The minimum power is verified in beam locked mode with the test metric of EIRP (Link=TX beam peak direction, Meas=Link angle).

**Table 6.3A.1.1-1: Minimum output power for power class 1**

Operating band	Channel bandwidth (MHz)	Minimum output power (dBm)	Measurement bandwidth (MHz)
n257, n258, n260, n261, n262	50	4	47.58
	100	4	95.16
	200	4	190.20
	400	4	380.28
n263	100	4	95.16
	400	4	381.12
	800	4	715.20
	1600	4	1429.44
	2000	4	1705.92

For inter-band carrier aggregation with uplink assigned to two NR bands, and each UL band is configured with a single CC, the minimum output power is defined per carrier and is specified in clause 6.3.1.1.

### 6.3A.1.2 Minimum output power for power class 2, 3, and 4

For intra-band contiguous and non-contiguous carrier aggregation, the minimum output power shall not exceed the values specified in Table 6.3A.1.2-1 for each operating band supported. The minimum power is verified in beam locked mode with the test metric of EIRP (Link=TX beam peak direction, Meas=Link angle).

**Table 6.3A.1.2-1: Minimum output power for CA for power class 2, 3, and 4**

Operating band	Channel bandwidth (MHz)	Minimum output power (dBm)	Measurement bandwidth (MHz)
n257, n258, n259, n260, n261, n262	50	-13	47.58
	100	-13	95.16
	200	-13	190.20
	400	-13	380.28
n263	100	-13	95.16
	400	-13	381.12
	800	-13	715.20
	1600	-13	1429.44
	2000	-13	1705.92
NOTE 1: n260 is not applied for power class 2.			
NOTE 2: n259 is not applied for power class 4.			

For inter-band carrier aggregation with uplink assigned to two NR bands, and each UL band is configured with a single CC, the minimum output power is defined per carrier and is specified in clause 6.3.1.2.



### 6.3A.1.3 Minimum output power for power class 5

For intra-band contiguous and non-contiguous carrier aggregation, the minimum output power shall not exceed the values specified in Table 6.3A.1.3-1 for each operating band supported. The minimum power is verified in beam locked mode with the test metric of EIRP (Link=TX beam peak direction, Meas=Link angle).

**Table 6.3A.1.3-1: Minimum output power for CA for power class 5**

Operating band	Channel bandwidth (MHz)	Minimum output power (dBm)	Measurement bandwidth (MHz)
n257, n258, n259	50	-6	47.58
	100	-6	95.16
	200	-6	190.20
	400	-6	380.28

For inter-band carrier aggregation with uplink assigned to two NR bands, and each UL band is configured with a single CC, the minimum output power is defined per carrier and is specified in clause 6.3.1.3.

### 6.3A.2 Transmit OFF power for CA

For intra-band contiguous and non-contiguous carrier aggregation, the transmit OFF power is defined as the TRP in the channel bandwidth per component carrier when the transmitter is OFF. The transmitter is considered OFF when the UE is not allowed to transmit on any of it sports.

The transmit OFF power shall not exceed the values specified in Table 6.3A.2-1 and Table 6.3A.2-2 for each operating band supported.

**Table 6.3A.2-1: Transmit OFF power for CA for FR2-1**

Operating band	Channel bandwidth / Transmit OFF power (dBm) / measurement bandwidth			
	50 MHz	100 MHz	200 MHz	400 MHz
n257, n258, n259, n260, n261, n262	-35	-35	-35	-35
	47.58 MHz	95.16 MHz	190.20 MHz	380.28 MHz

**Table 6.3A.2-2: Transmit OFF power for CA for FR2-2**

Operating band	Channel bandwidth / Transmit OFF power (dBm) / measurement bandwidth				
	100 MHz	400 MHz	800 MHz	1600 MHz	2000 MHz
n263	-35	-35	-35	-35	-35
	95.16 MHz	381.12 MHz	715.20	1429.44	1705.92

For inter-band carrier aggregation with uplink assigned to two NR bands, and each UL band is configured with a single CC, the transmit OFF power specified in clause 6.3.2.1 is applicable for each CC when the transmitter is OFF on all CCs. The transmitter is considered to be OFF when the UE is not allowed to transmit on any of its ports.

### 6.3A.3 Transmit ON/OFF time mask for CA

For intra-band contiguous and non-contiguous UL carrier aggregation, the general output power ON/OFF time mask specified in clause 6.3.3.2 is applicable for each component carrier during the ON power period and the transient periods. The OFF period as specified in clause 6.3.3.2 shall only be applicable for each component carrier when all the component carriers are OFF.

For inter-band carrier aggregation with uplink assigned to two NR bands, and each UL band is configured with a single CC, the general output power ON/OFF time mask specified in clause 6.3.3.1 is applicable for each CC during the ON power period and the transient periods. The OFF period is specified in clause 6.3.3.1 for each CC separately when all the CCs are OFF.

## 6.3A.4 Power control for CA

### 6.3A.4.1 General

The requirements in this clause apply to a UE when it has at least one of UL or DL configured for CA operation. The requirements on power control accuracy in CA operation apply under normal conditions and are defined as a directional requirement. The requirements are verified in beam locked mode on beam peak direction. The requirements apply for one single PUCCH, PUSCH or SRS transmission of contiguous PRB allocation per configured UL CC with power setting in accordance with Clause 7.1 of [10]

### 6.3A.4.2 Absolute power tolerance

For intra-band contiguous and non-contiguous UL carrier aggregation, the absolute power tolerance is the ability of the UE transmitter to set its initial output power to a specific value for the first sub-frame at the start of a contiguous transmission or non-contiguous transmission with a transmission gap on each active component carriers larger than 20 ms. For SRS switching, the absolute power tolerance is the ability of the UE transmitter to set its initial output power to a specific value for the first sub-frame at the start of a contiguous transmission or non-contiguous transmission with a transmission gap on component carriers (to which SRS switching occurs) larger than 20 ms. The requirement can be tested by time aligning any transmission gaps on the component carriers. For intra-band contiguous CA, the absolute power control tolerance per configured UL CC is given in Tables 6.3.4.2-1 and 6.3.4.2-2.

### 6.3A.4.3 Relative power tolerance

For intra-band contiguous and non-contiguous UL carrier aggregation, the relative power tolerance is the ability of the UE transmitter to set its output power in a target sub-frame relative to the power of the most recently transmitted reference sub-frame if the transmission gap between these sub-frames is less than or equal to 20ms.

For intra-band contiguous CA, the requirements apply when the power of the target and reference sub-frames on each component carrier exceed the minimum output power as defined in clause 6.3A.1 and the total power is limited by  $P_{UMAX}$  as defined in clause 6.2A.4. For the purpose of these requirements, the power in each component carrier is specified over only the transmitted resource blocks. The UE shall meet the requirements in tables 6.3.4.3-1 and 6.3.4.3-2 for transmission on each assigned component carrier, when the average PSDs over each CC are aligned with each other in the reference sub-frame. The requirements apply per component carrier to:

- a. All possible combinations of PUSCH and PUCCH transitions
- b. SRS and PUSCH/PUCCH transitions, only with simultaneous SRS of constant SRS bandwidth allocated in the target and reference subframes
- c. RACH, primary component carrier

When applicable, the power step  $\Delta P$  between the reference and target subframes shall be set by a TPC command and/or an uplink scheduling grant transmitted by means of an appropriate DCI Format.

### 6.3A.4.4 Aggregate power tolerance

For intra-band contiguous and non-contiguous UL carrier aggregation, the aggregate power control tolerance is the ability of the UE transmitter to maintain its power during non-contiguous transmissions within 21 ms in response to 0 dB TPC commands with respect to the first UE transmission and all other power control parameters as specified in [10] kept constant.

For intra-band contiguous CA, the aggregate power tolerance per CC is given in Tables 6.3.4.4.1-1 and 6.3.4.4.1-2, with simultaneous PUSCH configured. The average PSDs over each assigned CC shall be aligned before the start of the test. The requirement can be tested with the transmission gaps time aligned between component carriers.

## 6.3D Output power dynamics for UL MIMO

### 6.3D.0 General

The requirements in subclause 6.3D shall be met with configurations specified in sub-clause 6.2D.1.x, where 'x' depends on power class. Unless otherwise specified, the requirements shall be verified in beam locked mode with the test metric of EIRP (Link=TX beam peak direction, Meas=Link angle).

### 6.3D.1 Minimum output power for UL MIMO

#### 6.3D.1.0 General

The minimum output power is defined as the mean power in at least one sub frame (1ms). The minimum controlled output power is defined as the EIRP, i.e. the sum of the power in the channel bandwidth for all transmit bandwidth configurations (resource blocks), when the UE power is set to a minimum value.

#### 6.3D.1.1 Minimum output power for UL MIMO for power class 1

For UE supporting UL MIMO, the minimum output power shall not exceed the sum of the values specified in Table 6.3.1.1-1 and the quantity  $10 \cdot \log_{10}(\text{Number of Layers})$ .

#### 6.3D.1.2 Minimum output power for UL MIMO for power class 2, 3 and 4

minimum output power shall not exceed the sum of the values specified in Table 6.3.1.2-1 and the quantity  $10 \cdot \log_{10}(\text{Number of Layers})$ .

#### 6.3D.1.3 Minimum output power for UL MIMO for power class 5 and 6

For UE supporting UL MIMO, the minimum controlled output power is defined as the EIRP, i.e. the sum of the power in the channel bandwidth for all transmit bandwidth configurations (resource blocks), when the UE power is set to a minimum value. The minimum output power shall not exceed the values specified in Table 6.3.1.3-1. The minimum power is verified in beam locked mode with the test metric of EIRP (Link=TX beam peak direction, Meas=Link angle).

### 6.3D.2 Transmit OFF power for UL MIMO

For UE supporting UL MIMO, the transmit OFF power is defined as the TRP in the channel bandwidth when the transmitter is OFF. The transmitter is considered OFF when the UE is not allowed to transmit on any of its ports. During DTX and measurements gaps, the transmitter is not considered OFF. The minimum output power shall not exceed the values specified in Table 6.3.2-1. The requirement is verified with the test metric of TRP (Link=TX beam peak direction, Meas=TRP grid).

### 6.3D.3 Transmit ON/OFF time mask for UL MIMO

For UE supporting UL MIMO, the ON/OFF time mask requirements in clause 6.3.3 apply.

## 6.4 Transmit signal quality

### 6.4.1 Frequency Error

The UE basic measurement interval of modulated carrier frequency is 1 UL slot. The mean value of basic measurements of UE modulated carrier frequency shall be accurate to within  $\pm 0.1$  PPM observed over a period of 1 msec of cumulated measurement intervals compared to the carrier frequency received from the NR gNB.

The frequency error is defined as a directional requirement. The requirement is verified in beam locked mode with the test metric of Frequency (Link=TX beam peak direction, Meas=Link angle).

## 6.4.2 Transmit modulation quality

### 6.4.2.0 General

Transmit modulation quality defines the modulation quality for expected in-channel RF transmissions from the UE. The transmit modulation quality is specified in terms of:

- Error Vector Magnitude (EVM) for the allocated resource blocks (RBs)
- EVM equalizer spectrum flatness derived from the equalizer coefficients generated by the EVM measurement process
- Carrier leakage
- In-band emissions for the non-allocated RB

All the parameters defined in clause 6.4.2 are defined using the measurement methodology specified in Annex F.

All the requirements in 6.4.2 are defined as directional requirement. The requirements are verified in beam locked mode on beam peak direction, with parameter *maxRank* (as defined in TS 38.331 [13]) set to 1. The requirements are applicable to UL transmission from each configurable antenna port (as defined in TS 38.331 [13]) of UE, enabled one at a time.

In case the parameter 3300 or 3301 is reported from UE via the parameter *txDirectCurrentLocation* in *UplinkTxDirectCurrentList* IE (as defined in TS 38.331 [13]), carrier leakage measurement requirement in clause 6.4.2.2 and 6.4.2.3 shall be waived, and the RF correction with regard to the carrier leakage and IQ image shall be omitted during the calculation of transmit modulation quality.

### 6.4.2.1 Error vector magnitude

The Error Vector Magnitude is a measure of the difference between the reference waveform and the measured waveform. This difference is called the error vector. Before calculating the EVM, the measured waveform is corrected by the sample timing offset and RF frequency offset. Then the carrier leakage shall be removed from the measured waveform before calculating the EVM.

The measured waveform is further equalised using the channel estimates subjected to the EVM equaliser spectrum flatness requirement specified in sub-clauses 6.4.2.4 and 6.4.2.5. For DFT-s-OFDM waveforms, the EVM result is defined after the front-end FFT and IDFT as the square root of the ratio of the mean error vector power to the mean reference power expressed as a %. For CP-OFDM waveforms, the EVM result is defined after the front-end FFT as the square root of the ratio of the mean error vector power to the mean reference power expressed as a %.

The basic EVM measurement interval in the time domain is one preamble sequence for the PRACH and one slot for PUCCH and PUSCH in the time domain. The EVM measurement interval is reduced by any symbols that contains an allowable power transient in the measurement interval as defined in clause 6.3.3.

The RMS average of the basic EVM measurements over 10 subframes for the average EVM case, and over 60 subframes for the reference signal EVM case, for the different modulation schemes shall not exceed the values specified in Table 6.4.2.1-1 for the parameters defined in Table 6.4.2.1-2 or 6.4.2.1-3, depending on UE power class. For EVM evaluation purposes, all 13 PRACH preamble formats and all 5 PUCCH formats are considered to have the same EVM requirement as QPSK modulated.

The requirement is verified with the test metric of EVM (Link=TX beam peak direction, Meas=Link angle).

**Table 6.4.2.1-1: Minimum requirements for error vector magnitude**

Parameter	Unit	Average EVM level	Reference signal EVM level
Pi/2 BPSK	%	30.0	30.0
QPSK	%	17.5	17.5
16 QAM	%	12.5	12.5
64 QAM	%	8.0	8.0

**Table 6.4.2.1-2: Parameters for Error Vector Magnitude for power class 1 in FR2-1**

Parameter	Unit	Level
UE EIRP	dBm	≥ 4
UE EIRP for UL 16 QAM	dBm	≥ 7
UE EIRP for UL 64 QAM	dBm	≥ 11
Operating conditions		Normal conditions

**Table 6.4.2.1-2a: Parameters for Error Vector Magnitude for power class 1 in FR2-2**

Parameter	Unit	Level				
		100 MHz	400 MHz	800 MHz	1600 MHz	2000 MHz
UE EIRP	dBm	≥ 4	≥ 2	≥ 5	≥ 8	≥ 9
UE EIRP for UL 16 QAM	dBm	≥ 7	≥ 5	≥ 8	≥ 11	≥ 12
UE EIRP for UL 64 QAM	dBm	≥ 11	≥ 9	≥ 12	≥ 15	≥ 16
Operating conditions		Normal Conditions				

NOTE 1: PTRS is configured for 16 QAM and 64 QAM

**Table 6.4.2.1-3: Parameters for Error Vector Magnitude for power class 2, 3, 4 and 7 in FR2-1**

Parameter	Unit	Level
UE EIRP	dBm	≥ -13
UE EIRP for UL 16 QAM	dBm	≥ -10
UE EIRP for UL 64 QAM	dBm	≥ -6
Operating conditions		Normal conditions

**Table 6.4.2.1-3a: Parameters for Error Vector Magnitude for power class 3 in FR2-2**

Parameter	Unit	Level				
		100 MHz	400 MHz	800 MHz	1600 MHz	2000 MHz
UE EIRP	dBm	≥ -13	≥ -11	≥ -8	≥ -5	≥ -4
UE EIRP for UL 16 QAM	dBm	≥ -10	≥ -8	≥ -5	≥ -2	≥ -1
UE EIRP for UL 64 QAM	dBm	≥ -6	≥ -4	≥ -1	≥ 2	≥ 3
Operating conditions		Normal Conditions				

NOTE 1: PTRS is configured for 16 QAM and 64 QAM

**Table 6.4.2.1-3b: Parameters for Error Vector Magnitude for power class 2 in FR2-2**

Parameter	Unit	Level				
		100 MHz	400 MHz	800 MHz	1600 MHz	2000 MHz
UE EIRP	dBm	≥ -13	≥ -11	≥ -8	≥ -5	≥ -4
UE EIRP for UL 16 QAM	dBm	≥ -10	≥ -8	≥ -5	≥ -2	≥ -1
UE EIRP for UL 64 QAM	dBm	≥ -6	≥ -4	≥ -1	≥ 2	≥ 3
Operating conditions		Normal Conditions				

NOTE 1: PTRS is configured for 16 QAM and 64 QAM

**Table 6.4.2.1-4: Parameters for Error Vector Magnitude for power class 5 in FR2-1**

Parameter	Unit	Level
UE EIRP	dBm	$\geq -6$
UE EIRP for UL 16 QAM	dBm	$\geq -3$
UE EIRP for UL 64 QAM	dBm	$\geq 1$
Operating conditions		Normal conditions

## 6.4.2.2 Carrier leakage

### 6.4.2.2.1 General

Carrier leakage is an additive sinusoid waveform. The carrier leakage requirement is defined for each component carrier. The measurement interval is one slot in the time domain. The relative carrier leakage power is a power ratio of the additive sinusoid waveform to the power in the modulated waveform.

The requirement is verified with the test metric of Carrier Leakage (Link=TX beam peak direction, Meas=Link angle).

### 6.4.2.2.2 Carrier leakage for power class 1

When carrier leakage is contained inside the spectrum confined within the configured UL and DL CCs, the relative carrier leakage power shall not exceed the values specified in Table 6.4.2.2.2-1 and Table 6.4.2.2.2-2 for power class 1 UEs.

**Table 6.4.2.2.2-1: Minimum requirements for relative carrier leakage power for power class 1 in FR2-1**

Parameters	Relative Limit (dBc)
EIRP > 17 dBm	-25
4 dBm $\leq$ EIRP $\leq$ 17 dBm	-20

**Table 6.4.2.2.2-2: Minimum requirements for relative carrier leakage power for power class 1 in FR2-2**

Parameters	Relative Limit (dBc)
EIRP > 13.4 dBm	-25
0.4 dBm $\leq$ EIRP $\leq$ 13.4 dBm	-20

### 6.4.2.2.3 Carrier leakage for power class 2

When carrier leakage is contained inside the spectrum occupied by the configured UL CCs and DL CCs, the relative carrier leakage power shall not exceed the values specified in Table 6.4.2.2.3-1 and Table 6.4.2.2.3-2 for power class 2.

**Table 6.4.2.2.3-1: Minimum requirements for relative carrier leakage power for power class 2 in FR2-1**

Parameters	Relative Limit (dBc)
EIRP > 6 dBm	-25
-13 dBm $\leq$ EIRP $\leq$ 6 dBm	-20

**Table 6.4.2.2.3-2: Minimum requirements for relative carrier leakage power for power class 2 in FR2-2**

Parameters	Relative Limit (dBc)
EIRP > 5.8 dBm	-25
-13.2 dBm $\leq$ EIRP $\leq$ 5.8 dBm	-20

#### 6.4.2.2.4 Carrier leakage for power class 3

When carrier leakage is contained inside the spectrum occupied by the configured UL CCs and DL CCs, the relative carrier leakage power shall not exceed the values specified in Table 6.4.2.2.4-1 and Table 6.4.2.2.4-2 for power class 3 UEs.

**Table 6.4.2.2.4-1: Minimum requirements for relative carrier leakage power for power class 3 in FR2-1**

Parameters	Relative Limit (dBc)
EIRP > 0 dBm	-25
-13 dBm ≤ EIRP ≤ 0 dBm	-20

**Table 6.4.2.2.4-2: Minimum requirements for relative carrier leakage power for power class 3 in FR2-2**

Parameters	Relative Limit (dBc)
EIRP > -1.9 dBm	-25
-14.9 dBm ≤ EIRP ≤ -1.9 dBm	-20

#### 6.4.2.2.5 Carrier leakage for power class 4

When carrier leakage is contained inside the spectrum occupied by the configured UL CCs and DL CCs, the relative carrier leakage power shall not exceed the values specified in Table 6.4.2.2.5-1 for power class 4.

**Table 6.4.2.2.5-1: Minimum requirements for relative carrier leakage power for power class 4 in FR2-1**

Parameters	Relative Limit (dBc)
EIRP > 11 dBm	-25
-13 dBm ≤ EIRP ≤ 11 dBm	-20

#### 6.4.2.2.6 Carrier leakage for power class 5

When carrier leakage is contained inside the spectrum occupied by the configured UL CCs and DL CCs, the relative carrier leakage power shall not exceed the values specified in Table 6.4.2.2.6-1 for power class 5.

**Table 6.4.2.2.6-1: Minimum requirements for relative carrier leakage power for power class 5 in FR2-1**

Parameters	Relative Limit (dBc)
EIRP > 7 dBm	-25
-6 dBm ≤ EIRP ≤ 7 dBm	-20

#### 6.4.2.2.7 Carrier leakage for power class 6

For power class 6, the carrier leakage requirement specified in clause 6.4.2.2.6 for power class 5 applies.

#### 6.4.2.2.8 Carrier leakage for power class 7

When carrier leakage is contained inside the spectrum occupied by the configured UL CCs and DL CCs, the relative carrier leakage power specified in subclause 6.4.2.2.4 applies.

6.4.2.3 In-band emissions

6.4.2.3.1 General

The in-band emission is defined as the average across 12 sub-carriers and as a function of the RB offset from the edge of the allocated UL transmission bandwidth. The in-band emission is measured as the ratio of the UE output power in a non-allocated RB to the UE output power in an allocated RB. The IBE requirement does not apply if UE declares support for *mpr-PowerBoost-FR2-r16*, UL transmission is QPSK,  $MPR_{f,c} = 0$  and when NS\_200 applies, and the network configures the UE to operate with *mpr-PowerBoost-FR2-r16*.

The basic in-band emissions measurement interval is identical to that of the EVM test.

The requirement is verified with the test metric of In-band emission (Link=TX beam peak direction, Meas=Link angle).

6.4.2.3.2 In-band emissions for power class 1

The average of the in-band emission measurement over 10 sub-frames shall not exceed the values specified in Table 6.4.2.3.2-1 for power class 1 UEs.

**Table 6.4.2.3.2-1: Requirements for in-band emissions for power class 1**

Parameter description	Unit	Limit (NOTE 1)		Applicable Frequencies	
General	dB	$\max \left[ \begin{array}{l} -25 - 10 \cdot \log_{10} \left( \frac{N_{RB}}{L_{CRB}} \right), \\ 20 \cdot \log_{10}(\text{EVM}) - 5 \cdot \frac{( \Delta_{RB}  - 1)}{L_{CRB}}, \\ -55.1 \text{ dBm} - \overline{P_{RB}} \end{array} \right]$		Any non-allocated (NOTE 2)	
			Output power for FR2-1	Output Power for FR2-2	
IQ Image	dB	-25	> 27 dBm	> 23.4 dBm	Image frequencies (NOTES 2, 3)
		-20	≤ 27 dBm	≤ 23.4 dBm	
Carrier leakage	dBc	-25	> 17 dBm	> 13.4 dBm	Carrier frequency (NOTES 4, 5)
		-20	4 dBm ≤ Output power ≤ 17 dBm	0.4 dBm ≤ Output power ≤ 13.4 dBm	
<p>NOTE 1: An in-band emissions combined limit is evaluated in each non-allocated RB. For each such RB, the minimum requirement is calculated as the higher of <math>(\overline{P_{RB}} - 25 \text{ dB})</math> and the power sum of all limit values (General, IQ Image or Carrier leakage) that apply. <math>\overline{P_{RB}}</math> is defined in NOTE 10.</p> <p>NOTE 2: The measurement bandwidth is 1 RB and the limit is expressed as a ratio of measured power in one non-allocated RB to the measured average power per allocated RB, where the averaging is done across all allocated RBs. For pi/2 BPSK with Spectrum Shaping, the limit is expressed as a ratio of measured power in one non-allocated RB to the measured power in the allocated RB with highest PSD</p> <p>NOTE 3: The applicable frequencies for this limit are those that are enclosed in the reflection of the allocated bandwidth, based on symmetry with respect to the carrier frequency, but excluding any allocated RBs.</p> <p>NOTE 4: The measurement bandwidth is 1 RB and the limit is expressed as a ratio of measured power in one non-allocated RB to the measured total power in all allocated RBs.</p> <p>NOTE 5: The applicable frequencies for this limit depend on the parameter <i>txDirectCurrentLocation</i> in <i>UplinkTxDirectCurrent</i> IE, and are those that are enclosed in the RBs containing the DC frequency but excluding any allocated RB.</p> <p>NOTE 6: <math>L_{CRB}</math> is the Transmission Bandwidth (see Clause 5.3).</p> <p>NOTE 7: <math>N_{RB}</math> is the Transmission Bandwidth Configuration (see Clause 5.3).</p> <p>NOTE 8: EVM is the limit for the modulation format used in the allocated RBs.</p> <p>NOTE 9: <math>\Delta_{RB}</math> is the starting frequency offset between the allocated RB and the measured non-allocated RB (e.g. <math>\Delta_{RB} = 1</math> or <math>\Delta_{RB} = -1</math> for the first adjacent RB outside of the allocated bandwidth).</p> <p>NOTE 10: <math>\overline{P_{RB}}</math> is an average of the transmitted power over 10 sub-frames normalized by the number of allocated RBs, measured in dBm.</p> <p>NOTE 11: All powers are EIRP in beam peak direction.</p>					



6.4.2.3.3 In-band emissions for power class 2

The average of the in-band emission measurement over 10 sub-frames shall not exceed the values specified in Table 6.4.2.3.3-1 for power class 2.

**Table 6.4.2.3.3-1: Requirements for in-band emissions for power class 2**

Parameter description	Unit	Limit (NOTE 1)			Applicable Frequencies
General	dB	$\max \left[ \begin{array}{l} -25 - 10 \cdot \log_{10} \left( \frac{N_{RB}}{L_{CRB}} \right), \\ 20 \cdot \log_{10}(\text{EVM}) - 5 \cdot \frac{( \Delta_{RB}  - 1)}{L_{CRB}}, \\ -55.1 \text{ dBm} - \overline{P_{RB}} \end{array} \right]$			Any non-allocated RB in allocated component carrier and not allocated component carriers (NOTE 2)
			Output power for FR2-1	Output Power for FR2-2	
IQ Image	dB	-25	Output power > 16 dBm	Output power > 15.8 dBm	Image frequencies (NOTES 2, 3)
		-20	Output power ≤ 16 dBm	Output power ≤ 15.8 dBm	
Carrier leakage	dBc	-25	Output power > 6 dBm	Output power > 5.8 dBm	Carrier frequency (NOTES 4, 5)
		-20	-13 dBm ≤ Output power ≤ 6 dBm	-13.2 dBm ≤ Output power ≤ 5.8 dBm	
<p>NOTE 1: An in-band emissions combined limit is evaluated in each non-allocated RB. For each such RB, the minimum requirement is calculated as the higher of (<math>\overline{P_{RB}} - 25</math> dB) and the power sum of all limit values (General, IQ Image or Carrier leakage) that apply. <math>\overline{P_{RB}}</math> is defined in NOTE 9.</p> <p>NOTE 2: The measurement bandwidth is 1 RB and the limit is expressed as a ratio of measured power in one non-allocated RB to the measured average power per allocated RB, where the averaging is done across all allocated RBs. For Pi/2 BPSK with Spectrum Shaping, the limit is expressed as a ratio of measured power in one non-allocated RB to the measured power in the allocated RB with highest PSD.</p> <p>NOTE 3: Image frequencies for UL CA are specified in relation to either UL or DL carrier frequency.</p> <p>NOTE 4: The measurement bandwidth is 1 RB and the limit is expressed as a ratio of measured power in one non-allocated RB to the measured total power in all allocated RBs.</p> <p>NOTE 5: The applicable frequencies for this limit are those that are enclosed in the RBs containing the DC frequency, or in the two RBs immediately adjacent to the DC frequency but excluding any allocated RB.</p> <p>NOTE 6: <math>L_{CRB}</math> is the Transmission Bandwidth for kth allocated component carrier (see Figure 5.3.3-1).</p> <p>NOTE 7: EVM is the limit for the modulation format used in the allocated RBs.</p> <p>NOTE 8: <math>\Delta_{RB}</math> is the starting frequency offset between the allocated RB and the measured non-allocated RB (e.g. <math>\Delta_{RB} = 1</math> or <math>\Delta_{RB} = -1</math> for the first adjacent RB outside of the allocated bandwidth), and may take non-integer values when the carrier spacing between the CCs is not a multiple of RB.</p> <p>NOTE 9: <math>\overline{P_{RB}}</math> is an average of the transmitted power over 10 sub-frames normalized by the number of allocated RBs, measured in dBm.</p> <p>NOTE 10: All powers are EIRP in beam peak direction.</p>					

**Table 6.4.2.3.3-2: Void**

6.4.2.3.4 In-band emissions for power class 3

The average of the in-band emission measurement over 10 sub-frames shall not exceed the values specified in Table 6.4.2.3.4-1 for power class 3 UEs.

**Table 6.4.2.3.4-1: Requirements for in-band emissions for power class 3**

Parameter description	Unit	Limit (NOTE 1)			Applicable Frequencies
<b>General</b>	dB	$\max \left[ \begin{array}{l} -25 - 10 \cdot \log_{10} \left( \frac{N_{RB}}{L_{CRB}} \right), \\ 20 \cdot \log_{10}(\text{EVM}) - 5 \cdot \frac{( \Delta_{RB}  - 1)}{L_{CRB}}, \\ -55.1 \text{ dBm} - \overline{P_{RB}} \end{array} \right]$			Any non-allocated (NOTE 2)
			Output power for FR2-1	Output Power for FR2-2	
<b>IQ Image</b>	dB	-25	> 10 dBm	> 8.1 dBm	Image frequencies (NOTES 2, 3)
		-20	≤ 10 dBm	≤ 8.1 dBm	
<b>Carrier leakage</b>	dBc	-25	> 0 dBm	> -1.9dBm	Carrier frequency (NOTES 4, 5)
		-20	-13 dBm ≤ Output power ≤ 0 dBm	-14.9 dBm ≤ Output power ≤ -1.9 dBm	
<p>NOTE 1: An in-band emissions combined limit is evaluated in each non-allocated RB. For each such RB, the minimum requirement is calculated as the higher of (<math>\overline{P_{RB}} - 25</math> dB) and the power sum of all limit values (General, IQ Image or Carrier leakage) that apply. <math>\overline{P_{RB}}</math> is defined in NOTE 10.</p> <p>NOTE 2: The measurement bandwidth is 1 RB and the limit is expressed as a ratio of measured power in one non-allocated RB to the measured average power per allocated RB, where the averaging is done across all allocated RBs. For Pi/2 BPSK with Spectrum Shaping, the limit is expressed as a ratio of measured power in one non-allocated RB to the measured power in the allocated RB with highest PSD</p> <p>NOTE 3: The applicable frequencies for this limit are those that are enclosed in the reflection of the allocated bandwidth, based on symmetry with respect to the carrier frequency, but excluding any allocated RBs.</p> <p>NOTE 4: The measurement bandwidth is 1 RB and the limit is expressed as a ratio of measured power in one non-allocated RB to the measured total power in all allocated RBs.</p> <p>NOTE 5: The applicable frequencies for this limit depend on the parameter <i>txDirectCurrentLocation</i> in <i>UplinkTxDirectCurrent</i> IE, and are those that are enclosed in the RBs containing the DC frequency but excluding any allocated RB.</p> <p>NOTE 6: <math>L_{CRB}</math> is the Transmission Bandwidth (see Clause 5.3).</p> <p>NOTE 7: <math>N_{RB}</math> is the Transmission Bandwidth Configuration (see Clause 5.3).</p> <p>NOTE 8: EVM is the limit for the modulation format used in the allocated RBs.</p> <p>NOTE 9: <math>\Delta_{RB}</math> is the starting frequency offset between the allocated RB and the measured non-allocated RB (e.g. <math>\Delta_{RB} = 1</math> or <math>\Delta_{RB} = -1</math> for the first adjacent RB outside of the allocated bandwidth).</p> <p>NOTE 10: <math>\overline{P_{RB}}</math> is an average of the transmitted power over 10 sub-frames normalized by the number of allocated RBs, measured in dBm.</p> <p>NOTE 11: All powers are EIRP in beam peak direction.</p>					

**6.4.2.3.5 In-band emissions for power class 4**

The average of the in-band emission measurement over 10 sub-frames shall not exceed the values specified in Table 6.4.2.3.5-1 for power class 4 UEs.

**Table 6.4.2.3.5-1: Requirements for in-band emissions for power class 4 in FR2-1**

Parameter description	Unit	Limit (NOTE 1)		Applicable Frequencies
<b>General</b>	dB	$\max \left[ \begin{array}{l} -25 - 10 \cdot \log_{10} \left( \frac{N_{RB}}{L_{CRB}} \right), \\ 20 \cdot \log_{10}(\text{EVM}) - 5 \cdot \frac{( \Delta_{RB}  - 1)}{L_{CRB}}, \\ -55.1 \text{ dBm} - \overline{P_{RB}} \end{array} \right]$		Any non-allocated (NOTE 2)
<b>IQ Image</b>	dB	-25	Output power > 21 dBm	Image frequencies (NOTES 2, 3)
		-20	Output power ≤ 21 dBm	
<b>Carrier leakage</b>	dBc	-25	Output power > 11 dBm	Carrier frequency (NOTES 4, 5)
		-20	-13 dBm ≤ Output power ≤ 11 dBm	
<p>NOTE 1: An in-band emissions combined limit is evaluated in each non-allocated RB. For each such RB, the minimum requirement is calculated as the higher of (<math>\overline{P_{RB}}</math> - 25 dB) and the power sum of all limit values (General, IQ Image or Carrier leakage) that apply. <math>\overline{P_{RB}}</math> is defined in NOTE 10.</p> <p>NOTE 2: The measurement bandwidth is 1 RB and the limit is expressed as a ratio of measured power in one non-allocated RB to the measured average power per allocated RB, where the averaging is done across all allocated RBs. For Pi/2 BPSK with Spectrum Shaping, the limit is expressed as a ratio of measured power in one non-allocated RB to the measured power in the allocated RB with highest PSD</p> <p>NOTE 3: The applicable frequencies for this limit are those that are enclosed in the reflection of the allocated bandwidth, based on symmetry with respect to the carrier frequency, but excluding any allocated RBs.</p> <p>NOTE 4: The measurement bandwidth is 1 RB and the limit is expressed as a ratio of measured power in one non-allocated RB to the measured total power in all allocated RBs.</p> <p>NOTE 5: The applicable frequencies for this limit depend on the parameter <i>txDirectCurrentLocation</i> in <i>UplinkTxDirectCurrent</i> IE, and are those that are enclosed in the RBs containing the DC frequency but excluding any allocated RB.</p> <p>NOTE 6: <math>L_{CRB}</math> is the Transmission Bandwidth (see Clause 5.3).</p> <p>NOTE 7: <math>N_{RB}</math> is the Transmission Bandwidth Configuration (see Clause 5.3).</p> <p>NOTE 8: EVM is the limit for the modulation format used in the allocated RBs.</p> <p>NOTE 9: <math>\Delta_{RB}</math> is the starting frequency offset between the allocated RB and the measured non-allocated RB (e.g. <math>\Delta_{RB} = 1</math> or <math>\Delta_{RB} = -1</math> for the first adjacent RB outside of the allocated bandwidth).</p> <p>NOTE 10: <math>\overline{P_{RB}}</math> is an average of the transmitted power over 10 sub-frames normalized by the number of allocated RBs, measured in dBm.</p> <p>NOTE 11: All powers are EIRP in beam peak direction.</p>				

**6.4.2.3.6 In-band emissions for power class 5**

The average of the in-band emission measurement over 10 sub-frames shall not exceed the values specified in Table 6.4.2.3.6-1 for power class 5 UEs.

Table 6.4.2.3.6-1: Requirements for in-band emissions for power class 5 in FR2-1

Parameter description	Unit	Limit (NOTE 1)		Applicable Frequencies
General	dB	$\max \left[ \begin{array}{l} -25 - 10 \cdot \log_{10} \left( \frac{N_{RB}}{L_{CRB}} \right), \\ 20 \cdot \log_{10}(\text{EVM}) - 5 \cdot \frac{( \Delta_{RB}  - 1)}{L_{CRB}}, \\ -55.1 \text{ dBm} - \overline{P_{RB}} \end{array} \right]$		Any non-allocated (NOTE 2)
IQ Image	dB	-25	Output power > 17 dBm	Image frequencies (NOTES 2, 3)
		-20	Output power ≤ 17 dBm	
Carrier leakage	dBc	-25	Output power > 7 dBm	Carrier frequency (NOTES 4, 5)
		-20	-6 dBm ≤ Output power ≤ 7 dBm	
<p>NOTE 1: An in-band emissions combined limit is evaluated in each non-allocated RB. For each such RB, the minimum requirement is calculated as the higher of (<math>\overline{P_{RB}} - 25</math> dB) and the power sum of all limit values (General, IQ Image or Carrier leakage) that apply. <math>\overline{P_{RB}}</math> is defined in NOTE 10.</p> <p>NOTE 2: The measurement bandwidth is 1 RB and the limit is expressed as a ratio of measured power in one non-allocated RB to the measured average power per allocated RB, where the averaging is done across all allocated RBs. For Pi/2 BPSK with Spectrum Shaping, the limit is expressed as a ratio of measured power in one non-allocated RB to the measured power in the allocated RB with highest PSD</p> <p>NOTE 3: The applicable frequencies for this limit are those that are enclosed in the reflection of the allocated bandwidth, based on symmetry with respect to the carrier frequency, but excluding any allocated RBs.</p> <p>NOTE 4: The measurement bandwidth is 1 RB and the limit is expressed as a ratio of measured power in one non-allocated RB to the measured total power in all allocated RBs.</p> <p>NOTE 5: The applicable frequencies for this limit depend on the parameter <i>txDirectCurrentLocation</i> in <i>UplinkTxDirectCurrent</i> IE, and are those that are enclosed in the RBs containing the DC frequency but excluding any allocated RB.</p> <p>NOTE 6: <math>L_{CRB}</math> is the Transmission Bandwidth (see Clause 5.3).</p> <p>NOTE 7: <math>N_{RB}</math> is the Transmission Bandwidth Configuration (see Clause 5.3).</p> <p>NOTE 8: EVM is the limit for the modulation format used in the allocated RBs.</p> <p>NOTE 9: <math>\Delta_{RB}</math> is the starting frequency offset between the allocated RB and the measured non-allocated RB (e.g. <math>\Delta_{RB} = 1</math> or <math>\Delta_{RB} = -1</math> for the first adjacent RB outside of the allocated bandwidth).</p> <p>NOTE 10: <math>\overline{P_{RB}}</math> is an average of the transmitted power over 10 sub-frames normalized by the number of allocated RBs, measured in dBm.</p> <p>NOTE 11: All powers are EIRP in beam peak direction.</p>				

### 6.4.2.3.7 In-band emissions for power class 6

For power class 6, the in-band emissions requirement specified in clause 6.4.2.3.6 for power class 5 applies.

### 6.4.2.3.8 In-band emissions for power class 7

The average of the in-band emission specified in subclause 6.4.2.3.4 applies.

### 6.4.2.4 EVM equalizer spectrum flatness

The EVM measurement process (as described in Annex F) entails generation of a zero-forcing equalizer. The EVM equalizer spectrum flatness is defined in terms of the maximum peak-to-peak ripple of the equalizer coefficients (dB) across the allocated uplink block. The basic measurement interval is the same as for EVM.

For Pi/2 BPSK modulation, the minimum requirements are defined in Clause 6.4.2.5.

The peak-to-peak variation of the EVM equalizer coefficients contained within the frequency range of the uplink allocation shall not exceed the maximum ripple specified in Table 6.4.2.4-1 for normal conditions. For uplink allocations contained within both Range 1 and Range 2, the coefficients evaluated within each of these frequency ranges shall meet the corresponding ripple requirement and the following additional requirements: the relative difference between the maximum coefficient in Range 1 and the minimum coefficient in Range 2 (Table 6.4.2.4-1) must not be larger than 7 dB, and the relative difference between the maximum coefficient in Range 2 and the minimum coefficient in Range 1 must not be larger than 8 dB (see Figure 6.4.2.4-1).

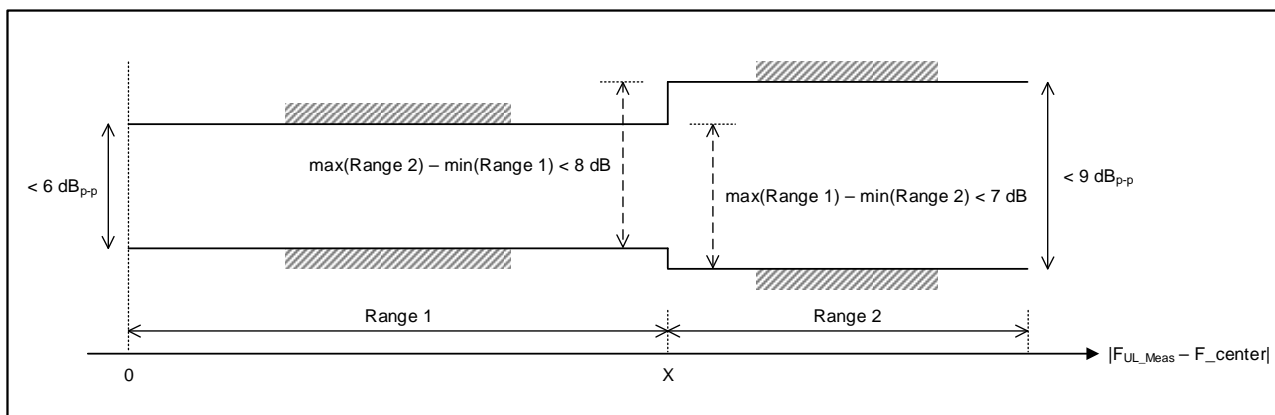
The requirement is verified with the test metric of EVM SF (Link=TX beam peak direction, Meas=Link angle).

**Table 6.4.2.4-1: Minimum requirements for EVM equalizer spectrum flatness (normal conditions)**

Frequency range	Maximum ripple (dB)
$ F_{UL\_Meas} - F_{center}  \leq X$ MHz (Range 1)	6 (p-p)
$ F_{UL\_Meas} - F_{center}  > X$ MHz (Range 2)	9 (p-p)

NOTE 1:  $F_{UL\_Meas}$  refers to the sub-carrier frequency for which the equalizer coefficient is evaluated  
 NOTE 2:  $F_{center}$  refers to the center frequency of the CC  
 NOTE 3: X, in MHz, is equal to 30 % of the CC bandwidth

**Table 6.4.2.4-2: (Void)**



**Figure 6.4.2.4-1: The limits for EVM equalizer spectral flatness with the maximum allowed variation of the coefficients indicated under normal conditions**

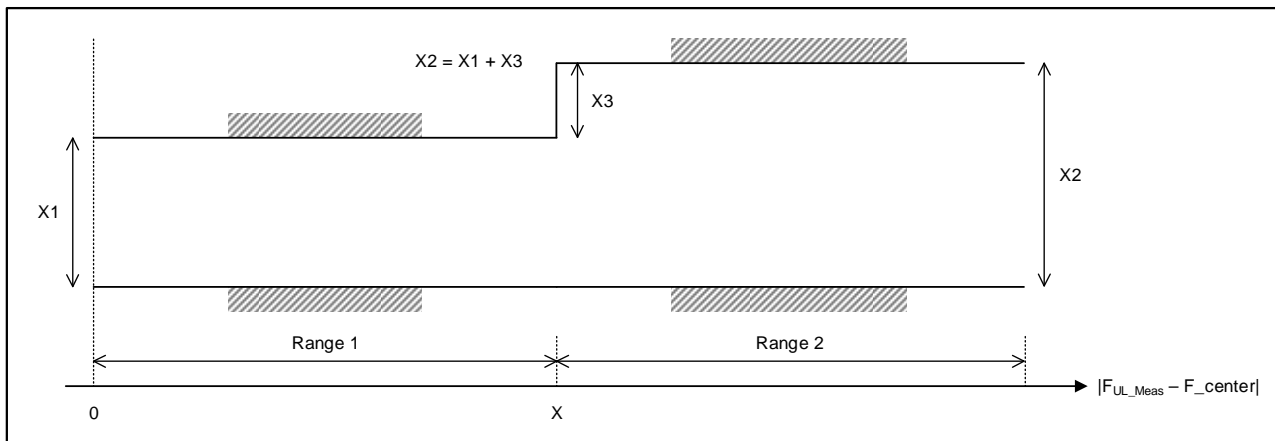
6.4.2.5 EVM spectral flatness for Pi/2 BPSK modulation

These requirements are defined for Pi/2 BPSK modulation. The EVM equalizer coefficients across the allocated uplink block shall be modified to fit inside the mask specified in Table 6.4.2.5-1 for normal conditions, prior to the calculation of EVM. The limiting mask shall be placed to minimize the change in equalizer coefficients in a sum of squares sense.

**Table 6.4.2.5-1: Mask for EVM equalizer coefficients for pi/2 BPSK (normal conditions)**

Frequency range	Parameter	Maximum ripple (dB)
$ F_{UL\_Meas} - F_{center}  \leq X$ MHz (Range 1)	X1	6 (p-p)
$ F_{UL\_Meas} - F_{center}  > X$ MHz (Range 2)	X2	14 (p-p)

NOTE 1:  $F_{UL\_Meas}$  refers to the sub-carrier frequency for which the equalizer coefficient is evaluated  
 NOTE 2:  $F_{center}$  refers to the center frequency of an allocated block of PRBs  
 NOTE 3: X, in MHz, is equal to 25% of the bandwidth of the PRB allocation  
 NOTE 4: See Figure 6.4.2.5-1 for description of X1, X2 and X3



**Figure 6.4.2.5-1: The limits for EVM equalizer spectral flatness with the maximum allowed variation.  $F_{center}$  denotes the center frequency of the allocated block of PRBs.**

This requirement does not apply to other modulation types. The UE shall be allowed to employ spectral shaping for Pi/2 BPSK. The shaping filter shall be restricted so that the impulse response of the transmit chain shall meet

$$|\tilde{a}_i(t,0)| \geq |\tilde{a}_i(t,\tau)| \quad \forall \tau \neq 0$$

$$20\log_{10} |\tilde{a}_i(t,\tau)| < -15 \text{ dB} \quad 1 < \tau < M - 1,$$

Where:

$$|\tilde{a}_i(t,\tau)| = \text{IDFT} \{ |\tilde{a}_i(t,f)| e^{j\phi(t,f)} \},$$

f is the frequency of the M allocated subcarriers,

$\tilde{a}_i(t,f)$  and  $\phi(t,f)$  are the amplitude and phase response, respectively of the transmit chain

0dB reference is defined as  $20\log_{10} |\tilde{a}_i(t,0)|$

### 6.4.2.6 Phase continuity requirements for DMRS bundling

For bands that UE indicates the support of DMRS bundling, when the UE is configured with DMRS bundling, the maximum allowable difference between the measured phase value in any slot  $p-1$  and slot  $p$  shall satisfy the requirements as listed in Table 6.4.2.6-1 for the measurement conditions defined in Table 6.4.2.6-2, within a measurement time window limited by the UE capability of maximum duration for DMRS bundling [maxDurationDMRS-Bundling-r17], and defined for each frequency band separately. The phase value for each slot is measured as shown in Annex F.8. These requirements apply to PUCCH and PUSCH transmissions with DFT-s-OFDM and CP-OFDM waveforms.

**Table 6.4.2.6-1: Maximum allowable phase difference for DMRS bundling**

UL channel	Modulation order	Phase difference between any slot $p-1$ and slot $p$ (NOTE 2)
PUSCH	Pi/2 BPSK, QPSK	[25] degrees
PUCCH	Pi/2 BPSK, BPSK, QPSK	
NOTE 1: The UE capability of the length of maximum duration refers to the maximum time duration during which UE is able to meet the phase continuity requirements, assuming no phase consistency violating events defined in TS 38.214 in between.		
NOTE 2: This requirement applies for TDD bands, for supported DMRS bundling configurations $\leq 8$ slots.		

The above requirements are applicable when all the following conditions are met within the measurement time window.

- RB allocation in terms of length and frequency position does not change, and intra-slot and inter-slot frequency hopping is not activated.
- Modulation order does not change.
- No network commanded TA takes effect.
- The TPMI precoder does not change.
- There is no change in UE EIRP level, and no change in the level of P-MPR applied by the UE.
- UE is not scheduled with uplink transmission of other physical channel/signal in-between the PUSCH or PUCCH transmissions.
- For TDD, no downlink slot(s) or downlink symbol(s) or flexible symbol(s) with/without DL monitoring occasion configured in-between the PUSCH or PUCCH transmissions.
- No uplink beam switching occurs.

**Table 6.4.2.6-2: Measurement conditions for the maximum allowable phase difference**

Parameter	Unit	Level
UE EIRP	dBm	$P_{UMAX,f,c}$ in clause 6.2.4, P-MPR = 0
UE downlink received power		Not change
Operating conditions		Normal conditions
Transmission bandwidth		Confined within $F_{UL,low} + [4]$ MHz and $F_{UL,high} - [4]$ MHz
DL signal frequency		Not change before and during the measurement window
DL signal timing		Maintained constant before and during the measurement window
UL slots for testing		Tested on consecutive UL slots
PUSCH waveform for testing		DFT-s-OFDM

NOTE: Phase continuity requirements for DMRS bundling is defined only within FR2-1 in this release of the specification.

## 6.4A Transmit signal quality for CA

### 6.4A.0 General

For intra-band contiguous and non-contiguous carrier aggregation, the requirements in this clause apply if the UE has at least one of UL or DL configured for CA.

## 6.4A.1 Frequency error

The requirements in this clause apply to UEs of all power classes.

For intra-band contiguous and non-contiguous carrier aggregation, the UE basic measurement interval of modulated carrier frequency is 1 UL slot. The mean value of basic measurements of UE modulated carrier frequencies per band shall be accurate to within  $\pm 0.1$  PPM observed over a period of 1ms of cumulated measurement intervals compared to the carrier frequency of primary component carrier received from the gNB.

For inter-band carrier aggregation with uplink assigned to two NR bands, and each UL band is configured with a single CC, the frequency error requirement is specified in clause 6.4.1 and is applicable for each CC with all CCs active with non-zero UL RB allocation.

The frequency error is defined as a directional requirement. The requirement is verified in beam locked mode on beam peak direction.

## 6.4A.2 Transmit modulation quality

### 6.4A.2.0 General

For intra-band contiguous and non-contiguous carrier aggregation, the requirements in clauses 6.4A.2.1, 6.4A.2.2, and 6.4A.2.3 apply.

All the parameters defined in clause 6.4A.2 are defined using the measurement methodology specified in Annex F.

All the requirements in 6.4A.2 are defined as directional requirement. The requirements are verified in beam locked mode on beam peak direction.

The carrier leakage frequency is optionally indicated with IE *UplinkTxDirectCurrentList*, *UplinkTxDirectCurrentTwoCarrierList-r16* for CA with two component carriers configured for uplink or IE *UplinkTxDirectCurrentMoreCarrierList-r17* for any CA configuration.

If the UE does not indicate DC location parameters, the carrier leakage measurement requirement in clauses 6.4A.2.2 and 6.4A.2.3 shall be waived and the UE's UL signal left uncorrected for carrier leakage. Any requirement relaxation to accommodate the IQ image shall be omitted.

If the UE indicates carrier leakage frequency as 3300 or 3301 with IE *UplinkTxDirectCurrentList* or *UplinkTxDirectCurrentTwoCarrierList-r16*, or if the carrier leakage frequency is outside the configured UL and DL carriers, the carrier leakage measurement requirement in clause 6.4A.2.2 and 6.4A.2.3 shall be waived and the UE's UL signal left uncorrected for carrier leakage. Any requirement relaxation to accommodate the IQ image shall be omitted.

For intra-band contiguous and non-contiguous carrier aggregation, the UE is defined to be configured for CA operation when it has at least one of UL or DL configured for CA.

For inter-band carrier aggregation with uplink assigned to two NR bands, and each UL band is configured with a single CC, the transmit modulation quality requirements are specified in clause 6.4.2 and are applicable for each CC with all CCs active with non-zero UL RB allocation.

### 6.4A.2.1 Error Vector magnitude

The requirements in this clause apply to UEs of all power classes. For intra-band contiguous and non-contiguous carrier aggregation, the Error Vector Magnitude requirement of clause 6.4.2.2 is defined for each component carrier. Requirements only apply with PRB allocation in one of the component carriers. Similar transmitter impairment removal procedures are applied for CA waveform before EVM calculation as is specified for non-CA waveform.

### 6.4A.2.2 Carrier leakage

#### 6.4A.2.2.1 General

Carrier leakage is an additive sinusoid waveform. The carrier leakage requirement is defined for each component carrier and is measured on the component carrier with PRBs allocated. The measurement interval is one slot in the time domain.



Note: When UE has DL configured for intra-band non-contiguous CA, indicated carrier leakage may land outside the spectrum occupied by all configured UL and DL CC. In this case the requirement does not apply.

The relative carrier leakage power is a power ratio of the additive sinusoid waveform and the modulated waveform. The requirement is verified with the test metric of Carrier Leakage (Link=TX beam peak direction, Meas=Link angle).

#### 6.4A.2.2.2 Carrier leakage for power class 1

For intra-band contiguous and non-contiguous carrier aggregation, when carrier leakage is contained inside the spectrum occupied by all configured UL and DL CCs, the relative carrier leakage power shall not exceed the values specified in Table 6.4A.2.2.2-1 and Table 6.4A.2.2.2-2 for power class 1 UEs.

**Table 6.4A.2.2.2-1: Minimum requirements for relative carrier leakage for power class 1 in FR2-1**

Parameters	Relative Limit (dBc)
EIRP > 17 dBm	-25
4 dBm ≤ EIRP ≤ 17 dBm	-20

**Table 6.4A.2.2.2-2: Minimum requirements for relative carrier leakage for power class 1 in FR2-2**

Parameters	Relative Limit (dBc)
EIRP > 13.4 dBm	-25
0.4 dBm ≤ EIRP ≤ 13.4 dBm	-20
NOTE: Not applicable for Inband non-contiguous carrier aggregation	

#### 6.4A.2.2.3 Carrier leakage for power class 2

For intra-band contiguous and non-contiguous carrier aggregation, when carrier leakage is contained inside the spectrum occupied by all configured UL and DL CCs, the relative carrier leakage power shall not exceed the values specified in Table 6.4A.2.2.3-1 and Table 6.4A.2.2.3-2 for power class 2.

**Table 6.4A.2.2.3-1: Minimum requirements for relative carrier leakage power class 2 in FR2-1**

Parameters	Relative limit (dBc)
EIRP > 6 dBm	-25
-13 dBm ≤ EIRP ≤ 6 dBm	-20

**Table 6.4A.2.2.3-2: Minimum requirements for relative carrier leakage power class 2 in FR2-2**

Parameters	Relative limit (dBc)
EIRP > 5.8 dBm	-25
-13.2 dBm ≤ EIRP ≤ 5.8 dBm	-20
NOTE: Not applicable for Inband non-contiguous carrier aggregation	

For inter-band carrier aggregation with uplink assigned to two NR bands, and each UL band is configured with a single CC, the carrier leakage requirements are specified in clause 6.4.2.2.3 and are applicable for each CC with all CCs active with non-zero UL RB allocation.

#### 6.4A.2.2.4 Carrier leakage for power class 3

For intra-band contiguous and non-contiguous carrier aggregation, when carrier leakage is contained inside the spectrum occupied by all configured UL and DL CCs, the relative carrier leakage power shall not exceed the values specified in Table 6.4A.2.2.4-1 and Table 6.4A.2.2.4-2 for power class 3 UEs.

**Table 6.4A.2.2.4-1: Minimum requirements for relative carrier leakage power class 3 in FR2-1**

Parameters	Relative limit (dBc)
Output power > 0 dBm	-25
-13 dBm ≤ Output power EIRP ≤ 0 dBm	-20

**Table 6.4A.2.2.4-2: Minimum requirements for relative carrier leakage power class 3 in FR2-2**

Parameters	Relative limit (dBc)
Output power > -1.9 dBm	-25
-14.9 dBm ≤ Output power EIRP ≤ -1.9 dBm	-20
NOTE: Not applicable for Inband non-contiguous carrier aggregation	

For inter-band carrier aggregation with uplink assigned to two NR bands, and each UL band is configured with a single CC, the carrier leakage requirements are specified in clause 6.4.2.2.4 and are applicable for each CC with all CCs active with non-zero UL RB allocation.

#### 6.4A.2.2.5 Carrier leakage for power class 4

For intra-band contiguous and non-contiguous carrier aggregation, when carrier leakage is contained inside the spectrum occupied by all configured UL and DL CCs, the relative carrier leakage power shall not exceed the values specified in Table 6.4A.2.2.5-1 for power class 4 UEs.

**Table 6.4A.2.2.5-1: Minimum requirements for relative carrier leakage power class 4**

Parameters	Relative limit (dBc)
Output power > 11 dBm	-25
-13 dBm ≤ Output power EIRP ≤ 11 dBm	-20

#### 6.4A.2.2.6 Carrier leakage for power class 5

For intra-band contiguous and non-contiguous carrier aggregation, when carrier leakage is contained inside the spectrum occupied by all configured UL and DL CCs, the relative carrier leakage power shall not exceed the values specified in Table 6.4A.2.2.6-1 for power class 5 UEs.

**Table 6.4A.2.2.6-1: Minimum requirements for relative carrier leakage power class 5**

Parameters	Relative limit (dBc)
Output power > 7 dBm	-25
-6 dBm ≤ Output power EIRP ≤ 7 dBm	-20

For inter-band carrier aggregation with uplink assigned to two NR bands, and each UL band is configured with a single CC, the carrier leakage requirements are specified in clause 6.4.2.2.6 and are applicable for each CC with all CCs active with non-zero UL RB allocation.

### 6.4A.2.3 Inband emissions

#### 6.4A.2.3.1 General

For intra-band contiguous and non-contiguous carrier aggregation, the Inband emission requirement is defined over the spectrum occupied by all configured UL and DL CCs. The measurement interval is as defined in clause 6.4.2.4. The requirement is verified with the test metric of In-band emission (Link=TX beam peak direction, Meas=Link angle).

For intra-band contiguous and non-contiguous carrier aggregation, the requirements in this clause apply with all component carriers active and with one single contiguous PRB allocation in one of uplink component carriers. The inband emission is defined as the interference falling into the non-allocated resource blocks for all component carriers.

For inter-band carrier aggregation with uplink assigned to two NR bands, and each UL band is configured with a single CC, the in-band emissions requirements are applicable for each CC with all CCs active with non-zero UL RB allocation.

6.4A.2.3.2 Inband emissions for power class 1

For intra-band contiguous and non-contiguous carrier aggregation, the average of the in-band emission measurement over 10 sub-frames shall not exceed the values specified in Table 6.4A.2.3.2-1 for power class 1 UEs.

For inter-band carrier aggregation with uplink assigned to two NR bands, and each UL band is configured with a single CC, the in-band emissions requirements are specified in clause 6.4.2.3.2 and are applicable for each CC with all CCs active with non-zero UL RB allocation.

Table 6.4A.2.3.2-1: Requirements for in-band emissions for power class 1

Parameter description	Unit	Limit (NOTE 1)			Applicable Frequencies
General	dB	$\max \left[ \begin{array}{l} -25 - 10 \cdot \log_{10} \left( \frac{N_{RB}}{L_{CRB}} \right), \\ 20 \cdot \log_{10}(\text{EVM}) - 5 \cdot \frac{( \Delta_{RB}  - 1)}{L_{CRB}}, \\ -55.1 \text{ dBm} - \overline{P_{RB}} \end{array} \right]$			Any non-allocated RB in allocated component carrier and not allocated component carriers (NOTE 2)
IQ Image	dB	-25	Output power for FR2-1 > 27 dBm	Output Power for FR2-2 > 23.4 dBm	Image frequencies (NOTES 2, 3)
		-20	Output power ≤ 27 dBm	≤ 23.4 dBm	
Carrier leakage	dBc	-25	Output power > 17 dBm	> 13.4 dBm	Carrier frequency (NOTES 4, 5)
		-20	4 dBm ≤ Output power ≤ 17 dBm	0.4 dBm ≤ Output power ≤ 13.4 dBm	
<p>NOTE 1: An in-band emissions combined limit is evaluated in each non-allocated RB. For each such RB, the minimum requirement is calculated as the higher of (<math>\overline{P_{RB}} - 25</math> dB) and the power sum of all limit values (General, IQ Image or Carrier leakage) that apply. <math>\overline{P_{RB}}</math> is defined in NOTE 9.</p> <p>NOTE 2: The measurement bandwidth is 1 RB and the limit is expressed as a ratio of measured power in one non-allocated RB to the measured average power per allocated RB, where the averaging is done across all allocated RBs. For Pi/2 BPSK with Spectrum Shaping, the limit is expressed as a ratio of measured power in one non-allocated RB to the measured power in the allocated RB with highest PSD.</p> <p>NOTE 3: Image frequencies for UL CA are specified in relation to either UL or DL carrier frequency.</p> <p>NOTE 4: The measurement bandwidth is 1 RB and the limit is expressed as a ratio of measured power in one non-allocated RB to the measured total power in all allocated RBs.</p> <p>NOTE 5: The applicable frequencies for this limit are those that are enclosed in the RBs containing the DC frequency, or in the two RBs immediately adjacent to the DC frequency but excluding any allocated RB.</p> <p>NOTE 6: <math>L_{CRB}</math> is the Transmission Bandwidth for kth allocated component carrier (see Figure 5.3.3-1).</p> <p>NOTE 7: EVM is the limit for the modulation format used in the allocated RBs.</p> <p>NOTE 8: <math>\Delta_{RB}</math> is the starting frequency offset between the allocated RB and the measured non-allocated RB (e.g. <math>\Delta_{RB} = 1</math> or <math>\Delta_{RB} = -1</math> for the first adjacent RB outside of the allocated bandwidth), and may take non-integer values when the carrier spacing between the CCs is not a multiple of RB.</p> <p>NOTE 9: <math>\overline{P_{RB}}</math> is an average of the transmitted power over 10 sub-frames normalized by the number of allocated RBs, measured in dBm.</p> <p>NOTE 10: All powers are EIRP in beam peak direction.</p>					

6.4A.2.3.3 Inband emissions for power class 2

For intra-band contiguous and non-contiguous carrier aggregation, the average of the in-band emission measurement over 10 sub-frames shall not exceed the values specified in Table 6.4A.2.3.3-1 for power class 2.

For inter-band carrier aggregation with uplink assigned to two NR bands, and each UL band is configured with a single CC, the in-band emissions requirements are specified in clause 6.4.2.3.3 and are applicable for each CC with all CCs active with non-zero UL RB allocation.

Table 6.4A.2.3.3-1: Requirements for in-band emissions for power class 2

Parameter description	Unit	Limit (NOTE 1)		Applicable Frequencies	
General	dB	$\max \left[ \begin{array}{l} -25 - 10 \cdot \log_{10} \left( \frac{N_{RB}}{L_{CRB}} \right), \\ 20 \cdot \log_{10}(\text{EVM}) - 5 \cdot \frac{( \Delta_{RB}  - 1)}{L_{CRB}}, \\ -55.1 \text{ dBm} - \overline{P_{RB}} \end{array} \right]$		Any non-allocated RB in allocated component carrier and not allocated component carriers (NOTE 2)	
IQ Image	dB	-25	Output power for FR2-1 Output power > 16 dBm	Output Power for FR2-2 Output power > 15.8 dBm	Image frequencies (NOTES 2, 3)
		-20	Output power ≤ 16 dBm	Output power ≤ 15.8 dBm	
Carrier leakage	dBc	-25	Output power > 6 dBm	Output power > 5.8 dBm	Carrier frequency (NOTES 4, 5)
		-20	-13 dBm ≤ Output power ≤ 6 dBm	-13.2 dBm ≤ Output power ≤ 5.8 dBm	
<p>NOTE 1: An in-band emissions combined limit is evaluated in each non-allocated RB. For each such RB, the minimum requirement is calculated as the higher of (<math>\overline{P_{RB}} - 25</math> dB) and the power sum of all limit values (General, IQ Image or Carrier leakage) that apply. <math>\overline{P_{RB}}</math> is defined in NOTE 9.</p> <p>NOTE 2: The measurement bandwidth is 1 RB and the limit is expressed as a ratio of measured power in one non-allocated RB to the measured average power per allocated RB, where the averaging is done across all allocated RBs. For Pi/2 BPSK with Spectrum Shaping, the limit is expressed as a ratio of measured power in one non-allocated RB to the measured power in the allocated RB with highest PSD.</p> <p>NOTE 3: Image frequencies for UL CA are specified in relation to either UL or DL carrier frequency.</p> <p>NOTE 4: The measurement bandwidth is 1 RB and the limit is expressed as a ratio of measured power in one non-allocated RB to the measured total power in all allocated RBs.</p> <p>NOTE 5: The applicable frequencies for this limit are those that are enclosed in the RBs containing the DC frequency, or in the two RBs immediately adjacent to the DC frequency but excluding any allocated RB.</p> <p>NOTE 6: <math>L_{CRB}</math> is the Transmission Bandwidth for kth allocated component carrier (see Figure 5.3.3-1).</p> <p>NOTE 7: EVM is the limit for the modulation format used in the allocated RBs.</p> <p>NOTE 8: <math>\Delta_{RB}</math> is the starting frequency offset between the allocated RB and the measured non-allocated RB (e.g. <math>\Delta_{RB} = 1</math> or <math>\Delta_{RB} = -1</math> for the first adjacent RB outside of the allocated bandwidth), and may take non-integer values when the carrier spacing between the CCs is not a multiple of RB.</p> <p>NOTE 9: <math>\overline{P_{RB}}</math> is an average of the transmitted power over 10 sub-frames normalized by the number of allocated RBs, measured in dBm.</p> <p>NOTE 10: All powers are EIRP in beam peak direction.</p>					

#### 6.4A.2.3.4 Inband emissions for power class 3

For intra-band contiguous and non-contiguous carrier aggregation, the average of the in-band emission measurement over 10 sub-frames shall not exceed the values specified in Table 6.4A.2.3.4-1 for power class 3 UEs.

For inter-band carrier aggregation with uplink assigned to two NR bands, and each UL band is configured with a single CC, the in-band emissions requirements are specified in clause 6.4.2.3.4 and are applicable for each CC with all CCs active with non-zero UL RB allocation.

**Table 6.4A.2.3.4-1: Requirements for in-band emissions for power class 3**

Parameter description	Unit	Limit (NOTE 1)		Applicable Frequencies	
General	dB	$\max \left[ \begin{array}{l} -25 - 10 \cdot \log_{10} \left( \frac{N_{RB}}{L_{CRB}} \right), \\ 20 \cdot \log_{10}(\text{EVM}) - 5 \cdot \frac{( \Delta_{RB}  - 1)}{L_{CRB}}, \\ -55.1 \text{ dBm} - \overline{P_{RB}} \end{array} \right]$		Any non-allocated RB in allocated component carrier and not allocated component carriers (NOTE 2)	
IQ Image	dB	-25	Output power for FR2-1 Output power > 10 dBm	Output Power for FR2-2 > 8.1 dBm	Image frequencies (NOTES 2, 3)
		-20	Output power ≤ 10 dBm	≤ 8.1 dBm	
Carrier leakage	dBc	-25	Output power > 0 dBm	> -1.9dBm	Carrier frequency (NOTES 4, 5)
		-20	-13 dBm ≤ Output power ≤ 0 dBm	-14.9 dBm ≤ Output power ≤ -1.9 dBm	
<p>NOTE 1: An in-band emissions combined limit is evaluated in each non-allocated RB. For each such RB, the minimum requirement is calculated as the higher of (<math>\overline{P_{RB}} - 25</math> dB) and the power sum of all limit values (General, IQ Image or Carrier leakage) that apply. <math>\overline{P_{RB}}</math> is defined in NOTE 9.</p> <p>NOTE 2: The measurement bandwidth is 1 RB and the limit is expressed as a ratio of measured power in one non-allocated RB to the measured average power per allocated RB, where the averaging is done across all allocated RBs. For Pi/2 BPSK with Spectrum Shaping, the limit is expressed as a ratio of measured power in one non-allocated RB to the measured power in the allocated RB with highest PSD.</p> <p>NOTE 3: Image frequencies for UL CA are specified in relation to either UL or DL carrier frequency.</p> <p>NOTE 4: The measurement bandwidth is 1 RB and the limit is expressed as a ratio of measured power in one non-allocated RB to the measured total power in all allocated RBs.</p> <p>NOTE 5: The applicable frequencies for this limit are those that are enclosed in the RBs containing the DC frequency, or in the two RBs immediately adjacent to the DC frequency but excluding any allocated RB.</p> <p>NOTE 6: <math>L_{CRB}</math> is the Transmission Bandwidth for kth allocated component carrier (see Figure 5.3.3-1).</p> <p>NOTE 7: EVM is the limit for the modulation format used in the allocated RBs.</p> <p>NOTE 8: <math>\Delta_{RB}</math> is the starting frequency offset between the allocated RB and the measured non-allocated RB (e.g. <math>\Delta_{RB} = 1</math> or <math>\Delta_{RB} = -1</math> for the first adjacent RB outside of the allocated bandwidth), and may take non-integer values when the carrier spacing between the CCs is not a multiple of RB.</p> <p>NOTE 9: <math>\overline{P_{RB}}</math> is an average of the transmitted power over 10 sub-frames normalized by the number of allocated RBs, measured in dBm.</p> <p>NOTE 10: All powers are EIRP in beam peak direction.</p>					

6.4A.2.3.5 Inband emissions for power class 4

For intra-band contiguous and non-contiguous carrier aggregation, the average of the in-band emission measurement over 10 sub-frames shall not exceed the values specified in Table 6.4A.2.3.5-1 for power class 4 UEs.

**Table 6.4A.2.3.5-1: Requirements for in-band emissions for power class 4**

Parameter description	Unit	Limit (NOTE 1)		Applicable Frequencies
General	dB	$\max \left[ \begin{array}{l} -25 - 10 \cdot \log_{10} \left( \frac{N_{RB}}{L_{CRB}} \right), \\ 20 \cdot \log_{10}(\text{EVM}) - 5 \cdot \frac{( \Delta_{RB}  - 1)}{L_{CRB}}, \\ -55.1 \text{ dBm} - \overline{P_{RB}} \end{array} \right]$		Any non-allocated RB in allocated component carrier and not allocated component carriers (NOTE 2)
IQ Image	dB	-25	Output power > 21 dBm	Image frequencies (NOTES 2, 3)
		-20	Output power ≤ 21 dBm	
Carrier leakage	dBc	-25	Output power > 11 dBm	Carrier frequency (NOTES 4, 5)
		-20	-13 dBm ≤ Output power ≤ 11 dBm	

NOTE 1: An in-band emissions combined limit is evaluated in each non-allocated RB. For each such RB, the minimum requirement is calculated as the higher of ( $\overline{P_{RB}} - 25$  dB) and the power sum of all limit values (General, IQ Image or Carrier leakage) that apply.  $\overline{P_{RB}}$  is defined in NOTE 9.

NOTE 2: The measurement bandwidth is 1 RB and the limit is expressed as a ratio of measured power in one non-allocated RB to the measured average power per allocated RB, where the averaging is done across all allocated RBs. For pi/2 BPSK with Spectrum Shaping, the limit is expressed as a ratio of measured power in one non-allocated RB to the measured power in the allocated RB with highest PSD.

NOTE 3: Image frequencies for UL CA are specified in relation to either UL or DL carrier frequency.

NOTE 4: The measurement bandwidth is 1 RB and the limit is expressed as a ratio of measured power in one non-allocated RB to the measured total power in all allocated RBs.

NOTE 5: The applicable frequencies for this limit are those that are enclosed in the RBs containing the DC frequency, or in the two RBs immediately adjacent to the DC frequency but excluding any allocated RB.

NOTE 6:  $L_{CRB}$  is the Transmission Bandwidth for kth allocated component carrier (see Figure 5.3.3-1).

NOTE 7: EVM is the limit for the modulation format used in the allocated RBs.

NOTE 8:  $\Delta_{RB}$  is the starting frequency offset between the allocated RB and the measured non-allocated RB (e.g.  $\Delta_{RB} = 1$  or  $\Delta_{RB} = -1$  for the first adjacent RB outside of the allocated bandwidth), and may take non-integer values when the carrier spacing between the CCs is not a multiple of RB.

NOTE 9:  $\overline{P_{RB}}$  is an average of the transmitted power over 10 sub-frames normalized by the number of allocated RBs, measured in dBm.

NOTE 10: All powers are EIRP in beam peak direction.

6.4A.2.3.6 Inband emissions for power class 5

For intra-band contiguous and non-contiguous carrier aggregation, the average of the in-band emission measurement over 10 sub-frames shall not exceed the values specified in Table 6.4A.2.3.6-1 for power class 6 UEs.

For inter-band carrier aggregation with uplink assigned to two NR bands, and each UL band is configured with a single CC, the in-band emissions requirements are specified in clause 6.4.2.3.6 and are applicable for each CC with all CCs active with non-zero UL RB allocation.

Table 6.4A.2.3.6-1: Requirements for in-band emissions for power class 5

Parameter description	Unit	Limit (NOTE 1)		Applicable Frequencies
General	dB	$\max \left[ \begin{array}{l} -25 - 10 \cdot \log_{10} \left( \frac{N_{RB}}{L_{CRB}} \right), \\ 20 \cdot \log_{10}(\text{EVM}) - 5 \cdot \frac{( \Delta_{RB}  - 1)}{L_{CRB}}, \\ -55.1 \text{ dBm} - \overline{P_{RB}} \end{array} \right]$		Any non-allocated RB in allocated component carrier and not allocated component carriers (NOTE 2)
IQ Image	dB	-25	Output power > 17 dBm	Image frequencies (NOTES 2, 3)
		-20	Output power ≤ 17 dBm	
Carrier leakage	dBc	-25	Output power > 7 dBm	Carrier frequency (NOTES 4, 5)
		-20	-6 dBm ≤ Output power ≤ 7 dBm	

- NOTE 1: An in-band emissions combined limit is evaluated in each non-allocated RB. For each such RB, the minimum requirement is calculated as the higher of ( $\overline{P_{RB}} - 25$  dB) and the power sum of all limit values (General, IQ Image or Carrier leakage) that apply.  $\overline{P_{RB}}$  is defined in NOTE 9.
- NOTE 2: The measurement bandwidth is 1 RB and the limit is expressed as a ratio of measured power in one non-allocated RB to the measured average power per allocated RB, where the averaging is done across all allocated RBs. For pi/2 BPSK with Spectrum Shaping, the limit is expressed as a ratio of measured power in one non-allocated RB to the measured power in the allocated RB with highest PSD.
- NOTE 3: Image frequencies for UL CA are specified in relation to either UL or DL carrier frequency.
- NOTE 4: The measurement bandwidth is 1 RB and the limit is expressed as a ratio of measured power in one non-allocated RB to the measured total power in all allocated RBs.
- NOTE 5: The applicable frequencies for this limit are those that are enclosed in the RBs containing the DC frequency, or in the two RBs immediately adjacent to the DC frequency but excluding any allocated RB.
- NOTE 6:  $L_{CRB}$  is the Transmission Bandwidth for kth allocated component carrier (see Figure 5.3.3-1).
- NOTE 7: EVM is the limit for the modulation format used in the allocated RBs.
- NOTE 8:  $\Delta_{RB}$  is the starting frequency offset between the allocated RB and the measured non-allocated RB (e.g.  $\Delta_{RB} = 1$  or  $\Delta_{RB} = -1$  for the first adjacent RB outside of the allocated bandwidth), and may take non-integer values when the carrier spacing between the CCs is not a multiple of RB.
- NOTE 9:  $\overline{P_{RB}}$  is an average of the transmitted power over 10 sub-frames normalized by the number of allocated RBs, measured in dBm.
- NOTE 10: All powers are EIRP in beam peak direction.

#### 6.4A.2.4 EVM equalizer spectrum flatness

For inter-band carrier aggregation with uplink assigned to two NR bands, and each UL band is configured with a single CC, the EVM equalizer spectrum flatness requirements are specified in clause 6.4.2.4 and are applicable for each CC with all CCs active with non-zero UL RB allocation.

## 6.4D Transmit signal quality for UL MIMO

### 6.4D.0 General

references to sub-clauses 6.3.1.x in clause 6.4 redirected to sub-clauses 6.3D.1.x, where 'x' depends on power class. The requirements apply when the UE is configured for 2-layer UL MIMO transmission as specified in Table 6.2D.1.0-1.

The requirement may alternatively be verified in each of the single layer UL MIMO configurations as specified in Table 6.4D.0-1. In this case, the transmit modulation quality requirements in clause 6.4 apply without modification.

**Table 6.4D.0-1: Alternative UL MIMO configuration for transmit signal quality tests**

Transmission scheme	DCI format	TPMI Index
Codebook based uplink	DCI format 0_1	0
Codebook based uplink	DCI format 0_1	1

### 6.4D.1 Frequency error for UL MIMO

For a UE supporting UL MIMO, the UE basic measurement interval of modulated carrier frequency is 1 UL slot. The mean value of basic measurements of UE modulated carrier frequency at each layer shall be accurate to within  $\pm 0.1$  PPM observed over a period of 1ms of cumulated measurement intervals compared to the carrier frequency received from the NR Node B.

### 6.4D.2 Transmit modulation quality for UL MIMO

For UE supporting UL MIMO, the transmit modulation quality requirements are specified per layer in terms of:

Error Vector Magnitude (EVM) for the allocated resource blocks (RBs)

EVM equalizer spectrum flatness derived from the equalizer coefficients generated by the EVM measurement process

Carrier leakage (caused by IQ offset)

For UE supporting UL MIMO, the transmit modulation quality requirements are specified as the total component of EIRP in terms of: In-band emissions for the non-allocated RB

The requirements are defined as directional requirements. The requirements are verified in beam locked mode in the TX beam peak direction (Link=TX beam peak direction, Meas=Link angle).

In case the parameter 3300 or 3301 is reported from UE via the parameter *txDirectCurrentLocation* in *UplinkTxDirectCurrentList* IE (as defined in TS 38.331 [13]), carrier leakage measurement requirement in clause 6.4D.2.2 and 6.4D.2.3 shall be waived, and the RF correction with regard to the carrier leakage and IQ image shall be omitted during the calculation of transmit modulation quality.

### 6.4D.3 Time alignment error for UL MIMO

For a UE with multiple physical antenna ports supporting UL MIMO, this requirement applies to frame timing differences between transmissions on multiple physical antenna ports in the codebook transmission scheme.

The time alignment error (TAE) is defined as the average frame timing difference between any two transmissions on different physical antenna ports.

For a UE with multiple physical antenna ports, the Time Alignment Error (TAE) shall not exceed 130 ns.

### 6.4D.4 Requirements for coherent UL MIMO

For coherent UL MIMO, Table 6.4D.4-1 lists the maximum allowable difference between the measured relative power and phase errors between different physical antenna ports in any slot within the specified time window from the last transmitted SRS on the same antenna ports, for the purpose of uplink transmission (codebook or non-codebook usage) and those measured at that last SRS. The requirements in Table 6.4D.4-1 apply when the UL transmission power at each physical antenna port is larger than 0 dBm for SRS transmission and for the duration of time window. The requirement is verified with the test metric of EIRP (Link=TX Beam peak direction, Meas=Link angle).

**Table 6.4D.4-1: Maximum allowable difference of relative phase and power errors in a given slot compared to those measured at last SRS transmitted**

Difference of relative phase error	Difference of relative power error	Time window
40 degrees	4 dB	20 msec

The above requirements apply when all of the following conditions are met within the specified time window:

- UE is not signaled with a change in number of SRS ports in *SRS-config*, or a change in *PUSCH-config*
- UE remains in DRX active time (UE does not enter DRX OFF time)
- No measurement gap occurs
- No instance of SRS transmission with the usage antenna switching occurs
- Active BWP remains the same
- EN-DC and CA configuration is not changed for the UE (UE is not configured or de-configured with PScell or SCell(s))



## 6.5 Output RF spectrum emissions

### 6.5.1 Occupied bandwidth

Occupied bandwidth is defined as the bandwidth containing 99 % of the total integrated mean power of the transmitted spectrum on the assigned channel. The occupied bandwidth for all transmission bandwidth configurations (Resources Blocks) shall be less than the channel bandwidth specified in Table 6.5.1-1.

The occupied bandwidth is defined as a directional requirement. The requirement is verified in beam locked mode with the test metric of OBW (Link=TX beam peak direction, Meas=Link angle).

**Table 6.5.1-1: Occupied channel bandwidth**

	Occupied channel bandwidth / Channel bandwidth						
	50 MHz	100 MHz	200 MHz	400 MHz	800 MHz	1600 MHz	2000 MHz
Channel bandwidth (MHz)	50	100	200	400	800	1600	2000

### 6.5.2 Out of band emissions

#### 6.5.2.0 General

The Out of band emissions are unwanted emissions immediately outside the assigned channel bandwidth resulting from the modulation process and non-linearity in the transmitter but excluding spurious emissions. This out of band emission limit is specified in terms of a spectrum emission mask and an adjacent channel leakage power ratio. Additional requirements to protect specific bands are also considered.

The requirements in clause 6.5.2.1 only apply when both UL and DL of a UE are configured for single CC operation, and they are of the same bandwidth. For a UE that is configured for single CC operation with different channel bandwidths in UL and DL, the requirements in clause 6.5A.2.1 apply.

All out of band emissions for frequency range 2 are TRP.

#### 6.5.2.1 Spectrum emission mask

The spectrum emission mask of the UE applies to frequencies ( $\Delta f_{\text{OOB}}$ ) starting from the  $\pm$  edge of the assigned NR channel bandwidth. For frequencies offset greater than  $F_{\text{OOB}}$  as specified in Table 6.5.2.1-1 the spurious requirements in clause 6.5.3 are applicable.

The power of any UE emission shall not exceed the levels specified in Table 6.5.2.1-1 for the specified channel bandwidth. The requirement is verified in beam locked mode with the test metric of TRP (Link=TX beam peak direction, Meas=TRP grid).

Table 6.5.2.1-1: General NR spectrum emission mask for frequency range 2.

$\Delta f_{\text{OoB}}$ (MHz)	Spectrum emission limit (dBm) / Channel bandwidth							Measurement bandwidth
	50 MHz	100 MHz	200 MHz	400 MHz	800 MHz	1600 MHz	2000 MHz	
± 0-5	-5	-5	-5	-5	-5	-5	-5	1 MHz
± 5-10	-13	-5	-5	-5	-5	-5	-5	1 MHz
± 10-20	-13	-13	-5	-5	-5	-5	-5	1 MHz
± 20-40	-13	-13	-13	-5	-5	-5	-5	1 MHz
± 40-80	-13	-13	-13	-13	-5	-5	-5	1 MHz
± 80-100	-13	-13	-13	-13	-13	-5	-5	1 MHz
± 100-160		-13	-13	-13	-13	-5	-5	1 MHz
± 160-200		-13	-13	-13	-13	-13	-5	1 MHz
± 200-400			-13	-13	-13	-13	-13	1 MHz
± 400-800				-13	-13	-13	-13	1 MHz
± 800-1600					-13	-13	-13	1 MHz
± 1600-3200						-13	-13	1 MHz
± 3200-4000							-13	1 MHz

NOTE 1: Void

### 6.5.2.2 Void

### 6.5.2.3 Adjacent channel leakage ratio

Adjacent Channel Leakage power Ratio (ACLR) is the ratio of the filtered mean power centred on the assigned channel frequency to the filtered mean power centred on an adjacent channel frequency. ACLR requirement is specified for a scenario in which adjacent carrier is another NR channel.

NR Adjacent Channel Leakage power Ratio ( $NR_{\text{ACLR}}$ ) is the ratio of the filtered mean power centred on the assigned channel frequency to the filtered mean power centred on an adjacent channel frequency at nominal channel spacing. The assigned NR channel power and adjacent NR channel power are measured with rectangular filters with measurement bandwidths specified in Table 6.5.2.3-1 for FR2-1 and in Table 6.5.2.3-2 for FR2-2.

If the measured adjacent channel power is greater than  $-35$  dBm then the  $NR_{\text{ACLR}}$  shall be higher than the value specified in Table 6.5.2.3-1. The requirement is verified in beam locked mode with the test metric of TRP (Link=TX beam peak direction, Meas=TRP grid).

Table 6.5.2.3-1: General requirements for  $NR_{\text{ACLR}}$  for FR2-1

	Channel bandwidth / $NR_{\text{ACLR}}$ / Measurement bandwidth			
	50 MHz	100 MHz	200 MHz	400 MHz
$NR_{\text{ACLR}}$ for band n257, n258, n261	17 dB	17 dB	17 dB	17 dB
$NR_{\text{ACLR}}$ for band n259, n260, n262	16 dB	16 dB	16 dB	16 dB
NR channel measurement bandwidth (MHz)	47.58	95.16	190.20	380.28
Adjacent channel centre frequency offset (MHz)	+50 / -50	+100 / -100	+200 / -200	+400 / -400

**Table 6.5.2.3-2: General requirements for NR<sub>ACL</sub>R for FR2-2**

	Channel bandwidth / NR <sub>ACL</sub> R / Measurement bandwidth				
	100 MHz	400 MHz	800 MHz	1600 MHz	2000 MHz
NR <sub>ACL</sub> R for band n263	15dB	15 dB	15 dB	15 dB	15 dB
NR channel measurement bandwidth (MHz)	95.16	381.12	715.20	1429.44	1705.92
Adjacent channel centre frequency offset (MHz)	+100 / -100	+400 / -400	+800 / -800	+1600 / -1600	+2000 / -2000

### 6.5.3 Spurious emissions

Spurious emissions are emissions which are caused by unwanted transmitter effects such as harmonics emission, parasitic emissions, intermodulation products and frequency conversion products, but exclude out of band emissions unless otherwise stated. The spurious emission limits are specified in terms of general requirements in line with SM.329 [7] and NR operating band requirement to address UE co-existence. Spurious emissions are measured as TRP.

To improve measurement accuracy, sensitivity and efficiency, the resolution bandwidth may be smaller than the measurement bandwidth. When the resolution bandwidth is smaller than the measurement bandwidth, the result should be integrated over the measurement bandwidth in order to obtain the equivalent noise bandwidth of the measurement bandwidth.

Unless otherwise stated, the spurious emission limits apply for the frequency ranges that are more than F<sub>OOB</sub> (MHz) in Table 6.5.3-1 starting from the edge of the assigned NR channel bandwidth. The spurious emission limits in Table 6.5.3-2 apply for all transmitter band configurations (NRB) and channel bandwidths. The requirement is verified in beam locked mode with the test metric of TRP (Link=TX beam peak direction, Meas=TRP grid).

NOTE: For measurement conditions at the edge of each frequency range, the lowest frequency of the measurement position in each frequency range should be set at the lowest boundary of the frequency range plus MBW/2. The highest frequency of the measurement position in each frequency range should be set at the highest boundary of the frequency range minus MBW/2. MBW denotes the measurement bandwidth defined for the protected band.

**Table 6.5.3-1: Boundary between NR out of band and spurious emission domain**

Channel bandwidth	50 MHz	100 MHz	200 MHz	400 MHz	800 MHz	1600 MHz	2000 MHz
OOB boundary F <sub>OOB</sub> (MHz)	100	200	400	800	1600	3200	4000

**Table 6.5.3-2: Spurious emissions limits**

Frequency Range	Maximum Level	Measurement bandwidth
30 MHz ≤ f < 1000 MHz	-36 dBm	100 kHz
1 GHz ≤ f < 12.75 GHz	-30 dBm	1 MHz
12.75 GHz ≤ f ≤ 2 <sup>nd</sup> harmonic of the upper frequency edge of the UL operating band in GHz	-13 dBm	1 MHz

#### 6.5.3.1 Spurious emission band UE co-existence

This clause specifies the requirements for the specified NR band, for coexistence with protected bands.

NOTE: For measurement conditions at the edge of each frequency range, the lowest frequency of the measurement position in each frequency range should be set at the lowest boundary of the frequency range plus MBW/2. The highest frequency of the measurement position in each frequency range should be set at the highest boundary of the frequency range minus MBW/2. MBW denotes the measurement bandwidth defined for the protected band.

**Table 6.5.3.1-1: Requirements**

NR Band	Spurious emission						
	Protected band/frequency range	Frequency range (MHz)		Maximum Level (dBm)	MBW (MHz)	NOTE	
n257	NR Band n260	F <sub>DL_low</sub>	-	F <sub>DL_high</sub>	-2	100	
	NR Band n263	F <sub>DL_low</sub>	-	F <sub>DL_high</sub>	TBD	100	
	Frequency range	57000	-	66000	2	100	
	Frequency range	23600	-	24000	1	200	3
n258	NR Band n263	F <sub>DL_low</sub>	-	F <sub>DL_high</sub>	TBD	100	
	Frequency range	57000	-	66000	2	100	
n259	NR Band 257	F <sub>DL_low</sub>	-	F <sub>DL_high</sub>	-5	100	
	NR Band 261	F <sub>DL_low</sub>	-	F <sub>DL_high</sub>	-5	100	
	NR Band 262	F <sub>DL_low</sub>	-	F <sub>DL_high</sub>	-5	100	
	NR Band n263	F <sub>DL_low</sub>	-	F <sub>DL_high</sub>	TBD	100	
	Frequency range	36000	-	37000	7	1000	
	Frequency range	57000	-	66000	2	100	
n260	NR Band 257	F <sub>DL_low</sub>	-	F <sub>DL_high</sub>	-5	100	
	NR Band 261	F <sub>DL_low</sub>	-	F <sub>DL_high</sub>	-5	100	
	NR Band 262	F <sub>DL_low</sub>	-	F <sub>DL_high</sub>	-5	100	
	NR Band n263	F <sub>DL_low</sub>	-	F <sub>DL_high</sub>	TBD	100	
	Frequency range	57000	-	66000	2	100	
n261	NR Band 260	F <sub>DL_low</sub>	-	F <sub>DL_high</sub>	-2	100	
	NR Band n263	F <sub>DL_low</sub>	-	F <sub>DL_high</sub>	TBD	100	
	Frequency range	57000	-	66000	2	100	
n262	NR Band 260	F <sub>DL_low</sub>	-	F <sub>DL_high</sub>	-2	100	
	NR Band 261	F <sub>DL_low</sub>	-	F <sub>DL_high</sub>	-5	100	
	NR Band n263	F <sub>DL_low</sub>	-	F <sub>DL_high</sub>	TBD	100	
	Frequency range	57000	-	66000	2	100	
n263	NR Band 257	F <sub>DL_low</sub>	-	F <sub>DL_high</sub>	-5	100	
	NR Band 258	F <sub>DL_low</sub>	-	F <sub>DL_high</sub>	-5	100	
	NR Band 259	F <sub>DL_low</sub>	-	F <sub>DL_high</sub>	-5	100	
	NR Band 260	F <sub>DL_low</sub>	-	F <sub>DL_high</sub>	-2	100	
	NR Band 261	F <sub>DL_low</sub>	-	F <sub>DL_high</sub>	-5	100	
	NR Band 262	F <sub>DL_low</sub>	-	F <sub>DL_high</sub>	-5	100	

NOTE 1: F<sub>DL\_low</sub> and F<sub>DL\_high</sub> refer to each NR frequency band specified in Table 5.2-1  
 NOTE 2: Void  
 NOTE 3: The protection of frequency range 23600-24000 MHz is meant for protection of satellite passive services.

### 6.5.3.2 Additional spurious emissions

#### 6.5.3.2.1 General

These requirements are specified in terms of an additional spectrum emission requirement. Additional spurious emission requirements are signalled by the network to indicate that the UE shall meet an additional requirement for a specific deployment scenario as part of the cell handover/broadcast message.

## 6.5.3.2.2 Void

**Table 6.5.3.2.2-1: (Void)**

## 6.5.3.2.3 Additional spurious emission requirements for NS\_202

When "NS\_202" is indicated in the cell, the power of any UE emission shall not exceed the levels specified in Table 6.5.3.2.3-1.

**Table 6.5.3.2.3-1: Additional requirements (NS\_202)**

Frequency Range	Maximum Level	Measurement bandwidth	NOTE
$7.25 \text{ GHz} \leq f \leq 2^{\text{nd}}$ harmonic of the upper frequency edge of the UL operating band	-10 dBm	100 MHz	
$23.6 \text{ GHz} \leq f \leq 24.0 \text{ GHz}$	+1 dBm	200 MHz	1
NOTE 1: This requirement also applies for the frequency ranges that are less than $F_{\text{OOB}}$ (MHz) in Table 6.5.3-1 from the edge of the channel bandwidth. The protection of frequency range 23600 - 24000 MHz is meant for protection of satellite passive services.			

## 6.5.3.2.4 Additional spurious emission requirements for NS\_203

When "NS\_203" is indicated in the cell, the power of any UE emission shall not exceed the levels specified in Table 6.5.3.2.4-1. This requirement also applies for the frequency ranges that are less than  $F_{\text{OOB}}$  (MHz) in Table 6.5.3-1 from the edge of the channel bandwidth.

**Table 6.5.3.2.4-1: Additional requirements (NS\_203)**

Frequency band (GHz)	Spectrum emission limit (dBm)	Measurement bandwidth
$23.6 \leq f \leq 24.0$	+1	200 MHz

## 6.5.3.2.5 Additional spurious emission requirements for NS\_204

When "NS\_204" is indicated in the cell, the power of any UE emission shall not exceed the levels specified in Table 6.5.3.2.5-1. This requirement also applies for the frequency ranges that are less than  $F_{\text{OOB}}$  (MHz) in Table 6.5.3-1 from the edge of the channel bandwidth.

**Table 6.5.3.2.5-1: Additional requirements (NS\_204)**

Frequency band (GHz)	Spectrum emission limit (dBm)	Measurement bandwidth
$12.75 \text{ GHz} \leq f \leq 2^{\text{nd}}$ harmonic of the upper frequency edge of the UL operating band	-10 dBm	100 MHz
$87.5 \text{ MHz} \leq f \leq 118 \text{ MHz}$	-54 dBm	100 kHz
$174 \text{ MHz} \leq f \leq 230 \text{ MHz}$	-54 dBm	100 kHz
$470 \text{ MHz} \leq f \leq 694 \text{ MHz}$	-54 dBm	100 kHz

## 6.5A Output RF spectrum emissions for CA

### 6.5A.1 Occupied bandwidth for CA

#### 6.5A.1.0 General

The occupied bandwidth for UL CA is defined as a directional requirement. The requirement is verified in beam locked mode on beam peak direction. In case the intra-band CA configuration consists of a single UL CC, the occupied bandwidth requirement defined in subclause 6.5.1 applies.

#### 6.5A.1.1 Occupied bandwidth for intra-band contiguous UL CA

For intra-band contiguous UL carrier aggregation, the occupied bandwidth is a measure of the bandwidth containing 99 % of the total integrated power of the transmitted spectrum. The occupied bandwidth for UL CA shall be less than the UL aggregated channel bandwidth defined in clause 5.3A.

#### 6.5A.1.2 Occupied bandwidth for intra-band non-contiguous UL CA

For intra-band non-contiguous UL carrier aggregation, the occupied bandwidth requirement is met when the ratio of the transmitted power in all sub-blocks of the UL CA configuration to the total integrated power of the transmitted spectrum is greater than 99%.

#### 6.5A.1.3 Occupied bandwidth for inter-band UL CA

For inter-band carrier aggregation with uplink assigned to two NR bands, and each UL band is configured with a single CC, the occupied bandwidth requirements is specified in clause 6.5.1 and is applicable for each CC with all CCs active with non-zero UL RB allocation.

### 6.5A.2 Out of band emissions

#### 6.5A.2.1 Spectrum emission mask for CA

##### 6.5A.2.1.0 General

For intra-band CA, the requirements specified in this clause shall apply if the UE has at least one of UL or DL configured for CA or if the UE is configured for single CC operation with different channel bandwidths in UL and DL carriers. In case the CA configuration consists of a single UL CC, spectrum emission mask defined in subclause 6.5.2.1 applies. Spectral emission mask requirements do not apply at any frequency where IBE requirements of clause 6.4A.2.3 apply.

The requirement is verified in beam locked mode with the test metric of TRP (Link=TX beam peak direction).

##### 6.5A.2.1.1 Spectrum emission mask for intra-band contiguous UL CA

For intra-band contiguous UL carrier aggregation, the spectrum emission mask of the UE applies to frequencies ( $\Delta f_{\text{OoB}}$ ) starting from the  $\pm$  edge of the UL aggregated channel bandwidth (Table 5.3A.4-1). For any bandwidth class defined in Table 5.3A.4-1, the UE emission shall not exceed the levels specified in Table Table 6.5A.2.1.1-1.

**Table 6.5A.2.1.1-1: General NR spectrum emission mask for intra-band contiguous CA in FR2-1 and FR2-2**

$\Delta f_{\text{OoB}}$ (MHz)	Spectrum emission limit (dBm)/Any carrier aggregation bandwidth class	Measurement bandwidth
$\pm 0-0.1 \cdot \text{BW}_{\text{Channel\_CA}}$	-5	1 MHz
$\pm 0.1 \cdot \text{BW}_{\text{Channel\_CA}} - 2 \cdot \text{BW}_{\text{Channel\_CA}}$	-13	1 MHz
NOTE 1: (void)		

### 6.5A.2.1.2 Spectrum emission mask for intra-band non-contiguous UL CA

For intra-band non-contiguous UL carrier aggregation, the spectrum emission mask requirement is defined as a composite spectrum emissions mask. Composite spectrum emission mask applies to frequencies up to  $\pm \Delta f_{\text{OoB}}$  starting from the edge of each UL sub-block. Composite spectrum emission mask is defined as follows:

- Composite spectrum emission mask is a combination of individual spectrum emissions masks defined for each sub-block. If for some frequency, spectrum emission masks from multiple sub-blocks overlap, the spectrum emission mask allowing the highest power spectral density applies for that frequency
- In case a sub-block comprises of multiple component carriers, the spectrum emissions mask is defined in subclause 6.5A.2.1.1 or in case of a single component carrier, the sub-block spectrum emission mask is defined in subclause 6.5.2.1
- If for some frequency the spectrum emission mask of one sub-block overlaps another sub-block, the emission mask does not apply for that frequency.
- If carrier leakage or I/Q image lands inside the spectrum occupied by the configured UL and DL CCs, exception to the general spectrum emission mask limit applies. For carrier leakage the requirements specified in section 6.4A.2.2 shall apply. For I/Q image the requirements specified in section 6.4A.2.3 shall apply.

### 6.5A.2.1.3 Spectrum emission mask for inter-band UL CA

For inter-band carrier aggregation with uplink assigned to two NR bands, and each UL band is configured with a single CC, the spectrum emission mask is specified in Table 6.5.2.1-1 for each CC separately while both CCs are active with non-zero UL RB allocation. If for some frequency spectrum emission masks of CCs overlap, then spectrum emission mask allowing higher power spectral density applies for that frequency. If for some frequency a CC spectrum emission mask overlaps with the channel bandwidth of another CC, then the emission mask does not apply for that frequency.

### 6.5A.2.2 Void

### 6.5A.2.3 Adjacent channel leakage ratio for CA

#### 6.5A.2.3.1 Adjacent channel leakage ratio for CA intra-band contiguous UL CA

In case the CA configuration consists of a single UL CC, the adjacent channel leakage ratio defined in subclause 6.5.2.3 applies. For intra-band contiguous UL carrier aggregation, the carrier aggregation NR adjacent channel leakage power ratio (CA NR<sub>ACLR</sub>) is the ratio of the filtered mean power centred on the UL aggregated channel bandwidth to the filtered mean power centred on an adjacent UL aggregated channel bandwidth at spacing equal to the UL aggregated channel bandwidth. The assigned UL aggregated channel bandwidth power and adjacent UL aggregated channel bandwidth power are measured with rectangular filters with measurement bandwidths specified in Table 6.5A.2.3.1-1. If the measured adjacent channel power is greater than -35 dBm then the CA NR<sub>ACLR</sub> shall be higher than the value specified in Table 6.5A.2.3.1-1.

**Table 6.5A.2.3.1-1: General requirements for contiguous UL CA NR<sub>ACLR</sub>**

	CA bandwidth class / CA NR <sub>ACLR</sub> / Measurement bandwidth
	Any CA bandwidth class
CA NR <sub>ACLR</sub> for band n257, n258, n261	17 dB
CA NR <sub>ACLR</sub> for band n259, n260, n262	16 dB
CA NR <sub>ACLR</sub> for band n263	15 dB
NR channel measurement bandwidth <sup>1</sup>	$BW_{\text{Channel\_CA}} - 2 \cdot BW_{\text{GB}}$
Adjacent channel centre frequency offset (in MHz)	$\begin{matrix} + BW_{\text{Channel\_CA}} \\ / \\ - BW_{\text{Channel\_CA}} \end{matrix}$
NOTE 1: $BW_{\text{GB}}$ is defined in clause 5.3A.2.	

### 6.5A.2.3.2 Adjacent channel leakage ratio for CA intra-band non-contiguous UL CA

For intra-band non-contiguous carrier aggregation, adjacent channel leakage power ratio (CA NR<sub>ACLR</sub>) is the ratio of the sum of the filtered mean powers centred on each sub-block bandwidth to the filtered mean power centred on an adjacent sub-block frequency at nominal spacing equal to the sub-block bandwidth. The power in the configured UL CCs and power in the sub-block bandwidth adjacent to each sub-block of configured UL CCs are measured with rectangular filters with measurement bandwidths specified in Table 6.5A.2.3.1-2. In case a sub-block consists of a single component carrier, the measurement bandwidths and adjacent frequency offset from subclause 6.5.2.3 shall be used. If the measured adjacent sub-block power is greater than -35 dBm then the CA NR<sub>ACLR</sub> shall be higher than the value specified in Table 6.5A.2.3.1-2.

No requirement applies in the gap between neighbouring sub-blocks if the frequency span between the lowest edge of the upper sub-block and the highest edge of the lower sub-block is smaller than the bandwidth of either sub-block.

**Table 6.5A.2.3.1-2: General requirements for NC UL CA NR<sub>ACLR</sub>**

	CA bandwidth class / CA NR <sub>ACLR</sub> / Measurement bandwidth
	Any CA bandwidth class
CA NR <sub>ACLR</sub> for band n257, n258, n261	17 dB
CA NR <sub>ACLR</sub> for band n260	16 dB
CA NR <sub>ACLR</sub> for band n263	15 dB
NR channel measurement bandwidth <sup>1</sup>	$\Sigma(BW_{\text{Channel\_block}})$
Adjacent sub-block centre frequency offset (in MHz)	$\begin{matrix} + BW_{\text{Channel\_block}} \\ / \\ - BW_{\text{Channel\_block}} \end{matrix}$
NOTE 1: $BW_{\text{Channel\_block}}$ is defined in clause 5.3A.2.	
NOTE 2: 'Adjacent sub-block centre frequency offset' is defined for each sub-block in the UL CA configuration	

### 6.5A.2.3.3 Adjacent channel leakage ratio for CA inter-band UL CA

For inter-band carrier aggregation with uplink assigned to two NR bands, and each UL band is configured with a single CC, the NR Adjacent Channel Leakage power Ratio (NR<sub>ACLR</sub>) is applicable for each CC while both CCs are active with non-zero UL RB allocation and the requirement is specified in clause 6.5.2.3.

## 6.5A.3 Spurious emissions for CA

### 6.5A.3.0 General spurious emissions for CA

#### 6.5A.3.0.0 General

This clause specifies the spurious emission requirements for carrier aggregation. The requirement is verified in beam locked mode with the test metric of TRP (Link=TX beam peak direction).



For intra-band CA, in case the CA configuration consists of a single UL CC, spurious emissions requirements defined in subclause 6.5.3 apply. Spurious emissions requirements do not apply at any frequency where IBE requirements of clause 6.4A.2.3 apply.

**NOTE:** For measurement conditions at the edge of each frequency range, the lowest frequency of the measurement position in each frequency range should be set at the lowest boundary of the frequency range plus MBW/2. The highest frequency of the measurement position in each frequency range should be set at the highest boundary of the frequency range minus MBW/2. MBW denotes the measurement bandwidth defined for the protected band.

#### 6.5A.3.0.1 Spurious emissions for intra-band contiguous UL CA

For intra-band contiguous UL carrier aggregation, the spurious emission limits apply for the frequency ranges that are more than  $F_{\text{OOB}}$  (MHz) from the edge of the UL aggregated channel bandwidth, where  $F_{\text{OOB}}$  is defined as the twice the UL aggregated channel bandwidth. For frequencies  $\Delta f_{\text{OOB}}$  greater than  $F_{\text{OOB}}$ , the spurious emission requirements in Table 6.5.3-2 are applicable.

#### 6.5A.3.0.2 Spurious emissions for intra-band non-contiguous UL CA

For intra-band non-contiguous UL carrier aggregation, the spurious emission requirement is defined as a composite spurious emission requirement which is a combination of individual spurious emission requirements defined for each UL sub-block. The limits in Table 6.5.3-2 apply for the frequency ranges that are more than  $F_{\text{OOB}}$  (MHz) from the edge of each UL sub-block but excludes frequency ranges that coincide with another UL sub-block. No spurious emission limit applies in the gap between neighbouring UL sub-blocks if the frequency span between the lowest edge of the upper sub-block and the highest edge of the lower sub-block is smaller than  $F_{\text{OOB\_L}} + F_{\text{OOB\_H}}$ .

#### 6.5A.3.0.3 Spurious emissions for inter-band UL CA

For inter-band carrier aggregation with uplink assigned to two NR bands, and each UL band is configured with a single CC, the spurious emission requirements are specified in clause 6.5.3 and are applicable for each CC with all CCs active with non-zero UL RB allocation.

#### 6.5A.3.1 Spurious emission band UE co-existence for UL CA

This clause specifies the requirements for the specified contiguous or non-contiguous UL carrier aggregation configurations for coexistence with protected bands.

**NOTE:** For measurement conditions at the edge of each frequency range, the lowest frequency of the measurement position in each frequency range should be set at the lowest boundary of the frequency range plus MBW/2. The highest frequency of the measurement position in each frequency range should be set at the highest boundary of the frequency range minus MBW/2. MBW denotes the measurement bandwidth defined for the protected band.

For intra-band contiguous, non-contiguous carrier aggregation and inter-band carrier aggregation, the requirements in Table 6.5A.3-1 apply.

Table 6.5A.3.1-1: Requirements for CA

CA operating band	Spurious emission						
	Protected band / frequency range	Frequency range (MHz)			Maximum Level (dBm)	MBW (MHz)	NOTE
CA_n257	NR Band n260	F <sub>DL_low</sub>	-	F <sub>DL_high</sub>	-2	100	
	Frequency range	57000	-	66000	2	100	
	Frequency range	23600	-	24000	1	200	2
CA_n258	Frequency range	57000	-	66000	2	100	
CA_n259	NR Band 257	F <sub>DL_low</sub>	-	F <sub>DL_high</sub>	-5	100	
	NR Band 261	F <sub>DL_low</sub>	-	F <sub>DL_high</sub>	-5	100	
	Frequency range	36000	-	37000	7	1000	
	Frequency range	57000	-	66000	2	100	
CA_n260	NR Band 257	F <sub>DL_low</sub>	-	F <sub>DL_high</sub>	-5	100	
	NR Band 261	F <sub>DL_low</sub>	-	F <sub>DL_high</sub>	-5	100	
	NR Band 262	F <sub>DL_low</sub>	-	F <sub>DL_high</sub>	-5	100	
	Frequency range	57000	-	66000	2	100	
CA_n261	NR Band 260	F <sub>DL_low</sub>	-	F <sub>DL_high</sub>	-2	100	
	NR Band 262	F <sub>DL_low</sub>	-	F <sub>DL_high</sub>	-5	100	
	Frequency range	57000	-	66000	2	100	
CA_n262	NR Band 260	F <sub>DL_low</sub>	-	F <sub>DL_high</sub>	-2	100	
	NR Band 261	F <sub>DL_low</sub>	-	F <sub>DL_high</sub>	-5	100	
	Frequency range	57000	-	66000	2	100	
CA_n257_n259	NR Band n260	F <sub>DL_low</sub>	-	F <sub>DL_high</sub>	-2	100	
	Frequency range	57000	-	66000	2	100	
	Frequency range	23600	-	24000	1	200	
	NR Band 257	F <sub>DL_low</sub>	-	F <sub>DL_high</sub>	-5	100	
	NR Band 261	F <sub>DL_low</sub>	-	F <sub>DL_high</sub>	-5	100	
	Frequency range	36000	-	37000	7	1000	
CA_n260_n261	NR Band 257	F <sub>DL_low</sub>	-	F <sub>DL_high</sub>	-5	100	
	NR Band 262	F <sub>DL_low</sub>	-	F <sub>DL_high</sub>	-5	100	
	Frequency range	57000	-	66000	2	100	

NOTE 1: F<sub>DL\_low</sub> and F<sub>DL\_high</sub> refer to each NR frequency band specified in Table 5.2-1  
NOTE 2: The protection of frequency range 23600-24000 MHz is meant for protection of satellite passive services.  
NOTE 3: Void

### 6.5A.3.2 Additional spurious emissions

#### 6.5A.3.2.1 General

These requirements are specified in terms of an additional spectrum emission requirement. Additional spurious emission requirements are signalled by the network to indicate that the UE shall meet an additional requirement for a specific deployment scenario as part of the cell handover/broadcast message.

#### 6.5A.3.2.2 Void

#### 6.5A.3.2.3 Additional spurious emission requirements for CA\_NS\_202

When "CA\_NS\_202" is indicated in the cell, the power of any UE emission shall not exceed the levels specified in Table 6.5.3.2.3-1.

#### 6.5A.3.2.4 Additional spurious emission requirements for CA\_NS\_203

When "CA\_NS\_203" is indicated in the cell, the power of any UE emission shall not exceed the levels specified in Table 6.5.3.2.4-1. This requirement also applies for the frequency ranges that are less than F<sub>OOB</sub> (MHz) as defined in section 6.5A.3.

## 6.5D Output RF spectrum emissions for UL MIMO

### 6.5D.1 Occupied bandwidth for UL MIMO

For UE(s) supporting UL MIMO, the occupied bandwidth requirement in clause 6.5.1 apply. The requirements shall be met with the UL MIMO configurations specified in Table 6.2D.1.0-1.

### 6.5D.2 Out of band emissions for UL MIMO

For UE(s) supporting UL MIMO, the out of band emissions requirements in clause 6.5.2 apply. The requirements shall be met with the UL MIMO configurations specified in Table 6.2D.1.0-1.

### 6.5D.3 Spurious emissions for UL MIMO

For UE(s) supporting UL MIMO, the spurious emissions requirements in clause 6.5.3 apply. The requirements shall be met with the UL MIMO configurations specified in Table 6.2D.1.0-1.

## 6.6 Beam correspondence

### 6.6.1 General

Beam correspondence is the ability of the UE to select a suitable beam for UL transmission based on DL measurements with or without relying on UL beam sweeping. Unless explicitly addressed in subclauses below, the beam correspondence requirement is fulfilled if the UE meets the corresponding minimum peak EIRP and spherical coverage requirement for that power class with its autonomously chosen UL beams and without uplink beam sweeping.

### 6.6.2 (Void)

### 6.6.3 (Void)

### 6.6.4 Beam correspondence for power class 3

#### 6.6.4.1 General

The beam correspondence requirement for power class 3 UEs consists of three components: UE minimum peak EIRP (as defined in Clause 6.2.1.3), UE spherical coverage (as defined in Clause 6.2.1.3), and beam correspondence tolerance (as defined in Clause 6.6.4.2). The beam correspondence requirement is fulfilled if the UE satisfies one of the following conditions, depending on the UE's beam correspondence capability IE *beamCorrespondenceWithoutUL-BeamSweeping*, as defined in TS 38.306 [14]:

UEs supporting FR2-2 shall support *beamCorrespondenceWithoutUL-BeamSweeping*.

- If *beamCorrespondenceWithoutUL-BeamSweeping* is supported, the UE shall meet the minimum peak EIRP requirement according to Table 6.2.1.3-1 and spherical coverage requirement according to Table 6.2.1.3-3 with its autonomously chosen UL beams and without uplink beam sweeping. Such a UE is considered to have met the beam correspondence tolerance requirement.
- If *beamCorrespondenceWithoutUL-BeamSweeping* and *beamCorrespondenceSSB-based-r16* are supported, the UE shall meet the minimum peak EIRP requirement according to Table 6.2.1.3-1 and spherical coverage requirement according to Table 6.2.1.3-3 using the side conditions for SSB based enhanced beam correspondence requirements as defined in Clause 6.6.4.3.2.
- If *beamCorrespondenceWithoutUL-BeamSweeping* and *beamCorrespondenceCSI-RS-based-r16* are supported, the UE shall meet the minimum peak EIRP requirement according to Table 6.2.1.3-1 and spherical coverage requirement according to Table 6.2.1.3-3 using the side conditions for CSI-RS based enhanced beam correspondence requirements as defined in Clause 6.6.4.3.3.

- If *beamCorrespondenceWithoutUL-BeamSweeping* is not present, the UE shall meet the minimum peak EIRP requirement according to Table 6.2.1.3-1 and spherical coverage requirement according to Table 6.2.1.3-3 with uplink beam sweeping. Such a UE shall meet the beam correspondence tolerance requirement defined in Clause 6.6.4.2 and shall support uplink beam management, as defined in TS 38.306 [14].
- If *beamCorrespondenceWithoutUL-BeamSweeping* is not present and *beamCorrespondenceSSB-based-r16* is supported, the UE shall meet the minimum peak EIRP requirement according to Table 6.2.1.3-1 and spherical coverage requirement according to Table 6.2.1.3-3 with uplink beam sweeping using the side conditions for SSB based enhanced beam correspondence requirements as defined in Clause 6.6.4.3.2. Such a UE shall meet the beam correspondence tolerance requirement defined in Clause 6.6.4.2 and shall support uplink beam management, as defined in TS 38.306 [14].
- If *beamCorrespondenceWithoutUL-BeamSweeping* is not present and *beamCorrespondenceCSI-RS-based-r16* is supported, the UE shall meet the minimum peak EIRP requirement according to Table 6.2.1.3-1 and spherical coverage requirement according to Table 6.2.1.3-3 with uplink beam sweeping using the side conditions for CSI-RS based enhanced beam correspondence requirements as defined in Clause 6.6.4.3.3. Such a UE shall meet the beam correspondence tolerance requirement defined in Clause 6.6.4.2 and shall support uplink beam management, as defined in TS 38.306 [14].

### 6.6.4.2 Beam correspondence tolerance for power class 3

The beam correspondence tolerance requirement  $\Delta\text{EIRP}_{\text{BC}}$  for power class 3 UEs is defined based on a percentile of the distribution of  $\Delta\text{EIRP}_{\text{BC}}$ , defined as  $\Delta\text{EIRP}_{\text{BC}} = \text{EIRP}_2 - \text{EIRP}_1$  over the link angles spanning a subset of the spherical coverage grid points, such that

- $\text{EIRP}_1$  is the total EIRP in dBm calculated based on the beam the UE chooses autonomously (corresponding beam) to transmit in the direction of the incoming DL signal, which is based on beam correspondence without relying on UL beam sweeping.
- $\text{EIRP}_2$  is the best total EIRP (beam yielding highest EIRP in a given direction) in dBm which is based on beam correspondence with relying on UL beam sweeping.
- The link angles are the ones corresponding to the top  $N^{\text{th}}$  percentile of the  $\text{EIRP}_2$  measurement over the whole sphere, where the value of  $N$  is according to the test point of EIRP spherical coverage requirement for power class 3, i.e.  $N = 50$ .

For power class 3 UEs, the requirement is fulfilled if the UE's corresponding UL beams satisfy the maximum limit in Table 6.6.4.2-1.

**Table 6.6.4.2-1: UE beam correspondence tolerance for power class 3**

Operating band	Max $\Delta\text{EIRP}_{\text{BC}}$ at 85 <sup>th</sup> %-tile $\Delta\text{EIRP}_{\text{BC}}$ CDF (dB)
n257	3.0
n258	3.0
n259	3.2
n260	3.2
n261	3.0
n262	3.2
NOTE: The requirements in this table are verified only under normal temperature conditions as defined in Annex E.2.1	

### 6.6.4.3 Side Conditions

#### 6.6.4.3.1 Side Condition for beam correspondence based on SSB and CSI-RS

The beam correspondence requirements are only applied under the following side conditions:

- The downlink reference signals including both SSB and CSI-RS are provided and Type D QCL shall be maintained between SSB and CSI-RS.

- The reference measurement channel for beam correspondence are fulfilled according to the CSI-RS configuration in Annex A.3.
- For beam correspondence, conditions for L1-RSRP measurements are fulfilled according to Table 6.6.4.3.1-1 and Table 6.6.4.3.1-2.

**Table 6.6.4.3.1-1: Conditions for SSB based L1-RSRP measurements for beam correspondence**

Angle of arrival	NR operating bands	Minimum SSB_RP <sup>Note 2</sup>		SSB
		dBm / SCS <sub>SSB</sub>		Ês/lot
		SCS <sub>SSB</sub> = 120 kHz		dB
All angles <sup>Note 1</sup>	n257	-96.2		≥6
	n258	-96.2		
	n259	-90.7		
	n260	-91.9		
	n261	-96.2		
	n262	-88.5		
	n263	-88.0		
NOTE 1: For UEs that support multiple FR2 bands, the Minimum SSB_RP values for all angles are increased by $\Delta MB_{S,n}$ , the UE multi-band relaxation factor in dB specified in clause 6.2.1.				
NOTE 2: Values specified at the radiated requirements reference point to give minimum SSB Ês/lot, with no applied noise.				

**Table 6.6.4.3.1-2: Conditions for CSI-RS based L1-RSRP measurements for beam correspondence**

Angle of arrival	NR operating bands	Minimum CSI-RS_RP <sup>Note 2</sup>		CSI-RS
		dBm / SCS <sub>CSI-RS</sub>		Ês/lot
		SCS <sub>CSI-RS</sub> = 120 kHz		dB
All angles <sup>Note 1</sup>	n257	-96.2		≥6
	n258	-96.2		
	n259	-90.7		
	n260	-91.9		
	n261	-96.2		
	n262	-88.5		
	n263	-88.0		
NOTE 1: For UEs that support multiple FR2 bands, the Minimum SSB_RP values for all angles are increased by $\Delta MB_{S,n}$ , the UE multi-band relaxation factor in dB specified in clause 6.2.1.				
NOTE 2: Values specified at the radiated requirements reference point to give minimum CSI-RS Ês/lot, with no applied noise.				

#### 6.6.4.3.2 Side Condition for SSB based enhanced Beam Correspondence requirements

The beam correspondence requirements for beam correspondence based on SSB are only applied under the following side conditions:

- The downlink reference signal SSB is provided, and CSI-RS is not provided.
- For beam correspondence, conditions for L1-RSRP measurements are fulfilled according to Table 6.6.4.3.1-1.

#### 6.6.4.3.3 Side Condition for CSI-RS based enhanced Beam Correspondence requirements

The beam correspondence requirements for beam correspondence based on CSI-RS are only applied under the following side conditions:

- The downlink reference signals including both SSB and CSI-RS are provided.
- The reference measurement channel for beam correspondence is fulfilled according to the CSI-RS configuration in Annex A.3.

- For beam correspondence, conditions for L1-RSRP measurements are fulfilled according to Table 6.6.4.3.1-2 and SSB signal is provided according to Table 6.6.4.3.3-1.

**Table 6.6.4.3.3-1: SSB signal conditions for CSI-RS based beam correspondence requirements**

Angle of arrival	NR operating bands	Minimum SSB_RP <sup>Note 2</sup>	
		dBm / SCS <sub>SSB</sub>	
		SCS <sub>SSB</sub> = 120 kHz	
			SSB $\hat{E}_s/\text{lot}$ dB
All angles Note 1	n257	-101,2	≥1
	n258	-101,2	
	n259	-95.7	
	n260	-96.9	
	n261	-101.2	
	n262	-93,5	
NOTE 1: For UEs that support multiple FR2 bands, the Minimum SSB_RP values for all angles are increased by $\Delta\text{MB}_{S,n}$ , the UE multi-band relaxation factor in dB specified in clause 6.2.1. NOTE 2: Values specified at the radiated requirements reference point to give minimum SSB $\hat{E}_s/\text{lot}$ , with no applied noise.			

#### 6.6.4.4 Applicability

For UEs supporting more than one type of beam correspondence, the following applicability rules apply:

- If a UE meets enhanced beam correspondence requirements either based on SSB or based on CSI-RS, it is considered to have met the beam correspondence requirements based on SSB and CSI-RS.
- For a UE supporting either SSB based or CSI-RS based enhanced beam correspondence, the UE shall meet the supported enhanced beam correspondence requirements.
- For a UE supporting both SSB based and CSI-RS based enhanced beam correspondence, the UE shall meet both SSB based and CSI-RS based enhanced beam correspondence requirements and the following applicability rules for verifying the requirements apply:
  - The enhanced beam correspondence requirements shall be verified with the SSB based enhanced beam correspondence side conditions in clause 6.6.4.3.2. If the UE meets the SSB based enhanced beam correspondence requirements using the side conditions in clause 6.6.4.3.2 and meets the minimum peak EIRP requirement as defined in clause 6.2.1.3 using the CSI-RS based side conditions in clause 6.6.4.3.3, where the link direction is determined in the SSB based enhanced beam correspondence test, the UE is considered to have met both the SSB based and CSI-RS based enhanced beam correspondence requirements.
  - Otherwise, if UE does not meet the minimum peak EIRP requirement as defined in clause 6.2.1.3 using the CSI-RS based side conditions in clause 6.6.4.3.3, the enhanced beam correspondence requirements shall be further verified for the UE with the CSI-RS based enhanced beam correspondence side conditions in clause 6.6.4.3.3.

#### 6.6.5 (Void)

### 6.6.6 Beam correspondence for power class 5

#### 6.6.6.1 General

The beam correspondence requirement for power class 5 UEs consists of two components: UE minimum peak EIRP (as defined in Clause 6.2.1.5), and UE spherical coverage (as defined in Clause 6.2.1.5). The beam correspondence requirement is fulfilled if the UE satisfies one of the following conditions, depending on the UE's beam correspondence capability IE *beamCorrespondenceWithoutUL-BeamSweeping*, as defined in TS 38.306 [14]:

- If *beamCorrespondenceWithoutUL-BeamSweeping* is supported, the UE shall meet the minimum peak EIRP requirement according to Table 6.2.1.5-1 and spherical coverage requirement according to Table 6.2.1.5-3 with

its autonomously chosen UL beams and without uplink beam sweeping. Such a UE is considered to have met the beam correspondence tolerance requirement.

- If *beamCorrespondenceWithoutUL-BeamSweeping* and *beamCorrespondenceSSB-based-r16* are supported, the UE shall meet the minimum peak EIRP requirement according to Table 6.2.1.5-1 and spherical coverage requirement according to Table 6.2.1.5-3 using the side conditions for SSB based enhanced beam correspondence requirements as defined in Clause 6.6.6.3.2.
- If *beamCorrespondenceWithoutUL-BeamSweeping* and *beamCorrespondenceCSI-RS-based-r16* are supported, the UE shall meet the minimum peak EIRP requirement according to Table 6.2.1.5-1 and spherical coverage requirement according to Table 6.2.1.5-3 using the side conditions for CSI-RS based enhanced beam correspondence requirements as defined in Clause 6.6.6.3.3.

6.6.6.2 (Reserved)

*Editor’s note: FFS if power class 5 UE can rely on UL beam sweeping to meet min peak EIRP and spherical requirements.*

6.6.6.3 Side Conditions

6.6.6.3.1 Side Condition for beam correspondence based on SSB and CSI-RS

The beam correspondence requirements are only applied under the following side conditions:

- The downlink reference signals including both SSB and CSI-RS are provided and Type D QCL shall be maintained between SSB and CSI-RS.
- The reference measurement channel for beam correspondence is fulfilled according to the CSI-RS configuration in Annex A.3.
- For beam correspondence, conditions for L1-RSRP measurements are fulfilled according to Table 6.6.6.3.1-1 and Table 6.6.6.3.1-2.

**Table 6.6.6.3.1-1: Conditions for SSB based L1-RSRP measurements for beam correspondence**

Angle of arrival	NR operating bands	Minimum SSB_RP <sup>Note 2</sup>	
		dBm / SCS <sub>SSB</sub>	
		SCS <sub>SSB</sub> = 120 kHz	
All angles <small>Note 1</small>	n257	-103.6	
	n258	-103.6	
	n259	-100.5	

NOTE 1: For UEs that support multiple FR2 bands, the Minimum SSB\_RP values for all angles are increased by  $\Delta$  MBs, the UE multi-band relaxation factor in dB specified in clause 6.2.1.5  
 NOTE 2: Values specified at the radiated requirements reference point to give minimum SSB  $\hat{E}_s/\text{lot}$ , with no applied noise.

**Table 6.6.6.3.1-2: Conditions for CSI-RS based L1-RSRP measurements for beam correspondence**

Angle of arrival	NR operating bands	Minimum CSI-RS_RP <sup>Note 2</sup>	
		dBm / SCS <sub>CSI-RS</sub>	
		SCS <sub>CSI-RS</sub> = 120 kHz	
All angles <small>Note 1</small>	n257	-103.6	
	n258	-103.6	
	n259	-100.5	

NOTE 1: For UEs that support multiple FR2 bands, the Minimum CSI-RS\_RP values are increased by  $\Delta$  MBs, the UE multi-band relaxation factor in dB specified in clause 6.2.1.5  
 NOTE 2: Values specified at the radiated requirements reference point to give minimum CSI-RS  $\hat{E}_s/\text{lot}$ , with no applied noise.

### 6.6.6.3.2 Side Condition for SSB based enhanced Beam Correspondence requirements

The beam correspondence requirements for beam correspondence based on SSB are only applied under the following side conditions:

- The downlink reference signal SSB is provided, and CSI-RS is not provided.
- For beam correspondence, conditions for L1-RSRP measurements are fulfilled according to Table 6.6.6.3.1-1.

### 6.6.6.3.3 Side Condition for CSI-RS based enhanced Beam Correspondence requirements

The beam correspondence requirements for beam correspondence based on CSI-RS are only applied under the following side conditions:

- The downlink reference signals including both SSB and CSI-RS are provided.
- The reference measurement channel for beam correspondence is fulfilled according to the CSI-RS configuration in Annex A.3.
- For beam correspondence, conditions for L1-RSRP measurements are fulfilled according to Table 6.6.4.3.1-2 and SSB signal is provided according to Table 6.6.6.3.3-1.

**Table 6.6.6.3.3-1: SSB signal conditions for CSI-RS based beam correspondence requirements**

Angle of arrival	NR operating bands	Minimum SSB_RP <sup>Note 2</sup>		SSB $\hat{E}_s/\text{lot}$ dB
		dBm / SCS <sub>SSB</sub>		
		SCS <sub>SSB</sub> = 120 kHz		
All angles <sup>Note 1</sup>	n257	-108.6		≥1
	n258	-108.6		
	n259	-105.5		
NOTE 1: For UEs that support multiple FR2 bands, the Minimum SSB_RP values for all angles are increased by $\Delta\text{MB}_s$ , the UE multi-band relaxation factor in dB specified in clause 6.2.1.5				
NOTE 2: Values specified at the radiated requirements reference point to give minimum SSB $\hat{E}_s/\text{lot}$ , with no applied noise.				

### 6.6.6.4 Applicability

For UEs supporting more than one type of beam correspondence, the following applicability rules apply:

- If a UE meets enhanced beam correspondence requirements either based on SSB or based on CSI-RS, it is considered to have met the beam correspondence requirements based on SSB and CSI-RS.
- For a UE supporting either SSB based or CSI-RS based enhanced beam correspondence, the UE shall meet the supported enhanced beam correspondence requirements.
- For a UE supporting both SSB based and CSI-RS based enhanced beam correspondence, the UE shall meet both SSB based and CSI-RS based enhanced beam correspondence requirements and the following applicability rules for verifying the requirements apply:
  - The enhanced beam correspondence requirements shall be verified with the SSB based enhanced beam correspondence side conditions in clause 6.6.6.3.2. If UE meets the SSB based enhanced beam correspondence requirements using the side conditions in clause 6.6.6.3.2 and meets the minimum peak EIRP requirement as defined in clause 6.2.1.5 using the CSI-RS based side conditions in clause 6.6.6.3.3, where the link direction is determined in the SSB based enhanced beam correspondence test, the UE is considered to have met both the SSB based and CSI-RS based enhanced beam correspondence requirements.
  - Otherwise, if UE does not meet the minimum peak EIRP requirement as defined in clause 6.2.1.3 using the CSI-RS based side conditions in clause 6.6.6.3.3, the enhanced beam correspondence requirements shall be further verified for the UE with the CSI-RS based enhanced beam correspondence side conditions in clause 6.6.6.3.3.



## 6.6.7 Beam correspondence for power class 6

### 6.6.7.1 General

The beam correspondence requirement for power class 6 UEs consists of two components: UE minimum peak EIRP (as defined in Clause 6.2.1.6), and UE spherical coverage (as defined in Clause 6.2.1.6).

Power class 6 UE shall mandatorily support *beamCorrespondenceWithoutUL-BeamSweeping* and *beamCorrespondenceSSB-based-r16*. The UE shall meet the minimum peak EIRP requirement according to Table 6.2.1.6-1 and spherical coverage requirement according to Table 6.2.1.6-3 using the side conditions for SSB based enhanced beam correspondence requirements as defined in Clause 6.6.7.3.2.

If the UE also support *beamCorrespondenceCSI-RS-based-r16*, the UE shall also meet the minimum peak EIRP requirement according to Table 6.2.1.6-1 and spherical coverage requirement according to Table 6.2.1.6-3 using the side conditions for CSI-RS based enhanced beam correspondence requirements as defined in Clause 6.6.7.3.3.

### 6.6.7.2 (Void)

*Editor's note: Not need to define beam correspondence tolerance requirement because power class 6 UE shall mandatorily support beamCorrespondenceWithoutUL-BeamSweeping.*

### 6.6.7.3 Side Conditions

#### 6.6.7.3.1 (Void)

*Editor's note: Not need to define the side condition for beam correspondence based on SSB and CSI-RS, because power class 6 UE shall mandatorily support SSB based enhanced beam correspondence.*

#### 6.6.7.3.2 Side Condition for SSB based enhanced Beam Correspondence requirements

The beam correspondence requirements for beam correspondence based on SSB are only applied under the following side conditions:

- The downlink reference signal SSB is provided, and CSI-RS is not provided.
- For beam correspondence, conditions for L1-RSRP measurements are fulfilled according to Table 6.6.7.3.2-1.

**Table 6.6.7.3.2-1: Conditions for SSB based L1-RSRP measurements for beam correspondence**

Angle of arrival	NR operating bands	Minimum SSB <sub>RP</sub> <sup>Note 2</sup>	
		dBm / SCS <sub>SSB</sub>	
		SCS <sub>SSB</sub> = 120 kHz	
All angles <sup>Note 1</sup>	n257	-101.4	
	n258	-101.6	
	n261	-101.4	
NOTE 1: For UEs that support multiple FR2 bands, the Minimum SSB <sub>RP</sub> values for all angles are increased by $\Delta$ MB <sub>S,n</sub> , the UE multi-band relaxation factor in dB specified in clause 6.2.1.6.			
NOTE 2: Values specified at the radiated requirements reference point to give minimum SSB $\hat{E}_s/\text{lot}$ , with no applied noise.			

#### 6.6.7.3.3 Side Condition for CSI-RS based enhanced Beam Correspondence requirements

The beam correspondence requirements for beam correspondence based on CSI-RS are only applied under the following side conditions:

- The downlink reference signals including both SSB and CSI-RS are provided.
- The reference measurement channel for beam correspondence is fulfilled according to the CSI-RS configuration in Annex A.3.
- For beam correspondence, conditions for L1-RSRP measurements are fulfilled according to Table 6.6.7.3.3-2 and SSB signal is provided according to Table 6.6.7.3.3-1.

**Table 6.6.7.3.3-1: SSB signal conditions for CSI-RS based beam correspondence requirements**

Angle of arrival	NR operating bands	Minimum SSB_RP <sup>Note 2</sup>		
		dBm / SCS <sub>SSB</sub>		
		SCS <sub>SSB</sub> = 120 kHz		
			SSB Ês/lot dB	
All angles <sup>Note 1</sup>	n257	-106.4		≥1
	n258	-106.6		
	n261	-106.4		
NOTE 1: For UEs that support multiple FR2 bands, the Minimum SSB_RP values for all angles are increased by ΔMB <sub>S,n</sub> , the UE multi-band relaxation factor in dB specified in clause 6.2.1.6				
NOTE 2: Values specified at the radiated requirements reference point to give minimum SSB Ês/lot, with no applied noise.				

**Table 6.6.7.3.3-2: Conditions for CSI-RS based L1-RSRP measurements for beam correspondence**

Angle of arrival	NR operating bands	Minimum CSI-RS_RP <sup>Note 2</sup>		
		dBm / SCS <sub>CSI-RS</sub>		
		SCS <sub>CSI-RS</sub> = 120 kHz		
			CSI-RS Ês/lot dB	
All angles <sup>Note 1</sup>	n257	-101.4		≥6
	n258	-101.6		
	n261	-101.4		
NOTE 1: For UEs that support multiple FR2 bands, the Minimum CSI-RS_RP values are increased by ΔMB <sub>S,n</sub> , the UE multi-band relaxation factor in dB specified in clause 6.2.1.6				
NOTE 2: Values specified at the radiated requirements reference point to give minimum CSI-RS Ês/lot, with no applied noise.				

### 6.6.7.4 Applicability

For UEs supporting more than one type of beam correspondence, the following applicability rules apply:

- If a UE meets enhanced beam correspondence requirements either based on SSB or based on CSI-RS, it is considered to have met the beam correspondence requirements based on SSB and CSI-RS.
- For a UE supporting either SSB based or CSI-RS based enhanced beam correspondence, the UE shall meet the supported enhanced beam correspondence requirements.
- For a UE supporting both SSB based and CSI-RS based enhanced beam correspondence UE shall meet the both SSB based and CSI-RS based enhanced beam correspondence requirements and the following applicability rules for verifying the requirements apply:
  - The enhanced beam correspondence requirements shall be verified with the SSB based enhanced beam correspondence side conditions in clause 6.6.7.3.2. If the UE meets the SSB based enhanced beam correspondence requirements using the side conditions in clause 6.6.7.3.2 and meets the minimum peak EIRP requirement as defined in clause 6.2.1.6 using the CSI-RS based side conditions in clause 6.6.7.3.3, where the link direction is determined in the SSB based enhanced beam correspondence test, the UE is considered to have met both the SSB based and CSI-RS based enhanced beam correspondence requirements.
  - Otherwise, if UE does not meet the minimum peak EIRP requirement as defined in clause 6.2.1.6 using the CSI-RS based side conditions in clause 6.6.7.3.3, the enhanced beam correspondence requirements

shall be further verified for the UE with the CSI-RS based enhanced beam correspondence side conditions in clause 6.6.7.3.3.

## 6.6.8 Beam correspondence for power class 7

### 6.6.8.1 General

The beam correspondence requirement for power class 7 UEs consists of two components: UE minimum peak EIRP (as defined in Clause 6.2.1.7), and UE spherical coverage (as defined in Clause 6.2.1.7).

Power class 7 UE shall mandatorily support IE *beamCorrespondenceWithoutUL-BeamSweeping*, as defined in TS 38.306 [14]. The UE shall meet the minimum peak EIRP requirement according to Table 6.2.1.7-1 and spherical coverage requirement according to Table 6.2.1.7-3.

If *beamCorrespondenceSSB-based-r16* is supported, the UE shall meet the minimum peak EIRP requirement according to Table 6.2.1.7-1 and spherical coverage requirement according to Table 6.2.1.7-3 using the side conditions for SSB based enhanced beam correspondence requirements as defined in Clause 6.6.8.3.2.

If *beamCorrespondenceCSI-RS-based-r16* is supported, the UE shall meet the minimum peak EIRP requirement according to Table 6.2.1.7-1 and spherical coverage requirement according to Table 6.2.1.7-3 using the side conditions for CSI-RS based enhanced beam correspondence requirements as defined in Clause 6.6.8.3.3.

### 6.6.8.2 Void

### 6.6.8.3 Side Conditions

#### 6.6.8.3.1 Side Condition for beam correspondence based on SSB and CSI-RS

The beam correspondence requirements are only applied under the following side conditions:

- The downlink reference signals including both SSB and CSI-RS are provided and Type D QCL shall be maintained between SSB and CSI-RS.
- The reference measurement channel for beam correspondence is fulfilled according to the CSI-RS configuration in Annex A.3.
- For beam correspondence, conditions for L1-RSRP measurements are fulfilled according to Table 6.6.8.3.1-1 and Table 6.6.8.3.1-2.

**Table 6.6.8.3.1-1: Conditions for SSB based L1-RSRP measurements for beam correspondence**

Angle of arrival	NR operating bands	Minimum SSB_RP <sup>Note 2</sup>	
		dBm / SCS <sub>SSB</sub>	
		SCS <sub>SSB</sub> = 120 kHz	
All angles Note 1	n257	-93.2	
	n258	-93.2	
	n261	-93.2	
NOTE 1: Void			
NOTE 2: Values specified at the radiated requirements reference point to give minimum SSB Ês/lot, with no applied noise.			

**Table 6.6.8.3.1-2: Conditions for CSI-RS based L1-RSRP measurements for beam correspondence**

Angle of arrival	NR operating bands	Minimum CSI-RS_RP <sup>Note 2</sup>		CSI-RS $\hat{E}_s/\text{lot}$
		dBm / $SCS_{\text{CSI-RS}}$		dB
		$SCS_{\text{CSI-RS}} = 120 \text{ kHz}$		
All angles <sup>Note 1</sup>	n257	-93.2		$\geq 6$
	n258	-93.2		
	n261	-93.2		
NOTE 1: For UEs that support multiple FR2 bands, the Minimum SSB_RP values for all angles are increased by $\Delta MB_{S,n}$ , the UE multi-band relaxation factor in dB specified in clause 6.2.1.				
NOTE 2: Values specified at the radiated requirements reference point to give minimum CSI-RS $\hat{E}_s/\text{lot}$ , with no applied noise.				

### 6.6.8.3.2 Side Condition for SSB based enhanced Beam Correspondence requirements

The beam correspondence requirements for beam correspondence based on SSB are only applied under the following side conditions:

- The downlink reference signal SSB is provided, and CSI-RS is not provided.
- For beam correspondence, conditions for L1-RSRP measurements are fulfilled according to Table 6.6.8.3.1-1.

### 6.6.8.3.3 Side Condition for CSI-RS based enhanced Beam Correspondence requirements

The beam correspondence requirements for beam correspondence based on CSI-RS are only applied under the following side conditions:

- The downlink reference signals including both SSB and CSI-RS are provided.
- The reference measurement channel for beam correspondence is fulfilled according to the CSI-RS configuration in Annex A.3.
- For beam correspondence, conditions for L1-RSRP measurements are fulfilled according to Table 6.6.8.3.1-2 and SSB signal is provided according to Table 6.6.8.3.3-1.

**Table 6.6.8.3.3-1: SSB signal conditions for CSI-RS based beam correspondence requirements**

Angle of arrival	NR operating bands	Minimum SSB_RP <sup>Note 2</sup>		SSB $\hat{E}_s/\text{lot}$
		dBm / $SCS_{\text{SSB}}$		dB
		$SCS_{\text{SSB}} = 120 \text{ kHz}$		
All angles <sup>Note 1</sup>	n257	-98.2		$\geq 1$
	n258	-98.2		
	n261	-98.2		
NOTE 1: For UEs that support multiple FR2 bands, the Minimum SSB_RP values for all angles are increased by $\Delta MB_{S,n}$ , the UE multi-band relaxation factor in dB specified in clause 6.2.1.				
NOTE 2: Values specified at the radiated requirements reference point to give minimum SSB $\hat{E}_s/\text{lot}$ , with no applied noise.				

### 6.6.8.4 Applicability

For UEs supporting more than one type of beam correspondence, the following applicability rules apply:

- If a UE meets enhanced beam correspondence requirements either based on SSB or based on CSI-RS, it is considered to have met the beam correspondence requirements based on SSB and CSI-RS.
- For a UE supporting either SSB based or CSI-RS based enhanced beam correspondence, the UE shall meet the supported enhanced beam correspondence requirements.

- For a UE supporting both SSB based and CSI-RS based enhanced beam correspondence, the UE shall meet both SSB based and CSI-RS based enhanced beam correspondence requirements and the following applicability rules for verifying the requirements apply:
  - The enhanced beam correspondence requirements shall be verified with the SSB based enhanced beam correspondence side conditions in clause 6.6.8.3.2. If UE meets the SSB based enhanced beam correspondence requirements using the side conditions in clause 6.6.8.3.2 and meets the minimum peak EIRP requirement as defined in clause 6.2.1.7 using the CSI-RS based side conditions in clause 6.6.8.3.3, where the link direction is determined in the SSB based enhanced beam correspondence test, the UE is considered to have met both the SSB based and CSI-RS based enhanced beam correspondence requirements.
  - Otherwise, if UE does not meet the minimum peak EIRP requirement as defined in clause 6.2.1.7 using the CSI-RS based side conditions in clause 6.6.8.3.3, the enhanced beam correspondence requirements shall be further verified for the UE with the CSI-RS based enhanced beam correspondence side conditions in clause 6.6.8.3.3.

## 6.6A Beam correspondence for CA

For intra-band CA in FR2, the same beam correspondence relationship for beam management is supported across CCs in this release of the specification and no requirement is specified. Beam correspondence performance for intra-band CA is fulfilled if the beam correspondence requirements defined in clause 6.6 is met for non-CA case.

For inter-band carrier aggregation with uplink assigned to two NR bands, and each UL band is configured with a single CC, with all CCs active with non-zero UL RB allocation, the following beam correspondence requirements apply for each CC:

- 1 The minimum peak EIRP requirement specified for UL inter-band CA in 6.2A, based on test conditions in clause 6.6. Reference signal power adjustments by  $\Delta MB_{S,n}$  are replaced by  $\Delta R_{IB,S,n}$ , where referenced.
- 2 The common spherical coverage requirement specified for UL inter-band CA in 6.2A, based on test conditions in clause 6.6. Reference signal power adjustments by  $\Delta MB_{S,n}$  are replaced by  $\Delta R_{IB,S,n}$ , where referenced.

## 7 Receiver characteristics

### 7.1 General

Unless otherwise stated, the receiver characteristics are specified over the air (OTA). The power levels for all DL signals and interferers are defined assuming a 0 dBi reference antenna located at the center of the quiet zone.

### 7.2 Diversity characteristics

The minimum requirements on effective isotropic sensitivity (EIS) apply to two measurements, corresponding to DL signals in orthogonal polarizations.

### 7.3 Reference sensitivity

#### 7.3.1 General

The reference sensitivity power level REFSENS is defined as the EIS level at the centre of the quiet zone in the RX beam peak direction, at which the throughput shall meet or exceed the requirements for the specified reference measurement channel.

#### 7.3.2 Reference sensitivity power level

##### 7.3.2.1 Reference sensitivity power level for power class 1

The throughput shall be  $\geq 95$  % of the maximum throughput of the reference measurement channels as specified in Annexes A.2.3.2 and A.3.3.2 (with one sided dynamic OCNG Pattern OP.1 TDD for the DL-signal as described in Annex A.5.2.1) with peak reference sensitivity specified in Table 7.3.2.1-1. The requirement is verified with the test metric of EIS (Link=RX beam peak direction, Meas=Link Angle).

**Table 7.3.2.1-1: Reference sensitivity for power class 1**

Operating band	REFSENS (dBm) / Channel bandwidth						
	50 MHz	100 MHz	200 MHz	400 MHz	800 MHz	1600 MHz	2000 MHz
n257	-97.5	-94.5	-91.5	-88.5	N/A	N/A	N/A
n258	-97.5	-94.5	-91.5	-88.5	N/A	N/A	N/A
n260	-94.5	-91.5	-88.5	-85.5	N/A	N/A	N/A
n261	-97.5	-94.5	-91.5	-88.5	N/A	N/A	N/A
n262	-92.5	-89.5	-86.5	-83.5	N/A	N/A	N/A
n263	N/A	-85	N/A	-79	-76	-73	-72

NOTE 1: The transmitter shall be set to  $P_{UMAX}$  as defined in clause 6.2.4

The REFSENS requirement shall be met for an uplink transmission using QPSK DFT-s-OFDM waveforms and for uplink transmission bandwidth less than or equal to that specified in Table 7.3.2.1-2.

**Table 7.3.2.1-2: Uplink configuration for reference sensitivity**

Operating band	NR Band / Channel bandwidth / NRB / SCS / Duplex mode								
	50 MHz	100 MHz	200 MHz	400 MHz	800 MHz	1600 MHz	2000 MHz	SCS	Duplex mode
n257	32	64	128	256	N/A	N/A	N/A	120 kHz	TDD
n258	32	64	128	256	N/A	N/A	N/A	120 kHz	TDD
n260	32	64	128	256	N/A	N/A	N/A	120 kHz	TDD
n261	32	64	128	256	N/A	N/A	N/A	120 kHz	TDD
n262	32	64	128	256	N/A	N/A	N/A	120 kHz	TDD
n263	N/A	64	N/A	256	N/A	N/A	N/A	120 kHz	TDD
	N/A	N/A	N/A	64	120	240	N/A	480 kHz	
	N/A	N/A	N/A	32	60	120	144	960 kHz	

Unless given by Table 7.3.2.1-3, the minimum requirements for reference sensitivity shall be verified with the network signalling value NS\_200 (Table 6.2.3-1) configured.

**Table 7.3.2.1-3: Reserved**

Operating band	Network Signalling value

### 7.3.2.2 Reference sensitivity power level for power class 2

The throughput shall be  $\geq 95\%$  of the maximum throughput of the reference measurement channels as specified in Annexes A.2.3.2 and A.3.3.2 (with one sided dynamic OCNG Pattern OP.1 TDD for the DL-signal as described in Annex A.5.2.1) with peak reference sensitivity specified in Table 7.3.2.2-1. The requirement is verified with the test metric of EIS (Link=RX beam peak direction, Meas=Link Angle).

**Table 7.3.2.2-1: Reference sensitivity for power class 2**

Operating band	REFSENS (dBm) / Channel bandwidth						
	50 MHz	100 MHz	200 MHz	400 MHz	800 MHz	1600 MHz	2000 MHz
n257	-92.0	-89.0	-86.0	-83.0	N.A	N.A	N.A
n258	-92.0	-89.0	-86.0	-83.0	N.A	N.A	N.A
n259	-88.7	-85.7	-82.7	-79.7	N.A	N.A	N.A
n261	-92.0	-89.0	-86.0	-83.0	N.A	N.A	N.A
n262	-86.8	-83.8	-80.8	-77.8	N.A	N.A	N.A
n263	N.A	-86.3	N.A	-80.3	-77.3	-74.3	-73.3

NOTE 1: The transmitter shall be set to P<sub>UMAX</sub> as defined in clause 6.2.4

The REFSENS requirement shall be met for an uplink transmission using QPSK DFT-s-OFDM waveforms and for uplink transmission bandwidth less than or equal to that specified in Table 7.3.2.1-2.

Unless given by Table 7.3.2.1-3, the minimum requirements for reference sensitivity shall be verified with the network signalling value NS\_200 (Table 6.2.3-1) configured.

### 7.3.2.3 Reference sensitivity power level for power class 3

The throughput shall be  $\geq 95\%$  of the maximum throughput of the reference measurement channels as specified in Annexes A.2.3.2 and A.3.3.2 (with one sided dynamic OCNG Pattern OP.1 TDD for the DL-signal as described in Annex A.5.2.1) with peak reference sensitivity specified in Table 7.3.2.3-1. The requirement is verified with the test metric of EIS (Link=RX beam peak direction, Meas=Link Angle).

For the UEs that support multiple FR2 bands, the minimum requirement for Reference sensitivity in Table 7.3.2.3-1 shall be increased per band, respectively, by the reference sensitivity relaxation parameter  $\Delta MB_{P,n}$  as specified in clause 6.2.1.3. The requirement for the UE which supports a single FR2 band is specified in Table 7.3.2.3-1. The requirement for the UE which supports multiple FR2 bands is specified in both Table 7.3.2.3-1 and Table 6.2.1.3-4.

**Table 7.3.2.3-1: Reference sensitivity**

Operating band	REFSENS (dBm) / Channel bandwidth						
	50 MHz	100 MHz	200 MHz	400 MHz	800 MHz	1600 MHz	2000 MHz
n257	-88.3	-85.3	-82.3	-79.3	N.A	N.A	N.A
n258	-88.3	-85.3	-82.3	-79.3	N.A	N.A	N.A
n259	-84.7	-81.7	-78.7	-75.7	N.A	N.A	N.A
n260	-85.7	-82.7	-79.7	-76.7	N.A	N.A	N.A
n261	-88.3	-85.3	-82.3	-79.3	N.A	N.A	N.A
n262	-82.8	-79.8	-76.8	-73.8	N.A	N.A	N.A
n263	N.A	-78	N.A	-72	-69	-66	-65

NOTE 1: The transmitter shall be set to  $P_{UMAX}$  as defined in clause 6.2.4

The REFSENS requirement shall be met for an uplink transmission using QPSK DFT-s-OFDM waveforms and for uplink transmission bandwidth less than or equal to that specified in Table 7.3.2.1-2.

Unless given by Table 7.3.2.1-3, the minimum requirements for reference sensitivity shall be verified with the network signalling value NS\_200 (Table 6.2.3-1) configured.

### 7.3.2.4 Reference sensitivity power level for power class 4

The throughput shall be  $\geq 95\%$  of the maximum throughput of the reference measurement channels as specified in Annexes A.2.3.2 and A.3.3.2 (with one sided dynamic OCNG Pattern OP.1 TDD for the DL-signal as described in Annex A.5.2.1) with peak reference sensitivity specified in Table 7.3.2.4-1. The requirement is verified with the test metric of EIS (Link=RX beam peak direction, Meas=Link Angle).

**Table 7.3.2.4-1: Reference sensitivity for power class 4**

Operating band	REFSENS (dBm) / Channel bandwidth			
	50 MHz	100 MHz	200 MHz	400 MHz
n257	-97.0	-94.0	-91.0	-88.0
n258	-97.0	-94.0	-91.0	-88.0
n260	-95.0	-92.0	-89.0	-86.0
n261	-97.0	-94.0	-91.0	-88.0
n262	-91.0	-88.0	-85.0	-82.0

NOTE 1: The transmitter shall be set to  $P_{UMAX}$  as defined in clause 6.2.4

The REFSENS requirement shall be met for an uplink transmission using QPSK DFT-s-OFDM waveforms and for uplink transmission bandwidth less than or equal to that specified in Table 7.3.2.1-2.

Unless given by Table 7.3.2.1-3, the minimum requirements for reference sensitivity shall be verified with the network signalling value NS\_200 (Table 6.2.3-1) configured.

### 7.3.2.5 Reference sensitivity power level for power class 5

The throughput shall be  $\geq 95\%$  of the maximum throughput of the reference measurement channels as specified in Annexes A.2.3.2 and A.3.3.2 (with one sided dynamic OCNG Pattern OP.1 TDD for the DL-signal as described in Annex A.5.2.1) with peak reference sensitivity specified in Table 7.3.2.5-1. The requirement is verified with the test metric of EIS (Link=RX beam peak direction, Meas=Link Angle).

**Table 7.3.2.5-1: Reference sensitivity for power class 5**

Operating band	REFSENS (dBm) / Channel bandwidth			
	50 MHz	100 MHz	200 MHz	400 MHz
n257	-92.6	-89.6	-86.6	-83.6
n258	-92.8	-89.8	-86.8	-83.8
n259	-89.7	-86.7	-83.7	-80.7

NOTE 1: The transmitter shall be set to  $P_{UMAX}$  as defined in clause 6.2.4



The REFSENS requirement shall be met for an uplink transmission using QPSK DFT-s-OFDM waveforms and for uplink transmission bandwidth less than or equal to that specified in Table 7.3.2.1-2.

Unless given by Table 7.3.2.1-3, the minimum requirements for reference sensitivity shall be verified with the network signalling value NS\_200 (Table 6.2.3-1) configured.

### 7.3.2.6 Reference sensitivity power level for power class 6

The throughput shall be  $\geq 95\%$  of the maximum throughput of the reference measurement channels as specified in Annexes A.2.3.2 and A.3.3.2 (with one sided dynamic OCNG Pattern OP.1 TDD for the DL-signal as described in Annex A.5.2.1) with peak reference sensitivity specified in Table 7.3.2.6-1. The requirement is verified with the test metric of EIS (Link=RX beam peak direction, Meas=Link Angle).

**Table 7.3.2.6-1: Reference sensitivity for power class 6**

Operating band	REFSENS (dBm) / Channel bandwidth			
	50 MHz	100 MHz	200 MHz	400 MHz
n257	-92.6	-89.6	-86.6	-83.6
n258	-92.8	-89.8	-86.8	-83.8
n261	-92.6	-89.6	-86.6	-83.6

NOTE 1: The transmitter shall be set to  $P_{UMAX}$  as defined in clause 6.2.4

The REFSENS requirement shall be met for an uplink transmission using QPSK DFT-s-OFDM waveforms and for uplink transmission bandwidth less than or equal to that specified in Table 7.3.2.1-2.

Unless given by Table 7.3.2.1-3, the minimum requirements for reference sensitivity shall be verified with the network signalling value NS\_200 (Table 6.2.3-1) configured.

### 7.3.2.7 Reference sensitivity power level for power class 7

The throughput shall be  $\geq 95\%$  of the maximum throughput of the reference measurement channels as specified in Annexes A.2.3.2 and A.3.3.2 (with one sided dynamic OCNG Pattern OP.1 TDD for the DL-signal as described in Annex A.5.2.1) with peak reference sensitivity specified in Table 7.3.2.7-1. The requirement is verified with the test metric of EIS (Link=RX beam peak direction, Meas=Link Angle).

**Table 7.3.2.7-1: Reference sensitivity**

Operating band	REFSENS (dBm) / Channel bandwidth	
	50 MHz	100 MHz
n257	-85.3	-82.3
n258	-85.3	-82.3
n261	-85.3	-82.3

NOTE 1: The transmitter shall be set to  $P_{UMAX}$  as defined in clause 6.2.4

The REFSENS requirement shall be met for an uplink transmission using QPSK DFT-s-OFDM waveforms and for uplink transmission bandwidth of 50MHz and 100MHz specified in Table 7.3.2.1-2.

Unless given by Table 7.3.2.1-3, the minimum requirements for reference sensitivity shall be verified with the network signalling value NS\_200 (Table 6.2.3-1) configured.

### 7.3.3 Void

### 7.3.4 EIS spherical coverage

#### 7.3.4.1 EIS spherical coverage for power class 1

The reference measurement channels and throughput criterion shall be as specified in clause 7.3.2.1

The maximum EIS at the 85<sup>th</sup> percentile of the CCDF of EIS measured over the full sphere around the UE is defined as the spherical coverage requirement and is found in Table 7.3.4.1-1 below. The requirement is verified with the test metric of EIS (Link=Spherical coverage grid, Meas=Link angle).

**Table 7.3.4.1-1: EIS spherical coverage for power class 1**

Operating band	EIS at 85 <sup>th</sup> %-tile CCDF (dBm) / Channel bandwidth						
	50 MHz	100 MHz	200 MHz	400 MHz	800 MHz	1600 MHz	2000 MHz
n257	-89.5	-86.5	-83.5	-80.5	N/A	N/A	N/A
n258	-89.5	-86.5	-83.5	-80.5	N/A	N/A	N/A
n260	-86.5	-83.5	-80.5	-77.5	N/A	N/A	N/A
n261	-89.5	-86.5	-83.5	-80.5	N/A	N/A	N/A
n262	-84.3	-81.3	-78.3	-75.3	N/A	N/A	N/A
n263	N/A	-73.5	N/A	-67.5	-64.5	-61.5	-60.5

The requirement shall be met for an uplink transmission using QPSK DFT-s-OFDM waveforms and for uplink transmission bandwidth less than or equal to that specified in Table 7.3.2.1-2.

Unless given by Table 7.3.2.1-3, the minimum requirements for reference sensitivity shall be verified with the network signalling value NS\_200 (Table 6.2.3-1) configured.

#### 7.3.4.2 EIS spherical coverage for power class 2

The reference measurement channels and throughput criterion shall be as specified in clause 7.3.2.2

The maximum EIS at the 60<sup>th</sup> percentile of the CCDF of EIS measured over the full sphere around the UE is defined as the spherical coverage requirement and is found in Table 7.3.4.2-1 below. The requirement is verified with the test metric of EIS (Link=Spherical coverage grid, Meas=Link angle).

**Table 7.3.4.2-1: EIS spherical coverage for power class 2**

Operating band	EIS at 60 <sup>th</sup> %-tile CCDF (dBm) / Channel bandwidth						
	50 MHz	100 MHz	200 MHz	400 MHz	800 MHz	1600 MHz	2000 MHz
n257	-81.0	-78.0	-75.0	-72.0	N.A	N.A	N.A
n258	-81.0	-78.0	-75.0	-72.0	N.A	N.A	N.A
n259	-76.2	-73.2	-70.2	-67.2	N.A	N.A	N.A
n261	-81.0	-78.0	-75.0	-72.0	N.A	N.A	N.A
n262	-74.9	-71.9	-68.9	-65.9	N.A	N.A	N.A
n263	N.A	-71.2	N.A	-65.2	-62.2	-59.2	-58.2

NOTE 1: The transmitter shall be set to P<sub>UMAX</sub> as defined in clause 6.2.4  
NOTE 2: The EIS spherical coverage requirements are verified only under normal thermal conditions as defined in Annex E.2.1.

The requirement shall be met for an uplink transmission using QPSK DFT-s-OFDM waveforms and for uplink transmission bandwidth less than or equal to that specified in Table 7.3.2.1-2.

Unless given by Table 7.3.2.1-3, the minimum requirements for reference sensitivity shall be verified with the network signalling value NS\_200 (Table 6.2.3-1) configured.

### 7.3.4.3 EIS spherical coverage for power class 3

The reference measurement channels and throughput criterion shall be as specified in clause 7.3.2.3

The maximum EIS at the 50<sup>th</sup> percentile of the CCDF of EIS measured over the full sphere around the UE is defined as the spherical coverage requirement and is found in Table 7.3.4.3-1 below. The requirement is verified with the test metric of EIS (Link=Spherical coverage grid, Meas=Link angle).

For the UEs that support multiple FR2 bands, the minimum requirement for EIS spherical coverage in Table 7.3.4.3-1 shall be increased per band, respectively, by the EIS spherical coverage relaxation parameter  $\Delta MB_{S,n}$  as specified in clause 6.2.1.3. The requirement for the UE which supports a single FR2 band is specified in Table 7.3.4.3-1. The requirement for the UE which supports multiple FR2 bands is specified in both Table 7.3.4.3-1 and Table 6.2.1.3-4.

**Table 7.3.4.3-1: EIS spherical coverage for power class 3**

Operating band	EIS at 50 <sup>th</sup> %-tile CCDF (dBm) / Channel bandwidth						
	50 MHz	100 MHz	200 MHz	400 MHz	800 MHz	1600 MHz	2000 MHz
n257	-77.4	-74.4	-71.4	-68.4	N.A	N.A	N.A
n258	-77.4	-74.4	-71.4	-68.4	N.A	N.A	N.A
n259	-71.9	-68.9	-65.9	-62.9	N.A	N.A	N.A
n260	-73.1	-70.1	-67.1	-64.1	N.A	N.A	N.A
n261	-77.4	-74.4	-71.4	-68.4	N.A	N.A	N.A
n262	-69.7	-66.7	-63.7	-60.7	N.A	N.A	N.A
n263	N.A	-66.2	N.A	-60.2	-57.2	-54.2	-53.2

NOTE 1: The transmitter shall be set to  $P_{UMAX}$  as defined in clause 6.2.4  
NOTE 2: The EIS spherical coverage requirements are verified only under normal thermal conditions as defined in Annex E.2.1.

The requirement shall be met for an uplink transmission using QPSK DFT-s-OFDM waveforms and for uplink transmission bandwidth less than or equal to that specified in Table 7.3.2.1-2.

Unless given by Table 7.3.2.1-3, the minimum requirements for reference sensitivity shall be verified with the network signalling value NS\_200 (Table 6.2.3-1) configured.

### 7.3.4.4 EIS spherical coverage for power class 4

The reference measurement channels and throughput criterion shall be as specified in clause 7.3.2.4

The maximum EIS at the 20<sup>th</sup> percentile of the CCDF of EIS measured over the full sphere around the UE is defined as the spherical coverage requirement and is found in Table 7.3.4.4-1 below. The requirement is verified with the test metric of EIS (Link=Spherical coverage grid, Meas=Link angle).

**Table 7.3.4.4-1: EIS spherical coverage for power class 4**

Operating band	EIS at 20 <sup>th</sup> %-tile CCDF (dBm) / Channel bandwidth			
	50 MHz	100 MHz	200 MHz	400 MHz
n257	-88.0	-85.0	-82.0	-79.0
n258	-88.0	-85.0	-82.0	-79.0
n260	-83.0	-80.0	-77.0	-74.0
n261	-88.0	-85.0	-82.0	-79.0
n262	-78.9	-75.9	-72.9	-69.9

NOTE 1: The transmitter shall be set to  $P_{UMAX}$  as defined in clause 6.2.4  
NOTE 2: The EIS spherical coverage requirements are verified only under normal thermal conditions as defined in Annex E.2.1.

The requirement shall be met for an uplink transmission using QPSK DFT-s-OFDM waveforms and for uplink transmission bandwidth less than or equal to that specified in Table 7.3.2.1-2.

Unless given by Table 7.3.2.1-3, the minimum requirements for reference sensitivity shall be verified with the network signalling value NS\_200 (Table 6.2.3-1) configured.

### 7.3.4.5 EIS spherical coverage for power class 5

The reference measurement channels and throughput criterion shall be as specified in clause 7.3.2.4

The maximum EIS at the 85<sup>th</sup> percentile of the CCDF of EIS measured over the full sphere around the UE is defined as the spherical coverage requirement and is found in Table 7.3.4.5-1 below. The requirement is verified with the test metric of EIS (Link=Spherical coverage grid, Meas=Link angle).

**Table 7.3.4.5-1: EIS spherical coverage for power class 5**

Operating band	EIS at 85 <sup>th</sup> %-tile CCDF (dBm) / Channel bandwidth			
	50 MHz	100 MHz	200 MHz	400 MHz
n257	-84.6	-81.6	-78.6	-75.6
n258	-84.8	-81.8	-78.8	-75.8
n259	-81.7	-78.7	-75.7	-72.7
NOTE 1: The transmitter shall be set to $P_{UMAX}$ as defined in clause 6.2.4				
NOTE 2: The EIS spherical coverage requirements are verified only under normal thermal conditions as defined in Annex E.2.1.				

The requirement shall be met for an uplink transmission using QPSK DFT-s-OFDM waveforms and for uplink transmission bandwidth less than or equal to that specified in Table 7.3.2.1-2.

Unless given by Table 7.3.2.1-3, the minimum requirements for reference sensitivity shall be verified with the network signalling value NS\_200 (Table 6.2.3-1) configured.

### 7.3.4.6 EIS spherical coverage for power class 6

The reference measurement channels and throughput criterion shall be as specified in clause 7.3.2.6

The maximum EIS measured over the spherical coverage evaluation areas is defined as the spherical coverage requirement and is found in Table 7.3.4.6-1 below. UE spherical coverage evaluation areas are found in Table 6.2.1.6-3a in clause 6.2.1.6, by consisting of Area-1 and Area-2, in the reference coordinate system in Annex J.1. The requirement is verified with the test metric of EIS (Link=Spherical coverage grid, Meas=Link angle).

**Table 7.3.4.6-1: EIS spherical coverage for power class 6**

Operating band	Max EIS over UE spherical coverage evaluation areas (dBm) / Channel bandwidth			
	50 MHz	100 MHz	200 MHz	400 MHz
n257	-82.6	-79.6	-76.6	-73.6
n258	-82.8	-79.8	-76.8	-73.8
n261	-82.6	-79.6	-76.6	-73.6
NOTE 1: The transmitter shall be set to $P_{UMAX}$ as defined in clause 6.2.4				
NOTE 2: The EIS spherical coverage requirements are verified only under normal thermal conditions as defined in Annex E.2.1.				
NOTE 3: The requirements in this table are applicable to FR2 PC6 UE with the network signalling <i>highSpeedMeasFlag-r17</i> configured as <i>set2</i> .				

The requirement shall be met for an uplink transmission using QPSK DFT-s-OFDM waveforms and for uplink transmission bandwidth less than or equal to that specified in Table 7.3.2.1-2.

Unless given by Table 7.3.2.1-3, the minimum requirements for reference sensitivity shall be verified with the network signalling value NS\_200 (Table 6.2.3-1) configured.

### 7.3.4.7 EIS spherical coverage for power class 7

The reference measurement channels and throughput criterion shall be as specified in clause 7.3.2.7.

The maximum EIS at the 50<sup>th</sup> percentile of the CCDF of EIS measured over the full sphere around the UE is defined as the spherical coverage requirement and is found in Table 7.3.4.7-1 below. The requirement is verified with the test metric of EIS (Link=Spherical coverage grid, Meas=Link angle).

**Table 7.3.4.7-1: EIS spherical coverage for power class 7**

Operating band	EIS at 50 <sup>th</sup> %-tile CCDF (dBm) / Channel bandwidth	
	50 MHz	100 MHz
n257	-74.4	-71.4
n258	-74.4	-71.4
n261	-74.4	-71.4
NOTE 1: The transmitter shall be set to P <sub>UMAX</sub> as defined in clause 6.2.4		
NOTE 2: The EIS spherical coverage requirements are verified only under normal thermal conditions as defined in Annex E.2.1.		

The requirement shall be met for an uplink transmission using QPSK DFT-s-OFDM waveforms and for uplink transmission bandwidth of 50MHz and 100MHz specified in Table 7.3.2.1-2.

Unless given by Table 7.3.2.1-3, the minimum requirements for reference sensitivity shall be verified with the network signalling value NS\_200 (Table 6.2.3-1) configured.

## 7.3A Reference sensitivity for DL CA

### 7.3A.1 General

### 7.3A.2 Reference sensitivity power level for CA

#### 7.3A.2.1 Intra-band contiguous CA

For each component carrier in the intra-band contiguous carrier aggregation, the throughput in QPSK  $R = 1/3$  shall be  $\geq 95\%$  of the maximum throughput of the reference measurement channels as specified in Annexes A.2.3.2 and A.3.3.2 (with one sided dynamic OCNB Pattern OP.1 TDD for the DL-signal as described in Annex A.5.2.1) with peak reference sensitivity values determined from clause 7.3.2, and relaxation applied to peak reference sensitivity requirement as specified in Table 7.3A.2.1-1.

**Table 7.3A.2.1-1:  $\Delta R_{IBC}$  EIS Relaxation for CA operation by aggregated channel bandwidth**

Aggregated Channel BW 'BW <sub>Channel_CA</sub> ' (MHz)	$\Delta R_{IBC}$ (dB)
$BW_{Channel\_CA} \leq 800$	0.0
$800 < BW_{Channel\_CA} \leq 1200$	0.5
$1200 < BW_{Channel\_CA} \leq 1600$	1.0
$1600 < BW_{Channel\_CA} \leq 2000$	1.5

#### 7.3A.2.2 Intra-band non-contiguous CA

For each component carrier in the intra-band non-contiguous carrier aggregation, the throughput shall be  $\geq 95\%$  of the maximum throughput of the reference measurement channels as specified in Annexes A.2.3.2 and A.3.3.2 (with one sided dynamic OCNB Pattern OP.1 TDD for the DL-signal as described in Annex A.5.2.1) with peak reference sensitivity values determined from clause 7.3.2, and relaxation applied to peak reference sensitivity requirement as specified in Table 7.3A.2.2-1. The configured downlink spectrum is defined as the frequency band from the lowest edge of the lowest CC to the upper edge of the highest CC of all UL and DL configured CCs.

**Table 7.3A.2.2-1:  $\Delta R_{IBNC}$  EIS Relaxation for CA operation**

Configured DL spectrum (MHz)	$\Delta R_{IBNC}$ (dB)
$\leq 800$	0.0
$> 800$ and $\leq 1400$	0.5
$> 1400$ and $\leq 2400$	1.5

### 7.3A.2.3 Inter-band CA

The inter-band requirement applies for all active component carriers. The throughput for each component carrier shall be  $\geq 95$  % of the maximum throughput of the reference measurement channels as specified in Annexes A.2.3.2 and A.3.3.2 (with one sided dynamic OCN Pattern OP.1 TDD for the DL-signal as described in Annex A.5.2.1) with peak reference sensitivity for each carrier specified in section 7.3.2, and relaxation  $\Delta R_{IB,P,n}$  applied to peak reference sensitivity requirement.  $\Delta R_{IB,P,n}$  is specified in Table 7.3A.2.3-1. The requirement on each component carrier shall be met when the power in the component carrier in the other band is set to its EIS spherical coverage requirement for inter-band CA specified in sub-clause 7.3A.3.3.

For the combination of intra-band and inter-band carrier aggregation, the intra-band CA relaxation,  $\Delta R_{IBC}$  and  $\Delta R_{IBNC}$ , are also applied according to the clause 7.3A.2.1 and 7.3A.2.2.

**Table 7.3A.2.3-1:  $\Delta R_{IB,P,n}$  reference sensitivity relaxation for inter-band CA**

NR CA band combinations	NR band	$\Delta R_{IB,P,n}$ (dB)			
		PC1	PC2	PC3	PC5
CA_n257-n259	n257		3.5	4.0	3.0
	n259		3.5	4.0	3.0
CA_n258-n260	n258			3.5	
	n260			3.5	
CA_n258-n261	n258			3.5	
	n261			3.5	
CA_n260-n261	n260	2.5		3.5	
	n261	2.5		3.5	

Note: For each power class, band combinations without specified  $\Delta R_{IB,P,n}$  are not enabled for inter-band downlink carrier aggregation in this release.

### 7.3A.3 EIS spherical coverage for DL CA

7.3A.3.1 Void

7.3A.3.2 Void

#### 7.3A.3.3 EIS spherical coverage for inter-band CA

The inter-band CA requirement applies per operating band, for all active component carriers with UL assigned to one band and one DL component carrier per band. The requirement on each component carrier shall be met when the power in the component carrier in the other band is set to its EIS spherical coverage requirement for inter-band CA specified in this sub-clause.

The inter-band CA spherical coverage requirement for each power class will be satisfied if the intersection set of spherical coverage areas exceeds the common coverage requirement. Intersection set of spherical coverage areas is defined as a fraction of area of full sphere measured around the UE where both bands meet their defined individual EIS spherical coverage requirements for inter-band CA operation. The common coverage requirement is determined as  $\langle 100\text{-percentile rank} \rangle \%$ , where 'percentile rank' is the percentile value in the specification of spherical coverage for that power class from clause 7.3.4. The requirement is verified with the test metric of EIS (Link=Beam peak search grids, Meas=Link angle).

The reference measurement channels and throughput criterion shall be as specified in clause 7.3A.2.3. The requirement shall be met for an uplink transmission using QPSK DFT-s-OFDM waveforms and for uplink transmission bandwidth less than or equal to that specified in clause 7.3.2.

Unless otherwise specified, the minimum requirements for reference sensitivity shall be verified with the network signalling value NS\_200 (Table 6.2.3.1-1) configured.

The required spherical coverage EIS for each band in inter-band CA operation is given in clause 7.3.4 and modified by  $\Delta R_{IB,S,n}$ . The value of  $\Delta R_{IB,S,n}$  is defined in Table 7.3A.3.3-1.

**Table 7.3A.3.3-1:  $\Delta R_{IB,S,n}$  EIS spherical coverage requirement relaxation for inter-band CA**

NR CA band combination	NR band	$\Delta R_{IB,S,n}$ (dB)			
		PC1	PC2	PC3	PC5
CA_n257-n259	n257		3.5	3.5	[2.5]
	n259		3.5	3.5	[2.5]
CA_n258-n260	n258			3.5	
	n260			3.5	
CA_n258-n261	n258			3.5	
	n261			3.5	
CA_n260-n261	n260	[2.5]		3.5	
	n261	[2.5]		3.5	

Note: For each power class, band combinations without specified  $\Delta R_{IB,S,n}$  are not enabled for inter-band downlink carrier aggregation in this release.

### 7.3D Void

## 7.4 Maximum input level

The maximum input level is defined as the maximum mean power, for which the throughput shall meet or exceed the minimum requirements for the specified reference measurement channel.

The maximum input level is defined as a directional requirement. The requirement is verified in beam locked mode in the direction where peak gain is achieved.

The throughput shall be  $\geq 95\%$  of the maximum throughput of the reference measurement channels as specified in Annex A (with one sided dynamic OCNG Pattern OP.1 TDD for the DL-signal as described in Annex A.5.2.1) with parameters specified in Table 7.4.-1. The requirement is verified with the test metric of EIS (Link=RX beam peak direction, Meas=Link angle).

**Table 7.4-1: Maximum input level**

Rx Parameter	Units	Channel bandwidth						
		50 MHz	100 MHz	200 MHz	400 MHz	800 MHz	1600 MHz	2000 MHz
Power in transmission bandwidth configuration	dBm	-25 (NOTE 2)						
		-27 (NOTE 3)						
NOTE 1: The transmitter shall be set to 4 dB below the $P_{UMAX,f,c}$ as defined in clause 6.2.4, with uplink configuration specified in Table 7.3.2.1-2.								
NOTE 2: Reference measurement channel is specified in Annex A.3.3.2: QPSK, R=1/3 variant with one sided dynamic OCNG Pattern as described in Annex A.								
NOTE 3: Reference measurement channel is specified in Annex A.3.3.5: 256QAM, R=4/5 variant with one sided dynamic OCNG Pattern as described in Annex A.								

**Table 7.4-2: Void**

## 7.4A Maximum input level for DL CA

Table 7.4A-1: Void

Table 7.4A-2: Void

### 7.4A.1 Maximum input level for Intra-band contiguous CA

For intra-band contiguous carrier aggregation the input level is defined as the cumulative received power, summed over the transmission bandwidth configurations of each active DL CC. All DL CCs shall be active throughout the test. The input power shall be distributed among the active DL CCs so their PSDs are aligned with each other. At the maximum input level, the specified relative throughput shall meet or exceed the minimum requirements for the specified reference measurement channel over each component carrier. The minimum requirement is specified in Table 7.4A-1.

The maximum input level is defined as a directional requirement. The requirement is verified in beam locked mode in the direction where peak gain is achieved. The requirement is verified with the test metric of EIS (Link=RX beam peak direction, Meas=Link angle).

**Table 7.4A.1-1: Maximum input level for Intra-band contiguous CA**

Rx Parameter	Units	Level
Power summed over transmission bandwidth configurations of all active DL CCs	dBm	-25 (NOTE 2) -27 (NOTE 3)
NOTE 1: The transmitter shall be set to 4 dB below the $P_{UMAX,f,c}$ as defined in clause 6.2.4, with uplink configuration specified in Table 7.3.2.1-2		
NOTE 2: Reference measurement channel in each CC is specified in Annex A.3.3.2: QPSK, R=1/3 variant with one sided dynamic OCNG Pattern as described in Annex A.		
NOTE 3: Reference measurement channel is specified in Annex A.3.3.5: 256QAM, R=4/5 variant with one sided dynamic OCNG Pattern as described in Annex A.		

### 7.4A.2 Maximum input level for Intra-band non-contiguous CA

For intra-band non-contiguous carrier aggregation the requirement of section 7.4A.1 applies

### 7.4A.3 Maximum input level for Inter-band CA

For inter-band carrier aggregation with one component carrier per operating band and the uplink assigned to one NR band, the maximum input level is defined with the uplink active on the band other than the band whose downlink is being tested. The UE shall meet the requirements specified in clause 7.4 for each component carrier while all downlink carriers are active.

For the combination of intra-band and inter-band carrier aggregation and uplink carrier(s) assigned to one NR band, the requirement is defined with the uplink active on the band other than the band whose downlink is being tested. The UE shall meet the requirements specified in clause 7.4A.1 and 7.4A.2 for each band while all downlink carriers are active.

## 7.4D Void

## 7.5 Adjacent channel selectivity

Adjacent Channel Selectivity (ACS) is a measure of a receiver's ability to receive a NR signal at its assigned channel frequency in the presence of an adjacent channel signal at a given frequency offset from the centre frequency of the assigned channel. ACS is the ratio of the receive filter attenuation on the assigned channel frequency to the receive filter attenuation on the adjacent channel(s).



The requirement applies at the RIB when the AoA of the incident wave of the wanted signal and the interfering signal are both from the direction where peak gain is achieved.

The wanted and interfering signals apply to all supported polarizations, under the assumption of polarization match.

The UE shall fulfil the minimum requirement specified in Table 7.5-1 for all values of an adjacent channel interferer up to -25 dBm. However, it is not possible to directly measure the ACS, instead the lower and upper range of test parameters are chosen in Table 7.5-2 and Table 7.5-3 where the throughput shall be ≥ 95 % of the maximum throughput of the reference measurement channels as specified in Annexes A.2.3.2 and A.3.3.2, with one sided dynamic OCNG Pattern OP.1 TDD for the DL-signal as described in Annex A.5.2.1. The requirement is verified with the test metric of EIS (Link=RX beam peak direction, Meas=Link angle).

**Table 7.5-1: Adjacent channel selectivity**

Operating band	Units	Adjacent channel selectivity / Channel bandwidth						
		50 MHz	100 MHz	200 MHz	400 MHz	800 MHz	1600 MHz	2000 MHz
n257, n258, n261	dB	23	23	23	23	N/A	N/A	N/A
n259, n260, n262	dB	22	22	22	22	N/A	N/A	N/A
n263	dB	N/A	21	N/A	21	20	20	20

**Table 7.5-2: Adjacent channel selectivity test parameters, Case 1**

Rx Parameter	Units	Channel bandwidth						
		50 MHz	100 MHz	200 MHz	400 MHz	800 MHz	1600 MHz	2000 MHz
Power in Transmission Bandwidth Configuration	dBm	REFSENS + 14 dB						
P <sub>Interferer</sub> for band n257, n258, n261	dBm	REFSENS + 35.5 dB	REFSENS +35.5 dB	REFSENS +35.5 dB	REFSENS +35.5 dB	N/A	N/A	N/A
P <sub>Interferer</sub> for band n259, n260, n262	dBm	REFSENS + 34.5 dB	REFSENS +34.5 dB	REFSENS +34.5 dB	REFSENS +34.5 dB	N/A	N/A	N/A
P <sub>Interferer</sub> for band n263	dBm	N/A	REFSENS +33.5 dB	N/A	REFSENS +33.5 dB	REFSENS + 32.5 dB	REFSENS + 32.5 dB	REFSENS + 32.5 dB
BW <sub>Interferer</sub>	MHz	50	100	200	400			
F <sub>Interferer</sub> (offset)	MHz	50 / -50 NOTE 3	100 / -100 NOTE 3	200 / -200 NOTE 3	400 / -400 NOTE 3	800 / -800 NOTE 3	1600 / -1600 NOTE 3	2000 / -2000 NOTE 3
<p>NOTE 1: The interferer consists of the Reference measurement channel specified in Annex A.3.3.2 with one sided dynamic OCNG Pattern OP.1 TDD as described in Annex A.5.2.1 and set-up according to Annex C.</p> <p>NOTE 2: The REFSENS power level is specified in Clause 7.3.2, which are applicable to different UE power classes.</p> <p>NOTE 3: The absolute value of the interferer offset F<sub>Interferer</sub> (offset) shall be further adjusted to (CEIL( F<sub>Interferer</sub>(offset) /SCS) + 0.5)*SCS MHz with SCS the sub-carrier spacing of the wanted signal in MHz. Wanted and interferer signal have same SCS.</p> <p>NOTE 4: The transmitter shall be set to 4 dB below the P<sub>UMAX,f,c</sub> as defined in clause 6.2.4, with uplink configuration specified in Table 7.3.2.1-2.</p>								

Table 7.5-3: Adjacent channel selectivity test parameters, Case 2

Rx Parameter	Units	Channel bandwidth						
		50 MHz	100 MHz	200 MHz	400 MHz	800 MHz	1600 MHz	2000 MHz
Power in Transmission Bandwidth Configuration for band n257, n258, n261	dBm	-46.5	-46.5	-46.5	-46.5	N/A	N/A	N/A
Power in Transmission Bandwidth Configuration for band n259, n260, n262	dBm	-45.5	-45.5	-45.5	-45.5	N/A	N/A	N/A
Power in Transmission Bandwidth Configuration for band n263	dBm	N/A	-44.5	N/A	-44.5	-43.5	-43.5	-43.5
$P_{\text{Interferer}}$	dBm	-25						
$BW_{\text{Interferer}}$	MHz	50	100	200	400	800	1600	2000
$F_{\text{Interferer}}$ (offset)	MHz	50 / -50 NOTE 2	100 / -100 NOTE 2	200 / -200 NOTE 2	400 / -400 NOTE 2	800 / -800 NOTE 2	1600 / -1600 NOTE 2	2000 / -2000 NOTE 2
<p>NOTE 1: The interferer consists of the Reference measurement channel specified in Annex A.3.3.2 with one sided dynamic OCNG Pattern OP.1 TDD as described in Annex A.5.2.1 and set-up according to Annex C.</p> <p>NOTE 2: The absolute value of the interferer offset <math>F_{\text{Interferer}}</math> (offset) shall be further adjusted to <math>(\text{CEIL}( F_{\text{Interferer}}(\text{offset}) /\text{SCS}) + 0.5) * \text{SCS}</math> MHz with SCS the sub-carrier spacing of the wanted signal in MHz. Wanted and interferer signal have same SCS.</p> <p>NOTE 3: The transmitter shall be set to 4 dB below the <math>P_{\text{UMAX},f,c}</math> as defined in clause 6.2.4, with uplink configuration specified in Table 7.3.2.1-2.</p>								

## 7.5A Adjacent channel selectivity for DL CA

Table 7.5A-1: Void

Table 7.5A-2: Void

Table 7.5A-3: Void

### 7.5A.1 Adjacent channel selectivity for Intra-band contiguous CA

For intra-band contiguous carrier aggregation, the SCC(s) shall be configured at nominal channel spacing to the PCC. The input power shall be distributed among the active DL CCs so their PSDs are aligned with each other. The UE shall fulfil the minimum requirement specified in Table 7.5A.1-1 for an adjacent channel interferer on either side of the aggregated downlink signal at a specified frequency offset and for an interferer power up to -25 dBm.

The throughput of each carrier shall be  $\geq 95\%$  of the maximum throughput of the reference measurement channels as specified in Annexes A.2.3.2 and A.3.3.2 (with one sided dynamic OCNG Pattern OP.1 TDD for the DL-signal as described in Annex A.5.2.1). The requirement is verified with the test metric of EIS (Link=RX beam peak direction, Meas=Link angle).

**Table 7.5A.1-1: Adjacent channel selectivity for intra-band contiguous CA**

Operating band	Units	Adjacent channel selectivity / CA bandwidth class
		All CA bandwidth class
n257, n258, n261	dB	23
n259, n260, n262	dB	22
n263	dB	21 for $BW_{\text{Channel\_CA}} \leq 400$ MHz. 20 for $BW_{\text{Channel\_CA}} > 400$ MHz.

**Table 7.5A.1-2: Adjacent channel selectivity test parameters for intra-band contiguous CA, Case 1**

Rx Parameter	Units	All CA bandwidth Classes
Pw in Transmission Bandwidth Configuration, per CC		REFSENS + 14 dB
$P_{\text{Interferer}}$ for band n257, n258, n261	dBm	Aggregated power + 21.5
$P_{\text{Interferer}}$ for band n259, n260, n262	dBm	Aggregated power + 20.5
$P_{\text{Interferer}}$ for band n263	dBm	Aggregated power + 19.5 for $BW_{\text{Channel\_CA}} \leq 400$ MHz. Aggregated power + 18.5 for $BW_{\text{Channel\_CA}} > 400$ MHz.
$BW_{\text{Interferer}}$	MHz	$BW_{\text{Channel\_CA}}$
$F_{\text{Interferer}}$ (offset)	MHz	+ $BW_{\text{channel CA}}$ / - $BW_{\text{channel CA}}$  NOTE 3
<p>NOTE 1: The interferer consists of the Reference measurement channel specified in Annex .3.3.2 with one sided dynamic OCNG Pattern OP.1 TDD as described in Annex A.5.2.1 and set-up according to Annex C.</p> <p>NOTE 2: The <math>F_{\text{interferer}}</math> (offset) is the frequency separation between the center of the aggregated CA bandwidth and the center frequency of the Interferer signal</p> <p>NOTE 3: The absolute value of the interferer offset <math>F_{\text{Interferer}}</math> (offset) shall be further adjusted to <math>(\text{CEIL}( F_{\text{Interferer}}(\text{offset}) /\text{SCS}) + 0.5) * \text{SCS}</math> MHz with SCS the sub-carrier spacing of the carrier closest to the interferer in MHz. The interfering signal has the same SCS as that of the closest carrier.</p> <p>NOTE 4: The transmitter shall be set to 4 dB below the <math>P_{\text{UMAX,f,c}}</math> as defined in clause 6.2.4, with uplink configuration specified in Table 7.3.2.1-2.</p>		

**Table 7.5A.1-3: Adjacent channel selectivity test parameters for intra-band contiguous CA, Case 2**

Rx Parameter	Units	All CA bandwidth classes
Pw in Transmission Bandwidth Configuration, aggregated power for band n257, n258, n261	dBm	- 46.5
Pw in Transmission Bandwidth Configuration, aggregated power for band n259, n260, n262	dBm	- 45.5
Pw in Transmission Bandwidth Configuration, aggregated power for band n263	dBm	-44.5 for $BW_{\text{Channel\_CA}} \leq 400$ MHz -43.5 for $BW_{\text{Channel\_CA}} > 400$ MHz.
$P_{\text{Interferer}}$	dBm	- 25
$BW_{\text{Interferer}}$	MHz	$BW_{\text{Channel\_CA}}$
$F_{\text{Interferer}}$ (offset)	MHz	+ $BW_{\text{channel CA}}$ / - $BW_{\text{channel CA}}$  NOTE 3

NOTE 1:	The interferer consists of the Reference measurement channel specified in Annex A.3.3.2 with one sided dynamic OCN Pattern OP.1 TDD as described in Annex A.5.2.1 and set-up according to Annex C.
NOTE 2:	The $F_{\text{interferer}}$ (offset) is the frequency separation between the center of the aggregated CA bandwidth and the center frequency of the Interferer signal
NOTE 3:	The absolute value of the interferer offset $F_{\text{interferer}}$ (offset) shall be further adjusted to $(\text{CEIL}( F_{\text{interferer}}(\text{offset}) /\text{SCS}) + 0.5) * \text{SCS}$ MHz with SCS the sub-carrier spacing of the carrier closest to the interferer in MHz. The interfering signal has the same SCS as that of the closest carrier.
NOTE 4:	The transmitter shall be set to 4 dB below the $P_{\text{UMAX},f,c}$ as defined in clause 6.2.4, with uplink configuration specified in Table 7.3.2.1-2.

## 7.5A.2 Adjacent channel selectivity for Intra-band non-contiguous CA

For intra-band non-contiguous carrier aggregation with two component carriers, two different requirements apply for out-of-gap and in-gap. For out-of-gap, the UE shall meet the requirements for each component carrier as specified in clauses 7.5. For in-gap, the requirement applies if the following minimum gap condition is met:

$$\Delta f_{\text{ACS}} \geq \text{BW}_1/2 + \text{BW}_2/2 + \max(\text{BW}_1, \text{BW}_2),$$

where  $\Delta f_{\text{ACS}}$  is the frequency separation between the center frequencies of the component carriers and  $\text{BW}_k$  are the channel bandwidths of carrier  $k$ ,  $k = 1, 2$ .

If the minimum gap condition is met, the UE shall meet the requirements specified in clauses 7.5 for each component carrier considered. The respective channel bandwidth of the component carrier under test will be used in the parameter calculations of the requirement. In case of more than two component carriers, the minimum gap condition is computed for any pair of adjacent component carriers following the same approach as the two component carriers. The in-gap requirement for the corresponding pairs shall apply if the minimum gap condition is met.

For every component carrier to which the requirements apply, the UE shall meet the requirement with one active interferer signal (in-gap or out-of-gap) while all downlink carriers are active and the input power shall be distributed among the active DL CCs so their PSDs are aligned with each other.

## 7.5A.3 Adjacent channel selectivity for Inter-band CA

For inter-band carrier aggregation with one component carrier per operating band and the uplink assigned to one NR band, the adjacent channel requirements are defined with the uplink active on the band other than the band whose downlink is being tested. The UE shall meet the requirements specified in clause 7.5 for each component carrier while all downlink carriers are active. The requirement does not apply if the interferer of the band being tested overlaps any part of the component carrier on the other band.

For the combination of intra-band and inter-band carrier aggregation and uplink carrier(s) assigned to one NR band, the requirement is defined with the uplink active on the band other than the band whose downlink is being tested. The UE shall meet the requirements specified in clauses 7.5A.1 and 7.5A.2 for each band while all downlink carriers are active.

## 7.5D Void

## 7.6 Blocking characteristics

### 7.6.1 General

The blocking characteristic is a measure of the receiver's ability to receive a wanted signal at its assigned channel frequency in the presence of an unwanted interferer on frequencies other than those of the spurious response or the adjacent channels, without this unwanted input signal causing a degradation of the performance of the receiver beyond a specified limit. The blocking performance shall apply at all frequencies except those at which a spurious response occurs.

The requirement applies at the RIB when the AoA of the incident wave of the wanted signal and the interfering signal are both from the direction where peak gain is achieved.

The wanted and interfering signals apply to all supported polarizations, under the assumption of polarization match.

### 7.6.2 In-band blocking

In-band blocking is a measure of a receiver's ability to receive a NR signal at its assigned channel frequency in the presence of an interferer at a given frequency offset from the centre frequency of the assigned channel.

The throughput shall be  $\geq 95\%$  of the maximum throughput of the reference measurement channels as specified in Annexes A.2.3.2 and A.3.3.2 (with one sided dynamic OCNG Pattern OP.1 TDD for the DL-signal as described in Annex A.5.2.1). The requirement is verified with the test metric of EIS (Link=RX beam peak direction, Meas=Link angle).

**Table 7.6.2-1: In band blocking requirements**

Rx parameter	Units	Channel bandwidth						
		50 MHz	100 MHz	200 MHz	400 MHz	800 MHz	1600 MHz	2000 MHz
Power in Transmission Bandwidth Configuration	dBm	REFSENS + 14 dB						
$BW_{Interferer}$	MHz	50	100	200	400	800	1600	2000
$P_{Interferer}$ for bands n257, n258, n261	dBm	REFSENS + 35.5 dB	REFSENS + 35.5 dB	REFSENS + 35.5 dB	REFSENS + 35.5 dB	N/A	N/A	N/A
$P_{Interferer}$ for bands n259, n260, n262	dBm	REFSENS + 34.5 dB	REFSENS + 34.5 dB	REFSENS + 34.5 dB	REFSENS + 34.5 dB	N/A	N/A	N/A
$P_{Interferer}$ for band n263	dBm	N/A	REFSENS + 33.5 dB	N/A	REFSENS + 33.5 dB	REFSENS + 33.5 dB	REFSENS + 33.5 dB	REFSENS + 33.5 dB
$F_{Interferer}$ (offset)	MHz	$\leq -100$ & $\geq 100$ NOTE 5	$\leq -200$ & $\geq 200$ NOTE 5	$\leq -400$ & $\geq 400$ NOTE 5	$\leq -800$ & $\geq 800$ NOTE 5	$\leq -1600$ & $\geq 1600$ NOTE 5	$\leq -3200$ & $\geq 3200$	$\leq -4000$ & $\geq 4000$
$F_{Interferer}$	MHz	$F_{DL\_low} + 25$ to $F_{DL\_high} - 25$	$F_{DL\_low} + 50$ to $F_{DL\_high} - 50$	$F_{DL\_low} + 100$ to $F_{DL\_high} - 100$	$F_{DL\_low} + 200$ to $F_{DL\_high} - 200$	$F_{DL\_low} + 400$ to $F_{DL\_high} - 400$	$F_{DL\_low} + 800$ to $F_{DL\_high} - 800$	$F_{DL\_low} + 1600$ to $F_{DL\_high} - 1600$
NOTE 1: The interferer consists of the Reference measurement channel specified in Annex A.3.3.2 with one sided dynamic OCNG Pattern OP.1. TDD as described in Annex A.5.2.1 and set-up according to Annex C.								
NOTE2: The REFSENS power level is specified in Clause 7.3.2, which are applicable according to different UE power classes.								
NOTE 3: The wanted signal consists of the reference measurement channel specified in Annex A.3.3.2 with one sided dynamic OCNG pattern OP.1 TDD as described in Annex A.5.2.1 and set-up according to Annex C.								
NOTE 4: Void								
NOTE 5: The absolute value of the interferer offset $F_{Interferer}$ (offset) shall be further adjusted $(\text{CEIL}( F_{Interferer}(\text{offset}) /\text{SCS}) + 0.5) * \text{SCS}$ MHz with SCS the sub-carrier spacing of the wanted signal in MHz. Wanted and interferer signal have same SCS.								
NOTE 6: $F_{Interferer}$ range values for unwanted modulated interfering signals are interferer center frequencies.								
NOTE 7: The transmitter shall be set to 4 dB below the $P_{UMAX,f,c}$ as defined in clause 6.2.4, with uplink configuration specified in Table 7.3.2.1-2.								

### 7.6.3 Void

## 7.6A Blocking characteristics for DL CA

### 7.6A.1 General

### 7.6A.2 In-band blocking

**Table 7.6A.2-1: Void**

**Table 7.6A.2-2: Void**

7.6A.2.1 In-band blocking for Intra-band contiguous CA For intra-band contiguous carrier aggregation, the SCC(s) shall be configured at nominal channel spacing to the PCC. The input power shall be distributed among the active DL CCs so their PSDs are aligned with each other. The UE shall fulfil the minimum requirement specified in Table 7.6A.2-1 for in the presence of an interferer at a given frequency offset from the centre frequency of the assigned channel and an interferer power shall not exceed -25 dBm. The throughput of each carrier shall be  $\geq 95\%$  of the maximum throughput of the reference measurement channels as specified in Annexes A.2.3.2 and A.3.3.2 (with one sided dynamic OCNG Pattern OP.1 TDD for the DL-signal as described in Annex A.5.2.1). The requirement is verified with the test metric of EIS (Link=RX beam peak direction, Meas=Link angle).

**Table 7.6A.2.1-1: In band blocking minimum requirements for intra-band contiguous CA**

Rx Parameter	Units	All CA bandwidth classes
Power in Transmission Bandwidth Configuration, per CC	dBm	REFSENS + 14 dB
Pinterferer for bands n257, n258, n261	dBm	Aggregated power + 21.5 dB
Pinterferer for bands n260, n262	dBm	Aggregated power + 20.5 dB
Pinterferer for band n263	dBm	Aggregated power + 19.5 dB
BW <sub>Interferer</sub>	MHz	BW <sub>Channel_CA</sub>
F <sub>Interferer</sub> (offset)	MHz	+2*BW <sub>Channel_CA</sub> / -2*BW <sub>Channel_CA</sub>  NOTE 5
F <sub>Interferer</sub>	MHz	F <sub>DL_low</sub> + 0.5*BW <sub>Channel_CA</sub> To F <sub>DL_high</sub> - 0.5*BW <sub>Channel_CA</sub>
<p>NOTE 1: The interferer consists of the Reference measurement channel specified in Annex A.3.3.2 with one sided dynamic OCNG Pattern OP.1 TDD as described in Annex A.5.2.1. and set-up according to Annex C.</p> <p>NOTE 2: The REFSENS power level is specified in Table 7.3.2-1.</p> <p>NOTE 3: The wanted signal consists of the reference measurement channel specified in Annex A.3.3.2 QPSK, R=1/3 with one sided dynamic OCNG pattern OP.1 TDD as described in Annex A.5.2.1 and set-up according to Annex C.</p> <p>NOTE 4: The F<sub>Interferer</sub> (offset) is the frequency separation between the center of the aggregated CA bandwidth and the center frequency of the Interferer signal.</p> <p>NOTE 5: The absolute value of the interferer offset F<sub>Interferer</sub> (offset) shall be further adjusted to (CEIL( F<sub>Interferer</sub>(offset) /SCS) + 0.5)*SCS MHz with SCS the sub-carrier spacing of the carrier closest to the interferer in MHz. The interfering signal has the same SCS as that of the closest carrier.</p> <p>NOTE 6: F<sub>Interferer</sub> range values for unwanted modulated interfering signals are interferer center frequencies.</p> <p>NOTE 7: The transmitter shall be set to 4 dB below the P<sub>UMAX,f,c</sub> as defined in clause 6.2.4, with uplink configuration specified in Table 7.3.2.1-2.</p>		

### 7.6A.2.2 In-band blocking for Intra-band non-contiguous CA

For intra-band non-contiguous carrier aggregation with two component carriers, the requirement applies to out-of-gap and in-gap. For out-of-gap, the UE shall meet the requirements for each component carrier with parameters as specified

in 7.6.2-1. The requirement associated to the maximum channel between across the component carriers is selected. For in-gap, the requirement shall apply if the following minimum gap condition is met:

$$\Delta f_{IBB} \geq 0.5(BW_1 + BW_2) + 2 \max(BW_1, BW_2),$$

where  $\Delta f_{IBB}$  is the frequency separation between the center frequencies of the component carriers and  $BW_k$  are the channel bandwidths of carrier  $k$ ,  $k = 1, 2$ .

If the minimum gap condition is met, the UE shall meet the requirement specified in Table 7.6.2-1 for each component carrier. The respective channel bandwidth of the component carrier under test will be used in the parameter calculations of the requirement. In case of more than two component carriers, the minimum gap condition is computed for any pair of adjacent component carriers following the same approach as the two component carriers. The in-gap requirement for the corresponding pairs shall apply if the minimum gap condition is met. For every component carrier to which the requirements apply, the UE shall meet the requirement with one active interferer signal (in-gap or out-of-gap) while all downlink carriers are active and the input power shall be distributed among the active DL CCs so their PSDs are aligned with each other.

### 7.6A.2.3 In-band blocking for Inter-band CA

For inter-band carrier aggregation with one component carrier per operating band and the uplink assigned to one NR band, the in-band blocking requirements are defined with the uplink active on the band other than the band whose downlink is being tested. The UE shall meet the requirements specified in clause 7.6.2 for each component carrier while all downlink carriers are active. The requirement does not apply if the interferer of the band being tested overlaps any part of the component carrier on the other band.

For the combination of intra-band and inter-band carrier aggregation and uplink carrier(s) assigned to one NR band, the requirement is defined with the uplink active on the band other than the band whose downlink is being tested. The UE shall meet the requirements specified in clauses 7.6A.2.1 and 7.6A.2.2 for each band while all downlink carriers are active.

7.6D Void

7.7 Void

7.8 Void

## 7.9 Spurious emissions

The spurious emissions power is the power of emissions generated or amplified in a receiver. The spurious emissions power level is measured as TRP.

The power of any narrow band CW spurious emission shall not exceed the maximum level specified in Table 7.9-1. The requirement is verified in beam locked mode with the test metric of TRP (Link=TX beam peak direction, Meas=TRP grid).

**Table 7.9-1: General receiver spurious emission requirements**

Frequency range	Measurement bandwidth	Maximum level	NOTE
$30\text{MHz} \leq f < 1\text{GHz}$	100 kHz	-57 dBm (NOTE 2)	1
$1\text{GHz} \leq f \leq 2^{\text{nd}}$ harmonic of the upper frequency edge of the DL operating band in GHz	1 MHz	-47 dBm (NOTE 3)	
NOTE 1: Unused PDCCH resources are padded with resource element groups with power level given by PDCCH as defined in Annex C.3.1.			
NOTE 2: This maximum level does not apply for Band n263 for which -36 dBm applies.			
NOTE 3: This maximum level does not apply for Band n263 for which -30 dBm applies.			

## 7.10 Void



---

## Annex A (normative): Measurement channels

---

### A.1 General

---

### A.2 UL reference measurement channels

#### A.2.1 General

#### A.2.2 Void

### A.2.3 Reference measurement channels for TDD

For UL RMCs defined below, TDD slot pattern defined in Table A.2.3-1 will be used for the requirements requiring at least one sub frame (1ms) for the measurement period. For other requirements, TDD slot patterns defined for reference sensitivity tests in Table A.3.3.1-1 will be used.

**Table A.2.3-1: Additional reference channels parameters for TDD**

Parameter		Value			
		SCS 60 kHz ( $\mu=2$ )	SCS 120 kHz ( $\mu=3$ )	SCS 480 kHz ( $\mu=5$ )	SCS 960 kHz ( $\mu=6$ )
<b>TDD Slot Configuration pattern (Note 1)</b>		<b>DDDSUUUU</b>	<b>7DS8U</b>	<b>31DS32U</b>	<b>63DS64U</b>
<b>Special Slot Configuration (Note 2)</b>		<b>S=4D+6G+4U</b>	<b>S=12D+2G</b>	<b>S=2D+12G</b>	<b>S=2D+12G</b>
<b>referenceSubcarrierSpacing</b>		<b>60 kHz</b>	<b>120 kHz</b>	<b>480 kHz</b>	<b>960 kHz</b>
UL-DL configuration	<i>dl-UL-TransmissionPeriodicity</i>	2 ms	2 ms	2 ms	2ms
	<i>nrofDownlinkSlots</i>	3	7	31	63
	<i>nrofDownlinkSymbols</i>	4	12	2	2
	<i>nrofUplinkSlot</i>	4	8	32	64
	<i>nrofUplinkSymbols</i>	4	0	0	0
Indexes of active UL slots		$\text{mod}(\text{slot index}, 40) = \{36, \dots, 39\}$	$\text{mod}(\text{slot index}, 80) = \{72, \dots, 79\}$	$\text{mod}(\text{slot index}, 320) = \{288, \dots, 319\}$	$\text{mod}(\text{slot index}, 640) = \{576, \dots, 639\}$
Indexes of active UL slots for UL Gap test		$\text{mod}(\text{slot index}, 40) = \{12, \dots, 15, 36, \dots, 39\}$	$\text{mod}(\text{slot index}, 80) = \{24, \dots, 31, 72, \dots, 79\}$		
Indexes of the UL slots for UL Gap when UL gap pattern configuration 3 (IE <i>UL-GapFR2-Config-r17</i> ) is configured		$\text{mod}(\text{slot index}, 40) = \{7, 28\}$	$\text{mod}(\text{slot index}, 80) = \{15, 56\}$		
Indexes of the UL slots for UL Gap when UL gap pattern configuration 1 (IE <i>UL-GapFR2-Config-r17</i> ) is configured		$\text{mod}(\text{slot index}, 160) = \{20, 21, 22, 23, 28, 29, 30, 31\}$	$\text{mod}(\text{slot index}, 320) = \{8, \dots, 15\}$		

NOTE 1: D denotes a slot with all DL symbols; S denotes a slot with a mix of DL, UL and guard symbols; U denotes a slot with all UL symbols. The field is for information.

NOTE 2: D, G, U denote DL, guard and UL symbols, respectively. The field is for information.

#### A.2.3.1 DFT-s-OFDM Pi/2-BPSK

**Table A.2.3.1-1: Reference Channels for DFT-s-OFDM pi/2-BPSK**

Parameter	Allocated resource blocks (L <sub>CRB</sub> )	DFT-s-OFDM Symbols per slot (Note 1)	Modulation	MCS Index (Note 2)	Payload size	Transport block CRC	LDPC Base Graph	Number of code blocks per slot (Note 3)	Total number of bits per slot	Total modulated symbols per slot
Unit					Bits	Bits			Bits <sup>9</sup>	
	1	11	pi/2 BPSK	0	24	16	2	1	132	132
	16	11	pi/2 BPSK	0	504	16	2	1	2112	2112
	32	11	pi/2 BPSK	0	1032	16	2	1	4224	4224
	60	11	pi/2 BPSK	0	1864	16	2	1	7920	7920
	64	11	pi/2 BPSK	0	2024	16	2	1	8448	8448
	120	11	pi/2 BPSK	0	3752	16	2	1	15840	15840
	128	11	pi/2 BPSK	0	3976	24	2	2	16896	16896
	144	11	pi/2 BPSK	0	4488	24	2	2	19008	19008
	243	11	pi/2 BPSK	0	7560	24	2	2	32076	32076
	256	11	pi/2 BPSK	0	7944	24	2	3	33792	33792

NOTE 1: PUSCH mapping Type-A and single-symbol DM-RS configuration Type-1 with 2 additional DM-RS symbols, such that the DM-RS positions are set to symbols 2, 7, 11. DMRS is [TDM'ed] with PUSCH data. DM-RS symbols are not counted.

NOTE 2: MCS Index is based on MCS table 6.1.4.1-1 defined in 38.214.

NOTE 3: If more than one Code Block is present, an additional CRC sequence of L = 24 Bits is attached to each Code Block (otherwise L = 0 Bit)

NOTE 4: Indexes of active UL slots are given by Table A.2.3-1 with TDD UL-DL configuration specified in A2.3 for the requirements requiring at least one sub frame (1ms) for the measurement period. For other requirements, indexes of active UL slots are given by the slots satisfying  $\text{mod}(\text{slot index}+1, 5) = 0$  with TDD UL-DL configuration specified in A.3.3.1.

NOTE 5: The RMCs apply to all channel bandwidth where  $L_{\text{CRB}} \leq N_{\text{RB}}$ .

Table A.2.3.1-2: Void

### A.2.3.2 DFT-s-OFDM QPSK

Table A.2.3.2-1: Reference Channels for DFT-s-OFDM QPSK

Parameter	Allocated resource blocks ( $L_{\text{CRB}}$ )	DFT-s-OFDM Symbols per slot (Note 1)	Modulation	MCS Index (Note 2)	Payload size	Transport block CRC	LDPC Base Graph	Number of code blocks per slot (Note 3)	Total number of bits per slot	Total modulated symbols per slot
Unit					Bits	Bits			Bits	
	1	11	QPSK	2	48	16	2	1	264	132
	16	11	QPSK	2	808	16	2	1	4224	2112
	20	11	QPSK	2	1032	16	2	1	5280	2640
	32	11	QPSK	2	1608	16	2	1	8448	4224
	60	11	QPSK	2	2976	16	2	1	15840	7920
	64	11	QPSK	2	3240	16	2	1	16896	8448
	120	11	QPSK	2	5896	24	2	2	31680	15840
	128	11	QPSK	2	6408	24	2	2	33792	16896
	144	11	QPSK	2	7176	24	2	2	38016	19008
	243	11	QPSK	2	12040	24	2	4	64152	32076
	256	11	QPSK	2	12808	24	2	4	67584	33792

NOTE 1: PUSCH mapping Type-A and single-symbol DM-RS configuration Type-1 with 2 additional DM-RS symbols, such that the DM-RS positions are set to symbols 2, 7, 11. DMRS is [TDM'ed] with PUSCH data. DM-RS symbols are not counted.

NOTE 2: MCS Index is based on MCS table 6.1.4.1-1 defined in 38.214.

NOTE 3: If more than one Code Block is present, an additional CRC sequence of  $L = 24$  Bits is attached to each Code Block (otherwise  $L = 0$  Bit)

NOTE 4: Indexes of active UL slots are given by Table A.2.3-1 with TDD UL-DL configuration specified in A2.3 for the requirements requiring at least one sub frame (1ms) for the measurement period. For other requirements, indexes of active UL slots are given by the slots satisfying  $\text{mod}(\text{slot index}+1, 5) = 0$  with TDD UL-DL configuration specified in A.3.3.1.

NOTE 5: The RMCs apply to all channel bandwidth where  $L_{\text{CRB}} \leq N_{\text{RB}}$ .

Table A.2.3.2-2: Void

### A.2.3.3 DFT-s-OFDM 16QAM

Table A.2.3.3-1: Reference Channels for DFT-s-OFDM 16QAM

Parameter	Allocated resource blocks ( $L_{\text{CRB}}$ )	DFT-s-OFDM Symbols per slot (Note 1)	Modulation	MCS Index (Note 2)	Payload size	Transport block CRC	LDPC Base Graph	Number of code blocks per slot (Note 3)	Total number of bits per slot	Total modulated symbols per slot
Unit					Bits	Bits			Bits	
	1	11	16QAM	10	176	16	2	1	528	132
	16	11	16QAM	10	2792	16	2	1	8448	2112
	32	11	16QAM	10	5632	24	1	1	16896	4224
	60	11	16QAM	10	10504	24	1	2	31680	7920
	64	11	16QAM	10	11272	24	1	2	33792	8448
	120	11	16QAM	10	21000	24	1	3	63360	15840
	128	11	16QAM	10	22536	24	1	3	67584	16896

	144	11	16QAM	10	25104	24	1	3	76032	19008
	243	11	16QAM	10	43032	24	1	6	128304	32076
	256	11	16QAM	10	45096	24	1	6	135168	33792

NOTE 1: PUSCH mapping Type-A and single-symbol DM-RS configuration Type-1 with 2 additional DM-RS symbols, such that the DM-RS positions are set to symbols 2, 7, 11. DMRS is [TDM'ed] with PUSCH data. DM-RS symbols are not counted.

NOTE 2: MCS Index is based on MCS table 6.1.4.1-1 defined in 38.214.

NOTE 3: If more than one Code Block is present, an additional CRC sequence of L = 24 Bits is attached to each Code Block (otherwise L = 0 Bit)

NOTE 4: Indexes of active UL slots are given by Table A.2.3-1 with TDD UL-DL configuration specified in A2.3 for the requirements requiring at least one sub frame (1ms) for the measurement period. For other requirements, indexes of active UL slots are given by the slots satisfying  $\text{mod}(\text{slot index}+1, 5) = 0$  with TDD UL-DL configuration specified in A.3.3.1.

NOTE 5: The RMCs apply to all channel bandwidth where  $L_{\text{CRB}} \leq N_{\text{RB}}$ .

Table A.2.3.3-2: Void

## A.2.3.4 DFT-s-OFDM 64QAM

Table A.2.3.4-1: Reference Channels for DFT-s-OFDM 64QAM

Parameter	Allocated resource blocks ( $L_{\text{CRB}}$ )	DFT-s-OFDM Symbols per slot (Note 1)	Modulation	MCS Index (Note 2)	Payload size	Transport block CRC	LDPC Base Graph	Number of code blocks per slot (Note 3)	Total number of bits per slot	Total modulated symbols per slot
Unit					Bits	Bits			Bits	
	1	11	64QAM	18	408	16	2	1	792	132
	16	11	64QAM	18	6400	24	1	1	12672	2112
	32	11	64QAM	18	12808	24	1	2	25344	4224
	60	11	64QAM	18	24072	24	1	3	47520	7920
	64	11	64QAM	18	25608	24	1	4	50688	8448
	120	11	64QAM	18	48168	24	1	6	95040	15840
	128	11	64QAM	18	51216	24	1	7	101376	16896
	144	11	64QAM	18	57376	24	1	7	114048	19008
	243	11	64QAM	18	96264	24	1	12	192456	32076
	256	11	64QAM	18	102416	24	1	13	202752	33792

NOTE 1: PUSCH mapping Type-A and single-symbol DM-RS configuration Type-1 with 2 additional DM-RS symbols, such that the DM-RS positions are set to symbols 2, 7, 11. DMRS is [TDM'ed] with PUSCH data. DM-RS symbols are not counted.

NOTE 2: MCS Index is based on MCS table 6.1.4.1-1 defined in 38.214.

NOTE 3: If more than one Code Block is present, an additional CRC sequence of L = 24 Bits is attached to each Code Block (otherwise L = 0 Bit)

NOTE 4: Indexes of active UL slots are given by Table A.2.3-1 with TDD UL-DL configuration specified in A2.3 for the requirements requiring at least one sub frame (1ms) for the measurement period. For other requirements, indexes of active UL slots are given by the slots satisfying  $\text{mod}(\text{slot index}+1, 5) = 0$  with TDD UL-DL configuration specified in A.3.3.1.

NOTE 5: The RMCs apply to all channel bandwidth where  $L_{\text{CRB}} \leq N_{\text{RB}}$ .

Table A.2.3.4-2: Void

## A.2.3.5 CP-OFDM QPSK

Table A.2.3.5-1: Reference Channels for CP-OFDM QPSK

Parameter	Allocated resource blocks ( $L_{\text{CRB}}$ )	DFT-s-OFDM Symbols per slot (Note 1)	Modulation	MCS Index (Note 2)	Payload size	Transport block CRC	LDPC Base Graph	Number of code blocks per slot (Note 3)	Total number of bits per slot	Total modulated symbols per slot
Unit					Bits	Bits			Bits	
	1	11	QPSK	2	48	16	2	1	264	132

	16	11	QPSK	2	808	16	2	1	4224	2112
	32	11	QPSK	2	1608	16	2	1	8448	4224
	33	11	QPSK	2	1672	16	2	1	8712	4356
	62	11	QPSK	2	3104	16	2	1	16368	8184
	66	11	QPSK	2	3368	16	2	1	17424	8712
	124	11	QPSK	2	6152	24	2	2	32736	16368
	132	11	QPSK	2	6536	24	2	2	34848	17424
	148	11	QPSK	2	7304	24	2	2	39072	19536
	248	11	QPSK	2	12296	24	2	4	65472	32736
	264	11	QPSK	2	13064	24	2	4	69696	34848

NOTE 1: PUSCH mapping Type-A and single-symbol DM-RS configuration Type-1 with 2 additional DM-RS symbols, such that the DM-RS positions are set to symbols 2, 7, 11. DMRS is [TDM'ed] with PUSCH data. DM-RS symbols are not counted.

NOTE 2: MCS Index is based on MCS table 5.1.3.1-1 defined in 38.214.

NOTE 3: If more than one Code Block is present, an additional CRC sequence of L = 24 Bits is attached to each Code Block (otherwise L = 0 Bit)

NOTE 4: Indexes of active UL slots are given by Table A.2.3-1 with TDD UL-DL configuration specified in A2.3 for the requirements requiring at least one sub frame (1ms) for the measurement period. For other requirements, indexes of active UL slots are given by the slots satisfying  $\text{mod}(\text{slot index}+1, 5) = 0$  with TDD UL-DL configuration specified in A.3.3.1.

NOTE 5: The RMCs apply to all channel bandwidth where  $L_{\text{CRB}} \leq N_{\text{RB}}$ .

Table A.2.3.5-2: Void

## A.2.3.6 CP-OFDM 16QAM

Table A.2.3.6-1: Reference Channels for CP-OFDM 16QAM

Parameter	Allocated resource blocks ( $L_{\text{CRB}}$ )	DFT-s-OFDM Symbols per slot (Note 1)	Modulation	MCS Index (Note 2)	Payload size	Transport block CRC	LDPC Base Graph	Number of code blocks per slot (Note 3)	Total number of bits per slot	Total modulated symbols per slot
Unit					Bits	Bits			Bits	
	1	11	16QAM	10	176	16	2	1	528	132
	16	11	16QAM	10	2792	16	2	1	8448	2112
	32	11	16QAM	10	5632	24	1	1	16896	4224
	33	11	16QAM	10	5760	24	1	1	17424	4356
	62	11	16QAM	10	10760	24	1	2	32736	8184
	66	11	16QAM	10	11528	24	1	2	34848	8712
	124	11	16QAM	10	21504	24	1	3	65472	16368
	132	11	16QAM	10	23040	24	1	3	69696	17424
	148	11	16QAM	10	26120	24	1	4	78144	19536
	248	11	16QAM	10	43032	24	1	6	130944	32736
	264	11	16QAM	10	46104	24	1	6	139392	34848

NOTE 1: PUSCH mapping Type-A and single-symbol DM-RS configuration Type-1 with 2 additional DM-RS symbols, such that the DM-RS positions are set to symbols 2, 7, 11. DMRS is [TDM'ed] with PUSCH data. DM-RS symbols are not counted.

NOTE 2: MCS Index is based on MCS table 5.1.3.1-1 defined in 38.214.

NOTE 3: If more than one Code Block is present, an additional CRC sequence of L = 24 Bits is attached to each Code Block (otherwise L = 0 Bit)

NOTE 4: Indexes of active UL slots are given by Table A.2.3-1 with TDD UL-DL configuration specified in A2.3 for the requirements requiring at least one sub frame (1ms) for the measurement period. For other requirements, indexes of active UL slots are given by the slots satisfying  $\text{mod}(\text{slot index}+1, 5) = 0$  with TDD UL-DL configuration specified in A.3.3.1.

NOTE 5: The RMCs apply to all channel bandwidth where  $L_{\text{CRB}} \leq N_{\text{RB}}$ .

Table A.2.3.6-2: Void

## A.2.3.7 CP-OFDM 64QAM

Table A.2.3.7-1: Reference Channels for CP-OFDM 64QAM

Parameter	Allocated resource blocks ( $L_{CRB}$ )	DFT-s-OFDM Symbols per slot (Note 1)	Modulation	MCS Index (Note 2)	Payload size	Transport block CRC	LDPC Base Graph	Number of code blocks per slot (Note 3)	Total number of bits per slot	Total modulated symbols per slot
Unit					Bits	Bits			Bits	
	1	11	64QAM	19	408	16	2	1	792	132
	16	11	64QAM	19	6400	24	1	1	12672	2112
	32	11	64QAM	19	12808	24	1	2	25344	4224
	33	11	64QAM	19	13064	24	1	2	26136	4356
	62	11	64QAM	19	24576	24	1	3	49104	8184
	66	11	64QAM	19	26120	24	1	4	52272	8712
	124	11	64QAM	19	49176	24	1	6	98208	16368
	132	11	64QAM	19	53288	24	1	7	104544	17424
	148	11	64QAM	19	59432	24	1	8	117216	19536
	248	11	64QAM	19	98376	24	1	12	196416	32736
	264	11	64QAM	19	106576	24	1	13	209088	34848

NOTE 1: PUSCH mapping Type-A and single-symbol DM-RS configuration Type-1 with 2 additional DM-RS symbols, such that the DM-RS positions are set to symbols 2, 7, 11. DMRS is [TDM'ed] with PUSCH data. DM-RS symbols are not counted.

NOTE 2: MCS Index is based on MCS table 5.1.3.1-1 defined in 38.214.

NOTE 3: If more than one Code Block is present, an additional CRC sequence of  $L = 24$  Bits is attached to each Code Block (otherwise  $L = 0$  Bit)

NOTE 4: Indexes of active UL slots are given by Table A.2.3-1 with TDD UL-DL configuration specified in A2.3 for the requirements requiring at least one sub frame (1ms) for the measurement period. For other requirements, indexes of active UL slots are given by the slots satisfying  $\text{mod}(\text{slot index}+1, 5) = 0$  with TDD UL-DL configuration specified in A.3.3.1.

NOTE 5: The RMCs apply to all channel bandwidth where  $L_{CRB} \leq N_{RB}$ .

Table A.2.3.7-2: Void

## A.3 DL reference measurement channels

### A.3.1 General

Unless otherwise stated, Tables A.3.3.2-1 and A.3.3.2-2 are applicable for measurements of the Receiver Characteristics (clause 7).

Unless otherwise stated, Tables A.3.3.2-1 and A.3.3.2-2 also apply for the modulated interferer used in Clauses 7.5 and 7.6 with test specific bandwidths.

CSI-RS configuration parameter defined in Table A.3.1-2 and Table A.3.1-3 are used for verifying the beam correspondence requirement, 2 slots of CSI-RS shall be provided at each test grid point. The DL channel shall be configured for zero power on all tones except those used by CSI-RS in slots containing CSI-RS for beam refinement, and the DL and UL channel sizes shall be the same during verification.

**Table A.3.1-1: Test parameters**

Parameter	Unit	Value
CORESET frequency domain allocation		Full BW
CORESET time domain allocation		2 OFDM symbols at the begin of each slot
PDSCH mapping type		Type A
PDSCH start symbol index (S)		2
Number of consecutive PDSCH symbols (L)		12
PDSCH PRB bundling	PRBs	2
Dynamic PRB bundling		false
MCS table for TBS determination		64QAM
Overhead value for TBS determination		0
First DMRS position for Type A PDSCH mapping		2
DMRS type		Type 1
Number of additional DMRS		2
FDM between DMRS and PDSCH		Disable
CSI-RS for tracking	First subcarrier index in the PRB used for CSI-RS ( $k_0$ )	0 for CSI-RS resource 1,2
	OFDM symbols in the PRB used for CSI-RS	$l_0 = 8$ for CSI-RS resource 1 $l_0 = 12$ for CSI-RS resource 2
	Number of CSI-RS ports	1 for CSI-RS resource 1,2
	CDM Type	'No CDM' for CSI-RS resource 1,2
	Density ( $\rho$ )	3 for CSI-RS resource 1,2
	CSI-RS periodicity	Slots 60 kHz SCS: 80 for CSI-RS resources 1 and 2 120 kHz SCS: 160 for CSI-RS resources 1 and 2
	CSI-RS offset	Slots 60 kHz SCS: 40 for CSI-RS resources 1 and 2 120kHz SCS: 80 for CSI-RS resources 1 and 2
	Frequency Occupation	Start PRB 0 Number of PRB = BWP size
	QCL info	TCI state #0
PTRS configuration		PTRS is not configured

Table A.3.1-2: CSI-RS parameters for beam correspondence based on SSB and CSI-RS

Resource Type	aperiodic
<b>Resource Set Config</b>	
repetition	on
aperiodicTriggeringOffset	Depending on UE capability
<b>Resource Config</b>	
nzp-CSI-RS-ResourceId	30 for resource #0
	31 for resource #1
	32 for resource #2
	33 for resource #3
	34 for resource #4
	35 for resource #5
	36 for resource #6
	37 for resource #7
powerControlOffset	0
powerControlOffsetSS	db0
nrofPorts	1
firstOFDMSymbolInTimeDomain	6 for resource #0
	7 for resource #1
	8 for resource #2
	9 for resource #3
	10 for resource #4
	11 for resource #5
	12 for resource #6
	13 for resource #7
cdm-Type	noCDM
density	3
nrofRBs	48 for channel bandwidth $\geq$ 100MHz 32 for channel bandwidth=50MHz
qcl-info	Type D to SSB

CSI-RS configuration parameter defined in Table A.3.1-3 is used for verifying the beam correspondence requirement, CSI-RS shall be provided once every 10msec.



**Table A.3.1-3: CSI-RS parameters for CSI-RS based beam correspondence**

<b>Resource Type</b>	<b>aperiodic</b>
<b>Resource Set Config</b>	
repetition	on
aperiodicTriggeringOffset	Depending on UE capability
<b>Resource Config</b>	
nzp-CSI-RS-ResourceId	30 for resource #0
	31 for resource #1
	32 for resource #2
	33 for resource #3
	...
	...
	29+N for resource #(N-1), where N is <i>maxNumberRxBeam</i> in UE capability IE of <i>MIMO-ParametersPerBand</i>
powerControlOffset	0
powerControlOffsetSS	db0
nrofPorts	1
firstOFDMSymbolInTimeDomain	6 for resource #0
	7 for resource #1
	8 for resource #2
	9 for resource #3
	...
	...
	5+N for resource #(N-1), where N= <i>maxNumberRxBeam</i> -1 in UE capability IE of <i>MIMO-ParametersPerBand</i>
cdm-Type	noCDM
density	3
nrofRBs	48 for channel bandwidth≥100MHz 32 for channel bandwidth=50MHz
qcl-info	Type D to SSB

### A.3.2 Void

### A.3.3 DL reference measurement channels for TDD

#### A.3.3.1 General

**Table A.3.3.1-1. Additional test parameters for TDD**

Parameter		Value			
		SCS 60 kHz ( $\mu=2$ )	SCS 120 kHz ( $\mu=3$ )	SCS 480 kHz ( $\mu=5$ )	SCS 960 kHz ( $\mu=6$ )
TDD Slot Configuration pattern (Note 1)		DDDSU	DDDSU	DDDSU	DDDSU
Special Slot Configuration (Note 2)		S=4D+6G+4U	S=10D+2G+2U	S=10D+2G+2U	S=10D+2G+2U
referenceSubcarrierSpacing		60 kHz	120 kHz	480 kHz	960 kHz
UL-DL configuration	<i>dl-UL-TransmissionPeriodicity</i>	1.25 ms	0.625 ms	0.3125 ms	0.15625 ms
	<i>nrofDownlinkSlots</i>	3	3	3	3
	<i>nrofDownlinkSymbols</i>	4	10	10	10
	<i>nrofUplinkSlot</i>	1	1	1	1
	<i>nrofUplinkSymbols</i>	4	2	2	2
Number of HARQ Processes		8	8	8	8
The number of slots between PDSCH and corresponding HARQ-ACK information (Note 3)		K1 = 4 if $\text{mod}(i,5) = 0$ K1 =3 if $\text{mod}(i,5) = 1$ K1 =7 if $\text{mod}(i,5) = 2$ where i is slot index per frame; $i = \{0, \dots, 39\}$	K1 = 4 if $\text{mod}(i,5) = 0$ K1 =3 if $\text{mod}(i,5) = 1$ K1 =7 if $\text{mod}(i,5) = 2$ where i is slot index per frame; $i = \{0, \dots, 79\}$	K1 = 4 if $\text{mod}(i,5) = 0$ K1 =3 if $\text{mod}(i,5) = 1$ K1 =7 if $\text{mod}(i,5) = 2$ where i is slot index per frame; $i = \{0, \dots, 319\}$	K1 = 4 if $\text{mod}(i,5) = 0$ K1 =3 if $\text{mod}(i,5) = 1$ K1 =7 if $\text{mod}(i,5) = 2$ where i is slot index per frame; $i = \{0, \dots, 639\}$
NOTE 1: D denotes a slot with all DL symbols; S denotes a slot with a mix of DL, UL and guard symbols; U denotes a slot with all UL symbols. The field is for information.					
NOTE 2: D, G, U denote DL, guard and UL symbols, respectively. The field is for information.					
NOTE 3: i is the slot index per frame.					

## A.3.3.2 FRC for receiver requirements for QPSK

Table A.3.3.2-1 Fixed Reference Channel for Receiver Requirements (SCS 60 kHz, TDD)

Parameter	Unit	Value		
		50	100	200
Channel bandwidth	MHz	50	100	200
Subcarrier spacing configuration $\mu$		2	2	2
Allocated resource blocks		66	132	264
Subcarriers per resource block		12	12	12
Allocated slots per Frame (NOTE 7)		23 / 24	23 / 24	23 / 24
MCS index		4	4	4
Modulation		QPSK	QPSK	QPSK
Target Coding Rate		1/3	1/3	1/3
Maximum number of HARQ transmissions		1	1	1
Information Bit Payload per Slot				
For Slots 0 and Slot i, if $\text{mod}(i, 5) = \{3,4\}$ for i from $\{0, \dots, 79\}$ (NOTE 5)	Bits	N/A	N/A	N/A
For Slot i, if $\text{mod}(i, 5) = \{0,1,2\}$ for i from $\{1, \dots, 79\}$ (NOTE 6)	Bits	4224	8456	16896
Transport block CRC	Bits	24	24	24
LDPC base graph		1	1	1
Number of Code Blocks per Slot				
For Slots 0 and Slot i, if $\text{mod}(i, 5) = \{3,4\}$ for i from $\{0, \dots, 79\}$ (NOTE 5)	CBs	N/A	N/A	N/A
For Slot i, if $\text{mod}(i, 5) = \{0,1,2\}$ for i from $\{1, \dots, 79\}$ (NOTE 6)	CBs	1	2	3
Binary Channel Bits Per Slot				
For Slots 0 and Slot i, if $\text{mod}(i, 5) = \{3,4\}$ for i from $\{0, \dots, 79\}$ (NOTE 5)	Bits	N/A	N/A	N/A
For Slot i, if $\text{mod}(i, 5) = \{0,1,2\}$ for i from $\{1, \dots, 79\}$ (NOTE 6)	Bits	14256	28512	57024
Max. Throughput averaged over 1 frame (NOTE 8)	Mbps	10.138	20.294	40.550
NOTE 1: Additional parameters are specified in Table A.3.1-1 and Table A.3.3.1-1.				
NOTE 2: If more than one Code Block is present, an additional CRC sequence of L = 24 Bits is attached to each Code Block (otherwise L = 0 Bit).				
NOTE 3: SS/PBCH block is transmitted in slot 0 with periodicity 20 ms				
NOTE 4: Slot i is slot index per 2 frames				
NOTE 5: When this DL RMC used together with the UL RMC for the transmitter requirements requiring at least one sub frame (1ms) for the measurement period, Slot i, if $\text{mod}(i, 8) = \{3,4,5,6,7\}$ for i from $\{0, \dots, 79\}$ together with the TDD UL-DL configuration specified in A2.3.				
NOTE 6: When this DL RMC used together with the UL RMC for the transmitter requirements requiring at least one sub frame (1ms) for the measurement period, Slot i, if $\text{mod}(i, 8) = \{0,1,2\}$ for i from $\{0, \dots, 79\}$ together with the TDD UL-DL configuration specified in A2.3.				
NOTE 7: First number corresponds to the number slots allocated in the first frame of the RMC; second number corresponds to the number slots allocated in the second frame of the RMC.				
NOTE 8: Throughput is averaged over 2nd frame of RMC.				

Table A.3.3.2-2 Fixed Reference Channel for Receiver Requirements (SCS 120 kHz, TDD)

Parameter	Unit	Value			
		50	100	200	400
Channel bandwidth	MHz	50	100	200	400
Subcarrier spacing configuration $\mu$		3	3	3	3
Allocated resource blocks		32	66	132	264
Subcarriers per resource block		12	12	12	12
Allocated slots per Frame (NOTE 7)		47 / 48	47 / 48	47 / 48	47 / 48
MCS index		4	4	4	4
Modulation		QPSK	QPSK	QPSK	QPSK
Target Coding Rate		1/3	1/3	1/3	1/3
Maximum number of HARQ transmissions		1	1	1	1
Information Bit Payload per Slot					
For Slots 0 and Slot i, if $\text{mod}(i, 5) = \{3,4\}$ for i from $\{0, \dots, 159\}$ (NOTE 5)	Bits	N/A	N/A	N/A	N/A
For Slot i, if $\text{mod}(i, 5) = \{0,1,2\}$ for i from $\{1, \dots, 159\}$ (NOTE 6)	Bits	2088	4224	8456	16896
Transport block CRC	Bits	16	24	24	24
LDPC base graph		2	1	1	1
Number of Code Blocks per Slot					
For Slots 0 and Slot i, if $\text{mod}(i, 5) = \{3,4\}$ for i from $\{0, \dots, 159\}$ (NOTE 5)	CBs	N/A	N/A	N/A	N/A
For Slot i, if $\text{mod}(i, 5) = \{0,1,2\}$ for i from $\{1, \dots, 159\}$ (NOTE 6)	CBs	1	1	2	3
Binary Channel Bits Per Slot					
For Slots 0 and Slot i, if $\text{mod}(i, 5) = \{3,4\}$ for i from $\{0, \dots, 159\}$ (NOTE 5)	Bits	N/A	N/A	N/A	N/A
For Slot i, if $\text{mod}(i, 5) = \{0,1,2\}$ for i from $\{1, \dots, 159\}$ (NOTE 6)	Bits	6912	14256	28512	57024
Max. Throughput averaged over 1 frame (NOTE 8)	Mbps	10.022	20.275	40.589	81.101
NOTE 1: Additional parameters are specified in Table A.3.1-1 and Table A.3.3.1-1.					
NOTE 2: If more than one Code Block is present, an additional CRC sequence of L = 24 Bits is attached to each Code Block (otherwise L = 0 Bit).					
NOTE 3: SS/PBCH block is transmitted in slot 0 with periodicity 20 ms					
NOTE 4: Slot i is slot index per 2 frames					
NOTE 5: When this DL RMC used together with the UL RMC for the transmitter requirements requiring at least one sub frame (1ms) for the measurement period, Slot i, if $\text{mod}(i, 16) = \{7, \dots, 15\}$ for i from $\{0, \dots, 159\}$ together with the TDD UL-DL configuration specified in A2.3.					
NOTE 6: When this DL RMC used together with the UL RMC for the transmitter requirements requiring at least one sub frame (1ms) for the measurement period, Slot i, if $\text{mod}(i, 16) = \{0, \dots, 6\}$ for i from $\{0, \dots, 159\}$ together with the TDD UL-DL configuration specified in A2.3.					
NOTE 7: First number corresponds to the number slots allocated in the first frame of the RMC; second number corresponds to the number slots allocated in the second frame of the RMC.					
NOTE 8: Throughput is averaged over 2nd frame of RMC.					

Table A.3.3.2-3 Fixed Reference Channel for Receiver Requirements (SCS 480 kHz, TDD)

Parameter	Unit	Value		
		400	800	1600
Channel bandwidth	MHz	400	800	1600
Subcarrier spacing configuration $\mu$		5	5	5
Allocated resource blocks		66	124	248
Subcarriers per resource block		12	12	12
Allocated slots per Frame (NOTE 7)		191 / 192	191 / 192	191 / 192
MCS index		4	4	4
Modulation		QPSK	QPSK	QPSK
Target Coding Rate		1/3	1/3	1/3
Maximum number of HARQ transmissions		1	1	1
Information Bit Payload per Slot				
For Slots 0 and Slot i, if $\text{mod}(i, 5) = \{3,4\}$ for i from $\{0, \dots, 639\}$ (NOTE 5)	Bits	N/A	N/A	N/A
For Slot i, if $\text{mod}(i, 5) = \{0,1,2\}$ for i from $\{1, \dots, 639\}$ (NOTE 6)	Bits	4224	8064	16136
Transport block CRC	Bits	24	24	24
LDPC base graph		1	1	1
Number of Code Blocks per Slot				
For Slots 0 and Slot i, if $\text{mod}(i, 5) = \{3,4\}$ for i from $\{0, \dots, 639\}$ (NOTE 5)	CBs	N/A	N/A	N/A
For Slot i, if $\text{mod}(i, 5) = \{0,1,2\}$ for i from $\{1, \dots, 639\}$ (NOTE 6)	CBs	1	1	2
Binary Channel Bits Per Slot				
For Slots 0 and Slot i, if $\text{mod}(i, 5) = \{3,4\}$ for i from $\{0, \dots, 639\}$ (NOTE 5)	Bits	N/A	N/A	N/A
For Slot i, if $\text{mod}(i, 5) = \{0,1,2\}$ for i from $\{1, \dots, 639\}$ (NOTE 6)	Bits	14256	26784	53568
Max. Throughput averaged over 1 frame (NOTE 8)	Mbps	81.101	154.829	309.811
NOTE 1: Additional parameters are specified in Table A.3.1-1 and Table A.3.3.1-1.				
NOTE 2: If more than one Code Block is present, an additional CRC sequence of $L = 24$ Bits is attached to each Code Block (otherwise $L = 0$ Bit).				
NOTE 3: SS/PBCH block is transmitted in slot 0 with periodicity 20 ms				
NOTE 4: Slot i is slot index per 2 frames				
NOTE 5: When this DL RMC used together with the UL RMC for the transmitter requirements requiring at least one sub frame (1ms) for the measurement period, Slot i, if $\text{mod}(i, 64) = \{31, \dots, 63\}$ for i from $\{0, \dots, 639\}$ together with the TDD UL-DL configuration specified in A2.3.				
NOTE 6: When this DL RMC used together with the UL RMC for the transmitter requirements requiring at least one sub frame (1ms) for the measurement period, Slot i, if $\text{mod}(i, 64) = \{0, \dots, 30\}$ for i from $\{0, \dots, 639\}$ together with the TDD UL-DL configuration specified in A2.3.				
NOTE 7: First number corresponds to the number slots allocated in the first frame of the RMC; second number corresponds to the number slots allocated in the second frame of the RMC.				
NOTE 8: Throughput is averaged over 2nd frame of RMC.				

**Table A.3.3.2-4 Fixed Reference Channel for Receiver Requirements (SCS 960 kHz, TDD)**

Parameter	Unit	Value			
		400	800	1600	2000
Channel bandwidth	MHz	400	800	1600	2000
Subcarrier spacing configuration $\mu$		6	6	6	6
Allocated resource blocks		33	62	124	148
Subcarriers per resource block		12	12	12	12
Allocated slots per Frame (NOTE 7)		383 / 384	383 / 384	383 / 384	383 / 384
MCS index		4	4	4	4
Modulation		QPSK	QPSK	QPSK	QPSK
Target Coding Rate		1/3	1/3	1/3	1/3
Maximum number of HARQ transmissions		1	1	1	1
Information Bit Payload per Slot					
For Slots 0 and Slot i, if $\text{mod}(i, 5) = \{3,4\}$ for i from $\{0, \dots, 1279\}$ (NOTE 5)	Bits	N/A	N/A	N/A	N/A
For Slot i, if $\text{mod}(i, 5) = \{0,1,2\}$ for i from $\{1, \dots, 1279\}$ (NOTE 6)	Bits	2152	4032	8064	9480
Transport block CRC	Bits	16	24	24	24
LDPC base graph		2	1	1	1
Number of Code Blocks per Slot					
For Slots 0 and Slot i, if $\text{mod}(i, 5) = \{3,4\}$ for i from $\{0, \dots, 1279\}$ (NOTE 5)	CBs	N/A	N/A	N/A	N/A
For Slot i, if $\text{mod}(i, 5) = \{0,1,2\}$ for i from $\{1, \dots, 1279\}$ (NOTE 6)	CBs	1	1	1	2
Binary Channel Bits Per Slot					
For Slots 0 and Slot i, if $\text{mod}(i, 5) = \{3,4\}$ for i from $\{0, \dots, 1279\}$ (NOTE 5)	Bits	N/A	N/A	N/A	N/A
For Slot i, if $\text{mod}(i, 5) = \{0,1,2\}$ for i from $\{1, \dots, 1279\}$ (NOTE 6)	Bits	7128	13392	26784	31968
Max. Throughput averaged over 1 frame (NOTE 8)	Mbps	82.637	154.829	309.658	364.032
NOTE 1: Additional parameters are specified in Table A.3.1-1 and Table A.3.3.1-1.					
NOTE 2: If more than one Code Block is present, an additional CRC sequence of L = 24 Bits is attached to each Code Block (otherwise L = 0 Bit).					
NOTE 3: SS/PBCH block is transmitted in slot 0 with periodicity 20 ms					
NOTE 4: Slot i is slot index per 2 frames					
NOTE 5: When this DL RMC used together with the UL RMC for the transmitter requirements requiring at least one sub frame (1ms) for the measurement period, Slot i, if $\text{mod}(i, 128) = \{63, \dots, 127\}$ for i from $\{0, \dots, 1279\}$ together with the TDD UL-DL configuration specified in A2.3.					
NOTE 6: When this DL RMC used together with the UL RMC for the transmitter requirements requiring at least one sub frame (1ms) for the measurement period, Slot i, if $\text{mod}(i, 128) = \{0, \dots, 62\}$ for i from $\{0, \dots, 1279\}$ together with the TDD UL-DL configuration specified in A2.3.					
NOTE 7: First number corresponds to the number slots allocated in the first frame of the RMC; second number corresponds to the number slots allocated in the second frame of the RMC.					
NOTE 8: Throughput is averaged over 2nd frame of RMC.					

### A.3.3.3 FRC for receiver requirements for 16QAM

## A.3.3.4 FRC for receiver requirements for 64QAM

Table A.3.3.4-1 Fixed Reference Channel for Receiver Requirements (SCS 60 kHz, TDD)

Parameter	Unit	Value		
		50	100	200
Channel bandwidth	MHz	50	100	200
Subcarrier spacing configuration $\mu$		2	2	2
Allocated resource blocks		66	132	264
Subcarriers per resource block		12	12	12
Allocated slots per Frame (NOTE 6)		23 / 24	23 / 24	23 / 24
MCS index		19	19	19
Modulation		64QAM	64QAM	64QAM
Target Coding Rate		1/2	1/2	1/2
Maximum number of HARQ transmissions		1	1	1
Information Bit Payload per Slot				
For Slots 0 and Slot i, if $\text{mod}(i, 5) = \{3,4\}$ for i from $\{0, \dots, 79\}$	Bits	N/A	N/A	N/A
For Slot i, if $\text{mod}(i, 5) = \{0,1,2\}$ for i from $\{1, \dots, 79\}$	Bits	20496	40976	81976
Transport block CRC	Bits	24	24	24
LDPC base graph		1	1	1
Number of Code Blocks per Slot				
For Slot i, if $\text{mod}(i, 10) = \{0,1,2\}$ for i from $\{1, \dots, 79\}$	CBs	N/A	N/A	N/A
For Slot i, if $\text{mod}(i, 5) = \{0,1,2\}$ for i from $\{1, \dots, 79\}$	CBs	3	5	10
Binary Channel Bits Per Slot				
For Slots 0 and Slot i, if $\text{mod}(i, 5) = \{3,4\}$ for i from $\{0, \dots, 79\}$	Bits	N/A	N/A	N/A
For Slot i, if $\text{mod}(i, 5) = \{0,1,2\}$ for i from $\{1, \dots, 79\}$	Bits	40986	81972	163944
Max. Throughput averaged over 1 frame (NOTE 7)	Mbps	49.190	98.343	196.742
NOTE 1: Additional parameters are specified in Table A.3.1-1 and Table A.3.3.1-1.				
NOTE 2: If more than one Code Block is present, an additional CRC sequence of L = 24 Bits is attached to each Code Block (otherwise L = 0 Bit).				
NOTE 3: SS/PBCH block is transmitted in slot 0 with periodicity 20 ms				
NOTE 4: Slot i is slot index per 2 frames				
NOTE 5: PTRS is configured on symbols containing PDSCH with 1 port, per 2PRB in frequency domain, per symbol in time domain. Overhead for TBS calculation is assumed to be 6.				
NOTE 6: First number corresponds to the number slots allocated in the first frame of the RMC; second number corresponds to the number slots allocated in the second frame of the RMC.				
NOTE 7: Throughput is averaged over 2nd frame of RMC.				

Table A.3.3.4-2 Fixed Reference Channel for Receiver Requirements (SCS 120 kHz, TDD)

Parameter	Unit	Value			
		50	100	200	400
Channel bandwidth	MHz	50	100	200	400
Subcarrier spacing configuration $\mu$		3	3	3	3
Allocated resource blocks		32	66	132	264
Subcarriers per resource block		12	12	12	12
Allocated slots per Frame (NOTE 6)		47 / 48	47 / 48	47 / 48	47 / 48
MCS index		19	19	19	19
Modulation		64QAM	64QAM	64QAM	64QAM
Target Coding Rate		1/2	1/2	1/2	1/2
Maximum number of HARQ transmissions		1	1	1	1
Information Bit Payload per Slot					
For Slots 0 and Slot i, if $\text{mod}(i, 5) = \{3,4\}$ for i from $\{0, \dots, 159\}$	Bits	N/A	N/A	N/A	N/A
For Slot i, if $\text{mod}(i, 5) = \{0,1,2\}$ for i from $\{1, \dots, 159\}$	Bits	9992	20496	40976	81976
Transport block CRC	Bits	24	24	24	24
LDPC base graph		1	1	1	1
Number of Code Blocks per Slot					
For Slots 0 and Slot i, if $\text{mod}(i, 5) = \{3,4\}$ for i from $\{0, \dots, 159\}$	CBs	N/A	N/A	N/A	N/A
For Slot i, if $\text{mod}(i, 5) = \{0,1,2\}$ for i from $\{1, \dots, 159\}$	CBs	2	3	5	10
Binary Channel Bits Per Slot					
For Slots 0 and Slot i, if $\text{mod}(i, 5) = \{3,4\}$ for i from $\{0, \dots, 159\}$	Bits	N/A	N/A	N/A	N/A
For Slot i, if $\text{mod}(i, 5) = \{0,1,2\}$ for i from $\{1, \dots, 159\}$	Bits	19872	40986	81972	163944
Max. Throughput averaged over 1 frame (NOTE 7)	Mbps	47.962	98.381	196.685	393.485
NOTE 1: Additional parameters are specified in Table A.3.1-1 and Table A.3.3.1-1.					
NOTE 2: If more than one Code Block is present, an additional CRC sequence of L = 24 Bits is attached to each Code Block (otherwise L = 0 Bit).					
NOTE 3: SS/PBCH block is transmitted in slot 0 of each frame					
NOTE 4: Slot i is slot index per frame					
NOTE 5: PTRS is configured on symbols containing PDSCH with 1 port, per 2PRB in frequency domain, per symbol in time domain. Overhead for TBS calculation is assumed to be 6.					
NOTE 6: First number corresponds to the number slots allocated in the first frame of the RMC; second number corresponds to the number slots allocated in the second frame of the RMC.					
NOTE 7: Throughput is averaged over 2nd frame of RMC.					



Table A.3.3.4-3 Fixed Reference Channel for Receiver Requirements (SCS 480 kHz, TDD)

Parameter	Unit	Value		
		400	800	1600
Channel bandwidth	MHz	400	800	1600
Subcarrier spacing configuration $\mu$		5	5	5
Allocated resource blocks		66	124	248
Subcarriers per resource block		12	12	12
Allocated slots per Frame (NOTE 6)		191 / 192	191 / 192	191 / 192
MCS index		19	19	19
Modulation		64QAM	64QAM	64QAM
Target Coding Rate		1/2	1/2	1/2
Maximum number of HARQ transmissions		1	1	1
Information Bit Payload per Slot				
For Slots 0 and Slot i, if $\text{mod}(i, 5) = \{3,4\}$ for i from $\{0, \dots, 639\}$	Bits	N/A	N/A	N/A
For Slot i, if $\text{mod}(i, 5) = \{0,1,2\}$ for i from $\{1, \dots, 639\}$	Bits	20496	37896	75792
Transport block CRC	Bits	24	24	24
LDPC base graph		1	1	1
Number of Code Blocks per Slot				
For Slots 0 and Slot i, if $\text{mod}(i, 5) = \{3,4\}$ for i from $\{0, \dots, 639\}$	CBs	N/A	N/A	N/A
For Slot i, if $\text{mod}(i, 5) = \{0,1,2\}$ for i from $\{1, \dots, 639\}$	CBs	3	5	9
Binary Channel Bits Per Slot				
For Slots 0 and Slot i, if $\text{mod}(i, 5) = \{3,4\}$ for i from $\{0, \dots, 639\}$	Bits	N/A	N/A	N/A
For Slot i, if $\text{mod}(i, 5) = \{0,1,2\}$ for i from $\{1, \dots, 639\}$	Bits	40986	77004	154008
Max. Throughput averaged over 1 frame (NOTE 7)	Mbps	393.523	727.603	1455.206
NOTE 1: Additional parameters are specified in Table A.3.1-1 and Table A.3.3.1-1.				
NOTE 2: If more than one Code Block is present, an additional CRC sequence of L = 24 Bits is attached to each Code Block (otherwise L = 0 Bit).				
NOTE 3: SS/PBCH block is transmitted in slot 0 with periodicity 20 ms				
NOTE 4: Slot i is slot index per 2 frames				
NOTE 5: PTRS is configured on symbols containing PDSCH with 1 port, per 2PRB in frequency domain, per symbol in time domain. Overhead for TBS calculation is assumed to be 6.				
NOTE 6: First number corresponds to the number slots allocated in the first frame of the RMC; second number corresponds to the number slots allocated in the second frame of the RMC.				
NOTE 7: Throughput is averaged over 2nd frame of RMC.				

Table A.3.3.4-4 Fixed Reference Channel for Receiver Requirements (SCS 960 kHz, TDD)

Parameter	Unit	Value			
		400	800	1600	2000
Channel bandwidth	MHz	400	800	1600	2000
Subcarrier spacing configuration $\mu$		6	6	6	6
Allocated resource blocks		33	62	124	148
Subcarriers per resource block		12	12	12	12
Allocated slots per Frame (NOTE 6)		383 / 384	383 / 384	383 / 384	383 / 384
MCS index		19	19	19	19
Modulation		64QAM	64QAM	64QAM	64QAM
Target Coding Rate		1/2	1/2	1/2	1/2
Maximum number of HARQ transmissions		1	1	1	1
Information Bit Payload per Slot					
For Slots 0 and Slot i, if $\text{mod}(i, 5) = \{3,4\}$ for i from $\{0, \dots, 1279\}$	Bits	N/A	N/A	N/A	N/A
For Slot i, if $\text{mod}(i, 5) = \{0,1,2\}$ for i from $\{1, \dots, 1279\}$	Bits	10248	18960	37896	46104
Transport block CRC	Bits	24	24	24	24
LDPC base graph		1	1	1	1
Number of Code Blocks per Slot					
For Slots 0 and Slot i, if $\text{mod}(i, 5) = \{3,4\}$ for i from $\{0, \dots, 1279\}$	CBs	N/A	N/A	N/A	N/A
For Slot i, if $\text{mod}(i, 5) = \{0,1,2\}$ for i from $\{1, \dots, 1279\}$	CBs	2	3	5	6
Binary Channel Bits Per Slot					
For Slots 0 and Slot i, if $\text{mod}(i, 5) = \{3,4\}$ for i from $\{0, \dots, 1279\}$	Bits	N/A	N/A	N/A	N/A
For Slot i, if $\text{mod}(i, 5) = \{0,1,2\}$ for i from $\{1, \dots, 1279\}$	Bits	20466	38502	77004	91908
Max. Throughput averaged over 1 frame (NOTE 7)	Mbps	393.523	728.064	1455.206	1770.394
NOTE 1: Additional parameters are specified in Table A.3.1-1 and Table A.3.3.1-1.					
NOTE 2: If more than one Code Block is present, an additional CRC sequence of L = 24 Bits is attached to each Code Block (otherwise L = 0 Bit).					
NOTE 3: SS/PBCH block is transmitted in slot 0 with periodicity 20 ms					
NOTE 4: Slot i is slot index per 2 frames					
NOTE 5: PTRS is configured on symbols containing PDSCH with 1 port, per 2PRB in frequency domain, per symbol in time domain. Overhead for TBS calculation is assumed to be 6.					
NOTE 6: First number corresponds to the number slots allocated in the first frame of the RMC; second number corresponds to the number slots allocated in the second frame of the RMC.					
NOTE 7: Throughput is averaged over 2nd frame of RMC.					

## A.3.3.5 FRC for receiver requirements for 256QAM

Table A.3.3.5-1 Fixed Reference Channel for Receiver Requirements (SCS 60 kHz, TDD)

Parameter	Unit	Value		
Channel bandwidth	MHz	50	100	200
Subcarrier spacing configuration $\mu$		2	2	2
Allocated resource blocks		66	132	264
Subcarriers per resource block		12	12	12
Allocated slots per Frame (NOTE 6)		23 / 24	23 / 24	23 / 24
MCS index		24	24	24
Modulation		256QAM	256QAM	256QAM
Target Coding Rate		4/5	4/5	4/5
Maximum number of HARQ transmissions		1	1	1
Information Bit Payload per Slot				
For Slots 0 and Slot i, if $\text{mod}(i, 5) = \{3,4\}$ for i from $\{0, \dots, 79\}$	Bits	N/A	N/A	N/A
For Slot i, if $\text{mod}(i, 5) = \{0,1,2\}$ for i from $\{1, \dots, 79\}$	Bits	44040	88064	176208
Transport block CRC	Bits	24	24	24
LDPC base graph		1	1	1
Number of Code Blocks per Slot				
For Slots 0 and Slot i, if $\text{mod}(i, 5) = \{3,4\}$ for i from $\{0, \dots, 79\}$	CBs	N/A	N/A	N/A
For Slot i, if $\text{mod}(i, 5) = \{0,1,2\}$ for i from $\{1, \dots, 79\}$	CBs	6	11	21
Binary Channel Bits Per Slot				
For Slots 0 and Slot i, if $\text{mod}(i, 5) = \{3,4\}$ for i from $\{0, \dots, 79\}$	Bits	N/A	N/A	N/A
For Slot i, if $\text{mod}(i, 5) = \{0,1,2\}$ for i from $\{1, \dots, 79\}$	Bits	54648	109296	218592
Max. Throughput averaged over 1 frame (NOTE 7)	Mbps	105.696	211.354	422.899
NOTE 1: Additional parameters are specified in Table A.3.1-1 and Table A.3.3.1-1.				
NOTE 2: If more than one Code Block is present, an additional CRC sequence of L = 24 Bits is attached to each Code Block (otherwise L = 0 Bit).				
NOTE 3: SS/PBCH block is transmitted in slot 0 of each frame				
NOTE 4: Slot i is slot index per 2 frames				
NOTE 5: PTRS is configured on symbols containing PDSCH with 1 port, per 2PRB in frequency domain, per symbol in time domain. Overhead for TBS calculation is assumed to be 6.				
NOTE 6: First number corresponds to the number slots allocated in the first frame of the RMC; second number corresponds to the number slots allocated in the second frame of the RMC.				
NOTE 7: Throughput is averaged over 2nd frame of RMC.				

**Table A.3.3.5-2 Fixed Reference Channel for Receiver Requirements (SCS 120 kHz, TDD)**

Parameter	Unit	Value			
		50	100	200	400
Channel bandwidth	MHz	50	100	200	400
Subcarrier spacing configuration $\mu$		3	3	3	3
Allocated resource blocks		32	66	132	264
Subcarriers per resource block		12	12	12	12
Allocated slots per Frame (NOTE 6)		47 / 48	47 / 48	47 / 48	47 / 48
MCS index		24	24	24	24
Modulation		256QAM	256QAM	256QAM	256QAM
Target Coding Rate		4/5	4/5	4/5	4/5
Maximum number of HARQ transmissions		1	1	1	1
Information Bit Payload per Slot					
For Slots 0 and Slot i, if $\text{mod}(i, 5) = \{3,4\}$ for i from $\{0, \dots, 159\}$	Bits	N/A	N/A	N/A	N/A
For Slot i, if $\text{mod}(i, 5) = \{0,1,2\}$ for i from $\{1, \dots, 159\}$	Bits	21504	44040	88064	176208
Transport block CRC	Bits	24	24	24	24
LDPC base graph		1	1	1	1
Number of Code Blocks per Slot					
For Slots 0 and Slot i, if $\text{mod}(i, 5) = \{3,4\}$ for i from $\{0, \dots, 159\}$	CBs	N/A	N/A	N/A	N/A
For Slot i, if $\text{mod}(i, 5) = \{0,1,2\}$ for i from $\{1, \dots, 159\}$	CBs	3	6	11	21
Binary Channel Bits Per Slot					
For Slots 0 and Slot i, if $\text{mod}(i, 5) = \{3,4\}$ for i from $\{0, \dots, 159\}$	Bits	N/A	N/A	N/A	N/A
For Slot i, if $\text{mod}(i, 5) = \{0,1,2\}$ for i from $\{1, \dots, 159\}$	Bits	26496	54648	109296	218592
Max. Throughput averaged over 1 frame (NOTE 7)	Mbps	103.219	211.392	422.707	845.798
NOTE 1: Additional parameters are specified in Table A.3.1-1 and Table A.3.3.1-1.					
NOTE 2: If more than one Code Block is present, an additional CRC sequence of L = 24 Bits is attached to each Code Block (otherwise L = 0 Bit).					
NOTE 3: SS/PBCH block is transmitted in slot 0 of each frame					
NOTE 4: Slot i is slot index per 2 frames					
NOTE 5: PTRS is configured on symbols containing PDSCH with 1 port, per 2PRB in frequency domain, per symbol in time domain. Overhead for TBS calculation is assumed to be 6.					
NOTE 6: First number corresponds to the number slots allocated in the first frame of the RMC; second number corresponds to the number slots allocated in the second frame of the RMC.					
NOTE 7: Throughput is averaged over 2nd frame of RMC.					

Table A.3.3.5-3 Fixed Reference Channel for Receiver Requirements (SCS 480 kHz, TDD)

Parameter	Unit	Value		
		400	800	1600
Channel bandwidth	MHz	400	800	1600
Subcarrier spacing configuration $\mu$		5	5	5
Allocated resource blocks		66	124	248
Subcarriers per resource block		12	12	12
Allocated slots per Frame (NOTE 6)		191 / 192	191 / 192	191 / 192
MCS index		24	24	24
Modulation		256QAM	256QAM	256QAM
Target Coding Rate		4/5	4/5	4/5
Maximum number of HARQ transmissions		1	1	1
Information Bit Payload per Slot				
For Slots 0 and Slot i, if $\text{mod}(i, 5) = \{3,4\}$ for i from $\{0, \dots, 639\}$	Bits	N/A	N/A	N/A
For Slot i, if $\text{mod}(i, 5) = \{0,1,2\}$ for i from $\{1, \dots, 639\}$	Bits	44040	83976	167976
Transport block CRC	Bits	24	24	24
LDPC base graph		1	1	1
Number of Code Blocks per Slot				
For Slots 0 and Slot i, if $\text{mod}(i, 5) = \{3,4\}$ for i from $\{0, \dots, 639\}$	CBs	N/A	N/A	N/A
For Slot i, if $\text{mod}(i, 5) = \{0,1,2\}$ for i from $\{1, \dots, 639\}$	CBs	6	10	20
Binary Channel Bits Per Slot				
For Slots 0 and Slot i, if $\text{mod}(i, 5) = \{3,4\}$ for i from $\{0, \dots, 639\}$	Bits	N/A	N/A	N/A
For Slot i, if $\text{mod}(i, 5) = \{0,1,2\}$ for i from $\{1, \dots, 639\}$	Bits	54648	102672	205344
Max. Throughput averaged over 1 frame (NOTE 7)	Mbps	845.568	1612.339	3225.139
NOTE 1: Additional parameters are specified in Table A.3.1-1 and Table A.3.3.1-1.				
NOTE 2: If more than one Code Block is present, an additional CRC sequence of L = 24 Bits is attached to each Code Block (otherwise L = 0 Bit).				
NOTE 3: SS/PBCH block is transmitted in slot 0 with periodicity 20 ms				
NOTE 4: Slot i is slot index per 2 frames				
NOTE 5: PTRS is configured on symbols containing PDSCH with 1 port, per 2PRB in frequency domain, per symbol in time domain. Overhead for TBS calculation is assumed to be 6.				
NOTE 6: First number corresponds to the number slots allocated in the first frame of the RMC; second number corresponds to the number slots allocated in the second frame of the RMC.				
NOTE 7: Throughput is averaged over 2nd frame of RMC.				

**Table A.3.3.5-4 Fixed Reference Channel for Receiver Requirements (SCS 960 kHz, TDD)**

Parameter	Unit	Value			
		400	800	1600	2000
Channel bandwidth	MHz	400	800	1600	2000
Subcarrier spacing configuration $\mu$		6	6	6	6
Allocated resource blocks		33	62	124	148
Subcarriers per resource block		12	12	12	12
Allocated slots per Frame (NOTE 6)		383 / 384	383 / 384	383 / 384	383 / 384
MCS index		24	24	24	24
Modulation		256QAM	256QAM	256QAM	256QAM
Target Coding Rate		4/5	4/5	4/5	4/5
Maximum number of HARQ transmissions		1	1	1	1
Information Bit Payload per Slot					
For Slots 0 and Slot i, if $\text{mod}(i, 5) = \{3,4\}$ for i from $\{0, \dots, 1279\}$	Bits	N/A	N/A	N/A	N/A
For Slot i, if $\text{mod}(i, 5) = \{0,1,2\}$ for i from $\{1, \dots, 1279\}$	Bits	22032	42016	83976	98376
Transport block CRC	Bits	24	24	24	24
LDPC base graph		1	1	1	1
Number of Code Blocks per Slot					
For Slots 0 and Slot i, if $\text{mod}(i, 5) = \{3,4\}$ for i from $\{0, \dots, 1279\}$	CBs	N/A	N/A	N/A	N/A
For Slot i, if $\text{mod}(i, 5) = \{0,1,2\}$ for i from $\{1, \dots, 1279\}$	CBs	3	5	10	12
Binary Channel Bits Per Slot					
For Slots 0 and Slot i, if $\text{mod}(i, 5) = \{3,4\}$ for i from $\{0, \dots, 1279\}$	Bits	N/A	N/A	N/A	N/A
For Slot i, if $\text{mod}(i, 5) = \{0,1,2\}$ for i from $\{1, \dots, 1279\}$	Bits	27288	51336	102672	122544
Max. Throughput averaged over 1 frame (NOTE 7)	Mbps	846.029	1613.414	3224.678	3777.638
<p>NOTE 1: Additional parameters are specified in Table A.3.1-1 and Table A.3.3.1-1.</p> <p>NOTE 2: If more than one Code Block is present, an additional CRC sequence of L = 24 Bits is attached to each Code Block (otherwise L = 0 Bit).</p> <p>NOTE 3: SS/PBCH block is transmitted in slot 0 with periodicity 20 ms</p> <p>NOTE 4: Slot i is slot index per 2 frames</p> <p>NOTE 5: PTRS is configured on symbols containing PDSCH with 1 port, per 2PRB in frequency domain, per symbol in time domain. Overhead for TBS calculation is assumed to be 6.</p> <p>NOTE 6: First number corresponds to the number slots allocated in the first frame of the RMC; second number corresponds to the number slots allocated in the second frame of the RMC.</p> <p>NOTE 7: Throughput is averaged over 2nd frame of RMC.</p>					

## A.4 Void

## A.5 OFDMA Channel Noise Generator (OCNG)

### A.5.1 OCNG Patterns for FDD

### A.5.2 OCNG Patterns for TDD

#### A.5.2.1 OCNG TDD pattern 1: Generic OCNG TDD Pattern for all unused REs

**Table A.5.2.1-1: OP.1 TDD: Generic OCNG TDD Pattern for all unused REs**

<b>OCNG Parameters</b>	<b>Control Region (Core Set)</b>	<b>Data Region</b>
Resources allocated	All unused REs (Note 1)	All unused REs (Note 2)
Structure	PDCCH	PDSCH
Content	Uncorrelated pseudo random QPSK modulated data	Uncorrelated pseudo random QPSK modulated data
Transmission scheme for multiple antennas ports transmission	Single Tx port transmission	Spatial multiplexing using any precoding matrix with dimensions same as the precoding matrix for PDSCH
Subcarrier Spacing	Same as for RMC PDCCH in the active BWP	Same as for RMC PDSCH in the active BWP
Power Level	Same as for RMC PDCCH	Same as for RMC PDSCH
Note 1: All unused REs in the active CORESETS appointed by the search spaces in use. Note 2: Unused available REs refer to REs in PRBs not allocated for any physical channels, CORESETS, synchronization signals or reference signals in channel bandwidth.		

## Annex B (informative): Void



# Annex C (normative): Downlink physical channels

## C.1 General

## C.2 Setup

Table C.2-1 describes the downlink Physical Channels that are required for connection set up.

**Table C.2-1: Downlink Physical Channels required for connection set-up**

Physical Channel
PBCH
SSS
PSS
PDCCH
PDSCH
PBCH DMRS
PDCCH DMRS
PDSCH DMRS
CSI-RS
PTRS

## C.3 Connection

### C.3.1 Measurement of Receiver Characteristics

Unless otherwise stated, Table C.3.1-1 is applicable for measurements on the Receiver Characteristics (clause 7).

**Table C.3.1-1: Downlink Physical Channels transmitted during a connection (TDD)**

Parameter	Unit	Value
<b>SSS transmit power</b>	<b>W</b>	<b>Test specific</b>
EPRE ratio of PSS to SSS	dB	0
EPRE ratio of PBCH to SSS	dB	0
EPRE ratio of PBCH to PBCH DMRS	dB	0
EPRE ratio of PDCCH to SSS	dB	0
EPRE ratio of PDCCH to PDCCH DMRS	dB	0
EPRE ratio of PDSCH to SSS	dB	0
EPRE ratio of PDSCH to PDSCH DMRS (Note 1)	dB	-3
EPRE ratio of CSI-RS to SSS	dB	0
EPRE ratio of PTRS to PDSCH	dB	Test specific
EPRE ratio of OCNG DMRS to SSS	dB	0
EPRE ratio of OCNG to OCNG DMRS (Note 1)	dB	0
Note 1:	No boosting is applied to any of the channels except PDSCH DMRS. For PDSCH DMRS, 3 dB power boosting is applied assuming DMRS Type 1 configuration when DMRS and PDSCH are TDM'ed and only half of the DMRS REs are occupied.	
Note 2:	Number of DMRS CDM groups without data for PDSCH DMRS configuration for OCNG is set to 1.	

## Annex D (normative): Characteristics of the interfering signal

### D.1 General

Unless otherwise stated, a modulated full bandwidth NR downlink signal, which equals to channel bandwidth of the wanted signal for Single Carrier case is used as interfering signals when RF performance requirements for NR UE receiver are defined. For intra-band contiguous CA case, a modulated NR downlink signal which equals to the aggregated channel bandwidth of the wanted signal is used.

### D.2 Interference signals

Table D.2-1 describes the modulated interferer for different channel bandwidth options.

**Table D.2-1: Description of modulated NR interferer**

	Channel bandwidth for Single Carrier				Intra band contiguous CA
	50 MHz	100 MHz	200 MHz	400 MHz	
BW <sub>interferer</sub>	50 MHz	100 MHz	200 MHz	400MHz	BW <sub>Channel_CA</sub>
RB	NOTE1				
NOTE 1: The RB configured for interfering signal is the same as maximum RB number defined in Table 5.3.2-1 for each sub-carrier spacing.					

# Annex E (normative): Environmental conditions

## E.1 General

This annex specifies the environmental requirements of the UE. Within these limits the requirements of the present documents shall be fulfilled.

## E.2 Environmental

The requirements in this clause apply to all types of UE(s).

### E.2.1 Temperature

All RF requirements for UEs operating in FR2 are defined over the air and can only be tested in an OTA chamber.

The UE shall fulfil all the requirements in the temperature range for extreme conditions, as defined in Table E.2.1-1, unless explicitly stated otherwise in any requirement.

**Table E.2.1-1: Temperature conditions**

+ 25 °C ± 10 °C	For normal (room temperature) conditions with relative humidity up to 75 %
-10°C to +55°C	For extreme conditions

Outside this temperature range the UE, if powered on, shall not make ineffective use of the radio frequency spectrum. In no case shall the UE exceed the transmitted levels as defined in clause 6.2 for extreme operation.

### E.2.2 Voltage

Editor's note: This requirement is incomplete. The following aspects are either missing or not yet determined:

Methodology to control the voltage in a case which a power cable is not connected to DUT is FFS since it is not agreed whether we can connect the power cable to DUT at the OTA measurement situation yet.

The UE shall fulfil all the requirements in the full voltage range, i.e. the voltage range between the extreme voltages.

The manufacturer shall declare the lower and higher extreme voltages and the approximate shutdown voltage. For the equipment that can be operated from one or more of the power sources listed below, the lower extreme voltage shall not be higher, and the higher extreme voltage shall not be lower than that specified below.

**Table E.2.2-1: Voltage conditions**

Power source	Lower extreme voltage	Higher extreme voltage	Normal conditions voltage
AC mains	0,9 * nominal	1,1 * nominal	nominal
Regulated lead acid battery	0,9 * nominal	1,3 * nominal	1,1 * nominal
Nonregulated batteries:			
Leclanché	0,85 * nominal	Nominal	Nominal
Lithium	0,95 * nominal	1,1 * Nominal	1,1 * Nominal
Mercury/nickel & cadmium	0,90 * nominal		Nominal

Outside this voltage range the UE if powered on, shall not make ineffective use of the radio frequency spectrum. In no case shall the UE exceed the transmitted levels as defined in clause 6.2 for extreme operation. In particular, the UE shall inhibit all RF transmissions when the power supply voltage is below the manufacturer declared shutdown voltage.

### E.2.3 Void

# Annex F (normative): Transmit modulation

## F.1 Measurement Point

Figure F.1-1 shows the measurement point for the unwanted emission falling into non-allocated RB(s) and the EVM for the allocated RB(s).

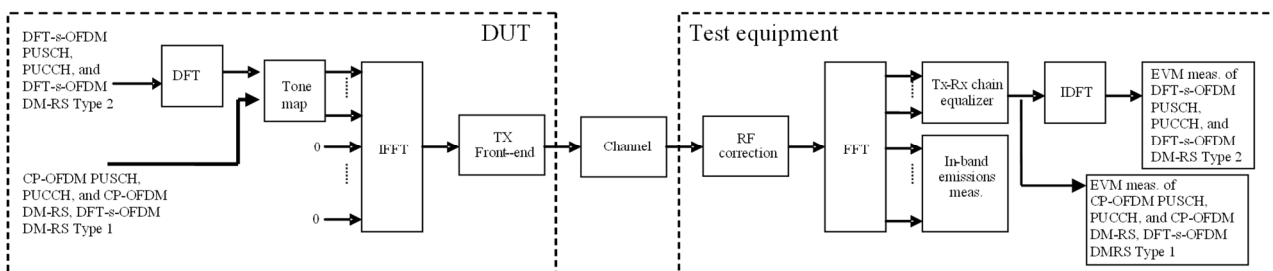


Figure F.1-1: EVM measurement points

## F.2 Basic Error Vector Magnitude measurement

The EVM is the difference between the ideal waveform and the measured waveform for the allocated RB(s)

$$EVM = \sqrt{\frac{\sum_{v \in T_m} |z'(v) - i(v)|^2}{|T_m| \cdot P_0}},$$

where

$T_m$  is a set of  $|T_m|$  modulation symbols with the considered modulation scheme being active within the measurement period,

$z'(v)$  are the samples of the signal evaluated for the EVM,

$i(v)$  is the ideal signal reconstructed by the measurement equipment, and

$P_0$  is the average power of the ideal signal. For normalized modulation symbols  $P_0$  is equal to 1.

The basic EVM measurement interval is defined over one slot in the time domain for PUCCH and PUSCH and over one preamble sequence for the PRACH.

## F.3 Basic in-band emissions measurement

The in-band emissions are a measure of the interference falling into the non-allocated resources blocks. The in-band emission requirement is evaluated for PUCCH and PUSCH transmissions. The in-band emission requirement is not evaluated for PRACH transmissions.

The in-band emissions are measured as follows

$$Emissions_{absolute}(\Delta_{RB}) = \begin{cases} \frac{1}{|T_s|} \sum_{t \in T_s} \sum_{f_i + (12 \cdot \Delta_{RB} + 11) \cdot \Delta f}^{\max(f_{\min}, f_i + 12 \cdot \Delta_{RB} \cdot \Delta f)} |Y(t, f)|^2, \Delta_{RB} < 0 \\ \frac{1}{|T_s|} \sum_{t \in T_s} \sum_{f_h + (12 \cdot \Delta_{RB} - 11) \cdot \Delta f}^{\min(f_{\max}, f_h + 12 \cdot \Delta_{RB} \cdot \Delta f)} |Y(t, f)|^2, \Delta_{RB} > 0 \end{cases},$$

where

$T_s$  is a set of  $|T_s|$  OFDM symbols with the considered modulation scheme being active within the measurement period,

$\Delta_{RB}$  is the starting frequency offset between the allocated RB and the measured non-allocated RB (e.g.  $\Delta_{RB} = 1$  or  $\Delta_{RB} = -1$  for the first adjacent RB),

$f_{\min}$  (resp.  $f_{\max}$ ) is the lower (resp. upper) edge of the UL system BW,

$f_l$  and  $f_h$  are the lower and upper edge of the allocated BW, and

$Y(t, f)$  is the frequency domain signal evaluated for in-band emissions as defined in the clause (ii)

The relative in-band emissions are, given by

$$Emissions_{relative}(\Delta_{RB}) = \frac{Emissions_{absolute}(\Delta_{RB})}{\frac{1}{|T_s|} \cdot N_{RB} \sum_{t \in T_s} \sum_{f_l}^{f_l + (12 \cdot N_{RB} - 1) \cdot \Delta f} |Y(t, f)|^2}$$

where

$N_{RB}$  is the number of allocated RBs

The basic in-band emissions measurement interval is defined over one slot in the time domain. When the PUSCH or PUCCH transmission slot is shortened due to multiplexing with SRS, the in-band emissions measurement interval is reduced by one OFDM symbol, accordingly.

In the evaluation of in-band emissions, the timing is set according to  $\Delta \tilde{t} = \Delta \tilde{c}$ , where sample time offsets  $\Delta \tilde{t}$  and  $\Delta \tilde{c}$  are defined in clause F.4.

## F.4 Modified signal under test

Implicit in the definition of EVM is an assumption that the receiver is able to compensate a number of transmitter impairments.

The DFT-s-OFDM modulated signals or PRACH signal under test is modified and, in the case of DFT-s-OFDM modulated signals, decoded according to:

$$Z'(t, f) = IDFT \left\{ \frac{FFT \left\{ z(v - \Delta\tilde{t}) \cdot e^{-j2\pi\Delta\tilde{f}v} \right\} e^{j2\pi f \Delta\tilde{t}}}{\tilde{a}(t, f) \cdot e^{j\tilde{\varphi}(t, f)}} \right\}$$

where

$z(v)$  is the time domain samples of the signal under test.

The CP-OFDM modulated signals or PUSCH demodulation reference signal or CP-OFDM modulated signals under test is equalised and, in the case of PUCCH data signal decoded according to:

$$Z'(t, f) = \frac{FFT \left\{ z(v - \Delta\tilde{t}) \cdot e^{-j2\pi\Delta\tilde{f}v} \right\} e^{j2\pi f \Delta\tilde{t}}}{\tilde{a}(t, f) \cdot e^{j\tilde{\varphi}(t, f)}}$$

where

$z(v)$  is the time domain samples of the signal under test.

To minimize the error, the signal under test should be modified with respect to a set of parameters following the procedure explained below.

Notation:

$\Delta\tilde{t}$  is the sample timing difference between the FFT processing window in relation to nominal timing of the ideal signal.

$\Delta\tilde{f}$  is the RF frequency offset.

$\tilde{\varphi}(t, f)$  is the phase response of the TX chain.

$\tilde{a}(t, f)$  is the amplitude response of the TX chain.

In the following  $\Delta\tilde{c}$  represents the middle sample of the EVM window of length  $W$  (defined in the next clauses) or the last sample of the first window half if  $W$  is even.

The EVM analyser shall

- detect the start of each slot and estimate  $\Delta\tilde{t}$  and  $\Delta\tilde{f}$ ,
- determine  $\Delta\tilde{c}$  so that the EVM window of length  $W$  is centred
  - on the time interval determined by the measured cyclic prefix minus  $16\kappa$  samples of the considered OFDM symbol for symbol  $l$  for subcarrier spacing configuration  $\mu$  in a subframe, with  $l = 0$  or  $l = 7 \cdot 2^\mu$  for normal CP, i.e. the first  $16\kappa$  samples of the CP should not be taken into account for this step. In the determination of the number of excluded samples, a sampling rate of  $1/T_c$  is assumed. If a different sampling rate is used, the number of excluded samples is scaled linearly.
  - on the measured cyclic prefix of the considered OFDM symbol for all other symbols for normal CP and for symbol 0 to 11 for extended CP.
  - on the measured preamble cyclic prefix for the PRACH

To determine the other parameters a sample timing offset equal to  $\Delta\tilde{c}$  is corrected from the signal under test. The EVM analyser shall then

- correct the RF frequency offset  $\Delta\tilde{f}$  for each time slot, and

- apply an FFT of appropriate size. The chosen FFT size shall ensure that in the case of an ideal signal under test, there is no measured inter-subcarrier interference.

The carrier leakage shall be removed from the evaluated signal before calculating the EVM and the in-band emissions; however, the removed relative carrier leakage power also has to satisfy the applicable requirement.

At this stage the allocated RBs shall be separated from the non-allocated RBs. In the case of PUCCH and PUSCH EVM, the signal on the non-allocated RB(s),  $Y(t, f)$ , is used to evaluate the in-band emissions.

Moreover, the following procedure applies only to the signal on the allocated RB(s).

- In the case of PUCCH and PUSCH, the UL EVM analyzer shall estimate the TX chain equalizer coefficients  $\tilde{a}(t, f)$  and  $\tilde{\varphi}(t, f)$  used by the ZF equalizer for all subcarriers by time averaging at each signal subcarrier of the amplitude and phase of the reference and data symbols. The time-averaging length is 1 slot. This process creates an average amplitude and phase for each signal subcarrier used by the ZF equalizer. The knowledge of data modulation symbols may be required in this step because the determination of symbols by demodulation is not reliable before signal equalization.
- In the case of PRACH, the UL EVM analyzer shall estimate the TX chain coefficients  $\tilde{a}(t)$  and  $\tilde{\varphi}(t)$  used for phase and amplitude correction and are selected so as to minimize the resulting EVM. The TX chain coefficients are not dependent on frequency, i.e.  $\tilde{a}(t, f) = \tilde{a}(t)$  and  $\tilde{\varphi}(t, f) = \tilde{\varphi}(t)$ . The TX chain coefficients are chosen independently for each preamble transmission and for each  $\Delta\tilde{t}$ .

At this stage estimates of  $\Delta\tilde{f}$ ,  $\tilde{a}(t, f)$ ,  $\tilde{\varphi}(t, f)$  and  $\Delta\tilde{c}$  are available.  $\Delta\tilde{t}$  is one of the extremities of the window  $W$ , i.e.  $\Delta\tilde{t}$  can be  $\Delta\tilde{c} + \alpha - \left\lfloor \frac{W}{2} \right\rfloor$  or  $\Delta\tilde{c} + \left\lfloor \frac{W}{2} \right\rfloor$ , where  $\alpha = 0$  if  $W$  is odd and  $\alpha = 1$  if  $W$  is even.

The EVM analyser shall then

- calculate  $\text{EVM}_l$  with  $\Delta\tilde{t}$  set to  $\Delta\tilde{c} + \alpha - \left\lfloor \frac{W}{2} \right\rfloor$ ,
- calculate  $\text{EVM}_h$  with  $\Delta\tilde{t}$  set to  $\Delta\tilde{c} + \left\lfloor \frac{W}{2} \right\rfloor$ .

---

## F.5 Window length

### F.5.1 Timing offset

As a result of using a cyclic prefix, there is a range of  $\Delta\tilde{t}$ , which, at least in the case of perfect Tx signal quality, would give close to minimum error vector magnitude. As a first order approximation, that range should be equal to the length of the cyclic prefix. Any time domain windowing or FIR pulse shaping applied by the transmitter reduces the  $\Delta\tilde{t}$  range within which the error vector is close to its minimum.

### F.5.2 Window length

The window length  $W$  affects the measured EVM and is expressed as a function of the configured cyclic prefix length. In the case where equalization is present, as with frequency domain EVM computation, the effect of FIR is reduced. This is because the equalization can correct most of the linear distortion introduced by the FIR. However, the time domain windowing effect can't be removed.



## F.5.3 Window length for normal CP

Table F.5.3-1 and Table F.5.3-2 below specify the EVM window length ( $W$ ) for normal CP for FR2.

**Table F.5.3-1: EVM window length for normal CP for 60 kHz SCS**

Channel Bandwidth (MHz)	FFT size	Cyclic prefix length in FFT samples	EVM window length $W$	Ratio of $W$ to total CP length <sup>1</sup> (%)
50	1024	72	36	50
100	2048	144	72	50
200	4096	288	144	50
Note 1: These percentages are informative and apply to all OFDM symbols within subframe except for symbol 0 of slot 0 and slot 2. Symbol 0 of slot 0 and slot 2 may have a longer CP and therefore a lower percentage.				

**Table F.5.3-2: EVM window length for normal CP for 120 kHz SCS**

Channel Bandwidth (MHz)	FFT size	Cyclic prefix length in FFT samples	EVM window length $W$	Ratio of $W$ to total CP length <sup>1</sup> (%)
50	512	36	18	50
100	1024	72	36	50
200	2048	144	72	50
400	4096	288	144	50
Note 1: These percentages are informative and apply to all OFDM symbols within subframe except for symbol 0 of slot 0 and slot 4. Symbol 0 of slot 0 and slot 4 may have a longer CP and therefore a lower percentage.				

## F.5.4 Window length for Extended CP

Table F.5.4-1 below specifies the EVM window length ( $W$ ) for extended CP. The number of CP samples excluded from the EVM window is the same as for normal CP length.

**Table F.5.4-1: EVM window length for extended CP for 60 kHz SCS**

Channel Bandwidth (MHz)	FFT size	Cyclic prefix length in FFT samples	EVM window length $W$	Ratio of $W$ to total CP length <sup>1</sup> (%)
50	1024	256	220	85.9
100	2048	512	440	85.9
200	4096	1024	880	85.9
Note 1: These percentages are informative.				

## F.5.5 Window length for PRACH

The table below specifies the EVM window length for PRACH preamble formats for  $L_{RA} = 139$  and  $\Delta f^{RA} = 15 \cdot 2^\mu$  kHz where  $\mu \in \{2, 3\}$ .

Table F.5.5-1: EVM window length for PRACH formats for  $L_{RA} = 139$ 

Preamble format	Cyclic prefix length $N_{cp}$	Nominal FFT size <sup>1</sup>	EVM window length $W$ in FFT samples	Ratio of $W$ to CP <sup>2</sup>
A1	$1152 \cdot 2^{-\mu}$	$8192 \cdot 2^{-\mu}$	$576 \cdot 2^{-\mu}$	50.0%
A2	$2304 \cdot 2^{-\mu}$	$8192 \cdot 2^{-\mu}$	$1728 \cdot 2^{-\mu}$	75.0%
A3	$3456 \cdot 2^{-\mu}$	$8192 \cdot 2^{-\mu}$	$2880 \cdot 2^{-\mu}$	83.3%
B1	$864 \cdot 2^{-\mu}$	$8192 \cdot 2^{-\mu}$	$288 \cdot 2^{-\mu}$	33.3%
B2	$1440 \cdot 2^{-\mu}$	$8192 \cdot 2^{-\mu}$	$864 \cdot 2^{-\mu}$	60.0%
B3	$2016 \cdot 2^{-\mu}$	$8192 \cdot 2^{-\mu}$	$1440 \cdot 2^{-\mu}$	71.4%
B4	$3744 \cdot 2^{-\mu}$	$8192 \cdot 2^{-\mu}$	$3168 \cdot 2^{-\mu}$	84.6%
C0	$4960 \cdot 2^{-\mu}$	$8192 \cdot 2^{-\mu}$	$4384 \cdot 2^{-\mu}$	88.4%
C2	$8192 \cdot 2^{-\mu}$	$8192 \cdot 2^{-\mu}$	$7616 \cdot 2^{-\mu}$	93.0%

Note 1: The use of other FFT sizes is possible as long as appropriate scaling of the window length is applied  
Note 2: These percentages are informative

## F.6 Averaged EVM

The general EVM is averaged over basic EVM measurements for  $n$  slots in the time domain.

$$\overline{EVM} = \sqrt{\frac{1}{n} \sum_{i=1}^n EVM_i^2},$$

where  $n$  is

$$n = \begin{cases} 40, & \text{for } 60 \text{ kHz SCS} \\ 80, & \text{for } 120 \text{ kHz SCS} \end{cases}$$

for PUCCH, PUSCH.

The EVM requirements shall be tested against the maximum of the RMS average at the window  $W$  extremities of the EVM measurements:

Thus  $\overline{EVM}_l$  is calculated using  $\Delta\tilde{t} = \Delta\tilde{t}_l$  in the expressions above and  $\overline{EVM}_h$  is calculated using  $\Delta\tilde{t} = \Delta\tilde{t}_h$ .

Thus we get:

$$EVM = \max(\overline{EVM}_l, \overline{EVM}_h)$$

The calculation of the EVM for the demodulation reference signal,  $EVM_{DMRS}$ , follows the same procedure as calculating the general EVM, with the exception that the modulation symbol set  $T_m$  defined in clause F.2 is restricted to symbols containing uplink demodulation reference signals.

The basic  $EVM_{DMRS}$  measurements are first averaged over  $n$  slots in the time domain to obtain an intermediate average  $\overline{EVM}_{DMRS}$ .

$$\overline{EVM}_{DMRS} = \sqrt{\frac{1}{n} \sum_{i=1}^n EVM_{DMRS,i}^2}$$

In the determination of each  $EVM_{DMRS,i}$ , the timing is set to  $\Delta\tilde{t} = \Delta\tilde{t}_l$  if  $\overline{EVM}_l > \overline{EVM}_h$ , and it is set to  $\Delta\tilde{t} = \Delta\tilde{t}_h$  otherwise, where  $\overline{EVM}_l$  and  $\overline{EVM}_h$  are the general average EVM values calculated in the same n slots over which the intermediate average  $\overline{EVM}_{DMRS}$  is calculated. Note that in some cases, the general average EVM may be calculated only for the purpose of timing selection for the demodulation reference signal EVM.

Then the results are further averaged to get the EVM for the demodulation reference signal,  $EVM_{DMRS}$ ,

$$EVM_{DMRS} = \sqrt{\frac{1}{6} \sum_{j=1}^6 \overline{EVM}_{DMRS,j}^2}$$

The PRACH EVM,  $EVM_{PRACH}$ , is averaged over 2 preamble sequence measurements for long preamble formats as defined in table 6.3.3.1-1 in [9] and averaged over 10 preamble sequence measurements for short preamble formats as defined in table 6.3.3.1-2 in [9].

The EVM requirements shall be tested against the maximum of the RMS average at the window  $W$  extremities of the EVM measurements:

Thus  $\overline{EVM}_{PRACH,l}$  is calculated using  $\Delta\tilde{t} = \Delta\tilde{t}_l$  and  $\overline{EVM}_{PRACH,h}$  is calculated using  $\Delta\tilde{t} = \Delta\tilde{t}_h$ .

Thus we get:

$$EVM_{PRACH} = \max(\overline{EVM}_{PRACH,l}, \overline{EVM}_{PRACH,h})$$

## F.7 Spectrum Flatness

The data shall be taken from FFT coded data symbols and the demodulation reference symbols of the allocated resource block.

## F.8 Phase offset measurement for DMRS bundling

### F.8.1 Measurement point

The measurement point for phase offset measurement is defined in Figure F.8.1-1.

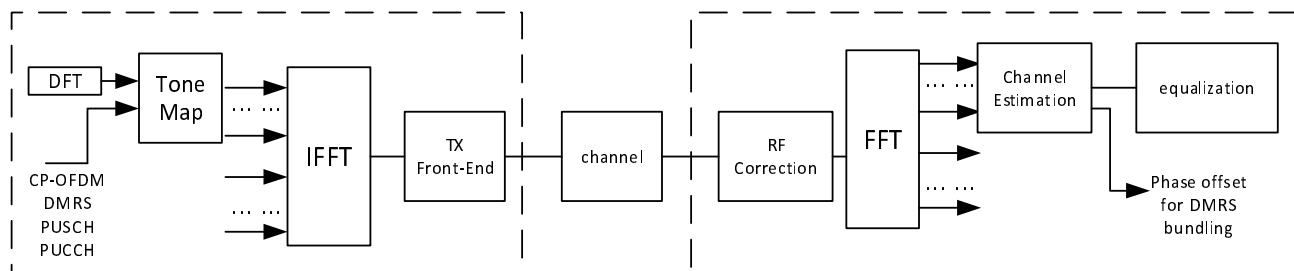


Figure F.8.1-1: Measurement point for phase offset for DMRS bundling

## F.8.2 Symbols used

Phase offset is determined based on DMRS REs (3 DMRS symbols per slot) with the option to use data symbols.

## F.8.3 Modified test signal

Same as described in Annex F.4.

## F.8.4 Phase offset measurement

The phase offset measurement is based on the phase response of the Tx chain  $\tilde{\varphi}(t, f)$  as derived based on Annex F.4.

The subcarrier at the carrier leakage frequency of the transmitted signal shall be excluded from the measured subcarriers.

The phase difference  $\Delta\tilde{\varphi}(f)$  for each measured subcarrier between a reference timeslot  $t_{ref}$  and the measurement timeslot  $t_m$  is then calculated as defined below:

$$\Delta\tilde{\varphi}(f) = \tilde{\varphi}(t_m, f) - \tilde{\varphi}(t_{ref}, f)$$

The phase offset between the reference and measurement timeslots are then calculated as the maximum over the results for all measured subcarriers as shown below:

$$PhaseOffset = \max_f(|\Delta\tilde{\varphi}(f)|)$$

---

## F.9 Reserved

---

## F.10 EVM for dual transmit polarizations

### F.10.1 General

A zero-forcing (ZF) MIMO receiver architecture is used so that transmissions by the UE, which are received by the test equipment on two polarizations, can be demodulated by the test equipment receiver.

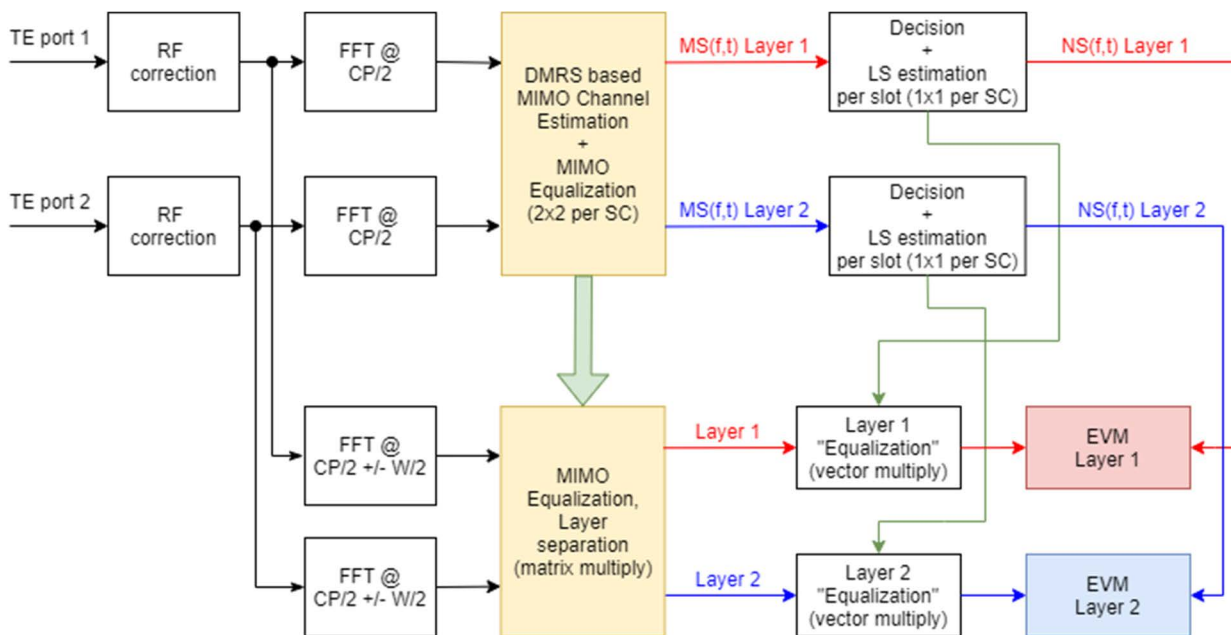


Figure F.10.1-1: EVM calculation block diagram for 2-Layer UL MIMO

The TE receives signals from 2 different ports on two antenna polarizations in the test system.

For UL MIMO measurements a MIMO equalization step as described in section F.10.2 is performed to separate the layers.

For single layer transmissions received on two polarizations the MIMO equalization step as described in section F.10.2 is replaced by a maximum ratio combining step as described in section F.10.3.

Each layer is then processed as described in section F.10.4 to receive the measurement results for each individual layer.

### F.10.2 MIMO Equalization (UL MIMO transmission)

The MIMO equalization is based only on reference signals (DMRS) without using any data symbols. For the equalization process all available DMRS symbols shall be used.

The effective 2x2 channel matrix is estimated using reference signals of different subcarriers, e.g. in case of DMRS antenna ports 0 and 2. In case that same subcarriers are used, e.g. DMRS antenna ports 0 and 1, a channel decomposition is necessary taking advantage of the orthogonal codes  $w_f$  and  $w_t$  and assuming identical channel coefficients for adjacent subcarriers of same CDM group.

Effective channel including the precoding matrix  $P$  is:

$$\tilde{H} = HP = \begin{bmatrix} \tilde{h}_{0,0} & \tilde{h}_{0,1} \\ \tilde{h}_{1,0} & \tilde{h}_{1,1} \end{bmatrix}$$

with

$$\tilde{h}_{n,v} = \frac{y_n r_v^*}{|r_v|^2}$$

where  $y$  denotes the received symbol on port index  $n$  and  $r$  the reference signal for layer index  $v$ .

Since reference signals of a specific layer are transmitted only on subcarriers of one CDM group channel, interpolation is needed in order to obtain channel coefficients for all subcarriers. Channel interpolation is done using the channel coefficients of active CDM group in all other CDM groups.

The channel coefficients used to calculate the equalizer coefficients are obtained after channel smoothing in frequency domain by computing the moving average of interpolated channel coefficients. The moving average window size is 7. For subcarriers at or near the edge of allocation the window size is reduced accordingly.

The ZF equalizer coefficients are calculated as the inverse of the effective channel matrix, in general:

$$G_{ZF} = \tilde{H}^{-1}$$

### F.10.3 Maximum Ratio combining (Tx diversity transmission)

The maximum ratio combining is based only on reference signals (DMRS) without using any data symbols. For the equalization process all available DMRS symbols shall be used.

The effective 2x1 channel matrix is estimated using reference signals of different subcarriers. In case of transmit diversity, the effective channel includes the precoding matrix  $P$ :

$$\tilde{H} = HP = \begin{bmatrix} \tilde{h}_0 \\ \tilde{h}_1 \end{bmatrix}$$

with

$$\tilde{h}_n = \frac{y_n r^*}{|r|^2}$$

where  $y$  denotes the received symbol on port index  $n$  and  $r$  the reference signal.

Since reference signals are transmitted only on subcarriers of one CDM group, channel interpolation is needed in order to obtain channel coefficients for all subcarriers. Channel interpolation is done using the channel coefficients of active CDM group in all other CDM groups.

The channel coefficients used to calculate the equalizer coefficients are obtained after channel smoothing in frequency domain by computing the moving average of interpolated channel coefficients. The moving average window size is 7. For subcarriers at or near the edge of allocation the window size is reduced accordingly.

The ZF equalizer coefficients for maximum ratio combining are calculated as pseudo inverse of effective channel, in general:

$$G_{ZF} = \tilde{H}^+ = (\tilde{H}^H \tilde{H})^{-1} \tilde{H}^H$$

### F.10.4 Layer processing

After performing either the MIMO equalization or maximum ratio combining as described in section F.10.2 or F.10.3 respectively, each layer is processed using the existing procedure as defined in Annex E of TS 38.521-2 [5].

Since the channel estimation is calculated only on the DMRS symbols, an averaging including all 14 symbols of one slot, i.e. data and reference signals, is needed in order to minimize EVM. The averaging is achieved by the least square (LS) equalization method described for single layer in Annex E.3. of TS 38.521-2 [5].

$MS(f,t)$  and  $NS(f,t)$  are processed with a LS estimator, to derive one equalizer coefficient per time slot and per allocated subcarrier.  $EC(f)$  is defined for each layer as:

$$EC_v(f) = \frac{\sum_{t=0}^{13} NS_v(f,t)^* NS_v(f,t)}{\sum_{t=0}^{13} MS_v(f,t)^* NS_v(f,t)}$$

With  $*$  denoting complex conjugation.  $EC(f)$  are used to equalize layer data symbols.

EVM equalizer spectral flatness is derived from equalizer coefficients for each layer as follows:

$$c_v = |EC_v(f)| \sqrt{|g_{v,0}|^2 + |g_{v,1}|^2}$$



# Annex G (normative): Difference of relative phase and power errors

## G.0 General

This annex gives further information needed for understanding and implementing 6.4D.4. The following terms should be understood as follows:

- Relative phase error: refers to the phase difference between signals at different antenna ports, which should be ideally 0. It should be understood as for a slot i.e. (slot) relative phase. It is calculated based on DMRS symbols of that slot or on SRS symbols.
- Difference of relative phase error: refers to the difference between the relative phase error determined per slot and the relative phase error determined based on the SRS transmitted.

## G.1 Measurement Point

Figure G.1-1 shows the measurement point for the difference of relative phase and power errors. To separate signals from the two transmitters, it is necessary for the test equipment to perform joint demodulation by inverting the 2x2 composite channel ('HGW') resulting from DUT precoding 'W' and antenna virtualization 'G' and OTA channel between DUT and test equipment 'H'. Post processing refers to the calculation of the phase/power errors, the averaging of phase and power errors per RB per slot per channel port and the calculation of difference between relative phases.

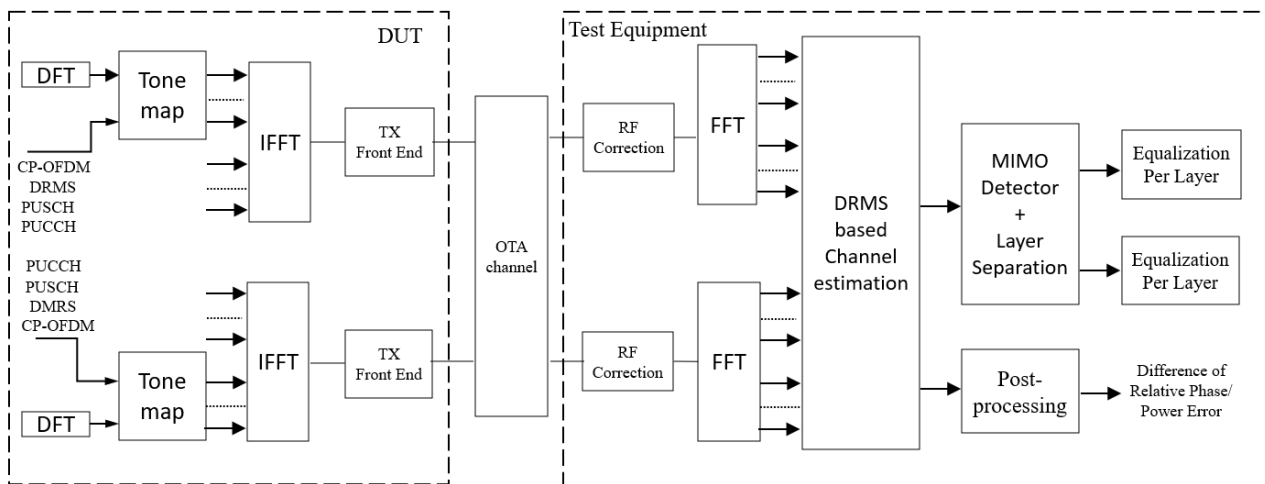


Figure G.1-1 - Measurement point for difference of relative phase/power error for UL coherent MIMO

## G.2 Relative Phase Error Measurement

Here are listed the different aspects that may lead to different interpretations.



## G.2.1 Symbols and subcarriers used

Phase error is determined based on DMRS REs (DMRS mapping type A with 3 DMRS symbols per slot, the REs corresponding to the odd subcarriers and DMRS symbols are non-allocated for data or DMRS) and SRS REs (with 4 SRS symbols in the SRS slot, same SRS resource mapping is used for non-codebook-based and codebook-based precoding).

For the DMRS and SRS to occupy identical SCs and maximize their frequency density, DMRS configuration type 1 and SRS comb2 configuration are used.

UL RMC described in Annex A.2 is used.

## G.2.2 CFO (carrier frequency offset) correction

The TE performs a CFO correction on a slot-by-slot basis using a common frequency correction at the two uplink layers.

## G.2.3 Steps of the measurement method

Below are detailed the steps necessary to obtain the maximum difference of relative phase error during the 20ms time window.

- 1 Determination for each subcarrier and at each antenna port, the SRS relative phase error based on the last SRS transmitted on Ant1 and Ant2, that relative phase error serves as a reference for the calculation of the difference of relative phase error for each slot inside the 20 ms time window.

The output is the “SRS relative phase error” vector for the last SRS transmitted:  $[1 \times \textit{number\_of\_subcarriers}]$ .

- 2 Calculation for the last SRS transmitted, for each RB of the SRS relative phase errors based on the arithmetic mean of the subcarrier SRS relative phase errors determined in previous step.

The output is the “SRS relative phase error” vector for the last SRS transmitted:  $[1 \times \textit{number\_of\_RBs}]$ .

- 3 CFO correction on slot-by-slot basis using a common frequency correction for both antenna ports.

- 4 Determination for each subcarrier and at each antenna, the phase over the slot being analyzed. The phase is extracted from the channel estimate derived from the 3 DMRS symbols of the slot using the LSE technique.

The output is one vector of dimension  $[1 \times \textit{number\_of\_subcarriers}]$  for each antenna port.

- 5 Calculation for a slot for each subcarrier of the relative phase error (difference between the vectors determined in the previous step).

The output is subcarrier relative phase errors of a slot:  $[1 \times \textit{number\_of\_subcarriers}]$ .

- 6 Calculation for a slot, for each RB of the relative phase errors based on the arithmetic mean of the subcarrier relative phase errors determined in previous step.

The output is a “slot relative phase error” vector for a slot:  $[1 \times \textit{number\_of\_RBs}]$ .

- 7 Calculation for a slot of the difference of relative phase errors based on the “SRS relative phase error” (reference) determined in step 2 and the “slot relative phase error” determined in previous step.

The output is a “difference of relative phase error” vector for a slot:  $[1 \times \textit{number\_of\_RBs}]$ .

- 8 Calculation for a slot of the arithmetic mean value of the “difference of relative phase error” vector determined in previous step, this value corresponds to an RB.

The output is a “difference of relative phase error” value for a slot:  $[1 \times 1]$ .

- 9 Perform for each slot of the 20ms time window, steps 3 to 8.

The output is a “difference of relative phase error” vector:  $[1 \times \textit{number\_of\_slots}]$ .

- 10 Calculation of the maximum value of the “difference of relative phase error”.

The output is the “difference of relative phase error” that should be verified as complying with the 40° maximum allowable difference of relative phase error requirement: [1 × 1].

# Annex H (Normative): Modified MPR behavior

## H.1 Indication of modified MPR behavior

This annex contains the definitions of the bits in the field *modifiedMPR-Behavior* indicated per supported NR band in the IE *RF-Parameters* [13] by a UE supporting an MPR or A-MPR modified in a given version of this specification. A modified MPR or A-MPR behaviour can apply to a supported NR band in stand-alone operation (including CA and NN-DC operation) or in non-standalone operation with the said NR band as part of an EN-DC or NE-DC band combination. Moreover, the bits in the field can explicitly indicate NS value(s) supported by a UE.

NOTE 1: In the present release, the *modifiedMPR-Behavior* is indicated [13] by an 8-bit bitmap per supported NR band.

**Table H.1-1: Definitions of the bits in the field *modifiedMPRbehavior***

NR Band	Index of field (bit number)	Definition (description of the supported functionality if indicator set to one)	Notes
n257	0 (leftmost bit)	- FR2 power class 3 MPR as defined in clause 6.2.2.3 of 38.101-2	- This bit shall be set to 1 by a UE supporting n257
n258	0 (leftmost bit)	- FR2 power class 3 MPR as defined in clause 6.2.2.3 of 38.101-2	- This bit shall be set to 1 by a UE supporting n258
	1	Void	
	2	- NS_203 as defined in clause 6.5.3.2.4 or both NS_203 and CA_NS_203 as defined in clause 6.5A.3.2.4 of 38.101-2 v15.12.0	- This bit shall be set to 1 by a UE supporting n258 or both n258 and CA_n258
n260	0 (leftmost bit)	- FR2 power class 3 MPR as defined in clause 6.2.2.3 of 38.101-2	- This bit shall be set to 1 by a UE supporting n260
n261	0 (leftmost bit)	- FR2 power class 3 MPR as defined in clause 6.2.2.3 of 38.101-2	- This bit shall be set to 1 by a UE supporting n261

## Annex I (informative): Void

## Annex J (normative): UE coordinate system

### J.1 Reference coordinate system

This annex defines the measurement coordinate system for the NR UE. The reference coordinate system as defined in IEEE Std 149 [15] is provided in Figure J.1-1 below while Figure J.1-2 shows the DUT in the default alignment, i.e., the DUT and the reference coordinate systems are aligned with  $\alpha = 0^\circ$  and  $\beta = 0^\circ$  and  $\gamma = 0^\circ$  where  $\alpha$ ,  $\beta$ , and  $\gamma$  describe the relative angles between the two coordinate systems.

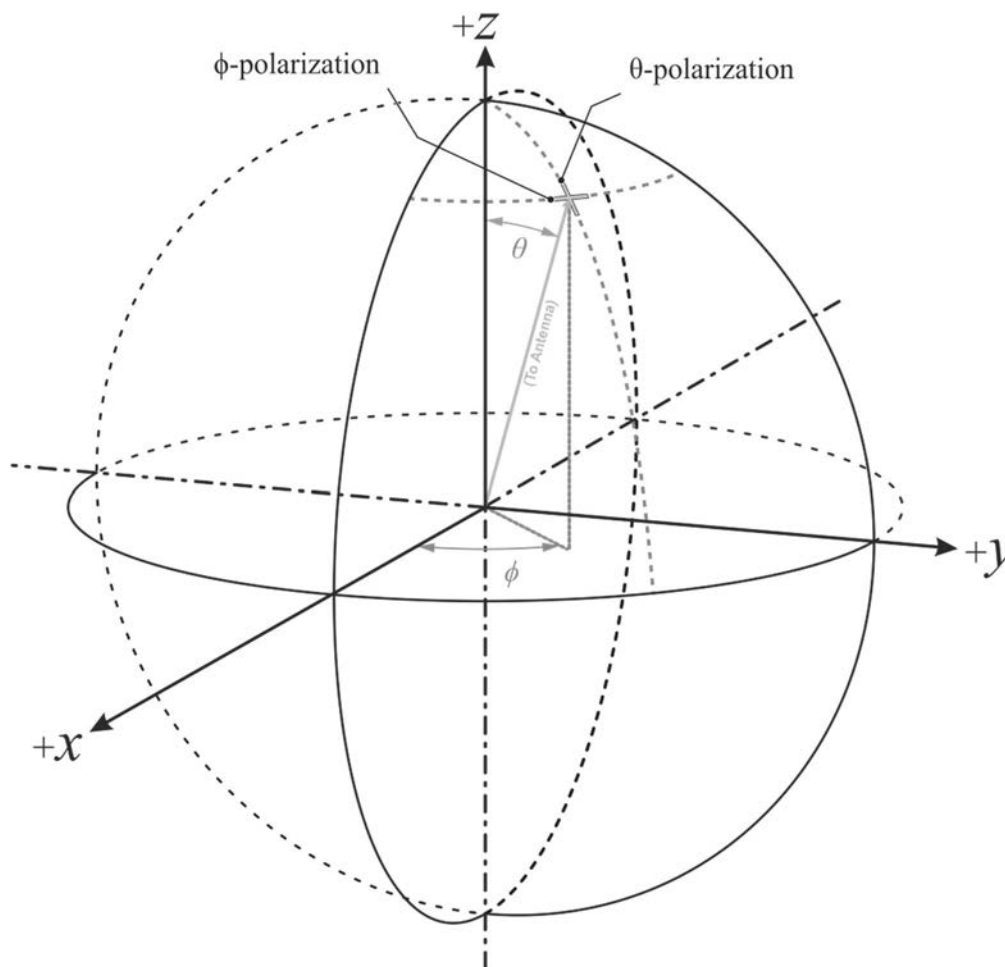
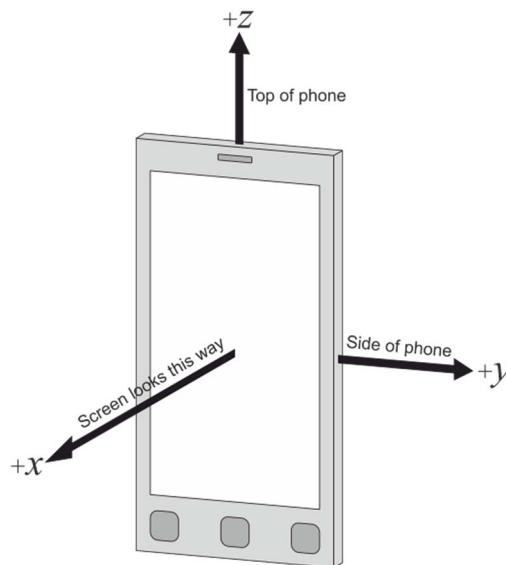


Figure J.1-1: Reference coordinate system



**Figure J.1-2: DUT default alignment to coordinate system**

The following aspects are necessary:

- A basic understanding of the top and bottom of the device is needed in order to define unambiguous DUT positioning requirements for the test, e.g., in the drawings used in this annex, the three buttons are on the bottom of the device (front) and the camera is on the top of the device (back).
- An understanding of the origin and alignment the coordinate system inside the test system i.e. the directions in which the x, y, z -axes points inside the test chamber is needed in order to define unambiguous DUT orientation, DUT beam, signal, interference, and measurement angles

---

## J.2 Test conditions and angle definitions

Tables J.2-1 through J.2-3 below provides the test conditions and angle definitions for three permitted device alignment for the default test condition, DUT orientation 1, and two different options for each permitted device alignment to re-position the device for DUT Orientation 2 as outlined by figures in Tables J.2-1 through J.2-3.

**Table J.2-1: Test conditions and angle definitions for Alignment Option 1**

Test condition	DUT orientation	Link angle	Measurement angle	Diagram
Free space DUT Orientation 1 (default)	$\alpha = 0^\circ$ ; $\beta = 0^\circ$ ; $\gamma = 0^\circ$	$\theta_{\text{Link}}$ ; $\phi_{\text{Link}}$ with polarization reference $\text{Pol}_{\text{Link}} = \theta$ or $\phi$	$\theta_{\text{Meas}}$ ; $\phi_{\text{Meas}}$ with polarization reference $\text{Pol}_{\text{Meas}} = \theta$ or $\phi$	
Free space DUT Orientation 2 – Option 1 (based on re-positioning approach)	$\alpha = 180^\circ$ ; $\beta = 0^\circ$ ; $\gamma = 0^\circ$	$\theta_{\text{Link}}$ ; $\phi_{\text{Link}}$ with polarization reference $\text{Pol}_{\text{Link}} = \theta$ or $\phi$	$\theta_{\text{Meas}}$ ; $\phi_{\text{Meas}}$ with polarization reference $\text{Pol}_{\text{Meas}} = \theta$ or $\phi$	
Free space DUT Orientation 2 – Option 2 (based on re-positioning approach)	$\alpha = 0^\circ$ ; $\beta = 180^\circ$ ; $\gamma = 0^\circ$	$\theta_{\text{Link}}$ ; $\phi_{\text{Link}}$ with polarization reference $\text{Pol}_{\text{Link}} = \theta$ or $\phi$	$\theta_{\text{Meas}}$ ; $\phi_{\text{Meas}}$ with polarization reference $\text{Pol}_{\text{Meas}} = \theta$ or $\phi$	

NOTE 1: A polarization reference, as defined in relation to the reference coordinate system in J.1-1, is maintained for each signal angle, link or interferer angle, and measurement angle.

NOTE 2: The combination of rotations is captured by matrix  $M=R_z(\gamma) \cdot R_y(\beta) \cdot R_x(\alpha)$

**Table J.2-2: Test conditions and angle definitions for Alignment Option 2**

Test condition	DUT orientation	Link angle	Measurement angle	Diagram
Free space DUT Orientation 1 (default)	$\alpha = 0^\circ;$ $\beta = -90^\circ;$ $\gamma = 0^\circ$	$\theta_{\text{Link}};$ $\phi_{\text{Link}}$ with polarization reference $\text{Pol}_{\text{Link}} = \theta$ or $\phi$	$\theta_{\text{Meas}};$ $\phi_{\text{Meas}}$ with polarization reference $\text{Pol}_{\text{Meas}} = \theta$ or $\phi$	
Free space DUT Orientation 2 – Option 1 (based on re-positioning approach)	$\alpha = 180^\circ;$ $\beta = 90^\circ;$ $\gamma = 0^\circ$	$\theta_{\text{Link}};$ $\phi_{\text{Link}}$ with polarization reference $\text{Pol}_{\text{Link}} = \theta$ or $\phi$	$\theta_{\text{Meas}};$ $\phi_{\text{Meas}}$ with polarization reference $\text{Pol}_{\text{Meas}} = \theta$ or $\phi$	
Free space DUT Orientation 2 – Option 2 (based on re-positioning approach)	$\alpha = 0^\circ;$ $\beta = 90^\circ;$ $\gamma = 0^\circ$	$\theta_{\text{Link}};$ $\phi_{\text{Link}}$ with polarization reference $\text{Pol}_{\text{Link}} = \theta$ or $\phi$	$\theta_{\text{Meas}};$ $\phi_{\text{Meas}}$ with polarization reference $\text{Pol}_{\text{Meas}} = \theta$ or $\phi$	
<p>NOTE 1: A polarization reference, as defined in relation to the reference coordinate system in J.1-1, is maintained for each signal angle, link or interferer angle, and measurement angle.</p> <p>NOTE 2: The combination of rotations is captured by matrix <math>M=R_z(\gamma) \cdot R_y(\beta) \cdot R_x(\alpha)</math></p>				



**Table J.2-3: Test conditions and angle definitions for Alignment Option 3**

Test condition	DUT orientation	Link angle	Measurement angle	Diagram
Free space DUT Orientation 1 (default)	$\alpha = 90^\circ;$ $\beta = 0^\circ;$ $\gamma = 0^\circ$	$\theta_{\text{Link}};$ $\phi_{\text{Link}}$ with polarization reference $\text{Pol}_{\text{Link}} = \theta$ or $\phi$	$\theta_{\text{Meas}};$ $\phi_{\text{Meas}}$ with polarization reference $\text{Pol}_{\text{Meas}} = \theta$ or $\phi$	
Free space DUT Orientation 2 – Option 1 (based on re-positioning approach)	$\alpha = -90^\circ;$ $\beta = 0^\circ;$ $\gamma = 0^\circ$	$\theta_{\text{Link}};$ $\phi_{\text{Link}}$ with polarization reference $\text{Pol}_{\text{Link}} = \theta$ or $\phi$	$\theta_{\text{Meas}};$ $\phi_{\text{Meas}}$ with polarization reference $\text{Pol}_{\text{Meas}} = \theta$ or $\phi$	
Free space DUT Orientation 2 – Option 2 (based on re-positioning approach)	$\alpha = 90^\circ;$ $\beta = 180^\circ;$ $\gamma = 0^\circ$	$\theta_{\text{Link}};$ $\phi_{\text{Link}}$ with polarization reference $\text{Pol}_{\text{Link}} = \theta$ or $\phi$	$\theta_{\text{Meas}};$ $\phi_{\text{Meas}}$ with polarization reference $\text{Pol}_{\text{Meas}} = \theta$ or $\phi$	

NOTE 1: A polarization reference, as defined in relation to the reference coordinate system in J.1-1, is maintained for each signal angle, link or interferer angle, and measurement angle.  
NOTE 2: The combination of rotations is captured by matrix  $M=R_z(\gamma) \cdot R_y(\beta) \cdot R_x(\alpha)$

For each UE requirement and test case, each of the parameters in Table J.2-1 through J.2-3 need to be recorded, such that DUT positioning, DUT beam direction, and angles of the signal, link/interferer, and measurement are specified in terms of the fixed coordinate system.

Due to the non-commutative nature of rotations, the order of rotations is important and needs to be defined when multiple DUT orientations are tested.

The rotations around the x, y, and z axes can be defined with the following rotation matrices

$$R_x(\alpha) = \begin{bmatrix} 1 & 0 & 0 & 0 \\ 0 & \cos \alpha & -\sin \alpha & 0 \\ 0 & \sin \alpha & \cos \alpha & 0 \\ 0 & 0 & 0 & 1 \end{bmatrix}$$

$$R_y(\beta) = \begin{bmatrix} \cos \beta & 0 & \sin \beta & 0 \\ 0 & 1 & 0 & 0 \\ -\sin \beta & 0 & \cos \beta & 0 \\ 0 & 0 & 0 & 1 \end{bmatrix}$$

and

$$R_z(\gamma) = \begin{bmatrix} \cos \gamma & -\sin \gamma & 0 & 0 \\ \sin \gamma & \cos \gamma & 0 & 0 \\ 0 & 0 & 1 & 0 \\ 0 & 0 & 0 & 1 \end{bmatrix}$$

with the respective angles of rotation,  $\alpha$ ,  $\beta$ ,  $\gamma$ , and

$$\begin{bmatrix} x' \\ y' \\ z' \\ 1 \end{bmatrix} = R \begin{bmatrix} x \\ y \\ z \\ 1 \end{bmatrix}$$

Additionally, any translation of the DUT can be defined with the translation matrix

$$T(t_x, t_y, t_z) = \begin{bmatrix} 1 & 0 & 0 & t_x \\ 0 & 1 & 0 & t_y \\ 0 & 0 & 1 & t_z \\ 0 & 0 & 0 & 1 \end{bmatrix}$$

with offsets  $t_x$ ,  $t_y$ ,  $t_z$  in x, y, and z, respectively and with

$$\begin{bmatrix} x' \\ y' \\ z' \\ 1 \end{bmatrix} = T \begin{bmatrix} x \\ y \\ z \\ 1 \end{bmatrix}$$

The combination of rotations and translation is captured by the multiplication of rotation and translation matrices.

For instance, the matrix M

$$M = T(t_x, t_y, t_z) \cdot R_z(\gamma) \cdot R_y(\beta) \cdot R_x(\alpha)$$

describes an initial rotation of the DUT around the x axis with angle  $\alpha$ , a subsequent rotation around the y axis with angle  $\beta$ , and a final rotation around the z axis with angle  $\gamma$ . After those rotations, the DUT is translated by  $t_x$ ,  $t_y$ ,  $t_z$  in x, y, and z, respectively.

---

## J.3 DUT positioning guidelines

The centre of the reference coordinate system shall be aligned with the geometric centre of the DUT in order to minimize the offset between antenna arrays integrated at any position of the UE and the centre of the quiet zone.

Near-field coupling effects between the antenna and the pedestals/positioners/fixtures generally cause increased signal ripples. Re-positioning the DUT by directing the beam peak away from those areas can reduce the effect of signal ripple on EIRP/EIS measurements. Figure J.3-1 and J.3-2 illustrate how to reposition the DUT in distributed axes and combined axes system, when the beam peak is directed to the DUTs upper hemisphere (DUT orientation 1) or the DUTs lower hemisphere (DUT orientation 2). While these figures are examples of different positioning systems and other implementations are not precluded, the relative orientation of the coordinate system with respect to the antennas/reflectors and the axes of rotation shall apply to any measurement setup.

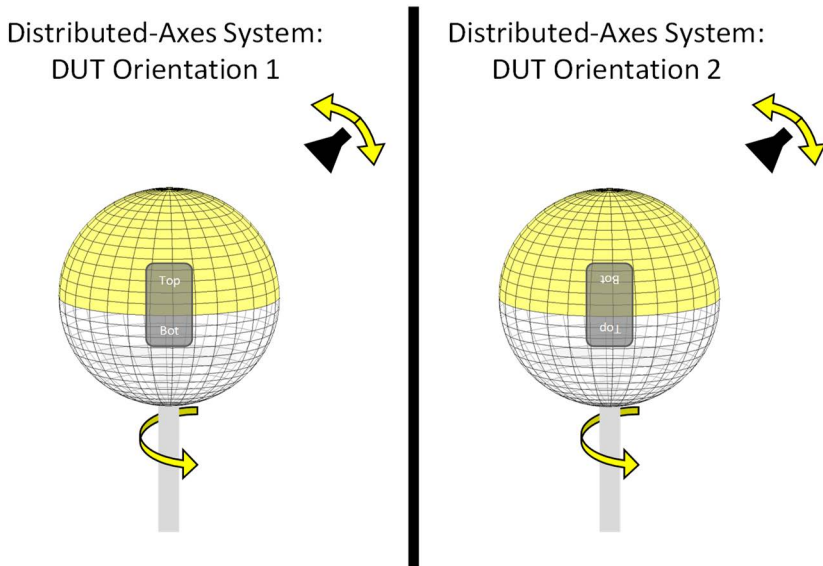


Figure J.3-1: DUT re-positioning for an example of distributed-axes system

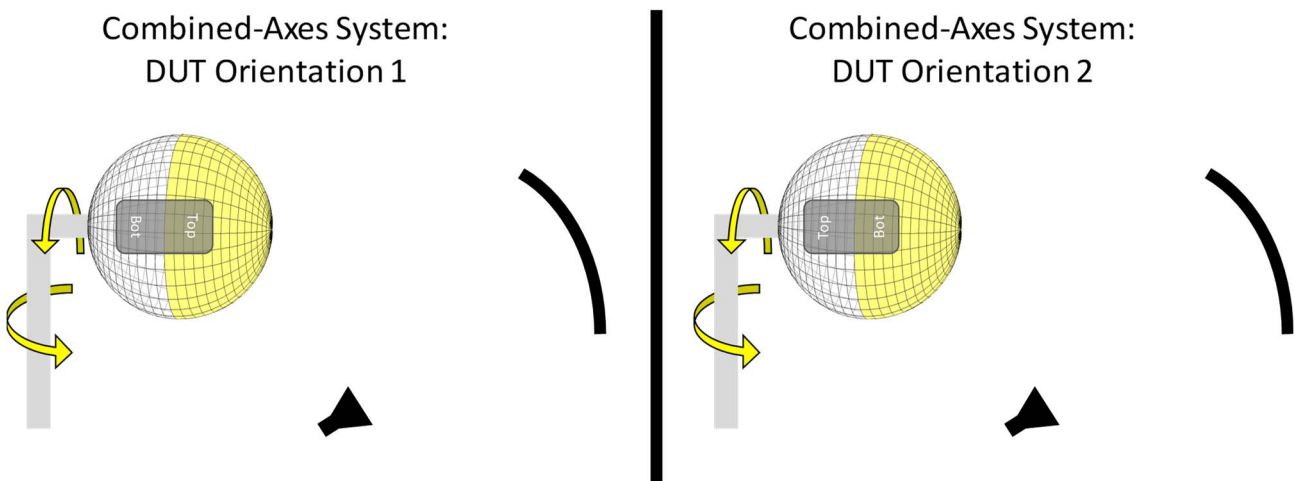


Figure J.3-2: DUT re-positioning for an example of combined-axes system

For EIRP/EIS measurements, re-positioning the DUT makes sure the pedestal is not obstructing the beam path and that the pedestal is not in closer proximity to the measurement antenna/reflector than the DUT. For TRP measurements, re-positioning the DUT makes sure that the beam peak direction is not obstructed by the pedestal and the pedestal is in the measurement path only when measuring the back-hemisphere. No re-positioning during the TRP measurement is required.

## Annex K (informative): Void

## Annex L (informative): Change history

Change history							
Date	Meeting	TDoc	CR	Rev	Cat	Subject/Comment	New version
2017-08	RAN4#84					Initial Skeleton	0.0.1
2017-10	RAN4#84 Bis	R4-1711979				TPs from R4#84Bis by editors	0.1.0
2017-12	RAN4#85	R4-1713806				<p>Approved TPs from R4#85</p> <p>R4-1714537, TP for TS 38.101-2: Channel Bandwidth Definition, Qualcomm Incorporated</p> <p>R4-1714115, TP for TS 38.101-2: Channel Arrangement, : Qualcomm Incorporated (Note: this TP was further discussed and edited in the reflector)</p> <p>R4-1713205, TP on general parts for 38.101-2 NR FR, : Ericsson</p> <p>R4-1712884, TP to TS38.101-2 on environmental conditions, Intel Corporation</p> <p>R4-1714018, TP to TS 38.101-2 for definition of UE RF terminologies, Anritsu Corporation</p> <p>R4-1714447, TP on UE power class for FR2, Intel Corporation</p> <p>R4-1714372, TP to TS38.101-2 on EVM equalizer spectrum flatness requirements, Intel Corporation</p> <p>R4-1714330, TP to TR 38.101-02 v0.1.0: ON/OFF mask design for NR UE transmissions for FR2, Ericsson</p> <p>R4-1714364, TP to TR 38.101: NR UE transmit OFF power for FR2, CATT</p> <p>R4-1714347, TP to TS38.101-2 on spurious emissions requirements for FR2, Intel Corporation (Note: this TP was further discussed and edited in the reflector)</p> <p>R4-1714456, TP on REFSENS for FR2, Intel Corporation</p> <p>R4-1714337 TP to TS 38.101-2 ACS requirement for mmW (section 7.5), Qualcomm Incorporated</p> <p>R4-1714338, TP to TS 38.101-2 IBB requirement for mmW (section 7.6.1), Qualcomm Incorporated</p> <p>R4-1714348, TP to TS38.101-2 on Rx spurious emissions for FR2, Intel Corporation</p> <p>Min power for EVM requirement according to R4-1711568, TP to TR 38.xxx - UE minimum transmit power for range 2, CATT</p> <p>Band list according to R4-1714542, List of bands and band combinations to be introduced into RAN4 NR core requirements by December 2017, RAN4 Chairmen</p>	0.2.0
2017-12	RAN4#85	R4-1714570				Further corrections and alignments with 38.104 after email review	0.3.0
2017-12	RAN#78	RP-172476				v1.0.0 submitted for plenary approval. Contents same as 0.3.0	1.0.0
2017-12	RAN#78					Approved by plenary – Rel-15 spec under change control	15.0.0
2018-03	RAN#79	RP-180264	0004		F	<p>Implementation of endorsed CR on to 38.101-2</p> <p>Endorsed draft CRs in RAN4-NR-AH#1801</p> <p>F: R4-1800918, Draft CR to 38.101-2 on channel bandwidth corrections (5.3.5), Nokia</p> <p>F: R4-1801097, Modification for TS38.101-2, CATT</p> <p>F: R4-1801098 Draft CR for TS38.101-2: On requirement metrics. Sumitomo Elec. Industries, Ltd</p> <p>F: R4-1800401, Editorial corections to 38.101-2, Qualcomm</p> <p>F: R4-1801122: Draft pCR for TS 38.101-2 version 15.0.0: Remaining ON/OFF masks for FR2 NR UE transmissions, Ericsson</p> <p>F: R4-1800418, Correction of NR SEM for FR2 table, vivo</p> <p>F: R4-1800316 Draft CR to 38.101-2: Tx spurious emission for NR FR2 (section 6.5.3 ), ZTE Corporation</p> <p>F: R4-1800918 Draft CR to 38.101-2 on channel bandwidth corrections (5.3.5), Nokia</p> <p>F: R4-1801013, Draft CR to 38.101-2: Clarifications to UE spectrum utilization section 5.3, Ericsson</p> <p>F: R4-1801229, Draft CR to 38.101-2: Channel spacing for CA for NR FR2(section 5.4.1.2), ZTE Corporation</p> <p>F: R4-1801232, Correction CR for channel spacing:38.101-2, Samsung</p>	15.1.0

					<p>F: R4-1801325, Draft CR to TS 38.101-2: Corrections on channel raster calculation in section 5.4.2, ZTE Corporation F: R4-1800860, Corrections of GSCN, Nokia</p> <p>Endorsed draft CRs in RAN4#86</p> <p>R4-1803054, Draft CR for new spec structure of 38.101-2, Ericsson R4-1801446, Modification for NR UE time mask requirement for FR2, CATT R4-1801729, Draft CR to 38.101-2: Corrections to In-band blocking requirements, Rohde &amp; Schwarz R4-1801967, CR on EVM spectrum flatness for FR2, Huawei R4-1802339, Draft CR to 38.101-2: Clarifications on peak directions and REFSENS, ROHDE &amp; SCHWARZ R4-1802567, Draft CR to TS 38.101-2: Clarification of mixed numerology guardband size, Ericsson R4-1803238, Draft CR for TS 38.101-2: ACLR requirement clarification, Huawei R4-1803365, Draft CR to 38.101-2: Clarification on REFSENS Definition, ROHDE &amp; SCHWARZ R4-1803453, draft CR for introduction of completed band combinations from 37.865-01-01 into 38.101-2, Ericsson R4-1803566, Draft CR for TS 38.101-2: Sync raster offset in re-farming bands (5.4.3), Ericsson</p>	
2018-06	RAN#80	RP-181262	0010	F	<p>CR to TS 38.101-2: Implementation of endorsed draft CRs from RAN4 #86bis and RAN4 #87</p> <p>Endorsed draft CRs from RAN4#86Bis</p> <p>R4-1803736, Draft CR on channel raster entry of band n258 for TS 38.101-2, ZTE Wistron Telecom AB R4-1804022, CR for modifications and clarifications for NR FR2 CA BW Classes, Nokia R4-1804585, Draft CR to 38.101-2: IBE Section Update, Qualcomm, Inc. R4-1804657, Introduction of UE to UE coexistence requirements requirements for FR2, Qualcomm Incorporated R4-1804949, Corrections to 5.3.3 in TS 38.101-2, Nokia R4-1805641, Corrections of BCS for n257 intraband contiguous CA in 38.101-2, Nokia R4-1805685, Draft CR to TS38.101-2: Channel Raster to Resource Element Mapping (Section 5.4.2.2) and RB alignment with different numerologies (Section 5.3.4), ZTE Corporation R4-1805704, Update of UE emission requirements for FR2, Qualcomm Incorporated R4-1805705, Draft CR to 38.101-2: Update of section 7.1, Rohde &amp; Schwarz R4-1805757, Update of ACS requirement for FR2, Qualcomm Incorporated R4-1805771, Update of IBB requirement for FR2, Qualcomm Incorporated R4-1805775, draft CR for TS 38.101-2 on US 28 GHz band number, Qualcomm Incorporated R4-1805949, Draft CR on minimum guardband of SCS 240 kHz SSB for TS 38.101-2, ZTE Wistron Telecom AB R4-1805982, draft CR for 38.101-2: sync raster, Samsung R4-1804878, draft CR introduction completed band combinations 37.865-01-01 -&gt; 38.101-2, Ericsson R4-1803628, pi/2 BPSK related CR, IITH</p> <p>Endorsed draft CRs from RAN#87</p> <p>R4-1806167, Draft CR on channel raster entry of band n261 for TS 38.101-2, ZTE Corporation R4-1806169, Draft CR on SSB clarification for TS 38.101-2, ZTE Corporation R4-1806383, Draft CR of clarifications on TRx RF test metrics for mmWave, Anritsu Corporation R4-1806946, Draft CR for TS 38.101-2: Channel raster and NR-ARFCN clarification (5.4.2), Ericsson R4-1807652, FR2 UE ACLR requirement for CA, Qualcomm R4-1807655, Further refinements for UE Rx requirements in FR2, Qualcomm R4-1807681, Draft CR on 38.101-2 on channel raster to achieve alignment of data and SSB subcarrier grids, Nokia R4-1807853, Draft CR to TS 38.101-2: UE maximum output power for UL CA, Nokia</p>	15.2.0

					<p>R4-1807855, Draft CR on 38.101-2: Transmit ON/OFF time mask for UL CA, Nokia</p> <p>R4-1807857, Draft CR on 38.101-2: Occupied BW for UL CA, Nokia</p> <p>R4-1808101, Draft CR to 38.101-2: On EVM Averaging Length, Wording, Qualcomm Incorporated</p> <p>R4-1808105, Configured maximum output power for FR2, Ericsson</p> <p>R4-1808124, draft CR on UE RF requirement for UE type 2 in FR2, LG Electronics</p> <p>R4-1808125, Draft CR to TS 38.101-2: Minimum output and OFF Power, Nokia</p> <p>R4-1808147, Draft CR for NR FR2 CA BW class modifications, MediaTek Inc.</p> <p>R4-1808148, EVM equaliser spectral flatness for FR2, Ericsson</p> <p>R4-1808149, UE Shaping Filter Requirement for pi/2 BPSK, Indian Institute of Tech (M)</p> <p>R4-1808152, Draft CR for Finalizing UE RF Requirement for FWA, Samsung</p> <p>R4-1808266, Draft CR for TS 38.101-2: Channel and sync raster corrections (5.4), Ericsson</p> <p>R4-1808545, Draft CR on UE RF requirement for UE type 3 in FR2, Verizon</p> <p>R4-1808546, Power class 3 Spherical coverage introduction and peak EIRP requirement update, Qualcomm</p> <p>R4-1808206, Draft CR to 38.101-2: FR2 Type 1 UE Power Control, Qualcomm</p> <p>R4-1808208, Draft CR to 38.101-2: FR2 Type 1 UE CA EIS update, Qualcomm</p> <p>R4-1808191, TP to TS38.101-2 - UE ON/OFF masks, Ericsson</p> <p>R4-1807102, draft CR introduction completed band combinations 37.865-01-01 -&gt; 38.101-2, Ericsson</p>	
2018-09	RAN#81	RP-181896	0015	F	<p>Big CR for 38.101-2</p> <p>Endorced draft CRs from RAN4#NR-AH-1807</p> <p>R4-1809336, Draft CR on UL RMC for FR2 RF tests, Qualcomm Incorporated</p> <p>R4-1809338, Draft CR on NR UE REFSENS SNR FRC for FR2, Intel Corporation</p> <p>R4-1809397, Draft CR on measurement of receiver characteristics for FR2 RF Tests, Qualcomm Incorporated</p> <p>R4-1809566, Draft CR on OCNG pattern for FR2 REFSENS test, Qualcomm Incorporated</p> <p>Endorced draft CR s from RAN4#88</p> <p>R4-1809817, TP to TS 38.101-2 on ON/OFF time mask, Intel Corporation</p> <p>R4-1809976, Draft CR for TS 38.101-2: Channel raster corrections (5.4.2), Ericsson</p> <p>R4-1810092, Draft CR TS 38.101-2 - UE ON-OFF mask clean up, Ericsson</p> <p>R4-1810211, Draft CR for TS 38.101-2: MPR inner and outer RB allocations formula correction, MediaTek Inc.</p> <p>R4-1810228, draft CR on UL-MIMO requirement for Power Class 2 in FR2, LG Electronics Inc</p> <p>R4-1810373, Draft CR to 38.101-2: Corrections on symbols and abbreviations in section 3, ZTE Corporation</p> <p>R4-1810805, Draft CR to TS 38.101-2: Spurious emissions, Nokia</p> <p>R4-1810863, Draft CR to 38.101-2: Addition of Transmit Modulation Annex, Rohde &amp; Schwarz</p> <p>R4-1811026, Draft CR to 38.101-2: FR2 UE CA Transmit Signal Quality update, Qualcomm Incorporated</p> <p>R4-1811104, Finalization of SEM requirements in FR2, Qualcomm Incorporated</p> <p>R4-1811140, FR2 ULMIMO Updates and enhancements, Qualcomm Incorporated</p> <p>R4-1811322, Draft CR to 38.101-2: REFSENS of power class 1, Intel Corporation</p> <p>R4-1811456, Draft CR on DL Physical Channel for FR2 RF tests, Qualcomm Inc</p> <p>R4-1811460, Draft CR to 38.101-2: Correct both Table 5.5A.2-1 and Table 5.5A.2-2, Verizon</p> <p>R4-1811489, Draft CR to 38.101-2: FR2 Power Control, Qualcomm Incorporated</p> <p>R4-1811499, Implementation of additional requirement to protect passive EESS in 23.6-24GHz, Qualcomm Incorporated</p> <p>R4-1811515, Draft CR to TS 38.101-2: Clarification on OCNG, Keysight Technologies UK Ltd</p>	15.3.0

					<p>R4-1811517, Draft CR on NR DL FRCs for FR2 UE RF requirements, Intel Corporation</p> <p>R4-1811519, Draft CR to 38.101-2: On FR2 MPR for single CC PC1 and PC3, Qualcomm</p> <p>R4-1811520, Draft CR to 38.101-2: FR2 Max. Input Power, Qualcomm Incorporated</p> <p>R4-1811524, Clarification of UL MIMO for FR2, OPPO</p> <p>R4-1811551, Draft CR to TS 38.101-2 on channel bandwidth and spacing descriptions, Ericsson</p> <p>R4-1811554, Draft CR to 38.101-2: Corrections on description of channel raster entries, ZTE Corporation</p> <p>R4-1811802, Draft CR to TS 38.101-2 update the P<sub>max</sub> tolerance table for configured transmitted power, Intel Corporation</p> <p>R4-1811807, Draft CR to 38.101-2: FR2 UE Transmit Signal Quality update, Qualcomm Incorporated</p> <p>R4-1811813, Correction on UE transmitter requirement for FR2, CATT</p> <p>R4-1811817, Updated ON/OFF mask for FR2, vivo</p> <p>R4-1811800, DRAFT CR for P<sub>max</sub> FR2 correction, Qualcomm Incorporated</p>	
2018-12	RAN#82	RP-182899	0016	2	<p>F</p> <p>Endorsed draft CR s from RAN4#88Bis:</p> <p>R4-1812122, Draft CR for FR2 ACLR Measurement BW, Qualcomm</p> <p>R4-1812134, CR on Out of Band Blocking for FR2, Intel Corporation</p> <p>R4-1812426, draft CR of MPR for Power Class 2 in FR2, LG Electronics</p> <p>R4-1812428, draft CR of transmit signal quality for Power Class 2 in FR2, LG Electronics</p> <p>R4-1812453, Draft CR to TS 38.101-2 Adjust placement of 0dB MPR reference waveform, Intel Corporation</p> <p>R4-1812495, Draft CR to 38.101-2: Corrections on channel raster &amp; SS raster, ZTE Corporation</p> <p>R4-1813470, draftCR on applicability of TDD configuratiin for CA in TS 38.101-2, Huawei</p> <p>R4-1813472, draftCR on CA spectrum Emission for TS 38.101-2, Huawei</p> <p>R4-1813473, draftCR on coherent UL MIMO for TS 38.101-2, Huawei</p> <p>R4-1813527, Correction to FR2 spurious emission requirement, Nokia</p> <p>R4-1813585, Draft CR to Specify UL Power for FR2 REFSSENS Test Cases, Keysight</p> <p>R4-1813815, Draft CR to 38.101-2: Corrections on configurations for intra-band non-contiguous CA, ZTE Corporation</p> <p>R4-1814149, Changes to FR2 UL MIMO, OPPO</p> <p>R4-1814180, Draft CR to TS 38.101-2 on channel arrangement descriptions, LG Electronics Inc.</p> <p>R4-1814181, Draft CR to 38.101-2: Corrections on the descriptions of UE channel bandwidth for CA, ZTE Corporation</p> <p>R4-1814163, draft CR of operating band for Power Class 2 in FR2, LG Electronics</p> <p>R4-1813834, Draft CR to 38.101-2: Update of Annex F, Rohde &amp; Schwarz</p> <p>R4-1814164, draftCR on MPR for TS 38.101-2, Huawei</p> <p>R4-1814165, Draft CR to 38.101-2: FR2 Power Control for CA, Qualcomm Incorporated</p> <p>R4-1814170, Draft CR to 38.101-2: FR2 UL Config for EIS Testing, Qualcomm Incorporated</p> <p>Endorsed draft CR's from RAN4#89</p> <p>R4-1815951, dCR on TS38.101-2 merging draft CRs from RAN4#89, Qualcomm Incorporated</p> <p>R4-1814497, Correction on UL MIMO requirement for PC1 UE, Samsung</p> <p>R4-1814585, Draft CR to TS 38.101-2 UL CA power control in FR2, Intel Corporation</p> <p>R4-1814698, Draft CR to TS38.101-2 updating references, Apple Inc.</p> <p>R4-1815623, Draft CR to 38.101-2: FR2 Max. Input Power UL Configuration, Qualcomm Incorporated</p> <p>R4-1815801, draft CR editorial correction in 38.101-2, Ericsson</p> <p>R4-1815810, draft Rel-15 CR to 38.101-2 to include n260 fallbacks needed, Ericsson</p> <p>R4-1815942, dCR on P-MPR for FR2, Qualcomm Incorporated</p> <p>R4-1815943, dCD Coherent UL MIMO parameters for FR2, Qualcomm Incorporated</p> <p>R4-1816205, Draft CR to TS38.101-2 correcting the P<sub>max</sub> requirement, Apple Inc.</p>	15.4.0



					<p>R4-1816206, draft CR on P<sub>max</sub> for ULCA and limitation on max aggregated ULCA BW, Qualcomm Incorporated</p> <p>R4-1816217, Draft CR to 38.101-2 on UE maximum output power with additional requirements, ZTE Corporation</p> <p>R4-1816218, Draft CR for Introducing missing requirement for power class 4 in FR2 for TS 38.101-2, NTT DOCOMO, INC.</p> <p>R4-1816219, draft CR of MPR for Power Class 2 in FR2, LG Electronics</p> <p>R4-1816220, Draft CR to 38.101-2: On FR2 CA MPR v2, Qualcomm Incorporated</p> <p>R4-1816239, Draft CR to 38.101-2: On FR2 EESS A-MPR for n258, Qualcomm Incorporated</p> <p>R4-1816245, Draft CR to 38.101-2: FR2 EIS DL Signal Polarization Clarification, Qualcomm Incorporated</p> <p>R4-1816257, Draft CR to TS38.101-2 to correct UL CA scope for FR2 in Rel-15, Apple Inc.</p> <p>R4-1816605, TDD configuration for UE Tx test in FR2, Ericsson</p> <p>R4-1816664, Draft CR to 38.101-2 (5.3.4) RB alignment, Huawei</p> <p>R4-1816751, Draft CR for RF exposure compliance in TS38.101-2, LG Electronics France</p> <p>R4-1816626, Draft CR to TS 38.101-2: Introducing multi-band applicability for PC3, Apple Inc.</p> <p>R4-1816634, Draft CR to 38.101-2: FR2 EIS Spherical Coverage Requirement, Qualcomm Incorporated</p> <p>R4-1816639, Verification of beam correspondence, Ericsson, Sony</p> <p>R4-1816633, draft CR on UE type for Power Class 2 in FR2, LG Electronics</p> <p>R4-1816644, Draft CR to TS 38.101-2: Temperature Condition for testing EIRP Spherical Coverage requirement, Apple Inc.</p>	
2019-03	RAN#83	RP-190747	0018	1	<p>F</p> <p>CR to TS 38.101-2: Implementation of endorsed draft CRs from RAN4#90 plus PC3 MPR changes to accommodate FR2 OBW</p> <p>Endorced draft CRs from RAN4#90</p> <p>R4-1900049, Draft CR on UL RMC for FR2 UE RF Tests, Qualcomm Incorporated</p> <p>R4-1900050, Draft CR on DL RMC for FR2 UE RF Tests, Qualcomm Incorporated</p> <p>R4-1900131, draft CR to 38101-2 Correction to EVM equalizer spectrum flatness for Pi2 BPSK, Intel Corporation</p> <p>R4-1900132, draft CR to 38101-2 FR2 transmit modulation quality for CA, Intel Corporation</p> <p>R4-1900254, Draft CR on clarification of maxUplinkDutyCycle in FR2, OPPO</p> <p>R4-1900301, Draft CR: Introduction of Annex on Characteristics of the Interfering Signal, Samsung</p> <p>R4-1900386, CR to 38.101-2 on CA BW Classes fallback groups, Intel Corporation</p> <p>R4-1900443, CR to chance Annex E2.1, Qualcomm Incorporated</p> <p>R4-1900509, Draft CR to TS 38.101-2 on BCS definition for intra-band non-contiguous CA, ZTE Corporation</p> <p>R4-1900531, draft CR on A-MPR for power class 2 in FR2, LG Electronics</p> <p>R4-1900533, draft CR on maximum output power reduction for CA for power class 2 in FR2, LG Electronics</p> <p>R4-1900535, draft CR on A-MPR for CA for power class 2 in FR2, LG Electronics</p> <p>R4-1900542, Draft CR on Measurement period of PRACH time mask, Qualcomm Incorporated</p> <p>R4-1900677, Draft CR to 38.101-2: FR2 ULMIMO max. output power, Qualcomm Incorporated</p> <p>R4-1900674, Draft CR to 38.101-2: UL config for DL NC CA, Qualcomm Incorporated</p> <p>R4-1900678, Draft CR to 38.101-2: EVM Requirement for PRACH, Qualcomm Incorporated</p> <p>R4-1900679, Draft CR to 38.101-2: IBB requirement update, Qualcomm Incorporated</p> <p>R4-1900680, Draft CR to 38.101-2: Complete P<sub>min</sub> requirement for CA, Qualcomm Incorporated</p> <p>R4-1900728, Update to PRACH EVM window length for FR2, Rohde &amp; Schwarz</p> <p>R4-1900736, Draft CR on editorial error of TS38.101-2, LG Electronics Inc.</p> <p>R4-1900755, Draft CR on spurious emission limit in 38.101-2, Qualcomm Incorporated</p> <p>R4-1902005, Draft CR to 38.101-2: Add annex for UE coordinate system, Qualcomm Incorporated</p>	15.5.0

					<p>R4-1902152, Editorial corrections for 38.101-2, Qualcomm Incorporated</p> <p>R4-1902180, Draft CR to 38.101-2: correction of the relationship between minimum requirements and test requirements, Apple Inc.</p> <p>R4-1902345, draft_CR TS 38.101-2 FR1 frequency range extension, Skyworks Solutions Inc.</p> <p>R4-1902474, Draft CR to 38.101-2: correction of multi-band aspects in REFSSENS for PC3, Apple Inc.</p> <p>R4-1902490, draftCR on maximum output power for TS 38.101-2, Huawei</p> <p>R4-1902491, Draft CR for Multi-band relaxation to TS 38.101-2, NTT DOCOMO, INC.</p> <p>R4-1902492, Draft CR on max input power in FR2, OPPO</p> <p>R4-1902590, Draft CR to TS 38.101-2: Introduction of the requirement on beam correspondence, Apple Inc</p> <p>Further changes in RAN#83: Changes in Section 6.2.2.0 to modify the MPR=0dB waveform and Section 6.2.2.3 to modify the MPR tables to accommodate the OBW requirements</p>	
2019-06	RAN#84	RP-191240	0021	F	<p>CR to TS 38.101-2: Implementation of endorsed draft CRs from RAN4#90bis and RAN4#91</p> <p>Endorsed draft CRs from RAN4#90Bis:</p> <p>R4-1902932: Draft CR to TS 38.101-2 Correction to P<sub>cm</sub>, Intel Corporation</p> <p>R4-1902976 Draft CR on PRACH and PUCCH format description for EVM in FR2Anritsu corporation</p> <p>R4-1903121 Draft CR on DL power allocation for TS 38.101-2 Intel Corporation</p> <p>R4-1903242 Adding BCS definition in TS38.101-2 CATT</p> <p>R4-1903474 draft CR of in-band emission for FR2 PC2 LG Electronics</p> <p>R4-1903888 Draft CR: Alignment of FR2 DL scheduling of DL RMC with UL RMCEricsson</p> <p>R4-1904001 Draft CR for TS 38.101-2 – UE coordinate system Rohde &amp; Schwarz</p> <p>R4-1904411 draft Rel-15 CR for editorial corrections in 38.101-2 Ericsson</p> <p>R4-1904553 Draft CR to 38.101-2: FR2 power dynamics DTX removal Qualcomm Incorporated</p> <p>R4-1904930 Draft CR to 38.101-2: Updating MPR wording in ULMIMO section Qualcomm Incorporated</p> <p>R4-1904931 Draft CR to clarify frequency of carrier leakage in RBs for FR2 Anritsu corporation</p> <p>R4-1904932 Draft CR on editorial error of TS38.101-2 LG Electronics France</p> <p>R4-1904933 Draft CR on UE optional bandwidth for FR2 Huawei, HiSilicon</p> <p>R4-1904956 Draft CR for TS 38.101-2: Corrections to configurations for intra-band non-contiguous CA MediaTek Inc.</p> <p>R4-1904961 Draft CR for TR38.101-2 – Update to EVM averaging Rohde &amp; Schwarz</p> <p>R4-1904962 Draft CR to 38.101-2: FR2 ULMIMO EVM Qualcomm Incorporated</p> <p>R4-1904966 Draft CR to TS 38.101-2 CA maximum input level Intel Corporation</p> <p>R4-1904986 Draft CR for TS 38.101-2: Corrections to EVM equalizer spectrum flatness requirements MediaTek Inc.</p> <p>R4-1904994 draft CR to 38.101-2 Correction to ACS and In-band Blocking notes Intel Corporation</p> <p>R4-1905003 Draft CR to 38.101-2: FR2 PC3 and PC1 MPR Qualcomm Incorporated</p> <p>R4-1905005 Draft CR for 38.101-2 frequency separation class Huawei, HiSilicon</p> <p>Endorsed draft CRs from RAN4#91:</p> <p>R4-1905504 Change description 4.2(d) in Applicability of minimum requirements for TS 38.101-2 vivo</p> <p>R4-1905685 Draft CR to 38.101-2: FR2 Sensitivity Qualcomm Incorporated</p> <p>R4-1905764 draft CR to 38.101-2 UE maximum output power reduction for UL-MIMO Intel Corporation</p> <p>R4-1905765 draft CR to 38.101-2 UE maximum output power for UL-MIMO Intel Corporation</p>	15.6.0

						<p>R4-1905796 Correction to a description of PRB for in-band emission in FR2 Anritsu Corporation</p> <p>R4-1905798 Correction to power control in FR2 Anritsu Corporation</p> <p>R4-1905821 draft CR of loosening EIS for FR2 PC2 LG Electronics Inc.</p> <p>R4-1907003 Draft CR for editorial corrections in TS 38.101-2 Google Inc.</p> <p>R4-1907420 draft CR of simple application for FR2 PC2 and 4 requirements with PC3 same requirements LG Electronics Inc.</p> <p>R4-1907423 Draft CR for TS 38.101-2 Correction of channel bandwidth set for NR CA Huawei, HiSilicon, CMCC</p> <p>R4-1907437 Draft CR to 38.101-2: Insert definitions Qualcomm Incorporated</p> <p>R4-1907443 Draft CR to TS38.101-2 Complete FR2 MPR/A-MPR Intel Corporation</p> <p>R4-1907444 Amendment of the relative power tolerance requirement Ericsson, Qualcomm Incorporated</p> <p>R4-1907446 Draft CR to 38.101-2: FR2 CA REFESNS Qualcomm Incorporated</p> <p>R4-1907447 Draft CR to 38.101-2 on UL RMC slot patterns Apple Inc.</p> <p>R4-1907466 Draft CR to 38.101-2: FR2 CA MPR enhancement Qualcomm Incorporated</p> <p>R4-1907468 Draft CR to 38.101-2: FR2 MPR Wording CleanUp Qualcomm Incorporated</p> <p>R4-1907473 Draft CR to TS38.101-2 on FR2 PC3 UE maxUplinkDutyCycle Nokia, Nokia Shanghai Bell</p> <p>R4-1907478 Draft CR to TS 38.101-2 on configurations for intra-band contiguous CA ZTE Corporation</p> <p>R4-1907493 Correction to P<sub>max</sub> and P<sub>max</sub> for CA Ericsson</p> <p>R4-1907611 Draft CR to TS38.101-2 on beam correspondence Samsung, Apple, Verizon</p> <p>R4-1907688 Correction to CA carrier spacing Ericsson</p>	
2019-06	RAN#84	RP-191241	0020		B	CR to REL-16 TS 38.101-2: Implementation of endorsed draft CRs on NR combinations and dual Connectivity combinations	16.0.0
2019-06	RAN#84	RP-191241	0022	1	B	CR introduction completed band combinations 38.716-01-01 -> 38.101-2	16.0.0
2019-09	RAN#85	RP-192049	0028		A	<p>CR to TS 38.101-2: Implementation of endorsed draft CRs from RAN4#92 (Rel-16)</p> <p>- Mirrors changes in R4-1910352 for Rel-15 TS 38.101-2</p> <p>Endorsed draft CRs from RAN4#92</p> <p>R4-1907999 Draft CR for NR non-contiguous CA configuration Verizon, Nokia, Ericsson, Qualcomm</p> <p>R4-1908082 draft CR to TS 38.101-2 on channel spacing for CA Samsung, ZTE</p> <p>R4-1908137 Update to FR2 EVM definition ROHDE &amp; SCHWARZ</p> <p>R4-1908153 dCR to 38.101-2: Editorial corrections for 38.101-2 Qualcomm Incorporated</p> <p>R4-1908573 Draft CR to TS 38.101-2: corrections on Rx requirements for intra-band CA ZTE Corporation</p> <p>R4-1908633 Draft CR to TS38.101-2: Corrections on EVM window length (Section F.5) ZTE Corporation</p> <p>R4-1908708 Draft CR to TS38.101-2: corrections on the receiver spurious emission (section 7.9) ZTE Corporation</p> <p>R4-1909117 Draft CR for 38.101-2 applicability for intra-band CA Huawei</p> <p>R4-1909316 Draft CR to TS 38.101-2 on symbols correction ZTE Corporation</p> <p>R4-1910235 Draft CR to TS38.101-2 for Rx RF requirements LG Electronics Finland</p> <p>R4-1910238 CR for Handling of fallbacks for combined contiguous and non-contiguous CA in FR2 Apple</p> <p>R4-1910241 Draft CR to TS 38.101-2 on NR CA configurations for FR2 ZTE Corporation</p> <p>R4-1910259 dCR to 38.101-2: Reference signal clarifications Qualcomm Incorporated</p> <p>R4-1910261 dCR to 38.101-2: FR2 AMPR updates, including ERC 74-01 changes Qualcomm Incorporated</p> <p>R4-1910287 dCR to 38.101-2: FR2 CA MPR refinement Qualcomm Incorporated</p>	16.1.0

						R4-1910328 Draft CR to TS 38.101-2: Corrections for UL and DL RMC for FR2 tests Intel Corporation R4-1910333 Draft CR for 38.101-2 reference measurement channel for beam correspondence Huawei R4-1910334 Draft CR for TS38.101-2, Editorial corrections CATT R4-1910412 Draft CR for 38.101-2 correction for channel raster Huawei R4-1910614 Draft CR for TS 38.101-2: Channel spacing for adjacent NR carriers ZTE Conditional agreements for BC for PC1/2/4 from R4-1902252	
2019-09	RAN#85	RP-192027	0025	1	F	Minor corrections of intra-band non-contiguous CA operating bands in TS 38.101-2	16.1.0
2019-09	RAN#85	RP-192027	0026		D	Rel-16 CR for further simplification of 38.101-2 Table 5.5A.2-2	16.1.0
2019-12	RAN#86	RP-193030	0032		A	CR to 38.101-2: DMRS exceptions	16.2.0
2019-12	RAN#86	RP-193030	0036		A	Sync raster to SSB resource element mapping	16.2.0
2019-12	RAN#86	RP-193030	0039		A	CR to 38.101-2 (Rel-16) to clarify measurement interval and observation window on frequency error	16.2.0
2019-12	RAN#86	RP-193031	0041		A	CR to TS 38.101-2 on beam correspondence side condition applicability	16.2.0
2019-12	RAN#86	RP-193031	0044		A	CR to TS 38.101-2: Correctin on FInterferer (offset) for CA ACS	16.2.0
2019-12	RAN#86	RP-193030	0048		A	CR for TS 38.101-2: Editorial correction on MPR for contiguous CA notation	16.2.0
2019-12	RAN#86	RP-193031	0050		A	CR for TS 38.101-2: CA bandwidth class definition amendment	16.2.0
2019-12	RAN#86	RP-193030	0052		A	CR to TS 38.101-2 on corrections to channel raster entries for NR band (Rel-16)	16.2.0
2019-12	RAN#86	RP-193030	0056		A	CR to transmit modulation quality in FR2	16.2.0
2019-12	RAN#86	RP-193030	0058		A	Frequency separation class clarification REL-16	16.2.0
2019-12	RAN#86	RP-193012	0064		B	CR introduction completed band combinations 38.716-01-01 -> 38.101-2	16.2.0
2019-12	RAN#86	RP-193011	0065	1	F	CR to 38.101-2-g10 Corrections to maximum output power reduction for power class 3	16.2.0
2019-12	RAN#86	RP-193030	0067		A	CR for TS 38.101-2: power classes and maxUplinkDutyCycle-FR2	16.2.0
2019-12	RAN#86	RP-193031	0074		A	CR for agreed MPR CA for FR2 intra-band contiguous	16.2.0
2019-12	RAN#86	RP-193031	0075	1	A	CR for 38.101-2 on NS_202 band defintion	16.2.0
2019-12	RAN#86	RP-193031	0077		A	CR to TS 38.101-2: Correctin on CA NRACLR	16.2.0
2020-03	RAN#87	RP-200395	0080		A	Correction of the FR2 RMC slot patterns for MOP test cases	16.3.0
2020-03	RAN#87	RP-200395	0099		A	CR to 38.101-2 (Rel-16) MPR for CA	16.3.0
2020-03	RAN#87	RP-200395	0106		F	CR FR2 CA tables REL16	16.3.0
2020-03	RAN#87	RP-200395	0108		A	CR to TS 38.101-2 on corrections to intra-band contiguous CA for FR2 bands (Rel-16)	16.3.0
2020-03	RAN#87	RP-200395	0110		A	CR to 38.101-2: Align Rx CA requirements structure with TS38.101-1	16.3.0
2020-03	RAN#87	RP-200395	0114		A	CR for TS 38.101-2: Editorial addition of CBW and CABW definitions in Abbreviations section	16.3.0
2020-03	RAN#87	RP-200395	0118		A	CR to TS 38.101-2: Correction on FRC table for FR2 DL 64QAM	16.3.0
2020-03	RAN#87	RP-200469	0126	2	A	CR for 38.101-2 side condition for BC_Rel16	16.3.0
2020-03	RAN#87	RP-200380	0132		F	Editorial corrections	16.3.0
2020-03	RAN#87	RP-200378	0133		F	Correction of Inner Allocation Definition for Powerclass 3	16.3.0
2020-03	RAN#87	RP-200395	0136		A	R16 CR to 38.101-2: TRS and SSB configurations in FR2	16.3.0
2020-04			0147		A	Change history corrected	16.3.1
2020-06	RAN#88	RP-200985	0148		F	CR on ACLR MBW definition in FR2	16.4.0
2020-06	RAN#88	RP-201046	0151		A	CR to 38.101-2: Revision to Multiband Relaxations	16.4.0
2020-06	RAN#88	RP-200985	0164		A	CR to 38.101-2 on correction of reference point for beam correspondence side conditions R16	16.4.0
2020-06	RAN#88	RP-200985	0168		A	CR to 38.101-2 to correct Link and Meas Angles	16.4.0
2020-06	RAN#88	RP-200985	0170		A	CR to 38.101-2: NS_202 update after changes to EU regulations	16.4.0
2020-06	RAN#88	RP-200985	0172		A	CR for TS 38.101-2: Intra-band non-contiguous CA configuration clarifications	16.4.0
2020-06	RAN#88	RP-200985	0174		A	CR for TS 38.101-2: Correction for configured transmitted power for CA	16.4.0
2020-06	RAN#88	RP-200985	0175		F	CR for TS 38.101-2: Clarifications on transmitter power for receiver requirements	16.4.0
2020-06	RAN#88	RP-200959	0181		A	CR for TS 38.101-2: Intra-band non-contiguous CA configuration clarifications	16.4.0
2020-06	RAN#88	RP-200985	0183		A	Update of CSI-RS definition for FR2 DL RMCs	16.4.0
2020-06	RAN#88	RP-200985	0184		F	Correction to FR2 QPSK UL RMC	16.4.0
2020-06	RAN#88	RP-200985	0188		B	Correction of Rel-16 UL RMCs	16.4.0
2020-06	RAN#88	RP-200972	0193		F	CR to TS 38.101-2: Introduction of FR2 DL 256QAM	16.4.0
2020-06	RAN#88	RP-200985	0198		A	ACS requirement correction	16.4.0
2020-06	RAN#88	RP-200985	0200		A	CR for intra-band CA DL Rx requirement-FR2_Rel-16	16.4.0
2020-06	RAN#88	RP-200985	0208		A	CR for modified MPR_Rel-16	16.4.0
2020-06	RAN#88	RP-200985	0162	1	B	CR to TS38.101-2 on Rel-15 beam correspondence	16.4.0

2020-06	RAN#88	RP-200959	0209		A	CR to 38.101-2: Introduce mmWave intra-band uplink CA configurations	16.4.0
2020-06	RAN#88	RP-200985	0161	1	B	CR to K1 value in Annex A.3.3 of 38.101-2	16.4.0
2020-06	RAN#88	RP-201046	0211		A	CR to 38.101-2 on FR2 frequency separation class enhancement	16.4.0
2020-06	RAN#88	RP-200985	0191	2	B	CR on P <sub>cm</sub> ax correction for CA	16.4.0
2020-06	RAN#88	RP-200978	0155	1	B	CR to 38.101-2 for Introduction of band n259	16.4.0
2020-06	RAN#88	RP-201046	0147		A	FR2 new MPR and modifiedmpr	16.4.0
2020-09	RAN#89	RP-201496	0216	1	B	Introduction of MPE related P-MPR operation in sub-clause 6.2.4	16.5.0
2020-09	RAN#89	RP-201512	0218		A	CR on Minimum output power and Off power MBW definition in FR2	16.5.0
2020-09	RAN#89	RP-201496	0221	1	B	CR to 38.101-2 (Rel-16) intra-band non-cont. DL CA	16.5.0
2020-09	RAN#89	RP-201512	0224		A	CR for R16 38.101-2: Correction of in-band emission tables	16.5.0
2020-09	RAN#89	RP-201512	0226	1	F	Correction for REL16 FR2 contiguous intra-band CA configuration table	16.5.0
2020-09	RAN#89	RP-201512	0230	1	F	modifiedMPR correction for FR2 REL16	16.5.0
2020-09	RAN#89	RP-201496	0231	2	B	Beam correspondence enhancement	16.5.0
2020-09	RAN#89	RP-201512	0234		A	CR to TS 38.101-2 on corrections to operating bands for intra-band CA (Rel-16)	16.5.0
2020-09	RAN#89	RP-201506	0235		F	Correction of ACS requiremet for n259	16.5.0
2020-09	RAN#89	RP-201496	0237	2	F	Introduction of FR2 inter-band DL CA	16.5.0
2020-09	RAN#89	RP-201512	0239		A	CR for introduction of EESS protection for n257 into general spurious emission	16.5.0
2020-09	RAN#89	RP-201512	0241		A	CR to TS 38.101-2: Correction on the Aggregated Channel Bandwidth	16.5.0
2020-09	RAN#89	RP-201512	0243		A	CR to TS 38.101-2: Correction on the PC3 MPR description	16.5.0
2020-09	RAN#89	RP-201512	0246		A	FR2 Minimum output power measurement period definition	16.5.0
2020-09	RAN#89	RP-201488	0249	2	F	CR to TS38.101-2 on ULFP <sub>tx</sub> and UE SRS port configuration clarification	16.5.0
2020-09	RAN#89	RP-201496	0250	1	F	CR to 38.101-2: DL CA BW Enhancement and CA REFSSENS	16.5.0
2020-09	RAN#89	RP-201496	0251	1	B	CR to 38.101-2: FR2 UE EIRP increase with IBE relaxation	16.5.0
2020-09	RAN#89	RP-201496	0252	1	B	FR2 intra-band non-contiguous UL CA feature	16.5.0
2020-09	RAN#89	RP-201507	0259		F	Correction of corrupted table	16.5.0
2020-12	RAN#90	RP-202485	0263		A	EESS protection related requirements for FR2 bands	16.6.0
2020-12	RAN#90	RP-202485	0267		A	CR to 38.101-2: ULCA clarifications	16.6.0
2020-12	RAN#90	RP-202485	0269		A	CR for TS38.101-2 Rel-16, Correction for definition of P-MPR	16.6.0
2020-12	RAN#90	RP-202443	0270	1	F	REL16 eBC capability alingment with 38.306	16.6.0
2020-12	RAN#90	RP-202443	0271	1	F	CR to 38.101-2 (Rel-16) inter-band DL CA	16.6.0
2020-12	RAN#90	RP-202443	0272	1	F	Clarification of EIS spherical coverage for inter-band CA	16.6.0
2020-12	RAN#90	RP-202485	0274		A	Transmission gap for relative power tolerance in FR2	16.6.0
2020-12	RAN#90	RP-202485	0276		A	CR to TS38.101-2 on DC location correction	16.6.0
2020-12	RAN#90	RP-202485	0280		A	CR for TS 38.101-2: Clarification for NS_202	16.6.0
2020-12	RAN#90	RP-202509	0282	1	F	CR to TS 38.101-2 on fallback group for intra-band contiguous CA (Rel-16)	16.6.0
2020-12	RAN#90	RP-202509	0283	1	F	CR to TS 38.101-2 on simplification for inter-band CA configuration	16.6.0
2020-12	RAN#90	RP-202485	0289		A	Correction to P <sub>cm</sub> ax: total radiated power	16.6.0
2020-12	RAN#90	RP-202485	0293		A	Correction to EIS definition	16.6.0
2020-12	RAN#90	RP-202428	0297	1	F	CR for editorial corrections 38.101-2	16.6.0
2020-12	RAN#90	RP-202485	0299		A	Mirror CR for 38.101-2: IBB and ACS corrections	16.6.0
2020-12	RAN#90	RP-202485	0310		A	CR to DMRS position in UL RMC for FR2	16.6.0
2020-12	RAN#90	RP-202466	0287		B	CR introduction completed band combinations Rel-17 NR Intra-band -	17.0.0
2021-03	RAN#91	RP-210117	0315		A	Removal of a remaining NS_201 related requirement	17.1.0
2021-03	RAN#91	RP-210117	0319		A	CR to TS 38.101-2 on correction to intra-band non-contiguous CA configurations (Rel-17)	17.1.0
2021-03	RAN#91	RP-210083	0324		A	P <sub>cm</sub> ax P <sub>IBE</sub> wording refinement and termonology improvemnt	17.1.0
2021-03	RAN#91	RP-210117	0334		A	CR to 38.101-2: correction on UL MIMO	17.1.0
2021-03	RAN#91	RP-210117	0337		A	CR to 38.101-2 on beam correspondence	17.1.0
2021-03	RAN#91	RP-210117	0346		A	CR on FR2 intra-band UL CA	17.1.0
2021-03	RAN#91	RP-210737	0347		B	CR for FR2 FWA RF requirements	17.1.0
2021-06	RAN#92	RP-211083	0353		A	P <sub>cm</sub> ax fix for the CA applicability	17.2.0
2021-06	RAN#92	RP-211084	0359		A	Update of FR2 UL RMC tables	17.2.0
2021-06	RAN#92	RP-211104	0364		A	Removal of CA_n260(*) notation and IE fix R17 CATA	17.2.0
2021-06	RAN#92	RP-211117	0366		A	Correction of the channel raster of n259 for TS 38.101-2	17.2.0
2021-06	RAN#92	RP-211079	0370		F	CR to TS 38.101-2 on UE channel bandwidth per operating band	17.2.0
2021-06	RAN#92	RP-211120	0371		B	Introduction of FR2 DL CA_n257+n259 and CA_n258-n260	17.2.0
2021-06	RAN#92	RP-211121	0372	1	B	Introduction of n262 UE RF requirements	17.2.0
2021-06	RAN#92	RP-211117	0378		A	CR to 38.101-2 on side conditions for beam correspondence based on SSB and CSI-RS for n259 (Rel-17)	17.2.0
2021-06	RAN#92	RP-211080	0385	1	F	CR Rel-17 38.101-2 to correct some errors in Table 5.5A.2-2	17.2.0
2021-06	RAN#92	RP-211107	0387		A	CR to TS38.101-2: Some Corrections on for CA_n260-n261	17.2.0
2021-06	RAN#92	RP-211115	0388		B	CR to reflect the completed NR inter band CA DC combinations for 2 bands DL with up to 2 bands UL into TS 38.101-2	17.2.0
2021-06	RAN#92	RP-211115	0389		B	CR 38.101-2 new combinations Rel-17 NR Intra-band	17.2.0

2021-06	RAN#92	RP-211114	0391		F	Rel-17 CR 38101-2-h10 corrections intra-band CA	17.2.0
2021-06	RAN#92	RP-211102	0396	1	A	CR on FR2 inter-band DL CA CBM and IBM_R17 CatA	17.2.0
2021-06	RAN#92	RP-211091	0405		A	CR to 38.101-2: CABW definition addition	17.2.0
2021-06	RAN#92	RP-211091	0408		A	CR for 38.101-2-h10: Removing ambiguity on MPR <sub>narrow</sub> for PC3 MPR	17.2.0
2021-06	RAN#92	RP-211120	0409		B	CR for TS 38.101-2: Introduction of FR2 new CA BW classes	17.2.0
2021-09	RAN#93	RP-211921	0410		A	CR to 38.101-2 on handling of fallbacks for FR2 CA	17.3.0
2021-09	RAN#93	RP-211900	0414		F	CR to TS 38.101-2 on corrections to intra-band non-contiguous CA	17.3.0
2021-09	RAN#93	RP-211900	0418		B	CR 38.101-2 new combinations Rel-17 NR Intra-band	17.3.0
2021-09	RAN#93	RP-211912	0419		F	Corrections of n262 UE RF requirements	17.3.0
2021-09	RAN#93	RP-211923	0423		A	Big CR for TS 38.101-2 Maintenance part1 (Rel-17)	17.3.0
2021-09	RAN#93	RP-211900	0424		F	Rel-17 CR 38.101-2, band combination corrections	17.3.0
2021-09	RAN#93	RP-211902	0425		B	CR to 38.101-2: PC5 requirements in n259	17.3.0
2021-12	RAN#94	RP-212830	0427		B	Big CR to reflect the completed NR inter band CA DC combinations for 2 bands DL with up to 2 bands UL into TS 38.101-2	17.4.0
2021-12	RAN#94	RP-212830	0433		F	CR to TS 38.101-2 on configurations for inter-band CA	17.4.0
2021-12	RAN#94	RP-212845	0436		F	Big CR for TS 38.101-2 Maintenance (Rel-17)	17.4.0
2022-03	RAN#95	RP-220373	0441	1	B	CR to introduce UE RF requirement for FR2 PC 6 UE	17.5.0
2022-03	RAN#95	RP-220360	0442		B	CR on UE RF requirements for DMRS bundling in TS 38.101-2	17.5.0
2022-03	RAN#95	RP-220337	0445		A	Big CR for TS 38.101-2 Maintenance (Rel-17)	17.5.0
2022-03	RAN#95	RP-220359	0446		F	Big CR to reflect the completed NR inter band CA DC combinations for 2 bands DL with up to 2 bands UL into TS 38.101-2	17.5.0
2022-03	RAN#95	RP-220360	0447		B	CR on measurement for DMRS bundling in TS 38.101-2	17.5.0
2022-03	RAN#95	RP-220360	0448		B	CR on measurement for DMRS bundling in TS 38.101-2 Note: The CR seems to be the same as CR as 0447	17.5.0
2022-03	RAN#95	RP-220371	0449		B	Big CR on RedCap UE FR2	17.5.0
2022-06	RAN#96	RP-221661	0450	1	B	CR to 38.101-2 FR2+FR2 ULCA Feature	17.6.0
2022-06	RAN#96	RP-221661	0451	1	B	CR to 38.101-2: FR2+FR2 IBM DLCA for PC1/2/5	17.6.0
2022-06	RAN#96	RP-221654	0452	1	F	CR 38101-2-h50 adding fallbacks	17.6.0
2022-06	RAN#96	RP-221661	0455		A	CR for 38.101-2-h50: Correction for PC3 MPR <sub>narrow</sub>	17.6.0
2022-06	RAN#96	RP-221686	0457		B	Big CR to reflect the completed NR inter band CA DC combinations for 2 bands DL with up to 2 bands UL into TS 38.101-2	17.6.0
2022-06	RAN#96	RP-221695	0458	1	B	Big CR to 38.101-2: update of simultaneous RxTx capability for band combinations	17.6.0
2022-06	RAN#96	RP-221661	0459	1	B	Addition of downlink CA_n258-n261 configuration	17.6.0
2022-06	RAN#96	RP-221676	0460	1	F	CR for 38.101-2 to correct the errors and add the missing requirements for FR2 RedCap UE	17.6.0
2022-06	RAN#96	RP-221677	0461		F	CR on DMRS bundling phase offset Requirement FR2	17.6.0
2022-06	RAN#96	RP-221677	0462	1	F	CR on DMRS bundling phase offset measurement FR2	17.6.0
2022-06	RAN#96	RP-221655	0468		A	Big CR for TS 38.101-2 Maintenance (Rel-17)	17.6.0
2022-06	RAN#96	RP-221661	0469		F	Big CR on NR FR2 enhancement Rel-17	17.6.0
2022-06	RAN#96	RP-221676	0470		B	Big CR on extending NR to 71GHz for TS 38.101-2	17.6.0
2022-06	RAN#96	RP-221676	0471		F	CR on RedCap FR2	17.6.0
2022-09	RAN#97	RP-222032	0473		F	CR: Maintenance of phase continuity requirements for DMRS bundling in FR2	17.7.0
2022-09	RAN#97	RP-222036	0481		F	CR on PC2 UE RF requirements for FR2-1 inter-band UL CA	17.7.0
2022-09	RAN#97	RP-222036	0482		F	CR on PC2 UE RF requirements for FR2-1 inter-band DL CA	17.7.0
2022-09	RAN#97	RP-222028	0484		F	CR 38.101-2: Rel-17 Adding missing fallback combinations	17.7.0
2022-09	RAN#97	RP-222036	0486	1	F	Amendment of the requirement on TX power management	17.7.0
2022-09	RAN#97	RP-222023	0489		A	CR to 38.101-2 Corrections to tables with wrong unit declarations	17.7.0
2022-09	RAN#97	RP-222036	0493		F	Correction CR on UL Gap	17.7.0
2022-09	RAN#97	RP-222026	0496		F	Big CR for 38.101-2 maintenance (Rel-17)	17.7.0
2022-09	RAN#97	RP-222036	0497		F	R17 FR2 CR on separate REFSSENS tables for different power classes	17.7.0
2022-09	RAN#97	RP-222557	0498	1	B	Big CR of TS38.101-2 for FR2-2 UE requirements	17.7.0
2022-12	RAN#98-e	RP-223307	0500	1	F	definition on RedCap	17.8.0
2022-12	RAN#98-e	RP-223306	0502	2	F	CR to 38.101-2 to clarify P-MPR behavior when DMRS bundling is configured	17.8.0
2022-12	RAN#98-e	RP-223308	0505	2	F	CR to TS38.101-2 PC3 TIB values for FR2 inter-band UL CA	17.8.0
2022-12	RAN#98-e	RP-223296	0506	1	F	CR R17 ModifiedMPR	17.8.0
2022-12	RAN#98-e	RP-223290	0510		A	Annex G Clarifications on diagram related to measurement point for difference of relative phase/power error for UL coherent MIMO (Rel-17)	17.8.0
2022-12	RAN#98-e	RP-223308	0516		F	CR on ACS/IBB of FR2 inter-band CA	17.8.0
2022-12	RAN#98-e	RP-223290	0521		A	CR for Rel-17 38.101-2 to correct the side condition for CSI-RS based	17.8.0
2022-12	RAN#98-e	RP-223296	0524		A	CR to 38.101-2 on removing ambiguity in CA MPR definition	17.8.0
2022-12	RAN#98-e	RP-223308	0525	3	F	R17 CR on introduction of FR2 CA DC location reporting	17.8.0
2022-12	RAN#98-e	RP-223291	0528		F	Correction to DL RMC (Rel-17)	17.8.0
2022-12	RAN#98-e	RP-223309	0529	2	F	Adding DL RMC for band n263	17.8.0
2023-03	RAN#99	RP-230519	0531		F	CR on updating the name of UE capability for UL gap	17.9.0

2023-03	RAN#99	RP-230514	0534		F	CR to 38.101-2: FR2-2 power class content	17.9.0
2023-03	RAN#99	RP-230501	0538		A	Addition of FR2 UL MIMO EVM measurement description	17.9.0
2023-03	RAN#99	RP-230502	0552		A	CR to F_offset and F_interferer (offset) adjustment in ACS and IBB	17.9.0
2023-03	RAN#99	RP-230502	0556		A	CR on 'Annex G Difference of relative phase and power errors' for FR2 UL coherent MIMO	17.9.0
2023-03	RAN#99	RP-230502	0564		A	On handheld UE and FWA UE definitions	17.9.0
2023-03	RAN#99	RP-230514	0566		F	Apply NOTE1 for n263 intra-band CA	17.9.0
2023-03	RAN#99	RP-230503	0581		A	CR for Rel-17 38.101-2 to correct the UL configuration for CA_n258C	17.9.0
2023-03	RAN#99	RP-230503	0590		A	CR to TS 38.101-2 on humidity condition for normal temperature	17.9.0
2023-06	RAN#100	RP-231347	0597		F	Maintenance CR to RF requirements for n263 (Rel-17)	17.10.0
2023-06	RAN#100	RP-231355	0602		A	CR for TS 38.101-2 on corrections to the minimum guardband calculation (R17_CAT_A)	17.10.0
2023-06	RAN#100	RP-231356	0612		A	Update of FR2 UL MIMO EVM measurement description	17.10.0
2023-06	RAN#100	RP-231343	0616		F	CR to clarify DC location wording	17.10.0
2023-09	RAN#101	RP-232505	0622		F	CR to TS 38.101-2 on correction of maximum input level (Rel-17)	17.11.0
2023-09	RAN#101	RP-232490	0628		F	[NR_ext_to_71GHz-Core] CR to TS38.101-2: Adding FR2-2 MPR table numbers to parameters definition	17.11.0
2023-09	RAN#101	RP-232490	0642		D	[NR_ext_to_71GHz-Core] Editorial modification CR for TS 38.101-2	17.11.0
2023-09	RAN#101	RP-232501	0645		A	[NR_newRAT-Core] Correction of AMPR requirement for CA	17.11.0
2023-09	RAN#101	RP-232488	0647	1	F	[NR_cov_enh-Core] Update of FR2 DMRS bundling measurements	17.11.0
2023-09	RAN#101	RP-232501	0652		A	[NR_newRAT-Core] CR on editorial correction for UE orientation illustrations	17.11.0
2023-09	RAN#101	RP-232487	0657		A	CR for clarification on maxUplinkDutyCycle-FR2	17.11.0
2023-12	RAN#102	RP-233331	0662		A	Fc terminology update	17.12.0
2023-12	RAN#102	RP-233331	0669		A	CR for Rel-17 38.101-2 to correct some errors in the clause of the spectrum emission mask for CA.	17.12.0
2023-12	RAN#102	RP-233331	0673		A	CR for Rel-17 38.101-2 to introduce the missed sub-clause 6.5A.2.2 as void	17.12.0
2023-12	RAN#102	RP-233332	0677		A	CR to 38.101-2 on adding missing definition of EIS spherical coverage link angle(Rel-17)	17.12.0
2023-12	RAN#102	RP-233351	0682	1	F	[NR_RF_FR2_req_enh] Removal of interlaced channel bandwidths for CA BW class fallback groups 1-4	17.12.0
2024-03	RAN#103	RP-240562	0694		A	(NR_newRAT-Core) CR on receiver sensitivity reference antenna - R17	17.13.0
2024-03	RAN#103	RP-240562	0698		A	(NR_newRAT-Core) Correction to CA A-MPR requirements	17.13.0
2024-03	RAN#103	RP-240573	0700	1	F	CR to TS 38.101-2 Correction on beam correspondence for RedCap Rel-17	17.13.0
2024-03	RAN#103	RP-240563	0704		A	(NR_newRAT-Core) FR2 ACS interferer specification fix	17.13.0
2024-03	RAN#103	RP-240564	0724		A	(NR_newRAT-Core) Clarification on requirements for initial access and RRC_Inactive	17.13.0
2024-03	RAN#103	RP-240565	0728		A	(NR_newRAT-Core) CR for Rel-17 TS 38.101-2 on correction of MPR requirement for CA	17.13.0
2024-03	RAN#103	RP-240559	0730	1	F	Clarification of highSpeedMeasFlag-r17 in PC6 spherical coverage requirement	17.13.0
2024-06	RAN#104	RP-241400	0739	1	F	CR for TS 38.101-2 Rel-17 clarification on Redcap Applicability in FR2 power classes	17.14.0
2024-06	RAN#104	RP-241394	0744		F	(NR_CA_R17_intra-Core) CR for 38.101-2 to correct UL configurations for intra-band non-contiguous CA NOTE: This CR is implemented using the format as defined in the current specification.	17.14.0
2024-06	RAN#104	RP-241383	0749	1	A	(NR_newRAT-Core) CR for TS 38.101-2 Correction on the modifiedMPR table	17.14.0
2024-09	RAN#105	RP-242164	0753		F	CR to TS 38.101-2: Correction on Measurement BW for FR2 PC5, 6	17.15.0
2024-09	RAN#105	RP-242184	0756	1	F	(NR_redcap-Core) CR for TS 38.101-2 to modify the applicable maximum BW for PC7 RedCap UE (R17)	17.15.0
2024-12	RAN#106	RP-243043	0761		F	(NR_FR2_FWA_Bn257_Bn258-Core) Rel-17 Reference correction in PC5 UL-MIMO MPR and A-MPR requirements	17.16.0

---

# History

<b>Document history</b>		
V17.5.0	April 2022	Publication
V17.6.0	August 2022	Publication
V17.7.0	October 2022	Publication
V17.8.0	January 2023	Publication
V17.9.0	April 2023	Publication
V17.10.0	July 2023	Publication
V17.11.0	October 2023	Publication
V17.12.0	January 2024	Publication
V17.13.0	May 2024	Publication
V17.14.0	August 2024	Publication
V17.15.0	October 2024	Publication
V17.16.0	January 2025	Publication