

ETSI TS 138 101-3 V15.11.0 (2020-11)



**5G;
NR;
User Equipment (UE) radio transmission and reception;
Part 3: Range 1 and Range 2 Interworking operation
with other radios
(3GPP TS 38.101-3 version 15.11.0 Release 15)**



Reference

RTS/TSGR-0438101-3vfb0

Keywords

5G

ETSI

650 Route des Lucioles
F-06921 Sophia Antipolis Cedex - FRANCE

Tel.: +33 4 92 94 42 00 Fax: +33 4 93 65 47 16

Siret N° 348 623 562 00017 - NAF 742 C
Association à but non lucratif enregistrée à la
Sous-Préfecture de Grasse (06) N° 7803/88

Important notice

The present document can be downloaded from:

<http://www.etsi.org/standards-search>

The present document may be made available in electronic versions and/or in print. The content of any electronic and/or print versions of the present document shall not be modified without the prior written authorization of ETSI. In case of any existing or perceived difference in contents between such versions and/or in print, the prevailing version of an ETSI deliverable is the one made publicly available in PDF format at www.etsi.org/deliver.

Users of the present document should be aware that the document may be subject to revision or change of status.

Information on the current status of this and other ETSI documents is available at

<https://portal.etsi.org/TB/ETSIDeliverableStatus.aspx>

If you find errors in the present document, please send your comment to one of the following services:

<https://portal.etsi.org/People/CommiteeSupportStaff.aspx>

Copyright Notification

No part may be reproduced or utilized in any form or by any means, electronic or mechanical, including photocopying and microfilm except as authorized by written permission of ETSI.

The content of the PDF version shall not be modified without the written authorization of ETSI.

The copyright and the foregoing restriction extend to reproduction in all media.

© ETSI 2020.

All rights reserved.

DECT™, **PLUGTESTS™**, **UMTS™** and the ETSI logo are trademarks of ETSI registered for the benefit of its Members.

3GPP™ and **LTE™** are trademarks of ETSI registered for the benefit of its Members and of the 3GPP Organizational Partners.

oneM2M™ logo is a trademark of ETSI registered for the benefit of its Members and of the oneM2M Partners.

GSM® and the GSM logo are trademarks registered and owned by the GSM Association.

Intellectual Property Rights

Essential patents

IPRs essential or potentially essential to normative deliverables may have been declared to ETSI. The information pertaining to these essential IPRs, if any, is publicly available for **ETSI members and non-members**, and can be found in ETSI SR 000 314: "*Intellectual Property Rights (IPRs); Essential, or potentially Essential, IPRs notified to ETSI in respect of ETSI standards*", which is available from the ETSI Secretariat. Latest updates are available on the ETSI Web server (<https://ipr.etsi.org/>).

Pursuant to the ETSI IPR Policy, no investigation, including IPR searches, has been carried out by ETSI. No guarantee can be given as to the existence of other IPRs not referenced in ETSI SR 000 314 (or the updates on the ETSI Web server) which are, or may be, or may become, essential to the present document.

Trademarks

The present document may include trademarks and/or tradenames which are asserted and/or registered by their owners. ETSI claims no ownership of these except for any which are indicated as being the property of ETSI, and conveys no right to use or reproduce any trademark and/or tradename. Mention of those trademarks in the present document does not constitute an endorsement by ETSI of products, services or organizations associated with those trademarks.

Legal Notice

This Technical Specification (TS) has been produced by ETSI 3rd Generation Partnership Project (3GPP).

The present document may refer to technical specifications or reports using their 3GPP identities. These shall be interpreted as being references to the corresponding ETSI deliverables.

The cross reference between 3GPP and ETSI identities can be found under <http://webapp.etsi.org/key/queryform.asp>.

Modal verbs terminology

In the present document "**shall**", "**shall not**", "**should**", "**should not**", "**may**", "**need not**", "**will**", "**will not**", "**can**" and "**cannot**" are to be interpreted as described in clause 3.2 of the [ETSI Drafting Rules](#) (Verbal forms for the expression of provisions).

"**must**" and "**must not**" are **NOT** allowed in ETSI deliverables except when used in direct citation.

Contents

Intellectual Property Rights	2
Legal Notice	2
Modal verbs terminology.....	2
Foreword.....	9
1 Scope	10
2 References	10
3 Definitions, symbols and abbreviations	11
3.1 Definitions	11
3.2 Symbols.....	11
3.3 Abbreviations	11
4 General	12
4.1 Relationship between minimum requirements and test requirements	12
4.2 Applicability of minimum requirements	12
4.3 Specification suffix information.....	13
5 Operating bands and channel arrangement.....	14
5.1 General	14
5.2 Operating bands.....	14
5.2A Operating bands for CA	14
5.2A.1 Inter-band CA between FR1 and FR2.....	14
5.2B Operating bands for DC	15
5.2B.1 General.....	15
5.2B.2 Void	15
5.2B.3 Void	15
5.2B.4 Void	15
5.2B.5 Void	15
5.2B.6 Void	15
5.2B.7 Void	15
5.3 UE Channel bandwidth	15
5.3A UE Channel bandwidth for CA	15
5.3A.1 Inter-band CA between FR1 and FR2.....	15
5.3B UE Channel bandwidth for EN-DC.....	15
5.3B.1 Intra-band EN-DC in FR1.....	16
5.3B.1.1 General	16
5.3B.1.2 BCS for Intra-band contiguous EN-DC	16
5.3B.1.3 BCS for Intra-band non-contiguous EN-DC.....	17
5.3B.2 Void.....	18
5.4 Channel arrangement for CA.....	18
5.4B Channel arrangement for DC.....	18
5.4B.1 Channel spacing for intra-band EN-DC carriers.....	18
5.5 Configuration	19
5.5A Configuration for CA	19
5.5A.1 Inter-band CA configurations between FR1 and FR2	19
5.5B Configuration for DC	22
5.5B.1 General.....	22
5.5B.2 Intra-band contiguous EN-DC	22
5.5B.3 Intra-band non-contiguous EN-DC.....	23
5.5B.4 Inter-band EN-DC within FR1.....	23
5.5B.4.1 Inter-band EN-DC configurations within FR1 (two bands)	23
5.5B.4.2 Inter-band EN-DC configurations within FR1 (three bands)	26
5.5B.4.3 Inter-band EN-DC configurations within FR1 (four bands)	30
5.5B.4.4 Inter-band EN-DC configurations within FR1 (five bands).....	34
5.5B.4.5 Inter-band EN-DC configurations within FR1 (six bands)	37
5.5B.4a Inter-band NE-DC within FR1.....	37

5.5B.4a.1	Inter-band NE-DC configurations within FR1 (two bands)	37
5.5B.5	Inter-band EN-DC including FR2	37
5.5B.5.1	Inter-band EN-DC configurations including FR2 (two bands)	37
5.5B.5.2	Inter-band EN-DC configurations including FR2 (three bands)	41
5.5B.5.3	Inter-band EN-DC configurations including FR2 (four bands)	44
5.5B.5.4	Inter-band EN-DC configurations including FR2 (five bands)	46
5.5B.5.5	Void	47
5.5B.6	Inter-band EN-DC including FR1 and FR2	47
5.5B.6.1	Void	47
5.5B.6.2	Inter-band EN-DC configurations including FR1 and FR2 (three bands)	47
5.5B.6.3	Inter-band EN-DC configurations including FR1 and FR2 (four bands)	50
5.5B.6.4	Inter-band EN-DC configurations including FR1 and FR2 (five bands)	51
5.5B.6.5	Inter-band EN-DC configurations including FR1 and FR2 (six bands)	52
5.5B.7	Inter-band NR-DC between FR1 and FR2	52
5.5B.7.1	Inter-band NR-DC configurations between FR1 and FR2 (two bands)	52
6	Transmitter characteristics	53
6.1	General	53
6.2	Void	53
6.2A	Transmitter power for CA	53
6.2A.1	UE maximum output power for CA	53
6.2A.1.1	Inter-band CA between FR1 and FR2	53
6.2A.2	UE maximum output power reduction for CA	53
6.2A.2.1	Inter-band CA between FR1 and FR2	53
6.2A.3	UE additional maximum output power reduction for CA	53
6.2A.4	Configured output power for CA	54
6.2A.4.1	Configured output power level	54
6.2A.4.2	$\Delta T_{IB,c}$ for CA	54
6.2A.4.2.1	$\Delta T_{IB,c}$ for Inter-band CA between FR1 and FR2	54
6.2B	Transmitter power for DC	54
6.2B.1	UE maximum output power for DC	54
6.2B.1.1	Intra-band contiguous EN-DC	54
6.2B.1.2	Intra-band non-contiguous EN-DC	55
6.2B.1.3	Inter-band EN-DC within FR1	55
6.2B.1.3a	Inter-band NE-DC within FR1	57
6.2B.1.4	Inter-band EN-DC including FR2	58
6.2B.1.5	Inter-band EN-DC including both FR1 and FR2	58
6.2B.2	UE maximum output power reduction for DC	58
6.2B.2.0	General	58
6.2B.2.1	Intra-band contiguous EN-DC	58
6.2B.2.1.1	General	58
6.2B.2.1.2	MPR for power class 3 and power class 2	59
6.2B.2.2	Intra-band non-contiguous EN-DC	59
6.2B.2.2.1	General	59
6.2B.2.2.2	MPR for power class 3 and power class 2	60
6.2B.2.3	Inter-band EN-DC within FR1	61
6.2B.2.3a	Inter-band NE-DC within FR1	61
6.2B.2.4	Inter-band EN-DC including FR2	61
6.2B.2.5	Inter-band EN-DC including both FR1 and FR2	61
6.2B.3	UE additional maximum output power reduction for EN-DC	61
6.2B.3.1	Intra-band contiguous EN-DC	61
6.2B.3.1.0	General	61
6.2B.3.1.1	A-MPR for DC _(n) 71AA	61
6.2B.3.1.2	A-MPR for NS_04	63
6.2B.3.2	Intra-band non-contiguous EN-DC	65
6.2B.3.2.0	General	65
6.2B.3.2.1	A-MPR for NS_04	65
6.2B.3.3	Inter-band EN-DC within FR1	67
6.2B.3.4	Inter-band EN-DC including FR2	67
6.2B.3.5	Inter-band EN-DC including both FR1 and FR2	67
6.2B.4	Configured output power for DC	67
6.2B.4.1	Configured output power level	67

6.2B.4.1.1	Intra-band contiguous EN-DC	67
6.2B.4.1.2	Intra-band non-contiguous EN-DC	71
6.2B.4.1.3a	Inter-band NE-DC within FR1	75
6.2B.4.1.4	Inter-band EN-DC including FR2	78
6.2B.4.1.5	Inter-band EN-DC including both FR1 and FR2	79
6.2B.4.2	$\Delta T_{IB,c}$ for DC	79
6.2B.4.2.0	General	79
6.2B.4.2.1	Intra-band contiguous EN-DC	79
6.2B.4.2.2	Intra-band non-contiguous EN-DC	79
6.2B.4.2.3	Inter-band EN-DC within FR1	79
6.2B.4.2.3.1	$\Delta T_{IB,c}$ for EN-DC two bands	79
6.2B.4.2.3.5	$\Delta T_{IB,c}$ for EN-DC six bands	92
6.2B.4.2.3a	Inter-band NE-DC within FR1	92
6.2B.4.2.4	Inter-band EN-DC including FR2	92
6.2B.4.2.4.1	$\Delta T_{IB,c}$ for EN-DC two bands	92
6.2B.4.2.4.2	$\Delta T_{IB,c}$ for EN-DC three bands	92
6.2B.4.2.4.3	$\Delta T_{IB,c}$ for EN-DC four bands	93
6.2B.4.2.4.4	$\Delta T_{IB,c}$ for EN-DC five bands	93
6.2B.4.2.4.5	Void	93
6.2B.4.2.5	Inter-band EN-DC including both FR1 and FR2	93
6.2B.4.2.5.1	$\Delta T_{IB,c}$ for EN-DC three bands	93
6.2B.4.2.5.2	$\Delta T_{IB,c}$ for EN-DC four bands	93
6.2B.4.2.5.3	$\Delta T_{IB,c}$ for EN-DC five bands	93
6.2B.4.2.5.4	$\Delta T_{IB,c}$ for EN-DC six bands	93
6.2B.5	Configured output power for NR-DC	93
6.2B.5.1	Configured output power level	93
6.2B.5.1.1	Inter-band NR-DC between FR1 and FR2	93
6.3	Output power dynamics	94
6.3A	Output power dynamics for CA	94
6.3B	Output power dynamics for DC	94
6.3B.0	General	94
6.3B.1	Output power dynamics for EN-DC with UL sharing from UE perspective	94
6.3B.1.1	E-UTRA and NR switching time mask for TDM based UL sharing from UE perspective	94
6.3B.1a	Output power dynamics for NE-DC with UL sharing from UE perspective	96
6.3B.2	Output power dynamics for intra-band EN-DC without dual PA capability	96
6.3B.3	Output power dynamics for intra-band EN-DC with dual PA capability	96
6.4	Void	97
6.4A	Transmit signal quality for CA	97
6.4A.1	Frequency error for CA	97
6.4A.2	Transmit modulation quality for CA	97
6.4B	Transmit signal quality for DC	97
6.4B.2	Transmit modulation quality for DC	98
6.4B.2.1	Transmit modulation quality for Intra-band contiguous EN-DC	98
6.4B.2.1.1	Error Vector Magnitude	98
6.4B.2.1.2	Carrier leakage	98
6.4B.2.1.3	In-band emissions	98
6.4B.2.2	Transmit modulation quality for Intra-band non-contiguous EN-DC	99
6.4B.2.2.1	Error Vector Magnitude	99
6.4B.2.2.2	Carrier leakage	99
6.4B.2.2.3	In-band emissions	99
6.4B.2.3a	Transmit modulation quality for Inter-band NE-DC within FR1	99
6.4B.2.4	Transmit modulation quality for Inter-band EN-DC including FR2	99
6.4B.2.5	Transmit modulation quality for inter-band EN-DC including both FR1 and FR2	99
6.5	Void	100
6.5A	Output RF spectrum emissions for CA	100
6.5A.1	Occupied bandwidth for CA	100
6.5A.2	Out-of-band emissions for CA	100
6.5A.3	Spurious emissions for CA	100
6.5A.3.1	Inter-band CA between FR1 and FR2	100
6.5A.4	Transmit intermodulation for CA	100
6.5B	Output RF spectrum emissions for DC	100
6.5B.1	Occupied bandwidth for EN-DC	100

6.5B.1.4	Inter-band EN-DC including FR2	100
6.5B.1.5	Inter-band EN-DC including both FR1 and FR2	101
6.5B.2	Out-of-band emissions for DC	101
6.5B.2.1	Intra-band contiguous EN-DC	101
6.5B.2.1.1	Spectrum emissions mask	101
6.5B.2.1.2	Additional spectrum emissions mask	101
6.5B.2.1.2.1	Requirements for network signalled value "NS_35"	101
6.5B.2.1.2.2	Requirements for network signalled value "NS_04"	102
6.5B.2.1.3	Adjacent channel leakage ratio	102
6.5B.2.2	Intra-band non-contiguous EN-DC	103
6.5B.2.2.1	Spectrum emissions mask	103
6.5B.2.2.2	Additional spectrum emissions mask	103
6.5B.2.2.3	Adjacent channel leakage ratio	103
6.5B.2.3	Inter-band EN-DC within FR1	103
6.5B.2.3a	Inter-band NE-DC within FR1	103
6.5B.2.4	Inter-band EN-DC including FR2	103
6.5B.2.5	Inter-band EN-DC including both FR1 and FR2	103
6.5B.3	Spurious emissions for DC	104
6.5B.3.1	Intra-band contiguous EN-DC	104
6.5B.3.1.1	General spurious emissions	104
6.5B.3.1.2	Spurious emission band UE co-existence	104
6.5B.3.2	Intra-band non-contiguous EN-DC	104
6.5B.3.2.1	General spurious emissions	104
6.5B.3.2.2	Spurious emission band UE co-existence	104
6.5B.3.3	Inter-band EN-DC within FR1	105
6.5B.3.3.2	Spurious emission band UE co-existence	105
6.5B.3.3a	Inter-band NE-DC within FR1	113
6.5B.3.3a.1	General spurious emissions	113
6.5B.3.3a.2	Spurious emission band UE co-existence	113
6.5B.3.4	Inter-band EN-DC including FR2	113
6.5B.3.4.1	Spurious emission band UE co-existence	113
6.5B.3.5	Inter-band EN-DC including both FR1 and FR2	113
6.5B.3.5.1	Spurious emission band UE co-existence	113
6.5B.4	Additional spurious emissions	114
6.5B.4.1	General	114
6.5B.4.1.1	Minimum requirement (network signalled value "NS_04")	114
6.5B.5	Transmit intermodulation for DC	114
6.5B.5.1	Intra-band contiguous EN-DC	114
6.5B.5.2	Intra-band non-contiguous EN-DC	114
6.5B.5.3	Inter-band EN-DC within FR1	114
6.5B.5.3a	Inter-band NE-DC within FR1	114
6.5B.5.4	Inter-band EN-DC including FR2	114
6.5B.5.5	Inter-band EN-DC including both FR1 and FR2	115
6.6B	Beam correspondence for DC	115
6.6B.1	Void	115
6.6B.2	Void	115
6.6B.3	Void	115
6.6B.4	Inter-band EN-DC including FR2	115
6.6B.5	Inter-band EN-DC including both FR1 and FR2	115
7	Receiver characteristics	115
7.1	General	115
7.2	Void	116
7.3	Void	116
7.3A	Reference sensitivity for CA	116
7.3A.1	General	116
7.3A.2	Reference sensitivity power level for CA	116
7.3A.3	$\Delta R_{IB,c}$ for CA	116
7.3A.3.1	$\Delta R_{IB,c}$ for Inter-band CA between FR1 and FR2	117
7.3A.4	Void	117
7.3B	Reference sensitivity level for DC	117
7.3B.1	General	117

7.3B.2	Reference sensitivity for DC.....	117
7.3B.2.1	Intra-band contiguous EN-DC	117
7.3B.2.2	Intra-band non-contiguous EN-DC	118
7.3B.2.3	Inter-band EN-DC within FR1	118
7.3B.2.3.1	Reference sensitivity exceptions due to UL harmonic interference for EN-DC in NR FR1	118
7.3B.2.3.2	Reference sensitivity exceptions due to receiver harmonic mixing for EN-DC in NR FR1.....	122
7.3B.2.3.3	Void.....	124
7.3B.2.3.4	Reference sensitivity exceptions due to cross band isolation for EN-DC in NR FR1	124
7.3B.2.3.5	MSD for intermodulation interference due to dual uplink operation for EN-DC in NR FR1	126
7.3B.2.3.5.1	MSD test points for intermodulation interference due to dual uplink operation for EN-DC in NR FR1 involving two bands	127
7.3B.2.3.5.2	MSD test points for intermodulation interference due to dual uplink operation for EN-DC in NR FR1 involving three bands	129
7.3B.2.3.5.3	Void	135
7.3B.2.3a	Inter-band NE-DC within FR1	135
7.3B.2.3a.1	Reference sensitivity exceptions due to UL harmonic interference for NE-DC in NR FR1	135
7.3B.2.4	Inter-band EN-DC including FR2	136
7.3B.2.4.1	Void.....	136
7.3B.2.5	Inter-band EN-DC including both FR1 and FR2	136
7.3B.2.5.1	Reference sensitivity exceptions due to UL harmonic interference for EN-DC including both FR1 and FR2	136
7.3B.3	$\Delta R_{IB,c}$, ΔR_{IBNC} for DC	136
7.3B.3.0	General	136
7.3B.3.1	Intra-band contiguous EN-DC	137
7.3B.3.2	Intra-band non-contiguous EN-DC	137
7.3B.3.3	Inter-band EN-DC within FR1	138
7.3B.3.3.1	$\Delta R_{IB,c}$ for EN-DC in two bands	138
7.3B.3.3.2	$\Delta R_{IB,c}$ for EN-DC three bands	140
7.3B.3.3.4	$\Delta R_{IB,c}$ for EN-DC five bands	147
7.3B.3.3.5	$\Delta R_{IB,c}$ for EN-DC six bands.....	149
7.3B.3.3a	Inter-band NE-DC within FR1	149
7.3B.3.4	Inter-band EN-DC including FR2	149
7.3B.3.4.1	$\Delta R_{IB,c}$ for EN-DC in two bands	149
7.3B.3.4.2	$\Delta R_{IB,c}$ for EN-DC three bands	149
7.3B.3.4.3	$\Delta R_{IB,c}$ for EN-DC four bands	150
7.3B.3.4.4	$\Delta R_{IB,c}$ for EN-DC five bands	150
7.3B.3.4.5	Void.....	150
7.3B.3.5	Inter-band EN-DC including both FR1 and FR2	150
7.3B.3.5.2	$\Delta R_{IB,c}$ for EN-DC three bands	150
7.3B.3.5.3	$\Delta R_{IB,c}$ for EN-DC four bands.....	150
7.3B.3.5.4	$\Delta R_{IB,c}$ for EN-DC five bands	150
7.3B.3.5.5	$\Delta R_{IB,c}$ for EN-DC six bands.....	150
7.4	Void.....	150
7.4A	Maximum input level for CA	150
7.4B	Maximum input level for DC in FR1	151
7.4B.1	Intra-band contiguous EN-DC in FR1	151
7.4B.2	Intra-band non-contiguous EN-DC in FR1	151
7.4B.3	Inter-band EN-DC within FR1.....	151
7.5	Void.....	151
7.5A	Adjacent channel selectivity for CA.....	151
7.5B	Adjacent channel selectivity for DC in FR1.....	152
7.5B.1	Intra-band contiguous EN-DC in FR1	152
7.5B.2	Intra-band non-contiguous EN-DC in FR1	152
7.5B.3	Inter-band EN-DC within FR1.....	152
7.6	Void.....	154
7.6A	Blocking characteristics for CA	154
7.6B	Blocking characteristics for DC in FR1	154
7.6B.1	General.....	154
7.6B.2	In-band blocking for DC in FR1	154
7.6B.2.1	Intra-band contiguous EN-DC in FR1.....	154
7.6B.2.2	Intra-band non-contiguous EN-DC in FR1	154
7.6B.2.3	Inter-band EN-DC within FR1	154

7.6B.3	Out-of-band blocking for DC in FR1	155
7.6B.3.1	Intra-band contiguous EN-DC in FR1	155
7.6B.3.2	Intra-band non-contiguous EN-DC in FR1	155
7.6B.3.3	Inter-band EN-DC within FR1	155
7.6B.3.3a	Inter-band NE-DC within FR1	156
7.6B.3.4	Inter-band EN-DC including FR2	157
7.6B.3.5	Inter-band EN-DC including both FR1 and FR2	157
7.6B.4	Narrow band blocking for DC in FR1	157
7.6B.4.1	Intra-band contiguous EN-DC in FR1	157
7.6B.4.2	Intra-band non-contiguous EN-DC in FR1	157
7.6B.4.3	Inter-band EN-DC within FR1	157
7.7	Void	158
7.7A	Spurious response for CA	158
7.7B	Spurious response for DC in FR1	158
7.7B.1	Intra-band contiguous EN-DC in FR1	158
7.7B.2	Intra-band non-contiguous EN-DC in FR1	158
7.7B.3	Inter-band EN-DC within FR1	158
7.8	Void	159
7.8A	Intermodulation characteristics for CA	159
7.8B	Intermodulation characteristics for DC in FR1	159
7.8B.1	General	159
7.8B.2	Wide band Intermodulation	159
7.8B.2.1	Intra-band contiguous EN-DC in FR1	159
7.8B.2.2	Intra-band non-contiguous EN-DC in FR1	160
7.8B.2.3	Inter-band EN-DC within FR1	160
7.9	Void	160
7.9A	Spurious emissions for CA	160
7.9B	Spurious emissions for DC in FR1	161
7.9B.1	Intra-band contiguous EN-DC in FR1	161
7.9B.2	Intra-band non-contiguous EN-DC in FR1	161
7.9B.3	Inter-band EN-DC within FR1	161
Annex A (normative):	Measurement channels	162
Annex B:	Void	174
Annex C:	Void	174
Annex D:	Void	174
Annex E:	Void	174
Annex F:	Void	174
Annex G:	Void	174
Annex H (normative):	Modified MPR behavior	175
Annex I (normative):	Dual uplink interferer	175
Annex J:	Void	176
Annex K:	Void	176
Annex L (informative):	Change history	177
History		185

Foreword

This Technical Specification has been produced by the 3rd Generation Partnership Project (3GPP).

The contents of the present document are subject to continuing work within the TSG and may change following formal TSG approval. Should the TSG modify the contents of the present document, it will be re-released by the TSG with an identifying change of release date and an increase in version number as follows:

Version x.y.z

where:

- x the first digit:
 - 1 presented to TSG for information;
 - 2 presented to TSG for approval;
 - 3 or greater indicates TSG approved document under change control.
- y the second digit is incremented for all changes of substance, i.e. technical enhancements, corrections, updates, etc.
- z the third digit is incremented when editorial only changes have been incorporated in the document.

1 Scope

The present document establishes the minimum RF requirements for NR User Equipment (UE) Interworking operation with other radios. This includes but is not limited to additional requirements for carrier aggregation or NR dual connectivity between Range 1 and Range 2 and additional requirements due to NR non-standalone (NSA) operation mode with E-UTRA.

2 References

The following documents contain provisions which, through reference in this text, constitute provisions of the present document.

- References are either specific (identified by date of publication, edition number, version number, etc.) or non-specific.
- For a specific reference, subsequent revisions do not apply.
- For a non-specific reference, the latest version applies. In the case of a reference to a 3GPP document (including a GSM document), a non-specific reference implicitly refers to the latest version of that document *in the same Release as the present document*.

- [1] 3GPP TR 21.905: "Vocabulary for 3GPP Specifications".
- [2] 3GPP TS 38.101-1: "NR; User Equipment (UE) radio transmission and reception; Part 1: Range 1 Standalone"
- [3] 3GPP TS 38.101-2: "NR; User Equipment (UE) radio transmission and reception; Part 2: Range 2 Standalone"
- [4] 3GPP TS 36.101: "Evolved Universal Terrestrial Radio Access (E-UTRA); User Equipment (UE) radio transmission and reception"
- [5] 3GPP TS 38.521-3: "NR; User Equipment (UE) conformance specification; Radio transmission and reception; Part 3: Range 1 and Range 2 Interworking operation with other radios"
- [6] Recommendation ITU-R M.1545: "Measurement uncertainty as it applies to test limits for the terrestrial component of International Mobile Telecommunications-2000"
- [7] 3GPP TS 36.211: "E-UTRA; Physical channels and modulation"
- [8] 3GPP TS 36.331: " Evolved Universal Terrestrial Radio Access (E-UTRA); Radio Resource Control (RRC); Protocol specification"
- [9] 3GPP TS 38.331: "NR; Radio Resource Control (RRC) protocol specification"
- [10] 3GPP TS 38.213: "NR; Physical layer procedures for control"
- [11] 3GPP TS 38.306: "NR; User Equipment (UE) radio access capabilities"
- [12] 3GPP TS 38.133: "NR; Requirements for support of radio resource management".
- [13] 3GPP TS 38.211: "NR; Physical channels and modulation".

3 Definitions, symbols and abbreviations

3.1 Definitions

For the purposes of the present document, the terms and definitions given in 3GPP TR 21.905 [1] and the following apply. A term defined in the present document takes precedence over the definition of the same term, if any, in 3GPP TR 21.905 [1].

3.2 Symbols

For the purposes of the present document, the following symbols apply:

$\Delta R_{IB,c}$	Allowed reference sensitivity relaxation due to support for CA or DC operation, for serving cell c .
$\Delta T_{IB,c}$	Allowed maximum configured output power relaxation due to support for CA or DC operation, for serving cell c
$BW_{E-UTRA_Channel}$	Channel bandwidth of E-UTRA carrier
$BW_{E-UTRA_Channel_CA}$	Channel bandwidth of E-UTRA sub-block which is composed of intra-band contiguous CA E-UTRA carriers
$BW_{NR_Channel}$	Channel bandwidth of NR carrier
$BW_{NR_Channel_CA}$	Channel bandwidth of NR sub-block which is composed of intra-band contiguous CA NR carriers
$Ceil(x)$	Rounding upwards; $ceil(x)$ is the smallest integer such that $ceil(x) \geq x$
$EN-DC_{ACLR}$	The ratio of the filtered mean power centred on the aggregated sub-block bandwidth ENBW to the filtered mean power centred on an adjacent bandwidth of the same size ENBW
$E-UTRA_{ACLR}$	E-UTRA ACLR
F_C	<i>RF reference frequency</i> for the carrier center on the channel raster
F_{DL_low}	The lowest frequency of the downlink <i>operating band</i>
F_{DL_high}	The highest frequency of the downlink <i>operating band</i>
F_{UL_low}	The lowest frequency of the uplink <i>operating band</i>
F_{UL_high}	The highest frequency of the uplink <i>operating band</i>
F_{OOB}	The boundary between the NR out of band emission and spurious emission domains
L_{CRB}	Transmission bandwidth which represents the length of a contiguous resource block allocation expressed in units of resource blocks
$Max()$	The largest of given numbers
$Min()$	The smallest of given numbers
NR_{ACLR}	NR ACLR
N_{RB}	Transmission bandwidth configuration, expressed in units of resource blocks
N_{RB_agg}	The number of the aggregated RBs within the fully allocated aggregated channel bandwidth $N_{RB_agg} = \sum_1^j N_{RB_j} * 2^{\mu_j}$ for carrier 1 to j , where μ is defined in TS 38.211 [13]
$N_{RB,c}$	The transmission bandwidth configuration of component carrier c , expressed in units of resource blocks $N_{RB,cj} = N_{RB_j} * 2^{\mu_j}$ for carrier j , where μ is defined in TS 38.211 [13]
P_{CMAX}	The configured maximum UE output power
RB_{start}	Indicates the lowest RB index of transmitted resource blocks
W_{gap}	The sub-block gap between the two sub-blocks

3.3 Abbreviations

For the purposes of the present document, the abbreviations given in 3GPP TR 21.905 [1] and the following apply. An abbreviation defined in the present document takes precedence over the definition of the same abbreviation, if any, in 3GPP TR 21.905 [1].

ACLR	Adjacent Channel Leakage Ratio
ACS	Adjacent Channel Selectivity
A-MPR	Additional Maximum Power Reduction
BCS	Bandwidth Combination Set
CA	Carrier Aggregation

CC	Component Carrier
DC	Dual Connectivity
EN-DC	E-UTRA/NR DC
EVM	Error Vector Magnitude
FDM	Frequency Division Multiplexing
FR	Frequency Range
ENBW	The aggregated bandwidth of an E-UTRA sub-block and an adjacent NR sub-block
ITU-R	Radiocommunication Sector of the International Telecommunication Union
MBW	Measurement bandwidth defined for the protected band
MPR	Allowed maximum power reduction
MSD	Maximum Sensitivity Degradation
MCG	Master Cell Group
NR	New Radio
NS	Network Signalling
NSA	Non-Standalone, a mode of operation where operation of an other radio is assisted with an other radio
OOB	Out-of-band
OOBE	Out-of-band emission
OTA	Over The Air
PRB	Physical Resource Block
RE	Resource Element
REFSENS	Reference Sensitivity
RF	Radio Frequency
Rx	Receiver
SCG	Secondary Cell Group
SCS	Subcarrier spacing
SEM	Spectrum Emission Mask
SUL	Supplementary uplink
TDM	Time Division Multiplex
Tx	Transmitter
UE	User Equipment
UL MIMO	Up Link Multiple Antenna transmission
ULSUP	Uplink sharing from UE perspective

4 General

4.1 Relationship between minimum requirements and test requirements

The present document is interwork specification for NR UE, covering RF characteristics and minimum performance requirements. Conformance to the present specification is demonstrated by fulfilling the test requirements specified in the conformance specification 3GPP TS 38.521-3 [5].

The Minimum Requirements given in this specification make no allowance for measurement uncertainty. The test specification TS 38.521-3 [5] defines test tolerances. These test tolerances are individually calculated for each test. The test tolerances are used to relax the minimum requirements in this specification to create test requirements. For some requirements, including regulatory requirements, the test tolerance is set to zero.

The measurement results returned by the test system are compared - without any modification - against the test requirements as defined by the shared risk principle.

The shared risk principle is defined in Recommendation ITU-R M.1545 [6].

4.2 Applicability of minimum requirements

- a) In this specification the Minimum Requirements are specified as general requirements and additional requirements. Where the Requirement is specified as a general requirement, the requirement is mandated to be met in all scenarios

- b) For specific scenarios for which an additional requirement is specified, in addition to meeting the general requirement, the UE is mandated to meet the additional requirements.
- c) The spurious emissions power requirements are for the long-term average of the power. For the purpose of reducing measurement uncertainty it is acceptable to average the measured power over a period of time sufficient to reduce the uncertainty due to the statistical nature of the signal
- d) Terminal that supports EN-DC configuration shall meet E-UTRA requirements as specified in TS 36.101 [4] and NR requirements as in TS 38.101-1 [2] and TS 38.101-2 [3] unless otherwise specified in this specification
- e) All the requirements for intra-band contiguous and non-contiguous EN-DC apply under the assumption of the same uplink-downlink and special subframe configurations in the E-UTRA and slot format indicated by UL-DL-configurationCommon and UL-DL-configurationDedicated in the NR for the EN-DC.
- f) For EN-DC combinations with CA configurations for E-UTRA and/or NR, all the requirements for E-UTRA and/or NR all the requirements for E-UTRA and/or NR intra-band contiguous and non-contiguous CA apply under the assumption of the same slot format indicated by UL-DL-configurationCommon and UL-DL-configurationDedicated in the PCell and SCells for NR and the same uplink-downlink and special subframe configurations in Pcell and SCells for E-UTRA.

A terminal which supports an EN-DC configuration shall support:

If any subsets of the EN-DC configuration do not specify its own bandwidth combination sets in 5.3B, then the terminal shall support the same E-UTRA bandwidth combination sets it signals the support for in E-UTRA CA configuration part of E-UTRA – NR DC and shall support the same NR bandwidth combination sets it signals the support for in NR CA configuration part of E-UTRA – NR DC.

Else if one of the subsets of the EN-DC configuration specify its own bandwidth combination sets in 5.3B, then the terminal shall support a product set of channel bandwidth for each band specified by E-UTRA bandwidth combination sets, NR bandwidth combination sets, and EN-DC bandwidth combination sets it signals the support.

A terminal which supports an inter-band EN-DC configuration with a certain UL configuration shall support the all lower order DL configurations of the lower order EN-DC combinations, which have this certain UL configuration and the fallbacks of this UL configuration.

A terminal which supports CA or DC configurations, which include FR2 intra-band CA combinations with multiple subblocks, where at least one of the subblocks consists of a contiguous CA combination, is not required to support all possible fallback combinations but can directly fall back to a single FR2 carrier. Deactivating carriers within the CA or DC combination is still possible.

Terminal that supports inter-band NR-DC between FR1 and FR2 configuration shall meet the requirements for corresponding CA configuration (suffix A), unless otherwise specified.

4.3 Specification suffix information

Unless stated otherwise the following suffixes are used for indicating at 2nd level clause, shown in Table 4.3-1.

Table 4.3-1: Definition of suffixes

Clause suffix	Variant
None	Single Carrier
A	Carrier Aggregation (CA) between FR1 and FR2
B	Dual-Connectivity (DC) with and without SUL including UL sharing from UE perspective, inter-band NR DC between FR1 and FR2
D	UL MIMO

5 Operating bands and channel arrangement

5.1 General

The channel arrangements presented in this clause are based on the operating bands and channel bandwidths defined in the present release of specifications.

NOTE: Other operating bands and channel bandwidths may be considered in future releases.

Requirements throughout the RF specifications are in many cases defined separately for different frequency ranges (FR). The frequency ranges in which NR can operate according to this version of the specifications are identified as described in Table 5.1-1.

Table 5.1-1: Definition of frequency ranges

Frequency range designation	Corresponding frequency range
FR1	410 MHz – 7125 MHz
FR2	24250 MHz – 52600 MHz

The present specification covers band combinations including

- at least one FR1 operating band and one FR2 operating band for carrier aggregation and dual connectivity operations;
- at least one E-UTRA operating band for dual connectivity operations.

5.2 Operating bands

NR is designed to operate in FR1 operating bands defined in TS 38.101-1 [2] and FR2 operating bands defined in TS 38.101-2 [3]. E-UTRA is designed to operate in operating bands defined in TS 36.101 [4].

5.2A Operating bands for CA

5.2A.1 Inter-band CA between FR1 and FR2

NR carrier aggregation are designed to operate in the operating bands defined in Table 5.2A.1-1. The band combinations include at least one FR1 operating band and one FR2 operating band.

Table 5.2A.1-1: Band combinations for inter-band NR CA between FR1 and FR2

NR CA Band	NR Band
CA_n8-n258 ¹	n8, n258
CA_n71-n257 ¹	n71, n257
CA_n77-n257 ¹	n77, n257
CA_n78-n257 ¹	n78, n257
CA_n79-n257 ¹	n79, n257
NOTE 1: Applicable for UE supporting inter-band carrier aggregation with mandatory simultaneous Rx/Tx capability.	

5.2B Operating bands for DC

5.2B.1 General

The operating bands are specified in clause 5.5B for operation with EN-DC, NGEN-DC, NE-DC or NR-DC configured.

5.2B.2 Void

5.2B.3 Void

5.2B.4 Void

5.2B.5 Void

5.2B.6 Void

5.2B.7 Void

5.3 UE Channel bandwidth

5.3A UE Channel bandwidth for CA

5.3A.1 Inter-band CA between FR1 and FR2

For inter-band NR CA between FR1 and FR2, a carrier aggregation configuration is a combination of operating bands, each supporting a carrier aggregation bandwidth class as specified in clause 5.3A.5 of TS 38.101-1 [2] and clause 5.3A.4 of TS 38.101-2 [3] independently.

5.3B UE Channel bandwidth for EN-DC

For intra-band contiguous EN-DC, the aggregated channel bandwidth is sum of the individual NR and E-UTRA channel bandwidths assuming nominal EN-DC channel with 0 kHz offset spacing as specified in clause 5.4.

$$ENBW = BW_{NR_Channel} + BW_{E-UTRA_Channel}$$

In the case where the NR sub-block and/or the E-UTRA sub-block itself is composed of intra-band contiguous CA carriers, the EN-DC aggregated channel bandwidth is the sum of the aggregated channel bandwidths of the NR and E-UTRA sub-blocks assuming nominal EN-DC channel spacing between the NR sub-block and E-UTRA sub-block.

$$ENBW = BW_{NR_Channel_CA} + BW_{E-UTRA_Channel_CA}$$

For NR inter-band dual connectivity specified in 5.5B.7, the corresponding NR CA configurations in 5.5A.1, i.e., dual uplink inter-band carrier aggregation between FR1 and FR2 with uplink assigned to two NR bands, are applicable to Dual Connectivity.

NOTE 1: Requirements for the dual connectivity configurations are defined in the clause corresponding NR uplink CA between FR1 and FR2 configurations, unless otherwise specified.

Intra-band contiguous EN-DC configurations are defined using intra-band contiguous EN-DC bandwidth class notation DC_(n)Xyz where the first EN-DC bandwidth class letter y indicates the number of contiguous E-UTRA carriers and the second EN-DC bandwidth class letter z indicates the number of contiguous NR carriers for the EN-DC combination of E-UTRA Band X and NR Band nX. Applicable contiguous intraband EN-DC bandwidth classes are listed in Table 5.3.B-1.

Table 5.3.B-1: Intra-band contiguous EN-DC bandwidth classes

Intra-band contiguous EN-DC bandwidth class	Number of contiguous CC	
	E-UTRA	NR
AA	1	1
CA	2	1
DA	3	1

5.3B.1 Intra-band EN-DC in FR1

5.3B.1.1 General

The requirements for intra-band EN-DC in this specification are defined for EN-DC configurations with associated bandwidth combination sets.

For each EN-DC configuration, requirements are specified for all bandwidth combinations contained in a *bandwidth combination set*, which is indicated per supported band combination in the UE radio access capability. A UE can indicate support of several bandwidth combination sets per band combination.

5.3B.1.2 BCS for Intra-band contiguous EN-DC

For intra-band contiguous EN-DC, an EN-DC configuration is a single operating band supporting an intra-band contiguous EN-DC bandwidth class.

Bandwidth combination sets for intra-band contiguous EN-DC are specified in Table 5.3B.1.2-1.

Table 5.3B.1.2-1: EN-DC configurations and bandwidth combination sets defined for intra-band contiguous EN-DC

E-UTRA – NR configuration / Bandwidth combination set						
Downlink EN-DC configuration	Uplink EN-DC configurations	Component carriers in order of increasing carrier frequency			Maximum aggregated bandwidth (MHz)	Bandwidth combination set
		Channel bandwidths for E-UTRA carrier (MHz)	Channel bandwidths for NR carrier (MHz)	Channel bandwidths for E-UTRA carrier (MHz)		
DC_(n)41AA	DC_(n)41AA	20	40, 60, 80,100		120	0
			40, 60, 80,100	20		
		20	40, 50, 60, 80,100		120	1
			40, 50, 60, 80,100	20		
DC_(n)41CA	DC_(n)41AA ¹ , DC_41A_n41A ²	20+20	40, 60, 80,100		140	0
			40, 60, 80,100	20+20		
		20+20	40, 50, 60, 80,100		140	1
			40, 50, 60, 80,100	20+20		
DC_(n)41DA	DC_(n)41AA ¹ , DC_41A_n41A ²	20+20+20	40, 60, 80,100		160	0
			40, 60, 80,100	20+20+20		
		20+20+20	40, 50, 60, 80,100		160	1
			40, 50, 60, 80,100	20+20+20		
DC_(n)71AA	DC_(n)71AA	15	5		20	0
		10	5, 10			
		5	5, 10, 15			
			5	15		
			5, 10	10		
			5, 10, 15	5		

NOTE 1: Void
NOTE 2: Void
NOTE 3: Void
NOTE 4: The channel bandwidths for E-UTRA or NR carrier should be at least supported in one of the BCS indicated in E-UTRA bandwidth combination sets or NR bandwidth combination sets if reported.

5.3B.1.3 BCS for Intra-band non-contiguous EN-DC

For intra-band non-contiguous EN-DC, an EN-DC configuration is a single operating band supporting E-UTRA and NR carriers, where E-UTRA configuration is indicated by using E-UTRA CA bandwidth class as defined in TS 36.101 [4] and NR configuration is indicated by using NR CA bandwidth class as defined in TS 38.101-1 [2].

Requirements for intra-band non-contiguous EN-DC are defined for the EN-DC configurations and bandwidth combination sets specified in Table 5.3B.1.3-1.

Table 5.3B.1.3-1: EN-DC configurations and bandwidth combination sets defined for intra-band non-contiguous EN-DC

E-UTRA – NR configuration / Bandwidth combination set						
Downlink EN-DC configuration	Uplink EN-DC configurations	Component carriers in order of increasing carrier frequency			Maximum aggregated bandwidth (MHz)	Bandwidth combination set
		Channel bandwidths for E-UTRA carrier (MHz)	Channel bandwidths for NR carrier (MHz)	Channel bandwidths for E-UTRA carrier (MHz)		

DC_3A_n3A	DC_3A_n3A ⁽¹⁾		5, 10, 15, 20, 25, 30	5, 10, 15, 20	50	0
DC_41A_n41A	DC_41A_n41A	20	40, 60, 80,100		120	0
			40, 60, 80,100	20		
		20	40, 50, 60, 80,100		120	1
			40, 50, 60, 80,100	20		
DC_41C_n41A	DC_41A_n41A	20+20	40, 60, 80,100		140	0
			40, 60, 80,100	20+20		
		20+20	40, 50, 60, 80,100		140	1
			40, 50, 60, 80,100	20+20		
DC_41D_n41A	DC_41A_n41A	20+20+20	40, 60, 80,100		160	0
			40, 60, 80,100	20+20+20		
		20+20+20	40, 50, 60, 80,100		160	1
			40, 50, 60, 80,100	20+20+20		

NOTE 1: Only single switched UL is supported in Rel.15

NOTE 2: Void

NOTE 3: The channel bandwidths for E-UTRA or NR carrier should be at least supported in one of the BCS indicated in E-UTRA bandwidth combination sets or NR bandwidth combination sets if reported

5.4 Void

5.4A Channel arrangement for CA

The channel arrangement for CA operations in FR1 and FR2 as specified in TS 38.101-1 [2] and TS 38.101-2 [3], respectively.

5.4B Channel arrangement for DC

The channel arrangement for intra-band EN-DC operations in FR1 is specified in TS 36.101 [4] and TS 38.101-1 [2], respectively.

5.4B.1 Channel spacing for intra-band EN-DC carriers

The spacing between carriers will depend on the deployment scenario, the size of the frequency block available and the channel bandwidths. The nominal channel spacing between and E-UTRA carrier and an adjacent NR carrier for intra-band contiguous EN-DC is defined as following:

- For NR operating bands with 100 kHz channel raster,

$$\text{Nominal Channel spacing} = (\text{BW}_{\text{E-UTRA_Channel}} + \text{BW}_{\text{NR_Channel}})/2$$

- For NR operating bands with 15 kHz channel raster,

- Nominal Channel spacing = $(\text{BW}_{\text{E-UTRA_Channel}} + \text{BW}_{\text{NR_Channel}})/2 + \{-5\text{kHz}, 0\text{kHz}, 5\text{kHz}\}$ for ΔF_{Raster} equals to 15 kHz
- Nominal Channel spacing = $(\text{BW}_{\text{E-UTRA_Channel}} + \text{BW}_{\text{NR_Channel}})/2 + \{-10\text{ kHz}, 0\text{ kHz}, 10\text{ kHz}\}$ for ΔF_{Raster} equals to 30 kHz

where $BW_{E-UTRA_Channel}$ and $BW_{NR_Channel}$ are the channel bandwidths of the E-UTRA and NR carriers, ΔF_{Raster} is the band dependent channel raster granularity defined in TS38.101-1[2]. The channel spacing can be adjusted depending on the channel raster to optimize performance in a particular deployment scenario.

For intra-band non-contiguous EN-DC the channel spacing between E-UTRA and NR carriers shall be larger than the nominal channel spacing defined in this clause.

5.5 Configuration

5.5A Configuration for CA

5.5A.1 Inter-band CA configurations between FR1 and FR2

Table 5.5A.1-1: Inter-band CA configurations and bandwidth combinations sets between FR1 and FR2 (two bands)

CA configuration	Uplink CA configuration	NR Band	SCS (kHz)	5 MHz	10 MHz	15 MHz	20 MHz	40 MHz	50 MHz	60 MHz	80 MHz	90 MHz	100 MHz	200 MHz	400 MHz	Bandwidth combination	
CA_n8A-258A	CA_n8A-n258A	n8	15	Yes	Yes	Yes	Yes										
			30		Yes	Yes	Yes										
			60														
		n258	60						Yes					Yes	Yes		
			120					Yes				Yes	Yes	Yes			
CA_n71A-257A	-	n71	15	Yes	Yes	Yes	Yes										
			30		Yes	Yes	Yes										
			60														
		n257	60						Yes					Yes	Yes		
			120					Yes				Yes	Yes	Yes			
CA_n77A-257A	CA_n77A-n257A	n77	15		Yes	Yes	Yes	Yes	Yes								
			30		Yes	Yes	Yes	Yes	Yes	Yes	Yes	Yes	Yes				
			60		Yes	Yes	Yes	Yes	Yes	Yes	Yes	Yes	Yes	Yes			
		n257	60						Yes					Yes	Yes		
			120					Yes				Yes	Yes	Yes			
CA_n77A-257D	CA_n77A-n257A	n77	15		Yes	Yes	Yes	Yes	Yes								
			30		Yes	Yes	Yes	Yes	Yes	Yes	Yes	Yes	Yes				
			60		Yes	Yes	Yes	Yes	Yes	Yes	Yes	Yes	Yes	Yes			
		n257		CA_n257D													
CA_n77A-257E	CA_n77A-n257A	n77	15	Yes	Yes	Yes	Yes	Yes	Yes								
			30	Yes	Yes	Yes	Yes	Yes	Yes	Yes	Yes	Yes	Yes				
			60	Yes	Yes	Yes	Yes	Yes	Yes	Yes	Yes	Yes	Yes	Yes			
		n257		CA_n257E													
CA_n77A-257F	CA_n77A-n257A	n77	15		Yes	Yes	Yes	Yes	Yes								
			30		Yes	Yes	Yes	Yes	Yes	Yes	Yes	Yes	Yes	Yes			
			60		Yes	Yes	Yes	Yes	Yes	Yes	Yes	Yes	Yes	Yes	Yes		
		n257		CA_n257F													
CA_n77C-257A	CA_n77A-n257A	n77		CA_n77C													
			60							Yes				Yes	Yes		
			120						Yes				Yes	Yes	Yes		
CA_n77C-257D	CA_n77A-n257A	n77		CA_n77C													
				CA_n257D													
CA_n77C-257E	CA_n77A-n257A	n77		CA_n77C													
				CA_n257E													
CA_n77C-257F	CA_n77A-n257A	n77		CA_n77C													
				CA_n257F													
CA_n78A-257A	CA_n78A-n257A	n78	15		Yes	Yes	Yes	Yes	Yes								
			30		Yes	Yes	Yes	Yes	Yes	Yes	Yes	Yes	Yes				
			60		Yes	Yes	Yes	Yes	Yes	Yes	Yes	Yes	Yes	Yes			
		n257	60							Yes				Yes	Yes		
			120						Yes				Yes	Yes	Yes		
CA_n78A-257D	CA_n78A-n257A	n78	15		Yes	Yes	Yes	Yes	Yes								
			30		Yes	Yes	Yes	Yes	Yes	Yes	Yes	Yes	Yes				
			60		Yes	Yes	Yes	Yes	Yes	Yes	Yes	Yes	Yes	Yes			
		n257		CA_n257D													
CA_n78A-257E	CA_n78A-n257A	n78	15		Yes	Yes	Yes	Yes	Yes								
			30		Yes	Yes	Yes	Yes	Yes	Yes	Yes	Yes	Yes	Yes			
			60		Yes	Yes	Yes	Yes	Yes	Yes	Yes	Yes	Yes	Yes			
		n257		CA_n257E													
CA_n78A-257F	CA_n78A-n257A	n78	15		Yes	Yes	Yes	Yes	Yes								
			30		Yes	Yes	Yes	Yes	Yes	Yes	Yes	Yes	Yes	Yes			
			60		Yes	Yes	Yes	Yes	Yes	Yes	Yes	Yes	Yes	Yes	Yes		
		n257		CA_n257F													
CA_n78C-257A	CA_n78A-n257A	n78		CA_n78C													
			60							Yes					Yes	Yes	

CA configuration	Uplink CA configuration	NR Band	SCS (kHz)	5 MHz	10 MHz	15 MHz	20 MHz	40 MHz	50 MHz	60 MHz	80 MHz	90 MHz	100 MHz	200 MHz	400 MHz	Bandwidth
			120						Yes				Yes	Yes	Yes	
_n78C 257D	CA_n78A -n257A	n78 n257		CA_n78C CA_n257D												
_n78C 257E	CA_n78A -n257A	n78 n257		CA_n78C CA_n257E												
_n78C 257F	CA_n78A -n257A	n78 n257		CA_n78C CA_n257F												
_n79A 257A	CA_n79A -n257A	n79	15					Yes	Yes							
			30					Yes	Yes	Yes	Yes		Yes			
			60					Yes	Yes	Yes	Yes		Yes			
		n257	60						Yes					Yes	Yes	
120							Yes					Yes	Yes	Yes		
_n79A 257D	CA_n79A -n257A	n79	15					Yes	Yes							
			30					Yes	Yes	Yes	Yes		Yes			
			60					Yes	Yes	Yes	Yes		Yes			
		n257		CA_n257D												
_n79A 257E	CA_n79A -n257A	n79	15					Yes	Yes							
			30					Yes	Yes	Yes	Yes		Yes			
			60					Yes	Yes	Yes	Yes		Yes			
		n257		CA_n257E												
_n79A 257F	CA_n79A -n257A	n79	15					Yes	Yes							
			30					Yes	Yes	Yes	Yes		Yes			
			60					Yes	Yes	Yes	Yes		Yes			
		n257		CA_n257F												
_n79C 257A	CA_n79A -n257A	n79	See CA_n79C in Table 5.5A.1-1 in TS 38.101-1													
		n257	60							Yes					Yes	Yes
			120						Yes					Yes	Yes	Yes
_n79C 257D	CA_n79A -n257A	n79 n257		CA_n79C CA_n257D												
_n79C 257E	CA_n79A -n257A	n79 n257		CA_n79C CA_n257E												
_n79C 257F	CA_n79A -n257A	n79 n257		CA_n79C CA_n257F												

TE: The CA configurations are given in Table 5.5A.1-1 of either TS 38.101-1 or TS 38.101-2 where unless otherwise stated BCS0 is referred

5.5B Configuration for DC

5.5B.1 General

The operating bands and bandwidth classes are specified for operation with EN-DC, NGEN-DC, NE-DC or NR-DC configured. The EN-DC, NGEN-DC or NE-DC band combinations include at least one E-UTRA operating band.

For EN-DC or NE-DC configurations indicated by column "Single Uplink allowed" (e.g., problematic band combinations as defined in TS 38.306 [11]) in tables in this clause the UE may indicate capability of not supporting simultaneous dual and triple uplink operation due to possible intermodulation interference to its own primary downlink channel bandwidth of PCell or PSCell if the intermodulation order is 2 or if the intermodulation order is 3 for the combinations when both operating bands are between 450 MHz – 960 MHz or between 1427 MHz – 2690 MHz.

In the case for EN-DC or NE-DC configurations listed in tables in this clause for which the intermodulation products caused by the dual and triple uplink operation fall into the receive band but do not interfere with its own primary downlink channel bandwidth of PCell or PSCell as defined in Annex I the UE is mandated to operate in dual and triple uplink mode. Single Uplink is also allowed for certain band combinations where intermodulation or reverse intermodulation products could create difficulty for meeting emission requirements.

For EN-DC combinations of order 3 or higher, "Single Uplink allowed" UL configurations captured in Table 5.5B.2-1, Table 5.5B.3-1, and Table 5.5B.4-1 apply.

If multiple UL DC configurations are listed for multiple DL DC configurations, valid uplink configurations are such that uplink does not have more carriers than downlink.

Non-contiguous resource allocation and almost contiguous allocation are not applicable for E-UTRA or NR carrier part of intra-band EN-DC configuration.

5.5B.2 Intra-band contiguous EN-DC

Table 5.5B.2-1: Intra-band contiguous EN-DC configurations

EN-DC configuration	Uplink EN-DC configuration (NOTE 1)	Single UL allowed
DC_(n)41AA ⁵ DC_(n)41CA ⁵ DC_(n)41DA ⁵	DC_(n)41AA	Yes ³
DC_(n)41CA ⁵ DC_(n)41DA ⁵	DC_41A_n41A	Yes ³
DC_(n)71AA ²	DC_(n)71AA	No ⁴
NOTE 1: Uplink EN-DC configurations are the configurations supported by the present release of specifications.		
NOTE 2: Requirements in this specification apply for NR SCS of 15 kHz only.		
NOTE 3: Single UL allowed due to potential emission issues, not self-interference.		
NOTE 4: For UE(s) supporting dynamic power sharing it is mandatory to do dual simultaneous UL. For UE(s) not supporting dynamic power sharing single UL is allowed.		
NOTE 5: The minimum requirements only apply for non-simultaneous Tx/Rx between all carriers.		

5.5B.3 Intra-band non-contiguous EN-DC

Table 5.5B.3-1: Intra-band non-contiguous EN-DC configurations

EN-DC configuration	Uplink EN-DC configuration (NOTE 1)	Single UL allowed
DC_3A_n3A	DC_3A_n3A ²	Yes ²
DC_41A_n41A ³ DC_41C_n41A ³ DC_41D_n41A ³	DC_41A_n41A	Yes ⁴
NOTE 1: Uplink EN-DC configurations are the configurations supported by the present release of specifications. NOTE 2: Only single switched UL is supported in Rel.15 NOTE 3: The minimum requirements only apply for non-simultaneous Tx/Rx between all carriers. NOTE 4: Single UL allowed due to potential emission issues, not self-interference.		

5.5B.4 Inter-band EN-DC within FR1

5.5B.4.1 Inter-band EN-DC configurations within FR1 (two bands)

Table 5.5B.4.1-1: Inter-band EN-DC configurations within FR1 (two bands)

EN-DC configuration	Uplink EN-DC configuration (NOTE 1)	Single UL allowed
DC_1A_n28A	DC_1A_n28A	No
DC_1A_n40A	DC_1A_n40A	No
DC_1A_n51A	DC_1A_n51A	No
DC_1A_n77A ⁷ DC_1A_n77C ⁷	DC_1A_n77A	DC_1_n77
DC_1A_n78A ⁷ DC_1A_n78C ⁷	DC_1A_n78A	No
DC_1A_n79A ⁷ DC_1A_n79C ⁷	DC_1A_n79A	No
DC_2A_n5A	DC_2A_n5A	No
DC_2A_n66A	DC_2A_n66A	DC_2_n66
DC_2A_n71A	DC_2A_n71A	No
DC_2A_n78A	DC_2A_n78A	DC_2_n78
DC_3A_n7A	DC_3A_n7A	No
DC_3A_n28A	DC_3A_n28A	No
DC_3A_n40A	DC_3A_n40A	No
DC_3A_n51A	DC_3A_n51A	No
DC_3A_n77A ⁷ DC_3A_n77C ⁷	DC_3A_n77A	DC_3_n77
DC_3A_n78A ⁷ DC_3A_n78C ⁷ DC_3C_n78A ⁷	DC_3A_n78A	DC_3_n78
DC_3A_n79A ⁷ DC_3A_n79C ⁷	DC_3A_n79A	No
DC_5A_n40A	DC_5A_n40A	No
DC_5A_n66A	DC_5A_n66A	DC_5_n66
DC_5A_n78A ⁷	DC_5A_n78A	No
DC_7A-7A_n78A ⁷	DC_7A_n78A	No
DC_7A_n28A	DC_7A_n28A	No
DC_7A_n51A	DC_7A_n51A	No
DC_7A_n78A ⁷	DC_7A_n78A	No

EN-DC configuration	Uplink EN-DC configuration (NOTE 1)	Single UL allowed
DC_7C_n78A ⁷	DC_7A_n78A	No
DC_8A_n40A ⁷	DC_8A_n40A	No
DC_8A_n77A ⁷	DC_8A_n77A	No
DC_8A_n78A ⁷	DC_8A_n78A	No
DC_8A_n79A ⁷	DC_8A_n79A	No
DC_11A_n77A ⁷	DC_11A_n77A	No
DC_11A_n78A ⁷	DC_11A_n78A	No
DC_11A_n79A ⁷	DC_11A_n79A	No
DC_12A_n5A	DC_12A_n5A	No
DC_12A_n66A	DC_12A_n66A	No
DC_18A_n77A ⁷	DC_18A_n77A	No
DC_18A_n78A ⁷	DC_18A_n78A	No
DC_18A_n79A ⁷	DC_18A_n79A	No
DC_19A_n77A ⁷ DC_19A_n77C ⁷	DC_19A_n77A	No
DC_19A_n78A ⁷ DC_19A_n78C ⁷	DC_19A_n78A	No
DC_19A_n79A ⁷ DC_19A_n79C ⁷	DC_19A_n79A	No
DC_20A_n8A	DC_20A_n8A	DC_20_n8
DC_20A_n28A ^{8,10,11}	DC_20A_n28A	No
DC_20A_n51A	DC_20A_n51A	No
DC_20A_n77A ⁷	DC_20A_n77A	No
DC_20A_n78A ⁷	DC_20A_n78A	No
DC_21A_n77A ⁷ DC_21A_n77C ⁷	DC_21A_n77A	No
DC_21A_n78A ⁷ DC_21A_n78C ⁷	DC_21A_n78A	No
DC_21A_n79A ⁷ DC_21A_n79C ⁷	DC_21A_n79A	No
DC_25A_n41A	DC_25A_n41A	No
DC_26A_n41A	DC_26A_n41A	No
DC_26A_n77A ⁷	DC_26A_n77A	No
DC_26A_n78A ⁷	DC_26A_n78A	No
DC_26A_n79A ⁷	DC_26A_n79A	No
DC_28A_n51A	DC_28A_n51A	No
DC_28A_n77A ⁷ DC_28A_n77C ⁷	DC_28A_n77A	No
DC_28A_n78A ⁷ DC_28A_n78C ⁷	DC_28A_n78A	No
DC_28A_n79A ⁷ DC_28A_n79C ⁷	DC_28A_n79A	No
DC_30A_n5A	DC_30A_n5A	No
DC_30A_n66A	DC_30A_n66A	No
DC_38A_n78A ⁷	DC_38A_n78A	No
DC_39A_n78A ^{5,7}	DC_39A_n78A	No
DC_39A_n79A ⁷	DC_39A_n79A	No
DC_40A_n77A	DC_40A_n77A	No
DC_41A_n77A DC_41C_n77A	DC_41A_n77A	No
DC_41A_n78A DC_41C_n78A	DC_41A_n78A	No

EN-DC configuration	Uplink EN-DC configuration (NOTE 1)	Single UL allowed
DC_41A_n79A ^{6,7} DC_41C_n79A ^{6,7}	DC_41A_n79A	No
DC_42A_n51A	DC_42A_n51A	No
DC_42A_n77A ^{3,4,9} DC_42A_n77C ^{3,4,9} DC_42C_n77A ^{3,4,9} DC_42C_n77C ^{3,4,9} DC_42D_n77A ^{3,4,9} DC_42E_n77A ^{3,4,9}	N/A	N/A
DC_42A_n78A ^{3,4,9} DC_42A_n78C ^{3,4,9} DC_42C_n78A ^{3,4,9} DC_42C_n78C ^{3,4,9} DC_42D_n78A ^{3,4,9} DC_42E_n78A ^{3,4,9}	N/A	N/A
DC_42A_n79A ⁹ DC_42A_n79C ⁹ DC_42C_n79A ⁹ DC_42C_n79C ⁹ DC_42D_n79A ⁹ DC_42E_n79A ⁹	N/A	N/A
DC_46A_n78A ² DC_46C_n78A ² DC_46D_n78A ² DC_46E_n78A ²	N/A	N/A
DC_66A_n5A	DC_66A_n5A	DC_66_n5
DC_66A_n71A	DC_66A_n71A	No
DC_66A_n78A	DC_66A_n78A	No
<p>NOTE 1: Uplink EN-DC configurations are the configurations supported by the present release of specifications.</p> <p>NOTE 2: Restricted to E-UTRA operation when inter-band carrier aggregation is configured. The downlink operating band for Band 46 is paired with the uplink operating band (external E-UTRA band) of the carrier aggregation configuration that is supporting the configured Pcell.</p> <p>NOTE 3: The minimum requirements apply only when there is non-simultaneous Tx/Rx operation between E-UTRA and NR carriers. This restriction applies also for these carriers when applicable EN-DC configuration is part of a higher order EN-DC configuration.</p> <p>NOTE 4: The minimum requirements for intra-band contiguous or non-contiguous EN-DC apply. The intra-band requirements also apply for these carriers when applicable EN-DC configuration is a subset of a higher order EN-DC configuration.</p> <p>NOTE 5: The frequency range above 3600 MHz for Band n78 is not used in this combination.</p> <p>NOTE 6: The frequency range below 2506 MHz for Band 41 is not used in this combination.</p> <p>NOTE 7: Applicable for UE supporting inter-band EN-DC with mandatory simultaneous Rx/Tx capability.</p> <p>NOTE 8: The frequency range in band n28 is restricted for this band combination to 703 - 733 MHz for the UL and 758-788 MHz for the DL.</p> <p>NOTE 9: The combination is not used alone as fall back mode of other band combinations in which UL in Band 42 is not used.</p> <p>NOTE 10: The maximum power spectral density imbalance between downlink carriers is within 6 dB. The power spectral density imbalance condition also applies for these carriers when applicable EN-DC configuration is a subset of a higher order EN-DC configuration</p> <p>NOTE 11: The minimum requirements apply for synchronized DL carriers with a maximum receive time difference ≤ 3 usec. The requirements also apply for these carriers when applicable EN-DC configuration is a subset of a higher order EN-DC configuration</p>		

5.5B.4.2 Inter-band EN-DC configurations within FR1 (three bands)

Table 5.5B.4.2-1: Inter-band EN-DC configurations within FR1 (three bands)

EN-DC configuration	Uplink EN-DC configuration (NOTE 1)
DC_1A-3A_n28A	DC_1A_n28A DC_3A_n28A
DC_1A-3A_n77A ⁵ DC_1A-3A_n77C ⁵	DC_1A_n77A DC_3A_n77A
DC_1A-3A_n78A ⁵ DC_1A-3A_n78C ⁵ DC_1A-3C_n78A ⁵	DC_1A_n78A DC_3A_n78A
DC_1A-3A_n79A ⁵ DC_1A-3A_n79C ⁵	DC_1A_n79A DC_3A_n79A
DC_1A-5A_n78A ⁵	DC_1A_n78A DC_5A_n78A
DC_1A-7A_n28A ⁵	DC_1A_n28A DC_7A_n28A
DC_1A-7A_n78A ⁵	DC_1A_n78A DC_7A_n78A
DC_1A-7A-7A_n78A ⁵	DC_1A_n78A DC_7A_n78A
DC_1A-8A_n78A ⁵	DC_1A_n78A DC_8A_n78A
DC_1A-18A_n77A ⁵	DC_1A_n77A DC_18A_n77A
DC_1A-18A_n78A ⁵	DC_1A_n78A DC_18A_n78A
DC_1A-18A_n79A	DC_1A_n79A DC_18A_n79A
DC_1A-19A_n77A ⁵ DC_1A-19A_n77C ⁵	DC_1A_n77A DC_19A_n77A
DC_1A-19A_n78A ⁵ DC_1A-19A_n78C ⁵	DC_1A_n78A DC_19A_n78A
DC_1A-19A_n79A ⁵ DC_1A-19A_n79C ⁵	DC_1A_n79A DC_19A_n79A
DC_1A-20A_n28A ⁶	DC_1A_n28A DC_20A_n28A
DC_1A-20A_n78A ⁵	DC_1A_n78A DC_20A_n78A
DC_1A-21A_n77A ⁵ DC_1A-21A_n77C ⁵	DC_1A_n77A DC_21A_n77A
DC_1A-21A_n78A ⁵ DC_1A-21A_n78C ⁵	DC_1A_n78A DC_21A_n78A
DC_1A-21A_n79A ⁵ DC_1A-21A_n79C ⁵	DC_1A_n79A DC_21A_n79A
DC_1A-28A_n77A ⁵ DC_1A-28A_n77C ⁵	DC_1A_n77A DC_28A_n77A
DC_1A-28A_n78A ⁵ DC_1A-28A_n78C ⁵	DC_1A_n78A DC_28A_n78A
DC_1A_n28A-n78A ⁵	DC_1A_n28A DC_1A_n78A
DC_1A-28A_n79A DC_1A-28A_n79C	DC_1A_n79A DC_28A_n79A
DC_1A-41A_n77A DC_1A-41C_n77A	DC_1A_n77A DC_41A_n77A
DC_1A-41A_n78A DC_1A-41C_n78A	DC_1A_n78A DC_41A_n78A
DC_1A-41C_n79A	DC_1A_n79A
DC_1A-42A_n77A DC_1A-42A_n77C DC_1A-42C_n77A	DC_1A_n77A

EN-DC configuration	Uplink EN-DC configuration (NOTE 1)
DC_1A-42C_n77C DC_1A-42D_n77A DC_1A-42E_n77A	
DC_1A-42A_n78A DC_1A-42A_n78C DC_1A-42C_n78A DC_1A-42C_n78C DC_1A-42D_n78A DC_1A-42E_n78A	DC_1A_n78A
DC_1A-42A_n79A DC_1A-42A_n79C DC_1A-42C_n79A DC_1A-42C_n79C DC_1A-42D_n79A DC_1A-42E_n79A	DC_1A_n79A
DC_1A_n77A-n79A	DC_1A_n77A DC_1A_n79A
DC_1A_n78A-n79A	DC_1A_n78A DC_1A_n79A
DC_1A_SUL_n78A-n84A ⁵	DC_1A_n78A, DC_1A_n84A_ULSUP-TDM_n78A,
DC_2A-5A_n66A	DC_2A_n66A DC_5A_n66A
DC_2A-12A_n66A	DC_2A_n66A DC_12A_n66A
DC_2A-30A_n66A	DC_2A_n66A DC_30A_n66A
DC_2A-66A_n71A	DC_2A_n71A DC_66A_n71A
DC_2A-(n)71AA	DC_2A_n71A DC_(n)71AA
DC_3A_n3A-n77A	DC_3A_n77A DC_3A_n3A ²
DC_3A_n3A-n78A	DC_3A_n78A DC_3A_n3A ²
DC_3A-5A_n78A ⁵	DC_3A_n78A DC_5A_n78A
DC_3A-7A_n28A	DC_3A_n28A DC_7A_n28A
DC_3A-7A_n78A ⁵ DC_3C-7A_n78A ⁵	DC_3A_n78A DC_7A_n78A
DC_3A-7C_n78A ⁵ DC_3C-7C_n78A ⁵	DC_3A_n78A DC_7A_n78A
DC_3A-7A-7A_n78A ⁵	DC_3A_n78A DC_7A_n78A
DC_3A-8A_n78A	DC_3A_n78A DC_8A_n78A
DC_3A-19A_n77A ⁵ DC_3A-19A_n77C ⁵	DC_3A_n77A DC_19A_n77A
DC_3A-19A_n78A ⁵ DC_3A-19A_n78C ⁵	DC_3A_n78A DC_19A_n78A
DC_3A-19A_n79A ⁵ DC_3A-19A_n79C ⁵	DC_3A_n79A DC_19A_n79A
DC_3A-20A_n28A ^{5,6}	DC_3A_n28A DC_20A_n28A
DC_3A-20A_n78A ⁵ DC_3C-20A_n78A ⁵	DC_3A_n78A DC_20A_n78A
DC_3A-21A_n77A ⁵ DC_3A-21A_n77C ⁵	DC_3A_n77A DC_21A_n77A
DC_3A-21A_n78A ⁵ DC_3A-21A_n78C ⁵	DC_3A_n78A DC_21A_n78A
DC_3A-21A_n79A ⁵ DC_3A-21A_n79C ⁵	DC_3A_n79A DC_21A_n79A

EN-DC configuration	Uplink EN-DC configuration (NOTE 1)
DC_3A-28A_n77A DC_3A-28A_n77C	DC_3A_n77A DC_28A_n77A
DC_3A-28A_n78A ⁵ DC_3A-28A_n78C ⁵	DC_3A_n78A DC_28A_n78A
DC_3A_n28A-n78A ⁵	DC_3A_n28A DC_3A_n78A
DC_3A-28A_n79A DC_3A-28A_n79C	DC_3A_n79A DC_28A_n79A
DC_3A-38A_n78A	DC_3A_n78A
DC_3A-41A_n78A	DC_3A_n78A DC_41A_n78A
DC_3A-42A_n77A DC_3A-42A_n77C DC_3A-42C_n77A DC_3A-42C_n77C DC_3A-42D_n77A DC_3A-42E_n77A	DC_3A_n77A
DC_3A-42A_n78A DC_3A-42A_n78C DC_3A-42C_n78A DC_3A-42C_n78C DC_3A-42D_n78A DC_3A-42E_n78A	DC_3A_n78A
DC_3A-42A_n79A DC_3A-42A_n79C DC_3A-42C_n79A DC_3A-42C_n79C DC_3A-42D_n79A DC_3A-42E_n79A	DC_3A_n79A
DC_3A_n77A-n79A	DC_3A_n77A DC_3A_n79A
DC_3A_n78A-n79A	DC_3A_n78A DC_3A_n79A
DC_3A_SUL_n78A-n80A ⁵	DC_3A_n78A DC_3A_n80A_ULSUP-TDM_n78A
DC_3A_SUL_n78A-n82A ⁵	DC_3A_n78A DC_3A_n82A
DC_3A_SUL_n79A-n80A ⁵	DC_3A_n79A, DC_3A_n80A_ULSUP-TDM_n79A
DC_5A-7A_n78A	DC_5A_n78A DC_7A_n78A
DC_5A-7A-7A_n78A	DC_5A_n78A DC_7A_n78A
DC_5A-30A_n66A	DC_5A_n66A DC_30A_n66A
DC_7A-20A_n28A ⁶	DC_7A_n28A DC_20A_n28A
DC_7A-20A_n78A ⁵	DC_7A_n78A DC_20A_n78A
DC_7A-28A_n78A ⁵	DC_7A_n78A DC_28A_n78A
DC_7C-28A_n78A ⁵	DC_7A_n78A DC_28A_n78A
DC_7A_n28A-n78A ⁵	DC_7A_n28A, DC_7A_n78A
DC_7A-46A_n78A ³ DC_7A-46C_n78A ³ DC_7A-46D_n78A ³ DC_7A-46E_n78A ³	DC_7A_n78A
DC_8A_SUL_n78A-n81A ⁵	DC_8A_n78A, DC_8A_n81A_ULSUP-TDM_n78A,

EN-DC configuration	Uplink EN-DC configuration (NOTE 1)
DC_8A_SUL_n79A-n81A ⁵	DC_8A_n79A, DC_8A_n81A_ULSUP-TDM_n79A,
DC_12A-30A_n66A	DC_12A_n66A DC_30A_n66A
DC_18A-28A_n77A ⁵	DC_18A_n77A DC_28A_n77A
DC_18A-28A_n78A ⁵	DC_18A_n78A DC_28A_n78A
DC_18A-28A_n79A ⁵	DC_18A_n79A DC_28A_n79A
DC_19A-21A_n78A ⁵ DC_19A-21A_n78C ⁵	DC_19A_n78A DC_21A_n78A
DC_19A-21A_n79A ⁵ DC_19A-21A_n79C ⁵	DC_19A_n79A DC_21A_n79A
DC_19A-21A_n77A ⁵ DC_19A-21A_n77C ⁵	DC_19A_n77A DC_21A_n77A
DC_19A-42A_n77A DC_19A-42A_n77C DC_19A-42C_n77A DC_19A-42C_n77C	DC_19A_n77A
DC_19A-42A_n78A DC_19A-42A_n78C DC_19A-42C_n78A DC_19A-42C_n78C	DC_19A_n78A
DC_19A-42A_n79A DC_19A-42A_n79C DC_19A-42C_n79A DC_19A-42C_n79C	DC_19A_n79A
DC_19A_n77A-n79A	DC_19A_n77A DC_19A_n79A
DC_19A_n78A-n79A	DC_19A_n78A DC_19A_n79A
DC_20A_n8A-n75A ⁶	DC_20A_n8A
DC_20A_n28A-n75A ⁶	DC_20A_n28A
DC_20A_n28A-n78A ^{5,6}	DC_20A_n28A DC_20A_n78A
DC_20A_n75A-n78A ⁵	DC_20A_n78A
DC_20A_n76A-n78A ⁵	DC_20A_n78A
DC_20A_SUL_n78A-n82A ⁵	DC_20A_n78A DC_20A_n82A_ULSUP-TDM_n78A
DC_20A_SUL_n78A-n83A ⁵	DC_20A_n78A DC_20A_n83A
DC_21A-28A_n77A DC_21A-28A_n77C	DC_21A_n77A DC_28A_n77A
DC_21A-28A_n78A DC_21A-28A_n78C	DC_21A_n78A DC_28A_n78A
DC_21A-28A_n79A DC_21A-28A_n79C	DC_21A_n79A DC_28A_n79A
DC_21A-42A_n77A DC_21A-42A_n77C DC_21A-42C_n77A DC_21A-42C_n77C	DC_21A_n77A
DC_21A-42A_n78A DC_21A-42A_n78C DC_21A-42C_n78A DC_21A-42C_n78C	DC_21A_n78A

EN-DC configuration	Uplink EN-DC configuration (NOTE 1)
DC_21A-42A_n79A DC_21A-42A_n79C DC_21A-42C_n79A DC_21A-42C_n79C	DC_21A_n79A
DC_21A_n77A-n79A	DC_21A_n77A DC_21A_n79A
DC_21A_n78A-n79A	DC_21A_n78A DC_21A_n79A
DC_28A-42A_n77A DC_28A-42A_n77C DC_28A-42C_n77A	DC_28A_n77A
DC_28A-42A_n78A DC_28A-42A_n78C DC_28A-42C_n78A	DC_28A_n78A
DC_28A-42A_n79A DC_28A-42A_n79C DC_28A-42C_n79A	DC_28A_n79A
DC_28A_SUL_n78A-n83A ⁵	DC_28A_n78A, DC_28A_n83A_ULSUP-TDM_n78A,
DC_41A-42A_n77A DC_41A-42C_n77A DC_41C-42A_n77A DC_41C-42C_n77A	DC_41A_n77A
DC_41A-42A_n78A DC_41A-42C_n78A DC_41C-42A_n78A DC_41C-42C_n78A	DC_41A_n78A
DC_41A-42A_n79A DC_41A-42C_n79A DC_41C-42A_n79A DC_41C-42C_n79A	DC_41A_n79A
DC_66A_(n)71AA	DC_66A_n71A DC_(n)71AA
DC_66A_SUL_n78A-n86A ⁵	DC_66A_n78A DC_66A_n86A_ULSUP-TDM_n78A
<p>NOTE 1: Uplink EN-DC configurations are the configurations supported by the present release of specifications.</p> <p>NOTE 2: Only single switched UL is supported in Rel-15</p> <p>NOTE 3: Restricted to E-UTRA operation when inter-band carrier aggregation is configured. The downlink operating band for Band 46 is paired with the uplink operating band (external E-UTRA band) of the carrier aggregation configuration that is supporting the configured Pcell.</p> <p>NOTE 4: If a UE is configured with both NR UL and NR SUL carriers in a cell, the switching time between NR UL carrier and NR SUL carrier can be up to 140us and placed in SUL resources.</p> <p>NOTE 5: Applicable for UE supporting inter-band EN-DC with mandatory simultaneous Rx/Tx capability</p> <p>NOTE 6: The frequency range in band n28 is restricted for this band combination to 703-733 MHz for the UL and 758-788 MHz for the DL.</p>	

5.5B.4.3 Inter-band EN-DC configurations within FR1 (four bands)

Table 5.5B.4.3-1: Inter-band EN-DC configurations within FR1 (four bands)

EN-DC configuration	Uplink EN-DC configuration (NOTE 1)
DC_1A-3A-5A_n78A ²	DC_1A_n78A DC_3A_n78A DC_5A_n78A
DC_1A-3A-7A_n28A	DC_1A_n28A DC_3A_n28A

EN-DC configuration	Uplink EN-DC configuration (NOTE 1)
	DC_7A_n28A
DC_1A-3A-7A_n78A ² DC_1A-3C-7A_n78A ²	DC_1A_n78A DC_3A_n78A DC_7A_n78A
DC_1A-3A-7A-7A_n78A ²	DC_1A_n78A DC_3A_n78A DC_7A_n78A
DC_1A-3A-8A_n78A ²	DC_1A_n78A DC_3A_n78A DC_8A_n78A
DC_1A-3A-19A_n77A ² DC_1A-3A-19A_n77C ²	DC_1A_n77A DC_3A_n77A DC_19A_n77A
DC_1A-3A-19A_n78A ² DC_1A-3A-19A_n78C ²	DC_1A_n78A DC_3A_n78A DC_19A_n78A
DC_1A-3A-19A_n79A ² DC_1A-3A-19A_n79C ²	DC_1A_n79A DC_3A_n79A DC_19A_n79A
DC_1A-3A-20A_n28A ³	DC_1A_n28A DC_3A_n28A DC_20A_n28A
DC_1A-3A-20A_n78A ²	DC_1A_n78A DC_3A_n78A DC_20A_n78A
DC_1A-3A-21A_n77A ² DC_1A-3A-21A_n77C ²	DC_1A_n77A DC_3A_n77A DC_21A_n77A
DC_1A-3A-21A_n78A ² DC_1A-3A-21A_n78C ²	DC_1A_n78A DC_3A_n78A DC_21A_n78A
DC_1A-3A-21A_n79A ² DC_1A-3A-21A_n79C ²	DC_1A_n79A DC_3A_n79A DC_21A_n79A
DC_1A-3A-28A_n77A ²	DC_1A_n77A DC_3A_n77A DC_28A_n77A
DC_1A-3A-28A_n78A ²	DC_1A_n78A DC_3A_n78A DC_28A_n78A
DC_1A-3A-28A_n79A ²	DC_1A_n79A DC_3A_n79A DC_28A_n79A
DC_1A-3A_n28A-n78A ²	DC_1A_n28A DC_1A_n78A DC_3A_n28A DC_3A_n78A
DC_1A-3A-42A_n77A DC_1A-3A-42A_n77C DC_1A-3A-42C_n77A DC_1A-3A-42C_n77C	DC_1A_n77A DC_3A_n77A
DC_1A-3A-42A_n78A DC_1A-3A-42A_n78C DC_1A-3A-42C_n78A DC_1A-3A-42C_n78C	DC_1A_n78A DC_3A_n78A
DC_1A-3A-42A_n79A DC_1A-3A-42A_n79C DC_1A-3A-42C_n79A DC_1A-3A-42C_n79C	DC_1A_n79A DC_3A_n79A
DC_1A-5A-7A_n78A	DC_1A_n78A DC_5A_n78A DC_7A_n78A
DC_1A-5A-7A-7A_n78A	DC_1A_n78A DC_5A_n78A

EN-DC configuration	Uplink EN-DC configuration (NOTE 1)
	DC_7A_n78A
DC_1A-7A-20A_n28A ³	DC_1A_n28A DC_7A_n28A DC_20A_n28A
DC_1A-7A-20A_n78A ²	DC_1A_n78A DC_7A_n78A DC_20A_n78A
DC_1A-7A_n28A-n78A ²	DC_1A_n28A DC_1A_n78A DC_7A_n28A DC_7A_n78A
DC_1A-18A-28A_n77A	DC_1A_n77A DC_18A_n77A DC_28A_n77A
DC_1A-18A-28A_n78A	DC_1A_n78A DC_18A_n78A DC_28A_n78A
DC_1A-18A-28A_n79A ²	DC_1A_n79A DC_18A_n79A DC_28A_n79A
DC_1A-19A-21A_n77A DC_1A-19A-21A_n77C	DC_1A_n77A DC_19A_n77A DC_21A_n77A
DC_1A-19A-21A_n78A DC_1A-19A-21A_n78C	DC_1A_n78A DC_19A_n78A DC_21A_n78A
DC_1A-19A-21A_n79A DC_1A-19A-21A_n79C	DC_1A_n79A DC_19A_n79A DC_21A_n79A
DC_1A-19A-42A_n77A DC_1A-19A-42A_n77C DC_1A-19A-42C_n77A DC_1A-19A-42C_n77C	DC_1A_n77A DC_19A_n77A
DC_1A-19A-42A_n78A DC_1A-19A-42A_n78C DC_1A-19A-42C_n78A DC_1A-19A-42C_n78C	DC_1A_n78A DC_19A_n78A
DC_1A-19A-42A_n79A DC_1A-19A-42A_n79C DC_1A-19A-42C_n79A DC_1A-19A-42C_n79C	DC_1A_n79A DC_19A_n79A
DC_1A-20A_n28A-n78A ^{2,3}	DC_1A_n28A DC_1A_n78A DC_20A_n28A DC_20A_n78A
DC_1A-21A-28A_n77A ²	DC_1A_n77A DC_21A_n77A DC_28A_n77A
DC_1A-21A-28A_n78A ²	DC_1A_n78A DC_21A_n78A DC_28A_n78A
DC_1A-21A-28A_n79A ²	DC_1A_n79A DC_21A_n79A DC_28A_n79A
DC_1A-21A-42A_n77A DC_1A-21A-42A_n77C DC_1A-21A-42C_n77A DC_1A-21A-42C_n77C	DC_1A_n77A DC_21A_n77A
DC_1A-21A-42A_n78A DC_1A-21A-42A_n78C DC_1A-21A-42C_n78A DC_1A-21A-42C_n78C	DC_1A_n78A DC_21A_n78A
DC_1A-21A-42A_n79A DC_1A-21A-42A_n79C	DC_1A_n79A DC_21A_n79A

EN-DC configuration	Uplink EN-DC configuration (NOTE 1)
DC_1A-21A-42C_n79A DC_1A-21A-42C_n79C	
DC_1A-28A-42A_n77A DC_1A-28A-42C_n77A	DC_1A_n77A DC_28A_n77A
DC_1A-28A-42A_n78A DC_1A-28A-42C_n78A	DC_1A_n78A DC_28A_n78A
DC_1A-28A-42A_n79A DC_1A-28A-42C_n79A	DC_1A_n79A DC_28A_n79A
DC_1A-41A-42A_n77A DC_1A-41A-42C_n77A DC_1A-41C-42A_n77A DC_1A-41C-42C_n77A	DC_1A_n77A DC_41A_n77A
DC_1A-41A-42A_n78A DC_1A-41A-42C_n78A DC_1A-41C-42A_n78A DC_1A-41C-42C_n78A	DC_1A_n78A DC_41A_n78A
DC_1A-41A-42A_n79A DC_1A-41A-42C_n79A DC_1A-41C-42A_n79A DC_1A-41C-42C_n79A	DC_1A_n79A DC_41A_n79A
DC_2A-66A-(n)71AA	DC_2A_n71A DC_66A_n71A DC_(n)71AA
DC_3A-5A-7A_n78A	DC_3A_n78A DC_5A_n78A DC_7A_n78A
DC_3A-5A-7A-7A_n78A	DC_3A_n78A DC_5A_n78A DC_7A_n78A
DC_3A-7A-20A_n28A ³	DC_3A_n28A DC_7A_n28A DC_20A_n28A
DC_3A-7A-20A_n78A ²	DC_3A_n78A DC_20A_n78A DC_7A_n78A
DC_3A-7A-28A_n78A ² DC_3A-7C-28A_n78A ²	DC_3A_n78A DC_7A_n78A DC_28A_n78A
DC_3A-7A_n28A-n78A ²	DC_3A_n28A DC_3A_n78A DC_7A_n28A DC_7A_n78A
DC_3A-19A-21A_n77A ² DC_3A-19A-21A_n77C ²	DC_3A_n77A DC_19A_n77A DC_21A_n77A
DC_3A-19A-21A_n78A ² DC_3A-19A-21A_n78C ²	DC_3A_n78A DC_19A_n78A DC_21A_n78A
DC_3A-19A-21A_n79A ² DC_3A-19A-21A_n79C ²	DC_3A_n79A DC_19A_n79A DC_21A_n79A
DC_3A-19A-42A_n77A DC_3A-19A-42A_n77C DC_3A-19A-42C_n77A DC_3A-19A-42C_n77C	DC_3A_n77A DC_19A_n77A
DC_3A-19A-42A_n78A DC_3A-19A-42A_n78C DC_3A-19A-42C_n78A DC_3A-19A-42C_n78C	DC_3A_n78A DC_19A_n78A
DC_3A-19A-42A_n79A ² DC_3A-19A-42A_n79C ² DC_3A-19A-42C_n79A ² DC_3A-19A-42C_n79C ²	DC_3A_n79A DC_19A_n79A
DC_3A-20A_n28A-n78A ^{2,3}	DC_3A_n28A

EN-DC configuration	Uplink EN-DC configuration (NOTE 1)
	DC_3A_n78A DC_20A_n28A DC_20A_n78A
DC_3A-21A-42A_n77A DC_3A-21A-42A_n77C DC_3A-21A-42C_n77A DC_3A-21A-42C_n77C	DC_3A_n77A DC_21A_n77A
DC_3A-21A-42A_n78A DC_3A-21A-42A_n78C DC_3A-21A-42C_n78A DC_3A-21A-42C_n78C	DC_3A_n78A DC_21A_n78A
DC_3A-21A-42A_n79A DC_3A-21A-42A_n79C DC_3A-21A-42C_n79A DC_3A-21A-42C_n79C	DC_3A_n79A DC_21A_n79A
DC_3A-28A-42A_n77A DC_3A-28A-42C_n77A	DC_3A_n77A DC_28A_n77A
DC_3A-28A-42A_n78A DC_3A-28A-42C_n78A	DC_3A_n78A DC_28A_n78A
DC_3A-28A-42A_n79A DC_3A-28A-42C_n79A	DC_3A_n79A DC_28A_n79A
DC_7A-20A_n28A-n78A ^{2,3}	DC_7A_n28A DC_7A_n78A DC_20A_n28A DC_20A_n78A
DC_19A-21A-42A_n77A DC_19A-21A-42A_n77C DC_19A-21A-42C_n77A DC_19A-21A-42C_n77C	DC_19A_n77A DC_21A_n77A
DC_19A-21A-42A_n78A DC_19A-21A-42A_n78C DC_19A-21A-42C_n78A DC_19A-21A-42C_n78C	DC_19A_n78A DC_21A_n78A
DC_19A-21A-42A_n79A DC_19A-21A-42A_n79C DC_19A-21A-42C_n79A DC_19A-21A-42C_n79C	DC_19A_n79A DC_21A_n79A
DC_21A-28A-42A_n77A DC_21A-28A-42C_n77A	DC_21A_n77A DC_28A_n77A
DC_21A-28A-42A_n78A DC_21A-28A-42C_n78A	DC_21A_n78A DC_28A_n78A
DC_21A-28A-42A_n79A DC_21A-28A-42C_n79A	DC_21A_n79A DC_28A_n79A
NOTE 1: Uplink EN-DC configurations are the configurations supported by the present release of specifications.	
NOTE 2: Applicable for UE supporting inter-band EN-DC with mandatory simultaneous Rx/Tx capability	
NOTE 3: The frequency range in band n28 is restricted for this band combination to 703-733 MHz for the UL and 758-788 MHz for the DL.	

5.5B.4.4 Inter-band EN-DC configurations within FR1 (five bands)

Table 5.5B.4.4-1: Inter-band EN-DC configurations within FR1 (five bands)

EN-DC configuration	Uplink EN-DC configuration (NOTE 1)
DC_1A-3A-5A-7A_n78A	DC_1A_n78A DC_3A_n78A DC_5A_n78A DC_7A_n78A
DC_1A-3A-5A-7A-7A_n78A	DC_1A_n78A

EN-DC configuration	Uplink EN-DC configuration (NOTE 1)
	DC_3A_n78A DC_5A_n78A DC_7A_n78A
DC_1A-3A-7A-20A_n28A ³	DC_1A_n28A DC_3A_n28A DC_7A_n28A DC_20A_n28A
DC_1A-3A-7A-20A_n78A ²	DC_1A_n78A DC_3A_n78A DC_7A_n78A DC_20A_n78A
DC_1A-3A-7A_n28A-n78A ²	DC_1A_n28A DC_1A_n78A DC_3A_n28A DC_3A_n78A DC_7A_n28A DC_7A_n78A
DC_1A-3A-19A-21A_n77A ² DC_1A-3A-19A-21A_n77C ²	DC_1A_n77A DC_3A_n77A DC_19A_n77A DC_21A_n77A
DC_1A-3A-19A-21A_n78A ² DC_1A-3A-19A-21A_n78C ²	DC_1A_n78A DC_3A_n78A DC_19A_n78A DC_21A_n78A
DC_1A-3A-19A-21A_n79A ² DC_1A-3A-19A-21A_n79C ²	DC_1A_n79A DC_3A_n79A DC_19A_n79A DC_21A_n79A
DC_1A-3A-19A-42A_n77A DC_1A-3A-19A-42A_n77C DC_1A-3A-19A-42C_n77A DC_1A-3A-19A-42C_n77C	DC_1A_n77A DC_3A_n77A DC_19A_n77A
DC_1A-3A-19A-42A_n78A DC_1A-3A-19A-42A_n78C DC_1A-3A-19A-42C_n78A DC_1A-3A-19A-42C_n78C	DC_1A_n78A DC_3A_n78A DC_19A_n78A
DC_1A-3A-19A-42A_n79A DC_1A-3A-19A-42A_n79C DC_1A-3A-19A-42C_n79A DC_1A-3A-19A-42C_n79C	DC_1A_n79A DC_3A_n79A DC_19A_n79A
DC_1A-3A-20A_n28A-n78A ^{2,3}	DC_1A_n28A DC_1A_n78A DC_3A_n28A DC_3A_n78A DC_20A_n28A DC_20A_n78A
DC_1A-3A-21A-42A_n77A DC_1A-3A-21A-42A_n77C DC_1A-3A-21A-42C_n77A DC_1A-3A-21A-42C_n77C	DC_1A_n77A DC_3A_n77A DC_21A_n77A
DC_1A-3A-21A-42A_n78A DC_1A-3A-21A-42A_n78C DC_1A-3A-21A-42C_n78A DC_1A-3A-21A-42C_n78C	DC_1A_n78A DC_3A_n78A DC_21A_n78A
DC_1A-3A-21A-42A_n79A DC_1A-3A-21A-42A_n79C DC_1A-3A-21A-42C_n79A DC_1A-3A-21A-42C_n79C	DC_1A_n79A DC_3A_n79A DC_21A_n79A
DC_1A-3A-28A-42A_n77A DC_1A-3A-28A-42C_n77A	DC_1A_n77A DC_3A_n77A DC_28A_n77A
DC_1A-3A-28A-42A_n78A DC_1A-3A-28A-42C_n78A	DC_1A_n78A DC_3A_n78A DC_28A_n78A

EN-DC configuration	Uplink EN-DC configuration (NOTE 1)
DC_1A-3A-28A-42A_n79A DC_1A-3A-28A-42C_n79A	DC_1A_n79A DC_3A_n79A DC_28A_n79A
DC_1A-7A-20A_n28A-n78A ^{2,3}	DC_1A_n28A DC_1A_n78A DC_7A_n28A DC_7A_n78A DC_20A_n28A DC_20A_n78A
DC_1A-19A-21A-42A_n77A DC_1A-19A-21A-42A_n77C DC_1A-19A-21A-42C_n77A DC_1A-19A-21A-42C_n77C	DC_1A_n77A DC_19A_n77A DC_21A_n77A
DC_1A-19A-21A-42A_n78A DC_1A-19A-21A-42A_n78C DC_1A-19A-21A-42C_n78A DC_1A-19A-21A-42C_n78C	DC_1A_n78A DC_19A_n78A DC_21A_n78A
DC_1A-19A-21A-42A_n79A DC_1A-19A-21A-42A_n79C DC_1A-19A-21A-42C_n79A DC_1A-19A-21A-42C_n79C	DC_1A_n79A DC_19A_n79A DC_21A_n79A
DC_1A-21A-28A-42A_n77A DC_1A-21A-28A-42C_n77A	DC_1A_n77A DC_21A_n77A DC_28A_n77A
DC_1A-21A-28A-42A_n78A DC_1A-21A-28A-42C_n78A	DC_1A_n78A DC_21A_n78A DC_28A_n78A
DC_1A-21A-28A-42A_n79A DC_1A-21A-28A-42C_n79A	DC_1A_n79A DC_21A_n79A DC_28A_n79A
DC_3A-7A-20A_n28A-n78A ^{2,3}	DC_3A_n28A DC_3A_n78A DC_7A_n28A DC_7A_n78A DC_20A_n28A DC_20A_n78A
<p>NOTE 1: Uplink EN-DC configurations are the configurations supported by the present release of specifications.</p> <p>NOTE 2: Applicable for UE supporting inter-band EN-DC with mandatory simultaneous Rx/Tx capability</p> <p>NOTE 3: The frequency range in band n28 is restricted for this band combination to 703-733 MHz for the UL and 758-788 MHz for the DL</p>	

5.5B.4.5 Inter-band EN-DC configurations within FR1 (six bands)

Table 5.5B.4.5-1: Inter-band EN-DC configurations within FR1 (six bands)

EN-DC configuration	Uplink EN-DC configuration (NOTE 1)
DC_1A-3A-7A-20A_n28A-n78A ^{2,3}	DC_1A_n28A DC_1A_n78A DC_3A_n28A DC_3A_n78A DC_7A_n28A DC_7A_n78A DC_20A_n28A DC_20A_n78A
NOTE 1: Uplink EN-DC configurations are the configurations supported by the present release of specifications.	
NOTE 2: Applicable for UE supporting inter-band EN-DC with mandatory simultaneous Rx/Tx capability	
NOTE 3: The frequency range in band n28 is restricted for this band combination to 703-733 MHz for the UL and 758-788 MHz for the DL	

5.5B.4a Inter-band NE-DC within FR1

5.5B.4a.1 Inter-band NE-DC configurations within FR1 (two bands)

Table 5.5B.4a.1-1: Inter-band NE-DC configurations within FR1 (two bands)

NE-DC configuration	Uplink NE-DC configuration (NOTE 1)	Single UL allowed
DC_n1A_28A	DC_n1A_28A	No
NOTE 1: Uplink NE-DC configurations are the configurations supported by the present release of specifications.		

5.5B.5 Inter-band EN-DC including FR2

5.5B.5.1 Inter-band EN-DC configurations including FR2 (two bands)

Table 5.5B.5.1-1: Inter-band EN-DC configurations including FR2 (two bands)

EN-DC configuration	Uplink EN-DC configuration (NOTE 1)
DC_1A_n257A DC_1A_n257D DC_1A_n257E DC_1A_n257F	DC_1A_n257A
DC_2A_n257A DC_2C_n257A	DC_2A_n257A
DC_2A_n257(2A)	DC_2A_n257A
DC_2A-2A_n257A	DC_2A_n257A
DC_2A_n260A DC_2A_n260G DC_2A_n260H DC_2A_n260I DC_2A_n260J DC_2A_n260K DC_2A_n260L DC_2A_n260M	DC_2A_n260A

EN-DC configuration	Uplink EN-DC configuration (NOTE 1)
DC_2C_n260A	
DC_2A_n260(2A)	DC_2A_n260
DC_2A-2A_n260A DC_2A-2A_n260G DC_2A-2A_n260H DC_2A-2A_n260I DC_2A-2A_n260J DC_2A-2A_n260K DC_2A-2A_n260L DC_2A-2A_n260M	DC_2A_n260A
DC_3A_n257A DC_3A_n257D DC_3A_n257E DC_3A_n257F	DC_3A_n257A
DC_3A_n258A	DC_3A_n258A
DC_5A_n257A DC_5B_n257A	DC_5A_n257A DC_5B_n257A
DC_5A-5A_n257A	DC_5A_n257A
DC_5A_n260A DC_5A_n260B DC_5A_n260C DC_5A_n260D DC_5A_n260E DC_5A_n260F DC_5A_n260G DC_5A_n260H DC_5A_n260I DC_5A_n260J DC_5A_n260K DC_5A_n260L DC_5A_n260M DC_5A_n260O DC_5A_n260P DC_5A_n260Q DC_5B_n260A	DC_5A_n260A DC_5B_n260A
DC_5A_n260(2A) DC_5A_n260(3A) DC_5A_n260(4A) DC_5A_n260(A-I) DC_5A_n260(D-G) DC_5A_n260(D-H) DC_5A_n260(D-I) DC_5A_n260(D-O) DC_5A_n260(D-P) DC_5A_n260(D-Q) DC_5A_n260(E-O) DC_5A_n260(E-P) DC_5A_n260(E-Q) DC_5A_n260(G-I)	DC_5A_n260A
DC_5A-5A_n260A	DC_5A_n260A
DC_5A_n261A DC_5A_n261B DC_5A_n261C DC_5A_n261D DC_5A_n261E DC_5A_n261F DC_5A_n261G DC_5A_n261H DC_5A_n261I DC_5A_n261J DC_5A_n261K DC_5A_n261L DC_5A_n261M	DC_5A_n261A

EN-DC configuration	Uplink EN-DC configuration (NOTE 1)
DC_5A_n261O DC_5A_n261P DC_5A_n261Q	
DC_5A_n261(2A) DC_5A_n261(3A) DC_5A_n261(4A) DC_5A_n261(D-G) DC_5A_n261(D-H) DC_5A_n261(D-I) DC_5A_n261(D-O) DC_5A_n261(D-P) DC_5A_n261(D-Q) DC_5A_n261(E-O) DC_5A_n261(E-P) DC_5A_n261(E-Q)	DC_5A_n261A
DC_7A_n257A	DC_7A_n257A
DC_7A-7A_n257A	DC_7A_n257A
DC_7A_n258A	DC_7A_n258A
DC_8A_n257A	DC_8A_n257A
DC_8A_n258A	DC_8A_n258A
DC_11A_n257A	DC_11A_n257A
DC_12A_n260A DC_12A_n260G DC_12A_n260H DC_12A_n260I DC_12A_n260J DC_12A_n260K DC_12A_n260L DC_12A_n260M	DC_12A_n260A
DC_12A_n260(A-I) DC_12A_n260(G-I)	DC_12A_n260A
DC_13A_n257A	DC_13A_n257A
DC_13A_n260A	DC_13A_n260A
DC_18A_n257A	DC_18A_n257A
DC_19A_n257A DC_19A_n257D DC_19A_n257E DC_19A_n257F	DC_19A_n257A
DC_20A_n258A	DC_20A_n258A
DC_21A_n257A DC_21A_n257D DC_21A_n257E DC_21A_n257F	DC_21A_n257A
DC_26A_n257A	DC_26A_n257A
DC_28A_n257A DC_28A_n257D DC_28A_n257E DC_28A_n257F	DC_28A_n257A
DC_28A_n258A	DC_28A_n258A
DC_30A_n260A DC_30A_n260G DC_30A_n260H DC_30A_n260I DC_30A_n260J DC_30A_n260K DC_30A_n260L DC_30A_n260M	DC_30A_n260A
DC_30A_n260(A-I) DC_30A_n260(G-I)	DC_30A_n260A

EN-DC configuration	Uplink EN-DC configuration (NOTE 1)
DC_39A_n258A	DC_39A_n258A
DC_41A_n257A DC_41C_n257A	DC_41A_n257A DC_41C_n257A
DC_41A_n258A	DC_41A_n258A
DC_42A_n257A DC_42C_n257A DC_42A_n257D DC_42A_n257E DC_42A_n257F DC_42C_n257D DC_42C_n257E DC_42C_n257F DC_42D_n257A DC_42E_n257A	DC_42A_n257A DC_42C_n257A
DC_48A_n257A DC_48C_n257A	DC_48A_n257A DC_48C_n257A
DC_48A-48A_n257A	DC_48A_n257A
DC_48A_n260A DC_48C_n260A	DC_48A_n260A DC_48C_n260A
DC_48A-48A_n260A	DC_48A_n260A
DC_66A_n257A DC_66A_n257G DC_66A_n257H DC_66A_n257I DC_66A_n257J DC_66A_n257K DC_66A_n257L DC_66A_n257M DC_66C_n257A	DC_66A_n257A
DC_66A_n257(2A)	DC_66A_n257A
DC_66A-66A_n257A	DC_66A_n257A
DC_66A_n260A DC_66A_n260D DC_66A_n260E DC_66A_n260F DC_66A_n260G DC_66A_n260H DC_66A_n260I DC_66A_n260J DC_66A_n260K DC_66A_n260L DC_66A_n260M DC_66A_n260O DC_66A_n260P DC_66A_n260Q	DC_66A_n260A
DC_66A_n260(2A) DC_66A_n260(3A) DC_66A_n260(4A) DC_66A_n260(A-I) DC_66A_n260(D-G) DC_66A_n260(D-H) DC_66A_n260(D-I) DC_66A_n260(D-O) DC_66A_n260(D-P) DC_66A_n260(D-Q) DC_66A_n260(E-O) DC_66A_n260(E-P) DC_66A_n260(E-Q) DC_66A_n260(G-I)	DC_66A_n260A
DC_66A-66A_n260A DC_66A-66A_n260G DC_66A-66A_n260H	DC_66A_n260A

EN-DC configuration	Uplink EN-DC configuration (NOTE 1)
DC_66A-66A_n260I DC_66A-66A_n260J DC_66A-66A_n260K DC_66A-66A_n260L DC_66A-66A_n260M	
DC_66A_n261A DC_66A_n261D DC_66A_n261E DC_66A_n261F DC_66A_n261G DC_66A_n261H DC_66A_n261I DC_66A_n261J DC_66A_n261K DC_66A_n261L DC_66A_n261M DC_66A_n261O DC_66A_n261P DC_66A_n261Q	DC_66A_n261A
DC_66A_n261(2A) DC_66A_n261(3A) DC_66A_n261(4A) DC_66A_n261(D-G) DC_66A_n261(D-H) DC_66A_n261(D-I) DC_66A_n261(D-O) DC_66A_n261(D-P) DC_66A_n261(D-Q) DC_66A_n261(E-O) DC_66A_n261(E-P) DC_66A_n261(E-Q)	DC_66A_n261A
NOTE 1: Uplink EN-DC configurations are the configurations supported by the present release of specifications. NOTE 2: Applicable for UE supporting inter-band EN-DC with mandatory simultaneous Rx/Tx capability for all of the above combinations	

5.5B.5.2 Inter-band EN-DC configurations including FR2 (three bands)

Table 5.5B.5.2-1: Inter-band EN-DC configurations including FR2 (three bands)

EN-DC configuration	Uplink EN-DC configuration (NOTE 1)
DC_1A-3A_n257A ² DC_1A-3A_n257D ² DC_1A-3A_n257E ² DC_1A-3A_n257F ²	DC_1A_n257A DC_3A_n257A
DC_1A-5A_n257A ²	DC_1A_n257A DC_5A_n257A
DC_1A-7A_n257A ²	DC_1A_n257A DC_7A_n257A
DC_1A-7A-7A_n257A ²	DC_1A_n257A DC_7A_n257A
DC_1A-8A_n257A ²	DC_1A_n257A DC_8A_n257A
DC_1A-18A_n257A ²	DC_1A_n257A DC_18A_n257A
DC_1A-19A_n257A ² DC_1A-19A_n257D ² DC_1A-19A_n257E ² DC_1A-19A_n257F ²	DC_1A_n257A DC_19A_n257A
DC_1A-21A_n257A ²	DC_1A_n257A

EN-DC configuration	Uplink EN-DC configuration (NOTE 1)
DC_1A-21A_n257D ² DC_1A-21A_n257E ² DC_1A-21A_n257F ²	DC_21A_n257A
DC_1A-28A_n257A ² DC_1A-28A_n257D ² DC_1A-28A_n257E ² DC_1A-28A_n257F ²	DC_1A_n257A DC_28A_n257A
DC_1A-41A_n257A DC_1A-41C_n257A	DC_1A_n257A DC_41A_n257A DC_41C_n257A
DC_1A-42A_n257A DC_1A-42A_n257D DC_1A-42A_n257E DC_1A-42A_n257F DC_1A-42C_n257A DC_1A-42C_n257D DC_1A-42C_n257E DC_1A-42C_n257F DC_1A-42D_n257A DC_1A-42E_n257A	DC_1A_n257A DC_42A_n257A
DC_2A-5A_n257A ²	DC_2A_n257A DC_5A_n257A
DC_2A-5A_n260A DC_2A-5A_n260G DC_2A-5A_n260H DC_2A-5A_n260I DC_2A-5A_n260J DC_2A-5A_n260K DC_2A-5A_n260L DC_2A-5A_n260M	DC_2A_n260A DC_5A_n260A
DC_2A-12A_n260A DC_2A-12A_n260G DC_2A-12A_n260H DC_2A-12A_n260I DC_2A-12A_n260J DC_2A-12A_n260K DC_2A-12A_n260L DC_2A-12A_n260M	DC_2A_n260A DC_12A_n260A
DC_2A-13A_n257A ²	DC_2A_n257A DC_13A_n257A
DC_2A-13A_n260A ²	DC_2A_n260A DC_13A_n260A
DC_2A-30A_n260A DC_2A-30A_n260G DC_2A-30A_n260H DC_2A-30A_n260I DC_2A-30A_n260J DC_2A-30A_n260K DC_2A-30A_n260L DC_2A-30A_n260M	DC_2A_n260A DC_30A_n260A
DC_2A-66A_n257A ²	DC_2A_n257A DC_66A_n257A
DC_2A-66A_n260A DC_2A-66A_n260G DC_2A-66A_n260H DC_2A-66A_n260I DC_2A-66A_n260J DC_2A-66A_n260K DC_2A-66A_n260L DC_2A-66A_n260M	DC_2A_n260A DC_66A_n260A
DC_3A-5A_n257A ²	DC_3A_n257A DC_5A_n257A
DC_3A-7A_n257A ²	DC_3A_n257A

EN-DC configuration	Uplink EN-DC configuration (NOTE 1)
	DC_7A_n257A
DC_3A-7A-7A_n257A ²	DC_3A_n257A DC_7A_n257A
DC_3A-19A_n257A ² DC_3A-19A_n257D ² DC_3A-19A_n257E ² DC_3A-19A_n257F ²	DC_3A_n257A DC_19A_n257A
DC_3A-21A_n257A ² DC_3A-21A_n257D ² DC_3A-21A_n257E ² DC_3A-21A_n257F ²	DC_3A_n257A DC_21A_n257A
DC_3A-28A_n257A ² DC_3A-28A_n257D ² DC_3A-28A_n257E ² DC_3A-28A_n257F ²	DC_3A_n257A DC_28A_n257A
DC_3A-41A_n257A	DC_3A_n257A DC_41A_n257A
DC_3A-42A_n257A ² DC_3A-42A_n257D ² DC_3A-42A_n257E ² DC_3A-42A_n257F ² DC_3A-42C_n257A ² DC_3A-42C_n257D ² DC_3A-42C_n257E ² DC_3A-42C_n257F ² DC_3A-42D_n257A ² DC_3A-42E_n257A ²	DC_3A_n257A DC_42A_n257A
DC_5A-7A_n257A ²	DC_5A_n257A DC_7A_n257A
DC_5A-7A-7A_n257A	DC_5A_n257A DC_7A_n257A
DC_5A-30A_n260A DC_5A-30A_n260G DC_5A-30A_n260H DC_5A-30A_n260I DC_5A-30A_n260J DC_5A-30A_n260K DC_5A-30A_n260L DC_5A-30A_n260M	DC_5A_n260A DC_30A_n260A
DC_5A-66A_n257A	DC_5A_n257A DC_66A_n257A
DC_5A-66A_n260A DC_5A-66A_n260G DC_5A-66A_n260H DC_5A-66A_n260I DC_5A-66A_n260J DC_5A-66A_n260K DC_5A-66A_n260L DC_5A-66A_n260M	DC_5A_n260A DC_66A_n260A
DC_12A-30A_n260A DC_12A-30A_n260G DC_12A-30A_n260H DC_12A-30A_n260I DC_12A-30A_n260J DC_12A-30A_n260K DC_12A-30A_n260L DC_12A-30A_n260M	DC_12A_n260A DC_30A_n260A
DC_12A-66A_n260A DC_12A-66A_n260G DC_12A-66A_n260H DC_12A-66A_n260I DC_12A-66A_n260J DC_12A-66A_n260K	DC_12A_n260A DC_66A_n260A

EN-DC configuration	Uplink EN-DC configuration (NOTE 1)
DC_12A-66A_n260L DC_12A-66A_n260M	
DC_13A-66A_n257A ²	DC_13A_n257A DC_66A_n257A
DC_13A-66A_n260A ²	DC_13A_n260A DC_66A_n260A
DC_18A-28A_n257A ²	DC_18A_n257A DC_28A_n257A
DC_19A-21A_n257A ² DC_19A-21A_n257D ² DC_19A-21A_n257E ² DC_19A-21A_n257F ²	DC_19A_n257A DC_21A_n257A
DC_19A-42A_n257A ² DC_19A-42A_n257D ² DC_19A-42A_n257E ² DC_19A-42A_n257F ² DC_19A-42C_n257A ²	DC_19A_n257A DC_42A_n257A
DC_21A-28A_n257A ² DC_21A-28A_n257D ² DC_21A-28A_n257E ² DC_21A-28A_n257F ²	DC_21A_n257A DC_28A_n257A
DC_21A-42A_n257A ² DC_21A-42A_n257D ² DC_21A-42A_n257E ² DC_21A-42A_n257F ² DC_21A-42C_n257A ²	DC_21A_n257A DC_42A_n257A
DC_28A-42C_n257A ² DC_28A-42A_n257A ²	DC_28A_n257A DC_42A_n257A
DC_30A-66A_n260A DC_30A-66A_n260G DC_30A-66A_n260H DC_30A-66A_n260I DC_30A-66A_n260J DC_30A-66A_n260K DC_30A-66A_n260L DC_30A-66A_n260M	DC_30A_n260A DC_66A_n260A
DC_41A-42A_n257A DC_41A-42C_n257A DC_41C-42A_n257A DC_41C-42C_n257A	DC_41A_n257A DC_42A_n257A
NOTE 1: Uplink EN-DC configurations are the configurations supported by the present release of specifications.	
NOTE 2: Applicable for UE supporting inter-band EN-DC with mandatory simultaneous Rx/Tx capability	

5.5B.5.3 Inter-band EN-DC configurations including FR2 (four bands)

Table 5.5B.5.3-1: Inter-band EN-DC configurations including FR2 (four bands)

EN-DC configuration	Uplink EN-DC configuration (NOTE 1)
DC_1A-3A-5A_n257A ²	DC_1A_n257A DC_3A_n257A DC_5A_n257A
DC_1A-3A-7A_n257A ²	DC_1A_n257A DC_3A_n257A DC_7A_n257A
DC_1A-3A-7A-7A_n257A	DC_1A_n257A DC_3A_n257A DC_7A_n257A

EN-DC configuration	Uplink EN-DC configuration (NOTE 1)
DC_1A-3A-19A_n257A ²	DC_1A_n257A DC_3A_n257A DC_19A_n257A
DC_1A-3A-21A_n257A ²	DC_1A_n257A DC_3A_n257A DC_21A_n257A
DC_1A-3A-28A_n257A ²	DC_1A_n257A DC_3A_n257A DC_28A_n257A
DC_1A-3A-42A_n257A DC_1A-3A-42C_n257A DC_1A-3A-42C_n257D DC_1A-3A-42C_n257E DC_1A-3A-42C_n257F	DC_1A_n257A DC_3A_n257A DC_42A_n257A
DC_1A-5A-7A_n257A ²	DC_1A_n257A DC_5A_n257A DC_7A_n257A
DC_1A-5A-7A-7A_n257A	DC_1A_n257A DC_5A_n257A DC_7A_n257A
DC_1A-18A-28A_n257A ²	DC_1A_n257A DC_18A_n257A DC_28A_n257A
DC_1A-19A-21A_n257A DC_1A-19A-21A_n257D DC_1A-19A-21A_n257E DC_1A-19A-21A_n257F	DC_1A_n257A DC_19A_n257A DC_21A_n257A
DC_1A-19A-42A_n257A DC_1A-19A-42C_n257A DC_1A-19A-42C_n257D DC_1A-19A-42C_n257E DC_1A-19A-42C_n257F	DC_1A_n257A DC_19A_n257A DC_42A_n257A
DC_1A-21A-28A_n257A ²	DC_1A_n257A DC_21A_n257A DC_28A_n257A
DC_1A-21A-42A_n257A DC_1A-21A-42C_n257A DC_1A-21A-42C_n257D DC_1A-21A-42C_n257E DC_1A-21A-42C_n257F	DC_1A_n257A DC_21A_n257A DC_42A_n257A
DC_1A-28A-42A_n257A DC_1A-28A-42C_n257A	DC_1A_n257A DC_28A_n257A DC_42A_n257A
DC_1A-41A-42A_n257A DC_1A-41A-42C_n257A DC_1A-41C-42A_n257A DC_1A-41C-42C_n257A	DC_1A_n257A DC_41A_n257A DC_42A_n257A
DC_3A-5A-7A_n257A ²	DC_3A_n257A DC_5A_n257A DC_7A_n257A
DC_3A-5A-7A-7A_n257A ²	DC_3A_n257A DC_5A_n257A DC_7A_n257A
DC_3A-19A-21A_n257A ²	DC_3A_n257A DC_19A_n257A DC_21A_n257A
DC_3A-19A-42A_n257A DC_3A-19A-42C_n257A DC_3A-19A-42C_n257D DC_3A-19A-42C_n257E DC_3A-19A-42C_n257F	DC_3A_n257A DC_19A_n257A DC_42A_n257A

EN-DC configuration	Uplink EN-DC configuration (NOTE 1)
DC_3A-21A-42A_n257A DC_3A-21A-42C_n257A DC_3A-21A-42C_n257D DC_3A-21A-42C_n257E DC_3A-21A-42C_n257F	DC_3A_n257A DC_21A_n257A DC_42A_n257A
DC_3A-28A-42A_n257A DC_3A-28A-42C_n257A	DC_3A_n257A DC_28A_n257A DC_42A_n257A
DC_19A-21A-42A_n257A ² DC_19A-21A-42C_n257A ² DC_19A-21A-42C_n257D ² DC_19A-21A-42C_n257E ² DC_19A-21A-42C_n257F ²	DC_19A_n257A DC_21A_n257A DC_42A_n257A
DC_21A-28A-42A_n257A ² DC_21A-28A-42C_n257A ²	DC_21A_n257A DC_28A_n257A DC_42A_n257A
NOTE 1: Uplink EN-DC configurations are the configurations supported by the present release of specifications.	
NOTE 2: Applicable for UE supporting inter-band EN-DC with mandatory simultaneous Rx/Tx capability	

5.5B.5.4 Inter-band EN-DC configurations including FR2 (five bands)

Table 5.5B.5.4-1: Inter-band EN-DC configurations including FR2 (five bands)

EN-DC configuration	Uplink EN-DC configuration (NOTE 1)
DC_1A-3A-5A-7A_n257A	DC_1A_n257A DC_3A_n257A DC_5A_n257A DC_7A_n257A
DC_1A-3A-5A-7A-7A_n257A	DC_1A_n257A DC_3A_n257A DC_5A_n257A DC_7A_n257A
DC_1A-3A-19A-21A_n257A DC_1A-3A-19A-21A_n257D DC_1A-3A-19A-21A_n257E DC_1A-3A-19A-21A_n257F	DC_1A_n257A DC_3A_n257A DC_19A_n257A DC_21A_n257A
DC_1A-3A-19A-42A_n257A DC_1A-3A-19A-42A_n257D DC_1A-3A-19A-42A_n257E DC_1A-3A-19A-42A_n257F DC_1A-3A-19A-42C_n257A DC_1A-3A-19A-42C_n257D DC_1A-3A-19A-42C_n257E DC_1A-3A-19A-42C_n257F	DC_1A_n257A DC_3A_n257A DC_19A_n257A DC_42A_n257A

EN-DC configuration	Uplink EN-DC configuration (NOTE 1)
DC_1A-3A-21A-42A_n257A DC_1A-3A-21A-42C_n257A DC_1A-3A-21A-42C_n257D DC_1A-3A-21A-42C_n257E DC_1A-3A-21A-42C_n257F	DC_1A_n257A DC_3A_n257A DC_21A_n257A DC_42A_n257A
DC_1A-3A-28A-42A_n257A DC_1A-3A-28A-42C_n257A	DC_1A_n257A DC_3A_n257A DC_28A_n257A DC_42A_n257A
DC_1A-19A-21A-42A_n257A DC_1A-19A-21A-42A_n257D DC_1A-19A-21A-42A_n257E DC_1A-19A-21A-42A_n257F DC_1A-19A-21A-42C_n257A DC_1A-19A-21A-42C_n257D DC_1A-19A-21A-42C_n257E DC_1A-19A-21A-42C_n257F	DC_1A_n257A DC_19A_n257A DC_21A_n257A DC_42A_n257A
DC_1A-19A-28A-42C_n257A	DC_1A_n257A DC_19A_n257A DC_28A_n257A DC_42A_n257A
DC_1A-21A-28A-42A_n257A	DC_1A_n257A DC_21A_n257A DC_28A_n257A DC_42A_n257A
NOTE 1: Uplink EN-DC configurations are the configurations supported by the present release of specifications. NOTE 2: Void	

5.5B.5.5 Void

5.5B.6 Inter-band EN-DC including FR1 and FR2

5.5B.6.1 Void

5.5B.6.2 Inter-band EN-DC configurations including FR1 and FR2 (three bands)

Table 5.5B.6.2-1: Inter-band EN-DC configurations including FR1 and FR2 (three bands)

EN-DC configuration	Uplink EN-DC configuration (NOTE 1)
DC_1A_n77A-n257A DC_1A_n77A-n257D DC_1A_n77A-n257E DC_1A_n77A-n257F	DC_1A_n77A DC_1A_n257A DC_1A_n77A-n257A

EN-DC configuration	Uplink EN-DC configuration (NOTE 1)
DC_1A_n77C-n257A DC_1A_n77C-n257D DC_1A_n77C-n257E DC_1A_n77C-n257F	
DC_1A_n78A-n257A DC_1A_n78A-n257D DC_1A_n78A-n257E DC_1A_n78A-n257F DC_1A_n78C-n257A DC_1A_n78C-n257D DC_1A_n78C-n257E DC_1A_n78C-n257F	DC_1A_n78A DC_1A_n257A DC_1A_n78A-n257A
DC_1A_n79A-n257A DC_1A_n79A-n257D DC_1A_n79A-n257E DC_1A_n79A-n257F DC_1A_n79C-n257A DC_1A_n79C-n257D DC_1A_n79C-n257E DC_1A_n79C-n257F	DC_1A_n79A DC_1A_n257A DC_1A_n79A-n257A
DC_3A_n77A-n257A DC_3A_n77A-n257D DC_3A_n77A-n257E DC_3A_n77A-n257F DC_3A_n77C-n257A DC_3A_n77C-n257D DC_3A_n77C-n257E DC_3A_n77C-n257F	DC_3A_n77A DC_3A_n257A DC_3A_n77A-n257A
DC_3A_n78A-n257A DC_3A_n78A-n257D DC_3A_n78A-n257E DC_3A_n78A-n257F DC_3A_n78C-n257A DC_3A_n78C-n257D DC_3A_n78C-n257E DC_3A_n78C-n257F	DC_3A_n78A DC_3A_n257A DC_3A_n78A-n257A
DC_3A_n79A-n257A DC_3A_n79A-n257D DC_3A_n79A-n257E DC_3A_n79A-n257F DC_3A_n79C-n257A DC_3A_n79C-n257D DC_3A_n79C-n257E DC_3A_n79C-n257F	DC_3A_n79A DC_3A_n257A DC_3A_n79A-n257A
DC_5A_n78A-n257A ²	DC_5A_n78A DC_5A_n257A
DC_7A_n78A-n257A	DC_7A_n78A DC_7A_n257A
DC_7A-7A_n78A-n257A	DC_7A_n78A DC_7A_n257A DC_7A_n78A-n257A
DC_19A_n77A-n257A DC_19A_n77A-n257D DC_19A_n77A-n257E DC_19A_n77A-n257F DC_19A_n77C-n257A DC_19A_n77C-n257D DC_19A_n77C-n257E DC_19A_n77C-n257F	DC_19A_n77A DC_19A_n257A DC_19A_n77A-n257A
DC_19A_n78A-n257A DC_19A_n78A-n257D DC_19A_n78A-n257E DC_19A_n78A-n257F DC_19A_n78C-n257A	DC_19A_n78A DC_19A_n257A DC_19A_n78A-n257A

EN-DC configuration	Uplink EN-DC configuration (NOTE 1)
DC_19A_n78C-n257D DC_19A_n78C-n257E DC_19A_n78C-n257F	
DC_19A_n79A-n257A DC_19A_n79A-n257D DC_19A_n79A-n257E DC_19A_n79A-n257F DC_19A_n79C-n257A DC_19A_n79C-n257D DC_19A_n79C-n257E DC_19A_n79C-n257F	DC_19A_n79A DC_19A_n257A DC_19A_n79A-n257A
DC_21A_n77A-n257A	DC_21A_n77A DC_21A_n257A
DC_21A_n78A-n257A	DC_21A_n78A DC_21A_n257A
DC_21A_n79A-n257A	DC_21A_n79A DC_21A_n257A
<p>NOTE 1: Uplink EN-DC configurations are the configurations supported by the present release of specifications.</p> <p>NOTE 2: Applicable for UE supporting inter-band EN-DC with mandatory simultaneous Rx/Tx capability</p>	

5.5B.6.3 Inter-band EN-DC configurations including FR1 and FR2 (four bands)

Table 5.5B.6.3-1: Inter-band EN-DC configurations including FR1 and FR2 (four bands)

EN-DC configuration	Uplink EN-DC configuration (NOTE 1)
DC_1A-3A_n78A-n257A	DC_1A_n78A DC_1A_n257A DC_3A_n78A DC_3A_n257A
DC_1A-5A_n78A-n257A	DC_1A_n78A DC_1A_n257A DC_5A_n78A DC_5A_n257A
DC_1A-7A_n78A-n257A	DC_1A_n78A DC_1A_n257A DC_7A_n78A DC_7A_n257A
DC_1A-7A-7A_n78A-n257A	DC_1A_n78A DC_1A_n257A DC_7A_n78A DC_7A_n257A
DC_3A-5A_n78A-n257A	DC_3A_n78A DC_3A_n257A DC_5A_n78A DC_5A_n257A
DC_3A-7A_n78A-n257A	DC_3A_n78A DC_3A_n257A DC_7A_n78A DC_7A_n257A
DC_3A-7A-7A_n78A-n257A	DC_3A_n78A DC_3A_n257A DC_7A_n78A DC_7A_n257A
DC_5A-7A_n78A-n257A	DC_5A_n78A DC_5A_n257A DC_7A_n78A DC_7A_n257A
DC_5A-7A-7A_n78A-n257A	DC_5A_n78A DC_5A_n257A DC_7A_n78A DC_7A_n257A
NOTE 1: Uplink EN-DC configurations are the configurations supported by the present release of specifications.	

5.5B.6.4 Inter-band EN-DC configurations including FR1 and FR2 (five bands)

Table 5.5B.6.4-1: Inter-band EN-DC configurations including FR1 and FR2 (five bands)

EN-DC configuration	Uplink EN-DC configuration (NOTE 1)
DC_1A-3A-5A_n78A-n257A	DC_1A_n78A DC_1A_n257A DC_3A_n78A DC_3A_n257A DC_5A_n78A DC_5A_n257A
DC_1A-3A-7A_n78A-n257A	DC_1A_n78A DC_1A_n257A DC_3A_n78A DC_3A_n257A DC_7A_n78A DC_7A_n257A
DC_1A-3A-7A-7A_n78A-n257A	DC_1A_n78A DC_1A_n257A DC_3A_n78A DC_3A_n257A DC_7A_n78A DC_7A_n257A
DC_1A-5A-7A_n78A-n257A	DC_1A_n78A DC_1A_n257A DC_5A_n78A DC_5A_n257A DC_7A_n78A DC_7A_n257A
DC_1A-5A-7A-7A_n78A-n257A	DC_1A_n78A DC_1A_n257A DC_5A_n78A DC_5A_n257A DC_7A_n78A DC_7A_n257A
DC_3A-5A-7A_n78A-n257A	DC_3A_n78A DC_3A_n257A DC_5A_n78A DC_5A_n257A DC_7A_n78A DC_7A_n257A
DC_3A-5A-7A-7A_n78A-n257A	DC_3A_n78A DC_3A_n257A DC_5A_n78A DC_5A_n257A DC_7A_n78A DC_7A_n257A

NOTE 1: Uplink EN-DC configurations are the configurations supported by the present release of specifications.

5.5B.6.5 Inter-band EN-DC configurations including FR1 and FR2 (six bands)

Table 5.5B.6.5-1: Inter-band EN-DC configurations including FR1 and FR2 (six bands)

EN-DC configuration	Uplink EN-DC configuration (NOTE 1)
DC_1A-3A-5A-7A_n78A-n257A	DC_1A_n78A DC_1A_n257A DC_3A_n78A DC_3A_n257A DC_5A_n78A DC_5A_n257A DC_7A_n78A DC_7A_n257A
NOTE 1: Uplink EN-DC configurations are the configurations supported by the present release of specifications.	

5.5B.7 Inter-band NR-DC between FR1 and FR2

5.5B.7.1 Inter-band NR-DC configurations between FR1 and FR2 (two bands)

Table 5.5B.7-1: Inter-band NR-DC configurations between FR1 and FR2 (two bands)

Downlink NR DC configuration	Uplink NR DC configuration
DC_n77A-n257A DC_n77A-n257D DC_n77A-n257E DC_n77A-n257F DC_n77A-n257G DC_n77A-n257H DC_n77A-n257I DC_n77A-n257J DC_n77A-n257K DC_n77A-n257L DC_n77A-n257M DC_n77C-n257A DC_n77C-n257D DC_n77C-n257E DC_n77C-n257F	DC_n77A-n257A
DC_n78A-n257A DC_n78A-n257D DC_n78A-n257E DC_n78A-n257F DC_n78A-n257G DC_n78A-n257H DC_n78A-n257I DC_n78A-n257J DC_n78A-n257K DC_n78A-n257L DC_n78A-n257M DC_n78C-n257A DC_n78C-n257D DC_n78C-n257E DC_n78C-n257F	DC_n78A-n257A
DC_n79A-n257A DC_n79A-n257D DC_n79A-n257E DC_n79A-n257F DC_n79A-n257G DC_n79A-n257H	DC_n79A-n257A

Downlink NR DC configuration	Uplink NR DC configuration
DC_n79A-n257I DC_n79A-n257J DC_n79A-n257K DC_n79A-n257L DC_n79A-n257M DC_n79C-n257A DC_n79C-n257D DC_n79C-n257E DC_n79C-n257F	
NOTE 1: NR configuration for FR1 and FR2 are defined in TS 38.101-1 [2] and TS 38.101-2 [3] respectively.	

6 Transmitter characteristics

6.1 General

Unless otherwise stated the transmitter characteristics are specified at the antenna connector(s) of the UE for the bands operating on frequency range 1 and over the air of the UE for the bands operating on frequency range 2. The requirements for frequency range 1 and frequency range 2 can be verified separately. For the carrier in frequency range 1, requirements can be verified with NR FR2 link disabled. For the carrier in frequency range 2, requirements can be verified in OTA mode with E-UTRA connecting to the network by OTA without calibration.

Unless otherwise stated, requirements for NR transmitter written in TS 38.101-1 [2] and TS 38.101-2 [3] apply and are assumed anchor agnostic. Unless otherwise stated, if UE indicates IE maxNumberSRS-Ports-PerResource = n2 in NR standalone operation mode, the said UE shall meet the NR requirements for either power class 2 or power class 3 in EN-DC within FR1 if UE indicates IE maxNumberSRS-Ports-PerResource = n1 for EN-DC on this NR band. Requirements are verified under conditions where anchor resources do not interfere NR operation.

6.2 Void

6.2A Transmitter power for CA

6.2A.1 UE maximum output power for CA

6.2A.1.1 Inter-band CA between FR1 and FR2

Table 6.2A.1.1-1: Void

For inter-band NR CA in FR1 and FR2 combined, the UE shall meet each transmitter power requirement specified in clause 6.2.1 of TS 38.101-1 [2] and clause 6.2.1 TS 38.101-2 [3] independently.

6.2A.2 UE maximum output power reduction for CA

6.2A.2.1 Inter-band CA between FR1 and FR2

For inter-band NR CA between FR1 and FR2, UE maximum output power reduction specified in TS 38.101-1 [2] and TS 38.101-2 [3] apply for each frequency range respectively.

6.2A.3 UE additional maximum output power reduction for CA

For inter-band NR CA between FR1 and FR2, UE additional maximum output power reduction specified in TS 38.101-1 [2] and TS 38.101-2 [3] apply for each frequency range respectively.

6.2A.4 Configured output power for CA

6.2A.4.1 Configured output power level

For inter-band NR CA between FR1 and FR2, UE configured output power specified in TS 38.101-1 [2] and TS 38.101-2 [3] apply for each frequency range respectively.

6.2A.4.2 $\Delta T_{IB,c}$ for CA

6.2A.4.2.1 $\Delta T_{IB,c}$ for Inter-band CA between FR1 and FR2

$\Delta T_{IB,c}$ for NR CA For the UE which supports inter-band NR CA configuration, $\Delta T_{IB,c}$ in Tables below applies. Unless otherwise stated, $\Delta T_{IB,c}$ is set to zero.

Table 6.2A.4.2.1-1: Void

6.2B Transmitter power for DC

6.2B.1 UE maximum output power for DC

6.2B.1.1 Intra-band contiguous EN-DC

The following UE Power Classes define the total maximum output power for any transmission bandwidth(s) of the CG(s) configured.

The maximum output power is measured as the total maximum output power across the UE antenna connector(s). The period of measurement shall be at least one sub frame.

Table 6.2B.1.1-1: Maximum output power for EN-DC (continuous sub-blocks)

EN-DC configuration	Power class 2 (dBm)	Tolerance (dB)	Power class 3 (dBm)	Tolerance (dB)
DC_(n)71AA			23	+2/-3
DC_(n)41AA	26	+2/-3 ¹	23	+2/-3 ¹

NOTE 1: If all transmitted resource blocks over all component carriers are confined within F_{UL_low} and $F_{UL_low} + 4$ MHz or/and $F_{UL_high} - 4$ MHz and F_{UL_high} , the maximum output power requirement is relaxed by reducing the lower tolerance limit by 1.5 dB

NOTE 2: Power Class 3 is the default power class unless otherwise stated.

If UE supports a different power class than the default UE power class for EN-DC band combination, and the supported power class enables higher maximum output power than that of the default power class:

- if the E-UTRA UL/DL configuration is 0 or 6; or
- if the E-UTRA UL/DL configuration is 1 and special subframe configuration is 0 or 5; or
- if the IE *p-maxUE-FR1-r15* as defined in TS 36.331 [8] is provided and set to the maximum output power of the default power class or lower;
 - apply all requirements for the default power class, and set the configured transmitted power as specified in clause 6.2B.4;
- else
 - apply all requirements for the supported power class, and set the configured transmitted power class as specified in clause 6.2B.4;

6.2B.1.2 Intra-band non-contiguous EN-DC

Table 6.2B.1.2-1: Maximum output power for EN-DC (non-continuous sub-blocks)

EN-DC configuration	Power class 2 (dBm)	Tolerance (dB)	Power class 3 (dBm)	Tolerance (dB)
DC_3A_n3A ²			23	+2/-3
DC_41A_n41A	26	+2/-3 ¹	23	+2/-3 ¹
NOTE 1: If all transmitted resource blocks over all component carriers are confined within F_{UL_low} and $F_{UL_low} + 4$ MHz or/and $F_{UL_high} - 4$ MHz and F_{UL_high} , the maximum output power requirement is relaxed by reducing the lower tolerance limit by 1.5 dB				
NOTE 2: Only single switched UL is supported in Rel.15				
NOTE 3: Power Class 3 is the default power class unless otherwise stated.				

If UE supports a different power class than the default UE power class for EN-DC band combination, and the supported power class enables higher maximum output power than that of the default power class:

- if the E-UTRA UL/DL configuration is 0 or 6; or
- if the E-UTRA UL/DL configuration is 1 and special subframe configuration is 0 or 5; or
- if the IE *p-maxUE-FR1-r15* as defined in TS 36.331 [8] is provided and set to the maximum output power of the default power class or lower;
 - apply all requirements for the default power class, and set the configured transmitted power as specified in clause 6.2B.4;
- else
- apply all requirements for the supported power class, and set the configured transmitted power class as specified in clause 6.2B.4;

6.2B.1.3 Inter-band EN-DC within FR1

For inter-band EN-DC of E-UTRA and NR in FR1, the following UE Power Classes define the maximum output power for any transmission bandwidth within the aggregated channel bandwidth. The maximum output power is measured as the sum of the maximum output power at each UE antenna connector. The period of measurement shall be at least one sub frame (1ms). UE maximum output power shall be measured over all component carriers from different bands. If each band has separate antenna connectors, maximum output power is measured as the sum of maximum output power at each UE antenna connector.

Table 6.2B.1.3-1: Maximum output power for inter-band EN-DC (two bands)

EN-DC configuration	Power class 3 (dBm)	Tolerance (dB)
DC_1A_n28A	23	+2/-3
DC_1A_n40A	23	+2/-3
DC_1A_n51A	23	+2/-3
DC_1A_n77A	23	+2/-3
DC_1A_n78A DC_1A_n84A_ULSUP-TDM_n78A	23	+2/-3
DC_1A_n79A	23	+2/-3
DC_2A_n5A	23	+2/-3 ¹
DC_2A_n66A	23	+2/-3 ¹
DC_2A_n71A	23	+2/-3
DC_2A_n78A	23	+2/-3
DC_3A_n7A	23	+2/-3 ¹
DC_3A_n28A	23	+2/-3 ¹

EN-DC configuration	Power class 3 (dBm)	Tolerance (dB)
DC_3A_n40A	23	+2/-3 ¹
DC_3A_n51A	23	+2/-3 ¹
DC_3A_n77A	23	+2/-3 ¹
DC_3A_n78A DC_3A_n80A_ULSUP-TDM_n78A,	23	+2/-3 ¹
DC_3A_n79A DC_3A_n80A_ULSUP-TDM_n79A,	23	+2/-3 ¹
DC_3A_n82A	23	+2/-3 ¹
DC_5A_n40A	23	+2/-3 ¹
DC_5A_n66A	23	+2/-3 ¹
DC_5A_n78A	23	+2/-3
DC_7A_n28A	23	+2/-3 ¹
DC_7A_n51A	23	+2/-3 ¹
DC_7A_n78A DC_7C_n78A	23	+2/-3
DC_8A_n40A	23	+2/-3 ¹
DC_8A_n77A	23	+2/-3
DC_8A_n78A DC_8A_n81A_ULSUP-TDM_n78A,	23	+2/-3
DC_8A_n79A DC_8A_n81A_ULSUP-TDM_n79A,	23	+2/-3
DC_11A_n77A	23	+2/-3
DC_11A_n78A	23	+2/-3
DC_11A_n79A	23	+2/-3
DC_12A_n5A	23	+2/-3
DC_12A_n66A	23	+2/-3
DC_18A_n77A	23	+2/-3
DC_18A_n78A	23	+2/-3
DC_18A_n79A	23	+2/-3
DC_19A_n77A	23	+2/-3
DC_19A_n78A	23	+2/-3
DC_19A_n79A	23	+2/-3
DC_20A_n8A	23	+2/-3
DC_20A_n28A DC_20A_n83A	23	+2/-3
DC_20A_n51A	23	+2/-3
DC_20A_n77A	23	+2/-3
DC_20A_n78A DC_20A_n82A_ULSUP-TDM_n78A,	23	+2/-3
DC_21A_n77A	23	+2/-3
DC_21A_n78A	23	+2/-3
DC_21A_n79A	23	+2/-3
DC_25A_n41A	23	+2/-3
DC_26A_n41A	23	+2/-3
DC_26A_n77A	23	+2/-3
DC_26A_n78A	23	+2/-3
DC_26A_n79A	23	+2/-3

EN-DC configuration	Power class 3 (dBm)	Tolerance (dB)
DC_28A_n51A	23	+2/-3
DC_28A_n77A	23	+2/-3
DC_28A_n78A DC_28A_n83A_ULSUP-TDM_n78A,	23	+2/-3
DC_28A_n79A	23	+2/-3
DC_30A_n5A	23	+2/-3
DC_30A_n66A	23	+2/-3
DC_38A_n78A	N/A	N/A
DC_39A_n78A	23	+2/-3 ¹
DC_39A_n79A	23	+2/-3 ¹
DC_40A_n77A	N/A	N/A
DC_41A_n77A DC_41C_n77A	23	+2/-3 ¹
DC_41A_n78A DC_41C_n78A	23	+2/-3 ¹
DC_41A_n79A DC_41C_n79A	23	+2/-3 ¹
DC_42A_n51A	23	+2/-3
DC_42A_n77A	N/A	N/A
DC_42A_n78A	N/A	N/A
DC_42A_n79A	N/A	N/A
DC_66A_n5A	23	+2/-3 ¹
DC_66A_n71A	23	+2/-3
DC_66A_n78A, DC_66A_n86A_ULSUP-TDM_n78A,	23	+2/-3
NOTE 1: For the transmission bandwidths confined within F_{UL_low} and $F_{UL_low} + 4$ MHz or $F_{UL_high} - 4$ MHz and F_{UL_high} , the maximum output power requirement is relaxed by reducing the lower tolerance limit by 1.5 dB		
NOTE 2: $P_{PowerClass, EN-DC}$ is the maximum UE power specified without taking into account the tolerance		
NOTE 3: For inter-band EN-DC the maximum power requirement should apply to the total transmitted power over all component carriers (per UE).		
NOTE 4: Power Class 3 is the default power class unless otherwise stated.		

6.2B.1.3a Inter-band NE-DC within FR1

For inter-band NE-DC of E-UTRA and NR in FR1, the following UE power classes define the maximum output power for any transmission bandwidth within the aggregated channel bandwidth. The maximum output power is measured as the sum of the maximum output power at each UE antenna connector. The period of measurement shall be at least one sub frame (1 ms). UE maximum output power shall be measured over all component carriers from different bands. If each band has separate antenna connectors, maximum output power is measured as the sum of maximum output power at each UE antenna connector.

Table 6.2B.1.3a-1: Maximum output power for inter-band NE-DC (two bands)

NE-DC configuration	Power class 3 (dBm)	Tolerance (dB)
DC_n1A_28A	23	+2/-3

6.2B.1.4 Inter-band EN-DC including FR2

UE maximum output power requirement for E-UTRA single carrier and CA operation specified in clauses 6.2.2 and 6.2.2A of TS 36.101 [4] and for NR single carrier and CA operation specified in clause 6.2.1, 6.2A.1, and 6.2D.1 of TS 38.101-2 [3] apply.

6.2B.1.5 Inter-band EN-DC including both FR1 and FR2

UE maximum output power requirement for E-UTRA single carrier and CA operation specified in clauses 6.2.2 and 6.2.2A of TS 36.101 [4] and for NR single carrier and CA operation specified in clause 6.2.1 of TS 38.101-1 [2] and clause 6.2.1, 6.2A.1, and 6.2D.1 of TS 38.101-2 [3] apply. When uplink is EN-DC mode within FR1 only then UE maximum output power requirement is specified in clause 6.2B.1.3 of this specification.

6.2B.2 UE maximum output power reduction for DC

6.2B.2.0 General

The UE maximum output power reduction (MPR) specified in this clause is applicable for UEs configured with EN-DC when NS_01 is indicated in the MCG and the SCG. The MPR applies subject to indication in the field *modifiedMPRbehavior* for the SCG [2].

6.2B.2.1 Intra-band contiguous EN-DC

6.2B.2.1.1 General

When the UE is configured for intra-band contiguous EN-DC, the UE determines the total allowed maximum output power reduction as specified in this clause.

For UE supporting dynamic power sharing the following:

- for the MCG, MPR_c in accordance with TS 36.101 [4]
- for the SCG,

$$MPR'_c = MPR_{NR} = \text{MAX}(MPR_{\text{single,NR}}, MPR_{\text{ENDC}})$$

- for the total configured transmission power,

$$MPR_{\text{tot}} = P_{\text{PowerClass,EN-DC}} - \min(P_{\text{PowerClass,EN-DC}}, 10 \cdot \log_{10}(10^{(P_{\text{PowerClass,E-UTRA}} - MPR_{\text{E-UTRA}})/10}) + 10^{(P_{\text{PowerClass,NR}} - MPR_{\text{NR}})/10}))$$

where

$$MPR_{\text{E-UTRA}} = \text{MAX}(MPR_{\text{single,E-UTRA}}, MPR_{\text{ENDC}})$$

with

- $MPR_{\text{single,E-UTRA}}$ is the MPR defined for the E-UTRA transmission in TS 36.101 [4]
- $MPR_{\text{single,NR}}$ is the MPR defined for the NR transmission in TS 38.101-1 [2]

For UEs not supporting dynamic power sharing the following

- for the MCG,

$$MPR_c = \text{MAX}(MPR_{\text{single,E-UTRA}}, MPR_{\text{ENDC}})$$

- for the SCG,

$$MPR'_c = \text{MAX}(MPR_{\text{single,NR}}, MPR_{\text{ENDC}})$$

where

- $MPR_{\text{single,NR}}$ is the MPR defined for the NR transmission in TS 38.101-1 [2]

- $MPR_{\text{single,E-UTRA}}$ is the MPR defined for the E-UTRA transmission in TS 36.101 [4]

MPR_{ENDC} is defined in Clause 6.2B.2.1.2

6.2B.2.1.2 MPR for power class 3 and power class 2

MPR in this clause is applicable for power class 3 and power class 2 UEs indicating IE *dualPA-Architecture* supported with ENDC power class being the same as the E-UTRA and NR power class, otherwise the UE can use as much MPR as needed to fulfil emissions requirements when scheduled with dual uplink transmission. For UEs scheduled with single uplink transmission, MPR in clause 6.2.4 of TS 36.101 [4] and 6.2.2 of TS 38.101-1 [2] apply. For a UE supporting dynamic power sharing for DC_(n)71AA for which dual simultaneous uplink transmissions are mandatory and A-MPR defined in clause 6.2B.3.1.1 is applied as MPR. The allowed maximum output power reduction applied to transmission on the MCG and the SCG is defined as follows:

$$MPR_{\text{ENDC}} = M_A$$

Where M_A is defined as follows

$$M_A = \begin{array}{ll} 15 & ; \quad 0 \leq B < 0.5 \\ 10 & ; \quad 0.5 \leq B < 1.0 \\ 8 & ; \quad 1.0 \leq B < 2.0 \\ 6 & ; \quad 2.0 \leq B \end{array}$$

Where:

For UEs supporting dynamic power sharing,

$$B = (\text{LCRB}_{\text{alloc, E-UTRA}} * 12 * \text{SCS}_{\text{E-UTRA}} + \text{LCRB}_{\text{alloc, NR}} * 12 * \text{SCS}_{\text{NR}}) / 1,000,000$$

For UEs not supporting dynamic power sharing,

For E-UTRA

$$B = (\text{LCRB}_{\text{alloc, E-UTRA}} * 12 * \text{SCS}_{\text{E-UTRA}} + 12 * \text{SCS}_{\text{NR}}) / 1,000,000$$

Where $\text{SCS}_{\text{NR}} = 15$ kHz is assumed in calculation of B.

For NR

$$B = (12 * \text{SCS}_{\text{E-UTRA}} + \text{LCRB}_{\text{alloc, NR}} * 12 * \text{SCS}_{\text{NR}}) / 1,000,000$$

Where $\text{SCS}_{\text{E-UTRA}} = 15$ kHz is assumed in calculation of B.

and M_A is reduced by 1 dB for $B < 2$.

6.2B.2.2 Intra-band non-contiguous EN-DC

6.2B.2.2.1 General

When the UE is configured for intra-band non-contiguous EN-DC, the UE determines the total allowed maximum output power reduction as specified in this clause.

For UE supporting dynamic power sharing the following:

- for the MCG, MPR_c in accordance with TS 36.101 [4]
- for the SCG,

$$MPR'_c = MPR_{\text{NR}} = \text{MAX}(MPR_{\text{single, NR}}, MPR_{\text{ENDC}})$$

- for the total configured transmission power,

$$MPR_{tot} = P_{PowerClass,EN-DC} - \min(P_{PowerClass,EN-DC}, 10 \cdot \log_{10}(10^{(P_{PowerClass,E-UTRA} - MPR_{E-UTRA})/10}) + 10^{(P_{PowerClass,NR} - MPR_{NR})/10}))$$

where

$$MPR_{E-UTRA} = \text{MAX}(MPR_{single,E-UTRA}, MPR_{ENDC})$$

with

- $MPR_{single,E-UTRA}$ is the MPR defined for the E-UTRA transmission in TS 36.101 [4]
- $MPR_{single,NR}$ is the MPR defined for the NR transmission in TS 38.101-1 [2]

For UEs not supporting dynamic power sharing the following

- for the MCG,

$$MPR_c = \text{MAX}(MPR_{single,E-UTRA}, MPR_{ENDC})$$

- for the SCG,

$$MPR'_c = \text{MAX}(MPR_{single,NR}, MPR_{ENDC})$$

where

- $MPR_{single,NR}$ is the MPR defined for the NR transmission in TS 38.101-1 [2]
- $MPR_{single,E-UTRA}$ is the MPR defined for the E-UTRA transmission in TS 36.101 [4]

MPR_{ENDC} is defined in Clause 6.2B.2.2.2

6.2B.2.2.2 MPR for power class 3 and power class 2

MPR in this clause is applicable for power class 3 and power class 2 UEs indicating IE *dualPA-Architecture* supported with ENDC power class being the same as the E-UTRA and NR power class, otherwise the UE can use as much MPR as needed to fulfil emissions requirements when scheduled with dual uplink transmission. For UEs scheduled with single uplink transmission, MPR in clause 6.2.4 of TS 36.101 [4] and 6.2.2 of TS 38.101-1 [2] apply. The allowed maximum output power reduction for IM3 related emissions applied to transmission on the MCG and the SCG is defined as follows:

$$MPR_{ENDC} = M_A$$

Where M_A is defined as follows

$$M_A = \begin{array}{ll} 18 ; & 0 \leq B < 1.0 \\ 17 ; & 1.0 \leq B < 2.0 \\ 16 ; & 2.0 \leq B < 5.0 \\ 15 ; & 5.0 \leq B \end{array}$$

Where:

For UEs supporting dynamic power sharing,

$$B = (L_{CRB_alloc, E-UTRA} * 12 * SCS_{E-UTRA} + L_{CRB_alloc, NR} * 12 * SCS_{NR}) / 1,000,000$$

For UEs not supporting dynamic power sharing,

For E-UTRA

$$B = (L_{CRB_alloc, E-UTRA} * 12 * SCS_{E-UTRA} + 12 * SCS_{NR}) / 1,000,000$$

Where $SCS_{NR} = 15$ kHz is assumed in calculation of B.

For NR

$$B = (12 * SCS_{E-UTRA} + L_{CRB_alloc,NR} * 12 * SCS_{NR})/1,000.000$$

Where $SCS_{E-UTRA} = 15$ kHz is assumed in calculation of B.

and M_A is reduced by 1 dB for $B < 2$.

6.2B.2.3 Inter-band EN-DC within FR1

For inter-band EN-DC between E-UTRA and FR1 NR, UE maximum output power reduction specified in TS 36.101 [4] and TS 38.101-1 [2] apply for E-UTRA and NR respectively.

6.2B.2.3a Inter-band NE-DC within FR1

For inter-band NE-DC between E-UTRA and FR1 NR, UE maximum output power reduction specified in TS 36.101 [4] and TS 38.101-1 [2] apply for E-UTRA and NR respectively.

6.2B.2.4 Inter-band EN-DC including FR2

UE maximum output power reduction requirement for E-UTRA single carrier and CA operation specified in clauses 6.2.3 and 6.2.3A of TS 36.101 [4] and for NR single carrier and CA operation specified in clause 6.2.2, 6.2A.2, and 6.2D.2 of TS 38.101-2 [3] apply.

6.2B.2.5 Inter-band EN-DC including both FR1 and FR2

UE maximum output power reduction requirement for E-UTRA single carrier and CA operation specified in clauses 6.2.3 and 6.2.3A of TS 36.101 [4] and for NR single carrier and CA operation specified in clause 6.2.2 of TS 38.101-1 [2] and clause 6.2.2, 6.2A.2, and 6.2D.2 of TS 38.101-2 [3] apply.

6.2B.3 UE additional maximum output power reduction for EN-DC

6.2B.3.1 Intra-band contiguous EN-DC

6.2B.3.1.0 General

For intra-band contiguous EN-DC band combinations with additional requirements the allowed A-MPR is specified in Table 6.2B.3.1.0-1 for UEs configured with EN-DC and combinations of network signalling values indicated in the E-UTRA and NR cell groups.

Unless otherwise stated the A-MPR specified in clause 6.2B.3.1 for intra-band contiguous EN-DC configurations is the total power reduction allowed including MPR.

Table 6.2B.3.1.0-1: Additional maximum power reduction for Intra-band contiguous EN-DC

DC configuration	Requirement (clause)	E-UTRA network signalling value	NR network signalling value	A-MPR (clause)
DC_(n)71AA	6.5B.2.1.2.1	NS_35	NS_35	6.2B.3.1.1 ³
DC_(n)41AA ¹	6.5B.2.1.2.2	NS_01 or NS_04	NS_04	6.2B.3.1.2 ⁴
NOTE 1: Only applies to UEs that support dual UL transmission for this EN-DC combination.				
NOTE 2: The additional emission requirement is indicated when the combination of network signalling values in the two CGs is set (only for UEs configured with EN-DC).				
NOTE 3: The A-MPR is applied as MPR if NS_35 is not signalled.				
NOTE 4: Void				

6.2B.3.1.1 A-MPR for DC_(n)71AA

For UE supporting dynamic power sharing the following:

- for the MCG, A-MPR_c in accordance with TS 36.101 [4]

- for the SCG, $A\text{-MPR}'_c = A\text{-MPR}_{\text{DC}}$
- for the total configured transmission power, $A\text{-MPR}_{\text{tot}} = A\text{-MPR}_{\text{DC}}$

with $A\text{-MPR}_{\text{DC}}$ as defined in this clause.

For UEs not supporting dynamic power sharing the following

- for the MCG,

$$A\text{-MPR}_c = A\text{-MPR}_{\text{E-UTRA}}$$

- for the SCG,

$$A\text{-MPR}'_c = A\text{-MPR}_{\text{NR}}$$

with $A\text{-MPR}_{\text{E-UTRA}}$ and $A\text{-MPR}_{\text{NR}}$ as defined in this clause.

For DC_(n)71AA with configured with network signaling values as per Table 6.2B.3.1.0-1 the allowed A-MPR is defined by

- for UE indicating support of dynamicPowerSharing in the *UE-MRDC-Capability* IE

$$A\text{-MPR}_{\text{DC}} = \text{CEIL}\{ M_{\text{A,DC}}(A), 0.5\}$$

where $A\text{-MPR}_{\text{DC}}$ is the total power reduction allowed (dB),

- for OFDM:

$$\begin{aligned} M_{\text{A,DC}} &= 11.00 - 11.67 * A; & 0.00 < A \leq 0.30 \\ & 8.10 - 2.00 * A; & 0.30 < A \leq 0.80 \\ & 6.50; & 0.80 < A \leq 1.00 \end{aligned}$$

- for DFT-S-OFDM:

$$\begin{aligned} M_{\text{A,DC}} &= 11.00 - 13.33 * A; & 0.00 < A \leq 0.30 \\ & 8.00 - 3.33 * A; & 0.30 < A \leq 0.60 \\ & 6.00; & 0.60 < A \leq 1.00 \end{aligned}$$

where

$$A = \frac{L_{\text{CRB,E-UTRA}} + L_{\text{CRB,NR}}}{N_{\text{RB,E-UTRA}} + N_{\text{RB,NR}}}$$

with $L_{\text{CRB,E-UTRA}}$ and $N_{\text{RB,E-UTRA}}$ the number of allocated PRB and transmission bandwidth for MCG, $L_{\text{CRB,NR}}$ and $N_{\text{RB,NR}}$ the number of allocated PRB and transmission bandwidth for SCG with SCS = 15 kHz.

- for UE not indicating support of dynamicPowerSharing

$$A\text{-MPR}_{\text{E-UTRA}} = \text{CEIL}\{ M_{\text{A,E-UTRA}}, 0.5\}$$

$$A\text{-MPR}_{\text{NR}} = \text{CEIL}\{ M_{\text{A,NR}}, 0.5\}$$

where A-MPR is the total power reduction allowed per CG with

$$M_{\text{A,E-UTRA}} = M_{\text{A,DC}}(A_{\text{E-UTRA,wc}}) - 1 - \Delta_{\text{E-UTRA}}$$

$$M_{\text{A,NR}} = M_{\text{A,DC}}(A_{\text{NR,wc}}) - 1 - \Delta_{\text{NR}}$$

$$A_{\text{E-UTRA,wc}} = \frac{L_{\text{CRB,E-UTRA}} + 1}{N_{\text{RB,E-UTRA}} + N_{\text{RB,NR}}}$$

$$A_{\text{NR,wc}} = \frac{1 + L_{\text{CRB,NR}}}{N_{\text{RB,E-UTRA}} + N_{\text{RB,NR}}}$$

$$\Delta_{E-UTRA} = 10 \log_{10} \frac{N_{RB,E-UTRA}}{N_{RB,E-UTRA} + N_{RB,NR}}$$

$$\Delta_{NR} = 10 \log_{10} \frac{N_{RB,NR}}{N_{RB,E-UTRA} + N_{RB,NR}}$$

Where $L_{CRB,NR}$ and $N_{RB,NR}$ the number of allocated PRB and transmission bandwidth for SCG with SCS = 15 kHz.

6.2B.3.1.2 A-MPR for NS_04

6.2B.3.1.2.0 General

When the UE is configured for B41/n41 intra-band contiguous EN-DC and it receives IE NS_04, the UE determines the total allowed maximum output power reduction as specified in this clause. The A-MPR for EN-DC defined in this clause is used instead of MPR defined in 6.2B.2.1, not additively, so EN-DC MPR = 0 when NS_04 is signaled. For UEs scheduled with single uplink transmission, AMPR in clause 6.2.4 of [4] and 6.2.3 of [2] apply.

For UE supporting dynamic power sharing the following:

- for the MCG, A-MPR_c in accordance with TS 36.101 [4]
- for the SCG,

$$A-MPR'_c = A-MPR_{NR} = \text{MAX}(A-MPR_{\text{single,NR}}, A-MPR_{\text{IM3}})$$

- for the total configured transmission power,

$$A-MPR_{\text{tot}} = P_{\text{PowerClass,EN-DC}} - \min(P_{\text{PowerClass,EN-DC}}, 10^{\ast} \log_{10}(10^{\ast} (P_{\text{PowerClass,E-UTRA}} - A-MPR_{\text{E-UTRA}})/10) + 10^{\ast} (P_{\text{PowerClass,NR}} - A-MPR_{\text{NR}})/10))$$

where

$$A-MPR_{\text{E-UTRA}} = \text{MAX}(A-MPR_{\text{single,E-UTRA}} + MPR_{\text{single,E-UTRA}}, A-MPR_{\text{IM3}})$$

with

- A-MPR_{single, E-UTRA} is the A-MPR defined for the E-UTRA transmission in TS 36.101 [4]
- A-MPR_{single,NR} is the A-MPR defined for the NR transmission in TS 38.101-1 [2]
- MPR_{single,E-UTRA} is the MPR defined for the E-UTRA transmission in TS 36.101 [4]

For UEs not supporting dynamic power sharing the following

- for the MCG,

$$A-MPR_c = \text{MAX}(A-MPR_{\text{single, E-UTRA}} + MPR_{\text{single,E-UTRA}}, A-MPR_{\text{IM3}})$$

- for the SCG,

$$A-MPR'_c = \text{MAX}(A-MPR_{\text{single,NR}}, A-MPR_{\text{IM3}})$$

where

- A-MPR_{single, E-UTRA} is the A-MPR defined for the E-UTRA transmission in TS 36.101 [4]
- A-MPR_{single,NR} is the A-MPR defined for the NR transmission in TS 38.101-1 [2]
- MPR_{single,E-UTRA} is the MPR defined for the E-UTRA transmission in TS 36.101 [4]

The UE determines the Channel Configuration Case and the value of A-MPR_{IM3} as follows:

If $F_{\text{IM3,low_block,low}} < 2490.5$ MHz

Channel Configuration Case B. A-MPR_{IM3} defined in Clause 6.2B.3.1.2.2

Else

Channel Configuration Case A. A-MPR_{IM3} defined in Clause 6.2B.3.1.2.1

where

- $F_{IM3,low_block,low} = (2 * F_{low_channel,low_edge}) - F_{high_channel,high_edge}$
- $F_{low_channel,low_edge}$ is the lowermost frequency of lower transmission bandwidth configuration.
- $F_{high_channel,high_edge}$ is the uppermost frequency of upper transmission bandwidth configuration.

Where the transmission bandwidth configuration for NR is the maximum frequency span covering all the configured SCSSpecificCarrier for scenarios that carrier bandwidths with different SCS can be fully overlapped. 6.2B.3.1.2.1 A-MPR_{IM3} for NS_04 to meet -13 dBm / 1MHz for 26dBm UE power

A-MPR in this clause is relative to 26 dBm for a power class 2 Cell Group. The same A-MPR is used relative to 23 dBm for a power class 3 Cell Group. For the UE is configured with channel configurations Case A or Case C (defined in Clause 6.2B.3.2.1), the allowed maximum output power reduction for IM3s applied to transmission on the MCG and the SCG with non-contiguous resource allocation is defined as follows:

$$A-MPR_{IM3} = M_A$$

Where M_A is defined as follows

$$M_A = \begin{array}{ll} 15 & ; \quad 0 \leq B < 0.5 \\ 10 & ; \quad 0.5 \leq B < 1.0 \\ 8 & ; \quad 1.0 \leq B < 2.0 \\ 6 & ; \quad 2.0 \leq B \end{array}$$

Where:

For UEs supporting dynamic power sharing,

$$B = (L_{CRB_alloc, E-UTRA} * 12 * SCS_{E-UTRA} + L_{CRB_alloc, NR} * 12 * SCS_{NR}) / 1,000,000$$

For UEs not supporting dynamic power sharing,

For E-UTRA

$$B = (L_{CRB_alloc, E-UTRA} * 12 * SCS_{E-UTRA} + 12 * SCS_{NR}) / 1,000,000$$

Where $SCS_{NR} = 15$ kHz is assumed in calculation of B.

For NR

$$B = (12 * SCS_{E-UTRA} + L_{CRB_alloc, NR} * 12 * SCS_{NR}) / 1,000,000$$

Where $SCS_{E-UTRA} = 15$ kHz is assumed in calculation of B.

and M_A is reduced by 1 dB for $B < 2.0$.

6.2B.3.1.2.2 A-MPR for NS_04 to meet -25 dBm / 1MHz for 26 dBm UE power

A-MPR in this clause is relative to 26 dBm for a power class 2 Cell Group. The same A-MPR is used relative to 23 dBm for a power class 3 Cell Group. For the UE is configured with channel configurations Case B or Case D (defined in Clause 6.2B.3.2.1), the allowed maximum output power reduction for IM3s applied to transmission on the MCG and the SCG with non-contiguous resource allocation is defined as follows:

$$A-MPR_{IM3} = M_A$$

Where M_A is defined as follows

$$M_A = \begin{cases} 15 & ; \quad 0 \leq B < 1.0 \\ 14 & ; \quad 1.0 \leq B < 2.0 \\ 13 & ; \quad 2.0 \leq B < 5.0 \\ 12 & ; \quad 5.0 \leq B \end{cases}$$

Where:

For UEs supporting dynamic power sharing,

$$B = (L_{CRB_alloc, E-UTRA} * 12 * SCS_{E-UTRA} + L_{CRB_alloc, NR} * 12 * SCS_{NR}) / 1,000,000$$

For UEs not supporting dynamic power sharing,

For E-UTRA

$$B = (L_{CRB_alloc, E-UTRA} * 12 * SCS_{E-UTRA} + 12 * SCS_{NR}) / 1,000,000$$

Where $SCS_{NR} = 15$ kHz is assumed in calculation of B.

For NR

$$B = (12 * SCS_{E-UTRA} + L_{CRB_alloc, NR} * 12 * SCS_{NR}) / 1,000,000$$

Where $SCS_{E-UTRA} = 15$ kHz is assumed in calculation of B.

and M_A is reduced by 1 dB.

6.2B.3.2 Intra-band non-contiguous EN-DC

6.2B.3.2.0 General

For intra-band non-contiguous EN-DC band combinations with additional requirements the A-MPR allowed are specified in Table 6.2B.3.2.0-1 for UEs configured with EN-DC and combinations of network signalling values indicated in the E-UTRA and NR cell group(s). Unless otherwise stated the A-MPR specified in clause 6.2B.3.2 for intra-band non-contiguous EN-DC configurations is the total power reduction allowed including MPR. For UEs scheduled with single uplink transmission, AMPR in clause 6.2.4 of [4] and 6.2.3 of [2] apply.

Table 6.2B.3.2.0-1: Allowed power reduction for intra-band non-contiguous EN-DC

DC configuration	Requirement (clause)	E-UTRA network signalling value	NR network signalling value	A-MPR (clause)
DC_41A_n41A ¹	6.6.3.3.19 and 6.6.2.2.2 of [4] and 6.5.2.3.2 and 6.5.3.3.1 of [2]	NS_01 or NS_04	NS_04	6.2B.3.2.1
NOTE 1: Only applies to UEs that support dual UL transmission for this EN-DC combination. NOTE 2: The requirement applies when the combination of network signalling values in the two CGs is set (only for UEs configured with EN-DC).				

6.2B.3.2.1 A-MPR for NS_04

When the UE is configured for B41/n41 intra-band non-contiguous EN-DC and it receives IE NS_04, the UE determines the total allowed maximum output power reduction as specified in this clause. The A-MPR for EN-DC defined in this clause is used instead of MPR defined in 6.2B.2.2, not additively, so EN-DC MPR=0 when NS_04 is signaled.

For UE supporting dynamic power sharing the following:

- for the MCG, A-MPR_c in accordance with TS 36.101 [4]

- for the SCG,

$$A\text{-MPR}'_c = A\text{-MPR}_{\text{NR}} = \text{MAX}(A\text{-MPR}_{\text{single,NR}}, A\text{-MPR}_{\text{EN-DC}})$$

- for the total configured transmission power,

$$A\text{-MPR}_{\text{tot}} = P_{\text{PowerClass,EN-DC}} - \min(P_{\text{PowerClass,EN-DC}}, 10 * \log_{10}(10^{((P_{\text{PowerClass,E-UTRA}} - A\text{-MPR}_{\text{E-UTRA}})/10)} + 10^{((P_{\text{PowerClass,NR}} - A\text{-MPR}_{\text{NR}})/10)}))$$

where

$$A\text{-MPR}_{\text{E-UTRA}} = \text{MAX}(A\text{-MPR}_{\text{single,E-UTRA}} + \text{MPR}_{\text{single,E-UTRA}}, A\text{-MPR}_{\text{EN-DC}})$$

$$A\text{-MPR}_{\text{EN-DC}} = \text{MAX}(A\text{-MPR}_{\text{IM3}}, A\text{-MPR}_{\text{ACLROverlap}})$$

with

- $A\text{-MPR}_{\text{single,E-UTRA}}$ is the A-MPR defined for the E-UTRA transmission in TS 36.101 [4]
- $A\text{-MPR}_{\text{single,NR}}$ is the A-MPR defined for the NR transmission in TS 38.101-1 [2]
- $\text{MPR}_{\text{single,E-UTRA}}$ is the MPR defined for the E-UTRA transmission in TS 36.101 [4]

For UEs not supporting dynamic power sharing the following

- for the MCG,

$$A\text{-MPR}_c = \text{MAX}(A\text{-MPR}_{\text{single,E-UTRA}} + \text{MPR}_{\text{single,E-UTRA}}, A\text{-MPR}_{\text{IM3}}, A\text{-MPR}_{\text{ACLROverlap}})$$

- for the SCG,

$$A\text{-MPR}'_c = \text{MAX}(A\text{-MPR}_{\text{single,NR}}, A\text{-MPR}_{\text{IM3}}, A\text{-MPR}_{\text{ACLROverlap}})$$

where

- $A\text{-MPR}_{\text{single,E-UTRA}}$ is the A-MPR defined for the E-UTRA transmission in TS 36.101 [4]
- $A\text{-MPR}_{\text{single,NR}}$ is the A-MPR defined for the NR transmission in TS 38.101-1 [2]
- $\text{MPR}_{\text{single,E-UTRA}}$ is the MPR defined for the E-UTRA transmission in TS 36.101 [4]

The UE determines the Channel Configuration Case and the value of $A\text{-MPR}_{\text{IM3}}$ as follows:

$$\text{If AND}(F_{\text{IM3,low_block,high}} < F_{\text{filter,low}}, \text{MAX}(\text{SEM}_{-13,\text{high}}, F_{\text{IM3,high_block,low}}) > F_{\text{filter,high}})$$

Channel Configuration Case C. $A\text{-MPR}_{\text{IM3}}$ defined in Clause 6.2B.3.1.2.1

Else

Channel Configuration Case D. $A\text{-MPR}_{\text{IM3}}$ defined in Clause 6.2B.3.1.2.2

where

- $F_{\text{IM3,low_block,high}} = (2 * F_{\text{low_channel,high_edge}}) - F_{\text{high_channel,low_edge}}$
- $F_{\text{IM3,high_block,low}} = (2 * F_{\text{high_channel,low_edge}}) - F_{\text{low_channel,high_edge}}$
- $F_{\text{low_channel,low_edge}}$ is the lowermost frequency of lower transmission bandwidth configuration.
- $F_{\text{low_channel,high_edge}}$ is the uppermost frequency of lower transmission bandwidth configuration.
- $F_{\text{high_channel,low_edge}}$ is the lowermost frequency of upper transmission bandwidth configuration.
- $F_{\text{high_channel,high_edge}}$ is the uppermost frequency of upper transmission bandwidth configuration.
- $F_{\text{filter,low}} = 2480$ MHz
- $F_{\text{filter,high}} = 2745$ MHz

- $SEM_{13,high}$ = Threshold frequency where upper spectral emission mask for upper channel drops from -13 dBm / 1MHz to -25 dBm / 1MHz, as specified in Clause 6.6.2.2.2 in [4] and Clause 6.5.2.3.2 in [2] respectively.

Where the transmission bandwidth configuration for NR is the maximum frequency span covering all the configured SCSSpecificCarrier for scenarios that carrier bandwidths with different SCS can be fully overlapped.

The UE determines the value of $A-MPR_{ACLROverlap}$ as specified in Table 6.2B.3.2.1-1:

Table 6.2B.3.2.1-1: $A-MPR_{ACLROverlap}$

W_{gap}	$A-MPR_{ACLROverlap}$
$< BW_{channel,E-UTRA} + BW_{channel,NR}$	4 dB
$\geq BW_{channel,E-UTRA} + BW_{channel,NR}$	0 dB
NOTE 1: $W_{gap} = F_{high_channel,low_edge} - F_{low_channel,high_edge}$	

6.2B.3.3 Inter-band EN-DC within FR1

For inter-band EN-DC between E-UTRA and FR1 NR, UE additional maximum output power reduction specified in TS 36.101 [4] and TS 38.101-1 [2] apply for E-UTRA and NR respectively.

6.2B.3.4 Inter-band EN-DC including FR2

UE additional maximum output power reduction requirement for E-UTRA single carrier and CA operation specified in clauses 6.2.4 and 6.2.4A of TS 36.101 [4] and for NR single carrier and CA operation specified in clause 6.2.3, 6.2A.3 and 6.2D.3 of TS 38.101-2 [3] apply.

6.2B.3.5 Inter-band EN-DC including both FR1 and FR2

UE additional maximum output power reduction requirement for E-UTRA single carrier and CA operation specified in clauses 6.2.4 and 6.2.4A of TS 36.101 [4] and for NR single carrier and CA operation specified in clause 6.2.3 of TS 38.101-1 [2] and clause 6.2.3, 6.2A.3, and 6.2D.3 of TS 38.101-2 [3] apply.

6.2B.4 Configured output power for DC

6.2B.4.1 Configured output power level

6.2B.4.1.1 Intra-band contiguous EN-DC

The following requirements apply for one component carrier per CG configured for synchronous DC.

For intra-band dual connectivity with one uplink serving cell per CG on E-UTRA and NR respectively, the UE is allowed to set its configured maximum output power $P_{CMAX,c(i),i}$ for serving cell $c(i)$ of CG i , $i = 1,2$, and its total configured maximum transmission power for EN-DC operation $P_{Total}^{EN-DC} = 10\log_{10}(\hat{P}_{total}^{EN-DC})$ with \hat{P}_{total}^{EN-DC} as specified in clause 7.6 of TS 38.213 [10].

The configured maximum output power $P_{CMAX_E-UTRA,c}(p)$ in sub-frame p for the configured E-UTRA uplink carrier shall be set within the bounds:

$$P_{CMAX_L_E-UTRA,c}(p) \leq P_{CMAX_E-UTRA,c}(p) \leq P_{CMAX_H_E-UTRA,c}(p)$$

where $P_{CMAX_L_E-UTRA,c}$ and $P_{CMAX_H_E-UTRA,c}$ are the limits for a serving cell c as specified in TS 36.101 [4] clause 6.2.5 modified by P_{LTE} as follows:

$$P_{CMAX_L_E-UTRA,c} = \text{MIN} \{ \text{MIN}(P_{EMAX,c}, P_{EMAX,EN-DC}, P_{LTE}) - \Delta t_{C_E-UTRA,c}, (P_{PowerClass,EN-DC} - \Delta P_{PowerClass,EN-DC}), (P_{PowerClass,E-UTRA} - \Delta P_{PowerClass,E-UTRA}) - \text{MAX}(MPR_c + A-MPR_c + \Delta T_{IB,c} + \Delta T_{C_E-UTRA,c} + \Delta T_{ProSe}, P-MPR_c) \}$$

$$P_{CMAX_H_E-UTRA,c} = \text{MIN} \{ P_{EMAX,c}, P_{EMAX,EN-DC}, P_{LTE}, P_{PowerClass,EN-DC}, P_{PowerClass,E-UTRA} - \Delta P_{PowerClass,E-UTRA} \}$$

where

- $P_{EMAX,EN-DC}$ is the value given by the field *p-maxUE-FR1* of the *RRCConnectionReconfiguration-v1530* IE as defined in TS 36.331 [8];
- P_{LTE} is the value given by the field *p-maxEUTRA-r15* of the *RRCConnectionReconfiguration-v1510* IE as defined in TS 36.331 [8] which is the same as P_{LTE} in TS 38.213 [10];
- $\Delta T_{C,EUTRA,c} = 1.5$ dB when NOTE 2 in Table 6.2.2-1 of TS 36.101 [4] applies; $\Delta T_{C,EUTRA,c} = 0$ dB otherwise;

and whenever NS_01 is not indicated within CG 1:

- for a UE indicating support of dynamicPowerSharing, the MPR_c and the A- MPR_c are determined in accordance with the DCI of serving cell *c* of the CG 1 and the specification in clause 6.2.4 of TS 36.101 [4];
- for a UE not indicating support of dynamicPowerSharing, the A- MPR_c is determined in accordance with clause 6.2B.3.1 with parameters applicable for UEs not indicating support of dynamicPowerSharing and $MPR_c = 0$ dB;

and whenever NS_01 is indicated in CG 1:

- for a UE indicating support of dynamicPowerSharing, the MPR_c is determined in accordance with the DCI of serving cell *c* of the CG 1 and the specification in clause 6.2.4 of TS 36.101 [4];
- for a UE not indicating support of dynamicPowerSharing, the MPR_c is determined in accordance with clause 6.2B.2.1 with parameters applicable for UEs not indicating support of dynamicPowerSharing and A- $MPR_c = 0$ dB;

The configured maximum output power $P_{CMAX,f,c,NR}(q)$ in physical channel *q* for the configured NR carrier shall be set within the bounds:

$$P_{CMAX_L,f,c,NR}(q) \leq P_{CMAX,f,c,NR}(q) \leq P_{CMAX_H,f,c,NR}(q)$$

where $P_{CMAX_L,f,c,NR}$ and $P_{CMAX_H,f,c,NR}$ are the limits for a serving cell *c* as specified in clause 6.2.4 of TS 38.101-1 [2] modified as follows:

$$P_{CMAX_L,f,c,NR} = \text{MIN} \{ \text{MIN}(P_{EMAX,c}, P_{EMAX,EN-DC}, P_{NR}) - \Delta T_{C,NR,c}, (P_{PowerClass,EN-DC} - \Delta P_{PowerClass,EN-DC}), (P_{PowerClass,NR} - \Delta P_{PowerClass,NR}) - \text{MAX}(\text{MAX}(MPR_c, A-MPR_c) + \Delta T_{IB,c} + \Delta T_{C,NR,c} + \Delta T_{RxsRS}, P-MPR_c) \}$$

$$P_{CMAX_H,f,c,NR} = \text{MIN} \{ P_{EMAX,c}, P_{EMAX,EN-DC}, P_{NR}, P_{PowerClass,EN-DC}, P_{PowerClass,NR} - \Delta P_{PowerClass,NR} \}$$

where

- $P_{EMAX,EN-DC}$ is the value given by the field *p-maxUE-FR1* of the *RRCConnectionReconfiguration-v1530* IE as defined in TS 36.331 [8];
- P_{LTE} signalled by RRC as *p-MaxEUTRA-r15* in TS 36.331 [8]
- P_{NR} is the value given by the field *p-NR-FR1* of the *PhysicalCellGroupConfig* IE as defined in [9] and signalled by RRC;
- $\Delta T_{C,E-UTRA,c} = 1.5$ dB when NOTE 2 in Table 6.2.2-1 in TS 36.101 [4] applies for a serving cell *c*, otherwise $\Delta T_{C,E-UTRA,c} = 0$ dB;
- $\Delta T_{C,NR,c} = 1.5$ dB when NOTE 3 in Table 6.2.1-1 in TS 38.101-1 [2] applies for a serving cell *c*, otherwise $\Delta T_{C,NR,c} = 0$ dB;
- $\Delta T_{IB,c}$ specified in clause 6.2B.4.2.1 for EN-DC, the individual Power Class defined in table 6.2B.1.1 and any other additional power reductions parameters specified in clauses 6.2B.2 and 6.2B.3 for EN-DC are applicable to $P_{CMAX_E-UTRA,c}$ and $P_{CMAX,f,c,NR}$ evaluations.
- $P_{PowerClass,EN-DC}$ is defined in clause 6.2B.1.1 for intra-band contiguous EN-DC;
- $P_{PowerClass,NR}$ is the nominal UE power of the power class that the UE supports for the NR band of the EN-DC combination as defined in clause 6.2.1 of 38.101-1 [2];
- $P_{PowerClass,E-UTRA}$ is the nominal UE power of the power class that the UE supports for the E-UTRA band of the EN-DC combination as defined in clause 6.2.2 of 36.101 [4];

- $\Delta P_{\text{PowerClass,EN-DC}}$ is 3 dB for a power class 2 capable EN-DC UE when LTE UL/DL configuration is 0 or 6; or LTE UL/DL configuration is 1 and special subframe configuration is 0 or 5; $\Delta P_{\text{PowerClass,EN-DC}} = 3$ dB when the IE *p-maxUE-FRI* as defined in TS 36.331 [8] is provided and set to the maximum output power of the default power class or lower; otherwise $\Delta P_{\text{PowerClass,EN-DC}} = 0$ dB;

and whenever NS_01 is not indicated within CG 2:

- for a UE indicating support of dynamicPowerSharing, $A\text{-MPR}_c = A\text{-MPR}'_c$ with $A\text{-MPR}'_c$ determined in accordance with clause 6.2B.3.1 and $\text{MPR}_c = 0$ dB if transmission(s) in subframe p on CG 1 overlap in time with physical channel q on CG 2;
- for a UE indicating support of dynamicPowerSharing, $A\text{-MPR}_c$ is determined in accordance with TS 38.101-1 [2] if transmission(s) in subframe p on CG 1 does not overlap in time with physical channel q on CG 2;
- for a UE not indicating support of dynamicPowerSharing, the $A\text{-MPR}_c$ is determined in accordance with clause 6.2B.3.1 with parameters applicable for UEs not indicating support of dynamicPowerSharing and $\text{MPR}_c = 0$ dB;

and whenever NS_01 is indicated in CG 2.

- for a UE indicating support of dynamicPowerSharing, $\text{MPR}_c = \text{MPR}'_c$ with MPR'_c determined in accordance with clause 6.2B.2.1 and $A\text{-MPR}_c = 0$ dB if transmission(s) in subframe p on CG 1 overlap in time with physical channel q on CG 2;
- for a UE indicating support of dynamicPowerSharing, MPR_c is determined in accordance with TS 38.101-1 [2] if transmission(s) in subframe p on CG 1 does not overlap in time with physical channel q on CG 2;
- for a UE not indicating support of dynamicPowerSharing, the MPR_c is determined in accordance with clause 6.2B.2.1 with parameters applicable for UEs not indicating support of dynamicPowerSharing and $A\text{-MPR}_c = 0$ dB;

If the transmissions from NR and E-UTRA do not overlap, then the complete clauses for configured transmitted power for E-UTRA and NR respectively from their own specifications apply with the modifications specified above. The lower value between $P_{\text{PowerClass, EN-DC}}$ or $P_{\text{EMAX, EN-DC}}$ shall not be exceeded at any time by UE.

If the EN-DC UE is not supporting dynamic power sharing, then the complete clauses for configured transmitted power for E-UTRA and NR respectively from their own specifications TS 36.101 [4] and TS 38.101-1 [2] respectively apply with the modifications specified above.

If the UE does not support dynamic power sharing,

$$P_{\text{Total}}^{\text{EN-DC}} = \text{MIN} \{ P_{\text{EMAX, EN-DC}}, P_{\text{PowerClass, EN-DC}} - \Delta P_{\text{PowerClass, EN-DC}} \} + 0.3 \text{ dB}$$

For UEs indicating support of dynamicPowerSharing in the *UE-MRDC-Capability* IE the UE can configure the total maximum transmission power $P_{\text{Total}}^{\text{EN-DC}}$ within the range

$$P_{\text{EN-DC,tot_L}} \leq P_{\text{Total}}^{\text{EN-DC}} \leq P_{\text{EN-DC,tot_H}}$$

where

$$P_{\text{EN-DC,tot_L}}(p, q) = \text{MIN} \{ P_{\text{PowerClass, EN-DC}} - \Delta P_{\text{PowerClass, EN-DC}} - \text{MAX} \{ \text{MPR}_{\text{tot}}, A\text{-MPR}_{\text{tot}} \}, P_{\text{EMAX, EN-DC}} \}$$

$$P_{\text{EN-DC,tot_H}}(p, q) = \text{MIN} \{ P_{\text{PowerClass, EN-DC}}, P_{\text{EMAX, EN-DC}} \}$$

for sub-frame p on CG 1 overlapping with physical channel q on CG 2 and with MPR_{tot} and $A\text{-MPR}_{\text{tot}}$ in accordance with 6.2B.2.1 and clause 6.2B.3.1, respectively.

The measured total maximum output power P_{UMAX} over both CGs/RATs, measured over the transmission reference time duration is

$$P_{\text{UMAX}} = 10 \log_{10} [p_{\text{UMAX, c, E-UTRA}} + p_{\text{UMAX, f, c, NR}}],$$

where $p_{\text{UMAX, c, E-UTRA}}$ and $p_{\text{UMAX, c, NR}}$ denotes the measured output power of serving cell c for E-UTRA and NR respectively, expressed in linear scale.

For UEs indicating support of dynamicPowerSharing, the measured total configured maximum output power P_{UMAX} shall be within the following bounds:

$$P_{\text{CMAX_L}} - T_{\text{LOW}}(P_{\text{CMAX_L}}) \leq P_{\text{UMAX}} \leq P_{\text{CMAX_H}} + T_{\text{HIGH}}(P_{\text{CMAX_H}})$$

with the tolerances $T_{\text{LOW}}(P_{\text{CMAX_L}})$ and $T_{\text{HIGH}}(P_{\text{CMAX_H}})$ for applicable values of $P_{\text{CMAX_L}}$ and $P_{\text{CMAX_H}}$ specified in Table 6.2B.4.1.1-2.

When an UL subframe transmission p from E-UTRA overlap with a physical channel q from the NR, then for P_{UMAX} evaluation, the E-UTRA subframe p is taken as reference period T_{REF} and always considered as the reference measurement duration and the following rules are applicable.

T_{REF} and T_{eval} are specified in Table 6.2B.4.1.1-1 when same or different subframes and physical channel durations are used in aggregated carriers. $P_{\text{PowerClass_EN-DC}}$ shall not be exceeded by the UE during any evaluation period of time.

Table 6.2B.4.1.1-1: P_{CMAX} evaluation window

transmission duration	T_{REF}	T_{eval}
Different transmission duration in different RAT carriers	E-UTRA Subframe	$\text{Min}(T_{\text{no_hopping}}, \text{Physical Channel Length})$

For each T_{REF} , the $P_{\text{CMAX_H}}$ is evaluated per T_{eval} and given by the maximum value over the transmission(s) within the T_{eval} as follows:

$$P_{\text{CMAX_H}} = \text{MAX} \{ P_{\text{CMAX_EN-DC_H}}(p,q), P_{\text{CMAX_EN-DC_H}}(p,q+I), \dots, P_{\text{CMAX_EN-DC_H}}(p,q+n) \}$$

where $P_{\text{CMAX_EN-DC_H}}$ are the applicable upper limits for each overlapping scheduling unit pairs (p,q) , $(p,q+I)$, up to $(p,q+n)$ for each applicable T_{eval} duration, where $q+n$ is the last NR UL physical channel overlapping with E-UTRA subframe p .

While $P_{\text{CMAX_L}}$ is computed as follows:

$$P_{\text{CMAX_L}} = \text{MIN} \{ P_{\text{CMAX_EN-DC_L}}(p,q), P_{\text{CMAX_EN-DC_L}}(p,q+I), \dots, P_{\text{CMAX_EN-DC_L}}(p,q+n) \}$$

where $P_{\text{CMAX_EN-DC_L}}$ are the applicable lower limits for each overlapping scheduling unit pairs (p,q) , $(p,q+I)$, up to $(p,q+n)$ for each applicable T_{eval} duration, where $q+n$ is the last NR UL physical channel overlapping with E-UTRA subframe p ,

With

$$P_{\text{CMAX_EN-DC_H}}(p,q) = \text{MIN} \{ 10 \log_{10} [p_{\text{CMAX_H_E-UTRA,c}}(p) + p_{\text{CMAX_H,f,c,NR}}(q)], P_{\text{EMAX,EN-DC}}, P_{\text{PowerClass,EN-DC}} \}$$

And:

$$a = 10 \log_{10} [p_{\text{CMAX_E-UTRA,c}}(p) + p_{\text{CMAX,f,c,NR}}(q)] > P_{\text{EN-DC,tot,L}}$$

$$b = 10 \log_{10} [p_{\text{CMAX_E-UTRA,c}}(p) + p_{\text{CMAX,f,c,NR}}(q) / X_{\text{scale}}] > P_{\text{EN-DC,tot,L}}$$

If $a = \text{FALSE}$ and the configured transmission power spectral density between the MCG and SCG differs by less than 6 dB

$$P_{\text{CMAX_EN-DC_L}}(p,q) = \text{MIN} \{ 10 \log_{10} [p_{\text{CMAX_L_E-UTRA,c}}(p) + p_{\text{CMAX_L,f,c,NR}}(q)], P_{\text{EMAX,EN-DC}}, P_{\text{PowerClass,EN-DC}} - \Delta P_{\text{PowerClass,EN-DC}} \}$$

ELSE If $(a = \text{TRUE})$ AND $(b = \text{FALSE})$ and the configured transmission power spectral density between the MCG and SCG differs by less than 6 dB

$$P_{\text{CMAX_EN-DC_L}}(p,q) = \text{MIN} \{ 10 \log_{10} [p_{\text{CMAX_L_E-UTRA,c}}(p) + p_{\text{CMAX_L,f,c,NR}}(q) / X_{\text{scale}}], P_{\text{EMAX,EN-DC}}, P_{\text{PowerClass,EN-DC}} - \Delta P_{\text{PowerClass,EN-DC}} \}$$

ELSE If $b = \text{TRUE}$ or the transmission power after power scaling spectral density between the MCG and SCG differs by more than 6 dB

$$P_{\text{CMAX_EN-DC_L}}(p,q) = \text{MIN} \{ 10 \log_{10} [p_{\text{CMAX_L_E-UTRA,c}}(p)], P_{\text{EMAX,EN-DC}}, P_{\text{PowerClass,EN-DC}} - \Delta P_{\text{PowerClass,EN-DC}} \}$$

where

- $P_{\text{CMAX_H_E-UTRA},c}(p)$ is the E-UTRA higher limit of the maximum configured power expressed in linear scale;
- $P_{\text{CMAX_H},f,c,NR}(q)$ is the NR higher limit of the maximum configured power expressed in linear scale;
- $P_{\text{CMAX_L_E-UTRA},c}(p)$ is the E-UTRA lower limit of the maximum configured power expressed in linear scale;
- $P_{\text{CMAX_L},f,c,NR}(q)$ is the NR lower limit of the maximum configured power expressed in linear scale;
- $P_{\text{PowerClass, EN-DC}}$ is defined in clause 6.2B.1.1 for intra-band EN-DC;
- X_{scale} is the linear value of X dB which is configured by RRC and can only take values [0, 6] dB
- $P_{\text{CMAX_E-UTRA},c}(p)$ is the linear value of $P_{\text{CMAX_E-UTRA},c}(p)$, the real configured max power for E-UTRA
- $P_{\text{CMAX},f,c,NR}(q)$ is the linear value of $P_{\text{CMAX},f,c,NR}(q)$, the real configured max power of NR

Table 6.2B.4.1.1-2: P_{CMAX} tolerance for Dual Connectivity E-UTRA-NR

$P_{\text{CMAX}}(\text{dBm})$	Tolerance $T_{\text{LOW}}(P_{\text{CMAX_L}})$ (dB)	Tolerance $T_{\text{HIGH}}(P_{\text{CMAX_H}})$ (dB)
$23 \leq P_{\text{CMAX}} \leq 33$	3.0	2.0
$22 \leq P_{\text{CMAX}} < 23$	5.0	2.0
$21 \leq P_{\text{CMAX}} < 22$	5.0	3.0
$20 \leq P_{\text{CMAX}} < 21$	6.0	4.0
$16 \leq P_{\text{CMAX}} < 20$	5.0	
$11 \leq P_{\text{CMAX}} < 16$	6.0	
$-40 \leq P_{\text{CMAX}} < 11$	7.0	

If the UE supports dynamic power sharing, and when E-UTRA and NR transmissions overlap and the condition (If (a=TRUE) AND (b=FALSE)) is met, SCG shall be transmitted and the following supplementary minimum requirements apply for the measured SCG power, $P_{\text{UMAX},f,c,NR}(q)$, under nominal conditions and unless otherwise stated

$$10\log(p_{\text{CMAX_L},f,c,NR}(q)/X_{\text{scale}}) - T_{\text{LOW}}(10\log(p_{\text{CMAX_L},f,c,NR}(q)/X_{\text{scale}})) \leq P_{\text{UMAX},f,c,NR}(q) \leq 10\log(p_{\text{CMAX_H},f,c,NR}(q)) + T_{\text{HIGH}}(10\log(p_{\text{CMAX_H},f,c,NR}(q)))$$

with the tolerances T_{LOW} and T_{HIGH} for applicable values of P_{CMAX} specified in Table 6.2B.4.1.1-2.

If the UE supports dynamic power sharing, the measured maximum output power in subframe p on CG 1, $p_{\text{UMAX},c,E-UTRA}$, shall meet the requirements in clause 6.2.5 in TS 36.101 [4] with the limits $P_{\text{CMAX_L},c}$ and $P_{\text{CMAX_H},c}$ replaced by $P_{\text{CMAX_L_E-UTRA},c}$ and $P_{\text{CMAX_H_E-UTRA},c}$ as specified above, respectively.

If the configured transmission power spectral density between the MCG and SCG differs by more than 6 dB, then

$$P_{\text{UMAX},f,c,NR}(q) \leq 10\log(p_{\text{CMAX_H},f,c,NR}(q)) + T_{\text{HIGH}}(10\log(p_{\text{CMAX_H},f,c,NR}(q)))$$

6.2B.4.1.2 Intra-band non-contiguous EN-DC

The following requirements apply for one component carrier per CG configured for synchronous DC. The CG(s) are indexed by $j = 1$ for MCG and $j = 2$ for SCG.

The configured maximum output power $P_{\text{CMAX_E-UTRA},c}(p)$ in sub-frame p for the configured E-UTRA uplink carrier shall be set in accordance with clause 6.2B.4.1.1 but where

- for a UE not indicating support of dynamicPowerSharing, the $A\text{-MPR}_c$ determined in accordance with clause 6.2B.3.2 with parameters applicable for UEs not indicating support of dynamicPowerSharing and $\text{MPR}_c = 0$ dB;

whenever NS_01 is not indicated within CG 1 while

- for a UE not indicating support of dynamicPowerSharing, the MPR_c determined in accordance with clause 6.2B.2.2 with parameters applicable for UEs not indicating support of dynamicPowerSharing and $A\text{-MPR}_c = 0$ dB;

whenever NS_01 is indicated in CG 1.

The configured maximum output power $P_{\text{CMAX},f,c,NR}(q)$ in physical channel q for the configured NR carrier shall be set in accordance with clause 6.2B.4.1.1 but where

- for a UE indicating support of dynamicPowerSharing, $A\text{-MPR}_c = A\text{-MPR}'_c$ with $A\text{-MPR}'_c$ determined in accordance with clause 6.2B.3.2 and $\text{MPR}_c = 0$ dB if transmission(s) in subframe p on CG 1 overlap in time with physical channel q on CG 2;
- for a UE indicating support of dynamicPowerSharing, $A\text{-MPR}_c$ is determined in accordance with TS 38.101-1 [2] if transmission(s) in subframe p on CG 1 does not overlap in time with physical channel q on CG 2;
- for a UE not indicating support of dynamicPowerSharing, the $A\text{-MPR}_c$ is determined in accordance with clause 6.2B.3.2 with parameters applicable for UEs not indicating support of dynamicPowerSharing and $\text{MPR}_c = 0$ dB;

whenever NS_01 is not indicated in CG 2 while

- for a UE indicating support of dynamicPowerSharing, $\text{MPR}_c = \text{MPR}'_c$ with MPR'_c determined in accordance with clause 6.2B.2.2 and $A\text{-MPR}_c = 0$ dB if transmission(s) in subframe p on CG 1 overlap in time with physical channel q on CG 2;
- for a UE indicating support of dynamicPowerSharing, MPR_c is determined in accordance with TS 38.101-1 [2] if transmission(s) in subframe p on CG 1 does not overlap in time with physical channel q on CG 2;
- for a UE not indicating support of dynamicPowerSharing, the MPR_c is determined in accordance with clause 6.2B.2.2 with parameters applicable for UEs not indicating support of dynamicPowerSharing and $A\text{-MPR}_c = 0$ dB;

whenever NS_01 is indicated in CG 2.

For UEs indicating support of dynamicPowerSharing in the *UE-MRDC-Capability IE*, the UE can configure the total transmission power in accordance with clause 6.2B.4.1.1 but with $P_{\text{powerclass,EN-DC}}$ the EN-DC power class of the intra-band non-contiguous band combination configured and $A\text{-MPR}$ determined in accordance with clause 6.2B.3.2.

The total maximum output power P_{UMAX} over both CGs is measured in accordance with clause 6.2B.4.1.1 and shall be within the limits specified in clause 6.2B.4.1.1 but with parameters applicable for the non-contiguous band combination configured.

The maximum output power levels $p_{\text{UMAX},c,E\text{-UTRA}}$ and $p_{\text{UMAX},f,c,NR}$ for the CGs are measured in accordance with clause 6.2B.4.1.1 and shall be within the limits specified in clause 6.2B.4.1.1 but with parameters applicable for the non-contiguous band combination configured.

6.2B.4.1.3 Inter-band EN-DC within FR1

For inter-band dual connectivity with one uplink serving cell per CG on E-UTRA and NR respectively, the UE is allowed to set its configured maximum output power $P_{\text{CMAX},c(i)}$ for serving cell $c(i)$ of CG i , $i = 1, 2$, and its total configured maximum transmission power for EN-DC operation, $P_{\text{Total}}^{\text{EN-DC}} = 10\log_{10}(\hat{P}_{\text{total}}^{\text{EN-DC}})$ with $\hat{P}_{\text{total}}^{\text{EN-DC}}$ as specified in clause 7.6 of TS 38.213 [10].

The configured maximum output power $P_{\text{CMAX}_E\text{-UTRA},c}(p)$ in sub-frame p for the configured E-UTRA uplink carrier shall be set within the bounds:

$$P_{\text{CMAX}_L_E\text{-UTRA},c}(p) \leq P_{\text{CMAX}_E\text{-UTRA},c}(p) \leq P_{\text{CMAX}_H_E\text{-UTRA},c}(p)$$

where $P_{\text{CMAX}_L_E\text{-UTRA},c}$ and $P_{\text{CMAX}_H_E\text{-UTRA},c}$ are the limits for a serving cell c as specified in TS 36.101 [4] clause 6.2.5 modified by P_{LTE} as follows:

$$P_{\text{CMAX}_L_E\text{-UTRA},c} = \text{MIN} \{ P_{\text{EMAX, EN-DC}}, (P_{\text{PowerClass, EN-DC}} - \Delta P_{\text{PowerClass, EN-DC}}), \text{MIN}(P_{\text{EMAX},c}, P_{\text{LTE}}) - \Delta t_{c,E\text{-UTRA},c}, (P_{\text{PowerClass,E-UTRA}} - \Delta P_{\text{PowerClass,E-UTRA}}) - \text{MAX}(\text{MPR}_c + A\text{-MPR}_c + \Delta T_{\text{IB},c} + \Delta T_{c,E\text{-UTRA},c} + \Delta T_{\text{ProSe}}, P\text{-MPR}_c) \}$$

$$P_{\text{CMAX}_H_E\text{-UTRA},c} = \text{MIN} \{ P_{\text{EMAX},c}, P_{\text{EMAX, EN-DC}}, (P_{\text{PowerClass, EN-DC}} - \Delta P_{\text{PowerClass, EN-DC}}), P_{\text{LTE}}, P_{\text{PowerClass,E-UTRA}} - \Delta P_{\text{PowerClass,E-UTRA}} \}$$

The configured maximum output power $P_{\text{CMAX},f,c,NR}(q)$ in physical-channel q for the configured NR carrier shall be set within the bounds:

$$P_{\text{CMAX}_L,f,c,NR}(q) \leq P_{\text{CMAX},f,c,NR}(q) \leq P_{\text{CMAX}_H,f,c,NR}(q)$$

where $P_{\text{CMAX_L,f,c,NR}}$ and $P_{\text{CMAX_H,f,c,NR}}$ are the limits for a serving cell c as specified in clause 6.2.4 of TS 38.101-1 [2] modified as follows:

$$P_{\text{CMAX_L,f,c,NR}} = \text{MIN} \{ P_{\text{EMAX, EN-DC}}, (P_{\text{PowerClass, EN-DC}} - \Delta P_{\text{PowerClass, EN-DC}}), \text{MIN}(P_{\text{EMAX,c}}, P_{\text{NR}}) - \Delta T_{\text{C_NR, c}}, (P_{\text{PowerClass, NR}} - \Delta P_{\text{PowerClass, NR}}) - \text{MAX}(\text{MAX}(\text{MPR}_c, \text{A-MPR}_c) + \Delta T_{\text{IB,c}} + \Delta T_{\text{C_NR, c}} + \Delta T_{\text{RxsRS}}, \text{P-MPR}_c) \}$$

$$P_{\text{CMAX_H,f,c,NR}} = \text{MIN} \{ P_{\text{EMAX,c}}, P_{\text{EMAX, EN-DC}}, (P_{\text{PowerClass, EN-DC}} - \Delta P_{\text{PowerClass, EN-DC}}), P_{\text{NR}}, P_{\text{PowerClass, NR}} - \Delta P_{\text{PowerClass, NR}} \}$$

where

- $P_{\text{EMAX, EN-DC}}$ is the value given by the field *p-maxUE-FR1* of the *RRConnectionReconfiguration-v1530* IE as defined in TS 36.331 [8];
- P_{LTE} is the value given by the field *p-maxEUTRA-r15* of the *RRConnectionReconfiguration-v1510* IE as defined in TS 36.331 [8];
- P_{NR} is the value given by the field *p-NR-FR1* of the *PhysicalCellGroupConfig* IE as defined TS 38.331 [9];
- $\Delta T_{\text{c, E-UTRA, c}} = 1.5$ dB when NOTE 2 in Table 6.2.2-1 in TS 36.101 [4] applies for a serving cell c , otherwise $\Delta T_{\text{c, E-UTRA, c}} = 0$ dB;
- $\Delta T_{\text{C_NR, c}} = 1.5$ dB when NOTE 3 in Table 6.2.1-1 in TS 38.101-1 [2] applies for a serving cell c , otherwise $\Delta T_{\text{C_NR, c}} = 0$ dB;
- $\Delta T_{\text{IB, c}}$ specified in clause 6.2B.4.2.3 for EN-DC, the individual Power Class defined in table 6.2B.1.3 and any other additional power reductions parameters specified in clauses 6.2B.2 and 6.2B.3 for EN-DC are applicable to $P_{\text{CMAX_E-UTRA, c}}$ and $P_{\text{CMAX_f,c,NR}}$ evaluations.
- $P_{\text{PowerClass, EN-DC}}$ is defined in clause 6.2B.1.3 for inter-band EN-DC;
- $P_{\text{PowerClass, NR}}$ is the nominal UE power of the power class that the UE supports for the NR band of the EN-DC combination as defined in clause 6.2.1 of 38.101-1 [2];
- $P_{\text{PowerClass, E-UTRA}}$ is the nominal UE power of the power class that the UE supports for the E-UTRA band of the EN-DC combination as defined in clause 6.2.2 of 36.101 [4];
- $\Delta P_{\text{PowerClass, EN-DC}} = 3$ dB for a power class 2 capable EN-DC UE when IE *p-maxUE-FR1*, as defined in TS 38.331 [9], is provided and set to the maximum output power of the default power class or lower; otherwise $\Delta P_{\text{PowerClass, EN-DC}} = 0$ dB;

If the transmissions from NR and E-UTRA do not overlap, then the complete clauses for configured transmitted power for E-UTRA and NR respectively from their own specifications apply with the modifications specified above. The lower value between $P_{\text{PowerClass, EN-DC}}$ or $P_{\text{EMAX, EN-DC}}$ shall not be exceeded at any time by UE.

$P_{\text{Total}}^{\text{EN-DC}} = 10 \log_{10}(\hat{P}_{\text{total}}^{\text{EN-DC}})$ with $P_{\text{Total}}^{\text{EN-DC}}$ the configured maximum transmission power for EN-DC operation as specified in clause 7.6 of TS 38.213 [10].

The total configured maximum transmission power for both synchronous and non-synchronous operation is

$$P_{\text{Total}}^{\text{EN-DC}} = \text{MIN} \{ P_{\text{EMAX, EN-DC}}, P_{\text{PowerClass, EN-DC}} - \Delta P_{\text{PowerClass, EN-DC}} \}$$

If the UE does not support dynamic power sharing,

$$P_{\text{Total}}^{\text{EN-DC}} = \text{MIN} \{ P_{\text{EMAX, EN-DC}}, P_{\text{PowerClass, EN-DC}} - \Delta P_{\text{PowerClass, EN-DC}} \} + 0.3 \text{ dB}$$

If the EN-DC UE does not support dynamic power sharing, then the complete clauses for configured transmitted power for E-UTRA and NR respectively from their own specifications TS 36.101 [4] and TS 38.101-1 [2] respectively apply with the modifications specified above and $P_{\text{Total}}^{\text{EN-DC}}$ applies.

When a UE supporting dynamic sharing is configured for overlapping E-UTRA uplink and NR uplink transmissions, the UE can set its configured maximum output power $P_{\text{CMAX_E-UTRA, c}}$ and $P_{\text{CMAX_f,c,NR}}$ for the configured E-UTRA and NR uplink carriers, respectively, and its configured maximum transmission power for EN-DC operation, $\hat{P}_{\text{Total}}^{\text{EN-DC}}$, as specified above.

The measured total maximum output power P_{UMAX} over both CGs/RATs, measured over the transmission reference time duration is

$$P_{UMAX} = 10 \log_{10} [p_{UMAX,c,E-UTRA} + p_{UMAX,c,NR}],$$

where $p_{UMAX,c,E-UTRA}$ and $p_{UMAX,c,NR}$ denotes the measured output power of serving cell c for E-UTRA and NR respectively, expressed in linear scale.

The measured total configured maximum output power P_{UMAX} shall be within the following bounds:

$$P_{CMAX_L} - T_{LOW}(P_{CMAX_L}) \leq P_{UMAX} \leq P_{CMAX_H} + T_{HIGH}(P_{CMAX_H})$$

with the tolerances $T_{LOW}(P_{CMAX_H})$ and $T_{HIGH}(P_{CMAX_H})$ for applicable values of P_{CMAX} specified in Table 6.2B.4.1.3-2.

When an UL subframe transmission p from E-UTRA overlap with a physical-channel q from the NR, then for P_{UMAX} evaluation, the E-UTRA subframe p is taken as reference period T_{REF} and always considered as the reference measurement duration and the following rules are applicable.

T_{REF} and T_{eval} are specified in Table 6.2B.4.1.3-1 when same or different subframe and physical-channel durations are used in aggregated carriers. $P_{PowerClass_EN-DC}$ shall not be exceeded by the UE during any evaluation period of time.

Table 6.2B.4.1.3-1: P_{CMAX} evaluation window

transmission duration	T_{REF}	T_{eval}
Different transmission duration in different RAT carriers	E-UTRA Subframe	$\text{Min}(T_{no_hopping}, \text{Physical Channel Length})$

For each T_{REF} , the P_{CMAX_H} is evaluated per T_{eval} and given by the maximum value over the transmission(s) within the T_{eval} as follows:

$$P_{CMAX_H} = \text{MAX} \{ P_{CMAX_EN-DC_H}(p,q), P_{CMAX_EN-DC_H}(p,q+I), \dots, P_{CMAX_EN-DC_H}(p,q+n) \}$$

where $P_{CMAX_EN-DC_H}$ are the applicable upper limits for each overlapping scheduling unit pairs (p,q) , $(p,q+I)$, up to $(p,q+n)$ for each applicable T_{eval} duration, where $q+n$ is the last NR UL physical-channel overlapping with E-UTRA subframe p .

While P_{CMAX_L} is computed as follows:

$$P_{CMAX_L} = \text{MIN} \{ P_{CMAX_EN-DC_L}(p,q), P_{CMAX_EN-DC_L}(p,q+I), \dots, P_{CMAX_EN-DC_L}(p,q+n) \}$$

where $P_{CMAX_EN-DC_L}$ are the applicable lower limits for each overlapping scheduling unit pairs (p,q) , $(p,q+I)$, up to $(p,q+n)$ for each applicable T_{eval} duration, where $q+n$ is the last NR UL physical-channel overlapping with E-UTRA subframe p ,

With

$$P_{CMAX_EN-DC_H}(p,q) = \text{MIN} \{ 10 \log_{10} [p_{CMAX_H_E-UTRA,c}(p) + p_{CMAX_H,f,c,NR}(q)], P_{EMAX,EN-DC}, P_{PowerClass,EN-DC} \}$$

And:

$$a = 10 \log_{10} [p_{CMAX_E-UTRA,c}(p) + p_{CMAX,f,c,NR}(q)] > P_{Total}^{EN-DC}$$

$$b = 10 \log_{10} [p_{CMAX_E-UTRA,c}(p) + p_{CMAX,f,c,NR}(q) / X_scale] > P_{Total}^{EN-DC}$$

If a= FALSE

$$P_{CMAX_EN-DC_L}(p,q) = \text{MIN} \{ 10 \log_{10} [p_{CMAX_L_E-UTRA,c}(p) + p_{CMAX_L,f,c,NR}(q)], P_{EMAX,EN-DC}, P_{PowerClass,EN-DC} \}$$

ELSE If (a=TRUE) AND (b=FALSE)

$$P_{CMAX_EN-DC_L}(p,q) = \text{MIN} \{ 10 \log_{10} [p_{CMAX_L_E-UTRA,c}(p) + p_{CMAX_L,f,c,NR}(q) / X_scale], P_{EMAX,EN-DC}, P_{PowerClass,EN-DC} \}$$

ELSE If b= TRUE

$$P_{CMAX_EN-DC_L}(p,q) = \text{MIN} \{ 10 \log_{10} [p_{CMAX_L_E-UTRA,c}(p)], P_{EMAX,EN-DC}, P_{PowerClass,EN-DC} \}$$

where

- $P_{\text{CMAX_H_E-UTRA},c}(p)$ is the E-UTRA higher limit of the maximum configured power expressed in linear scale;
- $P_{\text{CMAX_H},f,c,NR}(q)$ is the NR higher limit of the maximum configured power expressed in linear scale;
- $P_{\text{CMAX_L_E-UTRA},c}(p)$ is the E-UTRA lower limit of the maximum configured power expressed in linear scale;
- $P_{\text{CMAX_L},f,c,NR}(q)$ is the NR lower limit of the maximum configured power expressed in linear scale;
- $P_{\text{PowerClass, EN-DC}}$ is defined in clause 6.2B.1.3-1 for inter-band EN-DC;
- X_{scale} is the linear value of X dB which is configured by RRC and can only take values [0, 6]
- $P_{\text{CMAX_E-UTRA},c}(p)$ is the linear value of $P_{\text{CMAX_E-UTRA},c}(p)$, the real configured max power for E-UTRA
- $P_{\text{CMAX},f,c,NR}(q)$ is the linear value of $P_{\text{CMAX},f,c,NR}(q)$, the real configured max power of NR

Table 6.2B.4.1.3-2: P_{CMAX} tolerance for Dual Connectivity E-UTRA-NR

$P_{\text{CMAX}}(\text{dBm})$	Tolerance $T_{\text{LOW}}(P_{\text{CMAX_L}})$ (dB)	Tolerance $T_{\text{HIGH}}(P_{\text{CMAX_H}})$ (dB)
$23 \leq P_{\text{CMAX}} \leq 33$	3.0	2.0
$22 \leq P_{\text{CMAX}} < 23$	5.0	2.0
$21 \leq P_{\text{CMAX}} < 22$	5.0	3.0
$20 \leq P_{\text{CMAX}} < 21$	6.0	4.0
$16 \leq P_{\text{CMAX}} < 20$	5.0	
$11 \leq P_{\text{CMAX}} < 16$	6.0	
$-40 \leq P_{\text{CMAX}} < 11$	7.0	
NOTE 1: For UEs not indicating support of dynamic power sharing, the upper tolerance T_{high} shall be reduced by 0.3 dB for $P \geq 20$ dBm.		

When E-UTRA and NR transmissions overlap and the condition (If (a=TRUE) AND (b=FALSE)) is met, SCG shall be transmitted and the following supplementary minimum requirement apply for the measured SCG power, $P_{\text{UMAX},f,c,NR}(q)$, under nominal conditions.

$$10\log(p_{\text{CMAX_L},f,c,NR}(q)/X_{\text{scale}}) - T_{\text{LOW}}(10\log(p_{\text{CMAX_L},f,c,NR}(q)/X_{\text{scale}})) \leq P_{\text{UMAX},f,c,NR}(q) \leq 10\log(p_{\text{CMAX_H},f,c,NR}(q)) + T_{\text{HIGH}}(10\log(p_{\text{CMAX_H},f,c,NR}(q))).$$

with the tolerances T_{LOW} and T_{HIGH} for applicable values of P_{CMAX} specified in Table 6.2B.4.1.3-2.

6.2B.4.1.3a Inter-band NE-DC within FR1

For inter-band dual connectivity with one uplink serving cell per CG on E-UTRA and NR respectively, the UE is allowed to set its configured maximum output power $P_{\text{CMAX},c(i),i}$ for serving cell $c(i)$ of CG i , $i = 1, 2$, and its total configured maximum transmission power for NE-DC operation, $P_{\text{Total}}^{\text{NE-DC}} = 10\log_{10}(\hat{P}_{\text{total}}^{\text{NE-DC}})$ with $\hat{P}_{\text{total}}^{\text{NE-DC}}$ as specified in clause 7.6.1A of TS 38.213 [10].

The configured maximum output power $P_{\text{CMAX_E-UTRA},c}(p)$ in sub-frame p for the configured E-UTRA uplink carrier shall be set within the bounds:

$$P_{\text{CMAX_L_E-UTRA},c}(p) \leq P_{\text{CMAX_E-UTRA},c}(p) \leq P_{\text{CMAX_H_E-UTRA},c}(p)$$

where $P_{\text{CMAX_L_E-UTRA},c}$ and $P_{\text{CMAX_H_E-UTRA},c}$ are the limits for a serving cell c as specified in TS 36.101 [4] clause 6.2.5 modified by P_{LTE} as follows:

$$P_{\text{CMAX_L_E-UTRA},c} = \text{MIN} \{ P_{\text{EMAX, NE-DC}}, (P_{\text{PowerClass, NE-DC}} - \Delta P_{\text{PowerClass, NE-DC}}), \text{MIN}(P_{\text{EMAX},c}, P_{\text{LTE}}) - \Delta t_{\text{C_E-UTRA},c}, (P_{\text{PowerClass, E-UTRA}} - \Delta P_{\text{PowerClass, E-UTRA}}) - \text{MAX}(M_{\text{PR},c} + A - M_{\text{PR},c} + \Delta T_{\text{IB},c} + \Delta T_{\text{C_E-UTRA},c} + \Delta T_{\text{ProSe}}, P - M_{\text{PR},c}) \}$$

$$P_{\text{CMAX_H_E-UTRA},c} = \text{MIN} \{ P_{\text{EMAX},c}, P_{\text{EMAX, EN-DC}}, (P_{\text{PowerClass, NE-DC}} - \Delta P_{\text{PowerClass, NE-DC}}), P_{\text{LTE}}, P_{\text{PowerClass, E-UTRA}} - \Delta P_{\text{PowerClass, E-UTRA}} \}$$

with exception that

- if no symbol of slot i_1 of the NR that is indicated as uplink or flexible by *TDD-UL-DL-ConfigurationCommon* or *TDD-UL-DL-ConfigDedicated* overlaps with subframe i_2 of the E-UTRA; or
- if NR slot(s) that is indicated as downlink by *TDD-UL-DL-ConfigurationCommon* or *TDD-UL-DL-ConfigDedicated* does not overlap with subframe i_2 of the E-UTRA; then

$$P_{\text{CMAX_L_E-UTRA},c} = \text{MIN} \{ P_{\text{EMAX, NE-DC}}, (P_{\text{PowerClass, NE-DC}} - \Delta P_{\text{PowerClass, NE-DC}}), P_{\text{EMAX},c} - \Delta T_{\text{C_E-UTRA},c}, (P_{\text{PowerClass,E-UTRA}} - \Delta P_{\text{PowerClass,E-UTRA}}) - \text{MAX}(M\text{PR}_c + A\text{-M}\text{PR}_c + \Delta T_{\text{IB},c} + \Delta T_{\text{C_E-UTRA},c} + \Delta T_{\text{ProSe}}, P\text{-M}\text{PR}_c) \}$$

$$P_{\text{CMAX_H_E-UTRA},c} = \text{MIN} \{ P_{\text{EMAX},c}, P_{\text{EMAX, EN-DC}}, (P_{\text{PowerClass, NE-DC}} - \Delta P_{\text{PowerClass, NE-DC}}), P_{\text{PowerClass,E-UTRA}} - \Delta P_{\text{PowerClass,E-UTRA}} \}$$

The configured maximum output power $P_{\text{CMAX},f,c,\text{NR}}(q)$ in physical-channel q for the configured NR carrier shall be set within the bounds:

$$P_{\text{CMAX_L},f,c,\text{NR}}(q) \leq P_{\text{CMAX},f,c,\text{NR}}(q) \leq P_{\text{CMAX_H},f,c,\text{NR}}(q)$$

where $P_{\text{CMAX_L},f,c,\text{NR}}$ and $P_{\text{CMAX_H},f,c,\text{NR}}$ are the limits for a serving cell c as specified in clause 6.2.4 of TS 38.101-1 [2] modified by P_{NR} as follows:

$$P_{\text{CMAX_L},f,c,\text{NR}} = \text{MIN} \{ P_{\text{EMAX, NE-DC}}, (P_{\text{PowerClass, NE-DC}} - \Delta P_{\text{PowerClass, NE-DC}}), \text{MIN}(P_{\text{EMAX},c}, P_{\text{NR}}) - \Delta T_{\text{C_NR},c}, (P_{\text{PowerClass,NR}} - \Delta P_{\text{PowerClass,NR}}) - \text{MAX}(M\text{PR}_c + A\text{-M}\text{PR}_c + \Delta T_{\text{IB},c} + \Delta T_{\text{C_NR},c} + \Delta T_{\text{R}\text{X}\text{S}\text{R}\text{S}}, P\text{-M}\text{PR}_c) \}$$

$$P_{\text{CMAX_H},f,c,\text{NR}} = \text{MIN} \{ P_{\text{EMAX},c}, P_{\text{EMAX, NE-DC}}, (P_{\text{PowerClass, NE-DC}} - \Delta P_{\text{PowerClass, NE-DC}}), P_{\text{NR}}, P_{\text{PowerClass,NR}} - \Delta P_{\text{PowerClass,NR}} \}$$

- P_{LTE} signalled by RRC as p-MaxEUTRA in [36.331]
- P_{NR} signalled by RRC as p-NR-FR1 defined in [38.331]
- $\Delta T_{\text{C_E-UTRA},c} = 1.5\text{dB}$ when NOTE 2 in Table 6.2.2-1 in TS 36.101 [4] applies for a serving cell c , otherwise $\Delta T_{\text{C_E-UTRA},c} = 0\text{dB}$;
- $\Delta T_{\text{C_NR},c} = 1.5\text{dB}$ when NOTE 3 in Table 6.2.1-1 in TS 38.101-1 [2] applies for a serving cell c , otherwise $\Delta T_{\text{C_NR},c} = 0\text{dB}$;
- $\Delta T_{\text{IB},c}$ specified in clause 6.2B.4.2.3 for NE-DC, the individual Power Class defined in table 6.2B.1.3a and any other additional power reductions parameters specified in clauses 6.2B.2.3a for NE-DC are applicable to $P_{\text{CMAX_E-UTRA},c}$ and $P_{\text{CMAX},f,c,\text{NR}}$ evaluations.
- $P_{\text{PowerClass, NE-DC}}$ is defined in clause 6.2B.1.3a for inter-band NE-DC;
- $P_{\text{PowerClass,NR}}$ is the nominal UE power of the power class that the UE supports for the NR band of the EN-DC combination as defined in clause 6.2.1 of 38.101-1 [2];
- $P_{\text{PowerClass,E-UTRA}}$ is the nominal UE power of the power class that the UE supports for the E-UTRA band of the EN-DC combination as defined in clause 6.2.2 of 36.101 [4];
- $\Delta P_{\text{PowerClass,NE-DC}} = 3\text{ dB}$ for a power class 2 capable NE-DC UE when the IE *p-maxUE-FR1* as defined in TS 38.331 [9] is provided and set to the maximum output power of the default power class or lower; otherwise $\Delta P_{\text{PowerClass,NE-DC}} = 0\text{ dB}$;

If the transmissions from NR and E-UTRA do not overlap, then the complete clauses for configured transmitted power for E-UTRA and NR respectively from their own specifications apply with the modifications specified above. The lower value between $P_{\text{PowerClass, NE-DC}}$ or $P_{\text{EMAX, NE-DC}}$ shall not be exceeded at any time by UE.

$P_{\text{Total}}^{\text{NE-DC}} = 10\log_{10}(\hat{P}_{\text{total}}^{\text{NE-DC}})$ with $P_{\text{Total}}^{\text{NE-DC}}$ the configured maximum transmission power for NE-DC operation as specified in clause 7.6 of TS 38.213 [10].

The total configured maximum transmission power for both synchronous and non-synchronous operation is

$$P_{\text{Total}}^{\text{NE-DC}} = \text{MIN} \{ P_{\text{EMAX, NE-DC}}, P_{\text{PowerClass, NE-DC}} - \Delta P_{\text{PowerClass, NE-DC}} \}$$

If the UE does not support dynamic power sharing,

$$P_{\text{Total}}^{\text{NE-DC}} = \text{MIN} \{ P_{\text{EMAX, NE-DC}}, P_{\text{PowerClass, NE-DC}} - \Delta P_{\text{PowerClass, NE-DC}} \} + 0.3\text{ dB}$$

If the NE-DC UE does not support dynamic power sharing, then the complete clauses for configured transmitted power for E-UTRA and NR respectively from their own specifications TS 36.101 [4] and TS 38.101-1 [2] respectively apply with the modifications specified above and P_{Total}^{NE-DC} applies.

When a UE supporting dynamic sharing is configured for overlapping E-UTRA uplink and NR uplink transmissions, the UE can set its configured maximum output power $P_{CMAX_E-UTRA,c}$ and $P_{CMAX,f,c,NR}$ for the configured E-UTRA and NR uplink carriers, respectively, and its configured maximum transmission power for NE-DC operation, \hat{P}_{Total}^{NE-DC} , as specified above.

The measured total maximum output power P_{UMAX} over both CGs/RATs, measured over the transmission reference time duration is

$$P_{UMAX} = 10 \log_{10} [p_{UMAX,c,E-UTRA} + p_{UMAX,c,NR}],$$

where $p_{UMAX,c,E-UTRA}$ and $p_{UMAX,c,NR}$ denotes the measured output power of serving cell c for E-UTRA and NR respectively, expressed in linear scale.

The measured total configured maximum output power P_{UMAX} shall be within the following bounds:

$$P_{CMAX_L} - T_{LOW}(P_{CMAX_L}) \leq P_{UMAX} \leq P_{CMAX_H} + T_{HIGH}(P_{CMAX_H})$$

with the tolerances $T_{LOW}(P_{CMAX_L})$ and $T_{HIGH}(P_{CMAX_H})$ for applicable values of P_{CMAX} specified in Table 6.2B.4.1.3a-2.

When an UL subframe transmission p from E-UTRA overlap with a physical-channel q from the NR, then for P_{UMAX} evaluation, the E-UTRA subframe p is taken as reference period T_{REF} and always considered as the reference measurement duration and the following rules are applicable.

T_{REF} and T_{eval} are specified in Table 6.2B.4.1.3a-1 when same or different subframe and physical-channel durations are used in aggregated carriers. $P_{PowerClass_NE-DC}$ shall not be exceeded by the UE during any evaluation period of time.

Table 6.2B.4.1.3a-1: P_{CMAX} evaluation window

transmission duration	T_{REF}	T_{eval}
Different transmission duration in different RAT carriers	LTE Subframe	Min($T_{no_hopping}$, Physical Channel Length)

For each T_{REF} , the P_{CMAX_H} is evaluated per T_{eval} and given by the maximum value over the transmission(s) within the T_{eval} as follows:

$$P_{CMAX_H} = \text{MAX} \{ P_{CMAX_NE-DC_H}(p,q), P_{CMAX_NE-DC_H}(p,q+I), \dots, P_{CMAX_NE-DC_H}(p,q+n) \}$$

where $P_{CMAX_NE-DC_H}$ are the applicable upper limits for each overlapping scheduling unit pairs (p,q) , $(p,q+I)$, up to $(p,q+n)$ for each applicable T_{eval} duration, where $q+n$ is the last NR UL physical-channel overlapping with LTE subframe p .

While P_{CMAX_L} is computed as follows:

$$P_{CMAX_L} = \text{MIN} \{ P_{CMAX_NE-DC_L}(p,q), P_{CMAX_NE-DC_L}(p,q+I), \dots, P_{CMAX_NE-DC_L}(p,q+n) \}$$

where $P_{CMAX_NE-DC_L}$ are the applicable lower limits for each overlapping scheduling unit pairs (p,q) , $(p,q+I)$, up to $(p,q+n)$ for each applicable T_{eval} duration, where $q+n$ is the last NR UL physical-channel overlapping with LTE subframe p ,

With

$$P_{CMAX_NE-DC_H}(p,q) = \text{MIN} \{ 10 \log_{10} [p_{CMAX_H_E-UTRA,c}(p) + p_{CMAX_H,f,c,NR}(q)], P_{EMAX,NE-DC}, P_{PowerClass,NE-DC} \}$$

And:

$$a = 10 \log_{10} [p_{CMAX_E-UTRA,c}(p) + p_{CMAX,f,c,NR}(q)] > P_{Total}^{NE-DC}$$

If $a = \text{TRUE}$

$$P_{CMAX_NE-DC_L}(p,q) = \text{MIN} \{ 10 \log_{10} [p_{CMAX_L_E-UTRA,c}(p)], P_{EMAX,NE-DC}, P_{PowerClass,NE-DC} \}$$

Else

$$P_{\text{CMAX_NE-DC_L}}(p,q) = \text{MIN} \{ 10 \log_{10} [P_{\text{CMAX_L_E-UTRA,c}}(p) + P_{\text{CMAX_L,f,c,NR}}(q)], P_{\text{EMAX, NE-DC}}, P_{\text{PowerClass, NE-DC}} \}$$

where

- $P_{\text{CMAX_H_E-UTRA,c}}(p)$ is the E-UTRA higher limit of the maximum configured power expressed in linear scale;
- $P_{\text{CMAX_H,f,c,NR}}(q)$ is the NR higher limit of the maximum configured power expressed in linear scale;
- $P_{\text{CMAX_L_E-UTRA,c}}(p)$ is the E-UTRA lower limit of the maximum configured power expressed in linear scale;
- $P_{\text{CMAX_L,f,c,NR}}(q)$ is the NR lower limit of the maximum configured power expressed in linear scale;
- $P_{\text{PowerClass, NE-DC}}$ is defined in clause 6.2B.1.3a for inter-band NE-DC;
- $P_{\text{CMAX_E-UTRA,c}}(p)$ is the linear value of $P_{\text{CMAX_E-UTRA,c}}(p)$, the real configured max power for E-UTRA
- $P_{\text{CMAX_f,c,NR}}(q)$ is the linear value of $P_{\text{CMAX_f,c,NR}}(q)$, the real configured max power of NR

Table 6.2B.4.1.3a-2: P_{CMAX} tolerance for Dual Connectivity E-UTRA-NR

$P_{\text{CMAX}}(\text{dBm})$	Tolerance $T_{\text{LOW}}(P_{\text{CMAX_L}})$ (dB)	Tolerance $T_{\text{HIGH}}(P_{\text{CMAX_H}})$ (dB)
$23 \leq P_{\text{CMAX}} \leq 33$	3.0	2.0
$22 \leq P_{\text{CMAX}} < 23$	5.0	2.0
$21 \leq P_{\text{CMAX}} < 22$	5.0	3.0
$20 \leq P_{\text{CMAX}} < 21$	6.0	4.0
$16 \leq P_{\text{CMAX}} < 20$	5.0	
$11 \leq P_{\text{CMAX}} < 16$	6.0	
$-40 \leq P_{\text{CMAX}} < 11$	7.0	
NOTE 1: For UEs not indicating support of dynamic power sharing, the upper tolerance T_{high} shall be reduced by 0.3 dB for $P \geq 20$ dBm.		

When E-UTRA and NR transmissions overlap and the condition $a = \text{TRUE}$, $P_{\text{UMAX,f,c,NR}}(q)$ for MCG, under nominal conditions, shall meet

$$P_{\text{UMAX,f,c,NR}}(q) \leq 10 \log(P_{\text{CMAX_H,f,c,NR}}(q)) + T_{\text{HIGH}}(10 \log(P_{\text{CMAX_H,f,c,NR}}(q))).$$

with the tolerances T_{LOW} and T_{HIGH} for applicable values of P_{CMAX} specified in Table 6.2B.4a.1.3-2.

When LTE and NR transmissions overlap and the condition $a = \text{FALSE}$, then P_{UMAX} , under nominal conditions, shall be within the following bounds:

$$P_{\text{CMAX_L}} - T_{\text{LOW}}(P_{\text{CMAX_L}}) \leq P_{\text{UMAX}} \leq P_{\text{CMAX_H}} + T_{\text{HIGH}}(P_{\text{CMAX_H}})$$

where $P_{\text{CMAX_L}}$, $P_{\text{CMAX_H}}$, and P_{UMAX} are specified above with the tolerances T_{LOW} and T_{HIGH} specified in Table 6.2B.4a.1.3-2 for applicable values of $P_{\text{CMAX_L}}$ and $P_{\text{CMAX_H}}$.

6.2B.4.1.4 Inter-band EN-DC including FR2

For inter-band dual connectivity with one uplink serving cell per CG on E-UTRA and NR respectively, with NR configured in FR2, the UE is allowed to set its configured maximum output power $P_{\text{CMAX,c(i),i}}$ for serving cell $c(i)$ of CG i , $i = 1, 2$.

The UE maximum configured power $P_{\text{CMAX,c(i),i}}$, on E-UTRA for the subframe i shall be set according to clause 6.2.5 from TS 36.101 [4]. Applicable inter-band $\Delta T_{\text{IB,c}}$ parameters shall be used according to the clauses 6.2B.4.2.4 or 6.2B.4.2.5.

The UE maximum configured power $P_{\text{CMAX,c(j),i}}$, on NR for the slot j shall be set according to subclass 6.2.4 from TS 38.101-2 [3].

For the configured power measurements TS 36.101 [4] clause 6.2.5 and TS 38.101-2 [3] clause 6.2.4 are applicable.

6.2B.4.1.5 Inter-band EN-DC including both FR1 and FR2

For inter-band dual connectivity with one uplink serving cell per CG on E-UTRA and NR respectively, with both CGs configured in FR1, the requirements specified in clause 6.2B.4.1.3 apply.

For inter-band dual connectivity with one uplink serving cell per CG on E-UTRA and NR respectively, with NR configured in FR2, the requirements specified in clause 6.2B.4.1.4 apply.

For inter-band dual connectivity with one uplink serving cell in first CG on E-UTRA and two uplink serving cells in second CG on NR FR1 and NR FR2 respectively, the UE is allowed to set its configured maximum output power $P_{\text{CMAX},c(i),i}$ for serving cell $c(i)$, $i = 1,2,3$ with $i=1$ for E-UTRA, $i=2$ for NR FR1 and $i=3$ for NR FR2.

- For serving cell on FR2, the requirements specified in clause 6.2.4 in TS 38.101-2 [3] apply to the UE maximum configured power $P_{\text{CMAX},c(3),3}$ and the measured maximum configured power.
- For remaining inter-band dual connectivity involving CG1 and CG2, the requirements specified in clause 6.2B.4.1.3 apply.

6.2B.4.2 $\Delta T_{\text{IB},c}$ for DC

6.2B.4.2.0 General

For the UE which supports inter-band EN-DC or NE-DC configuration, $\Delta T_{\text{IB},c}$ in Tables below applies where unless otherwise stated, the same $\Delta T_{\text{IB},c}$ is applicable to NR band(s) part for DC configurations which have the same NR operating band combination. Unless otherwise stated, $\Delta T_{\text{IB},c}$ is set to zero.

Unless $\Delta T_{\text{IB},c}$ is specified for the NE-DC configuration, the specified $\Delta T_{\text{IB},c}$ for the EN-DC configuration including same bands as the corresponding NE-DC configuration is applicable for the NE-DC configuration.

6.2B.4.2.1 Intra-band contiguous EN-DC

$\Delta T_{\text{IB},c}$ is not applicable for intra-band contiguous EN-DC.

6.2B.4.2.2 Intra-band non-contiguous EN-DC

$\Delta T_{\text{IB},c}$ is not applicable for intra-band non-contiguous EN-DC.

6.2B.4.2.3 Inter-band EN-DC within FR1

6.2B.4.2.3.1 $\Delta T_{\text{IB},c}$ for EN-DC two bands

Table 6.2B.4.2.3.1-1: $\Delta T_{\text{IB},c}$ due to EN-DC(two bands)

Inter-band EN-DC configuration	E-UTRA or NR Band	$\Delta T_{\text{IB},c}$ (dB)
DC_1_n28	1	0.3
	n28	0.6
DC_1_n40	1	0.5
	n40	0.5
DC_1_n51	1	0.6
	n51	0.6
DC_1_n77	1	0.6
	n77	0.8
DC_1_n78	1	0.3
	n78	0.8
DC_2_n5	2	0.3
	n5	0.3
DC_2_n66	2	0.5
	n66	0.5
DC_2_n71	2	0.3
	n71	0.3
DC_2_n78	2	0.6

Inter-band EN-DC configuration	E-UTRA or NR Band	$\Delta T_{B,c}$ (dB)
	n78	0.8
DC_3_n7	3	0.5
	n7	0.5
DC_3_n28	3	0.3
	n28	0.3
DC_3_n40	3	0.5
	n40	0.5
DC_3_n51	3	0.3
	n51	0.3
DC_3_n77	3	0.6
	n77	0.8
DC_3_n78	3	0.6
	n78	0.8
DC_5_n40	5	0.3
	n40	0.3
DC_5_n66	5	0.3
	n66	0.3
DC_5_n78	5	0.6
	n78	0.8
DC_7_n28	7	0.3
	n28	0.3
DC_7_n51	7	0.3
	n51	0.3
DC_7_n78 DC_7-7_n78	7	0.5
	n78	0.8
DC_8_n40	8	0.3
	n40	0.3
DC_8_n77	8	0.6
	n77	0.8
DC_8_n78	8	0.6
	n78	0.8
DC_11_n77	11	0.4
	n77	0.8
DC_11_n78	11	0.4
	n78	0.8
DC_12_n5	12	0.4
	n5	0.8
DC_12_n66	12	0.8
	n66	0.3
DC_18_n77	18	0.3
	n77	0.8
DC_18_n78	18	0.3
	n78	0.8
DC_19_n77	19	0.3
	n77	0.8
DC_19_n78	19	0.3
	n78	0.8
DC_20_n8	20	0.4
	n8	0.4
DC_20_n28	20	0.5
	n28	0.5
DC_20_n51	20	0.5
	n51	0.5
DC_20_n77	20	0.6
	n77	0.8
DC_20_n78	20	0.6
	n78	0.8
DC_21_n77	21	0.4
	n77	0.8
DC_21_n78	21	0.4
	n78	0.8
DC_25_n41	25	0.5
	n41	0.4 ¹

Inter-band EN-DC configuration	E-UTRA or NR Band	$\Delta T_{IB,c}$ (dB)
		0.9 ²
DC_26_n41	26	0.3
	n41	0.3
DC_26_n77	26	0.3
	n77	0.8
DC_26_n78	26	0.3
	n78	0.8
DC_28_n51	28	0.5
	n51	0.5
DC_28_n77	28	0.5
	n77	0.8
DC_28_n78	28	0.5
	n78	0.8
DC_30_n5	30	0.3
	n5	0.3
DC_30_n66	30	0.5
	n66	0.8
DC_38_n78	n78	0.5
DC_39_n78	39	0.3
	n78	0.8
DC_39_n79	39	0.3
	n79	0.8
DC_40_n77	n77	0.5
DC_41_n77	41	0.3
	n77	0.8
DC_41_n78	41	0.3
	n78	0.8
DC_41_n79	41	0.3
	n79	0.8
DC_42_n51	42	0.6
	n51	0.8
DC_66_n5	66	0.3
	n5	0.3
DC_66_n71	66	0.3
	n71	0.3
DC_66_n78	66	0.6
	n78	0.8

NOTE 1: The requirement is applied for UE transmitting on the frequency range of 2545-2690 MHz.
NOTE 2: The requirement is applied for UE transmitting on the frequency range of 2496-2545 MHz.

6.2B.4.2.3.2

 $\Delta T_{IB,c}$ for EN-DC three bandsTable 6.2B.4.2.3.2-1: $\Delta T_{IB,c}$ due to EN-DC (three bands)

Inter-band EN-DC configuration	E-UTRA or NR Band	$\Delta T_{IB,c}$ (dB)
DC_1-3_n28	1	0.3
	3	0.3
	n28	0.6
DC_1-3_n77	1	0.6
	3	0.6
	n77	0.8
DC_1-3_n78	1	0.6
	3	0.6
	n78	0.8
DC_1-3_n79	1	0.3
	3	0.3
DC_1-5_n78	1	0.3
	5	0.6
	n78	0.8
DC_1-7_n28	1	0.5
	7	0.6

Inter-band EN-DC configuration	E-UTRA or NR Band	$\Delta T_{IB,c}$ (dB)
	n28	0.6
DC_1-7_n78 DC_1-7-7_n78	1	0.6
	7	0.6
	n78	0.8
DC_1-8_n78	1	0.3
	8	0.6
	n78	0.8
DC_1-18_n77	1	0.3
	18	0.3
	n77	0.8
DC_1-18_n78	1	0.3
	18	0.3
	n78	0.8
DC_1-19_n77	1	0.3
	19	0.3
	n77	0.8
DC_1-19_n78	1	0.3
	19	0.3
	n78	0.8
DC_1-19_n79	1	0.3
	19	0.3
DC_1-20_n28	1	0.3
	20	0.6
	n28	0.6
DC_1-20_n78	1	0.3
	20	0.3
	n78	0.8
DC_1-21_n77	1	0.3
	21	0.3
	n77	0.8
DC_1-21_n78	1	0.6
	21	0.4
	n78	0.8
DC_1-21_n79	1	0.3
	21	0.3
DC_1-28_n77	1	0.3
	28	0.6
	n77	0.8
DC_1-28_n78 DC_1_n28-n78	1	0.3
	28 or n28	0.6
	n78	0.8
DC_1_n28-n79	1	0.3
	n28	0.3
DC_1-41_n77	1	0.5
	41	0.5
	n77	0.8
DC_1-41_n78	1	0.5
	41	0.5
	n78	0.8
DC_1-41_n79	1	0.5
	41	0.5
DC_1-42_n77	1	0.6
	42	0.8
	n77	0.8
DC_1-42_n78	1	0.3
	42	0.8
	n78	0.8
DC_1-42_n79	1	0.3
	42	0.8
DC_1_n77-n79	1	0.6
	n77	0.8
DC_1_SUL_n78-n84	1	0.3
	n78	0.8

Inter-band EN-DC configuration	E-UTRA or NR Band	$\Delta T_{IB,c}$ (dB)
	n84	0.3
DC_1_n78-n79	1	0.3
	n78	0.8
	n79	0.5
DC_2-5_n66	2	0.5
	5	0.3
	n66	0.5
DC_2-30_n66	2	0.5
	30	0.3
	n66	0.5
DC_2-66_n71	2	0.5
	66	0.5
	n71	0.3
DC_2-(n)71	2	0.3
	71	0.3
	n71	
DC_3_n3-n77	3	0.6
	n3	0.6
	n77	0.8
DC_3_n3-n78	3	0.6
	n3	0.6
	n78	0.8
DC_3-5_n78	3	0.6
	5	0.6
	n78	0.8
DC_3-7_n28	3	0.5
	7	0.5
	n28	0.3
DC_3-7_n78, DC_3-7-7_n78	3	0.6
	7	0.6
	n78	0.8
DC_3-8_n78	3	0.6
	8	0.6
	n78	0.8
DC_3-19_n77	3	0.6
	19	0.3
	n77	0.8
DC_3-19_n78	3	0.6
	19	0.3
	n78	0.8
DC_3-19_n79	3	0.3
	19	0.3
	n79	0.3
DC_3-20_n28	3	0.3
	20	0.5
	n28	0.5
DC_3-20_n78	3	0.5
	20	0.3
	n78	0.8
DC_3-21_n77	3	0.8
	21	0.9
	n77	0.8
DC_3-21_n78	3	0.8
	21	0.9
	n78	0.8
DC_3-21_n79	3	0.8
	21	0.9
	n79	0.9
DC_3-28_n78	3	0.5
	28	0.3
	n78	0.8
DC_3_n28-n78	3	0.5
	n28	0.3
	n78	0.8
DC_3-38_n78	3	0.6

Inter-band EN-DC configuration	E-UTRA or NR Band	$\Delta T_{IB,c}$ (dB)
	n78	0.8
DC_3-41_n78	3	0.6
	41	0.3 ¹
		0.8 ²
	n78	0.8
DC_3-42_n77	3	0.6
	42	0.8
	n77	0.8
DC_3-42_n78	3	0.6
	42	0.8
	n78	0.8
DC_3-42_n79	3	0.6
	42	0.8
DC_3_n77-n79	3	0.6
	n77	0.8
DC_3_n78-n79	3	0.6
	n78	0.8
	n79	0.5
DC_3_SUL_n78-n80	3	0.6
	n78	0.8
	n80	0.6
DC_3_SUL_n78-n82	3	0.5
	n78	0.8
	n82	0.3
DC_5-7_n78, DC_5-7-7_n78	5	0.6
	7	0.6
	n78	0.8
DC_5-30_n66	5	0.3
	30	0.3
	n66	0.5
DC_7-20_n28	7	0.3
	20	0.6
	n28	0.6
DC_7-20_n78	7	0.3
	20	0.3
	n78	0.8
DC_7-28_n78	7	0.3
	28	0.3
	n78	0.8
DC_7_n28-n78	7	0.3
	n28	0.3
	n78	0.8
DC_7-46_n78	7	0.5
	n78	0.8
DC_8_SUL_n78- n81	8	0.6
	n78	0.8
	n81	0.6
DC_18-28_n77	18	0.5
	28	0.5
	n77	0.8
DC_18-28_n78	18	0.5
	28	0.5
	n78	0.8
DC_18-28_n79	18	0.5
	28	0.5
DC_19-21_n77	19	0.3
	21	0.4
	n77	0.8
DC_19-21_n78	19	0.3
	21	0.4
	n78	0.8
DC_19-21_n79	19	0.3
	21	0.4

Inter-band EN-DC configuration	E-UTRA or NR Band	$\Delta T_{IB,c}$ (dB)
DC_19-42_n77	19	0.3
	42	0.8
	n77	0.8
DC_19-42_n78	19	0.3
	42	0.8
	n78	0.8
DC_19-42_n79	19	0.3
	42	0.8
DC_19_n77-n79	19	0.3
	n77	0.8
DC_19_n78-n79	19	0.3
	n78	0.8
	n79	0.5
DC_20_n8-n75	20	0.4
	n8	0.4
DC_20_n28-n75	20	0.5
	n28	0.7
DC_20_n28-n78	20	0.6
	n28	0.6
	n78	0.8
DC_20_n75-n78	20	0.5
	n78	0.8
DC_20_n76-n78	20	0.5
	n78	0.8
DC_20_SUL_n78-n82	20	0.6
	n78	0.8
	n82	0.6
DC_20_SUL_n78-n83	20	0.8
	n78	0.8
	n83	0.8
DC_21-42_n77	21	0.4
	42	0.8
	n77	0.8
DC_21-42_n78	21	0.4
	42	0.8
	n78	0.8
DC_21-42_n79	21	0.4
	42	0.8
DC_21_n77-n79	21	0.4
	n77	0.8
DC_21_n78-n79	21	0.4
	n78	0.8
	n79	0.5
DC_28-42_n77	28	0.5
	42	0.8
	n77	0.8
DC_28-42_n78	28	0.5
	42	0.8
	n78	0.8
DC_28-42_n79	28	0.5
	42	0.8
DC_28_SUL_n78-n83	28	0.5
	n78	0.8
	n83	0.5
DC_41-42_n77	41	0.5
	42	0.8
	n77	0.8
DC_41-42_n78	41	0.5
	42	0.8
	n78	0.8
DC_41-42_n79	41	0.3
	42	0.8
DC_66_(n)71	66	0.3

Inter-band EN-DC configuration	E-UTRA or NR Band	$\Delta T_{IB,c}$ (dB)
	71	0.3
	n71	0.3
DC_66_SUL_n78-n86	66	0.6
	n78	0.8
	n86	0.6
NOTE 1: The requirement is applied for UE transmitting on the frequency range of 2545-2690 MHz.		
NOTE 2: The requirement is applied for UE transmitting on the frequency range of 2496-2545 MHz.		

6.2B.4.2.3.3

 $\Delta T_{IB,c}$ for EN-DC four bandsTable 6.2B.4.2.3.3-1: $\Delta T_{IB,c}$ due to EN-DC(four bands)

Inter-band EN-DC configuration	E-UTRA or NR Band	$\Delta T_{IB,c}$ (dB)
DC_1-3-5_n78	1	0.6
	3	0.6
	5	0.3
	n78	0.8
DC_1-3-7_n28	1	0.6
	3	0.6
	7	0.6
	n28	0.6
DC_1-3-7_n78 DC_1-3-7-7_n78	1	0.7
	3	0.7
	7	0.7
	n78	0.8
DC_1-3-8_n78	1	0.6
	3	0.6
	8	0.6
	n78	0.8
DC_1-3-19_n78	1	0.6
	3	0.6
	19	0.3
	n78	0.8
DC_1-3-19_n79	1	0.3
	3	0.3
	19	0.3
DC_1-3-20_n28	1	0.3
	3	0.3
	20	0.6
	n28	0.6
DC_1-3-20_n78	1	0.6
	3	0.6
	20	0.3
	n78	0.8
DC_1-3-21_n77	1	0.6
	3	0.8
	21	0.9
	n77	0.8
DC_1-3-21_n78	1	0.6
	3	0.8
	21	0.9
	n78	0.8
DC_1-3-21_n79	1	0.3
	3	0.8
	21	0.9
DC_1-3-28_n77	1	0.6
	3	0.6
	28	0.6
	n77	0.8

Inter-band EN-DC configuration	E-UTRA or NR Band	$\Delta T_{IB,c}$ (dB)
DC_1-3-28_n78 DC_1-3_n28-n78	1	0.6
	3	0.6
	28 or n28	0.6
	n78	0.8
DC_1-3-28_n79	1	0.6
	3	0.6
	28	0.6
DC_1-3-42_n77	1	0.6
	3	0.6
	42	0.8
	n77	0.8
DC_1-3-42_n78	1	0.6
	3	0.6
	42	0.8
	n78	0.8
DC_1-3-42_n79	1	0.6
	3	0.6
	42	0.8
DC_1-5-7_n78 DC_1-5-7-7_n78	1	0.6
	5	0.6
	7	0.6
	n78	0.8
DC_1-7-20_n28	1	0.5
	7	0.6
	20	0.6
	n28	0.6
DC_1-7-20_n78	1	0.6
	7	0.7
	20	0.4
	n78	0.8
DC_1-7_n28-n78	1	0.6
	7	0.6
	n28	0.6
	n78	0.8
DC_1-18-28_n77	1	0.3
	18	0.5
	28	0.5
	n77	0.8
DC_1-18-28_n78	1	0.3
	18	0.5
	28	0.5
	n78	0.8
DC_1-18-28_n79	1	0.3
	18	0.5
	28	0.5
DC_1-19-42_n77	1	0.6
	19	0.3
	42	0.8
	n77	0.8
DC_1-19-42_n78	1	0.3
	19	0.3
	42	0.8
	n78	0.8
DC_1-19-42_n79	1	0.3
	19	0.3
	42	0.8
DC_1-20_n28-n78	1	0.3
	20	0.6
	n28	0.6
	n78	0.8
DC_1-21-28_n77	1	0.6
	21	0.4
	28	0.6

Inter-band EN-DC configuration	E-UTRA or NR Band	$\Delta T_{IB,c}$ (dB)
	n77	0.8
DC_1-21-28_n78	1	0.3
	21	0.4
	28	0.6
	n78	0.8
DC_1-21-28_n79	1	0.3
	21	0.4
	28	0.6
DC_1-21-42_n77	1	0.6
	21	0.4
	42	0.8
	n77	0.8
DC_1-21-42_n78	1	0.3
	21	0.4
	42	0.8
	n78	0.8
DC_1-21-42_n79	1	0.3
	21	0.4
	42	0.8
DC_1-28-42_n77	1	0.6
	28	0.6
	42	0.8
	n77	0.8
DC_1-28-42_n78	1	0.3
	28	0.6
	42	0.8
	n78	0.8
DC_1-28-42_n79	1	0.3
	28	0.6
	42	0.8
DC_1-41-42_n77	1	0.5
	41	0.5
	42	0.8
	n77	0.8
DC_1-41-42_n78	1	0.5
	41	0.5
	42	0.8
	n78	0.8
DC_1-41-42_n79	1	0.5
	41	0.5
	42	0.8
DC_2-66-(n)71	2	0.5
	66	0.5
	71	
	n71	0.3
DC_3-5-7_n78, DC_3-5-7-7_n78	3	0.6
	5	0.6
	7	0.6
	n78	0.8
DC_3-7-20_n28	3	0.5
	7	0.5
	20	0.6
	n28	0.5
DC_3-7-20_n78	3	0.6
	7	0.6
	20	0.3
	n78	0.8
DC_3-7-28_n78	3	0.6
	7	0.6
	28	0.6
	n78	0.8
DC_3-7_n28-n78	3	0.6
	7	0.6

Inter-band EN-DC configuration	E-UTRA or NR Band	$\Delta T_{IB,c}$ (dB)
	n28	0.6
	n78	0.8
DC_3-19-21_n77	3	0.8
	19	0.3
	21	0.9
	n77	0.8
DC_3-19-21_n78	3	0.8
	19	0.3
	21	0.9
	n78	0.8
DC_3-19-21_n79	3	0.8
	19	0.3
	21	0.9
DC_3-19-42_n77	3	0.6
	19	0.3
	42	0.8
	n77	0.8
DC_3-19-42_n78	3	0.6
	19	0.3
	42	0.8
	n78	0.8
DC_3-19-42_n79	3	0.6
	19	0.3
	42	0.8
DC_3-20_n28-n78	3	0.6
	20	0.6
	n28	0.6
	n78	0.8
DC_3-21-42_n77	3	0.8
	21	0.9
	42	0.8
	n77	0.8
DC_3-21-42_n78	3	0.8
	21	0.9
	42	0.8
	n78	0.8
DC_3-21-42_n79	3	0.8
	21	0.9
	42	0.8
DC_3-28-42_n77	3	0.6
	28	0.5
	42	0.8
	n77	0.8
DC_3-28-42_n78	3	0.6
	28	0.5
	42	0.8
	n78	0.8
DC_3-28-42_n79	3	0.6
	28	0.5
	42	0.8
DC_7-20_n28-n78	7	0.3
	20	0.6
	n28	0.6
	n78	0.8
DC_19-21-42_n77	19	0.3
	21	0.4
	42	0.8
	n77	0.8
DC_19-21-42_n78	19	0.3
	21	0.4
	42	0.8
	n78	0.8
DC_19-21-42_n79	19	0.3

Inter-band EN-DC configuration	E-UTRA or NR Band	$\Delta T_{IB,c}$ (dB)
	21	0.4
	42	0.8
DC_21-28-42_n77	21	0.4
	28	0.5
	42	0.8
	n77	0.8
DC_21-28-42_n78	21	0.4
	28	0.5
	42	0.8
	n78	0.8
DC_21-28-42_n79	21	0.4
	28	0.5
	42	0.8

6.2B.4.2.3.4 $\Delta T_{IB,c}$ for EN-DC five bandsTable 6.2B.4.2.3.4-1: $\Delta T_{IB,c}$ due to EN-DC (five bands)

Inter-band EN-DC configuration	E-UTRA or NR Band	$\Delta T_{IB,c}$ (dB)
DC_1-3-5-7_n78, DC_1-3-5-7-7_n78	1	0.6
	3	0.6
	5	0.6
	7	0.6
	n78	0.8
DC_1-3-7-20_n28	1	0.6
	3	0.6
	7	0.6
	20	0.6
	n28	0.6
DC_1-3-7-20_n78	1	0.6
	3	0.6
	7	0.6
	20	0.6
	n78	0.6
DC_1-3-7_n28-n78	1	0.7
	3	0.7
	7	0.7
	n28	0.6
	n78	0.8
DC_1-3-19-21_n77	1	0.6
	3	0.8
	19	0.3
	21	0.9
	n77	0.8
DC_1-3-19-21_n78	1	0.6
	3	0.8
	19	0.3
	21	0.9
	n78	0.8
DC_1-3-19-21_n79	1	0.3
	3	0.8
	19	0.3
	21	0.9
DC_1-3-19-42_n77	1	0.6
	3	0.6
	19	0.3
	42	0.8
	n77	0.8

Inter-band EN-DC configuration	E-UTRA or NR Band	$\Delta T_{IB,c}$ (dB)
DC_1-3-19-42_n78	1	0.6
	3	0.6
	19	0.3
	42	0.8
	n78	0.8
DC_1-3-19-42_n79	1	0.6
	3	0.6
	19	0.3
	42	0.8
DC_1-3-20_n28-n78	1	0.6
	3	0.6
	20	0.6
	n28	0.6
	n78	0.8
DC_1-3-21-42_n77	1	0.6
	3	0.8
	21	0.9
	42	0.8
	n77	0.6
DC_1-3-21-42_n78	1	0.6
	3	0.8
	21	0.9
	42	0.8
	n78	0.6
DC_1-3-21-42_n79	1	0.6
	3	0.8
	21	0.9
	42	0.8
DC_1-3-28-42_n77	1	0.6
	3	0.6
	28	0.6
	42	0.8
	n77	0.8
DC_1-3-28-42_n78	1	0.6
	3	0.6
	28	0.6
	42	0.8
	n78	0.8
DC_1-3-28-42_n79	1	0.6
	3	0.6
	28	0.6
	42	0.8
DC_1-7-20_n28-n78	1	0.6
	7	0.7
	20	0.6
	n28	0.6
	n78	0.8
DC_1-19-21-42_n77	1	0.3
	19	0.3
	21	0.4
	42	0.8
	n77	0.8
DC_1-19-21-42_n78	1	0.3
	19	0.3
	21	0.4
	42	0.8
	n78	0.8
DC_1-19-21-42_n79	1	0.3

Inter-band EN-DC configuration	E-UTRA or NR Band	$\Delta T_{IB,c}$ (dB)
	19	0.3
	21	0.4
	42	0.8
DC_1-21-28-42_n77	1	0.6
	21	0.4
	28	0.6
	42	0.8
	n77	0.8
DC_1-21-28-42_n78	1	0.3
	21	0.4
	28	0.6
	42	0.8
	n78	0.8
DC_1-21-28-42_n79	1	0.3
	21	0.4
	28	0.6
	42	0.8
DC_3-7-20_n28-n78	3	0.6
	7	0.6
	20	0.6
	n28	0.6
	n78	0.8

6.2B.4.2.3.5 $\Delta T_{IB,c}$ for EN-DC six bands

Table 6.2B.4.2.3.5-1: $\Delta T_{IB,c}$ due to EN-DC (six bands)

Inter-band EN-DC configuration	E-UTRA or NR Band	$\Delta T_{IB,c}$ (dB)
DC_1-3-7-20_n28-n78	1	0.7
	3	0.7
	7	0.7
	20	0.6
	n28	0.6
	n78	0.8

6.2B.4.2.3a Inter-band NE-DC within FR1

Unless $\Delta T_{IB,c}$ is specified in this clause, the value of $\Delta T_{IB,c}$ for the correspondingly specified EN-DC configuration in clause 6.2B.4.2.3 is applicable.

6.2B.4.2.4 Inter-band EN-DC including FR2

6.2B.4.2.4.1 $\Delta T_{IB,c}$ for EN-DC two bands

Unless otherwise stated, $\Delta T_{IB,c}$ for E-UTRA and FR2 NR bands of inter-band EN-DC combinations defined in table 5.5B.5.1-1 is set to zero.

Table 6.2B.4.2.4.1-1: Void

6.2B.4.2.4.2 $\Delta T_{IB,c}$ for EN-DC three bands

Unless otherwise stated, $\Delta T_{IB,c}$ for FR2 NR bands is set to zero, and $\Delta T_{IB,c}$ for constituent E-UTRA bands for inter-band EN-DC defined in table 5.5B.5.2-1 is the same as those for the corresponding E-UTRA CA configuration specified in TS 36.101 [4], without the FR2 NR bands.

Table 6.2B.4.2.4.2-1: Void6.2B.4.2.4.3 $\Delta T_{IB,c}$ for EN-DC four bands

Unless otherwise stated, $\Delta T_{IB,c}$ for FR2 NR bands is set to zero, and $\Delta T_{IB,c}$ for constituent E-UTRA bands for inter-band EN-DC defined in table 5.5B.5.3-1 is the same as those for the corresponding E-UTRA CA configuration specified in TS 36.101 [4], without the FR2 NR bands.

Table 6.2B.4.2.4.3-1: Void6.2B.4.2.4.4 $\Delta T_{IB,c}$ for EN-DC five bands

Unless otherwise stated, $\Delta T_{IB,c}$ for FR2 NR bands is set to zero, and $\Delta T_{IB,c}$ for constituent E-UTRA bands for inter-band EN-DC defined in table 5.5B.5.4-1 is the same as those for the corresponding E-UTRA CA configuration specified in TS 36.101 [4], without the FR2 NR bands.

Table 6.2B.4.2.4.4-1: Void

6.2B.4.2.4.5 Void

6.2B.4.2.5 Inter-band EN-DC including both FR1 and FR2

6.2B.4.2.5.1 $\Delta T_{IB,c}$ for EN-DC three bands

Unless otherwise stated, for inter-band EN-DC configurations defined in table 5.5B.6.2-1, $\Delta T_{IB,c}$ for constituent FR2 NR bands is set to zero, and $\Delta T_{IB,c}$ for constituent E-UTRA and FR1 NR bands is the same as those for the corresponding inter band EN-DC configuration without the FR2 bands specified in 6.2B.4.2.3.

Table 6.2B.4.2.5.1-1: Void6.2B.4.2.5.2 $\Delta T_{IB,c}$ for EN-DC four bands

Unless otherwise stated, for inter-band EN-DC configurations defined in table 5.5B.6.3-1, $\Delta T_{IB,c}$ for constituent FR2 NR bands is set to zero, and $\Delta T_{IB,c}$ for constituent E-UTRA and FR1 NR bands is the same as those for the corresponding inter band EN-DC configuration without the FR2 bands specified in 6.2B.4.2.3.

6.2B.4.2.5.3 $\Delta T_{IB,c}$ for EN-DC five bands

Unless otherwise stated, for inter-band EN-DC configurations defined in table 5.5B.6.4-1, $\Delta T_{IB,c}$ for constituent FR2 NR bands is set to zero, and $\Delta T_{IB,c}$ for constituent E-UTRA and FR1 NR bands is the same as those for the corresponding inter band EN-DC configuration without the FR2 bands specified in 6.2B.4.2.3.

6.2B.4.2.5.4 $\Delta T_{IB,c}$ for EN-DC six bands

Unless otherwise stated, for inter-band EN-DC configurations defined in table 5.5B.6.5-1, $\Delta T_{IB,c}$ for constituent FR2 NR bands is set to zero, and $\Delta T_{IB,c}$ for constituent E-UTRA and FR1 NR bands is the same as those for the corresponding inter band EN-DC configuration without the FR2 bands specified in 6.2B.4.2.3.

6.2B.5 Configured output power for NR-DC

6.2B.5.1 Configured output power level

6.2B.5.1.1 Inter-band NR-DC between FR1 and FR2

For synchronous inter-band NR-DC [12] with MCG in FR1 and SCG in FR2 combined with one uplink serving cell per CG, the UE is allowed to set its configured maximum output power $P_{C_{MAX,c(i),i}}$ for serving cell $c(i)$ of CG i , $i = 1,2$ as specified in clause 6.2.4 of TS 38.101-1 [2] and clause 6.2.4 TS 38.101-2 [3] independently.

6.3 Output power dynamics

Output power dynamics for EN-DC operations in FR1 and FR2 as specified in TS 38.101-1 [2] and TS 38.101-2 [3], respectively. E-UTRA as specified in TS 36.101 [4]. For intra-band contiguous EN-DC operation in FR1, minimum output power requirements specified in clause 6.3.1 of TS 38.101-1 [2] and clause 6.3.2 of TS 36.101 [4] shall only apply when the power of all NR and E-UTRA carriers are set to minimum value. Similarly, OFF power requirements specified in clause 6.3.2 of TS 38.101-1 [2] and clause 6.3.3 of TS 36.101 [4] shall only apply when the power of all NR and E-UTRA carriers are OFF. The OFF power condition in transmit ON/OFF time mask requirements specified in clause 6.3.3 of TS 38.101-1 [2] and clause 6.3.4 of TS 36.101 [4] is applicable only when all NR and E-UTRA carriers are OFF. If both E-UTRA and NR transition between ON and OFF states simultaneously, the longer transient time shall apply to both. If either E-UTRA or NR is OFF and the other carrier transitions from OFF to ON, then the transient time associated with that carrier applies.

6.3A Output power dynamics for CA

For inter-band NR CA between FR1 and FR2, output power dynamics as specified in TS 38.101-1 [2] and TS 38.101-2 [3] apply for FR1 and FR2 respectively.

6.3B Output power dynamics for DC

6.3B.0 General

The E-UTRA and NR switching time mask defines the observation period between E-UTRA subframe and NR slot/mini-slot boundary. Both E-UTRA subframe and NR slot/mini-slot have ON power transmissions. The ON power is defined as the mean power over the symbol duration excluding any transient period. For E-UTRA subframe or NR slot/mini-slot having OFF power transmission, the general time mask for E-UTRA or NR shall apply.

For inter-band EN-DC, output power dynamics requirement for E-UTRA single carrier and CA operation specified in clauses 6.3 of TS 36.101 [4] and for NR single carrier and CA operation specified in clause 6.3 of TS 38.101-1 [2] and clause 6.3, 6.3A and 6.3D of TS 38.101-2 [3] apply.

6.3B.1 Output power dynamics for EN-DC with UL sharing from UE perspective

6.3B.1.1 E-UTRA and NR switching time mask for TDM based UL sharing from UE perspective

The E-UTRA and NR switching time mask is applicable for non-simultaneous transmissions between E-UTRA and NR in TDM based UL sharing from the UE perspective in the same channel, which is shared by E-UTRA and NR .

For UEs reporting E-UTRA and NR switching time capability of type 1 with switching time < 0.5 us for TDM based UL sharing from UE perspective within FR1 time masks in Figure 6.3B.1.1-1 and Figure 6.3B.1.1-2 shall apply. For UEs reporting E-UTRA and NR switching time capability of type 2 with switching time < 20 us for TDM based UL sharing from UE perspective within FR1, time masks in Figure 6.3B.1.1-3 and Figure 6.3B.1.1-4 shall apply.

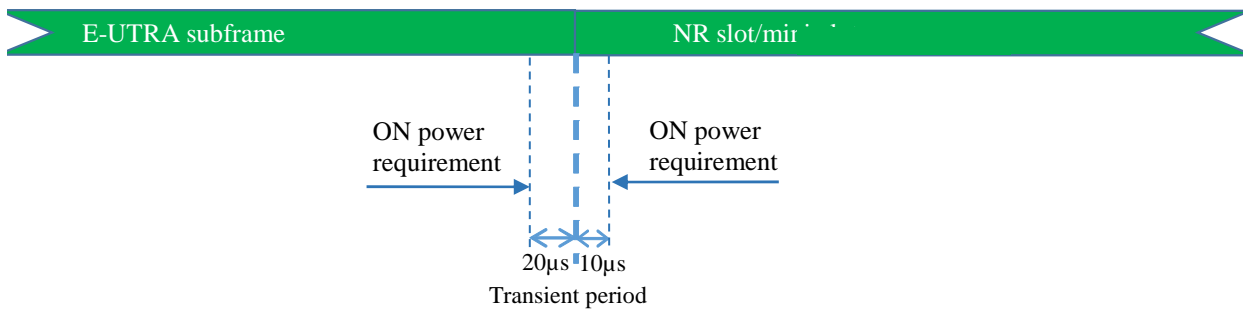

Figure 6.3B.1.1-1: E-UTRA to NR switching time mask for type 1 for TDM based UL sharing from UE perspective within FR1

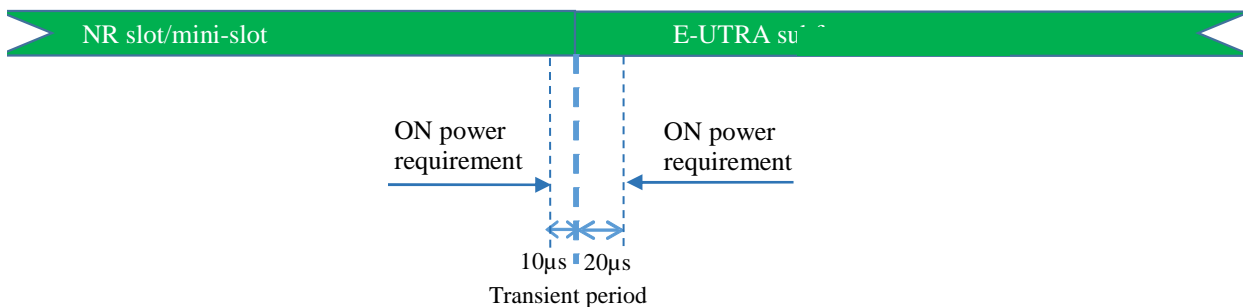

Figure 6.3B.1.1-2: NR to E-UTRA switching time mask for type 1 for TDM based UL sharing from UE perspective within FR1

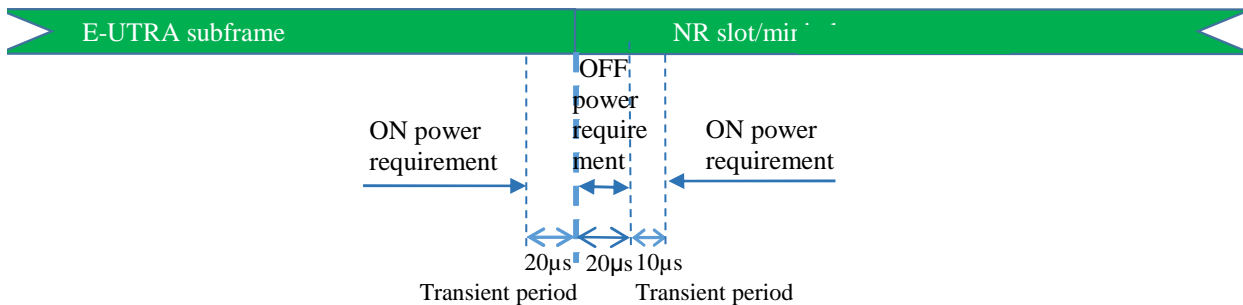

Figure 6.3B.1.1-3: E-UTRA to NR switching time mask for type 2 for TDM based UL sharing from UE perspective within FR1

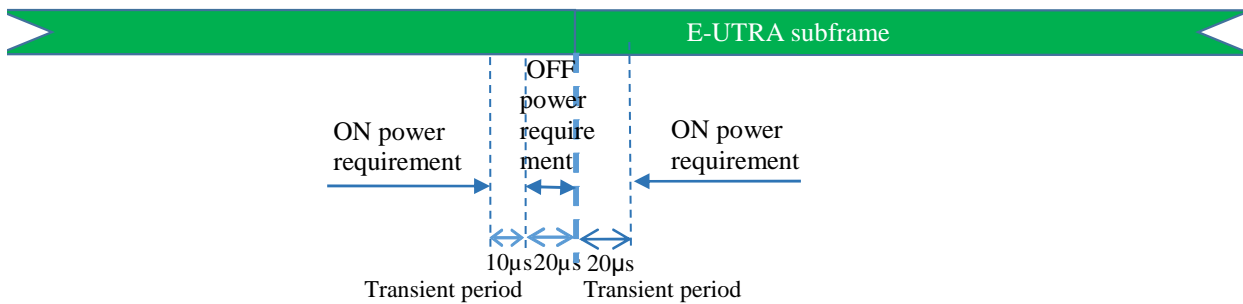

Figure 6.3B.1.1-4: NR to E-UTRA switching time mask for type 2 for TDM based UL sharing from UE perspective within FR1

6.3B.1a Output power dynamics for NE-DC with UL sharing from UE perspective

The E-UTRA and NR switching time mask is applicable for non-simultaneous transmissions between E-UTRA and NR in TDM based UL sharing from the UE perspective in the same channel, which is shared by E-UTRA and NR. Unless otherwise specified, the 6.3B.1.1 clauses for NE-DC are applicable.

6.3B.2 Output power dynamics for intra-band EN-DC without dual PA capability

For intra-band contiguous EN-DC configurations DC_(n)41 and DC_(n)71, and all intra-band non-contiguous EN-DC configurations without dual PA capability, maximum UL switching time is defined as 120 us and DL reception interruption is allowed during UL switching. Time masks in Figure 6.3B.2-1 and Figure 6.3B.2-2 shall apply. Unless otherwise stated, for other intra-band contiguous EN-DC configurations, the switching time in 6.3B.1.1 applies.

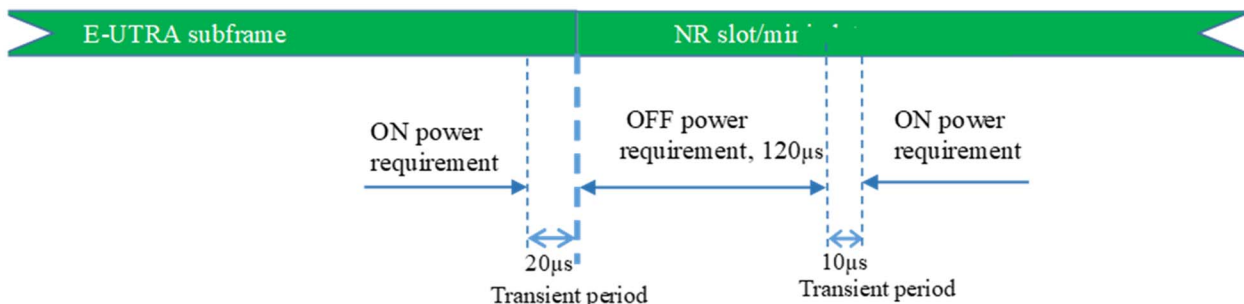

Figure 6.3B.2-1: E-UTRA to NR switching time mask for intra-band EN-DC without dual PA capability when single UL is allowed

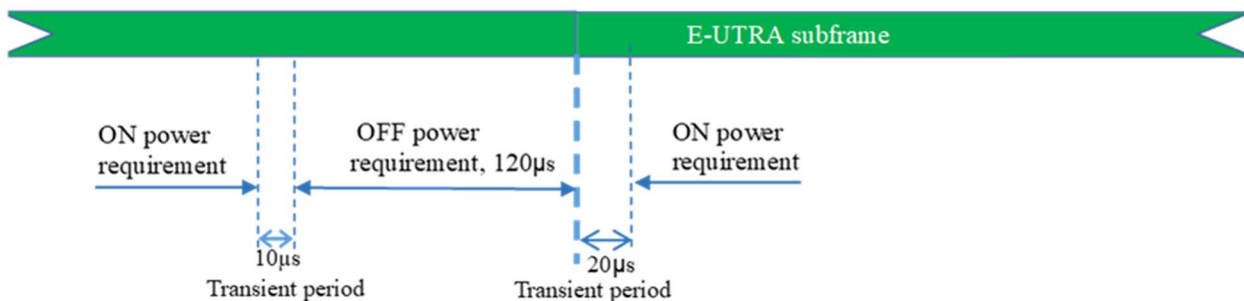

Figure 6.3B.2-2: NR to E-UTRA switching time mask for intra-band EN-DC without dual PA capability when single UL is allowed

6.3B.3 Output power dynamics for intra-band EN-DC with dual PA capability

For both intra-band contiguous and non-contiguous EN-DC with dual PA capability, time masks in Figure 6.3B.3-1 and Figure 6.3B.3-2 shall apply.

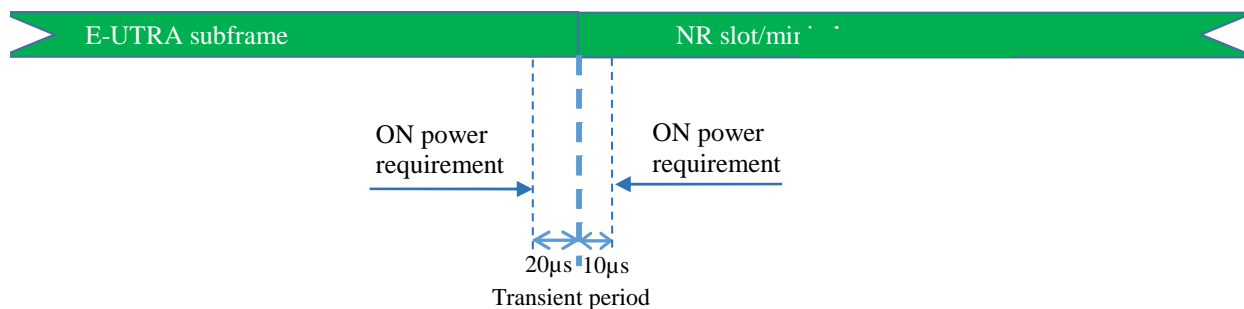

Figure 6.3B.3-1: E-UTRA to NR switching time mask for intra-band EN-DC with dual PA capability

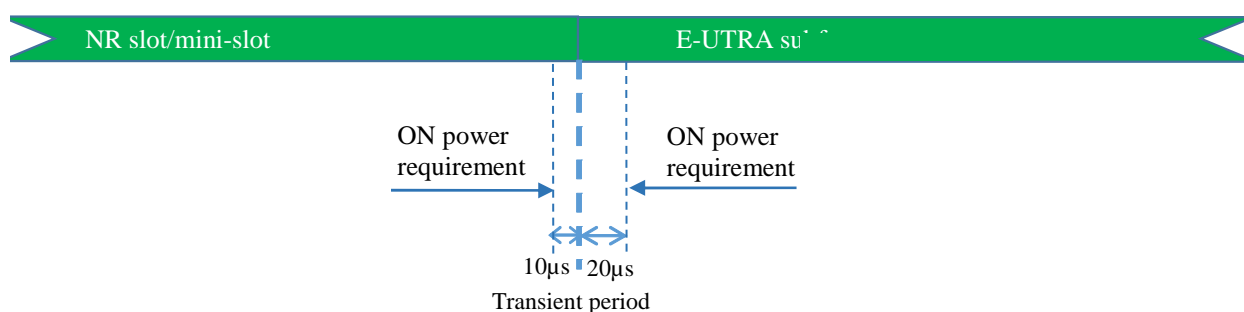

Figure 6.3B.3-2: NR to E-UTRA switching time mask for intra-band EN-DC with dual PA capability

6.4 Void

6.4A Transmit signal quality for CA

6.4A.1 Frequency error for CA

For inter-band NR CA between FR1 and FR2, frequency error as specified in TS 38.101-1 [2] and TS 38.101-2 [3] apply for FR1 and FR2 respectively.

6.4A.2 Transmit modulation quality for CA

For inter-band NR CA between FR1 and FR2, transmit modulation quality as specified in TS 38.101-1 [2] and TS 38.101-2 [3] apply for FR1 and FR2 respectively.

6.4B Transmit signal quality for DC

6.4B.1 Frequency error for DC

6.4B.1.1 Frequency error for Intra-band contiguous EN-DC

For intra-band contiguous EN-DC, the requirement shall apply on each component carrier as defined in clause 6.5.1 in TS 36.101 [4] and in clause 6.4.1 in TS 38.101-1 [2], respectively.

6.4B.1.2 Frequency error for Intra-band non-contiguous EN-DC

For intra-band non-contiguous EN-DC, the requirement shall apply on each component carrier as defined in clause 6.5.1 in TS 36.101 [4] and in clause 6.4.1 in TS 38.101-1 [2], respectively.

6.4B.1.3 Frequency error for inter-band EN-DC within FR1

For inter-band EN-DC with uplink assigned to one E-UTRA band and one NR band, the requirements shall apply on each component carrier as defined in clause 6.5.1 in TS 36.101 [4] and in clause 6.4.1 in TS 38.101-1 [2], respectively, with all component carriers active. If multiple component carriers are assigned to one E-UTRA band, the requirements in clauses 6.5.1A in TS 36.101 [4] apply for those component carriers.

6.4B.1.3a Frequency error for inter-band NE-DC within FR1

For inter-band NE-DC with uplink assigned to one E-UTRA band and one NR band, the requirements shall apply on each component carrier as defined in clause 6.5.1 in TS 36.101 [4] and in clause 6.4.1 in TS 38.101-1 [2], respectively, with all component carriers active. If multiple component carriers are assigned to one E-UTRA band, the requirements in clauses 6.5.1A in TS 36.101 [4] apply for those component carriers, and if multiple component carriers are assigned to one NR band, the requirements in clauses 6.4A.1 in TS 38.101-1 [2] apply for those component carriers.

6.4B.1.4 Frequency error for inter-band EN-DC including FR2

Frequency error requirement for E-UTRA single carrier and CA operation specified in clauses 6.5.1 and 6.5.1A of TS 36.101 [4] and for NR single carrier and CA operation specified in clause 6.4.1, 6.4A.1 and 6.4D.1 of TS 38.101-2 [3] apply.

6.4B.1.5 Frequency error for inter-band EN-DC including both FR1 and FR2

Frequency error requirement for E-UTRA single carrier and CA operation specified in clauses 6.5.1 and 6.5.1A of TS 36.101 [4] and for NR single carrier and CA operation specified in clause 6.4.1 of TS 38.101-1 [2] and clause 6.4.1, 6.4A.1 and 6.4D.1 of TS 38.101-2 [3] apply.

6.4B.2 Transmit modulation quality for DC

6.4B.2.1 Transmit modulation quality for Intra-band contiguous EN-DC

6.4B.2.1.1 Error Vector Magnitude

For the intra-band contiguous EN-DC with one component carrier per CG the EVM requirement applies with PRB allocation in one of the CG and the other CG unallocated.

The EVM requirements for each CG are according to clause 6.5.2 of TS 36.101 [4] for the MCG and 6.4.2 of TS 38.101-1 [2] for the SCG with EN-DC configured.

6.4B.2.1.2 Carrier leakage

The carrier leakage requirements for each CG are according to clause 6.5.2 of TS 36.101 [4] for the MCG and 6.4.2 of TS 38.101-1 [2] for the SCG with EN-DC configured.

6.4B.2.1.3 In-band emissions

For the MCG the in-band emission requirements in Table 6.5.2A.3.1-1 and 6.5.2A.3.1-2 in TS 36.101 [4] apply within the aggregated transmission bandwidth configuration of the EN-DC bandwidth with the carriers of both CGs active and one single contiguous PRB allocation of bandwidth L_{CRB} within the MCG at the edge of the said aggregated transmission bandwidth configuration.

For the SCG the in-band emission requirements in Table 6.4.2.3-1 in TS 38.101-1 [2] apply within the aggregated transmission bandwidth configuration of the EN-DC bandwidth with the carriers of both CGs active and one single contiguous PRB allocation of bandwidth L_{CRB} within the SCG at the edge of the aggregated transmission bandwidth configuration.

6.4B.2.2 Transmit modulation quality for Intra-band non-contiguous EN-DC

6.4B.2.2.1 Error Vector Magnitude

For the intra-band non-contiguous EN-DC with one component carrier per CG the EVM requirement applies with PRB allocation in one of the CG and the other CG unallocated.

The EVM requirements for each CG are according to clause 6.5.2 of TS 36.101 [4] for the MCG and 6.4.2 of TS 38.101-1 [2] for the SCG with EN-DC configured.

6.4B.2.2.2 Carrier leakage

The carrier leakage requirements for each CG are according to clause 6.5.2 of TS 36.101 [4] for the MCG and 6.4.2 of TS 38.101-1 [2] for the SCG with EN-DC configured and PRB allocation only in the CG being measured.

6.4B.2.2.3 In-band emissions

For the MCG the in-band emission requirements in Table 6.5.2A.3.1-1 and 6.5.2A.3.1-2 in TS 36.101 [4] apply within the transmission bandwidth configuration of the MCG with the carriers of both CGs active and one single contiguous PRB allocation of bandwidth L_{CRB} within the MCG at the edge of the transmission bandwidth configuration.

For the SCG the in-band emission requirements in Table 6.4.2.3-1 in TS 38.101-1 [2] apply within the transmission bandwidth configuration of the SCG with the carriers of both CGs active and one single contiguous PRB allocation of bandwidth L_{CRB} within the SCG at the edge of the transmission bandwidth configuration.

6.4B.2.3 Transmit modulation quality for Inter-band EN-DC within FR1

For inter-band EN-DC with uplink assigned to one E-UTRA band and one NR band, the requirements shall apply on each component carrier as defined in clause 6.5.2 in TS 36.101 [4] and in clause 6.4.2 in TS 38.101-1 [2], respectively, with all component carriers active, applies with PRB allocation in one of the CG and the other CG unallocated. If multiple component carriers are assigned to one E-UTRA band, the requirements in subclauses 6.5.2A in TS 36.101 [4] apply for those component carriers.

6.4B.2.3a Transmit modulation quality for Inter-band NE-DC within FR1

For inter-band NE-DC with uplink assigned to one E-UTRA band and one NR band, the requirements shall apply on each component carrier as defined in clause 6.5.2 in TS 36.101 [4] and in clause 6.4.2 in TS 38.101-1 [2], respectively, with all component carriers active, applies with PRB allocation in one of the CG and the other CG unallocated. If multiple component carriers are assigned to one E-UTRA band, the requirements in subclauses 6.5.2A in TS 36.101 [4] apply for those component carriers, and if multiple component carriers are assigned to one NR band, the requirements in subclauses 6.4A.2 in TS 38.101-1 [2] apply for those component carriers.

6.4B.2.4 Transmit modulation quality for Inter-band EN-DC including FR2

Transmit modulation quality requirement for E-UTRA single carrier and CA operation specified in clauses 6.5.2 and 6.5.2A of TS 36.101 [4] and for NR single carrier and CA operation specified in clause 6.4.2, 6.4A.2 and 6.4D.2 of TS 38.101-2 [3] apply.

6.4B.2.5 Transmit modulation quality for inter-band EN-DC including both FR1 and FR2

Transmit modulation quality requirement for E-UTRA single carrier and CA operation specified in clauses 6.5.2 and 6.5.2A of TS 36.101 [4] and for NR single carrier and CA operation specified in clause 6.4.2 of TS 38.101-1 [2] and clause 6.4.2, 6.4A.2 and 6.4D.2 of TS 38.101-2 [3] apply.

6.5 Void

6.5A Output RF spectrum emissions for CA

6.5A.1 Occupied bandwidth for CA

For inter-band NR CA between FR1 and FR2, occupied bandwidth specified in TS 38.101-1 [2] and TS 38.101-2 [3] apply for each frequency range respectively.

6.5A.2 Out-of-band emissions for CA

For inter-band NR CA between FR1 and FR2, out-of-band emissions specified in TS 38.101-1 [2] and TS 38.101-2 [3] apply for each frequency range respectively.

6.5A.3 Spurious emissions for CA

6.5A.3.1 Inter-band CA between FR1 and FR2

Unless otherwise stated, for inter-band CA between FR1 and FR2, spurious emission and UE co-existence requirements specified in TS 38.101-1 [2] and TS 38.101-2 [3] apply for each component carrier respectively.

Table 6.5A.3.1-1: Void

6.5A.4 Transmit intermodulation for CA

For inter-band NR CA between FR1 and FR2, transmit intermodulation specified in TS 38.101-1 [2] apply for each component carrier for NR FR1.

6.5B Output RF spectrum emissions for DC

6.5B.1 Occupied bandwidth for EN-DC

6.5B.1.1 Intra-band contiguous EN-DC

For intra-band contiguous EN-DC the occupied bandwidth is a measure of the bandwidth containing 99% of the total integrated power of the transmitted spectrum. The OBW shall be less than the aggregated channel bandwidth for EN-DC, denoted as ENBW in clause 5.3B.

6.5B.1.2 Intra-band non-contiguous EN-DC

For intra-band non-contiguous EN-DC, occupied bandwidth requirement for E-UTRA single carrier and CA operation specified in clauses 6.6.1 and 6.6.1A of TS 36.101 [4] and for NR single carrier specified in clause 6.5.1 of TS 38.101-1 [2] apply.

6.5B.1.3 Inter-band EN-DC within FR1

Occupied bandwidth requirement for E-UTRA single carrier and CA operation specified in clauses 6.6.1 and 6.6.1A of TS 36.101 [4] and for NR single carrier specified in clause 6.5.1 of TS 38.101-1 [2] apply.

6.5B.1.4 Inter-band EN-DC including FR2

Occupied bandwidth requirement for E-UTRA single carrier and CA operation specified in clauses 6.6.1 and 6.6.1A of TS 36.101 [4] and for NR single carrier and CA operation specified in clause 6.5.1, 6.5A.1 and 6.5D.1 of TS 38.101-2 [3] apply.

6.5B.1.5 Inter-band EN-DC including both FR1 and FR2

Occupied bandwidth requirement for E-UTRA single carrier and CA operation specified in clauses 6.6.1 and 6.6.1A of TS 36.101 [4] and for NR single carrier and CA operation specified in clause 6.5.1 of TS 38.101-1 [2] and clause 6.5.1, 6.5A.1 and 6.5D.1 of TS 38.101-2 [3] apply.

6.5B.2 Out-of-band emissions for DC

6.5B.2.1 Intra-band contiguous EN-DC

The out of band emissions are unwanted emissions immediately outside the EN-DC aggregated channel bandwidth resulting from the modulation process and non-linearity in the transmitter but excluding spurious emissions. This out of band emission limit is specified in terms of a spectrum emission mask and an adjacent channel leakage power ratio.

Unless otherwise stated, the OOB limits specified for the DC combination in this clause supercede any OOB requirements specified for each sub-block in the respective TS 36.101 [4] and TS 38.101-1 [2].

The requirements apply to the sum of transmissions across all antenna connectors.

6.5B.2.1.1 Spectrum emissions mask

The spectrum emission mask of the UE applies to frequencies (Δf_{OOB}) starting from the \pm edge of the EN-DC aggregated channel bandwidth. For frequencies offset greater than Δf_{OOB} as specified in Table 6.5B.2.1.1-1 the spurious requirements in clause 6.5B.3 are applicable.

The general spectrum emission for intra-band contiguous EN-DC is specified in Table 6.5B.2.1.1-1.

The power of any UE emission shall not exceed the levels specified in Table 6.5B.2.1.1-1 for the specified EN-DC aggregated channel bandwidth.

Table 6.5B.2.1.1-1. General spectrum emission mask for intra-band contiguous EN-DC

Δf_{OOB} (MHz)	Spectrum emission limit (dBm)	Measurement bandwidth
$\pm 0 - 1$	$\text{Max}(\text{Round}(10 \cdot \log(0.15/\text{ENBW})), -24)$	30 kHz
$\pm 1 - 5$	-10	1 MHz
$\pm 5 - \text{ENBW}$	-13	1 MHz
$\pm \text{ENBW} - (\text{ENBW} + 5)$	-25	1 MHz
NOTE: ENBW refers to the aggregated channel bandwidth in MHz as defined in clause 5.3B.		

6.5B.2.1.2 Additional spectrum emissions mask

6.5B.2.1.2.1 Requirements for network signalled value "NS_35"

When NS_35 is indicated in the MCG and NS_35 is indicated in the SCG, the requirements in Table 6.5B.2.1.2.1-1 apply in the frequency ranges immediately adjacent and outside the aggregated sub-blocks of the EN-DC configuration for DC_(n)71AA.

Table 6.5B.2.1.2.1-1: Additional requirements

Δf_{OOB} (MHz)	Frequency offset of measurement filter centre frequency, f_{offset}	Minimum requirement (dBm)	Measurement bandwidth
$0 \text{ MHz} \leq \Delta f < 0.1 \text{ MHz}$	$0.015 \text{ MHz} \leq f_{\text{offset}} < 0.085 \text{ MHz}$	-13	30 kHz
$0.1 \text{ MHz} \leq \Delta f < \text{ENBW}$	$0.15 \text{ MHz} \leq f_{\text{offset}} < \text{ENBW} - 0.05 \text{ MHz}$	-13	100 kHz
$\text{ENBW} \leq \Delta f < \text{ENBW} + 5 \text{ MHz}$	$\text{ENBW} + 0.5 \text{ MHz} \leq f_{\text{offset}} < \text{ENBW} + 4.5 \text{ MHz}$	-25	1 MHz
NOTE 1: ENBW is the aggregated bandwidth of an E-UTRA sub-block and an adjacent NR sub-block; there is no frequency separation between the said sub-blocks. The sub-block bandwidths include any internal guard bands.			

6.5B.2.1.2.2 Requirements for network signalled value "NS_04"

Additional spectrum emission requirements are signalled by the network to indicate that the UE shall meet an additional requirement for a specific deployment scenario as part of the cell handover/broadcast message.

The Band 41/n41 SEM transition point from -13 dBm/MHz to -25 dBm/MHz is based on the emission bandwidth. The emission bandwidth is defined as the width of the signal between two points, one below the carrier center frequency and one above the carrier center frequency, outside of which all emissions are attenuated at least 26 dB below the transmitter power. Since the 26 dB emission bandwidth is implementation dependent, the transmission bandwidths occupied by RBs is used for the SEM. The emission bandwidth for E-UTRA carriers is document in TS 36.101 [4], and the emission bandwidth for NR carriers is documented in TS 38.101-1 [2]. The total emission bandwidth for contiguous intra-band EN-DC is the sum of the emission bandwidth for each CC plus the guard band between contiguous CCs.

When "NS_04" is indicated in the cell, the power of any UE emission shall not exceed the levels specified in Table 6.5B.2.1.2.2-1.

Table 6.5B.2.1.2.2-1: DC_(n)41 SEM with NS_04

Δf_{OOB} MHz	Spectrum emission limit (dBm) / measurement bandwidth for each ENBW					Measurement bandwidth
	15 MHz	20 MHz	40 MHz	50 MHz	> 50 MHz	
$\pm 0 - 1$	-10	-10	-10			2 % ENBW
				-10		1 MHz
$\pm 1 - 5$			-10			1 MHz
$\pm 5 - X$			-13			
$\pm X - (ENBW + 5 \text{ MHz})$			-25			

NOTE: X is defined as the sum of the emission bandwidth of the component carriers plus the guard band between contiguous CCs.

6.5B.2.1.3 Adjacent channel leakage ratio

For EN-DC operation with an E-UTRA sub-block immediately adjacent to an NR sub-block, the ACLR is defined as the ratio of the filtered mean power centred on the aggregated sub-block bandwidth ENBW to the filtered mean power centred on an adjacent bandwidth of the same size ENBW at nominal channel spacing. The UE shall meet the ACLR minimum requirement EN-DC_{ACLR} specified in Table 6.5B.2.1.3-1 with ENBW the sum of the sub-block bandwidths.

The assigned channel power and adjacent channel power are measured with rectangular filters with measurement bandwidths specified in 6.5B.2.1.3-1.

Table 6.5B.2.1.3-1: ACLR for intra-band EN-DC (contiguous sub-blocks)

Parameter	Unit	Value
EN-DC _{ACLR} for PC3	dBc	30
EN-DC _{ACLR} for PC2	dBc	31
Measurement bandwidth of EN-DC channel		1.00*ENBW
Measurement bandwidth of adjacent channel		0.95*ENBW
Frequency offset of adjacent channel		ENBW / -ENBW

NOTE 1: ENBW is the aggregated bandwidth in MHz as defined in clause 5.3B.
NOTE 2: The frequency offset is that in between the centre frequencies of the measurement filters

6.5B.2.2 Intra-band non-contiguous EN-DC

6.5B.2.2.1 Spectrum emissions mask

The spectral emission mask for intra-band non-contiguous EN-DC is a composite of the emission mask for each CC with the level set to the maximum value from each mask for each frequency outside of the transmission bandwidth of either carrier. A composite spectrum emission mask is a combination of individual CC spectrum emissions masks. Where two masks overlap the most relaxed limit is used. Composite spectrum emission mask applies to frequencies up to $\pm \Delta f_{\text{OOB}}$ starting from the edges of the sub-blocks. If for some frequency an individual CC spectrum emission mask overlaps with the bandwidth of another CC then the emission mask does not apply for that frequency.

6.5B.2.2.2 Additional spectrum emissions mask

When additional spectrum emission mask or masks apply, the additional SEM(s) shall be used to calculate the composite SEM described in 6.5B.2.2.1.

6.5B.2.2.3 Adjacent channel leakage ratio

For intra-band non-contiguous EN-DC, the EN-DC Adjacent Channel Leakage power Ratio ($\text{EN-DC}_{\text{ACLR}}$) is the ratio of the sum of the filtered mean powers centred on the assigned E-UTRA and NR sub-block frequencies to the filtered mean power centred on an adjacent channel frequency at nominal channel spacing. In case the sub-block gap bandwidth W_{gap} is smaller than a E-UTRA or NR sub-block bandwidth, no $\text{EN-DC}_{\text{ACLR}}$ requirement is set for the corresponding sub-block for the gap. The assigned EN-DC sub-block power and adjacent channel power are measured with rectangular filters with measurement bandwidths specified in TS 36.101 [4] for the E-UTRA sub-block, and TS 38.101-1 [2], TS 38.101-2 [3] for the NR sub-block. If the measured adjacent channel power is greater than -50dBm then the $\text{EN-DC}_{\text{ACLR}}$ shall be higher than the value specified in for $\text{E-UTRA}_{\text{ACLR}}$ and NR_{ACLR} .

6.5B.2.3 Inter-band EN-DC within FR1

Unless otherwise stated, the OOB requirements specified in clause 6.6.2.1 of TS 36.101 [4], sub-clause 6.6.2 of TS 36.101 [4] and clause 6.5.2 of TS 38.101-1 [2] apply for each component carrier.

The requirements apply to each antenna connector.

6.5B.2.3a Inter-band NE-DC within FR1

Unless otherwise stated, the OOB requirements specified in clause 6.6.2.1 of TS 36.101 [4], sub-clause 6.6.2 of TS 36.101 [4] and clause 6.5.2 of TS 38.101-1 [2] apply for each component carrier.

The requirements apply to each antenna connector.

6.5B.2.4 Inter-band EN-DC including FR2

Unless otherwise stated, out-of-band emissions requirement for E-UTRA single carrier and CA operation specified in clauses 6.6.2 of TS 36.101 [4] and for NR single carrier and CA operation specified in clause 6.5.2, 6.5A.2 and 6.5D.2 of TS 38.101-2 [3] apply.

6.5B.2.5 Inter-band EN-DC including both FR1 and FR2

Unless otherwise stated, out-of-band emissions requirement for E-UTRA single carrier and CA operation specified in clauses 6.6.2 of TS 36.101 [4] and for NR single carrier and CA operation specified in clause 6.5.2 of TS 38.101-1 [2] and clause 6.5.2, 6.5A.2 and 6.5D.2 of TS 38.101-2 [3] apply.

6.5B.3 Spurious emissions for DC

6.5B.3.1 Intra-band contiguous EN-DC

6.5B.3.1.1 General spurious emissions

The general spurious emissions requirements specified in clause 6.6.3.1 of TS 36.101 [4] and clause 6.5.3.1 of TS 38.101-1 [2] apply beyond any frequencies for which the out-of-band emissions requirements in clause 6.5B.2.1 apply.

6.5B.3.1.2 Spurious emission band UE co-existence

The requirements in Table 6.5B.3.1.2-1 apply on each component carrier with all component carriers are active.

Table 6.5B.3.1.2-1: Requirements for intra-band contiguous EN-DC

EN-DC Configuration	Spurious emission						
	Protected band	Frequency range (MHz)		Maximum Level (dBm)	MBW (MHz)	NOTE	
DC_(n)71	E-UTRA Band 4, 5, 12, 13, 14, 17, 24, 26, 30, 48, 66	F _{DL_low}	-	F _{DL_high}	-50	1	
	E-UTRA Band 2, 25, 41, 70	F _{DL_low}	-	F _{DL_high}	-50	1	2
	E-UTRA Band 29	F _{DL_low}	-	F _{DL_high}	-38	1	3
	E-UTRA Band 71	F _{DL_low}	-	F _{DL_high}	-50	1	3
DC_(n)41	E-UTRA Band 1, 2, 3, 4, 5, 8, 10, 11, 12, 13, 14, 17, 18, 19, 21, 24, 25, 26, 27, 28, 29, 30, 34, 39, 42, 44, 45, 48, 50, 51, 66, 70, 71, 73, 74 NR Band n77, n78 and n79	F _{DL_low}	-	F _{DL_high}	-50	1	
	Frequency range	1884.5	-	1915.7	-41	0.3	4
	NR Band n79	F _{DL_low}	-	F _{DL_high}	-50	1	2
NOTE 1: F _{DL_low} and F _{DL_high} refer to each E-UTRA frequency band specified in Table 5.5-1							
NOTE 2: As exceptions, measurements with a level up to the applicable requirements defined in Table 6.6.3.1-2 are permitted for each assigned E-UTRA carrier used in the measurement due to 2 nd , 3 rd , 4 th or 5 th harmonic spurious emissions. Due to spreading of the harmonic emission the exception is also allowed for the first 1 MHz frequency range immediately outside the harmonic emission on both sides of the harmonic emission. This results in an overall exception interval centred at the harmonic emission of (2 MHz + N x L _{CRB} x 180 kHz), where N is 2, 3, 4, 5 for the 2 nd , 3 rd , 4 th or 5 th harmonic respectively. The exception is allowed if the measurement bandwidth (MBW) totally or partially overlaps the overall exception interval							
NOTE 3: These requirements also apply for the frequency ranges that are less than F _{OOB} (MHz) in Table 6.6.3.1-1 and Table 6.6.3.1A-1 [4] from the edge of the channel bandwidth.							
NOTE 4: Applicable when co-existence with PHS system operating in 1884.5 - 1915.7 MHz.							

NOTE: To simplify the above Table, E-UTRA band numbers are listed for bands which are specified only for E-UTRA operation or both E-UTRA and NR operation. NR band numbers are listed for bands which are specified only for NR operation.

6.5B.3.2 Intra-band non-contiguous EN-DC

6.5B.3.2.1 General spurious emissions

The general spurious emissions requirements specified in clause 6.6.3.1 of TS 36.101 [4] and clause 6.5.3.1 of TS 38.101-1 [2] apply beyond any frequencies for which the out-of-band emissions requirements in clause 6.5B.2.2 apply. If for some frequency an individual CC spurious emission requirement overlaps with the general spectrum emission mask or the bandwidth of another CC then it does not apply.

6.5B.3.2.2 Spurious emission band UE co-existence

The requirements in Table 6.5B.3.2.2-1 apply with all component carriers are active.

Table 6.5B.3.2-1: Requirements for intra-band non-contiguous EN-DC

EN-DC Configuration	Spurious emission					
	Protected band	Frequency range (MHz)		Maximum Level (dBm)	MBW (MHz)	
DC_41_n41	E-UTRA Band 1, 2, 3, 4, 5, 8, 10, 11, 12, 13, 14, 17, 18, 19, 21, 24, 25, 26, 27, 28, 29, 34, 39, 42, 44, 45, 48, 50, 51, 66, 70, 71, 73, 74 NR Band n77, n78 and n79	F _{DL_low}	-	F _{DL_high}	-50	1
	Frequency range	1884.5	-	1915.7	-41	0.3
	E-UTRA Band 30	F _{DL_low}	-	F _{DL_high}	-40	1
NOTE 1: F _{DL_low} and F _{DL_high} refer to each E-UTRA frequency band specified in Table 5.5-1						
NOTE 2: As exceptions, measurements with a level up to the applicable requirements defined in Table 6.6.3.1-2 are permitted for each assigned E-UTRA carrier used in the measurement due to 2 nd , 3 rd , 4 th or 5 th harmonic spurious emissions. Due to spreading of the harmonic emission the exception is also allowed for the first 1 MHz frequency range immediately outside the harmonic emission on both sides of the harmonic emission. This results in an overall exception interval centred at the harmonic emission of (2MHz + N x L _{CRB} x 180kHz), where N is 2, 3, 4, 5 for the 2 nd , 3 rd , 4 th or 5 th harmonic respectively. The exception is allowed if the measurement bandwidth (MBW) totally or partially overlaps the overall exception interval						
NOTE3: Applicable when co-existence with PHS system operating in 1884.5 - 1915.7 MHz.						

NOTE: To simplify the above Table, E-UTRA band numbers are listed for bands which are specified only for E-UTRA operation or both E-UTRA and NR operation. NR band numbers are listed for bands which are specified only for NR operation.

6.5B.3.3 Inter-band EN-DC within FR1

6.5B.3.3.1 General spurious emissions

The general spurious emissions requirements specified in clause 6.6.3.1 of TS 36.101 [4], clause 6.5.3.1 of TS 38.101-1 [2] and TS 38.101-2 [3] apply for each component carrier. For the case of inter-band EN-DC with a single carrier per cell group, the general spurious emissions requirements also apply with both downlink carrier and both both uplink carriers active. Limits on configured maximum output power for the uplink according to clause 6.2B.4 apply.

NOTE: The general spurious emission requirements with both uplink carriers active are allowed to be verified for only a single inter-band EN-DC configuration per NR band. Furthermore, the requirements are allowed to be verified by measuring spurious emissions at the specific frequencies where second and third order intermodulation products generated by the two transmitted carriers can occur.

Table 6.5B.3.3.1-1: (Void)

6.5B.3.3.2 Spurious emission band UE co-existence

This clause specifies the requirements for the specified EN-DC, for coexistence with protected bands. The requirements in Table 6.5B.3.3.2-1 apply on each component carrier with all component carriers are active.

NOTE: For inter-band EN-DC with uplink assigned to one LTE band and one NR band the requirements in Table 6.5B.3.3.2-1 could be verified by measuring spurious emissions at the specific frequencies where second and third order intermodulation products generated by the two transmitted carriers can occur;

Table 6.5B.3.3.2-1: Requirements

EN-DC Configuration	Spurious emission					NOTE	
	Protected band	Frequency range (MHz)		Maximum Level (dBm)	MBW (MHz)		
DC_1_n28	E-UTRA Band 5, 7, 8, 18, 19, 20, 26, 27, 31, 38, 40, 41, 72, 73 NR band n79	F _{DL_low}	-	F _{DL_high}	-50	1	
	E-UTRA Band 1, 22, 32, 42, 43, 50, 51, 52, 65, 74, 75, 76 NR band n77, n78	F _{DL_low}	-	F _{DL_high}	-50	1	2

EN-DC Configuration	Spurious emission						
	Protected band	Frequency range (MHz)		Maximum Level (dBm)	MBW (MHz)	NOTE	
	E-UTRA band 3, 34	F _{DL_low}	-	F _{DL_high}	-50	1	5
	E-UTRA Band 11, 21	F _{DL_low}	-	F _{DL_high}	-50	1	9, 11
	E-UTRA Band 1, 65	F _{DL_low}	-	F _{DL_high}	-50	1	9, 10
	Frequency range	470	-	694	-42	8	5, 17
	Frequency range	470	-	710	-26.2	6	14
	Frequency range	758	-	773	-32	1	5
	Frequency range	773	-	803	-50	1	
	Frequency range	662	-	694	-26.2	6	5
	Frequency range	1880	-	1895	-40	1	5,16
	Frequency range	1895	-	1915	-15.5	5	5, 7, 16
	Frequency range	1915	-	1920	+1.6	5	5, 7, 16
DC_1_n40	Band 1, 5, 7, 8, 20, 22, 26, 27, 28, 31, 32, 38, 41, 42, 43, 44, 45, 50, 51, 52, 65, 67, 68, 69, 72, 73, 74, 75, 76	F _{DL_low}	-	F _{DL_high}	-50	1	
	Band 3, 34	F _{DL_low}	-	F _{DL_high}	-50	1	5
	Frequency range	1880	-	1895	-40	1	5, 17
	Frequency range	1895	-	1915	-15.5	5	5, 7, 17
	Frequency range	1915	-	1920	+1.6	5	5, 7, 17
DC_1_n51	E-UTRA Band 7, 12, 13, 17, 20, 22, 27, 28, 29, 31, 38, 44, 48, 67, 68, 69, 72, 73	F _{DL_low}	-	F _{DL_high}	-50	1	
	E-UTRA Band 3, 34	F _{DL_low}	-	F _{DL_high}	-50	1	5, 2
	Frequency range	1880	-	1895	-40	1	5, 16
	Frequency range	1895	-	1915	-15.5	5	5, 7, 16
	Frequency range	1915	-	1920	+1.6	5	5, 7, 16
DC_1_n77	E-UTRA Band 1, 3, 5, 7, 8, 11, 18, 19, 20, 21, 26, 28, 34, 40, 41, 65, 74	F _{DL_low}	-	F _{DL_high}	-50	1	
	Frequency range	1880	-	1895	-40	1	5, 8
	Frequency range	1895	-	1915	-15.5	5	5, 7, 8
	Frequency range	1915	-	1920	+1.6	5	5, 7, 8
	Frequency range	1915	-	1920	+1.6	5	5, 7, 8
DC_1_n78 DC_1_n84_ULS UP-TDM_n78	E-UTRA Band 1, 3, 5, 7, 8, 11, 18, 19, 20, 21, 26, 28, 34, 40, 41, 65, 74	F _{DL_low}	-	F _{DL_high}	-50	1	
	Frequency range	1880	-	1895	-40	1	5, 8
	Frequency range	1895	-	1915	-15.5	5	5, 7, 8
	Frequency range	1915	-	1920	+1.6	5	5, 7, 8
DC_1_n79	E-UTRA Band 1, 3, 5, 7, 8, 11, 18, 19, 21, 26, 28, 34, 40, 41, 42, 65, 74	F _{DL_low}	-	F _{DL_high}	-50	1	
	Frequency range	1880	-	1895	-40	1	5, 8
	Frequency range	1895	-	1915	-15.5	5	5, 7, 8
	Frequency range	1915	-	1920	+1.6	5	5, 7, 8
DC_2_n5	E-UTRA Band 4, 5, 10, 12, 13, 14, 17, 24, 26, 28, 29, 30, 42, 48, 50, 51, 66, 70, 71, 74, 85	F _{DL_low}	-	F _{DL_high}	-50	1	
	E-UTRA Band 2, 25, 48	F _{DL_low}	-	F _{DL_high}	-50	1	2
	E-UTRA Band 41, 43	F _{DL_low}	-	F _{DL_high}	-50	1	
DC_2_n66	E-UTRA Band 4, 5, 10, 12, 13, 14, 17, 24, 26, 27, 28, 29, 30, 41, 50, 51, 66, 70, 71, 74, 85	F _{DL_low}	-	F _{DL_high}	-50	1	
	E-UTRA Band 2, 25	F _{DL_low}	-	F _{DL_high}	-50	1	5
	E-UTRA Band 42, 48	F _{DL_low}	-	F _{DL_high}	-50	1	2
DC_2_n71	E-UTRA Band 4, 5, 12, 13, 14, 17, 24, 26, 29, 30, 48, 66	F _{DL_low}	-	F _{DL_high}	-50	1	
	E-UTRA Band 2, 25, 41, 70	F _{DL_low}	-	F _{DL_high}	-50	1	2
	E-UTRA Band 71	F _{DL_low}	-	F _{DL_high}	-50	1	5
DC_2_n78	E-UTRA Band 4, 5, 10, 12, 13, 14, 17, 24, 26, 27, 28, 29, 30, 41, 50, 51, 66, 70, 71, 74, 85	F _{DL_low}	-	F _{DL_high}	-50	1	
	E-UTRA Band 2, 25	F _{DL_low}	-	F _{DL_high}	-50	1	2
DC_3_n7	E-UTRA Band 1, 5, 7, 8, 20, 26, 27, 28, 31, 32, 33, 34, 40, 43, 44, 50, 51, 65, 67, 72, 74, 75, 76	F _{DL_low}	-	F _{DL_high}	-50	1	
	E-UTRA band 3	F _{DL_low}	-	F _{DL_high}	-50	1	5
	E-UTRA band 22, 42	F _{DL_low}	-	F _{DL_high}	-50	1	2
	Frequency range	2570	-	2575	+1.6	5	5, 6, 7
	Frequency range	2575	-	2595	-15.5	5	5, 6, 7
Frequency range	2595	-	2620	-40	1	5, 6	

EN-DC Configuration	Spurious emission						
	Protected band	Frequency range (MHz)			Maximum Level (dBm)	MBW (MHz)	NOTE
DC_3_n28	E-UTRA Band 1, 42, 43, 50, 51, 65, 74, 75, 76 NR band n77, n78, n79	F _{DL_low}	-	F _{DL_high}	-50	1	2
	E-UTRA band 1	F _{DL_low}	-	F _{DL_high}	-50	1	9, 11
	E-UTRA band 3	F _{DL_low}	-	F _{DL_high}	-50	1	5
	E-UTRA Band 5, 7, 8, 18, 19, 20, 26, 27, 31, 34, 38, 40, 41, 72	F _{DL_low}	-	F _{DL_high}	-50	1	
	E-UTRA Band 11, 21	F _{DL_low}	-	F _{DL_high}	-50	1	9, 10
	Frequency range	1884.5	-	1915.7	-41	0.3	13
	Frequency range	470	-	710	-26.2	6	14
	Frequency range	758	-	773	-32	1	5
	Frequency range	773	-	803	-50	1	
DC_3_n40	E-UTRA Band 1, 5, 7, 8, 20, 26, 27, 28, 31, 32, 33, 34, 38, 39, 41, 43, 44, 45, 50, 51, 65, 67, 68, 69, 72, 73, 75, 76	F _{DL_low}	-	F _{DL_high}	-50	1	
	E-UTRA Band 3	F _{DL_low}	-	F _{DL_high}	-50	1	5
	E-UTRA Band 22, 42, 52	F _{DL_low}	-	F _{DL_high}	-50	1	2
DC_3_n51	E-UTRA Band 7, 8, 12, 13, 17, 20, 27, 28, 31, 33, 38, 48, 67, 68, 69, 72, 73	F _{DL_low}	-	F _{DL_high}	-50	1	
	E-UTRA Band 3	F _{DL_low}	-	F _{DL_high}	-50	1	5
	E-UTRA Band 1, 5, 6, 22, 26, 30, 34, 36, 40, 41, 42, 43, 44, 46, 65, 71	F _{DL_low}	-	F _{DL_high}	-50	1	2
DC_3_n77	E-UTRA Band 1, 3, 5, 7, 8, 11, 18, 19, 20, 21, 26, 28, 34, 39, 40, 41, 65, 74	F _{DL_low}	-	F _{DL_high}	-50	1	
	Frequency range	1884.5	-	1915.7	-41	0.3	3
DC_3_n78 DC_3_n80_ULS UP-TDM_n78,	E-UTRA Band 1, 3, 5, 7, 8, 11, 18, 19, 20, 21, 26, 28, 34, 39, 40, 41, 65, 74	F _{DL_low}	-	F _{DL_high}	-50	1	
	Frequency range	1884.5	-	1915.7	-41	0.3	3
DC_3_n79 DC_3_n80_ULS UP-TDM_n79,	E-UTRA Band 1, 3, 5, 8, 11, 18, 19, 21, 28, 34, 39, 40, 41, 65, 74	F _{DL_low}	-	F _{DL_high}	-50	1	
	E-UTRA Band 42	F _{DL_low}	-	F _{DL_high}	-50	1	2
	Frequency range	1884.5	-	1915.7	-41	0.3	3
DC_3_n82	E-UTRA Band 1, 3, 7, 8, 20, 22, 31, 32, 33, 34, 38, 40, 43, 50, 51, 65, 67, 68, 69, 72, 74, 75, 76	F _{DL_low}	-	F _{DL_high}	-50	1	
	E-UTRA Band 42	F _{DL_low}	-	F _{DL_high}	-50	1	2
DC_5_n40	E-UTRA Band 1, 3, 5, 7, 8, 28, 31, 34, 38, 42, 43, 45, 65, 73	F _{DL_low}	-	F _{DL_high}	-50	1	
	E-UTRA Band 26	859	-	869	-27	1	
	E-UTRA Band 41, 52	F _{DL_low}	-	F _{DL_high}	-50	1	
DC_5_n66	E-UTRA Band 1, 2, 3, 4, 5, 6, 7, 8, 10, 12, 13, 14, 17, 24, 25, 28, 29, 30, 34, 38, 40, 43, 45, 50, 51, 65, 66, 70, 71, 85	F _{DL_low}	-	F _{DL_high}	-50	1	
	E-UTRA Band 26	859	-	869	-27	1	
	E-UTRA Band 41, 42, 48, 52	F _{DL_low}	-	F _{DL_high}	-50	1	2
DC_5_n78	E-UTRA Band 1, 2, 3, 4, 5, 7, 8, 10, 12, 13, 14, 17, 24, 25, 28, 29, 30, 31, 34, 38, 40, 45, 65, 66, 70	F _{DL_low}	-	F _{DL_high}	-50	1	
	E-UTRA Band 26	859	-	869	-27	1	
	E-UTRA Band 41	F _{DL_low}	-	F _{DL_high}	-50	1	7
DC_7_n28	E-UTRA Band 2, 3, 5, 7, 8, 20, 26, 27, 31, 34, 40, 72	F _{DL_low}	-	F _{DL_high}	-50	1	
	E-UTRA Band 1, 4, 10, 42, 43, 50, 65, 66, 74, 75, 76 NR band n78	F _{DL_low}	-	F _{DL_high}	-50	1	2
	E-UTRA band 1	F _{DL_low}	-	F _{DL_high}	-50	1	9, 10
	Frequency range	758	-	773	-32	1	5
	Frequency range	773	-	803	-50	1	
	Frequency range	2570	-	2575	+1.6	5	5, 6, 7
	Frequency range	2575	-	2595	-15.5	5	5, 6, 7
	Frequency range	2595	-	2620	-40	1	5, 6

EN-DC Configuration	Spurious emission						
	Protected band	Frequency range (MHz)			Maximum Level (dBm)	MBW (MHz)	NOTE
DC_7_n51	E-UTRA Band 2, 3, 5, 8, 26, 30, 31, 32, 33, 34, 40, 48, 72	F _{DL_low}	-	F _{DL_high}	-50	1	
	Frequency range	2570	-	2575	+1.6	5	5, 7, 16
	Frequency range	2575	-	2595	-15.5	5	5, 7, 16
	Frequency range	2595	-	2620	-40	1	5
	E-UTRA Band 1, 4, 10, 12, 13, 14, 17, 20, 22, 23, 27, 28, 29, 42, 43, 44, 46, 65, 66, 67, 68 NR Band n77, n78, n79,	F _{DL_low}	-	F _{DL_high}	-50	1	2
DC_7_n78	E-UTRA Band 1, 2, 3, 4, 5, 7, 8, 10, 11, 18, 19, 20, 21, 26, 27, 28, 31, 32, 33, 34, 40, 50, 51, 65, 66, 67, 68, 72, 74, 75, 76	F _{DL_low}	-	F _{DL_high}	-50	1	
	Frequency range	2570	-	2575	+1.6	5	5, 6, 7
	Frequency range	2575	-	2595	-15.5	5	5, 6, 7
	Frequency range	2595	-	2620	-40	1	5, 6
DC_8_n40	E-UTRA Band 1, 20, 28, 31, 32, 33, 34, 38, 39,, 45, 50, 51, 65, 67, 68, 69, 72, 73, 74, 75, 76	F _{DL_low}	-	F _{DL_high}	-50	1	
	E-UTRA Band 3, 7, 22, 41, 42, 43, 52	F _{DL_low}	-	F _{DL_high}	-50	1	2
	E-UTRA Band 8	F _{DL_low}	-	F _{DL_high}	-50	1	5
DC_8_n77	E-UTRA Band 1, 20, 28, 31, 32, 33, 34, 38, 39, 40, 44, 45, 50, 51, 65, 67, 68, 69, 72, 73, 74, 75, 76	F _{DL_low}	-	F _{DL_high}	-50	1	
	E-UTRA band 3, 7, 41	F _{DL_low}	-	F _{DL_high}	-50	1	2
	E-UTRA Band 8	F _{DL_low}	-	F _{DL_high}	-50	1	5
	E-UTRA Band 11, 21	F _{DL_low}	-	F _{DL_high}	-50	1	12
	Frequency range	860	-	890	-40	1	5, 12
	Frequency range	1884.5	-	1915.7	-41	0.3	3, 12
	Frequency range	1884.5	-	1915.7	-41	0.3	3, 12
DC_8_n78 DC_8_n81_ULS UP-TDM_n78,	E-UTRA Band 1, 8, 20, 28, 34, 39, 40, 65, 74	F _{DL_low}	-	F _{DL_high}	-50	1	
	E-UTRA Band 3, 7, 41	F _{DL_low}	-	F _{DL_high}	-50	1	2
	E-UTRA Band 11, 21	F _{DL_low}	-	F _{DL_high}	-50	1	12
	Frequency range	860	-	890	-40	1	5, 12
	Frequency range	1884.5	-	1915.7	-41	0.3	3, 12
DC_8_n79 DC_8_n81_ULS UP-TDM_n79,	E-UTRA Band 1, 8, 28, 34, 39, 40, 65, 74	F _{DL_low}	-	F _{DL_high}	-50	1	
	E-UTRA Band 3,41,42	F _{DL_low}	-	F _{DL_high}	-50	1	2
	E-UTRA Band 11, 21	F _{DL_low}	-	F _{DL_high}	-50	1	12
	Frequency range	860	-	890	-40	1	5, 12
	Frequency range	1884.5	-	1915.7	-41	0.3	3
DC_11_n77	E-UTRA Band 1, 3, 18, 19, 28, 34, 65	F _{DL_low}	-	F _{DL_high}	-50	1	
	Frequency range	945	-	960	-50	1	
	Frequency range	1884.5	-	1915.7	-41	0.3	3
	Frequency range	2545	-	2575	-50	1	
	Frequency range	2595	-	2645	-50	1	
DC_11_n78	E-UTRA Band 1, 3, 18, 19, 28, 34, 65	F _{DL_low}	-	F _{DL_high}	-50	1	
	Frequency range	945	-	960	-50	1	
	Frequency range	1884.5	-	1915.7	-41	0.3	3
	Frequency range	2545	-	2575	-50	1	
	Frequency range	2595	-	2645	-50	1	
DC_11_n79	E-UTRA Band 1, 3, 18, 19, 28, 34, 42, 65	F _{DL_low}	-	F _{DL_high}	-50	1	
	Frequency range	945	-	960	-50	1	
	Frequency range	1884.5	-	1915.7	-41	0.3	3
	Frequency range	2545	-	2575	-50	1	
	Frequency range	2595	-	2645	-50	1	
DC_12_n5	E-UTRA Band 2, 5, 12, 13, 14, 17, 24, 25, 26, 30, 42, 43 50, 51, 71, 74	F _{DL_low}	-	F _{DL_high}	-50	1	
	E-UTRA Bands 4, 10, 41, 48, 66, 70	F _{DL_low}	-	F _{DL_high}	-50	1	2
	E-UTRA Band 12, 85	F _{DL_low}	-	F _{DL_high}	-50	1	
DC_12_n66	E-UTRA Band 2, 4, 5, 13, 14, 17, 24, 25, 26, 27, 30, 41, 50, 51, 70, 71, 74	F _{DL_low}	-	F _{DL_high}	-50	1	
	E-UTRA Band 4, 10, 48	F _{DL_low}	-	F _{DL_high}	-50	1	2
	E-UTRA Band 12, 85	F _{DL_low}	-	F _{DL_high}	-50	1	5

EN-DC Configuration	Spurious emission						
	Protected band	Frequency range (MHz)			Maximum Level (dBm)	MBW (MHz)	NOTE
	E-UTRA Band 2, 5, 12, 13, 14, 17, 24, 25, 30, 42, 43 50, 51, 71, 74	F _{DL_low}	-	F _{DL_high}	-50	1	
DC_18_n77	E-UTRA Band 1, 3, 11, 21, 28, 34, 65, 74	F _{DL_low}	-	F _{DL_high}	-50	1	
	Frequency range	945	-	960	-50	1	
	Frequency range	1884.5	-	1915.7	-41	0.3	3
	Frequency range	2545	-	2575	-50	1	
	Frequency range	2595	-	2645	-50	1	
DC_18_n78	E-UTRA Band 1, 3, 11, 21, 28, 34, 65, 74	F _{DL_low}	-	F _{DL_high}	-50	1	
	Frequency range	945	-	960	-50	1	
	Frequency range	1884.5	-	1915.7	-41	0.3	3
	Frequency range	2545	-	2575	-50	1	
	Frequency range	2595	-	2645	-50	1	
DC_18_n79	E-UTRA Band 1, 3, 11, 21, 28, 34, 42, 65, 74	F _{DL_low}	-	F _{DL_high}	-50	1	
	Frequency range	945	-	960	-50	1	
	Frequency range	1884.5	-	1915.7	-41	0.3	3
	Frequency range	2545	-	2575	-50	1	
	Frequency range	2595	-	2645	-50	1	
DC_19_n77	E-UTRA Band 1, 3, 11, 21, 28, 34, 65, 74	F _{DL_low}	-	F _{DL_high}	-50	1	
	Frequency range	945	-	960	-50	1	
	Frequency range	1884.5	-	1915.7	-41	0.3	3
	Frequency range	2545	-	2575	-50	1	
	Frequency range	2595	-	2645	-50	1	
DC_19_n78	E-UTRA Band 1, 3, 11, 21, 28, 34, 65, 74	F _{DL_low}	-	F _{DL_high}	-50	1	
	Frequency range	945	-	960	-50	1	
	Frequency range	1884.5	-	1915.7	-41	0.3	3
	Frequency range	2545	-	2575	-50	1	
	Frequency range	2595	-	2645	-50	1	
DC_19_n79	E-UTRA Band 1, 3, 11, 21, 28, 34, 42, 65, 74	F _{DL_low}	-	F _{DL_high}	-50	1	
	Frequency range	945	-	960	-50	1	
	Frequency range	1884.5	-	1915.7	-41	0.3	3
	Frequency range	2545	-	2575	-50	1	
	Frequency range	2595	-	2645	-50	1	
DC_20_n8	E-UTRA Band 1, 3, 7, 22, 28, 31, 32, 34, 38, 42, 43, 65, 75, 76 NR bandn78	F _{DL_low}	-	F _{DL_high}	-50	1	
DC_20_n28 DC_20_n83	E-UTRA Band 1, 3, 7, 8, 22, 31, 32, 34, 38, 42, 43, 65, 75, 76	F _{DL_low}	-	F _{DL_high}	-50	1	
DC_20_n51	E-UTRA Band 1, 3, 4, 8, 17, 22, 28, 29, 31, 40, 43, 48, 65, 66, 68, 72	F _{DL_low}	-	F _{DL_high}	-50	1	
	E-UTRA Band 20	F _{DL_low}	-	F _{DL_high}	-50	1	5
	Frequency range	758	-	788	-50	1	
DC_20_n77	E-UTRA Band 2, 7, 25, 32, 33, 34, 35, 36, 37, 38, 39, 41, 42, 46, 69, 70 NR Band n77, n78, n79,	F _{DL_low}	-	F _{DL_high}	-50	1	2
	E-UTRA Band 1, 3, 7, 8, 31, 32, 33, 34, 40, 50, 51, 65, 67, 68, 72, 74, 75, 76	F _{DL_low}	-	F _{DL_high}	-50	1	
	E-UTRA Band 20	F _{DL_low}	-	F _{DL_high}	-50	1	5
DC_20_n78, DC_20_n82_ULS UP-TDM_n78,	E-UTRA Band 38, 69	F _{DL_low}	-	F _{DL_high}	-50	1	2
	E-UTRA Band 1, 3, 7, 8, 31, 32, 33, 34, 40, 50, 51, 65, 67, 68, 72, 74, 75, 76	F _{DL_low}	-	F _{DL_high}	-50	1	
	E-UTRA Band 20	F _{DL_low}	-	F _{DL_high}	-50	1	5
DC_21_n77	E-UTRA Band 38, 69	F _{DL_low}	-	F _{DL_high}	-50	1	2
	E-UTRA Band 1, 3, 18, 19, 21, 28, 34, 65	F _{DL_low}	-	F _{DL_high}	-50	1	
	Frequency range	945	-	960	-50	1	
	Frequency range	1884.5	-	1915.7	-41	0.3	3
	Frequency range	2545	-	2575	-50	1	
DC_21_n78	Frequency range	2595	-	2645	-50	1	
	E-UTRA Band 1, 3, 18, 19, 21, 28, 34, 65	F _{DL_low}	-	F _{DL_high}	-50	1	
	Frequency range	945	-	960	-50	1	

EN-DC Configuration	Spurious emission						
	Protected band	Frequency range (MHz)		Maximum Level (dBm)	MBW (MHz)	NOTE	
	Frequency range	1884.5	-	1915.7	-41	0.3	3
	Frequency range	2545	-	2575	-50	1	
	Frequency range	2595	-	2645	-50	1	
DC_21_n79	E-UTRA Band 1, 3, 18, 19, 21, 28, 34, 42, 65	F _{DL_low}	-	F _{DL_high}	-50	1	
	Frequency range	945	-	960	-50	1	
	Frequency range	1884.5	-	1915.7	-41	0.3	3
	Frequency range	2545	-	2575	-50	1	
	Frequency range	2595	-	2645	-50	1	
DC_25_n41	E-UTRA Band 4, 5, 10, 12, 13, 14, 17, 24, 26, 27, 28, 29, 30, 42, 45, 48, 66, 70, 71	F _{DL_low}	-	F _{DL_high}	-50	1	
	E-UTRA/NR Band 2, 25	F _{DL_low}	-	F _{DL_high}	-50	1	5
DC_26_n41	E-UTRA Band 1, 2, 3, 4, 5, 10, 11, 12, 13, 14, 17, 18, 19, 21, 24, 25, 26, 29, 30, 31, 34, 39, 42, 43, 48, 50, 51, 65, 66, 70, 71, 74	F _{DL_low}	-	F _{DL_high}	-50	1	
	Frequency range	1884.5	-	1915.7	-41	0.3	3
	Frequency range	703	-	799	-50	1	
	Frequency range	799	-	803	-40	1	5
	Frequency range	945	-	960	-50	1	
DC_26_n77	E-UTRA Band 1, 3, 5, 11, 18, 19, 21, 26, 34, 39, 40, 41, 65, 74	F _{DL_low}	-	F _{DL_high}	-50	1	
	Frequency range	703	-	799	-50	1	
	Frequency range	799	-	803	-40	1	5
	Frequency range	945	-	960	-50	1	
	Frequency range	1884.5	-	1915.7	-41	0.3	3
	Frequency range	2545	-	2575	-50	1	
DC_26_n78	E-UTRA Band 1, 3, 5, 11, 18, 19, 21, 26, 34, 39, 40, 41, 65, 74	F _{DL_low}	-	F _{DL_high}	-50	1	
	Frequency range	703	-	799	-50	1	
	Frequency range	799	-	803	-40	1	5
	Frequency range	945	-	960	-50	1	
	Frequency range	1884.5	-	1915.7	-41	0.3	3
	Frequency range	2545	-	2575	-50	1	
DC_26_n79	E-UTRA Band 1, 3, 5, 11, 18, 19, 21, 26, 34, 39, 40, 41, 42, 65, 74	F _{DL_low}	-	F _{DL_high}	-50	1	
	Frequency range	703	-	799	-50	1	
	Frequency range	799	-	803	-40	1	5
	Frequency range	945	-	960	-50	1	
	Frequency range	1884.5	-	1915.7	-41	0.3	3
	Frequency range	2545	-	2575	-50	1	
DC_28_n51	E-UTRA Band 2, 3, 5, 7, 8, 25, 26, 31, 34, 38, 40, 41, 66, 72	F _{DL_low}	-	F _{DL_high}	-50	1	
	E-UTRA Band 4, 10, 20, 22, 24, 32, 42, 43, 45, 46, 65, 66, 71, 73 NR band n78, n79	F _{DL_low}	-	F _{DL_high}	-50	1	2
	E-UTRA Band 1	F _{DL_low}	-	F _{DL_high}	-50	1	2, 9, 10
	Frequency range	470	-	694	-42	8	5, 17
	Frequency range	470	-	710	-26.2	6	14
	Frequency range	662	-	694	-26.2	6	5
	Frequency range	758	-	773	-32	1	5
	Frequency range	773	-	803	-50	1	
DC_28_n77	E-UTRA Band 3, 5, 7, 8, 18, 19, 20, 26, 34, 39, 40, 41, 74	F _{DL_low}	-	F _{DL_high}	-50	1	
	E-UTRA Band 1, 65	F _{DL_low}	-	F _{DL_high}	-50	1	2
	E-UTRA Band 1	F _{DL_low}	-	F _{DL_high}	-50	1	9, 11
	E-UTRA Band 11, 21	F _{DL_low}	-	F _{DL_high}	-50	1	9, 10
	Frequency range	758	-	773	-32	1	
	Frequency range	773	-	803	-50	1	
	Frequency range	1884.5	-	1915.7	-41	0.3	3, 9
DC_28_n78 DC_28_n83_ULS UP-TDM_n78,	E-UTRA Band 3, 5, 7, 8, 18, 19, 20, 26, 34, 39, 40, 41	F _{DL_low}	-	F _{DL_high}	-50	1	
	E-UTRA Band 1, 65, 74	F _{DL_low}	-	F _{DL_high}	-50	1	2
	E-UTRA Band 1	F _{DL_low}	-	F _{DL_high}	-50	1	9, 11

EN-DC Configuration	Spurious emission						
	Protected band	Frequency range (MHz)		Maximum Level (dBm)	MBW (MHz)	NOTE	
	E-UTRA Band 11, 21	F_{DL_low}	-	F_{DL_high}	-50	1	9, 10
	Frequency range	758	-	773	-32	1	
	Frequency range	773	-	803	-50	1	
	Frequency range	1884.5	-	1915.7	-41	0.3	3, 9
DC_28_n79	E-UTRA Band 3, 5, 8, 18, 19, 34, 39, 40, 41, 42	F_{DL_low}	-	F_{DL_high}	-50	1	
	E-UTRA Band 1, 65, 74	F_{DL_low}	-	F_{DL_high}	-50	1	2
	E-UTRA Band 1	F_{DL_low}	-	F_{DL_high}	-50	1	9, 11
	E-UTRA Band 11, 21	F_{DL_low}	-	F_{DL_high}	-50	1	9, 10
	Frequency range	758	-	773	-32	1	
	Frequency range	773	-	803	-50	1	
DC_30_n5	Frequency range	1884.5	-	1915.7	-41	0.3	3, 9
	E-UTRA Band 1, 2, 3, 4, 5, 7, 8, 10, 12, 13, 14, 17, 24, 25, 26, 28, 29, 30, 31, 34, 38, 42, 43, 45, 48, 50, 51, 65, 66, 70, 71, 73, 74, 85	F_{DL_low}	-	F_{DL_high}	-50	1	
	E-UTRA Band 41, 48, 52	F_{DL_low}	-	F_{DL_high}	-50	1	2
	E-UTRA Band 18, 19	F_{DL_low}	-	F_{DL_high}	-40	1	
	E-UTRA Band 11, 21	F_{DL_low}	-	F_{DL_high}	-50	1	
DC_30_n66	Frequency range	1884.5	-	1915.7	-41	0.3	3
	E-UTRA Band 2, 4, 5, 10, 12, 13, 14, 17, 24, 25, 26, 27, 29, 30, 38, 41, 66, 70, 71	F_{DL_low}	-	F_{DL_high}	-50	1	
DC_38_n78	Band 48	F_{DL_low}	-	F_{DL_high}	-50	1	2
	N/A						
DC_39_n78	E-UTRA Band 1, 8, 34, 40, 41, 44, 45	F_{DL_low}	-	F_{DL_high}	-50	1	
	Frequency range	1805	-	1855	-40	1	18
	Frequency range	1855	-	1880	-15.5	5	18
DC_39_n79	E-UTRA Band 1, 8, 34, 40, 41, 44, 45	F_{DL_low}	-	F_{DL_high}	-50	1	
	Frequency range	1805	-	1855	-40	1	18
	Frequency range	1855	-	1880	-15.5	5	18
DC_40_n77	N/A						
DC_41_n77	E-UTRA Band 1, 3, 5, 8, 11, 18, 19, 21, 26, 28, 33, 34, 39, 40, 44, 45, 73, 74	F_{DL_low}	-	F_{DL_high}	-50	1	
	Frequency range	1884.5	-	1915.7	-41	0.3	3
DC_41_n78	E-UTRA Band 1, 3, 5, 8, 11, 18, 19, 21, 26, 28, 34, 39, 40, 44, 45, 74	F_{DL_low}	-	F_{DL_high}	-50	1	
	Frequency range	1884.5	-	1915.7	-41	0.3	3
DC_41_n79	E-UTRA Band 1, 3, 5, 8, 11, 18, 19, 21, 26, 28, 34, 40, 42, 44, 45, 65, 74	F_{DL_low}	-	F_{DL_high}	-50	1	
	Frequency range	1884.5	-	1915.7	-41	0.3	3
DC_42_n51	E-UTRA Band 3, 8, 20, 25, 30, 31, 34, 39, 41, 73	F_{DL_low}	-	F_{DL_high}	-50	1	
	E-UTRA Band 1, 2, 4, 5, 6, 7, 10, 12, 13, 14, 17, 23, 24, 26, 27, 28, 29, 32, 38, 40, 44, 46, 65, 66, 67, 68, 70, 71	F_{DL_low}	-	F_{DL_high}	-50	1	2
DC_42_n77	N/A						
DC_42_n78	N/A						
DC_42_n79	N/A						
DC_66_n5	E-UTRA Band 1, 2, 3, 4, 5, 6, 7, 8, 10, 12, 13, 14, 17, 24, 25, 26, 28, 29, 30, 34, 38, 40, 43, 45, 50, 51, 65, 66, 70, 71, 85	F_{DL_low}	-	F_{DL_high}	-50	1	
	E-UTRA Band 41, 42, 48, 52	F_{DL_low}	-	F_{DL_high}	-50	1	2
DC_66_n71	E-UTRA Band 4, 5, 7, 10, 13, 14, 17, 22, 24, 26, 27, 29, 30, 43, 50, 51, 66, 74	F_{DL_low}	-	F_{DL_high}	-50	1	
	E-UTRA Band 2, 25, 41, 42, 48, 70	F_{DL_low}	-	F_{DL_high}	-50	1	2
	E-UTRA Band 71	F_{DL_low}	-	F_{DL_high}	-50	1	5
DC_66_n78, DC_66_n86_ULS UP-TDM_n78,	E-UTRA Band 1, 3, 5, 7, 8, 20, 26, 28, 34, 39, 40, 41, 65	F_{DL_low}	-	F_{DL_high}	-50	1	

NOTE 1: F_{DL_low} and F_{DL_high} refer to each E-UTRA frequency band specified in Table 5.5-1 in TS 36.101 [4].

EN-DC Configuration	Spurious emission				
	Protected band	Frequency range (MHz)	Maximum Level (dBm)	MBW (MHz)	NOTE
NOTE 2:	As exceptions, measurements with a level up to the applicable requirements defined in Table 6.6.3.1-2 are permitted for each assigned E-UTRA carrier used in the measurement due to 2 nd , 3 rd , 4 th or 5 th harmonic spurious emissions. Due to spreading of the harmonic emission the exception is also allowed for the first 1 MHz frequency range immediately outside the harmonic emission on both sides of the harmonic emission. This results in an overall exception interval centred at the harmonic emission of (2 MHz + N x L _{CRB} x 180 kHz), where N is 2, 3, 4, 5 for the 2 nd , 3 rd , 4 th or 5 th harmonic respectively. The exception is allowed if the measurement bandwidth (MBW) totally or partially overlaps the overall exception interval.				
NOTE 3:	Applicable when co-existence with PHS system operating in 1884.5 - 1915.7 MHz				
NOTE 4:	Void				
NOTE 5:	These requirements also apply for the frequency ranges that are less than F _{OOB} (MHz) in Table 6.6.3.1-1 and Table 6.6.3.1A-1 from the edge of the channel bandwidth.				
NOTE 6:	This requirement is applicable for any channel bandwidths within the range 2500 - 2570 MHz with the following restriction: for carriers of 15 MHz bandwidth when carrier centre frequency is within the range 2560.5 - 2562.5 MHz and for carriers of 20 MHz bandwidth when carrier centre frequency is within the range 2552 - 2560 MHz the requirement is applicable only for an uplink transmission bandwidth less than or equal to 54 RB.				
NOTE 7:	For these adjacent bands, the emission limit could imply risk of harmful interference to UE(s) operating in the protected operating band.				
NOTE 8:	This requirement is applicable for any channel bandwidths within the range 1920 - 1980 MHz with the following restriction: for carriers of 15 MHz bandwidth when carrier centre frequency is within the range 1927.5 - 1929.5 MHz and for carriers of 20 MHz bandwidth when carrier centre frequency is within the range 1930 - 1938 MHz the requirement is applicable only for an uplink				
NOTE 9:	Applicable when the assigned E-UTRA carrier is confined within 718 MHz and 748 MHz and when the channel bandwidth used is 5 or 10 MHz.				
NOTE 10:	As exceptions, measurements with a level up to the applicable requirement of -38 dBm/MHz is permitted for each assigned E-UTRA carrier used in the measurement due to 2 nd harmonic spurious emissions. An exception is allowed if there is at least one individual RB within the transmission bandwidth (see Figure 5.6-1) for which the 2 nd harmonic totally or partially overlaps the measurement bandwidth (MBW).				
NOTE 11:	As exceptions, measurements with a level up to the applicable requirement of -38 dBm/MHz is permitted for each assigned E-UTRA carrier used in the measurement due to 3 rd harmonic spurious emissions. An exception is allowed if there is at least one individual RB within the transmission bandwidth (see Figure 5.6-1) for which the 3 rd harmonic totally or partially overlaps the measurement bandwidth (MBW).				
NOTE 12:	This requirement is applicable only for the following cases: A: for carriers of 5 MHz channel bandwidth when carrier centre frequency (F _c) is within the range 902.5 MHz ≤ F _c < 907.5 MHz with an uplink transmission bandwidth less than or equal to 20 RB; B: for carriers of 5 MHz channel bandwidth when carrier centre frequency (F _c) is within the range 907.5 MHz ≤ F _c ≤ 912.5 MHz without any restriction on uplink transmission bandwidth; C: for carriers of 10 MHz channel bandwidth when carrier centre frequency (F _c) is F _c = 910 MHz with an uplink transmission bandwidth less than or equal to 32 RB with RB _{start} > 3.				
NOTE 13:	Void				
NOTE 14:	This requirement is applicable for 5 and 10 MHz E-UTRA channel bandwidth allocated within 718-728MHz. For carriers of 10 MHz bandwidth, this requirement applies for an uplink transmission bandwidth less than or equal to 30 RB with RB _{start} > 1 and RB _{start} < 48.				
NOTE 15:	Void				
NOTE 16:	This requirement is applicable for any channel bandwidths within the range 1920 - 1980 MHz with the following restriction: for carriers of 15 MHz bandwidth when carrier centre frequency is within the range 1927.5 - 1929.5 MHz and for carriers of 20 MHz bandwidth when carrier centre frequency is within the range 1930 - 1938 MHz the requirement is applicable only for an uplink transmission bandwidth less than or equal to 54 RB.				
NOTE 17:	This requirement is applicable in the case of a 10 MHz E-UTRA carrier confined within 703 MHz and 733 MHz, otherwise the requirement of -25 dBm with a measurement bandwidth of 8 MHz applies.				
NOTE 18:	This requirement is only applicable for E-UTRA carriers with bandwidth confined within 1885 - 1920 MHz (requirement for carriers with at least 1RB confined within 1880 - 1885 MHz is not specified). This requirement applies for an uplink transmission bandwidth less than or equal to 54 RB for E-UTRA carriers of 15 MHz bandwidth when carrier center frequency is within the range 1892.5 - 1894.5 MHz and for E-UTRA carriers of 20 MHz bandwidth when carrier center frequency is within the range 1895 - 1903 MHz.				
NOTE 19:	Void				

NOTE: To simplify the above Table, E-UTRA band numbers are listed for bands which are specified only for E-UTRA operation or both E-UTRA and NR operation. NR band numbers are listed for bands which are specified only for NR operation.

6.5B.3.3a Inter-band NE-DC within FR1

6.5B.3.3a.1 General spurious emissions

The general spurious emissions requirements specified in clause 6.6.3.1 of TS 36.101 [4], clause 6.5.3.1 of TS 38.101-1 [2] and TS 38.101-2 [3] apply for each component carrier.

6.5B.3.3a.2 Spurious emission band UE co-existence

This clause specifies the requirements for the specified NE-DC configurations that do not have a corresponding defined EN-DC, for coexistence with protected bands. For the NE-DC configurations that have a corresponding specified EN-DC configuration, the requirements in Table 6.5B.3.3.2-1 apply on each component carrier with all component carriers are active.

6.5B.3.4 Inter-band EN-DC including FR2

General spurious requirement for E-UTRA single carrier and CA operation specified in clauses 6.6.3.1 and 6.6.3.1A of TS 36.101 [4] and for NR single carrier and CA operation specified in clause 6.5.3, 6.5A.3 and 6.5D.3 of TS 38.101-2 [3] apply.

6.5B.3.4.1 Spurious emission band UE co-existence

This clause specifies the requirements for the specified EN-DC, for coexistence with protected bands. Unless otherwise stated, for inter-band EN-DC configurations defined in table 5.5B.5.1-1, no requirements for FR2 NR bands to protect E-UTRA and FR1 NR bands are applied to the constituent FR2 NR bands. Spurious emission band UE co-existence requirements specified in TS 36.101 [4] are applied to the constituent E-UTRA bands for the EN-DC configuration.

Spurious emission band UE co-existence requirement for E-UTRA single carrier and CA operation specified in clauses 6.6.3.2 and 6.6.3.2A of TS 36.101 [4] and for NR single carrier and CA operation specified in clause 6.5.3.1, 6.5A.3.1 and 6.5D.3.1 of TS 38.101-2 [3] apply.

Table 6.5B.3.4.1-1: Void

6.5B.3.5 Inter-band EN-DC including both FR1 and FR2

General spurious requirement for E-UTRA single carrier and CA operation specified in clauses 6.6.3.1 and 6.6.3.1A of TS 36.101 [4] and for NR single carrier and CA operation specified in clause 6.5.3.1 of TS 38.101-1 [2] and clause 6.5.3, 6.5A.3 and 6.5D.3 of TS 38.101-2 [3] apply.

6.5B.3.5.1 Spurious emission band UE co-existence

This clause specifies the requirements for the specified EN-DC, for coexistence with protected bands. Unless otherwise stated, for inter-band EN-DC configurations defined in clause 5.5B.6, no requirements for FR2 NR bands to protect E-UTRA and FR1 NR bands are applied to the constituent FR2 NR bands. Spurious emission band UE co-existence requirements for constituent E-UTRA and FR1 NR bands for the inter-band EN-DC are the same as those for the corresponding EN-DC configuration without the FR2 bands specified in 6.5B.3.2.2.

Spurious emission band UE co-existence requirement for E-UTRA single carrier and CA operation specified in clauses 6.6.3.2 and 6.6.3.2A of TS 36.101 [4] and for NR single carrier and CA operation specified in clause 6.5.3.2 of TS 38.101-1 [2] and clause 6.5.3.1, 6.5A.3.1 and 6.5D.3.1 of TS 38.101-2 [3] apply.

Table 6.5B.3.5.1-1: Void

6.5B.4 Additional spurious emissions

6.5B.4.1 General

These requirements are specified in terms of an additional spectrum emission requirement. Additional spurious emission requirements are signalled by the network to indicate that the UE shall meet an additional requirement for a specific deployment scenario as part of the cell handover/broadcast message.

NOTE: For measurement conditions at the edge of each frequency range, the lowest frequency of the measurement position in each frequency range should be set at the lowest boundary of the frequency range plus MBW/2. The highest frequency of the measurement position in each frequency range should be set at the highest boundary of the frequency range minus MBW/2. MBW denotes the measurement bandwidth defined for the protected band.

6.5B.4.1.1 Minimum requirement (network signalled value "NS_04")

When "NS 04" is indicated in the cell, the power of any UE emission shall not exceed the levels specified in Table 6.5B.4.1.1-1. This requirement also applies for the frequency ranges that are less than F_{OoB} (MHz) in Table 6.6.3.1-1 from the edge of the channel bandwidth.

Table 6.5B.4.1.1-1: Additional requirements

Frequency band (MHz)	Channel bandwidth / Spectrum emission limit (dBm)	Measurement bandwidth
$2495 \leq f < 2496$	-13	1 % of Channel BW for contiguous BW up to 100 MHz, 1 MHz for contiguous BW > 100 MHz
$2490.5 \leq f < 2495$	-13	1 MHz
$0 < f < 2490.5$	-25	1 MHz

6.5B.5 Transmit intermodulation for DC

6.5B.5.1 Intra-band contiguous EN-DC

Unless otherwise stated, no transmit intermodulation requirements are applied for intra-band contiguous EN-DC.

6.5B.5.2 Intra-band non-contiguous EN-DC

Unless otherwise stated, no transmit intermodulation requirements are applied for intra band non-contiguous EN DC.

6.5B.5.3 Inter-band EN-DC within FR1

The transmit intermodulation requirement specified in clauses 6.7.1 of TS 36.101 [4] and clauses 6.5.4 and 6.5A.4 of TS 38.101-1 [2] apply for each component carrier in E-UTRA bands and NR bands, respectively.

6.5B.5.3a Inter-band NE-DC within FR1

The transmit intermodulation requirement specified in clauses 6.7.1 and 6.7.1A of TS 36.101 [4] and clauses 6.5.4 and 6.5A.4 of TS 38.101-1 [2] apply for each component carrier in E-UTRA bands and NR bands, respectively.

6.5B.5.4 Inter-band EN-DC including FR2

Transmit intermodulation requirements specified in clause 6.7.1 and 6.7.1A of TS 36.101 [4] apply for each component carrier in E-UTRA bands.

6.5B.5.5 Inter-band EN-DC including both FR1 and FR2

Transmit intermodulation requirement specified in clauses 6.7.1 and 6.7.1A of TS 36.101 [4] and clauses 6.5.4 and 6.5A.4 of TS 38.101-1 [2] apply for each component carrier in E-UTRA bands and NR bands, respectively.

6.6B Beam correspondence for DC

6.6B.1 Void

6.6B.2 Void

6.6B.3 Void

6.6B.4 Inter-band EN-DC including FR2

Beam correspondence requirement specified in clause 6.6 and 6.6A of TS 38.101-2 [3] apply for NR FR2 bands.

6.6B.5 Inter-band EN-DC including both FR1 and FR2

Beam correspondence requirement specified in clause 6.6 and 6.6A of TS 38.101-2 [3] apply for NR FR2 bands.

7 Receiver characteristics

7.1 General

Unless otherwise stated the receiver characteristics are specified at the antenna connector(s) of the UE for the bands operating on frequency range 1 and over the air of the UE for the bands operating on frequency range 2. The requirements for frequency range 1 and frequency range 2 can be verified separately. For the carrier in frequency range 1, requirements can be verified with NR FR2 link disabled. For the carrier in frequency range 2, requirements can be verified in OTA mode with E-UTRA connecting to the network by OTA without calibration.

The requirements defined in this clause are the extra requirements compared with the single carrier requirements defined in TS 38.101-1 [2] and TS 38.101-2 [3].

Unless otherwise stated, the UL and DL reference measurement channels are the same with the configurations specified in TS 38.101-1 [2] and TS 38.101-2 [3].

Unless otherwise stated, requirements for NR receiver written in TS 38.101-1 [2] and TS 38.101-2 [3] apply and are assumed anchor agnostic. Requirements are verified under conditions where anchor resources do not interfere NR operation.

For intra-band non-contiguous EN-DC, the output power is configured as follows:

- One E-UTRA uplink carrier with the output power set to 4dB Below P_{CMAX_L} and the NR band whose downlink is being tested has its uplink carrier output power set to minimum output power as defined in clause 6.3.1 of TS 38.101-1 [2].
- One NR uplink carrier with the output power set to 4dB Below P_{CMAX_L} and the E-UTRA band whose downlink is being tested has its uplink carrier output power set to minimum output power as defined in clause 6.3.2.1 of TS 36.101 [4].

For the additional requirements for intra-band non-contiguous EN-DC of two sub-blocks, an in-gap test refers to the case when the interfering signal is located at a negative offset with respect to the assigned lowest channel frequency of the highest sub-block and located at a positive offset with respect to the assigned highest channel frequency of the lowest sub-block.

For the additional requirements for intra-band non-contiguous EN-DC of two sub-blocks, an out-of-gap test refers to the case when the interfering signal(s) is (are) located at a positive offset with respect to the assigned channel frequency of the highest carrier frequency or located at a negative offset with respect to the assigned channel frequency of the lowest carrier frequency.

For the additional requirements for intra-band non-contiguous EN-DC of two sub-blocks with channel bandwidth larger than or equal to 5 MHz, the existing adjacent channel selectivity requirements, in-band blocking requirements (for each case), and narrow band blocking requirements apply for in-gap tests only if the corresponding interferer frequency offsets with respect to the two measured carriers satisfy the following condition in relation to the sub-block gap size W_{gap} for at least one of the E-UTRA or NR sub-blocks, so that the interferer frequency position does not change the nature of the core requirement tested:

$$W_{\text{gap}} \geq 2 \cdot |F_{\text{Interferer (offset)}}| - BW_{\text{Channel}}$$

For the E-UTRA sub-block, the $F_{\text{Interferer (offset)}}$, for a sub-block with a single component carrier is the interferer frequency offset with respect to carrier as specified in clause 7.5.1, clause 7.6.1 and clause 7.6.3 for the respective requirement in TS 36.101 [4] and BW_{Channel} . $F_{\text{Interferer (offset)}}$ for the E-UTRA sub-block with two or more contiguous component carriers is the interference frequency offset with respect to the carrier adjacent to the gap is specified in clause 7.5.1A, 7.6.1A and 7.6.3A in TS 36.101 [4].

For the NR sub-block, the $F_{\text{Interferer (offset)}}$, for a sub-block with a single component carrier is the interferer frequency offset with respect to carrier as specified in clause 7.5.1, clause 7.6.1 and clause 7.6.3 for the respective requirement in TS 38.101-1 [2] and BW_{Channel} .

The interferer frequency offsets for adjacent channel selectivity, each in-band blocking case and narrow-band blocking shall be tested separately with a single in-gap interferer at a time.

7.2 Void

7.3 Void

7.3A Reference sensitivity for CA

7.3A.1 General

For NR CA operation NR single carrier REFSSENS requirements defined in TS 38.101-1 [2] and TS 38.101-2 [3] apply to all downlink bands part of NR CA configurations listed in Table 5.2A.1-1 unless sensitivity degradation is allowed as defined in clause 7.3A.

7.3A.2 Reference sensitivity power level for CA

7.3A.3 $\Delta R_{\text{IB,c}}$ for CA

For the UE which supports inter-band NR CA configuration, the minimum requirement for reference sensitivity in clause 7.3.2 in TS 38.101-1 [2] and clause 7.3.2, 7.3A.2 in TS 38.101-2 [3] shall be increased by the amount given in $\Delta R_{\text{IB,c}}$ in Tables below. Unless otherwise stated, $\Delta R_{\text{IB,c}}$ is set to zero.

In case the UE supports more than one of band combinations for CA, SUL or DC, and an operating band belongs to more than one band combinations then

- When the operating band frequency range is $\leq 1\text{GHz}$, the applicable additional $\Delta R_{\text{IB,c}}$ shall be the average value for all band combinations defined in clause 7.3A, 7.3B, 7.3C in this specification and 7.3A, 7.3B in TS 38.101-3 [3], truncated to one decimal place that apply for that operating band among the supported band combinations. In case there is a harmonic relation between low band UL and high band DL, then the maximum $\Delta R_{\text{IB,c}}$ among the different supported band combinations involving such band shall be applied

- When the operating band frequency range is > 1 GHz, the applicable additional $\Delta R_{IB,c}$ shall be the maximum value for all band combinations defined in clause 7.3A, 7.3B, 7.3C in this specification and 7.3A, 7.3B in TS 38.101-3 [3] for the applicable operating bands.

7.3A.3.1 $\Delta R_{IB,c}$ for Inter-band CA between FR1 and FR2

Unless otherwise stated, $\Delta R_{IB,c}$ for NR FR1 band and FR2 band of inter-band CA defined in table 5.5A.1-1 is set to zero.

Table 7.3A.3.1-1: Void

7.3A.4 Void

7.3B Reference sensitivity level for DC

7.3B.1 General

For EN-DC, E-UTRA and NR single carrier, CA, and MIMO operation of REFSENS requirements defined in TS 38.101-1 [2], TS 38.101-2 [3] and TS 36.101 [4] apply to all downlink bands of EN-DC configurations listed in clause 5.5B, unless sensitivity degradation exception is allowed in this clause of this specification, clause 7.3 in TS 38.101-1 [2], clause 7.3 in TS 38.101-2 [3] or clause 7.3 in TS 36.101 [4]. Allowed exceptions specified in this clause also apply to any higher order EN-DC configuration combination containing one of the band combinations that exception is allowed for. Reference sensitivity exceptions are specified by applying maximum sensitivity degradation (MSD) into applicable REFSENS requirement. EN-DC REFSENS requirements shall be met for NR uplink transmissions using QPSK DFT-s-OFDM waveforms as defined in clause 7.3.2 [2]. Unless otherwise specified UL allocation uses the lowest SCS allowable for a given channel BW. Limits on configured maximum output power for the uplink according to clause 6.2B.4 shall apply.

In case of interband EN-DC the receiver REFSENS requirements in this clause do not apply for 1.4 and 3 MHz E-UTRA carriers. For the case of inter-band EN-DC with a single carrier per cell group and multi-carrier per cell group, in addition to the E-UTRA and NR single carrier, CA, and MIMO operation of REFSENS requirements defined in TS 38.101-1 [2], TS 38.101-2 [3], and TS 36.101 [4], the REFSENS requirements specified therein also apply with both downlink carriers and both uplink carriers active unless sensitivity exceptions are allowed in this clause of this specification, clause 7.3 in TS 38.101-1 [2] or clause 7.3 in TS 36.101 [4].

NOTE: For inter-band EN-DC, the reference sensitivity requirement with both uplink carriers active is allowed to be verified for only a single inter-band EN-DC configuration per NR band.

7.3B.2 Reference sensitivity for DC

7.3B.2.1 Intra-band contiguous EN-DC

For intra-band contiguous EN-DC configurations, the reference sensitivity power level REFSENS is the minimum mean power applied to each one of the UE antenna ports at which the throughput for the carrier(s) of the E-UTRA and NR CGs shall meet or exceed the requirements for the specified E-UTRA and NR reference measurement channels. The reference sensitivity requirements apply with all uplink carriers and all downlink carriers active for EN-DC configuration and Uplink EN-DC configuration listed in Table 5.5B.2-1 and Table 5.5B.3-1, as supported by the UE. For EN-DC configurations where uplink is not available in either the MCG or the SCG or for EN-DC configurations where the UE only supports single uplink operation, reference sensitivity requirements apply with single uplink transmission. The downlink carrier(s) from the cell group with uplink shall be configured closer to the uplink operating band than any of the downlink carriers from the cell group without uplink.

Sensitivity degradation is allowed for Intra-band contiguous EN-DC configurations listed in Table 7.3B.2.1-1 the reference sensitivity is defined only for the specific uplink and downlink test points which are specified in Table 7.3B.2.1-1 and E-UTRA and NR single carrier requirements do not apply.

Table 7.3B.2.1-1: Reference sensitivity (MSD) for intra-band contiguous EN-DC

EN-DC configuration / channel allocations /MSD								
EN-DC configuration	E-UTRA/NR band	F _c (UL) (MHz)	Channel bandwidth (MHz)	UL allocation (LCRB)	F _c (DL) (MHz)	MSD (dB)	Duplex mode	
DC_(n)71AA	71	665.5	5	5 (RB _{end} =24)	619.5	0	FDD	
	n71	675.5	15	15 (RB _{start} = 0)	629.5	1.8		
DC_(n)71AA	71	670.5	15	15 (RB _{end} = 74)	624.5	0		
	n71	680.5	5	5 (RB _{start} = 0)	634.5	1.6		
DC_(n)71AA	71	668	10	10 (RB _{end} = 49)	622	0		
	n71	678	10	10 (RB _{start} = 0)	632	1.7		
DC_(n)71AA	71	668	10	10 (RB _{start} = 0)	622	17.2		
	n71	678	10	10 (RB _{end} = 51)	632	29.4		
NOTE 1: The transmitters powers shall be set to P _{UMAX} , as defined in TS 38.101-1 [2], TS 38.101-2 [3], and TS 36.101 [4], with additional limits on configured maximum output power for the uplink according to clause 6.2B.4.								

7.3B.2.2 Intra-band non-contiguous EN-DC

For intra-band non-contiguous EN-DC configurations, the reference sensitivity power level REFSENS is the minimum mean power applied to each one of the UE antenna ports at which the throughput for the carrier(s) of the E-UTRA and NR CGs shall meet or exceed the requirements for the specified E-UTRA and NR reference measurement channels.

For DC_3A_n3A intra-band non-contiguous EN-DC combination, only single switched UL is supported in rel.15 therefore, no MSD is specified and E-UTRA and NR single carrier requirements apply.

7.3B.2.3 Inter-band EN-DC within FR1

Reference sensitivity exceptions are specified for the condition when there is uplink transmission only in the aggressor band.

7.3B.2.3.1 Reference sensitivity exceptions due to UL harmonic interference for EN-DC in NR FR1

Sensitivity degradation is allowed for a band if it is impacted by UL harmonic interference from another band part of the same EN-DC configuration. Reference sensitivity exceptions for the victim band (high) are specified in Table 7.3B.2.3.1-1 with uplink configuration of the aggressor band (low) specified in Table 7.3B.2.3.1-2.

Table 7.3B.2.3.1-1: Reference sensitivity exceptions (MSD) due to UL harmonic for EN-DC in NR FR1

E-UTRA or NR Band / Channel bandwidth of the affected DL band / MSD													
UL band	DL band	5 MHz (dB)	10 MHz (dB)	15 MHz (dB)	20 MHz (dB)	25 MHz (dB)	30 MHz (dB)	40 MHz (dB)	50 MHz (dB)	60 MHz (dB)	80 MHz (dB)	90 MHz (dB)	100 MHz (dB)
1, 3	n77 ^{2,13}		23.9	22.1	20.9			17.9	16.8	16.0	14.8	14.3	13.8
	n77 ³		1.1	0.8	0.3								
2	n78 ^{2,13}		23.9	22.1	20.9			17.9	16.8	16.0	14.8	14.3	13.8
	n78 ³		1.1	0.8	0.3								
3	n78 ^{2,13}		23.9	22.1	20.9			17.9	16.8	16.0	14.8	14.3	13.8
	n78 ³		1.1	0.8	0.3								
5	n78 ^{6,7}		10.5	8.9	7.8			5.4	4.2	3.5	2.3	2.1	1.4
8	n77 ^{6,7} n78 ^{6,7}		10.8	9.1	8			5.1	4.2	3.5	2.3	2.1	1.4
8	n79 ^{4,5}							6.8	6.2	5.6	4.9		4.4
12	n66 ^{8,9,10}	10	7.5	6.2	5.5			2.4					
18, 19	n77 ^{4,5} n78 ^{4,5}		10.4	8.9	7.8			4.7	3.7	3	1.7	1.2	0.7
	n51 ^{2,13} n51 ³	27.8 1.9											
28	n77 ^{4,5} n78 ^{4,5}		10.4	8.9	7.8			4.7	3.7	3	1.7	1.2	0.7
20	n77 ^{6,7} n78 ^{6,7}		10.8	9.1	8			6	4.0	3.2	2.0	1.5	1.0
26	n41 ^{8,9}		10.3	8.4	7.4			5	4.3	3.9	3.1	2.9	2.7
26	n77 ^{6,7} n78 ^{6,7}		10.8	9.1	8			6	4.0	3.2	2.0	1.5	1.0
n28	1 ^{8,9,10}	10.2	7.6	6.2	5.3								
n71	2 ¹¹	4.6	1.0	0.7	0.6								
	2 ¹²	1.7	1.0	0.7	0.6								
66	n78 ^{2,13}		23.9	22.1	20.9			17.9	16.8	16.0	14.8	14.3	13.8
	n78 ³		1.1	0.8	0.3								

- NOTE 1: Void
- NOTE 2: The requirements should be verified for UL EARFCN or NR ARFCN of the aggressor (lower) band (superscript LB) such that $f_{UL}^{LB} = \lfloor f_{DL}^{HB} / 0.2 \rfloor \cdot 0.1$ in MHz and $F_{UL_low}^{LB} + BW_{Channel}^{LB} / 2 \leq f_{UL}^{LB} \leq F_{UL_high}^{LB} - BW_{Channel}^{LB} / 2$ with carrier frequency in the victim (higher) band in MHz and the channel bandwidth configured in the lower band.
- NOTE 3: The requirements are only applicable to channel bandwidths no larger than 20 MHz and with a carrier frequency at $\pm (20 + BW_{Channel}^{HB} / 2)$ MHz offset from $2f_{UL}^{LB}$ in the victim (higher band) with $F_{UL_low}^{LB} + BW_{Channel}^{LB} / 2 \leq f_{UL}^{LB} \leq F_{UL_high}^{LB} - BW_{Channel}^{LB} / 2$, whereand $BW_{Channel}^{HB}$ are the channel bandwidths configured in the aggressor (lower) and victim (higher) bands in MHz, respectively.
- NOTE 4: These requirements apply when there is at least one individual RE within the uplink transmission bandwidth of the aggressor (lower) band for which the 5th transmitter harmonic is within the downlink transmission bandwidth of a victim (higher) band.
- NOTE 5: The requirements should be verified for UL EARFCN of the aggressor (lower) band (superscript LB) such that $f_{UL}^{LB} = \lfloor f_{DL}^{HB} / 0.5 \rfloor \cdot 0.1$ in MHz and $F_{UL_low}^{LB} + BW_{Channel}^{LB} / 2 \leq f_{UL}^{LB} \leq F_{UL_high}^{LB} - BW_{Channel}^{LB} / 2$ with carrier frequency in the victim (higher) band in MHz and the channel bandwidth configured in the lower band.
- NOTE 6: These requirements apply when there is at least one individual RE within the uplink transmission bandwidth of the aggressor (lower) band for which the 4th transmitter harmonic is within the downlink transmission bandwidth of a victim (higher) band.
- NOTE 7: The requirements should be verified for UL EARFCN of the aggressor (lower) band (superscript LB) such that $f_{UL}^{LB} = \lfloor f_{DL}^{HB} / 0.4 \rfloor \cdot 0.1$ in MHz and $F_{UL_low}^{LB} + BW_{Channel}^{LB} / 2 \leq f_{UL}^{LB} \leq F_{UL_high}^{LB} - BW_{Channel}^{LB} / 2$ with carrier frequency in the victim (higher) band in MHz and the channel bandwidth configured in the lower band.
- NOTE 8: These requirements apply when there is at least one individual RE within the uplink transmission bandwidth of the aggressor (lower) band for which the 3rd transmitter harmonic is within the downlink transmission bandwidth of a victim (higher) band.
- NOTE 9 The requirements should be verified for UL EARFCN of the aggressor (lower) band (superscript LB) such that $f_{UL}^{LB} = \lfloor f_{DL}^{HB} / 0.3 \rfloor \cdot 0.1$ in MHz and $F_{UL_low}^{LB} + BW_{Channel}^{LB} / 2 \leq f_{UL}^{LB} \leq F_{UL_high}^{LB} - BW_{Channel}^{LB} / 2$ with the carrier frequency in the victim (higher) band in MHz and the channel bandwidth configured in the low band.
- NOTE 10: Applicable for the operations with 2 or 4 antenna ports supported in the band with carrier aggregation configured.
- NOTE 11: These requirements apply when the lower edge frequency of the 5 MHz uplink channel in Band 71 is located at or below 668 MHz and the downlink channel in Band 2 is located with its upper edge at 1990 MHz.
- NOTE 12: These requirements apply when the lower edge frequency of the 10 MHz, 15 MHz, or 20 MHz uplink channel in Band 71 is located at or below 668 MHz and the downlink channel in Band 2 is located with its upper edge at 1990 MHz.
- NOTE 13: These requirements apply when there is at least one individual RE within the uplink transmission bandwidth of the aggressor (lower) band for which the 2nd transmitter harmonic is within the downlink transmission bandwidth of a victim (higher) band and a range ΔF_{HD} above and below the edge of this downlink transmission bandwidth. The value ΔF_{HD} depends on the EN-DC band combination: $\Delta F_{HD} = 10$ MHz for DC_1_n77, DC_2_n77, DC_66_n77, DC_3_n77, DC_3_n78, DC_28_n51, DC_66_n78.
- NOTE 14: MSD test point can be chosen according to supported BW and lowest SCS supported by the UE.

Table 7.3B.2.3.1-2: Uplink configuration for reference sensitivity exceptions due to UL harmonic interference for EN-DC in NR FR1

E-UTRA or NR Band / Channel bandwidth of the affected DL band / UL RB allocation of the aggressor band														
UL band	DL band	SCS of UL band (kHz)	5 MHz (LCRB)	10 MHz (LCRB)	15 MHz (LCRB)	20 MHz (LCRB)	25 MHz (LCRB)	30 MHz (LCRB)	40 MHz (LCRB)	50 MHz (LCRB)	60 MHz (LCRB)	80 MHz (LCRB)	90 MHz (LCRB)	100 MHz (LCRB)
1	n77	15		25	36	50			100	100	100	100	100	100
2	n78	15		25	36	50			50	50	50	50	50	50
3	n77, n78	15		25	36	50			50	50	50	50	50	50
5	n78	15		16	25	25			25	25	25	25	25	25
8	n77 n78	15		16	25	25			25	25	25	25	25	25
8	n79	15							25	25	25	25		25
12	n66	15	8	16	20	20			20					
18	n77, n78	15		16	25	25			25	25	25	25	25	25
19	n77, n78	15		16	25	25			25	25	25	25	25	25
20	n77, n78	15		16	25	25			25	25	25	25	25	25
26	n41	15		16	25	25			25	25	25	25	25	25
26	n77, n78	15		16	25	25			25	25	25	25	25	25
n28	1	15	8	16	25	25								
28	n51	15	12											
28	n77, n78	15		10	15	20			25	25	25	25	25	25
66	n78	15		25	36	50			100	100	100	100	100	100
n71	2	15	25 ⁴ 8 ⁵	25 ⁴ 8 ⁵	20 ⁴ 8 ⁵	20 ⁴ 8 ⁵								

NOTE 1: The UL configuration applies regardless of the channel bandwidth of the UL band unless the UL resource blocks exceed that specified in Table 7.3.1-2 in TS 36.101 [4] or Table 7.3.2-3 in TS 38.101-1 [2] for the uplink bandwidth in which case the allocation according to Table 7.3.1-2 in TS 36.101 [4] or Table 7.3.2-3 in TS 38.101-1 [2] applies

NOTE 2: Void

NOTE 3: Unless stated otherwise, UL resource blocks shall be centred within the transmission bandwidth configuration for the channel bandwidth.

NOTE 4: These requirements apply when the lower edge frequency of the 5 MHz uplink channel in Band 71 is located at or below 668 MHz and the downlink channel in Band 2 is located with its upper edge at 1990 MHz.

NOTE 5: These requirements apply when the lower edge frequency of the 10 MHz, 15 MHz, or 20 MHz uplink channel in Band 71 is located at or below 668 MHz and the downlink channel in Band 2 is located with its upper edge at 1990 MHz.

NOTE 6: If the aggressor band is NR band, the test SCS and UL RB can be adjusted according to supported BW and lowest SCS supported by the UE

7.3B.2.3.2 Reference sensitivity exceptions due to receiver harmonic mixing for EN-DC in NR FR1

Sensitivity degradation is allowed for a band if it is impacted by receiver harmonic mixing due to another band part of the same EN-DC configuration. Reference sensitivity exceptions for the victim band (low) are specified in Table 7.3B.2.3.2-1 with uplink configuration of the aggressor band (high) specified in Table 7.3B.2.3.2-2.

Table 7.3B.2.3.2-1: Reference sensitivity exceptions (MSD) due to receiver harmonic mixing for EN-DC in NR FR1

E-UTRA or NR Band / Channel bandwidth of the affected DL band / MSD												
UL band	DL band	5 MHz (dB)	10 MHz (dB)	15 MHz (dB)	20 MHz (dB)	25 MHz (dB)	40 MHz (dB)	50 MHz (dB)	60 MHz (dB)	80 MHz (dB)	90 MHz (dB)	100 MHz (dB)
2	n71 ⁴	26.8	23.6	21.2	15.6							
n41	26 ⁴	24.3	24.3	22.5	N/A							
n77	3	5.7	4.0	3.0	2.7							
n78	3	5.7	4.0	3.0	2.7							
n77	41 ⁸	10.4	10.4	10.4	10.4							
n77	28 ²	28	25	23.2	22							
n78	41 ⁸	10.4	10.4	10.4	10.4							
n79	11 ⁴	39.3	36.3	34.5								
n79	19 ²	29.5	26.5	24.7								
n79	21 ⁴	39.3	36.3	34.5								
n79	26 ²	27	24	22.2								

NOTE 1: These requirements apply when there is at least one individual RE within the uplink transmission bandwidth of the aggressor (higher) band for which the mixing product due to harmonic of victim (lower) band LO with leakage of aggressor (higher) band is within the downlink transmission bandwidth of a victim (lower) band.

NOTE 2: The requirements should be verified for DL EARFCN of the victim (lower) band (superscript LB) such that $f_{DL}^{LB} = \lfloor f_{UL}^{HB} / 0.5 \rfloor 0.1$ with f_{DL}^{LB} the DL carrier frequency in the lower band and f_{UL}^{HB} the UL carrier frequency in the higher band, both in MHz.

NOTE 3: Void

NOTE 4: The requirements should be verified for DL EARFCN or NR-ARFCN of the victim (lower) band (superscript LB) such that $f_{DL}^{LB} = \lfloor f_{UL}^{HB} / 0.3 \rfloor 0.1$ with f_{DL}^{LB} the DL carrier frequency in the lower band and f_{UL}^{HB} the UL carrier frequency in the higher band, both in MHz.

NOTE 5: Void

NOTE 6: Void

NOTE 7: Void

NOTE 8: The requirements should be verified for DL EARFCN of the victim (lower) band (superscript LB) such that $f_{DL}^{LB} = \lfloor f_{UL}^{HB} / 0.15 \rfloor 0.1$ with f_{DL}^{LB} the DL carrier frequency in the lower band and f_{UL}^{HB} the UL carrier frequency in the higher band, both in MHz.

NOTE 9: MSD test point can be chosen according to supported BW and lowest SCS supported by the UE.

Table 7.3B.2.3.2-2: Uplink configuration for reference sensitivity exceptions due to receiver harmonic mixing for EN-DC in NR FR1

E-UTRA or NR Band / SCS / Channel bandwidth of the affected DL band / UL RB allocation of the agressor band													
UL band	DL band	SCS of UL band (kHz)	5 MHz (LCRB)	10 MHz (LCRB)	15 MHz (LCRB)	20 MHz (LCRB)	25 MHz (LCRB)	40 MHz (LCRB)	50 MHz (LCRB)	60 MHz (LCRB)	80 MHz (LCRB)	90 MHz (LCRB)	100 MHz (LCRB)
2	n71	15	25	50	50	50							
n41	26	15	25	50	75								
n77	3	15	25	50	75	100							
n78	3	15	25	50	75	100							
n77	28	15	25	50	75	100							
n77	41	15	12	25	36	50							
n78	41	15	12	25	36	50							
n79	11	15	25	50	75								
n79	19	15	25	50	75								
n79	21	15	25	50	75								
n79	26	15	25	50	75								
NOTE 1: Void NOTE 2: Void NOTE 3: The UL configuration applies regardless of the channel bandwidth of the UL band. UL resource blocks allocation in the table shall be further limited to that specified in Table 7.3.1-2 in TS 36.101 [4] or Table 7.3.2-3 in TS 38.101-1 [2]. NOTE 4: Unless otherwise stated, the UL resource blocks allocation is applied at the center of the channel bandwidth. The note applies to the entire table. NOTE 5: If the aggressor band is NR band, the test SCS and UL RB can be adjusted according to supported BW and lowest SCS supported by the UE.													

7.3B.2.3.3 Void

7.3B.2.3.4 Reference sensitivity exceptions due to cross band isolation for EN-DC in NR FR1

Sensitivity degradation is allowed for a band if it is impacted by UL of another band part of the same EN-DC configuration due to cross band isolation issues. Reference sensitivity exceptions for the victim band are specified in Table 7.3B.2.3.4-1 with uplink configuration of the agressor band specified in Table 7.3B.2.3.4-2.

Table 7.3B.2.3.4-1: Reference sensitivity exceptions (MSD) due to cross band isolation for EN-DC in NR FR1

E-UTRA or NR Band / Channel bandwidth of the affected DL band / MSD													
UL band	DL band	5 MHz (dB)	10 MHz (dB)	15 MHz (dB)	20 MHz (dB)	25 MHz (dB)	30 MHz (dB)	40 MHz (dB)	50 MHz (dB)	60 MHz (dB)	80 MHz (dB)	90 MHz (dB)	100 MHz (dB)
1	n40	6.6	6.6	6.6	6.6	6.6	6.6	6.6	6.6	6.6	6.6		
n40	1	8.3	8.3	8.3	8.3								
n41	25	0.6	0.6	0.6	0.6								
n77	41 ¹	4.5	4.5	4.5	4.5								
41	n77		8.3	8.3	8.3			6.3	5.3	4.5	4.0	3.9	3.8
3	n51	6.4											
30	n66	8.3	8.3	8.3	8.3			8.3					
n78	7 ¹	4.5	4.5	4.5	4.5								
n78	38	3.3	3.3	3.3	3.3								
n78	41 ¹	4.5	4.5	4.5	4.5								
n78	46				7								
41	n78		8.3	8.3	8.3			6.3	5.3	4.5	4.0	3.9	3.8

NOTE 1: Applicable only when harmonic mixing MSD for this combination is not applied.

NOTE 2: The DL victim band should be configured using the lowest SCS that is compatible with the highest CBW for which an MSD is specified.

NOTE 3: MSD test point can be chosen according to supported BW and lowest SCS supported by the UE.

Table 7.3B.2.3.4-2: Uplink configuration for reference sensitivity exceptions due to cross band isolation for EN-DC in NR FR1

E-UTRA or NR Band / SCS / Channel bandwidth of the affected DL band / UL RB allocation of the agressor band														
UL band	DL band	SCS of UL band (kHz)	5 MHz (LCRB)	10 MHz (LCRB)	15 MHz (LCRB)	20 MHz (LCRB)	25 MHz (LCRB)	30 MHz (LCRB)	40 MHz (LCRB)	50 MHz (LCRB)	60 MHz (LCRB)	80 MHz (LCRB)	90 MHz (LCRB)	100 MHz (LCRB)
1	n40	15	25	50	75	100	100	100	100	100	100	100		
n40	1	15	25	50	75	100								
n41	25	30	160	160	160	160								
n77	41	30	270	270	270	270								
41	n77	15		100	100	100			100	100	100	100	100	100
3	n51	15	25											
30	n66	15	25	25	25	25			25					
n78	7	30	270	270	270	270								
n78	38	30	270	270	270	270								
n78	41	30	270	270	270	270								
n78	46	30				270								
41	n78	15		100	100	100			100	100	100	100	100	100

NOTE 1: The UL configuration applies regardless of the channel bandwidth of the UL band. UL resource blocks allocation in the table shall be further limited to that specified in Table 7.3.1-2 in TS 36.101 [4] or Table 7.3.2-3 in TS 38.101-1 [2].

NOTE 2: When the maximum UL RB allocation "LCRB" value is less than the maximum transmission bandwidth configuration "NRB" defined in Table 5.3.2-1 in 38.101-1 [2] for the specified UL band SCS, the UL band should be configured using the lowest CBW that is compatible with the maximum specified LCRB value.

NOTE 3: If the aggressor band is NR band, the test SCS and UL RB can be adjusted according to supported BW and lowest SCS supported by the UE.

7.3B.2.3.5 MSD for intermodulation interference due to dual uplink operation for EN-DC in NR FR1

For EN-DC configurations in NR FR1 the UE may indicate capability of not supporting simultaneous dual uplink operation due to possible intermodulation interference overlapping in frequency to its own primary downlink channel bandwidth if

- the intermodulation order is 2;
- the intermodulation order is 3 when both operating bands are between 450 MHz – 960 MHz or between 1427 MHz – 2690 MHz

In the case for EN-DC configurations in NR FR1 for which the intermodulation products caused by dual uplink operation do not interfere with its own primary downlink channel bandwidth as defined in Annex I the UE is mandated to operate in dual and triple uplink mode.

For EN-DC configurations in NR FR1 with uplink and downlink assigned to E-UTRA and NR FR1 bands given in Table 7.3B.2.3.5.1-1, Table 7.3B.2.3.5.2-0 and Table 7.3B.2.3.5.2-1 the reference sensitivity is defined only for the specific uplink and downlink test points specified in Table 7.3B.2.3.5.1-1, Table 7.3B.2.3.5.2-0 and Table 7.3B.2.3.5.2-1. For these test points the reference sensitivity levels specified in clause 7.3.1 in TS 36.101 [4] and 7.3.2 of TS 38.101-1 [2] for the corresponding channel bandwidths or in clause 7.3.1 of TS 36.101 [4] are relaxed by the amount of the parameter MSD given in Table 7.3B.2.3.5.1-1, Table 7.3B.2.3.5.2-0 and Table 7.3B.2.3.5.2-1.

The throughput on each of the CGs shall be $\geq 95\%$ of the maximum throughput of the respective reference measurement channels as specified in Annex A of TS 38.101-1 [2] and Annex A of TS 36.101 [4], with parameters specified in Table 7.3B.2.3.5.1-1, Table 7.3B.2.3.5.2-0 and Table 7.3B.2.3.5.2-1 with dual UL transmissions overlapping in time unless otherwise stated.

7.3B.2.3.5.1 MSD test points for intermodulation interference due to dual uplink operation for EN-DC in NR FR1 involving two bands

Table 7.3B.2.3.5.1-1: MSD test points for PCell due to dual uplink operation for EN-DC in NR FR1 (two bands)

NR or E-UTRA Band / Channel bandwidth / N _{RB} / MSD							
EN-DC Configuration	EUTRA or NR band	UL F _c (MHz)	UL/DL BW (MHz)	UL L _{CRB}	DL F _c (MHz)	MSD (dB)	IMD order
DC_1A_n77A	1	1950	5	25	2140	29.8	IMD2 ³
						32.5 ⁴	
DC_1A_n77A, DC_1A_n78A, DC_1A_SUL_n78A- n84A	1	1950	5	25	2140	8.0	IMD4 ³
	n77, n78	3710	10	50	3710	N/A	
DC_2A_n66A	2	1855	5	25	1935	20	IMD3
	n66	1775	5	25	2175	N/A	N/A
DC_2A_n66A	2	1883.3	5	25	1963.3	N/A	N/A
	n66	1750	5	25	2150	4	IMD5
DC_2A_n78A	2	1855	5	25	1935	26	IMD2 ³
						28.7 ⁴	
DC_2A_n78A	n78	3790	10	50	3790	N/A	N/A
	2	1885	5	25	1965	8.0	IMD4 ³
n78	3690	10	50	3690	10.7 ⁴	N/A	
DC_3A_n7A	3	1730	5	25	1825	N/A	N/A
	n7	2535	10	50	2655	10.2	IMD4
DC_3A_n77A, DC_3A_n78A, DC_3A-SUL_n78A- n80A, DC_3C_n78A	3	1740	5	25	1835	26	IMD2 ³
						28.7 ⁴	
DC_3A_n77A, DC_3A_n78A, DC_3A-SUL_n78A- n80A, DC_3C_n78A	n77, n78	3575	10	50	3575	N/A	N/A
	3	1765	5	25	1860	8.0	IMD4 ³
n77, n78	3435	10	50	3435	10.7 ⁴	N/A	
DC_5A_n66A	5	838	5	25	883	30	IMD2 ³
	n66	1721	5	25	2121	N/A	N/A
DC_5A_n78A	5	844	5	25	889	8.3	IMD4
	n78	3421	10	50	3421	N/A	N/A
DC_8A_n77A, DC_8A_n78A, DC_8A-SUL_n78A- n81A	8	897.5	5	25	942.5	8.3	IMD4
	n77, n78	3635	10	50	3635	N/A	N/A
DC_8A_n79A, DC_8A-SUL_n79A- n81A	8	897.5	5	25	942.5	4.8	IMD5
	n79	4532.5	40	216	4532.5	N/A	N/A
DC_18A_n77A DC_18A_n78A	18	N/A	N/A	N/A	N/A	N/A	IMD4
	n77, n78	N/A	N/A	N/A	N/A	N/A	N/A
DC_19A_n78A	19	N/A	N/A	N/A	N/A	N/A	IMD4
	n78	N/A	N/A	N/A	N/A	N/A	N/A
DC_20A_n8A	20	849.5	5	25	808.5	25	IMD3
	n8	892.5	5	25	937.5	25	IMD3
DC_20A_n77A, DC_20A_n78A, DC_20A- SUL_n78A-n82A	20	850	5	25	809	11	IMD4
	n77, n78	3359	10	50	3359	N/A	N/A
DC_20A_n77A	20	840	5	25	799	6.5	IMD5
	n77	4159	10	50	4159	N/A	N/A
DC_21A_n79A	21	1457.5	5	25	1505.5	18.4	IMD3
	n79	4420.5	40	216	4420.5	N/A	N/A
DC_26A_n41A	26	839	5	25	884	15.6	IMD3 ³
	n41	2562	10	50	2562	N/A	N/A
DC_28A_n51A	28	742.3	5	25	797.3	5	IMD4
	n51	1429.5	5	25	1429.5	N/A	N/A
	26	836.5	5	25	881.5	11.1	IMD4

NR or E-UTRA Band / Channel bandwidth / N _{RB} / MSD							
EN-DC Configuration	EUTRA or NR band	UL F _c (MHz)	UL/DL BW (MHz)	UL L _{CRB}	DL F _c (MHz)	MSD (dB)	IMD order
DC_26A_n77A, DC_26A_n78A	n77, n78	3391	10	50	3391	N/A	N/A
DC_28A_n77A, DC_28A_n78A, DC_28A-SUL_n78A-n83A	28	705.5	5	25	760.5	5.5	IMD5
	n77, n78	3582.5	10	50	3582.5	N/A	N/A
DC_66A_n5A	n5	838	5	25	883	30	IMD2 ³
	66	1721	5	25	2121	N/A	N/A
DC_66A_n71A	66	1750	5	25	2150	5	IMD4
	n71	675	5	25	629	N/A	N/A
DC_66A_n78A	66	1730	5	25	2130	5.0	IMD5
	n78	3660	5	50	3660	N/A	N/A
NOTE 1: Both of the transmitters shall be set min(+20 dBm, P _{CMAX_L,c}) as defined in clause 6.2.5A.							
NOTE 2: RB _{start} = 0							
NOTE 3: This band is subject to IMD5 also which MSD is not specified.							
NOTE 4: Applicable only if operation with 4 antenna ports is supported in the band with EN-DC configured.							
NOTE 5: Void							
NOTE 6: For NR band, UL/DL BW and UL L _{CRB} can be adjusted according to the supported BW and lowest SCS supported by the UE.							

7.3B.2.3.5.2 MSD test points for intermodulation interference due to dual uplink operation for EN-DC in NR FR1 involving three bands

Table 7.3B.2.3.5.2-0: MSD test points for Pcell due to dual uplink operation for EN-DC in NR FR1 (three bands)

NR or E-UTRA Band / Channel bandwidth / N _{RB} / MSD							
EN-DC Configuration	EUTRA/NR band	UL F _c (MHz)	UL/DL BW (MHz)	UL L _{CRB}	DL F _c (MHz)	MSD (dB)	IMD order
DC_66A_(n)71AA	66	1750	5	25	2150	5	IMD4
	n71	678	10	10 (RB _{start} =0)	632	N/A	N/A
NOTE 1: For NR band, UL/DL BW and UL L _{CRB} can be adjusted according to the supported BW and lowest SCS supported by the UE.							

Table 7.3B.2.3.5.2-1: MSD test points for Scell due to dual uplink operation for EN-DC in NR FR1 (three bands)

NR or E-UTRA Band / Channel bandwidth / N _{RB} / MSD							
EN-DC Configuration	EUTRA / NR band	UL F _c (MHz)	UL/DL BW (MHz)	UL L _{CRB}	DL F _c (MHz)	MSD (dB)	IMD order
DC_1A-3A_n28A	1	1975	5	25	2165	N/A	N/A
	n28	710.5	5	25	765.5	N/A	N/A
	3	1723.5	5	25	1818.5	4.0	IMD5
DC_1A-3A_n28A	3	1780	5	25	1875	N/A	N/A
	n28	710.5	5	25	765.5	N/A	N/A
	1	1949	5	25	2139	11.0	IMD4
DC_1A-7A_n28A	1	1935	5	25	2125	N/A	N/A
	n28	718	5	25	773	N/A	N/A
	7	2533	10	50	2653	30.0	IMD2
DC_1A-3A_n77A	1	1950	5	25	2140	N/A	N/A
	3	1712.5	5	25	1807.5	31.5	IMD2
	n77	3757.5	10	50	3757.5	N/A	N/A
	1	1950	5	25	2140	N/A	N/A

NR or E-UTRA Band / Channel bandwidth / NRB / MSD							
EN-DC Configuration	EUTRA / NR band	UL F _c (MHz)	UL/DL BW (MHz)	UL L _{CRB}	DL F _c (MHz)	MSD (dB)	IMD order
	3	1775	5	25	1870	8.5	IMD4
	n77	3980	10	50	3980	N/A	N/A
	1	1950	5	25	2140	31.0	IMD2
	3	1775	5	25	1870	N/A	N/A
	n77	3915	10	50	3915	N/A	N/A
DC_1A-3A_n78A DC_1A-3C_n78A	1	1950	5	25	2140	N/A	N/A
	3	1712.5	5	25	1807.5	31.2	IMD2
	n78	3757.5	10	50	3757.5	N/A	N/A
	1	1935	5	25	2125	2.8	IMD5
	3	1775	5	25	1870	N/A	N/A
DC_1A-5A_n78A	n78	3725	10	50	3725	N/A	N/A
	1	1932	5	25	2122	18.1	IMD3
	5	829	5	25	874	N/A	N/A
	n78	3780	10	50	3780	N/A	N/A
	1	1975	5	25	2165	N/A	N/A
DC_1A-7A_n78A	5	840	5	25	885	3.1	IMD5
	n78	3405	10	50	3405	N/A	N/A
	1	1977.5	5	25	2167.5	N/A	N/A
	7	2507.5	5	25	2627.5	9.1	IMD4
	n78	3305	10	50	3305	N/A	N/A
DC_1A-8A_n78A	1	1950	5	25	2140	8.7	IMD4
	7	2510	10	50	2630	N/A	N/A
	n78	3580	10	50	3580	N/A	N/A
	1	1945	5	25	2135	N/A	N/A
	8	900	5	25	945	N/A	N/A
DC_1A-8A_n78A	n78	3745	10	52	3745	14.9	IMD3
	1	1940	5	25	2130	N/A	N/A
	8	895	5	25	940	3.3	IMD5
	n78	3380	10	52	3330	N/A	N/A
	1	1950	5	25	2140	3.6	IMD5
DC_1A-3A_n79A	3	1750	5	25	1845	N/A	N/A
	n79	4860	40	216	4860	N/A	N/A
	1	N/A	N/A	N/A	N/A	N/A	N/A
DC_1A-18A_n77A	18	N/A	N/A	N/A	N/A	N/A	IMD5
	n77	N/A	N/A	N/A	N/A	N/A	N/A
	1	1930	5	25	2120	16.4	IMD3
	18	825	5	25	870	N/A	N/A
	n77	3770	10	50	3770	N/A	N/A
DC_1A-18A_n78A	1	N/A	N/A	N/A	N/A	N/A	N/A
	18	N/A	N/A	N/A	N/A	N/A	IMD5
	n78	N/A	N/A	N/A	N/A	N/A	N/A
	1	1930	5	25	2120	16.4	IMD3
	18	819	5	25	864	N/A	N/A
DC_1A-18A_n79A	n78	3758	10	50	3758	N/A	N/A
	1	1935	5	25	2125	N/A	N/A
	18	822.5	5	25	867.5	18.3	IMD3
	n79	4737.5	40	216	4737.5	N/A	N/A
	1	1930	5	25	2120	N/A	N/A
	18	820	5	25	865	8.9	IMD4
	n79	4925	40	216	4925	N/A	N/A
	1	1935	5	25	2125	8.1	IMD4
DC_1A-19A_n77A DC_1A-19A_n78A	18	822.5	5	25	867.5	N/A	N/A
	n79	4592.5	40	216	4592.5	N/A	N/A
	1	1940	5	25	2130	17.8	IMD3
DC_1A-19A_n78A	19	832.5	5	25	877.5	N/A	N/A
	n77, n78	3795	10	50	3795	N/A	N/A

NR or E-UTRA Band / Channel bandwidth / NRB / MSD							
EN-DC Configuration	EUTRA / NR band	UL F _c (MHz)	UL/DL BW (MHz)	UL L _{CRB}	DL F _c (MHz)	MSD (dB)	IMD order
	1	N/A	N/A	N/A	N/A	N/A	N/A
	19	N/A	N/A	N/A	N/A	N/A	IMD5
	n78	N/A	N/A	N/A	N/A	N/A	N/A
DC_1A-19A_n79A	1	1950	5	25	2140	N/A	N/A
	19	837.5	5	25	882.5	18.3	IMD3
	n79	4782.5	40	216	4782.5	N/A	N/A
	1	1950	5	25	2140	8.1	IMD4
	19	837.5	5	25	882.5	N/A	N/A
DC_1A-20A_n78A	n79	4652.5	40	216	4652.5	N/A	N/A
	1	1930	5	25	2120	20.3	IMD3
	20	835	5	25	794	N/A	N/A
DC_1A-20A_n78A	n78	3790	10	50	3790	N/A	N/A
	1	1950	5	25	2140	N/A	N/A
	20	851	5	25	810	3.0	IMD5
DC_1A-20A_n78A	n78	3330	10	50	3330	N/A	N/A
	1	1964.6	5	25	2154.6	30.6	IMD2
	21	1450.4	5	25	1498.4	N/A	N/A
DC_1A-21A_n77A DC_1A-21A_n78A	n77, n78	3605	10	50	3605	N/A	N/A
	1	N/A	N/A	N/A	N/A	N/A	N/A
	21	N/A	N/A	N/A	N/A	N/A	IMD2
	n78	N/A	N/A	N/A	N/A	N/A	N/A
	1	1950	5	25	2140	N/A	N/A
	21	1452	5	25	1500	2.9	IMD5
	n77, n78	3675	10	50	3675	N/A	N/A
DC_1A-21A_n79A	1	N/A	N/A	N/A	N/A	N/A	N/A
	21	N/A	N/A	N/A	N/A	N/A	IMD4
	n79	N/A	N/A	N/A	N/A	N/A	N/A
DC_1A-28A_n77A	1	1960	5	25	2150	15.8	IMD3
	28	740	5	25	795	N/A	N/A
	n77	3630	10	50	3630	N/A	N/A
DC_1A-28A_n77A	1	1960	5	25	2150	N/A	N/A
	28	725	5	25	780	4.3	IMD5
	n77	3330	10	50	3330	N/A	N/A
DC_1A-28A_n78A	1	1960	5	25	2150	15.7	IMD3
	28	740	5	25	795	N/A	N/A
	n78	3630	10	50	3630	N/A	N/A
DC_1A-28A_n78A	1	1970	5	25	2160	N/A	N/A
	28	739	5	25	794	4.2	IMD5
	n78	3352	10	50	3352	N/A	N/A
DC_1A_n28A-n78A	1	1950	5	25	2140	N/A	N/A
	n28	733	5	25	788	N/A	N/A
	n78	3416	10	50	3416	15.7	IMD3
	1	1950	5	25	2140	N/A	N/A
	n78	3320	10	50	3320	N/A	N/A
DC_1A-28A_n79A	n28	735	5	25	790	3.3	IMD5
	1	1930	5	25	2120	N/A	N/A
	28	733	5	25	788	15.2	IMD3
	n79	4648	40	216	4648	N/A	N/A
	1	1925	5	25	2115	N/A	N/A
	28	740	5	25	795	10.0	IMD4
	n79	4980	40	216	4980	N/A	N/A
	1	1977.5	5	25	2167.5	1.2	IMD4
	28	745.5	5	25	800.5	N/A	N/A
	n79	4420	40	216	4420	N/A	N/A
	1	1935	5	25	2125	4.5	IMD5
DC_1A-41A_n77A	28	718	5	25	773	N/A	N/A
	n79	4807	40	216	4807	N/A	N/A
	1	1970	5	25	2160	N/A	N/A
	n77	3400	10	50	3400	N/A	
41	2510	5	25	2510	11.0	IMD4	
1	N/A	N/A	N/A	N/A	N/A	IMD4	

NR or E-UTRA Band / Channel bandwidth / NRB / MSD							
EN-DC Configuration	EUTRA / NR band	UL F _c (MHz)	UL/DL BW (MHz)	UL L _{CRB}	DL F _c (MHz)	MSD (dB)	IMD order
	n77	N/A	N/A	N/A	N/A	N/A	N/A
	41	N/A	N/A	N/A	N/A	N/A	N/A
	1	1930	5	25	2120	N/A	N/A
	n77	4150	10	50	4150	N/A	
	41	2510	5	25	2510	3.6	IMD5
DC_1A-41A_n78A	1	N/A	N/A	N/A	N/A	N/A	IMD4
	41	N/A	N/A	N/A	N/A	N/A	N/A
	n78	N/A	N/A	N/A	N/A	N/A	N/A
	1	1975	5	25	2165	N/A	N/A
	41		5	25	2515	12	IMD4
	n78	3410	10	50	3410	N/A	N/A
DC_1A-41A_n78A	1	1955	5	25	2145	8.7	IMD4
	41	2507.5	10	50	2507.5	N/A	N/A
	n78	3580	10	50	3580	N/A	N/A
DC_1A-41A_n79A	1	1970	5	25	2160	N/A	N/A
	n79	4500	40	216	4500	N/A	
	41	2530	5	25	2530	29.4	IMD2
DC_1A-42A_n79A	1	1977.5	5	25	2167.5	N/A	N/A
	n79	4420	40	216	4420	N/A	N/A
	42	3490	5	25	3490	4.8	IMD5
	42	3402.5	5	25	3402.5	N/A	N/A
	n79	4640	40	216	4640	N/A	N/A
	1	1975	5	25	2165	15.5	IMD3
	42	3450	5	25	3450	N/A	N/A
	n79	4520	40	216	4520	N/A	N/A
DC_1A_n78A-n79A	1	1950	5	25	2140	9.3	IMD4
	1	1950	5	25	2140	N/A	N/A
	n78	3410	10	50	3410	N/A	N/A
	n79	4870	40	216	4870	15.9	IMD3
	1	1950	5	25	2140	N/A	N/A
	n79	4670	40	216	4670	N/A	N/A
DC_2A-12A_n66A	2	N/A	N/A	N/A	N/A	N/A	IMD4
	12	N/A	N/A	N/A	N/A	N/A	N/A
	n66	N/A	N/A	N/A	N/A	N/A	N/A
DC_3A-5A_n78A	3	N/A	N/A	N/A	N/A	N/A	IMD3
	5	N/A	N/A	N/A	N/A	N/A	N/A
	n78	N/A	N/A	N/A	N/A	N/A	N/A
DC_3A-7A_n28A	3	1712.5	5	25	1807.5	N/A	N/A
	n28	743	5	25	798	N/A	N/A
	7	2562	10	50	2682	16.9	IMD3
	7	2543	10	50	2663	N/A	N/A
	n28	710.5	5	25	765.5	N/A	N/A
DC_3A-7A_n78A DC_3C-7A_n78A DC_3C-7C_n78A	3	1737.5	5	25	1832.5	26.0	IMD2
	3	1725	5	25	1820	17.6	IMD3
	7	2565	5	25	2685	N/A	N/A
	n78	3310	10	50	3310	N/A	N/A
	3	1725	5	25	1820	8.6	IMD4
	7	2565	5	25	2685	N/A	N/A
	n78	3475	10	50	3475	N/A	N/A
DC_3A-8A_n78A	8	910	5	25	955	N/A	N/A
	n78	3640	10	50	3640	N/A	N/A
	3	1725	5	25	1820	16.5	IMD3
DC_3A-19A_n78A	3	N/A	N/A	N/A	N/A	N/A	IMD3
	19	N/A	N/A	N/A	N/A	N/A	N/A
	n78	N/A	N/A	N/A	N/A	N/A	N/A
DC_3A-19A_n79A	3	1775	5	25	1870	N/A	N/A
	19	840	5	25	885	18.5	IMD3
	n79	4435	40	216	4435	N/A	N/A

NR or E-UTRA Band / Channel bandwidth / NRB / MSD							
EN-DC Configuration	EUTRA / NR band	UL F _c (MHz)	UL/DL BW (MHz)	UL L _{CRB}	DL F _c (MHz)	MSD (dB)	IMD order
	3	1782.5	5	25	1877.5	0.2	IMD4
	19	842.5	5	25	887.5	N/A	N/A
	n79	4420	40	216	4420	N/A	N/A
DC_3A-20A_n28A	20	852	5	25	811	N/A	N/A
	n28	738	5	25	793	N/A	N/A
	3	1723	5	25	1818	9.4	IMD4
DC_3A-20A_n78A DC_3C-20A_n78A	3	1725	5	25	1820	17.3	IMD3
	20	845	5	25	804	N/A	N/A
	n78	3510	10	50	3510	N/A	N/A
DC_3A-21A_n77A DC_3A-21A_n78A	3	1767.5	5	25	1862.5	N/A	N/A
	21	1459.5	5	25	1507.5	8.8	IMD4
	n77, n78	3795	10	50	3795	N/A	N/A
	3	N/A	N/A	N/A	N/A	N/A	IMD2
	21	N/A	N/A	N/A	N/A	N/A	N/A
	n78	N/A	N/A	N/A	N/A	N/A	N/A
DC_3A-21A_n77A	3	1771.6	5	25	1866.6	3.4	IMD5
	21	1450.4	5	25	1498.4	N/A	N/A
	n77	3935	10	50	3935	N/A	N/A
DC_3A-21A_n79A	3	N/A	N/A	N/A	N/A	N/A	N/A
	21	N/A	N/A	N/A	N/A	N/A	IMD3
	n79	N/A	N/A	N/A	N/A	N/A	N/A
	3	1774.2	5	25	1869.2	17.8	IMD3
	21	1450.4	5	25	1498.4	N/A	N/A
	n79	4770	40	216	4770	N/A	N/A
DC_3A-28A_n77A	3	1712.5	5	25	1807.5	N/A	N/A
	28	715	5	25	770	15.3	IMD3
	n77	4195	10	50	4195	N/A	N/A
	3	1755	5	25	1850	17.0	IMD3
	28	735	5	25	790	N/A	N/A
	n77	3320	10	50	3320	N/A	N/A
DC_3A-28A_n78A	3	1775	5	25	1870	17.3	IMD3
	28	740	5	25	760	N/A	N/A
	n78	3350	10	25	3350	N/A	N/A
DC_3A-28A_n79A	3	1770	5	25	1865	N/A	N/A
	28	725	5	25	780	10.3	IMD4
	n79	4530	40	216	4530	N/A	N/A
	3	1775	5	25	1870	5.7	IMD5
	28	725	5	25	780	N/A	N/A
	n79	4770	40	216	4770	N/A	N/A
DC_3A_n28A-n78A	3	1750	5	25	1845	N/A	N/A
	n28	743	5	25	798	N/A	N/A
	n78	3764	10	50	3764	4.5	IMD5
DC_3A-41A_n78A	41	2620	5	25	2620	N/A	N/A
	n78	3400	10	52	3400	N/A	N/A
	3	1745	5	25	1840	16.4	IMD3
DC_3A_n78A-n79A	3	1770	5	25	1865	N/A	N/A
	n78	3340	10	50	3340	N/A	N/A
	n79	4910	40	216	4910	16.3	IMD3
	3	1770	5	25	1865	N/A	N/A
	n79	4510	40	216	4510	N/A	N/A
	n78	3710	10	50	3710	4.2	IMD5
DC_3A-SUL_n78A-n82A	3	1775	5	25	1870	4	IMD4
	n82	840	5	25		N/A	N/A
DC_3A-21A_n79A	3	1774.2	5	25	1869.2	17.8	IMD3
	21	1450.4	5	25	1498.4	N/A	N/A
	n79	4770	40	216	4770	N/A	N/A
DC_5A-7A_n78A	5	844	5	25	889	N/A	N/A
	7	2525	5	25	2645	30.1	IMD2

NR or E-UTRA Band / Channel bandwidth / NRB / MSD							
EN-DC Configuration	EUTRA / NR band	UL F _c (MHz)	UL/DL BW (MHz)	UL L _{CRB}	DL F _c (MHz)	MSD (dB)	IMD order
	n78	3489	10	50	3489	N/A	N/A
	5	834	5	25	879	30.2	IMD2
	7	2550	5	25	2670	N/A	N/A
	n78	3429	10	50	3429	N/A	N/A
	5	830	5	25	875	3.3	IMD5
	7	2525	5	25	2645	N/A	N/A
	n78	3350	10	50	3350	N/A	N/A
DC_5A_41A_n78A	5	860	5	25	885	30.2	IMD2
	41	2615	5	25	2615	N/A	N/A
	n78	3500	10	50	3500	N/A	N/A
	5	856.5	5	25	881.5	3.1	IMD5
	41	2620.5	5	25	2620.5	N/A	N/A
	n78	3490	10	50	3490	N/A	N/A
DC_7A-20A_n28A	20	852	5	25	811	N/A	N/A
	n28	738	5	25	793	N/A	N/A
	7	2550	10	50	2670	5.9	IMD5
DC_7A-20A_n78A	7	2560	5	25	2680	N/A	N/A
	20	851	5	25	810	30.5	IMD2
	n78	3370	10	50	3370	N/A	N/A
DC_7A-20A_n78A	7	2560	5	25	2680	N/A	N/A
	20	851	5	25	810	3.0	IMD5
	n78	3435	10	50	3435	N/A	N/A
DC_7A-20A_n78A	7	2555	5	25	2675	30.8	IMD2
	20	845	5	25	804	N/A	N/A
	n78	3520	10	50	3520	N/A	N/A
DC_7A-28A_n78A	7	2567.5	5	25	2687.5	N/A	N/A
	28	727.5	5	25	782.5	28.8	IMD2
	n78	3350	10	50	3350	N/A	N/A
	7	2567.5	5	25	2687.5	N/A	N/A
	28	727.5	5	25	782.5	3.0	IMD5
	n78	3460	10	50	3460	N/A	N/A
	7	2530	5	25	2650	30.5	IMD2
	28	740	5	25	795	N/A	N/A
	n78	3390	10	50	3390	N/A	N/A
DC_7A_n28A-n78A	7	2565	5	25	2685	N/A	N/A
	n28	745	5	25	800	N/A	N/A
	n78	3310	10	50	3310	29.7	IMD2
	7	2565	5	25	2685	N/A	N/A
	n78	3365	10	50	3365	N/A	N/A
	n28	745	5	25	800	28.8	IMD2
DC_7A-46A_n78A ⁶	7	N/A	N/A	N/A	N/A	N/A	N/A
	46	N/A	N/A	N/A	N/A	N/A	IMD2, IMD5
DC_18A-28A_n77A	n78	N/A	N/A	N/A	N/A	N/A	N/A
	18	820	5	25	865	N/A	N/A
	28	723	5	25	778	4.4	IMD5
DC_18A-28A_n77A	n77	4058	10	50	4058	N/A	N/A
	18	820	5	25	865	3.9	IMD5
	28	723	5	25	778	N/A	N/A
DC_18A-28A_n78A	n77	3757	10	50	3757	N/A	N/A
	18	819	5	25	864	3.8	IMD5
	28	723	5	25	778	N/A	N/A
DC_19A-21A_n77A	n78	3756	10	50	3756	N/A	N/A
	19	837.5	5	25	882.5	18.7	IMD3
	21	1450.4	5	25	1498.4	N/A	N/A
DC_19A-21A_n78A	n77, n78	3783.3	10	50	3783.3	N/A	N/A
DC_19A-21A_n77A	19	837.5	5	25	882.5	N/A	N/A

NR or E-UTRA Band / Channel bandwidth / NRB / MSD							
EN-DC Configuration	EUTRA / NR band	UL F _c (MHz)	UL/DL BW (MHz)	UL L _{CRB}	DL F _c (MHz)	MSD (dB)	IMD order
	21	1454.5	5	25	1502.5	9.0	IMD4
	n77	4015	10	50	4015	N/A	N/A
DC_19A-21A_n79A	19	N/A	N/A	N/A	N/A	N/A	IMD5
	21	N/A	N/A	N/A	N/A	N/A	N/A
	n79	N/A	N/A	N/A	N/A	N/A	N/A
	19	837.5	5	25	882.2	N/A	N/A
	21	1452	5	25	1500	3.8	IMD5
	n79	4850	40	216	4850	N/A	N/A
DC_21A-28A_n77A	21	1452	5	25	1500	N/A	N/A
	28	730.5	5	25	785.5	16.9	IMD3
	n77	3689.5	10	50	3689.5	N/A	N/A
	21	1450.5	5	25	1498.5	9.9	IMD4
	28	730.5	5	25	785.5	N/A	N/A
	n77	3690	10	50	3690	N/A	N/A
DC_21A-28A_n79A	21	1450	5	25	1498	5.2	IMD5
	28	730.5	5	25	785.5	N/A	N/A
	n79	4420	40	216	4420	N/A	N/A
DC_28A-42A_79A	28	730	5	25	785	N/A	N/A
	42	3420	5	25	3420	15.3	IMD3
	n79	4880	40	216	4880	N/A	N/A
	28	745	5	25	800	16.2	IMD2
	42	3597.5	5	25	3597.5	N/A	N/A
	n79	4420	40	216	4420	N/A	N/A
DC_19A_n78A-n79A	19	835	5	25	880	N/A	N/A
	n78	3680	10	50	3680	N/A	N/A
	n79	4515	40	216	4515	29.3	IMD2
	19	835	5	25	880	N/A	N/A
	n79	4550	40	216	4550	N/A	N/A
	n78	3715	10	50	3715	28.8	IMD2
DC_20A_n28A-n78A, DC_20A_SUL_n78A-n83A	20	857	5	25	816	N/A	N/A
	n28, n83	743	5	25	798	N/A	N/A
	n78	3314	10	50	3314	8.7	IMD4
	20	837	5	25	796	N/A	N/A
	n78	3310	10	50	3310	N/A	N/A
	n28	744	5	25	799	9.4	IMD4
DC_21A_n78A-n79A	21	1453	5	25	1501	N/A	N/A
	n78	3420	10	50	3420	N/A	N/A
	n79	4873	40	216	4873	30.1	IMD2
	21	1453	5	25	1501	N/A	N/A
	n79	4940	40	216	4940	N/A	N/A
	n78	3487	10	50	3487	29.8	IMD2
NOTE 1: For NR band, UL/DL BW and UL L _{CRB} can be adjusted according to the supported BW and lowest SCS supported by the UE.							

7.3B.2.3.5.3 Void

7.3B.2.3a Inter-band NE-DC within FR1

Reference sensitivity exceptions are specified for the condition when there is uplink transmission only in the aggressor band. This clause addresses directly only NE-DC configurations that don't have a corresponding specified EN-DC configuration or specific NE-DC exceptions.

7.3B.2.3a.1 Reference sensitivity exceptions due to UL harmonic interference for NE-DC in NR FR1

Sensitivity degradation is allowed for a band if it is impacted by UL harmonic interference from another band part of the same NE-DC configuration. For the NE-DC configurations that have an EN-DC defined configuration, the

reference sensitivity exceptions for the victim band (high) are specified in Table 7.3B.2.3.1-1 with uplink configuration of the aggressor band (low) specified in Table 7.3B.2.3.1-2 are applicable.

7.3B.2.4 Inter-band EN-DC including FR2

7.3B.2.4.1 Void

7.3B.2.5 Inter-band EN-DC including both FR1 and FR2

7.3B.2.5.1 Reference sensitivity exceptions due to UL harmonic interference for EN-DC including both FR1 and FR2

For inter-band EN-DC of E-UTRA and NR in both FR1 and FR2, the UE is allowed to apply each sensitivity degradation for EN-DC in FR1 specified in clause 7.3B.2.3 TS 38.101-3 and for EN-DC including FR2 specified in clause 7.3B.2.3 of TS 38.101-3 independently.

7.3B.3 $\Delta R_{IB,c}$, ΔR_{IBNC} for DC

7.3B.3.0 General

For the UE which supports inter-band EN-DC or NE-DC configuration, the minimum requirement for reference sensitivity in Table 7.3.1-1 and Table 7.3.1-1a in TS 36.101 [4], clause 7.3.2, 7.3A.2, 7.3C.2 in TS 38.101-1 [2] and clause 7.3.2, 7.3A.2 in TS 38.101-2 [3] shall be increased by the amount given in $\Delta R_{IB,c}$, ΔR_{IBNC} in Tables below where unless otherwise stated, the same $\Delta R_{IB,c}$, ΔR_{IBNC} are applicable to NR band(s) part for DC configurations which have the same NR operating band combination. Unless otherwise stated, $\Delta R_{IB,c}$ or ΔR_{IBNC} is set to zero.

In case the UE supports more than one of band combinations for CA, SUL or DC, and an operating band belongs to more than one band combinations then

- When the operating band frequency range is ≤ 1 GHz, the applicable additional $\Delta R_{IB,c}$ shall be the average value for all band combinations defined in clause 7.3A, 7.3B, 7.3C in this specification and 7.3A, 7.3B in TS 38.101-3 [3], truncated to one decimal place that apply for that operating band among the supported band combinations. In case there is a harmonic relation between low band UL and high band DL, then the maximum $\Delta R_{IB,c}$ among the different supported band combinations involving such band shall be applied
- When the operating band frequency range is > 1 GHz, the applicable additional $\Delta R_{IB,c}$ shall be the maximum value for all band combinations defined in clause 7.3A, 7.3B, 7.3C in this specification and 7.3A, 7.3B in TS 38.101-3 [3] for the applicable operating bands.

Unless $\Delta R_{IB,c}$ is specified for the NE-DC configuration, the specified $\Delta R_{IB,c}$ for the EN-DC configuration including same bands as the corresponding NE-DC configuration is applicable for the NE-DC configuration.

7.3B.3.1 Intra-band contiguous EN-DC

7.3B.3.2 Intra-band non-contiguous EN-DC

Table 7.3B.3.2-1: Intra-band non-contiguous EN-DC with one uplink configuration on E-UTRA for reference sensitivity

DC configuration	Aggregated channel bandwidth		W_{gap} / (MHz)	UL E-UTRA allocation	ΔR_{IBNC} (dB)	Duplex mode
	E-UTRA	NR				
DC_3A_n3A	5 MHz	5 MHz	$45.0 < W_{gap} \leq 65.0$	12 ¹	4.7	FDD
			$0.0 < W_{gap} \leq 45.0$	25 ¹	0	
	5 MHz	10 MHz	$40.0 < W_{gap} \leq 60.0$	12 ¹	3.8	
			$0.0 < W_{gap} \leq 40.0$	25 ¹	0	
	5 MHz	15 MHz	$35.0 < W_{gap} \leq 55.0$	12 ¹	3.6	
			$0.0 < W_{gap} \leq 35.0$	25 ¹	0	
	5 MHz	20 MHz	$30.0 < W_{gap} \leq 50.0$	12 ¹	3.4	
			$0.0 < W_{gap} \leq 30.0$	25 ¹	0	
	5 MHz	25 MHz	$25.0 < W_{gap} \leq 45.0$	12 ¹	3.2	
			$0.0 < W_{gap} \leq 25.0$	25 ¹	0	
	5 MHz	30 MHz	$20.0 < W_{gap} \leq 40.0$	12 ¹	3.0	
			$0.0 < W_{gap} \leq 20.0$	25 ¹	0	
	10 MHz	5 MHz	$30.0 < W_{gap} \leq 60.0$	12 ⁵	5.1	
			$0.0 < W_{gap} \leq 30.0$	32 ¹	0	
	10 MHz	10MHz	$25.0 < W_{gap} \leq 55.0$	12 ⁵	4.3	
			$0.0 < W_{gap} \leq 25.0$	32 ¹	0	
	10 MHz	15 MHz	$20.0 < W_{gap} \leq 50.0$	12 ⁵	3.8	
			$0.0 < W_{gap} \leq 20.0$	32 ¹	0	
	10 MHz	20 MHz	$15.0 < W_{gap} \leq 45.0$	12 ⁵	3.5	
			$0.0 < W_{gap} \leq 15.0$	32 ¹	0	
	10 MHz	25 MHz	$10.0 < W_{gap} \leq 40.0$	12 ⁵	3.2	
			$0.0 < W_{gap} \leq 10.0$	32 ¹	0	
	10 MHz	30 MHz	$5.0 < W_{gap} \leq 35.0$	12 ⁵	2.8	
			$0.0 < W_{gap} \leq 5.0$	32 ¹	0	
	15 MHz	5 MHz	$25.0 < W_{gap} \leq 55.0$	12 ⁶	6.0	
			$0.0 < W_{gap} \leq 25.0$	32 ¹	0	
	15 MHz	10 MHz	$20.0 < W_{gap} \leq 50.0$	12 ⁶	4.7	
			$0.0 < W_{gap} \leq 20.0$	32 ¹	0	
	15 MHz	15 MHz	$15.0 < W_{gap} \leq 45.0$	12 ⁶	4.2	
			$0.0 < W_{gap} \leq 15.0$	32 ¹	0	
	15 MHz	20 MHz	$10.0 < W_{gap} \leq 40.0$	12 ⁶	3.8	
			$0.0 < W_{gap} \leq 10.0$	32 ¹	0	
15 MHz	25 MHz	$5.0 < W_{gap} \leq 35.0$	12 ⁶	3.5		
		$0.0 < W_{gap} \leq 5.0$	32 ¹	0		
15 MHz	30 MHz	$0.0 < W_{gap} \leq 30.0$	12 ⁶	3.3		
20 MHz	5 MHz	$15.0 < W_{gap} \leq 50.0$	16 ⁷	6.5		
		$0.0 < W_{gap} \leq 15.0$	32 ¹	0		
20 MHz	10 MHz	$10.0 < W_{gap} \leq 45.0$	16 ⁷	5.1		
		$0.0 < W_{gap} \leq 10.0$	32 ¹	0		
20 MHz	15 MHz	$5.0 < W_{gap} \leq 40.0$	16 ⁷	4.5		
		$0.0 < W_{gap} \leq 5.0$	32 ¹	0		
20 MHz	20 MHz	$0.0 < W_{gap} \leq 35.0$	16 ⁷	4.1		
20 MHz	25 MHz	$0.0 < W_{gap} \leq 30.0$	16 ⁷	3.8		
20 MHz	30 MHz	$0.0 < W_{gap} \leq 25.0$	16 ⁷	3.6		

NOTE 1: UL resource blocks shall be located as close as possible to the downlink operating band but confined within the transmission.
 NOTE 2: W_{gap} is the sub-block gap between the two sub-blocks.
 NOTE 3: The table only applies when the center frequency of E-UTRA carrier is higher than the NR carrier, and the ΔR_{IBNC} applies to the NR DL carrier only
 NOTE 4: All combinations of channel bandwidths defined in Table 5.3B.1.3-1.
 NOTE 5: UL resource blocks shall be located at $RB_{start} = 25$.
 NOTE 6: UL resource blocks shall be located at $RB_{start} = 35$.
 NOTE 7: UL resource blocks shall be located at $RB_{start} = 50$.

7.3B.3.3 Inter-band EN-DC within FR1

7.3B.3.3.1 $\Delta R_{IB,c}$ for EN-DC in two bandsTable 7.3B.3.3.1-1: $\Delta R_{IB,c}$ due to EN-DC(two bands)

Inter-band EN-DC configuration	E-UTRA or NR Band	$\Delta R_{IB,c}$ (dB)
DC_1_n28	n28	0.2
DC_1_n51	n51	0.1
DC_1_n77	1	0.2
	n77	0.5
DC_1_n78	n78	0.5
DC_2_n66	2	0.3
	n66	0.3
DC_2_n78	2	0.2
	n78	0.5
DC_3_n51	3	0.2
	n51	0.2
DC_3_n77	3	0.2
	n77	0.5
DC_3_n78	3	0.2
	n78	0.5
DC_5_n78	5	0.2
	n78	0.5
DC_7_n51	n51	0.2
DC_7_n77	n77	0.5
DC_7_n78	n78	0.5
DC_7-7_n78		
DC_8_n77	8	0.2
	n77	0.5
DC_8_n78	8	0.2
	n78	0.5
DC_11_n77	n77	0.5
DC_11_n78	n78	0.5
DC_12_n5	12	0.3
	n5	0.5
DC_12_n66	12	0.5
DC_18_n77	n77	0.5
DC_19_n77	n77	0.5
DC_19_n78	n78	0.5
DC_20_n51	n51	0.2
DC_20_n77	n77	0.5
DC_20_n78	n78	0.5
DC_21_n77	n77	0.5
DC_21_n78	n78	0.5
DC_25_n41	n41	0 ¹
		0.5 ²
DC_26_n77	n77	0.5
DC_26_n78	n78	0.5
DC_28_n51	n51	0.2
DC_28_n77	28	0.2
	n77	0.5
DC_28_n78	28	0.2
	n78	0.5
DC_30_n66	30	0.5
	n66	0.4
DC_38_n78	38	0.4
	n78	0.5
DC_39_n78	n78	0.5
DC_39_n79	n79	0.5
DC_40_n77	40	0.4
	n77	0.5

DC_41_n77	n77	0.5
DC_41_n78	n78	0.5
DC_41_n79	n79	0.5
DC_42_n51	n51	0.2
DC_66_n78	66	0.2
	n78	0.5
NOTE 1: The requirement is applied for UE transmitting on the frequency range of 2545 – 2690 MHz.		
NOTE 2: The requirement is applied for UE transmitting on the frequency range of 2496 – 2545 MHz.		

7.3B.3.3.2 $\Delta R_{IB,c}$ for EN-DC three bands

Table 7.3B.3.3.2-1: $\Delta R_{IB,c}$ due to EN-DC (three bands)

Inter-band EN-DC configuration	E-UTRA or NR Band	$\Delta R_{B,c}$ (dB)
DC_1-3_n28	n28	0.2
DC_1-3_n77	1	0.2
	3	0.2
	n77	0.5
DC_1-3_n78	1	0.2
	3	0.2
	n78	0.5
DC_1-5_n78	1	0.2
	5	0.2
	n78	0.5
DC_1-7_n28	n28	0.2
DC_1-7_n78 DC_1-7-7_n78	1	0.2
	7	0.2
	n78	0.5
DC_1-8_n78	8	0.2
	n78	0.5
DC_1-18_n77	n77	0.5
DC_1-18_n78	n78	0.5
DC_1-19_n77	n77	0.5
DC_1-19_n78	n78	0.5
DC_1-19_n79	1	0.3
	19	0.3
DC_1-20_n28	20	0.2
	n28	0.2
DC_1-20_n78	n78	0.5
DC_1-21_n77	n77	0.5
DC_1-21_n78	1	0.2
	n78	0.5
DC_1-28_n77	28	0.2
	n77	0.5
DC_1-28_n78 DC_1_n28-n78	28 or n28 n78	0.2 0.5
DC_1_n28-n79	1	0.3
	28	0.3
DC_1-42_n77	1	0.2
	42	0.5
	n77	0.5
DC_1-41_n77	n77	0.5
DC_1-41_n78	n78	0.5
DC_1-42_n78	1	0.2
	42	0.5
	n78	0.5
DC_1-42_n79	42	0.5
DC_1_n77-n79	1	0.2
	n77	0.5
DC_1_n78-n79	n78	0.5
DC_1-SUL_n78-n84	n78	0.5
DC_2_5_n66	2	0.3
	n66	0.3
DC_2_30_n66	2	0.4
	30	0.5
	n66	0.4
DC_2-66_n71B	2	0.3
	66	0.3
DC_3_n3-n77	3	0.2
	n3	0.2
	n77	0.5
DC_3_n3-n78	3	0.2
	n3	0.2
	n78	0.5
DC_3-5_n78	3	0.2
	5	0.2

	n78	0.5
DC_3-7_n78, DC_3-7-7_n78	3	0.2
	7	0.2
	n78	0.5
DC_3-8_n78	3	0.2
	8	0.2
	n78	0.5
DC_3-19_n77	3	0.2
	n77	0.5
DC_3-19_n78	3	0.2
	n78	0.5
DC_3-20_n28	20	0.1
	n28	0.1
DC_3-20_n78	3	0.2
	n78	0.5
DC_3-21_n77	3	0.3
	21	0.5
	n77	0.5
DC_3-21_n78	3	0.3
	21	0.5
	n78	0.5
DC_3-21_n79	3	0.3
	21	0.5
DC_3-28_n78 DC_3_n28-n78	3	0.2
	n78	0.5
DC_3-38_n78	3	0.2
	38	0.4
	n78	0.5
DC_3-41_n78	3	0.2
	41	0 ¹
	n78	0.5 ²
DC_3-42_n77	3	0.2
	42	0.5
	n77	0.5
DC_3-42_n78	3	0.2
	42	0.5
	n78	0.5
DC_3-42_n79	3	0.2
	42	0.5
DC_3_n77-n79	3	0.2
	n77	0.5
DC_3_n78-n79	3	0.2
	n78	0.5
DC_3-SUL_n78-n80	3	0.2
	n78	0.5
DC_3-SUL_n78-n82	3	0.2
	n78	0.5
DC_5-7_n78	5	0.2
	7	0.2
	n78	0.5
DC_5_30_n66	30	0.5
	n66	0.4
DC_7-20_n28	20	0.2
	n28	0.2
DC_7-20_n78	n78	0.5
DC_7-28_n78	n78	0.5
DC_7_n28-n78	n78	0.5
DC_7-46_n78	n78	0.5
DC_8A-SUL_n78-n81	8	0.2
	n78	0.2
DC_18-28_n77	n77	0.5
DC_18-28_n78	n78	0.5
DC_19-21_n77	n77	0.5
DC_19-21_n78	n78	0.5

DC_19-42_n77	42	0.5
	n77	0.5
DC_19-42_n78	42	0.5
	n78	0.5
DC_19-42_n79	42	0.5
DC_19_n77-n79	n77	0.5
DC_19_n78-n79	n78	0.5
DC_20_n28-n75	n28	0.2
DC_20_n28-n78	20	0.2
	n28	0.2
	n78	0.5
DC_20_n75-n78	n78	0.5
DC_20_n76-n78	n78	0.5
DC_20-SUL_n78-n82	n78	0.5
DC_20-SUL_n78-n83	20	0.2
	n78	0.5
DC_21-42_n77	42	0.5
	n77	0.5
DC_21-42_n78	42	0.5
	n78	0.5
DC_21-42_n79	42	0.5
DC_21_n77-n79	n77	0.5
DC_21_n78-n79	n78	0.5
DC_28-SUL_n78-n83	28	0.2
	n78	0.5
DC_28-42_n77	28	0.2
	42	0.5
	n77	0.5
DC_28-42_n78	28	0.2
	42	0.5
	n78	0.5
DC_28-42_n79	28	0.2
	42	0.5
DC_41-42_n77	42	0.5
	n77	0.5
DC_41-42_n78	42	0.5
	n78	0.5
DC_41-42_n79	42	0.5
DC_66-SUL_n78-n86	66	0.2
	n78	0.5

NOTE 1: The requirement is applied for UE transmitting on the frequency range of 2545 – 2690 MHz.
NOTE 2: The requirement is applied for UE transmitting on the frequency range of 2496 – 2545 MHz.

7.3B.3.3.3

 $\Delta R_{IB,c}$ for EN-DC four bands**Table 7.3B.3.3.3-1: $\Delta R_{IB,c}$ due to EN-DC (four bands)**

Inter-band EN-DC configuration	E-UTRA or NR Band	$\Delta R_{IB,c}$ (dB)
DC_1-3-5_n78	1	0.2
	3	0.2
	n78	0.5
DC_1-3-7_n28	n28	0.2
DC_1-3-7_n78 DC_1-3-7-7_n78	1	0.3
	3	0.3
	7	0.3
	n78	0.5
DC_1-3-8_n78	1	0.2
	3	0.2
	8	0.2
	n78	0.5
DC_1-3-19_n78	1	0.2
	3	0.2
	n78	0.5
DC_1-3-20_n28	20	0.2
	n28	0.2
DC_1-3-20_n78	1	0.2
	3	0.2
	n78	0.5
DC_1-3-21_n77	1	0.2
	3	0.3
	21	0.5
	n77	0.5
DC_1-3-21_n78	1	0.2
	3	0.3
	21	0.5
	n78	0.5
DC_1-3-21_n79	3	0.3
	21	0.5
DC_1-3-28_n77	1	0.2
	3	0.2
	28	0.2
	n77	0.5
DC_1-3-28_n78 DC_1-3_n28-n78	1	0.2
	3	0.2
	28 or n28	0.2
	n78	0.5
DC_1-3-28_n79	1	0.2
	3	0.2
	28	0.2
DC_1-3-42_n77	1	0.2
	3	0.2
	42	0.5
	n77	0.5
DC_1-3-42_n78	1	0.2
	3	0.2
	42	0.5
	n78	0.5
DC_1-3-42_n79	1	0.2
	3	0.2
	42	0.5
DC_1-5-7_n78 DC_1-5-7-7_n78	1	0.2
	5	0.2
	7	0.2
	n78	0.5
DC_1-7-20_n28	20	0.2
	n28	0.2
DC_1-7-20_n78	1	0.2
	7	0.2
	20	0.2
	n78	0.5
DC_1-7_n28-n78	1	0.2

	7	0.2
	n28	0.2
	n78	0.5
DC_1-18-28_n77	n77	0.5
DC_1-18-28_n78	n78	0.5
DC_1-19-42_n77	1	0.2
	42	0.5
	n77	0.5
DC_1-19-42_n78	42	0.5
	n78	0.5
DC_1-19-42_n79	42	0.5
DC_1-20_n28-n78	20	0.2
	n28	0.2
	n78	0.5
DC_1-21-42_n77	1	0.2
	42	0.5
	n77	0.5
DC_1-21-42_n78	42	0.5
	n78	0.5
DC_1-21-42_n79	42	0.5
DC_1-28-42_n77	1	0.2
	28	0.2
	42	0.5
	n77	0.5
DC_1-28-42_n78	28	0.2
	42	0.5
	n78	0.5
DC_1-28-42_n79	28	0.2
	42	0.5
DC_1-41-42_n77	42	0.5
	n77	0.5
DC_1-41-42_n78	42	0.5
	n78	0.5
DC_1-41-42_n79	42	0.5
DC_1-41-42_n79	42	0.5
DC_2-66-(n)71	2	0.3
	66	0.3
DC_3-5-7_n78, DC_3-5-7-7_n78	3	0.2
	5	0.2
	7	0.2
	n78	0.5
DC_3-7-7_n78	3	0.2
	7	0.2
	n78	0.5
DC_3-7-20_n28	20	0.2
	n28	0.1
DC_3-7-20_n78	3	0.2
	7	0.2
	n78	0.5
DC_3-7-28_n78 DC_3-7_n28-n78	3	0.2
	7	0.2
	28 or n28	0.2
	n78	0.5
DC_3-19-21_n77	3	0.3
	21	0.5
	n77	0.5
DC_3-19-21_n78	3	0.3
	21	0.5
	n78	0.5
DC_3-19-21_n79	3	0.3
	21	0.5
DC_3-19-42_n77	3	0.2
	42	0.5
	n77	0.5
DC_3-19-42_n78	3	0.2

	42	0.5
	n78	0.5
DC_3-19-42_n79	3	0.2
	42	0.5
DC_3-20_n28-n78	3	0.2
	20	0.2
	n28	0.2
	n78	0.5
DC_3-21-42_n77	3	0.3
	21	0.5
	42	0.5
	n77	0.5
DC_3-21-42_n78	3	0.3
	21	0.5
	42	0.5
	n78	0.5
DC_3-21-42_n79	3	0.3
	21	0.5
	42	0.5
DC_3-28-42_n77	3	0.2
	28	0.2
	42	0.5
	n77	0.5
DC_3-28-42_n78	3	0.2
	28	0.2
	42	0.5
	n78	0.5
DC_3-28-42_n79	3	0.2
	28	0.2
	42	0.5
DC_5-7-7_n78	5	0.2
	7	0.2
	n78	0.5
DC_7-20_n28-n78	20	0.2
	n28	0.2
	n78	0.5
DC_19-21-42_n77	42	0.5
	n77	0.5
DC_19-21-42_n78	42	0.5
	n78	0.5
DC_19-21-42_n79	42	0.5
DC_21-28-42_n77	28	0.2
	42	0.5
	n77	0.5
DC_21-28-42_n78	28	0.2
	42	0.5
	n78	0.5
DC_21-28-42_n79	28	0.2
	42	0.5

7.3B.3.3.4 $\Delta R_{IB,c}$ for EN-DC five bands

Table 7.3B.3.3.4-1: $\Delta R_{IB,c}$ due to EN-DC (five bands)

Inter-band EN-DC configuration	E-UTRA or NR Band	$\Delta R_{IB,c}$ (dB)
DC_1-3-5-7_n78, DC_1-3-5-7-7_n78	1	0.2
	3	0.2
	5	0.2
	7	0.2
	n78	0.5
DC_1-3-7-20_n28	20	0.2
	n28	0.2
DC_1-3-7-20_n78	1	0.2
	3	0.2

Inter-band EN-DC configuration	E-UTRA or NR Band	$\Delta R_{IB,c}$ (dB)
	7	0.2
	n78	0.5
DC_1-3-7_n28-n78	1	0.2
	3	0.2
	7	0.2
	n28	0.2
	n78	0.5
DC_1-3-19-21_n77	1	0.2
	3	0.3
	21	0.5
	n77	0.5
DC_1-3-19-21_n78	1	0.2
	3	0.3
	21	0.5
	n78	0.5
DC_1-3-19-21_n79	3	0.3
	21	0.5
DC_1-3-19-42_n77	1	0.2
	3	0.2
	42	0.5
	n77	0.5
DC_1-3-19-42_n78	1	0.2
	3	0.2
	42	0.5
	n78	0.5
DC_1-3-19-42_n79	1	0.2
	3	0.2
	42	0.5
DC_1-3-28-42_n77	1	0.2
	3	0.2
	28	0.2
	42	0.5
	n77	0.5
DC_1-3-28-42_n78	1	0.2
	3	0.2
	28	0.2
	42	0.5
	n78	0.5
DC_1-3-28-42_n79	1	0.2
	3	0.2
	28	0.2
	42	0.5
DC_1-3-20_n28-n78	1	0.2
	3	0.2
	20	0.2
	n28	0.2
	n78	0.5
DC_1-3-21-42_n77	1	0.2
	3	0.3
	21	0.5
	42	0.5
	n77	0.2
DC_1-3-21-42_n78	1	0.2
	3	0.3
	21	0.5
	42	0.5
	n78	0.2
DC_1-3-21-42_n79	1	0.2
	3	0.3
	21	0.5
	42	0.5
DC_1-7-20_n28-n78	1	0.2
	7	0.2
	20	0.2

Inter-band EN-DC configuration	E-UTRA or NR Band	$\Delta R_{IB,c}$ (dB)
	n28	0.2
	n78	0.5
DC_1-19-21-42_n77	1	0.2
	42	0.5
	n77	0.5
DC_1-19-21-42_n78	42	0.5
	n78	0.5
DC_1-19-21-42_n79	42	0.5
DC_1-21-28-42_n77	1	0.2
	28	0.2
	42	0.5
	n77	0.5
DC_1-21-28-42_n78	28	0.2
	42	0.5
	n78	0.5
DC_1-21-28-42_n79	28	0.2
	42	0.5
DC_3-7-20_n28-n78	3	0.2
	7	0.2
	20	0.2
	n28	0.2

7.3B.3.3.5 $\Delta R_{IB,c}$ for EN-DC six bands

Table 7.3B.3.3.5-1: $\Delta R_{IB,c}$ due to EN-DC (six bands)

Inter-band EN-DC configuration	E-UTRA or NR Band	$\Delta R_{IB,c}$ (dB)
DC_1-3-7-20_n28-n78	1	0.2
	3	0.2
	7	0.2
	20	0.2
	n28	0.2
	n78	0.5

7.3B.3.3a Inter-band NE-DC within FR1

Unless $\Delta R_{IB,c}$ is specified in this clause, the value of $\Delta R_{IB,c}$ for the correspondingly specified EN-DC configuration in clause 7.3B.3.3 is applicable.

7.3B.3.4 Inter-band EN-DC including FR2

7.3B.3.4.1 $\Delta R_{IB,c}$ for EN-DC in two bands

Unless otherwise stated, $\Delta R_{IB,c}$ for E-UTRA and FR2 NR bands of inter-band EN-DC combinations defined in table 5.5B.5.1-1 is set to zero.

Table 7.3B.3.4.1-1: Void

7.3B.3.4.2 $\Delta R_{IB,c}$ for EN-DC three bands

Unless otherwise stated, $\Delta R_{IB,c}$ for FR2 NR bands is set to zero, and $\Delta R_{IB,c}$ for constituent E-UTRA bands for inter-band EN-DC defined in table 5.5B.5.3-1 is the same as those for the corresponding E-UTRA CA configuration specified in TS 36.101 [4], without the FR2 NR bands.

Table 7.3B.3.4.2-1: Void**7.3B.3.4.3 $\Delta R_{IB,c}$ for EN-DC four bands**

Unless otherwise stated, $\Delta R_{IB,c}$ for FR2 NR bands is set to zero, and $\Delta R_{IB,c}$ for constituent E-UTRA bands for inter-band EN-DC defined in table 5.2B.5.3-1 is the same as those for the corresponding E-UTRA CA configuration specified in TS 36.101 [4], without the FR2 NR bands.

Table 7.3B.3.4.3-1: Void**7.3B.3.4.4 $\Delta R_{IB,c}$ for EN-DC five bands**

Unless otherwise stated, $\Delta R_{IB,c}$ for FR2 NR bands is set to zero, and $\Delta R_{IB,c}$ for constituent E-UTRA bands for inter-band EN-DC defined in table 5.5B.5.4-1 is the same as those for the corresponding E-UTRA CA configuration specified in TS 36.101 [4], without the FR2 NR bands.

Table 7.3B.3.4.4-1: Void**7.3B.3.4.5 Void****7.3B.3.5 Inter-band EN-DC including both FR1 and FR2****7.3B.3.5.2 $\Delta R_{IB,c}$ for EN-DC three bands**

Unless otherwise stated, for inter-band EN-DC configurations defined in table 5.5B.6.2-1, $\Delta R_{IB,c}$ for constituent FR2 NR bands is set to zero, and $\Delta R_{IB,c}$ for constituent E-UTRA and FR1 NR bands is the same as those for the corresponding inter band EN-DC configuration without the FR2 bands specified in 7.3B.3.3.

Table 7.3B.3.5.2-1: Void**7.3B.3.5.3 $\Delta R_{IB,c}$ for EN-DC four bands**

Unless otherwise stated, for inter-band EN-DC configurations defined in table 5.5B.6.3-1, $\Delta R_{IB,c}$ for constituent FR2 NR bands is set to zero, and $\Delta R_{IB,c}$ for constituent E-UTRA and FR1 NR bands is the same as those for the corresponding inter band EN-DC configuration without the FR2 bands specified in 7.3B.3.3.

7.3B.3.5.4 $\Delta R_{IB,c}$ for EN-DC five bands

Unless otherwise stated, for a certain inter-band EN-DC configurations defined in table 5.5B.6.4-1, $\Delta R_{IB,c}$ for constituent FR2 NR bands is set to zero, and $\Delta R_{IB,c}$ for constituent E-UTRA and FR1 NR bands is the same as those for the corresponding inter band EN-DC configuration without the FR2 bands specified in 7.3B.3.3.

7.3B.3.5.5 $\Delta R_{IB,c}$ for EN-DC six bands

Unless otherwise stated, for inter-band EN-DC configurations defined in table 5.5B.6.5-1, $\Delta R_{IB,c}$ for constituent FR2 NR bands is set to zero, and $\Delta R_{IB,c}$ for constituent E-UTRA and FR1 NR bands is the same as those for the corresponding inter band EN-DC configuration without the FR2 bands specified in 7.3B.3.3.

7.4 Void**7.4A Maximum input level for CA**

For inter-band NR CA between FR1 and FR2, the maximum input level specified in TS 38.101-1 [2] and TS 38.101-2 [3] apply for FR1 and FR2 respectively.

7.4B Maximum input level for DC in FR1

7.4B.1 Intra-band contiguous EN-DC in FR1

Intra-band contiguous EN-DC maximum input level requirement and parameters are defined in Table 7.4B.1-1.

Table 7.4B.1-1: Maximum Input

Power in Largest CC, E-UTRA or NR, dBm	X^1
Power in each other CC, dBm	$X^1 - 10 \cdot \log_{10}(N_x \text{SCS}_x / N_y \text{SCS}_y)$
NOTE 1: Power in Largest E-UTRA or NR bandwidth CC, listed in Table 7.4-1 [2]	
NOTE 2: N_x, SCS_x is the number of RB's and Sub carrier spacing in the largest carrier bandwidth and could be E-UTRA or NR carrier	
NOTE 3: N_y, SCS_y is the number of RB's in any other carrier.	
NOTE 4: For NR carrier, the transmitter shall be set to 4dB below $P_{\text{CMAX_L,f,c,NR}}$ at the minimum uplink configuration specified in Table 7.3.2-3 [2] with $P_{\text{CMAX_L,f,c,NR}}$ as defined in subclause 6.2B.4.	
NOTE 5: For E-UTRA carrier, the transmitter shall be set to 4dB below $P_{\text{CMAX_L_E-UTRA,c}}$ at the minimum uplink configuration specified in Table 7.3.1-2 [4] with $P_{\text{CMAX_L_E-UTRA,c}}$ as defined in subclause 6.2B.4 for single carrier.	

7.4B.2 Intra-band non-contiguous EN-DC in FR1

For the E-UTRA sub-block containing one or multiple CC's, the requirement is defined in clause 7.4.1 for single carrier operation and in clause 7.4.1A for CA in TS 36.101 [4].

For the NR sub-block, the requirement is defined in clause 7.4 in TS 38.101-1 [2].

7.4B.3 Inter-band EN-DC within FR1

Maximum input level requirement for E-UTRA single carrier and CA operation specified in clauses 7.4.1 and 7.4.1A of TS 36.101 [4] and for NR single carrier and CA operation specified in clauses 7.4 and 7.4A of TS 38.101-1 [2] apply.

7.4B.3a Inter-band NE-DC within FR1

Maximum input level requirement for E-UTRA single carrier and CA operation specified in clauses 7.4.1 and 7.4.1A of TS 36.101 [4] and for NR single carrier and CA operation specified in clauses 7.4 and 7.4A of TS 38.101-1 [2] apply.

7.4B.4 Inter-band EN-DC including FR2

Maximum input level requirement for E-UTRA single carrier and CA operation specified in clauses 7.4.1 and 7.4.1A of TS 36.101 [4] and for NR single carrier and CA operation specified in clauses 7.4, 7. and 7.4B of TS 38.101-2 [3] apply.

7.4B.5 Inter-band EN-DC including both FR1 and FR2

Maximum input level requirement for E-UTRA single carrier and CA operation specified in clauses 7.4.1 and 7.4.1A of TS 36.101 [4] and for NR single carrier and CA operation specified in clauses 7.4, 7.4A and 7.4B of TS 38.101-1 [2] and TS 38.101-2 [3] apply.

7.5 Void

7.5A Adjacent channel selectivity for CA

For inter-band NR CA between FR1 and FR2, the adjacent channel selectivity specified in TS 38.101-1 [2] and TS 38.101-2 [3] apply for FR1 and FR2 respectively.

7.5B Adjacent channel selectivity for DC in FR1

7.5B.1 Intra-band contiguous EN-DC in FR1

Intra-band contiguous EN-DC ACS requirement and parameters are defined for test case 1 in Table 7.5B.1-1 and for test case 2 in Table 7.5B.1-2.

Table 7.5B.1-1: ACS test case 1

EN-DC Aggregated Bandwidth, MHz	<=100	>100, <=120	>120, <=140	>140, <=160
ACS, dB	X ¹	19.2	18.5	17.9
P _{interferer} , dBm	P _i ²	Aggregated power + 17.7 dB	Aggregated power + 17 dB	Aggregate d power + 16.4dB
P _w in Transmission BW configuration, per CC, dBm	REFSENS +14dB			
NOTE 1: X is ACS level at the specified EN-DC aggregated bandwidth from Table 7.5.1A-1 in TS 36.101 [4]				
NOTE 2: P _i is from Table 7.5.1A-2 in TS 36.101 [4]				
NOTE 3: Jammer BW and offset is from Table 7.5.1A-2 [4] and is applied from the lowest edge of the lowest carrier and the highest edge of the highest carrier				
NOTE 4: For NR carrier, the transmitter shall be set to 4dB below P _{C_{MAX}_L,f,c,NR} at the minimum uplink configuration specified in Table 7.3.2-3 [2] with P _{C_{MAX}_L,f,c,NR} as defined in subclause 6.2B.4.				
NOTE 5: For E-UTRA carrier, the transmitter shall be set to 4 dB below P _{C_{MAX}_L,E-UTRA,c} at the minimum uplink configuration specified in Table 7.3.1-2 [4] with P _{C_{MAX}_L,E-UTRA,c} as defined in subclause 6.2B.4 for single carrier.				

Table 7.5B.1-2: ACS test case 2

EN-DC Aggregated Bandwidth, ENBW, MHz	≤100	>100, ≤120	>120, ≤140	>140, ≤160
P _w in Transmission Bandwidth Configuration, perCC, dBm	P _w ¹	-42.7 +10log ₁₀ (N _{RB,c} /N _{RB_agg})	-42 +10log ₁₀ (N _{RB,c} /N _{RB_agg})	-41.4 +10log ₁₀ (N _{RB,c} /N _{RB_agg})
P _{interferer} , dBm	-25			
NOTE 1: P _w is wanted signal power level at the specified EN-DC aggregated Bandwidth from Table 7.5.1A-3 in TS 36.101 [4]				
NOTE 2: Jammer BW and offset is from Table 7.5.1A-3 [4] and is applied from the lowest edge of the lowest carrier and the highest edge of the highest carrier				
NOTE 3: For NR carrier, the transmitter shall be set to 24 dB below P _{C_{MAX}_L,f,c,NR} at the minimum uplink configuration specified in Table 7.3.2-3 [2] with P _{C_{MAX}_L,f,c,NR} as defined in subclause 6.2B.4.				
NOTE 4: For E-UTRA carrier, the transmitter shall be set to 24 dB below P _{C_{MAX}_L,E-UTRA,c} at the minimum uplink configuration specified in Table 7.3.1-2 [4] with P _{C_{MAX}_L,E-UTRA,c} as defined in subclause 6.2B.4 for single carrier.				

7.5B.2 Intra-band non-contiguous EN-DC in FR1

For the E-UTRA sub-block containing one or multiple CC's, the requirement is defined in clause 7.5.1 for single carrier operation and in clause 7.5.1A for CA in TS 36.101 [4].

For the NR sub-block, the requirement is defined in clause 7.5 in TS 38.101-1 [2].

The blocker configuration is defined in the general clause 7.1.

7.5B.3 Inter-band EN-DC within FR1

Adjacent channel selectivity requirement for E-UTRA single carrier and CA operation specified in clauses 7.5.1 and 7.5.1A of TS 36.101 [4] and for NR single carrier and CA operation specified in clauses 7.5 and 7.5A of TS 38.101-1 [2] apply.

7.5B.3a Inter-band NE-DC within FR1

Adjacent channel selectivity requirement for E-UTRA single carrier and CA operation specified in clauses 7.5.1 and 7.5.1A of TS 36.101 [4] and for NR single carrier and CA operation specified in clauses 7.5 and 7.5A of TS 38.101-1 [2] apply.

7.5B.4 Inter-band EN-DC including FR2

Adjacent channel selectivity requirement for E-UTRA single carrier and CA operation specified in clauses 7.5.1 and 7.5.1A of TS 36.101 [4] and for NR single carrier and CA operation specified in clauses 7.5, 7.5A and 7.5B of TS 38.101-2 [3] apply.

7.5B.5 Inter-band EN-DC including both FR1 and FR2

Adjacent channel selectivity requirement for E-UTRA single carrier and CA operation specified in clauses 7.5.1 and 7.5.1A of TS 36.101 [4] and for NR single carrier and CA operation specified in clauses 7.5, 7.5A and 7.5B of TS 38.101-1 [2] and TS 38.101-2 [3] apply.

7.6 Void

7.6A Blocking characteristics for CA

For inter-band NR CA between FR1 and FR2, the in-band blocking characteristics specified in TS 38.101-1 [2] and TS 38.101-2 [3] apply for FR1 and FR2 respectively. The narrow band blocking and out-of-band blocking specified in TS 38.101-1 [2] apply for FR1.

7.6B Blocking characteristics for DC in FR1

7.6B.1 General

7.6B.2 In-band blocking for DC in FR1

7.6B.2.1 Intra-band contiguous EN-DC in FR1

Intra-band contiguous EN-DC in-band blocking requirement and parameters are defined in Table 7.6B.2.1-1.

Table 7.6B.2.1-1: In-band blocking

EN-DC Aggregated Bandwidth, MHz	≤100	>100, ≤120	>120, ≤140	>140, ≤160
P _w in Transmission Bandwidth Configuration, perCC, dBm	P _w ¹	REFSENS + Aggregated BW specific value below		
		16.8	17.5	18
NOTE 1: P _w is wanted signal power level at the specified EN-DC aggregated Bandwidth from Table 7.6.1.1A-1 in TS 36.101 [4]				
NOTE 2: Interferer values are specified from Table 7.6.1.1A-2 in TS 36.101 [4]				
NOTE 3: Jammer BW and offset is from Table 7.6.1.1A-1[4] and is applied from the lowest edge of the lowest carrier and the highest edge of the highest carrier				
NOTE 4: For NR carrier, the transmitter shall be set to 4dB below P _{CMAX_L,f,c,NR} at the minimum uplink configuration specified in Table 7.3.2-3 [2] with P _{CMAX_L,f,c,NR} as defined in clause 6.2B.4.				
NOTE 5: For E-UTRA carrier, the transmitter shall be set to 4dB below P _{CMAX_L,E-UTRA,c} at the minimum uplink configuration specified in Table 7.3.1-2 [4] with P _{CMAX_L,E-UTRA,c} as defined in clause 6.2B.4 for single carrier.				

7.6B.2.2 Intra-band non-contiguous EN-DC in FR1

For the E-TRA sub-block containing one or multiple CC's, the requirement is defined in clause 7.6.1.1 for single carrier operation and in clause 7.6.1.1A for CA in TS 36.101 [4].

For the NR sub-block, the requirement is defined in clause 7.6.2 in TS 38.101-1 [2].

The blocker configuration is defined in the general clause 7.1.

7.6B.2.3 Inter-band EN-DC within FR1

Inband blocking requirement for E-UTRA single carrier and CA operation specified in clauses 7.6.1.1 and 7.6.1.1A of TS 36.101 [4] and for NR single carrier and CA operation specified in clauses 7.6.2 and 7.6A.2 of TS 38.101-1 [2] apply.

7.6B.2.3a Inter-band NE-DC within FR1

Inband blocking requirement for E-UTRA single carrier and CA operation specified in clauses 7.6.1.1 and 7.6.1.1A of TS 36.101 [4] and for NR single carrier and CA operation specified in clauses 7.6.2 and 7.6A.2 of TS 38.101-1 [2] apply.

7.6B.2.4 Inter-band EN-DC including FR2

Inband blocking requirement for E-UTRA single carrier and CA operation specified in clauses 7.6.1.1 and 7.6.1.1A of TS 36.101 [4] and for NR single carrier and CA operation specified in clauses 7.6.2, 7.6A.2 and 7.6B.2 of TS 38.101-1 [3] apply.

7.6B.2.5 Inter-band EN-DC including both FR1 and FR2

Inband blocking requirement for E-UTRA single carrier and CA operation specified in clauses 7.6.1.1 and 7.6.1.1A of TS 36.101 [4] and for NR single carrier and CA operation specified in clauses 7.6.2, 7.6A.2 and 7.6B.2 of TS 38.101-1 [2] and TS 38.101-2 [3] apply.

7.6B.3 Out-of-band blocking for DC in FR1

7.6B.3.1 Intra-band contiguous EN-DC in FR1

Intra-band contiguous EN-DC out-of-band requirement and parameters are defined in Table 7.6B.3.1-1.

Table 7.6B.3.1-1: Out-of-band blocking

EN-DC Aggregated Bandwidth, MHz	≤100	>100, ≤120	>120, ≤140	>140, ≤160
Pw in Transmission Bandwidth Configuration, perCC, dBm	REFSENS + Aggregated BW specific value below			
	9			
NOTE 1: Interferer values and offsets are specified from Table 7.6.2.1A-2 in TS 36.101 [4]. For inter-band combinations where the intra-band requirements are applicable, in which the E-UTRA band is a subset of an NR-only band, the NR band interferer values and offsets specified from Table 7.6A.3-2 in TS 38.101-1 [2] apply to both E-UTRA and NR carriers.				
NOTE 2: For NR carrier, the transmitter shall be set to 4dB below $P_{\text{CMAX_L,f,c,NR}}$ at the minimum uplink configuration specified in Table 7.3.2-3 [2] with $P_{\text{CMAX_L,f,c,NR}}$ as defined in clause 6.2B.4.				
NOTE 3: For E-UTRA carrier, the transmitter shall be set to 4dB below $P_{\text{CMAX_L,E-UTRA,c}}$ at the minimum uplink configuration specified in Table 7.3.1-2 [4] with $P_{\text{CMAX_L,E-UTRA,c}}$ as defined in clause 6.2B.4 for single carrier.				

7.6B.3.2 Intra-band non-contiguous EN-DC in FR1

For the E-UTRA sub-block containing one or multiple CC's, the requirement is defined in clause 7.6.2.1 for single carrier operation and in clause 7.6.2.1A for CA in TS 36.101 [4].

For the NR sub-block, the requirement is defined in clause 7.6.3 is [2].

7.6B.3.3 Inter-band EN-DC within FR1

Out-of band blocking requirements for E-UTRA single carrier and CA operation specified in clauses 7.6.2.1 and 7.6.2.1A of TS 36.101 [4] and for NR single carrier and CA operation specified in clauses 7.6.3 and 7.6A.3 of TS 38.101-1 [2] apply for lowest level EN-DC fallbacks (two bands) in clause 5.2.B.4.1 with following conditions

one E-UTRA uplink carrier with the output power set to 4 dB below $P_{\text{CMAX_L,c}}$ and the NR band whose downlink is being tested has its uplink carrier output power set to 29 dB below $P_{\text{CMAX_L,f,c}}$.

one NR uplink carrier with the output power set to 4 dB below $P_{\text{CMAX_L,f,c}}$ on the NR band with both E-UTRA and NR downlinks being tested with E-UTRA output power set to 29 dB below $P_{\text{CMAX_L,c}}$.

If CW interferer falls in a gap between $F_{\text{DL_high}}$ of the E-UTRA or NR band and $F_{\text{DL_low}}$ of the NR or EUTRA band, where the corresponding OOB ranges 1 and 2 overlap, then the lower level interferer limit of the overlapping OOB ranges applies.

If $F_{\text{DL_high}}$ of the lower E-UTRA or NR band is greater than or equal to the $F_{\text{DL_low}}$ of the upper NR or E-UTRA band as in overlapping RX frequency ranges, then the OOB range shall start from the $F_{\text{DL_low}}$ of the lower E-UTRA or NR band, and from the $F_{\text{DL_high}}$ of the upper NR or E-UTRA band.

For EN-DC combination listed in Table 7.6B.3.3-1 under the first test condition above, exceptions to the requirement specified in Table 7.6B.3.3-2 are allowed when the second order intermodulation product of the lower frequency band UL carrier and the CW interfering signal fully or partially overlaps with the higher frequency band DL carrier.

Table 7.6B.3.3-1: EN-DC combination with exceptions allowed

EN-DC combination
DC_5_n78
DC_8_n77
DC_8_n78
DC_8_n79
DC_11_n77
DC_18_n77
DC_18_n78
DC_18_n79
DC_19_n77
DC_19_n78
DC_19_n79
DC_20_n77
DC_20_n78
DC_21_n77
DC_26_n77
DC_26_n78
DC_26_n79
DC_28_n77
DC_28_n78
DC_28_n79

Parameter	Unit	Level
$P_{\text{Interferer}} \text{ (CW)}$	dBm	-44 ¹
NOTE 1: The requirement applies when $ f_{\text{Interferer}} \pm f_{\text{UL}}^{\text{LB}} - f_{\text{DL}}^{\text{HB}} \leq (BW_{\text{UL}}^{\text{LB}} + BW_{\text{DL}}^{\text{HB}})/2$, where $f_{\text{UL}}^{\text{LB}}$ and $f_{\text{DL}}^{\text{HB}}$ are the carrier frequencies for lower frequency band UL and higher frequency band DL, respectively. $BW_{\text{UL}}^{\text{LB}}$ and $BW_{\text{DL}}^{\text{HB}}$ are the channel bandwidths configured for lower frequency band UL carrier and higher frequency band DL carrier in MHz, respectively.		

For each of the two test cases in clauses 7.6.2.1 and 7.6.2.1A of TS 36.101 [4] and for NR single carrier and CA operation specified in clauses 7.6.3 and 7.6A.3 of TS 38.101-1 [2] for all interferer frequency ranges a maximum of

$$\lfloor \max\{24,6 \cdot \lceil n \cdot N_{\text{RB}} / 6 \rceil \} / \min\{\lfloor n \cdot N_{\text{RB}} / 10 \rfloor, 5\} \rfloor$$

exceptions are allowed for spurious response frequencies in each assigned frequency channel when measured using a step size of $\min(\lfloor CBW / 2 \rfloor, 5)$ MHz with N_{RB} the number of resource blocks in the downlink transmission bandwidth configuration, CBW the bandwidth of the frequency channel in MHz and $n = 1, 2, 3$ for SCS = 15, 30, 60 kHz, respectively. For these exceptions, the requirements in clause 7.7 apply.

7.6B.3.3a Inter-band NE-DC within FR1

Out-of band blocking requirements for E-UTRA single carrier and CA operation specified in clauses 7.6.2.1 and 7.6.2.1A of TS 36.101 [4] and for NR single carrier and CA operation specified in clauses 7.6.3 and 7.6A.3 of TS 38.101-1 [2] apply for lowest level NE-DC fallbacks (two bands) in clause 5.5.B.4a.1 with following conditions

one E-UTRA uplink carrier with the output power set to 4 dB below $P_{\text{CMAX_L,c}}$ and the NR band whose downlink is being tested has its uplink carrier output power set to 29 dB below $P_{\text{CMAX_L,f,c}}$.

one NR uplink carrier with the output power set to 4 dB below $P_{\text{CMAX_L,f,c}}$ on the NR band with both E-UTRA and NR downlinks being tested with E-UTRA output power set to 29 dB below $P_{\text{CMAX_L,c}}$.

7.6B.3.4 Inter-band EN-DC including FR2

Out-of band blocking requirements specified for E-UTRA single carrier and CA operation specified in clauses 7.6.2.1 and 7.6.2.1A of TS 36.101 [4] apply for lowest level EN-DC fallbacks (two bands) in clause 5.5B.5.1 with only E-UTRA UL with output power as in TS 36.101 [4] (4 dB below $P_{\text{CMAX_L}}$).

7.6B.3.5 Inter-band EN-DC including both FR1 and FR2

Out-of band blocking requirements specified for E-UTRA single carrier and CA operation specified in clauses 7.6.2.1 and 7.6.2.1A of TS 36.101 [4] and for NR single carrier and CA operation specified in clauses 7.6.3 and 7.6A.3 of TS 38.101-1 [2] apply for lowest level EN-DC fallbacks (three bands) in clause 5.5B.6.2 with only E-UTRA UL with output power as in TS 36.101 [4] (4 dB below $P_{\text{CMAX_L}}$).

7.6B.4 Narrow band blocking for DC in FR1

7.6B.4.1 Intra-band contiguous EN-DC in FR1

Intra-band contiguous EN-DC narrow band blocking requirement and parameters are defined in Table 7.6B.4.1-1.

Table 7.6B.4.1-1: Narrow band blocking parameters

EN-DC Aggregated Bandwidth, MHz	≤ 100	$>100, \leq 120$	$>120, \leq 140$	$>140, \leq 160$
Pw in Transmission Bandwidth Configuration, perCC, dBm	REFSENS + Aggregated BW specific value below			
P_{uw}, dBm (CW)	16			
	-55			
NOTE 1: Jammer offset is from Table 7.6.3.1A-1 [4] and is applied from the lowest edge of the lowest carrier and the highest edge of the highest carrier				
NOTE 2: For NR carrier, the transmitter shall be set to 4dB below $P_{\text{CMAX_L,f,c,NR}}$ at the minimum uplink configuration specified in Table 7.3.2-3 [2] with $P_{\text{CMAX_L,f,c,NR}}$ as defined in clause 6.2B.4.				
NOTE 3: For E-UTRA carrier, the transmitter shall be set to 4dB below $P_{\text{CMAX_L,E-UTRA,c}}$ at the minimum uplink configuration specified in Table 7.3.1-2 [4] with $P_{\text{CMAX_L,E-UTRA,c}}$ as defined in clause 6.2B.4 for single carrier.				
NOTE 4: If NR carrier BW > 40 MHz, no narrow band blocking requirements apply when blocker is applied at the edge of the NR carrier.				

7.6B.4.2 Intra-band non-contiguous EN-DC in FR1

For the E-TRA sub-block containing one or multiple CC's, the requirement is defined in clause 7.6.3.1 for single carrier operation and in clause 7.6.3.1A for CA in TS 36.101 [4].

For the NR sub-block, the requirement is defined in clause 7.6.4 in TS 38.101-1 [2].

The blocker configuration is defined in the general clause 7.1.

7.6B.4.3 Inter-band EN-DC within FR1

Narrow band blocking requirement for E-UTRA single carrier and CA operation specified in clauses 7.6.3.1 and 7.6.3.1A of TS 36.101 [4] and for NR single carrier and CA operation specified in clauses 7.6.4 and 7.6A.4 of TS 38.101-1 [2] apply.

7.6B.4.3a Inter-band NE-DC within FR1

Narrow band blocking requirement for E-UTRA single carrier and CA operation specified in clauses 7.6.3.1 and 7.6.3.1A of TS 36.101 [4] and for NR single carrier and CA operation specified in clauses 7.6.4 and 7.6A.4 of TS 38.101-1 [2] apply.

7.6B.4.4 Inter-band EN-DC including FR2

Narrow band blocking requirement for E-UTRA single carrier and CA operation specified in clauses 7.6.3.1 and 7.6.3.1A of TS 36.101 [4] apply.

7.6B.4.5 Inter-band EN-DC including both FR1 and FR2

Narrow band blocking requirement for E-UTRA single carrier and CA operation specified in clauses 7.6.3.1 and 7.6.3.1A of TS 36.101 [4] and for NR single carrier and CA operation specified in clauses 7.6.4 and 7.6A.4 of TS 38.101-1 [2] apply.

7.7 Void

7.7A Spurious response for CA

For inter-band NR CA between FR1 and FR2, the spurious response specified in TS 38.101-1 [2] apply for FR1.

7.7B Spurious response for DC in FR1

7.7B.1 Intra-band contiguous EN-DC in FR1

Intra-band contiguous EN-DC spurious response requirement and parameters are defined in Table 7.7B.1-1.

Table 7.7B.1-1: Spurious Response Parameters

EN-DC Aggregated Bandwidth, MHz	≤100	>100, ≤120	>120, ≤140	>140, ≤160
P _w in Transmission Bandwidth Configuration, perCC, dBm	REFSENS + Aggregated BW specific value below			
P _{interferer} , dBm (CW)	9			
	-44			
NOTE 1: For NR carrier, the transmitter shall be set to 4 dB below P _{CMAX_L,f,c,NR} at the minimum uplink configuration specified in Table 7.3.2-3 [2] with P _{CMAX_L,f,c,NR} as defined in clause 6.2B.4.				
NOTE 2: For E-UTRA carrier, the transmitter shall be set to 4 dB below P _{CMAX_L,E-UTRA,c} at the minimum uplink configuration specified in Table 7.3.1-2 [4] with P _{CMAX_L,E-UTRA,c} as defined in clause 6.2B.4 for single carrier.				

7.7B.2 Intra-band non-contiguous EN-DC in FR1

For the E-UTRA sub-block containing one or multiple CC's, the requirement is defined in clause 7.7.1 for single carrier operation and in clause 7.7.1A for CA in TS 36.101 [4].

For the NR sub-block, the requirement is defined in clause 7.7 is [2].

7.7B.3 Inter-band EN-DC within FR1

Spurious response requirement for E-UTRA single carrier and CA operation specified in clauses 7.7.1 and 7.7.1A of TS 36.101 [4] and for NR single carrier and CA operation specified in clauses 7.7 and 7.7A of TS 38.101-1 [2] apply for lowest level EN-DC fallbacks (two bands) in clause 5.2.B.4.1 with following conditions

- one E-UTRA uplink carrier with the output power set to 4 dB below P_{CMAX_L} and the NR band whose downlink is being tested has its uplink carrier output power set to minimum output power as defined in clause 6.3.1 of TS 38.101-1 [2]

- one NR uplink carrier with the output power set to 4 dB below $P_{\text{CMAX,L}}$ on the NR band with both E-UTRA and NR downlinks being tested with E-UTRA output power set to minimum output power as defined in clause 6.3.2.1 of TS 36.101 [4].

7.7B.3a Inter-band NE-DC within FR1

Spurious response requirement for E-UTRA single carrier and CA operation specified in clauses 7.7.1 and 7.7.1A of TS 36.101 [4] and for NR single carrier and CA operation specified in clauses 7.7 and 7.7A of TS 38.101-1 [2] apply.

7.7B.4 Inter-band EN-DC including FR2

Spurious response requirement for E-UTRA single carrier and CA operation specified in clauses 7.7.1 and 7.7.1A of TS 36.101 [4] apply for lowest level EN-DC fallbacks (two bands) in clause 5.5B.5.1 with only E-UTRA UL with output power as in TS 36.101 [4] (4 dB below $P_{\text{CMAX,L}}$).

7.7B.5 Inter-band EN-DC including both FR1 and FR2

Spurious response requirement for E-UTRA single carrier and CA operation specified in clauses 7.7.1 and 7.7.1A of TS 36.101 [4] and for NR single carrier and CA operation specified in clauses 7.7 and 7.7A of TS 38.101-1 [2] apply for lowest level EN-DC fallbacks (three bands) in clause 5.5B.6.2 with only E-UTRA UL with output power as in TS 36.101 [4] (4 dB below $P_{\text{CMAX,L}}$).

7.8 Void

7.8A Intermodulation characteristics for CA

For inter-band NR CA between FR1 and FR2, the intermodulation characteristics specified in TS 38.101-1 [2] apply for FR1.

7.8B Intermodulation characteristics for DC in FR1

7.8B.1 General

7.8B.2 Wide band Intermodulation

7.8B.2.1 Intra-band contiguous EN-DC in FR1

Intra-band contiguous EN-DC wide band intermodulation requirement and parameters are defined in Table 7.8B.2.1-1.

Table 7.8B.2.1-1: Wide band intermodulation

EN-DC Aggregated Bandwidth, MHz	<=100	>100, <=120	>120, <=140	>140, <=160
P _w in Transmission Bandwidth Configuration, perCC, dBm	P _w ¹	REFSENS + Aggregated BW specific value below		
		16.8	17.5	18.0
P _{interferer 1} , dBm (CW) ²	-46			
P _{interferer 2} , dBm (Modulated) ²	-46			
NOTE 1: P _w is wanted signal power level from Table 7.8.1A-1 in TS 36.101 [4]				
NOTE 2: Jammer BW and offsets is from Table 7.8.1A-1 [4] and is applied from the lowest edge of the lowest carrier and the highest edge of the highest carrier				
NOTE 3: For NR carrier, the transmitter shall be set to 4dB below P _{CMAX_L,f,c,NR} at the minimum uplink configuration specified in Table 7.3.2-3 [2] with P _{CMAX_L,f,c,NR} as defined in clause 6.2B.4.				
NOTE 4: For E-UTRA carrier, the transmitter shall be set to 4dB below P _{CMAX_L,E-UTRA,c} at the minimum uplink configuration specified in Table 7.3.1-2 [4] with P _{CMAX_L,E-UTRA,c} as defined in clause 6.2B.4 for single carrier.				

7.8B.2.2 Intra-band non-contiguous EN-DC in FR1

For the E-UTRA sub-block containing one or multiple CC's, the requirement is defined in clause 7.8.1 for single carrier operation and in clause 7.8.1A for CA in TS 36.101 [4].

For the NR sub-block, the requirement is defined in clause 7.8.2 in TS 38.101-1 [2].

The blocker configuration is defined in the general clause 7.1 and the requirement only apply for out of gap interferers.

7.8B.2.3 Inter-band EN-DC within FR1

Wide band Intermodulation requirement for E-UTRA single carrier and CA operation specified in clauses 7.8.1 and 7.8.1A of TS 36.101 [4] and for NR single carrier and CA operation specified in clauses 7.8.2 and 7.8A.2 of TS 38.101-1 [2] apply.

7.8B.2.3a Inter-band NE-DC within FR1

Wide band Intermodulation requirement for E-UTRA single carrier and CA operation specified in clauses 7.8.1 and 7.8.1A of TS 36.101 [4] and for NR single carrier and CA operation specified in clauses 7.8.2 and 7.8A.2 of TS 38.101-1 [2] apply.

7.8B.2.4 Inter-band EN-DC including FR2

Wide band Intermodulation requirement for E-UTRA single carrier and CA operation specified in clauses 7.8.1 and 7.8.1A of TS 36.101 [4] apply.

7.8B.2.5 Inter-band EN-DC including both FR1 and FR2

Wide band Intermodulation requirement for E-UTRA single carrier and CA operation specified in clauses 7.8.1 and 7.8.1A of TS 36.101 [4] and for NR single carrier and CA operation specified in clauses 7.8.2 and 7.8A.2 of TS 38.101-1 [2] apply.

7.9 Void

7.9A Spurious emissions for CA

For inter-band NR CA between FR1 and FR2, the spurious emission specified in TS 38.101-1 [2] and TS 38.101-2 [3] apply for FR1 and FR2 respectively.

7.9B Spurious emissions for DC in FR1

7.9B.1 Intra-band contiguous EN-DC in FR1

The requirement is defined in clause 7.9A.1 in TS 38.101-1 [2].

7.9B.2 Intra-band non-contiguous EN-DC in FR1

Spurious emissions requirement for E-UTRA single carrier and CA operation specified in clauses 7.9.1 and 7.9.1A of TS 36.101 [4] and for NR single carrier and CA operation specified in clauses 7.9 and 7.9A of TS 38.101-1 [2] apply.

7.9B.3 Inter-band EN-DC within FR1

E-UTRA requirements from TS 36.101 [4] and NR requirements from TS 38.101-1 [2] apply.

7.9B.3a Inter-band NE-DC within FR1

E-UTRA requirements from TS 36.101 [4] and NR requirements from TS 38.101-1 [2] apply.

7.9B.4 Inter-band EN-DC including FR2

Spurious emissions requirement for E-UTRA single carrier and CA operation specified in clauses 7.9.1 and 7.9.1A of TS 36.101 [4] and for NR single carrier and CA operation specified in clause 7.9 of TS 38.101-2 [3] apply.

7.9B.5 Inter-band EN-DC including both FR1 and FR2

Spurious emissions requirement for E-UTRA single carrier and CA operation specified in clauses 7.9.1 and 7.9.1A of TS 36.101 [4] and for NR single carrier and CA operation specified in clauses 7.9 and 7.9A of TS 38.101-1 [2] and TS 38.101-2 [3] apply.

Annex A (normative): Measurement channels

A.1 General

The throughput values defined in the measurement channels specified in Annex A, are calculated and are valid per datastream (codeword). For multi-stream (more than one codeword) transmissions, the throughput referenced in the minimum requirements is the sum of throughputs of all datastreams (codewords).

The UE category entry in the definition of the reference measurement channel in Annex A is only informative and reveals the UE categories, which can support the corresponding measurement channel. Whether the measurement channel is used for testing a certain UE category or not is specified in the individual minimum requirements.

A.2 UL reference measurement channels for E-UTRA TDD Config 2

A.2.1 General

The measurement channels in the following clauses are defined to derive the requirements in clause 6 (Transmitter Characteristics) and clause 7 (Receiver Characteristics). The measurement channels represent example configurations of physical channels for different data rates.

A.2.2 Reference measurement channels for E-UTRA

A.2.2.1 Full RB allocation

A.2.2.1.1 QPSK

Table A.2.2.1.1-1: Reference Channels for QPSK with full RB allocation

Parameter	Unit	Value					
		1.4	3	5	10	15	20
Channel bandwidth	MHz	1.4	3	5	10	15	20
Allocated resource blocks		6	15	25	50	75	100
Uplink-Downlink Configuration (NOTE 2)		2	2	2	2	2	2
Special subframe configuration (NOTE 3)		7	7	7	7	7	7
DFT-OFDM Symbols per Sub-Frame		12	12	12	12	12	12
Modulation		QPSK	QPSK	QPSK	QPSK	QPSK	QPSK
Target Coding rate		1/3	1/3	1/3	1/3	1/5	1/6
Payload size							
For Sub-Frame 2,7	Bits	600	1544	2216	5160	4392	4584
Transport block CRC	Bits	24	24	24	24	24	24
Number of code blocks per Sub-Frame (NOTE 1)							
For Sub-Frame 2,7		1	1	1	1	1	1
Total number of bits per Sub-Frame							
For Sub-Frame 2,7	Bits	1728	4320	7200	14400	21600	28800
Total symbols per Sub-Frame							
For Sub-Frame 2,7		864	2160	3600	7200	10800	14400
UE Category		≥ 1	≥ 1	≥ 1	≥ 1	≥ 1	≥ 1
NOTE 1: If more than one Code Block is present, an additional CRC sequence of L = 24 Bits is attached to each Code Block (otherwise L = 0 Bit)							
NOTE 2: As per Table 4.2-2 in TS 36.211 [7]							
NOTE 3: As per Table 4.2-1 in TS 36.211 [7]							

A.2.2.1.2 16-QAM

Table A.2.2.1.2-1: Reference Channels for 16-QAM with full RB allocation

Parameter	Unit	Value					
Channel bandwidth	MHz	1.4	3	5	10	15	20
Allocated resource blocks		6	15	25	50	75	100
Uplink-Downlink Configuration (NOTE 2)		2	2	2	2	2	2
Special subframe configuration (NOTE 3)		7	7	7	7	7	7
DFT-OFDM Symbols per Sub-Frame		12	12	12	12	12	12
Modulation		16QAM	16QAM	16QAM	16QAM	16QAM	16QAM
Target Coding rate		3/4	1/2	1/3	3/4	1/2	1/3
Payload size							
For Sub-Frame 2,7	Bits	2600	4264	4968	21384	21384	19848
Transport block CRC	Bits	24	24	24	24	24	24
Number of code blocks per Sub-Frame (NOTE 1)							
For Sub-Frame 2,7		1	1	1	4	4	4
Total number of bits per Sub-Frame							
For Sub-Frame 2,7	Bits	3456	8640	14400	28800	43200	57600
Total symbols per Sub-Frame							
For Sub-Frame 2,7		864	2160	3600	7200	10800	14400
UE Category		≥ 1	≥ 1	≥ 1	≥ 2	≥ 2	≥ 2
NOTE 1: If more than one Code Block is present, an additional CRC sequence of L = 24 Bits is attached to each Code Block (otherwise L = 0 Bit)							
NOTE 2: As per Table 4.2-2 in TS 36.211 [7]							
NOTE 3: As per Table 4.2-1 in TS 36.211 [7]							

A.2.2.1.3 64-QAM

Table A.2.2.1.3-1: Reference Channels for 64-QAM with full RB allocation

Parameter	Unit	Value					
		1.4	3	5	10	15	20
Channel bandwidth	MHz	1.4	3	5	10	15	20
Allocated resource blocks		6	15	25	50	75	100
Uplink-Downlink Configuration (NOTE 2)		2	2	2	2	2	2
Special subframe configuration (NOTE 3)		7	7	7	7	7	7
DFT-OFDM Symbols per Sub-Frame		12	12	12	12	12	12
Modulation		64QAM	64QAM	64QAM	64QAM	64QAM	64QAM
Target Coding rate		3/4	3/4	3/4	3/4	3/4	3/4
Payload size							
For Sub-Frame 2,7	Bits	3752	9528	15840	31704	46888	63776
Transport block CRC	Bits	24	24	24	24	24	24
Number of code blocks per Sub-Frame (NOTE 1)							
For Sub-Frame 2,7		1	2	3	6	8	11
Total number of bits per Sub-Frame							
For Sub-Frame 2,7	Bits	5184	12960	21600	43200	64800	86400
Total symbols per Sub-Frame							
For Sub-Frame 2,7		864	2160	3600	7200	10800	14400
UE Category (NOTE 4)		5, 8	5, 8	5, 8	5, 8	5, 8	5, 8
UE UL Category (NOTE 4)		5, 8, 13, 14	5, 8, 13, 14	5, 8, 13, 14	5, 8, 13, 14	5, 8, 13, 14	5, 8, 13, 14
NOTE 1: If more than one Code Block is present, an additional CRC sequence of L = 24 Bits is attached to each Code Block (otherwise L = 0 Bit)							
NOTE 2: As per Table 4.2-2 in TS 36.211 [7]							
NOTE 3: As per Table 4.2-1 in TS 36.211 [7]							
NOTE 4: If UE does not report UE UL category, then the applicability of reference channel is determined by UE category. If UE reports UE UL category, then the applicability of reference channel is determined by UE UL category.							

A.2.2.1.4 256 QAM

Table A.2.2.1.4-1: Reference Channels for 256 QAM with full RB allocation

Parameter	Unit	Value					
Channel bandwidth	MHz	1.4	3	5	10	15	20
Allocated resource blocks		6	15	25	50	75	100
Uplink-Downlink Configuration (NOTE 2)		2	2	2	2	2	2
Special subframe configuration (NOTE 3)		7	7	7	7	7	7
DFT-OFDM Symbols per Sub-Frame		12	12	12	12	12	12
Modulation		256QAM	256QAM	256QAM	256QAM	256QAM	256QAM
Target Coding rate		3/4	3/4	3/4	3/4	3/4	3/4
Payload size							
For Sub-Frame 2,7	Bits	5160	12960	21384	42368	63776	84760
Transport block CRC	Bits	24	24	24	24	24	24
Number of code blocks per Sub-Frame (NOTE 1)							
For Sub-Frame 2,7		1	3	4	8	11	15
Total number of bits per Sub-Frame							
For Sub-Frame 2,7	Bits	6912	17280	28800	57600	86400	115200
Total symbols per Sub-Frame							
For Sub-Frame 2,7		864	2160	3600	7200	10800	14400
UE UL Category		≥ 15	≥ 15	≥ 15	≥ 15	≥ 15	≥ 15
NOTE 1: If more than one Code Block is present, an additional CRC sequence of L = 24 Bits is attached to each Code Block (otherwise L = 0 Bit)							
NOTE 2: As per Table 4.2-2 in TS 36.211 [7]							
NOTE 3: As per Table 4.2-1 in TS 36.211 [7]							

A.2.2.2 Partial RB allocation

A.2.2.2.1 QPSK

Table A.2.2.2.1-1: Reference Channels for QPSK with partial RB allocation

Parameter	Ch BW	Allocated RBs	UL-DL Configuration (NOTE 2)	Special subframe configuration (NOTE 3)	DFT-OFDM Symbols per Sub-Frame	Mod'n	Target Coding rate	Payload size for Sub-Frame 2, 7	Transport block CRC	Number of code blocks per Sub-Frame (NOTE 1)	Total number of bits per Sub-Frame for Sub-Frame 2, 7	Total symbols per Sub-Frame for Sub-Frame 2, 7	UE Category
Unit	MHz							Bits	Bits		Bits		
	1.4 - 20	1	2	7	12	QPSK	1/3	72	24	1	288	144	≥ 1
	1.4 - 20	2	2	7	12	QPSK	1/3	176	24	1	576	288	≥ 1
	1.4 - 20	3	2	7	12	QPSK	1/3	256	24	1	864	432	≥ 1
	1.4 - 20	4	2	7	12	QPSK	1/3	392	24	1	1152	576	≥ 1
	1.4 - 20	5	2	7	12	QPSK	1/3	424	24	1	1440	720	≥ 1
	3-20	6	2	7	12	QPSK	1/3	600	24	1	1728	864	≥ 1
	3-20	8	2	7	12	QPSK	1/3	808	24	1	2304	1152	≥ 1
	3-20	9	2	7	12	QPSK	1/3	776	24	1	2592	1296	≥ 1
	3-20	10	2	7	12	QPSK	1/3	872	24	1	2880	1440	≥ 1
	3-20	12	2	7	12	QPSK	1/3	1224	24	1	3456	1728	≥ 1
	5-20	15	2	7	12	QPSK	1/3	1320	24	1	4320	2160	≥ 1
	5-20	16	2	7	12	QPSK	1/3	1384	24	1	4608	2304	≥ 1
	5-20	18	2	7	12	QPSK	1/3	1864	24	1	5184	2592	≥ 1
	5-20	20	2	7	12	QPSK	1/3	1736	24	1	5760	2880	≥ 1
	5-20	24	2	7	12	QPSK	1/3	2472	24	1	6912	3456	≥ 1
	10-20	25	2	7	12	QPSK	1/3	2216	24	1	7200	3600	≥ 1
	10-20	27	2	7	12	QPSK	1/3	2792	24	1	7776	3888	≥ 1
	10-20	30	2	7	12	QPSK	1/3	2664	24	1	8640	4320	≥ 1
	10-20	32	2	7	12	QPSK	1/3	2792	24	1	9216	4608	≥ 1
	10-20	36	2	7	12	QPSK	1/3	3752	24	1	10368	5184	≥ 1
	10-20	40	2	7	12	QPSK	1/3	4136	24	1	11520	5760	≥ 1
	10-20	45	2	7	12	QPSK	1/3	4008	24	1	12960	6480	≥ 1
	10-20	48	2	7	12	QPSK	1/3	4264	24	1	13824	6912	≥ 1
	15 - 20	50	2	7	12	QPSK	1/3	5160	24	1	14400	7200	≥ 1
	15 - 20	54	2	7	12	QPSK	1/3	4776	24	1	15552	7776	≥ 1
	15 - 20	60	2	7	12	QPSK	1/4	4264	24	1	17280	8640	≥ 1
	15 - 20	64	2	7	12	QPSK	1/4	4584	24	1	18432	9216	≥ 1
	15 - 20	72	2	7	12	QPSK	1/4	5160	24	1	20736	10368	≥ 1
	20	75	2	7	12	QPSK	1/5	4392	24	1	21600	10800	≥ 1
	20	80	2	7	12	QPSK	1/5	4776	24	1	23040	11520	≥ 1
	20	81	2	7	12	QPSK	1/5	4776	24	1	23328	11664	≥ 1
	20	90	2	7	12	QPSK	1/6	4008	24	1	25920	12960	≥ 1
	20	96	2	7	12	QPSK	1/6	4264	24	1	27648	13824	≥ 1

NOTE 1: If more than one Code Block is present, an additional CRC sequence of L = 24 Bits is attached to each Code Block (otherwise L = 0 Bit)
 NOTE 2: As per Table 4.2-2 in TS 36.211 [7]
 NOTE 3: As per Table 4.2-1 in TS 36.211 [7]

A.2.2.2.2 16-QAM

Table A.2.2.2-1: Reference Channels for 16QAM with partial RB allocation

Parameter	Ch BW	Allocated RBs	UL-DL Configuration (NOTE 2)	Special subframe configuration (NOTE 3)	DFT-OFDM Symbols per Sub-Frame	Mod'n	Target Coding rate	Payload size for Sub-Frame 2, 7	Transport block CRC	Number of code blocks per Sub-Frame (NOTE 1)	Total number of bits per Sub-Frame for Sub-Frame 2, 7	Total symbols per Sub-Frame for Sub-Frame 2, 7	UE Category
Unit	MHz							Bits	Bits		Bits		
	1.4 - 20	1	2	7	12	16QAM	3/4	408	24	1	576	144	≥ 1
	1.4 - 20	2	2	7	12	16QAM	3/4	840	24	1	1152	288	≥ 1
	1.4 - 20	3	2	7	12	16QAM	3/4	1288	24	1	1728	432	≥ 1
	1.4 - 20	4	2	7	12	16QAM	3/4	1736	24	1	2304	576	≥ 1
	1.4 - 20	5	2	7	12	16QAM	3/4	2152	24	1	2880	720	≥ 1
	3-20	6	2	7	12	16QAM	3/4	2600	24	1	3456	864	≥ 1
	3-20	8	2	7	12	16QAM	3/4	3496	24	1	4608	1152	≥ 1
	3-20	9	2	7	12	16QAM	3/4	3880	24	1	5184	1296	≥ 1
	3-20	10	2	7	12	16QAM	3/4	4264	24	1	5760	1440	≥ 1
	3-20	12	2	7	12	16QAM	3/4	5160	24	1	6912	1728	≥ 1
	5-20	15	2	7	12	16QAM	1/2	4264	24	1	8640	2160	≥ 1
	5-20	16	2	7	12	16QAM	1/2	4584	24	1	9216	2304	≥ 1
	5-20	18	2	7	12	16QAM	1/2	5160	24	1	10368	2592	≥ 1
	5-20	20	2	7	12	16QAM	1/3	4008	24	1	11520	2880	≥ 1
	5-20	24	2	7	12	16QAM	1/3	4776	24	1	13824	3456	≥ 1
	10-20	25	2	7	12	16QAM	1/3	4968	24	1	14400	3600	≥ 1
	10-20	27	2	7	12	16QAM	1/3	4776	24	1	15552	3888	≥ 1
	10-20	30	2	7	12	16QAM	3/4	12960	24	3	17280	4320	≥ 2
	10-20	32	2	7	12	16QAM	3/4	13536	24	3	18432	4608	≥ 2
	10-20	36	2	7	12	16QAM	3/4	15264	24	3	20736	5184	≥ 2
	10-20	40	2	7	12	16QAM	3/4	16992	24	3	23040	5760	≥ 2
	10-20	45	2	7	12	16QAM	3/4	19080	24	4	25920	6480	≥ 2
	10-20	48	2	7	12	16QAM	3/4	20616	24	4	27648	6912	≥ 2
	15 - 20	50	2	7	12	16QAM	3/4	21384	24	4	28800	7200	≥ 2
	15 - 20	54	2	7	12	16QAM	3/4	22920	24	4	31104	7776	≥ 2
	15 - 20	60	2	7	12	16QAM	2/3	23688	24	4	34560	8640	≥ 2
	15 - 20	64	2	7	12	16QAM	2/3	25456	24	4	36864	9216	≥ 2
	15 - 20	72	2	7	12	16QAM	1/2	20616	24	4	41472	10368	≥ 2
	20	75	2	7	12	16QAM	1/2	21384	24	4	43200	10800	≥ 2
	20	80	2	7	12	16QAM	1/2	22920	24	4	46080	11520	≥ 2
	20	81	2	7	12	16QAM	1/2	22920	24	4	46656	11664	≥ 2
	20	90	2	7	12	16QAM	2/5	20616	24	4	51840	12960	≥ 2
	20	96	2	7	12	16QAM	2/5	22152	24	4	55296	13824	≥ 2

NOTE 1: If more than one Code Block is present, an additional CRC sequence of L = 24 Bits is attached to each Code Block (otherwise L = 0 Bit)

NOTE 2: As per Table 4.2-2 in TS 36.211 [7]

NOTE 3: As per Table 4.2-1 in TS 36.211 [7]

A.2.2.2.3 64-QAM

Table A.2.2.2.3-1: Reference Channels for 64-QAM with partial RB allocation

Parameter	Ch BW	Allocated RBs	UL-DL Configuration (NOTE 2)	Special subframe configuration (NOTE 3)	DFT-OFDM Symbols per Sub-Frame	Mod'n	Target Coding rate	Payload size for Sub-Frame 2, 7	Transport block CRC	Number of code blocks per Sub-Frame (NOTE 1)	Total number of bits per Sub-Frame for Sub-Frame 2, 7	Total symbols per Sub-Frame for Sub-Frame 2, 7	UE Category (NOTE 4)
Unit	MHz							Bits	Bits		Bits		
	1.4 - 20	1	2	7	12	64QAM	3/4	616	24	1	864	144	5,8
	1.4 - 20	2	2	7	12	64QAM	3/4	1256	24	1	1728	288	5,8
	1.4 - 20	3	2	7	12	64QAM	3/4	1864	24	1	2592	432	5,8
	1.4 - 20	4	2	7	12	64QAM	3/4	2536	24	1	3456	576	5,8
	1.4 - 20	5	2	7	12	64QAM	3/4	3112	24	1	4320	720	5,8
	3-20	6	2	7	12	64QAM	3/4	3752	24	1	5184	864	5,8
	3-20	8	2	7	12	64QAM	3/4	5160	24	1	6912	1152	5,8
	3-20	9	2	7	12	64QAM	3/4	5736	24	1	7776	1296	5,8
	3-20	10	2	7	12	64QAM	3/4	6200	24	2	8640	1440	5,8
	3-20	12	2	7	12	64QAM	3/4	7480	24	2	10368	1728	5,8
	5-20	15	2	7	12	64QAM	3/4	9528	24	2	12960	2160	5,8
	5-20	16	2	7	12	64QAM	3/4	10296	24	2	13824	2304	5,8
	5-20	18	2	7	12	64QAM	3/4	11448	24	2	15552	2592	5,8
	5-20	20	2	7	12	64QAM	3/4	12576	24	3	17280	2880	5,8
	5-20	24	2	7	12	64QAM	3/4	15264	24	3	20736	3456	5,8
	10-20	25	2	7	12	64QAM	3/4	15840	24	3	21600	3600	5,8
	10-20	27	2	7	12	64QAM	3/4	16992	24	3	23328	3888	5,8
	10-20	30	2	7	12	64QAM	3/4	19080	24	4	25920	4320	5,8
	10-20	32	2	7	12	64QAM	3/4	20616	24	4	27648	4608	5,8
	10-20	36	2	7	12	64QAM	3/4	22920	24	4	31104	5184	5,8
	10-20	40	2	7	12	64QAM	3/4	25456	24	5	34560	5760	5,8
	10-20	45	2	7	12	64QAM	3/4	28336	24	5	38880	6480	5,8
	10-20	48	2	7	12	64QAM	3/4	30576	24	5	41472	6912	5,8
	15 - 20	50	2	7	12	64QAM	3/4	31704	24	6	43200	7200	5,8
	15 - 20	54	2	7	12	64QAM	3/4	34008	24	6	46656	7776	5,8
	15 - 20	60	2	7	12	64QAM	3/4	37888	24	7	51840	8640	5,8
	15 - 20	64	2	7	12	64QAM	3/4	40576	24	7	55296	9216	5,8
	1.4 - 20	1	2	7	12	64QAM	3/4	616	24	1	864	144	5,8
	1.4 - 20	2	2	7	12	64QAM	3/4	1256	24	1	1728	288	5,8
	1.4 - 20	3	2	7	12	64QAM	3/4	1864	24	1	2592	432	5,8
	1.4 - 20	4	2	7	12	64QAM	3/4	2536	24	1	3456	576	5,8
	1.4 - 20	5	2	7	12	64QAM	3/4	3112	24	1	4320	720	5,8
	3-20	6	2	7	12	64QAM	3/4	3752	24	1	5184	864	5,8
	3-20	8	2	7	12	64QAM	3/4	5160	24	1	6912	1152	5,8
	3-20	9	2	7	12	64QAM	3/4	5736	24	1	7776	1296	5,8
	3-20	10	2	7	12	64QAM	3/4	6200	24	2	8640	1440	5,8
	3-20	12	2	7	12	64QAM	3/4	7480	24	2	10368	1728	5,8
	5-20	15	2	7	12	64QAM	3/4	9528	24	2	12960	2160	5,8
	5-20	16	2	7	12	64QAM	3/4	10296	24	2	13824	2304	5,8
	5-20	18	2	7	12	64QAM	3/4	11448	24	2	15552	2592	5,8
	5-20	20	2	7	12	64QAM	3/4	12576	24	3	17280	2880	5,8
	5-20	24	2	7	12	64QAM	3/4	15264	24	3	20736	3456	5,8
	10-20	25	2	7	12	64QAM	3/4	15840	24	3	21600	3600	5,8
	10-20	27	2	7	12	64QAM	3/4	16992	24	3	23328	3888	5,8
	10-20	30	2	7	12	64QAM	3/4	19080	24	4	25920	4320	5,8
	15 - 20	50	2	7	12	64QAM	3/4	31704	24	6	43200	7200	5,8
	15 - 20	54	2	7	12	64QAM	3/4	34008	24	6	46656	7776	5,8
	15 - 20	60	2	7	12	64QAM	3/4	37888	24	7	51840	8640	5,8
	15 - 20	64	2	7	12	64QAM	3/4	40576	24	7	55296	9216	5,8
	15 - 20	72	2	7	12	64QAM	3/4	45352	24	8	62208	10368	5,8
	20	75	2	7	12	64QAM	3/4	46888	24	8	64800	10800	5,8
	20	80	2	7	12	64QAM	3/4	51024	24	9	69120	11520	5,8
	20	81	2	7	12	64QAM	3/4	51024	24	9	69984	11664	5,8
	20	90	2	7	12	64QAM	3/4	51024	24	9	77760	12960	5,8
	20	96	2	7	12	64QAM	3/4	61664	24	11	82944	13824	5,8

NOTE 1: If more than one Code Block is present, an additional CRC sequence of L = 24 Bits is attached to each Code Block (otherwise L = 0 Bit)
 NOTE 2: As per Table 4.2-2 in TS 36.211 [7].
 NOTE 3: As per Table 4.2-1 in TS 36.211 [7].
 NOTE 4: If UE does not report UE UL category, then the applicability of reference channel is determined by UE category. If UE reports UE UL category, then the applicability of reference channel is determined by UE UL category

A.2.2.2.4 256 QAM

Table A.2.2.2.4-1: Reference Channels for 256 QAM with partial RB allocation

Parameter	Ch BW	Allocated RBs	UL-DL Configuration (NOTE 2)	Special Slot Configuration (NOTE 3)	DFT-OFDM Symbols per Sub-Frame	Mod'n	Target Coding rate	Payload size for Sub-Frame 2, 7	Transport block CRC	Number of code blocks per Sub-Frame (NOTE 1)	Total number of bits per Sub-Frame for Sub-Frame 2, 7	Total symbols per Sub-Frame for Sub-Frame 2, 7	UE UL Category
Unit	MHz							Bits	Bits		Bits		
	1.4 - 20	1	2	7	12	256QAM	3/4	840	24	1	1152	144	≥ 15
	1.4 - 20	2	2	7	12	256QAM	3/4	1672	24	1	2304	288	≥ 15
	1.4 - 20	3	2	7	12	256QAM	3/4	2536	24	1	3456	432	≥ 15
	1.4 - 20	4	2	7	12	256QAM	3/4	3368	24	1	4608	576	≥ 15
	1.4 - 20	5	2	7	12	256QAM	3/4	4264	24	1	5760	720	≥ 15
	3-20	6	2	7	12	256QAM	3/4	5160	24	1	6912	864	≥ 15
	3-20	8	2	7	12	256QAM	3/4	6712	24	2	9216	1152	≥ 15
	3-20	9	2	7	12	256QAM	3/4	7736	24	2	10368	1296	≥ 15
	3-20	10	2	7	12	256QAM	3/4	8504	24	2	11520	1440	≥ 15
	3-20	12	2	7	12	256QAM	3/4	10296	24	2	13824	1728	≥ 15
	5-20	15	2	7	12	256QAM	3/4	12960	24	3	17280	2160	≥ 15
	5-20	16	2	7	12	256QAM	3/4	13536	24	3	18432	2304	≥ 15
	5-20	18	2	7	12	256QAM	3/4	15264	24	3	20736	2592	≥ 15
	5-20	20	2	7	12	256QAM	3/4	16992	24	3	23040	2880	≥ 15
	5-20	24	2	7	12	256QAM	3/4	20616	24	4	27648	3456	≥ 15
	10-20	25	2	7	12	256QAM	3/4	21384	24	4	28800	3600	≥ 15
	10-20	27	2	7	12	256QAM	3/4	22920	24	4	31104	3888	≥ 15
	10-20	30	2	7	12	256QAM	3/4	25456	24	5	34560	4320	≥ 15
	10-20	32	2	7	12	256QAM	3/4	27376	24	5	36864	4608	≥ 15
	10-20	36	2	7	12	256QAM	3/4	30576	24	6	41472	5184	≥ 15
	10-20	40	2	7	12	256QAM	3/4	34008	24	6	46080	5760	≥ 15
	10-20	45	2	7	12	256QAM	3/4	37888	24	7	51840	6480	≥ 15
	10-20	48	2	7	12	256QAM	3/4	40576	24	8	55296	6912	≥ 15
	15 - 20	50	2	7	12	256QAM	3/4	42368	24	8	57600	7200	≥ 15
	15 - 20	54	2	7	12	256QAM	3/4	46888	24	8	62208	7776	≥ 15
	15 - 20	60	2	7	12	256QAM	3/4	51024	24	9	69120	8640	≥ 15
	15 - 20	64	2	7	12	256QAM	3/4	55056	24	9	73728	9216	≥ 15
	15 - 20	72	2	7	12	256QAM	3/4	61664	24	11	82944	10368	≥ 15
	20	75	2	7	12	256QAM	3/4	63776	24	11	86400	10800	≥ 15
	20	80	2	7	12	256QAM	3/4	68808	24	12	92160	11520	≥ 15
	20	81	2	7	12	256QAM	3/4	68808	24	12	93312	11664	≥ 15
	20	90	2	7	12	256QAM	3/4	76208	24	13	103680	12960	≥ 15
	20	96	2	7	12	256QAM	3/4	81176	24	14	110592	13824	≥ 15

NOTE 1: If more than one Code Block is present, an additional CRC sequence of L = 24 Bits is attached to each Code Block (otherwise L = 0 Bit)
NOTE 2: As per Table 4.2-2 in TS 36.211 [7]
NOTE 3: As per Table 4.2-1 in TS 36.211 [7]

A.3 DL reference measurement channels for E-UTRA

A.3.1 General

The number of available channel bits varies across the sub-frames due to PBCH and PSS/SSS overhead. The payload size per sub-frame is varied in order to keep the code rate constant throughout a frame.

Unless otherwise stated, no user data is scheduled on subframes #5 in order to facilitate the transmission of system information blocks (SIB).

The algorithm for determining the payload size A is as follows; given a desired coding rate R and radio block allocation N_{RB}

1. Calculate the number of channel bits N_{ch} that can be transmitted during the first transmission of a given sub-frame.
2. Find A such that the resulting coding rate is as close to R as possible, that is,

$$\min \left\{ R - (A + 24 * (N_{CB} + 1)) / N_{ch}, \text{ where } N_{CB} = \begin{cases} 0, & \text{if } C = 1 \\ C, & \text{if } C > 1 \end{cases} \right.$$

subject to

- a) A is a valid TB size according to clause 7.1.7 of TS 36.213 [6] assuming an allocation of N_{RB} resource blocks.
 - b) C is the number of Code Blocks calculated according to clause 5.1.2 of TS 36.212 [5].
3. If there is more than one A that minimizes the equation above, then the larger value is chosen per default and the chosen code rate should not exceed 0.93.
 4. For TDD, the measurement channel is based on DL/UL configuration ratio of 3DL+DwPTS (10 OFDM symbol SSF7): 1UL

A.3.1.1 QPSK

Table A.3.1.1-1: Fixed Reference Channel for Receiver Requirements (TDD)

Parameter	Unit	Value					
		1.4	3	5	10	15	20
Channel Bandwidth	MHz	1.4	3	5	10	15	20
Allocated resource blocks		6	15	25	50	75	100
Uplink-Downlink Configuration (NOTE 5)		2	2	2	2	2	2
Special subframe configuration (NOTE 6)		7	7	7	7	7	7
Allocated subframes per Radio Frame (D+S)		3	3+2	3+2	3+2	3+2	3+2
Number of HARQ Processes	Processes	7	7	7	7	7	7
Maximum number of HARQ transmission		1	1	1	1	1	1
Modulation		QPSK	QPSK	QPSK	QPSK	QPSK	QPSK
Target coding rate		1/3	1/3	1/3	1/3	1/3	1/3
Information Bit Payload per Sub-Frame	Bits						
For Sub-Frame 3, 4, 8, 9		408	1320	2216	4392	6712	8760
For Sub-Frame 1, 6		N/A	776	1288	2664	4008	5352
For Sub-Frame 5		N/A	N/A	N/A	N/A	N/A	N/A
For Sub-Frame 0		208	1064	1800	4392	6712	8760
Transport block CRC	Bits	24	24	24	24	24	24
Number of Code Blocks per Sub-Frame (NOTE 4)							
For Sub-Frame 3, 4, 8, 9		1	1	1	1	2	2
For Sub-Frame 1, 6		N/A	1	1	1	1	1
For Sub-Frame 5		N/A	N/A	N/A	N/A	N/A	N/A
For Sub-Frame 0		1	1	1	1	2	2
Binary Channel Bits Per Sub-Frame	Bits						
For Sub-Frame 3, 4, 8, 9		1368	3780	6300	13800	20700	27600
For Sub-Frame 1, 6		N/A	2616	4456	9056	13656	18256
For Sub-Frame 5		N/A	N/A	N/A	N/A	N/A	N/A
For Sub-Frame 0		672	3084	5604	13104	20004	26904
Max. Throughput averaged over 1 frame	kbps	102.4	564	932	1965.6	3007.2	3970.4
UE Category		≥ 1	≥ 1	≥ 1	≥ 1	≥ 1	≥ 1
NOTE 1: For normal subframes(0,3,4,5,8,9), 2 symbols allocated to PDCCH for 20 MHz, 15 MHz and 10 MHz channel BW; 3 symbols allocated to PDCCH for 5 MHz and 3 MHz; 4 symbols allocated to PDCCH for 1.4 MHz. For special subframe (1&6), only 2 OFDM symbols are allocated to PDCCH for all BWs.							
NOTE 2: For 1.4MHz, no data shall be scheduled on special subframes(1&6) to avoid problems with insufficient PDCCH performance							
NOTE 3: Reference signal, Synchronization signals and PBCH allocated as per TS 36.211 [7]							
NOTE 4: If more than one Code Block is present, an additional CRC sequence of L = 24 Bits is attached to each Code Block (otherwise L = 0 Bit).							
NOTE 5: As per Table 4.2-2 in TS 36.211 [7]							
NOTE 6: As per Table 4.2-1 in TS 36.211 [7]							

A.3.1.2 64-QAM

Table A.3.1.2-1: Fixed Reference Channel for Maximum input level for UE Categories ≥ 3 (TDD)

Parameter	Unit	Value					
		1.4	3	5	10	15	20
Channel bandwidth	MHz	1.4	3	5	10	15	20
Allocated resource blocks		6	15	25	50	75	100
Subcarriers per resource block		12	12	12	12	12	12
Uplink-Downlink Configuration (NOTE 5)		2	2	2	2	2	2
Special subframe configuration (NOTE 6)		7	7	7	7	7	7
Allocated subframes per Radio Frame		2	3+2	3+2	3+2	3+2	3+2
Modulation		64QAM	64QAM	64QAM	64QAM	64QAM	64QAM
Target Coding Rate		$\frac{3}{4}$	$\frac{3}{4}$	$\frac{3}{4}$	$\frac{3}{4}$	$\frac{3}{4}$	$\frac{3}{4}$
Number of HARQ Processes	Processes	7	7	7	7	7	7
Maximum number of HARQ transmissions		1	1	1	1	1	1
Information Bit Payload per Sub-Frame							
For Sub-Frames 3, 4, 8, 9	Bits	2984	8504	14112	30576	46888	61664
For Sub-Frames 1,6	Bits	N/A	5544	9528	19848	30576	40576
For Sub-Frame 5	Bits	N/A	N/A	N/A	N/A	N/A	N/A
For Sub-Frame 0	Bits	N/A	6968	12576	30576	45352	61664
Transport block CRC	Bits	24	24	24	24	24	24
Number of Code Blocks per Sub-Frame (NOTE 4)							
For Sub-Frames 3, 4, 8, 9		1	2	3	5	8	11
For Sub-Frames 1,6		N/A	2	2	4	6	8
For Sub-Frame 5		N/A	N/A	N/A	N/A	N/A	N/A
For Sub-Frame 0		N/A	2	3	5	8	11
Binary Channel Bits per Sub-Frame							
For Sub-Frames 3, 4, 8, 9	Bits	4104	11340	18900	41400	62100	82800
For Sub-Frames 1,6		N/A	7848	13368	27168	40968	54768
For Sub-Frame 5	Bits	N/A	N/A	N/A	N/A	N/A	N/A
For Sub-Frame 0	Bits	N/A	9252	16812	39312	60012	80712
Max. Throughput averaged over 1 frame	kbps	596.8	3791.2	6369.6	13910	20945	27877
NOTE 1: For normal subframes(0,3,4,5,8,9), 2 symbols allocated to PDCCH for 20 MHz, 15 MHz and 10 MHz channel BW; 3 symbols allocated to PDCCH for 5 MHz and 3 MHz; 4 symbols allocated to PDCCH for 1.4 MHz. For special subframe (1&6), only 2 OFDM symbols are allocated to PDCCH for all BWs.							
NOTE 2: For 1.4MHz, no data shall be scheduled on special subframes(1&6) to avoid problems with insufficient PDCCH performance.							
NOTE 3: Reference signal, Synchronization signals and PBCH allocated as per TS 36.211 [7].							
NOTE 4: If more than one Code Block is present, an additional CRC sequence of L = 24 Bits is attached to each Code Block (otherwise L = 0 Bit).							
NOTE 5: As per Table 4.2-2 in TS 36.211 [7].							
NOTE 6: As per Table 4.2-1 in TS 36.211 [7]							

A.3.1.3 256-QAM

Table A.3.1.3-1: Fixed Reference Channel for Maximum input level for UE Categories 11/12 and UE DL categories ≥ 11 (TDD)

Parameter	Unit	Value					
		1.4	3	5	10	15	20
Channel bandwidth	MHz	1.4	3	5	10	15	20
Allocated resource blocks		6	15	25	50	75	100
Subcarriers per resource block		12	12	12	12	12	12
Uplink-Downlink Configuration (NOTE 5)		2	2	2	2	2	2
Special subframe configuration (NOTE 6)		7	7	7	7	7	7
Allocated subframes per Radio Frame		2	3+2	3+2	3+2	3+2	3+2
Modulation		256QAM	256QAM	256QAM	256QAM	256QAM	256QAM
Target Coding Rate		4/5	4/5	4/5	4/5	4/5	4/5
Number of HARQ Processes	Processes	7	7	7	7	7	7
Maximum number of HARQ transmissions		1	1	1	1	1	1
Information Bit Payload per Sub-Frame							
For Sub-Frames 3,4,8,9	Bits	4392	12216	19848	42368	63776	84760
For Sub-Frames 1,6	Bits	N/A	10464	17824	36224	54624	73024
For Sub-Frame 5	Bits	N/A	N/A	N/A	N/A	N/A	N/A
For Sub-Frame 0	Bits	N/A	9912	17568	42368	63776	84760
Transport block CRC	Bits	24	24	24	24	24	24
Number of Code Blocks per Sub-Frame (NOTE 4)							
For Sub-Frames 3,4,8,9		1	2	4	7	11	14
For Sub-Frames 1,6		N/A	2	3	6	9	13
For Sub-Frame 5		N/A	N/A	N/A	N/A	N/A	N/A
For Sub-Frame 0		N/A	2	3	7	11	14
Binary Channel Bits per Sub-Frame							
For Sub-Frames 3,4,8,9	Bits	5472	15120	25200	55200	82800	110400
For Sub-Frames 1,6		N/A	8248	13536	27376	40576	55056
For Sub-Frame 5	Bits	N/A	N/A	N/A	N/A	N/A	N/A
For Sub-Frame 0	Bits	N/A	12336	22416	52416	80016	107616
Max. Throughput averaged over 1 frame	kbits	878.4	5570.4	9240	20049.6	30144	40503.2
NOTE 1: For normal subframes(0,3,4,5,8,9), 2 symbols allocated to PDCCH for 20 MHz, 15 MHz and 10 MHz channel BW; 3 symbols allocated to PDCCH for 5 MHz and 3 MHz; 4 symbols allocated to PDCCH for 1.4 MHz. For special subframe (1&6), only 2 OFDM symbols are allocated to PDCCH for all BWs.							
NOTE 2: For 1.4MHz, no data shall be scheduled on special subframes(1&6) to avoid problems with insufficient PDCCH performance.							
NOTE 3: Reference signal, Synchronization signals and PBCH allocated as per TS 36.211 [7].							
NOTE 4: If more than one Code Block is present, an additional CRC sequence of L = 24 Bits is attached to each Code Block (otherwise L = 0 Bit).							
NOTE 5: As per Table 4.2-2 in TS 36.211 [7].							
NOTE 6: As per Table 4.2-1 in TS 36.211 [7]							

Annex B: Void

Annex C: Void

Annex D: Void

Annex E: Void

Annex F: Void

Annex G: Void

Annex H (normative): Modified MPR behavior

Annex I (normative): Dual uplink interferer

UE is mandated to support operation in dual and triple uplink mode for EN-DC configuration in NR FR1 listed in Table 5.5B.2-1, Table 5.5B.3-1, and Table 5.5B.4.1-1 and indicated by column single uplink allowed, Table 7.3B.2.3.5.1-1, Table 7.3B.2.3.5.2-0, Table 7.3B.2.3.5.2-1 or NE-DC configuration in NR FR1 listed in Table 5.5B.4a.1-1 and indicated by column single uplink allowed if the intermodulation products caused by the dual uplink operation do not interfere with its own primary downlink transmission channel bandwidth of PCell or PSCell. For intermodulation products falling into any secondary downlink channel bandwidth, UE single UL capability is not considered.

Formula for determining if the EN-DC in NR FR1 configuration with dual uplink operation interferes with its own downlink reception.

Interference bandwidth: $IBW = |a| * CBW1 + |b| * CBW2$

- $|a| + |b| = 2$ (or 3)
- CBW1 and CBW2 are the transmission bandwidth configurations of the UL channels

Center frequency of IBW: $f_{IBW} = |a * f1 + b * f2|$

- f1 and f2 are center frequency of the transmission bandwidth configurations of each UL channel

The range of IMD 2 (or 3): $[f_{IBW} - IBW/2, f_{IBW} + IBW/2]$

NOTE 1: UE shall be able to apply operations which are configured by RRC reconfiguration and corresponding HARQ timing on the transmission bandwidth.

NOTE 2: For identified difficult band combination, during two adjacent RRC reconfiguration, the changing of transmission bandwidth should not introduce IM2 and IM3, which will result in UE changing from 2Tx to 1Tx. Otherwise, UE behavior is not specified.

For DC_3A_n3A intra-band non-contiguous EN-DC combination, only single switched UL is supported in Rel-15.

Annex J: Void

Annex K: Void

Annex L (informative): Change history

Change history							
Date	Meeting	TDoc	CR	Rev	Cat	Subject/Comment	New version
2017-08	RAN4#84					Initial Skeleton	0.0.1
2017-11	RAN4#84 Bis	R4-1711980				Number TPs from editors	0.1.0
2017-12	RAN4#85	R4-1713807				Approved TPs in RAN4#85 R4-1714444, CA BW classes, TP, Ericsson R4-1714170, How to list DC configurations into TS 38.101-3, Nokia R4-1714530, TP on introducing operating bands for NR-LTE DC including SUL band combinations in 38.101-3, Qualcomm R4-1714098, TP to TS 38.101-3: UE RF requirements for non-standalone SUL, Huawei R4-1713206, TP on general parts for 38.101-3 NR interwork, Ericsson R4-1714443, TP to TS 38.101-3: On dual uplink operation for EN-DC in NR FR1 and single uplink, Nokia R4-1714450, TP to 38.101-3: maximum output power and unwanted emissions for EN-DC, Ericsson R4-1714346, TP to 38.101-3: REFSSENS for intra-band EN-DC, Ericsson R4-1714345, TP for TS 36.101-3: clause 7 receiver requirements, Huawei Band list according to R4-1714542, List of bands and band combinations to be introduced into RAN4 NR core requirements by December 2017, RAN4 Chairmen	0.2.0
2017-12	RAN4#85	R4-1714571				Further corrections after email review	0.3.0
2017-12	RAN#78	RP-172477				v1.0.0 submitted for plenary approval. Contents same as 0.3.0	1.0.0
2017-12	RAN#78					Approved by plenary – Rel-15 spec under change control	15.0.0
2018-03	RAN#79	RP-180264	0005		F	Implementation of endorsed CRs to 38.101-3 Endorsed draft CR F: R4-1801267, Draft CR on UE RF requirements for SUL in TS 38.101-3, Huawei B: R4-1801111, Draft CR for completed LTE 1CC + NR 1band for TS 38.101-3, NTT DOCOMO, INC. B: R4-1800716, Draft CR for introduction of completed band combinations from 37.863-03-01 into 38.101-3, Ericsson B: R4-1800063, Draft CR for completed EN-DC of LTE 4CC + NR 1band for TS 38.101-3, Nokia B: R4-1800717, Draft CR for introduction of completed band combinations from 37.865-01-01 into 38.101-3, Ericsson F: R4-1800049, Modification for TS38.101-3, CATT F: R4-1800287, 38.101-3 DC_(n)71B draft CR for section 6.2.4.1 - A-MPR for intra-band EN-DC - NS value, T-Mobile USA Inc. F: R4-1800288, 38.101-3 DC_(n)71B draft CR for section 7.3.3 Reference sensitivity for DC_(n)71B - MSD values, T-Mobile USA Inc. F: R4-1801139 Draft CR to 38.101-3: MSD for inter-band EN-DC, Ericsson	15.1.0
2018-06	RAN#80	RP-181374	0013	1	F	CR to TS 38.101-3: Implementation of endorsed draft CRs from RAN4 #87 Missing figures (Figure 6.3B.1.1-1, Figure 6.3B.1.1-2, Figure 6.3B.1.1-3 and Figure 6.3B.1.1-4) from the endorsed draftCR (R4-1807235) were added during the CR implementation.	15.2.0
2018-09	RAN#81	RP-182129	0020	2	F	Big CR for 38.101-3 Draft CRs from RAN4#88: R4-1809960 Draft CR to TS 38.101-3: to introduce new NR inter-band DC band combinations Samsung,KDDI,SKT,KT,LGU+ R4-1809991 CR to 38.101-3:Corrections on UE coexistence table for Table 6.5B.3.3.1-1 MediaTek Inc. R4-1810054 Pcmx for Rel-15 inter-band EN-DC for FR1 and NR in FR2 InterDigital, Inc. R4-1810111 Single UL allowed corrections for DC_28A-n51A EN-DC in 38.101-3 Skyworks Solutions Inc.	15.3.0

					<p>R4-1810125 Draft CR to 38.101-3 Single UL allowed corrections for DC_28A_51A EN-DC Skyworks Solutions Inc.</p> <p>R4-1810128 Draft CR to 38.101-3 Single UL allowed corrections for EN-DC operation in NR FR1 (two bands) Skyworks Solutions Inc.</p> <p>R4-1810167 TP for TR 37.863-01-01: MSD for DC_5A_n78A due to the 4th harmonic MediaTek Inc.</p> <p>R4-1810410 Draft CR to 38.101-3: Corrections on symbols and abbreviations in section 3 ZTE Corporation</p> <p>R4-1810417 Correction to DC_(n)71B MSD definition Nokia</p> <p>R4-1810433 Correction on EN-DC 8A_n79A SoftBank Corp.,ZTE</p> <p>R4-1810476 Draft CR to TS 38.101-3 correction for DC_3_n3-n77, DC_3_n3-n78 CHITL</p> <p>R4-1810976 Annex lettering change for 38.101-3 Qualcomm Incorporated</p> <p>R4-1811461 Clarification and corrections of EN-DC REFSENS exceptions requirement Nokia, Nokia Shanghai Bell</p> <p>R4-1811462 Correction to DC_(n)71B scs restriction for NR Nokia</p> <p>R4-1811466 EN DC_41-79 CATT</p> <p>R4-1811467 Draft CR TS 38.101-3 Corrections to Single UL Allowed Criteria for Mid-Band EN-DC in FR1 Skyworks Solutions Inc.</p> <p>R4-1811484 Pcmx for inter-band EN-DC FR1 draft CR InterDigital, Inc.</p> <p>R4-1811525 Draft CR TS 38.101-3 on missing requirements for FR1 EN-DC Skyworks Solutions, Inc.</p> <p>R4-1811542 Draft CR to 38.101-3 on correction on some errors Huawei, HiSilicon</p> <p>R4-1811796 Draft CR to 38.101-3 Corrections to Single UL allowed criteria for EN-DC Skyworks Solutions Inc.</p> <p>R4-1811800 DRAFT CR for PCmax FR2 correction Qualcomm Incorporated</p> <p>R4-1811810 Draft CR TS 38.101-3: Corrections for B41/n41 SPRINT Corporation</p>	
2018-12	RAN#82	RP-182359	0030	F	<p>Endorced draft CRs from RAN4#88Bis :</p> <p>R4-1812057, Introduction of Intra-band contiguous EN-DC bandwidth classes, Nokia</p> <p>R4-1812290 Draft CR on MSD for EN-DC including Band 66 and n78 Huawei, HiSilicon</p> <p>R4-1812293 Draft CR on switching time mask for EN-DC Huawei, HiSilicon</p> <p>R4-1812298 Draft CR to TS 38.101-3: to add missing requirements for inter-band CA between FR1 and FR2. Samsung</p> <p>R4-1812360 Draft CR to 38.101-3: Correction to UL configuration for EN-DC reference sensitivity exceptions Skyworks Solutions Inc.</p> <p>R4-1812361 Draft CR to 38.101-3: NR uplink DFT-S-OFDM waveforms for EN-DC reference sensitivity Skyworks Solutions Inc.</p> <p>R4-1812362 Draft CR to 38.101-3: Editorial and RB allocation corrections to table 7.3B.2.3.4-2 Skyworks Solutions Inc.</p> <p>R4-1812363 Draft CR to 38.101-3: Single UL allowed operation corrections in clause 7.3B.2.3.5 Skyworks Solutions Inc.</p> <p>R4-1812404 Non-contiguous intra-band EN-DC emission requirements Qualcomm Incorporated</p> <p>R4-1812410 Correction on REFSENS exception for EN-DC 41A-n77A/n78A SoftBank Corp.</p> <p>R4-1812670 Correction on REFSENS exceptions of DC_5A-7A_n78A to TS 38.101-3 LG Uplus</p> <p>R4-1813471 draft CR on applicability of TDD configuratiin for CA in TS 38.101-3 Huawei</p> <p>R4-1813796 Draft CR for 38.101-3: Intra-band Pcmx for Type 2 UEs Sprint Corporation</p> <p>R4-1813816 Renaming of DC_(n)71B into DC_(n)71AA Nokia</p> <p>R4-1813817 Correction to EN-DC operating bands and configurations Nokia</p> <p>R4-1813818 Draft CR on correction REFSENS exceptions due to dual uplink operation for inter-band EN-DC to TS 38.101-3 Samsung</p> <p>R4-1813822 Draft CR for 38.101-3: Single UL allowed criteria in Annex I Vodafone España SA</p> <p>R4-1814157 Draft CR for UE-to-UE coexistence requirements for intra-band EN-DC in TS38.101-3 LG Electronics France</p>	15.4.0

						<p>R4-1814167 Draft CR on Single UL for some EN-DC combinations Huawei</p> <p>Endorsed draft CRs from Ran4#89: R4-1815952 dCR on TS38.101-3 merging draft CRs from RAN4#(88Bis) Qualcomm Incorporated R4-1814803 Draft CR on editorial error for EN-DC band combinations to TS 38.101-3 Huawei, HiSilicon R4-1815802 draft CR editorial correction in 38.101-3 Ericsson R4-1814425 Simplification of requirements for EN-DC configuration including FR2 NTT DOCOMO, INC. R4-1814512 Draft CR to TS38.101-3_Corrections on MSD requirements for EN-DC combinations of band 8 and n77 n78(Section 7.3B.2.3.1) ZTE Corporation R4-1814938 Draft CR to 38.101-3 on operating bands for CA and DC ZTE Corporation Zhifeng Ma R4-1814976 Correction for Maximum output power for inter-band EN-DC (two bands) Nokia, Nokia Shanghai Bell R4-1814977 Correction for ?TIB,c for EN-DC Nokia, Nokia Shanghai Bell R4-1814978 MPR and A-MPR for interband EN-DC Nokia, Nokia Shanghai Bell R4-1814980 Correction for intra-band EN-DC bandwidth class Nokia, Nokia Shanghai Bell R4-1815065 draft CR for adding missing transmit signal quality for inter band EN-DC for TS 38.101-3 NTT DOCOMO, INC. R4-1815811 draft Rel-15 CR to 38.101-3 to correct n260 BW class Ericsson, AT&T R4-1815865 Draft CR for 38.101-3 Intra-band EN-DC nominal carrier spacing for 30 kHz raster SPRINT Corporation R4-1815973 Draft CR to 38.101-3 rel. 15 to fix MSD issues for higher order EN-DC combinations R4-1816227 Draft CR on Power Class for inter band EN-DC within FR1 OPPO R4-1816233 Receiver requirements for intra-band EN-DC Qualcomm Incorporated R4-1816621 Introduction of maxUplinkDutyCycle to ENDC HPUE in FR1 OPPO R4-1816638 Pcmx computation and evaluation for inter band ENDC Qualcomm R4-1816178 Draft CR for correction for missing agreed DC combinations in Rel-15 for TS 38.101-3 NTT DOCOMO, INC. R4-1816197 Draft CR to TS38.101-3_Clarifications on MSD and UL configuration tables for EN-DC ZTE Corporation R4-1816198 Simplification of EN-DC and CA between FR1 and FR2 UE to UE co-ex table by adopting CA band approach Nokia, Nokia Shanghai Bell R4-1816202 Correction to interband EN-DC OOB emission requirements Nokia, Nokia Shanghai Bell R4-1816203 Receiver requirements for interband EN-DC Nokia, Nokia Shanghai Bell R4-1816207 Draft CR to 38.101-3 rel. 15 to fix MPR issue Apple GmbH R4-1816224 Draft CR for 38.101-3 NS_04 applicability for intra-band EN-DC SPRINT Corporation R4-1816231 Draft CR on output power dynamic for DC OPPO R4-1816237 Correction for Intra-band contiguous EN-DC A-MPR definition Nokia, Nokia Shanghai Bell R4-1816246 Draft CR to TS38.101-3: Corrections on TS for MSD calculations based on ENDC bands combination including of bands 1,3,8, n77, and n78 MediaTek Inc. R4-1816247 Draft CR 38-101-3 Corrections for EN-DC Single Uplink allowed Operation Skyworks Solutions Inc. R4-1816250 draft CR for adding note about the fallback of EN-DC in Applicability of minimum requirements for TS 38.101-3 NTT DOCOMO, INC. R4-1816608 Draft CR on LTE RMC for TDD EN-DC UE RF Tests Qualcomm Incorporated R4-1816613 Draft CR for reducing AMPR for DC_(n)71AA without Dynamic Power Sharing" Motorola Mobility, T-Mobile"</p>	
2018-12	RAN#82	RP-182773	0033	1	F	Completion of configured maximum output power for intra-band contiguous EN-DC	15.4.0
2018-12	RAN#82	RP-182774	0034	1	F	Configured maximum output power for intra-band non-contiguous EN-DC	15.4.0

2019-03	RAN#83	RP-190403	0035	F	<p>CR to TS 38.101-3: Implementation of endorsed draft CRs from RAN4#90</p> <p>Endorced draft CRs from RAN4#90 R4-1900034, Editorial corrections for 38.101-3, Qualcomm Incorporated R4-1900460, Draft CR to TS38.101-3_corrections on MSD, ZTE Corporation R4-1900461, Draft CR to TS38.101-3_inter-band NR DC between FR1 and FR2, ZTE Corporation R4-1900524, Draft CR to TS 38.101-3 on inter-band CA & inter-band EN-DC configurations, ZTE Corporation R4-1900529, Draft CR to TS 38.101-3 on Single Uplink Allowed for EN-DC combinations of order 3 or higher, ZTE Corporation R4-1900726, Editorial corrections to delta Tib for EN-DC, Rohde & Schwarz R4-1901359, draft CR for correction for missing operating band for EN-DC, NTT DOCOMO INC. R4-1901428, draft CR to make editorial corrections in 38-101-3 Rel-15, Ericsson R4-1901848, Draft CR for 38.101-3: Addition of default power class, Sprint Corporation R4-1901850, Draft CR for 38.101-3: Intra-band P_{cmx} P_{EN-DC}_Total for non-DPS UEs, Sprint Corporation R4-1901851, Draft CR for 38.101-3: Intra-band P_{cmx} Editorial corrections, Sprint Corporation R4-1901874, Guardband for harmonic exception to reference sensitivity, Qualcomm Incorporated R4-1901878, Non-simultaneous Tx/Rx for TDD intra-band EN-DC, Qualcomm Incorporated R4-1901890, A-MPR for DC_(n)71AA without Dynamic Power Sharing, Motorola Mobility France S.A.S R4-1901926, Draft CR to 38.101-3 to clarify ACS2 wanted level, Qualcomm Incorporated R4-1901997, draft_CR TS 38.101-3 type 2 UE DC_(n)41 and DC_41_n41 NS04 AMPR correction, Skyworks Solutions Inc. R4-1902002, Draft CR to 38.101-3 on DC_n41-41 – B40 coexistence, Qualcomm Incorporated R4-1902154, Draft CR to TS38.101-3_clean up on inter-band CA between FR1 and FR2, ZTE Corporation R4-1902155, Draft CR for TS 38.101-3: Corrections to Table 7.3B.2.3.5.1-1 for reference sensitivity exceptions (two bands), MediaTek Inc. R4-1902156, draftCR corrections for TS 38.101-3, Huawei R4-1902157, CR on intraband ENDC channel configurations, Intel Corporation R4-1902160, Draft CR on some errors to TS 38.101-3, Huawei R4-1902161, CR to 38.101-3 to clarify non-simultaneous RXTX capability for co-bands, Qualcomm Incorporated R4-1902163, Draft CR to 38.101-3 to clarify DL carrier levels for bands in close frequency proximity, Qualcomm Incorporated R4-1902164, Draft CR to reflect agreed MSD analysis of DC_25A-n41A for TS 38.101-3, MediaTek Inc. R4-1902169, draft CR for inter-band EN-DC P_{cmx}, Huawei R4-1902172, Draft CR ACLR for NC intra-band EN-DC, Skyworks Solutions Inc. R4-1902176, Draft CR for 38.101-3 modification of requirements for intra-band non-contiguous EN-DC SEM, Huawei R4-1902179, draft CR for introduction of Tx IM for Inter-band EN-DC in TS38.101-3, NTT DOCOMO, INC. R4-1902182, Clarification for OOB boundary for intra-band contiguous and non-contiguous EN-DC, vivo R4-1902195, draft_CR TS 38.101-3 Footnote correction in Table 7.3B.2.3.1-2, Skyworks Solutions Inc. R4-1902232, Draft CR on SUL band combinations to TS 38.101-3, Huawei R4-1902478, Addition of power class 2 EN-DC ACLR requirement, Nokia R4-1902481, draftCR on inter-band EN-DC Rx requirement for TS 38.101-3, Huawei R4-1902486, Draft CR for 38.101-3 modification of requirements for network signalled value NS_04, Huawei R4-1902496, Draft CR for TS 38.101-3: Switching time for intra-band EN-DC upon dual PA UE capability, Huawei R4-1902500, Draft CR for 38.101-3: adding MPR for intra-band ENDC, Skyworks Solutions Inc R4-1902660, Introduction of modified MPR for 38.101-3, Nokia</p>	15.5.0
---------	--------	-----------	------	---	--	--------

					Editorial changes after RAN#83 To align the annex numbering with other specifications (TS 38.101-x series), 'Modified MPR behavior' was moved to annex H.	
2019-06	RAN#84	RP-191240	0041	F	<p>CR to TS 38.101-3: Implementation of endorsed draft CRs from RAN4#90bis and RAN4#91</p> <p>Endorced draft CRs from RAN4#90Bis R4-1902829, Draft CR for 38.101-3 editorial correction for editorial correction for intra-band contiguous EN-DC uplink configuration when Rx requirements are measured, Huawei R4-1903074 Draft CR to 38.101-3 rel. 15 to fix missing SUO note Apple Inc. R4-1903090 Pcmx for Rel-15 intra-band EN-DC within FR1 wrong references - fixes InterDigital Communications R4-1903150 Draft CR to TS 38.101-3_Spurious emission and Tx IM for inter-band CA between FR1 and FR2 ZTE Corporation R4-1903302 Draft CR to TS 38.101-3 correction for the DC_3_n3 delta R IBNC table CHTTL R4-1903426 draft CR for 38.101-3: Reflect the agreed MSD for DC_5_n78 China Telecom R4-1903515 Removal of reference sensitivity exception due to close proximity of bands for EN-DC in NR FR1 clause Nokia R4-1903958 Completion of defintions of EN-DC configured power Ericsson R4-1904639 Draft CR to 38.101-3 on DC_n41-41 – B40 coexistence, Qualcomm Incorporated R4-1904934 Harmonization of reference sensitivity level for DC clause Nokia R4-1904935 Change description 4.2(e) in Applicability of minimum requirements for TS 38.101-3 vivo R4-1904945 Draft CR to TS38.101-3_adding some exclusion frequencies for SEM and spurious emission for EN-DC ZTE Corporation R4-1904946 Draft CR to TS 38.101-3 on some minor corrections ZTE Corporation R4-1904951 Draft CR for 38.101-3 intra-band EN-DC AMPR Huawei R4-1904953 Draft CR for 38.101-3: NS_04 A-MPR power class relationship clarification Sprint Corporation R4-1904959 Draft CR on UE to UE coexistence for TS 38.101-3 Huawei R4-1904988 Draft CR to 38.101-1. Clarify EN-DC category for requirements of carrier imbalance Qualcomm Incorporated R4-1904995 draft CR to 38.101-3 Configured output power for inter-band EN-DC including both FR1 and FR2 Intel Corporation R4-1905085 Draft CR for TR 38.101-3 NE-DC RF requirement Huawei R4-1904925 Draft CR for improving EN-DC configuration tables in TS38.101-3 CATT</p> <p>Endorced draft CRs from RAN4#91 R4-1905628 Draft CR to TS38.101-3_Frequency error for intra-band for EN-DC ZTE Corporation R4-1905629 Draft CR to TS 38.101-3_removal of the reference sensitivity exception for NR CA between FR1 and FR2 ZTE Corporation R4-1905767 draft CR to 38.101-3 Correction of DeltaTIB,c in configured output power for EN-DC Intel Corporation R4-1905774 Draft CR to TS38.101-3 Correction to intra-band and inter-band EN-DC Pcmx Intel Corporation R4-1905793 CR for TS 38.101-3 (Rel-15): Support of n257D-F for DC_1-42_n257 and DC_3-42_n257 SoftBank Corp. R4-1905799 Correction of LTE anchor condition to Spurious response for EN-DC Anritsu Corporation R4-1907057 Draft CR for 38.101-3: Further UE coexistence table clean-up Sprint Corporation R4-1907063 Draft CR for 38.101-3: Global replacement of LTE with E-UTRA Sprint Corporation R4-1907136 Draft CR to 38.101-3 rel. 15 to fix missing Exceptions for Out-of-band Blocking Apple R4-1907137 Draft CR to 38.101-3 rel. 15 to fix missing SUO note Apple R4-1907181 Draft CR for 38.101-3: Removal of unnecessary ACLR notes Sprint Corporation R4-1907422 Draft CR for TS 38.101-1 Correction of channel bandwidth set for NR CA Huawei</p>	15.6.0

					<p>R4-1907424 Draft CR for clarification of note for B42_n77 and B42_n78 NTT DOCOMO, INC.</p> <p>R4-1907425 DraftCR TS 38.101-3 Corrections to Intra-band ENDC MPR text Skyworks Solutions Inc.</p> <p>R4-1907426 Definition of BCS support in inter-band EN-DC mode Qualcomm Incorporated</p> <p>R4-1907448 Correction to EN-DC spurious emissions ROHDE & SCHWARZ</p> <p>R4-1907476 draft CR for TS 38.101-3 intra-band EN-DC Pcmaw Huawei</p> <p>R4-1907482 Correction of RefSens exceptions due to UL harmonic interference for EN-DC in 38.101-3 vivo</p> <p>R4-1907483 [Rx]Draft CR for 38.101-3 defining Reference sensitivity for intra-band non-contiguous, Huawei</p> <p>R4-1907485 Corrections to MPR/A-MPR and additional requirements for intra-band EN-DC Ericsson</p> <p>R4-1907489 Draft CR to 38.101-3. Revise MSD for DC_20A-n8A Qualcomm Incorporated</p> <p>R4-1907492 Modification of reference sensitivity and general spurious emissions in 38.101-3 Qualcomm Incorporated</p> <p>R4-1907594 draft CR of modification on reference for inter-band EN-DC including FR2 for TS 38.101-3 NTT DOCOMO INC.</p> <p>R4-1907808 Draft CR to 38.101-3 NE-DC introduction InterDigital Communications</p>	
2019-12	RAN#86	RP-192049	0063	F	<p>CR to TS 38.101-3: Implementation of endorsed draft CRs from RAN4#92 (Rel-15)</p> <p>R4-1907957 Reference sensitivity for intra-band EN-DC with single uplink Qualcomm Incorporated</p> <p>R4-1908028 Draft CR for handling of fallbacks for combined contiguous and non-contiguous CA in FR2</p> <p>R4-1908162 dCR to 38.101-3: EN-DC REFSSENS editorial updates Qualcomm Incorporated</p> <p>R4-1908376 Draft CR for TS38.101-3, Editorial corrections CATT</p> <p>R4-1908434 Further correction of RefSens exceptions due to UL harmonic interference for EN-DC in 38.101-3 vivo</p> <p>R4-1908692 Editorial correction on SUO mark for BC 3+78 Apple Inc.</p> <p>R4-1908959 Draft CR for 38.101-3 adding note for spurious emission band UE co-existence Huawei, HiSilicon</p> <p>R4-1908960 Draft CR for 38.101-3 clean up for inter-band NE-DC Huawei, HiSilicon</p> <p>R4-1909065 Draft CR for editorial correction on EN-DC of 4LTE bands + 1NR band for Rel-15 TS 38.101-3 NTT DOCOMO, INC.</p> <p>R4-1909354 Draft CR to TS 38.101-3 on UE additional maximum output power reduction for EN-DC ZTE Corporation</p> <p>R4-1909357 Draft CR to TS 38.101-3 on UE maximum output power for DC ZTE Corporation</p> <p>R4-1909798 Correction of DC configurations in tables chapter 5 Ericsson</p> <p>R4-1909903 Draft CR for 38.101-3: Correction of Note 2 in Table 5.5B.2-1 Sprint, Ericsson, Google</p> <p>R4-1909956 dCR to 38.101-3 EN-DC RX Out-of-Band Blocking for Inter-bands treated as Intra-band Qualcomm Inc.</p> <p>R4-1909977 draftCR to 38.101-3 for missing Harmonic Mixing MSD fo DC_11A_n79A like DC 21A n79A Qualcomm Inc.</p> <p>R4-1910236 Draft CR of modification on reference to 38.101-2 requirements for inter-band EN-DC with FR2 for TS 38.101-3 NTT DOCOMO, INC.</p> <p>R4-1910245 draft CR to correct band of band26 related EN-DC KDDI</p> <p>R4-1910246 Draft CR to add simultaneous RX/TX capability requirements in R15 TS 38.101-3 CMCC</p> <p>R4-1910248 Draft CR to TS 38.101-3 for DC_38_n78 mandatory simultaneous Rx/Tx capability Vodafone</p> <p>R4-1910249 Draft CR for handling of EN-DC BCS for TS 38.101-3 NTT DOCOMO, INC.</p> <p>R4-1910250 draftCR to 38.101-3 for missing IMD MSD for shared bands that already have MSD Qualcomm Inc.</p> <p>R4-1910251 Draft CR for 38.101-3: non-contiguous resource allocation Huawei, HiSilicon</p> <p>R4-1910255 Draft Minor Corrections to 38.101-3 clause 6.2B.4.1.1 Motorola Mobility, T-Mobile USA</p> <p>R4-1910256 draft CR for 38.101-3 specifying occupied bandwidth for intra-band non-contiguous EN-DC Huawei, HiSilicon</p>	15.7.0

						R4-1910257 Draft CR to TS 38.101-3: transmit intermodulation for intra-band EN-DC ZTE Corporation R4-1910268 Draft CR for TS 38.101-3: Corrections to reference sensitivity exceptions due to receiver harmonic mixing and cross band isolation for EN-DC in NR FR1 MediaTek Inc. R4-1910317 Draft CR for TS 38.101-3: Additional out-of-band blocking exceptions for inter-band EN-DC MediaTek Inc. R4-1910318 Draft CR for 38.101-3: EN-DC Pcmaw Huawei, HiSilicon R4-1909111 Draft CR for 38.101-3 applicability for intra-band CA and ENDC Huawei, HiSilicon	
2019-12	RAN#86	RP-193032	0074		F	CR for 38.101-3 EN-DC RX Out-of-Band Blocking for shared bands and bands in close proximity	15.8.0
2019-12	RAN#86	RP-193032	0076		F	CR to 38.101-3 Missing Harmonic Mixing MSD for DC_3_n77/n78	15.8.0
2019-12	RAN#86	RP-193032	0078		F	CR for 38.101-3 EN-DC DL Synchronous Carriers	15.8.0
2019-12	RAN#86	RP-193032	0084		F	CR for 38.101-3: Correction to DC Config and dual UL interferer (Rel-15)	15.8.0
2019-12	RAN#86	RP-193032	0086		F	CR for 38.101-3: Correction to EN-DC and NE-DC Configurations (Rel-15)	15.8.0
2019-12	RAN#86	RP-193033	0088	1	F	CR to 38.101-3: clarification of ENDC power class in R15	15.8.0
2019-12	RAN#86	RP-193032	0089	1	F	CR to TS38.101-3: Correction on channel spacing for intra-band EN-DC carriers (section 5.4B.1)	15.8.0
2019-12	RAN#86	RP-193032	0098		F	CR to TS 38.101-3 on inter-band EN-DC configurations including FR2 for five bands (Rel-15)	15.8.0
2019-12	RAN#86	RP-193032	0103		F	CR to TS 38.101-3 on inter-band CA, EN-DC, NE-DC and NR-DC configurations (Rel-15)	15.8.0
2019-12	RAN#86	RP-193032	0104		F	CR to TS 38.101-3: clarification for MPR statement	15.8.0
2019-12	RAN#86	RP-193032	0105		F	CR for TS 38.101-3: Removing MSD requirements for EN-DC combinations due to receiver even order harmonic mixing with UL 3rd harmonic	15.8.0
2019-12	RAN#86	RP-193033	0110		F	CR to TS 38.101-3: adding missing 90MHz channel BW support for n77, n78 related CA	15.8.0
2019-12	RAN#86	RP-193033	0113		F	Removal of brackets from MPR and MSD 38.101-3 REL15	15.8.0
2019-12	RAN#86	RP-193033	0119		F	Pcmaw for EN-DC: applicability of NS values and removal of a duty-cycle capability	15.8.0
2019-12	RAN#86	RP-193033	0124		B	CR for TS 38.101-3: Additional out-of-band blocking exceptions for inter-band EN-DC	15.8.0
2019-12	RAN#86	RP-193033	0127		F	CR for 38.101-3: correct MSD exception for DC_2_n78(Rel-15)	15.8.0
2019-12	RAN#86	RP-193033	0135	1	F	CR for 38.101-3: Clarification of the notation for intra-band EN-DC combinations	15.8.0
2019-12	RAN#86	RP-193033	0137		F	CR to 38.101-3-f70 Corrections to MSD Due to Cross-band Isolation for EN-DC in FR1	15.8.0
2019-12	RAN#86	RP-193033	0141		F	CR to 38.101-3 on only synchronous NR-DC between FR1 and FR2 support in Rel-15	15.8.0
2019-12	RAN#86	RP-193033	0142	2	F	CR for 38.101-3 Correction of EN-DC BCS	15.8.0
2019-12	RAN#86	RP-193033	0144		F	CR for 38.101-3 correction for intra-band EN-DC Pcmaw	15.8.0
2019-12	RAN#86	RP-193033	0145		F	CR for 38.101-3 intra-band EN-DC MPR/AMPR	15.8.0
2020-03	RAN#87	RP-200396	0163		F	CR for 38.101-3: Correction of MOP tolerance for B41/n41 EN-DC	15.9.0
2020-03	RAN#87	RP-200396	0171		F	CR to TS 38.101-3: corrections on ACS for intra-band contiguous EN-DC	15.9.0
2020-03	RAN#87	RP-200396	0173	1	D	CR to TS 38.101-3: editorial corrections on Rx requirements for intra-band contiguous EN-DC	15.9.0
2020-03	RAN#87	RP-200396	0176	1	F	CR to TS 38.101-3: Correct the intra-band ENDC channel spacing	15.9.0
2020-03	RAN#87	RP-200396	0192		F	CR to TS 38.101-3: editorial correction for output power dynamics for intra-band EN-DC	15.9.0
2020-03	RAN#87	RP-200396	0198		F	CR on correction of 38.101-3 NEDC Ppowerclass (Rel-15)	15.9.0
2020-03	RAN#87	RP-200396	0209	1	F	Rel-15 CR to 38.101-3 for editorial corrections	15.9.0
2020-03	RAN#87	RP-200396	0210		F	CR to 38.101-3 R15 to remove FDM ULSUP combinations	15.9.0
2020-03	RAN#87	RP-200396	0212		F	CR for inter-band ENDC Tx requirement_Rel-15	15.9.0
2020-03	RAN#87	RP-200396	0216	1	F	EN-DC configuration table corrections	15.9.0
2020-06	RAN#88	RP-200985	0239		F	CR for TS 38.101-3: MSD due to UL harmonic	15.10.0
2020-06	RAN#88	RP-200985	0244		F	MOP for interband EN-DC including both FR1 and FR2 REL15	15.10.0
2020-06	RAN#88	RP-200985	0258		F	CR to TS 38.101-3 on configured output power relaxation due to EN-DC (Rel-15)	15.10.0
2020-06	RAN#88	RP-200985	0260		F	CR to TS 38.101-3 on REFSENS relaxation due to EN-DC (Rel-15)	15.10.0
2020-06	RAN#88	RP-200985	0250	1	F	CR for 38.101-3: Corrections for Ppowerclass and referenced sections	15.10.0
2020-06	RAN#88	RP-200985	0266	1	F	CR to TS 38.101-3: Clean up the MSD test point for ENDC(three band)	15.10.0
2020-06	RAN#88	RP-200985	0231	1	F	CR Coexistence cleanup for 38101-3 Rel15	15.10.0
2020-06	RAN#88	RP-200985	0237	1	F	CR for TS 38.101-3: Missing MSD due to cross band isolation	15.10.0
2020-06	RAN#88	RP-200985	0242	1	F	FR1+FR2 CA interband CA BCS support REL15	15.10.0

2020-06	RAN#88	RP-200985	0247	1	B	CR to 38.101-3 MSD due to UL harmonics and intermodulation interference	15.10.0
2020-06	RAN#88	RP-200985	0233	1	F	CR to TS 38.101-3 R15: corrections on ACS for intra-band contiguous EN-DC	15.10.0
2020-06	RAN#88	RP-200985	0235	1	F	CR to TS 38.101-3: editorial corrections on wide band Intermodulation for intra-band contiguous EN-DC in FR1	15.10.0
2020-06	RAN#88	RP-200988	0295		F	CR to remove TBD in 38.101-3	15.10.0
2020-06	RAN#88	RP-200985	0271	2	F	Removal of the Annex modified MPR-Behaviour from the NSA specification	15.10.0
2020-06	RAN#88	RP-200985	0239		F	CR for TS 38.101-3: MSD due to UL harmonic	15.10.0
2020-09	RAN#89	RP-201512	0306	1	F	CR for missing IMD MSD in 38.101-3 for DC_1A-41A_n78A, DC_7A-28A_n78A	15.11.0
2020-09	RAN#89	RP-201512	0308		F	Correction to in-band emissions for intra-band contiguous EN-DC	15.11.0
2020-09	RAN#89	RP-201512	0316	2	F	CR to 38.101-3 MSD due to UL harmonics and intermodulation interference	15.11.0
2020-09	RAN#89	RP-201512	0318		F	CR to correct protected band of intra-band EN-DC	15.11.0
2020-09	RAN#89	RP-201512	0322	1	F	CR for TS 38.101-3: FR1 inter-band EN-DC out-of-band blocking UL configuration	15.11.0
2020-09	RAN#89	RP-201512	0325	1	F	Corrections of Japan-related EN-DC co-ex tables for REL-15 combo	15.11.0

History

Document history		
V15.2.0	July 2018	Publication
V15.3.0	October 2018	Publication
V15.4.0	April 2019	Publication
V15.5.0	May 2019	Publication
V15.6.0	July 2019	Publication
V15.7.0	October 2019	Publication
V15.8.0	April 2020	Publication
V15.9.0	April 2020	Publication
V15.10.0	July 2020	Publication
V15.11.0	November 2020	Publication