

# ETSI TS 138 101-3 V16.4.0 (2020-07)



**5G;  
NR;  
User Equipment (UE) radio transmission and reception;  
Part 3: Range 1 and Range 2 Interworking operation with other  
radios  
(3GPP TS 38.101-3 version 16.4.0 Release 16)**



---

Reference

RTS/TSGR-0438101-3vG40

---

Keywords

---

5G

**ETSI**

650 Route des Lucioles  
F-06921 Sophia Antipolis Cedex - FRANCE

---

Tel.: +33 4 92 94 42 00 Fax: +33 4 93 65 47 16

Siret N° 348 623 562 00017 - NAF 742 C  
Association à but non lucratif enregistrée à la  
Sous-Préfecture de Grasse (06) N° 7803/88

---

**Important notice**

---

The present document can be downloaded from:

<http://www.etsi.org/standards-search>

The present document may be made available in electronic versions and/or in print. The content of any electronic and/or print versions of the present document shall not be modified without the prior written authorization of ETSI. In case of any existing or perceived difference in contents between such versions and/or in print, the prevailing version of an ETSI deliverable is the one made publicly available in PDF format at [www.etsi.org/deliver](http://www.etsi.org/deliver).

Users of the present document should be aware that the document may be subject to revision or change of status.

Information on the current status of this and other ETSI documents is available at

<https://portal.etsi.org/TB/ETSIDeliverableStatus.aspx>

If you find errors in the present document, please send your comment to one of the following services:

<https://portal.etsi.org/People/CommitteeSupportStaff.aspx>

---

**Copyright Notification**

---

No part may be reproduced or utilized in any form or by any means, electronic or mechanical, including photocopying and microfilm except as authorized by written permission of ETSI.

The content of the PDF version shall not be modified without the written authorization of ETSI.

The copyright and the foregoing restriction extend to reproduction in all media.

© ETSI 2020.

All rights reserved.

**DECT™**, **PLUGTESTS™**, **UMTS™** and the ETSI logo are trademarks of ETSI registered for the benefit of its Members.

**3GPP™** and **LTE™** are trademarks of ETSI registered for the benefit of its Members and of the 3GPP Organizational Partners.

**oneM2M™** logo is a trademark of ETSI registered for the benefit of its Members and of the oneM2M Partners.

**GSM®** and the GSM logo are trademarks registered and owned by the GSM Association.

---

## Intellectual Property Rights

### Essential patents

IPRs essential or potentially essential to normative deliverables may have been declared to ETSI. The information pertaining to these essential IPRs, if any, is publicly available for **ETSI members and non-members**, and can be found in ETSI SR 000 314: *"Intellectual Property Rights (IPRs); Essential, or potentially Essential, IPRs notified to ETSI in respect of ETSI standards"*, which is available from the ETSI Secretariat. Latest updates are available on the ETSI Web server (<https://ipr.etsi.org/>).

Pursuant to the ETSI IPR Policy, no investigation, including IPR searches, has been carried out by ETSI. No guarantee can be given as to the existence of other IPRs not referenced in ETSI SR 000 314 (or the updates on the ETSI Web server) which are, or may be, or may become, essential to the present document.

### Trademarks

The present document may include trademarks and/or tradenames which are asserted and/or registered by their owners. ETSI claims no ownership of these except for any which are indicated as being the property of ETSI, and conveys no right to use or reproduce any trademark and/or tradename. Mention of those trademarks in the present document does not constitute an endorsement by ETSI of products, services or organizations associated with those trademarks.

---

## Legal Notice

This Technical Specification (TS) has been produced by ETSI 3rd Generation Partnership Project (3GPP).

The present document may refer to technical specifications or reports using their 3GPP identities. These shall be interpreted as being references to the corresponding ETSI deliverables.

The cross reference between 3GPP and ETSI identities can be found under <http://webapp.etsi.org/key/queryform.asp>.

---

## Modal verbs terminology

In the present document "**shall**", "**shall not**", "**should**", "**should not**", "**may**", "**need not**", "**will**", "**will not**", "**can**" and "**cannot**" are to be interpreted as described in clause 3.2 of the [ETSI Drafting Rules](#) (Verbal forms for the expression of provisions).

"**must**" and "**must not**" are **NOT** allowed in ETSI deliverables except when used in direct citation.

# Contents

Intellectual Property Rights .....	2
Legal Notice .....	2
Modal verbs terminology.....	2
Foreword.....	11
1 Scope .....	13
2 References .....	13
3 Definitions, symbols and abbreviations .....	14
3.1 Definitions .....	14
3.2 Symbols.....	14
3.3 Abbreviations .....	14
4 General .....	15
4.1 Relationship between minimum requirements and test requirements .....	15
4.2 Applicability of minimum requirements .....	16
4.3 Specification suffix information.....	16
5 Operating bands and channel arrangement.....	17
5.1 General .....	17
5.2 Operating bands.....	17
5.2A Operating bands for CA .....	17
5.2A.1 Inter-band CA between FR1 and FR2.....	17
5.2B Operating bands for DC .....	19
5.2B.1 General.....	19
5.2B.2 Void .....	19
5.2B.3 Void .....	19
5.2B.4 Void .....	19
5.2B.5 Void .....	19
5.2B.6 Void .....	19
5.2B.7 Void .....	19
5.2C Operating bands for V2X .....	19
5.2C.1 Intra-band V2X bands.....	19
5.2C.2 Inter-band V2X bands.....	19
5.3 UE Channel bandwidth .....	20
5.3A UE Channel bandwidth for CA .....	20
5.3A.1 Inter-band CA between FR1 and FR2.....	20
5.3B UE Channel bandwidth for EN-DC.....	20
5.3B.1 Intra-band EN-DC in FR1.....	21
5.3B.1.1 General .....	21
5.3B.1.2 BCS for Intra-band contiguous EN-DC .....	21
5.3B.1.3 BCS for Intra-band non-contiguous EN-DC .....	23
5.3C Void.....	26
5.3D Void.....	26
5.3E UE Channel bandwidth for V2X .....	26
5.3E.1 Intra-band contiguous V2X in FR1.....	27
5.3E.2 Intra-band non-contiguous V2X in FR1 .....	27
5.3E.3 Inter-band V2X in FR1 .....	27
5.4 Void.....	27
5.4A Channel arrangement for CA.....	27
5.4B Channel arrangement for DC.....	27
5.4B.1 Channel spacing for intra-band EN-DC carriers.....	28
5.5 Configuration .....	29
5.5A Configuration for CA .....	29
5.5A.1 Inter-band CA configurations between FR1 and FR2.....	29
5.5B Configuration for DC .....	71
5.5B.1 General.....	71

5.5B.2	Intra-band contiguous EN-DC .....	72
5.5B.3	Intra-band non-contiguous EN-DC .....	72
5.5B.4	Inter-band EN-DC within FR1 .....	73
5.5B.4.1	Inter-band EN-DC configurations within FR1 (two bands) .....	73
5.5B.4.2	Inter-band EN-DC configurations within FR1 (three bands) .....	82
5.5B.4.3	Inter-band EN-DC configurations within FR1 (four bands) .....	103
5.5B.4.4	Inter-band EN-DC configurations within FR1 (five bands) .....	123
5.5B.4.5	Inter-band EN-DC configurations within FR1 (six bands) .....	131
5.5B.4a	Inter-band NE-DC within FR1 .....	132
5.5B.4a.1	Inter-band NE-DC configurations within FR1 (two bands) .....	132
5.5B.5	Inter-band EN-DC including FR2 .....	132
5.5B.5.1	Inter-band EN-DC configurations including FR2 (two bands) .....	132
5.5B.5.2	Inter-band EN-DC configurations including FR2 (three bands) .....	149
5.5B.5.3	Inter-band EN-DC configurations including FR2 (four bands) .....	176
5.5B.5.4	Inter-band EN-DC configurations including FR2 (five bands) .....	193
5.5B.5.5	Void .....	199
5.5B.6	Inter-band EN-DC including FR1 and FR2 .....	199
5.5B.6.1	Void .....	199
5.5B.6.2	Inter-band EN-DC configurations including FR1 and FR2 (three bands) .....	199
5.5B.6.3	Inter-band EN-DC configurations including FR1 and FR2 (four bands) .....	208
5.5B.6.4	Inter-band EN-DC configurations including FR1 and FR2 (five bands) .....	226
5.5B.6.5	Inter-band EN-DC configurations including FR1 and FR2 (six bands) .....	241
5.5B.7	Inter-band NR-DC between FR1 and FR2 .....	245
5.5B.7.1	Inter-band NR-DC configurations between FR1 and FR2 (two bands) .....	245
5.5B.7.2	Inter-band NR-DC configurations between FR1 and FR2 (three bands) .....	248
5.5C	Void .....	249
5.5D	Void .....	249
5.5E	Configuration for V2X operation .....	249
5.5E.1	General .....	249
5.5E.2	Intra-band contiguous V2X operation in FR1 .....	249
5.5E.3	Intra-band non-contiguous V2X operation in FR1 .....	249
5.5E.4	Inter-band V2X operation in FR1 .....	249
5.5E.4.1	Inter-band V2X configurations within FR1 (two bands) .....	249
6	Transmitter characteristics .....	250
6.1	General .....	250
6.2	Void .....	250
6.2A	Transmitter power for CA .....	250
6.2A.1	UE maximum output power for CA .....	250
6.2A.1.1	Inter-band CA between FR1 and FR2 .....	250
6.2A.2	UE maximum output power reduction for CA .....	250
6.2A.2.1	Inter-band CA between FR1 and FR2 .....	250
6.2A.3	UE additional maximum output power reduction for CA .....	250
6.2A.4	Configured output power for CA .....	250
6.2A.4.1	Configured output power level .....	250
6.2A.4.2	$\Delta T_{IB,c}$ for CA .....	251
6.2A.4.2.1	$\Delta T_{IB,c}$ for Inter-band CA between FR1 and FR2 .....	251
6.2B	Transmitter power for DC .....	251
6.2B.1	UE maximum output power for DC .....	251
6.2B.1.1	Intra-band contiguous EN-DC .....	251
6.2B.1.2	Intra-band non-contiguous EN-DC .....	252
6.2B.1.3	Inter-band EN-DC within FR1 .....	253
6.2B.1.3a	Inter-band NE-DC within FR1 .....	260
6.2B.1.4	Inter-band EN-DC including FR2 .....	260
6.2B.1.5	Inter-band EN-DC including both FR1 and FR2 .....	260
6.2B.2	UE maximum output power reduction for DC .....	260
6.2B.2.0	General .....	260
6.2B.2.1	Intra-band contiguous EN-DC .....	260
6.2B.2.1.1	General .....	260
6.2B.2.1.2	MPR for power class 3 and power class 2 .....	261
6.2B.2.2	Intra-band non-contiguous EN-DC .....	262
6.2B.2.2.1	General .....	262

6.2B.2.2.2	MPR for power class 3 and power class 2 .....	262
6.2B.2.3	Inter-band EN-DC within FR1 .....	263
6.2B.2.3a	Inter-band NE-DC within FR1 .....	263
6.2B.2.4	Inter-band EN-DC including FR2 .....	263
6.2B.2.5	Inter-band EN-DC including both FR1 and FR2 .....	263
6.2B.3	UE additional maximum output power reduction for EN-DC .....	263
6.2B.3.1	Intra-band contiguous EN-DC .....	263
6.2B.3.1.0	General .....	263
6.2B.3.1.1	A-MPR for DC_(n)71AA .....	264
6.2B.3.1.2	A-MPR for NS_04 .....	265
6.2B.3.2	Intra-band non-contiguous EN-DC .....	268
6.2B.3.2.0	General .....	268
6.2B.3.2.1	A-MPR for NS_04 .....	268
6.2B.3.3	Inter-band EN-DC within FR1 .....	269
6.2B.3.4	Inter-band EN-DC including FR2 .....	269
6.2B.3.5	Inter-band EN-DC including both FR1 and FR2 .....	270
6.2B.4	Configured output power for DC .....	270
6.2B.4.1	Configured output power level .....	270
6.2B.4.1.1	Intra-band contiguous EN-DC .....	270
6.2B.4.1.2	Intra-band non-contiguous EN-DC .....	274
6.2B.4.1.3a	Inter-band NE-DC within FR1 .....	278
6.2B.4.1.4	Inter-band EN-DC including FR2 .....	282
6.2B.4.1.5	Inter-band EN-DC including both FR1 and FR2 .....	282
6.2B.4.2	$\Delta T_{IB,c}$ for DC .....	282
6.2B.4.2.0	General .....	282
6.2B.4.2.1	Intra-band contiguous EN-DC .....	282
6.2B.4.2.2	Intra-band non-contiguous EN-DC .....	282
6.2B.4.2.3	Inter-band EN-DC within FR1 .....	283
6.2B.4.2.3.1	$\Delta T_{IB,c}$ for EN-DC two bands .....	283
6.2B.4.2.3.2	$\Delta T_{IB,c}$ for EN-DC three bands .....	289
6.2B.4.2.3.3	$\Delta T_{IB,c}$ for EN-DC four bands .....	308
6.2B.4.2.3.4	$\Delta T_{IB,c}$ for EN-DC five bands .....	326
6.2B.4.2.3.5	$\Delta T_{IB,c}$ for EN-DC six bands .....	333
6.2B.4.2.3a	Inter-band NE-DC within FR1 .....	333
6.2B.4.2.4	Inter-band EN-DC including FR2 .....	333
6.2B.4.2.4.1	$\Delta T_{IB,c}$ for EN-DC two bands .....	333
6.2B.4.2.4.2	$\Delta T_{IB,c}$ for EN-DC three bands .....	333
6.2B.4.2.4.3	$\Delta T_{IB,c}$ for EN-DC four bands .....	333
6.2B.4.2.4.4	$\Delta T_{IB,c}$ for EN-DC five bands .....	333
6.2B.4.2.4.5	Void .....	334
6.2B.4.2.5	Inter-band EN-DC including both FR1 and FR2 .....	334
6.2B.4.2.5.1	$\Delta T_{IB,c}$ for EN-DC three bands .....	334
6.2B.4.2.5.2	$\Delta T_{IB,c}$ for EN-DC four bands .....	334
6.2B.4.2.5.3	$\Delta T_{IB,c}$ for EN-DC five bands .....	334
6.2B.4.2.5.4	$\Delta T_{IB,c}$ for EN-DC six bands .....	334
6.2B.5	Configured output power for NR-DC .....	334
6.2B.5.1	Configured output power level .....	334
6.2B.5.1.1	Inter-band NR-DC between FR1 and FR2 .....	334
6.2C	Transmitter power for V2X in FR1 .....	334
6.2C.1	UE maximum output power for V2X .....	334
6.2C.1.1	UE maximum output power for Intra-band contiguous V2X .....	334
6.2C.1.2	UE maximum output power for Intra-band non-contiguous V2X .....	335
6.2C.1.2	UE maximum output power for Inter-band V2X .....	335
6.2C.2	UE maximum output power reduction for V2X .....	335
6.2C.2.1	UE maximum output power reduction for Intra-band V2X .....	335
6.2C.2.2	UE maximum output power reduction for Inter-band V2X .....	335
6.2C.3	UE additional maximum output power reduction for V2X .....	336
6.2C.3.1	UE additional maximum output power reduction for Intra-band V2X .....	336
6.2C.3.2	UE additional maximum output power reduction for Inter-band V2X .....	336
6.2C.4	Configured output power for V2X .....	336
6.2C.4.1	UE configured output power for Intra-band V2X .....	336
6.2C.4.2	UE configured output power for Inter-band V2X .....	336

6.3	Output power dynamics.....	337
6.3A	Output power dynamics for CA .....	337
6.3B	Output power dynamics for DC .....	337
6.3B.0	General.....	337
6.3B.1	Output power dynamics for EN-DC with UL sharing from UE perspective .....	337
6.3B.1.1	E-UTRA and NR switching time mask for TDM based UL sharing from UE perspective .....	337
6.3B.1a	Output power dynamics for NE-DC with UL sharing from UE perspective .....	339
6.3B.2	Output power dynamics for intra-band EN-DC without dual PA capability .....	339
6.3B.3	Output power dynamics for intra-band EN-DC with dual PA capability .....	339
6.3B.4	Output power dynamics for switching between two uplink carriers.....	340
6.3B.4.1	E-UTRA and NR switching time mask between two uplink carriers.....	340
6.4	Void.....	341
6.4A	Transmit signal quality for CA.....	341
6.4A.1	Frequency error for CA.....	341
6.4A.2	Transmit modulation quality for CA.....	341
6.4B	Transmit signal quality for DC.....	341
6.4B.2	Transmit modulation quality for DC.....	342
6.4B.2.1	Transmit modulation quality for Intra-band contiguous EN-DC .....	342
6.4B.2.1.1	Error Vector Magnitude.....	342
6.4B.2.1.2	Carrier leakage.....	342
6.4B.2.1.3	In-band emissions .....	342
6.4B.2.2	Transmit modulation quality for Intra-band non-contiguous EN-DC .....	342
6.4B.2.2.1	Error Vector Magnitude.....	342
6.4B.2.2.2	Carrier leakage.....	342
6.4B.2.2.3	In-band emissions .....	342
6.4B.2.3a	Transmit modulation quality for Inter-band NE-DC within FR1 .....	343
6.4B.2.4	Transmit modulation quality for Inter-band EN-DC including FR2 .....	343
6.4B.2.5	Transmit modulation quality for inter-band EN-DC including both FR1 and FR2.....	343
6.4C	Transmit signal quality for V2X operation in FR1 .....	343
6.4C.1	Frequency error for V2X .....	343
6.4C.2	Transmit modulation quality for V2X.....	343
6.4C.2.1	Transmit modulation quality for Intra-band V2X .....	343
6.4C.2.2.1	Error Vector Magnitude.....	343
6.4C.2.2.2	Carrier leakage.....	343
6.4C.2.2.3	In-band emissions .....	344
6.4C.2.2	Transmit modulation quality for Inter-band V2X .....	344
6.5	Void.....	344
6.5A	Output RF spectrum emissions for CA.....	344
6.5A.1	Occupied bandwidth for CA .....	344
6.5A.2	Out-of-band emissions for CA.....	344
6.5A.3	Spurious emissions for CA .....	344
6.5A.3.1	Inter-band CA between FR1 and FR2 .....	344
6.5A.4	Transmit intermodulation for CA .....	344
6.5B	Output RF spectrum emissions for DC.....	344
6.5B.1	Occupied bandwidth for EN-DC .....	344
6.5B.1.4	Inter-band EN-DC including FR2 .....	345
6.5B.1.5	Inter-band EN-DC including both FR1 and FR2 .....	345
6.5B.2	Out-of-band emissions for DC.....	345
6.5B.2.1	Intra-band contiguous EN-DC .....	345
6.5B.2.1.1	Spectrum emissions mask.....	345
6.5B.2.1.2	Additional spectrum emissions mask .....	345
6.5B.2.1.2.1	Requirements for network signalled value "NS_35" .....	345
6.5B.2.1.2.2	Requirements for network signalled value "NS_04" .....	346
6.5B.2.1.3	Adjacent channel leakage ratio.....	346
6.5B.2.2	Intra-band non-contiguous EN-DC .....	347
6.5B.2.2.1	Spectrum emissions mask.....	347
6.5B.2.2.2	Additional spectrum emissions mask .....	347
6.5B.2.2.3	Adjacent channel leakage ratio.....	347
6.5B.2.3	Inter-band EN-DC within FR1 .....	347
6.5B.2.3a	Inter-band NE-DC within FR1 .....	347
6.5B.2.4	Inter-band EN-DC including FR2 .....	347
6.5B.2.5	Inter-band EN-DC including both FR1 and FR2 .....	348

6.5B.3	Spurious emissions for DC .....	348
6.5B.3.1	Intra-band contiguous EN-DC .....	348
6.5B.3.1.1	General spurious emissions .....	348
6.5B.3.1.2	Spurious emission band UE co-existence .....	348
6.5B.3.2	Intra-band non-contiguous EN-DC .....	348
6.5B.3.2.1	General spurious emissions .....	348
6.5B.3.2.2	Spurious emission band UE co-existence .....	349
6.5B.3.3	Inter-band EN-DC within FR1 .....	349
6.5B.3.3.2	Spurious emission band UE co-existence .....	350
6.5B.3.3a	Inter-band NE-DC within FR1 .....	373
6.5B.3.3a.1	General spurious emissions .....	373
6.5B.3.3a.2	Spurious emission band UE co-existence .....	373
6.5B.3.4	Inter-band EN-DC including FR2 .....	373
6.5B.3.4.1	Spurious emission band UE co-existence .....	373
6.5B.3.5	Inter-band EN-DC including both FR1 and FR2 .....	374
6.5B.3.5.1	Spurious emission band UE co-existence .....	374
6.5B.4	Additional spurious emissions .....	374
6.5B.4.1	General .....	374
6.5B.4.1.1	Minimum requirement (network signalled value "NS_04") .....	374
6.5B.5	Transmit intermodulation for DC .....	374
6.5B.5.1	Intra-band contiguous EN-DC .....	374
6.5B.5.2	Intra-band non-contiguous EN-DC .....	375
6.5B.5.3	Inter-band EN-DC within FR1 .....	375
6.5B.5.3a	Inter-band NE-DC within FR1 .....	375
6.5B.5.4	Inter-band EN-DC including FR2 .....	375
6.5B.5.5	Inter-band EN-DC including both FR1 and FR2 .....	375
6.5C	Output RF spectrum emissions for V2X operation in FR1 .....	375
6.5C.1	Occupied bandwidth .....	375
6.5C.1.1	Intra-band V2X .....	375
6.5C.1.2	inter-band V2X con-current operation .....	375
6.5C.2	Out-of-band emissions .....	375
6.5C.2.1	Intra-band V2X .....	375
6.5C.2.2	Inter-band V2X con-current operation .....	375
6.5C.3	Spurious emissions .....	376
6.5C.3.1	Intra-band V2X .....	376
6.5C.3.1.1	General spurious emissions .....	376
6.5C.3.1.2	Spurious emission band UE co-existence .....	376
6.5C.3.2	Inter-band V2X con-current operation .....	376
6.5C.3.2.1	General spurious emissions .....	376
6.5C.3.2.2	Spurious emission band UE co-existence .....	376
6.5C.4	Transmit intermodulation .....	377
6.5C.4.1	Intra-band V2X .....	377
6.5C.4.2	Inter-band V2X con-current operation .....	377
6.6B	Beam correspondence for DC .....	377
6.6B.1	Void .....	377
6.6B.2	Void .....	377
6.6B.3	Void .....	377
6.6B.4	Inter-band EN-DC including FR2 .....	377
6.6B.5	Inter-band EN-DC including both FR1 and FR2 .....	377
7	Receiver characteristics .....	377
7.1	General .....	377
7.2	Void .....	378
7.3	Void .....	378
7.3A	Reference sensitivity for CA .....	378
7.3A.1	General .....	378
7.3A.2	Reference sensitivity power level for CA .....	379
7.3A.3	$\Delta R_{IB,c}$ for CA .....	379
7.3A.3.1	$\Delta R_{IB,c}$ for Inter-band CA between FR1 and FR2 .....	379
7.3A.4	Void .....	379
7.3B	Reference sensitivity level for DC .....	379
7.3B.1	General .....	379



7.3B.2	Reference sensitivity for DC.....	380
7.3B.2.1	Intra-band contiguous EN-DC .....	380
7.3B.2.2	Intra-band non-contiguous EN-DC .....	381
7.3B.2.3	Inter-band EN-DC within FR1 .....	382
7.3B.2.3.1	Reference sensitivity exceptions due to UL harmonic interference for EN-DC in NR FR1 .....	382
7.3B.2.3.2	Reference sensitivity exceptions due to receiver harmonic mixing for EN-DC in NR FR1.....	388
7.3B.2.3.3	Void.....	389
7.3B.2.3.4	Reference sensitivity exceptions due to cross band isolation for EN-DC in NR FR1 .....	389
7.3B.2.3.5	MSD for intermodulation interference due to dual uplink operation for EN-DC in NR FR1 .....	392
7.3B.2.3.5.1	MSD test points for intermodulation interference due to dual uplink operation for EN-DC in NR FR1 involving two bands .....	393
7.3B.2.3.5.2	MSD test points for intermodulation interference due to dual uplink operation for EN-DC in NR FR1 involving three bands .....	397
7.3B.2.3.5.3	Void .....	420
7.3B.2.3.5.4	MSD test points for intermodulation interference due to dual uplink operation for EN-DC in NR FR1 involving four bands.....	420
7.3B.2.3a	Inter-band NE-DC within FR1 .....	420
7.3B.2.3a.1	Reference sensitivity exceptions due to UL harmonic interference for NE-DC in NR FR1 .....	420
7.3B.2.4	Inter-band EN-DC including FR2 .....	421
7.3B.2.4.1	Void.....	421
7.3B.2.5	Inter-band EN-DC including both FR1 and FR2 .....	421
7.3B.2.5.1	Reference sensitivity exceptions due to UL harmonic interference for EN-DC including both FR1 and FR2 .....	421
7.3B.3	$\Delta R_{IB,c}$ , $\Delta R_{IBNC}$ for DC .....	421
7.3B.3.0	General.....	421
7.3B.3.1	Intra-band contiguous EN-DC .....	422
7.3B.3.2	Intra-band non-contiguous EN-DC .....	422
7.3B.3.3	Inter-band EN-DC within FR1 .....	427
7.3B.3.3.1	$\Delta R_{IB,c}$ for EN-DC in two bands .....	427
7.3B.3.3.2	$\Delta R_{IB,c}$ for EN-DC three bands .....	429
7.3B.3.3.3	$\Delta R_{IB,c}$ for EN-DC four bands.....	438
7.3B.3.3.4	$\Delta R_{IB,c}$ for EN-DC five bands .....	449
7.3B.3.3.5	$\Delta R_{IB,c}$ for EN-DC six bands.....	454
7.3B.3.3a	Inter-band NE-DC within FR1 .....	454
7.3B.3.4	Inter-band EN-DC including FR2 .....	454
7.3B.3.4.1	$\Delta R_{IB,c}$ for EN-DC in two bands .....	454
7.3B.3.4.2	$\Delta R_{IB,c}$ for EN-DC three bands .....	454
7.3B.3.4.3	$\Delta R_{IB,c}$ for EN-DC four bands .....	454
7.3B.3.4.4	$\Delta R_{IB,c}$ for EN-DC five bands .....	455
7.3B.3.4.5	Void.....	455
7.3B.3.5	Inter-band EN-DC including both FR1 and FR2 .....	455
7.3B.3.5.2	$\Delta R_{IB,c}$ for EN-DC three bands .....	455
7.3B.3.5.3	$\Delta R_{IB,c}$ for EN-DC four bands.....	455
7.3B.3.5.4	$\Delta R_{IB,c}$ for EN-DC five bands .....	455
7.3B.3.5.5	$\Delta R_{IB,c}$ for EN-DC six bands.....	455
7.3C	Reference sensitivity for V2X operation in FR1 .....	455
7.3C.1	General.....	455
7.3C.2	Reference sensitivity for V2X .....	455
7.3C.2.1	Intra-band contiguous V2X.....	455
7.3C.2.2	Intra-band non-contiguous V2X.....	456
7.3C.2.3	Inter-band V2X con-current operation .....	456
7.4	Void.....	456
7.4A	Maximum input level for CA .....	456
7.4B	Maximum input level for DC in FR1 .....	456
7.4B.1	Intra-band contiguous EN-DC in FR1 .....	456
7.4B.2	Intra-band non-contiguous EN-DC in FR1 .....	456
7.4B.3	Inter-band EN-DC within FR1.....	457
7.4C	Maximum input level for V2X operation in FR1 .....	457
7.5	Void.....	457
7.5A	Adjacent channel selectivity for CA.....	457
7.5B	Adjacent channel selectivity for DC in FR1 .....	457
7.5B.1	Intra-band contiguous EN-DC in FR1 .....	457

7.5B.2	Intra-band non-contiguous EN-DC in FR1 .....	458
7.5B.3	Inter-band EN-DC within FR1 .....	458
7.5C	Adjacent channel selectivity for V2X operation in FR1 .....	460
7.6	Void .....	460
7.6A	Blocking characteristics for CA .....	460
7.6B	Blocking characteristics for DC in FR1 .....	460
7.6B.1	General .....	460
7.6B.2	In-band blocking for DC in FR1 .....	460
7.6B.2.1	Intra-band contiguous EN-DC in FR1 .....	460
7.6B.2.2	Intra-band non-contiguous EN-DC in FR1 .....	460
7.6B.2.3	Inter-band EN-DC within FR1 .....	461
7.6B.3	Out-of-band blocking for DC in FR1 .....	461
7.6B.3.1	Intra-band contiguous EN-DC in FR1 .....	461
7.6B.3.2	Intra-band non-contiguous EN-DC in FR1 .....	461
7.6B.3.3	Inter-band EN-DC within FR1 .....	461
7.6B.4	Narrow band blocking for DC in FR1 .....	463
7.6B.4.1	Intra-band contiguous EN-DC in FR1 .....	463
7.6B.4.2	Intra-band non-contiguous EN-DC in FR1 .....	463
7.6B.4.3	Inter-band EN-DC within FR1 .....	464
7.6C	Blocking characteristics for V2X in FR1 .....	464
7.7	Void .....	464
7.7A	Spurious response for CA .....	464
7.7B	Spurious response for DC in FR1 .....	464
7.7B.1	Intra-band contiguous EN-DC in FR1 .....	464
7.7B.2	Intra-band non-contiguous EN-DC in FR1 .....	465
7.7B.3	Inter-band EN-DC within FR1 .....	465
7.7C	Spurious response for V2X in FR1 .....	465
7.8	Void .....	466
7.8A	Intermodulation characteristics for CA .....	466
7.8B	Intermodulation characteristics for DC in FR1 .....	466
7.8B.1	General .....	466
7.8B.2	Wide band Intermodulation .....	466
7.8B.2.1	Intra-band contiguous EN-DC in FR1 .....	466
7.8B.2.2	Intra-band non-contiguous EN-DC in FR1 .....	466
7.8B.2.3	Inter-band EN-DC within FR1 .....	466
7.8C	Intermodulation characteristics for V2X operation in FR1 .....	467
7.9	Void .....	467
7.9A	Spurious emissions for CA .....	467
7.9B	Spurious emissions for DC in FR1 .....	467
7.9B.1	Intra-band contiguous EN-DC in FR1 .....	467
7.9B.2	Intra-band non-contiguous EN-DC in FR1 .....	467
7.9B.3	Inter-band EN-DC within FR1 .....	467
<b>Annex A (normative):</b>	<b>Measurement channels .....</b>	<b>469</b>
Annex B:	Void .....	480
Annex C:	Void .....	480
Annex D:	Void .....	480
Annex E:	Void .....	481
Annex F:	Void .....	481
Annex G:	Void .....	481
<b>Annex H (normative):</b>	<b>Modified MPR behavior .....</b>	<b>481</b>
<b>Annex I (normative):</b>	<b>Dual uplink interferer .....</b>	<b>482</b>
<b>Annex J:</b>	<b>Void .....</b>	<b>482</b>
<b>Annex K:</b>	<b>Void .....</b>	<b>482</b>

**Annex L (informative):**      **Change history** .....483  
History .....492

---

# Foreword

This Technical Specification has been produced by the 3rd Generation Partnership Project (3GPP).

The contents of the present document are subject to continuing work within the TSG and may change following formal TSG approval. Should the TSG modify the contents of the present document, it will be re-released by the TSG with an identifying change of release date and an increase in version number as follows:

Version x.y.z

where:

- x the first digit:
  - 1 presented to TSG for information;
  - 2 presented to TSG for approval;
  - 3 or greater indicates TSG approved document under change control.
- y the second digit is incremented for all changes of substance, i.e. technical enhancements, corrections, updates, etc.
- z the third digit is incremented when editorial only changes have been incorporated in the document.

In the present document, modal verbs have the following meanings:

- shall** indicates a mandatory requirement to do something
- shall not** indicates an interdiction (prohibition) to do something

The constructions "shall" and "shall not" are confined to the context of normative provisions, and do not appear in Technical Reports.

The constructions "must" and "must not" are not used as substitutes for "shall" and "shall not". Their use is avoided insofar as possible, and they are not used in a normative context except in a direct citation from an external, referenced, non-3GPP document, or so as to maintain continuity of style when extending or modifying the provisions of such a referenced document.

- should** indicates a recommendation to do something
- should not** indicates a recommendation not to do something
- may** indicates permission to do something
- need not** indicates permission not to do something

The construction "may not" is ambiguous and is not used in normative elements. The unambiguous constructions "might not" or "shall not" are used instead, depending upon the meaning intended.

- can** indicates that something is possible
- cannot** indicates that something is impossible

The constructions "can" and "cannot" are not substitutes for "may" and "need not".

- will** indicates that something is certain or expected to happen as a result of action taken by an agency the behaviour of which is outside the scope of the present document
- will not** indicates that something is certain or expected not to happen as a result of action taken by an agency the behaviour of which is outside the scope of the present document
- might** indicates a likelihood that something will happen as a result of action taken by some agency the behaviour of which is outside the scope of the present document

**might not** indicates a likelihood that something will not happen as a result of action taken by some agency the behaviour of which is outside the scope of the present document

In addition:

**is** (or any other verb in the indicative mood) indicates a statement of fact

**is not** (or any other negative verb in the indicative mood) indicates a statement of fact

The constructions "is" and "is not" do not indicate requirements.

---

# 1 Scope

The present document establishes the minimum RF requirements for NR User Equipment (UE) Interworking operation with other radios. This includes but is not limited to additional requirements for carrier aggregation or NR dual connectivity between Range 1 and Range 2 and additional requirements due to NR non-standalone (NSA) operation mode with E-UTRA.

---

# 2 References

The following documents contain provisions which, through reference in this text, constitute provisions of the present document.

- References are either specific (identified by date of publication, edition number, version number, etc.) or non-specific.
- For a specific reference, subsequent revisions do not apply.
- For a non-specific reference, the latest version applies. In the case of a reference to a 3GPP document (including a GSM document), a non-specific reference implicitly refers to the latest version of that document *in the same Release as the present document*.

- [1] 3GPP TR 21.905: "Vocabulary for 3GPP Specifications".
- [2] 3GPP TS 38.101-1: "NR; User Equipment (UE) radio transmission and reception; Part 1: Range 1 Standalone"
- [3] 3GPP TS 38.101-2: "NR; User Equipment (UE) radio transmission and reception; Part 2: Range 2 Standalone"
- [4] 3GPP TS 36.101: "Evolved Universal Terrestrial Radio Access (E-UTRA); User Equipment (UE) radio transmission and reception"
- [5] 3GPP TS 38.521-3: "NR; User Equipment (UE) conformance specification; Radio transmission and reception; Part 3: Range 1 and Range 2 Interworking operation with other radios"
- [6] Recommendation ITU-R M.1545: "Measurement uncertainty as it applies to test limits for the terrestrial component of International Mobile Telecommunications-2000"
- [7] 3GPP TS 36.211: "E-UTRA; Physical channels and modulation"
- [8] 3GPP TS 36.331: " Evolved Universal Terrestrial Radio Access (E-UTRA); Radio Resource Control (RRC); Protocol specification"
- [9] 3GPP TS 38.331: "NR; Radio Resource Control (RRC) protocol specification"
- [10] 3GPP TS 38.213: "NR; Physical layer procedures for control"
- [11] 3GPP TS 38.306: "NR; User Equipment (UE) radio access capabilities"
- [12] 3GPP TS 38.133: "NR; Requirements for support of radio resource management"
- [13] 3GPP TS 38.211: "NR; Physical channels and modulation".
- [14] 3GPP TS 38.214: "NR; Physical layer procedures for data"

## 3 Definitions, symbols and abbreviations

### 3.1 Definitions

For the purposes of the present document, the terms and definitions given in 3GPP TR 21.905 [1] and the following apply. A term defined in the present document takes precedence over the definition of the same term, if any, in 3GPP TR 21.905 [1].

**Con-current operation:** The simultaneous transmission and reception of sidelink and Uu interfaces while operation is agnostic of the service used on each interface.

### 3.2 Symbols

For the purposes of the present document, the following symbols apply:

$\Delta R_{IB,c}$	Allowed reference sensitivity relaxation due to support for CA or DC operation, for serving cell $c$ .
$\Delta T_{IB,c}$	Allowed maximum configured output power relaxation due to support for CA or DC operation, for serving cell $c$
$BW_{E-UTRA\_Channel}$	Channel bandwidth of E-UTRA carrier
$BW_{E-UTRA\_Channel\_CA}$	Channel bandwidth of E-UTRA sub-block which is composed of intra-band contiguous CA E-UTRA carriers
$BW_{NR\_Channel}$	Channel bandwidth of NR carrier
$BW_{NR\_Channel\_CA}$	Channel bandwidth of NR sub-block which is composed of intra-band contiguous CA NR carriers
$Ceil(x)$	Rounding upwards; $ceil(x)$ is the smallest integer such that $ceil(x) \geq x$
$EN-DC_{ACLR}$	The ratio of the filtered mean power centred on the aggregated sub-block bandwidth ENBW to the filtered mean power centred on an adjacent bandwidth of the same size ENBW
$E-UTRA_{ACLR}$	E-UTRA ACLR
$F_C$	<i>RF reference frequency</i> for the carrier center on the channel raster
$F_{DL\_low}$	The lowest frequency of the downlink <i>operating band</i>
$F_{DL\_high}$	The highest frequency of the downlink <i>operating band</i>
$F_{UL\_low}$	The lowest frequency of the uplink <i>operating band</i>
$F_{UL\_high}$	The highest frequency of the uplink <i>operating band</i>
$F_{OOB}$	The boundary between the NR out of band emission and spurious emission domains
$L_{CRB}$	Transmission bandwidth which represents the length of a contiguous resource block allocation expressed in units of resource blocks
$Max()$	The largest of given numbers
$Min()$	The smallest of given numbers
$NR_{ACLR}$	NR ACLR
$N_{RB}$	Transmission bandwidth configuration, expressed in units of resource blocks
$N_{RB\_agg}$	The number of the aggregated RBs within the fully allocated aggregated channel bandwidth $N_{RB\_agg} = \sum_1^j N_{RB_j} * 2^{\mu_j}$ for carrier 1 to $j$ , where $\mu$ is defined in TS 38.211 [13]
$N_{RB,c}$	The transmission bandwidth configuration of component carrier $c$ , expressed in units of resource blocks $N_{RB,cj} = N_{RB_j} * 2^{\mu_j}$ for carrier $j$ , where $\mu$ is defined in TS 38.211 [13]
$P_{CMAX}$	The configured maximum UE output power
$RB_{start}$	Indicates the lowest RB index of transmitted resource blocks
$W_{gap}$	The sub-block gap between the two sub-blocks

### 3.3 Abbreviations

For the purposes of the present document, the abbreviations given in 3GPP TR 21.905 [1] and the following apply. An abbreviation defined in the present document takes precedence over the definition of the same abbreviation, if any, in 3GPP TR 21.905 [1].

ACLR	Adjacent Channel Leakage Ratio
ACS	Adjacent Channel Selectivity
A-MPR	Additional Maximum Power Reduction
BCS	Bandwidth Combination Set

CA	Carrier Aggregation
CC	Component Carrier
DC	Dual Connectivity
EIRP	Equivalent Isotropically Radiated Power
EN-DC	E-UTRA/NR DC
EVM	Error Vector Magnitude
FDM	Frequency Division Multiplexing
FR	Frequency Range
ENBW	The aggregated bandwidth of an E-UTRA sub-block and an adjacent NR sub-block
ITS	Intelligent Transportation System
ITU-R	Radiocommunication Sector of the International Telecommunication Union
MBW	Measurement bandwidth defined for the protected band
MPR	Allowed maximum power reduction
MSD	Maximum Sensitivity Degradation
MCG	Master Cell Group
NR	New Radio
NS	Network Signalling
NSA	Non-Standalone, a mode of operation where operation of an other radio is assisted with an other radio
OOB	Out-of-band
OOBE	Out-of-band emission
OTA	Over The Air
PRB	Physical Resource Block
PSCCH	Physical Sidelink Control CHannel
PSSCH	Physical Sidelink Shared CHannel
RE	Resource Element
REFSENS	Reference Sensitivity
RF	Radio Frequency
Rx	Receiver
SCG	Secondary Cell Group
SCS	Subcarrier spacing
SEM	Spectrum Emission Mask
SL	Sidelink
SUL	Supplementary uplink
TDM	Time Division Multiplex
Tx	Transmitter
UE	User Equipment
UL MIMO	Up Link Multiple Antenna transmission
ULSUP	Uplink sharing from UE perspective

---

## 4 General

### 4.1 Relationship between minimum requirements and test requirements

The present document is interwork specification for NR UE, covering RF characteristics and minimum performance requirements. Conformance to the present specification is demonstrated by fulfilling the test requirements specified in the conformance specification 3GPP TS 38.521-3 [5].

The Minimum Requirements given in this specification make no allowance for measurement uncertainty. The test specification TS 38.521-3 [5] defines test tolerances. These test tolerances are individually calculated for each test. The test tolerances are used to relax the minimum requirements in this specification to create test requirements. For some requirements, including regulatory requirements, the test tolerance is set to zero.

The measurement results returned by the test system are compared - without any modification - against the test requirements as defined by the shared risk principle.

The shared risk principle is defined in Recommendation ITU-R M.1545 [6].



## 4.2 Applicability of minimum requirements

- a) In this specification the Minimum Requirements are specified as general requirements and additional requirements. Where the Requirement is specified as a general requirement, the requirement is mandated to be met in all scenarios
- b) For specific scenarios for which an additional requirement is specified, in addition to meeting the general requirement, the UE is mandated to meet the additional requirements.
- c) The spurious emissions power requirements are for the long-term average of the power. For the purpose of reducing measurement uncertainty it is acceptable to average the measured power over a period of time sufficient to reduce the uncertainty due to the statistical nature of the signal
- d) Terminal that supports EN-DC configuration shall meet E-UTRA requirements as specified in TS 36.101 [4] and NR requirements as in TS 38.101-1 [2] and TS 38.101-2 [3] unless otherwise specified in this specification
- e) All the requirements for intra-band contiguous and non-contiguous EN-DC apply under the assumption of the same uplink-downlink and special subframe configurations in the E-UTRA and slot format indicated by UL-DL-configurationCommon and UL-DL-configurationDedicated in the NR for the EN-DC.
- f) For EN-DC combinations with CA configurations for E-UTRA and/or NR, all the requirements for E-UTRA and/or NR all the requirements for E-UTRA and/or NR intra-band contiguous and non-contiguous CA apply under the assumption of the same slot format indicated by UL-DL-configurationCommon and UL-DL-configurationDedicated in the PSCell and SCells for NR and the same uplink-downlink and special subframe configurations in Pcell and SCells for E-UTRA.

A terminal which supports an EN-DC configuration shall support:

If any subsets of the EN-DC configuration do not specify its own bandwidth combination sets in 5.3B, then the terminal shall support the same E-UTRA bandwidth combination sets it signals the support for in E-UTRA CA configuration part of E-UTRA – NR DC and shall support the same NR bandwidth combination sets it signals the support for in NR CA configuration part of E-UTRA – NR DC.

Else if one of the subsets of the EN-DC configuration specify its own bandwidth combination sets in 5.3B, then the terminal shall support a product set of channel bandwidth for each band specified by E-UTRA bandwidth combination sets, NR bandwidth combination sets, and EN-DC bandwidth combination sets it signals the support. A terminal which supports an inter-band EN-DC configuration with a certain UL configuration shall support the all lower order DL configurations of the lower order EN-DC combinations, which have this certain UL configuration and the fallbacks of this UL configuration.

A terminal which supports CA or DC configurations, which include FR2 intra-band CA combinations with multiple subblocks, where at least one of the subblocks consists of a contiguous CA combination, is not required to support all possible fallback combinations but can directly fall back to a single FR2 carrier. Deactivating carriers within the CA or DC combination is still possible.

Terminal that supports inter-band NR-DC between FR1 and FR2 configuration shall meet the requirements for corresponding CA configuration (suffix A), unless otherwise specified.

## 4.3 Specification suffix information

Unless stated otherwise the following suffixes are used for indicating at 2<sup>nd</sup> level clause, shown in Table 4.3-1.

**Table 4.3-1: Definition of suffixes**

Clause suffix	Variant
None	Single Carrier
A	Carrier Aggregation (CA) between FR1 and FR2
B	Dual-Connectivity (DC) with and without SUL including UL sharing from UE perspective, inter-band NR DC between FR1 and FR2
D	UL MIMO
E	V2X

## 5 Operating bands and channel arrangement

### 5.1 General

The channel arrangements presented in this clause are based on the operating bands and channel bandwidths defined in the present release of specifications.

NOTE: Other operating bands and channel bandwidths may be considered in future releases.

Requirements throughout the RF specifications are in many cases defined separately for different frequency ranges (FR). The frequency ranges in which NR can operate according to this version of the specifications are identified as described in Table 5.1-1.

**Table 5.1-1: Definition of frequency ranges**

Frequency range designation	Corresponding frequency range
FR1	410 MHz – 7125 MHz
FR2	24250 MHz – 52600 MHz

The present specification covers band combinations including

- at least one FR1 operating band and one FR2 operating band for carrier aggregation and dual connectivity operations;
- at least one E-UTRA operating band for dual connectivity operations.

### 5.2 Operating bands

NR is designed to operate in FR1 operating bands defined in TS 38.101-1 [2] and FR2 operating bands defined in TS 38.101-2 [3]. E-UTRA is designed to operate in operating bands defined in TS 36.101 [4].

#### 5.2A Operating bands for CA

##### 5.2A.1 Inter-band CA between FR1 and FR2

NR carrier aggregation is designed to operate in the operating bands defined in Table 5.2A.1-1 and Table 5.2A.1-2. The band combinations include at least one FR1 operating band and one FR2 operating band.

Operating bands for CA including Band n90 are defined by the corresponding operating bands for CA including Band n41 with Band n90 replacing Band n41. For brevity the said operating bands for CA including Band n90 are not listed in the tables below but are covered by this specification.

**Table 5.2A.1-1: Band combinations for inter-band CA between FR1 and FR2 (two bands)**

NR CA Band	NR Band
CA_n1-n257 <sup>1</sup>	n1, n257
CA_n3-n257 <sup>1</sup>	n3, n257
CA_n5-n260 <sup>1</sup>	n5, n260
CA_n5-n261 <sup>1</sup>	n5, n261
CA_n8-n258	n8, n258
CA_n25-n260 <sup>1</sup>	n25, n260
CA_n25-n261 <sup>1</sup>	n25, n261
CA_n28-n257 <sup>1</sup>	n28, n257
CA_n41-n260 <sup>1</sup>	n41, n260
CA_n41-n261 <sup>1</sup>	n41, n261
CA_n66-n260	n66, n260
CA_n66-n261	n66, n261
CA_n71-n257 <sup>1</sup>	n71, n257
CA_n71-n260 <sup>1</sup>	n71, n260
CA_n71-n261 <sup>1</sup>	n71, n261
CA_n77-n257 <sup>1</sup>	n77, n257
CA_n77-n258 <sup>1</sup>	n77, n258
CA_n77-n261 <sup>1</sup>	n77, n261
CA_n78-n257 <sup>1</sup>	n78, n257
CA_n78-n258 <sup>1</sup>	n78, n258
CA_n79-n257 <sup>1</sup>	n79, n257
CA_n79-n258 <sup>1</sup>	n79, n258
NOTE 1: Applicable for UE supporting inter-band carrier aggregation with mandatory simultaneous Rx/Tx capability.	

**Table 5.2A.1-2: Band combinations for inter-band CA between FR1 and FR2 (three bands)**

NR CA Band	NR Band
CA_n1-n78-n257	n1, n78, n257
CA_n3-n28-n257	n3, n28, n257
CA_n3-n77-n257	n3, n77, n257
CA_n3-n78-n257	n3, n78, n257
CA_n28-n77-n257	n28, n77, n257
CA_n28-n78-n257	n28, n78, n257
CA_n77-n79-n257	n77, n79, n257
CA_n78-n79-n257	n78, n79, n257

**Table 5.2A.1-3: Band combinations for inter-band CA between FR1 and FR2 (four bands)**

NR CA Band	NR Band
CA_n3-n28-n77-n257	n3, n28, n77, n257
CA_n3-n28-n78-n257	n3, n28, n78, n257

## 5.2B Operating bands for DC

### 5.2B.1 General

The operating bands are specified in clause 5.5B for operation with EN-DC, NGEN-DC, NE-DC or NR-DC configured.

### 5.2B.2 Void

### 5.2B.3 Void

### 5.2B.4 Void

### 5.2B.5 Void

### 5.2B.6 Void

### 5.2B.7 Void

## 5.2C Operating bands for V2X

### 5.2C.1 Intra-band V2X bands

NR V2X operation is designed to operate concurrent with E-UTRA uplink/downlink or sidelink on the operating bands combinations listed in Table 5.2C.1-1.

**Table 5.2C.1-1: Intra-band V2X operating bands**

V2X con-current operating band	E-UTRA or NR Band	Interface
V2X_47_n47 <sup>1</sup>	47	PC5
	n47	PC5
NOTE 1: Only single switched SL is supported.		

### 5.2C.2 Inter-band V2X bands

NR V2X operation is designed to operate concurrent with E-UTRA uplink/downlink on the operating bands combinations listed in Table 5.2C.2-1.

**Table 5.2C.2-1: Inter-band con-current V2X operating bands**

E-UTRA-NR V2X Band Combination	E-UTRA or NR Band	Interface
V2X_20_n38	20	Uu
	n38	PC5
V2X_n71_47	47	PC5
	n71	Uu
V2X_n71_(n) 47 <sup>1</sup>	47	PC5
	n47	PC5
	n71	Uu
NOTE 1: Only single switched SL in ITS band is supported.		

## 5.3 UE Channel bandwidth

### 5.3A UE Channel bandwidth for CA

#### 5.3A.1 Inter-band CA between FR1 and FR2

For inter-band NR CA between FR1 and FR2, a carrier aggregation configuration is a combination of operating bands, each supporting a carrier aggregation bandwidth class as specified in clause 5.3A.5 of TS 38.101-1 [2] and clause 5.3A.4 of TS 38.101-2 [3] independently.

#### 5.3B UE Channel bandwidth for EN-DC

For intra-band contiguous EN-DC, the aggregated channel bandwidth is sum of the individual NR and E-UTRA channel bandwidths assuming nominal EN-DC channel with 0 kHz offset spacing as specified in clause 5.4.

$$ENBW = BW_{NR\_Channel} + BW_{E-UTRA\_Channel}$$

In the case where the NR sub-block and/or the E-UTRA sub-block itself is composed of intra-band contiguous CA carriers, the EN-DC aggregated channel bandwidth is the sum of the aggregated channel bandwidths of the NR and E-UTRA sub-blocks assuming nominal EN-DC channel spacing between the NR sub-block and E-UTRA sub-block.

$$ENBW = BW_{NR\_Channel\_CA} + BW_{E-UTRA\_Channel\_CA}$$

For NR inter-band dual connectivity specified in 5.5B.7, the corresponding NR CA configurations in 5.5A.1, i.e., dual uplink inter-band carrier aggregation between FR1 and FR2 with uplink assigned to two NR bands, are applicable to Dual Connectivity.

NOTE 1: Requirements for the dual connectivity configurations are defined in the clause corresponding NR uplink CA between FR1 and FR2 configurations, unless otherwise specified.

Intra-band contiguous EN-DC configurations are defined using intra-band contiguous EN-DC bandwidth class notation DC\_(n)Xyz where the first EN-DC bandwidth class letter y indicates the number of contiguous E-UTRA carriers and the second EN-DC bandwidth class letter z indicates the number of contiguous NR carriers for the EN-DC combination of E-UTRA Band X and NR Band nX. Applicable contiguous intraband EN-DC bandwidth classes are listed in Table 5.3.B-1.

**Table 5.3.B-1: Intra-band contiguous EN-DC bandwidth classes**

Intra-band contiguous EN-DC bandwidth class	Number of contiguous CC	
	E-UTRA	NR
AA	1	1
CA	2	1
DA	3	1

The UE channel bandwidths for band combinations including Band n41 also apply for the corresponding band combinations with Band n90 replacing Band n41 but with otherwise identical parameters. For brevity the said UE channel bandwidths for band combinations with Band n90 are not listed in the tables below but are covered by this specification.

## 5.3B.1 Intra-band EN-DC in FR1

### 5.3B.1.1 General

The requirements for intra-band EN-DC in this specification are defined for EN-DC configurations with associated bandwidth combination sets.

For each EN-DC configuration, requirements are specified for all bandwidth combinations contained in a *bandwidth combination set*, which is indicated per supported band combination in the UE radio access capability. A UE can indicate support of several bandwidth combination sets per band combination.

### 5.3B.1.2 BCS for Intra-band contiguous EN-DC

For intra-band contiguous EN-DC, an EN-DC configuration is a single operating band supporting an intra-band contiguous EN-DC bandwidth class.

Bandwidth combination sets for intra-band contiguous EN-DC are specified in Table 5.3B.1.2-1.

**Table 5.3B.1.2-1: EN-DC configurations and bandwidth combination sets defined for intra-band contiguous EN-DC**

E-UTRA – NR configuration / Bandwidth combination set						
Downlink EN-DC configuration	Uplink EN-DC configurations	Component carriers in order of increasing carrier frequency			Maximum aggregated bandwidth (MHz)	Bandwidth combination set
		Channel bandwidths for E-UTRA carrier (MHz)	Channel bandwidths for NR carrier (MHz)	Channel bandwidths for E-UTRA carrier (MHz)		
DC_(n)5AA	DC_(n)5AA <sup>4</sup>	5, 10	5, 10, 15, 20		25	0
			5, 10, 15, 20	5, 10		
DC_(n)12AA	DC_(n)12AA <sup>4</sup>	5, 10	5, 10		15	0
			5, 10	5, 10		
DC_(n)38AA	DC_(n)38AA <sup>4</sup>	5, 10, 15, 20	5, 10, 15, 20, 40		50	0
			5, 10, 15, 20, 40	5, 10, 15, 20		
DC_(n)41AA	DC_(n)41AA	20	40, 60, 80,100		120	0
			40, 60, 80,100	20		
		20	40, 50, 60, 80,100		120	1
			40, 50, 60, 80,100	20		
		20	10, 20, 30, 40, 50, 60, 80,100		120	2
			10, 20, 30, 40, 50, 60, 80,100	20		
		10	20, 30, 40, 50, 60, 80,100			
			20, 30, 40, 50, 60, 80,100	10		
DC_(n)41AB	DC_(n)41AA, DC_41A_n41A	10	20+20		70	0
			20+20	10		
		20	10+20			
			10+20	20		

E-UTRA – NR configuration / Bandwidth combination set						
Downlink EN-DC configuration	Uplink EN-DC configurations	Component carriers in order of increasing carrier frequency			Maximum aggregated bandwidth (MHz)	Bandwidth combination set
		Channel bandwidths for E-UTRA carrier (MHz)	Channel bandwidths for NR carrier (MHz)	Channel bandwidths for E-UTRA carrier (MHz)		
		20	20+30	20		
DC_(n)41CA	DC_(n)41AA <sup>1</sup> , DC_41A_n41A <sup>2</sup>	20+20	40, 60, 80,100		140	0
			40, 60, 80,100	20+20		
		20+20	40, 50, 60, 80,100		140	1
			40, 50, 60, 80,100	20+20		
		20+20	10, 20, 30, 40, 50, 60, 80,100		140	2
			10, 20, 30, 40, 50, 60, 80,100	20+20		
		10+20	10, 20, 30, 40, 50, 60, 80,100			
DC_(n)41DA	DC_(n)41AA <sup>1</sup> , DC_41A_n41A <sup>2</sup>	20+20+20	40, 60, 80,100		160	0
			40, 60, 80,100	20+20+20		
		20+20+20	40, 50, 60, 80,100		160	1
			40, 50, 60, 80,100	20+20+20		
		20+20+20	30, 40, 50, 60, 80,100		160	2
			30, 40, 50, 60, 80,100	20+20+20		
		20+20+15	30, 40, 50, 60, 80,100			
DC_(n)48AA <sup>5</sup>	DC_(n)48AA <sup>4</sup>	5, 10, 15, 20	5, 10, 15, 20, 40		60	0
			5, 10, 15, 20, 40	5, 10, 15, 20		
DC_(n)48CA <sup>5</sup>	DC_(n)48AA <sup>4</sup> , DC_48A_n48A <sup>4</sup>	See CA_48C Bandwidth Combination Set 0 in TS 36.101 Table 5.6A.1-1	5, 10, 15, 20, 40		80	0
			5, 10, 15, 20, 40	See CA_48C Bandwidth Combination Set 0 in TS 36.101 Table 5.6A.1-1		
DC_(n)48DA <sup>5</sup>	DC_(n)48AA <sup>4</sup> , DC_48A_n48A <sup>4</sup>	See CA_48D Bandwidth Combination Set 0 in TS 36.101 Table 5.6A.1-1	5, 10, 15, 20, 40		100	0
			5, 10, 15, 20, 40	See CA_48D Bandwidth Combination Set 0 in TS 36.101 Table 5.6A.1-1		

E-UTRA – NR configuration / Bandwidth combination set							
Downlink EN-DC configuration	Uplink EN-DC configurations	Component carriers in order of increasing carrier frequency			Maximum aggregated bandwidth (MHz)	Bandwidth combination set	
		Channel bandwidths for E-UTRA carrier (MHz)	Channel bandwidths for NR carrier (MHz)	Channel bandwidths for E-UTRA carrier (MHz)			
DC_(n)71AA	DC_(n)71AA <sup>3</sup>	15	5		20	0	
		10	5, 10				
		5	5, 10, 15				
			5	15			
			5, 10	10			
			5, 10, 15	5			
			5	5,10,15,20		25 <sup>3</sup>	1
			10	5,10,15			
			15	5,10			
				5,10,15,20	5		
				5,10,15	10		
				5,10	15		

NOTE 1: Void  
 NOTE 2: Void  
 NOTE 3: For maximum DL aggregated bandwidth of 25 MHz the asymmetric UL and DL channel bandwidth combination of Table 5.3.6-1 in TS 38.101-1 [2] is used with a maximum UL contiguous aggregated bandwidth of 20 MHz. Furthermore, a restriction is imposed on bandwidth combinations so that only a subset of BCS1 is allowed to be used on the uplink, and this subset is equivalent to BCS0.  
 NOTE4: Only single switched UL is supported.  
 NOTE5: The minimum requirements only apply for non-simultaneous Tx/Rx between all carriers.

### 5.3B.1.3 BCS for Intra-band non-contiguous EN-DC

For intra-band non-contiguous EN-DC, an EN-DC configuration is a single operating band supporting E-UTRA and NR carriers, where E-UTRA configuration is indicated by using E-UTRA CA bandwidth class as defined in TS 36.101 [4] and NR configuration is indicated by using NR CA bandwidth class as defined in TS 38.101-1 [2].

Requirements for intra-band non-contiguous EN-DC are defined for the EN-DC configurations and bandwidth combination sets specified in Table 5.3B.1.3-1.



**Table 5.3B.1.3-1: EN-DC configurations and bandwidth combination sets defined for intra-band non-contiguous EN-DC**

E-UTRA – NR configuration / Bandwidth combination set						
Downlink EN-DC configuration	Uplink EN-DC configurations	Component carriers in order of increasing carrier frequency			Maximum aggregated bandwidth (MHz)	Bandwidth combination set
		Channel bandwidths for E-UTRA carrier (MHz)	Channel bandwidths for NR carrier (MHz)	Channel bandwidths for E-UTRA carrier (MHz)		
DC_2A_n2A	DC_2A_n2A <sup>2</sup>	5, 10, 15, 20	5, 10, 15, 20		40	0
DC_3A_n3A	DC_3A_n3A <sup>(1)</sup>		5, 10, 15, 20, 25, 30	5, 10, 15, 20	50	0
			5, 10, 15, 20, 25, 30	5, 10, 15, 20	50	1
		5, 10, 15, 20	5, 10, 15, 20, 25, 30			
DC_5A_n5A	DC_5A_n5A <sup>2</sup>	5, 10	5, 10, 15		20	0
DC_7A_n7A <sup>3</sup>	DC_7A_n7A <sup>2</sup>	5, 10, 15, 20	5, 10, 15, 20		40	0
DC_41A_n41A	DC_41A_n41A	20	40, 60, 80, 100		120	0
			40, 60, 80, 100	20		
		20	40, 50, 60, 80, 100		120	1
			40, 50, 60, 80, 100	20		
		20	10, 20, 30, 40, 50, 60, 80, 100		120	2
			10, 20, 30, 40, 50, 60, 80, 100	20		
		10	20, 30, 40, 50, 60, 80, 100			
			20, 30, 40, 50, 60, 80, 100	10		
DC_41C_n41A	DC_41A_n41A	20+20	40, 60, 80, 100		140	0
			40, 60, 80, 100	20+20		
		20+20	40, 50, 60, 80, 100		140	1
			40, 50, 60, 80, 100	20+20		
DC_41D_n41A	DC_41A_n41A	20+20+20	40, 60, 80, 100		160	0
			40, 60, 80, 100	20+20+20		
		20+20+20	40, 50, 60, 80, 100		160	1
			40, 50, 60, 80, 100	20+20+20		
DC_48A_n48A <sup>4</sup>	DC_48A_n48A <sup>2</sup>	5, 10, 15, 20	5, 10, 15, 20, 40		60	0
			5, 10, 15, 20, 40	5, 10, 15, 20		
DC_48A_(n)48AA <sup>4</sup>	DC_(n)48AA <sup>2</sup> DC_48A_n48A <sup>2</sup>	See CA_48A-48A Bandwidth Combination Set 0 in TS 36.101 Table 5.6A.1-3	5, 10, 15, 20, 40		80	0

			5, 10, 15, 20, 40	See CA_48A-48A Bandwidth Combination Set 0 in TS 36.101 Table 5.6A.1-3		
DC_48A-48A_n48A <sup>4</sup>	DC_48A_n48A <sup>2</sup>	See CA_48A-48A Bandwidth Combination Set 0 in TS 36.101 Table 5.6A.1-3	5, 10, 15, 20, 40		80	0
			5, 10, 15, 20, 40	See CA_48A-48A Bandwidth Combination Set 0 in TS 36.101 Table 5.6A.1-3		
DC_48C_n48A <sup>4</sup>	DC_48A_n48A <sup>2</sup>	See CA_48C Bandwidth Combination Set 0 in TS 36.101 Table 5.6A.1-1	5, 10, 15, 20, 40		80	0
			5, 10, 15, 20, 40	See CA_48C Bandwidth Combination Set 0 in TS 36.101 Table 5.6A.1-1		
DC_48D_n48A <sup>4</sup>	DC_48A_n48A <sup>2</sup>	See CA_48D Bandwidth Combination Set 0 in TS 36.101 Table 5.6A.1-1	5, 10, 15, 20, 40		100	0
			5, 10, 15, 20, 40	See CA_48D Bandwidth Combination Set 0 in TS 36.101 Table 5.6A.1-1		
DC_66A_n66A	DC_66A_n66A <sup>2</sup>	5, 10, 15, 20	5, 10, 15, 20, 40		50	0

NOTE 1: Only single switched UL is supported in Rel.15.

NOTE 2: Only single switched UL is supported.

NOTE 3: Requirements in this specification apply for NR SCS of 15 kHz only.

NOTE 4: The minimum requirements only apply for non-simultaneous Tx/Rx between all carriers.

5.3C Void

5.3D Void

5.3E UE Channel bandwidth for V2X

The requirements specified in clause 5.3B are applicable to NR V2X UE.

### 5.3E.1 Intra-band contiguous V2X in FR1

For intra-band contiguous E-UTRA NR V2X UE, an EN-DC bandwidth class in Table 5.3.B-1 are considered to specify the V2X transmission/reception configurations.

Bandwidth combination sets and V2X transmission/reception configurations for intra-band contiguous V2X UE are specified in Table 5.3E.1-1.

**Table 5.3E.1-1: E-UTRA-NR V2X configurations and bandwidth combination sets for intra-band contiguous V2X UE**

V2X configuration	SL transmissison band	Channel bandwidths for E-UTRA carrier (MHz)	Channel bandwidths for NR carrier (MHz)	Maximum aggregated bandwidth (MHz)	Bandwidth combination set
V2X_(n)47AA	E-UTRA Band 47 or NR band n47	10	10,20,30,40	60	0
		20	10,20,30,40		

### 5.3E.2 Intra-band non-contiguous V2X in FR1

For intra-band non-contiguous E-UTRA NR V2X UE, an EN-DC bandwidth class in Table 5.3.B-1 are considered to specify the V2X transmission/reception configurations.

Bandwidth combination sets and SL transmission/reception configurations for intra-band non-contiguous V2X are specified in Table 5.3E.2-1.

**Table 5.3E.2-1: E-UTRA-NR V2X configurations and bandwidth combination sets for intra-band non-contiguous V2X UE**

V2X configuration	SL transmissison band	Channel bandwidths for E-UTRA carrier (MHz)	Channel bandwidths for NR carrier (MHz)	Maximum aggregated bandwidth (MHz)	Bandwidth combination set
V2X_47A_n47A	E-UTRA Band 47 or NR band n47	10	10,20,30,40	60	0
		20	10,20,30,40		

### 5.3E.3 Inter-band V2X in FR1

For inter-band E-UTRA NR V2X UE, the each channel bandwidth for inter-band V2X operations in FR1 is specified in TS 36.101 [4] and TS 38.101-1 [2], respectively.

## 5.4 Void

### 5.4A Channel arrangement for CA

The channel arrangement for CA operations in FR1 and FR2 as specified in TS 38.101-1 [2] and TS 38.101-2 [3], respectively.

### 5.4B Channel arrangement for DC

The channel arrangement for intra-band EN-DC operations in FR1 is specified in TS 36.101 [4] and TS 38.101-1 [2], respectively.

### 5.4B.1 Channel spacing for intra-band EN-DC carriers

The spacing between carriers will depend on the deployment scenario, the size of the frequency block available and the channel bandwidths. The nominal channel spacing between an E-UTRA carrier and an adjacent NR carrier for intra-band contiguous EN-DC is defined as following:

- For NR operating bands with 100 kHz channel raster,

$$\text{Nominal Channel spacing} = (BW_{\text{E-UTRA\_Channel}} + BW_{\text{NR\_Channel}})/2$$

- For NR operating bands with 15 kHz channel raster,
  - Nominal Channel spacing =  $(BW_{\text{E-UTRA\_Channel}} + BW_{\text{NR\_Channel}})/2 + \{-5\text{kHz}, 0\text{kHz}, 5\text{kHz}\}$  for  $\Delta F_{\text{Raster}}$  equals to 15 kHz
  - Nominal Channel spacing =  $(BW_{\text{E-UTRA\_Channel}} + BW_{\text{NR\_Channel}})/2 + \{-10\text{ kHz}, 0\text{ kHz}, 10\text{ kHz}\}$  for  $\Delta F_{\text{Raster}}$  equals to 30 kHz

where  $BW_{\text{E-UTRA\_Channel}}$  and  $BW_{\text{NR\_Channel}}$  are the channel bandwidths of the E-UTRA and NR carriers,  $\Delta F_{\text{Raster}}$  is the band dependent channel raster granularity defined in TS38.101-1[2]. The channel spacing can be adjusted depending on the channel raster to optimize performance in a particular deployment scenario.

For intra-band non-contiguous EN-DC the channel spacing between E-UTRA and NR carriers shall be larger than the nominal channel spacing defined in this clause

## 5.5 Configuration

### 5.5A Configuration for CA

#### 5.5A.1 Inter-band CA configurations between FR1 and FR2

The configurations for operating bands for CA including Band n41 also apply for the corresponding operating bands for CA with Band n90 replacing Band n41 but with otherwise identical parameters. For brevity the said configuration for operating bands for CA with Band n90 are not listed in the tables below but are covered by this specification.

**Table 5.5A.1-1: Inter-band CA configurations and bandwidth combinations sets between FR1 and FR2 (two bands)**

NR CA configuration	Uplink CA configuration	NR Band	SCS (kHz)	5 MHz	10 MHz	15 MHz	20 MHz	25 MHz	30 MHz	40 MHz	50 MHz	60 MHz	70 MHz	80 MHz	90 MHz	100 MHz	200 MHz	400 MHz	Band width combination set
CA_n1A-n257A	CA_n1A-n257A	n1	15	Yes	Yes	Yes	Yes												0
			30		Yes	Yes	Yes												
			60		Yes	Yes	Yes												
		n257	60								Yes					Yes	Yes		
			120								Yes					Yes	Yes	Yes	
CA_n3A-n257A	CA_n3A-n257A	n3	15	Yes	Yes	Yes	Yes	Yes	Yes										0
			30		Yes	Yes	Yes	Yes	Yes										
			60		Yes	Yes	Yes	Yes	Yes										
		n257	60								Yes					Yes	Yes		
			120								Yes					Yes	Yes	Yes	
CA_n3A-n257D	CA_n3A-n257A, CA_n3A-n257D	n3	15	Yes	Yes	Yes	Yes	Yes	Yes										0
			30		Yes	Yes	Yes	Yes	Yes										
			60		Yes	Yes	Yes	Yes	Yes										
		n257	CA_n257D																
CA_n3A-n257G	CA_n3A-n257A, CA_n3A-n257G	n3	15	Yes	Yes	Yes	Yes	Yes	Yes										0
			30		Yes	Yes	Yes	Yes	Yes										
			60		Yes	Yes	Yes	Yes	Yes										
		n257	CA_n257G																
CA_n3A-n257H	CA_n3A-n257A, CA_n3A-n257G, CA_n3A-n257H	n3	15	Yes	Yes	Yes	Yes	Yes	Yes										0
			30		Yes	Yes	Yes	Yes	Yes										
			60		Yes	Yes	Yes	Yes	Yes										
		n257	CA_n257H																
CA_n3A-n257I	CA_n3A-n257A, CA_n3A-n257G, CA_n3A-n257H, CA_n3A-n257I	n3	15	Yes	Yes	Yes	Yes	Yes	Yes										0
			30		Yes	Yes	Yes	Yes	Yes										
			60		Yes	Yes	Yes	Yes	Yes										
		n257	CA_n257I																
CA_n5A-n260A	CA_n5A-n260A	n5	15	Yes	Yes	Yes	Yes												0
			30		Yes	Yes	Yes												
			60																
		n260	60								Yes					Yes	Yes		
			120								Yes					Yes	Yes	Yes	
CA_n5A-n260(2A)	CA_n5A-n260A	n5	15	Yes	Yes	Yes	Yes											0	
			30		Yes	Yes	Yes												
			60																
		n260	CA_n260(2A)																



NR CA configuration	Uplink CA configuration	NR Band	SCS (kHz)	5 MHz	10 MHz	15 MHz	20 MHz	25 MHz	30 MHz	40 MHz	50 MHz	60 MHz	70 MHz	80 MHz	90 MHz	100 MHz	200 MHz	400 MHz	Band width combination set		
CA_n5A-n260(3A)	CA_n5A-n260A	n5	15	Yes	Yes	Yes	Yes													0	
			30		Yes	Yes	Yes														
			60																		
		n260	CA_n260(3A)																		
CA_n5A-n260(4A)	CA_n5A-n260A	n5	15	Yes	Yes	Yes	Yes													0	
			30		Yes	Yes	Yes														
			60																		
		n260	CA_n260(4A)																		
CA_n5A-n260(5A)	CA_n5A-n260A	n5	15	Yes	Yes	Yes	Yes													0	
			30		Yes	Yes	Yes														
			60																		
		n260	CA_n260(5A)																		
CA_n5A-n260(6A)	CA_n5A-n260A	n5	15	Yes	Yes	Yes	Yes													0	
			30		Yes	Yes	Yes														
			60																		
		n260	CA_n260(6A)																		
CA_n5A-n260(7A)	CA_n5A-n260A	n5	15	Yes	Yes	Yes	Yes													0	
			30		Yes	Yes	Yes														
			60																		
		n260	CA_n260(7A)																		
CA_n5A-n260(8A)	CA_n5A-n260A	n5	15	Yes	Yes	Yes	Yes													0	
			30		Yes	Yes	Yes														
			60																		
		n260	CA_n260(8A)																		
CA_n5A-n261A	CA_n5A-n261A	n5	15	Yes	Yes	Yes	Yes													0	
			30		Yes	Yes	Yes														
			60																		
		120									Yes						Yes	Yes	Yes		
		n261	CA_n261(2A)																		
CA_n5A-n261(2A)	CA_n5A-n261A	n5	15	Yes	Yes	Yes	Yes													0	
			30		Yes	Yes	Yes														
			60																		
		n261	CA_n261(2A)																		
CA_n5A-n261(3A)	CA_n5A-n261A	n5	15	Yes	Yes	Yes	Yes													0	
			30		Yes	Yes	Yes														
			60																		
		n261	CA_n261(3A)																		
CA_n5A-n261(4A)	CA_n5A-n261A	n5	15	Yes	Yes	Yes	Yes													0	
			30		Yes	Yes	Yes														
			60																		

NR CA configuration	Uplink CA configuration	NR Band	SCS (kHz)	5 MHz	10 MHz	15 MHz	20 MHz	25 MHz	30 MHz	40 MHz	50 MHz	60 MHz	70 MHz	80 MHz	90 MHz	100 MHz	200 MHz	400 MHz	Band width combination set	
		n261	CA_n261(4A)																	
CA_n5A-n261G	CA_n5A-n261A, CA_n5A-n261G	n5	15	Yes	Yes	Yes	Yes													0
			30		Yes	Yes	Yes													
			60																	
		n261	CA_n261G																	
CA_n5A-n261H	CA_n5A-n261A, CA_n5A-n261G, CA_n5A-n261H	n5	15	Yes	Yes	Yes	Yes													0
			30		Yes	Yes	Yes													
			60																	
		n261	CA_n261H																	
CA_n5A-n261I	CA_n5A-n261A, CA_n5A-n261G, CA_n5A-n261H, CA_n5A-n261I	n5	15	Yes	Yes	Yes	Yes													0
			30		Yes	Yes	Yes													
			60																	
		n261	CA_n261I																	
CA_n5A-n261J	CA_n5A-n261A, CA_n5A-n261G, CA_n5A-n261H, CA_5A_n261I	n5	15	Yes	Yes	Yes	Yes													0
			30		Yes	Yes	Yes													
			60																	
		n261	CA_n261J																	
CA_n5A-n261K	CA_n5A-n261A, CA_n5A-n261G, CA_n5A-n261H, CA_n5A-n261I	n5	15	Yes	Yes	Yes	Yes													0
			30		Yes	Yes	Yes													
			60																	
		n261	CA_n261J																	
CA_n5A-n261L		n5	15	Yes	Yes	Yes	Yes													0
			30		Yes	Yes	Yes													
			60																	

NR CA configuration	Uplink CA configuration	NR Band	SCS (kHz)	5 MHz	10 MHz	15 MHz	20 MHz	25 MHz	30 MHz	40 MHz	50 MHz	60 MHz	70 MHz	80 MHz	90 MHz	100 MHz	200 MHz	400 MHz	Band width combination set
	CA_n5A-n261A CA_n5A_n261G CA_n5A_n261H CA_n5A_n261L	n261	CA_n261L																
CA_n5A-n261M	CA_n5A-n261A, CA_n5A-n261G, CA_n5A-n261H, CA_n5A-n261L	n5	15	Yes	Yes	Yes	Yes												
			30		Yes	Yes	Yes												
		n261	CA_n261M																0
CA_n8A-n258A	CA_n8A-n258A	n8	15	Yes	Yes	Yes	Yes												
			30		Yes	Yes	Yes												
		n258	60								Yes					Yes	Yes		
			120								Yes					Yes	Yes	Yes	
CA_n25A-n260A	-	n25	15	Yes	Yes	Yes	Yes												
			30		Yes	Yes	Yes												
		n260	60		Yes	Yes	Yes				Yes					Yes	Yes		
			120								Yes					Yes	Yes	Yes	
CA_n25A-n260(2A)	-	n25	15	Yes	Yes	Yes	Yes												
			30		Yes	Yes	Yes												
		n260	60		Yes	Yes	Yes												
			CA_n260(2A)																
CA_n25A-n260(3A)	-	n25	15	Yes	Yes	Yes	Yes												
			30		Yes	Yes	Yes												
		n260	60		Yes	Yes	Yes												
			CA_n260(3A)																
CA_n25A-n260(4A)	-	n25	15	Yes	Yes	Yes	Yes												
			30		Yes	Yes	Yes												
		n260	60		Yes	Yes	Yes												
			CA_n260(4A)																
CA_n25A-n261A	-	n25	15	Yes	Yes	Yes	Yes												
			30		Yes	Yes	Yes												
			60		Yes	Yes	Yes												

NR CA configuration	Uplink CA configuration	NR Band	SCS (kHz)	5 MHz	10 MHz	15 MHz	20 MHz	25 MHz	30 MHz	40 MHz	50 MHz	60 MHz	70 MHz	80 MHz	90 MHz	100 MHz	200 MHz	400 MHz	Band width combination set	
		n261	60								Yes					Yes	Yes			
			120								Yes					Yes	Yes	Yes		
CA_n25A-n261(2A)	-	n25	15	Yes	Yes	Yes	Yes													
			30		Yes	Yes	Yes													
			60		Yes	Yes	Yes													
		n261	CA_n261(2A)																	
CA_n28A-n257A	CA_n28A-n257A	n28	15	Yes	Yes	Yes	Yes													
			30		Yes	Yes	Yes													
			60																	
CA_n28A-n257D	CA_n28A-n257A, CA_n28A-n257D	n28	60								Yes					Yes	Yes			
			120							Yes					Yes	Yes	Yes			
			CA_n257D																	
CA_n28A-n257G	CA_n28A-n257A, CA_n28A-n257G	n28	15	Yes	Yes	Yes	Yes													
			30		Yes	Yes	Yes													
			60																	
		n257	CA_n257G																	
CA_n28A-n257H	CA_n28A-n257A, CA_n28A-n257G, CA_n28A-n257H	n28	15	Yes	Yes	Yes	Yes													
			30		Yes	Yes	Yes													
			60																	
		n257	CA_n257H																	
CA_n28A-n257I	CA_n28A-n257A, CA_n28A-n257G, CA_n28A-n257H, CA_n28A-n257I	n28	15	Yes	Yes	Yes	Yes													
			30		Yes	Yes	Yes													
			60																	
		n257	CA_n257I																	
CA_n41A-n260A	-	n41	15		Yes	Yes	Yes			Yes	Yes									
			30		Yes	Yes	Yes			Yes	Yes	Yes		Yes	Yes	Yes				
			60		Yes	Yes	Yes			Yes	Yes	Yes		Yes	Yes	Yes				
		n260	60							Yes						Yes	Yes			
			120							Yes						Yes	Yes	Yes		
CA_n41A-n260(2A)	-	n41	15		Yes	Yes	Yes			Yes	Yes									
			30		Yes	Yes	Yes			Yes	Yes	Yes		Yes	Yes	Yes				
			60		Yes	Yes	Yes			Yes	Yes	Yes		Yes	Yes	Yes				

NR CA configuration	Uplink CA configuration	NR Band	SCS (kHz)	5 MHz	10 MHz	15 MHz	20 MHz	25 MHz	30 MHz	40 MHz	50 MHz	60 MHz	70 MHz	80 MHz	90 MHz	100 MHz	200 MHz	400 MHz	Band width combination set	
		n260	CA_n260(2A)																	
CA_n41A-n260(3A)	-	n41	15		Yes	Yes	Yes			Yes	Yes									0
			30		Yes	Yes	Yes			Yes	Yes	Yes		Yes	Yes	Yes				
			60		Yes	Yes	Yes			Yes	Yes	Yes		Yes	Yes	Yes				
		n260	CA_n260(3A)																	
CA_n41A-n260(4A)	-	n41	15		Yes	Yes	Yes			Yes	Yes									0
			30		Yes	Yes	Yes			Yes	Yes	Yes		Yes	Yes	Yes				
			60		Yes	Yes	Yes			Yes	Yes	Yes		Yes	Yes	Yes				
		n260	CA_n260(4A)																	
CA_n41C-n260A	-	n41	CA_n41C																0	
		n260	60								Yes						Yes	Yes		
		n260	120							Yes						Yes	Yes	Yes		
CA_n41C-n260(2A)	-	n41	CA_n41C																0	
		n260	CA_n260(2A)																	
CA_n41(2A)-n260A	-	n41	CA_n41(2A) BCS1																0	
		n260	60								Yes						Yes	Yes		
		n260	120							Yes						Yes	Yes	Yes		
CA_n41(2A)-n260(2A)	-	n41	CA_n41(2A) BCS1																0	
		n260	CA_n260(2A)																	
CA_n41A-n261A	-	n41	15		Yes	Yes	Yes			Yes	Yes									0
			30		Yes	Yes	Yes			Yes	Yes	Yes		Yes	Yes	Yes				
			60		Yes	Yes	Yes			Yes	Yes	Yes		Yes	Yes	Yes				
		n261	60							Yes						Yes	Yes			
		n261	120							Yes					Yes	Yes	Yes			
CA_n41A-n261(2A)	-	n41	15		Yes	Yes	Yes			Yes	Yes									0
			30		Yes	Yes	Yes			Yes	Yes	Yes		Yes	Yes	Yes				
			60		Yes	Yes	Yes			Yes	Yes	Yes		Yes	Yes	Yes				
		n261	CA_n261(2A)																	
CA_n41C-n261A	-	n41	CA_n41C																0	
		n261	60								Yes						Yes	Yes		
		n261	120							Yes						Yes	Yes	Yes		
CA_n41(2A)-n261A	-	n41	CA_n41(2A) BCS1																0	
		n261	60								Yes						Yes	Yes		Yes
		n261	120							Yes						Yes	Yes			
CA_n41C-n261(2A)	-	n41	CA_n41C																0	
		n261	CA_n261(2A)																	
CA_n41(2A)-n261(2A)	-	n41	CA_n41(2A) BCS1																0	
		n261	CA_n261(2A)																	
		n66	15	Yes	Yes	Yes	Yes			Yes									0	

NR CA configuration	Uplink CA configuration	NR Band	SCS (kHz)	5 MHz	10 MHz	15 MHz	20 MHz	25 MHz	30 MHz	40 MHz	50 MHz	60 MHz	70 MHz	80 MHz	90 MHz	100 MHz	200 MHz	400 MHz	Band width combination set	
CA_n66A-n260A	CA_n66A-n260A	n260	30		Yes	Yes	Yes			Yes										
			60		Yes	Yes	Yes			Yes										
CA_n66A-n260(2A)	CA_n66A-n260A	n66	15	Yes	Yes	Yes	Yes			Yes										0
			30		Yes	Yes	Yes			Yes										
			60		Yes	Yes	Yes			Yes										
		n260									Yes					Yes	Yes			
										Yes					Yes	Yes	Yes			
CA_n66A-n260(3A)	CA_n66A-n260A	n66	15	Yes	Yes	Yes	Yes			Yes										0
			30		Yes	Yes	Yes			Yes										
			60		Yes	Yes	Yes			Yes										
		n260																		
CA_n66A-n260(4A)	CA_n66A-n260A	n66	15	Yes	Yes	Yes	Yes			Yes										0
			30		Yes	Yes	Yes			Yes										
			60		Yes	Yes	Yes			Yes										
		n260																		
CA_n66A-n260(5A)	CA_n66A-n260A	n66	15	Yes	Yes	Yes	Yes			Yes										0
			30		Yes	Yes	Yes			Yes										
			60		Yes	Yes	Yes			Yes										
		n260																		
CA_n66A-n260(6A)	CA_n66A-n260A	n66	15	Yes	Yes	Yes	Yes			Yes										0
			30		Yes	Yes	Yes			Yes										
			60		Yes	Yes	Yes			Yes										
		n260																		
CA_n66A-n260(7A)	CA_n66A-n260A	n66	15	Yes	Yes	Yes	Yes			Yes										0
			30		Yes	Yes	Yes			Yes										
			60		Yes	Yes	Yes			Yes										
		n260																		
CA_n66A-n260(8A)	CA_n66A-n260A	n66	15	Yes	Yes	Yes	Yes			Yes										0
			30		Yes	Yes	Yes			Yes										
			60		Yes	Yes	Yes			Yes										
		n260																		
CA_n66A-n261A	CA_n66A-n261A	n66	15	Yes	Yes	Yes	Yes			Yes										0
			30		Yes	Yes	Yes			Yes										
			60		Yes	Yes	Yes			Yes										
		n261									Yes					Yes	Yes			
										Yes				Yes	Yes	Yes				
		n66	15	Yes	Yes	Yes	Yes			Yes									0	

NR CA configuration	Uplink CA configuration	NR Band	SCS (kHz)	5 MHz	10 MHz	15 MHz	20 MHz	25 MHz	30 MHz	40 MHz	50 MHz	60 MHz	70 MHz	80 MHz	90 MHz	100 MHz	200 MHz	400 MHz	Band width combination set		
CA_n66A-n261(2A)	CA_n66A-n261A	n261	30		Yes	Yes	Yes			Yes											
			60		Yes	Yes	Yes			Yes											
CA_n261(2A)																					
CA_n66A-n261(3A)	CA_n66A-n261A	n66	15	Yes	Yes	Yes	Yes			Yes										0	
			30		Yes	Yes	Yes			Yes											
			60		Yes	Yes	Yes			Yes											
CA_n261(3A)																					
CA_n66A-n261(4A)	CA_n66A-n261A	n66	15	Yes	Yes	Yes	Yes			Yes										0	
			30		Yes	Yes	Yes			Yes											
			60		Yes	Yes	Yes			Yes											
CA_n261(4A)																					
CA_n66A-n261G	CA_n66A-n261A CA_n66A_n261G	n66	15	Yes	Yes	Yes	Yes			Yes										0	
			30		Yes	Yes	Yes			Yes											
			60		Yes	Yes	Yes			Yes											
CA_n261G																					
CA_n66A-n261H	CA_n66A-n261A CA_n66A_n261G CA_n66A_n261H	n66	15	Yes	Yes	Yes	Yes			Yes										0	
			30		Yes	Yes	Yes			Yes											
			60		Yes	Yes	Yes			Yes											
CA_n261H																					
CA_n66A-n261I	CA_n66A-n261A CA_n66A_n261G CA_n66A_n261H CA_n66A_n261I	n66	15	Yes	Yes	Yes	Yes			Yes										0	
			30		Yes	Yes	Yes			Yes											
			60		Yes	Yes	Yes			Yes											
CA_n261I																					
CA_n66A-n261J	CA_n66A-n261A	n66	15	Yes	Yes	Yes	Yes			Yes										0	
			30		Yes	Yes	Yes			Yes											
			60		Yes	Yes	Yes			Yes											
CA_n261J																					
CA_n66A-n261K	CA_n66A-n261A	n66	15	Yes	Yes	Yes	Yes			Yes										0	
			30		Yes	Yes	Yes			Yes											
			60		Yes	Yes	Yes			Yes											
CA_n261K																					
CA_n66A-n261L	CA_n66A-n261A	n66	15	Yes	Yes	Yes	Yes			Yes										0	
			30		Yes	Yes	Yes			Yes											
			60		Yes	Yes	Yes			Yes											
CA_n261L																					

NR CA configuration	Uplink CA configuration	NR Band	SCS (kHz)	5 MHz	10 MHz	15 MHz	20 MHz	25 MHz	30 MHz	40 MHz	50 MHz	60 MHz	70 MHz	80 MHz	90 MHz	100 MHz	200 MHz	400 MHz	Band width combination set
CA_n66A-n261M	CA_n66A-n261A CA_n66A_n261G CA_n66A_n261H CA_n66A_n261I	n66	15	Yes	Yes	Yes	Yes			Yes									0
			30		Yes	Yes	Yes			Yes									
			60		Yes	Yes	Yes			Yes									
	n261	CA_n261M																	
CA_n71A-n257A	-	n71	15	Yes	Yes	Yes	Yes												0
			30		Yes	Yes	Yes												
			60																
		n257	60							Yes					Yes	Yes			
			120						Yes					Yes	Yes	Yes			
CA_n71A-n260A	-	n71	15	Yes	Yes	Yes	Yes												0
			30		Yes	Yes	Yes												
			60																
		n260	60							Yes					Yes	Yes			
			120						Yes				Yes	Yes	Yes				
CA_n71A-n260(2A)	-	n71	15	Yes	Yes	Yes	Yes												0
			30		Yes	Yes	Yes												
			60																
n260	CA_n260(2A)																		
CA_n71A-n260(3A)	-	n71	15	Yes	Yes	Yes	Yes												0
			30		Yes	Yes	Yes												
			60																
n260	CA_n260(3A)																		
CA_n71A-n260(4A)	-	n71	15	Yes	Yes	Yes	Yes												0
			30		Yes	Yes	Yes												
			60																
n260	CA_n260(4A)																		
CA_n71A-n261A	-	n71	15	Yes	Yes	Yes	Yes												0
			30		Yes	Yes	Yes												
			60																
		n261	60							Yes					Yes	Yes			
			120						Yes				Yes	Yes	Yes				
CA_n71A-n261(2A)	-	n71	15	Yes	Yes	Yes	Yes												0
			30		Yes	Yes	Yes												
			60																
n261	CA_n261(2A)																		
CA_n77A-n257A	CA_n77A-n257A	n77	15		Yes	Yes	Yes			Yes	Yes								0
			30		Yes	Yes	Yes			Yes	Yes	Yes		Yes	Yes	Yes			



NR CA configuration	Uplink CA configuration	NR Band	SCS (kHz)	5 MHz	10 MHz	15 MHz	20 MHz	25 MHz	30 MHz	40 MHz	50 MHz	60 MHz	70 MHz	80 MHz	90 MHz	100 MHz	200 MHz	400 MHz	Band width combination set
		n257	60		Yes	Yes	Yes			Yes	Yes	Yes		Yes	Yes	Yes			
			60								Yes					Yes	Yes		
			120								Yes						Yes	Yes	
CA_n77A-n257D	CA_n77A-n257A, CA_n77A-n257D	n77	15		Yes	Yes	Yes			Yes	Yes								0
			30		Yes	Yes	Yes			Yes	Yes	Yes		Yes	Yes	Yes			
			60		Yes	Yes	Yes			Yes	Yes	Yes		Yes	Yes	Yes			
		n257	CA_n257D																
CA_n77A-n257E	CA_n77A-n257A	n77	15		Yes	Yes	Yes			Yes	Yes								0
			30		Yes	Yes	Yes			Yes	Yes	Yes		Yes	Yes	Yes			
			60		Yes	Yes	Yes			Yes	Yes	Yes		Yes	Yes	Yes			
		n257	CA_n257E																
CA_n77A-n257F	CA_n77A-n257A	n77	15		Yes	Yes	Yes			Yes	Yes								0
			30		Yes	Yes	Yes			Yes	Yes	Yes		Yes	Yes	Yes			
			60		Yes	Yes	Yes			Yes	Yes	Yes		Yes	Yes	Yes			
		n257	CA_n257F																
CA_n77A-n257G	CA_n257G, CA_n77A-n257A, CA_n77A-n257G	n77	15		Yes	Yes	Yes			Yes	Yes								0
			30		Yes	Yes	Yes			Yes	Yes	Yes		Yes		Yes			
			60		Yes	Yes	Yes			Yes	Yes	Yes		Yes		Yes			
		n257	CA_n257G																
CA_n77A-n257H	CA_n257G, CA_n257H, CA_n77A-n257A, CA_n77A-n257G, CA_n77A-n257H	n77	15		Yes	Yes	Yes			Yes	Yes								0
			30		Yes	Yes	Yes			Yes	Yes	Yes		Yes		Yes			
			60		Yes	Yes	Yes			Yes	Yes	Yes		Yes		Yes			
		n257	CA_n257H																
CA_n77A-n257I		n77	15		Yes	Yes	Yes			Yes	Yes								0
			30		Yes	Yes	Yes			Yes	Yes	Yes		Yes		Yes			
			60		Yes	Yes	Yes			Yes	Yes	Yes		Yes		Yes			

NR CA configuration	Uplink CA configuration	NR Band	SCS (kHz)	5 MHz	10 MHz	15 MHz	20 MHz	25 MHz	30 MHz	40 MHz	50 MHz	60 MHz	70 MHz	80 MHz	90 MHz	100 MHz	200 MHz	400 MHz	Band width combination set	
	CA_n257G CA_n257H CA_n257I CA_n77A-n257A, CA_n77A-n257G, CA_n77A-n257H, CA_n77A-n257I	n257	CA_n257I																	
CA_n77A-n257J	CA_n257G CA_n257H CA_n257I CA_n257J CA_n77A-n257A, CA_n77A-n257G, CA_n77A-n257H, CA_n77A-n257I CA_n77A-n257J	n77	15		Yes	Yes	Yes			Yes	Yes									0
			30		Yes	Yes	Yes			Yes	Yes	Yes		Yes		Yes				
			60		Yes	Yes	Yes			Yes	Yes	Yes		Yes		Yes				
			See CA_n257J in Table 5.5A.1-1 in TS 38.101-2																	
CA_n77A-n257K		n77	15		Yes	Yes	Yes			Yes	Yes									0
			30		Yes	Yes	Yes			Yes	Yes	Yes		Yes		Yes				
			60		Yes	Yes	Yes			Yes	Yes	Yes		Yes		Yes				

NR CA configuration	Uplink CA configuration	NR Band	SCS (kHz)	5 MHz	10 MHz	15 MHz	20 MHz	25 MHz	30 MHz	40 MHz	50 MHz	60 MHz	70 MHz	80 MHz	90 MHz	100 MHz	200 MHz	400 MHz	Band width combination set	
	CA_n257G CA_n257H CA_n257I CA_n257J CA_n257K CA_n77A-n257A, CA_n77A-n257G, CA_n77A-n257H, CA_n77A-n257I, CA_n77A-n257J, CA_n77A-n257K	n257	See CA_n257K in Table 5.5A.1-1 in TS 38.101-2																	
CA_n77A-n257L		n77	15		Yes	Yes	Yes			Yes	Yes									0
			30		Yes	Yes	Yes			Yes	Yes	Yes		Yes		Yes				
			60		Yes	Yes	Yes			Yes	Yes	Yes		Yes		Yes				

NR CA configuration	Uplink CA configuration	NR Band	SCS (kHz)	5 MHz	10 MHz	15 MHz	20 MHz	25 MHz	30 MHz	40 MHz	50 MHz	60 MHz	70 MHz	80 MHz	90 MHz	100 MHz	200 MHz	400 MHz	Band width combination set	
	CA_n257G CA_n257H CA_n257I CA_n257J CA_n257K CA_n257L CA_n77A-n257A, CA_n77A-n257G, CA_n77A-n257H, CA_n77A-n257I, CA_n77A-n257J, CA_n77A-n257K, CA_n77A-n257L	n257	See CA_n257L in Table 5.5A.1-1 in TS 38.101-2																	
CA_n77A-n257M		n77	15		Yes	Yes	Yes			Yes	Yes									0
			30		Yes	Yes	Yes			Yes	Yes	Yes		Yes		Yes				
			60		Yes	Yes	Yes			Yes	Yes	Yes		Yes		Yes				

NR CA configuration	Uplink CA configuration	NR Band	SCS (kHz)	5 MHz	10 MHz	15 MHz	20 MHz	25 MHz	30 MHz	40 MHz	50 MHz	60 MHz	70 MHz	80 MHz	90 MHz	100 MHz	200 MHz	400 MHz	Band width combination set	
	CA_n257G CA_n257H CA_n257I CA_n257J CA_n257K CA_n257L CA_n257M CA_n77A-n257A, CA_n77A-n257G, CA_n77A-n257H, CA_n77A-n257I, CA_n77A-n257J, CA_n77A-n257K, CA_n77A-n257L, CA_n77A-n257M	n257	See CA_n257M in Table 5.5A.1-1 in TS 38.101-2																	
CA_n77C-n257A	CA_n77A-n257A	n77	CA_n77C																0	
		n257	60								Yes					Yes	Yes			
		n257	120								Yes					Yes	Yes	Yes		
CA_n77C-n257D	CA_n77A-n257A	n77	CA_n77C																0	
		n257	CA_n257D																	
CA_n77C-n257E	CA_n77A-n257A	n77	CA_n77C																0	
		n257	CA_n257E																	
CA_n77C-n257F	CA_n77A-n257A	n77	CA_n77C																0	
		n257	CA_n257F																	
CA_n77(2A)-n257A	CA_n77A-n257A	n77	CA_n77(2A)																0	
		n257	60								Yes					Yes	Yes			
		n257	120								Yes					Yes	Yes	Yes		
		n77	CA_n77(2A)																0	

NR CA configuration	Uplink CA configuration	NR Band	SCS (kHz)	5 MHz	10 MHz	15 MHz	20 MHz	25 MHz	30 MHz	40 MHz	50 MHz	60 MHz	70 MHz	80 MHz	90 MHz	100 MHz	200 MHz	400 MHz	Band width combination set	
CA_n77(2A)-n257D	CA_n77A-n257A CA_n77A-n257D	n257								CA_n257D										
CA_n77(2A)-n257G	CA_n77A-n257A, CA_n77A-n257G	n77								CA_n77(2A)										0
		n257								CA_n257G										
CA_n77(2A)-n257H	CA_n77A-n257A, CA_n77A-n257G, CA_n77A-n257H	n77								CA_n77(2A)										0
		n257								CA_n257H										
CA_n77(2A)-n257I	CA_n77A-n257A, CA_n77A-n257G, CA_n77A-n257H, CA_n77A-n257I	n77								CA_n77(2A)										0
		n257								See CA_n257I in Table 5.5A.1-1 in TS 38.101-2										
CA_n77(2A)-n257J	CA_n77A-n257A, CA_n77A-n257G, CA_n77A-n257H, CA_n77A-n257I, CA_n77A-n257J	n77								See CA_n77(2A) in Table 5.5A.2-1 in TS 38.101-1										0
		n257								See CA_n257J in Table 5.5A.1-1 in TS 38.101-2										
		n77								See CA_n77(2A) in Table 5.5A.2-1 in TS 38.101-1										0

NR CA configuration	Uplink CA configuration	NR Band	SCS (kHz)	5 MHz	10 MHz	15 MHz	20 MHz	25 MHz	30 MHz	40 MHz	50 MHz	60 MHz	70 MHz	80 MHz	90 MHz	100 MHz	200 MHz	400 MHz	Band width combination set
CA_n77(2A)-n257K	CA_n77A-n257A, CA_n77A-n257G, CA_n77A-n257H, CA_n77A-n257I, CA_n77A-n257J, CA_n77A-n257K	n257		See CA_n257K in Table 5.5A.1-1 in TS 38.101-2															
CA_n77(2A)-n257L	CA_n77A-n257A, CA_n77A-n257G, CA_n77A-n257H, CA_n77A-n257I, CA_n77A-n257J, CA_n77A-n257K, CA_n77A-n257L	n77		See CA_n77(2A) in Table 5.5A.2-1 in TS 38.101-1															0
		n257		See CA_n257L in Table 5.5A.1-1 in TS 38.101-2															
CA_n77(2A)-n257M	CA_n77A-n257A, CA_n77A-n257G, CA_n77A-n257H, CA_n77A-n257I, CA_n77A-n257J, CA_n77A-n257K, CA_n77A-n257L, CA_n77A-n257M	n77		See CA_n77(2A) in Table 5.5A.2-1 in TS 38.101-1															0
		n257		See CA_n257M in Table 5.5A.1-1 in TS 38.101-2															

NR CA configuration	Uplink CA configuration	NR Band	SCS (kHz)	5 MHz	10 MHz	15 MHz	20 MHz	25 MHz	30 MHz	40 MHz	50 MHz	60 MHz	70 MHz	80 MHz	90 MHz	100 MHz	200 MHz	400 MHz	Band width combination set	
CA_n77A-n258A	-	n77	15		Yes	Yes	Yes			Yes	Yes								0	
			30		Yes	Yes	Yes			Yes	Yes	Yes		Yes		Yes				
			60		Yes	Yes	Yes			Yes	Yes	Yes		Yes		Yes				
		n258	60								Yes						Yes	Yes		
			120								Yes						Yes	Yes		Yes
CA_n77A-n261A	CA_n77A-n261A	n77	15		Yes	Yes	Yes			Yes	Yes								0	
			30		Yes	Yes	Yes			Yes	Yes	Yes	Yes <sup>1</sup>	Yes	Yes	Yes				
			60		Yes	Yes	Yes			Yes	Yes	Yes	Yes <sup>1</sup>	Yes	Yes	Yes				
		n261	60								Yes						Yes	Yes		
			120								Yes						Yes	Yes		Yes
CA_n77A-n261D	CA_n77A-n261A, CA_n77A-n261D	n77	15		Yes	Yes	Yes			Yes	Yes								0	
			30		Yes	Yes	Yes			Yes	Yes	Yes	Yes <sup>1</sup>	Yes	Yes	Yes				
			60		Yes	Yes	Yes			Yes	Yes	Yes	Yes <sup>1</sup>	Yes	Yes	Yes				
		n261	CA_n261D																	
CA_n77A-n261G	CA_n77A-n261A, CA_n77A-n261G	n77	15		Yes	Yes	Yes			Yes	Yes								0	
			30		Yes	Yes	Yes			Yes	Yes	Yes	Yes <sup>1</sup>	Yes	Yes	Yes				
			60		Yes	Yes	Yes			Yes	Yes	Yes	Yes <sup>1</sup>	Yes	Yes	Yes				
		n261	CA_n261G																	
CA_n77A-n261H	CA_n77A-n261A, CA_n77A-n261G, CA_n77A-n261H	n77	15		Yes	Yes	Yes			Yes	Yes								0	
			30		Yes	Yes	Yes			Yes	Yes	Yes	Yes <sup>1</sup>	Yes	Yes	Yes				
			60		Yes	Yes	Yes			Yes	Yes	Yes	Yes <sup>1</sup>	Yes	Yes	Yes				
		n261	CA_n261H																	
CA_n77A-n261I	CA_n77A-n261A, CA_n77A-n261G, CA_n77A-n261H, CA_n77A-n261I	n77	15		Yes	Yes	Yes			Yes	Yes								0	
			30		Yes	Yes	Yes			Yes	Yes	Yes	Yes <sup>1</sup>	Yes	Yes	Yes				
			60		Yes	Yes	Yes			Yes	Yes	Yes	Yes <sup>1</sup>	Yes	Yes	Yes				
		n261	CA_n261I																	
CA_n77A-n261J		n77	15		Yes	Yes	Yes	Yes	Yes	Yes	Yes								0	
			30		Yes	Yes	Yes	Yes	Yes	Yes	Yes	Yes	Yes	Yes <sup>1</sup>	Yes	Yes	Yes	Yes		
			60		Yes	Yes	Yes	Yes	Yes	Yes	Yes	Yes	Yes	Yes <sup>1</sup>	Yes	Yes	Yes	Yes		



NR CA configuration	Uplink CA configuration	NR Band	SCS (kHz)	5 MHz	10 MHz	15 MHz	20 MHz	25 MHz	30 MHz	40 MHz	50 MHz	60 MHz	70 MHz	80 MHz	90 MHz	100 MHz	200 MHz	400 MHz	Band width combination set	
	CA_n77A-n261A CA_n77A-n261G CA_n77A-n261H CA_n77A-n261I CA_n77A-n261J	n261		See CA_n261J in Table 5.5A.1-1 in TS 38.101-2																
CA_n77A-n261K	CA_n77A-n261A CA_n77A-n261G CA_n77A-n261H CA_n77A-n261I CA_n77A-n261J CA_n77A-n261K	n77	15		Yes	Yes	Yes	Yes	Yes	Yes	Yes									0
			30		Yes	Yes	Yes	Yes	Yes	Yes	Yes	Yes	Yes <sup>1</sup>	Yes	Yes	Yes	Yes	Yes		
		n261		See CA_n261K in Table 5.5A.1-1 in TS 38.101-2																
CA_n77A-n261L	CA_n77A-n261A CA_n77A-n261G CA_n77A-n261H CA_n77A-n261I CA_n77A-n261J CA_n77A-n261K CA_n77A-n261L	n77	15		Yes	Yes	Yes	Yes	Yes	Yes	Yes									0
			30		Yes	Yes	Yes	Yes	Yes	Yes	Yes	Yes	Yes <sup>1</sup>	Yes	Yes	Yes	Yes	Yes		
		n261		See CA_n261L in Table 5.5A.1-1 in TS 38.101-2																
CA_n77A-n261M		n77	15		Yes	Yes	Yes	Yes	Yes	Yes	Yes									0
			30		Yes	Yes	Yes	Yes	Yes	Yes	Yes	Yes	Yes <sup>1</sup>	Yes	Yes	Yes	Yes	Yes		
			60		Yes	Yes	Yes	Yes	Yes	Yes	Yes	Yes	Yes	Yes <sup>1</sup>	Yes	Yes	Yes	Yes		

NR CA configuration	Uplink CA configuration	NR Band	SCS (kHz)	5 MHz	10 MHz	15 MHz	20 MHz	25 MHz	30 MHz	40 MHz	50 MHz	60 MHz	70 MHz	80 MHz	90 MHz	100 MHz	200 MHz	400 MHz	Band width combination set
	CA_n77A-n261A CA_n77A-n261G CA_n77A-n261H CA_n77A-n261I CA_n77A-n261J CA_n77A-n261K CA_n77A-n261L CA_n77A-n261M	n261	See CA_n261M in Table 5.5A.1-1 in TS 38.101-2																
CA_n77A-n261(2A)	CA_n77A-n261A	n77	15		Yes	Yes	Yes	Yes	Yes	Yes	Yes								0
			30		Yes	Yes	Yes	Yes	Yes	Yes	Yes	Yes	Yes <sup>1</sup>	Yes	Yes	Yes	Yes		
60			Yes	Yes	Yes	Yes	Yes	Yes	Yes	Yes	Yes	Yes	Yes <sup>1</sup>	Yes	Yes	Yes	Yes		
		n261	See CA_n261(2A) in Table 5.5A.2-1 in TS 38.101-2																
CA_n77A-n261(2G)	CA_n77A-n261A	n77	15		Yes	Yes	Yes	Yes	Yes	Yes	Yes								0
			30		Yes	Yes	Yes	Yes	Yes	Yes	Yes	Yes	Yes <sup>1</sup>	Yes	Yes	Yes	Yes		
			60		Yes	Yes	Yes	Yes	Yes	Yes	Yes	Yes	Yes <sup>1</sup>	Yes	Yes	Yes	Yes		
		n261	See CA_n261(2G) in Table 5.5A.2-1 in TS 38.101-2																
CA_n77A-n261(2H)	CA_n77A-n261A	n77	15		Yes	Yes	Yes	Yes	Yes	Yes	Yes								0
			30		Yes	Yes	Yes	Yes	Yes	Yes	Yes	Yes	Yes <sup>1</sup>	Yes	Yes	Yes	Yes		
			60		Yes	Yes	Yes	Yes	Yes	Yes	Yes	Yes	Yes <sup>1</sup>	Yes	Yes	Yes	Yes		
		n261	See CA_n261(2H) in Table 5.5A.2-1 in TS 38.101-2																
CA_n77A-n261(2I)	CA_n77A-n261A	n77	15		Yes	Yes	Yes	Yes	Yes	Yes	Yes								0
			30		Yes	Yes	Yes	Yes	Yes	Yes	Yes	Yes	Yes <sup>1</sup>	Yes	Yes	Yes	Yes		
			60		Yes	Yes	Yes	Yes	Yes	Yes	Yes	Yes	Yes <sup>1</sup>	Yes	Yes	Yes	Yes		
		n261	See CA_n261(2I) in Table 5.5A.2-1 in TS 38.101-2																
CA_n77A-n261(3A)	CA_n77A-n261A	n77	15		Yes	Yes	Yes	Yes	Yes	Yes	Yes								0
			30		Yes	Yes	Yes	Yes	Yes	Yes	Yes	Yes	Yes <sup>1</sup>	Yes	Yes	Yes	Yes		
			60		Yes	Yes	Yes	Yes	Yes	Yes	Yes	Yes	Yes <sup>1</sup>	Yes	Yes	Yes	Yes		
		n261	See CA_n261(3A) in Table 5.5A.2-1 in TS 38.101-2																
CA_n77A-n261(4A)	CA_n77A-n261A	n77	15		Yes	Yes	Yes	Yes	Yes	Yes	Yes								0
			30		Yes	Yes	Yes	Yes	Yes	Yes	Yes	Yes	Yes <sup>1</sup>	Yes	Yes	Yes	Yes		
			60		Yes	Yes	Yes	Yes	Yes	Yes	Yes	Yes	Yes <sup>1</sup>	Yes	Yes	Yes	Yes		
		n261	See CA_n261(4A) in Table 5.5A.2-1 in TS 38.101-2																
		n77	15		Yes	Yes	Yes	Yes	Yes	Yes	Yes								0

NR CA configuration	Uplink CA configuration	NR Band	SCS (kHz)	5 MHz	10 MHz	15 MHz	20 MHz	25 MHz	30 MHz	40 MHz	50 MHz	60 MHz	70 MHz	80 MHz	90 MHz	100 MHz	200 MHz	400 MHz	Band width combination set	
CA_n77A-n261(A-G)	CA_n77A-n261A	n261	30		Yes	Yes	Yes	Yes	Yes	Yes	Yes	Yes	Yes <sup>1</sup>	Yes	Yes	Yes	Yes			
			60		Yes	Yes	Yes	Yes	Yes	Yes	Yes	Yes	Yes	Yes <sup>1</sup>	Yes	Yes	Yes	Yes		
			See CA_n261(A-G) in Table 5.5A.2-2 in TS 38.101-2																	
CA_n77A-n261(A-H)	CA_n77A-n261A	n77	15		Yes	Yes	Yes	Yes	Yes	Yes	Yes								0	
			30		Yes	Yes	Yes	Yes	Yes	Yes	Yes	Yes	Yes	Yes <sup>1</sup>	Yes	Yes	Yes	Yes		
			60		Yes	Yes	Yes	Yes	Yes	Yes	Yes	Yes	Yes	Yes <sup>1</sup>	Yes	Yes	Yes	Yes		
See CA_n261(A-H) in Table 5.5A.2-2 in TS 38.101-2																				
CA_n77A-n261(A-I)	CA_n77A-n261A	n77	15		Yes	Yes	Yes	Yes	Yes	Yes	Yes								0	
			30		Yes	Yes	Yes	Yes	Yes	Yes	Yes	Yes	Yes	Yes <sup>1</sup>	Yes	Yes	Yes	Yes		
			60		Yes	Yes	Yes	Yes	Yes	Yes	Yes	Yes	Yes	Yes <sup>1</sup>	Yes	Yes	Yes	Yes		
See CA_n261(A-I) in Table 5.5A.2-2 in TS 38.101-2																				
CA_n77A-n261(G-H)	CA_n77A-n261A	n77	15		Yes	Yes	Yes	Yes	Yes	Yes	Yes								0	
			30		Yes	Yes	Yes	Yes	Yes	Yes	Yes	Yes	Yes	Yes <sup>1</sup>	Yes	Yes	Yes	Yes		
			60		Yes	Yes	Yes	Yes	Yes	Yes	Yes	Yes	Yes	Yes <sup>1</sup>	Yes	Yes	Yes	Yes		
See CA_n261(G-H) in Table 5.5A.2-2 in TS 38.101-2																				
CA_n77A-n261(G-I)	CA_n77A-n261A	n77	15		Yes	Yes	Yes	Yes	Yes	Yes	Yes								0	
			30		Yes	Yes	Yes	Yes	Yes	Yes	Yes	Yes	Yes	Yes <sup>1</sup>	Yes	Yes	Yes	Yes		
			60		Yes	Yes	Yes	Yes	Yes	Yes	Yes	Yes	Yes	Yes <sup>1</sup>	Yes	Yes	Yes	Yes		
See CA_n261(G-I) in Table 5.5A.2-1 in TS 38.101-2																				
CA_n77A-n261(H-I)	CA_n77A-n261A	n77	15		Yes	Yes	Yes	Yes	Yes	Yes	Yes								0	
			30		Yes	Yes	Yes	Yes	Yes	Yes	Yes	Yes	Yes	Yes <sup>1</sup>	Yes	Yes	Yes	Yes		
			60		Yes	Yes	Yes	Yes	Yes	Yes	Yes	Yes	Yes	Yes <sup>1</sup>	Yes	Yes	Yes	Yes		
See CA_n261(H-I) in Table 5.5A.2-2 in TS 38.101-2																				
CA_n78A-n257A	CA_n78A-n257A	n78	15		Yes	Yes	Yes			Yes	Yes							0		
			30		Yes	Yes	Yes			Yes	Yes	Yes		Yes	Yes	Yes				
			60		Yes	Yes	Yes			Yes	Yes	Yes		Yes	Yes	Yes				
		n257	60							Yes						Yes	Yes			
120								Yes						Yes	Yes	Yes				
CA_n78A-n257D	CA_n78A-n257A, CA_n78A-n257D	n78	15		Yes	Yes	Yes			Yes	Yes							0		
			30		Yes	Yes	Yes			Yes	Yes	Yes		Yes	Yes	Yes				
			60		Yes	Yes	Yes			Yes	Yes	Yes		Yes	Yes	Yes				
CA_n257D																				
CA_n78A-n257E	CA_n78A-n257A	n78	15		Yes	Yes	Yes			Yes	Yes							0		
			30		Yes	Yes	Yes			Yes	Yes	Yes		Yes	Yes	Yes				
			60		Yes	Yes	Yes			Yes	Yes	Yes		Yes	Yes	Yes				
CA_n257E																				
CA_n78A-n257F	CA_n78A-n257A	n78	15		Yes	Yes	Yes			Yes	Yes							0		
			30		Yes	Yes	Yes			Yes	Yes	Yes		Yes	Yes	Yes				
			60		Yes	Yes	Yes			Yes	Yes	Yes		Yes	Yes	Yes				
CA_n257F																				

NR CA configuration	Uplink CA configuration	NR Band	SCS (kHz)	5 MHz	10 MHz	15 MHz	20 MHz	25 MHz	30 MHz	40 MHz	50 MHz	60 MHz	70 MHz	80 MHz	90 MHz	100 MHz	200 MHz	400 MHz	Band width combination set	
CA_n78C-n257A	CA_n78A-n257A	n78	CA_n78C																0	
		n257	60								Yes						Yes	Yes		
			120									Yes						Yes		Yes
CA_n78C-n257D	CA_n78A-n257A	n78	CA_n78C																0	
		n257	CA_n257D																	
CA_n78C-n257E	CA_n78A-n257A	n78	CA_n78C																0	
		n257	CA_n257E																	
CA_n78C-n257F	CA_n78A-n257A	n78	CA_n78C																0	
		n257	CA_n257F																	
CA_n78A-n257G	CA_n257G CA_n78A-n257A, CA_n78A-n257G	n78	15		Yes	Yes	Yes			Yes	Yes									
			30		Yes	Yes	Yes			Yes	Yes	Yes		Yes	Yes	Yes				
			60		Yes	Yes	Yes			Yes	Yes	Yes		Yes	Yes	Yes				
	n257	CA_n257G																		
CA_n78A-n257H	CA_n257G CA_n257H CA_n78A-n257A, CA_n78A-n257G, CA_n78A-n257H	n78	15		Yes	Yes	Yes			Yes	Yes									
			30		Yes	Yes	Yes			Yes	Yes	Yes		Yes	Yes	Yes				
			60		Yes	Yes	Yes			Yes	Yes	Yes		Yes	Yes	Yes				
	n257	CA_n257H																		
CA_n78A-n257I	CA_n257G CA_n257H CA_n257I CA_n78A-n257A, CA_n78A-n257G, CA_n78A-n257H, CA_n78A-n257I	n78	15		Yes	Yes	Yes			Yes	Yes									
			30		Yes	Yes	Yes			Yes	Yes	Yes		Yes	Yes	Yes				
			60		Yes	Yes	Yes			Yes	Yes	Yes		Yes	Yes	Yes				
	n257	CA_n257I																		
CA_n78A-n257J	CA_n78A-n257A-	n78	15		Yes	Yes	Yes			Yes	Yes									
			30		Yes	Yes	Yes			Yes	Yes	Yes		Yes	Yes	Yes				
			60		Yes	Yes	Yes			Yes	Yes	Yes		Yes	Yes	Yes				
	n257	CA_n257J																		

NR CA configuration	Uplink CA configuration	NR Band	SCS (kHz)	5 MHz	10 MHz	15 MHz	20 MHz	25 MHz	30 MHz	40 MHz	50 MHz	60 MHz	70 MHz	80 MHz	90 MHz	100 MHz	200 MHz	400 MHz	Band width combination set	
CA_n78A-n257K	CA_n78A-n257A-	n78	15		Yes	Yes	Yes			Yes	Yes								0	
			30		Yes	Yes	Yes			Yes	Yes	Yes		Yes	Yes	Yes				
			60		Yes	Yes	Yes			Yes	Yes	Yes		Yes	Yes	Yes				
		n257	CA_n257K																	
CA_n78A-n257L	CA_n78A-n257A-	n78	15		Yes	Yes	Yes			Yes	Yes								0	
			30		Yes	Yes	Yes			Yes	Yes	Yes		Yes	Yes	Yes				
			60		Yes	Yes	Yes			Yes	Yes	Yes		Yes	Yes	Yes				
		n257	CA_n257L																	
CA_n78A-n257M	CA_n78A-n257A-	n78	15		Yes	Yes	Yes			Yes	Yes								0	
			30		Yes	Yes	Yes			Yes	Yes	Yes		Yes	Yes	Yes				
			60		Yes	Yes	Yes			Yes	Yes	Yes		Yes	Yes	Yes				
		n257	CA_n257M																	
CA_n78A-n258A	CA_n78A-n258A	n78	15		Yes	Yes	Yes			Yes	Yes								0	
			30		Yes	Yes	Yes			Yes	Yes	Yes		Yes		Yes				
			60		Yes	Yes	Yes			Yes	Yes	Yes		Yes		Yes				
		n258	60							Yes					Yes	Yes	Yes			
		n258	120							Yes				Yes	Yes	Yes				
CA_n78A-n258G	CA_n78A-n258A CA_n78A-n258G	n78	15		Yes	Yes	Yes			Yes	Yes								0	
			30		Yes	Yes	Yes			Yes	Yes	Yes		Yes	Yes	Yes				
			60		Yes	Yes	Yes			Yes	Yes	Yes		Yes	Yes	Yes				
		n258	See CA_n258G Bandwidth Combination Set 0 in Table 5.5A.1-1 from 38.101-2																	
CA_n78A-n258H	CA_n78A-n258A CA_n78A-n258G CA_n78A-n258H	n78	15		Yes	Yes	Yes			Yes	Yes								0	
			30		Yes	Yes	Yes			Yes	Yes	Yes		Yes		Yes				
			60		Yes	Yes	Yes			Yes	Yes	Yes		Yes		Yes				
		n258	See CA_n258H Bandwidth Combination Set 0 in Table 5.5A.1-1 from 38.101-2																	
CA_n78A-n258I	CA_n78A-n258A CA_n78A-n258G CA_n78A-n258H CA_n78A-n258I	n78	15		Yes	Yes	Yes			Yes	Yes								0	
			30		Yes	Yes	Yes			Yes	Yes	Yes		Yes	Yes	Yes				
			60		Yes	Yes	Yes			Yes	Yes	Yes		Yes	Yes	Yes				
	n258	See CA_n258I Bandwidth Combination Set 0 in Table 5.5A.1-1 from 38.101-2																		
CA_n78A-n258J		n78	15		Yes	Yes	Yes			Yes	Yes							0		
			30		Yes	Yes	Yes			Yes	Yes	Yes		Yes	Yes	Yes				
			60		Yes	Yes	Yes			Yes	Yes	Yes		Yes	Yes	Yes				

NR CA configuration	Uplink CA configuration	NR Band	SCS (kHz)	5 MHz	10 MHz	15 MHz	20 MHz	25 MHz	30 MHz	40 MHz	50 MHz	60 MHz	70 MHz	80 MHz	90 MHz	100 MHz	200 MHz	400 MHz	Band width combination set
	CA_n78A-n258A CA_n78A-n258G CA_n78A-n258H CA_n78A-n258I CA_n78A-n258J	n258	See CA_n258J Bandwidth Combination Set 0 in Table 5.5A.1-1 from 38.101-2																
CA_n78A-n258K	CA_n78A-n258A CA_n78A-n258G CA_n78A-n258H CA_n78A-n258I CA_n78A-n258J CA_n78A-n258K	n78	15		Yes	Yes	Yes			Yes	Yes								
			30		Yes	Yes	Yes			Yes	Yes	Yes		Yes	Yes	Yes			
		n258	See CA_n258K Bandwidth Combination Set 0 in Table 5.5A.1-1 from 38.101-2																0
CA_n78A-n258L	CA_n78A-n258A CA_n78A-n258G CA_n78A-n258H CA_n78A-n258I CA_n78A-n258J CA_n78A-n258K CA_n78A-n258L	n78	15		Yes	Yes	Yes			Yes	Yes								
			30		Yes	Yes	Yes			Yes	Yes	Yes		Yes	Yes	Yes			
		n258	See CA_n258L Bandwidth Combination Set 0 in Table 5.5A.1-1 from 38.101-2																0
CA_n78A-n258M		n78	15		Yes	Yes	Yes			Yes	Yes								
			30		Yes	Yes	Yes			Yes	Yes	Yes		Yes	Yes	Yes			
			60		Yes	Yes	Yes			Yes	Yes	Yes		Yes	Yes	Yes			

NR CA configuration	Uplink CA configuration	NR Band	SCS (kHz)	5 MHz	10 MHz	15 MHz	20 MHz	25 MHz	30 MHz	40 MHz	50 MHz	60 MHz	70 MHz	80 MHz	90 MHz	100 MHz	200 MHz	400 MHz	Band width combination set	
	CA_n78A-n258A CA_n78A-n258G CA_n78A-n258H CA_n78A-n258I CA_n78A-n258J CA_n78A-n258K CA_n78A-n258L CA_n78A-n258M	n258	See CA_n258M Bandwidth Combination Set 0 in Table 5.5A.1-1 from 38.101-2																	
CA_n79A-n257A	CA_n79A-n257A	n79	15							Yes	Yes									0
			30							Yes	Yes	Yes		Yes		Yes				
			60							Yes	Yes	Yes		Yes		Yes				
		n257	60								Yes						Yes	Yes		
			120									Yes					Yes	Yes	Yes	
CA_n79A-n257D	CA_n79A-n257A	n79	15							Yes	Yes									0
			30							Yes	Yes	Yes		Yes		Yes				
			60							Yes	Yes	Yes		Yes		Yes		Yes		
		n257	CA_n257D																	
CA_n79A-n257E	CA_n79A-n257A	n79	15							Yes	Yes									0
			30							Yes	Yes	Yes		Yes		Yes				
			60							Yes	Yes	Yes		Yes		Yes		Yes		
		n257	CA_n257E																	
CA_n79A-n257F	CA_n79A-n257A	n79	15							Yes	Yes									0
			30							Yes	Yes	Yes		Yes		Yes				
			60							Yes	Yes	Yes		Yes		Yes		Yes		
		n257	CA_n257F																	
CA_n79A-n257G	CA_n257G CA_n79A-n257A, CA_n79A-n257G	n79	15							Yes	Yes									0
			30							Yes	Yes	Yes		Yes		Yes				
			60							Yes	Yes	Yes		Yes		Yes		Yes		
	n257	CA_n257G																		
CA_n79A-n257H		n79	15							Yes	Yes									0
			30							Yes	Yes	Yes		Yes		Yes				

NR CA configuration	Uplink CA configuration	NR Band	SCS (kHz)	5 MHz	10 MHz	15 MHz	20 MHz	25 MHz	30 MHz	40 MHz	50 MHz	60 MHz	70 MHz	80 MHz	90 MHz	100 MHz	200 MHz	400 MHz	Band width combination set
	CA_n257G CA_n257H CA_n79A-n257A, CA_n79A-n257G CA_n79A-n257H	n257	60							Yes	Yes	Yes		Yes		Yes			
	CA_n257G CA_n257H CA_n79A-n257A, CA_n79A-n257G CA_n79A-n257H	n79	15							Yes	Yes								
	CA_n257G CA_n257H CA_n79A-n257A, CA_n79A-n257G CA_n79A-n257H CA_n79A-n257I	n79	30							Yes	Yes	Yes		Yes		Yes			
	CA_n257G CA_n257H CA_n79A-n257A, CA_n79A-n257G CA_n79A-n257H CA_n79A-n257I	n79	60							Yes	Yes	Yes		Yes		Yes			
CA_n79A-n257I	CA_n257I CA_n79A-n257A, CA_n79A-n257G CA_n79A-n257H CA_n79A-n257I	n257																	0
CA_n79C-n257A	CA_n79A-n257A	n79																	
		n257	60								Yes					Yes	Yes		0
			120								Yes					Yes	Yes	Yes	
CA_n79C-n257D	CA_n79A-n257A	n79																	0
		n257																	0
CA_n79C-n257E	CA_n79A-n257A	n79																	0
		n257																	0
CA_n79C-n257F	CA_n79A-n257A	n79																	0
		n257																	0
CA_n79A-n258A	-	n79	15							Yes	Yes								
			30							Yes	Yes	Yes		Yes		Yes			
			60							Yes	Yes	Yes		Yes		Yes			
		n258	60								Yes					Yes	Yes		
			120								Yes					Yes	Yes	Yes	
NOTE 1: This UE channel bandwidth is optional in this release of the specification. (From Table 5.3.5-1 of 38.101-1)																			
NOTE 2: The CA configurations are given in Table 5.5A.1-1 of either TS 38.101-1 or TS 38.101-2 where unless otherwise stated BCS0 is referred to.																			



**Table 5.5A.1-2: Inter-band CA configurations and bandwidth combination sets between FR1 and FR2 (three bands)**

NR CA configuration	Uplink configuration	NR Band	SCS (kHz)	5 MHz	10 MHz	15 MHz	20 MHz	25 MHz	30 MHz	40 MHz	50 MHz	60 MHz	80 MHz	90 MHz	100 MHz	200 MHz	400 MHz	Bandwidth combination set			
CA_n1A-n78A-n257A	-	n1	15	Yes	Yes	Yes	Yes											0			
			30		Yes	Yes	Yes														
			60		Yes	Yes	Yes														
		n78	15		Yes	Yes	Yes				Yes	Yes									
			30		Yes	Yes	Yes				Yes	Yes	Yes	Yes	Yes	Yes					
			60		Yes	Yes	Yes				Yes	Yes	Yes	Yes	Yes	Yes					
		n257	60									Yes				Yes	Yes				
			120									Yes				Yes	Yes		Yes		
		CA_n3A-n28A-n257A	CA_n3A-n28A CA_n3A-n257A CA_n28A-n257A	n3	15	Yes	Yes	Yes	Yes	Yes	Yes										0
30					Yes	Yes	Yes	Yes	Yes												
60					Yes	Yes	Yes	Yes	Yes												
n28	15			Yes	Yes	Yes	Yes														
	30				Yes	Yes	Yes														
	60																				
n257	60											Yes				Yes	Yes				
	120											Yes				Yes	Yes	Yes			
CA_n3A-n28A-n257D	CA_n3A-n28A CA_n3A-n257A CA_n3A-n257D CA_n28A-n257A  CA_n28A-n257D			n3	15	Yes	Yes	Yes	Yes	Yes	Yes									0	
		30			Yes	Yes	Yes	Yes	Yes												
		60			Yes	Yes	Yes	Yes	Yes	Yes											
		n28	15	Yes	Yes	Yes	Yes														
			30		Yes	Yes	Yes														
			60																		
		n257	See CA_n257D BCS0 in Table 5.5A.1-1 in TS 38.101-2																		
		CA_n3A-n28A-n257G	CA_n3A-n28A CA_n3A-n257A CA_n3A-n257G CA_n28A-n257A  CA_n28A-n257G	n3	15	Yes	Yes	Yes	Yes	Yes	Yes										0
					30		Yes	Yes	Yes	Yes	Yes										
60					Yes	Yes	Yes	Yes	Yes												
n28	15			Yes	Yes	Yes	Yes														
	30				Yes	Yes	Yes														
	60																				
n257	See CA_n257G BCS0 in Table 5.5A.1-1 in TS 38.101-2																				
CA_n3A-n28A-n257H	CA_n3A-n28A CA_n3A-n257A CA_n3A-n257G CA_n3A-n257H CA_n28A-n257A CA_n28A-n257G CA_n28A-n257H			n3	15	Yes	Yes	Yes	Yes	Yes	Yes									0	
					30		Yes	Yes	Yes	Yes	Yes										
		60			Yes	Yes	Yes	Yes	Yes												
		n28	15	Yes	Yes	Yes	Yes														
			30		Yes	Yes	Yes														
			60																		
		n257	See CA_n257H BCS0 in Table 5.5A.1-1 in TS 38.101-2																		
		CA_n3A-n28A-n257I		n3	15	Yes	Yes	Yes	Yes	Yes	Yes										0
					30		Yes	Yes	Yes	Yes	Yes										
60					Yes	Yes	Yes	Yes	Yes												

NR CA configuration	Uplink configuration	NR Band	SCS (kHz)	5 MHz	10 MHz	15 MHz	20 MHz	25 MHz	30 MHz	40 MHz	50 MHz	60 MHz	80 MHz	90 MHz	100 MHz	200 MHz	400 MHz	Bandwidth combination set	
	CA_n3A-n28A CA_n3A-n257A CA_n3A-n257G CA_n3A-n257H CA_n3A-n257I CA_n28A-n257A CA_n28A-n257G CA_n28A-n257H CA_n28A-n257I	n28	15	Yes	Yes	Yes	Yes												
			30		Yes	Yes	Yes												
			60																
		n257	See CA_n257I BCS0 in Table 5.5A.1-1 in TS 38.101-2																
CA_n3A-n77A-n257A	CA_n3A-n77A CA_n3A-n257A CA_n77A-n257A	n3	15	Yes	Yes	Yes	Yes	Yes	Yes									0	
			30		Yes	Yes	Yes	Yes	Yes										
			60		Yes	Yes	Yes	Yes	Yes										
		n77	15		Yes	Yes	Yes			Yes	Yes								
			30		Yes	Yes	Yes			Yes	Yes	Yes	Yes	Yes	Yes	Yes			
			60		Yes	Yes	Yes			Yes	Yes	Yes	Yes	Yes	Yes	Yes			
n257	60								Yes					Yes	Yes				
	120								Yes					Yes	Yes	Yes			
CA_n3A-n77A-n257D	CA_n3A-n77A CA_n3A-n257A CA_n3A-n257D CA_n77A-n257A CA_n77A-n257D	n3	15	Yes	Yes	Yes	Yes	Yes	Yes									0	
			30		Yes	Yes	Yes	Yes	Yes										
			60		Yes	Yes	Yes	Yes	Yes										
		n77	15		Yes	Yes	Yes			Yes	Yes								
			30		Yes	Yes	Yes			Yes	Yes	Yes	Yes	Yes	Yes	Yes			
			60		Yes	Yes	Yes			Yes	Yes	Yes	Yes	Yes	Yes	Yes			
n257	See CA_n257D in Table 5.5A.1-2 in TS 38.101-2																		
CA_n3A-n77A-n257G	CA_n3A-n77A CA_n3A-n257A CA_n3A-n257G CA_n77A-n257A CA_n77A-n257G	n3	15	Yes	Yes	Yes	Yes	Yes	Yes									0	
			30		Yes	Yes	Yes	Yes	Yes										
			60		Yes	Yes	Yes	Yes	Yes										
		n77	15		Yes	Yes	Yes			Yes	Yes								
			30		Yes	Yes	Yes			Yes	Yes	Yes	Yes	Yes	Yes	Yes			
			60		Yes	Yes	Yes			Yes	Yes	Yes	Yes	Yes	Yes	Yes			
n257	See CA_n257G in Table 5.5A.1-2 in TS 38.101-2																		
CA_n3A-n77A-n257H	CA_n3A-n77A CA_n3A-n257A CA_n3A-n257G CA_n3A-n257H CA_n77A-n257A CA_n77A-n257G CA_n77A-n257H	n3	15	Yes	Yes	Yes	Yes	Yes	Yes									0	
			30		Yes	Yes	Yes	Yes	Yes										
			60		Yes	Yes	Yes	Yes	Yes										
		n77	15		Yes	Yes	Yes			Yes	Yes								
			30		Yes	Yes	Yes			Yes	Yes	Yes	Yes	Yes	Yes	Yes			
			60		Yes	Yes	Yes			Yes	Yes	Yes	Yes	Yes	Yes	Yes			
n257	See CA_n257H in Table 5.5A.1-2 in TS 38.101-2																		
CA_n3A-n77A-n257I		n3	15	Yes	Yes	Yes	Yes	Yes	Yes									0	
			30		Yes	Yes	Yes	Yes	Yes										
			60		Yes	Yes	Yes	Yes	Yes										

NR CA configuration	Uplink configuration	NR Band	SCS (kHz)	5 MHz	10 MHz	15 MHz	20 MHz	25 MHz	30 MHz	40 MHz	50 MHz	60 MHz	80 MHz	90 MHz	100 MHz	200 MHz	400 MHz	Bandwidth combination set	
	CA_n3A-n77A CA_n3A-n257A CA_n3A-n257G CA_n3A-n257H CA_n3A-n257I CA_n77A-n257A CA_n77A-n257G CA_n77A-n257H CA_n77A-n257I	n77	15		Yes	Yes	Yes			Yes	Yes								
			30		Yes	Yes	Yes			Yes	Yes	Yes	Yes	Yes	Yes				
			60		Yes	Yes	Yes			Yes	Yes	Yes	Yes	Yes	Yes	Yes			
		n257	See CA_n257I in Table 5.5A.1-2 in TS 38.101-2																
CA_n3A-n77(2A)-n257A	CA_n3A-n77A CA_n3A-n257A CA_n77A-n257A	n3	15	Yes	Yes	Yes	Yes	Yes	Yes									0	
			30		Yes	Yes	Yes	Yes	Yes										
			60		Yes	Yes	Yes	Yes	Yes										
		n77	See CA_n77(2A) Bandwidth Combination Set 0																
		n257	60									Yes				Yes	Yes		
			120									Yes				Yes	Yes		Yes
CA_n3A-n77(2A)-n257D	CA_n3A-n77A CA_n3A-n257A CA_n3A-n257D CA_n77A-n257A CA_n77A-n257D	n3	15	Yes	Yes	Yes	Yes	Yes	Yes									0	
			30		Yes	Yes	Yes	Yes	Yes										
			60		Yes	Yes	Yes	Yes	Yes										
		n77	See CA_n77(2A) in Table 5.5A.2-1 in TS 38.101-1																
		n257	See CA_n257D in Table 5.5A.1-2 in TS 38.101-2																
CA_n3A-n77(2A)-n257G	CA_n3A-n77A CA_n3A-n257A CA_n3A-n257D CA_n3A-n257G CA_n77A-n257A CA_n77A-n257G	n3	15	Yes	Yes	Yes	Yes	Yes	Yes									0	
			30		Yes	Yes	Yes	Yes	Yes										
			60		Yes	Yes	Yes	Yes	Yes										
		n77	See CA_n77(2A) in Table 5.5A.2-1 in TS 38.101-1																
		n257	See CA_n257G in Table 5.5A.1-2 in TS 38.101-2																
CA_n3A-n77(2A)-n257H	CA_n3A-n77A CA_n3A-n257A CA_n3A-n257G CA_n3A-n257H CA_n77A-n257A CA_n77A-n257G CA_n77A-n257H	n3	15	Yes	Yes	Yes	Yes	Yes	Yes									0	
			30		Yes	Yes	Yes	Yes	Yes										
			60		Yes	Yes	Yes	Yes	Yes										
		n77	See CA_n77(2A) in Table 5.5A.2-1 in TS 38.101-1																
		n257	See CA_n257H in Table 5.5A.1-2 in TS 38.101-2																
CA_n3A-n77(2A)-n257I	CA_n3A-n77A CA_n3A-n257A CA_n3A-n257G CA_n3A-n257H CA_n3A-n257I CA_n77A-n257A CA_n77A-n257G CA_n77A-n257H CA_n77A-n257I	n3	15	Yes	Yes	Yes	Yes	Yes	Yes									0	
			30		Yes	Yes	Yes	Yes	Yes										
			60		Yes	Yes	Yes	Yes	Yes										
		n77	See CA_n77(2A) in Table 5.5A.2-1 in TS 38.101-1																
		n257	See CA_n257I in Table 5.5A.1-2 in TS 38.101-2																

NR CA configuration	Uplink configuration	NR Band	SCS (kHz)	5 MHz	10 MHz	15 MHz	20 MHz	25 MHz	30 MHz	40 MHz	50 MHz	60 MHz	80 MHz	90 MHz	100 MHz	200 MHz	400 MHz	Bandwidth combination set	
CA_n3A-n78A-n257A	CA_n3A-n78A CA_n3A-n257A CA_n78A-n257A	n3	15	Yes	Yes	Yes	Yes	Yes	Yes									0	
			30		Yes	Yes	Yes	Yes	Yes										
			60		Yes	Yes	Yes	Yes	Yes										
		n78	15		Yes	Yes	Yes			Yes	Yes								
			30		Yes	Yes	Yes			Yes	Yes	Yes	Yes	Yes	Yes	Yes			
			60		Yes	Yes	Yes			Yes	Yes	Yes	Yes	Yes	Yes	Yes			
n257	60								Yes					Yes	Yes				
	120								Yes					Yes	Yes	Yes			
CA_n3A-n78A-n257D	CA_n3A-n78A CA_n3A-n257A CA_n3A-n257D CA_n78A-n257A CA_n78A-n257D	n3	15	Yes	Yes	Yes	Yes	Yes	Yes									0	
			30		Yes	Yes	Yes	Yes	Yes										
			60		Yes	Yes	Yes	Yes	Yes										
		n78	15		Yes	Yes	Yes			Yes	Yes								
			30		Yes	Yes	Yes			Yes	Yes	Yes	Yes	Yes	Yes	Yes			
			60		Yes	Yes	Yes			Yes	Yes	Yes	Yes	Yes	Yes	Yes			
n257	See CA_n257D in Table 5.5A.1-2 in TS 38.101-2																		
CA_n3A-n78A-n257G	CA_n3A-n78A CA_n3A-n257A CA_n3A-n257G CA_n78A-n257A CA_n78A-n257G	n3	15	Yes	Yes	Yes	Yes	Yes	Yes									0	
			30		Yes	Yes	Yes	Yes	Yes										
			60		Yes	Yes	Yes	Yes	Yes										
		n78	15		Yes	Yes	Yes			Yes	Yes								
			30		Yes	Yes	Yes			Yes	Yes	Yes	Yes	Yes	Yes	Yes			
			60		Yes	Yes	Yes			Yes	Yes	Yes	Yes	Yes	Yes	Yes			
n257	See CA_n257G in Table 5.5A.1-2 in TS 38.101-2																		
CA_n3A-n78A-n257H	CA_n3A-n78A CA_n3A-n257A CA_n3A-n257G CA_n3A-n257H CA_n78A-n257A CA_n78A-n257G CA_n78A-n257H	n3	15	Yes	Yes	Yes	Yes	Yes	Yes									0	
			30		Yes	Yes	Yes	Yes	Yes										
			60		Yes	Yes	Yes	Yes	Yes										
		n78	15		Yes	Yes	Yes			Yes	Yes								
			30		Yes	Yes	Yes			Yes	Yes	Yes	Yes	Yes	Yes	Yes			
			60		Yes	Yes	Yes			Yes	Yes	Yes	Yes	Yes	Yes	Yes			
n257	See CA_n257H in Table 5.5A.1-2 in TS 38.101-2																		
CA_n3A-n78A-n257I	CA_n3A-n78A CA_n3A-n257A CA_n3A-n257G CA_n3A-n257H CA_n3A-n257I CA_n78A-n257A CA_n78A-n257G CA_n78A-n257H CA_n78A-n257I	n3	15	Yes	Yes	Yes	Yes	Yes	Yes									0	
			30		Yes	Yes	Yes	Yes	Yes										
			60		Yes	Yes	Yes	Yes	Yes										
		n78	15		Yes	Yes	Yes			Yes	Yes								
			30		Yes	Yes	Yes			Yes	Yes	Yes	Yes	Yes	Yes	Yes			
			60		Yes	Yes	Yes			Yes	Yes	Yes	Yes	Yes	Yes	Yes			
n257	See CA_n257I in Table 5.5A.1-2 in TS 38.101-2																		
CA_n28A-n77A-n257A	CA_n28A-n77A, CA_n28A-n257A, CA_n77A-n257A	n28	15	Yes	Yes	Yes	Yes											0	
			30		Yes	Yes	Yes												
			60																

NR CA configuration	Uplink configuration	NR Band	SCS (kHz)	5 MHz	10 MHz	15 MHz	20 MHz	25 MHz	30 MHz	40 MHz	50 MHz	60 MHz	80 MHz	90 MHz	100 MHz	200 MHz	400 MHz	Bandwidth combination set		
		n77	15		Yes	Yes	Yes			Yes	Yes									
			30		Yes	Yes	Yes			Yes	Yes	Yes	Yes	Yes	Yes					
			60		Yes	Yes	Yes			Yes	Yes	Yes	Yes	Yes	Yes					
		n257	60								Yes					Yes	Yes			
			120								Yes					Yes	Yes		Yes	
			See CA_n257D in Table 5.5A.1-1 in TS 38.101-2																	
CA_n28A-n77A-n257D	CA_n28A-n77A, CA_n28A-n257A, CA_n28A-n257D, CA_n77A-n257A, CA_n77A-n257D	n28	15	Yes	Yes	Yes	Yes											0		
			30		Yes	Yes	Yes													
			60																	
		n77	15		Yes	Yes	Yes				Yes	Yes								
			30		Yes	Yes	Yes				Yes	Yes	Yes	Yes	Yes	Yes	Yes			
			60		Yes	Yes	Yes				Yes	Yes	Yes	Yes	Yes	Yes	Yes			
n257	See CA_n257D in Table 5.5A.1-1 in TS 38.101-2																			
CA_n28A-n77A-n257G	CA_n28A-n77A, CA_n28A-n257A, CA_n28A-n257G, CA_n77A-n257A, CA_n77A-n257G	n28	15	Yes	Yes	Yes	Yes											0		
			30		Yes	Yes	Yes													
			60																	
		n77	15		Yes	Yes	Yes				Yes	Yes								
			30		Yes	Yes	Yes				Yes	Yes	Yes	Yes	Yes	Yes	Yes			
			60		Yes	Yes	Yes				Yes	Yes	Yes	Yes	Yes	Yes	Yes			
n257	See CA_n257G in Table 5.5A.1-1 in TS 38.101-2																			
CA_n28A-n77A-n257H	CA_n28A-n77A, CA_n28A-n257A, CA_n28A-n257G, CA_n28A-n257H, CA_n77A-n257A, CA_n77A-n257G, CA_n77A-n257H	n28	15	Yes	Yes	Yes	Yes											0		
			30		Yes	Yes	Yes													
			60																	
		n77	15		Yes	Yes	Yes				Yes	Yes								
			30		Yes	Yes	Yes				Yes	Yes	Yes	Yes	Yes	Yes	Yes			
			60		Yes	Yes	Yes				Yes	Yes	Yes	Yes	Yes	Yes	Yes			
n257	See CA_n257H in Table 5.5A.1-1 in TS 38.101-2																			
CA_n28A-n77A-n257I	CA_n28A-n77A, CA_n28A-n257A, CA_n28A-n257G, CA_n28A-n257H, CA_n28A-n257I, CA_n77A-n257A, CA_n77A-n257G, CA_n77A-n257H, CA_n77A-n257I	n28	15	Yes	Yes	Yes	Yes											0		
			30		Yes	Yes	Yes													
			60																	
		n78	15		Yes	Yes	Yes				Yes	Yes								
			30		Yes	Yes	Yes				Yes	Yes	Yes	Yes	Yes	Yes	Yes			
			60		Yes	Yes	Yes				Yes	Yes	Yes	Yes	Yes	Yes	Yes			
n257	See CA_n257I in Table 5.5A.1-1 in TS 38.101-2																			
CA_n28A-n77(2A)-n257A	CA_n28A-n77A, CA_n28A-n257A, CA_n77A-n257A	n28	15	Yes	Yes	Yes	Yes											0		
			30		Yes	Yes	Yes													
			60																	
		n77	See CA_n77(2A) in Table 5.5A.2-1 in TS 38.101-1																	
			n257	60									Yes				Yes		Yes	
				120									Yes				Yes		Yes	Yes

NR CA configuration	Uplink configuration	NR Band	SCS (kHz)	5 MHz	10 MHz	15 MHz	20 MHz	25 MHz	30 MHz	40 MHz	50 MHz	60 MHz	80 MHz	90 MHz	100 MHz	200 MHz	400 MHz	Bandwidth combination set	
CA_n28A-n77(2A)-n257D	CA_n28A-n77A CA_n28A-n257A CA_n28A-n257D CA_n77A-n257A CA_n77A-n257D	n28	15	Yes	Yes	Yes	Yes											0	
			30		Yes	Yes	Yes												
			60																
		n77	See CA_n77(2A) in Table 5.5A.2-1 in TS 38.101-1																
		n257	See CA_n257D in Table 5.5A.1-2 in TS 38.101-2																
CA_n28A-n77(2A)-n257G	CA_n28A-n77A CA_n28A-n257A CA_n28A-n257G CA_n77A-n257A CA_n77A-n257G	n28	15	Yes	Yes	Yes	Yes											0	
			30		Yes	Yes	Yes												
			60																
		n77	See CA_n77(2A) in Table 5.5A.2-1 in TS 38.101-1																
		n257	See CA_n257G in Table 5.5A.1-2 in TS 38.101-2																
CA_n28A-n77(2A)-n257H	CA_n28A-n77A CA_n28A-n257A CA_n28A-n257G CA_n28A-n257H CA_n77A-n257A CA_n77A-n257G CA_n77A-n257H	n28	15	Yes	Yes	Yes	Yes											0	
			30		Yes	Yes	Yes												
			60																
		n77	See CA_n77(2A) in Table 5.5A.2-1 in TS 38.101-1																
		n257	See CA_n257H in Table 5.5A.1-2 in TS 38.101-2																
CA_n28A-n77(2A)-n257I	CA_n28A-n77A CA_n28A-n257A CA_n28A-n257G CA_n28A-n257H CA_n28A-n257I CA_n77A-n257A CA_n77A-n257G CA_n77A-n257H CA_n77A-n257I	n28	15	Yes	Yes	Yes	Yes											0	
			30		Yes	Yes	Yes												
			60																
		n77	See CA_n77(2A) in Table 5.5A.2-1 in TS 38.101-1																
		n257	See CA_n257I in Table 5.5A.1-2 in TS 38.101-2																
CA_n28A-n78A-n257A	CA_n28A-n78A, CA_n28A-n257A, CA_n78A-n257A	n28	15	Yes	Yes	Yes	Yes											0	
			30		Yes	Yes	Yes												
			60																
		n78	15		Yes	Yes	Yes			Yes	Yes								
			30		Yes	Yes	Yes			Yes	Yes	Yes	Yes	Yes	Yes				
			60		Yes	Yes	Yes			Yes	Yes	Yes	Yes	Yes	Yes				
		n257	60								Yes					Yes	Yes		
120									Yes					Yes	Yes	Yes			
CA_n28A-n78A-n257D		n28	15	Yes	Yes	Yes	Yes											0	
			30		Yes	Yes	Yes												
			60																
		n78	15		Yes	Yes	Yes			Yes	Yes								

NR CA configuration	Uplink configuration	NR Band	SCS (kHz)	5 MHz	10 MHz	15 MHz	20 MHz	25 MHz	30 MHz	40 MHz	50 MHz	60 MHz	80 MHz	90 MHz	100 MHz	200 MHz	400 MHz	Bandwidth combination set	
	CA_n28A-n78A, CA_n28A-n257A, CA_n28A-n257D, CA_n78A-n257A, CA_n78A-n257D	n257	30		Yes	Yes	Yes			Yes	Yes	Yes	Yes	Yes	Yes				
			60		Yes	Yes	Yes			Yes	Yes	Yes	Yes	Yes	Yes	Yes			
CA_n28A-n78A-n257G	CA_n28A-n78A, CA_n28A-n257A, CA_n28A-n257G, CA_n78A-n257A, CA_n78A-n257G	n28	15	Yes	Yes	Yes	Yes											0	
			30		Yes	Yes	Yes												
			60																
		n78	15		Yes	Yes	Yes				Yes	Yes							
			30		Yes	Yes	Yes				Yes	Yes	Yes	Yes	Yes	Yes			
			60		Yes	Yes	Yes				Yes	Yes	Yes	Yes	Yes	Yes			
n257	See CA_n257G in Table 5.5A.1-1 in TS 38.101-2																		
CA_n28A-n78A-n257H	CA_n28A-n78A, CA_n28A-n257A, CA_n28A-n257G, CA_n28A-n257H, CA_n78A-n257A, CA_n78A-n257G, CA_n78A-n257H	n28	15	Yes	Yes	Yes	Yes											0	
			30		Yes	Yes	Yes												
			60																
		n78	15		Yes	Yes	Yes				Yes	Yes							
			30		Yes	Yes	Yes				Yes	Yes	Yes	Yes	Yes	Yes			
			60		Yes	Yes	Yes				Yes	Yes	Yes	Yes	Yes	Yes			
n257	See CA_n257H in Table 5.5A.1-1 in TS 38.101-2																		
CA_n28A-n78A-n257I	CA_n28A-n78A, CA_n28A-n257A, CA_n28A-n257G, CA_n28A-n257H, CA_n28A-n257I, CA_n78A-n257A, CA_n78A-n257G, CA_n78A-n257H, CA_n78A-n257I	n28	15	Yes	Yes	Yes	Yes											0	
			30		Yes	Yes	Yes												
			60																
		n78	15		Yes	Yes	Yes				Yes	Yes							
			30		Yes	Yes	Yes				Yes	Yes	Yes	Yes	Yes	Yes			
			60		Yes	Yes	Yes				Yes	Yes	Yes	Yes	Yes	Yes			
n257	See CA_n257I in Table 5.5A.1-1 in TS 38.101-2																		
CA_n77A-n79A-n257A	-	n77	15		Yes	Yes	Yes			Yes	Yes							0	
			30		Yes	Yes	Yes			Yes	Yes	Yes	Yes	Yes	Yes				
			60		Yes	Yes	Yes			Yes	Yes	Yes	Yes	Yes	Yes				
		n79	15								Yes	Yes							
			30								Yes	Yes	Yes	Yes		Yes			
			60								Yes	Yes	Yes	Yes		Yes			
n257	60									Yes				Yes	Yes				
	120									Yes				Yes	Yes	Yes			
CA_n77A-n79A-n257G	CA_n257G	n77	15		Yes	Yes	Yes			Yes	Yes							0	
			30		Yes	Yes	Yes			Yes	Yes	Yes	Yes	Yes	Yes				
			60		Yes	Yes	Yes			Yes	Yes	Yes	Yes	Yes	Yes				
		n79	15								Yes	Yes							
			30								Yes	Yes	Yes	Yes		Yes			



NR CA configuration	Uplink configuration	NR Band	SCS (kHz)	5 MHz	10 MHz	15 MHz	20 MHz	25 MHz	30 MHz	40 MHz	50 MHz	60 MHz	80 MHz	90 MHz	100 MHz	200 MHz	400 MHz	Bandwidth combination set	
			60							Yes	Yes	Yes	Yes		Yes				
		n257	See CA_n257G in Table 5.5A.1-1 in TS 38.101-2																
CA_n77A-n79A-n257H	CA_n257G CA_n257H	n77	15		Yes	Yes	Yes			Yes	Yes							0	
			30		Yes	Yes	Yes			Yes	Yes	Yes	Yes	Yes	Yes				
			60		Yes	Yes	Yes			Yes	Yes	Yes	Yes	Yes	Yes				
		n79	15								Yes	Yes							
			30								Yes	Yes	Yes	Yes		Yes			
			60								Yes	Yes	Yes	Yes		Yes			
n257	See CA_n257G and CA_n257H in Table 5.5A.1-1 in TS 38.101-2																		
CA_n77A-n79A-n257I	CA_n257G CA_n257H CA_n257I	n77	15		Yes	Yes	Yes			Yes	Yes							0	
			30		Yes	Yes	Yes			Yes	Yes	Yes	Yes	Yes	Yes				
			60		Yes	Yes	Yes			Yes	Yes	Yes	Yes	Yes	Yes				
		n79	15								Yes	Yes							
			30								Yes	Yes	Yes	Yes		Yes			
			60								Yes	Yes	Yes	Yes		Yes			
n257	See CA_n257G, n257H, and n257I in Table 5.5A.1-1 in TS 38.101-2																		
CA_n78A-n79A-n257A	-	n78	15		Yes	Yes	Yes			Yes	Yes							0	
			30		Yes	Yes	Yes			Yes	Yes	Yes	Yes	Yes	Yes				
			60		Yes	Yes	Yes			Yes	Yes	Yes	Yes	Yes	Yes				
		n79	15								Yes	Yes							
			30								Yes	Yes	Yes	Yes		Yes			
			60								Yes	Yes	Yes	Yes		Yes			
n257	60									Yes				Yes	Yes				
	120									Yes				Yes	Yes	Yes			
CA_n78A-n79A-n257G	CA_n257G	n78	15		Yes	Yes	Yes			Yes	Yes							0	
			30		Yes	Yes	Yes			Yes	Yes	Yes	Yes	Yes	Yes				
			60		Yes	Yes	Yes			Yes	Yes	Yes	Yes	Yes	Yes				
		n79	15								Yes	Yes							
			30								Yes	Yes	Yes	Yes		Yes			
			60								Yes	Yes	Yes	Yes		Yes			
n257	See CA_n257G in Table 5.5A.1-1 in TS 38.101-2																		
CA_n78A-n79A-n257H	CA_n257G CA_n257H	n78	15		Yes	Yes	Yes			Yes	Yes							0	
			30		Yes	Yes	Yes			Yes	Yes	Yes	Yes	Yes	Yes				
			60		Yes	Yes	Yes			Yes	Yes	Yes	Yes	Yes	Yes				
		n79	15								Yes	Yes							
			30								Yes	Yes	Yes	Yes		Yes			
			60								Yes	Yes	Yes	Yes		Yes			
n257	See CA_n257G and CA_n257H in Table 5.5A.1-1 in TS 38.101-2																		
CA_n78A-n79A-n257I		n78	15		Yes	Yes	Yes			Yes	Yes							0	
			30		Yes	Yes	Yes			Yes	Yes	Yes	Yes	Yes	Yes				

NR CA configuration	Uplink configuration	NR Band	SCS (kHz)	5 MHz	10 MHz	15 MHz	20 MHz	25 MHz	30 MHz	40 MHz	50 MHz	60 MHz	80 MHz	90 MHz	100 MHz	200 MHz	400 MHz	Bandwidth combination set	
	CA_n257G CA_n257H CA_n257I	n79	60		Yes	Yes	Yes			Yes	Yes	Yes	Yes	Yes	Yes				
			15							Yes	Yes								
			30								Yes	Yes	Yes	Yes		Yes			
			60								Yes	Yes	Yes	Yes		Yes			
		n257	See CA_n257G, CA_n257H, and CA_n257I in Table 5.5A.1-1 in TS 38.101-2																
CA_n77A-n79A-n257A	CA_n77A-n257A CA_n79A-n257A	n77	15		Yes	Yes	Yes			Yes	Yes							0	
			30		Yes	Yes	Yes			Yes	Yes	Yes	Yes	Yes	Yes				
			60		Yes	Yes	Yes			Yes	Yes	Yes	Yes	Yes	Yes				
		n79	15								Yes	Yes							
			30								Yes	Yes	Yes	Yes		Yes			
			60								Yes	Yes	Yes	Yes		Yes	Yes		
		n257	60							Yes				Yes	Yes				
			120							Yes				Yes	Yes	Yes			
CA_n77A-n79A-n257G	CA_n77A-n257A CA_n77A-n257G CA_n79A-n257A CA_n79A-n257G	n77	15		Yes	Yes	Yes			Yes	Yes							0	
			30		Yes	Yes	Yes			Yes	Yes	Yes	Yes	Yes	Yes				
			60		Yes	Yes	Yes			Yes	Yes	Yes	Yes	Yes	Yes				
		n79	15								Yes	Yes							
			30								Yes	Yes	Yes	Yes		Yes			
			60								Yes	Yes	Yes	Yes		Yes			
		n257	See CA_n257G in Table 5.5A.1-1 in TS 38.101-2																
CA_n77A-n79A-n257H	CA_n77A-n257A CA_n77A-n257G CA_n77A-n257H CA_n79A-n257A CA_n79A-n257G CA_n79A-n257H	n77	15		Yes	Yes	Yes			Yes	Yes							0	
			30		Yes	Yes	Yes			Yes	Yes	Yes	Yes	Yes	Yes				
			60		Yes	Yes	Yes			Yes	Yes	Yes	Yes	Yes	Yes				
		n79	15								Yes	Yes							
			30								Yes	Yes	Yes	Yes		Yes			
			60								Yes	Yes	Yes	Yes		Yes			
		n257	See CA_n257G and n257H in Table 5.5A.1-1 in TS 38.101-2																
CA_n77A-n79A-n257I	CA_n77A-n257A CA_n77A-n257G CA_n77A-n257H CA_n77A-n257I CA_n79A-n257A CA_n79A-n257G CA_n79A-n257H CA_n79A-n257I	n77	15		Yes	Yes	Yes			Yes	Yes							0	
			30		Yes	Yes	Yes			Yes	Yes	Yes	Yes	Yes	Yes				
			60		Yes	Yes	Yes			Yes	Yes	Yes	Yes	Yes	Yes				
		n79	15								Yes	Yes							
			30								Yes	Yes	Yes	Yes		Yes			
			60								Yes	Yes	Yes	Yes		Yes			
		n257	See CA_n257G, n257H, and n257I in Table 5.5A.1-1 in TS 38.101-2																
CA_n78A-n79A-n257A	CA_n78A-n257A CA_n79A-n257A	n78	15		Yes	Yes	Yes			Yes	Yes							0	
			30		Yes	Yes	Yes			Yes	Yes	Yes	Yes	Yes	Yes				
			60		Yes	Yes	Yes			Yes	Yes	Yes	Yes	Yes	Yes				
		n79	15								Yes	Yes							
			30								Yes	Yes	Yes	Yes		Yes			
			60							Yes	Yes	Yes	Yes		Yes				

NR CA configuration	Uplink configuration	NR Band	SCS (kHz)	5 MHz	10 MHz	15 MHz	20 MHz	25 MHz	30 MHz	40 MHz	50 MHz	60 MHz	80 MHz	90 MHz	100 MHz	200 MHz	400 MHz	Bandwidth combination set	
		n257	60								Yes				Yes	Yes			
			120								Yes				Yes	Yes	Yes		
CA_n78A-n79A-n257G	CA_n78A-n257A CA_n78A-n257G CA_n79A-n257A CA_n79A-n257G	n78	15		Yes	Yes	Yes			Yes	Yes							0	
			30		Yes	Yes	Yes			Yes	Yes	Yes	Yes	Yes					
			60		Yes	Yes	Yes			Yes	Yes	Yes	Yes	Yes					
		n79	15								Yes	Yes							
			30								Yes	Yes	Yes	Yes		Yes			
			60								Yes	Yes	Yes	Yes		Yes			
n257	See CA_n257G in Table 5.5A.1-1 in TS 38.101-2																		
CA_n78A-n79A-n257H	CA_n78A-n257A CA_n78A-n257G CA_n78A-n257H CA_n79A-n257A CA_n79A-n257G CA_n79A-n257H	n78	15		Yes	Yes	Yes			Yes	Yes							0	
			30		Yes	Yes	Yes			Yes	Yes	Yes	Yes	Yes	Yes				
			60		Yes	Yes	Yes			Yes	Yes	Yes	Yes	Yes	Yes				
		n79	15								Yes	Yes							
			30								Yes	Yes	Yes	Yes		Yes			
			60								Yes	Yes	Yes	Yes		Yes			
n257	See CA_n257G and n257H in Table 5.5A.1-1 in TS 38.101-2																		
CA_n78A-n79A-n257I	CA_n78A-n257A CA_n78A-n257G CA_n78A-n257H CA_n78A-n257I CA_n79A-n257A CA_n79A-n257G CA_n79A-n257H CA_n79A-n257I	n78	15		Yes	Yes	Yes			Yes	Yes							0	
			30		Yes	Yes	Yes			Yes	Yes	Yes	Yes	Yes	Yes				
			60		Yes	Yes	Yes			Yes	Yes	Yes	Yes	Yes	Yes				
		n79	15								Yes	Yes							
			30								Yes	Yes	Yes	Yes		Yes			
			60								Yes	Yes	Yes	Yes		Yes			
n257	See CA_n257G, n257H, and n257I in Table 5.5A.1-1 in TS 38.101-2																		

Table 5.5A.1-3: Inter-band CA configurations and bandwidth combination sets between FR1 and FR2 (four bands)

NR CA configuration	Uplink configuration	NR Band	SCS (kHz)	5 MHz	10 MHz	15 MHz	20 MHz	25 MHz	30 MHz	40 MHz	50 MHz	60 MHz	80 MHz	90 MHz	100 MHz	200 MHz	400 MHz	Bandwidth combination set		
CA_n3A-n28A-n77A-n257A	-	n3	15	Yes	Yes	Yes	Yes	Yes	Yes									0		
			30		Yes	Yes	Yes	Yes	Yes	Yes										
			60		Yes	Yes	Yes	Yes	Yes	Yes										
		n28	15	Yes	Yes	Yes	Yes													
			30		Yes	Yes	Yes													
			60																	
		n77	15		Yes	Yes	Yes					Yes	Yes							
			30		Yes	Yes	Yes					Yes	Yes	Yes	Yes	Yes				
			60		Yes	Yes	Yes					Yes	Yes	Yes	Yes	Yes	Yes			
		n257	60									Yes				Yes	Yes			

NR CA configuration	Uplink configuration	NR Band	SCS (kHz)	5 MHz	10 MHz	15 MHz	20 MHz	25 MHz	30 MHz	40 MHz	50 MHz	60 MHz	80 MHz	90 MHz	100 MHz	200 MHz	400 MHz	Bandwidth combination set		
			120								Yes				Yes	Yes	Yes			
CA_n3A-n28A-n77A-n257D	-	n3	15	Yes	Yes	Yes	Yes	Yes	Yes										0	
			30		Yes	Yes	Yes	Yes	Yes											
			60		Yes	Yes	Yes	Yes	Yes											
		n28	15	Yes	Yes	Yes	Yes													
			30		Yes	Yes	Yes													
			60																	
		n77	15		Yes	Yes	Yes				Yes	Yes								
			30		Yes	Yes	Yes				Yes	Yes	Yes	Yes	Yes	Yes	Yes			
			60		Yes	Yes	Yes				Yes	Yes	Yes	Yes	Yes	Yes	Yes			
		n257	See CA_n257D BCS0 in Table 5.5A.1-1 in TS 38.101-2																	
CA_n3A-n28A-n77A-n257G	-	n3	15	Yes	Yes	Yes	Yes	Yes	Yes										0	
			30		Yes	Yes	Yes	Yes	Yes											
			60		Yes	Yes	Yes	Yes	Yes											
		n28	15	Yes	Yes	Yes	Yes													
			30		Yes	Yes	Yes													
			60																	
		n77	15		Yes	Yes	Yes				Yes	Yes								
			30		Yes	Yes	Yes				Yes	Yes	Yes	Yes	Yes	Yes	Yes			
			60		Yes	Yes	Yes				Yes	Yes	Yes	Yes	Yes	Yes	Yes			
		n257	See CA_n257G BCS0 in Table 5.5A.1-1 in TS 38.101-2																	
CA_n3A-n28A-n77A-n257H	-	n3	15	Yes	Yes	Yes	Yes	Yes	Yes										0	
			30		Yes	Yes	Yes	Yes	Yes											
			60		Yes	Yes	Yes	Yes	Yes											
		n28	15	Yes	Yes	Yes	Yes													
			30		Yes	Yes	Yes													
			60																	
		n77	15		Yes	Yes	Yes				Yes	Yes								
			30		Yes	Yes	Yes				Yes	Yes	Yes	Yes	Yes	Yes	Yes			
			60		Yes	Yes	Yes				Yes	Yes	Yes	Yes	Yes	Yes	Yes			
		n257	See CA_n257H BCS0 in Table 5.5A.1-1 in TS 38.101-2																	
CA_n3A-n28A-n77A-n257I	-	n3	15	Yes	Yes	Yes	Yes	Yes	Yes										0	
			30		Yes	Yes	Yes	Yes	Yes											
			60		Yes	Yes	Yes	Yes	Yes											
		n28	15	Yes	Yes	Yes	Yes													
			30		Yes	Yes	Yes													
			60																	
		n77	15		Yes	Yes	Yes				Yes	Yes								
			30		Yes	Yes	Yes				Yes	Yes	Yes	Yes	Yes	Yes	Yes			
			60		Yes	Yes	Yes				Yes	Yes	Yes	Yes	Yes	Yes	Yes			
		n257	See CA_n257I BCS0 in Table 5.5A.1-1 in TS 38.101-2																	
	-	n3	15	Yes	Yes	Yes	Yes	Yes	Yes									0		

NR CA configuration	Uplink configuration	NR Band	SCS (kHz)	5 MHz	10 MHz	15 MHz	20 MHz	25 MHz	30 MHz	40 MHz	50 MHz	60 MHz	80 MHz	90 MHz	100 MHz	200 MHz	400 MHz	Bandwidth combination set		
CA_n3A-n28A-n77(2A)-n257A			30		Yes	Yes	Yes	Yes	Yes											
			60		Yes	Yes	Yes	Yes	Yes											
			15	Yes	Yes	Yes	Yes													
		n28	30		Yes	Yes														
			60																	
			n77	See CA_n77(2A) BCS0 in Table 5.5A.2-1 in TS 38.101-1																
			n257	60										Yes					Yes	Yes
120											Yes				Yes	Yes	Yes			
CA_n3A-n28A-n77(2A)-n257D		n3	15	Yes	Yes	Yes	Yes	Yes	Yes									0		
			30		Yes	Yes	Yes	Yes	Yes											
			60		Yes	Yes	Yes	Yes	Yes											
		n28	15	Yes	Yes	Yes	Yes													
			30		Yes	Yes	Yes													
			60																	
		n77	See CA_n77(2A) BCS0 in Table 5.5A.2-1 in TS 38.101-1																	
n257	See CA_n257D BCS0 in Table 5.5A.1-1 in TS 38.101-2																			
CA_n3A-n28A-n77(2A)-n257G		n3	15	Yes	Yes	Yes	Yes	Yes	Yes									0		
			30		Yes	Yes	Yes	Yes	Yes											
			60		Yes	Yes	Yes	Yes	Yes											
		n28	15	Yes	Yes	Yes	Yes													
			30		Yes	Yes	Yes													
			60																	
		n77	See CA_n77(2A) BCS0 in Table 5.5A.2-1 in TS 38.101-1																	
n257	See CA_n257G BCS0 in Table 5.5A.1-1 in TS 38.101-2																			
CA_n3A-n28A-n77(2A)-n257H		n3	15	Yes	Yes	Yes	Yes	Yes	Yes									0		
			30		Yes	Yes	Yes	Yes	Yes											
			60		Yes	Yes	Yes	Yes	Yes											
		n28	15	Yes	Yes	Yes	Yes													
			30		Yes	Yes	Yes													
			60																	
		n77	See CA_n77(2A) BCS0 in Table 5.5A.2-1 in TS 38.101-1																	
n257	See CA_n257H BCS0 in Table 5.5A.1-1 in TS 38.101-2																			
CA_n3A-n28A-n77(2A)-n257I		n3	15	Yes	Yes	Yes	Yes	Yes	Yes									0		
			30		Yes	Yes	Yes	Yes	Yes											
			60		Yes	Yes	Yes	Yes	Yes											
		n28	15	Yes	Yes	Yes	Yes													
			30		Yes	Yes	Yes													
			60																	
		n77	See CA_n77(2A) BCS0 in Table 5.5A.2-1 in TS 38.101-1																	
n257	See CA_n257I BCS0 in Table 5.5A.1-1 in TS 38.101-2																			
CA_n3A-n28A-n78A-n257A		n3	15	Yes	Yes	Yes	Yes	Yes	Yes									0		
			30		Yes	Yes	Yes	Yes	Yes											

NR CA configuration	Uplink configuration	NR Band	SCS (kHz)	5 MHz	10 MHz	15 MHz	20 MHz	25 MHz	30 MHz	40 MHz	50 MHz	60 MHz	80 MHz	90 MHz	100 MHz	200 MHz	400 MHz	Bandwidth combination set				
		n28	60		Yes	Yes	Yes	Yes	Yes													
			15	Yes	Yes	Yes	Yes															
			30		Yes	Yes	Yes															
			60																			
		n78	15		Yes	Yes	Yes					Yes	Yes									
			30		Yes	Yes	Yes					Yes	Yes	Yes	Yes	Yes	Yes					
			60		Yes	Yes	Yes					Yes	Yes	Yes	Yes	Yes	Yes					
		n257	60										Yes				Yes	Yes				
			120										Yes				Yes	Yes		Yes		
		CA_n3A-n28A-n78A-n257D	-	n3	15	Yes	Yes	Yes	Yes	Yes	Yes											0
					30		Yes	Yes	Yes	Yes	Yes	Yes										
					60		Yes	Yes	Yes	Yes	Yes	Yes										
n28	15			Yes	Yes	Yes	Yes															
	30				Yes	Yes	Yes															
	60																					
n78	15				Yes	Yes	Yes					Yes	Yes									
	30				Yes	Yes	Yes					Yes	Yes	Yes	Yes	Yes	Yes					
	60				Yes	Yes	Yes					Yes	Yes	Yes	Yes	Yes	Yes					
n257	See CA_n257D BCS0 in Table 5.5A.1-1 in TS 38.101-2																					
CA_n3A-n28A-n78A-n257G	-			n3	15	Yes	Yes	Yes	Yes	Yes	Yes										0	
					30		Yes	Yes	Yes	Yes	Yes											
		60			Yes	Yes	Yes	Yes	Yes													
		n28	15	Yes	Yes	Yes	Yes															
			30		Yes	Yes	Yes															
			60																			
		n78	15		Yes	Yes	Yes					Yes	Yes									
			30		Yes	Yes	Yes					Yes	Yes	Yes	Yes	Yes	Yes					
			60		Yes	Yes	Yes					Yes	Yes	Yes	Yes	Yes	Yes					
		n257	See CA_n257G BCS0 in Table 5.5A.1-1 in TS 38.101-2																			
		CA_n3A-n28A-n78A-n257H	-	n3	15	Yes	Yes	Yes	Yes	Yes	Yes											0
					30		Yes	Yes	Yes	Yes	Yes											
60					Yes	Yes	Yes	Yes	Yes													
n28	15			Yes	Yes	Yes	Yes															
	30				Yes	Yes	Yes															
	60																					
n78	15				Yes	Yes	Yes					Yes	Yes									
	30				Yes	Yes	Yes					Yes	Yes	Yes	Yes	Yes	Yes					
	60				Yes	Yes	Yes					Yes	Yes	Yes	Yes	Yes	Yes					
n257	See CA_n257H BCS0 in Table 5.5A.1-1 in TS 38.101-2																					
CA_n3A-n28A-n78A-n257I	-			n3	15	Yes	Yes	Yes	Yes	Yes	Yes										0	
					30		Yes	Yes	Yes	Yes	Yes											
		60			Yes	Yes	Yes	Yes	Yes													

NR CA configuration	Uplink configuration	NR Band	SCS (kHz)	5 MHz	10 MHz	15 MHz	20 MHz	25 MHz	30 MHz	40 MHz	50 MHz	60 MHz	80 MHz	90 MHz	100 MHz	200 MHz	400 MHz	Bandwidth combination set
		n28	15	Yes	Yes	Yes	Yes											
			30		Yes	Yes	Yes											
			60															
		n78	15		Yes	Yes	Yes			Yes	Yes							
			30		Yes	Yes	Yes			Yes	Yes	Yes	Yes	Yes	Yes			
			60		Yes	Yes	Yes			Yes	Yes	Yes	Yes	Yes	Yes			
		n257	See CA_n257  BCS0 in Table 5.5A.1-1 in TS 38.101-2															

## 5.5B Configuration for DC

### 5.5B.1 General

The operating bands and bandwidth classes are specified for operation with EN-DC, NGEN-DC, NE-DC or NR-DC configured. The EN-DC, NGEN-DC or NE-DC band combinations include at least one E-UTRA operating band.

For EN-DC or NE-DC configurations indicated by column "Single Uplink allowed" (e.g., problematic band combinations as defined in TS 38.306 [11]) in tables in this clause the UE may indicate capability of not supporting simultaneous dual and triple uplink operation due to possible intermodulation interference to its own primary downlink channel bandwidth of PCell or PSCell if the intermodulation order is 2 or if the intermodulation order is 3 for the combinations when both operating bands are between 450 MHz – 960 MHz or between 1427 MHz – 2690 MHz.

In the case for EN-DC or NE-DC configurations listed in tables in this clause for which the intermodulation products caused by the dual and triple uplink operation fall into the receive band but do not interfere with its own primary downlink channel bandwidth of PCell or PSCell as defined in Annex I the UE is mandated to operate in dual and triple uplink mode. Single Uplink is also allowed for certain band combinations where intermodulation or reverse intermodulation products could create difficulty for meeting emission requirements. For EN-DC combinations of order 3 or higher, "Single Uplink allowed" UL configurations captured in Table 5.5B.2-1, Table 5.5B.3-1, and Table 5.5B.4-1 apply.

If multiple UL DC configurations are listed for multiple DL DC configurations, valid uplink configurations are such that uplink does not have more carriers than downlink.

The configurations for operating bands for DC including Band n41 also apply for the corresponding operating bands for DC with Band n90 replacing Band n41 but with otherwise identical parameters. For brevity the said configuration for operating bands for DC with Band n90 are not listed in the tables below but are covered by this specification.

Non contiguous resource allocation and almost contiguous allocation are not applicable for E UTRA or NR carrier part of intra band EN DC configuration.



## 5.5B.2 Intra-band contiguous EN-DC

**Table 5.5B.2-1: Intra-band contiguous EN-DC configurations**

EN-DC configuration	Uplink EN-DC configuration (NOTE 1)	Single UL allowed
DC_(n)5AA	DC_(n)5AA <sup>6</sup>	Yes <sup>6</sup>
DC_(n)12AA	DC_(n)12AA <sup>6</sup>	Yes <sup>6</sup>
DC_(n)38AA <sup>5</sup>	DC_(n)38AA <sup>6</sup>	Yes <sup>6</sup>
DC_(n)41AA <sup>5</sup> DC_(n)41AB <sup>5</sup> DC_(n)41CA <sup>5</sup> DC_(n)41DA <sup>5</sup>	DC_(n)41AA	Yes <sup>3</sup>
DC_(n)41AB <sup>5</sup> DC_(n)41CA <sup>5</sup> DC_(n)41DA <sup>5</sup>	DC_41A_n41A	Yes <sup>3</sup>
DC_(n)48AA <sup>5</sup>	DC_(n)48AA <sup>6</sup>	Yes <sup>6</sup>
DC_(n)48CA <sup>5</sup>	DC_(n)48AA <sup>6</sup> DC_48A_n48A <sup>6</sup>	Yes <sup>6</sup>
DC_(n)48DA <sup>5</sup>	DC_(n)48AA <sup>6</sup> DC_48A_n48A <sup>6</sup>	Yes <sup>6</sup>
DC_(n)71AA <sup>2</sup>	DC_(n)71AA	No <sup>4</sup>
NOTE 1: Uplink EN-DC configurations are the configurations supported by the present release of specifications.		
NOTE 2: Requirements in this specification apply for NR SCS of 15 kHz only.		
NOTE 3: Single UL allowed due to potential emission issues, not self-interference.		
NOTE 4: For UE(s) supporting dynamic power sharing it is mandatory to do dual simultaneous UL. For UE(s) not supporting dynamic power sharing single UL is allowed.		
NOTE 5: The minimum requirements only apply for non-simultaneous Tx/Rx between all carriers.		
NOTE 6: Only single switched UL is supported		

## 5.5B.3 Intra-band non-contiguous EN-DC

**Table 5.5B.3-1: Intra-band non-contiguous EN-DC configurations**

EN-DC configuration	Uplink EN-DC configuration (NOTE 1)	Single UL allowed
DC_2A_n2A	DC_2A_n2A <sup>5</sup>	Yes <sup>5</sup>
DC_3A_n3A	DC_3A_n3A <sup>2</sup>	Yes <sup>2</sup>
DC_5A_n5A	DC_5A_n5A <sup>5</sup>	Yes <sup>5</sup>
DC_7A_n7A <sup>6</sup>	DC_7A_n7A <sup>5</sup>	Yes <sup>5</sup>
DC_41A_n41A <sup>3</sup> DC_41C_n41A <sup>3</sup> DC_41D_n41A <sup>3</sup>	DC_41A_n41A	Yes <sup>4</sup>
DC_48A_n48A <sup>3</sup>	DC_48A_n48A <sup>5</sup>	Yes <sup>5</sup>
DC_48A_(n)48AA <sup>3</sup>	DC_(n)48AA <sup>5</sup> DC_48A_n48A <sup>5</sup>	Yes <sup>5</sup>
DC_48A-48A_n48A <sup>3</sup>	DC_48A_n48A <sup>5</sup>	Yes <sup>5</sup>
DC_48C_n48A <sup>3</sup>	DC_48A_n48A <sup>5</sup>	Yes <sup>5</sup>
DC_48D_n48A <sup>3</sup>	DC_48A_n48A <sup>5</sup>	Yes <sup>5</sup>
DC_66A_n66A	DC_66A_n66A <sup>5</sup>	Yes <sup>5</sup>
NOTE 1: Uplink EN-DC configurations are the configurations supported by the present release of specifications.		
NOTE 2: Only single switched UL is supported in Rel.15		
NOTE 3: The minimum requirements only apply for non-simultaneous Tx/Rx between all carriers.		
NOTE 4: Single UL allowed due to potential emission issues, not self-interference.		
NOTE 5: Only single switched UL is supported.		
NOTE 6: Requirements in this specification apply for NR SCS of 15 kHz only.		

## 5.5B.4 Inter-band EN-DC within FR1

### 5.5B.4.1 Inter-band EN-DC configurations within FR1 (two bands)

**Table 5.5B.4.1-1: Inter-band EN-DC configurations within FR1 (two bands)**

EN-DC configuration	Uplink EN-DC configuration (NOTE 1)	Single UL allowed
DC_1A_n3A DC_1C_n3A	DC_1A_n3A DC_1C_n3A	DC_1_n3
DC_1A_n5A	DC_1A_n5A	No
DC_1A_n7A DC_1A_n7B	DC_1A_n7A	No
DC_1A-1A_n7A DC_1A-1A_n7B	DC_1A_n7A	No
DC_1A_n8A	DC_1A_n8A	No
DC_1A_n20A	DC_1A_n20A	No
DC_1A_n28A	DC_1A_n28A	No
DC_1A_n38A DC_1C_n38A	DC_1A_n38A	No
DC_1A_n40A	DC_1A_n40A	No
DC_1A_n41A	DC_1A_n41A	No
DC_1A_n50A	DC_1A_n50A	No
DC_1A_n51A	DC_1A_n51A	No
DC_1A_n71A DC_1A_n71B	DC_1A_n71A	No
DC_1A_n77A <sup>7</sup> DC_1A_n77C <sup>7</sup>	DC_1A_n77A	DC_1_n77
DC_1A_n77(2A)	DC_1A_n77A	DC_1_n77
DC_1A_n78A <sup>7</sup> DC_1A_n78C <sup>7</sup>	DC_1A_n78A	No
DC_1A_n78(2A) <sup>7</sup>	DC_1A_n78A	No
DC_1A_n79A <sup>7</sup> DC_1A_n79C <sup>7</sup>	DC_1A_n79A	No
DC_2A_n5A	DC_2A_n5A	No
DC_2A-2A_n5A	DC_2A_n5A	No
DC_2A_n7A	DC_2A_n7A	No
DC_2A_n7(2A)	DC_2A_n7A	No
DC_2A_n12A	DC_2A_n12A	No
DC_2A_n38A	DC_2A_n38A	No
DC_2A-2A_n38A	DC_2A_n38A	No
DC_2A_n41A DC_2A_n41C DC_2C_n41A	DC_2A_n41A DC_2C_n41A	No
DC_2A-2A_n41A DC_2A_n41(2A)	DC_2A_n41A	No
DC_2A_n48A DC_2A_n48B	DC_2A_n48A	No
DC_2A_n66A	DC_2A_n66A	DC_2_n66
DC_2A-2A_n66A	DC_2A_n66A	DC_2_n66
DC_2A_n71A DC_2A_n71B DC_2C_n71A	DC_2A_n71A DC_2C_n71A	No
DC_2A-2A_n71A	DC_2A_n71A	No
DC_2A_n78A	DC_2A_n78A	DC_2_n78
DC_2A_n78(2A)	DC_2A_n78A	DC_2_n78
DC_2A-2A_n78A	DC_2A_n78A	DC_2_n78
DC_3A_n1A DC_3C_n1A	DC_3A_n1A DC_3C_n1A	DC_3_n1
DC_3A-3A_n1A	DC_3A_n1A	DC_3_n1
DC_3A_n5A DC_3C_n5A	DC_3A_n5A DC_3C_n5A	DC_3_n5

EN-DC configuration	Uplink EN-DC configuration (NOTE 1)	Single UL allowed
DC_3A_n7A DC_3A_n7B DC_3C_n7A DC_3C_n7B	DC_3A_n7A DC_3A_n7B DC_3C_n7A	No
DC_3A-3A_n7A DC_3A-3A_n7B	DC_3A_n7A	No
DC_3A_n8A	DC_3A_n8A	No
DC_3A_n20A	DC_3A_n20A	No
DC_3A_n28A DC_3C_n28A	DC_3A_n28A DC_3C_n28A	No
DC_3A_n34A	DC_3A_n34A	No
DC_3A_n38A DC_3C_n38A	DC_3A_n38A	No
DC_3A_n40A	DC_3A_n40A	No
DC_3A_n41A DC_3C_n41A	DC_3A_n41A DC_3C_n41A	DC_3_n41
DC_3A_n50A	DC_3A_n50A	No
DC_3A_n51A	DC_3A_n51A	No
DC_3A_n71A DC_3A_n71B	DC_3A_n71A	No
DC_3A_n77A <sup>7</sup> DC_3A_n77C <sup>7</sup>	DC_3A_n77A	DC_3_n77
DC_3A_n77(2A) <sup>7</sup>	DC_3A_n77A	DC_3_n77
DC_3A-3A_n77A	DC_3A_n77A	DC_3_n77
DC_3A_n78A <sup>7</sup> DC_3A_n78C <sup>7</sup> DC_3C_n78A <sup>7</sup>	DC_3A_n78A	DC_3_n78
DC_3A_n78(2A) <sup>7</sup> DC_3C_n78(2A) <sup>7</sup>	DC_3A_n78A	DC_3_n78
DC_3A-3A_n78A	DC_3A_n78A	DC_3_n78
DC_3A_n79A <sup>7</sup> DC_3A_n79C <sup>7</sup> DC_3C_n79A <sup>7</sup>	DC_3A_n79A DC_3C_n79A	No
DC_4A_n38A	DC_4A_n38A	No
DC_4A_n41A	DC_4A_n41A	No
DC_4A_n78A	DC_4A_n78A	No
DC_4A_n78(2A)	DC_4A_n78A	No
DC_5A_n2A DC_5B_n2A	DC_5A_n2A	No
DC_5A-5A_n2A	DC_5A_n2A	No
DC_5A_n7A	DC_5A_n7A	DC_5_n7
DC_5A_n7(2A)	DC_5A_n7A	DC_5_n7
DC_5A_n12A	DC_5A_n12A	No
DC_5A_n38A	DC_5A_n38A	DC_5_n38
DC_5A_n40A	DC_5A_n40A	No
DC_5A_n48A DC_5A_n48B	DC_5A_n48A	No
DC_5A_n66A DC_5B_n66A	DC_5A_n66A	DC_5_n66
DC_5A-5A_n66A	DC_5A_n66A	DC_5_n66
DC_5A_n71A	DC_5A_n71A	No
DC_5A_n78A <sup>7</sup>	DC_5A_n78A	No
DC_5A_n78(2A) <sup>7</sup>	DC_5A_n78A	No
DC_5A_n79A	DC_5A_n79A	No

EN-DC configuration	Uplink EN-DC configuration (NOTE 1)	Single UL allowed
DC_7A_n1A DC_7C_n1A	DC_7A_n1A DC_7C_n1A	No
DC_7A-7A_n1A	DC_7A_n1A	No
DC_7A_n3A DC_7C_n3A	DC_7A_n3A DC_7C_n3A	No
DC_7A_n5A DC_7C_n5A	DC_7A_n5A DC_7C_n5A	DC_7_n5
DC_7A-7A_n5A	DC_7A_n5A	DC_7_n5
DC_7A_n8A	DC_7A_n8A	No
DC_7A-7A_n78A <sup>7</sup>	DC_7A_n78A	No
DC_7A-7A_n78(2A) <sup>7</sup>	DC_7A_n78A	No
DC_7A_n20A	DC_7A_n20A	No
DC_7A_n28A DC_7C_n28A	DC_7A_n28A DC_7C_n28A	No
DC_7A_n40A	DC_7A_n40A	Yes
DC_7A_n51A	DC_7A_n51A	No
DC_7A_n66A DC_7C_n66A	DC_7A_n66A	No
DC_7A-7A_n66A	DC_7A_n66A	No
DC_7A_n71A	DC_7A_n71A	No
DC_7A_n77A	DC_7A_n77A	No
DC_7A-7A_n77A	DC_7A_n77A	No
DC_7A_n78A <sup>7</sup> DC_7C_n78A <sup>7</sup>	DC_7A_n78A DC_7C_n78A	No
DC_7A_n78(2A) <sup>7</sup> DC_7C_n78(2A) <sup>7</sup>	DC_7A_n78A DC_7C_n78A	No
DC_8A_n1A	DC_8A_n1A	No
DC_8A_n3A	DC_8A_n3A	No
DC_8A_n20A	DC_8A_n20A	Yes
DC_8A_n28A	DC_8A_n28A	No
DC_8A_n34A	DC_8A_n34A	No
DC_8A_n39A	DC_8A_n39A	No
DC_8A_n40A <sup>7</sup>	DC_8A_n40A	No
DC_8A_n41A DC_8A_n41C	DC_8A_n41A	No
DC_8A_n41(2A)	DC_8A_n41A	No
DC_8A_n77A <sup>7</sup>	DC_8A_n77A	No
DC_8A_n77(2A) <sup>7</sup>	DC_8A_n77A	No
DC_8A_n78A <sup>7</sup>	DC_8A_n78A	No
DC_8A_n79A <sup>7</sup> DC_8A_n79C	DC_8A_n79A DC_8A_n79C	No
DC_8A_n93A	DC_8A_n93A_ULSUP-TDM	N/A
DC_8A_n94A	DC_8A_n94A_ULSUP-TDM	N/A
DC_11A_n3A	DC_11A_n3A	No
DC_11A_n28A	DC_11A_n28A	No

EN-DC configuration	Uplink EN-DC configuration (NOTE 1)	Single UL allowed
DC_11A_n77A <sup>7</sup>	DC_11A_n77A	No
DC_11A_n77(2A) <sup>7</sup>	DC_11A_n77A	No
DC_11A_n78A <sup>7</sup>	DC_11A_n78A	No
DC_11A_n79A <sup>7</sup>	DC_11A_n79A	No
DC_12A_n2A	DC_12A_n2A	No
DC_12A_n5A	DC_12A_n5A	No
DC_12A_n7A DC_12A_n7(2A)	DC_12A_n7A	No
DC_12A_n25A	DC_12A_n25A	No
DC_12A_n38A	DC_12A_n38A	No
DC_12A_n41A	DC_12A_n41A	No
DC_12A_n66A	DC_12A_n66A	No
DC_12A_n78A DC_12A_n78(2A)	DC_12A_n78A	DC_12_n78
<b>DC_13A_n2A</b>	DC_13A_n2A	No
DC_13A_n5A	DC_13A_n5A	DC_13_n5
DC_13A_n7A DC_13A_n7(2A)	DC_13A_n7A	No
DC_13A_n48A DC_13A_n48B	DC_13A_n48A	No
DC_13A_n66A	DC_13A_n66A	No
DC_13A_n71A	DC_13A_n71A	No
DC_13A_n78A DC_13A_n78(2A)	DC_13A_n78A	No
DC_14A_n2A	DC_14A_n2A	No
DC_14A_n66A	DC_14A_n66A	No
DC_18A_n3A	DC_18A_n3A	No
DC_18A_n77A <sup>7</sup>	DC_18A_n77A	No
DC_18A_n78A <sup>7</sup>	DC_18A_n78A	No
DC_20A_n91A	DC_20A_n91A_ULSUP-TDM	N/A
DC_20A_n92A	DC_20A_n92A_ULSUP-TDM	N/A
DC_18A_n79A <sup>7</sup>	DC_18A_n79A	No
DC_19A_n77A <sup>7</sup> DC_19A_n77C <sup>7</sup>	DC_19A_n77A	No
DC_19A_n78A <sup>7</sup> DC_19A_n78C <sup>7</sup>	DC_19A_n78A	No
DC_19A_n79A <sup>7</sup> DC_19A_n79C <sup>7</sup>	DC_19A_n79A	No
DC_20A_n1A	DC_20A_n1A	No
DC_20A_n3A	DC_20A_n3A	No
DC_20A_n7A	DC_20A_n7A	DC_20_n7
DC_20A_n8A	DC_20A_n8A	DC_20_n8
DC_20A_n28A <sup>8,10,11,13</sup>	DC_20A_n28A	No
DC_20A_n38A	DC_20A_n38A	No
DC_20A_n41A	DC_20A_n41A	DC_20_n41
DC_20A_n50A	DC_20A_n50A	No
DC_20A_n51A	DC_20A_n51A	No
DC_20A_n77A <sup>7</sup>	DC_20A_n77A	No
DC_20A_n78A <sup>7</sup>	DC_20A_n78A	No

EN-DC configuration	Uplink EN-DC configuration (NOTE 1)	Single UL allowed
DC_20A_n78(2A) <sup>7</sup>	DC_20A_n78A	No
DC_21A_n77A <sup>7</sup> DC_21A_n77C <sup>7</sup>	DC_21A_n77A	No
DC_21A_n78A <sup>7</sup> DC_21A_n78C <sup>7</sup>	DC_21A_n78A	No
DC_21A_n79A <sup>7</sup> DC_21A_n79C <sup>7</sup>	DC_21A_n79A	No
DC_25A_n41A	DC_25A_n41A	No
DC_25A-25A_n41A	DC_25A_n41A	No
DC_26A_n25A	DC_26A_n25A	No
DC_26A_n41A	DC_26A_n41A	No
DC_26A_n77A <sup>7</sup>	DC_26A_n77A	No
DC_26A_n78A <sup>7</sup>	DC_26A_n78A	No
DC_26A_n79A <sup>7</sup>	DC_26A_n79A	No
DC_28A_n3A	DC_28A_n3A	No
DC_28A_n5A <sup>8</sup>	DC_28A_n5A	No
DC_28A_n7A DC_28A_n7B	DC_28A_n7A DC_28A_n7B	No
DC_28A_n51A	DC_28A_n51A	No
DC_28A_n8A	DC_28A_n8A	No
DC_28A_n40A	DC_28A_n40A	No
DC_28A_n41A	DC_28A_n41A	No
DC_28A_n50A	DC_28A_n50A	No
DC_28A_n77A <sup>7</sup> DC_28A_n77C <sup>7</sup>	DC_28A_n77A	No
DC_28A_n77(2A) <sup>7</sup>	DC_28A_n77A	No
DC_28A_n78A <sup>7</sup> DC_28A_n78C <sup>7</sup>	DC_28A_n78A	No
DC_28A_n78(2A)	DC_28A_n78A	No
DC_28A_n79A <sup>7</sup> DC_28A_n79C <sup>7</sup>	DC_28A_n79A	No
DC_30A_n2A	DC_30A_n2A	No
DC_30A_n5A	DC_30A_n5A	No
DC_30A_n66A	DC_30A_n66A	No
DC_38A_n78A <sup>7</sup>	DC_38A_n78A	No
DC_39A_n40A <sup>3</sup>	DC_39A_n40A	No
DC_39A_n41A DC_39C_n41A	DC_39A_n41A DC_39C_n41A	No
DC_39A_n78A <sup>5,7</sup>	DC_39A_n78A	No
DC_39A_n79A <sup>7</sup> DC_39A_n79C <sup>7</sup>	DC_39A_n79A	No
DC_40A_n1A	DC_40A_n1A	No
DC_40A_n41A <sup>3</sup> DC_40C_n41A <sup>3</sup>	DC_40A_n41A	No
DC_40A_n77A	DC_40A_n77A	No
DC_40A_n78A DC_40C_n78A	DC_40A_n78A DC_40C_n78A	No
DC_40A_n79A <sup>7,12</sup> DC_40C_n79A <sup>7,12</sup>	DC_40A_n79A	No
DC_41A_n3A DC_41C_n3A	DC_41A_n3A DC_41C_n3A	No
DC_41A_n28A DC_41C_n28A	DC_41A_n28A DC_41C_n28A	No

EN-DC configuration	Uplink EN-DC configuration (NOTE 1)	Single UL allowed
DC_41A_n77A DC_41C_n77A	DC_41A_n77A DC_41C_n77A	No
DC_41A_n77(2A) DC_41C_n77(2A)	DC_41A_n77A DC_41C_n77A	No
DC_41A_n78A DC_41C_n78A DC_41D_n78A	DC_41A_n78A DC_41C_n78A	No
DC_41A_n78(2A) DC_41C_n78(2A)	DC_41A_n78A DC_41C_n78A	No
DC_41A_n79A <sup>6,7</sup> DC_41A_n79C <sup>6,7</sup> DC_41C_n79A <sup>6,7</sup>	DC_41A_n79A DC_41C_n79A	No
DC_42A_n28A DC_42C_n28A	DC_42A_n28A DC_42C_n28A	No
DC_42A_n51A	DC_42A_n51A	No
DC_42A_n77A <sup>3,4,9,11</sup> DC_42A_n77C <sup>3,4,9,11</sup> DC_42C_n77A <sup>3,4,9,11</sup> DC_42C_n77C <sup>3,4,9,11</sup> DC_42D_n77A <sup>3,4,9,11</sup> DC_42D_n77C DC_42E_n77A <sup>3,4,9,11</sup> DC_42E_n77C	N/A	N/A
DC_42A_n77(2A) <sup>3,4,9,11</sup> DC_42C_n77(2A) <sup>3,4,9,11</sup>	N/A	N/A
DC_42A_n78A <sup>3,4,9,11</sup> DC_42A_n78C <sup>3,4,9,11</sup> DC_42C_n78A <sup>3,4,9,11</sup> DC_42C_n78C <sup>3,4,9,11</sup> DC_42D_n78A <sup>3,4,9,11</sup> DC_42D_n78C DC_42E_n78A <sup>3,4,9,11</sup> DC_42E_n78C	N/A	N/A
DC_42A_n79A <sup>9</sup> DC_42A_n79C <sup>9</sup> DC_42C_n79A <sup>9</sup> DC_42C_n79C <sup>9</sup> DC_42D_n79A <sup>9</sup> DC_42D_n79C DC_42E_n79A <sup>9</sup> DC_42E_n79C	N/A	N/A
DC_46A_n78A <sup>2</sup> DC_46C_n78A <sup>2</sup> DC_46D_n78A <sup>2</sup> DC_46E_n78A <sup>2</sup>	N/A	N/A
DC_48A_n5A	DC_48A_n5A	No
DC_48A_n12A	DC_48A_n12A	No
DC_48A_n66A	DC_48A_n66A	No
DC_48A_n71A DC_48B_n71A DC_48C_n71A DC_48D_n71A	DC_48A_n71A	No
DC_48A-48A_n71A DC_48A-48A-48A_n71A	DC_48A_n71A	No
DC_66A_n2A	DC_66A_n2A	DC_66_n2
DC_66A-66A_n2A	DC_66A_n2A	DC_66_n2
DC_66A_n5A DC_66B_n5A DC_66C_n5A	DC_66A_n5A	DC_66_n5
DC_66A-66A_n5A DC_66A-66A-66A_n5A	DC_66A_n5A	DC_66_n5



EN-DC configuration	Uplink EN-DC configuration (NOTE 1)	Single UL allowed
DC_66A_n7A DC_66A-66A_n7A DC_66A_n7(2A) DC_66A-66A_n7(2A)	DC_66A_n7A	No
DC_66A_n12A	DC_66A_n12A	No
DC_66A_n25A	DC_66A_n25A	DC_66_n25
<b>DC_66A_n38A</b>	DC_66A_n38A	No
DC_66A-66A_n38A	DC_66A_n38A	No
DC_66A_n41A DC_66A_n41C	DC_66A_n41A	No
DC_66A_n41(2A)	DC_66A_n41A	No
DC_66A_n48A DC_66A_n48B	DC_66A_n48A	No
DC_66A-66A_n48A DC_66A-66A_n48B	DC_66A_n48A	No
DC_66A_n71A DC_66C_n71A DC_66A_n71B	DC_66A_n71A	No
DC_66A-66A_n71A	DC_66A-66A_n71A	DC_66A-66A_n71A
DC_66A_n78A	DC_66A_n78A	No
DC_66A_n78(2A)	DC_66A_n78A	No
DC_66A-66A_n78A	DC_66A_n78A	No
DC_66A-66A_n78(2A)	DC_66A_n78A	No
DC_71A_n5A	DC_71A_n5A	No
DC_71A_n38A	DC_71A_n38A	No
DC_71A_n48A	DC_71A_n48A	
DC_71A_n66A	DC_71A_n66A	No
DC_71A_n78A	DC_71A_n78A	No

EN-DC configuration	Uplink EN-DC configuration (NOTE 1)	Single UL allowed
<p>NOTE 1: Uplink EN-DC configurations are the configurations supported by the present release of specifications.</p> <p>NOTE 2: Restricted to E-UTRA operation when inter-band carrier aggregation is configured. The downlink operating band for Band 46 is paired with the uplink operating band (external E-UTRA band) of the carrier aggregation configuration that is supporting the configured Pcell.</p> <p>NOTE 3: The minimum requirements apply only when there is non-simultaneous Tx/Rx operation between E-UTRA and NR carriers. This restriction applies also for these carriers when applicable EN-DC configuration is part of a higher order EN-DC configuration.</p> <p>NOTE 4: The minimum requirements for intra-band contiguous or non-contiguous EN-DC apply. The intra-band requirements also apply for these carriers when applicable EN-DC configuration is a subset of a higher order EN-DC configuration.</p> <p>NOTE 5: The frequency range above 3600 MHz for Band n78 is not used in this combination.</p> <p>NOTE 6: The frequency range below 2506 MHz for Band 41 is not used in this combination.</p> <p>NOTE 7: Applicable for UE supporting inter-band EN-DC with mandatory simultaneous Rx/Tx capability.</p> <p>NOTE 8: The frequency range in band n28 is restricted for this band combination to 703 - 733 MHz for the UL and 758-788 MHz for the DL.</p> <p>NOTE 9: The combination is not used alone as fall back mode of other band combinations in which UL in Band 42 is not used.</p> <p>NOTE 10: The maximum power spectral density imbalance between downlink carriers is within 6 dB. The power spectral density imbalance condition also applies for these carriers when applicable EN-DC configuration is a subset of a higher order EN-DC configuration.</p> <p>NOTE 11: The minimum requirements for inter-band EN-DC apply when the maximum power spectral density imbalance between downlink carriers is within 6 dB. The power spectral density imbalance condition also applies for these carriers when applicable EN-DC configuration is a subset of a higher order EN-DC configuration.</p> <p>NOTE 12: Applicable for frequency range above 4800 MHz for Band n79 in this combination.</p> <p>NOTE 13: The minimum requirements apply for synchronized DL carriers with a maximum receive time difference <math>\leq 3</math> usec. The requirements also apply for these carriers when applicable EN-DC configuration is a subset of a higher order EN-DC configuration.</p>		

5.5B.4.2 Inter-band EN-DC configurations within FR1 (three bands)

**Table 5.5B.4.2-1: Inter-band EN-DC configurations within FR1 (three bands)**

EN-DC configuration	Uplink EN-DC configuration (NOTE 1)
DC_1A-3A_n5A DC_1A-3C_n5A	DC_1A_n5A DC_3A_n5A DC_3C_n5A
DC_1A-3A_n7A DC_1A-3A_n7B DC_1A-3C_n7A DC_1A-3C_n7B	DC_1A_n7A DC_3A_n7A DC_3C_n7A
DC_1A-1A-3A_n7A DC_1A-1A-3A_n7B DC_1A-1A-3C_n7A DC_1A-1A-3C_n7B DC_1A-3A-3A_n7A DC_1A-3A-3A_n7B DC_1A-1A-3A-3A_n7A	DC_1A_n7A DC_3A_n7A DC_3C_n7A
DC_1A-3A_n8A	DC_1A_n8A DC_3A_n8A
DC_1A-3A_n28A DC_1A-3C_n28A	DC_1A_n28A DC_3A_n28A DC_3C_n28A
DC_1A_n3A-n28A	DC_1A_n3A DC_1A_n28A
DC_1A-3A_n38A	DC_1A_n38A DC_3A_n38A
DC_1A-3A_n40A	DC_1A_n40A DC_3A_n40A
DC_1A-3A_n41A DC_1A-3C_n41A	DC_1A_n41A DC_3A_n41A DC_3C_n41A
DC_1A-3A_n71A DC_1A-3A_n71B	DC_1A_n71A DC_3A_n71A
DC_1A-3A_n77A <sup>5</sup> DC_1A-3A_n77C <sup>5</sup>	DC_1A_n77A DC_3A_n77A
DC_1A-3A_n77(2A)	DC_1A_n77A DC_3A_n77A
DC_1A-3A_n78A <sup>5</sup> DC_1A-3A_n78C <sup>5</sup> DC_1A-3C_n78A <sup>5</sup>	DC_1A_n78A DC_3A_n78A
DC_1A-3A_n78(2A) <sup>5</sup> DC_1A-3C_n78(2A) <sup>5</sup>	DC_1A_n78A DC_3A_n78A DC_3C_n78A
DC_1A_n3A-n78A	DC_1A_n3A DC_1A_n78A
DC_1A-3A_n79A <sup>5</sup> DC_1A-3A_n79C <sup>5</sup>	DC_1A_n79A DC_3A_n79A
DC_1A-5A_n78A <sup>5</sup>	DC_1A_n78A DC_5A_n78A
DC_1A-5A_n79A	DC_1A_n79A DC_5A_n79A
DC_1A_n5A-n78A	DC_1A_n5A DC_1A_n78A
DC_1A-7A_n3A DC_1A-7C_n3A	DC_1A_n3A DC_7A_n3A DC_7C_n3A
DC_1A-7A_n5A DC_1A-7C_n5A	DC_1A_n5A DC_7A_n5A DC_7C_n5A
DC_1A-7A_n7A	DC_1A_n7A DC_7A_n7A <sup>2</sup>
DC_1A-1A-7A_n7A	DC_1A_n7A DC_7A_n7A <sup>2</sup>
DC_1A-7A_n8A	DC_1A_n8A DC_7A_n8A

EN-DC configuration	Uplink EN-DC configuration (NOTE 1)
DC_1A-7A_n28A <sup>5</sup> DC_1A-7C_n28A	DC_1A_n28A DC_7A_n28A DC_7C_n28A
DC_1A-7A_n40A	DC_1A_n40A DC_7A_n40A
DC_1A-7A_n78A <sup>5</sup> DC_1A-7C_n78A	DC_1A_n78A DC_7A_n78A DC_7C_n78A
DC_1A-7A_n78(2A) <sup>5</sup> DC_1A-7C_n78(2A) <sup>5</sup>	DC_1A_n78A DC_7A_n78A DC_7C_n78A
DC_1A-7A-7A_n78A <sup>5</sup>	DC_1A_n78A DC_7A_n78A
DC_1A_n7A-n78A DC_1A_n7B-n78A	DC_1A_n7A DC_1A_n78A
DC_1A-8A_n3A	DC_1A_n3A DC_8A_n3A
DC_1A-8A_n28A	DC_1A_n28A DC_8A_n28A
DC_1A_n8A-n40A	DC_1A_n8A DC_1A_n40A
DC_1A-8A_n77A	DC_1A_n77A DC_8A_n77A
DC_1A-8A_n77(2A)	DC_1A_n77A DC_8A_n77A
DC_1A-8A_n78A <sup>5</sup>	DC_1A_n78A DC_8A_n78A
DC_1A_n8A-n78A	DC_1A_n8A DC_1A_n78A
DC_1A-8A_n79A	DC_1A_n79A DC_8A_n79A
DC_1A-11A_n3A	DC_1A_n3A DC_11A_n3A
DC_1A-11A_n77A	DC_1A_n77A DC_11A_n77A
DC_1A-11A_n77(2A)	DC_1A_n77A DC_11A_n77A
DC_1A-11A_n78A	DC_1A_n78A DC_11A_n78A
DC_1A-18A_n3A	DC_1A_n3A DC_18A_n3A
DC_1A-18A_n77A <sup>5</sup>	DC_1A_n77A DC_18A_n77A
DC_1A-18A_n78A <sup>5</sup>	DC_1A_n78A DC_18A_n78A
DC_1A-18A_n79A	DC_1A_n79A DC_18A_n79A
DC_1A-19A_n77A <sup>5</sup> DC_1A-19A_n77C <sup>5</sup>	DC_1A_n77A DC_19A_n77A
DC_1A-19A_n78A <sup>5</sup> DC_1A-19A_n78C <sup>5</sup>	DC_1A_n78A DC_19A_n78A
DC_1A-19A_n79A <sup>5</sup> DC_1A-19A_n79C <sup>5</sup>	DC_1A_n79A DC_19A_n79A
DC_1A-20A_n3A DC_1C-20A_n3A	DC_1A_n3A DC_20A_n3A
DC_1A-20A_n8A	DC_1A_n8A DC_20A_n8A
DC_1A-20A_n28A <sup>6</sup>	DC_1A_n28A DC_20A_n28A
DC_1A-20A_n38A	DC_1A_n38A DC_20A_n38A
DC_1A-20A_n41A	DC_1A_n41 DC_20A_n41

EN-DC configuration	Uplink EN-DC configuration (NOTE 1)
DC_1A-20A_n78A <sup>5</sup>	DC_1A_n78A DC_20A_n78A
DC_1A-21A_n77A <sup>5</sup> DC_1A-21A_n77C <sup>5</sup>	DC_1A_n77A DC_21A_n77A
DC_1A-21A_n78A <sup>5</sup> DC_1A-21A_n78C <sup>5</sup>	DC_1A_n78A DC_21A_n78A
DC_1A-21A_n79A <sup>5</sup> DC_1A-21A_n79C <sup>5</sup>	DC_1A_n79A DC_21A_n79A
DC_1A-28A_n3A	DC_1A_n3A DC_28A_n3A
DC_1A-28A_n5A <sup>6</sup>	DC_1A_n5A DC_28A_n5A
DC_1A-28A_n7A DC_1A-28A_n7B	DC_1A_n7A DC_28A_n7A DC_1A_n7B DC_28A_n7B
DC_1A-1A-28A_n7A DC_1A-1A-28A_n7B	DC_1A_n7A DC_28A_n7A DC_1A_n7B DC_28A_n7B
DC_1A_n28A-n40A	DC_1A_n28A DC_1A_n40A
DC_1A-28A_n40A	DC_1A_n40A DC_28A_n40A
DC_1A-28A_n77A <sup>5</sup> DC_1A-28A_n77C <sup>5</sup>	DC_1A_n77A DC_28A_n77A
DC_1A-28A_n78A <sup>5</sup> DC_1A-28A_n78C <sup>5</sup>	DC_1A_n78A DC_28A_n78A
DC_1A_n28A-n77A <sup>5</sup> DC_1A_n28A-n77(2A) <sup>5</sup>	DC_1A_n28A DC_1A_n77A
DC_1A_n28A-n78A <sup>5</sup>	DC_1A_n28A DC_1A_n78A
DC_1A-28A_n79A DC_1A-28A_n79C	DC_1A_n79A DC_28A_n79A
DC_1A-32A_n78A DC_1A-32A_n78(2A)	DC_1A_n78A
DC_1A-(n)38AA	DC_1A_n38A
DC_1A_n40A-n78A DC_1A_n40A-n78(2A)	DC_1A_n40A DC_1A_n78A

EN-DC configuration	Uplink EN-DC configuration (NOTE 1)
DC_1A-41A_n3A DC_1A-41C_n3A	DC_41A_n3A DC_41C_n3A
DC_1A-41A_n28A DC_1A-41C_n28A	DC_1A_n28A DC_41A_n28A DC_41C_n28A
DC_1A-(n)41AA DC_1A-(n)41CA DC_1A-(n)41DA	DC_1A_n41A
DC_1A-41A_n41A DC_1A-41C_n41A	DC_1A_n41A
DC_1A-41A_n77A DC_1A-41C_n77A	DC_1A_n77A DC_41A_n77A
DC_1A-41A_n77(2A) DC_1A-41C_n77(2A)	DC_1A_n77A DC_41A_n77A DC_41C_n77A
DC_1A-41A_n78A DC_1A-41C_n78A	DC_1A_n78A DC_41A_n78A
DC_1A_n41A-n78A	DC_1A_n41A DC_1A_n78A
DC_1A-41A_n78(2A) DC_1A-41C_n78(2A)	DC_1A_n78A DC_41A_n78A DC_41C_n78A
DC_1A-41A_n79A DC_1A-41C_n79A	DC_1A_n79A
DC_1A-42A_n28A	DC_1A_n28A DC_42A_n28A
DC_1A-42C_n28A	DC_1A_n28A DC_42A_n28A DC_42C_n28A
DC_1A-42A_n77A DC_1A-42A_n77C DC_1A-42C_n77A DC_1A-42C_n77C DC_1A-42D_n77A DC_1A-42D_n77C DC_1A-42E_n77A DC_1A-42E_n77C	DC_1A_n77A
DC_1A-42A_n77(2A) DC_1A-42C_n77(2A)	DC_1A_n77A
DC_1A-42A_n78A DC_1A-42A_n78C DC_1A-42C_n78A DC_1A-42C_n78C DC_1A-42D_n78A DC_1A-42D_n78C DC_1A-42E_n78A DC_1A-42E_n78C	DC_1A_n78A
DC_1A-42A_n79A DC_1A-42A_n79C DC_1A-42C_n79A DC_1A-42C_n79C DC_1A-42D_n79A DC_1A-42D_n79C DC_1A-42E_n79A DC_1A-42E_n79C	DC_1A_n79A
DC_1A_n75A-n78A DC_1A_n75A-n78(2A)	DC_1A_n78A

EN-DC configuration	Uplink EN-DC configuration (NOTE 1)
DC_1A_n77A-n79A	DC_1A_n77A DC_1A_n79A
DC_1A_SUL_n77A-n80A	DC_1A_n77A DC_1A_n80A
DC_1A_SUL_n77A-n84A	DC_1A_n77A DC_1A_n84A_ULSUP-TDM_n77A
DC_1A_n78A-n79A	DC_1A_n78A DC_1A_n79A
DC_1A_SUL_n78A-n80A	DC_1A_n78A DC_1A_n80A
DC_1A_SUL_n78A-n84A <sup>5</sup>	DC_1A_n78A, DC_1A_n84A_ULSUP-TDM_n78A
DC_1A_SUL_n79A-n84A	DC_1A_n79A, DC_1A_n84A_ULSUP-TDM_n79A
DC_2A-4A_n38A	DC_2A_n38A DC_4A_n38A
DC_2A-4A_n41A	DC_2A_n41A DC_4A_n41A
DC_2A-5A_n2A	DC_5A_n2A
DC_2A-5B_n2A	DC_5A_n2A
DC_2A-5A-5A_n2A	DC_5A_n2A
DC_2A-5A_n5A	DC_2A_n5A
DC_2A-2A-5A_n5A	DC_2A_n5A
DC_2A-5A_n66A DC_2A-5B_n66A	DC_2A_n66A DC_5A_n66A
DC_2A-5A-5A_n66A	DC_2A_n66A DC_5A_n66A
DC_2A-5A_n71A	DC_2A_n71A DC_5A_n71A
DC_2A-7A_n38A	2A <sup>8</sup>
DC_2A-2A-7A_n38A	2A <sup>8</sup>
DC_2A-7A_n66A DC_2A-7C_n66A	DC_2A_n66A DC_7A_n66A
DC_2A-7A-7A_n66A DC_2A-2A-7A_n66A	DC_2A_n66A DC_7A_n66A
DC_2A-7A_n71A	DC_2A_n71A DC_7A_n71A
DC_2A-2A-7A_n71A	DC_2A_n71A DC_7A_n71A
DC_2A-7A_n78A DC_2A-7C_n78A DC_2A-7A_n78(2A) DC_2A-7C_n78(2A)	DC_2A_n78A DC_7A_n78A DC_7C_n78A
DC_2A_n7A-n78A	DC_2A_n7A DC_2A_n78A
DC_2A_n7(2A)-n78A	DC_2A_n7A DC_2A_n78A
DC_2A_n7A-n78(2A)	DC_2A_n7A DC_2A_n78A
DC_2A_n7(2A)-n78(2A)	DC_2A_n7A DC_2A_n78A
DC_2A-7A-7A_n78A DC_2A-7A-7A_n78(2A)	DC_2A_n78A DC_7A_n78A
DC_2A-12A_n2A	DC_12A_n2A
DC_2A_(n)12AA	DC_2A_n12A DC_(n)12AA <sup>2</sup>
DC_2A-12A_n66A	DC_2A_n66A DC_12A_n66A
DC_2A-2A-12A_n66A	DC_2A_n66A DC_12A_n66A



EN-DC configuration	Uplink EN-DC configuration (NOTE 1)
DC_2A-13A_n2A	DC_13A_n2A
DC_2A-13A_n5A	DC_2A_n5A
DC_2A-2A-13A_n5A	DC_2A_n5A
DC_2A-13A_n66A	DC_2A_n66A DC_13A_n66A
DC_2A-2A-13A_n66A	DC_2A_n66A DC_13A_n66A
DC_2A-14A_n2A	DC_2A_n2A <sup>2</sup> DC_14A_n2A
DC_2A-14A_n66A	DC_2A_n66A DC_14A_n66A
DC_2A-2A-14A_n66A	DC_2A_n66A DC_14A_n66A
DC_2A-29A_n66A	DC_2A_n66A
DC_2A-2A-29A_n66A	DC_2A_n66A
DC_2A-30A_n5A	DC_2A_n5A DC_30A_n5A
DC_2A-2A-30A_n5A	DC_2A_n5A DC_30A_n5A
DC_2A-30A_n66A	DC_2A_n66A DC_30A_n66A
DC_2A-2A-30A_n66A	DC_2A_n66A DC_30A_n66A
DC_2A_n38A-n78A	DC_2A_n38A DC_2A_n78A
DC_2A_n41A-n66A DC_2A_n41C-n66A	DC_2A_n41A DC_2A_n66A
DC_2A_n41(2A)-n66A	DC_2A_n41A DC_2A_n66A
DC_2A_n41A-n71A DC_2A_n41C-n71A	DC_2A_n41A DC_2A_n71A
DC_2A_n41(2A)-n71A	DC_2A_n41A DC_2A_n71A
DC_2A-46A_n41A DC_2A-46C_n41A DC_2A-46D_n41A	DC_2A_n41A
DC_2A-46A_n41(2A) DC_2A-46C_n41(2A) DC_2A-46D_n41(2A)	DC_2A_n41A
DC_2A-46A_n66A DC_2A-46C_n66A DC_2A-46D_n66A	DC_2A_n66A
DC_2A-46A_n71A DC_2A-46C_n71A DC_2A-46D_n71A	DC_2A_n71A
DC_2A-48A_n71A	DC_2A_n71A DC_48A_n71A
DC_2A-48A_n12A	DC_2A_n12A DC_48A_n12A
DC_2A-48A_n66A	DC_2A_n66A DC_48A_n66A
DC_2A-66A_n5A	DC_2A_n5A DC_66A_n5A
DC_2A-2A-66A_n5A DC_2A-66A-66A_n5A DC_2A-2A-66A-66A_n5A DC_2A-66A-66A-66A_n5A	DC_2A_n5A DC_66A_n5A
DC_2A-66A_n12A	DC_2A_n12A DC_66A_n12A
DC_2A-66A_n25A	DC_66A_n25A
DC_2A-66A_n38A	DC_2A_n38A DC_66A_n38A

EN-DC configuration	Uplink EN-DC configuration (NOTE 1)
DC_2A-2A-66A_n38A DC_2A-66A-66A_n38A	DC_2A_n38A DC_66A_n38A
DC_2A-66A_n41A DC_2A-66A_n41C DC_2C-66A_n41A	DC_2A_n41A DC_66A_n41A
DC_2A-2A-66A_n41A DC_2A-66A_n41(2A)	DC_2A_n41A DC_66A_n41A
DC_2A-66A_n48A	DC_2A_n48A DC_66A_n48A
DC_2A-66A_n48B	DC_2A_n48A DC_66A_n48A
DC_2A-66A-66A_n48A	DC_2A_n48A DC_66A_n48A
DC_2A-66A-66A_n48B	DC_2A_n48A DC_66A_n48A
DC_2A-66A_n66A	DC_2A_n66A DC_66A_n66A <sup>2</sup>
DC_2A-2A-66A_n66A	DC_2A_n66A DC_66A_n66A <sup>2</sup>
DC_2A-66A_n71A DC_2A-66A_n71B DC_2A-66C_n71A DC_2C-66A_n71A	DC_2A_n71A DC_66A_n71A
DC_2A-2A-66A_n71A DC_2A-66A-66A_n71A DC_2A-2A-66A-66A_n71A	DC_2A_n71A DC_66A_n71A
DC_2A_n66A-n71A	DC_2A_n66A DC_2A_n71A
DC_2A-66A_n78A DC_2A-66A_n78(2A)	DC_2A_n78A DC_66A_n78A
DC_2A_n66A-n78A	DC_2A_n66A DC_2A_n78A
DC_2A-66A-66A_n78A DC_2A-66A-66A_n78(2A)	DC_2A_n78A DC_66A_n78A
DC_2A-71A_n38A	DC_71A_n38A DC_2A_n38A
DC_2A-2A-71A_n38A	DC_71A_n38A DC_2A_n38A
DC_2A-71A_n66A	DC_2A_n66A DC_71A_n66A
DC_2A-2A-71A_n66A	DC_2A_n66A DC_71A_n66A
DC_2A-71A_n78A	DC_71A_n78A DC_2A_n78A
DC_2A-2A-71A_n78A	DC_71A_n78A DC_2A_n78A
DC_2A-(n)71AA	DC_2A_n71A DC_(n)71AA
DC_3A_n1A-n7A	DC_3A_n1A DC_3A_n7A
DC_3C_n1A-n7A	DC_3A_n1A DC_3A_n7A DC_3C_n1A DC_3C_n7A
DC_3A_n1A-n28A	DC_3A_n1A DC_3A_n28A
DC_3C_n1A-n28A	DC_3A_n1A DC_3A_n28A DC_3C_n1A DC_3C_n28A
DC_3A_n1A-n40A	DC_3A_n1A DC_3A_n40A
DC_3A_n1A-n77A	DC_3A_n1A DC_3A_n77A

EN-DC configuration	Uplink EN-DC configuration (NOTE 1)
DC_3A_n1A-n78A DC_3C_n1A-n78A	DC_3A_n1A DC_3A_n78A
DC_3A-3A_n1A-n78A	DC_3A_n1A DC_3A_n78A
DC_3A_n1A-n79A	DC_3A_n1A DC_3A_n79A
DC_3A_n3A-n77A	DC_3A_n77A DC_3A_n3A <sup>2</sup>
DC_3A_n3A-n78A	DC_3A_n78A DC_3A_n3A <sup>2</sup>
DC_3A-5A_n78A <sup>5</sup>	DC_3A_n78A DC_5A_n78A
DC_3A_n5A-n78A DC_3C_n5A-n78A	DC_3A_n5A DC_3A_n78A DC_3C_n5A DC_3C_n78A
DC_3A-5A_n79A	DC_3A_n79A DC_5A_n79A
DC_3A-7A_n1A DC_3A-7C_n1A DC_3C-7A_n1A DC_3C-7C_n1A	DC_3A_n1A DC_3C_n1A DC_7A_n1A DC_7C_n1A
DC_3A-3A-7A_n1A DC_3A-7A-7A_n1A DC_3A-3A-7A-7A_n1A	DC_3A_n1A DC_7A_n1A
DC_3A-7A_n5A DC_3C-7A_n5A DC_3A-7C_n5A DC_3C-7C_n5A	DC_3A_n5A DC_3C_n5A DC_7A_n5A DC_7C_n5A
DC_3A-7A_n7A DC_3C-7A_n7A	DC_3A_n7A DC_3C_n7A DC_7A_n7A <sup>2</sup>
DC_3A-3A-7A_n7A	DC_3A_n7A DC_7A_n7A <sup>2</sup>
DC_3A-7A_n8A	DC_3A_n8A DC_7A_n8A
DC_3A-7A_n28A DC_3A-7C_n28A DC_3C-7A_n28A DC_3C-7C_n28A	DC_3A_n28A DC_3C_n28A DC_7A_n28A DC_7C_n28A
DC_3A-7A_n40A	DC_3A_n40A DC_7A_n40A
DC_3A-7A_n77A	DC_3A_n77A DC_7A_n77A
DC_3A-3A-7A_n77A DC_3A-7A-7A_n77A DC_3A-3A-7A-7A_n77A	DC_3A_n77A DC_7A_n77A
DC_3A-7A_n78A <sup>5</sup> DC_3C-7A_n78A <sup>5</sup> DC_3A-7C_n78A <sup>5</sup> DC_3C-7C_n78A <sup>5</sup>	DC_3A_n78A DC_3C_n78A DC_7A_n78A DC_7C_n78A
DC_3A-7A_n78(2A) <sup>5</sup> DC_3C-7A_n78(2A) <sup>5</sup> DC_3A-7C_n78(2A) <sup>5</sup> DC_3C-7C_n78(2A) <sup>5</sup>	DC_3A_n78A DC_7A_n78A DC_3C_n78A DC_7C_n78A
DC_3A-3A-7A_n78A DC_3A-7A-7A_n78A <sup>5</sup> DC_3A-3A-7A-7A_n78A	DC_3A_n78A DC_7A_n78A
DC_3A_n7A-n78A DC_3A_n7B-n78A DC_3C_n7A-n78A DC_3C_n7B-n78A	DC_3A_n7A DC_3C_n7A DC_3A_n78A

EN-DC configuration	Uplink EN-DC configuration (NOTE 1)
DC_3A-3A_n7A-n78A DC_3A-3A_n7B-n78A	DC_3A_n7A DC_3A_n7B DC_3A_n78A
DC_3A-8A_n1A DC_3C-8A_n1A	DC_3A_n1A DC_8A_n1A
DC_3A-3A-8A_n1A	DC_3A_n1A DC_8A_n1A
DC_3A_n8A-n40A	DC_3A_n8A DC_3A_n40A
DC_3A-8A_n28A	DC_3A_n28A DC_8A_n28A
DC_3A-8A_n77A	DC_3A_n77A DC_8A_n77A
DC_3A-8A_n77(2A)	DC_3A_n77A DC_8A_n77A
DC_3A-8A_n78A DC_3C-8A_n78A	DC_3A_n78A DC_8A_n78A
DC_3A-3A-8A_n78A	DC_3A_n78A DC_8A_n78A
DC_3A-8A_n79A	DC_3A_n79A DC_8A_n79A
DC_3A_n8A-n78A	DC_3A_n8A DC_3A_n78A
DC_3A-18A_n77A	DC_3A_n77A DC_18A_n77A
DC_3A-18A_n78A	DC_3A_n78A DC_18A_n78A
DC_3A-18A_n79A	DC_3A_n79A DC_18A_n79A
DC_3A-19A_n77A <sup>5</sup> DC_3A-19A_n77C <sup>5</sup>	DC_3A_n77A DC_19A_n77A
DC_3A-19A_n78A <sup>5</sup> DC_3A-19A_n78C <sup>5</sup>	DC_3A_n78A DC_19A_n78A
DC_3A-19A_n79A <sup>5</sup> DC_3A-19A_n79C <sup>5</sup>	DC_3A_n79A DC_19A_n79A
DC_3A-20A_n1A DC_3C-20A_n1A	DC_3A_n1A DC_3C_n1A DC_20A_n1A
DC_3A-20A_n7A DC_3C-20A_n7A	DC_3A_n7A DC_3C_n7A DC_20A_n7A
DC_3A-20A_n8A	DC_3A_n8A DC_20A_n8A
DC_3A-20A_n28A <sup>5,6</sup> DC_3C-20A_n28A	DC_3A_n28A DC_3C_n28A DC_20A_n28A
DC_3A-20A_n41A	DC_3A_n41A DC_20A_n41A
DC_3C-20A_n41A	DC_3C_n41A DC_20A_n41A
DC_3A-20A_n38A	DC_3A_n38A DC_20A_n38A
DC_3A-20A_n78A <sup>5</sup> DC_3C-20A_n78A <sup>5</sup>	DC_3A_n78A DC_20A_n78A
DC_3A_n20A-n78A	DC_3A_n20A DC_3A_n78A
DC_3A-21A_n77A <sup>5</sup> DC_3A-21A_n77C <sup>5</sup>	DC_3A_n77A DC_21A_n77A
DC_3A-21A_n78A <sup>5</sup> DC_3A-21A_n78C <sup>5</sup>	DC_3A_n78A DC_21A_n78A
DC_3A-21A_n79A <sup>5</sup> DC_3A-21A_n79C <sup>5</sup>	DC_3A_n79A DC_21A_n79A

EN-DC configuration	Uplink EN-DC configuration (NOTE 1)
DC_3A-28A_n5A DC_3C-28A_n5A	DC_3A_n5A DC_3C_n5A DC_28A_n5A
DC_3A-28A_n7A DC_3C-28A_n7A DC_3A-28A_n7B DC_3C-28A_n7B	DC_3A_n7A DC_3C_n7A DC_28A_n7A DC_3A_n7B DC_3C_n7B DC_28A_n7B
DC_3A-28A_n40A	DC_3A_n40A DC_28A_n40A
DC_3A-3A-28A_n7A DC_3A-3A-28A_n7B	DC_3A_n7A DC_28A_n7A DC_3A_n7B DC_28A_n7B
DC_3A_n28A-n40A	DC_3A_n28A <b>DC_3A_n40A</b>
DC_3A-28A_n41A	DC_3A_n41A DC_28A_n41A
DC_3A-28A_n77A DC_3A-28A_n77C	DC_3A_n77A DC_28A_n77A
DC_3A-28A_n77(2A)	DC_3A_n77A DC_28A_n77A
DC_3A_n28A-n77A	DC_3A_n28A DC_3A_n77A
DC_3A_n28A-n77(2A)	DC_3A_n28A DC_3A_n77A

EN-DC configuration	Uplink EN-DC configuration (NOTE 1)
DC_3A-28A_n78A <sup>5</sup> DC_3C-28A_n78A DC_3A-28A_n78C <sup>5</sup>	DC_3A_n78A DC_28A_n78A
DC_3A-3A-28A_n78A	DC_3A_n78A DC_28A_n78A
DC_3A_n28A-n78A <sup>5</sup> DC_3C_n28A-n78A	DC_3A_n28A DC_3A_n78A DC_3C_n28A
DC_3A-28A_n79A DC_3A-28A_n79C	DC_3A_n79A DC_28A_n79A
DC_3A-32A_n78A DC_3A-32A_n78(2A)	DC_3A_n78A
DC_3A-38A_n78A	DC_3A_n78A
DC_3A-40A_n1A	DC_3A_n1A DC_40A_n1A
DC_3A_n40A-n41A	DC_3A_n40A DC_3A_n41A
DC_3A_n40A-n78A	DC_3A_n40A DC_3A_n78A
DC_3A_n40A-n79A	DC_3A_n40A DC_3A_n79A
DC_3A-41A_n28A	DC_3A_n28A DC_41A_n28A
DC_3A-41C_n28A	DC_3A_n28A DC_41A_n28A DC_41C_n28A
DC_3A-41A_n41A DC_3A-41C_n41A DC_3A-41D_n41A	DC_3A_n41A
DC_3A-(n)41AA DC_3A-(n)41CA DC_3A-(n)41DA	DC_3A_n41A
DC_3A-41A_n77A DC_3A-41C_n77A	DC_3A_n77A DC_41A_n77A
DC_3A-41A_n77(2A) DC_3A-41C_n77(2A)	DC_3A_n77A DC_41A_n77A DC_41C_n77A
DC_3A-41A_n78A DC_3A-41C_n78A	DC_3A_n78A DC_41A_n78A DC_41C_n78A
DC_3A_n41A-n78A	DC_3A_n41A DC_3A_n78A
DC_3A-41A_n78(2A) DC_3A-41C_n78(2A)	DC_3A_n78A DC_41A_n78A DC_41C_n78A
DC_3A-42A_n28A	DC_3A_n28A DC_42A_n28A
DC_3A-42C_n28A	DC_3A_n28A DC_42A_n28A DC_42C_n28A
DC_3A-41A_n79A DC_3A-41C_n79A	DC_3A_n79A DC_41A_n79A
DC_3A_n41A-n79A	DC_3A_n41A DC_3A_n79A
DC_3A_SUL_n41A-n80A DC_3C_SUL_n41A-n80A	DC_3A_n41A DC_3C_n41A DC_3A_n80A_ULSUP-TDM_n41A DC_3C_n80A_ULSUP-TDM_n41A

EN-DC configuration	Uplink EN-DC configuration (NOTE 1)
DC_3A-42A_n77A DC_3A-42A_n77C DC_3A-42C_n77A DC_3A-42C_n77C DC_3A-42D_n77A DC_3A-42D_n77C DC_3A-42E_n77A DC_3A-42E_n77C	DC_3A_n77A
DC_3A-42A_n77(2A) DC_3A-42C_n77(2A)	DC_3A_n77A
DC_3A-42A_n78A DC_3A-42A_n78C DC_3A-42C_n78A DC_3A-42C_n78C DC_3A-42D_n78A DC_3A-42D_n78C DC_3A-42E_n78A DC_3A-42E_n78C	DC_3A_n78A
DC_3A-42A_n79A DC_3A-42A_n79C DC_3A-42C_n79A DC_3A-42C_n79C DC_3A-42D_n79A DC_3A-42D_n79C DC_3A-42E_n79A DC_3A-42E_n79C	DC_3A_n79A
DC_3A_n75A-n78A	DC_3A_n78A
DC_3A_n75A-n78(2A)	DC_3A_n78A
DC_3A_n77A-n79A	DC_3A_n77A DC_3A_n79A
DC_3A_n78A-n79A	DC_3A_n78A DC_3A_n79A
DC_3A_SUL_n77A-n80A	DC_3A_n77A DC_3A_n80A_ULSUP-TDM_n77A
DC_3A_SUL_n77A-n84A	DC_3A_n77A DC_3A_n84A
DC_3A_SUL_n78A-n80A <sup>5</sup> DC_3C_SUL_n78A-n80A	DC_3A_n78A DC_3A_n80A_ULSUP-TDM_n78A
DC_3A_SUL_n78A-n82A <sup>5</sup>	DC_3A_n78A DC_3A_n82A
DC_3A_SUL_n78A-n84A	DC_3A_n78A DC_3A_n84A
DC_3A_SUL_n79A-n80A <sup>5</sup>	DC_3A_n79A, DC_3A_n80A_ULSUP-TDM_n79A
DC_5A-7A_n71A	DC_5A_n71A DC_7A_n71A
DC_5A-7A_n78A	DC_5A_n78A DC_7A_n78A
DC_5A_n7A-n78A	DC_5A_n7A DC_5A_n78A
DC_5A_n7(2A)-n78A	DC_5A_n7A DC_5A_n78A
DC_5A_n7A-n78(2A)	DC_5A_n7A DC_5A_n78A
DC_5A_n7(2A)-n78(2A)	DC_5A_n7A DC_5A_n78A
DC_5A-7A-7A_n78A	DC_5A_n78A DC_7A_n78A
DC_5A_(n)12AA	DC_5A_n12A DC_(n)12AA <sup>2</sup>
DC_5A-30A_n66A	DC_5A_n66A DC_30A_n66A

EN-DC configuration	Uplink EN-DC configuration (NOTE 1)
DC_5A-41A_n79A	DC_5A_n79A DC_41A_n79A
DC_5A-66A_n2A DC_5B-66A_n2A	DC_5A_n2A
DC_5A-5A-66A_n2A DC_5A-66A-66A_n2A DC_5B-66A-66A_n2A DC_5A-5A-66A-66A_n2A	DC_5A_n2A
DC_5A-66A_n5A	DC_66A_n5A
DC_5A-66A-66A_n5A	DC_66A_n5A
DC_5A-66A_n66A	DC_5A_n66A
DC_5A-5A-66A_n66A DC_5B-66A_n66A	DC_5A_n66A
DC_5A-5A-66A-66A_n66A DC_5A-66A-66A_n66A DC_5B-66A-66A_n66A	DC_5A_n66A
DC_5A-66A_n71A	DC_5A_n71A DC_66A_n71A
DC_5A-66A_n78A DC_5A-66A_n78(2A)	DC_5A_n78A DC_66A_n78A
DC_5A-13A_n2A	DC_5A_n2A DC_13A_n2A
DC_7A_n1A-n40A	DC_7A_n1A DC_7A_n40A
DC_7A_n1A-n78A DC_7C_n1A-n78A	DC_7A_n1A DC_7A_n78A DC_7C_n1A DC_7C_n78A
DC_7A-7A_n1A-n78A	DC_7A_n1A DC_7A_n78A
DC_7A_n3A-n78A DC_7C_n3A-n78A	DC_7A_n3A DC_7A_n78A DC_7C_n3A DC_7C_n78A
DC_7A_n5A-n78A DC_7C_n5A-n78A	DC_7A_n5A DC_7C_n5A C_7A_n78A DC_7C_n78A
DC_7A_n7A-n78A	DC_7A_n78A DC_7A_n7A <sup>2</sup>
DC_7A_n7A-n78(2A)	DC_7A_n78A DC_7A_n7A <sup>2</sup>
DC_7A-8A_n1A	DC_7A_n1A, DC_8A_n1A
DC_7A-7A-8A_n1A	DC_7A_n1A DC_8A_n1A
DC_7A-8A_n3A	DC_7A_n3A DC_8A_n3A
DC_7A_n8A-n40A	DC_7A_n8A DC_7A_n40A
DC_7A-8A_n77A	DC_7A_n77A, DC_8A_n77A
DC_7A-8A_n78A	DC_7A_n78A, DC_8A_n78A
DC_7A-7A-8A_n78A	DC_7A_n78A DC_8A_n78A
DC_7A_n8A-n78A	DC_7A_n8A DC_7A_n78A
DC_7A-13A_n66A DC_7A-7A-13A_n66A DC_7C-13A_n66A	DC_7A_n66A DC_13A_n66A
DC_7A-20A_n1A DC_7C-20A_n1A	DC_7A_n1A DC_7C_n1A DC_20A_n1A



EN-DC configuration	Uplink EN-DC configuration (NOTE 1)
DC_7A-20A_n3A DC_7C-20A_n3A	DC_7A_n3A DC_7C_n3A DC_20A_n3A
DC_7A-20A_n8A	DC_7A_n8A DC_20A_n8A
DC_7A-20A_n28A <sup>6</sup>	DC_7A_n28A DC_20A_n28A
DC_7A-20A_n78A <sup>5</sup>	DC_7A_n78A DC_20A_n78A
DC_7A-28A_n3A DC_7C-28A_n3A	DC_7A_n3A DC_7C_n3A DC_28A_n3A
DC_7A-28A_n5A <sup>6</sup> DC_7C-28A_n5A <sup>6</sup>	DC_7A_n5A DC_7C_n5A DC_28A_n5A
DC_7A-28A_n7A	DC_7A_n7A <sup>2</sup> DC_28A_n7A
DC_7A_n28A-n40A	DC_7A_n28A DC_7A_n40A
DC_7A-28A_n40A	DC_7A_n40A DC_28A_n40A
DC_7A-28A_n78A <sup>5</sup> DC_7C-28A_n78A <sup>5</sup>	DC_7A_n78A DC_7C_n78A DC_28A_n78A
DC_7A_n28A-n78A <sup>5</sup> DC_7C_n28A-n78A	DC_7A_n28A DC_7A_n78A DC_7C_n28A DC_7C_n78A
DC_7A-40A_n1A	DC_7A_n1A DC_40A_n1A
DC_7A-46A_n78A <sup>3</sup> DC_7A-46C_n78A <sup>3</sup> DC_7A-46D_n78A <sup>3</sup> DC_7A-46E_n78A <sup>3</sup>	DC_7A_n78A
DC_7A-66A_n38A	66A <sup>9</sup>
DC_7A-66A_n66A DC_7C-66A_n66A	DC_7A_n66A DC_66A_n66A <sup>2</sup>
DC_7A-7A-66A_n66A	DC_7A_n66A DC_66A_n66A <sup>2</sup>
DC_7A-66A_n71A	DC_7A_n71A DC_66A_n71A
DC_7A-66A-66A_n71A	DC_7A_n71A DC_66A_n71A
DC_7A_n66A-n78A DC_7A-7A_n66A-n78A DC_7C_n66A-n78A	DC_7A_n66A DC_7A_n78A
DC_7A-66A_n78A DC_7C-66A_n78A DC_7A-66A_n78(2A) DC_7C-66A_n78(2A)	DC_7A_n78A DC_7C_n78A DC_66A_n78A
DC_7A-7A-66A_n78A DC_7A-7A-66A_n78(2A)	DC_7A_n78A DC_66A_n78A
DC_7A-7A-66A-66A_n78A DC_7A-7A-66A-66A_n78(2A)	DC_7A_n78A DC_66A_n78A
DC_7A-66A-66A_n78A DC_7C-66A-66A_n78A DC_7A-66A-66A_n78(2A) DC_7C-66A-66A_n78(2A)	DC_7A_n78A DC_66A_n78A
DC_7A_SUL_n78A-n80A	DC_7A_n78A DC_7A_n80A
DC_8A_n1A-n78A	DC_8A_n1A DC_8A_n78A
DC_8A_n3A-n28A	DC_8A_n3A DC_8A_n28A

EN-DC configuration	Uplink EN-DC configuration (NOTE 1)
DC_8A-11A_n3A	DC_8A_n3A DC_11A_n3A
DC_8A-11A_n77A	DC_8A_n77A DC_11A_n77A
DC_8A-11A_n77(2A)	DC_8A_n77A DC_11A_n77A
DC_8A-11A_n78A	DC_8A_n78A DC_11A_n78A
DC_8A-20A_n78A	DC_8A_n78A DC_20A_n78A
DC_8A_n28A-n77A	DC_8A_n28A DC_8A_n77A
DC_8A_n28A-n77(2A)	DC_8A_n28A DC_8A_n77A
DC_8A_n40A-n41A	DC_8A_n40A DC_8A_n41A
DC_8A_n40A-n79A	DC_8A_n40A DC_8A_n79A
DC_8A_n41A-n79A	DC_8A_n41A DC_8A_n79A
DC_8A-42A_n28A	DC_8A_n28A DC_42A_n28A
DC_8A-42C_n28A	DC_8A_n28A DC_42A_n28A DC_42C_n28A
DC_8A-42A_n77A DC_8A-42C_n77A	DC_8A_n77A
DC_8A-42A_n77(2A) DC_8A-42C_n77(2A)	DC_8A_n77A
DC_8A_SUL_n41A-n81A	DC_8A_41A, DC_8A_n81A_ULSUP-TDM_n41A
DC_8A_SUL_n78A-n80A	DC_8A_n78A DC_8A_n80A
DC_8A_SUL_n78A-n81A <sup>5</sup>	DC_8A_n78A, DC_8A_n81A_ULSUP-TDM_n78A
DC_8A_SUL_n79A-n81A <sup>5</sup>	DC_8A_n79A, DC_8A_n81A_ULSUP-TDM_n79A
DC_11A-18A_n77A	DC_11A_n77A DC_18A_n77A
DC_11A-18A_n78A	DC_11A_n78A DC_18A_n78A
DC_12A_(n)5AA	DC_12A_n5A DC_(n)5AA <sup>2</sup>
DC_12A_n7A-n78A	DC_12A_n7A DC_12A_n78A
DC_12A_n7(2A)-n78A	DC_12A_n7A DC_12A_n78A
DC_12A_n7A-n78(2A)	DC_12A_n7A DC_12A_n78A
DC_12A_n7(2A)-n78(2A)	DC_12A_n7A DC_12A_n78A
DC_12A-30A_n2A	DC_12A_n2A DC_30A_n2A
DC_12A-30A_n66A	DC_12A_n66A DC_30A_n66A
DC_12A-66A_n2A	DC_12A_n2A DC_66A_n2A
DC_12A-66A-66A_n2A	DC_12A_n2A DC_66A_n2A
DC_12A-66A_n25A	DC_12A_n25A DC_66A_n25A
DC_12A-66A_n66A	DC_12A_n66A DC_66A_n66A <sup>2</sup>
DC_13A-46A_n5A	DC_13A_n5A

EN-DC configuration	Uplink EN-DC configuration (NOTE 1)
DC_13A-66A_n2A	DC_13A_n2A DC_66A_n2A
DC_13A-66A-66A_n2A	DC_13A_n2A DC_66A_n2A
DC_13A-66A_n48A DC_13A-66A_n48B	DC_13A_n48A DC_66A_n48A
DC_13A-66A-66A_n48A DC_13A-66A-66A_n48B	DC_13A_n48A DC_66A_n48A
DC_13A-66A_n66A	DC_13A_n66A
DC_13A-66A-66A_n66A	DC_13A_n66A
DC_18A_n3A-n78A	DC_18A_n3A DC_18A_n78A
DC_13A-48A_n2A DC_13A-48B_n2A DC_13A-48D_n2A DC_13A-48E_n2A	DC_13A_n2A
DC_13A-48A_n66A DC_13A-48B_n66A DC_13A-48D_n66A DC_13A-48E_n66A	DC_13A_n66A
DC_18A_n3A-n77A	DC_18A_n3A DC_18A_n77A
DC_14A-66A_n2A	DC_14A_n2A DC_66A_n2A
DC_14A-66A-66A_n2A	DC_14A_n2A DC_66A_n2A
DC_14A-66A_n66A	DC_14A_n66A DC_66A_n66A <sup>2</sup>
DC_18A-28A_n77A <sup>5</sup>	DC_18A_n77A DC_28A_n77A
DC_18A-28A_n78A <sup>5</sup>	DC_18A_n78A DC_28A_n78A
DC_18A-28A_n79A <sup>5</sup>	DC_18A_n79A DC_28A_n79A
DC_18A-41A_n3A DC_18A-41C_n3A	DC_18A_n3A DC_41A_n3A DC_41C_n3A
DC_18A-41A_n77A DC_18A-41C_n77A	DC_18A_n77A DC_41A_n77A DC_41C_n77A
DC_18A-41A_n78A DC_18A-41C_n78A	DC_18A_n78A DC_41A_n78A DC_41C_n78A
DC_18A-42A_n77A DC_18A-42C_n77A	DC_18A_n77A
DC_18A-42A_n78A DC_18A-42C_n78A	DC_18A_n78A
DC_18A-42A_n79A DC_18A-42C_n79A	DC_18A_n79A
DC_19A-21A_n78A <sup>5</sup> DC_19A-21A_n78C <sup>5</sup>	DC_19A_n78A DC_21A_n78A
DC_19A-21A_n79A <sup>5</sup> DC_19A-21A_n79C <sup>5</sup>	DC_19A_n79A DC_21A_n79A
DC_19A-21A_n77A <sup>5</sup> DC_19A-21A_n77C <sup>5</sup>	DC_19A_n77A DC_21A_n77A
DC_19A-42A_n77A DC_19A-42A_n77C DC_19A-42C_n77A DC_19A-42C_n77C DC_19A-42D_n77A DC_19A-42D_n77C	DC_19A_n77A

EN-DC configuration	Uplink EN-DC configuration (NOTE 1)
DC_19A-42A_n78A DC_19A-42A_n78C DC_19A-42C_n78A DC_19A-42C_n78C DC_19A-42D_n78A DC_19A-42D_n78C	DC_19A_n78A
DC_19A-42A_n79A DC_19A-42A_n79C DC_19A-42C_n79A DC_19A-42C_n79C DC_19A-42D_n79A DC_19A-42D_n79C	DC_19A_n79A
DC_19A_n77A-n79A	DC_19A_n77A DC_19A_n79A
DC_19A_n78A-n79A	DC_19A_n78A DC_19A_n79A
DC_20A_n1A-n7A	DC_20A_n1A DC_20A_n7A
DC_20A_n1A-n28A	DC_20A_n1A DC_20A_n28A
DC_20A_n1A-n78A	DC_20A_n1A DC_20A_n78A
DC_20A_n3A-n78A	DC_20A_n3A DC_20A_n78A
DC_20A_n7A-n28A <sup>5,6</sup>	DC_20A_n7A DC_20A_n28A
DC_20A_n8A-n75A <sup>6</sup>	DC_20A_n8A
DC_20A_n28A-n75A <sup>6</sup>	DC_20A_n28A
DC_20A_n28A-n78A <sup>5,6</sup>	DC_20A_n28A DC_20A_n78A
DC_20A-32A_n78A DC_20A-32A_n78(2A)	DC_20A_n78A
DC_20A-(n)38AA	DC_20A_n38A
DC_20A-38A_n78A	DC_20A_n78A DC_38A_n78A
DC_20A_n41A-n78A	DC_20A_n41A DC_20A_n78A
DC_20A-(n)41AA DC_20A-(n)41CA DC_20A-(n)41DA	DC_20A_n41A
DC_20A_n75A-n78A <sup>5</sup>	DC_20A_n78A
DC_20A_n76A-n78A <sup>5</sup>	DC_20A_n78A
DC_20A_SUL_n78A-n80A	DC_20A_n78A DC_20A_n80A
DC_20A_SUL_n78A-n82A <sup>5</sup>	DC_20A_n78A DC_20A_n82A_ULSUP-TDM_n78A
DC_20A_SUL_n78A-n83A <sup>5</sup>	DC_20A_n78A DC_20A_n83A
DC_20A_n78A-n92A DC_20A_n78(2A)-n92A	DC_20A_n78A DC_20A_n92A_ULSUP-TDM_n78A

EN-DC configuration	Uplink EN-DC configuration (NOTE 1)
DC_21A-28A_n77A DC_21A-28A_n77C	DC_21A_n77A DC_28A_n77A
DC_21A-28A_n78A DC_21A-28A_n78C	DC_21A_n78A DC_28A_n78A
DC_21A-28A_n79A DC_21A-28A_n79C	DC_21A_n79A DC_28A_n79A
DC_21A-42A_n77A DC_21A-42A_n77C DC_21A-42C_n77A DC_21A-42C_n77C DC_21A-42D_n77A DC_21A-42D_n77C DC_21A-42E_n77A DC_21A-42E_n77C	DC_21A_n77A
DC_21A-42A_n78A DC_21A-42A_n78C DC_21A-42C_n78A DC_21A-42C_n78C DC_21A-42D_n78A DC_21A-42D_n78C DC_21A-42E_n78A DC_21A-42E_n78C	DC_21A_n78A
DC_21A-42A_n79A DC_21A-42A_n79C DC_21A-42C_n79A DC_21A-42C_n79C DC_21A-42D_n79A DC_21A-42D_n79C DC_21A-42E_n79A DC_21A-42E_n79C	DC_21A_n79A
DC_21A_n77A-n79A	DC_21A_n77A DC_21A_n79A
DC_21A_n78A-n79A	DC_21A_n78A DC_21A_n79A
DC_25A-41A_n41A DC_25A-41C_n41A DC_25A-41D_n41A DC_25A-25A-41A_n41A DC_25A-25A-41C_n41A DC_25A-25A-41D_n41A	DC_25A_n41A DC_41A_n41A
DC_25A-(n)41AA DC_25A-25A-(n)41AA	DC_25A_n41A DC_(n)41AA
DC_25A-(n)41CA DC_25A-(n)41DA DC_25A-25A-(n)41CA DC_25A-25A-(n)41DA	DC_25A_n41A DC_(n)41AA DC_41A_n41A
DC_28A-41A_n77A DC_28A-41C_n77A	DC_28A_n77A DC_41A_n77A
DC_28A-41A_n78A DC_28A-41C_n78A	DC_28A_n78A DC_41A_n78A
DC_28A-41A_n79A DC_28A-41C_n79A	DC_28A_n79A DC_41A_n79A
DC_28A_n3A-n77A	DC_28A_n3A DC_28A_n77A
DC_28A_n3A-n78A	DC_28A_n3A DC_28A_n78A
DC_28A_n5A-n78A	DC_28A_n5A DC_28A_n78A
DC_28A_n7A-n78A	DC_28A_n7A DC_28A_n78A
DC_28A_n7B-n78A	DC_28A_n7A DC_28A_n7B DC_28A_n78A

EN-DC configuration	Uplink EN-DC configuration (NOTE 1)
DC_28A_n8A-n78A	DC_28A_n8A DC_28A_n78A
DC_28A_n40A-n78A	DC_28A_n40A DC_28A_n78A
DC_28A-42A_n77A DC_28A-42A_n77C DC_28A-42C_n77A	DC_28A_n77A
DC_28A-42A_n78A DC_28A-42A_n78C DC_28A-42C_n78A	DC_28A_n78A
DC_28A-42A_n79A DC_28A-42A_n79C DC_28A-42C_n79A	DC_28A_n79A
DC_28A_SUL_n78A-n83A <sup>5</sup>	DC_28A_n78A DC_28A_n83A_ULSUP-TDM_n78A
DC_29A-66A_n2A	DC_66A_n2A
DC_29A-66A-66A_n2A	DC_66A_n2A
DC_30A-66A_n2A	DC_30A_n2A DC_66A_n2A
DC_30A-66A-66A_n2A	DC_30A_n2A DC_66A_n2A
DC_30A-66A_n5A	DC_30A_n5A DC_66A_n5A
DC_30A-66A-66A_n5A DC_30A-66A-66A-66A_n5A	DC_30A_n5A DC_66A_n5A
DC_39A_n40A-n41A	DC_39A_n40A DC_39A_n41A
DC_39A_n40A-n79A	DC_39A_n40A DC_39A_n79A
DC_39A_n41A-n79A	DC_39A_n41A DC_39A_n79A
DC_40A_n41A-n79A	DC_40A_n41A DC_40A_n79A
DC_41A_n3A-n77A	DC_41A_n3A DC_41A_n77A
DC_41C_n3A-n77A	DC_41A_n3A DC_41A_n77A DC_41C_n3A DC_41C_n77A
DC_41A_n3A-n78A	DC_41A_n3A DC_41A_n78A
DC_41C_n3A-n78A	DC_41A_n3A DC_41A_n78A DC_41C_n3A DC_41C_n78A
DC_41A_n28A-n77A	DC_41A_n28A DC_41A_n77A
DC_41C_n28A-n77A	DC_41A_n28A DC_41A_n77A DC_41C_n28A DC_41C_n77A
DC_41A_n28A-n78A	DC_41A_n28A DC_41A_n78A
DC_41C_n28A-n78A	DC_41A_n28A DC_41A_n78A DC_41C_n28A DC_41C_n78A
DC_(n)41AA-n78A DC_(n)41CA-n78A DC_(n)41DA-n78A	DC_41A_n78A

EN-DC configuration	Uplink EN-DC configuration (NOTE 1)
DC_41A-42A_n77A DC_41A-42C_n77A DC_41C-42A_n77A DC_41C-42C_n77A	DC_41A_n77A
DC_41A-42A_n78A DC_41A-42C_n78A DC_41C-42A_n78A DC_41C-42C_n78A	DC_41A_n78A
DC_41A-42A_n79A DC_41A-42C_n79A DC_41C-42A_n79A DC_41C-42C_n79A	DC_41A_n79A
DC_42A_n28A-n77A	DC_42A_n28A
DC_42A_n28A-n77(2A)	DC_42A_n28A
DC_42C_n28A-n77A	DC_42A_n28A DC_42C_n28A
DC_42C_n28A-n77(2A)	DC_42A_n28A DC_42C_n28A
DC_46A-66A_n5A DC_46C-66A_n5A DC_46D-66A_n5A DC_46E-66A_n5A	DC_66A_n5A
DC_46A-66A_n25A DC_46C-66A_n25A DC_46D-66A_n25A	DC_66A_n25A
DC_46A-66A_n41A DC_46C-66A_n41A DC_46D-66A_n41A	DC_66A_n41A
DC_46A-66A_n41(2A) DC_46C-66A_n41(2A) DC_46D-66A_n41(2A)	DC_66A_n41A
DC_46A-66A_n71A DC_46C-66A_n71A DC_46D-66A_n71A	DC_66A_n71A
DC_48A_(n)5AA	DC_48A_n5A DC_(n)5AA <sup>2</sup>
DC_48A_(n)12AA	DC_48A_n12A DC_(n)12AA <sup>2</sup>
DC_48A-66A_n5A DC_48B-66A_n5A DC_48D-66A_n5A DC_48E-66A_n5A	DC_66A_n5A
DC_48A-66A_n12A	DC_48A_n12A DC_66A_n12A
DC_48A-66A_n71A	DC_48A_n71A DC_66A_n71A
DC_66A_n7A-n78A DC_66A-66A_n7A-n78A	DC_66A_n7A DC_66A_n78A
DC_66A_n7(2A)-n78A DC_66A-66A_n7(2A)-n78A	DC_66A_n7A DC_66A_n78A
DC_66A_n7A-n78(2A) DC_66A-66A_n7A-n78(2A)	DC_66A_n7A DC_66A_n78A
DC_66A_n7(2A)-n78(2A) DC_66A-66A_n7(2A)-n78(2A)	DC_66A_n7A DC_66A_n78A
DC_66A_n25A-n71A	DC_66A_n25A DC_66A_n71A
DC_66A_n38A-n78A	DC_66A_n38A DC_66A_n78A
DC_66A_n66A-n78A	DC_66A_n66A <sup>2</sup> DC_66A_n78A
DC_66A_(n)12AA	DC_66A_n12A DC_(n)12AA <sup>2</sup>

EN-DC configuration	Uplink EN-DC configuration (NOTE 1)
DC_66A-(n)71AA DC_66C-(n)71AA	DC_66A_n71A DC_(n)71AA
DC_66A_n25A-n41A DC_66A_n25A-n41C	DC_66A_n25A DC_66A_n41A
DC_66A_n25A-n41(2A)	DC_66A_n25A DC_66A_n41A
DC_66A_n41A-n71A DC_66A_n41C-n71A	DC_66A_n41A DC_66A_n71A
DC_66A_n41(2A)-n71A	DC_66A_n41A DC_66A_n71A
DC_66A-71A_n38A	DC_71A_n38A DC_66A_n38A
DC_66A-71A_n66A	DC_71A_n66A DC_66A_n66A <sup>2</sup>
DC_66A-71A_n78A	DC_71A_n78A DC_66A_n78A
DC_66A_SUL_n78A-n86A <sup>5</sup> DC_66A_n78(2A)_SUL_n78A-n86A <sup>5</sup>	DC_66A_n78A DC_66A_n86A_ULSUP-TDM_n78A
<p>NOTE 1: Uplink EN-DC configurations are the configurations supported by the present release of specifications.</p> <p>NOTE 2: Only single switched UL is supported</p> <p>NOTE 3: Restricted to E-UTRA operation when inter-band carrier aggregation is configured. The downlink operating band for Band 46 is paired with the uplink operating band (external E-UTRA band) of the carrier aggregation configuration that is supporting the configured Pcell.</p> <p>NOTE 4: If a UE is configured with both NR UL and NR SUL carriers in a cell, the switching time between NR UL carrier and NR SUL carrier can be up to 140us and placed in SUL resources.</p> <p>NOTE 5: Applicable for UE supporting inter-band EN-DC with mandatory simultaneous Rx/Tx capability</p> <p>NOTE 6: The frequency range in band n28 is restricted for this band combination to 703-733 MHz for the UL and 758 – 788 MHz for the DL.</p> <p>NOTE 7: Void.</p> <p>NOTE 8: UL carrier shall be supported in Band 2 only. Power imbalance between downlink carriers on Band 7 and Band 38 is assumed to be within 6dB.</p> <p>NOTE 9: UL carrier shall be supported in Band 66 only. Power imbalance between downlink carriers on Band 7 and Band 38 is assumed to be within 6dB.</p>	

5.5B.4.3 Inter-band EN-DC configurations within FR1 (four bands)

Table 5.5B.4.3-1: Inter-band EN-DC configurations within FR1 (four bands)

EN-DC configuration	Uplink EN-DC configuration (NOTE 1)
DC_1A-3A-5A_n78A <sup>2</sup>	DC_1A_n78A DC_3A_n78A DC_5A_n78A



EN-DC configuration	Uplink EN-DC configuration (NOTE 1)
DC_1A-3A_n5A-n78A DC_1A-3C_n5A-n78A	DC_1A_n5A DC_1A_n78A DC_3A_n5A DC_3A_n78A DC_3C_n5A DC_3C_n78A
DC_1A-3A-5A_n79A	DC_1A_n79A DC_3A_n79A DC_5A_n79A
DC_1A-3A-7A_n5A DC_1A-3A-7C_n5A DC_1A-3C-7A_n5A DC_1A-3C-7C_n5A	DC_1A_n5A DC_3A_n5A DC_3C_n5A DC_7A_n5A DC_7C_n5A
DC_1A-3A-7A_n7A DC_1A-3C-7A_n7A	DC_1A_n7A DC_3A_n7A DC_7A_n7A <sup>4</sup>
DC_1A-1A-3A-7A_n7A DC_1A-1A-3C-7A_n7A DC_1A-3A-3A-7A_n7A	DC_1A_n7A DC_3A_n7A DC_3C_n7A DC_7A_n7A <sup>4</sup>
DC_1A-3A-7A_n8A	DC_1A_n8A DC_3A_n8A DC_7A_n8A
DC_1A-3A-7A_n28A DC_1A-3A-7C_n28A DC_1A-3C-7A_n28A DC_1A-3C-7C_n28A	DC_1A_n28A DC_3A_n28A DC_3C_n28A DC_7A_n28A DC_7C_n28A
DC_1A-3A-7A_n40A	DC_1A_n40A DC_3A_n40A DC_7A_n40A
DC_1A-3A-7A_n78A <sup>2</sup> DC_1A-3A-7C_n78A DC_1A-3C-7A_n78A <sup>2</sup> DC_1A-3C-7C_n78A	DC_1A_n78A DC_3A_n78A DC_3C_n78A DC_7A_n78A DC_7C_n78A
DC_1A-3A-7A_n78(2A) DC_1A-3C-7A_n78(2A) DC_1A-3A-7C_n78(2A) DC_1A-3C-7C_n78(2A)	DC_1A_n78A DC_3A_n78A DC_3C_n78A DC_7A_n78A DC_7C_n78A
DC_1A-3A_n7A-n78A DC_1A-3A_n7B-n78A	DC_1A_n7A DC_1A_n78A DC_3A_n7A DC_3A_n78A
DC_1A-3A_n7A-n78(2A) DC_1A-3C_n7A-n78(2A)	DC_1A_n7A DC_1A_n78A DC_3A_n7A DC_3A_n78A
DC_1A-3C_n7A-n78A	DC_1A_n7A DC_1A_n78A DC_3A_n7A DC_3A_n78A DC_3C_n7A
DC_1A-3A-7A-7A_n78A <sup>2</sup>	DC_1A_n78A DC_3A_n78A DC_7A_n78A
DC_1A-3A-8A_n28A	DC_1A_n28A DC_3A_n28A DC_8A_n28A
DC_1A-3A-8A_n77A	DC_1A_n77A DC_3A_n77A DC_8A_n77A

EN-DC configuration	Uplink EN-DC configuration (NOTE 1)
DC_1A-3A-8A_n77(2A)	DC_1A_n77A DC_3A_n77A DC_8A_n77A
DC_1A-3A-8A_n78A <sup>2</sup> DC_1A-3C-8A_n78A	DC_1A_n78A DC_3A_n78A DC_8A_n78A
DC_1A-3A-8A_n79A	DC_1A_n79A DC_3A_n79A DC_8A_n79A
DC_1A-3A-18A_n77A	DC_1A_n77A DC_3A_n77A DC_18A_n77A
DC_1A-3A-18A_n78A	DC_1A_n78A DC_3A_n78A DC_18A_n78A
DC_1A-3A-18A_n79A	DC_1A_n79A DC_3A_n79A DC_18A_n79A
DC_1A-3A-19A_n77A <sup>2</sup> DC_1A-3A-19A_n77C <sup>2</sup>	DC_1A_n77A DC_3A_n77A DC_19A_n77A
DC_1A-3A-19A_n78A <sup>2</sup> DC_1A-3A-19A_n78C <sup>2</sup>	DC_1A_n78A DC_3A_n78A DC_19A_n78A
DC_1A-3A-19A_n79A <sup>2</sup> DC_1A-3A-19A_n79C <sup>2</sup>	DC_1A_n79A DC_3A_n79A DC_19A_n79A
DC_1A-3A-20A_n8A	DC_1A_n8A DC_3A_n8A DC_20A_n8A
DC_1A-3A-20A_n28A <sup>3</sup>	DC_1A_n28A DC_3A_n28A DC_20A_n28A
DC_1A-3A-20A_n38A	DC_3A_n38A DC_20A_n38A
DC_1A-3A-20A_n41A DC_1A-3C-20A_n41A	DC_1A_n41A DC_3A_n41A DC_3C_n41A DC_20A_n41A
DC_1A-3A-20A_n78A <sup>2</sup>	DC_1A_n78A DC_3A_n78A DC_20A_n78A
DC_1A-3A-21A_n77A <sup>2</sup> DC_1A-3A-21A_n77C <sup>2</sup>	DC_1A_n77A DC_3A_n77A DC_21A_n77A
DC_1A-3A-21A_n78A <sup>2</sup> DC_1A-3A-21A_n78C <sup>2</sup>	DC_1A_n78A DC_3A_n78A DC_21A_n78A
DC_1A-3A-21A_n79A <sup>2</sup> DC_1A-3A-21A_n79C <sup>2</sup>	DC_1A_n79A DC_3A_n79A DC_21A_n79A

EN-DC configuration	Uplink EN-DC configuration (NOTE 1)
DC_1A-3A-28A_n5A DC_1A-3C-28A_n5A	DC_1A_n5A DC_3A_n5A DC_3C_n5A DC_28A_n5A
DC_1A-3A-28A_n7A DC_1A-3C-28A_n7A DC_1A-3A-28A_n7B DC_1A-3C-28A_n7B	DC_1A_n7A DC_3A_n7A DC_3C_n7A DC_28A_n7A
DC_1A-3A-3A-28A_n7A DC_1A-1A-3A-28A_n7A DC_1A-1A-3C-28A_n7A DC_1A-1A-3A-3A-28A_n7A DC_1A-3A-3A-28A_n7B DC_1A-1A-3A-28A_n7B DC_1A-1A-3C-28A_n7B DC_1A-1A-3A-3A-28A_n7B	DC_1A_n7A DC_3A_n7A DC_3C_n7A DC_28A_n7A
DC_1A-3A-28A_n40A	DC_1A_n40A DC_3A_n40A DC_28A_n40A
DC_1A-3A-28A_n77A <sup>2</sup> DC_1A-3A-28A_n77C	DC_1A_n77A DC_3A_n77A DC_28A_n77A
DC_1A-3A_n28A-n77A	DC_1A_n28A DC_1A_n77A DC_3A_n28A DC_3A_n77A
DC_1A-3A_n28A-n77(2A)	DC_1A_n28A DC_1A_n77A DC_3A_n28A DC_3A_n77A
DC_1A-3A-28A_n78A <sup>2</sup> DC_1A-3C-28A_n78A DC_1A-3A-28A_n78C	DC_1A_n78A DC_3A_n78A DC_28A_n78A
DC_1A-3A-28A_n79A <sup>2</sup> DC_1A-3A-28A_n79C	DC_1A_n79A DC_3A_n79A DC_28A_n79A
DC_1A-3A_n28A-n78A <sup>2</sup> DC_1A-3C_n28A-n78A	DC_1A_n28A DC_1A_n78A DC_3A_n28A DC_3A_n78A DC_3C_n28A
DC_1A-3A-32A_n78A DC_1A-3A-32A_n78(2A)	DC_1A_n78A DC_3A_n78A
DC_1A-3A_n38A-n78A	DC_3A_n38A DC_3A_n78A
DC_1A-3A_n40A-n78A	DC_1A_n40A DC_1A_n78A DC_3A_n40A DC_3A_n78A

EN-DC configuration	Uplink EN-DC configuration (NOTE 1)
DC_1A-3A-41A_n77A DC_1A-3A-41C_n77A	DC_1A_n77A DC_3A_n77A DC_41A_n77A
DC_1A-3A-41A_n77(2A) DC_1A-3A-41C_n77(2A)	DC_1A_n77A DC_3A_n77A DC_41A_n77A DC_41C_n77A
DC_1A-3A-41A_n78A DC_1A-3A-41C_n78A	DC_1A_n78A DC_3A_n78A DC_41A_n78A
DC_1A-3A_n41A-n78A	DC_1A_n41A DC_1A_n78A DC_3A_n41A DC_3A_n78A
DC_1A-3A-41A_n78(2A) DC_1A-3A-41C_n78(2A)	DC_1A_n78A DC_3A_n78A DC_41A_n78A DC_41C_n78A
DC_1A-3A-41A_n79A DC_1A-3A-41C_n79A	DC_1A_n79A DC_3A_n79A DC_41A_n79A
DC_1A-3A-42A_n77A DC_1A-3A-42A_n77C DC_1A-3A-42C_n77A DC_1A-3A-42C_n77C DC_1A-3A-42D_n77A	DC_1A_n77A DC_3A_n77A
DC_1A-3A-42A_n78A DC_1A-3A-42A_n78C DC_1A-3A-42C_n78A DC_1A-3A-42C_n78C DC_1A-3A-42D_n78A	DC_1A_n78A DC_3A_n78A
DC_1A-3A-42A_n79A DC_1A-3A-42A_n79C DC_1A-3A-42C_n79A DC_1A-3A-42C_n79C DC_1A-3A-42D_n79A	DC_1A_n79A DC_3A_n79A
DC_1A-3A_n77A-n79A	DC_1A_n77A DC_1A_n79A DC_3A_n77A DC_3A_n79A
DC_1A-3A_n78A-n79A	DC_1A_n78A DC_1A_n79A DC_3A_n78A DC_3A_n79A
DC_1A-3A_SUL_n78A-n80A	DC_1A_n78A DC_1A_n80A DC_3A_n78A DC_3A_n80A_ULSUP-TDM_n78A
DC_1A-5A-7A_n78A	DC_1A_n78A DC_5A_n78A DC_7A_n78A
DC_1A-5A-7A-7A_n78A	DC_1A_n78A DC_5A_n78A DC_7A_n78A
DC_1A-5A-41A_n79A	DC_1A_n79A DC_5A_n79A DC_41A_n79A
DC_1A-7A_n3A-n78A	DC_1A_n3A DC_1A_n78A DC_7A_n3A DC_7A_n78A

EN-DC configuration	Uplink EN-DC configuration (NOTE 1)
DC_1A-7A_n5A-n78A DC_1A-7C_n5A-n78A	DC_1A_n5A DC_1A_n78A DC_7A_n5A DC_7A_n78A DC_7C_n5A DC_7C_n78A
DC_1A-7A-8A_n3A	DC_1A_n3A DC_7A_n3A DC_8A_n3A
DC_1A-7A_n7A-n78A	DC_1A_n7A DC_7A_n7A <sup>4</sup> DC_1A_n78A DC_7A_n78A
DC_1A-7A-8A_n78A	DC_1A_n78A DC_7A_n78A DC_8A_n78A
DC_1A-7A-20A_n3A DC_1A-7C-20A_n3A	DC_1A_n3A DC_7A_n3A DC_7C_n3A DC_20A_n3A
DC_1A-7A-20A_n8A	DC_1A_n8A DC_7A_n8A DC_20A_n8A
DC_1A-7A-20A_n28A <sup>3</sup>	DC_1A_n28A DC_7A_n28A DC_20A_n28A
DC_1A-7A-20A_n78A <sup>2</sup>	DC_1A_n78A DC_7A_n78A DC_20A_n78A
DC_1A-7A-28A_n5A DC_1A-7C-28A_n5A	DC_1A_n5A DC_7A_n5A DC_7C_n5A DC_28A_n5A
DC_1A-7A-28A_n7A	DC_1A_n7A DC_7A_n7A <sup>4</sup> DC_28A_n7A
DC_1A-1A-7A-28A_n7A	DC_1A_n7A DC_7A_n7A <sup>4</sup> DC_28A_n7A
DC_1A-7A-28A_n40A	DC_1A_n40A DC_7A_n40A DC_28A_n40A
DC_1A-7A-28A_n78A DC_1A-7C-28A_n78A	DC_1A_n78A DC_7A_n78A DC_7C_n78A DC_28A_n78A
DC_1A-7A_n28A-n78A <sup>2</sup> DC_1A-7C_n28A-n78A	DC_1A_n28A DC_1A_n78A DC_7A_n28A DC_7A_n78A DC_7C_n28A DC_7C_n78A
DC_1A-8A_n3A-n28A	DC_1A_n3A DC_1A_n28A DC_8A_n3A DC_8A_n28A
DC_1A-8A-11A_n77A	DC_1A_n77A DC_8A_n77A DC_11A_n77A
DC_1A-8A-11A_n77(2A)	DC_1A_n77A DC_8A_n77A DC_11A_n77A
DC_1A-8A-11A_n78A	DC_1A_n78A DC_8A_n78A DC_11A_n78A

EN-DC configuration	Uplink EN-DC configuration (NOTE 1)
DC_1A-8A-20A_n78A	DC_1A_n78A DC_8A_n78A DC_20A_n78A
DC_1A-8A_n28A-n77A	DC_1A_n28A DC_1A_n77A DC_8A_n28A DC_8A_n77A
DC_1A-8A_n28A-n77(2A)	DC_1A_n28A DC_1A_n77A DC_8A_n28A DC_8A_n77A
DC_1A-8A-42A_n77A DC_1A-8A-42C_n77A	DC_1A_n77A DC_8A_n77A
DC_1A-8A-42A_n77(2A) DC_1A-8A-42C_n77(2A)	DC_1A_n77A DC_8A_n77A
DC_1A-11A-18A_n77A	DC_1A_n77A DC_11A_n77A DC_18A_n77A
DC_1A-11A-18A_n78A	DC_1A_n78A DC_11A_n78A DC_18A_n78A
DC_1A-18A_n3A-n77A	DC_18A_n3A DC_18A_n77A
DC_1A-18A_n3A-n78A	DC_1A_n3A DC_1A_n78A DC_18A_n3A DC_18A_n78A
DC_1A-18A-28A_n77A	DC_1A_n77A DC_18A_n77A DC_28A_n77A
DC_1A-18A-28A_n78A	DC_1A_n78A DC_18A_n78A DC_28A_n78A
DC_1A-18A-28A_n79A <sup>2</sup>	DC_1A_n79A DC_18A_n79A DC_28A_n79A
DC_1A-18A-41A_n3A DC_1A-18A-41C_n3A	DC_1A_n3A DC_18A_n3A DC_41A_n3A DC_41C_n3A
DC_1A-18A-41A_n77A DC_1A-18A-41C_n77A	DC_1A_n77A DC_18A_n77A DC_41A_n77A DC_41C_n77A
DC_1A-18A-41A_n78A DC_1A-18A-41C_n78A	DC_1A_n78A DC_18A_n78A DC_41A_n78A DC_41C_n78A
DC_1A-18A-42A_n77A DC_1A-18A-42C_n77A	DC_1A_n77A DC_18A_n77A
DC_1A-18A-42A_n78A DC_1A-18A-42C_n78A	DC_1A_n78A DC_18A_n78A
DC_1A-18A-42A_n79A DC_1A-18A-42C_n79A	DC_1A_n79A DC_18A_n79A
DC_1A-19A-21A_n77A DC_1A-19A-21A_n77C	DC_1A_n77A DC_19A_n77A DC_21A_n77A
DC_1A-19A-21A_n78A DC_1A-19A-21A_n78C	DC_1A_n78A DC_19A_n78A DC_21A_n78A
DC_1A-19A-21A_n79A DC_1A-19A-21A_n79C	DC_1A_n79A DC_19A_n79A DC_21A_n79A
DC_1A-19A-42A_n77A	DC_1A_n77A

EN-DC configuration	Uplink EN-DC configuration (NOTE 1)
DC_1A-19A-42A_n77C DC_1A-19A-42C_n77A DC_1A-19A-42C_n77C	DC_19A_n77A
DC_1A-19A-42A_n78A DC_1A-19A-42A_n78C DC_1A-19A-42C_n78A DC_1A-19A-42C_n78C	DC_1A_n78A DC_19A_n78A
DC_1A-19A-42A_n79A DC_1A-19A-42A_n79C DC_1A-19A-42C_n79A DC_1A-19A-42C_n79C	DC_1A_n79A DC_19A_n79A
DC_1A-19A_n77A-n79A	DC_19A_n77A DC_19A_n79A
DC_1A-19A_n78A-n79A	DC_19A_n78A DC_19A_n79A
DC_1A-20A_n3A-n38A	DC_1A_n3A DC_20A_n3A DC_1A_n38A DC_20A_n38A
DC_1A-20A_n3A-n78A	DC_1A_n3A DC_20A_n3A DC_1A_n78A DC_20A_n78A
DC_1A-20A_n28A-n78A <sup>2,3</sup>	DC_1A_n28A DC_1A_n78A DC_20A_n28A DC_20A_n78A
DC_1A-20A_(n)38AA	DC_1A_n38A DC_20A_n38A
DC_1A-20A-38A_n78A	DC_1A_n78A
DC_1A-20A_n41A-n78A	DC_1A_n41A DC_1A_n78A DC_20A_n41A DC_20A_n78A
DC_1A-21A-28A_n77A <sup>2</sup>	DC_1A_n77A DC_21A_n77A DC_28A_n77A
DC_1A-21A-28A_n78A <sup>2</sup>	DC_1A_n78A DC_21A_n78A DC_28A_n78A
DC_1A-21A-28A_n79A <sup>2</sup>	DC_1A_n79A DC_21A_n79A DC_28A_n79A
DC_1A-21A-42A_n77A DC_1A-21A-42A_n77C DC_1A-21A-42C_n77A DC_1A-21A-42C_n77C DC_1A-21A-42D_n77A DC_1A-21A-42D_n77C	DC_1A_n77A DC_21A_n77A
DC_1A-21A-42A_n78A DC_1A-21A-42A_n78C DC_1A-21A-42C_n78A DC_1A-21A-42C_n78C DC_1A-21A-42D_n78A DC_1A-21A-42D_n78C	DC_1A_n78A DC_21A_n78A
DC_1A-21A-42A_n79A DC_1A-21A-42A_n79C DC_1A-21A-42C_n79A DC_1A-21A-42C_n79C DC_1A-21A-42D_n79A DC_1A-21A-42D_n79C	DC_1A_n79A DC_21A_n79A
DC_1A-21A_n77A-n79A	DC_1A_n77A DC_1A_n79A

EN-DC configuration	Uplink EN-DC configuration (NOTE 1)
DC_1A-21A_n78A-n79A	DC_1A_n78A DC_1A_n79A
DC_1A-28A_n3A-n77A	DC_28A_n3A DC_28A_n77A
DC_1A-28A_n3A-n78A	DC_1A_n3A DC_1A_n78A DC_28A_n3A DC_28A_n78A
DC_1A-28A_n5A-n78A	DC_1A_n5A DC_1A_n78A DC_28A_n5A DC_28A_n78A
DC_1A-28A_n7A-n78A	DC_1A_n7A DC_28A_n7A DC_1A_n78A DC_28A_n78A
DC_1A-28A_n7B-n78A	DC_1A_n7A DC_1A_n7B DC_28A_n7A DC_28A_n7B DC_1A_n78A DC_28A_n78A
DC_1A-28A_n40A-n78A	DC_1A_n40A DC_1A_n78A DC_28A_n40A DC_28A_n78A
DC_1A-28A-42A_n77A	DC_1A_n77A
DC_1A-28A-42C_n77A	DC_28A_n77A
DC_1A-28A-42A_n78A	DC_1A_n78A
DC_1A-28A-42C_n78A	DC_28A_n78A
DC_1A-28A-42A_n79A	DC_1A_n79A
DC_1A-28A-42C_n79A	DC_28A_n79A
DC_1A-41A_n3A_n77A	DC_41A_n3A DC_41A_n77A
DC_1A-41C_n3A_n77A	DC_41A_n3A DC_41A_n77A DC_41C_n3A DC_41C_n77A
DC_1A-41A_n3A_n78A	DC_41A_n3A DC_41A_n78A
DC_1A-41C_n3A_n78A	DC_41A_n3A DC_41A_n78A DC_41C_n3A DC_41C_n78A
DC_1A-41A_n28A_n77A	DC_1A_n28A DC_1A_n77A DC_41A_n28A DC_41A_n77A
DC_1A-41C_n28A_n77A	DC_1A_n28A DC_1A_n77A DC_41A_n28A DC_41A_n77A DC_41C_n28A DC_41C_n77A
DC_1A-41A_n28A_n78A	DC_1A_n28A DC_1A_n78A DC_41A_n28A DC_41A_n78A
DC_1A-41C_n28A_n78A	DC_1A_n28A DC_1A_n78A DC_41A_n28A DC_41A_n78A DC_41C_n28A DC_41C_n78A



<b>EN-DC configuration</b>	<b>Uplink EN-DC configuration (NOTE 1)</b>
DC_1A-41A-42A_n77A DC_1A-41A-42C_n77A DC_1A-41C-42A_n77A DC_1A-41C-42C_n77A	DC_1A_n77A DC_41A_n77A
DC_1A-41A-42A_n78A DC_1A-41A-42C_n78A DC_1A-41C-42A_n78A DC_1A-41C-42C_n78A	DC_1A_n78A DC_41A_n78A
DC_1A-41A-42A_n79A DC_1A-41A-42C_n79A DC_1A-41C-42A_n79A DC_1A-41C-42C_n79A	DC_1A_n79A DC_41A_n79A

EN-DC configuration	Uplink EN-DC configuration (NOTE 1)
DC_1A-42A_n77A-n79A DC_1A-42C_n77A-n79A	DC_1A_n77A DC_1A_n79A
DC_1A-42A_n78A-n79A DC_1A-42C_n78A-n79A	DC_1A_n78A DC_1A_n79A
DC_2A-5A_(n)12AA	DC_5A_n12A DC_2A_n12A DC_(n)12AA <sup>4</sup>
DC_2A-12A_(n)5AA	DC_2A_n5A DC_12A_n5A DC_(n)5AA <sup>4</sup>
DC_2A-5A-48A_n12A	DC_2A_n12A DC_5A_n12A DC_48A_n12A
DC_2A-5A-48A_n71A	DC_2A_n71A DC_5A_n71A DC_48A_n71A
DC_2A-5A-66A_n2A DC_2A-5B-66A_n2A	DC_2A_n2A <sup>4</sup> DC_5A_n2A DC_66A_n2A
DC_2A-5A-5A-66A_n2A DC_2A-5A-66A-66A_n2A DC_2A-5B-66A-66A_n2A DC_2A-5A-5A-66A-66A_n2A	DC_2A_n2A <sup>4</sup> DC_5A_n2A DC_66A_n2A
DC_2A-5A-66A_n5A	DC_2A_n5A DC_66A_n5A
DC_2A-2A-5A-66A_n5A DC_2A-2A-5A-66A-66A_n5A DC_2A-5A-66A-66A_n5A	DC_2A_n5A DC_66A_n5A
DC_2A-5A-66A_n12A	DC_2A_n12A DC_5A_n12A DC_66A_n12A
DC_2A-5A-66A_n66A DC_2A-5B-66A_n66A	DC_5A_n66A
DC_2A-5A-5A-66A_n66A DC_2A-5A-66A-66A_n66A DC_2A-5B-66A-66A_n66A DC_2A-2A-5A-66A-66A_n66A DC_2A-5A-5A-66A-66A_n66A	DC_5A_n66A
DC_2A-5A-66A_n71A	DC_2A_n71A DC_5A_n71A DC_66A_n71A
DC_2A-7A-13A_n66A DC_2A-7A-7A-13A_n66A DC_2A-7C-13A_n66A	DC_2A_n66A DC_7A_n66A DC_13A_n66A
DC_2A-7A_n38A-n78A DC_2A-7A-7A_n38A-n78A DC_2A-7C_n38A-n78A	DC_2A_n78A
DC_2A-7A-66A_n38A DC_2A-2A-7A-66A_n38A	2A <sup>5</sup> 66A <sup>5</sup>
DC_2A-7A-66A_n66A DC_2A-7C-66A_n66A DC_2A-7A-7A-66A_n66A	DC_2A_n66A DC_7A_n66A DC_66A_n66A <sup>4</sup>
DC_2A-7A-66A_n71A	DC_2A_n71A DC_7A_n71A DC_66A_n71A
DC_2A-7A-66A_n78A DC_2A-7C-66A_n78A	DC_2A_n78A DC_7A_n78A DC_66A_n78A
DC_2A-7A_n66A-n78A DC_2A-7A-7A_n66A-n78A DC_2A-7C_n66A-n78A	DC_2A_n66A DC_2A_n78A DC_7A_n66A DC_7A_n78A

EN-DC configuration	Uplink EN-DC configuration (NOTE 1)
DC_2A-7A-66A_n78(2A) DC_2A-7A-7A-66A_n78A DC_2A-7A-7A-66A_n78(2A) DC_2A-7C-66A_n78(2A) DC_2A-7A-66A-66A_n78A DC_2A-7A-66A-66A_n78(2A) DC_2A-7A-7A-66A-66A_n78A DC_2A-7A-7A-66A-66A_n78(2A) DC_2A-7C-66A-66A_n78A DC_2A-7C-66A-66A_n78(2A)	DC_2A_n78A DC_7A_n78A DC_66A_n78A
DC_2A-12A-30A_n2A	DC_12A_n2A DC_30A_n2A
DC_2A-12A-48A_n5A	DC_2A_n5A DC_12A_n5A DC_48A_n5A
DC_2A-12A-66A_n5A	DC_2A_n5A DC_12A_n5A DC_66A_n5A
DC_2A-12A-30A_n66A DC_2A-2A-12A-30A_n66A	DC_2A_n66A DC_12A_n66A DC_30A_n66A
DC_2A-12A-66A_n2A	DC_12A_n2A DC_66A_n2A
DC_2A-12A-66A-66A_n2A	DC_12A_n2A DC_66A_n2A
DC_2A-12A-66A_n66A	DC_2A_n66A DC_12A_n66A DC_66A_n66A <sup>4</sup>
DC_2A-2A-12A-66A_n66A	DC_2A_n66A DC_12A_n66A DC_66A_n66A <sup>4</sup>
DC_2A-13A-66A_n2A	DC_13A_n2A
DC_2A-13A-66A-66A_n2A	DC_13A_n2A
DC_2A-13A-66A_n5A DC_2A-2A-13A-66A_n5A DC_2A-13A-66A-66A_n5A DC_2A-2A-13A-66A-66A_n5A	DC_2A_n5A DC_66A_n5A
DC_2A-13A-66A_n48A DC_2A-13A-66A_n48B	DC_2A_n48A DC_13A_n48A DC_66A_n48A
DC_2A-13A-66A-66A_n48A DC_2A-13A-66A-66A_n48B	DC_2A_n48A DC_13A_n48A DC_66A_n48A
DC_2A-13A-66A_n66A DC_2A-2A-13A-66A_n66A DC_2A-13A-66A-66A_n66A DC_2A-2A-13A-66A-66A_n66A	DC_2A_n66A DC_13A_n66A DC_66A_n66A <sup>4</sup>

EN-DC configuration	Uplink EN-DC configuration (NOTE 1)
DC_2A-14A-66A_n2A	DC_2A_n2A <sup>4</sup> DC_14A_n2A DC_66A_n2A
DC_2A-14A-66A-66A_n2A	DC_2A_n2A <sup>4</sup> DC_14A_n2A DC_66A_n2A
DC_2A-14A-66A_n66A	DC_2A_n66A DC_14A_n66A DC_66A_n66A <sup>4</sup>
DC_2A-2A-14A-66A_n66A	DC_2A_n66A DC_14A_n66A DC_66A_n66A <sup>4</sup>
DC_2A-29A-30A_n2A	DC_2A_n2A <sup>4</sup> DC_30A_n2A
DC_2A-29A-66A_n2A	DC_2A_n2A <sup>4</sup> DC_66A_n2A
DC_2A-29A-66A-66A_n2A	DC_2A_n2A <sup>4</sup> DC_66A_n2A
DC_2A-29A-66A_n66A	DC_2A_n66A DC_66A_n66A <sup>4</sup>
DC_2A-30A-66A_n2A	DC_2A_n2A <sup>4</sup> DC_30A_n2A DC_66A_n2A
DC_2A-30A-66A-66A_n2A	DC_2A_n2A <sup>4</sup> DC_30A_n2A DC_66A_n2A
DC_2A-30A-66A_n5A DC_2A-2A-30A-66A_n5A DC_2A-30A-66A-66A_n5A	DC_2A_n5A DC_30A_n5A DC_66A_n5A
DC_2A-30A-66A_n66A	DC_2A_n66A DC_30A_n66A DC_66A_n66A <sup>4</sup>
DC_2A-46A_n41A-n66A DC_2A-46C_n41A-n66A DC_2A-46D_n41A-n66A	DC_2A_n41A DC_2A_n66A
DC_2A-46A_n41A-n71A DC_2A-46C_n41A-n71A DC_2A-46D_n41A-n71A	DC_2A_n41A DC_2A_n71A
DC_2A-46A_n41(2A)-n71A DC_2A-46C_n41(2A)-n71A DC_2A-46D_n41(2A)-n71A	DC_2A_n41A DC_2A_n71A
DC_2A-46A-48A_n5A DC_2A-46C-48A_n5A DC_2A-46D-48A_n5A DC_2A-46E-48A_n5A	DC_2A_n5A DC_48A_n5A
DC_2A-46A-48A_n66A DC_2A-46C-48A_n66A DC_2A-46D-48A_n66A DC_2A-46E-48A_n66A	DC_2A_n66A DC_48A_n66A
DC_2A-46A-66A_n41A DC_2A-46C-66A_n41A DC_2A-46D-66A_n41A	DC_2A_n41A DC_66A_n41A
DC_2A-46A-66A_n41(2A) DC_2A-46C-66A_n41(2A) DC_2A-46D-66A_n41(2A)	DC_2A_n41A DC_66A_n41A
DC_2A-46A-66A_n71A DC_2A-46C-66A_n71A DC_2A-46D-66A_n71A	DC_2A_n71A DC_66A_n71A
DC_2A-48A_(n)5AA	DC_2A_n5A DC_48A_n5A DC_(n)5AA <sup>4</sup>
DC_2A-46A_n66A-n71A DC_2A-46C_n66A-n71A DC_2A-46D_n66A-n71A	DC_2A_n66A DC_2A_n71A

EN-DC configuration	Uplink EN-DC configuration (NOTE 1)
DC_2A-48A-66A_n5A	DC_2A_n5A DC_48A_n5A DC_66A_n5A
DC_2A-48A-66A_n12A	DC_2A_n12A DC_48A_n12A DC_66A_n12A
DC_2A-48A-66A_n71A	DC_2A_n71A DC_48A_n71A DC_66A_n71A
DC_2A-66A_(n)5AA	DC_2A_n5A DC_66A_n5A DC_(n)5AA <sup>4</sup>
DC_2A-66A_n38A-n78A	DC_2A_n38A DC_2A_n78A DC_66A_n38A DC_66A_n78A
DC_2A-66A-71A_n38A DC_2A-2A-66A-71A_n38A	DC_2A_n38A DC_66A_n38A DC_71A_n38A
DC_2A-66A-71A_n66A	DC_2A_n66A DC_66A_n66A <sup>4</sup> DC_71A_n66A
DC_2A-66A-71A_n78A DC_2A-2A-66A-71A_n78A	DC_2A_n78A DC_66A_n78A DC_71A_n78A
DC_2A-66A-(n)71AA DC_2A-66C-(n)71AA	DC_2A_n71A DC_66A_n71A DC_(n)71AA
DC_2A-66A_n41A-n71A DC_2A-66A_n41C-n71A	DC_2A_n41A DC_2A_n71A DC_66A_n41A DC_66A_n71A
DC_2A-66A_n41(2A)-n71A	DC_2A_n41A DC_2A_n71A DC_66A_n41A DC_66A_n71A
DC_2A-66A_n66A-n78A	DC_2A_n66A DC_2A_n78A DC_66A_n66A <sup>4</sup>
DC_3A-5A-7A_n78A DC_3A-5A-7A-7A_n78A	DC_3A_n78A DC_5A_n78A DC_7A_n78A
DC_3A-7A_n1A-n78A DC_3C-7A_n1A-n78A DC_3A-3A-7A_n1A-n78A DC_3A-7A-7A_n1A-n78A DC_3A-3A-7A-7A_n1A-n78A	DC_3A_n1A DC_3A_n78A DC_7A_n1A DC_7A_n78A
DC_3A-7C_n1A-n78A DC_3C-7C_n1A-n78A	DC_3A_n1A DC_3A_n78A DC_7A_n1A DC_7A_n78A DC_7C_n1A DC_7C_n78A
DC_3A-5A-41A_n79A	DC_3A_n79A DC_5A_n79A DC_41A_n79A
DC_3A-7A_n5A-n78A DC_3A-7C_n5A-n78A DC_3C-7A_n5A-n78A DC_3C-7C_n5A-n78A	DC_3A_n5A DC_3C_n5A DC_3A_n78A DC_3C_n78A DC_7A_n5A DC_7C_n5A DC_7A_n78A DC_7C_n78A

EN-DC configuration	Uplink EN-DC configuration (NOTE 1)
DC_3A-7A_n7A-n78A DC_3A-3A-7A_n7A-n78A	DC_3A_n7A DC_7A_n7A <sup>4</sup> DC_3A_n78A DC_7A_n78A
DC_3C-7A_n7A-n78A	DC_3A_n7A DC_3C_n7A DC_7A_n7A <sup>4</sup> DC_3A_n78A DC_3C_n78A DC_7A_n78A
DC_3A-7A-8A_n1A	DC_3A_n1A DC_7A_n1A DC_8A_n1A
DC_3A-3A-7A-8A_n1A DC_3A-7A-7A-8A_n1A DC_3A-3A-7A-7A-8A_n1A	DC_3A_n1A DC_7A_n1A DC_8A_n1A
DC_3A-7A-8A_n77A	DC_3A_n77A DC_7A_n77A DC_8A_n77A
DC_3A-7A-8A_n78A	DC_3A_n78A, DC_7A_n78A, DC_8A_n78A
DC_3A-3A-7A-8A_n78A DC_3A-7A-7A-8A_n78A DC_3A-3A-7A-7A-8A_n78A	DC_3A_n78A DC_7A_n78A DC_8A_n78A
DC_3A-7A-20A_n1A DC_3C-7A-20A_n1A DC_3A-7C-20A_n1A DC_3C-7C-20A_n1A	DC_3A_n1A DC_3C_n1A DC_7A_n1A DC_7C_n1A DC_20A_n1A
DC_3A-7A-20A_n8A	DC_3A_n8A DC_7A_n8A DC_20A_n8A
DC_3A-7A-20A_n28A <sup>3</sup>	DC_3A_n28A DC_7A_n28A DC_20A_n28A
DC_3A-7A-20A_n78A <sup>2</sup> DC_3C-7A-20A_n78A <sup>2</sup>	DC_3A_n78A DC_20A_n78A DC_7A_n78A
DC_3A-7A-28A_n5A DC_3A-7C-28A_n5A DC_3C-7A-28A_n5A DC_3C-7C-28A_n5A	DC_3A_n5A DC_3C_n5A DC_7A_n5A DC_7C_n5A DC_28A_n5A
DC_3A-7A-28A_n7A DC_3C-7A-28A_n7A	DC_3A_n7A DC_3C_n7A DC_7A_n7A <sup>4</sup> DC_28A_n7A
DC_3A-3A-7A-28A_n7A	DC_3A_n7A DC_7A_n7A <sup>4</sup> DC_28A_n7A
DC_3A-7A-28A_n40A	DC_3A_n40A DC_7A_n40A DC_28A_n40A
DC_3A-7A-28A_n78A <sup>2</sup> DC_3A-7C-28A_n78A <sup>2</sup> DC_3C-7A-28A_n78A DC_3C-7C-28A_n78A	DC_3A_n78A DC_3C_n78A DC_7A_n78A DC_7C_n78A DC_28A_n78A
DC_3A-7A_n28A-n78A <sup>2</sup> DC_3A-7C_n28A-n78A DC_3C-7A_n28A-n78A DC_3C-7C_n28A-n78A	DC_3A_n28A DC_3A_n78A DC_3C_n28A DC_7A_n28A DC_7A_n78A

EN-DC configuration	Uplink EN-DC configuration (NOTE 1)
	DC_7C_n28A DC_7C_n78A
DC_3A-7A-40A_n1A	DC_3A_n1A DC_7A_n1A DC_40A_n1A
DC_3A-7A_SUL_n78A-n80A DC_3C-7A_SUL_n78A-n80A	DC_3A_n78A DC_3A_n80A_ULSUP-TDM_n78A DC_7A_n78A DC_7A_n80A
DC_3A-8A_n1A-n78A DC_3A-3A-8A_n1A-n78A	DC_3A_n1A DC_3A_n78A DC_8A_n1A DC_8A_n78A
DC_3A-8A-20A_n78A	DC_3A_n78A DC_8A_n78A DC_20A_n78A
DC_3A-8A_n28A-n77A	DC_3A_n28A DC_3A_n77A DC_8A_n28A DC_8A_n77A
DC_3A-8A_n28A-n77(2A)	DC_3A_n28A DC_3A_n77A DC_8A_n28A DC_8A_n77A
DC_3A-8A-42A_n77A DC_3A-8A-42C_n77A	DC_3A_n77A DC_8A_n77A
DC_3A-8A_SUL_n78A-n80A	DC_3A_n78A DC_3A_n80A_ULSUP-TDM_n78A DC_8A_n78A DC_8A_n80A
DC_3A-18A-42A_n77A DC_3A-18A-42C_n77A	DC_3A_n77A DC_18A_n77A
DC_3A-18A-42A_n78A DC_3A-18A-42C_n78A	DC_3A_n78A DC_18A_n78A
DC_3A-18A-42A_n79A DC_3A-18A-42C_n79A	DC_3A_n79A DC_18A_n79A
DC_3A-19A-21A_n77A <sup>2</sup> DC_3A-19A-21A_n77C <sup>2</sup>	DC_3A_n77A DC_19A_n77A DC_21A_n77A
DC_3A-19A-21A_n78A <sup>2</sup> DC_3A-19A-21A_n78C <sup>2</sup>	DC_3A_n78A DC_19A_n78A DC_21A_n78A
DC_3A-19A-21A_n79A <sup>2</sup> DC_3A-19A-21A_n79C <sup>2</sup>	DC_3A_n79A DC_19A_n79A DC_21A_n79A
DC_3A-19A-42A_n77A DC_3A-19A-42A_n77C DC_3A-19A-42C_n77A DC_3A-19A-42C_n77C DC_3A-19A-42D_n77A DC_3A-19A-42D_n77C	DC_3A_n77A DC_19A_n77A
DC_3A-19A-42A_n78A DC_3A-19A-42A_n78C DC_3A-19A-42C_n78A DC_3A-19A-42C_n78C DC_3A-19A-42D_n78A DC_3A-19A-42D_n78C	DC_3A_n78A DC_19A_n78A
DC_3A-19A-42A_n79A <sup>2</sup> DC_3A-19A-42A_n79C <sup>2</sup> DC_3A-19A-42C_n79A <sup>2</sup> DC_3A-19A-42C_n79C <sup>2</sup> DC_3A-19A-42D_n79A DC_3A-19A-42D_n79C	DC_3A_n79A DC_19A_n79A
DC_3A-19A_n77A-n79A	DC_19A_n77A DC_19A_n79A

EN-DC configuration	Uplink EN-DC configuration (NOTE 1)
DC_3A-19A_n78A-n79A	DC_19A_n78A DC_19A_n79A
DC_3A-20A_n1A-n7A	DC_3A_n1A DC_3A_n7A DC_20A_n1A DC_20A_n7A
DC_3C-20A_n1A-n7A	DC_3A_n1A DC_3C_n1A DC_3A_n7A DC_3C_n7A DC_20A_n1A DC_20A_n7A
DC_3A-20A_n1A-n28A	DC_3A_n1A DC_3A_n28A DC_20A_n1A DC_20A_n28A
DC_3C-20A_n1A-n28A	DC_3A_n1A DC_3A_n28A DC_20A_n1A DC_3C_n1A DC_3C_n28A DC_20A_n28A
DC_3A-20A_n7A-n28A	DC_3A_n7A DC_3A_n28A DC_20A_n7A DC_20A_n28A
DC_3C-20A_n7A-n28A	DC_3A_n7A DC_3A_n28A DC_3C_n7A DC_3C_n28A DC_20A_n7A DC_20A_n28A
DC_3A-20A_n28A-n78A <sup>2,3</sup> DC_3C-20A_n28A-n78A <sup>2,3</sup>	DC_3A_n28A DC_3A_n78A DC_20A_n28A DC_20A_n78A
DC_3A-20A-38A_n78A	DC_3A_n78A
DC_3A-20A_n38A-n78A	DC_3A_n78A DC_20A_n78A DC_3A_n38A DC_20A_n38A
DC_3A-20A_n41A-n78A	DC_3A_n41A DC_3A_n78A DC_20A_n41A DC_20A_n78A
DC_3A_20A_SUL_n78A-n80A DC_3C_20A_SUL_n78A-n80A	DC_3A_n78A DC_3A_n80A_ULSUP-TDM_n78A DC_20A_n78A DC_20A_n80A
DC_3A-21A-42A_n77A DC_3A-21A-42A_n77C DC_3A-21A-42C_n77A DC_3A-21A-42C_n77C DC_3A-21A-42D_n77A DC_3A-21A-42D_n77C	DC_3A_n77A DC_21A_n77A
DC_3A-21A-42A_n78A DC_3A-21A-42A_n78C DC_3A-21A-42C_n78A DC_3A-21A-42C_n78C DC_3A-21A-42D_n78A DC_3A-21A-42D_n78C	DC_3A_n78A DC_21A_n78A
DC_3A-21A-42A_n79A DC_3A-21A-42A_n79C DC_3A-21A-42C_n79A	DC_3A_n79A DC_21A_n79A



EN-DC configuration	Uplink EN-DC configuration (NOTE 1)
DC_3A-21A-42C_n79C DC_3A-21A-42D_n79A DC_3A-21A-42D_n79C	
DC_3A-21A_n77A-n79A	DC_3A_n77A DC_3A_n79A DC_21A_n77A DC_21A_n79A
DC_3A-21A_n78A-n79A	DC_3A_n78A DC_3A_n79A DC_21A_n78A DC_21A_n79A
DC_3A-28A_n5A-n78A DC_3C-28A_n5A-n78A	DC_3A_n5A DC_3C_n5A DC_3A_n78A DC_3C_n78A DC_28A_n5A DC_28A_n78A
DC_3A-28A_n7A-n78A DC_3A-3A-28A_n7A-n78A	DC_3A_n7A DC_28A_n7A DC_3A_n78A DC_28A_n78A
DC_3A-28A_n7B-n78A DC_3A-3A-28A_n7B-n78A	DC_3A_n7A DC_3A_n7B DC_28A_n7A DC_28A_n7B DC_3A_n78A DC_28A_n78A
DC_3C-28A_n7A-n78A	DC_3A_n7A DC_3C_n7A DC_28A_n7A DC_3A_n78A DC_3C_n78A DC_28A_n78A
DC_3C-28A_n7B-n78A	DC_3A_n7A DC_3C_n7A DC_3A_n7B DC_3C_n7B DC_28A_n7A DC_28A_n7B DC_3A_n78A DC_3C_n78A DC_28A_n78A
DC_3A-28A_n40A-n78A	DC_3A_n40A DC_3A_n78A DC_28A_n40A DC_28A_n78A
DC_3A-28A-41A_n78A DC_3A-28A-41C_n78A	DC_3A_n78A DC_28A_n78A DC_41A_n78A DC_41C_n78A
DC_3A-28A-42A_n77A DC_3A-28A-42C_n77A	DC_3A_n77A DC_28A_n77A
DC_3A-28A-42A_n78A DC_3A-28A-42C_n78A	DC_3A_n78A DC_28A_n78A
DC_3A-28A-42A_n79A DC_3A-28A-42C_n79A	DC_3A_n79A DC_28A_n79A
DC_3A-41A_n28A-n77A	DC_3A_n28A DC_3A_n77A DC_41A_n28A DC_41A_n77A
DC_3A-41C_n28A-n77A	DC_3A_n28A DC_3A_n77A DC_41A_n28A DC_41A_n77A DC_41C_n28A

EN-DC configuration	Uplink EN-DC configuration (NOTE 1)
	DC_41C_n77A
DC_3A-41A_n28A-n78A	DC_3A_n28A DC_3A_n78A DC_41A_n28A DC_41A_n78A
DC_3A-41C_n28A-n78A	DC_3A_n28A DC_3A_n78A DC_41A_n28A DC_41A_n78A DC_41C_n28A DC_41C_n78A
DC_3A-41A-42A_n77A DC_3A-41A-42C_n77A DC_3A-41C-42A_n77A DC_3A-41C-42C_n77A	DC_3A_n77A DC_41A_n77A
DC_3A-41A-42A_n78A DC_3A-41A-42C_n78A DC_3A-41C-42A_n78A DC_3A-41C-42C_n78A	DC_3A_n78A DC_41A_n78A
DC_3A-41A-42A_n79A DC_3A-41A-42C_n79A DC_3A-41C-42A_n79A DC_3A-41C-42C_n79A	DC_3A_n79A DC_41A_n79A
DC_3A-42A_n77A-n79A DC_3A-42C_n77A-n79A	DC_3A_n77A DC_3A_n79A
DC_3A-42A_n78A-n79A DC_3A-42C_n78A-n79A	DC_3A_n78A DC_3A_n79A
DC_5A-48A_(n)12AA	DC_5A_n12A DC_48A_n12A DC_(n)12AA <sup>4</sup>
DC_5A-48A-66A_n12A	DC_5A_n12A DC_48A_n12A DC_66A_n12A
DC_5A-48A-66A_n71A	DC_5A_n71A DC_48A_n71A DC_66A_n71A
DC_5A-66A_(n)12AA	DC_5A_n12A DC_66A_n12A DC_(n)12AA <sup>4</sup>
DC_7A-8A_n1A-n78A DC_7A-7A-8A_n1A-n78A	DC_7A_n1A DC_7A_n78A DC_8A_n1A DC_8A_n78A
DC_7A-13A-66A_n66A DC_7C-13A-66A_n66A	DC_7A_n66A DC_13A_n66A DC_66A_n66A <sup>4</sup>
DC_7A-20A_n3A-n78A	DC_7A_n3A DC_20A_n3A DC_7A_n78A DC_20A_n78A
DC_7A-20A_n28A-n78A <sup>2,3</sup>	DC_7A_n28A DC_7A_n78A DC_20A_n28A DC_20A_n78A
DC_7A-28A_n3A-n78A	DC_7A-n3A DC_28A_n3A DC_7A_n78A DC_28A_n78A
DC_7C-28A_n3A-n78A	DC_7A-n3A DC_7C-n3A DC_28A_n3A DC_7A_n78A DC_7C_n78A DC_28A_n78A

EN-DC configuration	Uplink EN-DC configuration (NOTE 1)
DC_7A-28A_n5A-n78A DC_7C-28A_n5A-n78A	DC_7A_n5A DC_7C_n5A DC_7A_n78A DC_7C_n78A DC_28A_n5A DC_28A_n78A
DC_7A-28A_n7A-n78A	DC_7A_n7A <sup>4</sup> DC_28A_n7A DC_7A_n78A DC_28A_n78A
DC_7A-66A_n66A-n78A DC_7A-7A-66A_n66A-n78A DC_7C-66A_n66A-n78A	DC_7A_n66A DC_7A_n78A DC_66A_n66A <sup>4</sup> DC_66A_n78A
DC_12A-30A-66A_n2A DC_12A-30A-66A-66A_n2A	DC_12A_n2A DC_30A_n2A DC_66A_n2A
DC_12A-30A-66A_n66A	DC_12A_n66A DC_30A_n66A DC_66A_n66A <sup>4</sup>
DC_12A-48A_(n)5AA	DC_12A_n5A DC_48A_n5A DC_(n)5AA <sup>4</sup>
DC_12A-48A-66A_n5A	DC_12A_n5A DC_48A_n5A DC_66A_n5A
DC_12A-66A_(n)5AA	DC_12A_n5A DC_66A_n5A DC_(n)5AA <sup>4</sup>
DC_18A-41A_n3A-n77A	DC_18A_n3A DC_18A_n77A DC_41A_n3A DC_41A_n77A
DC_18A-41C_n3A-n77A	DC_18A_n3A DC_18A_n77A DC_41A_n3A DC_41A_n77A DC_41C_n3A DC_41C_n77A
DC_18A-41A_n3A-n78A	DC_18A_n3A DC_18A_n78A DC_41A_n3A DC_41A_n78A
DC_18A-41C_n3A-n78A	DC_18A_n3A DC_18A_n78A DC_41A_n3A DC_41A_n78A DC_41C_n3A DC_41C_n78A
DC_19A-21A-42A_n77A DC_19A-21A-42A_n77C DC_19A-21A-42C_n77A DC_19A-21A-42C_n77C	DC_19A_n77A DC_21A_n77A
DC_19A-21A-42A_n78A DC_19A-21A-42A_n78C DC_19A-21A-42C_n78A DC_19A-21A-42C_n78C	DC_19A_n78A DC_21A_n78A
DC_19A-21A-42A_n79A DC_19A-21A-42A_n79C DC_19A-21A-42C_n79A DC_19A-21A-42C_n79C	DC_19A_n79A DC_21A_n79A
DC_19A-21A_n77A-n79A	DC_19A_n77A DC_19A_n79A
DC_19A-21A_n78A-n79A	DC_19A_n78A DC_19A_n79A

EN-DC configuration	Uplink EN-DC configuration (NOTE 1)
DC_19A-42A_n77A-n79A DC_19A-42C_n77A-n79A	DC_19A_n77A DC_19A_n79A
DC_19A-42A_n78A-n79A DC_19A-42C_n78A-n79A	DC_19A_n78A DC_19A_n79A
DC_21A-28A-42A_n77A DC_21A-28A-42C_n77A	DC_21A_n77A DC_28A_n77A
DC_21A-28A-42A_n78A DC_21A-28A-42C_n78A	DC_21A_n78A DC_28A_n78A
DC_21A-28A-42A_n79A DC_21A-28A-42C_n79A	DC_21A_n79A DC_28A_n79A
DC_21A-42A_n77A-n79A DC_21A-42C_n77A-n79A	DC_21A_n77A DC_21A_n79A
DC_21A-42A_n78A-n79A DC_21A-42C_n78A-n79A	DC_21A_n78A DC_21A_n79A
DC_28A-41A-42A_n78A DC_28A-41C-42A_n78A DC_28A-41A-42C_n78A DC_28A-41C-42C_n78A	DC_28A_n78A DC_41A_n78A DC_41C_n78A DC_42A_n78A DC_42C_n78A
DC_29A-30A-66A_n2A	DC_30A_n2A DC_66A_n2A
DC_29A-30A-66A-66A_n2A	DC_30A_n2A DC_66A_n2A
DC_29A-30A-66A_n66A	DC_30A_n66A DC_66A_n66A <sup>4</sup>
DC_46A-66A_n25A-n41A DC_46C-66A_n25A-n41A DC_46D-66A_n25A-n41A	DC_66A_n25A DC_66A_n41A
DC_46A-66A_n25A-n71A DC_46C-66A_n25A-n71A DC_46D-66A_n25A-n71A	DC_66A_n25A DC_66A_n71A
DC_46A-66A_n41A-n71A DC_46C-66A_n41A-n71A DC_46D-66A_n41A-n71A	DC_66A_n41A DC_66A_n71A
DC_46A-66A_n41(2A)-n71A DC_46C-66A_n41(2A)-n71A DC_46D-66A_n41(2A)-n71A	DC_66A_n41A DC_66A_n71A
NOTE 1: Uplink EN-DC configurations are the configurations supported by the present release of specifications. NOTE 2: Applicable for UE supporting inter-band EN-DC with mandatory simultaneous Rx/Tx capability NOTE 3: The frequency range in band n28 is restricted for this band combination to 703-733 MHz for the UL and 758-788 MHz for the DL. NOTE 4: Only single switched UL is supported. NOTE 5: UL carrier shall be supported in Band 2 or band 66 only. Power imbalance between downlink carriers on Band 7 and Band 38 is assumed to be within 6dB.	

#### 5.5B.4.4 Inter-band EN-DC configurations within FR1 (five bands)

**Table 5.5B.4.4-1: Inter-band EN-DC configurations within FR1 (five bands)**

EN-DC configuration	Uplink EN-DC configuration (NOTE 1)
DC_1A-3A-5A-7A_n78A	DC_1A_n78A DC_3A_n78A DC_5A_n78A DC_7A_n78A

EN-DC configuration	Uplink EN-DC configuration (NOTE 1)
DC_1A-3A-5A-7A-7A_n78A	DC_1A_n78A DC_3A_n78A DC_5A_n78A DC_7A_n78A
DC_1A-3A-5A-41A_n79A	DC_1A_n79A DC_3A_n79A DC_5A_n79A DC_41A_n79A
DC_1A-3A-7A_n5A-n78A DC_1A-3C-7A_n5A-n78A DC_1A-3A-7C_n5A-n78A DC_1A-3C-7C_n5A-n78A	DC_1A_n5A DC_1A_n78A DC_3A_n5A DC_3C_n5A DC_3A_n78A DC_3C_n78A DC_7A_n5A DC_7C_n5A DC_7A_n78A DC_7C_n78A
DC_1A-3A-7A_n7A-n78A	DC_1A-n7A DC_3A-n7A DC_7A_n7A <sup>4</sup> DC_1A_n78A DC_3A_n78A DC_7A_n78A
DC_1A-3C-7A_n7A-n78A	DC_1A-n7A DC_3A-n7A DC_3C-n7A DC_7A_n7A <sup>4</sup> DC_1A_n78A DC_3A_n78A DC_3C_n78A DC_7A_n78A
DC_1A-3A-7A-8A_n78A	DC_1A_n78A DC_3A_n78A DC_7A_n78A DC_8A_n78A
DC_1A-3A-7A-20A_n8A	DC_1A_n8A DC_3A_n8A DC_7A_n8A DC_20A_n8A
DC_1A-3A-7A-20A_n28A <sup>3</sup>	DC_1A_n28A DC_3A_n28A DC_7A_n28A DC_20A_n28A
DC_1A-3A-7A-20A_n78A <sup>2</sup>	DC_1A_n78A DC_3A_n78A DC_7A_n78A DC_20A_n78A
DC_1A-3A-7A-28A_n5A DC_1A-3C-7A-28A_n5A DC_1A-3A-7C-28A_n5A DC_1A-3C-7C-28A_n5A	DC_1A_n5A DC_3A_n5A DC_3C_n5A DC_7A_n5A DC_7C_n5A DC_28A_n5A

EN-DC configuration	Uplink EN-DC configuration (NOTE 1)
DC_1A-3A-7A-28A_n7A DC_1A-3C-7A-28A_n7A DC_1A-1A-3A-7A-28A_n7A DC_1A-1A-3A-3A-7A-28A_n7A DC_1A-3A-3A-7A-28A_n7A DC_1A-1A-3C-7A-28A_n7A	DC_1A_n7A DC_3A_n7A DC_3C_n7A DC_7A_n7A <sup>4</sup> DC_28A_n7A
DC_1A-3A-7A-28A_n40A	DC_1A_n40A DC_3A_n40A DC_7A_n40A DC_28A_n40A
DC_1A-3A-7A-28A_n78A DC_1A-3A-7C-28A_n78A DC_1A-3C-7A-28A_n78A DC_1A-3C-7C-28A_n78A	DC_1A_n78A DC_3A_n78A DC_3C_n78A DC_7A_n78A DC_7C_n78A DC_28A_n78A
DC_1A-3A-7A_n28A-n78A <sup>2</sup> DC_1A-3A-7C_n28A-n78A DC_1A-3C-7A_n28A-n78A DC_1A-3C-7C_n28A-n78A	DC_1A_n28A DC_1A_n78A DC_3A_n28A DC_3C_n28A DC_3A_n78A DC_7A_n28A DC_7A_n78A DC_7C_n28A DC_7C_n78A
DC_1A-3A-8A-42A_n77A DC_1A-3A-8A-42C_n77A	DC_1A_n77A DC_3A_n77A DC_8A_n77A
DC_1A-3A-18A-42A_n77A DC_1A-3A-18A-42C_n77A	DC_1A_n77A DC_3A_n77A DC_18A_n77A
DC_1A-3A-18A-42A_n78A DC_1A-3A-18A-42C_n78A	DC_1A_n78A DC_3A_n78A DC_18A_n78A
DC_1A-3A-18A-42A_n79A DC_1A-3A-18A-42C_n79A	DC_1A_n79A DC_3A_n79A DC_18A_n79A
DC_1A-3A-19A-21A_n77A <sup>2</sup> DC_1A-3A-19A-21A_n77C <sup>2</sup>	DC_1A_n77A DC_3A_n77A DC_19A_n77A DC_21A_n77A
DC_1A-3A-19A-21A_n78A <sup>2</sup> DC_1A-3A-19A-21A_n78C <sup>2</sup>	DC_1A_n78A DC_3A_n78A DC_19A_n78A DC_21A_n78A
DC_1A-3A-19A-21A_n79A <sup>2</sup> DC_1A-3A-19A-21A_n79C <sup>2</sup>	DC_1A_n79A DC_3A_n79A DC_19A_n79A DC_21A_n79A
DC_1A-3A-19A-42A_n77A DC_1A-3A-19A-42A_n77C DC_1A-3A-19A-42C_n77A DC_1A-3A-19A-42C_n77C	DC_1A_n77A DC_3A_n77A DC_19A_n77A
DC_1A-3A-19A-42A_n78A DC_1A-3A-19A-42A_n78C DC_1A-3A-19A-42C_n78A DC_1A-3A-19A-42C_n78C	DC_1A_n78A DC_3A_n78A DC_19A_n78A
DC_1A-3A-19A-42A_n79A DC_1A-3A-19A-42A_n79C DC_1A-3A-19A-42C_n79A DC_1A-3A-19A-42C_n79C	DC_1A_n79A DC_3A_n79A DC_19A_n79A
DC_1A-3A-20A_n28A-n78A <sup>2,3</sup>	DC_1A_n28A DC_1A_n78A DC_3A_n28A DC_3A_n78A

EN-DC configuration	Uplink EN-DC configuration (NOTE 1)
	DC_20A_n28A DC_20A_n78A
DC_1A-3A-20A-38A_n78A	DC_3A_n78A DC_20A_n78A
DC_1A-3A-20A_n38A-n78A	DC_1A_n78A DC_3A_n78A DC_20A_n78A DC_1A_n38A DC_3A_n38A DC_20A_n38A
DC_1A-3A-20A_n41A-n78A	DC_1A_n41A DC_1A_n78A DC_3A_n41A DC_3A_n78A DC_20A_n41A DC_20A_n78A
DC_1A-3A-21A-42A_n77A DC_1A-3A-21A-42A_n77C DC_1A-3A-21A-42C_n77A DC_1A-3A-21A-42C_n77C	DC_1A_n77A DC_3A_n77A DC_21A_n77A
DC_1A-3A-21A-42A_n78A DC_1A-3A-21A-42A_n78C DC_1A-3A-21A-42C_n78A DC_1A-3A-21A-42C_n78C	DC_1A_n78A DC_3A_n78A DC_21A_n78A
DC_1A-3A-21A-42A_n79A DC_1A-3A-21A-42A_n79C DC_1A-3A-21A-42C_n79A DC_1A-3A-21A-42C_n79C	DC_1A_n79A DC_3A_n79A DC_21A_n79A
DC_1A-3A-21A_n77A-n79A	DC_3A_n77A DC_3A_n79A
DC_1A-3A-21A_n78A-n79A	DC_3A_n78A DC_3A_n79A
DC_1A-3A-28A_n5A-n78A DC_1A-3C-28A_n5A-n78A	DC_1A_n5A DC_1A_n78A DC_3A_n5A DC_3C_n5A DC_3A_n78A DC_3C_n78A DC_28A_n5A DC_28A_n78A
DC_1A-3A-28A_n7A-n78A	DC_1A-n7A DC_3A-n7A DC_28A_n7A DC_1A_n78A DC_3A_n78A DC_28A_n78A
DC_1A-3A-28A_n7B-n78A	DC_1A-n7A DC_3A-n7A DC_28A_n7A DC_1A-n7B DC_3A-n7B DC_28A_n7B DC_1A_n78A DC_3A_n78A DC_28A_n78A
DC_1A-3C-28A_n7A-n78A	DC_1A-n7A DC_3A-n7A DC_3C-n7A DC_28A_n7A DC_1A_n78A DC_3A_n78A DC_3C_n78A DC_28A_n78A

EN-DC configuration	Uplink EN-DC configuration (NOTE 1)
DC_1A-3C-28A_n7B-n78A	DC_1A-n7A DC_3A-n7A DC_3C-n7A DC_28A_n7A DC_1A-n7B DC_3A-n7B DC_3C-n7B DC_28A_n7B DC_1A_n78A DC_3A_n78A DC_3C_n78A DC_28A_n78A
DC_1A-3A-28A_n40A-n78A	DC_1A-n40A DC_1A-n78A DC_3A_n40A DC_3A-n78A DC_28A_n40A DC_28A_n78A
DC_1A-3A-28A-42A_n77A DC_1A-3A-28A-42A_n77C DC_1A-3A-28A-42C_n77A DC_1A-3A-28A-42C_n77C	DC_1A_n77A DC_3A_n77A DC_28A_n77A
DC_1A-3A-28A-42A_n78A DC_1A-3A-28A-42A_n78C DC_1A-3A-28A-42C_n78A DC_1A-3A-28A-42C_n78C	DC_1A_n78A DC_3A_n78A DC_28A_n78A
DC_1A-3A-28A-42A_n79A DC_1A-3A-28A-42A_n79C DC_1A-3A-28A-42C_n79A DC_1A-3A-28A-42C_n79C	DC_1A_n79A DC_3A_n79A DC_28A_n79A
DC_1A-3A-41A_n28A-n77A	DC_1A_n28A DC_1A_n77A DC_3A_n28A DC_3A_n77A DC_41A_n28A DC_41A_n77A
DC_1A-3A-41C_n28A-n77A	DC_1A_n28A DC_1A_n77A DC_3A_n28A DC_3A_n77A DC_41A_n28A DC_41A_n77A DC_41C_n28A DC_41C_n77A
DC_1A-3A-41A_n28A-n78A	DC_1A_n28A DC_1A_n78A DC_3A_n28A DC_3A_n78A DC_41A_n28A DC_41A_n78A
DC_1A-3A-41C_n28A-n78A	DC_1A_n28A DC_1A_n78A DC_3A_n28A DC_3A_n78A DC_41A_n28A DC_41A_n78A DC_41C_n28A DC_41C_n77A



EN-DC configuration	Uplink EN-DC configuration (NOTE 1)
DC_1A-3A-41A-42A_n77A DC_1A-3A-41A-42C_n77A DC_1A-3A-41C-42A_n77A DC_1A-3A-41C-42C_n77A	DC_1A_n77A DC_3A_n77A DC_41A_n77A
DC_1A-3A-41A-42A_n78A DC_1A-3A-41A-42C_n78A DC_1A-3A-41C-42A_n78A DC_1A-3A-41C-42C_n78A	DC_1A_n78A DC_3A_n78A DC_41A_n78A
DC_1A-3A-41A-42A_n79A DC_1A-3A-41A-42C_n79A DC_1A-3A-41C-42A_n79A DC_1A-3A-41C-42C_n79A	DC_1A_n79A DC_3A_n79A DC_41A_n79A
DC_1A-7A-20A_n3A-n78A	DC_1A_n3A
DC_1A-7A-28A_n5A-n78A DC_1A-7C-28A_n5A-n78A	DC_1A_n5A DC_1A_n78A DC_7A_n5A DC_7C_n5ADC_7A_n78A DC_7C_n78A DC_28A_n5A DC_28A_n78A
DC_1A-7A-28A_n7A-n78A	DC_1A-n7A DC_7A-n7A <sup>4</sup> DC_28A_n7A DC_1A_n78A DC_7A_n78A DC_28A_n78A
DC_1A-7A-20A_n28A-n78A <sup>2,3</sup>	DC_1A_n28A DC_1A_n78A DC_7A_n28A DC_7A_n78A DC_20A_n28A DC_20A_n78A
DC_1A-19A-21A-42A_n77A DC_1A-19A-21A-42A_n77C DC_1A-19A-21A-42C_n77A DC_1A-19A-21A-42C_n77C	DC_1A_n77A DC_19A_n77A DC_21A_n77A
DC_1A-19A-21A-42A_n78A DC_1A-19A-21A-42A_n78C DC_1A-19A-21A-42C_n78A DC_1A-19A-21A-42C_n78C	DC_1A_n78A DC_19A_n78A DC_21A_n78A
DC_1A-19A-21A-42A_n79A DC_1A-19A-21A-42A_n79C DC_1A-19A-21A-42C_n79A DC_1A-19A-21A-42C_n79C	DC_1A_n79A DC_19A_n79A DC_21A_n79A
DC_1A-19A-42A_n77A-n79A DC_1A-19A-42C_n77A-n79A	DC_19A_n77A DC_19A_n79A
DC_1A-19A-42A_n78A-n79A DC_1A-19A-42C_n78A-n79A	DC_19A_n78A DC_19A_n79A
DC_1A-20A-38A_n3A-n78A	DC_1A_n3A DC_20A_n3A DC_38A_n3A DC_1A_n78A DC_20A_n78A DC_38A_n78A
DC_1A-21A-28A-42A_n77A DC_1A-21A-28A-42C_n77A	DC_1A_n77A DC_21A_n77A DC_28A_n77A
DC_1A-21A-28A-42A_n78A DC_1A-21A-28A-42C_n78A	DC_1A_n78A DC_21A_n78A DC_28A_n78A
DC_1A-21A-28A-42A_n79A DC_1A-21A-28A-42C_n79A	DC_1A_n79A DC_21A_n79A DC_28A_n79A

EN-DC configuration	Uplink EN-DC configuration (NOTE 1)
DC_1A-21A-42A_n77A-n79A DC_1A-21A-42C_n77A-n79A	DC_1A_n77A DC_1A_n79A
DC_1A-21A-42A_n78A-n79A DC_1A-21A-42C_n78A-n79A	DC_1A_n78A DC_1A_n79A
DC_2A-7A-13A-66A_n66A DC_2A-7C-13A-66A_n66A	DC_2A_n66A DC_7A_n66A DC_13A_n66A DC_66A_n66A <sup>4</sup>
DC_2A-7A-66A_n66A-n78A DC_2A-7A-7A-66A_n66A-n78A DC_2A-7C-66A_n66A-n78A	DC_2A_n66A DC_2A_n78A DC_7A_n66A DC_7A_n78A DC_66A_n66A <sup>4</sup> DC_66A_n78A
DC_2A-12A-30A-66A_n2A	DC_12A_n2A DC_30A_n2A DC_66A_n2A
DC_2A-12A-30A-66A_n66A	DC_2A_n66A DC_12A_n66A DC_30A_n66A DC_66A_n66A <sup>4</sup>
DC_2A-29A-30A-66A_n2A	DC_2A_n2A DC_30A_n2A DC_66A_n2A
DC_2A-46A-66A_n41A-n71A DC_2A-46C-66A_n41A-n71A DC_2A-46D-66A_n41A-n71A	DC_2A_n41A DC_2A_n71A DC_66A_n41A DC_66A_n71A
DC_3A-7A-8A_n1A-n78A DC_3A-3A-7A-8A_n1A-n78A DC_3A-7A-7A-8A_n1A-n78A DC_3A-3A-7A-7A-8A_n1A-n78A	DC_3A_n1A DC_3A_n78A DC_7A_n1A DC_7A_n78A DC_8A_n1A DC_8A_n78A
DC_3A-7A-20A_n28A-n78A <sup>2,3</sup>	DC_3A_n28A DC_3A_n78A DC_7A_n28A DC_7A_n78A DC_20A_n28A DC_20A_n78A
DC_3A-7A-28A_n5A-n78A DC_3C-7A-28A_n5A-n78A DC_3A-7C-28A_n5A-n78A DC_3C-7C-28A_n5A-n78A	DC_3A_n5A DC_3C_n5A DC_3A_n78A DC_3C_n78A DC_7A_n5A DC_7C_n5A DC_7A_n78A DC_7C_n78A DC_28A_n5A DC_28A_n78A
DC_3A-7A-28A_n7A-n78A	DC_3A-n7A DC_7A-n7A <sup>4</sup> DC_28A_n7A DC_3A_n78A DC_7A_n78A DC_28A_n78A
DC_3C-7A-28A_n7A-n78A	DC_3A-n7A DC_3C-n7A DC_7A-n7A <sup>4</sup> DC_28A_n7A DC_3A_n78A DC_3C_n78A DC_7A_n78A DC_28A_n78A

EN-DC configuration	Uplink EN-DC configuration (NOTE 1)
DC_3A-19A-21A-42A_n77A DC_3A-19A-21A-42A_n77C DC_3A-19A-21A-42C_n77A DC_3A-19A-21A-42C_n77C	DC_3A_n77A DC_19A_n77A DC_21A_n77A
DC_3A-19A-21A-42A_n78A DC_3A-19A-21A-42A_n78C DC_3A-19A-21A-42C_n78A DC_3A-19A-21A-42C_n78C	DC_3A_n78A DC_19A_n78A DC_21A_n78A
DC_3A-19A-21A-42A_n79A DC_3A-19A-21A-42A_n79C DC_3A-19A-21A-42C_n79A DC_3A-19A-21A-42C_n79C	DC_3A_n79A DC_19A_n79A DC_21A_n79A
DC_3A-28A-41A-42A_n78A DC_3A-28A-41A-42C_n78A DC_3A-28A-41C-42A_n78A DC_3A-28A-41C-42C_n78A	DC_1A_n78A DC_3A_n78A DC_41A_n78A DC_41C_n78A
DC_19A-21A-42A_n77A-n79A DC_19A-21A-42C_n77A-n79A	DC_19A_n77A DC_19A_n79A
DC_19A-21A-42A_n78A-n79A DC_19A-21A-42C_n78A-n79A	DC_19A_n78A DC_19A_n79A
<p>NOTE 1: Uplink EN-DC configurations are the configurations supported by the present release of specifications.</p> <p>NOTE 2: Applicable for UE supporting inter-band EN-DC with mandatory simultaneous Rx/Tx capability</p> <p>NOTE 3: The frequency range in band n28 is restricted for this band combination to 703-733 MHz for the UL and 758-788 MHz for the DL</p> <p>NOTE 4: Only single switched UL is supported</p>	

5.5B.4.5 Inter-band EN-DC configurations within FR1 (six bands)

**Table 5.5B.4.5-1: Inter-band EN-DC configurations within FR1 (six bands)**

EN-DC configuration	Uplink EN-DC configuration (NOTE 1)
DC_1A-3A-7A-20A_n28A-n78A <sup>2,3</sup>	DC_1A_n28A DC_1A_n78A DC_3A_n28A DC_3A_n78A DC_7A_n28A DC_7A_n78A DC_20A_n28A DC_20A_n78A
DC_1A-3A-7A-28A_n5A-n78A DC_1A-3A-7C-28A_n5A-n78A DC_1A-3C-7A-28A_n5A-n78A DC_1A-3C-7C-28A_n5A-n78A	DC_1A_n5A DC_1A_n78A DC_3A_n5A DC_3C_n5A DC_3A_n78A DC_3C_n78A DC_7A_n5A DC_7C_n5A DC_7A_n78A DC_7C_n78A DC_28A_n5A DC_28A_n78A
DC_1A-3A-7A-28A_n7A-n78A	DC_1A-n7A DC_3A-n7A DC_7A-n7A <sup>4</sup> DC_28A_n7A DC_1A_n78A DC_3A_n78A DC_7A_n78A DC_28A_n78A
DC_1A-3C-7A-28A_n7A-n78A	DC_1A-n7A DC_3A-n7A DC_3C-n7A DC_7A-n7A <sup>4</sup> DC_28A_n7A DC_1A_n78A DC_3A_n78A DC_3C_n78A DC_7A_n78A DC_28A_n78A
<p>NOTE 1: Uplink EN-DC configurations are the configurations supported by the present release of specifications.</p> <p>NOTE 2: Applicable for UE supporting inter-band EN-DC with mandatory simultaneous Rx/Tx capability.</p> <p>NOTE 3: The frequency range in band n28 is restricted for this band combination to 703-733 MHz for the UL and 758-788 MHz for the DL.</p> <p>NOTE 4: Only single switched UL is supported.</p>	

### 5.5B.4a Inter-band NE-DC within FR1

#### 5.5B.4a.1 Inter-band NE-DC configurations within FR1 (two bands)

**Table 5.5B.4a.1-1: Inter-band NE-DC configurations within FR1 (two bands)**

NE-DC configuration	Uplink NE-DC configuration (NOTE 1)	Single UL allowed
DC_n1A_28A	DC_n1A_28A	No

NOTE 1: Uplink NE-DC configurations are the configurations supported by the present release of specifications.

### 5.5B.5 Inter-band EN-DC including FR2

#### 5.5B.5.1 Inter-band EN-DC configurations including FR2 (two bands)

**Table 5.5B.5.1-1: Inter-band EN-DC configurations including FR2 (two bands)**

EN-DC configuration	Uplink EN-DC configuration (NOTE 1)
DC_1A_n257A DC_1A_n257D DC_1A_n257E DC_1A_n257F DC_1A_n257G DC_1A_n257H DC_1A_n257I DC_1A_n257J DC_1A_n257K DC_1A_n257L DC_1A_n257M	DC_1A_n257A DC_1A_n257D DC_1A_n257G DC_1A_n257H DC_1A_n257I DC_1A_n257J DC_1A_n257K DC_1A_n257L DC_1A_n257M
DC_1A_n258A DC_1A_n258D	DC_1A_n258A DC_1A_n258D
DC_2A_n257A DC_2C_n257A	DC_2A_n257A
DC_2A_n257(2A)	DC_2A_n257A
DC_2A-2A_n257A	DC_2A_n257A
DC_2A_n258A	DC_2A_n258A
DC_2A_n258(2A) DC_2A_n258(3A) DC_2A_n258(4A) DC_2A_n258(5A)	DC_2A_n258A
DC_2A_n260A DC_2A_n260G DC_2A_n260H DC_2A_n260I DC_2A_n260J DC_2A_n260K DC_2A_n260L DC_2A_n260M DC_2A_n260O DC_2A_n260P DC_2A_n260Q DC_2C_n260A	DC_2A_n260A DC_2A_n260G DC_2A_n260H DC_2A_n260O DC_2A_n260P DC_2A_n260Q
DC_2A_n260(2A) DC_2A_n260(3A) DC_2A_n260(4A) DC_2A_n260(5A) DC_2A_n260(6A) DC_2A_n260(7A) DC_2A_n260(8A)	DC_2A_n260A DC_2A_n260G DC_2A_n260H DC_2A_n260O DC_2A_n260P DC_2A_n260Q

DC_2A_n260(2D) DC_2A_n260(2G) DC_2A_n260(3G) DC_2A_n260(4G) DC_2A_n260(2H) DC_2A_n260(2O) DC_2A_n260(3O) DC_2A_n260(4O) DC_2A_n260(A-G) DC_2A_n260(A-H) DC_2A_n260(A-P) DC_2A_n260(A-Q) DC_2A_n260(A-2G) DC_2A_n260(A-2H) DC_2A_n260(2A-G) DC_2A_n260(2A-H) DC_2A_n260(2A-2G) DC_2A_n260(2A-2H) DC_2A_n260(3A-G) DC_2A_n260(3A-O) DC_2A_n260(3A-2O) DC_2A_n260(3A-P) DC_2A_n260(4A-O) DC_2A_n260(4A-2O) DC_2A_n260(G-H) DC_2A_n260(P-Q) DC_2A_n260(A-P-Q) DC_2A_n260(2A-O-P) DC_2A_n260(3A-O-P)	
DC_2A-2A_n260A DC_2A-2A_n260G DC_2A-2A_n260H DC_2A-2A_n260I DC_2A-2A_n260J DC_2A-2A_n260K DC_2A-2A_n260L DC_2A-2A_n260M	DC_2A_n260A
DC_2A_n261A DC_2A_n261(2A) DC_2A_n261(3A) DC_2A_n261(4A)	DC_2A_n261A
DC_2A_n261G DC_2A_n261H DC_2A_n261I DC_2A_n261J DC_2A_n261K DC_2A_n261L DC_2A_n261M	DC_2A_n261A DC_2A_n261G DC_2A_n261H DC_2A_n261I
DC_2A_n261(2I) DC_2A_n261(2H) DC_2A_n261(A-G) DC_2A_n261(A-J) DC_2A_n261(A-K) DC_2A_n261(A-2G) DC_2A_n261(A-H) DC_2A_n261(A-I) DC_2A_n261(2A-G) DC_2A_n261(2A-I) DC_2A_n261(2A-H) DC_2A_n261(3A-G) DC_2A_n261(G-H) DC_2A_n261(G-I) DC_2A_n261(G-J) DC_2A_n261(2G) DC_2A_n261(H-I) DC_2A_n261(A-G-H) DC_2A_n261(A-G-I)	DC_2A_n261A DC_2A_n261G DC_2A_n261H DC_2A_n261I
DC_3A_n257A	DC_3A_n257A

<p>DC_3A_n257B DC_3A_n257C DC_3A_n257D DC_3A_n257E DC_3A_n257F DC_3A_n257G DC_3A_n257H DC_3A_n257I DC_3A_n257J DC_3A_n257K DC_3A_n257L DC_3A_n257M DC_3C_n257A DC_3C_n257D DC_3C_n257E DC_3C_n257F DC_3C_n257G DC_3C_n257H DC_3C_n257I DC_3C_n257J DC_3C_n257K DC_3C_n257L DC_3C_n257M</p>	<p>DC_3A_n257B DC_3A_n257D DC_3A_n257G DC_3A_n257H DC_3A_n257I DC_3A_n257J DC_3A_n257K DC_3A_n257L DC_3A_n257M DC_3C_n257A</p>
<p>DC_3A_n258A DC_3A_n258B DC_3A_n258C DC_3A_n258D DC_3A_n258E DC_3A_n258F DC_3A_n258G DC_3A_n258H DC_3A_n258I DC_3A_n258J DC_3A_n258K DC_3A_n258L DC_3A_n258M</p>	<p>DC_3A_n258A</p>
<p>DC_3A-3A_n257A DC_3A-3A_n257D DC_3A-3A_n257E DC_3A-3A_n257F DC_3A-3A_n257G DC_3A-3A_n257H DC_3A-3A_n257I DC_3A-3A_n257J DC_3A-3A_n257K DC_3A-3A_n257L DC_3A-3A_n257M</p>	<p>DC_3A_n257A</p>
<p>DC_4A_n260(2A) DC_4A_n260(3A) DC_4A_n260(4A) DC_4A_n260(5A) DC_4A_n260(6A) DC_4A_n260(7A) DC_4A_n260(8A) DC_4A_n260(2D) DC_4A_n260(2G) DC_4A_n260(3G) DC_4A_n260(4G) DC_4A_n260(2H) DC_4A_n260(2O) DC_4A_n260(3O) DC_4A_n260(4O) DC_4A_n260(A-D) DC_4A_n260(2A-D) DC_4A_n260(A-O) DC_4A_n260(2A-O) DC_4A_n260(A-D-O) DC_4A_n260(2A-D-O)</p>	<p>DC_4A_n260A DC_4A_n260G DC_4A_n260H DC_4A_n260O DC_4A_n260P DC_4A_n260Q</p>

DC_4A_n260(A-2O) DC_4A_n260(D-2O) DC_4A_n260(A-D-2O) DC_4A_n260(2A-D-2O) DC_4A_n260(A-2D) DC_4A_n260(2A-2D) DC_4A_n260(A-P) DC_4A_n260(2A-P) DC_4A_n260(A-2P) DC_4A_n260(2A-2P) DC_4A_n260(A-G) DC_4A_n260(2A-G) DC_4A_n260(A-2G) DC_4A_n260(2A-2G) DC_4A_n260(G-O) DC_4A_n260(2G-O) DC_4A_n260(A-G-O) DC_4A_n260(2A-G-O) DC_4A_n260(A-2G-O) DC_4A_n260(2A-2G-O) DC_4A_n260(A-H) DC_4A_n260(A-2H) DC_4A_n260(2A-H) DC_4A_n260(2A-2H) DC_4A_n260(2A-2O) DC_4A_n260(A-3O) DC_4A_n260(2A-3O) DC_4A_n260(A-4O) DC_4A_n260(2A-4O) DC_4A_n260(3A-O) DC_4A_n260(3A-2O) DC_4A_n260(3A-3O) DC_4A_n260(3A-G) DC_4A_n260(3A-2G) DC_4A_n260(4A-G) DC_4A_n260(4A-2G) DC_4A_n260(4A-O) DC_4A_n260(4A-2O) DC_4A_n260(D-2G) DC_4A_n260(2D-O) DC_4A_n260(G-2O) DC_4A_n260(2G-2O) DC_4A_n260(G-3O) DC_4A_n260(2G-3O) DC_4A_n260(G-4O) DC_4A_n260(2G-4O) DC_4A_n260(3G-O) DC_4A_n260(4G-O) DC_4A_n260(H-O) DC_4A_n260(2H-O) DC_4A_n260(A-P-Q) DC_4A_n260(3A-O-P)	
DC_4A_n260G DC_4A_n260H DC_4A_n260O DC_4A_n260P DC_4A_n260Q	DC_4A_n260A DC_4A_n260G DC_4A_n260H DC_4A_n260O DC_4A_n260P DC_4A_n260Q
DC_4A_n261(2A) DC_4A_n261(3A) DC_4A_n261(4A) DC_4A_n261(2H) DC_4A_n261(2I) DC_4A_n261(A-D) DC_4A_n261(A-H) DC_4A_n261(A-2H) DC_4A_n261(A-D-H)	DC_4A_n261A DC_4A_n261H DC_4A_n261I DC_4A_n261G



DC_4A_n261(A-G) DC_4A_n261(A-G-H) DC_4A_n261(A-I) DC_4A_n261(A-2I) DC_4A_n261(G-I) DC_4A_n261(A-G-I) DC_4A_n261(A-H-I) DC_4A_n261(G-H) DC_4A_n261(H-I) DC_4A_n261(D-H)	
DC_4A_n261A DC_4A_n261D DC_4A_n261G DC_4A_n261H DC_4A_n261I DC_4A_n261L DC_4A_n261M	DC_4A_n261A DC_4A_n261D DC_4A_n261G DC_4A_n261H DC_4A_n261I
DC_4A_n260A	DC_4A_n260A
DC_4A_n260(A-Q) DC_4A_n260(P-Q) DC_4A_n260(2A-O-P) DC_4A_n260(3A-P) DC_4A_n260(A-O-P)	DC_4A_n260A DC_4A_n260G DC_4A_n260H DC_4A_n260O DC_4A_n260P DC_4A_n260Q
DC_5A_n257A DC_5A_n257D DC_5A_n257E DC_5A_n257F DC_5A_n257G DC_5A_n257H DC_5A_n257I DC_5A_n257J DC_5A_n257K DC_5A_n257L DC_5A_n257M DC_5B_n257A	DC_5A_n257A DC_5B_n257A
DC_5A-5A_n257A	DC_5A_n257A
DC_5A_n258A	DC_5A_n258A
DC_5A_n260A DC_5A_n260B DC_5A_n260C DC_5A_n260D DC_5A_n260E DC_5A_n260F DC_5A_n260G DC_5A_n260H DC_5A_n260I DC_5A_n260J DC_5A_n260K DC_5A_n260L DC_5A_n260M DC_5A_n260O DC_5A_n260P DC_5A_n260Q DC_5B_n260A	DC_5A_n260A DC_5A_n260G DC_5A_n260H DC_5A_n260O DC_5A_n260P DC_5A_n260Q DC_5B_n260A
DC_5A_n260(2A) DC_5A_n260(3A) DC_5A_n260(4A) DC_5A_260(5A) DC_5A_260(6A) DC_5A_260(7A) DC_5A_260(8A) DC_5A_260(9A) DC_5A_260(10A) DC_5A_n260(A-I) DC_5A_n260(A-P-Q) DC_5A_n260(3A-O-P) DC_5A_n260(D-G)	DC_5A_n260A DC_5A_n260G DC_5A_n260H DC_5A_n260O DC_5A_n260P DC_5A_n260Q

DC_5A_n260(D-H)	
DC_5A_n260(D-I)	
DC_5A_n260(D-O)	
DC_5A_n260(D-P)	
DC_5A_n260(D-Q)	
DC_5A_n260(E-O)	
DC_5A_n260(E-P)	
DC_5A_n260(E-Q)	
DC_5A_n260(G-I)	
DC_5A_n260(2G)	
DC_5A_n260(2H)	
DC_5A_n260(2O)	
DC_5A_n260(3O)	
DC_5A_n260(4O)	
DC_5A_n260(2P)	
DC_5A_n260(3P)	
DC_5A_n260(4P)	
DC_5A_n260(2A-O)	
DC_5A_n260(A-2O)	
DC_5A_n260(2A-G)	
DC_5A_n260(A-2G)	
DC_5A_n260(2A-2G)	
DC_5A_n260(2G-O)	
DC_5A_n260(2A-2G-O)	
DC_5A_n260(A-2H)	
DC_5A_n260(2A-H)	
DC_5A_n260(2A-2H)	
DC_5A_n260(2A-2O)	
DC_5A_n260(2A-3O)	
DC_5A_n260(A-4O)	
DC_5A_n260(2A-4O)	
DC_5A_n260(3A-2O)	
DC_5A_n260(3A-2G)	
DC_5A_n260(4A-G)	
DC_5A_n260(4A-2G)	
DC_5A_n260(4A-O)	
DC_5A_n260(4A-2O)	
DC_5A_n260(A-O)	
DC_5A_n260(A-G)	
DC_5A_n260(G-O)	
DC_5A_n260(A-G-O)	
DC_5A_n260(2A-G-O)	
DC_5A_n260(A-2G-O)	
DC_5A_n260(A-H)	
DC_5A_n260(A-3O)	
DC_5A_n260(3A-O)	
DC_5A_n260(3A-G)	
DC_5A_n260(2D)	
DC_5A_n260(3G)	
DC_5A_n260(4G)	
DC_5A_n260(A-D)	
DC_5A_n260(2A-D)	
DC_5A_n260(A-D-O)	
DC_5A_n260(2A-D-O)	
DC_5A_n260(D-2O)	
DC_5A_n260(A-D-2O)	
DC_5A_n260(2A-D-2O)	
DC_5A_n260(A-2D)	
DC_5A_n260(2A-2D)	
DC_5A_n260(A-P)	
DC_5A_n260(2A-P)	
DC_5A_n260(A-2P)	
DC_5A_n260(2A-2P)	
DC_5A_n260(3A-3O)	
DC_5A_n260(D-2G)	
DC_5A_n260(2D-O)	
DC_5A_n260(G-2O)	
DC_5A_n260(2G-2O)	

<p>DC_5A_n260(G-3O)                  DC_5A_n260(2G-3O)                  DC_5A_n260(G-4O)                  DC_5A_n260(2G-4O)                  DC_5A_n260(3G-O)                  DC_5A_n260(4G-O)                  DC_5A_n260(H-O)                  DC_5A_n260(2H-O)                  DC_5A_n260(A-Q)                  DC_5A_n260(P-Q)                  DC_5A_n260(2A-4P)                  DC_5A_n260(2O-2P)                  DC_5A_n260(3A-P)                  DC_5A_n260(4A-4O)                  DC_5A_n260(4A-2Q)                  DC_5A_n260(6A-2O)                  DC_5A_n260(6A-2P)                  DC_5A_n260(6A-3O)                  DC_5A_n260(8A-2O)                  DC_5A_n260(2A-O-P)                  DC_5A_n260(2A-2G-2O)                  DC_5A_n260(2A-2O-2P)                  DC_5A_n260(2A-2O-2Q)                  DC_5A_n260(O-P)                  DC_5A_n260(A-O-P)                  DC_5A-5A_n260A</p>	
<p>DC_5A_n261A                  DC_5A_n261B                  DC_5A_n261C                  DC_5A_n261D                  DC_5A_n261E                  DC_5A_n261F                  DC_5A_n261G                  DC_5A_n261H                  DC_5A_n261I                  DC_5A_n261J                  DC_5A_n261K                  DC_5A_n261L                  DC_5A_n261M                  DC_5A_n261O                  DC_5A_n261P                  DC_5A_n261Q</p>	<p>DC_5A_n261A                  DC_5A_n261G                  DC_5A_n261H                  DC_5A_n261I</p>
<p>DC_5A_n261(2A)                  DC_5A_n261(2G)                  DC_5A_n261(3A)                  DC_5A_n261(4A)                  DC_5A_n261(D-G)                  DC_5A_n261(D-H)                  DC_5A_n261(D-I)                  DC_5A_n261(D-O)                  DC_5A_n261(D-P)                  DC_5A_n261(D-Q)                  DC_5A_n261(E-O)                  DC_5A_n261(E-P)                  DC_5A_n261(E-Q)                  DC_5A_n261(2H)                  DC_5A_n261(2I)                  DC_5A_n261(A-H)                  DC_5A_n261(A-I)                  DC_5A_n261(2A-H)                  DC_5A_n261(A-K)                  DC_5A_n261(A-D)                  DC_5A_n261(A-D-H)                  DC_5A_n261(A-D-2O)                  DC_5A_n261(A-G)                  DC_5A_n261(A-G-H)                  DC_5A_n261(G-I)                  DC_5A_n261(A-G-I)</p>	<p>DC_5A_n261A                  DC_5A_n261G                  DC_5A_n261H                  DC_5A_n261I</p>

DC_5A_n261(A-H-I) DC_5A_n261(G-H) DC_5A_n261(G-J) DC_5A_n261(H-I) DC_5A_n261(A-2D) DC_5A_n261(A-2H) DC_5A_n261(A-2P) DC_5A_n261(A-2Q) DC_5A_n261(A-2I) DC_5A_n261(A-4G) DC_5A_n261(A-4O) DC_5A_n261(A-7O) DC_5A_n261(A-2G-2O) DC_5A_n261(A-3G-O) DC_5A_n261(2A-G) DC_5A_n261(2A-H) DC_5A_n261(2A-I) DC_5A_n261(3A-G)	
DC_7A_n257A DC_7A_n257D DC_7A_n257E DC_7A_n257F DC_7A_n257G DC_7A_n257H DC_7A_n257I DC_7A_n257J DC_7A_n257K DC_7A_n257L DC_7A_n257M	DC_7A_n257A
DC_7A-7A_n257A DC_7A-7A_n257D DC_7A-7A_n257E DC_7A-7A_n257F DC_7A-7A_n257G DC_7A-7A_n257H DC_7A-7A_n257I DC_7A-7A_n257J DC_7A-7A_n257K DC_7A-7A_n257L DC_7A-7A_n257M	DC_7A_n257A
DC_7A_n258A DC_7A_n258B DC_7A_n258C DC_7A_n258D DC_7A_n258E DC_7A_n258F DC_7A_n258G DC_7A_n258H DC_7A_n258I DC_7A_n258J DC_7A_n258K DC_7A_n258L DC_7A_n258M DC_7C_n258A DC_7C_n258B DC_7C_n258C DC_7C_n258D DC_7C_n258E DC_7C_n258F DC_7C_n258G DC_7C_n258H DC_7C_n258I DC_7C_n258J DC_7C_n258K DC_7C_n258L DC_7C_n258M	DC_7A_n258A DC_7A_n258B DC_7A_n258C DC_7A_n258D DC_7A_n258E DC_7A_n258F DC_7A_n258G DC_7A_n258H DC_7A_n258I DC_7A_n258J DC_7A_n258K DC_7A_n258L DC_7A_n258M DC_7C_n258A DC_7C_n258B DC_7C_n258C DC_7C_n258D DC_7C_n258E DC_7C_n258F DC_7C_n258G DC_7C_n258H DC_7C_n258I DC_7C_n258J DC_7C_n258K DC_7C_n258L DC_7C_n258M
DC_8A_n257A DC_8A_n257D	DC_8A_n257A

DC_8A_n257E DC_8A_n257F DC_8A_n257G DC_8A_n257H DC_8A_n257I DC_8A_n257J DC_8A_n257K DC_8A_n257L DC_8A_n257M	
DC_8A_n258A	DC_8A_n258A
DC_11A_n257A DC_11A_n257D DC_11A_n257G DC_11A_n257H DC_11A_n257I	DC_11A_n257A
DC_12A_n257A	DC_12A_n257A
DC_12A_n258A	DC_12A_n258A
DC_12A_n260A DC_12A_n260G DC_12A_n260H DC_12A_n260I DC_12A_n260J DC_12A_n260K DC_12A_n260L DC_12A_n260M	DC_12A_n260A
DC_12A_n260(A-I) DC_12A_n260(G-I)	DC_12A_n260A
DC_12A_n261A	DC_12A_n261A
DC_13A_n257A	DC_13A_n257A
DC_13A_n260A DC_13A_n260G DC_13A_n260H DC_13A_n260I DC_13A_n260J DC_13A_n260K DC_13A_n260L DC_13A_n260M DC_13A_n260O DC_13A_n260P DC_13A_n260Q	DC_13A_n260A DC_13A_n260G DC_13A_n260H DC_13A_n260O DC_13A_n260P DC_13A_n260Q
DC_13A_n260(2A) DC_13A_n260(3A) DC_13A_n260(4A) DC_13A_n260(5A) DC_13A_n260(6A) DC_13A_n260(7A) DC_13A_n260(8A) DC_13A_n260(2D) DC_13A_n260(2G) DC_13A_n260(3G) DC_13A_n260(4G) DC_13A_n260(2H) DC_13A_n260(2O) DC_13A_n260(3O) DC_13A_n260(4O) DC_13A_n260(A-G) DC_13A_n260(A-2G) DC_13A_n260(A-P) DC_13A_n260(A-Q) DC_13A_n260(2A-G) DC_13A_n260(2A-H) DC_13A_n260(2A-2G) DC_13A_n260(2A-2H) DC_13A_n260(3A-G) DC_13A_n260(3A-O) DC_13A_n260(3A-P) DC_13A_n260(3A-2O) DC_13A_n260(4A-O)	DC_13A_n260A DC_13A_n260G DC_13A_n260H DC_13A_n260O DC_13A_n260P DC_13A_n260Q

DC_13A_n260(4A-2O) DC_13A_n260(P-Q) DC_13A_n260(A-P-Q) DC_13A_n260(2A-O-P) DC_13A_n260(3A-O-P) DC_13A_n260(A-H) DC_13A_n260(A-2H) DC_13A_n260(2A-O) DC_13A_n260(A-O) DC_13A_n260(2A-P) DC_13A_n260(A-O-P) DC_13A_n260(O-P) DC_13A_n260(2A-2O) DC_13A_n260(A-2O) DC_13A_n260(G-H)	
DC_13A_n261A DC_13A_n261G DC_13A_n261H DC_13A_n261J DC_13A_n261K DC_13A_n261I DC_13A_n261L DC_13A_n261M	DC_13A_n261A DC_13A_n261G DC_13A_n261H DC_13A_n261I
DC_13A_n261(2A) DC_13A_n261(2G) DC_13A_n261(3A) DC_13A_n261(4A) DC_13A_n261(2H) DC_13A_n261(2I) DC_13A_n261(A-G) DC_13A_n261(A-K) DC_13A_n261(A-2G) DC_13A_n261(A-H) DC_13A_n261(A-I) DC_13A_n261(A-J) DC_13A_n261(2A-G) DC_13A_n261(2A-H) DC_13A_n261(2A-I) DC_13A_n261(3A-G) DC_13A_n261(G-H) DC_13A_n261(G-I) DC_13A_n261(G-J) DC_13A_n261(H-I) DC_13A_n261(A-G-H) DC_13A_n261(A-G-I)	DC_13A_n261A DC_13A_n261G DC_13A_n261H DC_13A_n261I
DC_14A_n260A DC_14A_n260G DC_14A_n260H DC_14A_n260I DC_14A_n260J DC_14A_n260K DC_14A_n260L DC_14A_n260M	DC_14A_n260A DC_14A_n260G DC_14A_n260H DC_14A_n260I DC_14A_n260J DC_14A_n260K DC_14A_n260L DC_14A_n260M
DC_18A_n257A DC_18A_n257D DC_18A_n257E DC_18A_n257F DC_18A_n257G DC_18A_n257H DC_18A_n257I DC_18A_n257J DC_18A_n257K DC_18A_n257L DC_18A_n257M	DC_18A_n257A DC_18A_n257G DC_18A_n257H DC_18A_n257I
DC_19A_n257A DC_19A_n257D DC_19A_n257E DC_19A_n257F	DC_19A_n257A DC_19A_n257G DC_19A_n257H DC_19A_n257I

DC_19A_n257G DC_19A_n257H DC_19A_n257I DC_19A_n257J DC_19A_n257K DC_19A_n257L DC_19A_n257M	DC_19A_n257J DC_19A_n257K DC_19A_n257L DC_19A_n257M
DC_20A_n258A	DC_20A_n258A
DC_21A_n257A DC_21A_n257D DC_21A_n257E DC_21A_n257F DC_21A_n257G DC_21A_n257H DC_21A_n257I DC_21A_n257J DC_21A_n257K DC_21A_n257L DC_21A_n257M	DC_21A_n257A DC_21A_n257G DC_21A_n257H DC_21A_n257I DC_21A_n257J DC_21A_n257K DC_21A_n257L DC_21A_n257M
DC_26A_n257A	DC_26A_n257A
DC_28A_n257A DC_28A_n257D DC_28A_n257E DC_28A_n257F DC_28A_n257G DC_28A_n257H DC_28A_n257I DC_28A_n257J DC_28A_n257K DC_28A_n257L DC_28A_n257M	DC_28A_n257A DC_28A_n257G DC_28A_n257H DC_28A_n257I DC_28A_n257J DC_28A_n257K DC_28A_n257L DC_28A_n257M
DC_28A_n258A DC_28A_n258B DC_28A_n258C DC_28A_n258D DC_28A_n258E DC_28A_n258F DC_28A_n258G DC_28A_n258H DC_28A_n258I DC_28A_n258J DC_28A_n258K DC_28A_n258L DC_28A_n258M	DC_28A_n258A
DC_30A_n260A DC_30A_n260G DC_30A_n260H DC_30A_n260I DC_30A_n260J DC_30A_n260K DC_30A_n260L DC_30A_n260M	DC_30A_n260A
DC_30A_n260(A-I) DC_30A_n260(G-I)	DC_30A_n260A
DC_39A_n257A DC_39A_n257D DC_39A_n257E DC_39A_n257F DC_39A_n257G DC_39A_n257H DC_39A_n257I DC_39A_n257J DC_39A_n257K DC_39A_n257L DC_39A_n257M	DC_39A_n257A
DC_39A_n258A	DC_39A_n258A

DC_41A_n257A DC_41A_n257D DC_41A_n257E DC_41A_n257F DC_41A_n257G DC_41A_n257H DC_41A_n257I DC_41A_n257J DC_41A_n257K DC_41A_n257L DC_41A_n257M DC_41C_n257A DC_41C_n257D DC_41C_n257E DC_41C_n257F DC_41C_n257G DC_41C_n257H DC_41C_n257I DC_41C_n257J DC_41C_n257K DC_41C_n257L DC_41C_n257M	DC_41A_n257A DC_41A_n257D DC_41A_n257G DC_41A_n257H DC_41A_n257I DC_41C_n257A DC_41C_n257D DC_41C_n257G DC_41C_n257H DC_41C_n257I
DC_41A_n258A	DC_41A_n258A
DC_42A_n257A DC_42A_n257D DC_42A_n257E DC_42A_n257F DC_42A_n257G DC_42A_n257H DC_42A_n257I DC_42A_n257J DC_42A_n257K DC_42A_n257L DC_42A_n257M DC_42C_n257A DC_42C_n257D DC_42C_n257E DC_42C_n257F DC_42C_n257G DC_42C_n257H DC_42C_n257I DC_42C_n257J DC_42C_n257K DC_42C_n257L DC_42C_n257M DC_42D_n257A DC_42D_n257D DC_42D_n257E DC_42D_n257F DC_42D_n257G DC_42D_n257H DC_42D_n257I DC_42D_n257J DC_42D_n257K DC_42D_n257L DC_42D_n257M DC_42E_n257A DC_42E_n257D DC_42E_n257E DC_42E_n257F DC_42E_n257G DC_42E_n257H DC_42E_n257I DC_42E_n257J DC_42E_n257K DC_42E_n257L DC_42E_n257M	DC_42A_n257A DC_42A_n257D DC_42A_n257E DC_42A_n257F DC_42A_n257G DC_42A_n257H DC_42A_n257I DC_42A_n257J DC_42A_n257K DC_42A_n257L DC_42A_n257M DC_42C_n257A DC_42C_n257D DC_42C_n257E DC_42C_n257F DC_42D_n257A DC_42D_n257D DC_42D_n257E DC_42D_n257F DC_42D_n257G DC_42D_n257H DC_42D_n257I DC_42D_n257J DC_42E_n257A DC_42E_n257D DC_42E_n257E DC_42E_n257F
DC_48A_n257A	DC_48A_n257A



DC_48C_n257A	DC_48C_n257A
DC_48A-48A_n257A	DC_48A_n257A
DC_48A_n260A DC_48A_n260G DC_48A_n260H DC_48A_n260I DC_48A_n260J DC_48A_n260K DC_48A_n260L DC_48A_n260M DC_48C_n260A DC_48D_n260A DC_48A_n260(2A) DC_48C_n260(2A) DC_48D_n260(2A) DC_48A_n260(3A) DC_48C_n260(3A) DC_48D_n260(3A) DC_48A_n260(4A) DC_48C_n260(4A) DC_48D_n260(4A)	DC_48A_n260A DC_48C_n260A
DC_48A-48A_n260A	DC_48A_n260A
DC_48A_n261A DC_48A_n261G DC_48A_n261H DC_48A_n261I DC_48A_n261J DC_48A_n261K DC_48A_n261L DC_48A_n261M DC_48C_n261A DC_48D_n261A DC_48A_n261(A-G) DC_48A_n261(A-H) DC_48A_n261(A-I) DC_48A_n261(A-J) DC_48A_n261(A-K) DC_48A_n261(G-H) DC_48A_n261(G-I) DC_48A_n261(G-J) DC_48A_n261(H-I) DC_48A_n261(2A) DC_48C_n261(2A) DC_48D_n261(2A) DC_48A_n261(3A) DC_48A_n261(2A-G) DC_48A_n261(2A-H) DC_48A_n261(2A-I) DC_48A_n261(2G) DC_48A_n261(2H) DC_48A_n261(4A) DC_48A_n261(3A-G)	DC_48A_n261A DC_48A_n261G DC_48A_n261H DC_48A_n261I DC_48C_n261A
DC_66A_n257A DC_66A_n257G DC_66A_n257H DC_66A_n257I DC_66A_n257J DC_66A_n257K DC_66A_n257L DC_66A_n257M DC_66C_n257A	DC_66A_n257A
DC_66A_n257(2A) DC_66A-66A_n257A	DC_66A_n257A
DC_66A_n258A	DC_66A_n258A
DC_66A_n258(2A) DC_66A_n258(3A) DC_66A_n258(4A) DC_66A_n258(5A)	DC_66A_n258A

<p>DC_66A_n260A                  DC_66A_n260D                  DC_66A_n260E                  DC_66A_n260F                  DC_66A_n260G                  DC_66A_n260H                  DC_66A_n260I                  DC_66A_n260J                  DC_66A_n260K                  DC_66A_n260L                  DC_66A_n260M                  DC_66A_n260O                  DC_66A_n260P                  DC_66A_n260Q</p>	<p>DC_66A_n260A                  DC_66A_n260G                  DC_66A_n260H                  DC_66A_n260O                  DC_66A_n260P                  DC_66A_n260Q</p>
<p>DC_66A_n260(2A)                  DC_66A_n260(3A)                  DC_66A_n260(4A)                  DC_66A_n260(5A)                  DC_66A_n260(6A)                  DC_66A_n260(7A)                  DC_66A_n260(8A)                  DC_66A_n260(9A)                  DC_66A_n260(10A)                  DC_66A_n260(A-I)                  DC_66A_n260(D-G)                  DC_66A_n260(D-H)                  DC_66A_n260(D-I)                  DC_66A_n260(D-O)                  DC_66A_n260(D-P)                  DC_66A_n260(D-Q)                  DC_66A_n260(E-O)                  DC_66A_n260(E-P)                  DC_66A_n260(E-Q)                  DC_66A_n260(G-I)                  DC_66A_n260(2G)                  DC_66A_n260(2H)                  DC_66A_n260(2O)                  DC_66A_n260(3O)                  DC_66A_n260(4O)                  DC_66A_n260(2P)                  DC_66A_n260(3P)                  DC_66A_n260(4P)                  DC_66A_n260(2A-O)                  DC_66A_n260(A-2O)                  DC_66A_n260(2A-G)                  DC_66A_n260(A-2G)                  DC_66A_n260(2A-2G)                  DC_66A_n260(2G-O)                  DC_66A_n260(2A-2G-O)                  DC_66A_n260(A-2H)                  DC_66A_n260(2A-H)                  DC_66A_n260(2A-2H)                  DC_66A_n260(2A-2O)                  DC_66A_n260(2A-3O)                  DC_66A_n260(A-4O)                  DC_66A_n260(2A-4O)                  DC_66A_n260(3A-2O)                  DC_66A_n260(3A-2G)                  DC_66A_n260(4A-G)                  DC_66A_n260(4A-2G)                  DC_66A_n260(4A-O)                  DC_66A_n260(4A-2O)                  DC_66A_n260(A-O)                  DC_66A_n260(A-G)                  DC_66A_n260(G-O)                  DC_66A_n260(A-G-O)                  DC_66A_n260(2A-G-O)                  DC_66A_n260(A-2G-O)</p>	<p>DC_66A_n260A                  DC_66A_n260G                  DC_66A_n260H                  DC_66A_n260I                  DC_66A_n260O                  DC_66A_n260P                  DC_66A_n260Q</p>

DC_66A_n260(A-H) DC_66A_n260(A-3O) DC_66A_n260(3A-O) DC_66A_n260(3A-O-P) DC_66A_n260(3A-P) DC_66A_n260(3A-G) DC_66A_n260(2D) DC_66A_n260(3G) DC_66A_n260(4G) DC_66A_n260(A-D) DC_66A_n260(2A-D) DC_66A_n260(A-D-O) DC_66A_n260(2A-D-O) DC_66A_n260(D-2O) DC_66A_n260(A-D-2O) DC_66A_n260(2A-D-2O) DC_66A_n260(2A-O-P) DC_66A_n260(A-2D) DC_66A_n260(2A-2D) DC_66A_n260(A-P) DC_66A_n260(A-P-Q) DC_66A_n260(2A-P) DC_66A_n260(A-2P) DC_66A_n260(2A-2P) DC_66A_n260(3A-3O) DC_66A_n260(D-2G) DC_66A_n260(2D-O) DC_66A_n260(G-H) DC_66A_n260(G-2O) DC_66A_n260(2G-2O) DC_66A_n260(G-3O) DC_66A_n260(2G-3O) DC_66A_n260(G-4O) DC_66A_n260(2G-4O) DC_66A_n260(3G-O) DC_66A_n260(4G-O) DC_66A_n260(H-O) DC_66A_n260(2H-O) DC_66A_n260(2A-2G-2O) DC_66A_n260(6A-2O) DC_66A_n260(8A-2O) DC_66A_n260(2A-2O-2P) DC_66A_n260(6A-3O) DC_66A_n260(4A-4O) DC_66A_n260(6A-2P) DC_66A_n260(2O-2P) DC_66A_n260(2A-4P) DC_66A_n260(2A-2Q-2O) DC_66A_n260(4A-2Q) DC_66A_n260(2A-2O-2Q) DC_66A_n260(A-Q) DC_66A_n260(P-Q) DC_66A-66A_n260A DC_66A-66A_n260G DC_66A-66A_n260H DC_66A-66A_n260I DC_66A-66A_n260J DC_66A-66A_n260K DC_66A-66A_n260L DC_66A-66A_n260M DC_66A_n260(A-O-P) DC_66A_n260(O-P) DC_66A-66A_n260(2A) DC_66A-66A_n260(2G) DC_66A-66A_n260(2H) DC_66A-66A_n260(3A) DC_66A-66A_n260(4A) DC_66A-66A_n260(5A)	
--	--

<p>DC_66A-66A_n260(6A)                  DC_66A-66A_n260(A-G)                  DC_66A-66A_n260(A-H)                  DC_66A-66A_n260(A-2G)                  DC_66A-66A_n260(G-H)                  DC_66A-66A_n260(2A-G)                  DC_66A-66A_n260(2A-2G)                  DC_66A-66A_n260(3A-G)</p>	
<p>DC_66A_n261A                  DC_66A_n261D                  DC_66A_n261E                  DC_66A_n261F                  DC_66A_n261G                  DC_66A_n261H                  DC_66A_n261I                  DC_66A_n261J                  DC_66A_n261K                  DC_66A_n261L                  DC_66A_n261M                  DC_66A_n261O                  DC_66A_n261P                  DC_66A_n261Q</p>	<p>DC_66A_n261A                  DC_66A_n261G                  DC_66A_n261H                  DC_66A_n261I</p>
<p>DC_66A_n261(2A)                  DC_66A_n261(3A)                  DC_66A_n261(4A)                  DC_66A_n261(2G)                  DC_66A_n261(D-G)                  DC_66A_n261(D-H)                  DC_66A_n261(D-I)                  DC_66A_n261(D-O)                  DC_66A_n261(D-P)                  DC_66A_n261(D-Q)                  DC_66A_n261(E-O)                  DC_66A_n261(E-P)                  DC_66A_n261(E-Q)                  DC_66A_n261(2H)                  DC_66A_n261(2I)                  DC_66A_n261(A-H)                  DC_66A_n261(A-I)                  DC_66A_n261(A-J)                  DC_66A_n261(A-K)                  DC_66A_n261(A-D)                  DC_66A_n261(A-D-H)                  DC_66A_n261(A-G)                  DC_66A_n261(A-G-H)                  DC_66A_n261(G-I)                  DC_66A_n261(G-J)                  DC_66A_n261(A-G-I)                  DC_66A_n261(A-H-I)                  DC_66A_n261(G-H)                  DC_66A_n261(H-I)                  DC_66A_n261(A-D-2O)                  DC_66A_n261(A-2D)                  DC_66A_n261(A-2G)                  DC_66A_n261(A-2G-2O)                  DC_66A_n261(A-3G-O)                  DC_66A_n261(A-4G)                  DC_66A_n261(A-2H)                  DC_66A_n261(A-2I)                  DC_66A_n261(A-4O)                  DC_66A_n261(A-7O)                  DC_66A_n261(A-2P)                  DC_66A_n261(A-2Q)                  DC_66A_n261(2A-G)                  DC_66A_n261(2A-H)                  DC_66A_n261(2A-I)                  DC_66A_n261(3A-G)</p>	<p>DC_66A_n261A                  DC_66A_n261G                  DC_66A_n261H                  DC_66A_n261I</p>
<p>DC_66A-66A_n261A</p>	<p>DC_66A_n261A</p>

DC_66A-66A_n261G	DC_66A_n261G
DC_66A-66A_n261H	DC_66A_n261H
DC_66A-66A_n261I	DC_66A_n261I
DC_66A-66A_n261J	
DC_66A-66A_n261K	
DC_66A-66A_n261L	
DC_66A-66A_n261M	
DC_66A-66A_n261(2A)	
DC_66A-66A_n261(2G)	
DC_66A-66A_n261(3A)	
DC_66A-66A_n261(4A)	
DC_66A-66A_n261(A-G)	
DC_66A-66A_n261(A-G-H)	
DC_66A-66A_n261(A-G-I)	
DC_66A-66A_n261(A-2G)	
DC_66A-66A_n261(A-H)	
DC_66A-66A_n261(A-I)	
DC_66A-66A_n261(A-J)	
DC_66A-66A_n261(A-K)	
DC_66A-66A_n261(G-H)	
DC_66A-66A_n261(G-I)	
DC_66A-66A_n261(G-J)	
DC_66A-66A_n261(H-I)	
DC_66A-66A_n261(2H)	
DC_66A-66A_n261(2A-G)	
DC_66A-66A_n261(2A-H)	
DC_66A-66A_n261(2A-I)	
DC_66A-66A_n261(3A-G)	
DC_71A_n257A	DC_71A_n257A
DC_71A_n258A	DC_71A_n258A
DC_71A_n260A	DC_71A_n260A
DC_71A_n261A	DC_71A_n261A
NOTE 1: Uplink EN-DC configurations are the configurations supported by the present release of specifications.	
NOTE 2: Applicable for UE supporting inter-band EN-DC with mandatory simultaneous Rx/Tx capability for all of the above combinations	

5.5B.5.2 Inter-band EN-DC configurations including FR2 (three bands)

**Table 5.5B.5.2-1: Inter-band EN-DC configurations including FR2 (three bands)**

EN-DC configuration	Uplink EN-DC configuration (NOTE 1)
DC_1A-3A_n257A <sup>2</sup> DC_1A-3A_n257D <sup>2</sup> DC_1A-3A_n257E <sup>2</sup> DC_1A-3A_n257F <sup>2</sup> DC_1A-3A_n257G DC_1A-3A_n257H DC_1A-3A_n257I DC_1A-3A_n257J DC_1A-3A_n257K DC_1A-3A_n257L DC_1A-3A_n257M DC_1A-3C_n257A DC_1A-3C_n257D DC_1A-3C_n257E DC_1A-3C_n257F DC_1A-3C_n257G DC_1A-3C_n257H DC_1A-3C_n257I DC_1A-3C_n257J DC_1A-3C_n257K DC_1A-3C_n257L DC_1A-3C_n257M	DC_1A_n257A DC_1A_n257D DC_1A_n257G DC_1A_n257H DC_1A_n257IDC_3A_n257A DC_3A_n257D DC_3A_n257G DC_3A_n257H DC_3A_n257I DC_3A_n257J DC_3A_n257K DC_3A_n257L DC_3A_n257M
DC_1A-5A_n257A <sup>2</sup> DC_1A-5A_n257D DC_1A-5A_n257E DC_1A-5A_n257F DC_1A-5A_n257G DC_1A-5A_n257H DC_1A-5A_n257I DC_1A-5A_n257J DC_1A-5A_n257K DC_1A-5A_n257L DC_1A-5A_n257M	DC_1A_n257A DC_5A_n257A
DC_1A-7A_n257A <sup>2</sup> DC_1A-7A_n257D DC_1A-7A_n257E DC_1A-7A_n257F DC_1A-7A_n257G DC_1A-7A_n257H DC_1A-7A_n257I DC_1A-7A_n257J DC_1A-7A_n257K DC_1A-7A_n257L DC_1A-7A_n257M	DC_1A_n257A DC_7A_n257A
DC_1A-7A-7A_n257A <sup>2</sup> DC_1A-7A-7A_n257D DC_1A-7A-7A_n257E DC_1A-7A-7A_n257F DC_1A-7A-7A_n257G DC_1A-7A-7A_n257H DC_1A-7A-7A_n257I DC_1A-7A-7A_n257J DC_1A-7A-7A_n257K DC_1A-7A-7A_n257L DC_1A-7A-7A_n257M	DC_1A_n257A DC_7A_n257A DC_7A-7A_n257A

EN-DC configuration	Uplink EN-DC configuration (NOTE 1)
DC_1A-8A_n257A <sup>2</sup> DC_1A-8A_n257D DC_1A-8A_n257E DC_1A-8A_n257F DC_1A-8A_n257G DC_1A-8A_n257H DC_1A-8A_n257I DC_1A-8A_n257J DC_1A-8A_n257K DC_1A-8A_n257L DC_1A-8A_n257M	DC_1A_n257A DC_8A_n257A
DC_1A-11A_n257A DC_1A-11A_n257D DC_1A-11A_n257G DC_1A-11A_n257H DC_1A-11A_n257I	DC_1A_n257A DC_1A-257G DC_1A-257H DC_1A-257I DC_11A_n257A DC_11A-257G DC_11A-257H DC_11A-257I
DC_1A-18A_n257A <sup>2</sup> DC_1A-18A_n257D DC_1A-18A_n257E DC_1A-18A_n257F DC_1A-18A_n257G DC_1A-18A_n257H DC_1A-18A_n257I DC_1A-18A_n257J DC_1A-18A_n257K DC_1A-18A_n257L DC_1A-18A_n257M	DC_1A-257A DC_1A-257G DC_1A-257H DC_1A-257I DC_18A_n257A DC_18A-257G DC_18A-257H DC_18A-257I
DC_1A-19A_n257A <sup>2</sup> DC_1A-19A_n257D <sup>2</sup> DC_1A-19A_n257E <sup>2</sup> DC_1A-19A_n257F <sup>2</sup> DC_1A-19A_n257G DC_1A-19A_n257H DC_1A-19A_n257I DC_1A-19A_n257J DC_1A-19A_n257K DC_1A-19A_n257L DC_1A-19A_n257M	DC_1A_n257A DC_1A-257D DC_1A_n257G DC_1A_n257H DC_1A_n257I DC_1A_n257J DC_1A_n257K DC_1A_n257L DC_1A_n257M DC_19A_n257A DC_19A_n257D DC_19A_n257G DC_19A_n257H DC_19A_n257I
DC_1A-21A_n257A <sup>2</sup> DC_1A-21A_n257D <sup>2</sup> DC_1A-21A_n257E <sup>2</sup> DC_1A-21A_n257F <sup>2</sup> DC_1A-21A_n257G DC_1A-21A_n257H DC_1A-21A_n257I DC_1A-21A_n257J DC_1A-21A_n257K DC_1A-21A_n257L DC_1A-21A_n257M	DC_1A_n257A DC_1A_n257G DC_1A_n257H DC_1A_n257I DC_1A_n257J DC_1A_n257K DC_1A_n257L DC_1A_n257M DC_21A_n257A DC_21A_n257G DC_21A_n257H DC_21A_n257I DC_21A_n257J DC_21A_n257K DC_21A_n257L DC_21A_n257M



EN-DC configuration	Uplink EN-DC configuration (NOTE 1)
DC_1A-28A_n257A <sup>2</sup> DC_1A-28A_n257D <sup>2</sup> DC_1A-28A_n257E <sup>2</sup> DC_1A-28A_n257F <sup>2</sup> DC_1A-28A_n257G <sup>2</sup> DC_1A-28A_n257H <sup>2</sup> DC_1A-28A_n257I <sup>2</sup>	DC_1A_n257A DC_1A_n257D DC_1A_n257G DC_1A_n257H DC_1A_n257I DC_28A_n257A DC_28A_n257D DC_28A_n257G DC_28A_n257H DC_28A_n257I
DC_1A-41A_n257A DC_1A-41A_n257D DC_1A-41A_n257E DC_1A-41A_n257F DC_1A-41A_n257G DC_1A-41A_n257H DC_1A-41A_n257I DC_1A-41A_n257J DC_1A-41A_n257K DC_1A-41A_n257L DC_1A-41A_n257M DC_1A-41C_n257A DC_1A-41C_n257D DC_1A-41C_n257E DC_1A-41C_n257F DC_1A-41C_n257G DC_1A-41C_n257H DC_1A-41C_n257I DC_1A-41C_n257J DC_1A-41C_n257K DC_1A-41C_n257L DC_1A-41C_n257M	DC_1A_n257A DC_1A_n257G DC_1A_n257H DC_1A_n257I DC_41A_n257A DC_41A_n257G DC_41A_n257H DC_41A_n257I DC_41C_n257A DC_41C_n257G DC_41C_n257H DC_41C_n257I

EN-DC configuration	Uplink EN-DC configuration (NOTE 1)
DC_1A-42A_n257A DC_1A-42A_n257D DC_1A-42A_n257E DC_1A-42A_n257F DC_1A-42A_n257G DC_1A-42A_n257H DC_1A-42A_n257I DC_1A-42A_n257J DC_1A-42A_n257K DC_1A-42A_n257L DC_1A-42A_n257M DC_1A-42C_n257A DC_1A-42C_n257D DC_1A-42C_n257E DC_1A-42C_n257F DC_1A-42C_n257G DC_1A-42C_n257H DC_1A-42C_n257I DC_1A-42C_n257J DC_1A-42C_n257K DC_1A-42C_n257L DC_1A-42C_n257M DC_1A-42D_n257A DC_1A-42D_n257D DC_1A-42D_n257E DC_1A-42D_n257F DC_1A-42D_n257G DC_1A-42D_n257H DC_1A-42D_n257I DC_1A-42D_n257J DC_1A-42D_n257K DC_1A-42D_n257L DC_1A-42D_n257M DC_1A-42E_n257A DC_1A-42E_n257D DC_1A-42E_n257E DC_1A-42E_n257F DC_1A-42E_n257G DC_1A-42E_n257H DC_1A-42E_n257I DC_1A-42E_n257J DC_1A-42E_n257K DC_1A-42E_n257L DC_1A-42E_n257M	DC_1A_n257A DC_1A_n257D DC_1A_n257A DC_1A_n257G DC_1A_n257H DC_1A_n257I DC_1A_n257J DC_1A_n257K DC_1A_n257L DC_1A_n257M DC_42A_n257A DC_42A_n257D DC_42A_n257G DC_42A_n257H DC_42A_n257I DC_42C_n257A DC_42C_n257G DC_42C_n257H DC_42C_n257I
DC_2A-5A_n257A <sup>2</sup>	DC_2A_n257A DC_5A_n257A
DC_2A-5A_n260A DC_2A-5A_n260G DC_2A-5A_n260H DC_2A-5A_n260I DC_2A-5A_n260J DC_2A-5A_n260K DC_2A-5A_n260L DC_2A-5A_n260M DC_2A-2A-5A_n260A DC_2A-2A-5A_n260G DC_2A-2A-5A_n260H DC_2A-2A-5A_n260I DC_2A-2A-5A_n260J DC_2A-2A-5A_n260K DC_2A-2A-5A_n260L DC_2A-2A-5A_n260M	DC_2A_n260A DC_5A_n260A

EN-DC configuration	Uplink EN-DC configuration (NOTE 1)
DC_2A-5A_n260I DC_2A-5A_n260J DC_2A-5A_n260K DC_2A-5A_n260L DC_2A-5A_n260M	DC_2A_n260I DC_5A_n260I
DC_2A-5A_n261A DC_2A-5A_n261I DC_2A-5A_n261J DC_2A-5A_n261K DC_2A-5A_n261L DC_2A-5A_n261M	DC_2A_n261A DC_5A_n261A
DC_2A-5A_n261(A-G) DC_2A-5A_n261(A-H) DC_2A-5A_n261(A-J) DC_2A-5A_n261(A-K) DC_2A-5A_n261(2A-G) DC_2A-5A_n261(2A-H) DC_2A-5A_n261(2A-I) DC_2A-5A_n261(3A-G) DC_2A-5A_n261(G-H) DC_2A-5A_n261(G-I) DC_2A-5A_n261(G-J) DC_2A-5A_n261(2G) DC_2A-5A_n261(2H) DC_2A-5A_n261(H-I)	DC_2A_n261A DC_5A_n261A
DC_2A-5A_n261(A-G) DC_2A-5A_n261(2A-G) DC_2A-5A_n261(3A-G) DC_2A-5A_n261(2G)	DC_2A_n261G DC_5A_n261G
DC_2A-5A_n261(2A-H) DC_2A-5A_n261(G-H) DC_2A-5A_n261(2H)	DC_2A_n261H DC_5A_n261H
DC_2A-5A_n261I DC_2A-5A_n261J DC_2A-5A_n261K DC_2A-5A_n261L DC_2A-5A_n261M DC_2A-5A_n261(A-J) DC_2A-5A_n261(A-K) DC_2A-5A_n261(2A-I) DC_2A-5A_n261(G-I) DC_2A-5A_n261(G-J) DC_2A-5A_n261(H-I)	DC_2A_n261I DC_5A_n261I
DC_2A-12A_n260A DC_2A-12A_n260G DC_2A-12A_n260H DC_2A-12A_n260I DC_2A-12A_n260J DC_2A-12A_n260K DC_2A-12A_n260L DC_2A-12A_n260M DC_2A-2A-12A_n260A DC_2A-2A-12A_n260G DC_2A-2A-12A_n260H DC_2A-2A-12A_n260I DC_2A-2A-12A_n260J DC_2A-2A-12A_n260K DC_2A-2A-12A_n260L DC_2A-2A-12A_n260M	DC_2A_n260A DC_12A_n260A
DC_2A-13A_n257A <sup>2</sup>	DC_2A_n257A DC_13A_n257A

EN-DC configuration	Uplink EN-DC configuration (NOTE 1)
DC_2A-29A_n260A DC_2A-29A_n260G DC_2A-29A_n260H DC_2A-29A_n260I DC_2A-29A_n260J DC_2A-29A_n260K DC_2A-29A_n260L DC_2A-29A_n260M	DC_2A_n260A
DC_2A-13A_n260A <sup>2</sup> DC_2A-13A_n260G DC_2A-13A_n260H DC_2A-13A_n260I DC_2A-13A_n260J DC_2A-13A_n260K DC_2A-13A_n260L DC_2A-13A_n260M	DC_2A_n260A DC_13A_n260A
DC_2A-13A_n260(2A) DC_2A-13A_n260(3A) DC_2A-13A_n260(4A) DC_2A-13A_n260(5A) DC_2A-13A_n260(6A) DC_2A-13A_n260(2G) DC_2A-13A_n260(2H) DC_2A-13A_n260(A-G) DC_2A-13A_n260(A-H) DC_2A-13A_n260(A-2G) DC_2A-13A_n260(2A-G) DC_2A-13A_n260(2A-2G) DC_2A-13A_n260(3A-G) DC_2A-13A_n260(G-H)	DC_2A_n260A DC_13A_n260A
DC_2A-13A_n260I DC_2A-13A_n260J DC_2A-13A_n260K DC_2A-13A_n260L DC_2A-13A_n260M	DC_2A_n260I DC_13A_n260I
DC_2A-13A_n261A DC_2A-13A_n261G DC_2A-13A_n261H DC_2A-13A_n261I DC_2A-13A_n261J DC_2A-13A_n261K DC_2A-13A_n261L DC_2A-13A_n261M	DC_2A_n261A DC_13A_n261A
DC_2A-13A_n261(2A) DC_2A-13A_n261(3A) DC_2A-13A_n261(4A) DC_2A-13A_n261(2G) DC_2A-13A_n261(2H) DC_2A-13A_n261(A-G) DC_2A-13A_n261(A-H) DC_2A-13A_n261(A-I) DC_2A-13A_n261(A-J) DC_2A-13A_n261(A-K) DC_2A-13A_n261(A-2G) DC_2A-13A_n261(A-G-H) DC_2A-13A_n261(A-G-I) DC_2A-13A_n261(2A-G) DC_2A-13A_n261(2A-H) DC_2A-13A_n261(2A-I) DC_2A-13A_n261(3A-G) DC_2A-13A_n261(G-H) DC_2A-13A_n261(G-I) DC_2A-13A_n261(G-J) DC_2A-13A_n261(H-I)	DC_2A_n261A DC_13A_n261A

EN-DC configuration	Uplink EN-DC configuration (NOTE 1)
DC_2A-13A_n261(A-G) DC_2A-13A_n261(2A-G) DC_2A-13A_n261(3A-G) DC_2A-13A_n261(2G)	DC_2A_n261G DC_13A_n261G
DC_2A-13A_n261(A-H) DC_2A-13A_n261(2A-H) DC_2A-13A_n261(G-H) DC_2A-13A_n261(2H)	DC_2A_n261H DC_13A_n261H
DC_2A-14A_n260A DC_2A-14A_n260G DC_2A-14A_n260H DC_2A-14A_n260I DC_2A-14A_n260J DC_2A-14A_n260K DC_2A-14A_n260L DC_2A-14A_n260M DC_2A-2A-14A_n260A DC_2A-2A-14A_n260G DC_2A-2A-14A_n260H DC_2A-2A-14A_n260I DC_2A-2A-14A_n260J DC_2A-2A-14A_n260K DC_2A-2A-14A_n260L DC_2A-2A-14A_n260M	DC_2A_n260A DC_2A_n260G DC_2A_n260H DC_2A_n260I DC_2A_n260J DC_2A_n260K DC_2A_n260L DC_2A_n260M DC_14A_n260A DC_14A_n260G DC_14A_n260H DC_14A_n260I DC_14A_n260J DC_14A_n260K DC_14A_n260L DC_14A_n260M
DC_2A-30A_n260A DC_2A-30A_n260G DC_2A-30A_n260H DC_2A-30A_n260I DC_2A-30A_n260J DC_2A-30A_n260K DC_2A-30A_n260L DC_2A-30A_n260M	DC_2A_n260A DC_30A_n260A
DC_2A-2A-30A_n260A DC_2A-2A-30A_n260G DC_2A-2A-30A_n260H DC_2A-2A-30A_n260I DC_2A-2A-30A_n260J DC_2A-2A-30A_n260K DC_2A-2A-30A_n260L DC_2A-2A-30A_n260M	DC_2A_n260A DC_30A_n260A
DC_2A-46A_n258A DC_2A-46C_n258A DC_2A-46D_n258A	DC_2A_n258A
DC_2A-46A_n258(2A) DC_2A-46A_n258(3A) DC_2A-46A_n258(4A) DC_2A-46A_n258(5A) DC_2A-46C_n258(2A) DC_2A-46C_n258(3A) DC_2A-46C_n258(4A) DC_2A-46C_n258(5A) DC_2A-46D_n258(2A) DC_2A-46D_n258(3A) DC_2A-46D_n258(4A) DC_2A-46D_n258(5A)	DC_2A_n258A

EN-DC configuration	Uplink EN-DC configuration (NOTE 1)
DC_2A-46A_n260A DC_2A-46C_n260A DC_2A-46D_n260A DC_2A-46E_n260A DC_2A-46A_n260G DC_2A-46C_n260G DC_2A-46D_n260G DC_2A-46E_n260G DC_2A-46A_n260H DC_2A-46C_n260H DC_2A-46D_n260H DC_2A-46E_n260H DC_2A-46A_n260I DC_2A-46C_n260I DC_2A-46D_n260I DC_2A-46E_n260I DC_2A-46A_n260J DC_2A-46C_n260J DC_2A-46D_n260J DC_2A-46E_n260J DC_2A-46A_n260K DC_2A-46C_n260K DC_2A-46D_n260K DC_2A-46E_n260K DC_2A-46A_n260L DC_2A-46C_n260L DC_2A-46D_n260L DC_2A-46E_n260L DC_2A-46A_n260M DC_2A-46C_n260M DC_2A-46D_n260M DC_2A-46E_n260M	DC_2A_n260A DC_2A_n260G DC_2A_n260H DC_2A_n260I DC_2A_n260J DC_2A_n260K DC_2A_n260L DC_2A_n260M
DC_2A-2A-46A_n260A DC_2A-2A-46C_n260A DC_2A-2A-46D_n260A DC_2A-2A-46E_n260A DC_2A-2A-46A_n260G DC_2A-2A-46C_n260G DC_2A-2A-46D_n260G DC_2A-2A-46E_n260G DC_2A-2A-46A_n260H DC_2A-2A-46C_n260H DC_2A-2A-46D_n260H DC_2A-2A-46E_n260H DC_2A-2A-46A_n260I DC_2A-2A-46C_n260I DC_2A-2A-46D_n260I DC_2A-2A-46E_n260I DC_2A-2A-46A_n260J DC_2A-2A-46C_n260J DC_2A-2A-46D_n260J DC_2A-2A-46E_n260J DC_2A-2A-46A_n260K DC_2A-2A-46C_n260K DC_2A-2A-46D_n260K DC_2A-2A-46E_n260K DC_2A-2A-46A_n260L DC_2A-2A-46C_n260L DC_2A-2A-46D_n260L DC_2A-2A-46E_n260L DC_2A-2A-46A_n260M DC_2A-2A-46C_n260M DC_2A-2A-46D_n260M DC_2A-2A-46E_n260M	DC_2A_n260A DC_2A_n260G DC_2A_n260H DC_2A_n260I DC_2A_n260J DC_2A_n260K DC_2A_n260L DC_2A_n260M

EN-DC configuration	Uplink EN-DC configuration (NOTE 1)
DC_2A-46A_n261A DC_2A-46C_n261A DC_2A-46D_n261A DC_2A-46A_n261(2A) DC_2A-46C_n261(2A) DC_2A-46D_n261(2A)	DC_2A_n261A
DC_2A-66A_n257A <sup>2</sup> DC_2A-66A_n257(2A)	DC_2A_n257A DC_66A_n257A
DC_2A-66A_n260A DC_2A-66A_n260G DC_2A-66A_n260H DC_2A-66A_n260I DC_2A-66A_n260J DC_2A-66A_n260K DC_2A-66A_n260L DC_2A-66A_n260M	DC_2A_n260A DC_66A_n260A
DC_2A-66A_n260(2A) DC_2A-66A_n260(3A) DC_2A-66A_n260(4A) DC_2A-66A_n260(5A) DC_2A-66A_n260(6A) DC_2A-66A_n260(2G) DC_2A-66A_n260(2H) DC_2A-66A_n260(A-G) DC_2A-66A_n260(A-H) DC_2A-66A_n260(A-2G) DC_2A-66A_n260(2A-G) DC_2A-66A_n260(2A-2G) DC_2A-66A_n260(3A-G) DC_2A-66A_n260(G-H)	DC_2A_n260A DC_66A_n260A
DC_2A-66A_n260I DC_2A-66A_n260J DC_2A-66A_n260K DC_2A-66A_n260L DC_2A-66A_n260M DC_2A-66A-66A_n260I DC_2A-66A-66A_n260J DC_2A-66A-66A_n260K DC_2A-66A-66A_n260L DC_2A-66A-66A_n260M	DC_2A_n260I DC_66A_n260I
DC_2A-2A-66A_n260A DC_2A-2A-66A_n260G DC_2A-2A-66A_n260H DC_2A-2A-66A_n260I DC_2A-2A-66A_n260J DC_2A-2A-66A_n260K DC_2A-2A-66A_n260L DC_2A-2A-66A_n260M DC_2A-66A-66A_n260A DC_2A-66A-66A_n260G DC_2A-66A-66A_n260H DC_2A-66A-66A_n260I DC_2A-66A-66A_n260J DC_2A-66A-66A_n260K DC_2A-66A-66A_n260L DC_2A-66A-66A_n260M	DC_2A_n260A DC_66A_n260A
DC_2A-66A_n261A	DC_2A_n261A DC_66A_n261A

EN-DC configuration	Uplink EN-DC configuration (NOTE 1)
DC_2A-66A_n261G DC_2A-66A_n261H DC_2A-66A_n261I DC_2A-66A_n261J DC_2A-66A_n261K DC_2A-66A_n261L DC_2A-66A_n261M	DC_2A_n261A DC_66A_n261A
DC_2A-66A_n261(2A) DC_2A-66A_n261(3A) DC_2A-66A_n261(4A) DC_2A-66A_n261(2G) DC_2A-66A_n261(2H) DC_2A-66A_n261(A-G) DC_2A-66A_n261(A-H) DC_2A-66A_n261(A-I) DC_2A-66A_n261(A-J) DC_2A-66A_n261(A-K) DC_2A-66A_n261(A-2G) DC_2A-66A_n261(A-G-H) DC_2A-66A_n261(A-G-I) DC_2A-66A_n261(2A-G) DC_2A-66A_n261(2A-H) DC_2A-66A_n261(2A-I) DC_2A-66A_n261(3A-G) DC_2A-66A_n261(G-H) DC_2A-66A_n261(G-I) DC_2A-66A_n261(G-J) DC_2A-66A_n261(H-I) DC_2A-66A-66A_n261A DC_2A-66A-66A_n261I DC_2A-66A-66A_n261J DC_2A-66A-66A_n261K DC_2A-66A-66A_n261L DC_2A-66A-66A_n261M DC_2A-66A-66A_n261(A-G) DC_2A-66A-66A_n261(A-H) DC_2A-66A-66A_n261(A-J) DC_2A-66A-66A_n261(A-K) DC_2A-66A-66A_n261(2A-G) DC_2A-66A-66A_n261(2A-H) DC_2A-66A-66A_n261(2A-I) DC_2A-66A-66A_n261(3A-G) DC_2A-66A-66A_n261(2G) DC_2A-66A-66A_n261(G-H) DC_2A-66A-66A_n261(G-I) DC_2A-66A-66A_n261(G-J) DC_2A-66A-66A_n261(2H) DC_2A-66A-66A_n261(H-I)	DC_2A_n261A DC_66A_n261A
DC_2A-66A_n261(A-G) DC_2A-66A_n261(2A-G) DC_2A-66A_n261(3A-G) DC_2A-66A_n261(2G) DC_2A-66A-66A_n261(A-G) DC_2A-66A-66A_n261(2A-G) DC_2A-66A-66A_n261(3A-G) DC_2A-66A-66A_n261(2G)	DC_2A_n261G DC_66A_n261G
DC_2A-66A_n261(A-H) DC_2A-66A_n261(2A-H) DC_2A-66A_n261(G-H) DC_2A-66A_n261(2H) DC_2A-66A-66A_n261(A-H) DC_2A-66A-66A_n261(2A-H) DC_2A-66A-66A_n261(G-H) DC_2A-66A-66A_n261(2H)	DC_2A_n261H DC_66A_n261H



EN-DC configuration	Uplink EN-DC configuration (NOTE 1)
DC_2A-66A_n261I DC_2A-66A_n261J DC_2A-66A_n261K DC_2A-66A_n261L DC_2A-66A_n261M DC_2A-66A-66A_n261I DC_2A-66A-66A_n261J DC_2A-66A-66A_n261K DC_2A-66A-66A_n261L DC_2A-66A-66A_n261M DC_2A-66A_n261(A-J) DC_2A-66A_n261(A-K) DC_2A-66A_n261(2A-I) DC_2A-66A_n261(G-I) DC_2A-66A_n261(G-J) DC_2A-66A_n261(H-I) DC_2A-66A-66A_n261(A-J) DC_2A-66A-66A_n261(A-K) DC_2A-66A-66A_n261(2A-I) DC_2A-66A-66A_n261(G-I) DC_2A-66A-66A_n261(G-J) DC_2A-66A-66A_n261(H-I)	DC_2A_n261I DC_66A_n261I
DC_3A-3A-7A_n257A DC_3A-3A-7A_n257D DC_3A-3A-7A_n257E DC_3A-3A-7A_n257F DC_3A-3A-7A_n257G DC_3A-3A-7A_n257H DC_3A-3A-7A_n257I DC_3A-3A-7A_n257J DC_3A-3A-7A_n257K DC_3A-3A-7A_n257L DC_3A-3A-7A_n257M	DC_3A_n257A DC_7A_n257A
DC_3A-3A-7A-7A_n257A DC_3A-3A-7A-7A_n257D DC_3A-3A-7A-7A_n257E DC_3A-3A-7A-7A_n257F DC_3A-3A-7A-7A_n257G DC_3A-3A-7A-7A_n257H DC_3A-3A-7A-7A_n257I DC_3A-3A-7A-7A_n257J DC_3A-3A-7A-7A_n257K DC_3A-3A-7A-7A_n257L DC_3A-3A-7A-7A_n257M	DC_3A_n257A DC_7A_n257A
DC_3A-5A_n257A <sup>2</sup> DC_3A-5A_n257D DC_3A-5A_n257E DC_3A-5A_n257F DC_3A-5A_n257G DC_3A-5A_n257H DC_3A-5A_n257I DC_3A-5A_n257J DC_3A-5A_n257K DC_3A-5A_n257L DC_3A-5A_n257M	DC_3A_n257A DC_5A_n257A

EN-DC configuration	Uplink EN-DC configuration (NOTE 1)
DC_3A-7A_n257A <sup>2</sup> DC_3A-7A_n257D DC_3A-7A_n257E DC_3A-7A_n257F DC_3A-7A_n257G DC_3A-7A_n257H DC_3A-7A_n257I DC_3A-7A_n257J DC_3A-7A_n257K DC_3A-7A_n257L DC_3A-7A_n257M	DC_3A_n257A DC_7A_n257A
DC_3A-7A-7A_n257A <sup>2</sup> DC_3A-7A-7A_n257D DC_3A-7A-7A_n257E DC_3A-7A-7A_n257F DC_3A-7A-7A_n257G DC_3A-7A-7A_n257H DC_3A-7A-7A_n257I DC_3A-7A-7A_n257J DC_3A-7A-7A_n257K DC_3A-7A-7A_n257L DC_3A-7A-7A_n257M	DC_3A_n257A DC_7A_n257A
DC_3A-8A_n257A DC_3A-8A_n257D DC_3A-8A_n257E DC_3A-8A_n257F DC_3A-8A_n257G DC_3A-8A_n257H DC_3A-8A_n257I DC_3A-8A_n257J DC_3A-8A_n257K DC_3A-8A_n257L DC_3A-8A_n257M	DC_3A_n257A DC_8A_n257A
DC_3A-18A_n257A DC_3A-18A_n257D DC_3A-18A_n257E DC_3A-18A_n257F DC_3A-18A_n257G DC_3A-18A_n257H DC_3A-18A_n257I DC_3A-18A_n257J DC_3A-18A_n257K DC_3A-18A_n257L DC_3A-18A_n257M	DC_3A_n257A DC_3A_n257G DC_3A_n257H DC_3A_n257I DC_18A_n257A DC_18A_n257G DC_18A_n257H DC_18A_n257I
DC_3A-19A_n257A <sup>2</sup> DC_3A-19A_n257D <sup>2</sup> DC_3A-19A_n257E <sup>2</sup> DC_3A-19A_n257F <sup>2</sup> DC_3A-19A_n257G DC_3A-19A_n257H DC_3A-19A_n257I DC_3A-19A_n257J DC_3A-19A_n257K DC_3A-19A_n257L DC_3A-19A_n257M	DC_3A_n257A DC_3A_n257D DC_3A_n257G DC_3A_n257H DC_3A_n257I DC_3A_n257J DC_3A_n257K DC_3A_n257L DC_3A_n257M DC_19A_n257A DC_19A_n257D DC_19A_n257G DC_19A_n257H DC_19A_n257I

EN-DC configuration	Uplink EN-DC configuration (NOTE 1)
DC_3A-21A_n257A <sup>2</sup> DC_3A-21A_n257D <sup>2</sup> DC_3A-21A_n257E <sup>2</sup> DC_3A-21A_n257F <sup>2</sup> DC_3A-21A_n257G DC_3A-21A_n257H DC_3A-21A_n257I DC_3A-21A_n257J DC_3A-21A_n257K DC_3A-21A_n257L DC_3A-21A_n257M	DC_3A_n257A DC_3A_n257D DC_3A_n257G DC_3A_n257H DC_3A_n257I DC_3A_n257J DC_3A_n257K DC_3A_n257L DC_3A_n257M DC_21A_n257A DC_21A_n257D DC_21A_n257G DC_21A_n257H DC_21A_n257I
DC_3A-28A_n257A <sup>2</sup> DC_3A-28A_n257D <sup>2</sup> DC_3A-28A_n257E <sup>2</sup> DC_3A-28A_n257F <sup>2</sup> DC_3A-28A_n257G DC_3A-28A_n257H DC_3A-28A_n257I DC_3A-28A_n257J DC_3A-28A_n257K DC_3A-28A_n257L DC_3A-28A_n257M	DC_3A_n257A DC_3A_n257D DC_3A_n257G DC_3A_n257H DC_3A_n257I DC_3A_n257J DC_3A_n257K DC_3A_n257L DC_3A_n257M DC_28A_n257A DC_28A_n257D DC_28A_n257G DC_28A_n257H DC_28A_n257I
DC_3A-41A_n257A DC_3A-41A_n257D DC_3A-41A_n257E DC_3A-41A_n257F DC_3A-41A_n257G DC_3A-41A_n257H DC_3A-41A_n257I DC_3A-41A_n257J DC_3A-41A_n257K DC_3A-41A_n257L DC_3A-41A_n257M DC_3A-41C_n257A DC_3A-41C_n257D DC_3A-41C_n257E DC_3A-41C_n257F DC_3A-41C_n257G DC_3A-41C_n257H DC_3A-41C_n257I DC_3A-41C_n257J DC_3A-41C_n257K DC_3A-41C_n257L DC_3A-41C_n257M	DC_3A_n257A DC_3A_n257G DC_3A_n257H DC_3A_n257I DC_41A_n257A DC_41A_n257G DC_41A_n257H DC_41A_n257I DC_41C_n257A DC_41C_n257G DC_41C_n257H DC_41C_n257I

EN-DC configuration	Uplink EN-DC configuration (NOTE 1)
DC_3A-42A_n257A <sup>2</sup> DC_3A-42A_n257D <sup>2</sup> DC_3A-42A_n257E <sup>2</sup> DC_3A-42A_n257F <sup>2</sup> DC_3A-42A_n257G DC_3A-42A_n257H DC_3A-42A_n257I DC_3A-42A_n257J DC_3A-42A_n257K DC_3A-42A_n257L DC_3A-42A_n257M DC_3A-42C_n257A <sup>2</sup> DC_3A-42C_n257D <sup>2</sup> DC_3A-42C_n257E <sup>2</sup> DC_3A-42C_n257F <sup>2</sup> DC_3A-42C_n257G DC_3A-42C_n257H DC_3A-42C_n257I DC_3A-42C_n257J DC_3A-42C_n257K DC_3A-42C_n257L DC_3A-42C_n257M DC_3A-42D_n257A <sup>2</sup> DC_3A-42D_n257D DC_3A-42D_n257E DC_3A-42D_n257F DC_3A-42D_n257G DC_3A-42D_n257H DC_3A-42D_n257I DC_3A-42D_n257J DC_3A-42D_n257K DC_3A-42D_n257L DC_3A-42D_n257M DC_3A-42E_n257A <sup>2</sup> DC_3A-42E_n257D DC_3A-42E_n257E DC_3A-42E_n257F DC_3A-42E_n257G DC_3A-42E_n257H DC_3A-42E_n257I DC_3A-42E_n257J DC_3A-42E_n257K DC_3A-42E_n257L DC_3A-42E_n257M	DC_3A_n257A DC_3A_n257D DC_3A_n257G DC_3A_n257H DC_3A_n257I DC_3A_n257J DC_3A_n257K DC_3A_n257L DC_3A_n257M DC_42A_n257A DC_42A_n257D DC_42A_n257G DC_42A_n257H DC_42A_n257I DC_42C_n257ADC_42C_n257G DC_42C_n257H DC_42C_n257I
DC_5A-7A_n257A <sup>2</sup> DC_5A-7A_n257D DC_5A-7A_n257E DC_5A-7A_n257F DC_5A-7A_n257G DC_5A-7A_n257H DC_5A-7A_n257I DC_5A-7A_n257J DC_5A-7A_n257K DC_5A-7A_n257L DC_5A-7A_n257M	DC_5A_n257A DC_7A_n257A
DC_5A-7A-7A_n257A	DC_5A_n257A DC_7A_n257A

EN-DC configuration	Uplink EN-DC configuration (NOTE 1)
DC_5A-7A-7A_n257D DC_5A-7A-7A_n257E DC_5A-7A-7A_n257F DC_5A-7A-7A_n257G DC_5A-7A-7A_n257H DC_5A-7A-7A_n257I DC_5A-7A-7A_n257J DC_5A-7A-7A_n257K DC_5A-7A-7A_n257L DC_5A-7A-7A_n257M	DC_5A_n257A DC_7A_n257A
DC_5A-30A_n260A DC_5A-30A_n260G DC_5A-30A_n260H DC_5A-30A_n260I DC_5A-30A_n260J DC_5A-30A_n260K DC_5A-30A_n260L DC_5A-30A_n260M	DC_5A_n260A DC_30A_n260A
DC_8A-11A_n257A DC_8A-11A_n257D DC_8A-11A_n257G DC_8A-11A_n257H DC_8A-11A_n257I	DC_8A_n257A DC_11A_n257A
DC_5A-66A_n260A DC_5A-66A_n260G DC_5A-66A_n260H DC_5A-66A_n260I DC_5A-66A_n260J DC_5A-66A_n260K DC_5A-66A_n260L DC_5A-66A_n260M	DC_5A_n260A DC_66A_n260A
DC_5A-66A_n260I DC_5A-66A_n260J DC_5A-66A_n260K DC_5A-66A_n260L DC_5A-66A_n260M DC_5A-66A-66A_n260I DC_5A-66A-66A_n260J DC_5A-66A-66A_n260K DC_5A-66A-66A_n260L DC_5A-66A-66A_n260M	DC_5A_n260I DC_66A_n260I
DC_5A-66A-66A_n260A DC_5A-66A-66A_n260G DC_5A-66A-66A_n260H DC_5A-66A-66A_n260I DC_5A-66A-66A_n260J DC_5A-66A-66A_n260K DC_5A-66A-66A_n260L DC_5A-66A-66A_n260M	DC_5A_n260A DC_66A_n260A
DC_5A-66A_n261A DC_5A-66A_n261I DC_5A-66A_n261J DC_5A-66A_n261K DC_5A-66A_n261L DC_5A-66A_n261M	DC_5A_n261A DC_66A_n261A

EN-DC configuration	Uplink EN-DC configuration (NOTE 1)
DC_5A-66A_n261(2G) DC_5A-66A_n261(2H) DC_5A-66A_n261(A-G) DC_5A-66A_n261(A-H) DC_5A-66A_n261(A-J) DC_5A-66A_n261(A-K) DC_5A-66A_n261(2A-G) DC_5A-66A_n261(2A-H) DC_5A-66A_n261(2A-I) DC_5A-66A_n261(3A-G) DC_5A-66A_n261(G-H) DC_5A-66A_n261(G-I) DC_5A-66A_n261(G-J) DC_5A-66A_n261(H-I) DC_5A-66A-66A_n261A DC_5A-66A-66A_n261I DC_5A-66A-66A_n261J DC_5A-66A-66A_n261K DC_5A-66A-66A_n261L DC_5A-66A-66A_n261M DC_5A-66A-66A_n261(A-G) DC_5A-66A-66A_n261(A-H) DC_5A-66A-66A_n261(A-J) DC_5A-66A-66A_n261(A-K) DC_5A-66A-66A_n261(2A-G) DC_5A-66A-66A_n261(2A-H) DC_5A-66A-66A_n261(2A-I) DC_5A-66A-66A_n261(3A-G) DC_5A-66A-66A_n261(2G) DC_5A-66A-66A_n261(G-H) DC_5A-66A-66A_n261(G-I) DC_5A-66A-66A_n261(G-J) DC_5A-66A-66A_n261(2H) DC_5A-66A-66A_n261(H-I)	DC_5A_n261A DC_66A_n261A
DC_5A-66A_n261(A-G) DC_5A-66A_n261(2A-G) DC_5A-66A_n261(3A-G) DC_5A-66A_n261(2G) DC_5A-66A-66A_n261(A-G) DC_5A-66A-66A_n261(2A-G) DC_5A-66A-66A_n261(3A-G) DC_5A-66A-66A_n261(2G)	DC_5A_n261G DC_66A_n261G
DC_5A-66A_n261(A-H) DC_5A-66A_n261(2A-H) DC_5A-66A_n261(G-H) DC_5A-66A_n261(2H) DC_5A-66A-66A_n261(A-H) DC_5A-66A-66A_n261(2A-H) DC_5A-66A-66A_n261(G-H) DC_5A-66A-66A_n261(2H)	DC_5A_n261H DC_66A_n261H

EN-DC configuration	Uplink EN-DC configuration (NOTE 1)
DC_5A-66A_n261I DC_5A-66A_n261J DC_5A-66A_n261K DC_5A-66A_n261L DC_5A-66A_n261M DC_5A-66A-66A_n261I DC_5A-66A-66A_n261J DC_5A-66A-66A_n261K DC_5A-66A-66A_n261L DC_5A-66A-66A_n261M DC_5A-66A_n261(A-J) DC_5A-66A_n261(A-K) DC_5A-66A_n261(2A-I) DC_5A-66A_n261(G-I) DC_5A-66A_n261(G-J) DC_5A-66A_n261(H-I) DC_5A-66A-66A_n261(A-J) DC_5A-66A-66A_n261(A-K) DC_5A-66A-66A_n261(2A-I) DC_5A-66A-66A_n261(G-I) DC_5A-66A-66A_n261(G-J) DC_5A-66A-66A_n261(H-I)	DC_5A_n261I DC_66A_n261I
DC_11A-18A_n257A DC_11A-18A_n257G DC_11A-18A_n257H DC_11A-18A_n257I	DC_11A_n257A DC_11A_n257G DC_11A_n257H DC_11A_n257I DC_18A_n257A DC_18A_n257G DC_18A_n257H DC_18A_n257I
DC_13A-66A-66A_n260A DC_13A-66A-66A_n260G DC_13A-66A-66A_n260H DC_13A-66A-66A_n260I DC_13A-66A-66A_n260J DC_13A-66A-66A_n260K DC_13A-66A-66A_n260L DC_13A-66A-66A_n260M	DC_13A_n260A DC_66A_n260A
DC_13A-66A_n260A DC_13A-66A_n260G DC_13A-66A_n260H DC_13A-66A_n260I DC_13A-66A_n260J DC_13A-66A_n260K DC_13A-66A_n260L DC_13A-66A_n260M	DC_13A_n260A DC_66A_n260A

EN-DC configuration	Uplink EN-DC configuration (NOTE 1)
DC_13A-66A_n260(2A) DC_13A-66A_n260(3A) DC_13A-66A_n260(4A) DC_13A-66A_n260(5A) DC_13A-66A_n260(6A) DC_13A-66A_n260(2G) DC_13A-66A_n260(2H) DC_13A-66A_n260(A-G) DC_13A-66A_n260(A-H) DC_13A-66A_n260(A-2G) DC_13A-66A_n260(2A-G) DC_13A-66A_n260(2A-2G) DC_13A-66A_n260(3A-G) DC_13A-66A_n260(G-H) DC_13A-66A-66A_n260(2A) DC_13A-66A-66A_n260(3A) DC_13A-66A-66A_n260(4A) DC_13A-66A-66A_n260(5A) DC_13A-66A-66A_n260(6A) DC_13A-66A-66A_n260(2G) DC_13A-66A-66A_n260(2H) DC_13A-66A-66A_n260(A-G) DC_13A-66A-66A_n260(A-H) DC_13A-66A-66A_n260(A-2G) DC_13A-66A-66A_n260(2A-G) DC_13A-66A-66A_n260(2A-2G) DC_13A-66A-66A_n260(3A-G) DC_13A-66A-66A_n260(G-H)	DC_13A_n260A DC_66A_n260A
DC_13A-66A_n260I DC_13A-66A_n260J DC_13A-66A_n260K DC_13A-66A_n260L DC_13A-66A_n260M DC_13A-66A-66A_n260I DC_13A-66A-66A_n260J DC_13A-66A-66A_n260K DC_13A-66A-66A_n260L DC_13A-66A-66A_n260M	DC_13A_n260I DC_66A_n260I
DC_13A-66A-66A_n261A DC_13A-66A-66A_n261G DC_13A-66A-66A_n261H DC_13A-66A-66A_n261I DC_13A-66A-66A_n261J DC_13A-66A-66A_n261K DC_13A-66A-66A_n261L DC_13A-66A-66A_n261M	DC_13A_n261A DC_66A_n261A
DC_13A-66A_n261A DC_13A-66A_n261G DC_13A-66A_n261H DC_13A-66A_n261I DC_13A-66A_n261J DC_13A-66A_n261K DC_13A-66A_n261L DC_13A-66A_n261M	DC_13A_n261A DC_66A_n261A



EN-DC configuration	Uplink EN-DC configuration (NOTE 1)
DC_13A-66A_n261(2A) DC_13A-66A_n261(3A) DC_13A-66A_n261(4A) DC_13A-66A_n261(2G) DC_13A-66A_n261(2H) DC_13A-66A_n261(A-G) DC_13A-66A_n261(A-H) DC_13A-66A_n261(A-I) DC_13A-66A_n261(A-J) DC_13A-66A_n261(A-K) DC_13A-66A_n261(A-2G) DC_13A-66A_n261(A-G-H) DC_13A-66A_n261(A-G-I) DC_13A-66A_n261(2A-G) DC_13A-66A_n261(2A-H) DC_13A-66A_n261(2A-I) DC_13A-66A_n261(3A-G) DC_13A-66A_n261(G-H) DC_13A-66A_n261(G-I) DC_13A-66A_n261(G-J) DC_13A-66A_n261(H-I) DC_13A-66A-66A_n261(2A) DC_13A-66A-66A_n261(3A) DC_13A-66A-66A_n261(4A) DC_13A-66A-66A_n261(2G) DC_13A-66A-66A_n261(2H) DC_13A-66A-66A_n261(A-G) DC_13A-66A-66A_n261(A-H) DC_13A-66A-66A_n261(A-I) DC_13A-66A-66A_n261(A-J) DC_13A-66A-66A_n261(A-K) DC_13A-66A-66A_n261(A-2G) DC_13A-66A-66A_n261(A-G-H) DC_13A-66A-66A_n261(A-G-I) DC_13A-66A-66A_n261(2A-G) DC_13A-66A-66A_n261(2A-H) DC_13A-66A-66A_n261(2A-I) DC_13A-66A-66A_n261(3A-G) DC_13A-66A-66A_n261(G-H) DC_13A-66A-66A_n261(G-I) DC_13A-66A-66A_n261(G-J) DC_13A-66A-66A_n261(H-I)	DC_13A_n261A DC_66A_n261A
DC_13A-66A_n261(A-G) DC_13A-66A_n261(2A-G) DC_13A-66A_n261(3A-G) DC_13A-66A_n261(2G) DC_13A-66A-66A_n261(A-G) DC_13A-66A-66A_n261(2A-G) DC_13A-66A-66A_n261(3A-G) DC_13A-66A-66A_n261(2G)	DC_13A_n261G DC_66A_n261G
DC_13A-66A_n261(A-H) DC_13A-66A_n261(2A-H) DC_13A-66A_n261(G-H) DC_13A-66A_n261(2H) DC_13A-66A-66A_n261(A-H) DC_13A-66A-66A_n261(2A-H) DC_13A-66A-66A_n261(G-H) DC_13A-66A-66A_n261(2H)	DC_13A_n261H DC_66A_n261H
DC_8A-11A_n257A DC_8A-11A_n257D	DC_8A_n257A DC_11A_n257A

EN-DC configuration	Uplink EN-DC configuration (NOTE 1)
DC_12A-30A_n260A DC_12A-30A_n260G DC_12A-30A_n260H DC_12A-30A_n260I DC_12A-30A_n260J DC_12A-30A_n260K DC_12A-30A_n260L DC_12A-30A_n260M	DC_12A_n260A DC_30A_n260A
DC_12A-66A_n260A DC_12A-66A_n260G DC_12A-66A_n260H DC_12A-66A_n260I DC_12A-66A_n260J DC_12A-66A_n260K DC_12A-66A_n260L DC_12A-66A_n260M	DC_12A_n260A DC_66A_n260A
DC_12A-66A-66A_n260A DC_12A-66A-66A_n260G DC_12A-66A-66A_n260H DC_12A-66A-66A_n260I DC_12A-66A-66A_n260J DC_12A-66A-66A_n260K DC_12A-66A-66A_n260L DC_12A-66A-66A_n260M	DC_12A_n260A DC_66A_n260A
DC_14A-30A_n260A DC_14A-30A_n260G DC_14A-30A_n260H DC_14A-30A_n260I DC_14A-30A_n260J DC_14A-30A_n260K DC_14A-30A_n260L DC_14A-30A_n260M	DC_14A_n260A DC_14A_n260G DC_14A_n260H DC_14A_n260I DC_14A_n260J DC_14A_n260K DC_14A_n260L DC_14A_n260M DC_30A_n260A DC_30A_n260G DC_30A_n260H DC_30A_n260I DC_30A_n260J DC_30A_n260K DC_30A_n260L DC_30A_n260M
DC_14A-66A_n260A DC_14A-66A_n260G DC_14A-66A_n260H DC_14A-66A_n260I DC_14A-66A_n260J DC_14A-66A_n260K DC_14A-66A_n260L DC_14A-66A_n260M DC_14A-66A-66A_n260A DC_14A-66A-66A_n260G DC_14A-66A-66A_n260H DC_14A-66A-66A_n260I DC_14A-66A-66A_n260J DC_14A-66A-66A_n260K DC_14A-66A-66A_n260L DC_14A-66A-66A_n260M	DC_14A_n260A DC_14A_n260G DC_14A_n260H DC_14A_n260I DC_14A_n260J DC_14A_n260K DC_14A_n260L DC_14A_n260M DC_66A_n260A DC_66A_n260G DC_66A_n260H DC_66A_n260I DC_66A_n260J DC_66A_n260K DC_66A_n260L DC_66A_n260M
DC_13A-66A_n257A <sup>2</sup>	DC_13A_n257A DC_66A_n257A
DC_13A-66A_n260A <sup>2</sup>	DC_13A_n260A DC_66A_n260A
DC_18A-28A_n257A <sup>2</sup>	DC_18A_n257A DC_28A_n257A

EN-DC configuration	Uplink EN-DC configuration (NOTE 1)
DC_18A-42A_n257A DC_18A-42A_n257D DC_18A-42A_n257E DC_18A-42A_n257F DC_18A-42A_n257G DC_18A-42A_n257H DC_18A-42A_n257I DC_18A-42A_n257J DC_18A-42A_n257K DC_18A-42A_n257L DC_18A-42A_n257M DC_18A-42C_n257A DC_18A-42C_n257D DC_18A-42C_n257E DC_18A-42C_n257F DC_18A-42C_n257G DC_18A-42C_n257H DC_18A-42C_n257I DC_18A-42C_n257J DC_18A-42C_n257K DC_18A-42C_n257L DC_18A-42C_n257M	DC_18A_n257A DC_18A_n257G DC_18A_n257H DC_18A_n257I DC_42A_n257A DC_42A_n257G DC_42A_n257H DC_42A_n257I DC_42C_n257A DC_42C_n257G DC_42C_n257H DC_42C_n257I
DC_18A-41A_n257A DC_18A-41A_n257G DC_18A-41A_n257H DC_18A-41A_n257I DC_18A-41C_n257A DC_18A-41C_n257G DC_18A-41C_n257H DC_18A-41C_n257I	DC_18A_n257A DC_18A_n257G DC_18A_n257H DC_18A_n257I DC_41A_n257A DC_41A_n257G DC_41A_n257H DC_41A_n257I DC_41C_n257A DC_41C_n257G DC_41C_n257H DC_41C_n257I
DC_19A-21A_n257A <sup>2</sup> DC_19A-21A_n257D <sup>2</sup> DC_19A-21A_n257E <sup>2</sup> DC_19A-21A_n257F <sup>2</sup> DC_19A-21A_n257G DC_19A-21A_n257H DC_19A-21A_n257I DC_19A-21A_n257J DC_19A-21A_n257K DC_19A-21A_n257L DC_19A-21A_n257M	DC_19A_n257A DC_19A_n257D DC_19A_n257G DC_19A_n257H DC_19A_n257I DC_21A_n257A DC_21A_n257D DC_21A_n257G DC_21A_n257H DC_21A_n257I DC_21A_n257J DC_21A_n257K DC_21A_n257L DC_21A_n257M
DC_19A-42A_n257A <sup>2</sup> DC_19A-42A_n257D <sup>2</sup> DC_19A-42A_n257E <sup>2</sup> DC_19A-42A_n257F <sup>2</sup> DC_19A-42A_n257G <sup>2</sup> DC_19A-42A_n257H <sup>2</sup> DC_19A-42A_n257I <sup>2</sup> DC_19A-42C_n257A <sup>2</sup> DC_19A-42C_n257G <sup>2</sup> DC_19A-42C_n257H <sup>2</sup> DC_19A-42C_n257I <sup>2</sup> DC_19A-42D_n257D <sup>2</sup> DC_19A-42D_n257E <sup>2</sup> DC_19A-42D_n257F <sup>2</sup>	DC_19A_n257A DC_19A_n257D DC_19A_n257G DC_19A_n257H DC_19A_n257I DC_42A_n257A DC_42A_n257D DC_42A_n257G DC_42A_n257H DC_42A_n257I

EN-DC configuration	Uplink EN-DC configuration (NOTE 1)
DC_21A-28A_n257A <sup>2</sup> DC_21A-28A_n257D <sup>2</sup> DC_21A-28A_n257E <sup>2</sup> DC_21A-28A_n257F <sup>2</sup>	DC_21A_n257A DC_21A_n257D DC_28A_n257A DC_28A_n257D
DC_21A-42A_n257A <sup>2</sup> DC_21A-42A_n257D <sup>2</sup> DC_21A-42A_n257E <sup>2</sup> DC_21A-42A_n257F <sup>2</sup> DC_21A-42A_n257G DC_21A-42A_n257H DC_21A-42A_n257I DC_21A-42A_n257J DC_21A-42A_n257K DC_21A-42A_n257L DC_21A-42A_n257M DC_21A-42C_n257A <sup>2</sup> DC_21A-42C_n257G DC_21A-42C_n257H DC_21A-42C_n257I DC_21A-42C_n257J DC_21A-42C_n257K DC_21A-42C_n257L DC_21A-42C_n257M DC_21A-42D_n257A DC_21A-42D_n257D DC_21A-42D_n257E DC_21A-42D_n257F DC_21A-42D_n257G DC_21A-42D_n257H DC_21A-42D_n257I DC_21A-42D_n257J DC_21A-42D_n257K DC_21A-42D_n257L DC_21A-42D_n257M DC_21A-42E_n257A DC_21A-42E_n257D DC_21A-42E_n257E DC_21A-42E_n257F DC_21A-42E_n257G DC_21A-42E_n257H DC_21A-42E_n257I DC_21A-42E_n257J DC_21A-42E_n257K DC_21A-42E_n257L DC_21A-42E_n257M	DC_21A_n257A DC_21A_n257D DC_21A_n257G DC_21A_n257H DC_21A_n257I DC_21A_n257J DC_21A_n257K DC_21A_n257L DC_21A_n257M DC_42A_n257A DC_42A_n257D DC_42A_n257G DC_42A_n257H DC_42A_n257I
DC_28A-41A_n257A DC_28A-41A_n257G DC_28A-41A_n257H DC_28A-41A_n257IDC_28A-41C_n257A DC_28A-41C_n257G DC_28A-41C_n257H DC_28A-41C_n257I	DC_28A_n257A DC_28A_n257G DC_28A_n257H DC_28A_n257I DC_41A_n257A DC_41A_n257G DC_41A_n257H DC_41A_n257I DC_41C_n257A DC_41C_n257G DC_41C_n257H DC_41C_n257I

EN-DC configuration	Uplink EN-DC configuration (NOTE 1)
DC_28A-42A_n257A <sup>2</sup> DC_28A-42A_n257D <sup>2</sup> DC_28A-42A_n257G <sup>2</sup> DC_28A-42A_n257H <sup>2</sup> DC_28A-42A_n257I <sup>2</sup> DC_28A-42C_n257A <sup>2</sup> DC_28A-42C_n257D <sup>2</sup> DC_28A-42C_n257G <sup>2</sup> DC_28A-42C_n257H <sup>2</sup> DC_28A-42C_n257I <sup>2</sup>	DC_28A_n257A DC_28A_n257G DC_28A_n257H DC_28A_n257I DC_42A_n257A DC_42A_n257G DC_42A_n257H DC_42A_n257I DC_42C_n257A DC_42C_n257G DC_42C_n257H DC_42C_n257I
DC_29A-30A_n260A DC_29A-30A_n260G DC_29A-30A_n260H DC_29A-30A_n260I DC_29A-30A_n260J DC_29A-30A_n260K DC_29A-30A_n260L DC_29A-30A_n260M	DC_30A_n260A
DC_30A-66A_n260A DC_30A-66A_n260G DC_30A-66A_n260H DC_30A-66A_n260I DC_30A-66A_n260J DC_30A-66A_n260K DC_30A-66A_n260L DC_30A-66A_n260M	DC_30A_n260A DC_66A_n260A
DC_30A-66A-66A_n260A DC_30A-66A-66A_n260G DC_30A-66A-66A_n260H DC_30A-66A-66A_n260I DC_30A-66A-66A_n260J DC_30A-66A-66A_n260K DC_30A-66A-66A_n260L DC_30A-66A-66A_n260M	DC_30A_n260A DC_66A_n260A

EN-DC configuration	Uplink EN-DC configuration (NOTE 1)
DC_41A-42A_n257A	
DC_41A-42A_n257D	
DC_41A-42A_n257E	
DC_41A-42A_n257F	
DC_41A-42A_n257G	
DC_41A-42A_n257H	
DC_41A-42A_n257I	
DC_41A-42A_n257J	
DC_41A-42A_n257K	
DC_41A-42A_n257L	
DC_41A-42A_n257M	
DC_41A-42C_n257A	
DC_41A-42C_n257D	
DC_41A-42C_n257E	DC_41A_n257A
DC_41A-42C_n257F	DC_41A_n257G
DC_41A-42C_n257G	DC_41A_n257H
DC_41A-42C_n257H	DC_41A_n257I
DC_41A-42C_n257I	DC_41C_n257A
DC_41A-42C_n257J	DC_41C_n257G
DC_41A-42C_n257K	DC_41C_n257H
DC_41A-42C_n257L	DC_41C_n257I
DC_41A-42C_n257M	DC_41C_n257I
DC_41C-42A_n257A	DC_42A_n257A
DC_41C-42A_n257D	DC_42A_n257G
DC_41C-42A_n257E	DC_42A_n257H
DC_41C-42A_n257F	DC_42A_n257I
DC_41C-42A_n257G	DC_42C_n257A
DC_41C-42A_n257H	DC_42C_n257G
DC_41C-42A_n257I	DC_42C_n257H
DC_41C-42A_n257J	DC_42C_n257I
DC_41C-42A_n257K	
DC_41C-42A_n257L	
DC_41C-42A_n257M	
DC_41C-42C_n257A	
DC_41C-42C_n257D	
DC_41C-42C_n257E	
DC_41C-42C_n257F	
DC_41C-42C_n257G	
DC_41C-42C_n257H	
DC_41C-42C_n257I	
DC_41C-42C_n257J	
DC_41C-42C_n257K	
DC_41C-42C_n257L	
DC_41C-42C_n257M	

EN-DC configuration	Uplink EN-DC configuration (NOTE 1)
DC_46A-48A_n260A DC_46C-48A_n260A DC_46D-48A_n260A DC_46A-48C_n260A DC_46A-48D_n260A DC_46C-48C_n260A DC_46C-48D_n260A DC_46D-48C_n260A DC_46D-48D_n260A DC_46A-48A_n260(2A) DC_46C-48A_n260(2A) DC_46D-48A_n260(2A) DC_46A-48C_n260(2A) DC_46A-48D_n260(2A) DC_46C-48C_n260(2A) DC_46C-48D_n260(2A) DC_46D-48C_n260(2A) DC_46D-48D_n260(2A) DC_46A-48A_n260(3A) DC_46C-48A_n260(3A) DC_46D-48A_n260(3A) DC_46A-48C_n260(3A) DC_46A-48D_n260(3A) DC_46C-48C_n260(3A) DC_46C-48D_n260(3A) DC_46D-48C_n260(3A) DC_46D-48D_n260(3A) DC_46A-48A_n260(4A) DC_46C-48A_n260(4A) DC_46D-48A_n260(4A) DC_46A-48C_n260(4A) DC_46A-48D_n260(4A) DC_46C-48C_n260(4A) DC_46C-48D_n260(4A) DC_46D-48C_n260(4A) DC_46D-48D_n260(4A)	DC_48A_n260A DC_48C_n260A
DC_46A-48A_n261A DC_46C-48A_n261A DC_46D-48A_n261A DC_46A-48C_n261A DC_46A-48D_n261A DC_46C-48C_n261A DC_46C-48D_n261A DC_46D-48C_n261A DC_46D-48D_n261A DC_46A-48A_n261(2A) DC_46C-48A_n261(2A) DC_46D-48A_n261(2A) DC_46A-48C_n261(2A) DC_46A-48D_n261(2A) DC_46C-48C_n261(2A) DC_46C-48D_n261(2A) DC_46D-48C_n261(2A) DC_46D-48D_n261(2A)	DC_48A_n261A DC_48C_n261A
DC_46A-66A_n258A DC_46C-66A_n258A DC_46D-66A_n258A	DC_66A_n258A

EN-DC configuration	Uplink EN-DC configuration (NOTE 1)
DC_46A-66A_n258(2A) DC_46A-66A_n258(3A) DC_46A-66A_n258(4A) DC_46A-66A_n258(5A) DC_46C-66A_n258(2A) DC_46C-66A_n258(3A) DC_46C-66A_n258(4A) DC_46C-66A_n258(5A) DC_46D-66A_n258(2A) DC_46D-66A_n258(3A) DC_46D-66A_n258(4A) DC_46D-66A_n258(5A)	DC_66A_n258A
DC_46A-66A_n260A DC_46C-66A_n260A DC_46D-66A_n260A DC_46E-66A_n260A DC_46A-66A_n260G DC_46C-66A_n260G DC_46D-66A_n260G DC_46E-66A_n260G DC_46A-66A_n260H DC_46C-66A_n260H DC_46D-66A_n260H DC_46E-66A_n260H DC_46A-66A_n260I DC_46C-66A_n260I DC_46D-66A_n260I DC_46E-66A_n260I DC_46A-66A_n260J DC_46C-66A_n260J DC_46D-66A_n260J DC_46E-66A_n260J DC_46A-66A_n260K DC_46C-66A_n260K DC_46D-66A_n260K DC_46E-66A_n260K DC_46A-66A_n260L DC_46C-66A_n260L DC_46D-66A_n260L DC_46E-66A_n260L DC_46A-66A_n260M DC_46C-66A_n260M DC_46D-66A_n260M DC_46E-66A_n260M	DC_66A_n260A DC_66A_n260G DC_66A_n260H DC_66A_n260I DC_66A_n260J DC_66A_n260K DC_66A_n260L DC_66A_n260M
DC_46A-66A_n260(2A) DC_46C-66A_n260(2A) DC_46D-66A_n260(2A)	DC_66A_n260A
DC_46A-66A_n261A DC_46C-66A_n261A DC_46D-66A_n261A DC_46A-66A_n261(2A) DC_46C-66A_n261(2A) DC_46D-66A_n261(2A)	DC_66A_n261A

NOTE 1: Uplink EN-DC configurations are the configurations supported by the present release of specifications.

NOTE 2: Applicable for UE supporting inter-band EN-DC with mandatory simultaneous Rx/Tx capability



5.5B.5.3 Inter-band EN-DC configurations including FR2 (four bands)

**Table 5.5B.5.3-1: Inter-band EN-DC configurations including FR2 (four bands)**

EN-DC configuration	Uplink EN-DC configuration (NOTE 1)
DC_1A-3A-5A_n257A <sup>2</sup> DC_1A-3A-5A_n257D DC_1A-3A-5A_n257E DC_1A-3A-5A_n257F DC_1A-3A-5A_n257G DC_1A-3A-5A_n257H DC_1A-3A-5A_n257I DC_1A-3A-5A_n257J DC_1A-3A-5A_n257K DC_1A-3A-5A_n257L DC_1A-3A-5A_n257M	DC_1A_n257A DC_3A_n257A DC_5A_n257A
DC_1A-3A-7A_n257A <sup>2</sup> DC_1A-3A-7A_n257D DC_1A-3A-7A_n257E DC_1A-3A-7A_n257F DC_1A-3A-7A_n257G DC_1A-3A-7A_n257H DC_1A-3A-7A_n257I DC_1A-3A-7A_n257J DC_1A-3A-7A_n257K DC_1A-3A-7A_n257L DC_1A-3A-7A_n257M	DC_1A_n257A DC_3A_n257A DC_7A_n257A
DC_1A-3A-7A-7A_n257A	DC_1A_n257A DC_3A_n257A DC_7A_n257A
DC_1A-3A-8A_n257A DC_1A-3A-8A_n257D DC_1A-3A-8A_n257E DC_1A-3A-8A_n257F DC_1A-3A-8A_n257G DC_1A-3A-8A_n257H DC_1A-3A-8A_n257I DC_1A-3A-8A_n257J DC_1A-3A-8A_n257K DC_1A-3A-8A_n257L DC_1A-3A-8A_n257M DC_1A-3C-8A_n257A DC_1A-3C-8A_n257D DC_1A-3C-8A_n257E DC_1A-3C-8A_n257F DC_1A-3C-8A_n257G DC_1A-3C-8A_n257H DC_1A-3C-8A_n257I DC_1A-3C-8A_n257J DC_1A-3C-8A_n257K DC_1A-3C-8A_n257L DC_1A-3C-8A_n257M	DC_1A_n257A DC_3A_n257A DC_8A_n257A
DC_1A-3A-18A_n257A DC_1A-3A-18A_n257D DC_1A-3A-18A_n257E DC_1A-3A-18A_n257F DC_1A-3A-18A_n257G DC_1A-3A-18A_n257H DC_1A-3A-18A_n257I DC_1A-3A-18A_n257J DC_1A-3A-18A_n257K DC_1A-3A-18A_n257L DC_1A-3A-18A_n257M	DC_1A_n257A DC_1A_n257G DC_1A_n257H DC_1A_n257I DC_3A_n257A DC_3A_n257G DC_3A_n257H DC_3A_n257I DC_18A_n257A DC_18A_n257G DC_18A_n257H DC_18A_n257I

EN-DC configuration	Uplink EN-DC configuration (NOTE 1)
<p>DC_1A-3A-19A_n257A<sup>2</sup>                      DC_1A-3A-19A_n257G                      DC_1A-3A-19A_n257H                      DC_1A-3A-19A_n257I                      DC_1A-3A-19A_n257J                      DC_1A-3A-19A_n257K                      DC_1A-3A-19A_n257L                      DC_1A-3A-19A_n257M</p>	<p>DC_1A_n257A                      DC_1A_n257G                      DC_1A_n257H                      DC_1A_n257I                      DC_3A_n257A                      DC_3A_n257G                      DC_3A_n257H                      DC_3A_n257I                      DC_3A_n257J                      DC_3A_n257K                      DC_3A_n257L                      DC_3A_n257M                      DC_19A_n257A                      DC_19A_n257G                      DC_19A_n257H                      DC_19A_n257I</p>
<p>DC_1A-3A-21A_n257A<sup>2</sup>                      DC_1A-3A-21A_n257G                      DC_1A-3A-21A_n257H                      DC_1A-3A-21A_n257I                      DC_1A-3A-21A_n257J                      DC_1A-3A-21A_n257K                      DC_1A-3A-21A_n257L                      DC_1A-3A-21A_n257M</p>	<p>DC_1A_n257A                      DC_1A_n257G                      DC_1A_n257H                      DC_1A_n257I                      DC_3A_n257A                      DC_3A_n257G                      DC_3A_n257H                      DC_3A_n257I                      DC_3A_n257J                      DC_3A_n257K                      DC_3A_n257L                      DC_3A_n257M                      DC_21A_n257A                      DC_21A_n257G                      DC_21A_n257H                      DC_21A_n257I</p>
<p>DC_1A-3A-28A_n257A<sup>2</sup>                      DC_1A-3A-28A_n257G                      DC_1A-3A-28A_n257H                      DC_1A-3A-28A_n257I                      DC_1A-3A-28A_n257J                      DC_1A-3A-28A_n257K                      DC_1A-3A-28A_n257L                      DC_1A-3A-28A_n257M</p>	<p>DC_1A_n257A                      DC_1A_n257G                      DC_1A_n257H                      DC_1A_n257I                      DC_3A_n257A                      DC_3A_n257G                      DC_3A_n257H                      DC_3A_n257I                      DC_3A_n257J                      DC_3A_n257K                      DC_3A_n257L                      DC_3A_n257M                      DC_28A_n257A                      DC_28A_n257G                      DC_28A_n257H                      DC_28A_n257I</p>

EN-DC configuration	Uplink EN-DC configuration (NOTE 1)
DC_1A-3A-41A_n257A DC_1A-3A-41A_n257D DC_1A-3A-41A_n257E DC_1A-3A-41A_n257F DC_1A-3A-41A_n257G DC_1A-3A-41A_n257H DC_1A-3A-41A_n257I DC_1A-3A-41A_n257J DC_1A-3A-41A_n257K DC_1A-3A-41A_n257L DC_1A-3A-41A_n257M DC_1A-3A-41C_n257A DC_1A-3A-41C_n257D DC_1A-3A-41C_n257E DC_1A-3A-41C_n257F DC_1A-3A-41C_n257G DC_1A-3A-41C_n257H DC_1A-3A-41C_n257I DC_1A-3A-41C_n257J DC_1A-3A-41C_n257K DC_1A-3A-41C_n257L DC_1A-3A-41C_n257M	DC_1A_n257A DC_1A_n257G DC_1A_n257H DC_1A_n257I DC_3A_n257A DC_3A_n257G DC_3A_n257H DC_3A_n257I DC_41A_n257A DC_41A_n257G DC_41A_n257H DC_41A_n257I DC_41C_n257A DC_41C_n257G DC_41C_n257H DC_41C_n257I
DC_1A-3A-42A_n257A DC_1A-3A-42A_n257G DC_1A-3A-42A_n257H DC_1A-3A-42A_n257I DC_1A-3A-42A_n257J DC_1A-3A-42A_n257K DC_1A-3A-42A_n257L DC_1A-3A-42A_n257M DC_1A-3A-42C_n257A DC_1A-3A-42C_n257D DC_1A-3A-42C_n257E DC_1A-3A-42C_n257F DC_1A-3A-42C_n257G DC_1A-3A-42C_n257H DC_1A-3A-42C_n257I DC_1A-3A-42C_n257J DC_1A-3A-42C_n257K DC_1A-3A-42C_n257L DC_1A-3A-42C_n257M DC_1A-3A-42D_n257A DC_1A-3A-42D_n257G DC_1A-3A-42D_n257H DC_1A-3A-42D_n257I DC_1A-3A-42D_n257J DC_1A-3A-42D_n257K DC_1A-3A-42D_n257L DC_1A-3A-42D_n257M	DC_1A_n257A DC_1A_n257G DC_1A_n257H DC_1A_n257I DC_1A_n257J DC_1A_n257K DC_1A_n257L DC_1A_n257M DC_3A_n257A DC_3A_n257G DC_3A_n257H DC_3A_n257I DC_3A_n257J DC_3A_n257K DC_3A_n257L DC_3A_n257M DC_42A_n257A DC_42A_n257G DC_42A_n257H DC_42A_n257I DC_42C_n257A DC_42C_n257G DC_42C_n257H DC_42C_n257I
DC_1A-5A-7A_n257A <sup>2</sup> DC_1A-5A-7A_n257D DC_1A-5A-7A_n257E DC_1A-5A-7A_n257F DC_1A-5A-7A_n257G DC_1A-5A-7A_n257H DC_1A-5A-7A_n257I DC_1A-5A-7A_n257J DC_1A-5A-7A_n257K DC_1A-5A-7A_n257L DC_1A-5A-7A_n257M	DC_1A_n257A DC_5A_n257A DC_7A_n257A

EN-DC configuration	Uplink EN-DC configuration (NOTE 1)
DC_1A-5A-7A-7A_n257A DC_1A-5A-7A-7A_n257D DC_1A-5A-7A-7A_n257E DC_1A-5A-7A-7A_n257F DC_1A-5A-7A-7A_n257G DC_1A-5A-7A-7A_n257H DC_1A-5A-7A-7A_n257I DC_1A-5A-7A-7A_n257J DC_1A-5A-7A-7A_n257K DC_1A-5A-7A-7A_n257L DC_1A-5A-7A-7A_n257M	DC_1A_n257A DC_5A_n257A DC_7A_n257A
DC_1A-8A-11A_n257A DC_1A-8A-11A_n257D DC_1A-8A-11A_n257G DC_1A-8A-11A_n257H DC_1A-8A-11A_n257I	DC_1A_n257A DC_8A_n257A DC_11A_n257A
DC_1A-11A-18A_n257A DC_1A-11A-18A_n257G DC_1A-11A-18A_n257H DC_1A-11A-18A_n257I	DC_1A_n257A DC_1A_n257G DC_1A_n257H DC_1A_n257I DC_11A_n257A DC_11A_n257G DC_11A_n257H DC_11A_n257I DC_18A_n257A DC_18A_n257G DC_18A_n257H DC_18A_n257I
DC_1A-18A-28A_n257A <sup>2</sup>	DC_1A_n257A DC_18A_n257A DC_28A_n257A
DC_1A-18A-41A_n257A DC_1A-18A-41A_n257G DC_1A-18A-41A_n257H DC_1A-18A-41A_n257I DC_1A-18A-41C_n257A DC_1A-18A-41C_n257G DC_1A-18A-41C_n257H DC_1A-18A-41C_n257I	DC_1A_n257A DC_1A_n257G DC_1A_n257H DC_1A_n257I DC_18A_n257A DC_18A_n257G DC_18A_n257H DC_18A_n257I DC_41A_n257A DC_41A_n257G DC_41A_n257H DC_41A_n257I DC_41C_n257A DC_41C_n257G DC_41C_n257H DC_41C_n257I

EN-DC configuration	Uplink EN-DC configuration (NOTE 1)
DC_1A-18A-42A_n257A DC_1A-18A-42A_n257D DC_1A-18A-42A_n257E DC_1A-18A-42A_n257F DC_1A-18A-42A_n257G DC_1A-18A-42A_n257H DC_1A-18A-42A_n257I DC_1A-18A-42A_n257J DC_1A-18A-42A_n257K DC_1A-18A-42A_n257L DC_1A-18A-42A_n257M DC_1A-18A-42C_n257A DC_1A-18A-42C_n257D DC_1A-18A-42C_n257E DC_1A-18A-42C_n257F DC_1A-18A-42C_n257G DC_1A-18A-42C_n257H DC_1A-18A-42C_n257I DC_1A-18A-42C_n257J DC_1A-18A-42C_n257K DC_1A-18A-42C_n257L DC_1A-18A-42C_n257M	DC_1A_n257A DC_1A_n257G DC_1A_n257H DC_1A_n257I DC_18A_n257A DC_18A_n257G DC_18A_n257H DC_18A_n257I DC_42A_n257A DC_42A_n257G DC_42A_n257H DC_42A_n257I DC_42C_n257A DC_42C_n257G DC_42C_n257H DC_42C_n257I
DC_1A-19A-21A_n257A DC_1A-19A-21A_n257D DC_1A-19A-21A_n257E DC_1A-19A-21A_n257F DC_1A-19A-21A_n257G DC_1A-19A-21A_n257H DC_1A-19A-21A_n257I DC_1A-19A-21A_n257J DC_1A-19A-21A_n257K DC_1A-19A-21A_n257L DC_1A-19A-21A_n257M	DC_1A_n257A DC_1A_n257G DC_1A_n257H DC_1A_n257I DC_1A_n257J DC_1A_n257K DC_1A_n257L DC_1A_n257M DC_19A_n257A DC_19A_n257G DC_19A_n257H DC_19A_n257I DC_21A_n257A DC_21A_n257G DC_21A_n257H DC_21A_n257I DC_21A_n257J DC_21A_n257K DC_21A_n257L DC_21A_n257M
DC_1A-19A-42A_n257A DC_1A-19A-42C_n257A DC_1A-19A-42C_n257D DC_1A-19A-42C_n257E DC_1A-19A-42C_n257F DC_1A-19A-42A_n257G DC_1A-19A-42A_n257H DC_1A-19A-42A_n257I DC_1A-19A-42A_n257J DC_1A-19A-42A_n257K DC_1A-19A-42A_n257L DC_1A-19A-42A_n257M DC_1A-19A-42C_n257G DC_1A-19A-42C_n257H DC_1A-19A-42C_n257I DC_1A-19A-42C_n257J DC_1A-19A-42C_n257K DC_1A-19A-42C_n257L DC_1A-19A-42C_n257M	DC_1A_n257A DC_1A_n257G DC_1A_n257H DC_1A_n257I DC_1A_n257J DC_1A_n257K DC_1A_n257L DC_1A_n257M DC_19A_n257A DC_42A_n257A DC_42A_n257G DC_42A_n257H DC_42A_n257I
DC_1A-21A-28A_n257A <sup>2</sup>	DC_1A_n257A DC_21A_n257A DC_28A_n257A

EN-DC configuration	Uplink EN-DC configuration (NOTE 1)
DC_1A-21A-42A_n257A DC_1A-21A-42A_n257G DC_1A-21A-42A_n257H DC_1A-21A-42A_n257I DC_1A-21A-42A_n257J DC_1A-21A-42A_n257K DC_1A-21A-42A_n257L DC_1A-21A-42A_n257M DC_1A-21A-42C_n257A DC_1A-21A-42C_n257D DC_1A-21A-42C_n257E DC_1A-21A-42C_n257F DC_1A-21A-42C_n257G DC_1A-21A-42C_n257H DC_1A-21A-42C_n257I DC_1A-21A-42C_n257J DC_1A-21A-42C_n257K DC_1A-21A-42C_n257L DC_1A-21A-42C_n257M DC_1A-21A-42D_n257A DC_1A-21A-42D_n257D DC_1A-21A-42D_n257E DC_1A-21A-42D_n257F	DC_1A_n257A DC_1A_n257G DC_1A_n257H DC_1A_n257I DC_1A_n257J DC_1A_n257K DC_1A_n257L DC_1A_n257M DC_21A_n257A DC_21A_n257G DC_21A_n257H DC_21A_n257I DC_21A_n257J DC_21A_n257K DC_21A_n257L DC_21A_n257M DC_42A_n257A DC_42A_n257D DC_42A_n257G DC_42A_n257H DC_42A_n257I
DC_1A-28A-42A_n257A DC_1A-28A-42A_n257D DC_1A-28A-42A_n257G DC_1A-28A-42A_n257H DC_1A-28A-42A_n257I DC_1A-28A-42C_n257A DC_1A-28A-42C_n257D DC_1A-28A-42C_n257G DC_1A-28A-42C_n257H DC_1A-28A-42C_n257I	DC_1A_n257A DC_1A_n257G DC_1A_n257H DC_1A_n257I DC_28A_n257A DC_28A_n257G DC_28A_n257H DC_28A_n257I DC_42A_n257A DC_42A_n257G DC_42A_n257H DC_42A_n257I DC_42C_n257A DC_42C_n257G DC_42C_n257H DC_42C_n257I

EN-DC configuration	Uplink EN-DC configuration (NOTE 1)
DC_1A-41A-42A_n257A DC_1A-41A-42A_n257D DC_1A-41A-42A_n257E DC_1A-41A-42A_n257F DC_1A-41A-42A_n257G DC_1A-41A-42A_n257H DC_1A-41A-42A_n257I DC_1A-41A-42A_n257J DC_1A-41A-42A_n257K DC_1A-41A-42A_n257L DC_1A-41A-42A_n257M DC_1A-41A-42C_n257A DC_1A-41A-42C_n257D DC_1A-41A-42C_n257E DC_1A-41A-42C_n257F DC_1A-41A-42C_n257G DC_1A-41A-42C_n257H DC_1A-41A-42C_n257I DC_1A-41A-42C_n257J DC_1A-41A-42C_n257K DC_1A-41A-42C_n257L DC_1A-41A-42C_n257M DC_1A-41C-42A_n257A DC_1A-41C-42A_n257D DC_1A-41C-42A_n257E DC_1A-41C-42A_n257F DC_1A-41C-42A_n257G DC_1A-41C-42A_n257H DC_1A-41C-42A_n257I DC_1A-41C-42A_n257J DC_1A-41C-42A_n257K DC_1A-41C-42A_n257L DC_1A-41C-42A_n257M DC_1A-41C-42C_n257A DC_1A-41C-42C_n257D DC_1A-41C-42C_n257E DC_1A-41C-42C_n257F DC_1A-41C-42C_n257G DC_1A-41C-42C_n257H DC_1A-41C-42C_n257I DC_1A-41C-42C_n257J DC_1A-41C-42C_n257K DC_1A-41C-42C_n257L DC_1A-41C-42C_n257M	DC_1A_n257A DC_1A_n257G DC_1A_n257H DC_1A_n257I DC_41A_n257A DC_41A_n257G DC_41A_n257H DC_41A_n257I DC_41C_n257A DC_41C_n257G DC_41C_n257H DC_41C_n257I DC_42A_n257A DC_42A_n257G DC_42A_n257H DC_42A_n257I DC_42C_n257A DC_42C_n257G DC_42C_n257H DC_42C_n257I
DC_2A-5A-30A_n260A DC_2A-5A-30A_n260G DC_2A-5A-30A_n260H DC_2A-5A-30A_n260I DC_2A-5A-30A_n260J DC_2A-5A-30A_n260K DC_2A-5A-30A_n260L DC_2A-5A-30A_n260M	DC_2A_n260A DC_5A_n260A DC_30A_n260A
DC_2A-2A-5A-30A_n260A	DC_2A_n260A DC_5A_n260A DC_30A_n260A
DC_2A-5A-66A_n260A DC_2A-5A-66A_n260G DC_2A-5A-66A_n260H DC_2A-5A-66A_n260I DC_2A-5A-66A_n260J DC_2A-5A-66A_n260K DC_2A-5A-66A_n260L DC_2A-5A-66A_n260M	DC_2A_n260A DC_5A_n260A DC_66A_n260A



EN-DC configuration	Uplink EN-DC configuration (NOTE 1)
DC_2A-2A-5A-66A_n260A DC_2A-5A-66A-66A_n260A	DC_2A_n260A DC_5A_n260A DC_66A_n260A
DC_2A-12A-30A_n260A DC_2A-12A-30A_n260G DC_2A-12A-30A_n260H DC_2A-12A-30A_n260I DC_2A-12A-30A_n260J DC_2A-12A-30A_n260K DC_2A-12A-30A_n260L DC_2A-12A-30A_n260M	DC_2A_n260A DC_12A_n260A DC_30A_n260A
DC_2A-2A-12A-30A_n260A	DC_2A_n260A DC_12A_n260A DC_30A_n260A
DC_2A-12A-66A_n260A DC_2A-12A-66A_n260G DC_2A-12A-66A_n260H DC_2A-12A-66A_n260I DC_2A-12A-66A_n260J DC_2A-12A-66A_n260K DC_2A-12A-66A_n260L DC_2A-12A-66A_n260M	DC_2A_n260A DC_12A_n260A DC_66A_n260A
DC_2A-2A-12A-66A_n260A DC_2A-12A-66A-66A_n260A	DC_2A_n260A DC_12A_n260A DC_66A_n260A
DC_2A-13A-66A_n260A DC_2A-13A-66A_n260G DC_2A-13A-66A_n260H DC_2A-13A-66A_n260I DC_2A-13A-66A_n260J DC_2A-13A-66A_n260K DC_2A-13A-66A_n260L DC_2A-13A-66A_n260M	DC_2A_n260A DC_2A_n260G DC_2A_n260H DC_2A_n260I DC_2A_n260J DC_2A_n260K DC_2A_n260L DC_2A_n260M DC_13A_n260A DC_13A_n260G DC_13A_n260H DC_13A_n260I DC_13A_n260J DC_13A_n260K DC_13A_n260L DC_13A_n260M DC_66A_n260A DC_66A_n260G DC_66A_n260H DC_66A_n260I DC_66A_n260J DC_66A_n260K DC_66A_n260L DC_66A_n260M
DC_2A-13A-66A_n260(A-G) DC_2A-13A-66A_n260(A-H) DC_2A-13A-66A_n260(A-2G) DC_2A-13A-66A_n260(2A) DC_2A-13A-66A_n260(2A-G) DC_2A-13A-66A_n260(2A-2G) DC_2A-13A-66A_n260(3A) DC_2A-13A-66A_n260(3A-G) DC_2A-13A-66A_n260(4A) DC_2A-13A-66A_n260(5A) DC_2A-13A-66A_n260(6A) DC_2A-13A-66A_n260(G-H) DC_2A-13A-66A_n260(2G) DC_2A-13A-66A_n260(2H)	DC_2A_n260A DC_2A_n260G DC_2A_n260H DC_13A_n260A DC_13A_n260G DC_13A_n260H DC_66A_n260A DC_66A_n260G DC_66A_n260H

EN-DC configuration	Uplink EN-DC configuration (NOTE 1)
<p>DC_2A-13A-66A_n261A                      DC_2A-13A-66A_n261G                      DC_2A-13A-66A_n261H                      DC_2A-13A-66A_n261I                      DC_2A-13A-66A_n261J                      DC_2A-13A-66A_n261K                      DC_2A-13A-66A_n261L                      DC_2A-13A-66A_n261M</p>	<p>DC_2A_n261A                      DC_2A_n261G                      DC_2A_n261H                      DC_2A_n261I                      DC_2A_n261J                      DC_2A_n261K                      DC_2A_n261L                      DC_2A_n261M                      DC_13A_n261A                      DC_13A_n261G                      DC_13A_n261H                      DC_13A_n261I                      DC_13A_n261J                      DC_13A_n261K                      DC_13A_n261L                      DC_13A_n261M                      DC_66A_n261A                      DC_66A_n261G                      DC_66A_n261H                      DC_66A_n261I                      DC_66A_n261J                      DC_66A_n261K                      DC_66A_n261L                      DC_66A_n261M</p>
<p>DC_2A-13A-66A_n261(A-G)                      DC_2A-13A-66A_n261(A-G-H)                      DC_2A-13A-66A_n261(A-G-I)                      DC_2A-13A-66A_n261(A-2G)                      DC_2A-13A-66A_n261(A-H)                      DC_2A-13A-66A_n261(A-I)                      DC_2A-13A-66A_n261(A-J)                      DC_2A-13A-66A_n261(A-K)                      DC_2A-13A-66A_n261(2A)                      DC_2A-13A-66A_n261(2A-G)                      DC_2A-13A-66A_n261(2A-H)                      DC_2A-13A-66A_n261(2A-I)                      DC_2A-13A-66A_n261(3A)                      DC_2A-13A-66A_n261(3A-G)                      DC_2A-13A-66A_n261(4A)                      DC_2A-13A-66A_n261(G-H)                      DC_2A-13A-66A_n261(G-I)                      DC_2A-13A-66A_n261(G-J)                      DC_2A-13A-66A_n261(2G)                      DC_2A-13A-66A_n261(H-I)                      DC_2A-13A-66A_n261(2H)</p>	<p>DC_2A_n261A                      DC_2A_n261G                      DC_2A_n261H                      DC_2A_n261I                      DC_2A_n261J                      DC_2A_n261K                      DC_13A_n261A                      DC_13A_n261G                      DC_13A_n261H                      DC_13A_n261I                      DC_13A_n261J                      DC_13A_n261K                      DC_66A_n261A                      DC_66A_n261G                      DC_66A_n261H                      DC_66A_n261I                      DC_66A_n261J                      DC_66A_n261K</p>

EN-DC configuration	Uplink EN-DC configuration (NOTE 1)
<p>DC_2A-14A-30A_n260A                      DC_2A-14A-30A_n260G                      DC_2A-14A-30A_n260H                      DC_2A-14A-30A_n260I                      DC_2A-14A-30A_n260J                      DC_2A-14A-30A_n260K                      DC_2A-14A-30A_n260L                      DC_2A-14A-30A_n260M</p>	<p>DC_2A_n260A                      DC_2A_n260G                      DC_2A_n260H                      DC_2A_n260I                      DC_2A_n260J                      DC_2A_n260K                      DC_2A_n260L                      DC_2A_n260M                      DC_14A_n260A                      DC_14A_n260G                      DC_14A_n260H                      DC_14A_n260I                      DC_14A_n260J                      DC_14A_n260K                      DC_14A_n260L                      DC_14A_n260M                      DC_30A_n260A                      DC_30A_n260G                      DC_30A_n260H                      DC_30A_n260I                      DC_30A_n260J                      DC_30A_n260K                      DC_30A_n260L                      DC_30A_n260M</p>
<p>DC_2A-14A-66A_n260A                      DC_2A-14A-66A_n260G                      DC_2A-14A-66A_n260H                      DC_2A-14A-66A_n260I                      DC_2A-14A-66A_n260J                      DC_2A-14A-66A_n260K                      DC_2A-14A-66A_n260L                      DC_2A-14A-66A_n260M</p>	<p>DC_2A_n260A                      DC_2A_n260G                      DC_2A_n260H                      DC_2A_n260I                      DC_2A_n260J                      DC_2A_n260K                      DC_2A_n260L                      DC_2A_n260M                      DC_14A_n260A                      DC_14A_n260G                      DC_14A_n260H                      DC_14A_n260I                      DC_14A_n260J                      DC_14A_n260K                      DC_14A_n260L                      DC_14A_n260M                      DC_66A_n260A                      DC_66A_n260G                      DC_66A_n260H                      DC_66A_n260I                      DC_66A_n260J                      DC_66A_n260K                      DC_66A_n260L                      DC_66A_n260M</p>

EN-DC configuration	Uplink EN-DC configuration (NOTE 1)
<p>DC_2A-2A-14A-66A_n260A                      DC_2A-2A-14A-66A_n260G                      DC_2A-2A-14A-66A_n260H                      DC_2A-2A-14A-66A_n260I                      DC_2A-2A-14A-66A_n260J                      DC_2A-2A-14A-66A_n260K                      DC_2A-2A-14A-66A_n260L                      DC_2A-2A-14A-66A_n260M</p>	<p>DC_2A_n260A                      DC_2A_n260G                      DC_2A_n260H                      DC_2A_n260I                      DC_2A_n260J                      DC_2A_n260K                      DC_2A_n260L                      DC_2A_n260M                      DC_14A_n260A                      DC_14A_n260G                      DC_14A_n260H                      DC_14A_n260I                      DC_14A_n260J                      DC_14A_n260K                      DC_14A_n260L                      DC_14A_n260M                      DC_66A_n260A                      DC_66A_n260G                      DC_66A_n260H                      DC_66A_n260I                      DC_66A_n260J                      DC_66A_n260K                      DC_66A_n260L                      DC_66A_n260M</p>
<p>DC_2A-14A-66A-66A_n260A                      DC_2A-14A-66A-66A_n260G                      DC_2A-14A-66A-66A_n260H                      DC_2A-14A-66A-66A_n260I                      DC_2A-14A-66A-66A_n260J                      DC_2A-14A-66A-66A_n260K                      DC_2A-14A-66A-66A_n260L                      DC_2A-14A-66A-66A_n260M</p>	<p>DC_2A_n260A                      DC_2A_n260G                      DC_2A_n260H                      DC_2A_n260I                      DC_2A_n260J                      DC_2A_n260K                      DC_2A_n260L                      DC_2A_n260M                      DC_14A_n260A                      DC_14A_n260G                      DC_14A_n260H                      DC_14A_n260I                      DC_14A_n260J                      DC_14A_n260K                      DC_14A_n260L                      DC_14A_n260M                      DC_66A_n260A                      DC_66A_n260G                      DC_66A_n260H                      DC_66A_n260I                      DC_66A_n260J                      DC_66A_n260K                      DC_66A_n260L                      DC_66A_n260M</p>
<p>DC_2A-29A-30A_n260A                      DC_2A-29A-30A_n260G                      DC_2A-29A-30A_n260H                      DC_2A-29A-30A_n260I                      DC_2A-29A-30A_n260J                      DC_2A-29A-30A_n260K                      DC_2A-29A-30A_n260L                      DC_2A-29A-30A_n260M</p>	<p>DC_2A_n260A                      DC_30A_n260A</p>
<p>DC_2A-2A-29A-30A_n260A</p>	<p>DC_2A_n260A                      DC_30A_n260A</p>

EN-DC configuration	Uplink EN-DC configuration (NOTE 1)
DC_2A-30A-66A_n260A DC_2A-30A-66A_n260G DC_2A-30A-66A_n260H DC_2A-30A-66A_n260I DC_2A-30A-66A_n260J DC_2A-30A-66A_n260K DC_2A-30A-66A_n260L DC_2A-30A-66A_n260M	DC_2A_n260A DC_30A_n260A DC_66A_n260A
DC_2A-30A-66A-66A_n260A	DC_2A_n260A DC_30A_n260A DC_66A_n260A
DC_2A-46A-66A_n261A DC_2A-46C-66A_n261A DC_2A-46D-66A_n261A	DC_2A_n261A DC_66A_n261A
DC_2A-46A-66A_n261(2A) DC_2A-46C-66A_n261(2A) DC_2A-46D-66A_n261(2A)	DC_2A_n261A DC_66A_n261A
DC_3A-5A-7A_n257A <sup>2</sup> DC_3A-5A-7A_n257D DC_3A-5A-7A_n257E DC_3A-5A-7A_n257F DC_3A-5A-7A_n257G DC_3A-5A-7A_n257H DC_3A-5A-7A_n257I DC_3A-5A-7A_n257J DC_3A-5A-7A_n257K DC_3A-5A-7A_n257L DC_3A-5A-7A_n257M	DC_3A_n257A DC_5A_n257A DC_7A_n257A
DC_3A-5A-7A-7A_n257A <sup>2</sup> DC_3A-5A-7A-7A_n257D DC_3A-5A-7A-7A_n257E DC_3A-5A-7A-7A_n257F DC_3A-5A-7A-7A_n257G DC_3A-5A-7A-7A_n257H DC_3A-5A-7A-7A_n257I DC_3A-5A-7A-7A_n257J DC_3A-5A-7A-7A_n257K DC_3A-5A-7A-7A_n257L DC_3A-5A-7A-7A_n257M	DC_3A_n257A DC_5A_n257A DC_7A_n257A
DC_3A-18A-42A_n257A DC_3A-18A-42A_n257D DC_3A-18A-42A_n257E DC_3A-18A-42A_n257F DC_3A-18A-42A_n257G DC_3A-18A-42A_n257H DC_3A-18A-42A_n257I DC_3A-18A-42A_n257J DC_3A-18A-42A_n257K DC_3A-18A-42A_n257L DC_3A-18A-42A_n257M DC_3A-18A-42C_n257A DC_3A-18A-42C_n257D DC_3A-18A-42C_n257E DC_3A-18A-42C_n257F DC_3A-18A-42C_n257G DC_3A-18A-42C_n257H DC_3A-18A-42C_n257I DC_3A-18A-42C_n257J DC_3A-18A-42C_n257K DC_3A-18A-42C_n257L DC_3A-18A-42C_n257M	DC_3A_n257A DC_3A_n257G DC_3A_n257H DC_3A_n257I DC_18A_n257A DC_18A_n257G DC_18A_n257H DC_18A_n257I DC_42A_n257A DC_42A_n257G DC_42A_n257H DC_42A_n257I DC_42C_n257A DC_42C_n257G DC_42C_n257H DC_42C_n257I
DC_3A-19A-21A_n257A <sup>2</sup>	DC_3A_n257A DC_19A_n257A DC_21A_n257A

EN-DC configuration	Uplink EN-DC configuration (NOTE 1)
DC_3A-19A-42A_n257A DC_3A-19A-42A_n257D DC_3A-19A-42A_n257E DC_3A-19A-42A_n257F DC_3A-19A-42A_n257G DC_3A-19A-42A_n257H DC_3A-19A-42A_n257I DC_3A-19A-42C_n257A DC_3A-19A-42C_n257D DC_3A-19A-42C_n257E DC_3A-19A-42C_n257F DC_3A-19A-42C_n257G DC_3A-19A-42C_n257H DC_3A-19A-42C_n257I DC_3A-19A-42D_n257A DC_3A-19A-42D_n257D DC_3A-19A-42D_n257E DC_3A-19A-42D_n257F	DC_3A_n257A DC_3A_n257D DC_3A_n257G DC_3A_n257H DC_3A_n257I DC_19A_n257A DC_19A_n257D DC_19A_n257G DC_19A_n257H DC_19A_n257I DC_42A_n257A DC_42A_n257D DC_42A_n257G DC_42A_n257H DC_42A_n257I
DC_3A-21A-42A_n257A DC_3A-21A-42A_n257D DC_3A-21A-42A_n257E DC_3A-21A-42A_n257F DC_3A-21A-42A_n257G DC_3A-21A-42A_n257H DC_3A-21A-42A_n257I DC_3A-21A-42C_n257A DC_3A-21A-42C_n257D DC_3A-21A-42C_n257E DC_3A-21A-42C_n257F DC_3A-21A-42C_n257G DC_3A-21A-42C_n257H DC_3A-21A-42C_n257I DC_3A-21A-42D_n257A DC_3A-21A-42D_n257D DC_3A-21A-42D_n257E DC_3A-21A-42D_n257F	DC_3A_n257A DC_3A_n257D DC_3A_n257G DC_3A_n257H DC_3A_n257I DC_21A_n257A DC_21A_n257D DC_21A_n257G DC_21A_n257H DC_21A_n257I DC_42A_n257A DC_42A_n257D DC_42A_n257G DC_42A_n257H DC_42A_n257I
DC_3A-28A-41A_n257A DC_3A-28A-41A_n257G DC_3A-28A-41A_n257H DC_3A-28A-41A_n257I DC_3A-28A-41C_n257A DC_3A-28A-41C_n257G DC_3A-28A-41C_n257H DC_3A-28A-41C_n257I	DC_3A_n257A DC_3A_n257G DC_3A_n257H DC_3A_n257I DC_28A_n257A DC_28A_n257G DC_28A_n257H DC_28A_n257I DC_41A_n257A DC_41A_n257G DC_41A_n257H DC_41A_n257I DC_41C_n257A DC_41C_n257G DC_41C_n257H DC_41C_n257I

EN-DC configuration	Uplink EN-DC configuration (NOTE 1)
<p>DC_3A-28A-42A_n257A                      DC_3A-28A-42A_n257D                      DC_3A-28A-42A_n257G                      DC_3A-28A-42A_n257H                      DC_3A-28A-42A_n257I                      DC_3A-28A-42C_n257A                      DC_3A-28A-42C_n257D                      DC_3A-28A-42C_n257G                      DC_3A-28A-42C_n257H                      DC_3A-28A-42C_n257I</p>	<p>DC_3A_n257A                      DC_3A_n257G                      DC_3A_n257H                      DC_3A_n257I                      DC_28A_n257A                      DC_28A_n257G                      DC_28A_n257H                      DC_28A_n257I                      DC_42A_n257A                      DC_42A_n257G                      DC_42A_n257H                      DC_42A_n257I                      DC_42C_n257A                      DC_42C_n257G                      DC_42C_n257H                      DC_42C_n257I</p>
<p>DC_3A-41A-42A_n257A                      DC_3A-41A-42A_n257D                      DC_3A-41A-42A_n257E                      DC_3A-41A-42A_n257F                      DC_3A-41A-42A_n257G                      DC_3A-41A-42A_n257H                      DC_3A-41A-42A_n257I                      DC_3A-41A-42A_n257J                      DC_3A-41A-42A_n257K                      DC_3A-41A-42A_n257L                      DC_3A-41A-42A_n257M                      DC_3A-41A-42C_n257A                      DC_3A-41A-42C_n257D                      DC_3A-41A-42C_n257E                      DC_3A-41A-42C_n257F                      DC_3A-41A-42C_n257G                      DC_3A-41A-42C_n257H                      DC_3A-41A-42C_n257I                      DC_3A-41A-42C_n257J                      DC_3A-41A-42C_n257K                      DC_3A-41A-42C_n257L                      DC_3A-41A-42C_n257M                      DC_3A-41C-42A_n257A                      DC_3A-41C-42A_n257D                      DC_3A-41C-42A_n257E                      DC_3A-41C-42A_n257F                      DC_3A-41C-42A_n257G                      DC_3A-41C-42A_n257H                      DC_3A-41C-42A_n257I                      DC_3A-41C-42A_n257J                      DC_3A-41C-42A_n257K                      DC_3A-41C-42A_n257L                      DC_3A-41C-42A_n257M                      DC_3A-41C-42C_n257A                      DC_3A-41C-42C_n257D                      DC_3A-41C-42C_n257E                      DC_3A-41C-42C_n257F                      DC_3A-41C-42C_n257G                      DC_3A-41C-42C_n257H                      DC_3A-41C-42C_n257I                      DC_3A-41C-42C_n257J                      DC_3A-41C-42C_n257K                      DC_3A-41C-42C_n257L                      DC_3A-41C-42C_n257M</p>	<p>DC_3A_n257A                      DC_3A_n257G                      DC_3A_n257H                      DC_3A_n257I                      DC_41A_n257A                      DC_41A_n257G                      DC_41A_n257H                      DC_41A_n257I                      DC_41C_n257A                      DC_41C_n257G                      DC_41C_n257H                      DC_41C_n257I                      DC_42A_n257A                      DC_42A_n257G                      DC_42A_n257H                      DC_42A_n257I                      DC_42C_n257A                      DC_42C_n257G                      DC_42C_n257H                      DC_42C_n257I</p>

EN-DC configuration	Uplink EN-DC configuration (NOTE 1)
DC_5A-30A-66A_n260A DC_5A-30A-66A_n260G DC_5A-30A-66A_n260H DC_5A-30A-66A_n260I DC_5A-30A-66A_n260J DC_5A-30A-66A_n260K DC_5A-30A-66A_n260L DC_5A-30A-66A_n260M	DC_5A_n260A DC_30A_n260A DC_66A_n260A
DC_5A-30A-66A-66A_n260A	DC_5A_n260A DC_30A_n260A DC_66A_n260A
DC_12A-30A-66A_n260A DC_12A-30A-66A_n260G DC_12A-30A-66A_n260H DC_12A-30A-66A_n260I DC_12A-30A-66A_n260J DC_12A-30A-66A_n260K DC_12A-30A-66A_n260L DC_12A-30A-66A_n260M	DC_12A_n260A DC_30A_n260A DC_66A_n260A
DC_12A-30A-66A-66A_n260A	DC_12A_n260A DC_30A_n260A DC_66A_n260A
DC_14A-30A-66A_n260A DC_14A-30A-66A_n260G DC_14A-30A-66A_n260H DC_14A-30A-66A_n260I DC_14A-30A-66A_n260J DC_14A-30A-66A_n260K DC_14A-30A-66A_n260L DC_14A-30A-66A_n260M	DC_14A_n260A DC_14A_n260G DC_14A_n260H DC_14A_n260I DC_14A_n260J DC_14A_n260K DC_14A_n260L DC_14A_n260M DC_30A_n260A DC_30A_n260G DC_30A_n260H DC_30A_n260I DC_30A_n260J DC_30A_n260K DC_30A_n260L DC_30A_n260M DC_66A_n260A DC_66A_n260G DC_66A_n260H DC_66A_n260I DC_66A_n260J DC_66A_n260K DC_66A_n260L DC_66A_n260M



EN-DC configuration	Uplink EN-DC configuration (NOTE 1)
DC_14A-30A-66A-66A_n260A DC_14A-30A-66A-66A_n260G DC_14A-30A-66A-66A_n260H DC_14A-30A-66A-66A_n260I DC_14A-30A-66A-66A_n260J DC_14A-30A-66A-66A_n260K DC_14A-30A-66A-66A_n260L DC_14A-30A-66A-66A_n260M	DC_14A_n260A DC_14A_n260G DC_14A_n260H DC_14A_n260I DC_14A_n260J DC_14A_n260K DC_14A_n260L DC_14A_n260M DC_30A_n260A DC_30A_n260G DC_30A_n260H DC_30A_n260I DC_30A_n260J DC_30A_n260K DC_30A_n260L DC_30A_n260M DC_66A_n260A DC_66A_n260G DC_66A_n260H DC_66A_n260I DC_66A_n260J DC_66A_n260K DC_66A_n260L DC_66A_n260M
DC_19A-21A-42A_n257A <sup>2</sup> DC_19A-21A-42A_n257D <sup>2</sup> DC_19A-21A-42A_n257E <sup>2</sup> DC_19A-21A-42A_n257F <sup>2</sup> DC_19A-21A-42A_n257G <sup>2</sup> DC_19A-21A-42A_n257H <sup>2</sup> DC_19A-21A-42A_n257I <sup>2</sup> DC_19A-21A-42C_n257A <sup>2</sup> DC_19A-21A-42C_n257D <sup>2</sup> DC_19A-21A-42C_n257E <sup>2</sup> DC_19A-21A-42C_n257F <sup>2</sup> DC_19A-21A-42C_n257G <sup>2</sup> DC_19A-21A-42C_n257H <sup>2</sup> DC_19A-21A-42C_n257I <sup>2</sup>	DC_19A_n257A DC_19A_n257D DC_19A_n257G DC_19A_n257H DC_19A_n257I DC_21A_n257A DC_21A_n257D DC_21A_n257G DC_21A_n257H DC_21A_n257I DC_42A_n257A DC_42A_n257D DC_42A_n257G DC_42A_n257H DC_42A_n257I
DC_21A-28A-42A_n257A <sup>2</sup> DC_21A-28A-42C_n257A <sup>2</sup>	DC_21A_n257A DC_28A_n257A DC_42A_n257A
DC_28A-41A-42A_n257A DC_28A-41A-42A_n257G DC_28A-41A-42A_n257H DC_28A-41A-42A_n257I DC_28A-41C-42A_n257A DC_28A-41C-42A_n257G DC_28A-41C-42A_n257H DC_28A-41C-42A_n257I DC_28A-41A-42C_n257A DC_28A-41A-42C_n257G DC_28A-41A-42C_n257H DC_28A-41A-42C_n257I DC_28A-41C-42C_n257A DC_28A-41C-42C_n257G DC_28A-41C-42C_n257H DC_28A-41C-42C_n257I	DC_28A_n257A DC_28A_n257G DC_28A_n257H DC_28A_n257I DC_41A_n257A DC_41A_n257G DC_41A_n257H DC_41A_n257I DC_41C_n257A DC_41C_n257G DC_41C_n257H DC_41C_n257I DC_42A_n257A DC_42A_n257G DC_42A_n257H DC_42A_n257I DC_42C_n257A DC_42C_n257G DC_42C_n257H DC_42C_n257I

NOTE 1: Uplink EN-DC configurations are the configurations supported by the present release of specifications.

NOTE 2: Applicable for UE supporting inter-band EN-DC with mandatory simultaneous Rx/Tx capability

5.5B.5.4 Inter-band EN-DC configurations including FR2 (five bands)

**Table 5.5B.5.4-1: Inter-band EN-DC configurations including FR2 (five bands)**

EN-DC configuration	Uplink EN-DC configuration (NOTE 1)
DC_1A-3A-5A-7A_n257A DC_1A-3A-5A-7A_n257D DC_1A-3A-5A-7A_n257E DC_1A-3A-5A-7A_n257F DC_1A-3A-5A-7A_n257G DC_1A-3A-5A-7A_n257H DC_1A-3A-5A-7A_n257I DC_1A-3A-5A-7A_n257J DC_1A-3A-5A-7A_n257K DC_1A-3A-5A-7A_n257L DC_1A-3A-5A-7A_n257M	DC_1A_n257A DC_3A_n257A DC_5A_n257A DC_7A_n257A
DC_1A-3A-5A-7A-7A_n257A <sup>2</sup> DC_1A-3A-5A-7A-7A_n257D DC_1A-3A-5A-7A-7A_n257E DC_1A-3A-5A-7A-7A_n257F DC_1A-3A-5A-7A-7A_n257G DC_1A-3A-5A-7A-7A_n257H DC_1A-3A-5A-7A-7A_n257I DC_1A-3A-5A-7A-7A_n257J DC_1A-3A-5A-7A-7A_n257K DC_1A-3A-5A-7A-7A_n257L DC_1A-3A-5A-7A-7A_n257M	DC_1A_n257A DC_3A_n257A DC_5A_n257A DC_7A_n257A
DC_1A-3A-18A-42A_n257A DC_1A-3A-18A-42A_n257D DC_1A-3A-18A-42A_n257E DC_1A-3A-18A-42A_n257F DC_1A-3A-18A-42A_n257G DC_1A-3A-18A-42A_n257H DC_1A-3A-18A-42A_n257I DC_1A-3A-18A-42A_n257J DC_1A-3A-18A-42A_n257K DC_1A-3A-18A-42A_n257L DC_1A-3A-18A-42A_n257M DC_1A-3A-18A-42C_n257A DC_1A-3A-18A-42C_n257D DC_1A-3A-18A-42C_n257E DC_1A-3A-18A-42C_n257F DC_1A-3A-18A-42C_n257G DC_1A-3A-18A-42C_n257H DC_1A-3A-18A-42C_n257I DC_1A-3A-18A-42C_n257J DC_1A-3A-18A-42C_n257K DC_1A-3A-18A-42C_n257L DC_1A-3A-18A-42C_n257M	DC_1A_n257A DC_1A_n257G DC_1A_n257H DC_1A_n257I DC_3A_n257A DC_3A_n257G DC_3A_n257H DC_3A_n257I DC_18A_n257A DC_18A_n257G DC_18A_n257H DC_18A_n257I DC_42A_n257A DC_42A_n257G DC_42A_n257H DC_42A_n257I DC_42C_n257A DC_42C_n257G DC_42C_n257H DC_42C_n257I
DC_1A-3A-19A-21A_n257A <sup>2</sup> DC_1A-3A-19A-21A_n257D <sup>2</sup> DC_1A-3A-19A-21A_n257E <sup>2</sup> DC_1A-3A-19A-21A_n257F <sup>2</sup>	DC_1A_n257A DC_3A_n257A DC_19A_n257A DC_21A_n257A

EN-DC configuration	Uplink EN-DC configuration (NOTE 1)
DC_1A-3A-19A-42A_n257A DC_1A-3A-19A-42A_n257D DC_1A-3A-19A-42A_n257E DC_1A-3A-19A-42A_n257F DC_1A-3A-19A-42A_n257G DC_1A-3A-19A-42A_n257H DC_1A-3A-19A-42A_n257I DC_1A-3A-19A-42A_n257J DC_1A-3A-19A-42A_n257K DC_1A-3A-19A-42A_n257L DC_1A-3A-19A-42A_n257M DC_1A-3A-19A-42C_n257A DC_1A-3A-19A-42C_n257D DC_1A-3A-19A-42C_n257E DC_1A-3A-19A-42C_n257F DC_1A-3A-19A-42C_n257G DC_1A-3A-19A-42C_n257H DC_1A-3A-19A-42C_n257I DC_1A-3A-19A-42C_n257J DC_1A-3A-19A-42C_n257K DC_1A-3A-19A-42C_n257L DC_1A-3A-19A-42C_n257M	DC_1A_n257A DC_1A_n257G DC_1A_n257H DC_1A_n257I DC_3A_n257A DC_3A_n257G DC_3A_n257H DC_3A_n257I DC_3A_n257J DC_3A_n257K DC_3A_n257L DC_3A_n257M DC_19A_n257A DC_19A_n257G DC_19A_n257H DC_19A_n257I DC_42A_n257A DC_42A_n257G DC_42A_n257H DC_42A_n257I
DC_1A-3A-21A-42A_n257A DC_1A-3A-21A-42A_n257G DC_1A-3A-21A-42A_n257H DC_1A-3A-21A-42A_n257I DC_1A-3A-21A-42A_n257J DC_1A-3A-21A-42A_n257K DC_1A-3A-21A-42A_n257L DC_1A-3A-21A-42A_n257M DC_1A-3A-21A-42C_n257A DC_1A-3A-21A-42C_n257D DC_1A-3A-21A-42C_n257E DC_1A-3A-21A-42C_n257F DC_1A-3A-21A-42C_n257G DC_1A-3A-21A-42C_n257H DC_1A-3A-21A-42C_n257I DC_1A-3A-21A-42C_n257J DC_1A-3A-21A-42C_n257K DC_1A-3A-21A-42C_n257L DC_1A-3A-21A-42C_n257M	DC_1A_n257A DC_1A_n257G DC_1A_n257H DC_1A_n257I DC_3A_n257A DC_3A_n257G DC_3A_n257H DC_3A_n257I DC_3A_n257J DC_3A_n257K DC_3A_n257L DC_3A_n257M DC_21A_n257A DC_21A_n257G DC_21A_n257H DC_21A_n257I DC_42A_n257A DC_42A_n257G DC_42A_n257H DC_42A_n257I
DC_1A-3A-28A-42A_n257A DC_1A-3A-28A-42A_n257G DC_1A-3A-28A-42A_n257H DC_1A-3A-28A-42A_n257I DC_1A-3A-28A-42A_n257J DC_1A-3A-28A-42A_n257K DC_1A-3A-28A-42A_n257L DC_1A-3A-28A-42A_n257M DC_1A-3A-28A-42C_n257A DC_1A-3A-28A-42C_n257G DC_1A-3A-28A-42C_n257H DC_1A-3A-28A-42C_n257I DC_1A-3A-28A-42C_n257J DC_1A-3A-28A-42C_n257K DC_1A-3A-28A-42C_n257L DC_1A-3A-28A-42C_n257M	DC_1A_n257A DC_1A_n257G DC_1A_n257H DC_1A_n257I DC_3A_n257A DC_3A_n257G DC_3A_n257H DC_3A_n257I DC_3A_n257J DC_3A_n257K DC_3A_n257L DC_3A_n257M DC_28A_n257A DC_28A_n257G DC_28A_n257H DC_28A_n257I DC_42A_n257A DC_42A_n257G DC_42A_n257H DC_42A_n257I DC_42C_n257A DC_42C_n257G DC_42C_n257H DC_42C_n257I

EN-DC configuration	Uplink EN-DC configuration (NOTE 1)
DC_1A-3A-41A-42A_n257A	
DC_1A-3A-41A-42A_n257D	
DC_1A-3A-41A-42A_n257E	
DC_1A-3A-41A-42A_n257F	
DC_1A-3A-41A-42A_n257G	
DC_1A-3A-41A-42A_n257H	
DC_1A-3A-41A-42A_n257I	
DC_1A-3A-41A-42A_n257J	
DC_1A-3A-41A-42A_n257K	
DC_1A-3A-41A-42A_n257L	
DC_1A-3A-41A-42A_n257M	
DC_1A-3A-41A-42C_n257A	DC_1A_n257A
DC_1A-3A-41A-42C_n257D	DC_1A_n257G
DC_1A-3A-41A-42C_n257E	DC_1A_n257H
DC_1A-3A-41A-42C_n257F	DC_1A_n257I
DC_1A-3A-41A-42C_n257G	DC_3A_n257A
DC_1A-3A-41A-42C_n257H	DC_3A_n257G
DC_1A-3A-41A-42C_n257I	DC_3A_n257H
DC_1A-3A-41A-42C_n257J	DC_3A_n257I
DC_1A-3A-41A-42C_n257K	DC_41A_n257A
DC_1A-3A-41A-42C_n257L	DC_41A_n257G
DC_1A-3A-41A-42C_n257M	DC_41A_n257H
DC_1A-3A-41C-42A_n257A	DC_41A_n257I
DC_1A-3A-41C-42A_n257D	DC_41C_n257A
DC_1A-3A-41C-42A_n257E	DC_41C_n257G
DC_1A-3A-41C-42A_n257F	DC_41C_n257H
DC_1A-3A-41C-42A_n257G	DC_41C_n257I
DC_1A-3A-41C-42A_n257H	DC_42A_n257A
DC_1A-3A-41C-42A_n257I	DC_42A_n257G
DC_1A-3A-41C-42A_n257J	DC_42A_n257H
DC_1A-3A-41C-42A_n257K	DC_42A_n257I
DC_1A-3A-41C-42A_n257L	DC_42C_n257A
DC_1A-3A-41C-42A_n257M	DC_42C_n257G
DC_1A-3A-41C-42C_n257A	DC_42C_n257H
DC_1A-3A-41C-42C_n257D	DC_42C_n257I
DC_1A-3A-41C-42C_n257E	
DC_1A-3A-41C-42C_n257F	
DC_1A-3A-41C-42C_n257G	
DC_1A-3A-41C-42C_n257H	
DC_1A-3A-41C-42C_n257I	
DC_1A-3A-41C-42C_n257J	
DC_1A-3A-41C-42C_n257K	
DC_1A-3A-41C-42C_n257L	
DC_1A-3A-41C-42C_n257M	

EN-DC configuration	Uplink EN-DC configuration (NOTE 1)
DC_1A-19A-21A-42A_n257A DC_1A-19A-21A-42A_n257D DC_1A-19A-21A-42A_n257E DC_1A-19A-21A-42A_n257F DC_1A-19A-21A-42A_n257G DC_1A-19A-21A-42A_n257H DC_1A-19A-21A-42A_n257I DC_1A-19A-21A-42A_n257J DC_1A-19A-21A-42A_n257K DC_1A-19A-21A-42A_n257L DC_1A-19A-21A-42A_n257M DC_1A-19A-21A-42C_n257A DC_1A-19A-21A-42C_n257D DC_1A-19A-21A-42C_n257E DC_1A-19A-21A-42C_n257F DC_1A-19A-21A-42C_n257G DC_1A-19A-21A-42C_n257H DC_1A-19A-21A-42C_n257I DC_1A-19A-21A-42C_n257J DC_1A-19A-21A-42C_n257K DC_1A-19A-21A-42C_n257L DC_1A-19A-21A-42C_n257M	DC_1A_n257A DC_1A_n257G DC_1A_n257H DC_1A_n257I DC_1A_n257J DC_1A_n257K DC_1A_n257L DC_1A_n257M DC_19A_n257A DC_19A_n257G DC_19A_n257H DC_19A_n257I DC_21A_n257A DC_21A_n257G DC_21A_n257H DC_21A_n257I DC_21A_n257J DC_21A_n257K DC_21A_n257L DC_21A_n257M DC_42A_n257A DC_42A_n257G DC_42A_n257H DC_42A_n257I
DC_1A-19A-28A-42C_n257A	DC_1A_n257A DC_19A_n257A DC_28A_n257A DC_42A_n257A
DC_1A-21A-28A-42A_n257A	DC_1A_n257A DC_21A_n257A DC_28A_n257A DC_42A_n257A
DC_2A-5A-30A-66A_n260A	DC_2A_n260A DC_5A_n260A DC_30A_n260A DC_66A_n260A
DC_2A-12A-30A-66A_n260A	DC_2A_n260A DC_12A_n260A DC_30A_n260A DC_66A_n260A

EN-DC configuration	Uplink EN-DC configuration (NOTE 1)
<p>DC_2A-14A-30A-66A_n260A                      DC_2A-14A-30A-66A_n260G                      DC_2A-14A-30A-66A_n260H                      DC_2A-14A-30A-66A_n260I                      DC_2A-14A-30A-66A_n260J                      DC_2A-14A-30A-66A_n260K                      DC_2A-14A-30A-66A_n260L                      DC_2A-14A-30A-66A_n260M</p>	<p>DC_2A_n260A                      DC_2A_n260G                      DC_2A_n260H                      DC_2A_n260I                      DC_2A_n260J                      DC_2A_n260K                      DC_2A_n260L                      DC_2A_n260M                      DC_14A_n260A                      DC_14A_n260G                      DC_14A_n260H                      DC_14A_n260I                      DC_14A_n260J                      DC_14A_n260K                      DC_14A_n260L                      DC_14A_n260M                      DC_30A_n260A                      DC_30A_n260G                      DC_30A_n260H                      DC_30A_n260I                      DC_30A_n260J                      DC_30A_n260K                      DC_30A_n260L                      DC_30A_n260M                      DC_66A_n260A                      DC_66A_n260G                      DC_66A_n260H                      DC_66A_n260I                      DC_66A_n260J                      DC_66A_n260K                      DC_66A_n260L                      DC_66A_n260M</p>
<p>DC_3A-19A-21A-42A_n257A                      DC_3A-19A-21A-42A_n257D                      DC_3A-19A-21A-42A_n257E                      DC_3A-19A-21A-42A_n257F                      DC_3A-19A-21A-42C_n257A                      DC_3A-19A-21A-42C_n257D                      DC_3A-19A-21A-42C_n257E                      DC_3A-19A-21A-42C_n257F</p>	<p>DC_3A_n257A                      DC_19A_n257A                      DC_21A_n257A                      DC_3A_n257D                      DC_19A_n257D                      DC_21A_n257D</p>
<p>DC_3A-28A-41A-42A_n257A                      DC_3A-28A-41A-42A_n257G                      DC_3A-28A-41A-42A_n257H                      DC_3A-28A-41A-42A_n257I                      DC_3A-28A-41A-42C_n257A                      DC_3A-28A-41A-42C_n257G                      DC_3A-28A-41A-42C_n257H                      DC_3A-28A-41A-42C_n257I                      DC_3A-28A-41C-42A_n257A                      DC_3A-28A-41C-42A_n257G                      DC_3A-28A-41C-42A_n257H                      DC_3A-28A-41C-42A_n257I                      DC_3A-28A-41C-42C_n257A                      DC_3A-28A-41C-42C_n257G                      DC_3A-28A-41C-42C_n257H                      DC_3A-28A-41C-42C_n257I</p>	<p>DC_1A_n257A                      DC_1A_n257G                      DC_1A_n257H                      DC_1A_n257I                      DC_3A_n257A                      DC_3A_n257G                      DC_3A_n257H                      DC_3A_n257I                      DC_41A_n257A                      DC_41A_n257G                      DC_41A_n257H                      DC_41A_n257I                      DC_41C_n257A                      DC_41C_n257G                      DC_41C_n257H                      DC_41C_n257I                      DC_42A_n257A                      DC_42A_n257G                      DC_42A_n257H                      DC_42A_n257I                      DC_42C_n257A                      DC_42C_n257G                      DC_42C_n257H                      DC_42C_n257I</p>
<p>NOTE 1: Uplink EN-DC configurations are the configurations supported by the present release of specifications.                      NOTE 2: Applicable for UE supporting inter-band EN-DC with mandatory simultaneous Rx/Tx capability</p>	

5.5B.5.5 Void

5.5B.6 Inter-band EN-DC including FR1 and FR2

5.5B.6.1 Void

5.5B.6.2 Inter-band EN-DC configurations including FR1 and FR2 (three bands)

**Table 5.5B.6.2-1: Inter-band EN-DC configurations including FR1 and FR2 (three bands)**

EN-DC configuration	Uplink EN-DC configuration (NOTE 1)
DC_1A_n3A-n257A DC_1A_n3A-n257G DC_1A_n3A-n257H DC_1A_n3A-n257I	DC_1A_n3A DC_1A_n257A DC_1A_n257G DC_1A_n257H DC_1A_n257I
DC_1A_n28A-n257A DC_1A_n28A-n257G DC_1A_n28A-n257H DC_1A_n28A-n257I	DC_1A_n28A DC_1A_n257A DC_1A_n257G DC_1A_n257H DC_1A_n257I
DC_1A_n77A-n257A DC_1A_n77A-n257D DC_1A_n77A-n257E DC_1A_n77A-n257F DC_1A_n77A-n257G DC_1A_n77A-n257H DC_1A_n77A-n257I DC_1A_n77C-n257A DC_1A_n77C-n257D DC_1A_n77C-n257E DC_1A_n77C-n257F	DC_1A_n77A DC_1A_n257A DC_1A_n257D DC_1A_n257G DC_1A_n257H DC_1A_n257I DC_1A_n77A-n257A DC_1A_n77A-n257G DC_1A_n77A-n257H DC_1A_n77A-n257I
DC_1A_n77(2A)-n257A DC_1A_n77(2A)-n257D DC_1A_n77(2A)-n257G DC_1A_n77(2A)-n257H DC_1A_n77(2A)-n257I	DC_1A_n77A DC_1A_n257A DC_1A_n257D DC_1A_n257G DC_1A_n257H DC_1A_n257I
DC_1A_n77A-n258A	DC_1A_n77A DC_1A_n258A
DC_1A_n78A-n257A DC_1A_n78A-n257D DC_1A_n78A-n257E DC_1A_n78A-n257F DC_1A_n78C-n257A DC_1A_n78C-n257D DC_1A_n78C-n257E DC_1A_n78C-n257F	DC_1A_n78A DC_1A_n257A DC_1A_n257D DC_1A_n78A-n257A
DC_1A_n78A-n257G DC_1A_n78A-n257H DC_1A_n78A-n257I DC_1A_n78A-n257J DC_1A_n78A-n257K DC_1A_n78A-n257L DC_1A_n78A-n257M	DC_1A_n78A DC_1A_n257A DC_1A_n257G DC_1A_n257H DC_1A_n257I DC_1A_n78A-n257A DC_1A_n78A-n257G DC_1A_n78A-n257H DC_1A_n78A-n257I
DC_1A_n78A-n258A	DC_1A_n78A DC_1A_n258A



EN-DC configuration	Uplink EN-DC configuration (NOTE 1)
DC_1A_n79A-n257A DC_1A_n79A-n257D DC_1A_n79A-n257E DC_1A_n79A-n257F DC_1A_n79A-n257G DC_1A_n79A-n257H DC_1A_n79A-n257I DC_1A_n79C-n257A DC_1A_n79C-n257D DC_1A_n79C-n257E DC_1A_n79C-n257F DC_1A_n79A-n257G DC_1A_n79A-n257H DC_1A_n79A-n257I	DC_1A_n79A DC_1A_n257A DC_1A_n257G DC_1A_257H DC_1A_n257I DC_1A_n79A-n257A DC_1A_n79A-n257G DC_1A_n79A-n257H DC_1A_n79A-n257I
DC_1A_n79A-n258A	DC_1A_n79A DC_1A_n258A
DC_2A_n12A-n258A	DC_2A_n258A DC_2A_n12A
DC_2A_n12A-n260A	DC_2A_n260A DC_2A_n12A
DC_2A_n12A-n261A	DC_2A_n261A DC_2A_n12A
DC_2A_n41A-n260A DC_2A_n41A-n260(2A) DC_2A_n41A-n260(3A) DC_2A_n41A-n260(4A)	DC_2A_n41A
DC_2A_n41A-n261A DC_2A_n41A-n261(2A)	DC_2A_n41A
DC_2A_n71A-n261A DC_2A_n71A-n261(2A)	DC_2A_n261A DC_2A_n71A
DC_3A_n1A-n257A	DC_3A_n1A DC_3A_n257A
DC_3A_n40A-n258A	DC_3A_n40A-n258A
DC_3A_n28A-n257A DC_3A_n28A-n257G DC_3A_n28A-n257H DC_3A_n28A-n257I	DC_3A_n28A DC_3A_n257A DC_3A_n257G DC_3A_n257H DC_3A_n257I
DC_3A_n40A-n258A	DC_3A_n40A DC_3A_n258A
DC_3A_n77A-n257A DC_3A_n77A-n257D DC_3A_n77A-n257E DC_3A_n77A-n257F DC_3A_n77A-n257G DC_3A_n77A-n257H DC_3A_n77A-n257I DC_3A_n77C-n257A DC_3A_n77C-n257D DC_3A_n77C-n257E DC_3A_n77C-n257F	DC_3A_n77A DC_3A_n257A DC_3A_n257D DC_3A_n257G DC_3A_n257H DC_3A_n257I DC_3A_n77A-n257A DC_3A_n77A-n257G DC_3A_n77A-n257H DC_3A_n77A-n257I
DC_3A_n77(2A)-n257A DC_3A_n77(2A)-n257D DC_3A_n77(2A)-n257G DC_3A_n77(2A)-n257H DC_3A_n77(2A)-n257I	DC_3A_n77A DC_3A_n257A DC_3A_n257D DC_3A_n257G DC_3A_n257H DC_3A_n257I
DC_3A_n77A-n258A	DC_3A_n79A DC_3A_n258A DC_3A_n79A-n258A

EN-DC configuration	Uplink EN-DC configuration (NOTE 1)
DC_3A_n78A-n257A DC_3A_n78A-n257D DC_3A_n78A-n257E DC_3A_n78A-n257F DC_3A_n78A-n257G DC_3A_n78A-n257H DC_3A_n78A-n257I DC_3A_n78A-n257J DC_3A_n78A-n257K DC_3A_n78A-n257L DC_3A_n78A-n257M DC_3A_n78C-n257A DC_3A_n78C-n257D DC_3A_n78C-n257E DC_3A_n78C-n257F	DC_3A_n78A DC_3A_n257A DC_3A_n257D DC_3A_n257G DC_3A_n257H DC_3A_n257I DC_3A_n78A-n257A DC_3A_n78A-n257G DC_3A_n78A-n257H DC_3A_n78A-n257I
DC_3C_n78A-n257A DC_3C_n78A-n257D DC_3C_n78A-n257E DC_3C_n78A-n257F DC_3C_n78A-n257G DC_3C_n78A-n257H DC_3C_n78A-n257I DC_3C_n78A-n257J DC_3C_n78A-n257K DC_3C_n78A-n257L DC_3C_n78A-n257M	DC_3A_n78A DC_3A_n257A
DC_3A_n78A-n258A	DC_3A_n78A DC_3A_n258A
DC_3A-3A_n78A-n257A DC_3A-3A_n78A-n257D DC_3A-3A_n78A-n257E DC_3A-3A_n78A-n257F DC_3A-3A_n78A-n257G DC_3A-3A_n78A-n257H DC_3A-3A_n78A-n257I DC_3A-3A_n78A-n257J DC_3A-3A_n78A-n257K DC_3A-3A_n78A-n257L DC_3A-3A_n78A-n257M	DC_3A_n78A DC_3A_n257A

EN-DC configuration	Uplink EN-DC configuration (NOTE 1)
DC_3A_n79A-n257A DC_3A_n79A-n257D DC_3A_n79A-n257E DC_3A_n79A-n257F DC_3A_n79A-n257G DC_3A_n79A-n257H DC_3A_n79A-n257I DC_3A_n79C-n257A DC_3A_n79C-n257D DC_3A_n79C-n257E DC_3A_n79C-n257F	DC_3A_n79A DC_3A_n257A DC_3A_n257G DC_3A_n257H DC_3A_n257I DC_3A_n79A-n257A DC_3A_n79A-n257G DC_3A_n79A-n257H DC_3A_n79A-n257I
DC_3A_n79A-n258A DC_3A_n79A-n258D DC_3A_n79A-n258E DC_3A_n79A-n258F DC_3A_n79A-n258G DC_3A_n79A-n258H DC_3A_n79A-n258I DC_3A_n79A-n258J DC_3A_n79A-n258K DC_3A_n79A-n258L	DC_3A_n79A DC_3A_n258A DC_3A_n79A-n258A
DC_5A_n78A-n257A <sup>2</sup> DC_5A_n78A-n257D DC_5A_n78A-n257E DC_5A_n78A-n257F DC_5A_n78A-n257G DC_5A_n78A-n257H DC_5A_n78A-n257I DC_5A_n78A-n257J DC_5A_n78A-n257K DC_5A_n78A-n257L DC_5A_n78A-n257M	DC_5A_n78A DC_5A_n257A
DC_7A_n1A-n257A DC_7A-7A_n1A-n257A	DC_7A_n1A DC_7A_n257A
DC_7A_n78A-n257A DC_7A_n78A-n257D DC_7A_n78A-n257E DC_7A_n78A-n257F DC_7A_n78A-n257G DC_7A_n78A-n257H DC_7A_n78A-n257I DC_7A_n78A-n257J DC_7A_n78A-n257K DC_7A_n78A-n257L DC_7A_n78A-n257M	DC_7A_n78A DC_7A_n257A
DC_7A-7A_n78A-n257A DC_7A-7A_n78A-n257D DC_7A-7A_n78A-n257E DC_7A-7A_n78A-n257F DC_7A-7A_n78A-n257G DC_7A-7A_n78A-n257H DC_7A-7A_n78A-n257I DC_7A-7A_n78A-n257J DC_7A-7A_n78A-n257K DC_7A-7A_n78A-n257L DC_7A-7A_n78A-n257M	DC_7A_n78A DC_7A_n257A DC_7A_n78A-n257A
DC_8A_n77A-n257A DC_8A_n77A-n257D DC_8A_n77A-n257G DC_8A_n77A-n257H DC_8A_n77A-n257I	DC_8A_n77A DC_8A_n257A
DC_8A_n77(2A)-n257A DC_8A_n77(2A)-n257D	DC_8A_n77A DC_8A_n257A

EN-DC configuration	Uplink EN-DC configuration (NOTE 1)
DC_8A_n77(2A)-n257G DC_8A_n77(2A)-n257H DC_8A_n77(2A)-n257I	
DC_11A_n77A-n257A DC_11A_n77A-n257D DC_11A_n77A-n257G DC_11A_n77A-n257H DC_11A_n77A-n257I	DC_11A_n77A DC_11A_n257A
DC_11A_n77(2A)-n257A DC_11A_n77(2A)-n257D DC_11A_n77(2A)-n257G DC_11A_n77(2A)-n257H DC_11A_n77(2A)-n257I	DC_11A_n77A DC_11A_n257A
DC_19A_n77A-n257A DC_19A_n77A-n257D DC_19A_n77A-n257E DC_19A_n77A-n257F DC_19A_n77A-n257G DC_19A_n77A-n257H DC_19A_n77A-n257I DC_19A_n77C-n257A DC_19A_n77C-n257D DC_19A_n77C-n257E DC_19A_n77C-n257F	DC_19A_n77A DC_19A_n257A DC_19A_n257GDC_19A_n257H DC_19A_n257I DC_19A_n77A-n257A DC_19A_n77A-n257G DC_19A_n77A-n257H DC_19A_n77A-n257I
DC_19A_n78A-n257A DC_19A_n78A-n257D DC_19A_n78A-n257E DC_19A_n78A-n257F DC_19A_n78A-n257G DC_19A_n78A-n257H DC_19A_n78A-n257I DC_19A_n78C-n257A DC_19A_n78C-n257D DC_19A_n78C-n257E DC_19A_n78C-n257F	DC_19A_n78A DC_19A_n257A DC_19A_n257G DC_19A_n257H DC_19A_n257I DC_19A_n78A-n257A DC_19A_n78A-n257G DC_19A_n78A-n257H DC_19A_n78A-n257I
DC_19A_n79A-n257A DC_19A_n79A-n257D DC_19A_n79A-n257E DC_19A_n79A-n257F DC_19A_n79A-n257G DC_19A_n79A-n257H DC_19A_n79A-n257I DC_19A_n79C-n257A DC_19A_n79C-n257D DC_19A_n79C-n257E DC_19A_n79C-n257F	DC_19A_n79A DC_19A_n257A DC_19A_n257G DC_19A_n257H DC_19A_n257I DC_19A_n79A-n257A DC_19A_n79A-n257G DC_19A_n79A-n257H DC_19A_n79A-n257I
DC_21A_n77A-n257A DC_21A_n77A-n257G DC_21A_n77A-n257H DC_21A_n77A-n257I	DC_21A_n77A DC_21A_n257A DC_21A_n257G DC_21A_n257H DC_21A_n257I DC_21A_n77A-n257A DC_21A_n77A-n257G DC_21A_n77A-n257H DC_21A_n77A-n257I
DC_8A_n78A-n257A DC_8A_n78A-n257D DC_8A_n78A-n257E DC_8A_n78A-n257F DC_8A_n78A-n257G DC_8A_n78A-n257H DC_8A_n78A-n257I DC_8A_n78A-n257J DC_8A_n78A-n257K DC_8A_n78A-n257L	DC_8A_n78A DC_8A_n257A

EN-DC configuration	Uplink EN-DC configuration (NOTE 1)
DC_8A_n78A-n257M	
DC_18A_n3A-n257A DC_18A_n3A-n257G DC_18A_n3A-n257H DC_18A_n3A-n257I	DC_18A_n3A DC_18A_n257A DC_18A_n257G DC_18A_n257H DC_18A_n257I
DC_18A_n78A-n257A DC_18A_n78A-n257G DC_18A_n78A-n257H DC_18A_n78A-n257I	DC_18A_n78A DC_18A_n257A DC_18A_n257G DC_18A_n257H DC_18A_n257I
DC_21A_n78A-n257A DC_21A_n78A-n257G DC_21A_n78A-n257H DC_21A_n78A-n257I	DC_21A_n78A DC_21A_n257A DC_21A_n257G DC_21A_n257H DC_21A_n257I DC_21A_n78A-n257A DC_21A_n78A-n257G DC_21A_n78A-n257H DC_21A_n78A-n257I
DC_21A_n79A-n257A DC_21A_n79A-n257G DC_21A_n79A-n257H DC_21A_n79A-n257I	DC_21A_n79A DC_21A_n257A DC_21A_n257G DC_21A_n257H DC_21A_n257I DC_21A_n79A-n257A DC_21A_n79A-n257G DC_21A_n79A-n257H DC_21A_n79A-n257I
DC_28A_n3A-n257A DC_28A_n3A-n257G DC_28A_n3A-n257H DC_28A_n3A-n257I	DC_28A_n3A DC_28A_n257A DC_28A_n257G DC_28A_n257H DC_28A_n257I
DC_28A_n77A-n257A DC_28A_n77A-n257D DC_28A_n77A-n257G DC_28A_n77A-n257H DC_28A_n77A-n257I	DC_28A_n77A DC_28A_n257A DC_28A_n257G DC_28A_n257H DC_28A_n257I
DC_28A_n77(2A)-n257A DC_28A_n77(2A)-n257D DC_28A_n77(2A)-n257G DC_28A_n77(2A)-n257H DC_28A_n77(2A)-n257I	DC_28A_n77A DC_28A_n257A DC_28A_n257G DC_28A_n257H DC_28A_n257I
DC_28A_n78A-n257A DC_28A_n78A-n257G DC_28A_n78A-n257H DC_28A_n78A-n257I	DC_28A_n78A DC_28A_n257A DC_28A_n257G DC_28A_n257H DC_28A_n257I
DC_28A_n8A-n258A	DC_28A_n8A DC_28A_n258A
DC_41A_n3A-n257A DC_41A_n3A-n257G DC_41A_n3A-n257H DC_41A_n3A-n257I DC_41C_n3A-n257A DC_41C_n3A-n257G DC_41C_n3A-n257H DC_41C_n3A-n257I	DC_41A_n3A DC_41A_n257A DC_41A_n257G DC_41A_n257H DC_41A_n257I DC_41C_n3A DC_41C_n257A DC_41C_n257G DC_41C_n257H DC_41C_n257I

EN-DC configuration	Uplink EN-DC configuration (NOTE 1)
DC_41A_n28A-n257A DC_41A_n28A-n257G DC_41A_n28A-n257H DC_41A_n28A-n257I DC_41C_n28A-n257A DC_41C_n28A-n257G DC_41C_n28A-n257H DC_41C_n28A-n257I	DC_41A_n28A DC_41A_n257A DC_41A_n257G DC_41A_n257H DC_41A_n257I DC_41C_n28A DC_41C_n257A DC_41C_n257G DC_41C_n257H DC_41C_n257I
DC_41A_n77A-n257A DC_41A_n77A-n257G DC_41A_n77A-n257H DC_41A_n77A-n257I DC_41C_n77A-n257A DC_41C_n77A-n257G DC_41C_n77A-n257H DC_41C_n77A-n257I	DC_41A_n77A DC_41A_n257A DC_41A_n257G DC_41A_n257H DC_41A_n257I DC_41C_n77A DC_41C_n257A DC_41C_n257G DC_41C_n257H DC_41C_n257I
DC_41A_n78A-n257A DC_41A_n78A-n257G DC_41A_n78A-n257H DC_41A_n78A-n257I DC_41C_n78A-n257A DC_41C_n78A-n257G DC_41C_n78A-n257H DC_41C_n78A-n257I	DC_41A_n78A DC_41A_n257A DC_41A_n257G DC_41A_n257H DC_41A_n257I DC_41C_n78A DC_41C_n257A DC_41C_n257G DC_41C_n257H DC_41C_n257I
DC_42A_n77A-n257A DC_42A_n77A-n257G DC_42A_n77A-n257H DC_42A_n77A-n257I DC_42C_n77A-n257A DC_42C_n77A-n257G DC_42C_n77A-n257H DC_42C_n77A-n257I	DC_42A_n257A DC_42A_n257G DC_42A_n257H DC_42A_n257I
DC_42A_n78A-n257A DC_42A_n78A-n257G DC_42A_n78A-n257H DC_42A_n78A-n257I DC_42C_n78A-n257A DC_42C_n78A-n257G DC_42C_n78A-n257H DC_42C_n78A-n257I	DC_42A_n257A DC_42A_n257G DC_42A_n257H DC_42A_n257I DC_42C_n257A DC_42C_n257G DC_42C_n257H DC_42C_n257I
DC_42A_n79A-n257A DC_42A_n79A-n257G DC_42A_n79A-n257H DC_42A_n79A-n257I DC_42C_n79A-n257A DC_42C_n79A-n257G DC_42C_n79A-n257H DC_42C_n79A-n257I	DC_42A_n257A DC_42A_n257G DC_42A_n257H DC_42A_n257I

EN-DC configuration	Uplink EN-DC configuration (NOTE 1)
DC_66A_n5A-n260A DC_66A_n5A-n260G DC_66A_n5A-n260H DC_66A_n5A-n260I DC_66A_n5A-n260J DC_66A_n5A-n260K DC_66A_n5A-n260L DC_66A_n5A-n260M	DC_66A_n5A DC_66A_n260A DC_66A_n5A-n260A
DC_66A_n12A-n258A	DC_66A_n258A DC_66A_n12A
DC_66A_n12A-n260A	DC_66A_n260A DC_66A_n12A
DC_66A_n12A-n261A	DC_66A_n261A DC_66A_n12A
DC_66A_n5A-n260(2A) DC_66A_n5A-n260(3A) DC_66A_n5A-n260(4A) DC_66A_n5A-n260(5A) DC_66A_n5A-n260(6A) DC_66A_n5A-n260(2H) DC_66A_n5A-n260(2G) DC_66A_n5A-n260(A-2G) DC_66A_n5A-n260(A-H) DC_66A_n5A-n260(A-G) DC_66A_n5A-n260(G-H) DC_66A_n5A-n260(2A-G) DC_66A_n5A-n260(2A-2G) DC_66A_n5A-n260(3A-G)	DC_66A_n5A-n260A
DC_66A_n5A-n261A DC_66A_n5A-n261G DC_66A_n5A-n261H DC_66A_n5A-n261I DC_66A_n5A-n261J DC_66A_n5A-n261K DC_66A_n5A-n261L DC_66A_n5A-n261M	DC_66A_n5A-n260A
DC_66A_n5A-n261A DC_66A_n5A-n261G DC_66A_n5A-n261H DC_66A_n5A-n261I DC_66A_n5A-n261J DC_66A_n5A-n261K DC_66A_n5A-n261L DC_66A_n5A-n261M	DC_66A_n5A-n261A
DC_66A_n5A-n261(2A) DC_66A_n5A-n261(3A) DC_66A_n5A-n261(2G) DC_66A_n5A-n261(2H) DC_66A_n5A-n261(A-G) DC_66A_n5A-n261(A-H) DC_66A_n5A-n261(A-I) DC_66A_n5A-n261(A-J) DC_66A_n5A-n261(A-K) DC_66A_n5A-n261(G-H) DC_66A_n5A-n261(G-I) DC_66A_n5A-n261(G-J) DC_66A_n5A-n261(H-I) DC_66A_n5A-n261(A-2G) DC_66A_n5A-n261(A-G-H) DC_66A_n5A-n261(A-G-I) DC_66A_n5A-n261(2A-G) DC_66A_n5A-n261(2A-H) DC_66A_n5A-n261(2A-I) DC_66A_n5A-n261(3A-G)	DC_66A_n5A-n260A

EN-DC configuration	Uplink EN-DC configuration (NOTE 1)
DC_66A_n5A-n261(2A) DC_66A_n5A-n261(3A) DC_66A_n5A-n261(2G) DC_66A_n5A-n261(2H) DC_66A_n5A-n261(A-G) DC_66A_n5A-n261(A-H) DC_66A_n5A-n261(A-I) DC_66A_n5A-n261(A-J) DC_66A_n5A-n261(A-K) DC_66A_n5A-n261(G-H) DC_66A_n5A-n261(G-I) DC_66A_n5A-n261(G-J) DC_66A_n5A-n261(H-I) DC_66A_n5A-n261(A-2G) DC_66A_n5A-n261(A-G-H) DC_66A_n5A-n261(A-G-I) DC_66A_n5A-n261(2A-G) DC_66A_n5A-n261(2A-H) DC_66A_n5A-n261(2A-I) DC_66A_n5A-n261(3A-G)	DC_66A_n5A-n261A
DC_66A_n41A-n260A DC_66A_n41A-n260(2A) DC_66A_n41A-n260(3A) DC_66A_n41A-n260(4A)	DC_66A_n41A
DC_66A_n41A-n261A DC_66A_n41A-n261(2A)	DC_66A_n41A
DC_66A_n71A-n260A DC_66A_n71A-n260(2A)	DC_66A_n71A DC_66A_n260A
DC_66A_n71A-n261A DC_66A_n71A-n261(2A)	DC_66A_n71A DC_66A_n261A
NOTE 1: Uplink EN-DC configurations are the configurations supported by the present release of specifications. NOTE 2: Applicable for UE supporting inter-band EN-DC with mandatory simultaneous Rx/Tx capability	



5.5B.6.3 Inter-band EN-DC configurations including FR1 and FR2 (four bands)

**Table 5.5B.6.3-1: Inter-band EN-DC configurations including FR1 and FR2 (four bands)**

EN-DC configuration	Uplink EN-DC configuration (NOTE 1)
DC_1A-3A_n28A-n257A DC_1A-3A_n28A-n257G DC_1A-3A_n28A-n257H DC_1A-3A_n28A-n257I	DC_1A_n28A DC_1A_n257A DC_1A_n257G DC_1A_n257H DC_1A_n257I DC_3A_n28A DC_3A_n257A DC_3A_n257G DC_3A_n257H DC_3A_n257I
DC_1A-3A_n77A-n257A	DC_1A_n77A DC_3A_n77A DC_1A_n257A DC_3A_n257A
DC_1A-3A_n77A-n257D	DC_1A_n77A DC_3A_n77A DC_1A_n257A DC_1A_n257D DC_3A_n257A DC_3A_n257D
DC_1A-3A_n77A-n257G	DC_1A_n77A DC_3A_n77A DC_1A_n257A DC_1A_n257G DC_3A_n257A DC_3A_n257G DC_1A_n77A-n257A DC_1A_n77A-n257G DC_3A_n77A-n257A DC_3A_n77A-n257G
DC_1A-3A_n77A-n257H	DC_1A_n77A DC_3A_n77A DC_1A_n257A DC_1A_n257G DC_1A_n257H DC_3A_n257A DC_3A_n257G DC_3A_n257H DC_1A_n77A-n257A DC_1A_n77A-n257G DC_1A_n77A-n257H DC_3A_n77A-n257A DC_3A_n77A-n257G DC_3A_n77A-n257H
DC_1A-3A_n77A-n257I	DC_1A_n77A DC_3A_n77A DC_1A_n257A DC_1A_n257G DC_1A_n257H DC_1A_n257I DC_3A_n257A DC_3A_n257G DC_3A_n257H DC_3A_n257I DC_1A_n77A-n257A DC_1A_n77A-n257G DC_1A_n77A-n257H DC_1A_n77A-n257I DC_3A_n77A-n257A DC_3A_n77A-n257G DC_3A_n77A-n257H DC_3A_n77A-n257I

EN-DC configuration	Uplink EN-DC configuration (NOTE 1)
DC_1A-3A_n78A-n257A DC_1A-3A_n78A-n257D DC_1A-3A_n78A-n257E DC_1A-3A_n78A-n257F DC_1A-3A_n78A-n257G DC_1A-3A_n78A-n257H DC_1A-3A_n78A-n257I DC_1A-3A_n78A-n257J DC_1A-3A_n78A-n257K DC_1A-3A_n78A-n257L DC_1A-3A_n78A-n257M	DC_1A_n78A DC_1A_n257A DC_1A_n257D DC_1A_n257G DC_1A_n257H DC_1A_n257I DC_3A_n78A DC_3A_n257A DC_3A_n257D DC_3A_n257G DC_3A_n257H DC_3A_n257I DC_1A_n78A-n257A DC_1A_n78A-n257G DC_1A_n78A-n257H DC_1A_n78A-n257I DC_3A_n78A-n257A DC_3A_n78A-n257G DC_3A_n78A-n257H DC_3A_n78A-n257I
DC_1A-3A_n79A-n257A DC_1A-3A_n79A-n257G DC_1A-3A_n79A-n257H DC_1A-3A_n79A-n257I	DC_1A_n79A DC_1A_n257A DC_1A_n257G DC_1A_n257H DC_1A_n257I DC_3A_n79A DC_3A_n257A DC_3A_n257G DC_3A_n257H DC_3A_n257I
DC_1A-3A_n79A-n257A DC_1A-3A_n79A-n257G DC_1A-3A_n79A-n257H DC_1A-3A_n79A-n257I	DC_1A_n79A-n257A DC_1A_n79A-n257G DC_1A_n79A-n257H DC_1A_n79A-n257I DC_3A_n79A-n257A DC_3A_n79A-n257G DC_3A_n79A-n257H DC_3A_n79A-n257I
DC_1A-5A_n78A-n257A DC_1A-5A_n78A-n257D DC_1A-5A_n78A-n257E DC_1A-5A_n78A-n257F DC_1A-5A_n78A-n257G DC_1A-5A_n78A-n257H DC_1A-5A_n78A-n257I DC_1A-5A_n78A-n257J DC_1A-5A_n78A-n257K DC_1A-5A_n78A-n257L DC_1A-5A_n78A-n257M	DC_1A_n78A DC_1A_n257A DC_5A_n78A DC_5A_n257A
DC_1A-7A_n78A-n257A DC_1A-7A_n78A-n257D DC_1A-7A_n78A-n257E DC_1A-7A_n78A-n257F DC_1A-7A_n78A-n257G DC_1A-7A_n78A-n257H DC_1A-7A_n78A-n257I DC_1A-7A_n78A-n257J DC_1A-7A_n78A-n257K DC_1A-7A_n78A-n257L DC_1A-7A_n78A-n257M	DC_1A_n78A DC_1A_n257A DC_7A_n78A DC_7A_n257A
DC_1A-7A-7A_n78A-n257A DC_1A-7A-7A_n78A-n257D DC_1A-7A-7A_n78A-n257E DC_1A-7A-7A_n78A-n257F DC_1A-7A-7A_n78A-n257G	DC_1A_n78A DC_1A_n257A DC_7A_n78A DC_7A_n257A

EN-DC configuration	Uplink EN-DC configuration (NOTE 1)
DC_1A-7A-7A_n78A-n257H DC_1A-7A-7A_n78A-n257I DC_1A-7A-7A_n78A-n257J DC_1A-7A-7A_n78A-n257K DC_1A-7A-7A_n78A-n257L DC_1A-7A-7A_n78A-n257M	
DC_1A-8A_n77A-n257A DC_1A-8A_n77A-n257D DC_1A-8A_n77A-n257G DC_1A-8A_n77A-n257H DC_1A-8A_n77A-n257I	DC_1A_n77A DC_1A_n257A DC_8A_n77A DC_8A_n257A
DC_1A-8A_n77(2A)-n257A DC_1A-8A_n77(2A)-n257D DC_1A-8A_n77(2A)-n257G DC_1A-8A_n77(2A)-n257H DC_1A-8A_n77(2A)-n257I	DC_1A_n77A DC_1A_n257A DC_8A_n77A DC_8A_n257A
DC_1A-8A_n78A-n257A DC_1A-8A_n78A-n257D DC_1A-8A_n78A-n257E DC_1A-8A_n78A-n257F DC_1A-8A_n78A-n257G DC_1A-8A_n78A-n257H DC_1A-8A_n78A-n257I DC_1A-8A_n78A-n257J DC_1A-8A_n78A-n257K DC_1A-8A_n78A-n257L DC_1A-8A_n78A-n257M	DC_1A_n78A DC_8A_n78A DC_1A_n257A DC_8A_n257A
DC_1A-11A_n77A-n257A DC_1A-11A_n77A-n257D DC_1A-11A_n77A-n257G DC_1A-11A_n77A-n257H DC_1A-11A_n77A-n257I	DC_1A_n77A DC_1A_n257A DC_11A_n77A DC_11A_n257A
DC_1A-11A_n77(2A)-n257A DC_1A-11A_n77(2A)-n257D DC_1A-11A_n77(2A)-n257G DC_1A-11A_n77(2A)-n257H DC_1A-11A_n77(2A)-n257I	DC_1A_n77A DC_1A_n257A DC_11A_n77A DC_11A_n257A
DC_1A-18A_n3A-n257A DC_1A-18A_n3A-n257G DC_1A-18A_n3A-n257H DC_1A-18A_n3A-n257I	DC_1A_n3A DC_1A_n257A DC_1A_n257G DC_1A_n257H DC_1A_n257I DC_18A_n3A DC_18A_n257A DC_18A_n257G DC_18A_n257H DC_18A_n257I
DC_1A-18A_n78A-n257A DC_1A-18A_n78A-n257G DC_1A-18A_n78A-n257H DC_1A-18A_n78A-n257I	DC_1A_n78A DC_1A_n257A DC_1A_n257G DC_1A_n257H DC_1A_n257I DC_18A_n78A DC_18A_n257A DC_18A_n257G DC_18A_n257H DC_18A_n257I

EN-DC configuration	Uplink EN-DC configuration (NOTE 1)
DC_1A-19A_n77A-n257A DC_1A-19A_n77A-n257G DC_1A-19A_n77A-n257H DC_1A-19A_n77A-n257I	DC_1A_n77A DC_1A_n257A DC_1A_n257G DC_1A_n257H DC_1A_n257I DC_19A_n77A DC_19A_n257A DC_19A_n257G DC_19A_n257H DC_19A_n257I
DC_1A-19A_n78A-n257A DC_1A-19A_n78A-n257G DC_1A-19A_n78A-n257H DC_1A-19A_n78A-n257I	DC_1A_n78A DC_1A_n257A DC_1A_n257G DC_1A_n257H DC_1A_n257I DC_19A_n78A DC_19A_n257A DC_19A_n257G DC_19A_n257H DC_19A_n257I
DC_1A-19A_n79A-n257A DC_1A-19A_n79A-n257G DC_1A-19A_n79A-n257H DC_1A-19A_n79A-n257I	DC_1A_n79A DC_1A_n257A DC_1A_n257G DC_1A_n257H DC_1A_n257I DC_19A_n79A DC_19A_n257A DC_19A_n257G DC_19A_n257H DC_19A_n257I
DC_1A-21A_n77A-n257A DC_1A-21A_n77A-n257G DC_1A-21A_n77A-n257H DC_1A-21A_n77A-n257I	DC_1A_n77A DC_1A_n257A DC_1A_n257G DC_1A_n257H DC_1A_n257I DC_21A_n77A DC_21A_n257A DC_21A_n257G DC_21A_n257H DC_21A_n257I
DC_1A-21A_n78A-n257A DC_1A-21A_n78A-n257G DC_1A-21A_n78A-n257H DC_1A-21A_n78A-n257I	DC_1A_n78A DC_1A_n257A DC_1A_n257G DC_1A_n257H DC_1A_n257I DC_21A_n78A DC_21A_n257A DC_21A_n257G DC_21A_n257H DC_21A_n257I
DC_1A-21A_n79A-n257A DC_1A-21A_n79A-n257G DC_1A-21A_n79A-n257H DC_1A-21A_n79A-n257I	DC_1A_n79A DC_1A_n257A DC_1A_n257G DC_1A_n257H DC_1A_n257I DC_21A_n79A DC_21A_n257A DC_21A_n257G DC_21A_n257H DC_21A_n257I
DC_1A-19A_n79A-n257A DC_1A-19A_n79A-n257G DC_1A-19A_n79A-n257H DC_1A-19A_n79A-n257I	DC_1A_n79A-n257A DC_1A_n79A-n257G DC_1A_n79A-n257H DC_1A_n79A-n257I DC_19A_n79A-n257A

EN-DC configuration	Uplink EN-DC configuration (NOTE 1)
	DC_19A_n79A-n257G DC_19A_n79A-n257H DC_19A_n79A-n257I
DC_1A-21A_n77A-n257A DC_1A-21A_n77A-n257G DC_1A-21A_n77A-n257H DC_1A-21A_n77A-n257I	DC_1A_n77A-n257A DC_1A_n77A-n257G DC_1A_n77A-n257H DC_1A_n77A-n257I DC_21A_n77A-n257A DC_21A_n77A-n257G DC_21A_n77A-n257H DC_21A_n77A-n257I
DC_1A-21A_n78A-n257A DC_1A-21A_n78A-n257G DC_1A-21A_n78A-n257H DC_1A-21A_n78A-n257I	DC_1A_n78A-n257A DC_1A_n78A-n257G DC_1A_n78A-n257H DC_1A_n78A-n257I DC_21A_n78A-n257A DC_21A_n78A-n257G DC_21A_n78A-n257H DC_21A_n78A-n257I
DC_1A-21A_n79A-n257A DC_1A-21A_n79A-n257G DC_1A-21A_n79A-n257H DC_1A-21A_n79A-n257I	DC_1A_n79A-n257A DC_1A_n79A-n257G DC_1A_n79A-n257H DC_1A_n79A-n257I DC_21A_n79A-n257A DC_21A_n79A-n257G DC_21A_n79A-n257H DC_21A_n79A-n257I
DC_1A-28A_n3A-n257A DC_1A-28A_n3A-n257G DC_1A-28A_n3A-n257H DC_1A-28A_n3A-n257I	DC_1A_n3A DC_1A_n257A DC_1A_n257G DC_1A_n257H DC_1A_n257I DC_28A_n3A DC_28A_n257A DC_28A_n257G DC_28A_n257H DC_28A_n257I
DC_1A-28A_n78A-n257A DC_1A-28A_n78A-n257G DC_1A-28A_n78A-n257H DC_1A-28A_n78A-n257I	DC_1A_n78A DC_1A_n257A DC_1A_n257G DC_1A_n257H DC_1A_n257I DC_28A_n78A DC_28A_n257A DC_28A_n257G DC_28A_n257H DC_28A_n257I
DC_1A-41A_n3A-n257A DC_1A-41A_n3A-n257I	DC_41A_n3A DC_41A_n257A DC_41A_n257I
DC_1A-41C_n3A-n257A DC_1A-41C_n3A-n257I	DC_41A_n3A DC_41A_n257A DC_41A_n257I DC_41C_n3A DC_41C_n257A DC_41C_n257I

EN-DC configuration	Uplink EN-DC configuration (NOTE 1)
<p>DC_1A-41A_n28A-n257A                      DC_1A-41A_n28A-n257G                      DC_1A-41A_n28A-n257H                      DC_1A-41A_n28A-n257I                      DC_1A-41C_n28A-n257A                      DC_1A-41C_n28A-n257G                      DC_1A-41C_n28A-n257H                      DC_1A-41C_n28A-n257I</p>	<p>DC_1A_n28A                      DC_1A_n257A                      DC_1A_n257G                      DC_1A_n257H                      DC_1A_n257I                      DC_41A_n28A                      DC_41A_n257A                      DC_41A_n257G                      DC_41A_n257H                      DC_41A_n257I                      DC_41C_n28A                      DC_41C_n257A                      DC_41C_n257G                      DC_41C_n257H                      DC_41C_n257I</p>
<p>DC_1A-41A_n77A-n257A                      DC_1A-41A_n77A-n257G                      DC_1A-41A_n77A-n257H                      DC_1A-41A_n77A-n257I                      DC_1A-41C_n77A-n257A                      DC_1A-41C_n77A-n257G                      DC_1A-41C_n77A-n257H                      DC_1A-41C_n77A-n257I</p>	<p>DC_1A_n77A                      DC_1A_n257A                      DC_1A_n257G                      DC_1A_n257H                      DC_1A_n257I                      DC_41A_n77A                      DC_41A_n257A                      DC_41A_n257G                      DC_41A_n257H                      DC_41A_n257I                      DC_41C_n77A                      DC_41C_n257A                      DC_41C_n257G                      DC_41C_n257H                      DC_41C_n257I</p>
<p>DC_1A-41A_n78A-n257A                      DC_1A-41A_n78A-n257G                      DC_1A-41A_n78A-n257H                      DC_1A-41A_n78A-n257I                      DC_1A-41C_n78A-n257A                      DC_1A-41C_n78A-n257G                      DC_1A-41C_n78A-n257H                      DC_1A-41C_n78A-n257I</p>	<p>DC_1A_n78A                      DC_1A_n257A                      DC_1A_n257G                      DC_1A_n257H                      DC_1A_n257I                      DC_41A_n78A                      DC_41A_n257A                      DC_41A_n257G                      DC_41A_n257H                      DC_41A_n257I                      DC_41C_n78A                      DC_41C_n257A                      DC_41C_n257G                      DC_41C_n257H                      DC_41C_n257I</p>
<p>DC_1A-42A_n77A-n257A                      DC_1A-42A_n77A-n257G                      DC_1A-42A_n77A-n257H                      DC_1A-42A_n77A-n257I                      DC_1A-42C_n77A-n257A                      DC_1A-42C_n77A-n257G                      DC_1A-42C_n77A-n257H                      DC_1A-42C_n77A-n257I</p>	<p>DC_1A_n77A                      DC_1A_n257A                      DC_1A_n257G                      DC_1A_n257H                      DC_1A_n257I                      DC_42A_n257A                      DC_42A_n257G                      DC_42A_n257H                      DC_42A_n257I</p>
<p>DC_1A-42A_n77A-n257A                      DC_1A-42A_n77A-n257G                      DC_1A-42A_n77A-n257H                      DC_1A-42A_n77A-n257I                      DC_1A-42C_n77A-n257A                      DC_1A-42C_n77A-n257G                      DC_1A-42C_n77A-n257H</p>	<p>DC_1A_n77A-n257A                      DC_1A_n77A-n257G                      DC_1A_n77A-n257H                      DC_1A_n77A-n257I</p>

EN-DC configuration	Uplink EN-DC configuration (NOTE 1)
DC_1A-42C_n77A-n257I	
DC_1A-42A_n78A-n257A DC_1A-42A_n78A-n257G DC_1A-42A_n78A-n257H DC_1A-42A_n78A-n257I DC_1A-42C_n78A-n257A DC_1A-42C_n78A-n257G DC_1A-42C_n78A-n257H DC_1A-42C_n78A-n257I	DC_1A_n78A DC_1A_n257A DC_1A_n257G DC_1A_n257H DC_1A_n257I DC_42A_n257A DC_42A_n257G DC_42A_n257H DC_42A_n257I DC_42C_n257A DC_42C_n257G DC_42C_n257H DC_42C_n257I DC_1A_n78A-n257A DC_1A_n78A-n257G DC_1A_n78A-n257H DC_1A_n78A-n257I
DC_1A-42A_n79A-n257A DC_1A-42A_n79A-n257G DC_1A-42A_n79A-n257H DC_1A-42A_n79A-n257I DC_1A-42C_n79A-n257A DC_1A-42C_n79A-n257G DC_1A-42C_n79A-n257H DC_1A-42C_n79A-n257I	DC_1A_n79A-n257A DC_1A_n79A-n257G DC_1A_n79A-n257H DC_1A_n79A-n257I
DC_1A-42A_n79A-n257A DC_1A-42A_n79A-n257G DC_1A-42A_n79A-n257H DC_1A-42A_n79A-n257I DC_1A-42C_n79A-n257A DC_1A-42C_n79A-n257G DC_1A-42C_n79A-n257H DC_1A-42C_n79A-n257I	DC_1A_n79A DC_1A_n257A DC_1A_n257G DC_1A_n257H DC_1A_n257I DC_42A_n257A DC_42A_n257G DC_42A_n257H DC_42A_n257I
DC_2A-66A_n41A-n260A DC_2A-66A_n41A-n260(2A) DC_2A-66A_n41A-n260(3A) DC_2A-66A_n41A-n260(4A)	DC_2A_n41A DC_66A_n41A
DC_2A-66A_n41A-n261A DC_2A-66A_n41A-n261(2A)	DC_2A_n41A DC_66A_n41A
DC_2A-66A_n71A-n261A DC_2A-66A_n71A-n261(2A)	DC_2A_n71A DC_66A_n71A
DC_3A-5A_n78A-n257A DC_3A-5A_n78A-n257D DC_3A-5A_n78A-n257E DC_3A-5A_n78A-n257F DC_3A-5A_n78A-n257G DC_3A-5A_n78A-n257H DC_3A-5A_n78A-n257I DC_3A-5A_n78A-n257J DC_3A-5A_n78A-n257K DC_3A-5A_n78A-n257L DC_3A-5A_n78A-n257M	DC_3A_n78A DC_3A_n257A DC_7A_n78A DC_7A_n257A
DC_3A-7A_n1A-n257A DC_3A-3A-7A_n1A-n257A DC_3A-7A-7A_n1A-n257A DC_3A-3A-7A-7A_n1A-n257A	DC_3A_n1A DC_3A_n257A DC_7A_n1A DC_7A_n257A
DC_3A-3A-7A_n78A-n257A DC_3A-3A-7A_n78A-n257D DC_3A-3A-7A_n78A-n257E DC_3A-3A-7A_n78A-n257F DC_3A-3A-7A_n78A-n257G DC_3A-3A-7A_n78A-n257H	DC_3A_n78A DC_3A_n257A DC_7A_n78A DC_7A_n257A



EN-DC configuration	Uplink EN-DC configuration (NOTE 1)
DC_3A-3A-7A_n78A-n257I DC_3A-3A-7A_n78A-n257J DC_3A-3A-7A_n78A-n257K DC_3A-3A-7A_n78A-n257L DC_3A-3A-7A_n78A-n257M DC_3A-3A-7A-7A_n78A-n257A DC_3A-3A-7A-7A_n78A-n257D DC_3A-3A-7A-7A_n78A-n257E DC_3A-3A-7A-7A_n78A-n257F DC_3A-3A-7A-7A_n78A-n257G DC_3A-3A-7A-7A_n78A-n257H DC_3A-3A-7A-7A_n78A-n257I DC_3A-3A-7A-7A_n78A-n257J DC_3A-3A-7A-7A_n78A-n257K DC_3A-3A-7A-7A_n78A-n257L DC_3A-3A-7A-7A_n78A-n257M	
DC_3A-8A_n78A-n257A DC_3A-8A_n78A-n257D DC_3A-8A_n78A-n257E DC_3A-8A_n78A-n257F DC_3A-8A_n78A-n257G DC_3A-8A_n78A-n257H DC_3A-8A_n78A-n257I DC_3A-8A_n78A-n257J DC_3A-8A_n78A-n257K DC_3A-8A_n78A-n257L DC_3A-8A_n78A-n257M	DC_3A_n78A DC_8A_n78A DC_3A_n257A DC_8A_n257A
DC_3A-18A_n78A-n257A DC_3A-18A_n78A-n257G DC_3A-18A_n78A-n257H DC_3A-18A_n78A-n257I	DC_3A_n78A DC_3A_n257A DC_3A_n257G DC_3A_n257H DC_3A_n257I DC_18A_n78A DC_18A_n257A DC_18A_n257G DC_18A_n257H DC_18A_n257I
DC_3A-19A_n77A-n257A DC_3A-19A_n77A-n257G DC_3A-19A_n77A-n257H DC_3A-19A_n77A-n257I	DC_3A_n77A DC_3A_n257A DC_3A_n257G DC_3A_n257H DC_3A_n257I DC_19A_n77A DC_19A_n257A DC_19A_n257G DC_19A_n257H DC_19A_n257I
DC_3A-19A_n78A-n257A DC_3A-19A_n78A-n257G DC_3A-19A_n78A-n257H DC_3A-19A_n78A-n257I	DC_3A_n78A DC_3A_n257A DC_3A_n257G DC_3A_n257H DC_3A_n257I DC_19A_n78A DC_19A_n257A DC_19A_n257G DC_19A_n257H DC_19A_n257I

EN-DC configuration	Uplink EN-DC configuration (NOTE 1)
DC_3A-19A_n79A-n257A DC_3A-19A_n79A-n257G DC_3A-19A_n79A-n257H DC_3A-19A_n79A-n257I	DC_3A_n79A DC_3A_n257A DC_3A_n257G DC_3A_n257H DC_3A_n257I DC_19A_n79A DC_19A_n257A DC_19A_n257G DC_19A_n257H DC_19A_n257I
DC_3A-21A_n77A-n257A DC_3A-21A_n77A-n257G DC_3A-21A_n77A-n257H DC_3A-21A_n77A-n257I	DC_3A_n77A DC_3A_n257A DC_3A_n257G DC_3A_n257H DC_3A_n257I DC_21A_n77A DC_21A_n257A DC_21A_n257G DC_21A_n257H DC_21A_n257I
DC_3A-21A_n78A-n257A DC_3A-21A_n78A-n257G DC_3A-21A_n78A-n257H DC_3A-21A_n78A-n257I	DC_3A_n78A DC_3A_n257A DC_3A_n257G DC_3A_n257H DC_3A_n257I DC_21A_n78A DC_21A_n257A DC_21A_n257G DC_21A_n257H DC_21A_n257I
DC_3A-21A_n79A-n257A DC_3A-21A_n79A-n257G DC_3A-21A_n79A-n257H DC_3A-21A_n79A-n257I	DC_3A_n79A DC_3A_n257A DC_3A_n257G DC_3A_n257H DC_3A_n257I DC_21A_n79A DC_21A_n257A DC_21A_n257G DC_21A_n257H DC_21A_n257I

EN-DC configuration	Uplink EN-DC configuration (NOTE 1)
DC_3A-19A_n77A-n257A DC_3A-19A_n77A-n257G DC_3A-19A_n77A-n257H DC_3A-19A_n77A-n257I	DC_3A_n77A-n257A DC_3A_n77A-n257G DC_3A_n77A-n257H DC_3A_n77A-n257I DC_19A_n77A-n257A DC_19A_n77A-n257G DC_19A_n77A-n257H DC_19A_n77A-n257I
DC_3A-19A_n78A-n257A DC_3A-19A_n78A-n257G DC_3A-19A_n78A-n257H DC_3A-19A_n78A-n257I	DC_3A_n78A-n257A DC_3A_n78A-n257G DC_3A_n78A-n257H DC_3A_n78A-n257I DC_19A_n78A-n257A DC_19A_n78A-n257G DC_19A_n78A-n257H DC_19A_n78A-n257I
DC_3A-19A_n79A-n257A DC_3A-19A_n79A-n257G DC_3A-19A_n79A-n257H DC_3A-19A_n79A-n257I	DC_3A_n79A-n257A DC_3A_n79A-n257G DC_3A_n79A-n257H DC_3A_n79A-n257I DC_19A_n79A-n257A DC_19A_n79A-n257G DC_19A_n79A-n257H DC_19A_n79A-n257I
DC_3A-21A_n77A-n257A DC_3A-21A_n77A-n257G DC_3A-21A_n77A-n257H DC_3A-21A_n77A-n257I	DC_3A_n77A-n257A DC_3A_n77A-n257G DC_3A_n77A-n257H DC_3A_n77A-n257I DC_21A_n77A-n257A DC_21A_n77A-n257G DC_21A_n77A-n257H DC_21A_n77A-n257I
DC_3A-21A_n78A-n257A DC_3A-21A_n78A-n257G DC_3A-21A_n78A-n257H DC_3A-21A_n78A-n257I	DC_3A_n78A-n257A DC_3A_n78A-n257G DC_3A_n78A-n257H DC_3A_n78A-n257I DC_21A_n78A-n257A DC_21A_n78A-n257G DC_21A_n78A-n257H DC_21A_n78A-n257I
DC_3A-21A_n79A-n257A DC_3A-21A_n79A-n257G DC_3A-21A_n79A-n257H DC_3A-21A_n79A-n257I	DC_3A_n79A-n257A DC_3A_n79A-n257G DC_3A_n79A-n257H DC_3A_n79A-n257I DC_21A_n79A-n257A DC_21A_n79A-n257G DC_21A_n79A-n257H DC_21A_n79A-n257I
DC_3A-28A_n77A-n257A DC_3A-28A_n77A-n257D DC_3A-28A_n77A-n257G DC_3A-28A_n77A-n257H DC_3A-28A_n77A-n257I	DC_3A_n77A DC_3A_n257A DC_3A_n257D DC_3A_n257G DC_3A_n257H DC_3A_n257I DC_28A_n77A DC_28A_n257A DC_28A_n257D DC_28A_n257G DC_28A_n257H DC_28A_n257I

EN-DC configuration	Uplink EN-DC configuration (NOTE 1)
<p>DC_3A-28A_n77(2A)-n257A                      DC_3A-28A_n77(2A)-n257D                      DC_3A-28A_n77(2A)-n257G                      DC_3A-28A_n77(2A)-n257H                      DC_3A-28A_n77(2A)-n257I</p>	<p>DC_3A_n77A                      DC_3A_n257A                      DC_3A_n257D                      DC_3A_n257G                      DC_3A_n257H                      DC_3A_n257I                      DC_28A_n77A                      DC_28A_n257A                      DC_28A_n257D                      DC_28A_n257G                      DC_28A_n257H                      DC_28A_n257I</p>
<p>DC_3A-28A_n78A-n257A                      DC_3A-28A_n78A-n257G                      DC_3A-28A_n78A-n257H                      DC_3A-28A_n78A-n257I</p>	<p>DC_3A_n78A                      DC_3A_n257A                      DC_3A_n257G                      DC_3A_n257H                      DC_3A_n257I                      DC_28A_n78A                      DC_28A_n257A                      DC_28A_n257G                      DC_28A_n257H                      DC_28A_n257I</p>
<p>DC_3A-41A_n28A-n257A                      DC_3A-41A_n28A-n257G                      DC_3A-41A_n28A-n257H                      DC_3A-41A_n28A-n257I                      DC_3A-41C_n28A-n257A                      DC_3A-41C_n28A-n257G                      DC_3A-41C_n28A-n257H                      DC_3A-41C_n28A-n257I</p>	<p>DC_3A_n28A                      DC_3A_n257A                      DC_3A_n257G                      DC_3A_n257H                      DC_3A_n257I                      DC_41A_n28A                      DC_41A_n257A                      DC_41A_n257G                      DC_41A_n257H                      DC_41A_n257I                      DC_41C_n28A                      DC_41C_n257A                      DC_41C_n257G                      DC_41C_n257H                      DC_41C_n257I</p>
<p>DC_3A-41A_n77A-n257A                      DC_3A-41A_n77A-n257G                      DC_3A-41A_n77A-n257H                      DC_3A-41A_n77A-n257I                      DC_3A-41C_n77A-n257A                      DC_3A-41C_n77A-n257G                      DC_3A-41C_n77A-n257H                      DC_3A-41C_n77A-n257I</p>	<p>DC_3A_n77A                      DC_3A_n257A                      DC_3A_n257G                      DC_3A_n257H                      DC_3A_n257I                      DC_41A_n77A                      DC_41A_n257A                      DC_41A_n257G                      DC_41A_n257H                      DC_41A_n257I                      DC_41C_n77A                      DC_41C_n257A                      DC_41C_n257G                      DC_41C_n257H                      DC_41C_n257I</p>

EN-DC configuration	Uplink EN-DC configuration (NOTE 1)
DC_3A-41A_n78A-n257A DC_3A-41A_n78A-n257G DC_3A-41A_n78A-n257H DC_3A-41A_n78A-n257I DC_3A-41C_n78A-n257A DC_3A-41C_n78A-n257G DC_3A-41C_n78A-n257H DC_3A-41C_n78A-n257I	DC_3A_n78A DC_3A_n257A DC_3A_n257G DC_3A_n257H DC_3A_n257I DC_41A_n78A DC_41A_n257A DC_41A_n257G DC_41A_n257H DC_41A_n257I DC_41C_n78A DC_41C_n257A DC_41C_n257G DC_41C_n257H DC_41C_n257I
DC_3A-42A_n77A-n257A DC_3A-42A_n77A-n257G DC_3A-42A_n77A-n257H DC_3A-42A_n77A-n257I DC_3A-42C_n77A-n257A DC_3A-42C_n77A-n257G DC_3A-42C_n77A-n257H DC_3A-42C_n77A-n257I	DC_3A_n77A DC_3A_n257A DC_3A_n257G DC_3A_n257H DC_3A_n257I DC_42A_n257A DC_42A_n257G DC_42A_n257H DC_42A_n257I
DC_3A-42A_n77A-n257A DC_3A-42A_n77A-n257G DC_3A-42A_n77A-n257H DC_3A-42A_n77A-n257I DC_3A-42C_n77A-n257A DC_3A-42C_n77A-n257G DC_3A-42C_n77A-n257H DC_3A-42C_n77A-n257I	DC_3A_n77A-n257A DC_3A_n77A-n257G DC_3A_n77A-n257H DC_3A_n77A-n257I
DC_3A-42A_n78A-n257A DC_3A-42A_n78A-n257G DC_3A-42A_n78A-n257H DC_3A-42A_n78A-n257I DC_3A-42C_n78A-n257A DC_3A-42C_n78A-n257G DC_3A-42C_n78A-n257H DC_3A-42C_n78A-n257I	DC_3A_n78A DC_3A_n257A DC_3A_n257G DC_3A_n257H DC_3A_n257I DC_42A_n257A DC_42A_n257G DC_42A_n257H DC_42A_n257I DC_42C_n257A DC_42C_n257G DC_42C_n257H DC_42C_n257I DC_3A_n78A-n257A DC_3A_n78A-n257G DC_3A_n78A-n257H DC_3A_n78A-n257I
DC_3A-42A_n79A-n257A DC_3A-42A_n79A-n257G DC_3A-42A_n79A-n257H DC_3A-42A_n79A-n257I DC_3A-42C_n79A-n257A DC_3A-42C_n79A-n257G DC_3A-42C_n79A-n257H DC_3A-42C_n79A-n257I	DC_3A_n79A-n257A DC_3A_n79A-n257G DC_3A_n79A-n257H DC_3A_n79A-n257I

EN-DC configuration	Uplink EN-DC configuration (NOTE 1)
DC_3A-42A_n79A-n257A DC_3A-42A_n79A-n257G DC_3A-42A_n79A-n257H DC_3A-42A_n79A-n257I DC_3A-42C_n79A-n257A DC_3A-42C_n79A-n257G DC_3A-42C_n79A-n257H DC_3A-42C_n79A-n257I	DC_3A_n79A DC_3A_n257A DC_3A_n257G DC_3A_n257H DC_3A_n257I DC_42A_n257A DC_42A_n257G DC_42A_n257H DC_42A_n257I
DC_5A-7A_n78A-n257A DC_5A-7A_n78A-n257D DC_5A-7A_n78A-n257E DC_5A-7A_n78A-n257F DC_5A-7A_n78A-n257G DC_5A-7A_n78A-n257H DC_5A-7A_n78A-n257I DC_5A-7A_n78A-n257J DC_5A-7A_n78A-n257K DC_5A-7A_n78A-n257L DC_5A-7A_n78A-n257M	DC_5A_n78A DC_5A_n257A DC_7A_n78A DC_7A_n257A
DC_5A-7A-7A_n78A-n257A DC_5A-7A-7A_n78A-n257D DC_5A-7A-7A_n78A-n257E DC_5A-7A-7A_n78A-n257F DC_5A-7A-7A_n78A-n257G DC_5A-7A-7A_n78A-n257H DC_5A-7A-7A_n78A-n257I DC_5A-7A-7A_n78A-n257J DC_5A-7A-7A_n78A-n257K DC_5A-7A-7A_n78A-n257L DC_5A-7A-7A_n78A-n257M	DC_5A_n78A DC_5A_n257A DC_7A_n78A DC_7A_n257A
DC_8A-11A_n77A-n257A DC_8A-11A_n77A-n257D DC_8A-11A_n77A-n257G DC_8A-11A_n77A-n257H DC_8A-11A_n77A-n257I	DC_8A_n77A DC_8A_n257A DC_11A_n77A DC_11A_n257A
DC_8A-11A_n77(2A)-n257A DC_8A-11A_n77(2A)-n257D DC_8A-11A_n77(2A)-n257G DC_8A-11A_n77(2A)-n257H DC_8A-11A_n77(2A)-n257I	DC_8A_n77A DC_8A_n257A DC_11A_n77A DC_11A_n257A
DC_18A-41A_n3A-n257A DC_18A-41A_n3A-n257G DC_18A-41A_n3A-n257H DC_18A-41A_n3A-n257I DC_18A-41C_n3A-n257A DC_18A-41C_n3A-n257G DC_18A-41C_n3A-n257H DC_18A-41C_n3A-n257I	DC_18A_n3A DC_18A_n257A DC_18A_n257G DC_18A_n257H DC_18A_n257I DC_41A_n3A DC_41A_n257A DC_41A_n257G DC_41A_n257H DC_41A_n257I DC_41C_n3A DC_41C_n257A DC_41C_n257G DC_41C_n257H DC_41C_n257I
DC_18A-42A_n78A-n257A DC_18A-42A_n78A-n257G DC_18A-42A_n78A-n257H DC_18A-42A_n78A-n257I DC_18A-42C_n78A-n257A DC_18A-42C_n78A-n257G DC_18A-42C_n78A-n257H DC_18A-42C_n78A-n257I	DC_18A_n78A DC_18A_n257A DC_18A_n257G DC_18A_n257H DC_18A_n257I DC_42A_n257A DC_42A_n257G DC_42A_n257H DC_42A_n257I

EN-DC configuration	Uplink EN-DC configuration (NOTE 1)
	DC_42C_n257A DC_42C_n257G DC_42C_n257H DC_42C_n257I
DC_19A-21A_n77A-n257A DC_19A-21A_n77A-n257G DC_19A-21A_n77A-n257H DC_19A-21A_n77A-n257I	DC_19A_n77A DC_19A_n257A DC_19A_n257G DC_19A_n257H DC_19A_n257I DC_21A_n77A DC_21A_n257A DC_21A_n257G DC_21A_n257H DC_21A_n257I
DC_19A-21A_n78A-n257A DC_19A-21A_n78A-n257G DC_19A-21A_n78A-n257H DC_19A-21A_n78A-n257I	DC_19A_n78A DC_19A_n257A DC_19A_n257G DC_19A_n257H DC_19A_n257I DC_21A_n78A DC_21A_n257A DC_21A_n257G DC_21A_n257H DC_21A_n257I
DC_19A-21A_n79A-n257A DC_19A-21A_n79A-n257G DC_19A-21A_n79A-n257H DC_19A-21A_n79A-n257I	DC_19A_n79A DC_19A_n257A DC_19A_n257G DC_19A_n257H DC_19A_n257I DC_21A_n79A DC_21A_n257A DC_21A_n257G DC_21A_n257H DC_21A_n257I
DC_19A-42A_n77A-n257A DC_19A-42A_n77A-n257G DC_19A-42A_n77A-n257H DC_19A-42A_n77A-n257I DC_19A-42C_n77A-n257A DC_19A-42C_n77A-n257G DC_19A-42C_n77A-n257H DC_19A-42C_n77A-n257I	DC_19A_n77A DC_19A_n257A DC_19A_n257G DC_19A_n257H DC_19A_n257I DC_42A_n257A DC_42A_n257G DC_42A_n257H DC_42A_n257I
DC_19A-42A_n78A-n257A DC_19A-42A_n78A-n257G DC_19A-42A_n78A-n257H DC_19A-42A_n78A-n257I DC_19A-42C_n78A-n257A DC_19A-42C_n78A-n257G DC_19A-42C_n78A-n257H DC_19A-42C_n78A-n257I	DC_19A_n78A DC_19A_n257A DC_19A_n257G DC_19A_n257H DC_19A_n257I DC_42A_n257A DC_42A_n257G DC_42A_n257H DC_42A_n257I
DC_19A-42A_n79A-n257A DC_19A-42A_n79A-n257G DC_19A-42A_n79A-n257H DC_19A-42A_n79A-n257I DC_19A-42C_n79A-n257A DC_19A-42C_n79A-n257G DC_19A-42C_n79A-n257H DC_19A-42C_n79A-n257I	DC_19A_n79A DC_19A_n257A DC_19A_n257G DC_19A_n257H DC_19A_n257I DC_42A_n257A DC_42A_n257G DC_42A_n257H DC_42A_n257I

EN-DC configuration	Uplink EN-DC configuration (NOTE 1)
DC_21A-42A_n77A-n257A DC_21A-42A_n77A-n257G DC_21A-42A_n77A-n257H DC_21A-42A_n77A-n257I DC_21A-42C_n77A-n257A DC_21A-42C_n77A-n257G DC_21A-42C_n77A-n257H DC_21A-42C_n77A-n257I	DC_21A_n77A DC_21A_n257A DC_21A_n257G DC_21A_n257H DC_21A_n257I DC_42A_n257A DC_42A_n257G DC_42A_n257H DC_42A_n257I
DC_21A-42A_n78A-n257A DC_21A-42A_n78A-n257G DC_21A-42A_n78A-n257H DC_21A-42A_n78A-n257I DC_21A-42C_n78A-n257A DC_21A-42C_n78A-n257G DC_21A-42C_n78A-n257H DC_21A-42C_n78A-n257I	DC_21A_n78A DC_21A_n257A DC_21A_n257G DC_21A_n257H DC_21A_n257I DC_42A_n257A DC_42A_n257G DC_42A_n257H DC_42A_n257I
DC_21A-42A_n79A-n257A DC_21A-42A_n79A-n257G DC_21A-42A_n79A-n257H DC_21A-42A_n79A-n257I DC_21A-42C_n79A-n257A DC_21A-42C_n79A-n257G DC_21A-42C_n79A-n257H DC_21A-42C_n79A-n257I	DC_21A_n79A DC_21A_n257A DC_21A_n257G DC_21A_n257H DC_21A_n257I DC_42A_n257A DC_42A_n257G DC_42A_n257H DC_42A_n257I



EN-DC configuration	Uplink EN-DC configuration (NOTE 1)
DC_19A-21A_n77A-n257A DC_19A-21A_n77A-n257G DC_19A-21A_n77A-n257H DC_19A-21A_n77A-n257I	DC_19A_n77A-n257A DC_19A_n77A-n257G DC_19A_n77A-n257H DC_19A_n77A-n257I DC_21A_n77A-n257A DC_21A_n77A-n257G DC_21A_n77A-n257H DC_21A_n77A-n257I
DC_19A-21A_n78A-n257A DC_19A-21A_n78A-n257G DC_19A-21A_n78A-n257H DC_19A-21A_n78A-n257I	DC_19A_n78A-n257A DC_19A_n78A-n257G DC_19A_n78A-n257H DC_19A_n78A-n257I DC_21A_n78A-n257A DC_21A_n78A-n257G DC_21A_n78A-n257H DC_21A_n78A-n257I
DC_19A-21A_n79A-n257A DC_19A-21A_n79A-n257G DC_19A-21A_n79A-n257H DC_19A-21A_n79A-n257I	DC_19A_n79A-n257A DC_19A_n79A-n257G DC_19A_n79A-n257H DC_19A_n79A-n257I DC_21A_n79A-n257A DC_21A_n79A-n257G DC_21A_n79A-n257H DC_21A_n79A-n257I
DC_19A-42A_n77A-n257A DC_19A-42A_n77A-n257G DC_19A-42A_n77A-n257H DC_19A-42A_n77A-n257I DC_19A-42C_n77A-n257A DC_19A-42C_n77A-n257G DC_19A-42C_n77A-n257H DC_19A-42C_n77A-n257I	DC_19A_n77A-n257A DC_19A_n77A-n257G DC_19A_n77A-n257H DC_19A_n77A-n257I
DC_19A-42A_n78A-n257A DC_19A-42A_n78A-n257G DC_19A-42A_n78A-n257H DC_19A-42A_n78A-n257I DC_19A-42C_n78A-n257A DC_19A-42C_n78A-n257G DC_19A-42C_n78A-n257H DC_19A-42C_n78A-n257I	DC_19A_n78A-n257A DC_19A_n78A-n257G DC_19A_n78A-n257H DC_19A_n78A-n257I
DC_19A-42A_n79A-n257A DC_19A-42A_n79A-n257G DC_19A-42A_n79A-n257H DC_19A-42A_n79A-n257I DC_19A-42C_n79A-n257A DC_19A-42C_n79A-n257G DC_19A-42C_n79A-n257H DC_19A-42C_n79A-n257I	DC_19A_n79A-n257A DC_19A_n79A-n257G DC_19A_n79A-n257H DC_19A_n79A-n257I
DC_21A-42A_n77A-n257A DC_21A-42A_n77A-n257G DC_21A-42A_n77A-n257H DC_21A-42A_n77A-n257I DC_21A-42C_n77A-n257A DC_21A-42C_n77A-n257G DC_21A-42C_n77A-n257H DC_21A-42C_n77A-n257I	DC_21A_n77A-n257A DC_21A_n77A-n257G DC_21A_n77A-n257H DC_21A_n77A-n257I
DC_21A-42A_n78A-n257A DC_21A-42A_n78A-n257G DC_21A-42A_n78A-n257H DC_21A-42A_n78A-n257I DC_21A-42C_n78A-n257A DC_21A-42C_n78A-n257G DC_21A-42C_n78A-n257H DC_21A-42C_n78A-n257I	DC_21A_n78A-n257A DC_21A_n78A-n257G DC_21A_n78A-n257H DC_21A_n78A-n257I

EN-DC configuration	Uplink EN-DC configuration (NOTE 1)
DC_21A-42A_n79A-n257A DC_21A-42A_n79A-n257G DC_21A-42A_n79A-n257H DC_21A-42A_n79A-n257I DC_21A-42C_n79A-n257A DC_21A-42C_n79A-n257G DC_21A-42C_n79A-n257H DC_21A-42C_n79A-n257I	DC_21A_n79A-n257A DC_21A_n79A-n257G DC_21A_n79A-n257H DC_21A_n79A-n257I
DC_28A-41A_n78A-n257A DC_28A-41A_n78A-n257G DC_28A-41A_n78A-n257H DC_28A-41A_n78A-n257I DC_28A-41C_n78A-n257A DC_28A-41C_n78A-n257G DC_28A-41C_n78A-n257H DC_28A-41C_n78A-n257I	DC_28A_n78A DC_28A_n257A DC_28A_n257G DC_28A_n257H DC_28A_n257I DC_41A_n78A DC_41A_n257A DC_41A_n257G DC_41A_n257H DC_41A_n257I DC_41C_n78A DC_41C_n257A DC_41C_n257G DC_41C_n257H DC_41C_n257I
DC_28A-42A_n78A-n257A DC_28A-42A_n78A-n257G DC_28A-42A_n78A-n257H DC_28A-42A_n78A-n257I DC_28A-42C_n78A-n257A DC_28A-42C_n78A-n257G DC_28A-42C_n78A-n257H DC_28A-42C_n78A-n257I	DC_28A_n78A DC_28A_n257A DC_28A_n257G DC_28A_n257H DC_28A_n257I DC_42A_n257A DC_42A_n257G DC_42A_n257H DC_42A_n257I DC_42C_n257A DC_42C_n257G DC_42C_n257H DC_42C_n257I
DC_41A-42A_n77A-n257A DC_41A-42A_n77A-n257G DC_41A-42A_n77A-n257H DC_41A-42A_n77A-n257I DC_41A-42C_n77A-n257A DC_41A-42C_n77A-n257G DC_41A-42C_n77A-n257H DC_41A-42C_n77A-n257I DC_41C-42A_n77A-n257A DC_41C-42A_n77A-n257G DC_41C-42A_n77A-n257H DC_41C-42A_n77A-n257I DC_41C-42C_n77A-n257A DC_41C-42C_n77A-n257G DC_41C-42C_n77A-n257H DC_41C-42C_n77A-n257I	DC_41A_n77A DC_41A_n257A DC_41A_n257G DC_41A_n257H DC_41A_n257I DC_41C_n77A DC_41C_n257A DC_41C_n257G DC_41C_n257H DC_41C_n257I DC_42A_n257A DC_42A_n257G DC_42A_n257H DC_42A_n257I DC_42C_n257A DC_42C_n257G DC_42C_n257H DC_42C_n257I

EN-DC configuration	Uplink EN-DC configuration (NOTE 1)
DC_41A-42A_n78A-n257A	DC_41A_n78A
DC_41A-42A_n78A-n257G	DC_41A_n257A
DC_41A-42A_n78A-n257H	DC_41A_n257G
DC_41A-42A_n78A-n257I	DC_41A_n257H
DC_41A-42C_n78A-n257A	DC_41A_n257I
DC_41A-42C_n78A-n257G	DC_41C_n78A
DC_41A-42C_n78A-n257H	DC_41C_n257A
DC_41A-42C_n78A-n257I	DC_41C_n257G
DC_41C-42A_n78A-n257A	DC_41C_n257H
DC_41C-42A_n78A-n257G	DC_41C_n257I
DC_41C-42A_n78A-n257H	DC_42A_n257A
DC_41C-42A_n78A-n257I	DC_42A_n257G
DC_41C-42C_n78A-n257A	DC_42A_n257H
DC_41C-42C_n78A-n257G	DC_42A_n257I
DC_41C-42C_n78A-n257H	DC_42C_n257A
DC_41C-42C_n78A-n257I	DC_42C_n257G
	DC_42C_n257H
	DC_42C_n257I

NOTE 1: Uplink EN-DC configurations are the configurations supported by the present release of specifications.

5.5B.6.4 Inter-band EN-DC configurations including FR1 and FR2 (five bands)

Table 5.5B.6.4-1: Inter-band EN-DC configurations including FR1 and FR2 (five bands)

EN-DC configuration	Uplink EN-DC configuration (NOTE 1)
DC_1A-3A-5A_n78A-n257A	DC_1A_n78A
DC_1A-3A-5A_n78A-n257D	DC_1A_n257A
DC_1A-3A-5A_n78A-n257E	DC_3A_n78A
DC_1A-3A-5A_n78A-n257F	DC_3A_n257A
DC_1A-3A-5A_n78A-n257G	DC_5A_n78A
DC_1A-3A-5A_n78A-n257H	DC_5A_n257A
DC_1A-3A-5A_n78A-n257I	
DC_1A-3A-5A_n78A-n257J	
DC_1A-3A-5A_n78A-n257K	
DC_1A-3A-5A_n78A-n257L	
DC_1A-3A-5A_n78A-n257M	
DC_1A-3A-7A_n78A-n257A	DC_1A_n78A
DC_1A-3A-7A_n78A-n257D	DC_1A_n257A
DC_1A-3A-7A_n78A-n257E	DC_3A_n78A
DC_1A-3A-7A_n78A-n257F	DC_3A_n257A
DC_1A-3A-7A_n78A-n257G	DC_7A_n78A
DC_1A-3A-7A_n78A-n257H	DC_7A_n257A
DC_1A-3A-7A_n78A-n257I	
DC_1A-3A-7A_n78A-n257J	
DC_1A-3A-7A_n78A-n257K	
DC_1A-3A-7A_n78A-n257L	
DC_1A-3A-7A_n78A-n257M	
DC_1A-3A-7A-7A_n78A-n257A	DC_1A_n78A
DC_1A-3A-7A-7A_n78A-n257D	DC_1A_n257A
DC_1A-3A-7A-7A_n78A-n257E	DC_3A_n78A
DC_1A-3A-7A-7A_n78A-n257F	DC_3A_n257A
DC_1A-3A-7A-7A_n78A-n257G	DC_7A_n78A
DC_1A-3A-7A-7A_n78A-n257H	DC_7A_n257A
DC_1A-3A-7A-7A_n78A-n257I	
DC_1A-3A-7A-7A_n78A-n257J	
DC_1A-3A-7A-7A_n78A-n257K	
DC_1A-3A-7A-7A_n78A-n257L	
DC_1A-3A-7A-7A_n78A-n257M	
DC_1A-3A-8A_n78A-n257A	DC_1A_n78A
DC_1A-3A-8A_n78A-n257D	DC_1A_n257A
DC_1A-3A-8A_n78A-n257E	DC_3A_n78A
DC_1A-3A-8A_n78A-n257F	DC_3A_n257A

EN-DC configuration	Uplink EN-DC configuration (NOTE 1)
DC_1A-3A-8A_n78A-n257G DC_1A-3A-8A_n78A-n257H DC_1A-3A-8A_n78A-n257I DC_1A-3A-8A_n78A-n257J DC_1A-3A-8A_n78A-n257K DC_1A-3A-8A_n78A-n257L DC_1A-3A-8A_n78A-n257M DC_1A-3C-8A_n78A-n257A DC_1A-3C-8A_n78A-n257D DC_1A-3C-8A_n78A-n257E DC_1A-3C-8A_n78A-n257F DC_1A-3C-8A_n78A-n257G DC_1A-3C-8A_n78A-n257H DC_1A-3C-8A_n78A-n257I DC_1A-3C-8A_n78A-n257J DC_1A-3C-8A_n78A-n257K DC_1A-3C-8A_n78A-n257L DC_1A-3C-8A_n78A-n257M	DC_8A_n78A DC_8A_n257A
DC_1A-3A-18A_n78A-n257A DC_1A-3A-18A_n78A-n257G DC_1A-3A-18A_n78A-n257H DC_1A-3A-18A_n78A-n257I	DC_1A_n78A DC_1A_n257A DC_1A_n257G DC_1A_n257H DC_1A_n257I DC_3A_n78A DC_3A_n257A DC_3A_n257G DC_3A_n257H DC_3A_n257I DC_18A_n78A DC_18A_n257A DC_18A_n257G DC_18A_n257H DC_18A_n257I
DC_1A-3A-21A_n77A-n257A DC_1A-3A-21A_n77A-n257G DC_1A-3A-21A_n77A-n257H DC_1A-3A-21A_n77A-n257I	DC_1A_n77A DC_1A_n257A DC_1A_n257G DC_1A_n257H DC_1A_n257I DC_3A_n77A DC_3A_n257A DC_3A_n257G DC_3A_n257H DC_3A_n257I DC_21A_n77A DC_21A_n257A DC_21A_n257G DC_21A_n257H DC_21A_n257I
DC_1A-3A-21A_n78A-n257A DC_1A-3A-21A_n78A-n257G DC_1A-3A-21A_n78A-n257H DC_1A-3A-21A_n78A-n257I	DC_1A_n78A DC_1A_n257A DC_1A_n257G DC_1A_n257H DC_1A_n257I DC_3A_n78A DC_3A_n257A DC_3A_n257G DC_3A_n257H DC_3A_n257I DC_21A_n78A DC_21A_n257A DC_21A_n257G DC_21A_n257H DC_21A_n257I

EN-DC configuration	Uplink EN-DC configuration (NOTE 1)
DC_1A-3A-21A_n79A-n257A DC_1A-3A-21A_n79A-n257G DC_1A-3A-21A_n79A-n257H DC_1A-3A-21A_n79A-n257I	DC_1A_n79A DC_1A_n257A DC_1A_n257G DC_1A_n257H DC_1A_n257I DC_3A_n79A DC_3A_n257A DC_3A_n257G DC_3A_n257H DC_3A_n257I DC_21A_n79A DC_21A_n257A DC_21A_n257G DC_21A_n257H DC_21A_n257I

EN-DC configuration	Uplink EN-DC configuration (NOTE 1)
<p>DC_1A-3A-21A_n77A-n257A                      DC_1A-3A-21A_n77A-n257G                      DC_1A-3A-21A_n77A-n257H                      DC_1A-3A-21A_n77A-n257I</p>	<p>DC_1A_n77A-n257A                      DC_1A_n77A-n257G                      DC_1A_n77A-n257H                      DC_1A_n77A-n257I                      DC_3A_n77A-n257A                      DC_3A_n77A-n257G                      DC_3A_n77A-n257H                      DC_3A_n77A-n257I                      DC_21A_n77A-n257A                      DC_21A_n77A-n257G                      DC_21A_n77A-n257H                      DC_21A_n77A-n257I</p>
<p>DC_1A-3A-21A_n78A-n257A                      DC_1A-3A-21A_n78A-n257G                      DC_1A-3A-21A_n78A-n257H                      DC_1A-3A-21A_n78A-n257I</p>	<p>DC_1A_n78A-n257A                      DC_1A_n78A-n257G                      DC_1A_n78A-n257H                      DC_1A_n78A-n257I                      DC_3A_n78A-n257A                      DC_3A_n78A-n257G                      DC_3A_n78A-n257H                      DC_3A_n78A-n257I                      DC_21A_n78A-n257A                      DC_21A_n78A-n257G                      DC_21A_n78A-n257H                      DC_21A_n78A-n257I</p>
<p>DC_1A-3A-21A_n79A-n257A                      DC_1A-3A-21A_n79A-n257G                      DC_1A-3A-21A_n79A-n257H                      DC_1A-3A-21A_n79A-n257I</p>	<p>DC_1A_n79A-n257A                      DC_1A_n79A-n257G                      DC_1A_n79A-n257H                      DC_1A_n79A-n257I                      DC_3A_n79A-n257A                      DC_3A_n79A-n257G                      DC_3A_n79A-n257H                      DC_3A_n79A-n257I                      DC_21A_n79A-n257A                      DC_21A_n79A-n257G                      DC_21A_n79A-n257H                      DC_21A_n79A-n257I</p>
<p>DC_1A-3A-28A_n78A-n257A                      DC_1A-3A-28A_n78A-n257G                      DC_1A-3A-28A_n78A-n257H                      DC_1A-3A-28A_n78A-n257I</p>	<p>DC_1A_n78A                      DC_1A_n257A                      DC_1A_n257G                      DC_1A_n257H                      DC_1A_n257I                      DC_3A_n78A                      DC_3A_n257A                      DC_3A_n257G                      DC_3A_n257H                      DC_3A_n257I                      DC_28A_n78A                      DC_28A_n257A                      DC_28A_n257G                      DC_28A_n257H                      DC_28A_n257I</p>

EN-DC configuration	Uplink EN-DC configuration (NOTE 1)
DC_1A-3A-41A_n28A-n257A DC_1A-3A-41A_n28A-n257I	DC_1A_n28A DC_1A_n257A DC_3A_n28A DC_3A_n257A DC_41A_n28A DC_41A_n257A DC_41A_n257I
DC_1A-3A-41C_n28A-n257A DC_1A-3A-41C_n28A-n257I	DC_1A_n28A DC_1A_n257A DC_3A_n28A DC_3A_n257A DC_41A_n28A DC_41A_n257A DC_41A_n257I DC_41C_n28A DC_41C_n257A DC_41C_n257I
DC_1A-3A-41A_n77A-n257A DC_1A-3A-41A_n77A-n257G DC_1A-3A-41A_n77A-n257H DC_1A-3A-41A_n77A-n257I DC_1A-3A-41C_n77A-n257A DC_1A-3A-41C_n77A-n257G DC_1A-3A-41C_n77A-n257H DC_1A-3A-41C_n77A-n257I	DC_1A_n77A DC_1A_n257A DC_1A_n257G DC_1A_n257H DC_1A_n257I DC_3A_n77A DC_3A_n257A DC_3A_n257G DC_3A_n257H DC_3A_n257I DC_41A_n77A DC_41A_n257A DC_41A_n257G DC_41A_n257H DC_41A_n257I DC_41C_n77A DC_41C_n257A DC_41C_n257G DC_41C_n257H DC_41C_n257I
DC_1A-3A-41A_n78A-n257A DC_1A-3A-41A_n78A-n257G DC_1A-3A-41A_n78A-n257H DC_1A-3A-41A_n78A-n257I DC_1A-3A-41C_n78A-n257A DC_1A-3A-41C_n78A-n257G DC_1A-3A-41C_n78A-n257H DC_1A-3A-41C_n78A-n257I	DC_1A_n78A DC_1A_n257A DC_1A_n257G DC_1A_n257H DC_1A_n257I DC_3A_n78A DC_3A_n257A DC_3A_n257G DC_3A_n257H DC_3A_n257I DC_41A_n78A DC_41A_n257A DC_41A_n257G DC_41A_n257H DC_41A_n257I DC_41C_n78A DC_41C_n257A DC_41C_n257G DC_41C_n257H DC_41C_n257I

EN-DC configuration	Uplink EN-DC configuration (NOTE 1)
<p>DC_1A-3A-42A_n77A-n257A                      DC_1A-3A-42A_n77A-n257G                      DC_1A-3A-42A_n77A-n257H                      DC_1A-3A-42A_n77A-n257I                      DC_1A-3A-42C_n77A-n257A                      DC_1A-3A-42C_n77A-n257G                      DC_1A-3A-42C_n77A-n257H                      DC_1A-3A-42C_n77A-n257I</p>	<p>DC_1A_n77A                      DC_1A_n257A                      DC_1A_n257G                      DC_1A_n257H                      DC_1A_n257I                      DC_3A_n77A                      DC_3A_n257A                      DC_3A_n257G                      DC_3A_n257H                      DC_3A_n257I                      DC_42A_n257A                      DC_42A_n257G                      DC_42A_n257H                      DC_42A_n257I                      DC_42C_n257A                      DC_42C_n257G                      DC_42C_n257H                      DC_42C_n257I</p>
<p>DC_1A-3A-42A_n78A-n257A                      DC_1A-3A-42A_n78A-n257G                      DC_1A-3A-42A_n78A-n257H                      DC_1A-3A-42A_n78A-n257I                      DC_1A-3A-42C_n78A-n257A                      DC_1A-3A-42C_n78A-n257G                      DC_1A-3A-42C_n78A-n257H                      DC_1A-3A-42C_n78A-n257I</p>	<p>DC_1A_n78A                      DC_1A_n257A                      DC_1A_n257G                      DC_1A_n257H                      DC_1A_n257I                      DC_3A_n78A                      DC_3A_n257A                      DC_3A_n257G                      DC_3A_n257H                      DC_3A_n257I                      DC_42A_n257A                      DC_42A_n257G                      DC_42A_n257H                      DC_42A_n257I                      DC_42C_n257A                      DC_42C_n257G                      DC_42C_n257H                      DC_42C_n257I</p>
<p>DC_1A-5A-7A_n78A-n257A                      DC_1A-5A-7A_n78A-n257D                      DC_1A-5A-7A_n78A-n257E                      DC_1A-5A-7A_n78A-n257F                      DC_1A-5A-7A_n78A-n257G                      DC_1A-5A-7A_n78A-n257H                      DC_1A-5A-7A_n78A-n257I                      DC_1A-5A-7A_n78A-n257J                      DC_1A-5A-7A_n78A-n257K                      DC_1A-5A-7A_n78A-n257L                      DC_1A-5A-7A_n78A-n257M</p>	<p>DC_1A_n78A                      DC_1A_n257A                      DC_5A_n78A                      DC_5A_n257A                      DC_7A_n78A                      DC_7A_n257A</p>
<p>DC_1A-5A-7A-7A_n78A-n257A                      DC_1A-5A-7A-7A_n78A-n257D                      DC_1A-5A-7A-7A_n78A-n257E                      DC_1A-5A-7A-7A_n78A-n257F                      DC_1A-5A-7A-7A_n78A-n257G                      DC_1A-5A-7A-7A_n78A-n257H                      DC_1A-5A-7A-7A_n78A-n257I                      DC_1A-5A-7A-7A_n78A-n257J                      DC_1A-5A-7A-7A_n78A-n257K                      DC_1A-5A-7A-7A_n78A-n257L                      DC_1A-5A-7A-7A_n78A-n257M</p>	<p>DC_1A_n78A                      DC_1A_n257A                      DC_5A_n78A                      DC_5A_n257A                      DC_7A_n78A                      DC_7A_n257A</p>



EN-DC configuration	Uplink EN-DC configuration (NOTE 1)
DC_1A-8A-11A_n77A-n257A DC_1A-8A-11A_n77A-n257D DC_1A-8A-11A_n77A-n257G DC_1A-8A-11A_n77A-n257H DC_1A-8A-11A_n77A-n257I	DC_1A_n77A DC_1A_n257A DC_8A_n77A DC_8A_n257A DC_11A_n77A DC_11A_n257A
DC_1A-8A-11A_n77(2A)-n257A DC_1A-8A-11A_n77(2A)-n257D DC_1A-8A-11A_n77(2A)-n257G DC_1A-8A-11A_n77(2A)-n257H DC_1A-8A-11A_n77(2A)-n257I	DC_1A_n77A DC_1A_n257A DC_8A_n77A DC_8A_n257A DC_11A_n77A DC_11A_n257A
DC_1A-18A-41A_n3A-n77A	DC_18A_n3A DC_18A_n77A DC_41A_n3A DC_41A_n77A
DC_1A-18A-41C_n3A-n77A	DC_18A_n3A DC_18A_n77A DC_41A_n3A DC_41C_n3A DC_41A_n77A DC_41C_n77A
DC_1A-18A-41A_n3A-n78A	DC_18A_n3A DC_18A_n78A DC_41A_n3A DC_41A_n78A
DC_1A-18A-41C_n3A-n78A	DC_18A_n3A DC_18A_n78A DC_41A_n3A DC_41C_n3A DC_41A_n78A DC_41C_n78A
DC_1A-18A-41A_n3A-n257A DC_1A-18A-41A_n3A-n257I	DC_18A_n3A DC_18A_n257A DC_41A_n3A DC_41A_n257A DC_18A_n257I DC_41A_n257I
DC_1A-18A-41C_n3A-n257A DC_1A-18A-41C_n3A-n257I	DC_18A_n3A DC_18A_n257A DC_41A_n3A DC_41C_n3A DC_41A_n257A DC_41C_n257A DC_18A_n257I DC_41A_n257I DC_41C_n257I
DC_1A-18A-42A_n78A-n257A DC_1A-18A-42A_n78A-n257G DC_1A-18A-42A_n78A-n257H DC_1A-18A-42A_n78A-n257I DC_1A-18A-42C_n78A-n257A DC_1A-18A-42C_n78A-n257G DC_1A-18A-42C_n78A-n257H DC_1A-18A-42C_n78A-n257I	DC_1A_n78A DC_1A_n257A DC_1A_n257G DC_1A_n257H DC_1A_n257I DC_18A_n78A DC_18A_n257A DC_18A_n257G DC_18A_n257H DC_18A_n257I DC_42A_n257A DC_42A_n257G DC_42A_n257H DC_42A_n257I

EN-DC configuration	Uplink EN-DC configuration (NOTE 1)
	DC_42C_n257A DC_42C_n257G DC_42C_n257H DC_42C_n257I
DC_1A-19A-42A_n77A-n257A DC_1A-19A-42A_n77A-n257G DC_1A-19A-42A_n77A-n257H DC_1A-19A-42A_n77A-n257I DC_1A-19A-42C_n77A-n257A DC_1A-19A-42C_n77A-n257G DC_1A-19A-42C_n77A-n257H DC_1A-19A-42C_n77A-n257I	DC_1A_n77A DC_1A_n257A DC_1A_n257G DC_1A_n257H DC_1A_n257I DC_19A_n77A DC_19A_n257A DC_19A_n257G DC_19A_n257H DC_19A_n257I DC_42A_n257A DC_42A_n257G DC_42A_n257H DC_42A_n257I
DC_1A-19A-42A_n78A-n257A DC_1A-19A-42A_n78A-n257G DC_1A-19A-42A_n78A-n257H DC_1A-19A-42A_n78A-n257I DC_1A-19A-42C_n78A-n257A DC_1A-19A-42C_n78A-n257G DC_1A-19A-42C_n78A-n257H DC_1A-19A-42C_n78A-n257I	DC_1A_n78A DC_1A_n257A DC_1A_n257G DC_1A_n257H DC_1A_n257I DC_19A_n78A DC_19A_n257A DC_19A_n257G DC_19A_n257H DC_19A_n257I DC_42A_n257A DC_42A_n257G DC_42A_n257H DC_42A_n257I
DC_1A-19A-42A_n79A-n257A DC_1A-19A-42A_n79A-n257G DC_1A-19A-42A_n79A-n257H DC_1A-19A-42A_n79A-n257I DC_1A-19A-42C_n79A-n257A DC_1A-19A-42C_n79A-n257G DC_1A-19A-42C_n79A-n257H DC_1A-19A-42C_n79A-n257I	DC_1A_n79A DC_1A_n257A DC_1A_n257G DC_1A_n257H DC_1A_n257I DC_19A_n79A DC_19A_n257A DC_19A_n257G DC_19A_n257H DC_19A_n257I DC_42A_n257A DC_42A_n257G DC_42A_n257H DC_42A_n257I
DC_1A-21A-42A_n77A-n257A DC_1A-21A-42A_n77A-n257G DC_1A-21A-42A_n77A-n257H DC_1A-21A-42A_n77A-n257I DC_1A-21A-42C_n77A-n257A DC_1A-21A-42C_n77A-n257G DC_1A-21A-42C_n77A-n257H DC_1A-21A-42C_n77A-n257I	DC_1A_n77A DC_1A_n257A DC_1A_n257G DC_1A_n257H DC_1A_n257I DC_21A_n77A DC_21A_n257A DC_21A_n257G DC_21A_n257H DC_21A_n257I DC_42A_n257A DC_42A_n257G DC_42A_n257H DC_42A_n257I

EN-DC configuration	Uplink EN-DC configuration (NOTE 1)
<p>DC_1A-21A-42A_n78A-n257A                      DC_1A-21A-42A_n78A-n257G                      DC_1A-21A-42A_n78A-n257H                      DC_1A-21A-42A_n78A-n257I                      DC_1A-21A-42C_n78A-n257A                      DC_1A-21A-42C_n78A-n257G                      DC_1A-21A-42C_n78A-n257H                      DC_1A-21A-42C_n78A-n257I</p>	<p>DC_1A_n78A                      DC_1A_n257A                      DC_1A_n257G                      DC_1A_n257H                      DC_1A_n257I                      DC_21A_n78A                      DC_21A_n257A                      DC_21A_n257G                      DC_21A_n257H                      DC_21A_n257I                      DC_42A_n257A                      DC_42A_n257G                      DC_42A_n257H                      DC_42A_n257I</p>
<p>DC_1A-21A-42A_n79A-n257A                      DC_1A-21A-42A_n79A-n257G                      DC_1A-21A-42A_n79A-n257H                      DC_1A-21A-42A_n79A-n257I                      DC_1A-21A-42C_n79A-n257A                      DC_1A-21A-42C_n79A-n257G                      DC_1A-21A-42C_n79A-n257H                      DC_1A-21A-42C_n79A-n257I</p>	<p>DC_1A_n79A                      DC_1A_n257A                      DC_1A_n257G                      DC_1A_n257H                      DC_1A_n257I                      DC_21A_n79A                      DC_21A_n257A                      DC_21A_n257G                      DC_21A_n257H                      DC_21A_n257I                      DC_42A_n257A                      DC_42A_n257G                      DC_42A_n257H                      DC_42A_n257I</p>

EN-DC configuration	Uplink EN-DC configuration (NOTE 1)
DC_1A-19A-42A_n79A-n257A DC_1A-19A-42A_n79A-n257G DC_1A-19A-42A_n79A-n257H DC_1A-19A-42A_n79A-n257I DC_1A-19A-42C_n79A-n257A DC_1A-19A-42C_n79A-n257G DC_1A-19A-42C_n79A-n257H DC_1A-19A-42C_n79A-n257I	DC_1A_n79A-n257A DC_1A_n79A-n257G DC_1A_n79A-n257H DC_1A_n79A-n257I DC_19A_n79A-n257A DC_19A_n79A-n257G DC_19A_n79A-n257H DC_19A_n79A-n257I
DC_1A-21A-42A_n77A-n257A DC_1A-21A-42A_n77A-n257G DC_1A-21A-42A_n77A-n257H DC_1A-21A-42A_n77A-n257I DC_1A-21A-42C_n77A-n257A DC_1A-21A-42C_n77A-n257G DC_1A-21A-42C_n77A-n257H DC_1A-21A-42C_n77A-n257I	DC_1A_n77A-n257A DC_1A_n77A-n257G DC_1A_n77A-n257H DC_1A_n77A-n257I DC_21A_n77A-n257A DC_21A_n77A-n257G DC_21A_n77A-n257H DC_21A_n77A-n257I
DC_1A-21A-42A_n78A-n257A DC_1A-21A-42A_n78A-n257G DC_1A-21A-42A_n78A-n257H DC_1A-21A-42A_n78A-n257I DC_1A-21A-42C_n78A-n257A DC_1A-21A-42C_n78A-n257G DC_1A-21A-42C_n78A-n257H DC_1A-21A-42C_n78A-n257I	DC_1A_n78A-n257A DC_1A_n78A-n257G DC_1A_n78A-n257H DC_1A_n78A-n257I DC_21A_n78A-n257A DC_21A_n78A-n257G DC_21A_n78A-n257H DC_21A_n78A-n257I
DC_1A-21A-42A_n79A-n257A DC_1A-21A-42A_n79A-n257G DC_1A-21A-42A_n79A-n257H DC_1A-21A-42A_n79A-n257I DC_1A-21A-42C_n79A-n257A DC_1A-21A-42C_n79A-n257G DC_1A-21A-42C_n79A-n257H DC_1A-21A-42C_n79A-n257I	DC_1A_n79A-n257A DC_1A_n79A-n257G DC_1A_n79A-n257H DC_1A_n79A-n257I DC_21A_n79A-n257A DC_21A_n79A-n257G DC_21A_n79A-n257H DC_21A_n79A-n257I
DC_1A-28A-42A_n78A-n257A DC_1A-28A-42A_n78A-n257G DC_1A-28A-42A_n78A-n257H DC_1A-28A-42A_n78A-n257I DC_1A-28A-42C_n78A-n257A DC_1A-28A-42C_n78A-n257G DC_1A-28A-42C_n78A-n257H DC_1A-28A-42C_n78A-n257I	DC_1A_n78A DC_1A_n257A DC_1A_n257G DC_1A_n257H DC_1A_n257I DC_28A_n78A DC_28A_n257A DC_28A_n257G DC_28A_n257H DC_28A_n257I DC_42A_n257A DC_42A_n257G DC_42A_n257H DC_42A_n257I DC_42C_n257A DC_42C_n257G DC_42C_n257H DC_42C_n257I

EN-DC configuration	Uplink EN-DC configuration (NOTE 1)
<p>DC_1A-41A-42A_n77A-n257A                      DC_1A-41A-42A_n77A-n257G                      DC_1A-41A-42A_n77A-n257H                      DC_1A-41A-42A_n77A-n257I                      DC_1A-41A-42C_n77A-n257A                      DC_1A-41A-42C_n77A-n257G                      DC_1A-41A-42C_n77A-n257H                      DC_1A-41A-42C_n77A-n257I                      DC_1A-41C-42A_n77A-n257A                      DC_1A-41C-42A_n77A-n257G                      DC_1A-41C-42A_n77A-n257H                      DC_1A-41C-42A_n77A-n257I                      DC_1A-41C-42C_n77A-n257A                      DC_1A-41C-42C_n77A-n257G                      DC_1A-41C-42C_n77A-n257H                      DC_1A-41C-42C_n77A-n257I</p>	<p>DC_1A_n77A                      DC_1A_n257A                      DC_1A_n257G                      DC_1A_n257H                      DC_1A_n257I                      DC_41A_n77A                      DC_41A_n257A                      DC_41A_n257G                      DC_41A_n257H                      DC_41A_n257I                      DC_41C_n77A                      DC_41C_n257A                      DC_41C_n257G                      DC_41C_n257H                      DC_41C_n257I                      DC_42A_n257A                      DC_42A_n257G                      DC_42A_n257H                      DC_42A_n257I                      DC_42C_n257A                      DC_42C_n257G                      DC_42C_n257H                      DC_42C_n257I</p>
<p>DC_1A-41A-42A_n78A-n257A                      DC_1A-41A-42A_n78A-n257G                      DC_1A-41A-42A_n78A-n257H                      DC_1A-41A-42A_n78A-n257I                      DC_1A-41A-42C_n78A-n257A                      DC_1A-41A-42C_n78A-n257G                      DC_1A-41A-42C_n78A-n257H                      DC_1A-41A-42C_n78A-n257I                      DC_1A-41C-42A_n78A-n257A                      DC_1A-41C-42A_n78A-n257G                      DC_1A-41C-42A_n78A-n257H                      DC_1A-41C-42A_n78A-n257I                      DC_1A-41C-42C_n78A-n257A                      DC_1A-41C-42C_n78A-n257G                      DC_1A-41C-42C_n78A-n257H                      DC_1A-41C-42C_n78A-n257I</p>	<p>DC_1A_n78A                      DC_1A_n257A                      DC_1A_n257G                      DC_1A_n257H                      DC_1A_n257I                      DC_41A_n78A                      DC_41A_n257A                      DC_41A_n257G                      DC_41A_n257H                      DC_41A_n257I                      DC_41C_n78A                      DC_41C_n257A                      DC_41C_n257G                      DC_41C_n257H                      DC_41C_n257I                      DC_42A_n257A                      DC_42A_n257G                      DC_42A_n257H                      DC_42A_n257I                      DC_42C_n257A                      DC_42C_n257G                      DC_42C_n257H                      DC_42C_n257I</p>
<p>DC_3A-5A-7A_n78A-n257A                      DC_3A-5A-7A_n78A-n257D                      DC_3A-5A-7A_n78A-n257E                      DC_3A-5A-7A_n78A-n257F                      DC_3A-5A-7A_n78A-n257G                      DC_3A-5A-7A_n78A-n257H                      DC_3A-5A-7A_n78A-n257I                      DC_3A-5A-7A_n78A-n257J                      DC_3A-5A-7A_n78A-n257K                      DC_3A-5A-7A_n78A-n257L                      DC_3A-5A-7A_n78A-n257M</p>	<p>DC_3A_n78A                      DC_3A_n257A                      DC_5A_n78A                      DC_5A_n257A                      DC_7A_n78A                      DC_7A_n257A</p>
<p>DC_3A-5A-7A-7A_n78A-n257A                      DC_3A-5A-7A-7A_n78A-n257D                      DC_3A-5A-7A-7A_n78A-n257E                      DC_3A-5A-7A-7A_n78A-n257F                      DC_3A-5A-7A-7A_n78A-n257G                      DC_3A-5A-7A-7A_n78A-n257H                      DC_3A-5A-7A-7A_n78A-n257I                      DC_3A-5A-7A-7A_n78A-n257J                      DC_3A-5A-7A-7A_n78A-n257K</p>	<p>DC_3A_n78A                      DC_3A_n257A                      DC_5A_n78A                      DC_5A_n257A                      DC_7A_n78A                      DC_7A_n257A</p>

EN-DC configuration	Uplink EN-DC configuration (NOTE 1)
DC_3A-5A-7A-7A_n78A-n257L DC_3A-5A-7A-7A_n78A-n257M	
DC_3A-18A-42A_n78A-n257A DC_3A-18A-42A_n78A-n257G DC_3A-18A-42A_n78A-n257H DC_3A-18A-42A_n78A-n257I DC_3A-18A-42C_n78A-n257A DC_3A-18A-42C_n78A-n257G DC_3A-18A-42C_n78A-n257H DC_3A-18A-42C_n78A-n257I	DC_3A_n78A DC_3A_n257A DC_3A_n257G DC_3A_n257H DC_3A_n257I DC_18A_n78A DC_18A_n257A DC_18A_n257G DC_18A_n257H DC_18A_n257I DC_42A_n257A DC_42A_n257G DC_42A_n257H DC_42A_n257I DC_42C_n257A DC_42C_n257G DC_42C_n257H DC_42C_n257I
DC_3A-41A-42A_n77A-n257A DC_3A-41A-42A_n77A-n257G DC_3A-41A-42A_n77A-n257H DC_3A-41A-42A_n77A-n257I DC_3A-41A-42C_n77A-n257A DC_3A-41A-42C_n77A-n257G DC_3A-41A-42C_n77A-n257H DC_3A-41A-42C_n77A-n257I DC_3A-41C-42A_n77A-n257A DC_3A-41C-42A_n77A-n257G DC_3A-41C-42A_n77A-n257H DC_3A-41C-42A_n77A-n257I DC_3A-41C-42C_n77A-n257A DC_3A-41C-42C_n77A-n257G DC_3A-41C-42C_n77A-n257H DC_3A-41C-42C_n77A-n257I	DC_3A_n77A DC_3A_n257A DC_3A_n257G DC_3A_n257H DC_3A_n257I DC_41A_n77A DC_41A_n257A DC_41A_n257G DC_41A_n257H DC_41A_n257I DC_41C_n77A DC_41C_n257A DC_41C_n257G DC_41C_n257H DC_41C_n257I DC_42A_n257A DC_42A_n257G DC_42A_n257H DC_42A_n257I DC_42C_n257A DC_42C_n257G DC_42C_n257H DC_42C_n257I
DC_3A-28A-41A_n78A-n257A DC_3A-28A-41A_n78A-n257G DC_3A-28A-41A_n78A-n257H DC_3A-28A-41A_n78A-n257I DC_3A-28A-41C_n78A-n257A DC_3A-28A-41C_n78A-n257G DC_3A-28A-41C_n78A-n257H DC_3A-28A-41C_n78A-n257I	DC_3A_n78A DC_3A_n257A DC_3A_n257G DC_3A_n257H DC_3A_n257I DC_28A_n78A DC_28A_n257A DC_28A_n257G DC_28A_n257H DC_28A_n257I DC_41A_n78A DC_41A_n257A DC_41A_n257G DC_41A_n257H DC_41A_n257I

EN-DC configuration	Uplink EN-DC configuration (NOTE 1)
	DC_41C_n78A DC_41C_n257A DC_41C_n257G DC_41C_n257H DC_41C_n257I
DC_3A-28A-42A_n78A-n257A DC_3A-28A-42A_n78A-n257G DC_3A-28A-42A_n78A-n257H DC_3A-28A-42A_n78A-n257I DC_3A-28A-42C_n78A-n257A DC_3A-28A-42C_n78A-n257G DC_3A-28A-42C_n78A-n257H DC_3A-28A-42C_n78A-n257I	DC_3A_n78A DC_3A_n257A DC_3A_n257G DC_3A_n257H DC_3A_n257I DC_28A_n78A DC_28A_n257A DC_28A_n257G DC_28A_n257H DC_28A_n257I DC_42A_n257A DC_42A_n257G DC_42A_n257H DC_42A_n257I DC_42C_n257A DC_42C_n257G DC_42C_n257H DC_42C_n257I
DC_3A-41A-42A_n78A-n257A DC_3A-41A-42A_n78A-n257G DC_3A-41A-42A_n78A-n257H DC_3A-41A-42A_n78A-n257I DC_3A-41A-42C_n78A-n257A DC_3A-41A-42C_n78A-n257G DC_3A-41A-42C_n78A-n257H DC_3A-41A-42C_n78A-n257I DC_3A-41C-42A_n78A-n257A DC_3A-41C-42A_n78A-n257G DC_3A-41C-42A_n78A-n257H DC_3A-41C-42A_n78A-n257I DC_3A-41C-42C_n78A-n257A DC_3A-41C-42C_n78A-n257G DC_3A-41C-42C_n78A-n257H DC_3A-41C-42C_n78A-n257I	DC_3A_n78A DC_3A_n257A DC_3A_n257G DC_3A_n257H DC_3A_n257I DC_41A_n78A DC_41A_n257A DC_41A_n257G DC_41A_n257H DC_41A_n257I DC_41C_n78A DC_41C_n257A DC_41C_n257G DC_41C_n257H DC_41C_n257I DC_42A_n257A DC_42A_n257G DC_42A_n257H DC_42A_n257I DC_42C_n257A DC_42C_n257G DC_42C_n257H DC_42C_n257I
DC_19A-21A-42A_n77A-n257A DC_19A-21A-42A_n77A-n257G DC_19A-21A-42A_n77A-n257H DC_19A-21A-42A_n77A-n257I DC_19A-21A-42C_n77A-n257A DC_19A-21A-42C_n77A-n257G DC_19A-21A-42C_n77A-n257H DC_19A-21A-42C_n77A-n257I	DC_19A_n77A DC_19A_n257A DC_19A_n257G DC_19A_n257H DC_19A_n257I DC_21A_n77A DC_21A_n257A DC_21A_n257G DC_21A_n257H DC_21A_n257I DC_42A_n257A DC_42A_n257G DC_42A_n257H DC_42A_n257I

EN-DC configuration	Uplink EN-DC configuration (NOTE 1)
<p>DC_19A-21A-42A_n78A-n257A                      DC_19A-21A-42A_n78A-n257G                      DC_19A-21A-42A_n78A-n257H                      DC_19A-21A-42A_n78A-n257I                      DC_19A-21A-42C_n78A-n257A                      DC_19A-21A-42C_n78A-n257G                      DC_19A-21A-42C_n78A-n257H                      DC_19A-21A-42C_n78A-n257I</p>	<p>DC_19A_n78A                      DC_19A_n257A                      DC_19A_n257G                      DC_19A_n257H                      DC_19A_n257I                      DC_21A_n78A                      DC_21A_n257A                      DC_21A_n257G                      DC_21A_n257H                      DC_21A_n257I                      DC_42A_n257A                      DC_42A_n257G                      DC_42A_n257H                      DC_42A_n257I</p>
<p>DC_19A-21A-42A_n79A-n257A                      DC_19A-21A-42A_n79A-n257G                      DC_19A-21A-42A_n79A-n257H                      DC_19A-21A-42A_n79A-n257I                      DC_19A-21A-42C_n79A-n257A                      DC_19A-21A-42C_n79A-n257G                      DC_19A-21A-42C_n79A-n257H                      DC_19A-21A-42C_n79A-n257I</p>	<p>DC_19A_n79A                      DC_19A_n257A                      DC_19A_n257G                      DC_19A_n257H                      DC_19A_n257I                      DC_21A_n79A                      DC_21A_n257A                      DC_21A_n257G                      DC_21A_n257H                      DC_21A_n257I                      DC_42A_n257A                      DC_42A_n257G                      DC_42A_n257H                      DC_42A_n257I</p>



EN-DC configuration	Uplink EN-DC configuration (NOTE 1)
DC_19A-21A-42A_n77A-n257A DC_19A-21A-42A_n77A-n257G DC_19A-21A-42A_n77A-n257H DC_19A-21A-42A_n77A-n257I DC_19A-21A-42C_n77A-n257A DC_19A-21A-42C_n77A-n257G DC_19A-21A-42C_n77A-n257H DC_19A-21A-42C_n77A-n257I	DC_19A_n77A-n257A DC_19A_n77A-n257G DC_19A_n77A-n257H DC_19A_n77A-n257I DC_21A_n77A-n257A DC_21A_n77A-n257G DC_21A_n77A-n257H DC_21A_n77A-n257I
DC_19A-21A-42A_n78A-n257A DC_19A-21A-42A_n78A-n257G DC_19A-21A-42A_n78A-n257H DC_19A-21A-42A_n78A-n257I DC_19A-21A-42C_n78A-n257A DC_19A-21A-42C_n78A-n257G DC_19A-21A-42C_n78A-n257H DC_19A-21A-42C_n78A-n257I	DC_19A_n78A-n257A DC_19A_n78A-n257G DC_19A_n78A-n257H DC_19A_n78A-n257I DC_21A_n78A-n257A DC_21A_n78A-n257G DC_21A_n78A-n257H DC_21A_n78A-n257I
DC_19A-21A-42A_n79A-n257A DC_19A-21A-42A_n79A-n257G DC_19A-21A-42A_n79A-n257H DC_19A-21A-42A_n79A-n257I DC_19A-21A-42C_n79A-n257A DC_19A-21A-42C_n79A-n257G DC_19A-21A-42C_n79A-n257H DC_19A-21A-42C_n79A-n257I	DC_19A_n79A-n257A DC_19A_n79A-n257G DC_19A_n79A-n257H DC_19A_n79A-n257I DC_21A_n79A-n257A DC_21A_n79A-n257G DC_21A_n79A-n257H DC_21A_n79A-n257I
DC_28A-41A-42A_n78A-n257A DC_28A-41A-42A_n78A-n257G DC_28A-41A-42A_n78A-n257H DC_28A-41A-42A_n78A-n257I DC_28A-41A-42C_n78A-n257A DC_28A-41A-42C_n78A-n257G DC_28A-41A-42C_n78A-n257H DC_28A-41A-42C_n78A-n257I DC_28A-41C-42A_n78A-n257A DC_28A-41C-42A_n78A-n257G DC_28A-41C-42A_n78A-n257H DC_28A-41C-42A_n78A-n257I DC_28A-41C-42C_n78A-n257A DC_28A-41C-42C_n78A-n257G DC_28A-41C-42C_n78A-n257H DC_28A-41C-42C_n78A-n257I	DC_28A_n78A DC_28A_n257A DC_28A_n257G DC_28A_n257H DC_28A_n257I DC_41A_n78A DC_41A_n257A DC_41A_n257G DC_41A_n257H DC_41A_n257I DC_41C_n78A DC_41C_n257A DC_41C_n257G DC_41C_n257H DC_41C_n257I DC_42A_n257A DC_42A_n257G DC_42A_n257H DC_42A_n257I DC_42C_n257A DC_42C_n257G DC_42C_n257H DC_42C_n257I
NOTE 1: Uplink EN-DC configurations are the configurations supported by the present release of specifications.	

5.5B.6.5 Inter-band EN-DC configurations including FR1 and FR2 (six bands)

**Table 5.5B.6.5-1: Inter-band EN-DC configurations including FR1 and FR2 (six bands)**

EN-DC configuration	Uplink EN-DC configuration (NOTE 1)
DC_1A-3A-5A-7A-7A_n78A-n257A DC_1A-3A-5A-7A-7A_n78A-n257D DC_1A-3A-5A-7A-7A_n78A-n257E DC_1A-3A-5A-7A-7A_n78A-n257F DC_1A-3A-5A-7A-7A_n78A-n257G DC_1A-3A-5A-7A-7A_n78A-n257H DC_1A-3A-5A-7A-7A_n78A-n257I DC_1A-3A-5A-7A-7A_n78A-n257J DC_1A-3A-5A-7A-7A_n78A-n257K DC_1A-3A-5A-7A-7A_n78A-n257L DC_1A-3A-5A-7A-7A_n78A-n257M	DC_1A_n78A DC_3A_n78A DC_5A_n78A DC_7A_n78A DC_1A_n257A DC_3A_n257A DC_5A_n257A DC_7A_n257A
DC_1A-3A-5A-7A_n78A-n257A DC_1A-3A-5A-7A_n78A-n257D DC_1A-3A-5A-7A_n78A-n257E DC_1A-3A-5A-7A_n78A-n257F DC_1A-3A-5A-7A_n78A-n257G DC_1A-3A-5A-7A_n78A-n257H DC_1A-3A-5A-7A_n78A-n257I DC_1A-3A-5A-7A_n78A-n257J DC_1A-3A-5A-7A_n78A-n257K DC_1A-3A-5A-7A_n78A-n257L DC_1A-3A-5A-7A_n78A-n257M	DC_1A_n78A DC_1A_n257A DC_3A_n78A DC_3A_n257A DC_5A_n78A DC_5A_n257A DC_7A_n78A DC_7A_n257A
DC_1A-3A-18A-42A_n78A-n257A DC_1A-3A-18A-42A_n78A-n257G DC_1A-3A-18A-42A_n78A-n257H DC_1A-3A-18A-42A_n78A-n257I DC_1A-3A-18A-42C_n78A-n257A DC_1A-3A-18A-42C_n78A-n257G DC_1A-3A-18A-42C_n78A-n257H DC_1A-3A-18A-42C_n78A-n257I	DC_1A_n78A DC_1A_n257A DC_1A_n257G DC_1A_n257H DC_1A_n257I DC_3A_n78A DC_3A_n257A DC_3A_n257G DC_3A_n257H DC_3A_n257I DC_18A_n78A DC_18A_n257A DC_18A_n257G DC_18A_n257H DC_18A_n257I DC_42A_n257A DC_42A_n257G DC_42A_n257H DC_42A_n257I DC_42C_n257A DC_42C_n257G DC_42C_n257H DC_42C_n257I

<p>DC_1A-3A-28A-42A_n78A-n257A                  DC_1A-3A-28A-42A_n78A-n257G                  DC_1A-3A-28A-42A_n78A-n257H                  DC_1A-3A-28A-42A_n78A-n257I                  DC_1A-3A-28A-42C_n78A-n257A                  DC_1A-3A-28A-42C_n78A-n257G                  DC_1A-3A-28A-42C_n78A-n257H                  DC_1A-3A-28A-42C_n78A-n257I</p>	<p>DC_1A_n78A                  DC_1A_n257A                  DC_1A_n257G                  DC_1A_n257H                  DC_1A_n257I                  DC_3A_n78A                  DC_3A_n257A                  DC_3A_n257G                  DC_3A_n257H                  DC_3A_n257I                  DC_28A_n78A                  DC_28A_n257A                  DC_28A_n257G                  DC_28A_n257H                  DC_28A_n257I                  DC_42A_n257A                  DC_42A_n257G                  DC_42A_n257H                  DC_42A_n257I                  DC_42C_n257A                  DC_42C_n257G                  DC_42C_n257H                  DC_42C_n257I</p>
<p>DC_1A-3A-41A-42A_n77A-n257A                  DC_1A-3A-41A-42A_n77A-n257G                  DC_1A-3A-41A-42A_n77A-n257H                  DC_1A-3A-41A-42A_n77A-n257I                  DC_1A-3A-41C-42A_n77A-n257A                  DC_1A-3A-41C-42A_n77A-n257G                  DC_1A-3A-41C-42A_n77A-n257H                  DC_1A-3A-41C-42A_n77A-n257I                  DC_1A-3A-41A-42C_n77A-n257A                  DC_1A-3A-41A-42C_n77A-n257G                  DC_1A-3A-41A-42C_n77A-n257H                  DC_1A-3A-41A-42C_n77A-n257I                  DC_1A-3A-41C-42C_n77A-n257A                  DC_1A-3A-41C-42C_n77A-n257G                  DC_1A-3A-41C-42C_n77A-n257H                  DC_1A-3A-41C-42C_n77A-n257I</p>	<p>DC_1A_n77A                  DC_1A_n257A                  DC_1A_n257G                  DC_1A_n257H                  DC_1A_n257I                  DC_3A_n77A                  DC_3A_n257A                  DC_3A_n257G                  DC_3A_n257H                  DC_3A_n257I                  DC_41A_n77A                  DC_41A_n257A                  DC_41A_n257G                  DC_41A_n257H                  DC_41A_n257I                  DC_41C_n77A                  DC_41C_n257A                  DC_41C_n257G                  DC_41C_n257H                  DC_41C_n257I                  DC_42A_n257A                  DC_42A_n257G                  DC_42A_n257H                  DC_42A_n257I                  DC_42C_n257A                  DC_42C_n257G                  DC_42C_n257H                  DC_42C_n257I</p>

<p>DC_1A-3A-41A-42A_n78A-n257A                  DC_1A-3A-41A-42A_n78A-n257G                  DC_1A-3A-41A-42A_n78A-n257H                  DC_1A-3A-41A-42A_n78A-n257I                  DC_1A-3A-41A-42C_n78A-n257A                  DC_1A-3A-41A-42C_n78A-n257G                  DC_1A-3A-41A-42C_n78A-n257H                  DC_1A-3A-41A-42C_n78A-n257I                  DC_1A-3A-41C-42A_n78A-n257A                  DC_1A-3A-41C-42A_n78A-n257G                  DC_1A-3A-41C-42A_n78A-n257H                  DC_1A-3A-41C-42A_n78A-n257I                  DC_1A-3A-41C-42C_n78A-n257A                  DC_1A-3A-41C-42C_n78A-n257G                  DC_1A-3A-41C-42C_n78A-n257H                  DC_1A-3A-41C-42C_n78A-n257I</p>	<p>DC_1A_n78A                  DC_1A_n257A                  DC_1A_n257G                  DC_1A_n257H                  DC_1A_n257I                  DC_3A_n78A                  DC_3A_n257A                  DC_3A_n257G                  DC_3A_n257H                  DC_3A_n257I                  DC_41A_n78A                  DC_41A_n257A                  DC_41A_n257G                  DC_41A_n257H                  DC_41A_n257I                  DC_41C_n78A                  DC_41C_n257A                  DC_41C_n257G                  DC_41C_n257H                  DC_41C_n257I                  DC_42A_n257A                  DC_42A_n257G                  DC_42A_n257H                  DC_42A_n257I                  DC_42C_n257A                  DC_42C_n257G                  DC_42C_n257H                  DC_42C_n257I</p>
<p>DC_3A-28A-41A-42A_n78A-n257A                  DC_3A-28A-41A-42A_n78A-n257G                  DC_3A-28A-41A-42A_n78A-n257H                  DC_3A-28A-41A-42A_n78A-n257I                  DC_3A-28A-41A-42C_n78A-n257A                  DC_3A-28A-41A-42C_n78A-n257G                  DC_3A-28A-41A-42C_n78A-n257H                  DC_3A-28A-41A-42C_n78A-n257I                  DC_3A-28A-41C-42A_n78A-n257A                  DC_3A-28A-41C-42A_n78A-n257G                  DC_3A-28A-41C-42A_n78A-n257H                  DC_3A-28A-41C-42A_n78A-n257I                  DC_3A-28A-41C-42C_n78A-n257A                  DC_3A-28A-41C-42C_n78A-n257G                  DC_3A-28A-41C-42C_n78A-n257H                  DC_3A-28A-41C-42C_n78A-n257I</p>	<p>DC_3A_n78A                  DC_3A_n257A                  DC_3A_n257G                  DC_3A_n257H                  DC_3A_n257I                  DC_28A_n78A                  DC_28A_n257A                  DC_28A_n257G                  DC_28A_n257H                  DC_28A_n257I                  DC_41A_n78A                  DC_41A_n257A                  DC_41A_n257G                  DC_41A_n257H                  DC_41A_n257I                  DC_41C_n78A                  DC_41C_n257A                  DC_41C_n257G                  DC_41C_n257H                  DC_41C_n257I                  DC_42A_n257A                  DC_42A_n257G                  DC_42A_n257H                  DC_42A_n257I                  DC_42C_n257A                  DC_42C_n257G                  DC_42C_n257H                  DC_42C_n257I</p>
<p>NOTE 1: Uplink EN-DC configurations are the configurations supported by the present release of specifications</p>	

## 5.5B.7 Inter-band NR-DC between FR1 and FR2

### 5.5B.7.1 Inter-band NR-DC configurations between FR1 and FR2 (two bands)

**Table 5.5B.7-1: Inter-band NR-DC configurations between FR1 and FR2 (two bands)**

Downlink NR DC configuration	Uplink NR DC configuration
DC_n3A-n257A DC_n3A-n257D DC_n3A-n257G DC_n3A-n257H DC_n3A-n257I	DC_n3A-n257A DC_n3A-n257D DC_n3A-n257G DC_n3A-n257H DC_n3A-n257I
DC_n28A-n257A DC_n28A-n257D DC_n28A-n257G DC_n28A-n257H DC_n28A-n257I	DC_n28A-n257A DC_n28A-n257D DC_n28A-n257G DC_n28A-n257H DC_n28A-n257I
DC_n77A-n257A DC_n77A-n257D DC_n77A-n257E DC_n77A-n257F DC_n77A-n257G DC_n77A-n257H DC_n77A-n257I DC_n77A-n257J DC_n77A-n257K DC_n77A-n257L DC_n77A-n257M DC_n77C-n257A DC_n77C-n257D DC_n77C-n257E DC_n77C-n257F	DC_n77A-n257A DC_n77A-n257G DC_n77A-n257H DC_n77A-n257I DC_n77A-n257J DC_n77A-n257K DC_n77A-n257L DC_n77A-n257M
DC_n77(2A)-n257A DC_n77(2A)-n257G DC_n77(2A)-n257H DC_n77(2A)-n257I DC_n77(2A)-n257J DC_n77(2A)-n257K DC_n77(2A)-n257L DC_n77(2A)-n257M	DC_n77A-n257A DC_n77A-n257G DC_n77A-n257H DC_n77A-n257I DC_n77A-n257J DC_n77A-n257K DC_n77A-n257L DC_n77A-n257M
DC_n77A-n261A DC_n77A-n261G DC_n77A-n261H DC_n77A-n261I DC_n77A-n261J DC_n77A-n261K DC_n77A-n261L DC_n77A-n261M	DC_n77A-n261A DC_n77A-n261G DC_n77A-n261H DC_n77A-n261I DC_n77A-n261J DC_n77A-n261K DC_n77A-n261L DC_n77A-n261M
DC_n77A-n261(2A) DC_n77A-n261(2G) DC_n77A-n261(2H) DC_n77A-n261(2I) DC_n77A-n261(3A) DC_n77A-n261(4A)	DC_n77A-n261A
DC_n77A-n261(A-G) DC_n77A-n261(A-H) DC_n77A-n261(A-I) DC_n77A-n261(G-H) DC_n77A-n261(G-I) DC_n77A-n261(H-I)	DC_n77A-n261A
	DC_n78A-n257A DC_n78A-n257G DC_n78A-n257H DC_n78A-n257I

Downlink NR DC configuration	Uplink NR DC configuration
DC_n78A-n257A DC_n78A-n257D DC_n78A-n257E DC_n78A-n257F DC_n78A-n257G DC_n78A-n257H DC_n78A-n257I DC_n78A-n257J DC_n78A-n257K DC_n78A-n257L DC_n78A-n257M DC_n78C-n257A DC_n78C-n257D DC_n78C-n257E DC_n78C-n257F	
DC_n79A-n257A DC_n79A-n257D DC_n79A-n257E DC_n79A-n257F DC_n79A-n257G DC_n79A-n257H DC_n79A-n257I DC_n79A-n257J DC_n79A-n257K DC_n79A-n257L DC_n79A-n257M DC_n79C-n257A DC_n79C-n257D DC_n79C-n257E DC_n79C-n257F	DC_n79A-n257A
NOTE 1: NR configuration for FR1 and FR2 are defined in TS 38.101-1 [2] and TS 38.101-2 [3] respectively.	



5.5B.7.2 Inter-band NR-DC configurations between FR1 and FR2 (three bands)

Table 5.5B.7-2: Inter-band NR-DC configurations between FR1 and FR2 (three bands)

Downlink NR DC configuration	Uplink NR DC configuration
DC_n3A-n28A-n257A DC_n3A-n28A-n257G DC_n3A-n28A-n257H DC_n3A-n28A-n257I	DC_n3A-n28A DC_n3A-n257A DC_n3A-n257G DC_n3A-n257H DC_n3A-n257I DC_n28A-n257A DC_n28A-n257G DC_n28A-n257H DC_n28A-n257I
DC_n3A-n77A-n257A DC_n3A-n77A-n257G DC_n3A-n77A-n257H DC_n3A-n77A-n257I	DC_n3A-n77A DC_n3A-n257A DC_n3A-n257G DC_n3A-n257H DC_n3A-n257I DC_n77A-n257A DC_n77A-n257G DC_n77A-n257H DC_n77A-n257I
DC_n3A-n77(2A)-n257A DC_n3A-n77(2A)-n257G DC_n3A-n77(2A)-n257H DC_n3A-n77(2A)-n257I	DC_n3A-n77A DC_n3A-n257A DC_n3A-n257G DC_n3A-n257H DC_n3A-n257I DC_n77A-n257A DC_n77A-n257G DC_n77A-n257H DC_n77A-n257I
DC_n3A-n78A-n257A DC_n3A-n78A-n257G DC_n3A-n78A-n257H DC_n3A-n78A-n257I	DC_n3A-n78A DC_n3A-n257A DC_n3A-n257G DC_n3A-n257H DC_n3A-n257I DC_n78A-n257A DC_n78A-n257G DC_n78A-n257H DC_n78A-n257I
DC_n28A-n77A-n257A DC_n28A-n77A-n257G DC_n28A-n77A-n257H DC_n28A-n77A-n257I	DC_n28A-n77A DC_n28A-n257A DC_n28A-n257G DC_n28A-n257H DC_n28A-n257I DC_n77A-n257A DC_n77A-n257G DC_n77A-n257H DC_n77A-n257I
DC_n28A-n78A-n257A DC_n28A-n78A-n257G DC_n28A-n78A-n257H DC_n28A-n78A-n257I	DC_n28A-n78A DC_n28A-n257A DC_n28A-n257G DC_n28A-n257H DC_n28A-n257I DC_n78A-n257A DC_n78A-n257G DC_n78A-n257H DC_n78A-n257I
NOTE 1: NR configuration for FR1 and FR2 are defined in TS 38.101-1 [2] and TS 38.101-2 [3] respectively.	

5.5C Void

5.5D Void

5.5E Configuration for V2X operation

5.5E.1 General

The operating bands and bandwidth classes are specified for V2X operation.

5.5E.2 Intra-band contiguous V2X operation in FR1

**Table 5.5E.2-1: Intra-band contiguous V2X configurations**

V2X configuration	SL transmission
V2X_(n)47AA	E-UTRA Band 47 or NR band n47
NOTE 1: Only single switched SL is supported.	

5.5E.3 Intra-band non-contiguous V2X operation in FR1

**Table 5.5E.3-1: Intra-band non-contiguous V2X configurations**

V2X configuration	SL transmission
V2X_47A_n47A	E-UTRA Band 47 or NR band n47
NOTE 1: Only single switched SL is supported.	

5.5E.4 Inter-band V2X operation in FR1

5.5E.4.1 Inter-band V2X configurations within FR1 (two bands)

**Table 5.5E.4.1-1: Inter-band V2X configurations**

V2X configuration	V2X transmission configuration
V2X_20A_n38A	V2X_20A_n38A
V2X_n71A_47A	V2X_n71A_47A
NOTE 1: V2X transmission configurations are the configurations supported by the present release of specifications.	

---

## 6 Transmitter characteristics

### 6.1 General

Unless otherwise stated the transmitter characteristics are specified at the antenna connector(s) of the UE for the bands operating on frequency range 1 and over the air of the UE for the bands operating on frequency range 2. The requirements for frequency range 1 and frequency range 2 can be verified separately. For the carrier in frequency range 1, requirements can be verified with NR FR2 link disabled. For the carrier in frequency range 2, requirements can be verified in OTA mode with E-UTRA connecting to the network by OTA without calibration.

Unless otherwise stated, requirements for NR transmitter written in TS 38.101-1 [2] and TS 38.101-2 [3] apply and are assumed anchor agnostic. Requirements are verified under conditions where anchor resources do not interfere NR operation.

For sub-clauses with suffix A or B: the minimum requirements for band combinations including Band n41 also apply for the corresponding band combinations with Band n90 replacing Band n41 but with otherwise identical parameters. For brevity the said band combinations with Band n90 are not listed in the tables below but are covered by this specification.

### 6.2 Void

#### 6.2A Transmitter power for CA

##### 6.2A.1 UE maximum output power for CA

###### 6.2A.1.1 Inter-band CA between FR1 and FR2

**Table 6.2A.1.1-1: Void**

For inter-band NR CA in FR1 and FR2 combined, the UE shall meet each transmitter power requirement specified in clause 6.2.1 of TS 38.101-1 [2] and clause 6.2.1 TS 38.101-2 [3] independently.

##### 6.2A.2 UE maximum output power reduction for CA

###### 6.2A.2.1 Inter-band CA between FR1 and FR2

For inter-band NR CA between FR1 and FR2, UE maximum output power reduction specified in TS 38.101-1 [2] and TS 38.101-2 [3] apply for each frequency range respectively.

##### 6.2A.3 UE additional maximum output power reduction for CA

For inter-band NR CA between FR1 and FR2, UE additional maximum output power reduction specified in TS 38.101-1 [2] and TS 38.101-2 [3] apply for each frequency range respectively.

##### 6.2A.4 Configured output power for CA

###### 6.2A.4.1 Configured output power level

For inter-band NR CA between FR1 and FR2, UE configured output power specified in TS 38.101-1 [2] and TS 38.101-2 [3] apply for each frequency range respectively.

## 6.2A.4.2 $\Delta T_{IB,c}$ for CA

### 6.2A.4.2.1 $\Delta T_{IB,c}$ for Inter-band CA between FR1 and FR2

$\Delta T_{IB,c}$  is independent between FR1 and FR2. For inter-band CA between FR1 and FR2,  $\Delta T_{IB,c}$  for the FR1 band(s) in TS 38.101-1 [2] applies and  $\Delta T_{IB,c}$  for the FR2 NR band(s) is set to zero. Otherwise  $\Delta T_{IB,c}$  is set to zero.

**Table 6.2A.4.2.1-1: Void**

**Table 6.2A.4.2.1-2: Void**

**Table 6.2A.4.2.1-3: Void**

## 6.2B Transmitter power for DC

### 6.2B.1 UE maximum output power for DC

#### 6.2B.1.1 Intra-band contiguous EN-DC

The following UE Power Classes define the total maximum output power for any transmission bandwidth(s) of the CG(s) configured.

The maximum output power is measured as the total maximum output power across the UE antenna connector(s). The period of measurement shall be at least one sub frame.

**Table 6.2B.1.1-1: Maximum output power for EN-DC (continuous sub-blocks)**

Configuration	Power class 1.5 (dBm)	Tolerance (dB)	Power class 2 (dBm)	Tolerance (dB)	Power class 3 (dBm)	Tolerance (dB)
C_(n)5AA <sup>3</sup>					23	+2/-3
C_(n)12AA <sup>3</sup>					23	+2/-3
C_(n)71AA					23	+2/-3
C_(n)38AA <sup>3</sup>					23	+2/-3
C_(n)41AA	29	+2/-3 <sup>1</sup>	26	+2/-3 <sup>1</sup>	23	+2/-3
C_(n)48AA <sup>3</sup>					23	+2/-3

1: If all transmitted resource blocks over all component carriers are confined within  $F_{UL,low}$  and  $F_{UL,low} + 4$  MHz or/and  $F_{UL,high} - 4$  MHz and  $F_{UL,high}$  the maximum output power requirement is relaxed by reducing the lower tolerance limit by 1.5 dB

2: Power Class 3 is the default power class unless otherwise stated.

3: Only single switched UL is supported.

If UE supports a different power class than the default UE power class for EN-DC band combination, and the supported power class enables higher maximum output power than that of the default power class:

- if the E-UTRA UL/DL configuration is 0 or 6; or
- if the E-UTRA UL/DL configuration is 1 and special subframe configuration is 0 or 5; or
- if the IE *p-maxUE-FR1-r15* as defined in TS 36.331 [8] is provided and set to the maximum output power of the default power class or lower;
  - apply all requirements for the default power class, and set the configured transmitted power as specified in clause 6.2B.4;
- else
- if the UE does not support a power class with higher maximum output power than power class 2; or

- if the E-UTRA UL/DL configuration is not 2 or 4 or 5; or
- if the field of UE capability maxUplinkDutyCycle is absent and the percentage of uplink symbols transmitted in a certain evaluation period is larger than 25% (The exact evaluation period is no less than one radio frame); or
- if the field of UE capability maxUplinkDutyCycle is not absent and the percentage of uplink symbols transmitted in a certain evaluation period is larger than maxUplinkDutyCycle/2 (The exact evaluation period is no less than one radio frame); or
- if the IE P-Max as defined in TS 38.331 [9] is provided and set to the maximum output power of the power class 2 or lower;
  - apply all requirements for the power class 2 and set the configured transmitted power as specified in clause 6.2B.4;
- else
  - apply all requirements for the supported power class, and set the configured transmitted power class as specified in clause 6.2B.4;

### 6.2B.1.2 Intra-band non-contiguous EN-DC

**Table 6.2B.1.2-1: Maximum output power for EN-DC (non-continuous sub-blocks)**

EN-DC configuration	Power class 1.5 (dBm)	Tolerance (dB)	Power class 2 (dBm)	Tolerance (dB)	Power class 3 (dBm)	Tolerance (dB)
DC_2A_n2A <sup>4</sup>					23	+2/-3
DC_3A_n3A <sup>2</sup>					23	+2/-3
DC_5A_n5A <sup>4</sup>					23	+2/-3
DC_7A_n7A <sup>4</sup>					23	+2/-3
DC_48A_n48A <sup>4</sup>					23	+2/-3
DC_41A_n41A	29	+2/-3 <sup>1</sup>	26	+2/-3 <sup>1</sup>	23	+2/-3 <sup>1</sup>
DC_66A_n66A <sup>4</sup>					23	+2/-3

NOTE 1: If all transmitted resource blocks over all component carriers are confined within  $F_{UL\_low}$  and  $F_{UL\_low} + 4$  MHz or/and  $F_{UL\_high} - 4$  MHz and  $F_{UL\_high}$ , the maximum output power requirement is relaxed by reducing the lower tolerance limit by 1.5 dB

NOTE 2: Only single switched UL is supported in Rel.15

NOTE 3: Power Class 3 is the default power class unless otherwise stated.

NOTE 4: Only single switched UL is supported

If UE supports a different power class than the default UE power class for EN-DC band combination, and the supported power class enables higher maximum output power than that of the default power class:

- if the E-UTRA UL/DL configuration is 0 or 6; or
- if the E-UTRA UL/DL configuration is 1 and special subframe configuration is 0 or 5; or
- if the IE *p-maxUE-FR1-r15* as defined in TS 36.331 [8] is provided and set to the maximum output power of the default power class or lower;
  - apply all requirements for the default power class, and set the configured transmitted power as specified in clause 6.2B.4;
- else
  - if the UE does not support a power class with higher maximum output power than power class 2; or
  - if the E-UTRA UL/DL configuration is not 2 or 4 or 5; or
  - if the field of UE capability maxUplinkDutyCycle is absent and the percentage of uplink symbols transmitted in a certain evaluation period is larger than 25% (The exact evaluation period is no less than one radio frame); or

- if the field of UE capability `maxUplinkDutyCycle` is not absent and the percentage of uplink symbols transmitted in a certain evaluation period is larger than `maxUplinkDutyCycle/2` (The exact evaluation period is no less than one radio frame); or
- if the IE `P-Max` as defined in TS 38.331 [9] is provided and set to the maximum output power of the power class 2 or lower;
  - apply all requirements for the power class 2 and set the configured transmitted power as specified in clause 6.2B.4;
- else
  - apply all requirements for the supported power class, and set the configured transmitted power class as specified in clause 6.2B.4;

### 6.2B.1.3 Inter-band EN-DC within FR1

For inter-band EN-DC of E-UTRA and NR in FR1, the following UE Power Classes define the maximum output power for any transmission bandwidth within the aggregated channel bandwidth. The maximum output power is measured as the sum of the maximum output power at each UE antenna connector. The period of measurement shall be at least one sub frame (1ms). UE maximum output power shall be measured over all component carriers from different bands. If each band has separate antenna connectors, maximum output power is measured as the sum of maximum output power at each UE antenna connector.

**Table 6.2B.1.3-1: Maximum output power for inter-band EN-DC (two bands)**

EN-DC configuration	Power class 2 (dBm)	Tolerance (dB)	Power class 3 (dBm)	Tolerance (dB)
DC_1A_n3A			23	+2/-3
DC_1A_n5A			23	+2/-3
DC_1A_n7A			23	+2/-3
DC_1A_n8A			23	+2/-3
DC_1A_n20A			23	+2/-3
DC_1A_n28A			23	+2/-3
DC_1A_n38A			23	+2/-3
DC_1A_n40A			23	+2/-3
DC_1A_n41A			23	+2/-3
DC_1A_n50A			23	+2/-3
DC_1A_n51A			23	+2/-3
DC_1A_n71A			23	+2/-3
DC_1A_n77A			23	+2/-3
DC_1A_n84A_ULSUP-TDM_n77A			23	+2/-3
DC_1A_n78A			23	+2/-3
DC_1A_n84A_ULSUP-TDM_n78A			23	+2/-3
DC_1A_n79A			23	+2/-3
DC_1A_n84A_ULSUP-TDM_n79A			23	+2/-3
DC_1A_n80A			23	+2/-3
DC_2A_n5A			23	+2/-3 <sup>1</sup>
DC_2A_n7A			23	+2/-3
DC_2A_n12A			23	+2/-3
DC_2A_n38A			23	+2/-3
DC_2A_n41A			23	+2/-3
DC_2A_n48A			23	+2/-3
DC_2A_n66A			23	+2/-3 <sup>1</sup>
DC_2A_n71A			23	+2/-3
DC_2A_n78A			23	+2/-3
DC_3A_n1A			23	+2/-3
DC_3A_n5A			23	+2/-3
DC_3C_n5A			23	+2/-3
DC_3A_n7A			23	+2/-3 <sup>1</sup>
DC_3A_n8A			23	+2/-3
DC_3A_n20A			23	+2/-3
DC_3A_n28A			23	+2/-3 <sup>1</sup>
DC_3A_n34A			23	+2/-3 <sup>1</sup>
DC_3A_n38A			23	+2/-3
DC_3A_n40A			23	+2/-3 <sup>1</sup>
DC_3A_n41A, DC_3C_n41A, DC_3C_n41A,			23	+2/-3
DC_3A_n50A			23	+2/-3
DC_3A_n51A			23	+2/-3 <sup>1</sup>
DC_3A_n71A			23	+2/-3
DC_3A_n77A			23	+2/-3 <sup>1</sup>
DC_3A_n78A			23	+2/-3 <sup>1</sup>
DC_3A_n79A DC_3C_n79A			23	+2/-3 <sup>1</sup>
DC_3A_n80A_ULSUP-TDM_n41 DC_3C_n80A_ULSUP-TDM_n41			23	+2/-3



EN-DC configuration	Power class 2 (dBm)	Tolerance (dB)	Power class 3 (dBm)	Tolerance (dB)
DC_3A_n80A_ULSUP-TDM_n77A			23	+2/-3 <sup>1</sup>
DC_3A_n80A_ULSUP-TDM_n78A			23	+2/-3 <sup>1</sup>
DC_3A_n80A_ULSUP-TDM_n79A			23	+2/-3 <sup>1</sup>
DC_3A_n82A			23	+2/-3 <sup>1</sup>
DC_3A_n84A			23	+2/-3 <sup>1</sup>
DC_4A_n38A			23	+2/-3
DC_4A_n41A			23	+2/-3
DC_4A_n78A			23	+2/-3
DC_5A_n2A			23	+2/-3
DC_5A_n7A			23	+2/-3
DC_5A_n12A			23	+2/-3
DC_5A_n38A			23	+2/-3
DC_5A_n40A			23	+2/-3 <sup>1</sup>
DC_5A_n48A			23	+2/-3
DC_5A_n66A			23	+2/-3 <sup>1</sup>
DC_5A_n71A			23	+2/-3
DC_5A_n78A			23	+2/-3
DC_5A_n79A			23	+2/-3
DC_7A_n1A			23	+2/-3
DC_7A_n3A			23	+2/-3
DC_7A_n5A DC_7C_n5A			23	+2/-3
DC_7A_n8A			23	+2/-3
DC_7A_n20A			23	+2/-3
DC_7A_n28A			23	+2/-3 <sup>1</sup>
DC_7A_n40A			23	+2/-3
DC_7A_n51A			23	+2/-3 <sup>1</sup>
DC_7A_n66A			23	+2/-3 <sup>1</sup>
DC_7A_n71A			23	+2/-3
DC_7A_n77A			23	+2/-3
DC_7A_n78A DC_7C_n78A			23	+2/-3
DC_7A_n80A			23	+2/-3
DC_8A_n1A			23	+2/-3
DC_8A_n3A			23	+2/-3
DC_8A_n20A			23	+2/-3
DC_8A_n28A			23	+2/-3
DC_8A_n34A			23	+2/-3 <sup>1</sup>
DC_8A_n39A			23	+2/-3
DC_8A_n40A			23	+2/-3 <sup>1</sup>
DC_8A_n41A, DC_8A_n77A			23	+2/-3
DC_8A_n78A			23	+2/-3
DC_8A_n79A DC_8A_n79C			23	+2/-3
DC_8A_n80A			23	+2/-3
DC_8A_n81A_ULSUP-TDM_n41			23	+2/-3
DC_8A_n81A_ULSUP-TDM_n78A			23	+2/-3

EN-DC configuration	Power class 2 (dBm)	Tolerance (dB)	Power class 3 (dBm)	Tolerance (dB)
DC_8A_n81A_ULSUP-TDM_n79A			23	+2/-3
DC_11A_n3A			23	+2/-3
DC_11A_n28A			23	+2/-3
DC_11A_n77A			23	+2/-3
DC_11A_n78A			23	+2/-3
DC_11A_n79A			23	+2/-3
DC_12A_n2A			23	+2/-3
DC_12A_n5A			23	+2/-3
DC_12A_n7A			23	+2/-3
DC_12A_n25A			23	+2/-3
DC_12A_n38A			23	+2/-3
DC_12A_n41A			23	+2/-3
DC_12A_n66A			23	+2/-3
DC_12A_n78A			23	+2/-3
DC_13A_n2A			23	+2/-3
DC_13A_n5A			23	+2/-3
DC_13A_n7A			23	+2/-3
DC_13A_n48A			23	+2/-3
DC_13A_n66A			23	+2/-3
DC_13A_n71A			23	+2/-3
DC_13A_n78A			23	+2/-3
DC_14A_n2A			23	+2/-3
DC_14A_n66A			23	+2/-3
DC_18A_n3A			23	+2/-3
DC_18A_n77A			23	+2/-3
DC_18A_n78A			23	+2/-3
DC_18A_n79A			23	+2/-3
DC_19A_n77A			23	+2/-3
DC_19A_n78A			23	+2/-3
DC_19A_n79A			23	+2/-3
DC_20A_n1A			23	+2/-3
DC_20A_n3A			23	+2/-3
DC_20A_n7A			23	+2/-3
DC_20A_n8A			23	+2/-3
DC_20A_n38A			23	+2/-3
DC_20A_n28A			23	+2/-3
DC_20A_n41A			23	+2/-3
DC_20A_n50A			23	+2/-3
DC_20A_n51A			23	+2/-3
DC_20A_n77A			23	+2/-3
DC_20A_n80A			23	+2/-3
DC_20A_n78A			23	+2/-3
DC_20A_n82A_ULSUP-TDM_n78A			23	+2/-3
DC_20A_n83A			23	+2/-3
DC_21A_n77A			23	+2/-3
DC_21A_n78A			23	+2/-3

EN-DC configuration	Power class 2 (dBm)	Tolerance (dB)	Power class 3 (dBm)	Tolerance (dB)
DC_21A_n79A			23	+2/-3
DC_25A_n41A			23	+2/-3
DC_26A_n25A			23	+2/-3
DC_26A_n41A			23	+2/-3
DC_26A_n77A			23	+2/-3
DC_26A_n78A			23	+2/-3
DC_26A_n79A			23	+2/-3
DC_28A_n3A			23	+2/-3
DC_28A_n5A			23	+2/-3
DC_28A_n7A			23	+2/-3
DC_28A_n7B				
DC_28A_n8A			23	+2/-3
DC_28A_n40A			23	+2/-3
DC_28A_n41A			23	+2/-3
DC_28A_n50A			23	+2/-3
DC_28A_n51A			23	+2/-3
DC_28A_n77A			23	+2/-3
DC_28A_n78A			23	+2/-3
DC_28A_n79A			23	+2/-3
DC_28A_n83A_ULSUP-TDM_n78A			23	+2/-3
DC_30A_n2A			23	+2/-3
DC_30A_n5A			23	+2/-3
DC_30A_n66A			23	+2/-3
DC_38A_n78A			N/A	N/A
DC_39A_n40A			23	+2/-3
DC_39A_n41A	26 <sup>5</sup>	+2/-3 <sup>1</sup>	23	+2/-3
DC_39C_n41A				
DC_39A_n78A			23	+2/-3 <sup>1</sup>
DC_39A_n79A	26 <sup>5</sup>	+2/-3 <sup>1</sup>	23	+2/-3 <sup>1</sup>
DC_40A_n1A			23	+2/-3
DC_40A_n41A			23	+2/-3
DC_40C_n41A				
DC_40A_n77A			N/A	N/A
DC_40A_n78A			23	+2/-3
DC_40A_n79A			23	+2/-3
DC_41A_n3A			23	+2/-3
DC_41C_n3A				
DC_41A_n28A			23	+2/-3
DC_41C_n28A				
DC_41A_n77A			23	+2/-3 <sup>1</sup>
DC_41C_n77A				
DC_41A_n78A			23	+2/-3 <sup>1</sup>
DC_41C_n78A				
DC_41A_n79A	26 <sup>5</sup>	+2/-3 <sup>1</sup>	23	+2/-3 <sup>1</sup>
DC_41C_n79A				
DC_42A_n28A			23	+2/-3
DC_42C_n28A				
DC_42A_n51A			23	+2/-3
DC_42A_n77A			N/A	N/A
DC_42A_n78A			N/A	N/A
DC_42A_n79A			N/A	N/A

EN-DC configuration	Power class 2 (dBm)	Tolerance (dB)	Power class 3 (dBm)	Tolerance (dB)
DC_48A_n5A			23	+2/-3
DC_48A_n12A			23	+2/-3
DC_48A_n66A			23	+2/-3
DC_48A_n71A			23	+2/-3
DC_66A_n2A			23	+2/-3
DC_66A_n5A			23	+2/-3 <sup>1</sup>
DC_66A_n7A			23	+2/-3
DC_66A_n12A			23	+2/-3
DC_66A_n25A			23	+2/-3
DC_66A_n38A			23	+2/-3
DC_66A_n41A			23	+2/-3
DC_66A_n48A			23	+2/-3
DC_66A_n71A			23	+2/-3
DC_66A_n78A DC_66A-66A_n78A			23	+2/-3
DC_66A_n86A_ULSUP-TDM_n78A			23	+2/-3
DC_71A_n5A			23	+2/-3
DC_71A_n38A			23	+2/-3
DC_71A_n48A			23	+2/-3
DC_71A_n66A			23	+2/-3
DC_71A_n78A			23	+2/-3
NOTE 1: For the transmission bandwidths confined within $F_{UL\_low}$ and $F_{UL\_low} + 4$ MHz or $F_{UL\_high} - 4$ MHz and $F_{UL\_high}$ , the maximum output power requirement is relaxed by reducing the lower tolerance limit by 1.5 dB				
NOTE 2: $P_{PowerClass, EN-DC}$ is the maximum UE power specified without taking into account the tolerance				
NOTE 3: For inter-band EN-DC the maximum power requirement should apply to the total transmitted power over all component carriers (per UE).				
NOTE 4: Power Class 3 is the default power class unless otherwise stated.				
NOTE 5: The UE is not required to support PC2 within each individual cell group. Power class support within each individual cell group is signaled separately by the UE.				

If a UE supports a different power class than the default UE power class for an E-UTRA TDD and NR TDD Inter-band EN-DC band combination and the supported power class enables higher maximum output power than that of the default power class:

- if the field of UE capability *maxUplinkDutyCycle-interBandENDC-TDD-PC2-r16* is absent and the percentage of NR uplink symbols transmitted in a certain evaluation period is larger than 30% (The exact evaluation period is no less than one radio frame); or
- if the field of UE capability *maxUplinkDutyCycle-interBandENDC-TDD-PC2-r16* is not absent and the percentage of NR uplink symbols transmitted in a certain evaluation period is larger than *maxUplinkDutyCycle-interBandENDC-TDD-PC2-r16* as defined in TS38.331 (The exact evaluation period is no less than one radio frame); or
- if the IE *p-maxUE-FRI* as defined in TS 38.331 is provided and set to the maximum output power of the default power class or lower;
  - shall apply all requirements for the default power class to the supported power class and set the configured transmitted power as specified sub-clause 6.2B.4;
- Else if the IE *p-maxUE-FRI* as defined in TS 38.331 is not provided or set to the higher value than the maximum output power of the default power class and the percentage of NR uplink symbols transmitted in a certain evaluation period is less than or equal to *maxUplinkDutyCycle-interBandENDC-TDD-PC2-r16* as defined in TS 38.331; or
- if the IE *p-maxUE-FRI* as defined in TS 38.331 is not provided or set to the higher value than the maximum output power of the default power class and the percentage of NR uplink symbols transmitted in a certain

evaluation period is less than or equal to 30% when *maxUplinkDutyCycle-interBandENDC-TDD-PC2-r16* is absent. (The exact evaluation period is no less than one radio frame):

- shall apply all requirements for the supported power class and set the configured transmitted power class as specified in sub-clause 6.2B.4.

### 6.2B.1.3a Inter-band NE-DC within FR1

For inter-band NE-DC of E-UTRA and NR in FR1, the following UE power classes define the maximum output power for any transmission bandwidth within the aggregated channel bandwidth. The maximum output power is measured as the sum of the maximum output power at each UE antenna connector. The period of measurement shall be at least one sub frame (1 ms). UE maximum output power shall be measured over all component carriers from different bands. If each band has separate antenna connectors, maximum output power is measured as the sum of maximum output power at each UE antenna connector.

**Table 6.2B.1.3a-1: Maximum output power for inter-band NE-DC (two bands)**

NE-DC configuration	Power class 3 (dBm)	Tolerance (dB)
DC_n1A_28A	23	+2/-3

### 6.2B.1.4 Inter-band EN-DC including FR2

UE maximum output power requirement for E-UTRA single carrier and CA operation specified in clauses 6.2.2 and 6.2.2A of TS 36.101 [4] and for NR single carrier and CA operation specified in clause 6.2.1, 6.2A.1, and 6.2D.1 of TS 38.101-2 [3] apply.

### 6.2B.1.5 Inter-band EN-DC including both FR1 and FR2

UE maximum output power requirement for E-UTRA single carrier and CA operation specified in clauses 6.2.2 and 6.2.2A of TS 36.101 [4] and for NR single carrier and CA operation specified in clause 6.2.1 of TS 38.101-1 [2] and clause 6.2.1, 6.2A.1, and 6.2D.1 of TS 38.101-2 [3] apply. When uplink is EN-DC mode within FR1 only then UE maximum output power requirement is specified in clause 6.2B.1.3 of this specification.

## 6.2B.2 UE maximum output power reduction for DC

### 6.2B.2.0 General

The UE maximum output power reduction (MPR) specified in this clause is applicable for UEs configured with EN-DC when *NS\_01* is indicated in the MCG and the SCG. The MPR applies subject to indication in the field *modifiedMPRbehavior* for the SCG [2].

### 6.2B.2.1 Intra-band contiguous EN-DC

#### 6.2B.2.1.1 General

When the UE is configured for intra-band contiguous EN-DC, the UE determines the total allowed maximum output power reduction as specified in this clause.

For UE supporting dynamic power sharing the following:

- for the MCG,  $MPR_c$  in accordance with TS 36.101 [4]
- for the SCG,

$$MPR'_c = MPR_{NR} = \text{MAX}(MPR_{\text{single,NR}}, MPR_{\text{ENDC}})$$

- for the total configured transmission power,

$$MPR_{tot} = P_{PowerClass,EN-DC} - \min(P_{PowerClass,EN-DC}, 10 * \log_{10}(10^{(P_{PowerClass,E-UTRA} - MPR_{E-UTRA})/10}) + 10^{(P_{PowerClass,NR} - MPR_{NR})/10}))$$

where

$$MPR_{E-UTRA} = \text{MAX}(MPR_{single,E-UTRA}, MPR_{ENDC})$$

with

- $MPR_{single,E-UTRA}$  is the MPR defined for the E-UTRA transmission in TS 36.101 [4]
- $MPR_{single,NR}$  is the MPR defined for the NR transmission in TS 38.101-1 [2]

For UEs not supporting dynamic power sharing the following

- for the MCG,

$$MPR_c = \text{MAX}(MPR_{single,E-UTRA}, MPR_{ENDC})$$

- for the SCG,

$$MPR'_c = \text{MAX}(MPR_{single,NR}, MPR_{ENDC})$$

where

- $MPR_{single,NR}$  is the MPR defined for the NR transmission in TS 38.101-1 [2]
- $MPR_{single,E-UTRA}$  is the MPR defined for the E-UTRA transmission in TS 36.101 [4]

$MPR_{ENDC}$  is defined in Clause 6.2B.2.1.2

### 6.2B.2.1.2 MPR for power class 3 and power class 2

MPR in this clause is applicable for power class 3 and power class 2 UEs indicating IE *dualPA-Architecture* supported with EN-DC power class being the same as the E-UTRA and NR power class, otherwise the UE can use as much MPR as needed to fulfil emissions requirements when scheduled with dual uplink transmission. For UEs scheduled with single uplink transmission, MPR in clause 6.2.4 of TS 36.101 [4] and 6.2.2 of TS 38.101-1 [2] apply. For a UE supporting dynamic power sharing for DC\_(n)71AA for which dual simultaneous uplink transmissions are mandatory and A-MPR defined in clause 6.2B.3.1.1 is applied as MPR. The allowed maximum output power reduction applied to transmission on the MCG and the SCG is defined as follows:

$$MPR_{ENDC} = M_A$$

Where  $M_A$  is defined as follows

$$M_A = \begin{array}{ll} 15 ; & 0 \leq B < 0.5 \\ 10 ; & 0.5 \leq B < 1.0 \\ 8 ; & 1.0 \leq B < 2.0 \\ 6 ; & 2.0 \leq B \end{array}$$

Where:

For UEs supporting dynamic power sharing,

$$B = (L_{CRB\_alloc, E-UTRA} * 12 * SCS_{E-UTRA} + L_{CRB\_alloc, NR} * 12 * SCS_{NR}) / 1,000,000$$

For UEs not supporting dynamic power sharing,

For E-UTRA

$$B = (L_{CRB\_alloc, E-UTRA} * 12 * SCS_{E-UTRA} + 12 * SCS_{NR}) / 1,000,000$$

Where  $SCS_{NR} = 15$  kHz is assumed in calculation of B.

For NR

$$B = (12 * SCS_{E-UTRA} + L_{CRB\_alloc,NR} * 12 * SCS_{NR}) / 1,000,000$$

Where  $SCS_{E-UTRA} = 15$  kHz is assumed in calculation of B.

and  $M_A$  is reduced by 1 dB for  $B < 2$ .

## 6.2B.2.2 Intra-band non-contiguous EN-DC

### 6.2B.2.2.1 General

When the UE is configured for intra-band non-contiguous EN-DC, the UE determines the total allowed maximum output power reduction as specified in this clause.

For UE supporting dynamic power sharing the following:

- for the MCG,  $MPR_c$  in accordance with TS 36.101 [4]
- for the SCG,

$$MPR'_c = MPR_{NR} = \text{MAX}(MPR_{\text{single,NR}}, MPR_{\text{ENDC}})$$

- for the total configured transmission power,

$$MPR_{\text{tot}} = P_{\text{PowerClass,EN-DC}} - \min(P_{\text{PowerClass,EN-DC}}, 10 * \log_{10}(10^{(P_{\text{PowerClass,E-UTRA}} - MPR_{E-UTRA})/10} + 10^{(P_{\text{PowerClass,NR}} - MPR_{NR})/10}))$$

where

$$MPR_{E-UTRA} = \text{MAX}(MPR_{\text{single,E-UTRA}}, MPR_{\text{ENDC}})$$

with

- $MPR_{\text{single,E-UTRA}}$  is the MPR defined for the E-UTRA transmission in TS 36.101 [4]
- $MPR_{\text{single,NR}}$  is the MPR defined for the NR transmission in TS 38.101-1 [2]

For UEs not supporting dynamic power sharing the following

- for the MCG,

$$MPR_c = \text{MAX}(MPR_{\text{single,E-UTRA}}, MPR_{\text{ENDC}})$$

- for the SCG,

$$MPR'_c = \text{MAX}(MPR_{\text{single,NR}}, MPR_{\text{ENDC}})$$

where

- $MPR_{\text{single,NR}}$  is the MPR defined for the NR transmission in TS 38.101-1 [2]
- $MPR_{\text{single,E-UTRA}}$  is the MPR defined for the E-UTRA transmission in TS 36.101 [4]

$MPR_{\text{ENDC}}$  is defined in Clause 6.2B.2.2.2

### 6.2B.2.2.2 MPR for power class 3 and power class 2

MPR in this clause is applicable for power class 3 and power class 2 UEs indicating IE *dualPA-Architecture* supported with EN-DC power class being the same as the E-UTRA and NR power class, otherwise the UE can use as much MPR as needed to fulfil emissions requirements when scheduled with dual uplink transmission. For UEs scheduled with single uplink transmission, MPR in clause 6.2.4 of TS 36.101 [4] and 6.2.2 of TS 38.101-1 [2] apply. The allowed maximum output power reduction for IM3 related emissions applied to transmission on the MCG and the SCG is defined as follows:

$$MPR_{\text{ENDC}} = M_A$$

Where  $M_A$  is defined as follows

$$M_A = \begin{array}{ll} 18 ; & 0 \leq B < 1.0 \\ 17 ; & 1.0 \leq B < 2.0 \\ 16 ; & 2.0 \leq B < 5.0 \\ 15 ; & 5.0 \leq B \end{array}$$

Where:

For UEs supporting dynamic power sharing,

$$B = (L_{CRB\_alloc, E-UTRA} * 12 * SCS_{E-UTRA} + L_{CRB\_alloc, NR} * 12 * SCS_{NR}) / 1,000.000$$

For UEs not supporting dynamic power sharing,

For E-UTRA

$$B = (L_{CRB\_alloc, E-UTRA} * 12 * SCS_{E-UTRA} + 12 * SCS_{NR}) / 1,000.000$$

Where  $SCS_{NR} = 15$  kHz is assumed in calculation of B.

For NR

$$B = (12 * SCS_{E-UTRA} + L_{CRB\_alloc, NR} * 12 * SCS_{NR}) / 1,000.000$$

Where  $SCS_{E-UTRA} = 15$  kHz is assumed in calculation of B.

and  $M_A$  is reduced by 1 dB for  $B < 2$ .

### 6.2B.2.3 Inter-band EN-DC within FR1

For inter-band EN-DC between E-UTRA and FR1 NR, UE maximum output power reduction specified in TS 36.101 [4] and TS 38.101-1 [2] apply for E-UTRA and NR respectively.

### 6.2B.2.3a Inter-band NE-DC within FR1

For inter-band NE-DC between E-UTRA and FR1 NR, UE maximum output power reduction specified in TS 36.101 [4] and TS 38.101-1 [2] apply for E-UTRA and NR respectively.

### 6.2B.2.4 Inter-band EN-DC including FR2

UE maximum output power reduction requirement for E-UTRA single carrier and CA operation specified in clauses 6.2.3 and 6.2.3A of TS 36.101 [4] and for NR single carrier and CA operation specified in clause 6.2.2, 6.2A.2, and 6.2D.2 of TS 38.101-2 [3] apply.

### 6.2B.2.5 Inter-band EN-DC including both FR1 and FR2

UE maximum output power reduction requirement for E-UTRA single carrier and CA operation specified in clauses 6.2.3 and 6.2.3A of TS 36.101 [4] and for NR single carrier and CA operation specified in clause 6.2.2 of TS 38.101-1 [2] and clause 6.2.2, 6.2A.2, and 6.2D.2 of TS 38.101-2 [3] apply.

## 6.2B.3 UE additional maximum output power reduction for EN-DC

### 6.2B.3.1 Intra-band contiguous EN-DC

#### 6.2B.3.1.0 General

For intra-band contiguous EN-DC band combinations with additional requirements the allowed A-MPR is specified in Table 6.2B.3.1.0-1 for UEs configured with EN-DC and combinations of network signalling values indicated in the E-UTRA and NR cell groups.



Unless otherwise stated the A-MPR specified in clause 6.2B.3.1 for intra-band contiguous EN-DC configurations is the total power reduction allowed including MPR.

**Table 6.2B.3.1.0-1: Additional maximum power reduction for Intra-band contiguous EN-DC**

DC configuration	Requirement (clause)	E-UTRA network signalling value	NR network signalling value	A-MPR (clause)
DC_(n)71AA	6.5B.2.1.2.1	NS_35	NS_35	6.2B.3.1.1 <sup>3</sup>
DC_(n)41AA <sup>1</sup>	6.5B.2.1.2.2 6.5B.4.1.1	NS_01 or NS_04	NS_04	6.2B.3.1.2 <sup>4</sup>
NOTE 1: Only applies to UEs that support dual UL transmission for this EN-DC combination.				
NOTE 2: The additional emission requirement is indicated when the combination of network signalling values in the two CGs is set (only for UEs configured with EN-DC).				
NOTE 3: The A-MPR is applied as MPR if NS_35 is not signalled.				
NOTE 4: Void				

### 6.2B.3.1.1 A-MPR for DC\_(n)71AA

For UE supporting dynamic power sharing the following:

- for the MCG,  $A\text{-MPR}_c$  in accordance with TS 36.101 [4]
- for the SCG,  $A\text{-MPR}'_c = A\text{-MPR}_{DC}$
- for the total configured transmission power,  $A\text{-MPR}_{tot} = A\text{-MPR}_{DC}$

with  $A\text{-MPR}_{DC}$  as defined in this clause.

For UEs not supporting dynamic power sharing the following

- for the MCG,

$$A\text{-MPR}_c = A\text{-MPR}_{E\text{-UTRA}}$$

- for the SCG,

$$A\text{-MPR}'_c = A\text{-MPR}_{NR}$$

with  $A\text{-MPR}_{E\text{-UTRA}}$  and  $A\text{-MPR}_{NR}$  as defined in this clause.

For DC\_(n)71AA with configured with network signaling values as per Table 6.2B.3.1.0-1 the allowed A-MPR is defined by

- for UE indicating support of dynamicPowerSharing in the *UE-MRDC-Capability* IE

$$A\text{-MPR}_{DC} = \text{CEIL}\{ M_{A,DC}(A), 0.5\}$$

where  $A\text{-MPR}_{DC}$  is the total power reduction allowed (dB),

- for OFDM:

$$M_{A,DC} = 11.00 - 11.67 * A; \quad 0.00 < A \leq 0.30$$

$$8.10 - 2.00 * A; \quad 0.30 < A \leq 0.80$$

$$6.50; \quad 0.80 < A \leq 1.00$$

- for DFT-S-OFDM:

$$M_{A,DC} = 11.00 - 13.33 * A; \quad 0.00 < A \leq 0.30$$

$$8.00 - 3.33 * A; \quad 0.30 < A \leq 0.60$$

$$6.00; \quad 0.60 < A \leq 1.00$$

where

$$A = \frac{L_{CRB,E-UTRA} + L_{CRB,NR}}{N_{RB,E-UTRA} + N_{RB,NR}}$$

with  $L_{CRB,E-UTRA}$  and  $N_{RB,E-UTRA}$  the number of allocated PRB and transmission bandwidth for MCG,  $L_{CRB,NR}$  and  $N_{RB,NR}$  the number of allocated PRB and transmission bandwidth for SCG with SCS = 15 kHz.

- for UE not indicating support of dynamicPowerSharing

$$A\text{-MPR}_{E\text{-UTRA}} = \text{CEIL}\{ M_{A,E\text{-UTRA}}, 0.5 \}$$

$$A\text{-MPR}_{NR} = \text{CEIL}\{ M_{A,NR}, 0.5 \}$$

where A-MPR is the total power reduction allowed per CG with

$$M_{A,E\text{-UTRA}} = M_{A,DC}(A_{E\text{-UTRA},wc}) - 1 - \Delta_{E\text{-UTRA}}$$

$$M_{A,NR} = M_{A,DC}(A_{NR,wc}) - 1 - \Delta_{NR}$$

$$A_{E\text{-UTRA},wc} = \frac{L_{CRB,E\text{-UTRA}} + 1}{N_{RB,E\text{-UTRA}} + N_{RB,NR}}$$

$$A_{NR,wc} = \frac{1 + L_{CRB,NR}}{N_{RB,E\text{-UTRA}} + N_{RB,NR}}$$

$$\Delta_{E\text{-UTRA}} = 10 \log_{10} \frac{N_{RB,E\text{-UTRA}}}{N_{RB,E\text{-UTRA}} + N_{RB,NR}}$$

$$\Delta_{NR} = 10 \log_{10} \frac{N_{RB,NR}}{N_{RB,E\text{-UTRA}} + N_{RB,NR}}$$

Where  $L_{CRB,NR}$  and  $N_{RB,NR}$  the number of allocated PRB and transmission bandwidth for SCG with SCS = 15 kHz.

### 6.2B.3.1.2 A-MPR for NS\_04

#### 6.2B.3.1.2.0 General

When the UE is configured for B41/n41 intra-band contiguous EN-DC and it receives IE NS\_04, the UE determines the total allowed maximum output power reduction as specified in this clause. The A-MPR for EN-DC defined in this clause is used instead of MPR defined in 6.2B.2.1, not additively, so EN-DC MPR = 0 when NS\_04 is signaled. For UEs scheduled with single uplink transmission, AMPR in clause 6.2.4 of [4] and 6.2.3 of [2] apply.

For UE supporting dynamic power sharing the following:

- for the MCG,  $A\text{-MPR}'_c$  in accordance with TS 36.101 [4]
- for the SCG,

$$A\text{-MPR}'_c = A\text{-MPR}_{NR} = \text{MAX}(A\text{-MPR}_{\text{single,NR}}, A\text{-MPR}_{\text{IM3}})$$

- for the total configured transmission power,

$$A\text{-MPR}_{\text{tot}} = P_{\text{PowerClass,EN-DC}} - \min(P_{\text{PowerClass,EN-DC}}, 10 * \log_{10}(10^{((P_{\text{PowerClass,E-UTRA}} - A\text{-MPR}_{E\text{-UTRA}})/10)} + 10^{((P_{\text{PowerClass,NR}} - A\text{-MPR}_{NR})/10)}))$$

where

$$A\text{-MPR}_{E\text{-UTRA}} = \text{MAX}(A\text{-MPR}_{\text{single,E-UTRA}} + \text{MPR}_{\text{single,E-UTRA}}, A\text{-MPR}_{\text{IM3}})$$

with

- $A\text{-MPR}_{\text{single,E-UTRA}}$  is the A-MPR defined for the E-UTRA transmission in TS 36.101 [4]
- $A\text{-MPR}_{\text{single,NR}}$  is the A-MPR defined for the NR transmission in TS 38.101-1 [2]

- $MPR_{single,E-UTRA}$  is the MPR defined for the E-UTRA transmission in TS 36.101 [4]

For UEs not supporting dynamic power sharing the following

- for the MCG,

$$A-MPR_c = \text{MAX}( A-MPR_{single, E-UTRA} + MPR_{single,E-UTRA}, A-MPR_{IM3} )$$

- for the SCG,

$$A-MPR'_c = \text{MAX}( A-MPR_{single,NR}, A-MPR_{IM3} )$$

where

- $A-MPR_{single, E-UTRA}$  is the A-MPR defined for the E-UTRA transmission in TS 36.101 [4]
- $A-MPR_{single,NR}$  is the A-MPR defined for the NR transmission in TS 38.101-1 [2]
- $MPR_{single,E-UTRA}$  is the MPR defined for the E-UTRA transmission in TS 36.101 [4]

The UE determines the Allocation Configuration Case and the value of  $A-MPR_{IM3}$  as follows:

If  $F_{IM3,low\_block,low} < 2490.5$  MHz

Allocation Configuration Case B.  $A-MPR_{IM3}$  defined in Clause 6.2B.3.1.2.2

Else

Allocation Configuration Case A.  $A-MPR_{IM3}$  defined in Clause 6.2B.3.1.2.1

where

- $F_{IM3,low\_block,low} = (2 * F_{low\_alloc,low\_edge}) - F_{high\_alloc,high\_edge}$
- $F_{low\_alloc,low\_edge}$  is the lowermost frequency of lower transmission bandwidth configuration.
- $F_{high\_alloc,high\_edge}$  is the uppermost frequency of upper transmission bandwidth configuration.

Where the transmission bandwidth configuration for NR is the maximum frequency span covering all the configured  $SCSSpecificCarrier$  for scenarios that carrier bandwidths with different SCS can be fully overlapped.

NOTE: For non-dynamic power sharing capable UEs, since the allocation is unknown for one RAT, the edges of the channel transmission bandwidth are used instead of the edges of the RB allocations for that RAT.

#### 6.2B.3.1.2.1 $A-MPR_{IM3}$ for NS\_04 to meet -13 dBm / 1MHz

$A-MPR$  in this clause is relative to 26 dBm for a power class 2 Cell Group. The same  $A-MPR$  is used relative to 23 dBm for a power class 3 Cell Group. For the UE is configured with allocation configurations Case A or Case C (defined in Clause 6.2B.3.2.1), the allowed maximum output power reduction for IM3s applied to transmission on the MCG and the SCG with non-contiguous resource allocation is defined as follows:

$$A-MPR_{IM3} = M_A$$

Where  $M_A$  is defined as follows

$$M_A = \begin{array}{ll} 12 ; & 0 \leq B < 0.54 \\ 10 ; & 0.54 \leq B < 1.08 \\ 9 ; & 1.08 \leq B < 2.16 \\ 8.5 ; & 2.16 \leq B < 3.24 \\ 8 ; & 3.24 \leq B < 5.4 \\ 6 ; & 5.4 \leq B \end{array}$$

Where:

For UEs supporting dynamic power sharing,

$$B = (L_{CRB\_alloc, E-UTRA} * 12 * SCS_{E-UTRA} + L_{CRB\_alloc, NR} * 12 * SCS_{NR}) / 1,000,000$$

For UEs not supporting dynamic power sharing,

For E-UTRA

$$B = (L_{CRB\_alloc, E-UTRA} * 12 * SCS_{E-UTRA} + 12 * SCS_{NR}) / 1,000,000$$

Where  $SCS_{NR} = 15$  kHz is assumed in calculation of B.

For NR

$$B = (12 * SCS_{E-UTRA} + L_{CRB\_alloc, NR} * 12 * SCS_{NR}) / 1,000,000$$

Where  $SCS_{E-UTRA} = 15$  kHz is assumed in calculation of B.

and  $M_A$  is reduced by 1 dB for  $B < 2.0$ .

#### 6.2B.3.1.2.2 A-MPR for NS\_04 to meet -25 dBm / 1MHz for 26 dBm UE power

A-MPR in this clause is relative to 26 dBm for a power class 2 Cell Group. The same A-MPR is used relative to 23 dBm for a power class 3 Cell Group. For the UE is configured with allocation configurations Case B or Case D (defined in Clause 6.2B.3.2.1), the allowed maximum output power reduction for IM3s applied to transmission on the MCG and the SCG with non-contiguous resource allocation is defined as follows:

$$A-MPR_{IM3} = M_A$$

Where  $M_A$  is defined as follows

$$M_A = \begin{array}{ll} 15 ; & 0 \leq B < 1.08 \\ 14 ; & 1.08 \leq B < 5.4 \\ 13 ; & 5.4 \leq B < 8.1 \\ 12 ; & 8.1 \leq B < 25.2 \\ 10 ; & 25.2 \leq B \end{array}$$

Where:

For UEs supporting dynamic power sharing,

$$B = (L_{CRB\_alloc, E-UTRA} * 12 * SCS_{E-UTRA} + L_{CRB\_alloc, NR} * 12 * SCS_{NR}) / 1,000,000$$

For UEs not supporting dynamic power sharing,

For E-UTRA

$$B = (L_{CRB\_alloc, E-UTRA} * 12 * SCS_{E-UTRA} + 12 * SCS_{NR}) / 1,000,000$$

Where  $SCS_{NR} = 15$  kHz is assumed in calculation of B.

For NR

$$B = (12 * SCS_{E-UTRA} + L_{CRB\_alloc, NR} * 12 * SCS_{NR}) / 1,000,000$$

Where  $SCS_{E-UTRA} = 15$  kHz is assumed in calculation of B.

and  $M_A$  is reduced by 1 dB.

## 6.2B.3.2 Intra-band non-contiguous EN-DC

### 6.2B.3.2.0 General

For intra-band non-contiguous EN-DC band combinations with additional requirements the A-MPR allowed are specified in Table 6.2B.3.2.0-1 for UEs configured with EN-DC and combinations of network signalling values indicated in the E-UTRA and NR cell group(s). Unless otherwise stated the A-MPR specified in clause 6.2B.3.2 for intra-band non-contiguous EN-DC configurations is the total power reduction allowed including MPR. For UEs scheduled with single uplink transmission, AMPR in clause 6.2.4 of [4] and 6.2.3 of [2] apply.

**Table 6.2B.3.2.0-1: Allowed power reduction for intra-band non-contiguous EN-DC**

DC configuration	Requirement (clause)	E-UTRA network signalling value	NR network signalling value	A-MPR (clause)
DC_41A_n41A <sup>1</sup>	6.6.3.3.19 and 6.6.2.2.2 of TS 36.101 [4] and 6.5.2.3.2 and 6.5.3.3.1 of TS 38.101-1 [2]	NS_01 or NS_04	NS_04	6.2B.3.2.1
NOTE 1: Only applies to UEs that support dual UL transmission for this EN-DC combination. NOTE 2: The requirement applies when the combination of network signalling values in the two CGs is set (only for UEs configured with EN-DC)..				

### 6.2B.3.2.1 A-MPR for NS\_04

When the UE is configured for B41/n41 intra-band non-contiguous EN-DC and it receives IE NS\_04, the UE determines the total allowed maximum output power reduction as specified in this clause. The A-MPR for EN-DC defined in this clause is used instead of MPR defined in 6.2B.2.2, not additively, so EN-DC MPR=0 when NS\_04 is signaled.

For UE supporting dynamic power sharing the following:

- for the MCG, A-MPR<sub>c</sub> in accordance with TS 36.101 [4]
- for the SCG,

$$A-MPR'_c = A-MPR_{NR} = \text{MAX}( A-MPR_{\text{single,NR}}, A-MPR_{\text{EN-DC}} )$$

- for the total configured transmission power,

$$A-MPR_{\text{tot}} = P_{\text{PowerClass,EN-DC}} - \min(P_{\text{PowerClass,EN-DC}}, 10 \cdot \log_{10}(10^{(P_{\text{PowerClass,E-UTRA}} - A-MPR_{\text{E-UTRA}})/10}) + 10^{(P_{\text{PowerClass,NR}} - A-MPR_{\text{NR}})/10}))$$

where

$$A-MPR_{\text{E-UTRA}} = \text{MAX}( A-MPR_{\text{single,E-UTRA}} + MPR_{\text{single,E-UTRA}}, A-MPR_{\text{EN-DC}} )$$

$$A-MPR_{\text{EN-DC}} = \text{MAX}(A-MPR_{\text{IM3}}, A-MPR_{\text{ACLROverlap}} )$$

with

- A-MPR<sub>single, E-UTRA</sub> is the A-MPR defined for the E-UTRA transmission in TS 36.101 [4]
- A-MPR<sub>single,NR</sub> is the A-MPR defined for the NR transmission in TS 38.101-1 [2]
- MPR<sub>single,E-UTRA</sub> is the MPR defined for the E-UTRA transmission in TS 36.101 [4]

For UEs not supporting dynamic power sharing the following

- for the MCG,

$$A-MPR_c = \text{MAX}( A-MPR_{\text{single, E-UTRA}} + MPR_{\text{single,E-UTRA}}, A-MPR_{\text{IM3}}, A-MPR_{\text{ACLROverlap}} )$$

- for the SCG,

$$A\text{-MPR}'_c = \text{MAX}( A\text{-MPR}_{\text{single,NR}}, A\text{-MPR}_{\text{IM3}}, A\text{-MPR}_{\text{ACLROverlap}})$$

where

- $A\text{-MPR}_{\text{single, E-UTRA}}$  is the A-MPR defined for the E-UTRA transmission in TS 36.101 [4]
- $A\text{-MPR}_{\text{single,NR}}$  is the A-MPR defined for the NR transmission in TS 38.101-1 [2]
- $\text{MPR}_{\text{single,E-UTRA}}$  is the MPR defined for the E-UTRA transmission in TS 36.101 [4]

The UE determines the Allocation Configuration Case and the value of  $A\text{-MPR}_{\text{IM3}}$  as follows:

If  $\text{AND}( F_{\text{IM3,low\_block,high}} < F_{\text{filter,low}}, \text{MAX}( \text{SEM}_{\text{-13,high}}, F_{\text{IM3,high\_block,low}} ) > F_{\text{filter,high}} )$

Allocation Configuration Case C.  $A\text{-MPR}_{\text{IM3}}$  defined in Clause 6.2B.3.1.2.1

Else

Allocation Configuration Case D.  $A\text{-MPR}_{\text{IM3}}$  defined in Clause 6.2B.3.1.2.2

where

- $F_{\text{IM3,low\_block,high}} = (2 * F_{\text{low\_alloc,high\_edge}}) - F_{\text{high\_alloc,low\_edge}}$
- $F_{\text{IM3,high\_block,low}} = (2 * F_{\text{high\_alloc,low\_edge}}) - F_{\text{low\_alloc,high\_edge}}$
- $F_{\text{low\_alloc,low\_edge}}$  is the lowermost frequency of lower transmission bandwidth allocation.
- $F_{\text{low\_alloc,high\_edge}}$  is the uppermost frequency of lower transmission bandwidth allocation.
- $F_{\text{high\_alloc,low\_edge}}$  is the lowermost frequency of upper transmission bandwidth allocation.
- $F_{\text{high\_alloc,high\_edge}}$  is the uppermost frequency of upper transmission bandwidth allocation.
- $F_{\text{filter,low}} = 2480$  MHz
- $F_{\text{filter,high}} = 2745$  MHz
- $\text{SEM}_{\text{-13,high}} =$  Threshold frequency where upper spectral emission mask for upper channel drops from -13 dBm / 1MHz to -25 dBm / 1MHz, as specified in Clause 6.6.2.2.2 in [4] and Clause 6.5.2.3.2 in [2] respectively.

Where the transmission bandwidth configuration for NR is the maximum frequency span covering all the configured  $\text{SCSSpecificCarrier}$  for scenarios that carrier bandwidths with different SCS can be fully overlapped

The UE determines the value of  $A\text{-MPR}_{\text{ACLROverlap}}$  as specified in Table 6.2B.3.2.1-1:

**Table 6.2B.3.2.1-1:  $A\text{-MPR}_{\text{ACLROverlap}}$**

$W_{\text{gap}}$	$A\text{-MPR}_{\text{ACLROverlap}}$
$< BW_{\text{channel,E-UTRA}} + BW_{\text{channel,NR}}$	4 dB
$\geq BW_{\text{channel,E-UTRA}} + BW_{\text{channel,NR}}$	0 dB
NOTE 1: $W_{\text{gap}} = F_{\text{high\_channel,low\_edge}} - F_{\text{low\_channel,high\_edge}}$	

### 6.2B.3.3 Inter-band EN-DC within FR1

For inter-band EN-DC between E-UTRA and FR1 NR, UE additional maximum output power reduction specified in TS 36.101 [4] and TS 38.101-1 [2] apply for E-UTRA and NR respectively.

### 6.2B.3.4 Inter-band EN-DC including FR2

UE additional maximum output power reduction requirement for E-UTRA single carrier and CA operation specified in clauses 6.2.4 and 6.2.4A of TS 36.101 [4] and for NR single carrier and CA operation specified in clause 6.2.3, 6.2A.3 and 6.2D.3 of TS 38.101-2 [3] apply.

### 6.2B.3.5 Inter-band EN-DC including both FR1 and FR2

UE additional maximum output power reduction requirement for E-UTRA single carrier and CA operation specified in clauses 6.2.4 and 6.2.4A of TS 36.101 [4] and for NR single carrier and CA operation specified in clause 6.2.3 of TS 38.101-1 [2] and clause 6.2.3, 6.2A.3 and 6.2D.3 of TS 38.101-2 [3] apply.

## 6.2B.4 Configured output power for DC

### 6.2B.4.1 Configured output power level

#### 6.2B.4.1.1 Intra-band contiguous EN-DC

The following requirements apply for one component carrier per CG configured for synchronous DC.

For intra-band dual connectivity with one uplink serving cell per CG on E-UTRA and NR respectively, the UE is allowed to set its configured maximum output power  $P_{\text{CMAX},c(i)}$  for serving cell  $c(i)$  of CG  $i$ ,  $i = 1, 2$ , and its total configured maximum transmission power for EN-DC operation  $P_{\text{Total}}^{\text{EN-DC}} = 10\log_{10}(\hat{P}_{\text{total}}^{\text{EN-DC}})$  with  $\hat{P}_{\text{total}}^{\text{EN-DC}}$  as specified in clause 7.6 of TS 38.213 [10].

The configured maximum output power  $P_{\text{CMAX},f,c,NR}(q)$  in physical channel  $q$  for the configured NR carrier shall be set within the bounds:

$$P_{\text{CMAX}_L,f,c,NR}(q) \leq P_{\text{CMAX},f,c,NR}(q) \leq P_{\text{CMAX}_H,f,c,NR}(q)$$

where  $P_{\text{CMAX}_L,f,c,NR}$  and  $P_{\text{CMAX}_H,f,c,NR}$  are the limits for a serving cell  $c$  as specified in clause 6.2.4 of TS 38.101-1 [2] modified as follows:

$$P_{\text{CMAX}_L,f,c,NR} = \text{MIN} \{ \text{MIN}(P_{\text{EMAX},c}, P_{\text{EMAX,EN-DC}}, P_{\text{NR}}) - \Delta T_{\text{C}_NR,c}, (P_{\text{PowerClass,EN-DC}} - \Delta P_{\text{PowerClass,EN-DC}}), (P_{\text{PowerClass,E-UTRA}} - \Delta P_{\text{PowerClass,E-UTRA}}) - \text{MAX}(\text{MAX}(\text{MPR}_c, \text{A-MPR}_c) + \Delta T_{\text{IB},c} + \Delta T_{\text{C}_NR,c} + \Delta T_{\text{R}_SRS}, P - \text{MPR}_c) \}$$

$$P_{\text{CMAX}_H,f,c,NR} = \text{MIN} \{ P_{\text{EMAX},c}, P_{\text{EMAX,EN-DC}}, P_{\text{NR}}, P_{\text{PowerClass,EN-DC}}, P_{\text{PowerClass,E-UTRA}} - \Delta P_{\text{PowerClass,E-UTRA}} \}$$

where

- $P_{\text{EMAX,EN-DC}}$  is the value given by the field *p-maxUE-FR1* of the *RRConnectionReconfiguration-v1530* IE as defined in TS 36.331 [8];
- $P_{\text{LTE}}$  is the value given by the field *p-maxEUTRA-r15* of the *RRConnectionReconfiguration-v1510* IE as defined in TS 36.331 [8] which is the same as  $P_{\text{LTE}}$  in TS 38.213 [10];
- $\Delta T_{\text{C}_EUTRA,c} = 1.5$  dB when NOTE 2 in Table 6.2.2-1 of TS 36.101 [4] applies;  $\Delta T_{\text{C}_EUTRA,c} = 0$  dB otherwise;

and whenever NS\_01 is not indicated within CG 1:

- for a UE indicating support of dynamicPowerSharing, the  $\text{MPR}_c$  and the  $\text{A-MPR}_c$  are determined in accordance with the DCI of serving cell  $c$  of the CG 1 and the specification in clause 6.2.4 of TS 36.101 [4];
- for a UE not indicating support of dynamicPowerSharing, the  $\text{A-MPR}_c$  is determined in accordance with clause 6.2B.3.1 with parameters applicable for UEs not indicating support of dynamicPowerSharing and  $\text{MPR}_c = 0$  dB;

and whenever NS\_01 is indicated in CG 1:

- for a UE indicating support of dynamicPowerSharing, the  $\text{MPR}_c$  is determined in accordance with the DCI of serving cell  $c$  of the CG 1 and the specification in clause 6.2.4 of TS 36.101 [4];
- for a UE not indicating support of dynamicPowerSharing, the  $\text{MPR}_c$  is determined in accordance with clause 6.2B.2.1 with parameters applicable for UEs not indicating support of dynamicPowerSharing and  $\text{A-MPR}_c = 0$  dB;

The configured maximum output power  $P_{\text{CMAX}_NR,c}(q)$  in physical channel  $q$  for the configured NR carrier shall be set within the bounds:

$$P_{\text{CMAX}_L,f,c,NR}(q) \leq P_{\text{CMAX}_NR,c}(q) \leq P_{\text{CMAX}_H,f,c,NR}(q)$$

where  $P_{\text{CMAX\_L\_NR},c}$  and  $P_{\text{CMAX\_H\_NR},c}$  are the limits for a serving cell  $c$  as specified in clause 6.2.4 of TS 38.101-1 [2] modified as follows:

$$P_{\text{CMAX\_L},f,c, NR} = \text{MIN} \{ \text{MIN}(P_{\text{EMAX},c}, P_{\text{EMAX, EN-DC}}, P_{\text{NR}}) - \Delta T_{\text{C\_NR},c}, (P_{\text{PowerClass, EN-DC}} - \Delta P_{\text{PowerClass, EN-DC}}), (P_{\text{PowerClass, NR}} - \Delta P_{\text{PowerClass, NR}}) - \text{MAX}(\text{MAX}(\text{MPR}_c, \text{A-MPR}_c) + \Delta T_{\text{IB},c} + \Delta T_{\text{C\_NR},c} + \Delta T_{\text{RxSRS}}, P - \text{MPR}_c) \}$$

$$P_{\text{CMAX\_H},f,c, NR} = \text{MIN} \{ P_{\text{EMAX},c}, P_{\text{EMAX, EN-DC}}, P_{\text{NR}}, P_{\text{PowerClass, EN-DC}}, P_{\text{PowerClass, NR}} - \Delta P_{\text{PowerClass, NR}} \}$$

where

- $P_{\text{EMAX, EN-DC}}$  is the value given by the field *p-maxUE-FRI* of the *RRConnectionReconfiguration-v1530* IE as defined in TS 36.331 [8];
- $P_{\text{LTE}}$  signalled by RRC as *p-MaxEUTRA-r15* in TS 36.331 [8]
- $P_{\text{NR}}$  is the value given by the field *p-NR-FRI* of the *PhysicalCellGroupConfig* IE as defined in [9] and signalled by RRC;
- $\Delta T_{\text{c\_E-UTRA},c} = 1.5\text{dB}$  when NOTE 2 in Table 6.2.2-1 in TS 36.101 [4] applies for a serving cell  $c$ , otherwise  $\Delta T_{\text{c\_E-UTRA},c} = 0\text{dB}$ ;
- $\Delta T_{\text{C\_NR},c} = 1.5\text{dB}$  when NOTE 3 in Table 6.2.1-1 in TS 38.101-1 [2] applies for a serving cell  $c$ , otherwise  $\Delta T_{\text{C\_NR},c} = 0\text{dB}$ ;
- $\Delta T_{\text{IB},c}$  specified in clause 6.2B.4.2.1 for EN-DC, the individual Power Class defined in table 6.2B.1.1 and any other additional power reductions parameters specified in clauses 6.2B.2 and 6.2B.3 for EN-DC are applicable to  $P_{\text{CMAX\_E-UTRA},c}$  and  $P_{\text{CMAX},f,c, NR}$  evaluations.
- $P_{\text{PowerClass, EN-DC}}$  is defined in clause 6.2B.1.1 for intra-band contiguous EN-DC;
- $P_{\text{PowerClass, NR}}$  is the nominal UE power of the power class that the UE supports for the NR band of the EN-DC combination as defined in clause 6.2.1 of 38.101-1 [2];
- $P_{\text{PowerClass, E-UTRA}}$  is the nominal UE power of the power class that the UE supports for the E-UTRA band of the EN-DC combination as defined in clause 6.2.2 of 36.101 [4];-  $\Delta P_{\text{PowerClass, EN-DC}}$  is 3 dB for a power class 2 capable EN-DC UE when LTE UL/DL configuration is 0 or 6; or LTE UL/DL configuration is 1 and special subframe configuration is 0 or 5;  $\Delta P_{\text{PowerClass, EN-DC}} = 3\text{ dB}$  when the IE *p-maxUE-FRI* as defined in TS 36.331 [4] is provided and set to the maximum output power of the default power class or lower;  $\Delta P_{\text{PowerClass, EN-DC}}$  is 6 dB for a power class 1.5 capable EN-DC UE when the LTE UL duty cycle is greater than  $\text{max}(50\%, \text{maxUplinkDutyCycle})$ ;  $\Delta P_{\text{PowerClass, EN-DC}}$  is 3 dB for a power class 1.5 capable EN-DC UE when the LTE UL duty cycle is between  $\text{max}(50\%, \text{maxUplinkDutyCycle})$  and  $\text{max}(25\%, \text{maxUplinkDutyCycle}/2)$ ; otherwise  $\Delta P_{\text{PowerClass, EN-DC}} = 0\text{ dB}$ ;

and whenever an NS signalling other than NS\_01 is indicated within CG 2:

- for a UE indicating support of dynamicPowerSharing,  $\text{A-MPR}_c = \text{A-MPR}'_c$  with  $\text{A-MPR}'_c$  determined in accordance with clause 6.2B.3.1 and  $\text{MPR}_c = 0\text{ dB}$  if transmission(s) in subframe  $p$  on CG 1 overlap in time with physical channel  $q$  on CG 2;
- for a UE indicating support of dynamicPowerSharing,  $\text{A-MPR}_c$  is determined in accordance with TS 38.101-1 [2] if transmission(s) in subframe  $p$  on CG 1 does not overlap in time with physical channel  $q$  on CG 2;
- for a UE not indicating support of dynamicPowerSharing, the  $\text{A-MPR}_c$  is determined in accordance with clause 6.2B.3.1 with parameters applicable for UEs not indicating support of dynamicPowerSharing and  $\text{MPR}_c = 0\text{ dB}$ ;

and whenever NS\_01 is indicated in CG 2.

- for a UE indicating support of dynamicPowerSharing,  $\text{MPR}_c = \text{MPR}'_c$  with  $\text{MPR}'_c$  determined in accordance with clause 6.2B.2.1 and  $\text{A-MPR}_c = 0\text{ dB}$  if transmission(s) in subframe  $p$  on CG 1 overlap in time with physical channel  $q$  on CG 2;
- for a UE indicating support of dynamicPowerSharing,  $\text{MPR}_c$  is determined in accordance with TS 38.101-1 [2] if transmission(s) in subframe  $p$  on CG 1 does not overlap in time with physical channel  $q$  on CG 2;



- for a UE not indicating support of dynamicPowerSharing, the MPR<sub>c</sub> is determined in accordance with clause 6.2B.2.1 with parameters applicable for UEs not indicating support of dynamicPowerSharing and A-MPR<sub>c</sub> = 0 dB;

If the transmissions from NR and E-UTRA do not overlap, then the complete clauses for configured transmitted power for E-UTRA and NR respectively from their own specifications apply with the modifications specified above. The lower value between  $P_{\text{PowerClass, EN-DC}}$  or  $P_{\text{EMAX, EN-DC}}$  shall not be exceeded at any time by UE.

If the EN-DC UE is not supporting dynamic power sharing, then the complete clauses for configured transmitted power for E-UTRA and NR respectively from their own specifications TS 36.101 [4] and TS 38.101-1 [2] respectively apply with the modifications specified above.

If the UE does not support dynamic power sharing,

$$P_{\text{Total}}^{\text{EN-DC}} = \text{MIN} \{ P_{\text{EMAX, EN-DC}}, P_{\text{PowerClass, EN-DC}} - \Delta P_{\text{PowerClass, EN-DC}} \} + 0.3 \text{ dB}$$

For UEs indicating support of dynamicPowerSharing in the *UE-MRDC-Capability* IE the UE can configure the total maximum transmission power  $P_{\text{Total}}^{\text{EN-DC}}$  within the range

$$P_{\text{EN-DC, tot\_L}} \leq P_{\text{Total}}^{\text{EN-DC}} \leq P_{\text{EN-DC, tot\_H}}$$

where

$$P_{\text{EN-DC, tot\_L}}(p, q) = \text{MIN} \{ P_{\text{PowerClass, EN-DC}} - \Delta P_{\text{PowerClass, EN-DC}} - \text{MAX} \{ \text{MPR}_{\text{tot}}, \text{A-MPR}_{\text{tot}} \}, P_{\text{EMAX, EN-DC}} \}$$

$$P_{\text{EN-DC, tot\_H}}(p, q) = \text{MIN} \{ P_{\text{PowerClass, EN-DC}}, P_{\text{EMAX, EN-DC}} \}$$

for sub-frame  $p$  on CG 1 overlapping with physical channel  $q$  on CG 2 and with  $\text{MPR}_{\text{tot}}$  and  $\text{A-MPR}_{\text{tot}}$  in accordance with 6.2B.2.1 and clause 6.2B.3.1, respectively.

The measured total maximum output power  $P_{\text{UMAX}}$  over both CGs/RATs, measured over the transmission reference time duration is

$$P_{\text{UMAX}} = 10 \log_{10} [p_{\text{UMAX, c, E-UTRA}} + p_{\text{UMAX, f, c, NR}}],$$

where  $p_{\text{UMAX, c, E-UTRA}}$  and  $p_{\text{UMAX, c, NR}}$  denotes the measured output power of serving cell  $c$  for E-UTRA and NR respectively, expressed in linear scale.

For UEs indicating support of dynamicPowerSharing, the measured total configured maximum output power  $P_{\text{UMAX}}$  shall be within the following bounds:

$$P_{\text{CMAX\_L}} - T_{\text{LOW}}(P_{\text{CMAX\_L}}) \leq P_{\text{UMAX}} \leq P_{\text{CMAX\_H}} + T_{\text{HIGH}}(P_{\text{CMAX\_H}})$$

with the tolerances  $T_{\text{LOW}}(P_{\text{CMAX\_L}})$  and  $T_{\text{HIGH}}(P_{\text{CMAX\_H}})$  for applicable values of  $P_{\text{CMAX\_L}}$  and  $P_{\text{CMAX\_H}}$  specified in Table 6.2B.4.1.1-2.

When an UL subframe transmission  $p$  from E-UTRA overlap with a physical channel  $q$  from the NR, then for  $P_{\text{UMAX}}$  evaluation, the E-UTRA subframe  $p$  is taken as reference period  $T_{\text{REF}}$  and always considered as the reference measurement duration and the following rules are applicable.

$T_{\text{REF}}$  and  $T_{\text{eval}}$  are specified in Table 6.2B.4.1.1-1 when same or different subframes and physical channel durations are used in aggregated carriers.  $P_{\text{PowerClass, EN-DC}}$  shall not be exceeded by the UE during any evaluation period of time.

**Table 6.2B.4.1.1-1:  $P_{\text{CMAX}}$  evaluation window**

transmission duration	$T_{\text{REF}}$	$T_{\text{eval}}$
Different transmission duration in different RAT carriers	E-UTRA Subframe	$\text{Min}(T_{\text{no\_hopping}}, \text{Physical Channel Length})$

For each  $T_{\text{REF}}$ , the  $P_{\text{CMAX\_H}}$  is evaluated per  $T_{\text{eval}}$  and given by the maximum value over the transmission(s) within the  $T_{\text{eval}}$  as follows:

$$P_{\text{CMAX\_H}} = \text{MAX} \{ P_{\text{CMAX\_EN-DC\_H}}(p, q), P_{\text{CMAX\_EN-DC\_H}}(p, q+1), \dots, P_{\text{CMAX\_EN-DC\_H}}(p, q+n) \}$$

where  $P_{\text{CMAX\_EN-DC\_H}}$  are the applicable upper limits for each overlapping scheduling unit pairs  $(p, q)$ ,  $(p, q+1)$ , up to  $(p, q+n)$  for each applicable  $T_{\text{eval}}$  duration, where  $q+n$  is the last NR UL physical channel overlapping with E-UTRA subframe  $p$ .

While  $P_{\text{CMAX\_L}}$  is computed as follows:

$$P_{\text{CMAX\_L}} = \text{MIN} \{ P_{\text{CMAX\_EN-DC\_L}}(p, q), P_{\text{CMAX\_EN-DC\_L}}(p, q+1), \dots, P_{\text{CMAX\_EN-DC\_L}}(p, q+n) \}$$

where  $P_{\text{CMAX\_EN-DC\_L}}$  are the applicable lower limits for each overlapping scheduling unit pairs  $(p, q)$ ,  $(p, q+1)$ , up to  $(p, q+n)$  for each applicable  $T_{\text{eval}}$  duration, where  $q+n$  is the last NR UL physical channel overlapping with E-UTRA subframe  $p$ ,

With

$$P_{\text{CMAX\_EN-DC\_H}}(p, q) = \text{MIN} \{ 10 \log_{10} [p_{\text{CMAX\_H\_E-UTRA,c}}(p) + p_{\text{CMAX\_H,f,c,NR}}(q)], P_{\text{EMAX, EN-DC}}, P_{\text{PowerClass, EN-DC}} \}$$

And:

$$a = 10 \log_{10} [p_{\text{CMAX\_E-UTRA,c}}(p) + p_{\text{CMAX\_f,c,NR}}(q)] > P_{\text{EN-DC,tot,L}}$$

$$b = 10 \log_{10} [p_{\text{CMAX\_E-UTRA,c}}(p) + p_{\text{CMAX\_f,c,NR}}(q) / X_{\text{scale}}] > P_{\text{EN-DC,tot,L}}$$

If  $a = \text{FALSE}$  and the configured transmission power spectral density between the MCG and SCG differs by less than 6 dB

$$P_{\text{CMAX\_EN-DC\_L}}(p, q) = \text{MIN} \{ 10 \log_{10} [p_{\text{CMAX\_L\_E-UTRA,c}}(p) + p_{\text{CMAX\_L,f,c,NR}}(q)], P_{\text{EMAX, EN-DC}}, P_{\text{PowerClass, EN-DC}} - \Delta P_{\text{PowerClass, EN-DC}} \}$$

ELSE If  $(a = \text{TRUE})$  AND  $(b = \text{FALSE})$  and the configured transmission power spectral density between the MCG and SCG differs by less than 6 dB

$$P_{\text{CMAX\_EN-DC\_L}}(p, q) = \text{MIN} \{ 10 \log_{10} [p_{\text{CMAX\_L\_E-UTRA,c}}(p) + p_{\text{CMAX\_L,f,c,NR}}(q) / X_{\text{scale}}], P_{\text{EMAX, EN-DC}}, P_{\text{PowerClass, EN-DC}} - \Delta P_{\text{PowerClass, EN-DC}} \}$$

ELSE If  $b = \text{TRUE}$  or the transmission power after power scaling spectral density between the MCG and SCG differs by more than 6 dB

$$P_{\text{CMAX\_EN-DC\_L}}(p, q) = \text{MIN} \{ 10 \log_{10} [p_{\text{CMAX\_L\_E-UTRA,c}}(p)], P_{\text{EMAX, EN-DC}}, P_{\text{PowerClass, EN-DC}} - \Delta P_{\text{PowerClass, EN-DC}} \}$$

where

- $p_{\text{CMAX\_H\_E-UTRA,c}}(p)$  is the E-UTRA higher limit of the maximum configured power expressed in linear scale;
- $p_{\text{CMAX\_H,f,c,NR}}(q)$  is the NR higher limit of the maximum configured power expressed in linear scale;
- $p_{\text{CMAX\_L\_E-UTRA,c}}(p)$  is the E-UTRA lower limit of the maximum configured power expressed in linear scale;
- $p_{\text{CMAX\_L,f,c,NR}}(q)$  is the NR lower limit of the maximum configured power expressed in linear scale;
- $P_{\text{PowerClass, EN-DC}}$  is defined in clause 6.2B.1.1 for intra-band EN-DC;
- $X_{\text{scale}}$  is the linear value of  $X$  dB which is configured by RRC and can only take values  $[0, 6]$  dB
- $p_{\text{CMAX\_E-UTRA,c}}(p)$  is the linear value of  $P_{\text{CMAX\_E-UTRA,c}}(p)$ , the real configured max power for E-UTRA
- $p_{\text{CMAX\_f,c,NR}}(q)$  is the linear value of  $P_{\text{CMAX\_f,c,NR}}(q)$ , the real configured max power of NR

**Table 6.2B.4.1.1-2: P<sub>CMAX</sub> tolerance for Dual Connectivity E-UTRA-NR**

P <sub>CMAX</sub> (dBm)	Tolerance T <sub>LOW</sub> (P <sub>CMAX_L</sub> ) (dB)	Tolerance T <sub>HIGH</sub> (P <sub>CMAX_H</sub> ) (dB)
23 ≤ P <sub>CMAX</sub> ≤ 33	3.0	2.0
22 ≤ P <sub>CMAX</sub> < 23	5.0	2.0
21 ≤ P <sub>CMAX</sub> < 22	5.0	3.0
20 ≤ P <sub>CMAX</sub> < 21	6.0	4.0
16 ≤ P <sub>CMAX</sub> < 20	5.0	
11 ≤ P <sub>CMAX</sub> < 16	6.0	
-40 ≤ P <sub>CMAX</sub> < 11	7.0	

If the UE supports dynamic power sharing, and when E-UTRA and NR transmissions overlap and the condition (If (a=TRUE) AND (b=FALSE)) is met, SCG shall be transmitted and the following supplementary minimum requirement apply for the measured SCG power, P<sub>UMAX,f,c,NR</sub>(q), under nominal conditions and unless otherwise stated

$$10\log(p_{\text{CMAX}_{L,f,c,NR}}(q)/X_{\text{scale}}) - T_{\text{LOW}}(10\log(p_{\text{CMAX}_{L,f,c,NR}}(q)/X_{\text{scale}})) \leq P_{\text{UMAX},f,c,NR}(q) \leq 10\log(p_{\text{CMAX}_{H,f,c,NR}}(q)) + T_{\text{HIGH}}(10\log(p_{\text{CMAX}_{H,f,c,NR}}(q))).$$

with the tolerances T<sub>LOW</sub> and T<sub>HIGH</sub> for applicable values of P<sub>CMAX</sub> specified in Table 6.2B.4.1.1-2.

If the UE supports dynamic power sharing, the measured maximum output power in subframe *p* on CG 1, P<sub>UMAX,c,E-UTRA</sub>, shall meet the requirements in clause 6.2.5 in TS 36.101 [4] with the limits P<sub>CMAX\_L,c</sub> and P<sub>CMAX\_H,c</sub> replaced by P<sub>CMAX\_L,E-UTRA,c</sub> and P<sub>CMAX\_H,E-UTRA,c</sub> as specified above, respectively.

If the configured transmission power spectral density between the MCG and SCG differs by more than 6 dB, then

$$P_{\text{UMAX},f,c,NR}(q) \leq 10\log(p_{\text{CMAX}_{H,f,c,NR}}(q)) + T_{\text{HIGH}}(10\log(p_{\text{CMAX}_{H,f,c,NR}}(q))).$$

#### 6.2B.4.1.2 Intra-band non-contiguous EN-DC

The following requirements apply for one component carrier per CG configured for synchronous DC. The CG(s) are indexed by *j* = 1 for MCG and *j* = 2 for SCG.

The configured maximum output power P<sub>CMAX,E-UTRA,c</sub>(*p*) in sub-frame *p* for the configured E-UTRA uplink carrier shall be set in accordance with clause 6.2B.4.1.1 but where

- for a UE not indicating support of dynamicPowerSharing, the A-MPR<sub>c</sub> determined in accordance with clause 6.2B.3.2 with parameters applicable for UEs not indicating support of dynamicPowerSharing and MPR<sub>c</sub> = 0 dB;

whenever NS\_01 is not indicated within CG 1 while

- for a UE not indicating support of dynamicPowerSharing, the MPR<sub>c</sub> determined in accordance with clause 6.2B.2.2 with parameters applicable for UEs not indicating support of dynamicPowerSharing and A-MPR<sub>c</sub> = 0 dB;

whenever NS\_01 is indicated in CG 1.

The configured maximum output power P<sub>CMAX,f,c,NR</sub>(*q*) in physical channel *q* for the configured NR carrier shall be set in accordance with clause 6.2B.4.1.1 but where

- for a UE indicating support of dynamicPowerSharing, A-MPR<sub>c</sub> = A-MPR'<sub>c</sub> with A-MPR'<sub>c</sub> determined in accordance with clause 6.2B.3.2 and MPR<sub>c</sub> = 0 dB if transmission(s) in subframe *p* on CG 1 overlap in time with physical channel *q* on CG 2;
- for a UE indicating support of dynamicPowerSharing, A-MPR<sub>c</sub> is determined in accordance with TS 38.101-1 [2] if transmission(s) in subframe *p* on CG 1 does not overlap in time with physical channel *q* on CG 2;
- for a UE not indicating support of dynamicPowerSharing, the A-MPR<sub>c</sub> is determined in accordance with clause 6.2B.3.2 with parameters applicable for UEs not indicating support of dynamicPowerSharing and MPR<sub>c</sub> = 0 dB;

whenever NS\_01 is not indicated in CG 2 while

- for a UE indicating support of dynamicPowerSharing,  $MPR_c = MPR'_c$  with  $MPR'_c$  determined in accordance with clause 6.2B.2.2 and  $A-MPR_c = 0$  dB if transmission(s) in subframe  $p$  on CG 1 overlap in time with physical channel  $q$  on CG 2;
- for a UE indicating support of dynamicPowerSharing,  $MPR_c$  is determined in accordance with TS 38.101-1 [2] if transmission(s) in subframe  $p$  on CG 1 does not overlap in time with physical channel  $q$  on CG 2;
- for a UE not indicating support of dynamicPowerSharing, the  $MPR_c$  is determined in accordance with clause 6.2B.2.2 with parameters applicable for UEs not indicating support of dynamicPowerSharing and  $A-MPR_c = 0$  dB;

whenever NS\_01 is indicated in CG 2.

For UEs indicating support of dynamicPowerSharing in the *UE-MRDC-Capability IE*, the UE can configure the total transmission power in accordance with clause 6.2B.4.1.1 but with  $P_{\text{powerclass,EN-DC}}$  the EN-DC power class of the intra-band non-contiguous band combination configured and  $A-MPR$  determined in accordance with clause 6.2B.3.2.

The total maximum output power  $P_{\text{UMAX}}$  over both CGs is measured in accordance with clause 6.2B.4.1.1 and shall be within the limits specified in clause 6.2B.4.1.1 but with parameters applicable for the non-contiguous band combination configured.

The maximum output power levels  $p_{\text{UMAX,c,E-UTRA}}$  and  $p_{\text{UMAX,f,c,NR}}$  for the CGs are measured in accordance with clause 6.2B.4.1.1 and shall be within the limits specified in clause 6.2B.4.1.1 but with parameters applicable for the non-contiguous band combination configured.

### 6.2B.4.1.3 Inter-band EN-DC within FR1

For inter-band dual connectivity with one uplink serving cell or more than one uplink serving cells configured for intra-band UL CA on the E-UTRA CG and one uplink serving cell on the NR CG, the UE is allowed to set its configured maximum output power  $P_{\text{CMAX,c}(i),i}$  for serving cell  $c(i)$  of CG  $i$ ,  $i = 1,2$ , and its total configured maximum transmission power for EN-DC operation,  $P_{\text{Total}}^{\text{EN-DC}} = 10\log_{10}(\hat{P}_{\text{total}}^{\text{EN-DC}})$  with  $\hat{P}_{\text{total}}^{\text{EN-DC}}$  as specified in clause 7.6 of TS 38.213 [10]. For EN-DC with more than one uplink serving cells configured for intra-band UL CA on the E-UTRA CG, the  $P_{\text{CMAX}}$  applies to the entire E-UTRA CG.

For a UE configured with EN-DC and serving cell frame structure type 1, if the UE is configured with *subframeAssignment-r15* for the serving cell and E-UTRA Pcell is FDD, the UE is not expected to be configured with more than one serving cells in the uplink.

The configured maximum output power  $P_{\text{CMAX,E-UTRA,c}}(p)$  in sub-frame  $p$  for the configured E-UTRA uplink carrier(s) shall be set within the bounds:

$$P_{\text{CMAX,L,E-UTRA,c}}(p) \leq P_{\text{CMAX,E-UTRA,c}}(p) \leq P_{\text{CMAX,H,E-UTRA,c}}(p)$$

where  $P_{\text{CMAX,L,E-UTRA,c}}$  and  $P_{\text{CMAX,H,E-UTRA,c}}$  are the limits for a serving cell  $c$  as specified in TS 36.101 [4] clause 6.2.5 modified by  $P_{\text{LTE}}$  as follows:

$$P_{\text{CMAX,L,E-UTRA,c}} = \text{MIN} \{ P_{\text{EMAX,EN-DC}}, (P_{\text{PowerClass,EN-DC}} - \Delta P_{\text{PowerClass,EN-DC}}), \text{MIN}(P_{\text{EMAX,c}}, P_{\text{LTE}}) - \Delta t_{\text{C,E-UTRA,c}}, (P_{\text{PowerClass,E-UTRA}} - \Delta P_{\text{PowerClass,E-UTRA}}) - \text{MAX}(MPR_c + A-MPR_c + \Delta T_{\text{IB,c}} + \Delta t_{\text{C,E-UTRA,c}} + \Delta T_{\text{ProSe}}, P-MPR_c) \}$$

$$P_{\text{CMAX,H,E-UTRA,c}} = \text{MIN} \{ P_{\text{EMAX,c}}, P_{\text{EMAX,EN-DC}}, (P_{\text{PowerClass,EN-DC}} - \Delta P_{\text{PowerClass,EN-DC}}), P_{\text{LTE}}, P_{\text{PowerClass,E-UTRA}} - \Delta P_{\text{PowerClass,E-UTRA}} \}$$

For EN-DC with more than one uplink serving cells configured for intra-band UL CA on the E-UTRA CG,  $P_{\text{CMAX,L,E-UTRA,c}}$  and  $P_{\text{CMAX,H,E-UTRA,c}}$  are the limits for the E-UTRA CG as specified in TS 36.101 [4] clause 6.2.5A modified by  $P_{\text{LTE}}$  as follows:

$$P_{\text{CMAX,L,E-UTRA,c}} = \text{MIN} \{ 10 \log_{10} \sum p_{\text{EMAX,c}} - \Delta T_{\text{C}}, (P_{\text{PowerClass}} - \Delta P_{\text{PowerClass}}) - \text{MAX}(MPR + A-MPR + \Delta T_{\text{IB,c}} + \Delta T_{\text{C}} + \Delta T_{\text{ProSe}}, P-MPR) \}, P_{\text{LTE}}, P_{\text{powerclass,ENDC}} \}$$

$$P_{\text{CMAX,H,E-UTRA,c}} = \text{MIN} \{ 10 \log_{10} \sum p_{\text{EMAX,c}}, P_{\text{PowerClass}}, P_{\text{LTE}}, P_{\text{powerclass,ENDC}} \}$$

The configured maximum output power  $P_{\text{CMAX,f,c,NR}}(q)$  in physical-channel  $q$  for the configured NR carrier shall be set within the bounds:

$$P_{\text{CMAX\_L,f,c,NR}}(q) \leq P_{\text{CMAX,f,c,NR}}(q) \leq P_{\text{CMAX\_H,f,c,NR}}(q)$$

where  $P_{\text{CMAX\_L,f,c,NR}}$  and  $P_{\text{CMAX\_H,f,c,NR}}$  are the limits for a serving cell  $c$  as specified in clause 6.2.4 of TS 38.101-1 [2] modified as follows:

$$P_{\text{CMAX\_L,f,c,NR}} = \text{MIN} \{ P_{\text{EMAX, EN-DC}}, (P_{\text{PowerClass, EN-DC}} - \Delta P_{\text{PowerClass, EN-DC}}), \text{MIN}(P_{\text{EMAX,c}}, P_{\text{NR}}) - \Delta T_{\text{C\_NR, c}}, (P_{\text{PowerClass, NR}} - \Delta P_{\text{PowerClass, NR}}) - \text{MAX}(\text{MAX}(\text{MPR}_c, \text{A-MPR}_c) + \Delta T_{\text{IB, c}} + \Delta T_{\text{C\_NR, c}} + \Delta T_{\text{RxsRS}}, \text{P-MPR}_c) \}$$

$$P_{\text{CMAX\_H,f,c,NR}} = \text{MIN} \{ P_{\text{EMAX,c}}, P_{\text{EMAX, EN-DC}}, (P_{\text{PowerClass, EN-DC}} - \Delta P_{\text{PowerClass, EN-DC}}), P_{\text{NR}}, P_{\text{PowerClass, NR}} - \Delta P_{\text{PowerClass, NR}} \}$$

where

- $P_{\text{EMAX, EN-DC}}$  is the value given by the field *p-maxUE-FR1* of the *RRCCONNECTIONRECONFIGURATION-v1530* IE as defined in TS 36.331 [8];
- If more than one E-UTRA uplink serving cell is configured as intra-band UL CA in the E-UTRA CG,  $P_{\text{PowerClass}}$  refers to the maximum output power of the E-UTRA intra-band CA power class given in Table 6.2.2A-1 of TS 36.101 [4];
- $P_{\text{LTE}}$  is the value given by the field *p-maxEUTRA-r15* of the *RRCCONNECTIONRECONFIGURATION-v1510* IE as defined in TS 36.331 [8];
- If more than one E-UTRA uplink serving cell is configured as intra-band UL CA in the E-UTRA CG,  $\text{MPR}_c = \text{MPR}$  and  $\text{A-MPR}_c = \text{A-MPR}$  with  $\text{MPR}$  and  $\text{A-MPR}$  specified in clause 6.2.3A and clause 6.2.4A of TS 36.101 [4] respectively. There is one power management term for the UE, denoted  $\text{P-MPR}$ , and  $\text{P-MPR}_c = \text{P-MPR}$ .  $P_{\text{CMAX\_E-UTRA,c}}$  is calculated under the assumption that the transmit power is increased by the same amount in dB on all component carriers within the E-UTRA CG.
- $P_{\text{NR}}$  is the value given by the field *p-NR-FR1* of the *PhysicalCellGroupConfig* IE as defined in TS 38.331 [9];
- $\Delta t_{\text{c\_E-UTRA, c}} = 1.5$  dB when NOTE 2 in Table 6.2.2-1 in TS 36.101 [4] applies for a serving cell  $c$ , otherwise  $\Delta T_{\text{C\_E-UTRA, c}} = 0$  dB;
- $\Delta T_{\text{C\_NR, c}} = 1.5$  dB when NOTE 3 in Table 6.2.1-1 in TS 38.101-1 [2] applies for a serving cell  $c$ , otherwise  $\Delta T_{\text{C\_NR, c}} = 0$  dB;
- $P_{\text{PowerClass, EN-DC}}$  is defined in clause 6.2B.1.3 for inter-band EN-DC;
- $P_{\text{PowerClass, NR}}$  is the nominal UE power of the power class that the UE supports for the NR band of the EN-DC combination as defined in clause 6.2.1 of 38.101-1 [2];
- $P_{\text{PowerClass, E-UTRA}}$  is the nominal UE power of the power class that the UE supports for the E-UTRA band of the EN-DC combination as defined in clause 6.2.2 of 36.101 [4];
- $\Delta T_{\text{IB, c}}$  specified in clause 6.2B.4.2.3 for EN-DC, the individual Power Class defined in table 6.2B.1.3 and any other additional power reductions parameters specified in clauses 6.2B.2 and 6.2B.3 for EN-DC are applicable to  $P_{\text{CMAX\_E-UTRA,c}}$  and  $P_{\text{CMAX,f,c,NR}}$  evaluations.
- $\Delta P_{\text{PowerClass, EN-DC}} = 3$  dB for a power class 2 capable EN-DC UE when the IE *p-maxUE-FR1*, as defined in TS 38.331 [9], is provided and set to the maximum output power of the default power class or lower; otherwise  $\Delta P_{\text{PowerClass, EN-DC}} = 0$  dB;

If the transmissions from NR and E-UTRA do not overlap, then the complete clauses for configured transmitted power for E-UTRA and NR respectively from their own specifications apply with the modifications specified above. The lower value between  $P_{\text{PowerClass, EN-DC}}$  or  $P_{\text{EMAX, EN-DC}}$  shall not be exceeded at any time by UE.

$P_{\text{Total}}^{\text{EN-DC}} = 10 \log_{10}(\hat{P}_{\text{Total}}^{\text{EN-DC}})$  with  $P_{\text{Total}}^{\text{EN-DC}}$  the configured maximum transmission power for EN-DC operation as specified in clause 7.6 of TS 38.213 [10].

The total configured maximum transmission power for both synchronous and non-synchronous operation is

$$P_{\text{Total}}^{\text{EN-DC}} = \text{MIN} \{ P_{\text{EMAX, EN-DC}}, P_{\text{PowerClass, EN-DC}} - \Delta P_{\text{PowerClass, EN-DC}} \}$$

If the UE does not support dynamic power sharing,

$$P_{\text{Total}}^{\text{EN-DC}} = \text{MIN} \{ P_{\text{EMAX, EN-DC}}, P_{\text{PowerClass, EN-DC}} - \Delta P_{\text{PowerClass, EN-DC}} \} + 0.3 \text{ dB}$$

If the EN-DC UE does not support dynamic power sharing, then the complete clauses for configured transmitted power for E-UTRA and NR respectively from their own specifications TS 36.101 [4] and TS 38.101-1 [2] respectively apply with the modifications specified above and  $P_{Total}^{EN-DC}$  applies.

When a UE supporting dynamic sharing is configured for overlapping E-UTRA uplink and NR uplink transmissions, the UE can set its configured maximum output power  $P_{CMAX\_E-UTRA,c}$  and  $P_{CMAX,f,c,NR}$  for the configured E-UTRA and NR uplink carriers, respectively, and its configured maximum transmission power for EN-DC operation,  $\hat{P}_{Total}^{EN-DC}$ , as specified above.

The measured total maximum output power  $P_{UMAX}$  over both CGs/RATs, measured over the transmission reference time duration is

$$P_{UMAX} = 10 \log_{10} [p_{UMAX,c,E-UTRA} + p_{UMAX,c,NR}],$$

where  $p_{UMAX,c,E-UTRA}$  and  $p_{UMAX,c,NR}$  denotes the measured output power of serving cell  $c$  for E-UTRA and NR respectively, expressed in linear scale.

The measured total configured maximum output power  $P_{UMAX}$  shall be within the following bounds:

$$P_{CMAX\_L} - T_{LOW}(P_{CMAX\_H}) \leq P_{UMAX} \leq P_{CMAX\_H} + T_{HIGH}(P_{CMAX\_H})$$

with the tolerances  $T_{LOW}(P_{CMAX\_H})$  and  $T_{HIGH}(P_{CMAX\_H})$  for applicable values of  $P_{CMAX}$  specified in Table 6.2B.4.1.3-2.

When an UL subframe transmission  $p$  from E-UTRA overlap with a physical-channel  $q$  from the NR, then for  $P_{UMAX}$  evaluation, the E-UTRA subframe  $p$  is taken as reference period  $T_{REF}$  and always considered as the reference measurement duration and the following rules are applicable.

$T_{REF}$  and  $T_{eval}$  are specified in Table 6.2B.4.1.3-1 when same or different subframe and physical-channel durations are used in aggregated carriers.  $P_{PowerClass\_EN-DC}$  shall not be exceeded by the UE during any evaluation period of time.

**Table 6.2B.4.1.3-1:  $P_{CMAX}$  evaluation window**

transmission duration	$T_{REF}$	$T_{eval}$
Different transmission duration in different RAT carriers	E-UTRA Subframe on all aggregated cells of E-UTRA	$\text{Min}(T_{no\_hopping}, \text{Physical Channel Length})$

For each  $T_{REF}$ , the  $P_{CMAX\_H}$  is evaluated per  $T_{eval}$  and given by the maximum value over the transmission(s) within the  $T_{eval}$  as follows:

$$P_{CMAX\_H} = \text{MAX} \{ P_{CMAX\_EN-DC\_H}(p,q), P_{CMAX\_EN-DC\_H}(p,q+1), \dots, P_{CMAX\_EN-DC\_H}(p,q+n) \}$$

where  $P_{CMAX\_EN-DC\_H}$  are the applicable upper limits for each overlapping scheduling unit pairs  $(p,q)$ ,  $(p,q+1)$ , up to  $(p,q+n)$  for each applicable  $T_{eval}$  duration, where  $q+n$  is the last NR UL physical-channel overlapping with E-UTRA subframe  $p$ .

While  $P_{CMAX\_L}$  is computed as follows:

$$P_{CMAX\_L} = \text{MIN} \{ P_{CMAX\_EN-DC\_L}(p,q), P_{CMAX\_EN-DC\_L}(p,q+1), \dots, P_{CMAX\_EN-DC\_L}(p,q+n) \}$$

where  $P_{CMAX\_EN-DC\_L}$  are the applicable lower limits for each overlapping scheduling unit pairs  $(p,q)$ ,  $(p,q+1)$ , up to  $(p,q+n)$  for each applicable  $T_{eval}$  duration, where  $q+n$  is the last NR UL physical-channel overlapping with E-UTRA subframe  $p$ ,

With

$$P_{CMAX\_EN-DC\_H}(p,q) = \text{MIN} \{ 10 \log_{10} [P_{CMAX\_H\_E-UTRA,c}(p) + P_{CMAX\_H,f,c,NR}(q)], P_{EMAX,EN-DC}, P_{PowerClass,EN-DC} \}$$

And:

$$a = 10 \log_{10} [P_{CMAX\_E-UTRA,c}(p) + P_{CMAX,f,c,NR}(q)] > P_{Total}^{EN-DC}$$

$$b = 10 \log_{10} [P_{CMAX\_E-UTRA,c}(p) + P_{CMAX,f,c,NR}(q) / X\_scale] > P_{Total}^{EN-DC}$$

If a= FALSE

$$P_{\text{CMAX\_EN-DC\_L}}(p,q) = \text{MIN} \{ 10 \log_{10} [p_{\text{CMAX\_L\_E-UTRA,c}}(p) + p_{\text{CMAX\_L,f,c,NR}}(q)], P_{\text{EMAX, EN-DC}}, P_{\text{PowerClass, EN-DC}} \}$$

ELSE If (a=TRUE) AND (b=FALSE)

$$P_{\text{CMAX\_EN-DC\_L}}(p,q) = \text{MIN} \{ 10 \log_{10} [p_{\text{CMAX\_L\_E-UTRA,c}}(p) + p_{\text{CMAX\_L,f,c,NR}}(q) / X_{\text{scale}} ], P_{\text{EMAX, EN-DC}}, P_{\text{PowerClass, EN-DC}} \}$$

ELSE If b= TRUE

$$P_{\text{CMAX\_EN-DC\_L}}(p,q) = \text{MIN} \{ 10 \log_{10} [p_{\text{CMAX\_L\_E-UTRA,c}}(p) ], P_{\text{EMAX, EN-DC}}, P_{\text{PowerClass, EN-DC}} \}$$

where

- $p_{\text{CMAX\_H\_E-UTRA,c}}(p)$  is the E-UTRA higher limit of the maximum configured power expressed in linear scale;
- $p_{\text{CMAX\_L,f,c,NR}}(q)$  is the NR higher limit of the maximum configured power expressed in linear scale;
- $p_{\text{CMAX\_L\_E-UTRA,c}}(p)$  is the E-UTRA lower limit of the maximum configured power expressed in linear scale;
- $p_{\text{CMAX\_L,f,c,NR}}(q)$  is the NR lower limit of the maximum configured power expressed in linear scale;
- $P_{\text{PowerClass, EN-DC}}$  is defined in clause 6.2B.1.3-1 for inter-band EN-DC;
- $X_{\text{scale}}$  is the linear value of X dB which is configured by RRC and can only take values [0 , 6]
- $p_{\text{CMAX\_E-UTRA,c}}(p)$  is the linear value of  $P_{\text{CMAX\_E-UTRA,c}}(p)$ , the configured max power for E-UTRA. If more than one E-UTRA uplink serving cell is configured as intra-band UL CA in the E-UTRA CG,  $P_{\text{CMAX\_E-UTRA,c}}(p)$  will be replaced by  $P_{\text{CMAX}}(p)$  which is the configured maximum power for the entire E-UTRA CG.
- $p_{\text{CMAX\_L,f,c,NR}}(q)$  is the linear value of  $P_{\text{CMAX\_L,f,c,NR}}(q)$ , the configured max power of NR

**Table 6.2B.4.1.3-2:  $P_{\text{CMAX}}$  tolerance for Dual Connectivity E-UTRA-NR**

$P_{\text{CMAX}}(\text{dBm})$	Tolerance $T_{\text{LOW}}(P_{\text{CMAX\_L}})$ (dB)	Tolerance $T_{\text{HIGH}}(P_{\text{CMAX\_H}})$ (dB)
$23 \leq P_{\text{CMAX}} \leq 33$	3.0	2.0
$22 \leq P_{\text{CMAX}} < 23$	5.0	2.0
$21 \leq P_{\text{CMAX}} < 22$	5.0	3.0
$20 \leq P_{\text{CMAX}} < 21$	6.0	4.0
$16 \leq P_{\text{CMAX}} < 20$	5.0	
$11 \leq P_{\text{CMAX}} < 16$	6.0	
$-40 \leq P_{\text{CMAX}} < 11$	7.0	
NOTE 1: For UEs not indicating support of dynamic power sharing, the upper tolerance $T_{\text{high}}$ shall be reduced by 0.3 dB for $P \geq 20$ dBm.		

When E-UTRA and NR transmissions overlap and the condition (If (a=TRUE) AND (b=FALSE)) is met, SCG shall be transmitted and the following supplementary minimum requirement apply for the measured SCG power,  $P_{\text{UMAX,f,c,NR}}(q)$ , under nominal conditions.

$$10 \log(p_{\text{CMAX\_L,f,c,NR}}(q) / X_{\text{scale}}) - T_{\text{LOW}}(10 \log(p_{\text{CMAX\_L,f,c,NR}}(q) / X_{\text{scale}})) \leq P_{\text{UMAX,f,c,NR}}(q) \leq 10 \log(p_{\text{CMAX\_H,f,c,NR}}(q)) + T_{\text{HIGH}}(10 \log(p_{\text{CMAX\_H,f,c,NR}}(q))).$$

with the tolerances  $T_{\text{LOW}}$  and  $T_{\text{HIGH}}$  for applicable values of  $P_{\text{CMAX}}$  specified in Table 6.2B.4.1.3-2.

### 6.2B.4.1.3a Inter-band NE-DC within FR1

For inter-band dual connectivity with one uplink serving cell per CG on E-UTRA and NR respectively, the UE is allowed to set its configured maximum output power  $P_{\text{CMAX,c(i),i}}$  for serving cell  $c(i)$  of CG  $i$ ,  $i = 1, 2$ , and its total configured maximum transmission power for NE-DC operation,  $P_{\text{Total}}^{\text{NE-DC}} = 10 \log_{10}(\hat{P}_{\text{total}}^{\text{NE-DC}})$  with  $\hat{P}_{\text{total}}^{\text{NE-DC}}$  as specified in clause 7.6.1A of TS 38.213 [10].

The configured maximum output power  $P_{\text{CMAX\_E-UTRA,c}}(p)$  in sub-frame  $p$  for the configured E-UTRA uplink carrier shall be set within the bounds:

$$P_{\text{CMAX\_L\_E-UTRA},c}(p) \leq P_{\text{CMAX\_E-UTRA},c}(p) \leq P_{\text{CMAX\_H\_E-UTRA},c}(p)$$

where  $P_{\text{CMAX\_L\_E-UTRA},c}$  and  $P_{\text{CMAX\_H\_E-UTRA},c}$  are the limits for a serving cell  $c$  as specified in TS 36.101 [4] clause 6.2.5 modified by  $P_{\text{LTE}}$  as follows:

$$P_{\text{CMAX\_L\_E-UTRA},c} = \text{MIN} \{ P_{\text{EMAX, NE-DC}}, (P_{\text{PowerClass, NE-DC}} - \Delta P_{\text{PowerClass, NE-DC}}), \text{MIN}(P_{\text{EMAX},c}, P_{\text{LTE}}) - \Delta t_{\text{C\_E-UTRA},c}, (P_{\text{PowerClass, E-UTRA}} - \Delta P_{\text{PowerClass, E-UTRA}}) - \text{MAX}(M\text{PR}_c + A\text{-M}\text{PR}_c + \Delta T_{\text{IB},c} + \Delta T_{\text{C\_E-UTRA},c} + \Delta T_{\text{ProSe}}, P\text{-M}\text{PR}_c) \}$$

$$P_{\text{CMAX\_H\_E-UTRA},c} = \text{MIN} \{ P_{\text{EMAX},c}, P_{\text{EMAX, EN-DC}}, (P_{\text{PowerClass, NE-DC}} - \Delta P_{\text{PowerClass, NE-DC}}), P_{\text{LTE}}, P_{\text{PowerClass, E-UTRA}} - \Delta P_{\text{PowerClass, E-UTRA}} \}$$

with exception that

- if no symbol of slot  $i_1$  of the NR that is indicated as uplink or flexible by *TDD-UL-DL-ConfigurationCommon* or *TDD-UL-DL-ConfigDedicated* overlaps with subframe  $i_2$  of the E-UTRA; or
- if NR slot(s) that is indicated as downlink by *TDD-UL-DL-ConfigurationCommon* or *TDD-UL-DL-ConfigDedicated* does not overlap with subframe  $i_2$  of the E-UTRA; then

$$P_{\text{CMAX\_L\_E-UTRA},c} = \text{MIN} \{ P_{\text{EMAX, NE-DC}}, (P_{\text{PowerClass, NE-DC}} - \Delta P_{\text{PowerClass, NE-DC}}), P_{\text{EMAX},c} - \Delta t_{\text{C\_E-UTRA},c}, (P_{\text{PowerClass, E-UTRA}} - \Delta P_{\text{PowerClass, E-UTRA}}) - \text{MAX}(M\text{PR}_c + A\text{-M}\text{PR}_c + \Delta T_{\text{IB},c} + \Delta T_{\text{C\_E-UTRA},c} + \Delta T_{\text{ProSe}}, P\text{-M}\text{PR}_c) \}$$

$$P_{\text{CMAX\_H\_E-UTRA},c} = \text{MIN} \{ P_{\text{EMAX},c}, P_{\text{EMAX, EN-DC}}, (P_{\text{PowerClass, NE-DC}} - \Delta P_{\text{PowerClass, NE-DC}}), P_{\text{PowerClass, E-UTRA}} - \Delta P_{\text{PowerClass, E-UTRA}} \}$$

The configured maximum output power  $P_{\text{CMAX},f,c,\text{NR}}(q)$  in physical-channel  $q$  for the configured NR carrier shall be set within the bounds:

$$P_{\text{CMAX\_L},f,c,\text{NR}}(q) \leq P_{\text{CMAX},f,c,\text{NR}}(q) \leq P_{\text{CMAX\_H},f,c,\text{NR}}(q)$$

where  $P_{\text{CMAX\_L},f,c,\text{NR}}$  and  $P_{\text{CMAX\_H},f,c,\text{NR}}$  are the limits for a serving cell  $c$  as specified in clause 6.2.4 of TS 38.101-1 [2] modified by  $P_{\text{NR}}$  as follows:

$$P_{\text{CMAX\_L},f,c,\text{NR}} = \text{MIN} \{ P_{\text{EMAX, NE-DC}}, (P_{\text{PowerClass, NE-DC}} - \Delta P_{\text{PowerClass, NE-DC}}), \text{MIN}(P_{\text{EMAX},c}, P_{\text{NR}}) - \Delta T_{\text{C\_NR},c}, (P_{\text{PowerClass, NR}} - \Delta P_{\text{PowerClass, NR}}) - \text{MAX}(M\text{PR}_c + A\text{-M}\text{PR}_c + \Delta T_{\text{IB},c} + \Delta T_{\text{C\_NR},c} + \Delta T_{\text{RxsRS}}, P\text{-M}\text{PR}_c) \}$$

$$P_{\text{CMAX\_H},f,c,\text{NR}} = \text{MIN} \{ P_{\text{EMAX},c}, P_{\text{EMAX, NE-DC}}, (P_{\text{PowerClass, NE-DC}} - \Delta P_{\text{PowerClass, NE-DC}}), P_{\text{NR}}, P_{\text{PowerClass, NR}} - \Delta P_{\text{PowerClass, NR}} \}$$

- $P_{\text{LTE}}$  signalled by RRC as p-MaxEUTRA in TS 36.331 [8]
- $P_{\text{NR}}$  signalled by RRC as p-NR-FR1 defined in TS 38.331 [9]
- $\Delta T_{\text{C\_E-UTRA},c} = 1.5\text{dB}$  when NOTE 2 in Table 6.2.2-1 in TS 36.101 [4] applies for a serving cell  $c$ , otherwise  $\Delta T_{\text{C\_E-UTRA},c} = 0\text{dB}$ ;
- $\Delta T_{\text{C\_NR},c} = 1.5\text{dB}$  when NOTE 3 in Table 6.2.1-1 in TS 38.101-1 [2] applies for a serving cell  $c$ , otherwise  $\Delta T_{\text{C\_NR},c} = 0\text{dB}$ ;
- $\Delta T_{\text{IB},c}$  specified in clause 6.2B.4.2.3 for NE-DC, the individual Power Class defined in table 6.2B.1.3a and any other additional power reductions parameters specified in clauses 6.2B.2.3a for NE-DC are applicable to  $P_{\text{CMAX\_E-UTRA},c}$  and  $P_{\text{CMAX},f,c,\text{NR}}$  evaluations.
- $P_{\text{PowerClass, NE-DC}}$  is defined in clause 6.2B.1.3a for inter-band NE-DC;
- $P_{\text{PowerClass, NR}}$  is the nominal UE power of the power class that the UE supports for the NR band of the EN-DC combination as defined in clause 6.2.1 of 38.101-1 [2];
- $P_{\text{PowerClass, E-UTRA}}$  is the nominal UE power of the power class that the UE supports for the E-UTRA band of the EN-DC combination as defined in clause 6.2.2 of 36.101 [4];
- $\Delta P_{\text{PowerClass, NE-DC}} = 3\text{ dB}$  for a power class 2 capable NE-DC UE when the IE *p-maxUE-FRI* as defined in TS 38.331 [9] is provided and set to the maximum output power of the default power class or lower; otherwise  $\Delta P_{\text{PowerClass, NE-DC}} = 0\text{ dB}$ ;



If the transmissions from NR and E-UTRA do not overlap, then the complete clauses for configured transmitted power for E-UTRA and NR respectively from their own specifications apply with the modifications specified above. The lower value between  $P_{\text{PowerClass, NE-DC}}$  or  $P_{\text{EMAX, NE-DC}}$  shall not be exceeded at any time by UE.

$P_{\text{Total}}^{\text{NE-DC}} = 10 \log_{10}(\hat{P}_{\text{Total}}^{\text{NE-DC}})$  with  $P_{\text{Total}}^{\text{NE-DC}}$  the configured maximum transmission power for NE-DC operation as specified in clause 7.6 of TS 38.213 [10].

The total configured maximum transmission power for both synchronous and non-synchronous operation is

$$P_{\text{Total}}^{\text{NE-DC}} = \text{MIN} \{ P_{\text{EMAX, NE-DC}}, P_{\text{PowerClass, NE-DC}} - \Delta P_{\text{PowerClass, NE-DC}} \}$$

If the UE does not support dynamic power sharing,

$$P_{\text{Total}}^{\text{NE-DC}} = \text{MIN} \{ P_{\text{EMAX, NE-DC}}, P_{\text{PowerClass, NE-DC}} - \Delta P_{\text{PowerClass, NE-DC}} \} + 0.3 \text{ dB}$$

If the NE-DC UE does not support dynamic power sharing, then the complete clauses for configured transmitted power for E-UTRA and NR respectively from their own specifications TS 36.101 [4] and TS 38.101-1 [2] respectively apply with the modifications specified above and  $P_{\text{Total}}^{\text{NE-DC}}$  applies.

When a UE supporting dynamic sharing is configured for overlapping E-UTRA uplink and NR uplink transmissions, the UE can set its configured maximum output power  $P_{\text{CMAX\_E-UTRA},c}$  and  $P_{\text{CMAX},f,c,\text{NR}}$  for the configured E-UTRA and NR uplink carriers, respectively, and its configured maximum transmission power for NE-DC operation,  $\hat{P}_{\text{Total}}^{\text{NE-DC}}$ , as specified above.

The measured total maximum output power  $P_{\text{UMAX}}$  over both CGs/RATs, measured over the transmission reference time duration is

$$P_{\text{UMAX}} = 10 \log_{10} [p_{\text{UMAX},c,\text{E-UTRA}} + p_{\text{UMAX},c,\text{NR}}],$$

where  $p_{\text{UMAX},c,\text{E-UTRA}}$  and  $p_{\text{UMAX},c,\text{NR}}$  denotes the measured output power of serving cell  $c$  for E-UTRA and NR respectively, expressed in linear scale.

The measured total configured maximum output power  $P_{\text{UMAX}}$  shall be within the following bounds:

$$P_{\text{CMAX\_L}} - T_{\text{LOW}}(P_{\text{CMAX\_L}}) \leq P_{\text{UMAX}} \leq P_{\text{CMAX\_H}} + T_{\text{HIGH}}(P_{\text{CMAX\_H}})$$

with the tolerances  $T_{\text{LOW}}(P_{\text{CMAX\_L}})$  and  $T_{\text{HIGH}}(P_{\text{CMAX\_H}})$  for applicable values of  $P_{\text{CMAX}}$  specified in Table 6.2B.4.1.3a-2.

When an UL subframe transmission  $p$  from E-UTRA overlap with a physical-channel  $q$  from the NR, then for  $P_{\text{UMAX}}$  evaluation, the E-UTRA subframe  $p$  is taken as reference period  $T_{\text{REF}}$  and always considered as the reference measurement duration and the following rules are applicable.

$T_{\text{REF}}$  and  $T_{\text{eval}}$  are specified in Table 6.2B.4.1.3a-1 when same or different subframe and physical-channel durations are used in aggregated carriers.  $P_{\text{PowerClass, NE-DC}}$  shall not be exceeded by the UE during any evaluation period of time.

**Table 6.2B.4.1.3a-1:  $P_{\text{CMAX}}$  evaluation window**

transmission duration	$T_{\text{REF}}$	$T_{\text{eval}}$
Different transmission duration in different RAT carriers	LTE Subframe	$\text{Min}(T_{\text{no\_hopping}}, \text{Physical Channel Length})$

For each  $T_{\text{REF}}$ , the  $P_{\text{CMAX\_H}}$  is evaluated per  $T_{\text{eval}}$  and given by the maximum value over the transmission(s) within the  $T_{\text{eval}}$  as follows:

$$P_{\text{CMAX\_H}} = \text{MAX} \{ P_{\text{CMAX\_NE-DC\_H}}(p, q), P_{\text{CMAX\_NE-DC\_H}}(p, q+1), \dots, P_{\text{CMAX\_NE-DC\_H}}(p, q+n) \}$$

where  $P_{\text{CMAX\_NE-DC\_H}}$  are the applicable upper limits for each overlapping scheduling unit pairs  $(p, q)$ ,  $(p, q+1)$ , up to  $(p, q+n)$  for each applicable  $T_{\text{eval}}$  duration, where  $q+n$  is the last NR UL physical-channel overlapping with LTE subframe  $p$ .

While  $P_{\text{CMAX\_L}}$  is computed as follows:

$$P_{\text{CMAX\_L}} = \text{MIN} \{ P_{\text{CMAX\_NE-DC\_L}}(p, q), P_{\text{CMAX\_NE-DC\_L}}(p, q+1), \dots, P_{\text{CMAX\_NE-DC\_L}}(p, q+n) \}$$

where  $P_{\text{CMAX\_NE-DC\_L}}$  are the applicable lower limits for each overlapping scheduling unit pairs  $(p, q)$ ,  $(p, q+1)$ , up to  $(p, q+n)$  for each applicable  $T_{\text{eval}}$  duration, where  $q+n$  is the last NR UL physical-channel overlapping with LTE subframe  $p$ ,

With

$$P_{\text{CMAX\_NE-DC\_H}}(p, q) = \text{MIN} \{ 10 \log_{10} [p_{\text{CMAX\_H\_E-UTRA},c}(p) + p_{\text{CMAX\_H},f,c,NR}(q)], P_{\text{EMAX, NE-DC}}, P_{\text{PowerClass, NE-DC}} \}$$

And:

$$a = 10 \log_{10} [p_{\text{CMAX\_E-UTRA},c}(p) + p_{\text{CMAX},f,c,NR}(q)] > P_{\text{Total}}^{\text{NE-DC}}$$

If  $a = \text{TRUE}$

$$P_{\text{CMAX\_NE-DC\_L}}(p, q) = \text{MIN} \{ 10 \log_{10} [p_{\text{CMAX\_L\_E-UTRA},c}(p)], P_{\text{EMAX, NE-DC}}, P_{\text{PowerClass, NE-DC}} \}$$

Else

$$P_{\text{CMAX\_NE-DC\_L}}(p, q) = \text{MIN} \{ 10 \log_{10} [p_{\text{CMAX\_L\_E-UTRA},c}(p) + p_{\text{CMAX\_L},f,c,NR}(q)], P_{\text{EMAX, NE-DC}}, P_{\text{PowerClass, NE-DC}} \}$$

where

- $p_{\text{CMAX\_H\_E-UTRA},c}(p)$  is the E-UTRA higher limit of the maximum configured power expressed in linear scale;
- $p_{\text{CMAX\_H},f,c,NR}(q)$  is the NR higher limit of the maximum configured power expressed in linear scale;
- $p_{\text{CMAX\_L\_E-UTRA},c}(p)$  is the E-UTRA lower limit of the maximum configured power expressed in linear scale;
- $p_{\text{CMAX\_L},f,c,NR}(q)$  is the NR lower limit of the maximum configured power expressed in linear scale;
- $P_{\text{PowerClass, NE-DC}}$  is defined in clause 6.2B.1.3a for inter-band NE-DC;
- $p_{\text{CMAX\_E-UTRA},c}(p)$  is the linear value of  $P_{\text{CMAX\_E-UTRA},c}(p)$ , the real configured max power for E-UTRA
- $p_{\text{CMAX},f,c,NR}(q)$  is the linear value of  $P_{\text{CMAX},f,c,NR}(q)$ , the real configured max power of NR

**Table 6.2B.4.1.3a-2:  $P_{\text{CMAX}}$  tolerance for Dual Connectivity E-UTRA-NR**

$P_{\text{CMAX}}(\text{dBm})$	Tolerance $T_{\text{LOW}}(P_{\text{CMAX\_L}})$ (dB)	Tolerance $T_{\text{HIGH}}(P_{\text{CMAX\_H}})$ (dB)
$23 \leq P_{\text{CMAX}} \leq 33$	3.0	2.0
$22 \leq P_{\text{CMAX}} < 23$	5.0	2.0
$21 \leq P_{\text{CMAX}} < 22$	5.0	3.0
$20 \leq P_{\text{CMAX}} < 21$	6.0	4.0
$16 \leq P_{\text{CMAX}} < 20$	5.0	
$11 \leq P_{\text{CMAX}} < 16$	6.0	
$-40 \leq P_{\text{CMAX}} < 11$	7.0	
NOTE 1: For UEs not indicating support of dynamic power sharing, the upper tolerance $T_{\text{high}}$ shall be reduced by 0.3 dB for $P \geq 20$ dBm.		

When E-UTRA and NR transmissions overlap and the condition  $a = \text{TRUE}$ ,  $P_{\text{UMAX},f,c,NR}(q)$  for MCG, under nominal conditions, shall meet

$$P_{\text{UMAX},f,c,NR}(q) \leq 10 \log(p_{\text{CMAX\_H},f,c,NR}(q)) + T_{\text{HIGH}}(10 \log(p_{\text{CMAX\_H},f,c,NR}(q)))$$

with the tolerances  $T_{\text{LOW}}$  and  $T_{\text{HIGH}}$  for applicable values of  $P_{\text{CMAX}}$  specified in Table 6.2B.4a.1.3-2.

When LTE and NR transmissions overlap and the condition  $a = \text{FALSE}$ , then  $P_{\text{UMAX}}$ , under nominal conditions, shall be within the following bounds:

$$P_{\text{CMAX\_L}} - T_{\text{LOW}}(P_{\text{CMAX\_L}}) \leq P_{\text{UMAX}} \leq P_{\text{CMAX\_H}} + T_{\text{HIGH}}(P_{\text{CMAX\_H}})$$

where  $P_{\text{CMAX\_L}}$ ,  $P_{\text{CMAX\_H}}$ , and  $P_{\text{UMAX}}$  are specified above with the tolerances  $T_{\text{LOW}}$  and  $T_{\text{HIGH}}$  specified in Table 6.2B.4a.1.3-2 for applicable values of  $P_{\text{CMAX\_L}}$  and  $P_{\text{CMAX\_H}}$ .

#### 6.2B.4.1.4 Inter-band EN-DC including FR2

For inter-band dual connectivity with one uplink serving cell per CG on E-UTRA and NR respectively, with NR configured in FR2, the UE is allowed to set its configured maximum output power  $P_{\text{CMAX},c(i),i}$  for serving cell  $c(i)$  of CG  $i$ ,  $i = 1, 2$ .

The UE maximum configured power  $P_{\text{CMAX},c(i)}$ , on E-UTRA for the subframe  $i$  shall be set according to clause 6.2.5 from TS 36.101 [4]. Applicable inter-band  $\Delta T_{\text{IB},c}$  parameters shall be used according to the clauses 6.2B.4.2.4 or 6.2B.4.2.5.

The UE maximum configured power  $P_{\text{CMAX},c(j)}$ , on NR for the slot  $j$  shall be set according to subclass 6.2.4 from TS 38.101-2 [3].

For the configured power measurements TS 36.101 [4] clause 6.2.5 and TS 38.101-2 [3] clause 6.2.4 are applicable.

#### 6.2B.4.1.5 Inter-band EN-DC including both FR1 and FR2

For inter-band dual connectivity with one uplink serving cell per CG on E-UTRA and NR respectively, with both CGs configured in FR1, the requirements specified in clause 6.2B.4.1.3 apply.

For inter-band dual connectivity with one uplink serving cell per CG on E-UTRA and NR respectively, with NR configured in FR2, the requirements specified in clause 6.2B.4.1.4 apply.

For inter-band dual connectivity with one uplink serving cell in first CG on E-UTRA and two uplink serving cells in second CG on NR FR1 and NR FR2 respectively, the UE is allowed to set its configured maximum output power  $P_{\text{CMAX},c(i),i}$  for serving cell  $c(i)$ ,  $i = 1, 2, 3$  with  $i=1$  for E-UTRA,  $i=2$  for NR FR1 and  $i=3$  for NR FR2.

- For serving cell on FR2, the requirements specified in clause 6.2.4 in TS 38.101-2 [3] apply to the UE maximum configured power  $P_{\text{CMAX},c(3),3}$  and the measured maximum configured power.
- For remaining inter-band dual connectivity involving CG1 and CG2, the requirements specified in clause 6.2B.4.1.3 apply.

### 6.2B.4.2 $\Delta T_{\text{IB},c}$ for DC

#### 6.2B.4.2.0 General

For the UE which supports inter-band EN-DC or NE-DC configuration,  $\Delta T_{\text{IB},c}$  in Tables below applies where unless otherwise stated, the same  $\Delta T_{\text{IB},c}$  is applicable to NR band(s) part for DC configurations which have the same NR operating band combination. Unless otherwise stated,  $\Delta T_{\text{IB},c}$  is set to zero.

Unless  $\Delta T_{\text{IB},c}$  is specified for the NE-DC configuration, the specified  $\Delta T_{\text{IB},c}$  for the EN-DC configuration including same bands as the corresponding NE-DC configuration is applicable for the NE-DC configuration.

#### 6.2B.4.2.1 Intra-band contiguous EN-DC

$\Delta T_{\text{IB},c}$  is not applicable for intra-band contiguous EN-DC.

#### 6.2B.4.2.2 Intra-band non-contiguous EN-DC

$\Delta T_{\text{IB},c}$  is not applicable for intra-band non-contiguous EN-DC.

6.2B.4.2.3 Inter-band EN-DC within FR1

6.2B.4.2.3.1  $\Delta T_{IB,c}$  for EN-DC two bands

**Table 6.2B.4.2.3.1-1:  $\Delta T_{IB,c}$  due to EN-DC(two bands)**

Inter-band EN-DC configuration	E-UTRA or NR Band	$\Delta T_{B,c}$ (dB)
DC_1_n3	1	0.3
	n3	0.3
DC_1_n5	1	0.3
	n5	0.3
DC_1_n7	1	0.5
	n7	0.6
DC_1_n8	1	0.3
	n8	0.3
DC_1_n20	1	0.3
	n20	0.3
DC_1_n28	1	0.3
	n28	0.6
DC_1_n38	1	0.5
	n38	0.5
DC_1_n40	1	0.5
	n40	0.5
DC_1_n50	1	0.5
	n50	0.5
DC_1_n41	1	0.5
	n41	0.5
DC_1_n51	1	0.6
	n51	0.6
DC_1_n71	1	0.3
	n71	0.3
DC_1_n77	1	0.6
	n77	0.8
DC_1_n78	1	0.3
	n78	0.8
DC_2_n5	2	0.3
	n5	0.3
DC_2_n7	2	0.5
	n7	0.5
DC_2_n12	2	0.3
	n12	0.3
DC_2_n38	2	0.5
	n38	0.9
DC_2_n41	2	0.5
	n41	0.4 <sup>1</sup>
		0.9 <sup>2</sup>
DC_2_n48	2	0.6
	n48	0.8
DC_2_n66	2	0.5
	n66	0.5
DC_2_n71	2	0.3
	n71	0.3
DC_2_n78	2	0.6
	n78	0.8
DC_3_n1	3	0.3
	n1	0.3
DC_3_n5	3	0.3
	n5	0.3
DC_3_n8	3	0.3
	n8	0.3
DC_3_n7	3	0.5
	n7	0.5
DC_3_n20	3	0.3
	n20	0.3
DC_3_n28	3	0.3
	n28	0.3
DC_3_n34	3	0.5
	n34	0.5
DC_3_n38	3	0.5
	n38	0.5

Inter-band EN-DC configuration	E-UTRA or NR Band	$\Delta T_{B,c}$ (dB)
DC_3_n40	3	0.5
	n40	0.5
DC_3_n41	3	0.5
	n41	0.3 <sup>3</sup> 0.8 <sup>4</sup>
DC_3_n50	3	0.5
	n50	0.5
DC_3_n51	3	0.3
	n51	0.3
DC_3_n71	3	0.3
	n71	0.3
DC_7_n66, DC_7-7_n66	7	0.5
	n66	0.5
DC_3_n77, DC_3-3_n77	3	0.6
	n77	0.8
DC_3_n78, DC_3-3_n78	3	0.6
	n78	0.8
DC_4_n38	4	0.5
	n38	0.8
DC_4_n41	4	0.5
	n41	0.8 <sup>1</sup> 1.3 <sup>2</sup>
DC_4_n78	4	0.6
	n78	0.8
DC_5_n2, DC_5-5_n2	5	0.3
	n2	0.3
DC_5_n7	5	0.3
	n7	0.3
DC_5_n12	5	0.8
	n12	0.4
DC_5_n38	5	0.3
	n38	0.3
DC_5_n40	5	0.3
	n40	0.3
DC_5_n48	5	0.3
	n48	0.3
DC_5_n66, DC_5-5_n66	5	0.3
	n66	0.3
DC_5_n71	5	0.5
	n71	0.5
DC_5_n78	5	0.6
	n78	0.8
DC_7_n1, DC_7-7_n1	7	0.6
	n1	0.5
DC_7_n3	7	0.5
	n3	0.5
DC_7_n5	7	0.3
	n5	0.3
DC_7_n8	7	0.3
	n8	0.6
DC_7_n20	7	0.3
	n20	0.3
DC_7_n28	7	0.3
	n28	0.3
DC_7_n40	7	0.5
	n40	0.6
DC_7_n51	7	0.3
	n51	0.3
DC_7_n71	7	0.3
	n71	0.6
DC_7_n77, DC_7-7_n77	7	0.5
	n77	0.8
DC_7_n78, DC_7-7_n78	7	0.5

Inter-band EN-DC configuration	E-UTRA or NR Band	$\Delta T_{B,c}$ (dB)
	n78	0.8
DC_8_n1	8	0.3
	n1	0.3
DC_8_n3	8	0.3
	n3	0.3
DC_8_n20	8	0.4
	n20	0.4
DC_8_n28	8	0.6
	n28	0.5
DC_8_n34	8	0.3
	n34	0.3
DC_8_n39	8	0.3
	n39	0.3
DC_8_n40	8	0.3
	n40	0.3
DC_8_n41	8	0.3
	n41	0.3
DC_8_n77	8	0.6
	n77	0.8
DC_8_n78	8	0.6
	n78	0.8
DC_11_n3	11	0.8
	n3	0.9
DC_11_n28	11	0.4
	n28	0.6
DC_11_n77	11	0.4
	n77	0.8
DC_11_n78	11	0.4
	n78	0.8
DC_12_n2	12	0.3
	n2	0.3
DC_12_n5	12	0.4
	n5	0.8
DC_12_n7	12	0.3
	n7	0.3
DC_12_n25	12	0.3
	n25	0.3
DC_12_n38	12	0.3
	n38	0.3
DC_12_n41	12	0.3
	n41	0.3
DC_12_n66	12	0.8
	n66	0.3
DC_12_n78	12	0.5
	n78	0.8
DC_13_n2	13	0.3
	n2	0.3
DC_13_n5	13	0.5
	n5	0.5
DC_13_n7	13	0.5
	n7	0.5
DC_13_n48	13	0.3
	n48	0.3
DC_13_n66	13	0.3
	n66	0.3
DC_13_n71	13	0.5
	n71	0.5
DC_13_n78	13	0.5
	n78	0.8
DC_14_n2	14	0.3
	n2	0.3
DC_14_n66	14	0.3
	n66	0.3

Inter-band EN-DC configuration	E-UTRA or NR Band	$\Delta T_{B,c}$ (dB)
DC_18_n3	18	0.3
	n3	0.3
DC_18_n77	18	0.3
	n77	0.8
DC_18_n78	18	0.3
	n78	0.8
DC_19_n77	19	0.3
	n77	0.8
DC_19_n78	19	0.3
	n78	0.8
DC_20_n1	20	0.3
	n1	0.3
DC_20_n3	20	0.3
	n3	0.3
DC_20_n7	20	0.3
	n7	0.3
DC_20_n8	20	0.4
	n8	0.4
DC_20_n28	20	0.5
	n28	0.5
DC_20_n38	20	0.3
	n38	0.3
DC_20_n41	20	0.3
	n41	0.3
DC_20_n50	20	0.3
	n50	0.4
DC_20_n51	20	0.5
	n51	0.5
DC_20_n77	20	0.6
	n77	0.8
DC_20_n78	20	0.6
	n78	0.8
DC_21_n77	21	0.4
	n77	0.8
DC_21_n78	21	0.4
	n78	0.8
DC_25_n41, DC_25-25_n41	25	0.5
	n41	0.4 <sup>1</sup>
		0.9 <sup>2</sup>
DC_26_n25	26	0.3
	n25	0.3
DC_26_n41	26	0.3
	n41	0.3
DC_26_n77	26	0.3
	n77	0.8
DC_26_n78	26	0.3
	n78	0.8
DC_28_n3	28	0.3
	n3	0.3
DC_28_n5	28	0.5
	n5	0.5
DC_28_n7	28	0.3
	n7	0.3
DC_28_n8	28	0.5
	n8	0.6
DC_28_n40	28	0.3
	n40	0.3
DC_28_n41	28	0.3
	n41	0.3
DC_28_n50	28	0.3
	n50	0.4
DC_28_n51	28	0.5
	n51	0.5



Inter-band EN-DC configuration	E-UTRA or NR Band	$\Delta T_{B,c}$ (dB)
DC_28_n77	28	0.5
	n77	0.8
DC_28_n78	28	0.5
	n78	0.8
DC_30_n2	30	0.3
	n2	0.5
DC_30_n5	30	0.3
	n5	0.3
DC_30_n66	30	0.5
	n66	0.8
DC_38_n78	n78	0.5
DC_39-n41	39	0.5
	n41	0.5
DC_39_n78	39	0.3
	n78	0.8
DC_39_n79	39	0.3
	n79	0.8
DC_40_n1	n1	0.5
	40	0.5
DC_40_n41 <sup>5</sup>	40	0.5
	n41	0.5
DC_40_n77	n77	0.5
DC_40_n78	n78	0.5 <sup>6</sup>
DC_40_n79	40	0.3
	n79	0.8
DC_41_n3	41	0.3 <sup>3</sup>
	n3	0.8 <sup>4</sup>
DC_41_n28	41	0.5
	n28	0.3
DC_41_n77	41	0.3
	n77	0.8
DC_41_n78	41	0.3
	n78	0.8
DC_41_n79	41	0.3
	n79	0.8
DC_42_n28	42	0.5
	n28	0.8
DC_42_n51	42	0.6
	n51	0.8
DC_48_n5	48	0.3
	n5	0.3
DC_48_n12	48	0.3
	n12	0.3
DC_48_n66	48	0.8
	n66	0.6
DC_48_n71	48	0.3
DC_48-48_n71	n71	0.3
DC_48-48-48_n71		
DC_66_n2	66	0.5
	n2	0.5
DC_66_n5, DC_66-66_n5, DC_66-66-66_n5	66	0.3
	n5	0.3
DC_66_n7	66	0.5
	n7	0.5
DC_66_n12	66	0.8
	n12	0.3
DC_66_n25	66	0.5
	n25	0.5
DC_66_n38	66	0.5
	n38	0.5
DC_66_n41	66	0.5
	n41	0.8 <sup>1</sup>

Inter-band EN-DC configuration	E-UTRA or NR Band	$\Delta T_{IB,c}$ (dB)
		1.3 <sup>2</sup>
DC_66_n48, DC_66-66_n48	66	0.6
	n48	0.8
DC_66_n71	66	0.3
	n71	0.3
DC_66_n78	66	0.6
	n78	0.8
DC_71_n5	71	0.5
	n5	0.5
DC_71_n38	71	0.6
	n38	0.3
DC_71_n48	71	0.3
	n48	0.3
DC_71_n66	71	0.3
	n66	0.3
DC_71_n78	71	0.5
	n78	0.8
NOTE 1: The requirement is applied for UE transmitting on the frequency range of 2545-2690 MHz.		
NOTE 2: The requirement is applied for UE transmitting on the frequency range of 2496-2545 MHz.		
NOTE 3: Applicable for the frequency range of 2515 – 2690 MHz.		
NOTE 4: Applicable for the frequency range of 2496 - 2515 MHz.		
NOTE 5: Applicable for UE supporting inter-band EN-DC without simultaneous Rx/Tx.		
NOTE 6: Only applicable for UE supporting inter-band carrier aggregation with uplink in one E-UTRA band and without simultaneous Rx/Tx.		

## 6.2B.4.2.3.2

 $\Delta T_{IB,c}$  for EN-DC three bandsTable 6.2B.4.2.3.2-1:  $\Delta T_{IB,c}$  due to EN-DC (three bands)

Inter-band EN-DC configuration	E-UTRA or NR Band	$\Delta T_{IB,c}$ (dB)
DC_1-3_n5	1	0.3
	3	0.3
	n5	0.3
DC_1-3_n7 DC_3-7_n1	1 or n1	0.6
	3	0.6
	7 or n7	0.6
DC_1-3_n8	1	0.3
	3	0.3
	n8	0.3
DC_1-3_n28	1	0.3
	3	0.3
	n28	0.6
DC_1_n3-n28	1	0.3
	n3	0.3
	n28	0.6
DC_1-3_n38	1	0.5
	3	0.5
	n38	0.5
DC_1-3_n40	1	0.5
	3	0.5
	n40	0.5
DC_1-3_n41	1	0.5

Inter-band EN-DC configuration	E-UTRA or NR Band	$\Delta T_{IB,c}$ (dB)
DC_1-41_n3	3 or n3	0.5
	n41 or 41	$0.3^3/0.8^4$
DC_1-3_n77	1	0.6
	3	0.6
	n77	0.8
DC_1-3_n71	1	0.3
	3	0.3
	n71	0.3
DC_1-3_n78	1	0.6
	3	0.6
	n78	0.8
DC_1-3_n79	1	0.3
	3	0.3
DC_1_n3-n78	1	0.6
	n3	0.6
	n78	0.8
DC_1-5_n78	1	0.3
	5	0.6
	n78	0.8
DC_1-5_n79	1	0.3
	5	0.3
DC_1-7_n3	1	0.6
	7	0.6
	n3	0.6
DC_1-7_n5	1	0.5
	7	0.6
	n5	0.3
DC_1-7_n7	1	0.5
	7	0.6
	n7	0.6
DC_1-7_n8	1	0.5
	7	0.6
	n8	0.6
DC_1-7_n28	1	0.5
	7	0.6
	n28	0.6
DC_1-7_n40	1	0.6
	7	0.8
	n40	0.9
DC_1-7_n78	1	0.6

Inter-band EN-DC configuration	E-UTRA or NR Band	$\Delta T_{IB,c}$ (dB)
DC_1-7-7_n78	7	0.6
	n78	0.8
DC_1_n7-n78	1	0.6
	n78	0.8
DC_1-8_n3	1	0.3
	8	0.3
	n3	0.3
DC_1-8_n28	1	0.3
	8	0.6
	n28	0.6
DC_1_n8-n40	1	0.3
	n8	0.3
	n40	0.5
DC_1-8_n77	1	0.3
	8	0.6
	n77	0.8
DC_1-8_n78 DC_1_n8-n78	1	0.3
	8	0.6
	n78	0.8
DC_1-8_n79	1	0.3
	8	0.3
DC_1-11_n3	1	0.3
	11	0.8
	n3	0.9
DC_1-11_n77	1	0.6
	11	0.4
	n77	0.8
DC_1-11_n78	1	0.3
	11	0.4
	n78	0.8
DC_1-18-n3	1	0.3
	18	0.3
	n3	0.3
DC_1-18_n77	1	0.3
	18	0.3
	n77	0.8
DC_1-18_n78	1	0.3
	18	0.3
	n78	0.8
DC_1-19_n77	1	0.3
	19	0.3
	n77	0.8
DC_1-19_n78	1	0.3
	19	0.3
	n78	0.8
DC_1-19_n79	1	0.3
	19	0.3
	n79	0.3
DC_1-18-41_n3	1	0.5
	18	0.3
	41	0.3 <sup>7</sup> /0.8 <sup>8</sup>
	n3	0.5
DC_1-18-41_n77	1	0.6
	18	0.3
	41	0.5
	n77	0.8
DC_1-18-41_n78	1	0.5
	18	0.3
	41	0.5
	n78	0.8
DC_1-20_n3	1	0.3
	20	0.3
	n3	0.3

Inter-band EN-DC configuration	E-UTRA or NR Band	$\Delta T_{IB,c}$ (dB)
DC_1-20_n8	1	0.3
	20	0.4
	n8	0.4
DC_1-20_n28	1	0.3
	20	0.6
	n28	0.6
DC_1-20_n38	1	0.5
	20	0.3
	n38	0.5
DC_1-20_n41	1	0.5
	20	0.3
	n41	0.5 <sup>1</sup>
		1.2 <sup>2</sup>
DC_1-20_n78	1	0.3
	20	0.3
	n78	0.8
DC_1-21_n77	1	0.3
	21	0.3
	n77	0.8
DC_1-21_n78	1	0.6
	21	0.4
	n78	0.8
DC_1-21_n79	1	0.3
	21	0.3
DC_1-28-n3	1	0.3
	28	0.6
	n3	0.3
DC_1-28_n5	1	0.3
	28	0.5
	n5	0.5
DC_1-28_n7	1	0.5
	28	0.6
	n7	0.6
DC_1-28_n77	1	0.3
	28	0.6
	n77	0.8
DC_1-28_n78	1	0.3

Inter-band EN-DC configuration	E-UTRA or NR Band	$\Delta T_{IB,c}$ (dB)
DC_1_n28-n78	28 or n28	0.6
	n78	0.8
DC_1_n28-n79	1	0.3
	n28	0.3
DC_1_n28-n40	1	0.6
	n28	0.3
	n40	0.5
DC_1_n28-n77	1	0.6
	n28	0.6
	n77	0.8
DC_1-28_n40	1	0.6
	28	0.3
	n40	0.5
DC_1-32_n78	1	0.5
	n78	0.8
DC_1-(n)38	1	0.5
	38	0.5
	n38	0.5
DC_1_n40-n78	1	0.3
	n40	0.5
	n78	0.8
DC_1-41_n3	1	0.5
	41	$0.3^1/0.8^2$
	n3	0.5
DC_1-41_n28	1	0.5
	41	0.5
	n28	0.5
DC_1-(n)41	1	0.5
	41	0.5
	n41	0.5
DC_1-41_n41	1	0.5
	41	0.5
	n41	0.5
DC_1-41_n77	1	0.5
	41	0.5
	n77	0.8
DC_1-41_n78	1	0.5

Inter-band EN-DC configuration	E-UTRA or NR Band	$\Delta T_{IB,c}$ (dB)
DC_1_n41-n78	41 or n41	0.5
	n78	0.8
DC_1-41_n79	1	0.5
	41	0.5
DC_1-42_n28	1	0.3
	42	0.8
	n28	0.8
DC_1-42_n77	1	0.6
	42	0.8
	n77	0.8
DC_1-42_n78	1	0.3
	42	0.8
	n78	0.8
DC_1-42_n79	1	0.3
	42	0.8
DC_1_n77-n79	1	0.6
	n77	0.8
DC_1_SUL_n77-n80	1	0.6
	n77	0.8
	n80	0.6
DC_1_SUL_n77-n84	1	0.6
	n77	0.8
	n84	0.6
DC_1_SUL_n78-n84	1	0.3
	n78	0.8
	n84	0.3
DC_1_n78-n79	1	0.3
	n78	0.8
	n79	0.5
DC_1_n75-n78	1	0.5
	n78	0.8
DC_1_SUL_n78-n80	1	0.6
	n80	0.6
	n78	0.8
DC_2-4_n38	2	0.5
	4	0.5
	n38	0.5
DC_2-4_n41	2	0.5
	4	0.5
	n41	0.5
DC_2-5_n2 DC_2-5-5_n2	2	0.3
	5	0.3
	n2	0.3
DC_2-5_n5 DC_2-2-5_n5	2	0.3
	5	0.3
	n5	0.3
DC_2-5_n66 DC_2-5-5_n66	2	0.5
	5	0.3
	n66	0.5
DC_2-5_n71	2	0.3
	5	0.5
	n71	0.5
DC_2-7_n38 DC_2-2-7_n38	2	0.5
DC_2-7_n71	2	0.5
	7	0.5
	n71	0.6
DC_2-7_n66 DC_2-7-7_n66	2	0.5
	7	0.5
	n66	0.5
DC_2-7_n78	2	0.5
	7	0.5
DC_2_n7-n78	2	0.6

Inter-band EN-DC configuration	E-UTRA or NR Band	$\Delta T_{IB,c}$ (dB)
	n7	0.5
	n78	0.8
DC_2-12_n2	2	0.3
	12	0.3
DC_2_(n)12	2	0.3
	12	0.3
	n12	0.3
DC_2-12_n66, DC_2-2-12_n66	2	0.5
	12	0.8
	n66	0.5
DC_2-13_n2	2	0.3
	13	0.3
	n2	0.3
DC_2-13_n5 DC_2-2-13_n5	2	0.3
	13	0.5
	n5	0.5
DC_2-13_n66 DC_2-2-13_n66	2	0.5
	13	0.3
	n66	0.5
DC_2-14_n2	2	0.3
	14	0.3
	n2	0.3
DC_2-14_n66 DC_2-2-14_n66	2	0.5
	14	0.3
	n66	0.5
DC_2-29_n66 DC_2-2-29_n66	2	0.5
	n66	0.5
DC_2-30_n5, DC_2-2-30_n5	2	0.5
	30	0.3
	n5	0.3
DC_2-30_n66, DC_2-2-30_n66	2	0.5
	30	0.3
	n66	0.5
DC_2_n38-n78	2	0.6
	n38	0.9
	n78	0.8
DC_2_n41-n66	2	0.5
	n41	0.5
	n66	0.5
DC_2_n41-n71	2	0.5
	n41	0.5
	n71	0.3
DC_2_n41-n66	2	0.5
	n41	0.5
	n66	0.5
DC_2_n41-n71	2	0.5
	n41	0.5
	n71	0.3
DC_2-46_n41	2	0.5
	n41	0.4 <sup>1</sup>
		0.9 <sup>2</sup>
DC_2-46_n66	2	0.5
	n66	0.5
DC_2-48_n12	2	0.6
	48	0.3
	n12	0.8
DC_2-48_n66	2	0.6
	48	0.8
	n66	0.6
DC_2-48_n71	2	0.6
	48	0.8
	n71	0.3
	2	0.5



Inter-band EN-DC configuration	E-UTRA or NR Band	$\Delta T_{IB,c}$ (dB)
DC_2-66_n5, DC_2A-2A-66A_n5A, DC_2-66-66_n5, DC_2A-2A-66A- 66A_n5A, DC_2-66-66-66_n5	66	0.5
	n5	0.3
DC_2-66_n12	2	0.5
	66	0.5
	n12	0.8
DC_2-66_n25	2	0.5
	66	0.5
	n25	0.5
DC_2-66_n38 DC_2-2-66_n38 DC_2-66-66_n38	2	0.5
	66	0.5
	n38	0.9
DC_2-66_n41	2	0.5
	66	0.5
	n41	0.8 <sup>1</sup>
		1.3 <sup>2</sup>
DC_2-66_n48 DC_2-66-66_n48	2	0.6
	66	0.6
	n48	0.8
DC_2-66_n66	2	0.5
	66	0.5
	n66	0.5
DC_2-66_n71 DC_2_n66-n71	2	0.5
	66	0.5
	n71	0.3
DC_2-66_n78 DC_2-66-66_n78 DC_2_n66-n78	2	0.6
	66	0.6
	n78	0.8
DC_2-71_n38 DC_2-2-71_n38	2	0.5
	71	0.3
	n38	0.5
DC_2-71_n66 DC_2-2-71_n66	2	0.5
	71	0.3
	n66	0.5
DC_2-(n)71	2	0.3
	71	0.3
	n71	
DC_2-71_n78 DC_2-2-71_n78	2	0.6
	71	0.6
	n78	0.8
DC_3_n1-n7	3	0.6
	n1	0.6
	n7	0.6
DC_3_n1-n28	3	0.3
	n1	0.3
	n28	0.6
DC_3_n1-n40	3	0.5
	n1	0.5
	n40	0.5
DC_3_n1-n77	3	0.6
	n1	0.6
	n77	0.8
DC_3_n1-n78	3	0.6
	n1	0.6
	n78	0.8
DC_3_n1-n79	3	0.3
	n1	0.3
	n79	0.0
DC_3_n3-n77	3	0.6
	n3	0.6
	n77	0.8

Inter-band EN-DC configuration	E-UTRA or NR Band	$\Delta T_{IB,c}$ (dB)
DC_3_n3-n78	3	0.6
	n3	0.6
	n78	0.8
DC_3-5_n78	3	0.6
	5	0.6
	n78	0.8
DC_3-5_n79	3	0.3
	5	0.3
DC_3-7_n1, DC_3-3-7_n1, DC_3-7-7_n1, DC_3-3-7-7_n1	3	0.3
	7	0.6
	n1	0.5
DC_3-7_n5	3	0.5
	7	0.5
	n5	0.3
DC_3-7_n7	3	0.5
	7	0.5
	n7	0.5
DC_3-7_n8	3	0.5
	7	0.5
	n8	0.6
DC_3-7_n28 DC_3_n7-n28	3	0.5
	7 or n7	0.5
	n28	0.3
DC_3-7_n40	3	0.6
	7	0.8
	n40	0.9
DC_3-7_n77 DC_3-3-7_n77 DC_3-7-7_n77 DC_3-3-7-7_n77	3	0.6
	7	0.6
	n77	0.8
DC_3-7_n78, DC_3-7- 7_n78, DC_3-3-7_n78, DC_3-3-7-7_n78	3	0.6
	7	0.6
	n78	0.8
DC_3_n7-n78	3	0.6
	n7	0.6
	n78	0.8
DC_3-8_n1 DC_3-3-8_n1	3	0.3
	8	0.3
	n1	0.3
DC_3_n8-n40	3	0.5
	n8	0.3
	n40	0.5
DC_3-8_n28	3	0.3
	8	0.6
	n28	0.5
DC_3-8_n77	3	0.6
	8	0.6
	n77	0.8
DC_3-8_n78	3	0.6

Inter-band EN-DC configuration	E-UTRA or NR Band	$\Delta T_{IB,c}$ (dB)
DC_3-3-8_n78	8 or n8	0.6
	n78	0.8
DC_3-8_n79	3	0.3
	8	0.3
DC_3-18-n77	3	0.6
	18	0.3
	n77	0.8
DC_3-18-n78	3	0.6
	18	0.3
	n78	0.8
DC_3-18-n79	3	0.3
	18	0.3
DC_3-19_n77	3	0.6
	19	0.3
	n77	0.8
DC_3-19_n78	3	0.6
	19	0.3
	n78	0.8
DC_3-19_n79	3	0.3
	19	0.3
DC_3-20_n1	3	0.3
	20	0.3
	n1	0.3
DC_3-20_n7	3	0.5
	20	0.3
	n7	0.5
DC_3-20_n8	3	0.3
	20	0.4
	n8	0.4
DC_3-20_n28	3	0.3
	20	0.5
	n28	0.5
DC_3-20_n38	3	0.5
	20	0.3
	n38	0.5
DC_3-20_n41	3	0.5
	20	0.3
	n41	0.5 <sup>1</sup> 1.2 <sup>2</sup>
DC_3-20_n78	3	0.5
	20	0.3
	n78	0.8
DC_3_n20-n78	3	0.5
	n20	0.3
	n78	0.8
DC_3-21_n77	3	0.8
	21	0.9
	n77	0.8
DC_3-21_n78	3	0.8
	21	0.9
	n78	0.8
DC_3-21_n79	3	0.8
	21	0.9
DC_3-28_n5	3	0.3
	28	0.5
	n5	0.5
DC_3-28_n7	3	0.5
	28	0.3
	n7	0.5
DC_3_n28-n40	3	0.5
	n28	0.3
	n40	0.5
DC_3-28_n40	3	0.5

Inter-band EN-DC configuration	E-UTRA or NR Band	$\Delta T_{IB,c}$ (dB)
	28	0.3
	n40	0.5
DC_3-28_n41	3	0.5
	28	0.5
	n41	$0.3^3/0.8^4$
DC_3-28_n77 DC_3_n28-n77	3	0.6
	28 or n28	0.5
	n77	0.8
DC_3-28_n78	3	0.5
	28	0.3
	n78	0.8
DC_3_n28-n78	3	0.5
	n28	0.3
	n78	0.8
DC_3-32_n78	3	0.6
	n78	0.8
DC_3-38_n78	3	0.6
	n78	0.8
DC_3-40_n1	3	0.5
	40	0.5
	n1	0.5
DC_3_n40-n41	3	0.5
	n40	0.5
	n41	$0.5^3$ $0.8^4$
DC_3_n40-n78	3	0.6
	n40	0.5
	n78	0.8
DC_3_n40-n79	3	0.5
	n40	0.5
DC_3-41_n28	3	0.5
	41	$0.3^1/0.8^2$
	n28	0.3
DC_3-(n)41	3	0.5
	41	$0.3^3$ $0.8^4$
		n41
	DC_3-41_n41	
41		$0.3^3$ $0.8^4$
		n41
DC_3-41-n77		
	41	$0.3^3$ $0.8^4$
		n77
DC_3-41_n78	3	0.6

Inter-band EN-DC configuration	E-UTRA or NR Band	$\Delta T_{IB,c}$ (dB)
DC_3_n41-n78	41 or n41	0.3 <sup>3</sup>
		0.8 <sup>4</sup>
	n78	0.8
DC_3-41-n79, DC_3_n41-n79	3	0.6
	41 or n41	0.3 <sup>3</sup>
		0.8 <sup>4</sup>
DC_3_SUL_n41-n80	3	0.5
	n41	0.3 <sup>3</sup>
		0.8 <sup>4</sup>
	n80	0.5
DC_3-42_n28	3	0.6
	42	0.8
	n28	0.8
DC_3-42_n77	3	0.6
	42	0.8
	n77	0.8
DC_3-42_n78	3	0.6
	42	0.8
	n78	0.8
DC_3-42_n79	3	0.6
	42	0.8
DC_3_n75-n78	3	0.6
	n78	0.8
DC_3_n77-n79	3	0.6
	n77	0.8
DC_3_SUL_n77-n80	3	0.6
	n77	0.8
	n80	0.6
DC_3_SUL_n77-n84	3	0.6
	n77	0.8
	n84	0.6
DC_3_n78-n79	3	0.6
	n78	0.8
	n79	0.5
DC_3_SUL_n78-n80	3	0.6
	n78	0.8
	n80	0.6
DC_3_SUL_n78-n82	3	0.5
	n78	0.8
	n82	0.3
DC_3_SUL_n78-n84	3	0.6
	n78	0.8
	n84	0.6
DC_5-7_n71	5	0.5
	7	0.3
	n71	0.6
DC_5-7_n78, DC_5-7- 7_n78, DC_5_n7-n78	5	0.6
	7 or n7	0.6
	n78	0.8
DC_5_(n)12	5	0.8
	12	0.4
	n12	0.4
DC_5-13_n2	5	0.5
	13	0.5
	n2	0.3
DC_5-30_n66	5	0.3
	30	0.3
	n66	0.5
DC_5-41_n79	5	0.3
	41	0.3
	5	0.3
	66	0.5

Inter-band EN-DC configuration	E-UTRA or NR Band	$\Delta T_{IB,c}$ (dB)
DC_5-66_n2 DC_5-5-66_n2 DC_5-66-66_n2 DC_5-5-66-66_n2	n2	0.5
DC_5-66_n5 DC_5-66-66_n5	5	0.3
	66	0.3
	n5	0.3
DC_5-66_n66 DC_5-5-66_n66 DC_5-66-66_n66 DC_5-5-66-66_n66	5	0.3
	66	0.3
	n66	0.3
DC_5-66_n71	5	0.5
	66	0.3
	n71	0.5
DC_5-66_n78	5	0.6
	66	0.6
	n78	0.8
DC_5-66_n5	5	0.3
	66	0.3
	n5	0.3
DC_5-66_n66	5	0.3
	66	0.3
	n66	0.3
DC_7_n1-n40	n1	0.6
	7	0.8
	n40	0.9
DC_7_n1-n78	7	0.6
	n1	0.6
	n78	0.8
DC_7_n3-n78	7	0.6
	n3	0.6
	n78	0.8
DC_7_n7-n78	7	0.5
	n7	0.5
	n78	0.8
DC_7-8_n1 DC_7-7-8_n1	7	0.6
	8	0.6
	n1	0.5
DC_7_n8-n40	7	0.5
	n8	0.6
	n40	0.6
DC_7-8_n3	7	0.5
	8	0.6
	n3	0.5
DC_7-8_n77	7	0.5
	8	0.6
	n77	0.8
DC_7-8_n78 DC_7-7-8_n78 DC_7_n8-n78	7	0.5
	8 or n8	0.6
	n78	0.8
DC_7-13_n66	7	0.5
	13	0.3
	n66	0.5
DC_7-20_n1	7	0.6
	20	0.3
	n1	0.5
DC_7-20_n3	7	0.5
	20	0.3
	n3	0.5
DC_7-20_n8	7	0.3
	20	0.4
	n8	0.4
DC_7-20_n28	7	0.3
	20	0.6

Inter-band EN-DC configuration	E-UTRA or NR Band	$\Delta T_{IB,c}$ (dB)
	n28	0.6
DC_7-20_n78	7	0.3
	20	0.3
	n78	0.8
DC_7-28_n3	7	0.5
	28	0.3
	n3	0.5
DC_7-28_n5	7	0.3
	28	0.5
	n5	0.5
DC_7-28_n7	7	0.3
	28	0.3
	n7	0.3
DC_7_n28-n40	7	0.5
	n28	0.3
	n40	0.6
DC_7-28_n40	7	0.5
	28	0.3
	n40	0.6
DC_7-28_n78	7	0.3
	28	0.3
	n78	0.8
DC_7_n28-n78	7	0.3
	n28	0.3
	n78	0.8
DC_7-40_n1	7	0.8
	40	0.9
	n1	0.6
DC_7-46_n78	7	0.5
	n78	0.8
DC_7-66_n38	66	0.5
DC_7-66_n66 DC_7-7-66_n66	7	0.5
	66	0.5
	n66	0.5
DC_7-66_n71 DC_7-66-66_n71	7	0.5
	66	0.5
	n71	0.5
DC_7-66_n78 DC_7-7-66_n78 DC_7-66-66_n78 DC_7-7-66-66_n78	7	0.5
	66	0.5
	66	0.5
	66	0.5
DC_7_n66-n78 DC_7-7_n66-n78	7	0.5
	n66	0.6
	n78	0.8
DC_7_SUL_n78-n80	7	0.6
	n80	0.6
	n78	0.8
DC_8_n1-n78	8	0.6
	n1	0.3
	n78	0.8
DC_8_n3-n28	8	0.6
	n3	0.3
	n28	0.5
DC_8-11_n3	8	0.3
	11	0.8
	n3	0.9
DC_8-11_n77	8	0.6
	11	0.4
	n77	0.8
DC_8-11_n78	8	0.6
	11	0.4
	n78	0.8
DC_8-20_n78	8	0.6

Inter-band EN-DC configuration	E-UTRA or NR Band	$\Delta T_{IB,c}$ (dB)
	20	0.6
	n78	0.8
DC_8_n28-n77	8	0.6
	n28	0.5
	n77	0.8
DC_8_n40-n41	8	0.3
	n40	0.3
	n41	0.3
DC_8_n40-n79	8	0.3
	n40	0.3
DC_8_n41-n79	8	0.3
	n41	0.3
DC_8_SUL_n41-n81	8	0.3
	n41	0.3
	n81	0.3
DC_8-42_n28	8	0.6
	42	0.8
	n28	0.8
DC_8-42_n77	8	0.6
	42	0.8
	n77	0.8
DC_8_SUL_n78-n80	8	0.6
	n80	0.6
	n78	0.8
DC_8_SUL_n78- n81	8	0.6
	n78	0.8
	n81	0.6
DC_11-18_n77	11	0.4
	18	0.3
	n77	0.8
DC_11-18_n78	11	0.4
	18	0.3
	n78	0.8
DC_12_(n)5	5	0.8
	12	0.4
	n5	0.8
DC_12_n7-n78	12	0.5
	n7	0.5
	n78	0.8
DC_12-30_n2	12	0.3
	30	0.3
	n2	0.5
DC_12-30_n66	12	0.8
	30	0.3
	n66	0.5
DC_13-46_n5	13	0.5
	n5	0.5
DC_12-66_n2	12	0.8
	66	0.5
	n2	0.5
DC_12-66_n25	12	0.8
	66	0.5
	n25	0.5
DC_12-66_n66	12	0.8
	66	0.3
	n66	0.3
DC_13-48_n2	13	0.3
	48	0.8
	n2	0.6
DC_13-48_n66	13	0.3
	48	0.8
	n66	0.6
	13	0.3



Inter-band EN-DC configuration	E-UTRA or NR Band	$\Delta T_{IB,c}$ (dB)
DC_13-66_n2 DC_13-66-66_n2	66	0.5
	n2	0.5
DC_13-66_n48 DC_13-66-66_n48	13	0.3
	66	0.6
DC_13-66_n66 DC_13-66-66_n66	n48	0.8
	13	0.3
	66	0.3
DC_18_n3-n77	n66	0.3
	18	0.3
	n3	0.6
DC_14-66_n2 DC_14-66-66_n2	n77	0.8
	14	0.3
	66	0.5
DC_14-66_n66	n2	0.5
	14	0.3
	66	0.3
DC_18_n3-n78	n66	0.3
	18	0.3
	n3	0.6
DC_18-28_n77	n78	0.8
	18	0.5
	28	0.5
DC_18-28_n78	n77	0.8
	18	0.5
	28	0.5
DC_18-28_n79	n78	0.8
	18	0.5
	28	0.5
DC_18-41_n3	18	0.3
	41	$0.3^1/0.8^2$
DC_18-41_n77	n3	0.5
	18	0.3
	41	0.3
DC_18-41_n78	n77	0.8
	18	0.3
	41	0.3
DC_18-42_n77	n78	0.8
	18	0.3
	42	0.8
DC_18-42_n78	n77	0.8
	18	0.3
	42	0.8
DC_18-42_n79	n78	0.8
	18	0.3
DC_19-21_n77	42	0.8
	19	0.3
	21	0.4
DC_19-21_n78	n77	0.8
	19	0.3
	21	0.4
DC_19-21_n79	n78	0.8
	19	0.3
DC_19-42_n77	21	0.4
	19	0.3
	42	0.8
DC_19-42_n78	n77	0.8
	19	0.3
	42	0.8
DC_19-42_n79	n78	0.8
	19	0.3
DC_19_n77-n79	42	0.8
	19	0.3

Inter-band EN-DC configuration	E-UTRA or NR Band	$\Delta T_{IB,c}$ (dB)
DC_19_n78-n79	19	0.3
	n78	0.8
	n79	0.5
DC_20_n1-n7	20	0.3
	n1	0.5
	n7	0.6
DC_20_n1-n28	20	0.3
	n1	0.6
	n28	0.6
DC_20_n1-n78	20	0.3
	n1	0.3
	n78	0.8
DC_20_n3-n78	20	0.3
	n3	0.5
	n78	0.8
DC_20_n7-n28	20	0.5
	n7	0.3
	n28	0.5
DC_20_n8-n75	20	0.4
	n8	0.4
DC_20_n28-n75	20	0.5
	n28	0.7
DC_20_n28-n78	20	0.6
	n28	0.6
	n78	0.8
DC_20-32_n78	20	0.5
	n78	0.8
DC_20-(n)38	20	0.3
	38	0.3
	n38	0.3
DC_20-38_n78	20	0.6
	n78	0.8
DC_20_n41-n78	20	0.5
	n41	0.3
	n78	0.8
DC_20_n75-n78	20	0.5
	n78	0.8
DC_20_n76-n78	20	0.5
	n78	0.8
DC_20_SUL_n78-n80	20	0.3
	n80	0.5
	n78	0.8
DC_20_SUL_n78-n82	20	0.6
	n78	0.8
	n82	0.6
DC_20_SUL_n78-n83	20	0.8
	n78	0.8
	n83	0.8
DC_20_n78-n92	20	0.6
	n78	0.8
DC_21-42_n77	21	0.4
	42	0.8
	n77	0.8
DC_21-42_n78	21	0.4
	42	0.8
	n78	0.8
DC_21-42_n79	21	0.4
	42	0.8
DC_21_n77-n79	21	0.4
	n77	0.8
DC_21_n78-n79	21	0.4
	n78	0.8
	n79	0.5

Inter-band EN-DC configuration	E-UTRA or NR Band	$\Delta T_{IB,c}$ (dB)
DC_25-41_n41 DC_25_(n)41 DC_25-25-41_n41 DC_25-25_(n)41	25	0.5
	41	0.4 <sup>1</sup>
	n41	0.9 <sup>2</sup>
		0.4 <sup>1</sup>
DC_28_n3-n77	28	0.5
	n3	0.6
	n77	0.8
DC_28_n3-n78	28	0.3
	n3	0.6
	n78	0.8
DC_28_n7-n78	28	0.3
	n7	0.3
	n78	0.8
DC_28-41_n77	28	0.5
	41	0.3
	n77	0.8
DC_28-41_n78	28	0.5
	41	0.3
	n78	0.8
DC_28-41_n79	28	0.3
	41	0.3
	n79	0.8
DC_28_n8-n78	28	0.5
	n8	0.6
	n78	0.3
DC_28_n40-n78	28	0.5
	n40	0.3 <sup>5</sup>
	n78	0.8 <sup>5</sup>
DC_28-42_n77	28	0.5
	42	0.8
	n77	0.8
DC_28-42_n78	28	0.5
	42	0.8
	n78	0.8
DC_28-42_n79	28	0.5
	42	0.8
DC_28_SUL_n78-n83	28	0.5
	n78	0.8
	n83	0.5
DC_29-66_n2 DC_29-66-66_n2	66	0.5
	n2	0.5
DC_30-66_n2	30	0.3
	66	0.5
	n2	0.5
DC_30-66_n5, DC_30-66-66_n5, DC_30-66-66-66_n5	30	0.3
	66	0.5
	n5	0.3
DC_39_n40-n41	39	0.3
	n40	0.3
	n41	0.3
DC_39_n40-n79	39	0.3
	n79	0.8
DC_39_n41-n79	39	0.5
	n41	0.5
	n79	0.8
DC_41_n3-n77	41	0.3 <sup>3</sup> /08 <sup>4</sup>
	n3	0.6
	n77	0.8
DC_41_n3-n78	41	0.3 <sup>3</sup> /08 <sup>4</sup>
	n3	0.6
	n78	0.8
DC_41_n28-n77	41	0.3

Inter-band EN-DC configuration	E-UTRA or NR Band	$\Delta T_{IB,c}$ (dB)
	n28	0.5
	n77	0.8
DC_41_n28-n78	41	0.3
	n28	0.5
	n78	0.8
DC_(n)41-n78	41	0.3
	n41	0.3
	n78	0.8
DC_41-42_n77	41	0.5
	42	0.8
	n77	0.8
DC_41-42_n78	41	0.5
	42	0.8
	n78	0.8
	66	0.5
	n41	0.8 <sup>1</sup>
		1.3 <sup>2</sup>
	66	0.3
n71	0.3	
DC_42_n28-n77	42	0.5
	n28	0.8
	n77	0.8
DC_46-66_n5	66	0.3
	n5	0.3
DC_46-66_n25	66	0.5
	n25	0.5
DC_48_(n)5	5	0.3
	48	0.3
	n5	0.3
DC_48_(n)12	12	0.3
	n12	0.3
	48	0.3
DC_48-66_n12	48	0.8
	66	0.6
	n12	0.3
DC_48-66_n71	48	0.8
	66	0.6
	n71	0.3
DC_48-66_n5	48	0.8
	66	0.6
	n5	0.3
DC_41-42_n79	41	0.3
	42	0.8
DC_66_n7-n78	66	0.6
	n7	0.5
	n78	0.8
DC_66_(n)12	12	0.8
	n12	0.8
	66	0.5
DC_66_n25-n41	66	0.5
	n25	0.5
	n41	0.8 <sup>1</sup>
		1.3 <sup>2</sup>
DC_66_n25-n71	66	0.5
	n25	0.5
	n71	0.3
DC_66_n38-n78	66	0.6
	n38	0.5
	n78	0.8
DC_66_n41-n71	66	0.5
	n41	0.8 <sup>1</sup>
		1.3 <sup>2</sup>
	n71	0.6

Inter-band EN-DC configuration	E-UTRA or NR Band	$\Delta T_{IB,c}$ (dB)
DC_66_n66-n78	66	0.6
	n66	0.6
	n78	0.8
DC_66_(n)71	66	0.3
	71	0.3
	n71	0.3
DC_66-71_n38	66	0.5
	71	0.5
	n38	0.8
DC_66-71_n66	66	0.3
	71	0.3
	n66	0.3
DC_66-71_n78	66	0.6
	71	0.6
	n78	0.8
DC_66_SUL_n78-n86	66	0.6
	n78	0.8
	n86	0.6
NOTE 1: The requirement is applied for UE transmitting on the frequency range of 2545 - 2690 MHz. NOTE 2: The requirement is applied for UE transmitting on the frequency range of 2496 - 2545 MHz. NOTE 3: The requirement is applied for UE transmitting on the frequency range of 2515 – 2690 MHz. NOTE 4: The requirement is applied for UE transmitting on the frequency range of 2496 – 2515 MHz. NOTE 5: Only applicable for UE supporting inter-band carrier aggregation with uplink in one NR band and without simultaneous Rx/Tx.		

## 6.2B.4.2.3.3

 $\Delta T_{IB,c}$  for EN-DC four bandsTable 6.2B.4.2.3.3-1:  $\Delta T_{IB,c}$  due to EN-DC(four bands)

Inter-band EN-DC configuration	E-UTRA or NR Band	$\Delta T_{IB,c}$ (dB)
DC_1-3-5_n78	1	0.6
	3	0.6
	5	0.3
	n78	0.8
DC_1-3-5_n79	1	0.3
	3	0.3
	5	0.3
DC_1-3-7_n5	1	0.6
	3	0.6
	7	0.6
	n5	0.3
DC_1-3-7_n7	1	0.6
	3	0.6
	7	0.6
	n7	0.6
DC_1-3-7_n8	1	0.6
	3	0.6
	7	0.6
	n8	0.3
DC_1-3-7_n28	1	0.6
	3	0.6
	7	0.6
	n28	0.6
DC_1-3-7_n40	1	0.6
	3	0.6
	7	0.8
	n40	0.9

Inter-band EN-DC configuration	E-UTRA or NR Band	$\Delta T_{IB,c}$ (dB)
DC_1-3-7_n78 DC_1-3-7-7_n78 DC_1-3_n7-n78	1	0.7
	3	0.7
	7 or n7	0.7
	n78	0.8
DC_1-3-8_n28	1	0.3
	3	0.3
	8	0.6
	n28	0.6
DC_1-3-8_n77	1	0.6
	3	0.6
	8	0.6
	n77	0.8
DC_1-3-8_n78	1	0.6
	3	0.6
	8	0.6
	n78	0.8
DC_1-3-8_n79	1	0.3
	3	0.3
	8	0.3
DC_1-3-28_n5	1	0.3
	3	0.3
	28	0.6
	n5	0.6
DC_1-3-28_n7	1	0.6
	3	0.6
	28	0.6
	n7	0.6
DC_1-3-28_n40	1	0.5
	3	0.5
	28	0.6
	n40	0.5
DC_1-3-18_n77	1	0.6
	3	0.6
	18	0.3
	n77	0.8
DC_1-3-18_n78	1	0.6
	3	0.6
	18	0.3
	n78	0.8
DC_1-3-18_n79	1	0.3
	3	0.3
	18	0.3
DC_1-3-19_n78	1	0.6
	3	0.6
	19	0.3
	n78	0.8
DC_1-3-19_n79	1	0.3
	3	0.3
	19	0.3
DC_1-3-20_n8	1	0.6
	3	0.6
	20	0.6
	n8	0.6
DC_1-3-20_n28	1	0.3
	3	0.3
	20	0.6
	n28	0.6
DC_1-3-20_n38	1	0.5
	3	0.5
	20	0.3
	n38	0.5
DC_1-3-20_n41	1	0.5
	3	0.5

Inter-band EN-DC configuration	E-UTRA or NR Band	$\Delta T_{IB,c}$ (dB)
	20	0.3
	n41	0.8 <sup>1</sup>
		1.3 <sup>2</sup>
DC_1-3-20_n78	1	0.6
	3	0.6
	20	0.3
	n78	0.8
DC_1-3-21_n77	1	0.6
	3	0.8
	21	0.9
	n77	0.8
DC_1-3-21_n78	1	0.6
	3	0.8
	21	0.9
	n78	0.8
DC_1-3-21_n79	1	0.3
	3	0.8
	21	0.9
DC_1-3-32_n78	1	0.6
	3	0.6
	n78	0.8
DC_1-3-28_n77	1	0.6
	3	0.6
	28	0.6
	n77	0.8
DC_1-3-28_n78 DC_1-3_n28-n78	1	0.6
	3	0.6
	28 or n28	0.6
	n78	0.8
DC_1-3-28_n79	1	0.6
	3	0.6
	28	0.6
DC_1-3_n28-n77	1	0.6
	3	0.6
	n28	0.6
	n77	0.8
DC_1-3_n38-n78	1	0.5
	3	0.6
	n38	0.6
	n78	0.8
DC_1-3_n40-n78	1	0.5
	3	0.6
	n40	0.3 <sup>6</sup>
	n78	0.8 <sup>6</sup>
DC_1-3-41_n28	1	0.6
	3	0.6
	41	0.3 <sup>4</sup> /0.8 <sup>5</sup>
	n28	0.5
DC_1-3-41_n77	1	0.6
	3	0.6
	41	0.5
	n77	0.8
DC_1-3-41_n78 DC_1-3_n41-n78	1	0.6
	3	0.6
	41 or n41	0.5
DC_1-3-41_n79	n78	0.8
	1	0.5
	3	0.5
	41	0.3 <sup>4</sup> /0.8 <sup>5</sup>
DC_1-3-42_n77	1	0.6
	3	0.6
	42	0.8
	n77	0.8

Inter-band EN-DC configuration	E-UTRA or NR Band	$\Delta T_{IB,c}$ (dB)
DC_1-3-42_n78	1	0.6
	3	0.6
	42	0.8
	n78	0.8
DC_1-3-42_n79	1	0.6
	3	0.6
	42	0.8
DC_1-3_n77-n79	1	0.6
	3	0.6
	n77	0.8
DC_1-3_n78-n79	1	0.6
	3	0.6
	n78	0.8
DC_1-3_SUL_n78-n80	1	0.6
	3, n80	0.6
	n78	0.8
DC_1-5-7_n78 DC_1-5-7-7_n78	1	0.6
	5	0.6
	7	0.6
	n78	0.8
DC_1-5-41_n79	1	0.5
	5	0.3
	41	0.5
DC_1-7-8_n3	1	0.6
	7	0.6
	8	0.3
	n3	0.6
DC_1-7_n3-n78	1	0.5
	7	0.2
	n3	0.6
	n78	0.8
DC_1-7_n7-n78	1	0.6
	7	0.6
	n7	0.6
	n78	0.8
DC_1-7-8_n78	1	0.6
	7	0.6
	8	0.6
	n78	0.8
DC_1-7-20_n3	1	0.3
	7	0.5
	20	0.3
	n3	0.5
DC_1-7-20_n8	1	0.6
	7	0.6
	20	0.6
	n8	0.6
DC_1-7-20_n28	1	0.5
	7	0.6
	20	0.6
	n28	0.6
DC_1-7-20_n78	1	0.6
	7	0.7
	20	0.4
	n78	0.8



Inter-band EN-DC configuration	E-UTRA or NR Band	$\Delta T_{IB,c}$ (dB)
DC_1-7-28_n5	1	0.3
	7	0.3
	28	0.6
	n5	0.6
DC_1-7-28_n7	1	0.5
	7	0.6
	28	0.6
	n7	0.6
DC_1-7-28_n40	1	0.6
	7	0.8
	28	0.6
	n40	0.9
DC_1-7-28_n78	1	0.6
	7	0.6
	28	0.6
	n78	0.8
DC_1-7_n28-n78	1	0.6
	7	0.6
	n28	0.6
	n78	0.8
DC_1-8_n3-n28	1	0.3
	8	0.6
	n3	0.3
	n28	0.6
DC_1-8-11_n77	1	0.6
	8	0.6
	11	0.4
	n77	0.8
DC_1-8-11_n78	1	0.3
	8	0.6
	11	0.4
	n78	0.8
DC_1-8-20_n78	1	0.3
	8	0.6
	20	0.6
	n78	0.8
DC_1-8_n28-n77	1	0.6
	8	0.6
	n28	0.6
	n77	0.8
DC_1-8-42_n77	1	0.6
	8	0.6
	42	0.8
	n77	0.8
DC_1-11-18_n77	1	0.6
	11	0.4
	18	0.3
	n77	0.8
DC_1-11-18_n78	1	0.3
	11	0.4
	18	0.3
	n78	0.8
DC_1-18_n3-n77	1	0.6
	18	0.3
	n3	0.6
	n77	0.8
DC_1-18_n3-n78	1	0.6
	18	0.3
	n3	0.6
	n78	0.8
DC_1-18-28_n77	1	0.3
	18	0.5
	28	0.5

Inter-band EN-DC configuration	E-UTRA or NR Band	$\Delta T_{IB,c}$ (dB)
	n77	0.8
DC_1-18-28_n78	1	0.3
	18	0.5
	28	0.5
	n78	0.8
DC_1-18-28_n79	1	0.3
	18	0.5
	28	0.5
DC_1-18-41_n3	1	0.5
	18	0.3
	41	0.3 <sup>7</sup> /0.8 <sup>8</sup>
	n3	0.5
DC_1-18-41_n77	1	0.6
	18	0.3
	41	0.5
	n77	0.8
DC_1-18-41_n78	1	0.5
	18	0.3
	41	0.5
DC_1-18-41_n3	1	0.5
	18	0.3
	41	0.3 <sup>4</sup> /0.8 <sup>5</sup>
	n3	0.5
DC_1-18-42_n77	1	0.3
	18	0.3
	42	0.8
	n77	0.8
DC_1-18-42_n78	1	0.3
	18	0.3
	42	0.8
	n78	0.8
DC_1-18-42_n79	1	0.3
	18	0.3
	42	0.8
DC_1-19-42_n77	1	0.6
	19	0.3
	42	0.8
	n77	0.8
DC_1-19-42_n78	1	0.3
	19	0.3
	42	0.8
	n78	0.8
DC_1-19-42_n79	1	0.3
	19	0.3
	42	0.8
DC_1-19_n77-n79	1	0.3
	19	0.3
	n77	0.8
DC_1-19_n78-n79	1	0.3
	19	0.3
	n78	0.8
DC_1-20_n3-n38	1	0.5
	20	0.3
	n3	0.3
	n38	0.5
DC_1-20_n3-n78	1	0.3
	20	0.6
	n3	0.3
	n78	0.8
DC_1-20_n28-n78	1	0.3
	20	0.6
	n28	0.6
	n78	0.8

Inter-band EN-DC configuration	E-UTRA or NR Band	$\Delta T_{IB,c}$ (dB)
DC_1-20_(n)38	1	0.5
	20	0.3
	38	0.5
	n38	0.5
DC_1-20-38_n78	1	0.3
	20	0.6
	n78	0.8
DC_1-20_n41-n78	1	0.5
	20	0.3
	n41	0.5
	n78	0.8
DC_1-21-28_n77	1	0.6
	21	0.4
	28	0.6
	n77	0.8
DC_1-21-28_n78	1	0.3
	21	0.4
	28	0.6
	n78	0.8
DC_1-21-28_n79	1	0.3
	21	0.4
	28	0.6
DC_1-21-42_n77	1	0.6
	21	0.4
	42	0.8
	n77	0.8
DC_1-21-42_n78	1	0.3
	21	0.4
	42	0.8
	n78	0.8
DC_1-21-42_n79	1	0.3
	21	0.4
	42	0.8
DC_1-21_n77-n79	1	0.3
	21	0.3
	n77	0.8
DC_1-21_n78-n79	1	0.3
	21	0.3
	n78	0.8
DC_1-28_n3-n77	1	0.6
	28	0.6
	n3	0.6
	n77	0.8
DC_1-28_n3-n78	1	0.6
	28	0.6
	n3	0.6
	n78	0.8
DC_1-28_n7-n78	1	0.6
	28	0.6
	n7	0.6
	n78	0.8
DC_1-28_n40-n78	1	0.5
	28	0.5
	n40	0.3 <sup>6</sup>
	n78	0.8 <sup>6</sup>
DC_1-28-42_n77	1	0.6
	28	0.6
	42	0.8
	n77	0.8
DC_1-28-42_n78	1	0.3
	28	0.6
	42	0.8
	n78	0.8

Inter-band EN-DC configuration	E-UTRA or NR Band	$\Delta T_{IB,c}$ (dB)
DC_1-28-42_n79	1	0.3
	28	0.6
	42	0.8
DC_1-41_n3-n77	1	0.6
	41	0.3 <sup>4</sup> /0.8 <sup>5</sup>
	n3	0.6
	n77	0.8
DC_1-41_n3-n78	1	0.6
	41	0.3 <sup>4</sup> /0.8 <sup>5</sup>
	n3	0.6
	n78	0.8
DC_1-41_n28-n77	1	0.6
	41	0.5
	n28	0.5
	n77	0.8
DC_1-41_n28-n78	1	0.5
	41	0.5
	n28	0.5
	n78	0.8
DC_1-41-42_n77	1	0.5
	41	0.5
	42	0.8
	n77	0.8
DC_1-41-42_n78	1	0.5
	41	0.5
	42	0.8
	n78	0.8
DC_1-41-42_n79	1	0.5
	41	0.5
	42	0.8
DC_1-42_n77-n79	1	0.6
	42	0.8
	n77	0.8
DC_1-42_n78-n79	1	0.3
	42	0.8
	n78	0.8
DC_2-5_(n)12	2	0.3
	5	0.8
	12	0.4
	n12	0.4
DC_2-12_(n)5	5	0.5
	12	0.3
	n5	0.5
DC_2-5-48_n12	2	0.6
	5	0.8
	48	0.8
	n12	0.4
DC_2-5-48_n71	2	0.6
	5	0.5
	48	0.8
	n71	0.5
DC_2-5-66_n2	2	0.5
	5	0.3
	66	0.5
	n2	0.5
DC_2-5-66_n5	2	0.5
	5	0.3
	66	0.5
	n5	0.3
DC_2-5-66_n12	2	0.3
	5	0.5
	66	0.5
	n12	0.3

Inter-band EN-DC configuration	E-UTRA or NR Band	$\Delta T_{IB,c}$ (dB)
DC_2-5-66_n66	2	0.5
DC_2-5-5-66_n66	5	0.3
DC_2-5-66-66_n66	66	0.5
DC_2-2-5-66-66_n66	n66	0.5
DC_2-5-66_n71	2	0.5
	5	0.5
	66	0.5
	n71	0.5
DC_2-7_n38-n78	2	0.6
DC_2-7-7_n38-n78	n78	0.8
DC_2-7-13_n66	2	0.5
	7	0.5
	13	0.3
	n66	0.5
DC_2-7-66_n38	2	0.5
DC_2-2-7-66_n38	66	0.5
DC_2-7-66_n66, DC_2-7-7-66_n66	2	0.5
	7	0.5
	66	0.5
	n66	
DC_2-7-66_n71	2	0.5
	7	0.5
	66	0.5
	n71	0.3
DC_2-7-66_n78	2	0.6
	7	0.5
	66	0.6
	n78	0.8
DC_2-12-30_n2	2	0.5
	12	0.3
	30	0.3
	n2	0.5

Inter-band EN-DC configuration	E-UTRA or NR Band	$\Delta T_{IB,c}$ (dB)
DC_2-12-30_n66	2	0.5
	12	0.8
	30	0.3
	n66	0.5
DC_2-12-48_n5	2	0.6
	12	0.4
	48	0.8
	n5	0.8
DC_2-12-66_n5	2	0.5
	12	0.8
	66	0.5
	n5	0.8
DC_2-12-66_n2	2	0.5
	12	0.3
	66	0.5
	n2	0.5
DC_2-12-66_n66	2	0.5
	12	0.8
	66	0.5
	n66	0.5
DC_2-13-66_n2	2	0.5
	13	0.3
	66	0.5
	n2	0.5
DC_2-13-66_n5	2	0.5
	13	0.3
	66	0.5
	n5	0.3
DC_2-13-66_n48	2	0.6
	13	0.3
	66	0.6
	n48	0.8
DC_2-13-66_n66	2	0.5
	13	0.3
	66	
	n66	0.5
DC_2-14-66_n2 DC_2-14-66-66_n2	2	0.5
	14	0.3
	66	0.5
	n2	0.5
DC_2-14-66_n66 DC_2-2-14-66_n66	2	0.5
	14	0.3
	66	0.5
	n66	0.5
DC_2-29-30_n2	2	0.5
	30	0.3
	n2	0.5
DC_2-29-66_n2 DC_2-29-66-66_n2	2	0.5
	66	0.5
	n2	0.5
DC_2-29-66_n66	2	0.5
	66	0.5
	n66	0.5
DC_2-30-66_n2 DC_2-30-66-66_n2	2	0.5
	30	0.3
	66	0.5
DC_2-30-66_n5	2	0.5
	30	0.3
	66	0.5
DC_2-30-66_n66	2	0.5
	30	0.3
	66	0.5

Inter-band EN-DC configuration	E-UTRA or NR Band	$\Delta T_{IB,c}$ (dB)
	66	0.5
	n66	0.5
DC_2-46_n41-n66	2	0.5
	n41	0.5
	n66	0.5
DC_2-46_n41-n71	2	0.5
	n41	0.5
	n71	0.6
DC_2-46-48_n5	2	0.6
	48	0.8
	n5	0.3
DC_2-46-48_n66	2	0.6
	48	0.8
	n66	0.6
DC_2-46-66_n41	2	0.5
	66	0.5
	n41	0.8 <sup>1</sup>
		1.3 <sup>2</sup>
DC_2-46-66_n71	66	0.3
	n71	0.3
DC_2-48_(n)5	2	0.6
	5	0.3
	48	0.8
	n5	0.3
DC_2-46_n66_n71	2	0.5
	n66	0.5
	n71	0.3
DC_2-48-66_n5	2	0.6
	48	0.8
	66	0.6
DC_2-48-66_n12	2	0.6
	48	0.8
	66	0.6
	n12	0.3
DC_2-48-66_n71	2	0.6
	48	0.8
	66	0.6
	n71	0.3
DC_2-66_(n)5	2	0.5
	5	0.3
	66	0.5
	n5	0.3
DC_2-66-71_n38 DC_2-2-66-71_n38	2	0.5
	66	0.5
	71	0.3
DC_2-66_n38-n78	n38	0.5
	2	0.6
	66	0.6
	n38	0.9
DC_2-66-71_n66	n78	0.8
	2	0.5
	66	0.5
	71	0.3
DC_2-66-71_n78 DC_2-2-66-71_n78	n66	0.5
	2	0.5
	66	0.5
	71	0.3
DC_2-66-(n)71	n78	0.5
	2	0.5
	66	0.5
	71	0.3
DC_2-66_n41-n71	n71	0.3
	2	0.5

Inter-band EN-DC configuration	E-UTRA or NR Band	$\Delta T_{IB,c}$ (dB)
	66	0.5
	n41	0.8 <sup>1</sup>
	n71	1.3 <sup>2</sup>
DC_2-66_n66-n78	2	0.6
	66	0.6
	n66	0.6
	n78	0.8
DC_3-5-7_n78, DC_3-5-7-7_n78	3	0.6
	5	0.6
	7	0.6
	n78	0.8
DC_3-5-41_n79	3	0.5
	5	0.3 <sup>3</sup>
	41	0.3 <sup>4</sup> /0.8 <sup>5</sup>
DC_3-7_n1-n78	3	0.7
	7	0.7
	n1	0.7
	n78	0.8
DC_3-7-8_n1 DC_3-3-7-8_n1 DC_3-7-7-8_n1 DC_3-3-7-7-8_n1	3	0.6
	7	0.6
	8	0.6
	n1	0.6
DC_3-7-8_n77	3	0.6
	7	0.6
	8	0.6
	n77	0.8
DC_3-7-8_n78 DC_3-3-7-8_n78 DC_3-7-7-8_n78 DC_3-3-7-7-8_n78	3	0.6
	7	0.6
	8	0.6
	n78	0.8
DC_3-7_n7-n78	3	0.6
	7	0.6
	n7	0.6
	n78	0.8
DC_3-7-20_n1	3	0.6
	7	0.6
	20	0.3
	n1	0.6
DC_3-7-20_n8	3	0.6
	7	0.6
	20	0.6
	n8	0.6
DC_3-7-20_n28	3	0.5
	7	0.5
	20	0.6
	n28	0.5
DC_3-7-20_n78	3	0.6
	7	0.6
	20	0.3
	n78	0.8
DC_3-7-28_n5	3	0.5
	7	0.5
	28	0.4
	n5	0.4
DC_3-7-28_n7	3	0.5
	7	0.5
	28	0.3
	n7	0.5



Inter-band EN-DC configuration	E-UTRA or NR Band	$\Delta T_{IB,c}$ (dB)
DC_3-7-28_n40	3	0.6
	7	0.8
	28	0.3
	n40	0.9
DC_3-7-28_n78	3	0.6
	7	0.6
	28	0.6
	n78	0.8
DC_3-7_n28-n78	3	0.6
	7	0.6
	n28	0.6
	n78	0.8
DC_3-7-40_n1	3	0.6
	7	0.8
	40	0.9
	n1	0.6
DC_3-7_SUL_n78-n80	7	0.6
	3, n80	0.6
	n78	0.8
DC_3-8_n1-n78 DC_3-3-8_n1-n78	3	0.6
	8	0.6
	n1	0.6
	n78	0.8
DC_3-8-20_n78	3	0.6
	8	0.6
	20	0.6
	n78	0.8
DC_3-8_n28-n77	3	0.6
	8	0.6
	n28	0.5
	n77	0.8
DC_3-8-42_n77	3	0.6
	8	0.6
	42	0.8
	n77	0.8
DC_3-8_SUL_n78-n80	3, n80	0.6
	8	0.6
	n78	0.8
DC_3-18-42_n77	3	0.3
	18	0.3
	42	0.8
	n77	0.8
DC_3-18-42_n78	3	0.3
	18	0.3
	42	0.8
	n78	0.8
DC_3-18-42_n79	3	0.6
	18	0.3
	42	0.8
DC_3-19-21_n77	3	0.8
	19	0.3
	21	0.9
	n77	0.8
DC_3-19-21_n78	3	0.8
	19	0.3
	21	0.9
	n78	0.8
DC_3-19-21_n79	3	0.8
	19	0.3
	21	0.9
DC_3-19-42_n77	3	0.6
	19	0.3
	42	0.8

Inter-band EN-DC configuration	E-UTRA or NR Band	$\Delta T_{IB,c}$ (dB)
	n77	0.8
DC_3-19-42_n78	3	0.6
	19	0.3
	42	0.8
	n78	0.8
DC_3-19-42_n79	3	0.6
	19	0.3
	42	0.8
DC_3-19_n77-n79	3	0.6
	19	0.3
	n77	0.8
DC_3-19_n78-n79	3	0.6
	19	0.3
	n78	0.8
DC_3-20_n1-n7	3	0.6
	20	0.3
	n1	0.6
	n7	0.6
DC_3-20_n1-n28	3	0.3
	20	0.3
	n1	0.6
	n28	0.6
DC_3-20_n7-n28	3	0.5
	20	0.5
	n7	0.5
	n28	0.5
DC_3-20_n28-n78	3	0.6
	20	0.6
	n28	0.6
	n78	0.8
DC_3-20-38_n78	3	0.6
	20	0.6
	38 or n38	0.5
	n78	0.8
DC_3-20_n41-n78	3	0.5
	20	0.3
	n41	0.5
	n78	0.8

Inter-band EN-DC configuration	E-UTRA or NR Band	$\Delta T_{IB,c}$ (dB)
DC_3_20_SUL_n78-n80	3, n80	0.5
	20	0.3
	n78	0.8
DC_3-21-42_n77	3	0.8
	21	0.9
	42	0.8
	n77	0.8
DC_3-21-42_n78	3	0.8
	21	0.9
	42	0.8
	n78	0.8
DC_3-21-42_n79	3	0.8
	21	0.9
	42	0.8
DC_3-21_n77-n79	3	0.8
	21	0.9
	n77	0.8
DC_3-21_n78-n79	3	0.8
	21	0.9
	n78	0.8
DC_3-28_n7-n78 DC_3-3-28_n7-n78	3	1
	28	0.5
	n7	0.8
	n78	0.8
DC_3-28_n40-n78	3	0.6
	28	0.5
	n40	0.3 <sup>6</sup>
	n78	0.8 <sup>6</sup>
DC_3-28-41_n78	3	1
	28	0.5
	41	0.3 <sup>4</sup> /0.8 <sup>5</sup>
	n78	0.8
DC_3-28-42_n77	3	0.6
	28	0.5
	42	0.8
	n77	0.8
DC_3-28-42_n78	3	0.6
	28	0.5
	42	0.8
	n78	0.8
DC_3-28-42_n79	3	0.6
	28	0.5
	42	0.8

Inter-band EN-DC configuration	E-UTRA or NR Band	$\Delta T_{IB,c}$ (dB)
DC_3-41_n28-n77	3	0.6
	41	0.3 <sup>4</sup> /0.8 <sup>5</sup>
	n28	0.5
	n77	0.8
DC_3-41_n28-n78	3	1.0
	41	0.3 <sup>4</sup> /0.8 <sup>5</sup>
	n28	0.5
	n78	0.8
DC_3-41-42_n77	3	1
	41	0.3 <sup>4</sup> /0.8 <sup>5</sup>
	42	0.8
	n77	0.8
DC_3-41-42_n78	3	1
	41	0.3 <sup>4</sup> /0.8 <sup>5</sup>
	42	0.8
	n78	0.8
DC_3-41-42_n79	3	1
	41	0.3 <sup>4</sup> /0.8 <sup>5</sup>
	42	0.8
DC_3-42_n77-n79	3	0.6
	42	0.8
	n77	0.8
DC_3-42_n78-n79	3	0.6
	42	0.8
	n78	0.8
DC_5-48_(n)12	5	0.8
	12	0.4
	48	0.3
	n12	0.8
DC_5-48-66_n12	5	0.8
	48	0.8
	66	0.6
	n12	0.4
DC_5-48-66_n71	5	0.5
	48	0.8
	66	0.6
	n71	0.5
DC_5-66_(n)12	5	0.3
	12	0.8
	66	0.8
	n12	0.8
DC_7-13-66_n66	7	0.5
	13	0.3
	66	
	n66	0.5
DC_7-8_n1-n78 DC_7-7-8_n1-n78	7	0.6
	8	0.6
	n1	0.6
	n78	0.8
DC_7-20_n3-n78	7	0.5
	20	0.6
	n3	0.5
	n78	0.8
DC_7-20_n28-n78	7	0.3
	20	0.6
	n28	0.6
	n78	0.8
DC_7-28_n3-n78	7	0.8
	28	0.5
	n3	1
	n78	0.8
DC_7-28_n7-n78	7	0.3
	28	0.3

Inter-band EN-DC configuration	E-UTRA or NR Band	$\Delta T_{IB,c}$ (dB)
	n7	0.3
	n78	0.8
DC_7-66_n66-n78 DC_7-7-66_n66-n78	7	0.5
	66	0.6
	n66	0.6
	n78	0.8
DC_12-30-66_n2	12	0.8
	30	0.3
	66	0.5
	n2	0.5
DC_12-30-66_n66	12	0.8
	30	0.3
	66	0.5
	n66	0.5
DC_12-48_(n)5	5	0.8
	12	0.4
	48	0.3
	n5	0.8
DC_12-48-66_n5	12	0.8
	48	0.8
	66	0.8
	n5	0.3
DC_12-66_(n)5	5	0.3
	12	0.8
	66	0.8
	n5	0.3
DC_18-41_n3-n77	18	0.3
	41	0.3 <sup>4</sup> /0.8 <sup>5</sup>
	n3	0.6
	n77	0.8
DC_18-41_n3-n78	18	0.3
	41	0.3 <sup>4</sup> /0.8 <sup>5</sup>
	n3	0.6
	n78	0.8
DC_19-21-42_n77	19	0.3
	21	0.4
	42	0.8
	n77	0.8
DC_19-21-42_n78	19	0.3
	21	0.4
	42	0.8
	n78	0.8
DC_19-21-42_n79	19	0.3
	21	0.4
	42	0.8
DC_19-21_n77-n79	19	0.3
	21	0.4
	n77	0.8
DC_19-21_n78-n79	19	0.3
	21	0.4
	n78	0.8
DC_19-42_n77-n79	19	0.3
	42	0.8
	n77	0.8
DC_19-42_n78-n79	19	0.3
	42	0.8
	n78	0.8
DC_21-28-42_n77	21	0.4
	28	0.5
	42	0.8
	n77	0.8
DC_21-28-42_n78	21	0.4
	28	0.5

Inter-band EN-DC configuration	E-UTRA or NR Band	$\Delta T_{IB,c}$ (dB)
	42	0.8
	n78	0.8
DC_21-28-42_n79	21	0.4
	28	0.5
	42	0.8
DC_21-42_n77-n79	21	0.4
	42	0.8
	n77	0.8
DC_21-42_n78-n79	21	0.4
	42	0.8
	n78	0.8
DC_28-41-42_n78	28	0.5
	41	0.3
	42	0.8
	n78	0.8
DC_29-30-66_n2 DC_29-30-66-66_n2	30	0.3
	66	0.5
	n2	0.5
DC_29-30-66_n66	30	0.3
	66	0.5
	n66	0.5
DC_46-66_n25-n41	66	0.5
	n25	0.5
	n41	0.4 <sup>1</sup>
		0.9 <sup>2</sup>
DC_46-66_n25-n71	66	0.5
	n25	0.5
	n71	0.3
DC_46-66_n41-n71	66	0.5
	n41	0.4 <sup>1</sup>
		0.9 <sup>2</sup>
	n71	0.6
NOTE 1: The requirement is applied for UE transmitting on the frequency range of 2545 - 2690 MHz.		
NOTE 2: The requirement is applied for UE transmitting on the frequency range of 2496 - 2545 MHz.		
NOTE 3: The values in the table reflect what can be achieved with the present state of the art technology. They shall be reconsidered when the state of the art technology progresses.		
NOTE 4: The requirement is applied for UE transmitting on the frequency range of 2515 – 2690 MHz.		
NOTE 5: The requirement is applied for UE transmitting on the frequency range of 2496 – 2515 MHz.		
NOTE 6: Only applicable for UE supporting inter-band carrier aggregation with uplink in one E-UTRA band and without simultaneous Rx/Tx.		
NOTE 7: The requirement is applied for UE transmitting on the frequency range of 2515 - 2690 MHz.		
NOTE 8: The requirement is applied for UE transmitting on the frequency range of 2496 - 2515 MHz.		

6.2B.4.2.3.4  $\Delta T_{IB,c}$  for EN-DC five bands

**Table 6.2B.4.2.3.4-1:  $\Delta T_{IB,c}$  due to EN-DC (five bands)**

Inter-band EN-DC configuration	E-UTRA or NR Band	$\Delta T_{IB,c}$ (dB)
DC_1-3-5-7_n78, DC_1-3-5-7-7_n78	1	0.6
	3	0.6
	5	0.6
	7	0.6
	n78	0.8
DC_1-3-5-41_n79	1	0.5
	3	0.5
	5	0.3
	41	0.5 <sup>1</sup> 0.8 <sup>2</sup>
DC_1-3-7_n7-n78	1	0.7
	3	0.7
	7	0.7
	n7	0.7
	n78	0.8
DC_1-3-7-8_n78	1	0.6
	3	0.6
	7	0.6
	8	0.6
	n78	0.8
DC_1-3-7-20_n8	1	0.6
	3	0.6
	7	0.6
	20	0.6
	n8	0.6
DC_1-3-7-20_n28	1	0.6
	3	0.6
	7	0.6
	20	0.6
	n28	0.6
DC_1-3-7-20_n78	1	0.6
	3	0.6
	7	0.6
	20	0.6
	n78	0.6
DC_1-3-7-28_n5	1	0.6
	3	0.6
	7	0.6
	28	0.6
	n5	0.6
DC_1-3-7-28_n7	1	0.6
	3	0.6
	7	0.6
	28	0.6
	n7	0.6
DC_1-3-7-28_n40	1	0.6
	3	0.6
	7	0.8
	28	0.6
	n40	0.9
DC_1-3-7-28_n78	1	0.7
	3	0.7
	7	0.7
	28	0.6
	n78	0.8
DC_1-3-7_n28-n78	1	0.7
	3	0.7
	7	0.7



Inter-band EN-DC configuration	E-UTRA or NR Band	$\Delta T_{IB,c}$ (dB)
	n28	0.6
	n78	0.8
DC_1-3-8-42_n77	1	0.6
	3	0.6
	8	0.6
	42	0.8
	n77	0.8
DC_1-3-18-42_n77	1	0.6
	3	0.6
	18	0.3
	42	0.8
	n77	0.8
DC_1-3-18-42_n78	1	0.6
	3	0.6
	18	0.3
	42	0.8
	n78	0.8
DC_1-3-18-42_n79	1	0.6
	3	0.6
	18	0.3
	42	0.8
DC_1-3-19-21_n77	1	0.6
	3	0.8
	19	0.3
	21	0.9
	n77	0.8
DC_1-3-19-21_n78	1	0.6
	3	0.8
	19	0.3
	21	0.9
	n78	0.8
DC_1-3-19-21_n79	1	0.3
	3	0.8
	19	0.3
	21	0.9
DC_1-3-19-42_n77	1	0.6
	3	0.6
	19	0.3
	42	0.8
	n77	0.8
DC_1-3-19-42_n78	1	0.6
	3	0.6
	19	0.3
	42	0.8
	n78	0.8
DC_1-3-19-42_n79	1	0.6
	3	0.6
	19	0.3
	42	0.8
DC_1-3-20_n28-n78	1	0.6
	3	0.6
	20	0.6
	n28	0.6
	n78	0.8
DC_1-3-20-38_n78 DC_1-3-20_n38-n78	1	0.3
	3	0.6
	20	0.6
	38 or n38	0.5

Inter-band EN-DC configuration	E-UTRA or NR Band	$\Delta T_{IB,c}$ (dB)
	n78	0.8
DC_1-3-20_n41-n78	1	0.5
	3	0.5
	20	0.3
	n41	0.5
	n78	0.8
DC_1-3-21-42_n77	1	0.6
	3	0.8
	21	0.9
	42	0.8
	n77	0.6
DC_1-3-21-42_n78	1	0.6
	3	0.8
	21	0.9
	42	0.8
	n78	0.6
DC_1-3-21-42_n79	1	0.6
	3	0.8
	21	0.9
	42	0.8
DC_1-3-21_n77-n79	1	0.6
	3	0.8
	21	0.9
	n77	0.8
DC_1-3-21_n78-n79	1	0.6
	3	0.8
	21	0.9
	n78	0.8
DC_1-3-28_n7-n78	1	0.7
	3	0.7
	28	0.6
	n7	0.7
	n78	0.8
DC_1-3-28_n40-n78	1	0.5
	3	0.6
	28	0.5
	n40	0.3 <sup>5</sup>
	n78	0.8 <sup>5</sup>
DC_1-3-28-42_n77	1	0.6
	3	0.6
	28	0.6
	42	0.8
	n77	0.8
DC_1-3-28-42_n78	1	0.6
	3	0.6
	28	0.6
	42	0.8
	n78	0.8
DC_1-3-28-42_n79	1	0.6
	3	0.6
	28	0.6
	42	0.8
DC_1-3-41_n28-n77	1	0.6
	3	0.6
	41	0.3 <sup>3</sup> /0.8 <sup>4</sup>
	n28	0.5
	n77	0.8
DC_1-3-41_n28-n78	1	0.5

Inter-band EN-DC configuration	E-UTRA or NR Band	$\Delta T_{IB,c}$ (dB)
	3	0.6
	41	0.3 <sup>3</sup> /0.8 <sup>4</sup>
	n28	0.5
	n78	0.8
DC_1-3-41-42_n77	1	0.6
	3	0.6
	41	0.5
	42	0.8
DC_1-3-41-42_n78	n77	0.8
	1	0.6
	3	0.6
	41	0.5
DC_1-3-41-42_n79	42	0.8
	n78	0.8
	1	0.6
	3	0.6
DC_1-7-20_n3-n78	41	0.5
	42	0.8
	1	0.3
	7	0.5
DC_1-7-20_n28-n78	20	0.6
	n3	0.5
	n78	0.8
	1	0.6
DC_1-7-28_n7-n78	7	0.7
	20	0.6
	n28	0.6
	n78	0.8
DC_1-7-28_n7-n78	1	0.6
	7	0.6
	28	0.6
	n7	0.6
DC_1-18-41_n3-n77	n78	0.8
	1	0.6
	18	0.3
	41	0.3 <sup>3</sup> /0.8 <sup>4</sup>
DC_1-18-41_n3-n78	n3	0.6
	n77	0.8
	1	0.6
	18	0.3
DC_1-18-41_n3-n78	41	0.3 <sup>3</sup> /0.8 <sup>4</sup>
	n3	0.6
	n78	0.8
	1	0.6
DC_1-19-21-42_n77	1	0.3
	19	0.3
	21	0.4
	42	0.8
DC_1-19-21-42_n78	n77	0.8
	1	0.3
	19	0.3
	21	0.4
DC_1-19-21-42_n79	42	0.8
	n78	0.8
	1	0.3
	19	0.3
DC_1-19-21-42_n79	21	0.4
	42	0.8
	1	0.6
DC_1-19-42_n77-n79	1	0.6

Inter-band EN-DC configuration	E-UTRA or NR Band	$\Delta T_{IB,c}$ (dB)
	19	0.3
	42	0.8
	n77	0.8
DC_1-19-42_n78-n79	1	0.3
	19	0.3
	42	0.8
	n78	0.8
DC_1-20-38_n3-n78	1	0.5
	20	0.6
	38	0.5
	n3	0.6
	n78	0.8
DC_1-21-28-42_n77	1	0.6
	21	0.4
	28	0.6
	42	0.8
	n77	0.8
DC_1-21-28-42_n78	1	0.3
	21	0.4
	28	0.6
	42	0.8
	n78	0.8
DC_1-21-28-42_n79	1	0.3
	21	0.4
	28	0.6
	42	0.8
DC_1-21-42_n77-n79	1	0.6
	21	0.4
	42	0.8
	n77	0.8
DC_1-21-42_n78-n79	1	0.3
	21	0.4
	42	0.8
	n78	0.8
DC_2-7-13-66_n66	2	0.5
	7	0.5
	13	0.3
	66	0.5
	n66	0.5
DC_2-7-66_n66-n78 DC_2-7-7-66_n66-n78	2	0.6
	7	0.5
	66	0.6
	n66	0.6
	n78	0.8
DC_2-12-30-66_n2	2	0.5
	12	0.8
	30	0.3
	66	0.5
	n2	0.5
DC_2-12-30-66_n66	2	0.5
	12	0.8
	30	0.3
	66	0.5
	n66	0.5
DC_2-29-30-66_n2	2	0.5
	30	0.3
	66	0.5
	n2	0.5

Inter-band EN-DC configuration	E-UTRA or NR Band	$\Delta T_{IB,c}$ (dB)
DC_2-46-66_n41-n71	2	0.5
	66	0.5
	n41	0.4 <sup>1</sup>
	n71	0.9 <sup>2</sup>
DC_3-7-8_n1-n78 DC_3-3-7-8_n1-n78, DC_3-7-7-8_n1-n78, DC_3-3-7-7-8_n1-n78	3	0.6
	7	0.6
	8	0.6
	n1	0.6
	n78	0.8
DC_3-7-20_n28-n78	3	0.6
	7	0.6
	20	0.6
	n28	0.6
	n78	0.8
DC_3-7-28_n7-n78	3	0.6
	7	0.6
	28	0.6
	n7	0.6
	n78	0.8
DC_3-19-21-42_n77	3	0.8
	19	0.3
	21	0.9
	42	0.8
	n77	0.8
DC_3-19-21-42_n78	3	0.8
	19	0.3
	21	0.9
	42	0.8
	n78	0.8
DC_3-19-21-42_n79	3	0.8
	19	0.3
	21	0.9
	42	0.8
	n79	0.8
DC_3-28-41-42_n78	3	1
	28	0.5
	41	0.3 <sup>3</sup>
	42	0.8 <sup>4</sup>
	n78	0.8
	n78	0.8
DC_19-21-42_n77-n79	3	1
	19	0.3
	21	0.4
	42	0.8
	n77	0.8
DC_19-21-42_n78-n79	19	0.3
	21	0.4
	42	0.8
	n78	0.8
	n79	0.8

NOTE 1: The requirement is applied for UE transmitting on the frequency range of 2545 – 2690 MHz.  
NOTE 2: The requirement is applied for UE transmitting on the frequency range of 2496 – 2545 MHz.  
NOTE 3: The requirement is applied for UE transmitting on the frequency range of 2515 – 2690 MHz.  
NOTE 4: The requirement is applied for UE transmitting on the frequency range of 2496 – 2515 MHz.  
NOTE 5: Only applicable for UE supporting inter-band carrier aggregation with uplink in one E-UTRA band and without simultaneous Rx/Tx

6.2B.4.2.3.5  $\Delta T_{IB,c}$  for EN-DC six bands**Table 6.2B.4.2.3.5-1:  $\Delta T_{IB,c}$  due to EN-DC (six bands)**

Inter-band EN-DC configuration	E-UTRA or NR Band	$\Delta T_{IB,c}$ (dB)
DC_1-3-7-20_n28-n78	1	0.7
	3	0.7
	7	0.7
	20	0.6
	n28	0.6
	n78	0.8
DC_1-3-7-28_n7-n78	1	0.7
	3	0.7
	7	0.7
	28	0.6
	n7	0.7
	n78	0.8

## 6.2B.4.2.3a Inter-band NE-DC within FR1

Unless  $\Delta T_{IB,c}$  is specified in this clause, the value of  $\Delta T_{IB,c}$  for the correspondingly specified EN-DC configuration in clause 6.2B.4.2.3 is applicable.

## 6.2B.4.2.4 Inter-band EN-DC including FR2

6.2B.4.2.4.1  $\Delta T_{IB,c}$  for EN-DC two bands

Unless otherwise stated,  $\Delta T_{IB,c}$  for E-UTRA and FR2 NR bands of inter-band EN-DC combinations defined in table 5.5B.5.1-1 is set to zero.

**Table 6.2B.4.2.4.1-1: Void**6.2B.4.2.4.2  $\Delta T_{IB,c}$  for EN-DC three bands

Unless otherwise stated,  $\Delta T_{IB,c}$  for FR2 NR bands is set to zero, and  $\Delta T_{IB,c}$  for constituent E-UTRA bands for inter-band EN-DC defined in table 5.5B.5.2-1 is the same as those for the corresponding E-UTRA CA configuration specified in TS 36.101 [4], without the FR2 NR bands.

**Table 6.2B.4.2.4.2-1: Void**6.2B.4.2.4.3  $\Delta T_{IB,c}$  for EN-DC four bands

Unless otherwise stated,  $\Delta T_{IB,c}$  for FR2 NR bands is set to zero, and  $\Delta T_{IB,c}$  for constituent E-UTRA bands for inter-band EN-DC defined in table 5.5B.5.3-1 is the same as those for the corresponding E-UTRA CA configuration specified in TS 36.101 [4], without the FR2 NR bands.

**Table 6.2B.4.2.4.3-1: Void**6.2B.4.2.4.4  $\Delta T_{IB,c}$  for EN-DC five bands

Unless otherwise stated,  $\Delta T_{IB,c}$  for FR2 NR bands is set to zero, and  $\Delta T_{IB,c}$  for constituent E-UTRA bands for inter-band EN-DC defined in table 5.5B.5.4-1 is the same as those for the corresponding E-UTRA CA configuration specified in TS 36.101 [4], without the FR2 NR bands.

**Table 6.2B.4.2.4.4-1: Void**

6.2B.4.2.4.5	Void
6.2B.4.2.5	Inter-band EN-DC including both FR1 and FR2
6.2B.4.2.5.1	$\Delta T_{IB,c}$ for EN-DC three bands

Unless otherwise stated, for inter-band EN-DC configurations defined in table 5.5B.6.2-1,  $\Delta T_{IB,c}$  for constituent FR2 NR bands is set to zero, and  $\Delta T_{IB,c}$  for constituent E-UTRA and FR1 NR bands is the same as those for the corresponding inter band EN-DC configuration without the FR2 bands specified in 6.2B.4.2.3.

**Table 6.2B.4.2.5.1-1: Void**

6.2B.4.2.5.2	$\Delta T_{IB,c}$ for EN-DC four bands
--------------	--

Unless otherwise stated, for inter-band EN-DC configurations defined in table 5.5B.6.3-1,  $\Delta T_{IB,c}$  for constituent FR2 NR bands is set to zero, and  $\Delta T_{IB,c}$  for constituent E-UTRA and FR1 NR bands is the same as those for the corresponding inter band EN-DC configuration without the FR2 bands specified in 6.2B.4.2.3.

6.2B.4.2.5.3	$\Delta T_{IB,c}$ for EN-DC five bands
--------------	--

Unless otherwise stated, for inter-band EN-DC configurations defined in table 5.5B.6.4-1,  $\Delta T_{IB,c}$  for constituent FR2 NR bands is set to zero, and  $\Delta T_{IB,c}$  for constituent E-UTRA and FR1 NR bands is the same as those for the corresponding inter band EN-DC configuration without the FR2 bands specified in 6.2B.4.2.3.

6.2B.4.2.5.4	$\Delta T_{IB,c}$ for EN-DC six bands
--------------	---------------------------------------

Unless otherwise stated, for inter-band EN-DC configurations defined in table 5.5B.6.5-1,  $\Delta T_{IB,c}$  for constituent FR2 NR bands is set to zero, and  $\Delta T_{IB,c}$  for constituent E-UTRA and FR1 NR bands is the same as those for the corresponding inter band EN-DC configuration without the FR2 bands specified in 6.2B.4.2.3.

## 6.2B.5 Configured output power for NR-DC

### 6.2B.5.1 Configured output power level

#### 6.2B.5.1.1 Inter-band NR-DC between FR1 and FR2

For both synchronous and non-synchronous inter-band NR-DC [12] with MCG in FR1 and SCG in FR2 combined with one uplink serving cell per CG, the UE is allowed to set its configured maximum output power  $P_{CMAX,c(i),i}$  for serving cell  $c(i)$  of CG  $i$ ,  $i = 1, 2$  as specified in clause 6.2.4 of TS 38.101-1 [2] and clause 6.2.4 TS 38.101-2 [3] independently.

## 6.2C Transmitter power for V2X in FR1

### 6.2C.1 UE maximum output power for V2X

#### 6.2C.1.1 UE maximum output power for Intra-band contiguous V2X

For intra-band contiguous V2X operating UE, the allowed UE maximum output power shall be applied in Table 6.2.2-1 [4] for E-UTRA SL transmission or applied in Table 6.2.1-1 [2] for NR SL transmission, respectively.

**Table 6.2C.1.1-1: Maximum output power for V2X combination (continuous sub-blocks)**

V2X configuration	Power class 2 (dBm)	Tolerance (dB)	Power class 3 (dBm)	Tolerance (dB)
DC_(n)47AA			23	+2/-3 <sup>1</sup>
NOTE 1: If all transmitted resource blocks over all component carriers are confined within $F_{UL\_low}$ and $F_{UL\_low} + 4$ MHz or/and $F_{UL\_high} - 4$ MHz and $F_{UL\_high}$ , the maximum output power requirement is relaxed by reducing the lower tolerance limit by 1.5 dB				
NOTE 2: Power Class 3 is the default power class unless otherwise stated.				
NOTE 3: Only single switched UL is supported				

### 6.2C.1.2 UE maximum output power for Intra-band non-contiguous V2X

For intra-band non-contiguous V2X operating UE, the allowed UE maximum output power shall be applied in Table 6.2.2-1[4] for E-UTRA SL transmission or applied in Table 6.2.1-1 [2] for NR SL transmission, respectively.

**Table 6.2C.1.2-1: Maximum output power for V2X combination (non-continuous sub-blocks)**

V2X configuration	Power class 2 (dBm)	Tolerance (dB)	Power class 3 (dBm)	Tolerance (dB)
DC_47A_n47A			23	+2/-3 <sup>1</sup>
NOTE 1: If all transmitted resource blocks over all component carriers are confined within $F_{UL\_low}$ and $F_{UL\_low} + 4$ MHz or/and $F_{UL\_high} - 4$ MHz and $F_{UL\_high}$ , the maximum output power requirement is relaxed by reducing the lower tolerance limit by 1.5 dB				
NOTE 2: Power Class 3 is the default power class unless otherwise stated.				
NOTE 3: Only single switched UL is supported				

### 6.2C.1.2 UE maximum output power for Inter-band V2X

For the inter-band con-current NR V2X operation, the maximum output power is specified in Table 6.2C.1.2-1. The period of measurement shall be at least one sub frame (1ms).

**Table 6.2C.1.2-1: Con-current V2X UE Power Class**

V2X con-current operating band Configuration	Class 1 (dBm)	Tolerance (dB)	Class 2 (dBm)	Tolerance (dB)	Class 3 (dBm)	Tolerance (dB)	Class 4 (dBm)	Tolerance (dB)
V2X_20A_n38A					23	+2/-3 <sup>2</sup>		
V2X_n71A_47A					23	+2/-3 <sup>2</sup>		
NOTE 1: The con-current band combinations is used for NR V2X Service.								
NOTE 2: $P_{PowerClass}$ is the maximum UE power specified without taking into account the tolerance								
NOTE 3: For inter-band con-current aggregation the maximum power requirement apply to the total transmitted power over all component carriers (per UE).								
NOTE 4: <sup>4</sup> refers to the transmission bandwidths (Figure 5.6-1) confined within $F_{UL\_low}$ and $F_{UL\_low} + 4$ MHz or $F_{UL\_high} - 4$ MHz and $F_{UL\_high}$ , the maximum output power requirement is relaxed by reducing the lower tolerance limit by 1.5 dB								

## 6.2C.2 UE maximum output power reduction for V2X

### 6.2C.2.1 UE maximum output power reduction for Intra-band V2X

For intra-band V2X operating UE, maximum output power reduction specified in clause 6.2.3G [4] and in clause 6.2C.2 [2] apply, respectively.

### 6.2C.2.2 UE maximum output power reduction for Inter-band V2X

For the inter-band con-current NR V2X operation, the allowed maximum power reduction (MPR) for the maximum output power shall be applied per each component carrier. The MPR requirements in subclause 6.2.3 of TS 36.101 [4] apply for E-UTRA Uu operation in licensed band, and the MPR requirements in subclause 6.2C.2 of TS 38.101-1 [2] apply for NR sidelink operation in Band n47.



## 6.2C.3 UE additional maximum output power reduction for V2X

### 6.2C.3.1 UE additional maximum output power reduction for Intra-band V2X

For intra-band V2X operating UE, additional maximum output power reduction specified in clause 6.2.4G [4] and in clause 6.2C.3 [2] apply, respectively.

### 6.2C.3.2 UE additional maximum output power reduction for Inter-band V2X

For the inter-band con-current NR V2X operation, the allowed additional maximum power reduction (A-MPR) for the maximum output power shall be applied per each component carrier. The A-MPR requirements in subclause 6.2.3 of TS 36.101 [4] apply for E-UTRA Uu operation in licensed band, and the A-MPR requirements in in subclause 6.2C.3 of TS 38.101-1 [2] apply for NR sidelink operation in Band n47.

## 6.2C.4 Configured output power for V2X

### 6.2C.4.1 UE configured output power for Intra-band V2X

For intra-band V2X operating UE, each UE configured output power specified in clause 6.2.5G [4] and in clause 6.2C.4 [2] apply, respectively.

### 6.2C.4.2 UE configured output power for Inter-band V2X

When a UE is configured for simultaneous NR V2X sidelink and NR uplink transmissions for inter-band con-current operation, the UE is allowed to set its configured maximum output power  $P_{\text{CMAX},c,Uu}$  and  $P_{\text{CMAX},c,V2X}$  for the configured E-UTRA or NR uplink carrier and the configured NR V2X SL or E-UTRA V2X SL carrier, respectively, and its total configured maximum output power  $P_{\text{CMAX},c}$ .

The configured maximum output power  $P_{\text{CMAX},c,Uu}(p)$  in subframe  $p$  for the configured E-UTRA or NR uplink carrier shall be set within the bounds:

$$P_{\text{CMAX},L,c,Uu}(p) \leq P_{\text{CMAX},c,Uu}(p) \leq P_{\text{CMAX},H,c,Uu}(p)$$

where  $P_{\text{CMAX},L,c,Uu}$  and  $P_{\text{CMAX},H,c,Uu}$  are the limits for a serving cell  $c$  as specified in subclause 6.2.5 TS 36.101 [4] or 6.2.4 TS 38.101-1 [2].

The configured maximum output power  $P_{\text{CMAX},c,V2X}(q)$  in slot  $q$  for the configured NR or E-UTRA V2X SL carrier shall be set within the bounds:

$$P_{\text{CMAX},c,V2X}(q) \leq P_{\text{CMAX},H,c,V2X}(q)$$

where  $P_{\text{CMAX},H,c,V2X}$  is the limit as specified in subclause 6.2C.4 of TS 38.101-1 [2] or 6.2.5G or TS 36.101 [5].

The total UE configured maximum output power  $P_{\text{CMAX}}(p,q)$  in a subframe  $p$  of E-UTRA uplink carrier and a slot  $q$  of NR V2X sidelink that overlap in time shall be set within the following bounds for synchronous and asynchronous operation unless stated otherwise:

$$P_{\text{CMAX},L}(p,q) \leq P_{\text{CMAX}}(p,q) \leq P_{\text{CMAX},H}(p,q)$$

with

$$P_{\text{CMAX},L}(p,q) = P_{\text{CMAX},L,c,Uu}(p)$$

$$P_{\text{CMAX},H}(p,q) = 10 \log_{10} [P_{\text{CMAX},H,c,Uu}(p) + P_{\text{CMAX},H,c,V2X}(q)]$$

where  $P_{\text{CMAX},H,c,V2X}$  and  $P_{\text{CMAX},H,c,Uu}$  are the limits  $P_{\text{CMAX},H,c,V2X}(q)$  and  $P_{\text{CMAX},H,c,Uu}(p)$  expressed in linear scale.

The measured total maximum output power  $P_{\text{UMAX}}$  over both the E-UTRA uplink and NR V2X carriers is

$$P_{\text{UMAX}} = 10 \log_{10} [P_{\text{UMAX},c,Uu} + P_{\text{UMAX},c,V2X}],$$

where  $P_{\text{UMAX},c,Uu}$  denotes the measured output power of serving cell  $c$  for the configured E-UTRA uplink carrier or NR uplink carrier, and  $P_{\text{UMAX},c,V2X}$  denotes the measured output power for the configured NR V2X SL carrier or E-UTRA V2X SL carrier expressed in linear scale.

When a UE is configured for synchronous V2X sidelink and uplink transmissions,

$$P_{\text{CMAX}_L}(p, q) - T_{\text{LOW}}(P_{\text{CMAX}_L}(p, q)) \leq P_{\text{UMAX}} \leq P_{\text{CMAX}_H}(p, q) + T_{\text{HIGH}}(P_{\text{CMAX}_H}(p, q))$$

where  $P_{\text{CMAX}_L}(p, q)$  and  $P_{\text{CMAX}_H}(p, q)$  are the limits for the pair  $(p, q)$  and with the tolerances  $T_{\text{LOW}}(P_{\text{CMAX}})$  and  $T_{\text{HIGH}}(P_{\text{CMAX}})$  for applicable values of  $P_{\text{CMAX}}$  specified in Table 6.2C.4-1.  $P_{\text{CMAX}_L}$  may be modified for any overlapping portion of slots  $(p, q)$  and  $(p+1, q+1)$ .

## 6.3 Output power dynamics

Output power dynamics for EN-DC operations in FR1 and FR2 as specified in TS 38.101-1 [2] and TS 38.101-2 [3], respectively. E-UTRA as specified in TS 36.101 [4]. For intra-band contiguous EN-DC operation in FR1, minimum output power requirements specified in clause 6.3.1 of TS 38.101-1 [2] and clause 6.3.2 of TS 36.101 [4] shall only apply when the power of all NR and E-UTRA carriers are set to minimum value. Similarly, OFF power requirements specified in clause 6.3.2 of TS 38.101-1 [2] and clause 6.3.3 of TS 36.101 [4] shall only apply when the power of all NR and E-UTRA carriers are OFF. The OFF power condition in transmit ON/OFF time mask requirements specified in clause 6.3.3 of TS 38.101-1 [2] and clause 6.3.4 of TS 36.101 [4] is applicable only when all NR and E-UTRA carriers are OFF. If both E-UTRA and NR transition between ON and OFF states simultaneously, the longer transient time shall apply to both. If either E-UTRA or NR is OFF and the other carrier transitions from OFF to ON, then the transient time associated with that carrier applies.

### 6.3A Output power dynamics for CA

For inter-band NR CA between FR1 and FR2, output power dynamics as specified in TS 38.101-1 [2] and TS 38.101-2 [3] apply for FR1 and FR2 respectively.

### 6.3B Output power dynamics for DC

#### 6.3B.0 General

The E-UTRA and NR switching time mask defines the observation period between E-UTRA subframe and NR slot/mini-slot boundary. Both E-UTRA subframe and NR slot/mini-slot have ON power transmissions. The ON power is defined as the mean power over the symbol duration excluding any transient period. For E-UTRA subframe or NR slot/mini-slot having OFF power transmission, the general time mask for E-UTRA or NR shall apply.

For inter-band EN-DC, output power dynamics requirement for E-UTRA single carrier and CA operation specified in clauses 6.3 of TS 36.101 [4] and for NR single carrier and CA operation specified in clause 6.3 of TS 38.101-1 [2] and clause 6.3, 6.3A and 6.3D of TS 38.101-2 [3] apply.

#### 6.3B.1 Output power dynamics for EN-DC with UL sharing from UE perspective

##### 6.3B.1.1 E-UTRA and NR switching time mask for TDM based UL sharing from UE perspective

The E-UTRA and NR switching time mask is applicable for non-simultaneous transmissions between E-UTRA and NR in TDM based UL sharing from the UE perspective in the same channel, which is shared by E-UTRA and NR.

For UEs reporting E-UTRA and NR switching time capability of type 1 with switching time  $< 0.5$  us for TDM based UL sharing from UE perspective within FR1 time masks in Figure 6.3B.1.1-1 and Figure 6.3B.1.1-2 shall apply. For UEs reporting E-UTRA and NR switching time capability of type 2 with switching time  $< 20$  us for TDM based UL sharing from UE perspective within FR1, time masks in Figure 6.3B.1.1-3 and Figure 6.3B.1.1-4 shall apply.

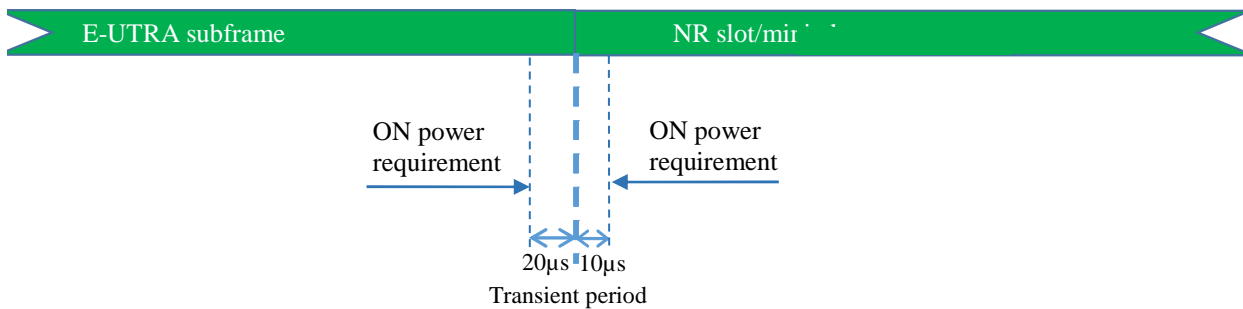

Figure 6.3B.1.1-1: E-UTRA to NR switching time mask for type 1 for TDM based UL sharing from UE perspective within FR1

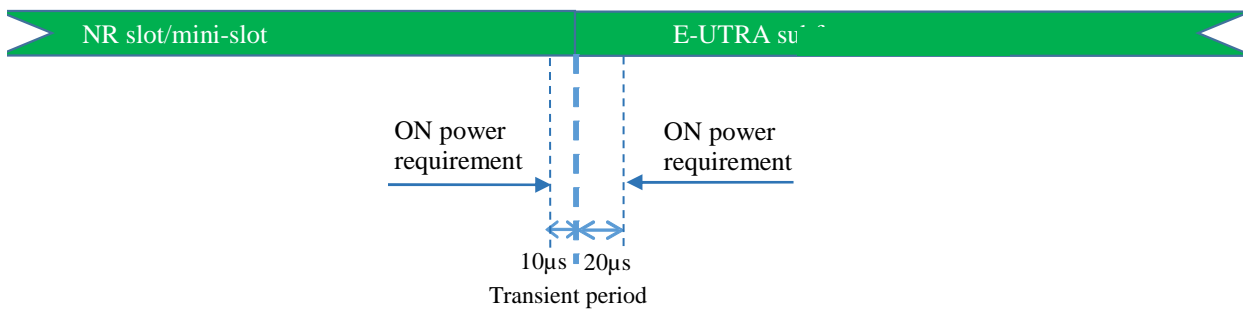

Figure 6.3B.1.1-2: NR to E-UTRA switching time mask for type 1 for TDM based UL sharing from UE perspective within FR1

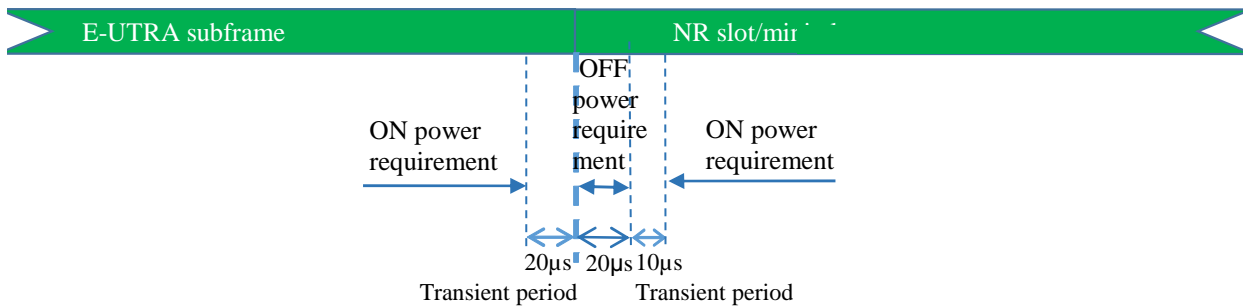

Figure 6.3B.1.1-3: E-UTRA to NR switching time mask for type 2 for TDM based UL sharing from UE perspective within FR1

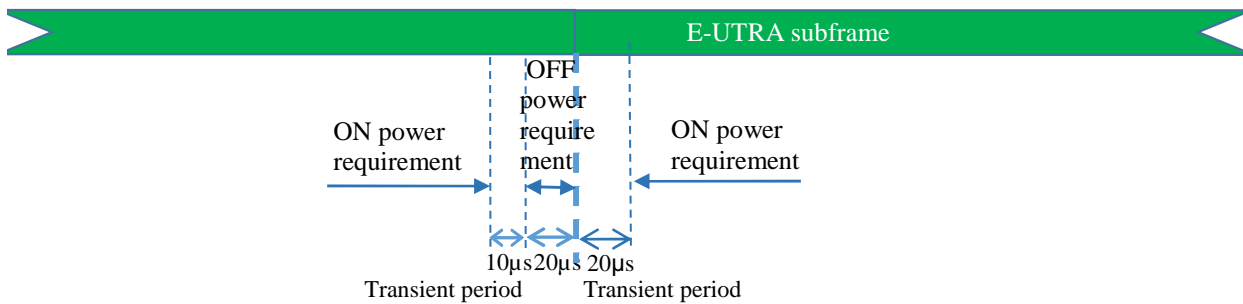

Figure 6.3B.1.1-4: NR to E-UTRA switching time mask for type 2 for TDM based UL sharing from UE perspective within FR1

### 6.3B.1a Output power dynamics for NE-DC with UL sharing from UE perspective

The E-UTRA and NR switching time mask is applicable for non-simultaneous transmissions between E-UTRA and NR in TDM based UL sharing from the UE perspective in the same channel, which is shared by E-UTRA and NR. Unless otherwise specified, the 6.3B.1.1 clauses for NE-DC are applicable.

### 6.3B.2 Output power dynamics for intra-band EN-DC without dual PA capability

For intra-band contiguous EN-DC configurations DC\_(n)41 and DC\_(n)71, and all intra-band non-contiguous EN-DC configurations without dual PA capability, maximum UL switching time is defined as 120 us and DL reception interruption is allowed during UL switching. Time masks in Figure 6.3B.2-1 and Figure 6.3B.2-2 shall apply. Unless otherwise stated, for other intra-band contiguous EN-DC configurations, the switching time in 6.3B.1.1 applies.

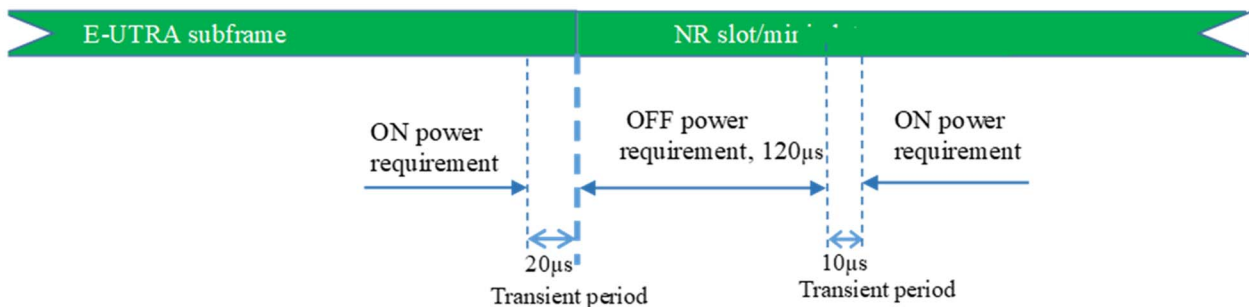

Figure 6.3B.2-1: E-UTRA to NR switching time mask for intra-band EN-DC without dual PA capability when single UL is allowed

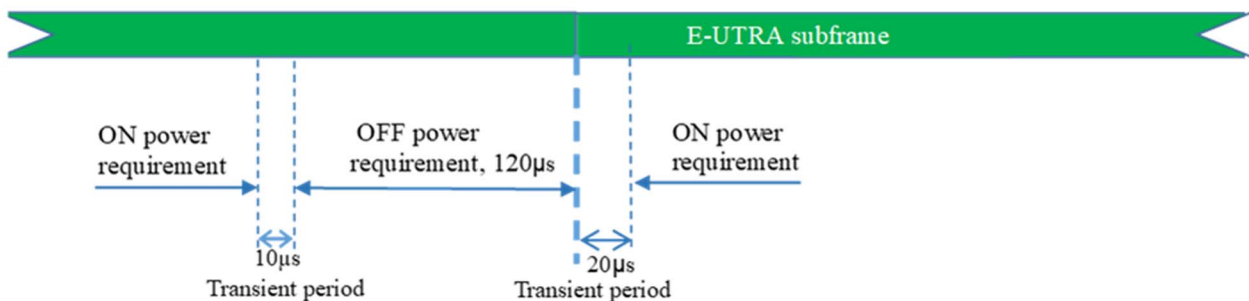

Figure 6.3B.2-2: NR to E-UTRA switching time mask for intra-band EN-DC without dual PA capability when single UL is allowed

### 6.3B.3 Output power dynamics for intra-band EN-DC with dual PA capability

For both intra-band contiguous and non-contiguous EN-DC with dual PA capability, time masks in Figure 6.3B.3-1 and Figure 6.3B.3-2 shall apply.

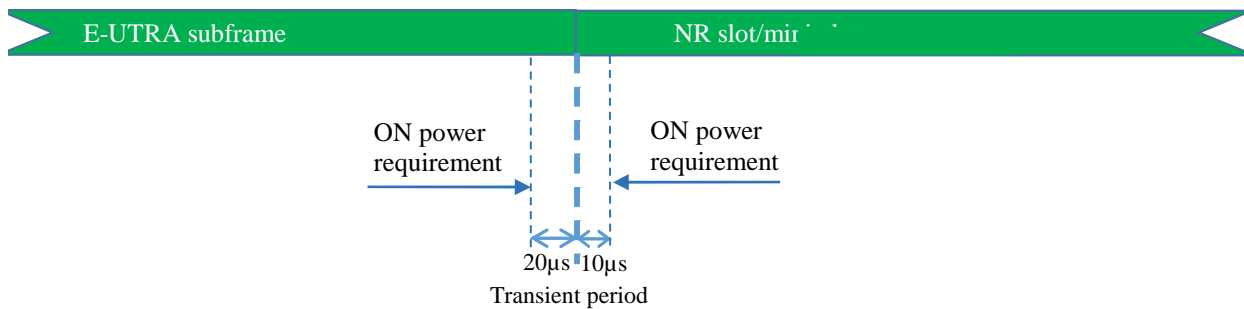

Figure 6.3B.3-1: E-UTRA to NR switching time mask for intra-band EN-DC with dual PA capability

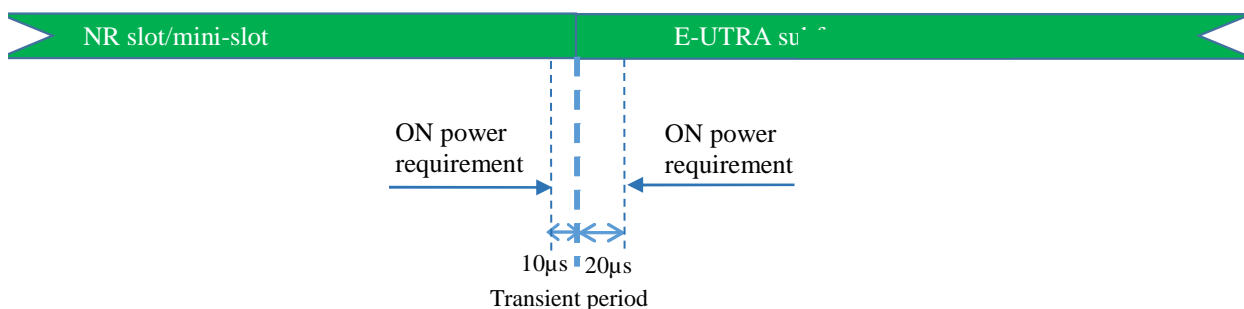

Figure 6.3B.3-2: NR to E-UTRA switching time mask for intra-band EN-DC with dual PA capability

### 6.3B.4 Output power dynamics for switching between two uplink carriers

#### 6.3B.4.1 E-UTRA and NR switching time mask between two uplink carriers

In addition to the requirements in 6.3B.0 and the maximum output power requirement specified in Table 6.2B.1.3-1 with inter-band EN-DC (two bands), the switching time mask specified in this sub-clause is applicable for an uplink band pair of a inter-band EN-DC configuration without SUL band when the capability *uplinkTxSwitchingPeriod* is present, and is only applicable for uplink switching mechanisms specified in sub-clause 6.1.0 of TS 38.214 [14], where E-UTRA UL carrier 1 is capable of one transmit antenna connector and NR UL carrier 2 is capable of two transmit antenna connectors, and the two uplink carriers are in different bands with different carrier frequencies. The UE shall support the switch between single layer transmission with one antenna port and two-layer transmission with two antenna ports on the two uplink carriers following the scheduling commands and rank adaptation, i.e., both single layer and two-layer transmission with 2 antenna ports, and single layer transmission with 1 antenna port shall be supported on NR UL carrier 2.

The switching periods described in Figure 6.3B.4.1-1 are only located in NR carrier, and the length of uplink switching period *X* is less than the value indicated by UE capability *uplinkTxSwitchingPeriod*.

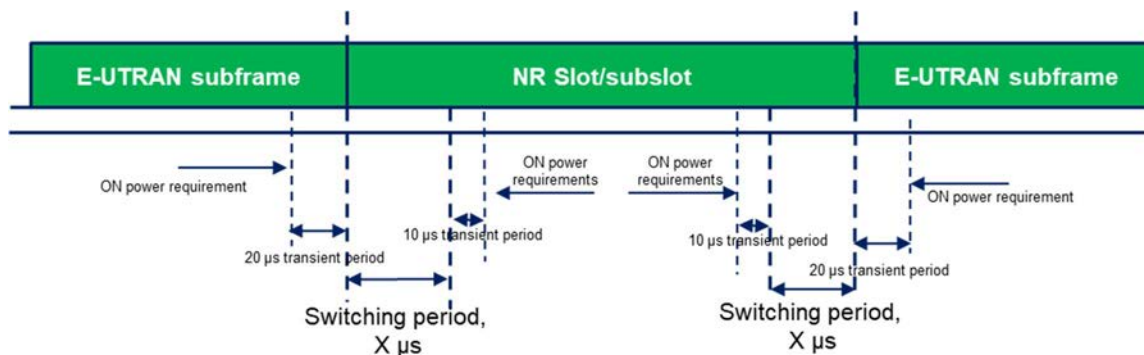

Figure 6.3B.4.1-1: Time mask for switching between E-UTRA UL carrier and NR UL carrier, where the switching period is located in NR carrier

The requirements apply for the case of co-located and synchronized network deployment for the two uplink carriers.

## 6.4 Void

### 6.4A Transmit signal quality for CA

#### 6.4A.1 Frequency error for CA

For inter-band NR CA between FR1 and FR2, frequency error as specified in TS 38.101-1 [2] and TS 38.101-2 [3] apply for FR1 and FR2 respectively.

#### 6.4A.2 Transmit modulation quality for CA

For inter-band NR CA between FR1 and FR2, transmit modulation quality as specified in TS 38.101-1 [2] and TS 38.101-2 [3] apply for FR1 and FR2 respectively.

### 6.4B Transmit signal quality for DC

#### 6.4B.1 Frequency error for DC

##### 6.4B.1.1 Frequency error for Intra-band contiguous EN-DC

For intra-band contiguous EN-DC, the requirement shall apply on each component carrier as defined in clause 6.5.1 in TS 36.101 [4] and in clause 6.4.1 in TS 38.101-1 [2], respectively.

##### 6.4B.1.2 Frequency error for Intra-band non-contiguous EN-DC

For intra-band non-contiguous EN-DC, the requirement shall apply on each component carrier as defined in clause 6.5.1 in TS 36.101 [4] and in clause 6.4.1 in TS 38.101-1 [2], respectively.

##### 6.4B.1.3 Frequency error for inter-band EN-DC within FR1

For inter-band EN-DC with uplink assigned to one E-UTRA band and one NR band, the requirements shall apply on each component carrier as defined in clause 6.5.1 in TS 36.101 [4] and in clause 6.4.1 in TS 38.101-1 [2], respectively, with all component carriers active. If multiple component carriers are assigned to one E-UTRA band, the requirements in clauses 6.5.1A in TS 36.101 [4] apply for those component carriers.

##### 6.4B.1.3a Frequency error for inter-band NE-DC within FR1

For inter-band NE-DC with uplink assigned to one E-UTRA band and one NR band, the requirements shall apply on each component carrier as defined in clause 6.5.1 in TS 36.101 [4] and in clause 6.4.1 in TS 38.101-1 [2], respectively, with all component carriers active. If multiple component carriers are assigned to one E-UTRA band, the requirements in clauses 6.5.1A in TS 36.101 [4] apply for those component carriers, and if multiple component carriers are assigned to one NR band, the requirements in clauses 6.4A.1 in TS 38.101-1 [2] apply for those component carriers.

##### 6.4B.1.4 Frequency error for inter-band EN-DC including FR2

Frequency error requirement for E-UTRA single carrier and CA operation specified in clauses 6.5.1 and 6.5.1A of TS 36.101 [4] and for NR single carrier and CA operation specified in clause 6.4.1, 6.4A.1 and 6.4D.1 of TS 38.101-2 [3] apply.

##### 6.4B.1.5 Frequency error for inter-band EN-DC including both FR1 and FR2

Frequency error requirement for E-UTRA single carrier and CA operation specified in clauses 6.5.1 and 6.5.1A of TS 36.101 [4] and for NR single carrier and CA operation specified in clause 6.4.1 of TS 38.101-1 [2] and clause 6.4.1, 6.4A.1 and 6.4D.1 of TS 38.101-2 [3] apply.

## 6.4B.2 Transmit modulation quality for DC

### 6.4B.2.1 Transmit modulation quality for Intra-band contiguous EN-DC

#### 6.4B.2.1.1 Error Vector Magnitude

For the intra-band contiguous EN-DC with one component carrier per CG the EVM requirement applies with PRB allocation in one of the CG and the other CG unallocated.

The EVM requirements for each CG are according to clause 6.5.2 of TS 36.101 [4] for the MCG and 6.4.2 of TS 38.101-1 [2] for the SCG with EN-DC configured.

#### 6.4B.2.1.2 Carrier leakage

The carrier leakage requirements for each CG are according to clause 6.5.2 of TS 36.101 [4] for the MCG and 6.4.2 of TS 38.101-1 [2] for the SCG with EN-DC configured.

#### 6.4B.2.1.3 In-band emissions

For the MCG the in-band emission requirements in Table 6.5.2A.3.1-1 and 6.5.2A.3.1-2 in TS 36.101 [4] apply within the aggregated transmission bandwidth configuration of the EN-DC bandwidth with the carriers of both CGs active and one single contiguous PRB allocation of bandwidth  $L_{CRB}$  within the MCG at the edge of the said aggregated transmission bandwidth configuration.

For the SCG the in-band emission requirements in Table 6.5.2A.3.1-1 and 6.5.2A.3.1-2 in TS 36.101 [4] apply within the aggregated transmission bandwidth configuration of the EN-DC bandwidth with the carriers of both CGs active and one single contiguous PRB allocation of bandwidth  $L_{CRB}$  within the SCG at the edge of the aggregated transmission bandwidth configuration.

### 6.4B.2.2 Transmit modulation quality for Intra-band non-contiguous EN-DC

#### 6.4B.2.2.1 Error Vector Magnitude

For the intra-band non-contiguous EN-DC with one component carrier per CG the EVM requirement applies with PRB allocation in one of the CG and the other CG unallocated.

The EVM requirements for each CG are according to clause 6.5.2 of TS 36.101 [4] for the MCG and 6.4.2 of TS 38.101-1 [2] for the SCG with EN-DC configured.

#### 6.4B.2.2.2 Carrier leakage

The carrier leakage requirements for each CG are according to clause 6.5.2 of TS 36.101 [4] for the MCG and 6.4.2 of TS 38.101-1 [2] for the SCG with EN-DC configured and PRB allocation only in the CG being measured.

#### 6.4B.2.2.3 In-band emissions

For the MCG the in-band emission requirements in Table 6.5.2A.3.1-1 and 6.5.2A.3.1-2 in TS 36.101 [4] apply within the transmission bandwidth configuration of the MCG with the carriers of both CGs active and one single contiguous PRB allocation of bandwidth  $L_{CRB}$  within the MCG at the edge of the transmission bandwidth configuration.

For the SCG the in-band emission requirements in Table 6.4.2.3-1 in TS 38.101-1 [2] apply within the transmission bandwidth configuration of the SCG with the carriers of both CGs active and one single contiguous PRB allocation of bandwidth  $L_{CRB}$  within the SCG at the edge of the transmission bandwidth configuration.

### 6.4B.2.3 Transmit modulation quality for Inter-band EN-DC within FR1

For inter-band EN-DC with uplink assigned to one E-UTRA band and one NR band, the requirements shall apply on each component carrier as defined in clause 6.5.2 in TS 36.101 [4] and in clause 6.4.2 in TS 38.101-1 [2], respectively, with all component carriers active, applies with PRB allocation in one of the CG and the other CG unallocated. If multiple component carriers are assigned to one E-UTRA band, the requirements in subclauses 6.5.2A in TS 36.101 [4] apply for those component carriers.

### 6.4B.2.3a Transmit modulation quality for Inter-band NE-DC within FR1

For inter-band NE-DC with uplink assigned to one E-UTRA band and one NR band, the requirements shall apply on each component carrier as defined in clause 6.5.2 in TS 36.101 [4] and in clause 6.4.2 in TS 38.101-1 [2], respectively, with all component carriers active, applies with PRB allocation in one of the CG and the other CG unallocated. If multiple component carriers are assigned to one E-UTRA band, the requirements in clauses 6.5.2A in TS 36.101 [4] apply for those component carriers, and if multiple component carriers are assigned to one NR band, the requirements in clauses 6.4A.2 in TS 38.101-1 [2] apply for those component carriers.

### 6.4B.2.4 Transmit modulation quality for Inter-band EN-DC including FR2

Transmit modulation quality requirement for E-UTRA single carrier and CA operation specified in clauses 6.5.2 and 6.5.2A of TS 36.101 [4] and for NR single carrier and CA operation specified in clause 6.4.2, 6.4A.2 and 6.4D.2 of TS 38.101-2 [3] apply.

### 6.4B.2.5 Transmit modulation quality for inter-band EN-DC including both FR1 and FR2

Transmit modulation quality requirement for E-UTRA single carrier and CA operation specified in clauses 6.5.2 and 6.5.2A of TS 36.101 [4] and for NR single carrier and CA operation specified in clause 6.4.2 of TS 38.101-1 [2] and clause 6.4.2, 6.4A.2 and 6.4D.2 of TS 38.101-2 [3] apply.

## 6.4C Transmit signal quality for V2X operation in FR1

### 6.4C.1 Frequency error for V2X

For intra-band V2X operating UE, the requirement shall apply on each component carrier as defined in clause 6.5.1G in TS 36.101 [4] and in clause 6.4C.1 in TS 38.101-1 [2], respectively.

For the inter-band con-current NR V2X operation, the requirements specified in subclause 6.4.1 of TS 36.101 [4] shall apply for the E-UTRA uplink in licensed band and the requirements specified in subclause 6.4C.1 of TS 38.101-1 [2] shall apply for the sidelink in NR Band n47.

### 6.4C.2 Transmit modulation quality for V2X

#### 6.4C.2.1 Transmit modulation quality for Intra-band V2X

##### 6.4C.2.2.1 Error Vector Magnitude

For intra-band V2X operating UE, the requirement shall apply on each SL transmission as defined in clause 6.5.2G.1 in TS 36.101 [4] and in clause 6.4C.2.1 in TS 38.101-1 [2], respectively.

For the inter-band con-current NR V2X operation, the requirements specified in subclause 6.5.2 of TS 36.101 [4] shall apply for the E-UTRA uplink in licensed band and the requirements specified in subclause 6.4C.2.1 of TS 38.101-1 [2] shall apply for the sidelink in NR Band n47.

##### 6.4C.2.2.2 Carrier leakage

For intra-band V2X operating UE, the requirement shall apply on each SL transmission as defined in clause 6.5.2G.2 in TS 36.101 [4] and in clause 6.4C.2.2 in TS 38.101-1 [2], respectively.



#### 6.4C.2.2.3 In-band emissions

For intra-band V2X operating UE, the requirement shall apply on each SL transmission as defined in clause 6.5.2G.3 in TS 36.101 [4] and in clause 6.4C.2.3 in TS 38.101-1 [2], respectively.

#### 6.4C.2.2 Transmit modulation quality for Inter-band V2X

For inter-band V2X with transmission assigned to one E-UTRA band and one NR band, the requirements shall apply on each component carrier as defined in clause 6.5.2 in TS 36.101 [4] and in clause 6.4.2 in TS 38.101-1 [2], respectively, with all component carriers active. If multiple component carriers are assigned to one E-UTRA band, the requirements in clauses 6.5.2A in TS 36.101 [4] apply for those component carriers.

### 6.5 Void

## 6.5A Output RF spectrum emissions for CA

### 6.5A.1 Occupied bandwidth for CA

For inter-band NR CA between FR1 and FR2, occupied bandwidth specified in TS 38.101-1 [2] and TS 38.101-2 [3] apply for each frequency range respectively.

### 6.5A.2 Out-of-band emissions for CA

For inter-band NR CA between FR1 and FR2, out-of-band emissions specified in TS 38.101-1 [2] and TS 38.101-2 [3] apply for each frequency range respectively.

### 6.5A.3 Spurious emissions for CA

#### 6.5A.3.1 Inter-band CA between FR1 and FR2

Unless otherwise stated, for inter-band CA between FR1 and FR2, spurious emission and UE co-existence requirements specified in TS 38.101-1 [2] and TS 38.101-2 [3] apply for each component carrier respectively.

**Table 6.5A.3.1-1: Void**

#### 6.5A.4 Transmit intermodulation for CA

For inter-band NR CA between FR1 and FR2, transmit intermodulation specified in TS 38.101-1 [2] apply for each component carrier for NR FR1.

## 6.5B Output RF spectrum emissions for DC

### 6.5B.1 Occupied bandwidth for EN-DC

#### 6.5B.1.1 Intra-band contiguous EN-DC

For intra-band contiguous EN-DC the occupied bandwidth is a measure of the bandwidth containing 99% of the total integrated power of the transmitted spectrum. The OBW shall be less than the aggregated channel bandwidth for EN-DC, denoted as ENBW in clause 5.3B.

#### 6.5B.1.2 Intra-band non-contiguous EN-DC

For intra-band non-contiguous EN-DC, occupied bandwidth requirement for E-UTRA single carrier and CA operation specified in clauses 6.6.1 and 6.6.1A of TS 36.101 [4] and for NR single carrier specified in clause 6.5.1 of TS 38.101-1 [2] apply.

### 6.5B.1.3 Inter-band EN-DC within FR1

Occupied bandwidth requirement for E-UTRA single carrier and CA operation specified in clauses 6.6.1 and 6.6.1A of TS 36.101 [4] and for NR single carrier specified in clause 6.5.1 of TS 38.101-1 [2] apply.

### 6.5B.1.4 Inter-band EN-DC including FR2

Occupied bandwidth requirement for E-UTRA single carrier and CA operation specified in clauses 6.6.1 and 6.6.1A of TS 36.101 [4] and for NR single carrier and CA operation specified in clause 6.5.1, 6.5A.1 and 6.5D.1 of TS 38.101-2 [3] apply.

### 6.5B.1.5 Inter-band EN-DC including both FR1 and FR2

Occupied bandwidth requirement for E-UTRA single carrier and CA operation specified in clauses 6.6.1 and 6.6.1A of TS 36.101 [4] and for NR single carrier and CA operation specified in clause 6.5.1 of TS 38.101-1 [2] and clause 6.5.1, 6.5A.1 and 6.5D.1 of TS 38.101-2 [3] apply.

## 6.5B.2 Out-of-band emissions for DC

### 6.5B.2.1 Intra-band contiguous EN-DC

The out of band emissions are unwanted emissions immediately outside the EN-DC aggregated channel bandwidth resulting from the modulation process and non-linearity in the transmitter but excluding spurious emissions. This out of band emission limit is specified in terms of a spectrum emission mask and an adjacent channel leakage power ratio.

Unless otherwise stated, the OOB limits specified for the DC combination in this clause supercede any OOB requirements specified for each sub-block in the respective TS [4] and TS 38.101-1 [2].

The requirements apply to the sum of transmissions across all antenna connectors.

#### 6.5B.2.1.1 Spectrum emissions mask

The spectrum emission mask of the UE applies to frequencies ( $\Delta f_{\text{OoB}}$ ) starting from the  $\pm$  edge of the EN-DC aggregated channel bandwidth. For frequencies offset greater than  $\Delta f_{\text{OoB}}$  as specified in Table 6.5B.2.1.1-1 the spurious requirements in clause 6.5B.3 are applicable.

The general spectrum emission for intra-band contiguous EN-DC is specified in Table 6.5B.2.1.1-1.

The power of any UE emission shall not exceed the levels specified in Table 6.5B.2.1.1-1 for the specified EN-DC aggregated channel bandwidth.

**Table 6.5B.2.1.1-1: General spectrum emission mask for intra-band contiguous EN-DC**

$\Delta f_{\text{OoB}}$ (MHz)	Spectrum emission limit (dBm)	Measurement bandwidth
$\pm 0 - 1$	$\text{Max}(\text{Round}(10 \cdot \log(0.15/\text{ENBW})), -24)$	30 kHz
$\pm 1 - 5$	-10	1 MHz
$\pm 5 - \text{ENBW}$	-13	1 MHz
$\pm \text{ENBW} - (\text{ENBW}+5)$	-25	1 MHz
NOTE:	ENBW refers to the aggregated channel bandwidth in MHz as defined in clause 5.3B.	

#### 6.5B.2.1.2 Additional spectrum emissions mask

##### 6.5B.2.1.2.1 Requirements for network signalled value "NS\_35"

When NS\_35 is indicated in the MCG and NS\_35 is indicated in the SCG, the requirements in Table 6.5B.2.1.2.1-1 apply in the frequency ranges immediately adjacent and outside the aggregated sub-blocks of the EN-DC configuration for DC\_(n)71AA.

Table 6.5B.2.1.2.1-1: Additional requirements

$\Delta f_{\text{OoB}}$ (MHz)	Frequency offset of measurement filter centre frequency, $f_{\text{offset}}$	Minimum requirement (dBm)	Measurement bandwidth
$0 \text{ MHz} \leq \Delta f < 0.1 \text{ MHz}$	$0.015 \text{ MHz} \leq f_{\text{offset}} < 0.085 \text{ MHz}$	-13	30 kHz
$0.1 \text{ MHz} \leq \Delta f < \text{ENBW}$	$0.15 \text{ MHz} \leq f_{\text{offset}} < \text{ENBW} - 0.05 \text{ MHz}$	-13	100 kHz
$\text{ENBW} \leq \Delta f < \text{ENBW} + 5 \text{ MHz}$	$\text{ENBW} + 0.5 \text{ MHz} \leq f_{\text{offset}} < \text{ENBW} + 4.5 \text{ MHz}$	-25	1 MHz
NOTE 1: ENBW is the aggregated bandwidth of an E-UTRA sub-block and an adjacent NR sub-block; there is no frequency separation between the said sub-blocks. The sub-block bandwidths include any internal guard bands.			

## 6.5B.2.1.2.2 Requirements for network signalled value "NS\_04"

Additional spectrum emission requirements are signalled by the network to indicate that the UE shall meet an additional requirement for a specific deployment scenario as part of the cell handover/broadcast message.

The Band 41/n41 SEM transition point from -13 dBm/MHz to -25 dBm/MHz is based on the emission bandwidth. The emission bandwidth is defined as the width of the signal between two points, one below the carrier center frequency and one above the carrier center frequency, outside of which all emissions are attenuated at least 26 dB below the transmitter power. Since the 26 dB emission bandwidth is implementation dependent, the transmission bandwidths occupied by RBs is used for the SEM. The emission bandwidth for E-UTRA carriers is document in TS 36.101 [4], and the emission bandwidth for NR carriers is documented in TS 38.101-1 [2]. The total emission bandwidth for contiguous intra-band EN-DC is the sum of the emission bandwidth for each CC plus the guard band between contiguous CCs.

When "NS\_04" is indicated in the cell, the power of any UE emission shall not exceed the levels specified in Table 6.5B.2.1.2.2-1.

Table 6.5B.2.1.2.2-1: DC\_(n)41 SEM with NS\_04

$\Delta f_{\text{OoB}}$ MHz	Spectrum emission limit (dBm) / measurement bandwidth for each ENBW					Measurement bandwidth
	15 MHz	20 MHz	40 MHz	50 MHz	> 50 MHz	
$\pm 0 - 1$	-10	-10	-10			2 % ENBW
				-10		1 MHz
$\pm 1 - 5$			-10			1 MHz
$\pm 5 - X$			-13			
$\pm X - (\text{ENBW} + 5 \text{ MHz})$			-25			
NOTE: X is defined as the sum of the emission bandwidth of the component carriers plus the guard band between contiguous CCs.						

## 6.5B.2.1.3 Adjacent channel leakage ratio

For EN-DC operation with an E-UTRA sub-block immediately adjacent to an NR sub-block, the ACLR is defined as the ratio of the filtered mean power centred on the aggregated sub-block bandwidth ENBW to the filtered mean power centred on an adjacent bandwidth of the same size ENBW at nominal channel spacing. The UE shall meet the ACLR minimum requirement  $\text{EN-DC}_{\text{ACLR}}$  specified in Table 6.5B.2.1.3-1 with ENBW the sum of the sub-block bandwidths.

The assigned channel power and adjacent channel power are measured with rectangular filters with measurement bandwidths specified in 6.5B.2.1.3-1.

**Table 6.5B.2.1.3-1: ACLR for intra-band EN-DC (contiguous sub-blocks)**

Parameter	Unit	Value
EN-DC <sub>ACLR</sub> for PC3	dBc	30
EN-DC <sub>ACLR</sub> for PC2	dBc	31
Measurement bandwidth of EN-DC channel		1.00*ENBW
Measurement bandwidth of adjacent channel		0.95*ENBW
Frequency offset of adjacent channel		ENBW / -ENBW
NOTE 1: ENBW is the aggregated bandwidth in MHz as defined in clause 5.3B.		
NOTE 2: The frequency offset is that in between the centre frequencies of the measurement filters		

## 6.5B.2.2 Intra-band non-contiguous EN-DC

### 6.5B.2.2.1 Spectrum emissions mask

The spectral emission mask for intra-band non-contiguous EN-DC is a composite of the emission mask for each CC with the level set to the maximum value from each mask for each frequency outside of the transmission bandwidth of either carrier. A composite spectrum emission mask is a combination of individual CC spectrum emissions masks. Where two masks overlap the most relaxed limit is used. Composite spectrum emission mask applies to frequencies up to  $\pm \Delta f_{\text{OOB}}$  starting from the edges of the sub-blocks. If for some frequency an individual CC spectrum emission mask overlaps with the bandwidth of another CC then the emission mask does not apply for that frequency.

### 6.5B.2.2.2 Additional spectrum emissions mask

When additional spectrum emission mask or masks apply, the additional SEM(s) shall be used to calculate the composite SEM described in 6.5B.2.2.1.

### 6.5B.2.2.3 Adjacent channel leakage ratio

For intra-band non-contiguous EN-DC, the EN-DC Adjacent Channel Leakage power Ratio (EN-DC<sub>ACLR</sub>) is the ratio of the sum of the filtered mean powers centred on the assigned E-UTRA and NR sub-block frequencies to the filtered mean power centred on an adjacent channel frequency at nominal channel spacing. In case the sub-block gap bandwidth  $W_{\text{gap}}$  is smaller than a E-UTRA or NR sub-block bandwidth, no EN-DC<sub>ACLR</sub> requirement is set for the corresponding sub-block for the gap. The assigned EN-DC sub-block power and adjacent channel power are measured with rectangular filters with measurement bandwidths specified in TS 36.101 [4] for the E-UTRA sub-block, and TS 38.101-1 [2], TS 38.101-2 [3] for the NR sub-block. If the measured adjacent channel power is greater than  $-50\text{dBm}$  then the EN-DC<sub>ACLR</sub> shall be higher than the value specified in for E-UTRA<sub>ACLR</sub> and NR<sub>ACLR</sub>.

## 6.5B.2.3 Inter-band EN-DC within FR1

Unless otherwise stated, the OOB requirements specified in clause 6.6.2.1 of TS 36.101 [4], sub-clause 6.6.2 of TS 36.101 [4] and clause 6.5.2 of TS 38.101-1 [2] apply for each component carrier.

The requirements apply to each antenna connector.

### 6.5B.2.3a Inter-band NE-DC within FR1

Unless otherwise stated, the OOB requirements specified in clause 6.6.2.1 of TS 36.101 [4], sub-clause 6.6.2 of TS 36.101 [4] and clause 6.5.2 of TS 38.101-1 [2] apply for each component carrier.

The requirements apply to each antenna connector.

## 6.5B.2.4 Inter-band EN-DC including FR2

Unless otherwise stated, out-of-band emissions requirement for E-UTRA single carrier and CA operation specified in clauses 6.6.2 of TS 36.101 [4] and for NR single carrier and CA operation specified in clause 6.5.2, 6.5A.2 and 6.5D.2 of TS 38.101-2 [3] apply.

## 6.5B.2.5 Inter-band EN-DC including both FR1 and FR2

Unless otherwise stated, out-of-band emissions requirement for E-UTRA single carrier and CA operation specified in clauses 6.6.2 of TS 36.101 [4] and for NR single carrier and CA operation specified in clause 6.5.2 of TS 38.101-1 [2] and clause 6.5.2, 6.5A.2 and 6.5D.2 of TS 38.101-2 [3] apply.

## 6.5B.3 Spurious emissions for DC

### 6.5B.3.1 Intra-band contiguous EN-DC

#### 6.5B.3.1.1 General spurious emissions

The general spurious emissions requirements specified in clause 6.6.3.1 of TS 36.101 [4] and clause 6.5.3.1 of TS 38.101-1 [2] apply beyond any frequencies for which the out-of-band emissions requirements in clause 6.5B.2.1 apply.

#### 6.5B.3.1.2 Spurious emission band UE co-existence

The requirements in Table 6.5B.3.1.2-1 apply on each component carrier with all component carriers are active.

**Table 6.5B.3.1.2-1: Requirements for intra-band contiguous EN-DC**

EN-DC Configuration	Spurious emission						
	Protected band	Frequency range (MHz)		Maximum Level (dBm)	MBW (MHz)	NOTE	
DC_(n)71	E-UTRA Band 4, 5, 12, 13, 14, 17, 24, 26, 30, 48, 66	F <sub>DL_low</sub>	-	F <sub>DL_high</sub>	-50	1	
	E-UTRA Band 2, 25, 41, 70, NR Band n77	F <sub>DL_low</sub>	-	F <sub>DL_high</sub>	-50	1	2
	E-UTRA Band 29	F <sub>DL_low</sub>	-	F <sub>DL_high</sub>	-38	1	3
	E-UTRA Band 71	F <sub>DL_low</sub>	-	F <sub>DL_high</sub>	-50	1	3
DC_(n)41	E-UTRA Band 1, 2, 3, 4, 5, 8, 10, 12, 13, 14, 17, 24, 25, 26, 27, 28, 29, 30, 34, 39, 42, 44, 45, 48, 50, 51, 66, 70, 71, 73, 74 NR Band n77, n78	F <sub>DL_low</sub>	-	F <sub>DL_high</sub>	-50	1	
	NR Band n79	F <sub>DL_low</sub>	-	F <sub>DL_high</sub>	-50	1	2
	NOTE 1: F <sub>DL_low</sub> and F <sub>DL_high</sub> refer to each E-UTRA frequency band specified in Table 5.5-1						
NOTE 2: As exceptions, measurements with a level up to the applicable requirements defined in Table 6.6.3.1-2 are permitted for each assigned E-UTRA carrier used in the measurement due to 2 <sup>nd</sup> , 3 <sup>rd</sup> , 4 <sup>th</sup> or 5 <sup>th</sup> harmonic spurious emissions. Due to spreading of the harmonic emission the exception is also allowed for the first 1 MHz frequency range immediately outside the harmonic emission on both sides of the harmonic emission. This results in an overall exception interval centred at the harmonic emission of (2 MHz + N x L <sub>CRB</sub> x 180 kHz), where N is 2, 3, 4, 5 for the 2 <sup>nd</sup> , 3 <sup>rd</sup> , 4 <sup>th</sup> or 5 <sup>th</sup> harmonic respectively. The exception is allowed if the measurement bandwidth (MBW) totally or partially overlaps the overall exception interval							
NOTE 3: These requirements also apply for the frequency ranges that are less than F <sub>OOB</sub> (MHz) in Table 6.6.3.1-1 and Table 6.6.3.1A-1 [4] from the edge of the channel bandwidth.							

NOTE: To simplify the above Table, E-UTRA band numbers are listed for bands which are specified only for E-UTRA operation or both E-UTRA and NR operation. NR band numbers are listed for bands which are specified only for NR operation.

### 6.5B.3.2 Intra-band non-contiguous EN-DC

#### 6.5B.3.2.1 General spurious emissions

The general spurious emissions requirements specified in clause 6.6.3.1 of TS 36.101 [4] and clause 6.5.3.1 of TS 38.101-1 [2] apply beyond any frequencies for which the out-of-band emissions requirements in clause 6.5B.2.2 apply. If for some frequency an individual CC spurious emission requirement overlaps with the general spectrum emission mask or the bandwidth of another CC then it does not apply.

## 6.5B.3.2.2 Spurious emission band UE co-existence

The requirements in Table 6.5B.3.2.2-1 apply with all component carriers are active.

**Table 6.5B.3.2.2-1: Requirements for intra-band non-contiguous EN-DC**

EN-DC Configuration	Spurious emission						
	Protected band	Frequency range (MHz)		Maximum Level (dBm)	MBW (MHz)	NOTE	
DC_3_n3	E-UTRA Band 1, 5, 7, 8, 20, 26, 27, 28, 31, 32, 33, 34, 38, 39, 40, 41, 43, 44, 45, 50, 51, 65, 67, 68, 69, 72, 73,74, 75, 76. NR Band n79	F <sub>DL_low</sub>	-	F <sub>DL_high</sub>	-50	1	
	E-UTRA Band 3	F <sub>DL_low</sub>	-	F <sub>DL_high</sub>	-50	1	3
	E-UTRA Band 11, 18, 19, 21	F <sub>DL_low</sub>	-	F <sub>DL_high</sub>	-50	1	4
	E-UTRA Band 22, 42, 52, NR Band n77, n78	F <sub>DL_low</sub>	-	F <sub>DL_high</sub>	-50	1	2
	Frequency range	1884.5	-	1915.7	-41	0.3	4
DC_41_n41	E-UTRA Band 1, 2, 3, 4, 5, 8, 10, 12, 13, 14, 17, 24, 25, 26, 27, 28, 29, 34, 39, 42, 44, 45, 48, 50, 51, 66, 70, 71, 73, 74 NR Band n77, n78 and n79	F <sub>DL_low</sub>	-	F <sub>DL_high</sub>	-50	1	
	E-UTRA Band 30	F <sub>DL_low</sub>	-	F <sub>DL_high</sub>	-40	1	
NOTE 1: F <sub>DL_low</sub> and F <sub>DL_high</sub> refer to each E-UTRA frequency band specified in Table 5.5-1							
NOTE 2: As exceptions, measurements with a level up to the applicable requirements defined in Table 6.6.3.1-2 are permitted for each assigned E-UTRA carrier used in the measurement due to 2 <sup>nd</sup> , 3 <sup>rd</sup> , 4 <sup>th</sup> or 5 <sup>th</sup> harmonic spurious emissions. Due to spreading of the harmonic emission the exception is also allowed for the first 1 MHz frequency range immediately outside the harmonic emission on both sides of the harmonic emission. This results in an overall exception interval centred at the harmonic emission of (2MHz + N x L <sub>CRB</sub> x 180kHz), where N is 2, 3, 4, 5 for the 2 <sup>nd</sup> , 3 <sup>rd</sup> , 4 <sup>th</sup> or 5 <sup>th</sup> harmonic respectively. The exception is allowed if the measurement bandwidth (MBW) totally or partially overlaps the overall exception interval							
NOTE 3: These requirements also apply for the frequency ranges that are less than F <sub>OOB</sub> (MHz) in Table 6.6.3.1-1 and Table 6.6.3.1A-1 from the edge of the channel bandwidth.							
NOTE 4: This requirement applies for 5, 10, 15 and 20 MHz E-UTRA channel bandwidth allocated within 1744.9MHz and 1784.9MHz.							

NOTE: To simplify the above Table, E-UTRA band numbers are listed for bands which are specified only for E-UTRA operation or both E-UTRA and NR operation. NR band numbers are listed for bands which are specified only for NR operation.

## 6.5B.3.3 Inter-band EN-DC within FR1

## 6.5B.3.3.1 General spurious emissions

The general spurious emissions requirements specified in clause 6.6.3.1 of TS 36.101 [4], clause 6.5.3.1 of TS 38.101-1 [2] and TS 38.101-2 [3] apply for each component carrier. For the case of inter-band EN-DC with a single carrier per cell group, the general spurious emissions requirements also apply with both downlink carrier and both both uplink carriers active. Limits on configured maximum output power for the uplink according to clause 6.2B.4 apply.

NOTE: The general spurious emission requirements with both uplink carriers active are allowed to be verified for only a single inter-band EN-DC configuration per NR band. Furthermore, the requirements are allowed to be verified by measuring spurious emissions at the specific frequencies where second and third order intermodulation products generated by the two transmitted carriers can occur.

**Table 6.5B.3.3.1-1: (Void)**

### 6.5B.3.3.2 Spurious emission band UE co-existence

This clause specifies the requirements for the specified EN-DC, for coexistence with protected bands. The requirements in Table 6.5B.3.3.2-1 apply on each component carrier with all component carriers are active.

NOTE: For inter-band EN-DC with uplink assigned to one LTE band and one NR band the requirements in Table 6.5B.3.3.2-1 could be verified by measuring spurious emissions at the specific frequencies where second and third order intermodulation products generated by the two transmitted carriers can occur;

**Table 6.5B.3.3.2-1: Requirements**



EN-DC Configuration	Spurious emission							
	Protected band	Frequency range (MHz)		Maximum Level (dBm)	MBW (MHz)	NOTE		
DC_1_n3	E-UTRA Band 1, 5, 7, 8, 11, 18, 19, 20, 21, 26, 27, 28, 31, 32, 38, 40, 41, 43, 44, 50, 51, 65, 67, 72, 73, 74, 75, 76	F <sub>DL_low</sub>	-	F <sub>DL_high</sub>	-50	1		
	E-UTRA band 3, 34	F <sub>DL_low</sub>	-	F <sub>DL_high</sub>	-50	1	5	
	E-UTRA band 22, 42, 52	F <sub>DL_low</sub>	-	F <sub>DL_high</sub>	-50	1	2	
	Frequency range	1884.5	-	1915.7	-41	0.3	16	
	Frequency range	1880	-	1895	-40	1	5,17	
	Frequency range	1895	-	1915	-15.5	5	5, 7, 17	
DC_1_n5	E-UTRA Band 1, 5, 7, 8, 22, 26, 28, 31, 38, 40, 42, 43, 50, 51, 65, 73, 74 NR Band n77, n78, n79	F <sub>DL_low</sub>	-	F <sub>DL_high</sub>	-50	1		
	E-UTRA band 3,34	F <sub>DL_low</sub>	-	F <sub>DL_high</sub>	-50	1	5	
	E-UTRA band 41, 52	F <sub>DL_low</sub>	-	F <sub>DL_high</sub>	-50	1	2	
	DC_1_n7	E-UTRA Band 1, 5, 7, 8, 20, 22, 26, 27, 28, 31,32, 40, 42, 43, 50, 51, 52, 65, 67, 72, 74, 75, 76 NR Band n78, n79	F <sub>DL_low</sub>	-	F <sub>DL_high</sub>	-50	1	
		band n77	F <sub>DL_low</sub>	-	F <sub>DL_high</sub>	-50	1	2
band 3, 34		F <sub>DL_low</sub>	-	F <sub>DL_high</sub>	-50	1	5	
Frequency range		1880	-	1895	-40	1	5,16	
Frequency range		1895	-	1915	-15.5	5	5, 7, 16	
Frequency range		1915	-	1920	+1.6	5	5, 7, 16	
Frequency range		2570	-	2575	+1.6	5	5, 6, 7	
Frequency range	2575	-	2595	-15.5	5	5, 6, 7		
DC_1_n8	Frequency range	2595	-	2620	-40	1	5, 6	
	E-UTRA Band 20, 28, 31, 32, 38, 40, 45, 50, 51, 65, 67, 68, 69, 72, 73, 74, 75, 76	F <sub>DL_low</sub>	-	F <sub>DL_high</sub>	-50	1		
	E-UTRA band 3, 7, 22, 41, 42, 43, 52 NR Band n77, n78, n79	F <sub>DL_low</sub>	-	F <sub>DL_high</sub>	-50	1	2	
	E-UTRA Band 1, 8, 34	F <sub>DL_low</sub>	-	F <sub>DL_high</sub>	-50	1	5	
	E-UTRA band 11, 21	F <sub>DL_low</sub>	-	F <sub>DL_high</sub>	-50	1	12	
	Frequency range	860	-	890	-40	1	5, 12	
	Frequency range	1884.5	-	1915.7	-41	0.3	12, 15	
	Frequency range	1880	-	1895	-40	1	5, 16	
	Frequency range	1895	-	1915	-15.5	5	5, 7, 16	
Frequency range	1915	-	1920	+1.6	5	5, 7, 16		
DC_1_n20	E-UTRA Band 1, 3, 7, 8, 22, 31, 32, 33, 40, 43, 50, 51, 65, 67, 68, 72, 74, 75, 76	F <sub>DL_low</sub>	-	F <sub>DL_high</sub>	-50	1		
	E-UTRA Band 38, 42, 69 NR Band n77, n78	F <sub>DL_low</sub>	-	F <sub>DL_high</sub>	-50	1	2	
	E-UTRA Band 20, 34	F <sub>DL_low</sub>	-	F <sub>DL_high</sub>	-50	1	5	
	Frequency range	758	-	788	-50	1		
DC_1_n28	E-UTRA Band 5, 7, 8, 18, 19, 20, 26, 27, 31, 32, 38, 40, 41, 50, 51, 72, 74	F <sub>DL_low</sub>	-	F <sub>DL_high</sub>	-50	1		
	E-UTRA Band 42, 43, 75, 76 NR band n78	F <sub>DL_low</sub>	-	F <sub>DL_high</sub>	-50	1	2	
	E-UTRA band 3, 34	F <sub>DL_low</sub>	-	F <sub>DL_high</sub>	-50	1	5	
	E-UTRA Band 11, 21	F <sub>DL_low</sub>	-	F <sub>DL_high</sub>	-50	1	9, 11	
	E-UTRA Band 1, 65	F <sub>DL_low</sub>	-	F <sub>DL_high</sub>	-50	1	9, 10	
	Frequency range	470	-	694	-42	8	5, 17	
	Frequency range	470	-	710	-26.2	6	14	
	Frequency range	758	-	773	-32	1	5	
	Frequency range	773	-	803	-50	1		
	Frequency range	662	-	694	-26.2	6	5	
	Frequency range	1880	-	1895	-40	1	5,16	
	Frequency range	1895	-	1915	-15.5	5	5, 7, 16	
	Frequency range	1915	-	1920	+1.6	5	5, 7, 16	
	Frequency range	1839.9	-	1879.9	-50	1	5	
Frequency range	1884.5	-	1915.7	-41	0.3	9, 15		
DC_1_n38	E-UTRA Band 1, 3, 5, 8, 20, 22, 27, 28, 31, 32, 33, 34, 40, 42, 43, 50, 51, 65, 67, 68, 72, 74, 75, 76	F <sub>DL_low</sub>	-	F <sub>DL_high</sub>	-50	1		

EN-DC Configuration	Spurious emission						
	Protected band	Frequency range (MHz)		Maximum Level (dBm)	MBW (MHz)	NOTE	
DC_1_n40	E-UTRA Band 1, 5, 7, 8, 11, 18, 19, 20, 21, 22, 26, 27, 28, 31, 32, 38, 41, 42, 43, 44, 45, 50, 51, 52, 65, 67, 68, 69, 72, 73, 74, 75, 76	F <sub>DL_low</sub>	-	F <sub>DL_high</sub>	-50	1	
	Band 3, 34	F <sub>DL_low</sub>	-	F <sub>DL_high</sub>	-50	1	5
	Frequency range	1880	-	1895	-40	1	5, 17
	Frequency range	1895	-	1915	-15.5	5	5, 7, 17
	Frequency range	1915	-	1920	+1.6	5	5, 7, 17
DC_1_n41	E-UTRA Band 3, 4, 5, 8, 12, 13, 14, 17, 19, 20, 21, 24, 26, 27, 28, 29, 30, 31, 32, 40, 42, 43, 44, 45, 50, 51, 52, 66, 67, 68, 71, 72, 73, 75, 76, 85 NR Band n78	F <sub>DL_low</sub>	-	F <sub>DL_high</sub>	-50	1	
	E-UTRA Band 34	F <sub>DL_low</sub>	-	F <sub>DL_high</sub>	-50	1	5
	NR Band n77, n79	F <sub>DL_low</sub>	-	F <sub>DL_high</sub>	-50	1	2
	Frequency range	1880	-	1895	-40	1	5, 8
	Frequency range	1895	-	1915	-15.5	5	5, 7, 8
	Frequency range	1915	-	1920	+1.6	5	5, 7, 8, 20
	E-UTRA Band 9, 11, 18, 19, 21, 74	F <sub>DL_low</sub>	-	F <sub>DL_high</sub>	-50	1	20
Frequency range	1884.5	-	1915.7	-41	0.3	3, 20	
DC_1A_n50A	E-UTRA Band 3, 4, 5, 7, 8, 12, 13, 17, 18, 19, 20, 26, 27, 28, 29, 31, 38, 40, 41, 42, 43, 44, 48, 52, 66, 67, 68, 69, 72, 73, 85 NR Band n78, n79	F <sub>DL_low</sub>	-	F <sub>DL_high</sub>	-50	1	
	E-UTRA Band 34	F <sub>DL_low</sub>	-	F <sub>DL_high</sub>	-50	1	5
	NR Band n77	F <sub>DL_low</sub>	-	F <sub>DL_high</sub>	-50	1	2
	Frequency range	1880	-	1895	-40	1	5, 16
	Frequency range	1895	-	1915	-15.5	5	5, 7, 16
	Frequency range	1915	-	1920	+1.6	5	5, 7, 16
	Frequency range	1400	-	1427	-32	27	
DC_1_n51	E-UTRA Band 7, 12, 13, 17, 20, 22, 27, 28, 29, 31, 38, 44, 48, 67, 68, 69, 72, 73	F <sub>DL_low</sub>	-	F <sub>DL_high</sub>	-50	1	
	E-UTRA Band 3, 34	F <sub>DL_low</sub>	-	F <sub>DL_high</sub>	-50	1	5, 2
	Frequency range	1880	-	1895	-40	1	5, 16
	Frequency range	1895	-	1915	-15.5	5	5, 7, 16
	Frequency range	1915	-	1920	+1.6	5	5, 7, 16
DC_1_n71	E-UTRA Band 1, 5, 26,	F <sub>DL_low</sub>	-	F <sub>DL_high</sub>	-50	1	
	E-UTRA Band 41	F <sub>DL_low</sub>	-	F <sub>DL_high</sub>	-50	1	2
	E-UTRA Band 71	F <sub>DL_low</sub>	-	F <sub>DL_high</sub>	-50	1	5
DC_1_n77 DC_1_n84_ULSUP -TDM_n77	E-UTRA Band 1, 3, 5, 7, 8, 11, 18, 19, 20, 21, 26, 28, 34, 40, 41, 65	F <sub>DL_low</sub>	-	F <sub>DL_high</sub>	-50	1	
	Frequency range	1880	-	1895	-40	1	5, 8
	Frequency range	1895	-	1915	-15.5	5	5, 7, 8
DC_1_n78 DC_1_n84_ULSUP -TDM_n78	E-UTRA Band 1, 3, 5, 7, 8, 11, 18, 19, 20, 21, 26, 28, 34, 40, 41, 65	F <sub>DL_low</sub>	-	F <sub>DL_high</sub>	-50	1	
	Frequency range	1880	-	1895	-40	1	5, 8
	Frequency range	1895	-	1915	-15.5	5	5, 7, 8
DC_1_n79 DC_1_n84_ULSUP -TDM_n79	E-UTRA Band 1, 3, 5, 7, 8, 11, 18, 19, 21, 26, 28, 34, 40, 41, 42, 65	F <sub>DL_low</sub>	-	F <sub>DL_high</sub>	-50	1	
	Frequency range	1880	-	1895	-40	1	5, 8
	Frequency range	1895	-	1915	-15.5	5	5, 7, 8
DC_1_n80	E-UTRA Band 1, 5, 7, 8, 11, 18, 19, 20, 21, 26, 27, 28, 31, 32, 38, 40, 41, 43, 44, 45, 50, 51, 65, 67, 68, 69, 72, 73, 74, 75, 76, NR Band n79	F <sub>DL_low</sub>	-	F <sub>DL_high</sub>	-50	1	
	E-UTRA Band 3, 34	F <sub>DL_low</sub>	-	F <sub>DL_high</sub>	-50	1	5
	E-UTRA Band 22, 42, NR Band n77, n78	F <sub>DL_low</sub>	-	F <sub>DL_high</sub>	-50	1	2
	Frequency range	1884.5	-	1915.7	-41	0.3	13

EN-DC Configuration	Spurious emission						
	Protected band	Frequency range (MHz)		Maximum Level (dBm)	MBW (MHz)	NOTE	
DC_2_n5	E-UTRA Band 4, 5, 10, 12, 13, 14, 17, 24, 26, 28, 29, 30, 42, 48, 50, 51, 66, 70, 71, 74, 85, NR Band n77	F <sub>DL_low</sub>	-	F <sub>DL_high</sub>	-50	1	
	E-UTRA Band 2, 25, 48	F <sub>DL_low</sub>	-	F <sub>DL_high</sub>	-50	1	2
	E-UTRA Band 41, 43	F <sub>DL_low</sub>	-	F <sub>DL_high</sub>	-50	1	
DC_2_n7	E-UTRA Band 2, 4, 5, 7, 10, 12, 13, 14, 17, 26, 27, 28, 29, 30, 42, 50, 51, 66, 74, 85	F <sub>DL_low</sub>	-	F <sub>DL_high</sub>	-50	1	
	E-UTRA Band 43	F <sub>DL_low</sub>	-	F <sub>DL_high</sub>	-50	1	2
	Frequency range	2570	-	2575	1.6	5	5, 6, 7
	Frequency range	2575	-	2595	-15.5	5	5, 6, 7
	Frequency range	2595	-	2620	-40	1	5, 6
DC_2_n12	E-UTRA Band 5, 13, 14, 17, 24, 26, 27, 30, 41, 50, 53, 71, 74	F <sub>DL_low</sub>	-	F <sub>DL_high</sub>	-50	1	
	E-UTRA Band 25, 85 NR band n12	F <sub>DL_low</sub>	-	F <sub>DL_high</sub>	-50	1	3
	E-UTRA Band 2	F <sub>DL_low</sub>	-	F <sub>DL_high</sub>	-50	1	5
	E-UTRA Band 4, 10, 51, 66, 70, NR Band n77	F <sub>DL_low</sub>	-	F <sub>DL_high</sub>	-50	1	2
DC_2_n38	E-UTRA Band 4, 5, 10, 12, 13, 14, 17, 27, 28, 29, 30, 42, 50, 51, 66, 74, 85	F <sub>DL_low</sub>	-	F <sub>DL_high</sub>	-50	1	
	E-UTRA Band 2	F <sub>DL_low</sub>	-	F <sub>DL_high</sub>	-50	1	5
	E-UTRA Band 43	F <sub>DL_low</sub>	-	F <sub>DL_high</sub>	-50	1	2
DC_2_n41	E-UTRA Band 4, 5, 10, 12, 13, 14, 17, 24, 26, 27, 28, 29, 30, 42, 48, 50, 51, 53, 66, 70, 71, 74, 85	F <sub>DL_low</sub>	-	F <sub>DL_high</sub>	-50	1	
	E-UTRA Band 2, 25	F <sub>DL_low</sub>	-	F <sub>DL_high</sub>	-50	1	5
	E-UTRA Band 43, NR Band n77	F <sub>DL_low</sub>	-	F <sub>DL_high</sub>	-50	1	2
DC_2A_n48A	E-UTRA Band 4, 5, 12, 13, 14, 17, 24, 26, 29, 30, 41, 50, 51, 66, 70, 71, 74, 85	F <sub>DL_low</sub>	-	F <sub>DL_high</sub>	-50	1	
	E-UTRA Band 2, 25	F <sub>DL_low</sub>	-	F <sub>DL_high</sub>	-50	1	5
DC_2_n66	E-UTRA Band 4, 5, 10, 12, 13, 14, 17, 24, 26, 27, 28, 29, 30, 41, 50, 51, 66, 70, 71, 74, 85	F <sub>DL_low</sub>	-	F <sub>DL_high</sub>	-50	1	
	E-UTRA Band 2, 25	F <sub>DL_low</sub>	-	F <sub>DL_high</sub>	-50	1	5
	E-UTRA Band 42, 48, NR Band n77	F <sub>DL_low</sub>	-	F <sub>DL_high</sub>	-50	1	2
DC_2_n71	E-UTRA Band 4, 5, 12, 13, 14, 17, 24, 26, 29, 30, 48, 66	F <sub>DL_low</sub>	-	F <sub>DL_high</sub>	-50	1	
	E-UTRA Band 2, 25, 41, 70, NR Band n77	F <sub>DL_low</sub>	-	F <sub>DL_high</sub>	-50	1	2
	E-UTRA Band 71	F <sub>DL_low</sub>	-	F <sub>DL_high</sub>	-50	1	5
DC_2_n78	E-UTRA Band 4, 5, 10, 12, 13, 14, 17, 24, 26, 27, 28, 29, 30, 41, 50, 51, 66, 70, 71, 74, 85	F <sub>DL_low</sub>	-	F <sub>DL_high</sub>	-50	1	
	E-UTRA Band 2, 25	F <sub>DL_low</sub>	-	F <sub>DL_high</sub>	-50	1	2
DC_3_n1	E-UTRA Band 1, 5, 7, 8, 11, 18, 19, 20, 21, 26, 27, 28, 31, 32, 38, 40, 41, 43, 44, 50, 51, 65, 67, 72, 73, 74, 75, 76	F <sub>DL_low</sub>	-	F <sub>DL_high</sub>	-50	1	
	E-UTRA band 3, 34	F <sub>DL_low</sub>	-	F <sub>DL_high</sub>	-50	1	5
	E-UTRA band 22, 42, 52	F <sub>DL_low</sub>	-	F <sub>DL_high</sub>	-50	1	2
	Frequency range	1884.5	-	1915.7	-41	0.3	16
	Frequency range	1880	-	1895	-40	1	5, 17
	Frequency range	1895	-	1915	-15.5	5	5, 7, 17
	Frequency range	1915	-	1920	+1.6	5	5, 7, 17
DC_3_n5	E-UTRA Band 1, 5, 7, 8, 22, 26, 28, 31, 38, 40, 42, 43, 50, 51, 65, 73, 74	F <sub>DL_low</sub>	-	F <sub>DL_high</sub>	-50	1	
	E-UTRA band 3, 34	F <sub>DL_low</sub>	-	F <sub>DL_high</sub>	-50	1	5
	E-UTRA Band 52	F <sub>DL_low</sub>	-	F <sub>DL_high</sub>	-50	1	2
DC_3_n7	E-UTRA Band 1, 5, 7, 8, 20, 26, 27, 28, 31, 32, 33, 34, 40, 43, 44, 50, 51, 65, 67, 72, 74, 75, 76	F <sub>DL_low</sub>	-	F <sub>DL_high</sub>	-50	1	
	E-UTRA band 3	F <sub>DL_low</sub>	-	F <sub>DL_high</sub>	-50	1	5
	E-UTRA band 22, 42	F <sub>DL_low</sub>	-	F <sub>DL_high</sub>	-50	1	2

EN-DC Configuration	Spurious emission						
	Protected band	Frequency range (MHz)			Maximum Level (dBm)	MBW (MHz)	NOTE
	Frequency range	2570	-	2575	+1.6	5	5, 6, 7
	Frequency range	2575	-	2595	-15.5	5	5, 6, 7
	Frequency range	2595	-	2620	-40	1	5, 6
DC_3_n8	E-UTRA Band 1, 20, 28, 31, 32, 33, 34, 38, 39, 40, 45, 50, 51, 65, 67, 68, 69, 72, 73, 74, 75, 76	F <sub>DL_low</sub>	-	F <sub>DL_high</sub>	-50	1	
	E-UTRA band 3, 8	F <sub>DL_low</sub>	-	F <sub>DL_high</sub>	-50	1	2, 5
	E-UTRA band 11, 21	F <sub>DL_low</sub>	-	F <sub>DL_high</sub>	-50	1	12
	E-UTRA band 7, 22, 41, 42, 43, 52 NR Band n77, n78, n79	F <sub>DL_low</sub>	-	F <sub>DL_high</sub>	-50	1	2
	Frequency range	1884.5	-	1915.7	-41	0.3	3.12
	Frequency range	860	-	890	-40	1	5, 12
DC_3_n20	E-UTRA Band 1, 7, 8, 31, 32, 33, 34, 40, 43, 50, 51, 65, 67, 72, 74, 75, 76	F <sub>DL_low</sub>	-	F <sub>DL_high</sub>	-50	1	
	E-UTRA Band 3 NR band n20	F <sub>DL_low</sub>	-	F <sub>DL_high</sub>	-50	1	5
	E-UTRA Band 22, 38, 42, 52	F <sub>DL_low</sub>	-	F <sub>DL_high</sub>	-50	1	2
	Frequency range	758	-	788	-50	1	
DC_3_n28	E-UTRA Band 1, 42, 43, 50, 51, 65, 74, 75, 76 NR band n78	F <sub>DL_low</sub>	-	F <sub>DL_high</sub>	-50	1	2
	E-UTRA band 1	F <sub>DL_low</sub>	-	F <sub>DL_high</sub>	-50	1	9, 10
	E-UTRA band 3	F <sub>DL_low</sub>	-	F <sub>DL_high</sub>	-50	1	5
	E-UTRA Band 5, 7, 8, 20, 26, 27, 31, 34, 38, 40, 41, 72	F <sub>DL_low</sub>	-	F <sub>DL_high</sub>	-50	1	
	E-UTRA Band 11, 18, 19, 21	F <sub>DL_low</sub>	-	F <sub>DL_high</sub>	-50	1	13
	Frequency range	1884.5	-	1915.7	-41	0.3	13
	Frequency range	470	-	710	-26.2	6	14
	Frequency range	758	-	773	-32	1	5
	Frequency range	773	-	803	-50	1	
Frequency range	1884.5	-	1915.7	-41	0.3	3, 9	
DC_3_n34	E-UTRA Band 1, 7, 8, 11, 18, 19, 20, 21, 26, 28, 31, 32, 33, 38, 39, 40, 41, 43, 44, 45, 50, 51, 65, 67, 69, 72, 73, 74, 75, 76, 79	F <sub>DL_low</sub>	-	F <sub>DL_high</sub>	-50	1	
	E-UTRA Band 22, 42, 52 NR Band n78	F <sub>DL_low</sub>	-	F <sub>DL_high</sub>	-50	1	2
	E-UTRA Band 3	F <sub>DL_low</sub>	-	F <sub>DL_high</sub>	-50	1	5
	Frequency range	1884.5	-	1915.7	-41	0.3	3
DC_3_n38	E-UTRA Band 1, 5, 8, 20, 27, 28, 31, 32, 33, 34, 40, 42, 43, 50, 51, 65, 67, 68, 72, 74, 75, 76	F <sub>DL_low</sub>	-	F <sub>DL_high</sub>	-50	1	
	E-UTRA Band 22, 42	F <sub>DL_low</sub>	-	F <sub>DL_high</sub>	-50	1	2
DC_3_n40	E-UTRA Band 1, 5, 7, 8, 20, 26, 27, 28, 31, 32, 33, 34, 38, 39, 41, 43, 44, 45, 50, 51, 65, 67, 68, 69, 72, 73, 75, 76	F <sub>DL_low</sub>	-	F <sub>DL_high</sub>	-50	1	
	E-UTRA Band 3	F <sub>DL_low</sub>	-	F <sub>DL_high</sub>	-50	1	5
	E-UTRA Band 22, 42, 52	F <sub>DL_low</sub>	-	F <sub>DL_high</sub>	-50	1	2
	Frequency range	1884.5	-	1915.7	-41	0.3	3
DC_3_n41	E-UTRA Band 1, 5, 8, 20, 26, 27, 28, 34, 39, 40, 44, 45, 50, 51, 65, 73, 74	F <sub>DL_low</sub>	-	F <sub>DL_high</sub>	-50	1	
	E-UTRA Band 3	F <sub>DL_low</sub>	-	F <sub>DL_high</sub>	-50	1	5
	E-UTRA Band 11, 18, 19, 21	F <sub>DL_low</sub>	-	F <sub>DL_high</sub>	-50	1	14, 20
	E-UTRA Band 42, NR Band n77, n78, n79	F <sub>DL_low</sub>	-	F <sub>DL_high</sub>	-50	1	2
	Frequency range	1884.5	-	1915.7	-41	0.3	3, 20
DC_3_n41, DC_3_n80_ULSUP -TDM_n41	E-UTRA Band 1, 5, 8, 26, 27, 28, 34, 39, 40, 44, 45, 50, 51, 65, 73, 74	F <sub>DL_low</sub>	-	F <sub>DL_high</sub>	-50	1	
	E-UTRA Band 11, 18, 19, 21	F <sub>DL_low</sub>	-	F <sub>DL_high</sub>	-50	1	
	Frequency range	1884.5	-	1915.7	-41	0.3	3
DC_3A_n50A	E-UTRA Band 5, 7, 8, 12, 13, 17, 18, 19, 20, 26, 27, 28, 29, 31, 32, 38, 40, 41, 43, 44, 48, 52, 67, 68, 69, 72, 73	F <sub>DL_low</sub>	-	F <sub>DL_high</sub>	-50	1	
	E-UTRA Band 1, 2, 4, 33, 34, 39, 42, 65, 66 NR Band n77, n78, n79	F <sub>DL_low</sub>	-	F <sub>DL_high</sub>	-50	1	2
	Frequency range	1884.5	-	1915.7	-41	0.3	
	Frequency range	1400	-	1427	-42	27	

EN-DC Configuration	Spurious emission						
	Protected band	Frequency range (MHz)			Maximum Level (dBm)	MBW (MHz)	NOTE
DC_3_n51	E-UTRA Band 7, 8, 12, 13, 17, 20, 27, 28, 31, 33, 38, 48, 67, 68, 69, 72, 73	F <sub>DL_low</sub>	-	F <sub>DL_high</sub>	-50	1	
	E-UTRA Band 3	F <sub>DL_low</sub>	-	F <sub>DL_high</sub>	-50	1	5
	E-UTRA Band 1, 5, 6, 22, 26, 30, 34, 36, 40, 41, 42, 43, 44, 46, 65, 71	F <sub>DL_low</sub>	-	F <sub>DL_high</sub>	-50	1	2
DC_3_n71	E-UTRA Band 5, 26,	F <sub>DL_low</sub>	-	F <sub>DL_high</sub>	-50	1	
	E-UTRA Band 41	F <sub>DL_low</sub>	-	F <sub>DL_high</sub>	-50	1	2
	E-UTRA Band 3, 71	F <sub>DL_low</sub>	-	F <sub>DL_high</sub>	-50	1	5
DC_3_n77 DC_3_n80_ULSUP -TDM_n77	E-UTRA Band 1, 3, 5, 7, 8, 11, 18, 19, 20, 21, 26, 28, 34, 39, 40, 41, 65	F <sub>DL_low</sub>	-	F <sub>DL_high</sub>	-50	1	
	Frequency range	1884.5	-	1915.7	-41	0.3	3
DC_3_n78 DC_3_n80_ULSUP -TDM_n78	E-UTRA Band 1, 3, 5, 7, 8, 11, 18, 19, 20, 21, 26, 28, 34, 39, 40, 41, 65	F <sub>DL_low</sub>	-	F <sub>DL_high</sub>	-50	1	
	Frequency range	1884.5	-	1915.7	-41	0.3	3
DC_3_n79 DC_3_n80_ULSUP -TDM_n79	E-UTRA Band 1, 3, 5, 8, 11, 18, 19, 21, 28, 34, 39, 40, 41, 65	F <sub>DL_low</sub>	-	F <sub>DL_high</sub>	-50	1	
	E-UTRA Band 42	F <sub>DL_low</sub>	-	F <sub>DL_high</sub>	-50	1	2
	Frequency range	1884.5	-	1915.7	-41	0.3	3
DC_3_n82	E-UTRA Band 1, 3, 7, 8, 20, 22, 31, 32, 33, 34, 38, 40, 43, 50, 51, 65, 67, 68, 69, 72, 74, 75, 76	F <sub>DL_low</sub>	-	F <sub>DL_high</sub>	-50	1	
	E-UTRA Band 42	F <sub>DL_low</sub>	-	F <sub>DL_high</sub>	-50	1	2
DC_3_n84	E-UTRA Band 1, 5, 7, 8, 11, 18, 19, 20, 21, 26, 27, 28, 31, 32, 38, 40, 41, 43, 44, 45, 50, 51, 65, 67, 68, 69, 72, 73, 74, 75, 76 NR Band n79	F <sub>DL_low</sub>	-	F <sub>DL_high</sub>	-50	1	
	E-UTRA Band 3	F <sub>DL_low</sub>	-	F <sub>DL_high</sub>	-50	1	5
	NR Band n77, n78	F <sub>DL_low</sub>	-	F <sub>DL_high</sub>	-50	1	2
DC_4_n38	E-UTRA Band 2, 4, 5, 10, 12, 13, 14, 17, 27, 28, 29, 30, 43, 50, 51, 66, 74, 85	F <sub>DL_low</sub>	-	F <sub>DL_high</sub>	-50	1	
	E-UTRA Band 42	F <sub>DL_low</sub>	-	F <sub>DL_high</sub>	-50	1	2
DC_4_n41	E-UTRA Band 2, 4, 5, 10, 12, 13, 14, 17, 24, 25, 26, 27, 28, 29, 30, 48, 50, 51, 66, 70, 71, 74, 85	F <sub>DL_low</sub>	-	F <sub>DL_high</sub>	-50	1	
	E-UTRA Band 42, NR Band n77	F <sub>DL_low</sub>	-	F <sub>DL_high</sub>	-50	1	2
DC_4_n78	E-UTRA Band 5, 7, 26, 28, 41	F <sub>DL_low</sub>	-	F <sub>DL_high</sub>	-50	1	
DC_5_n2	E-UTRA Band 4, 5, 10, 12, 13, 14, 17, 24, 28, 29, 30, 42, 50, 51, 53, 66, 70, 71, 74, 85	F <sub>DL_low</sub>	-	F <sub>DL_high</sub>	-50	1	
	E-UTRA Band 25	F <sub>DL_low</sub>	-	F <sub>DL_high</sub>	-50	1	5
	NR Band n2	F <sub>DL_low</sub>	-	F <sub>DL_high</sub>	-50	1	5
	E-UTRA Band 26	859	-	869	-27	1	
	E-UTRA Band 41, 43, NR Band n77	F <sub>DL_low</sub>	-	F <sub>DL_high</sub>	-50	1	2
DC_5_n7	E-UTRA Band 1, 2, 3, 4, 5, 7, 8, 10, 12, 13, 14, 17, 28, 29, 30, 31, 34, 40, 42, 43, 65, 66, 71, 85	F <sub>DL_low</sub>	-	F <sub>DL_high</sub>	-50	1	
	E-UTRA Band 52 NR Band n77, n78	F <sub>DL_low</sub>	-	F <sub>DL_high</sub>	-50	1	2
	E-UTRA band 26	859	-	869	-27	1	
	Frequency range	2570	-	2575	+1.6	5	5, 7, 6
	Frequency range	2575	-	2595	-15.5	5	5, 7, 6
	Frequency range	2595	-	2620	-40	1	5, 14
DC_5_n12	E-UTRA Band 2, 5, 12, 13, 14, 17, 24, 25, 26, 30, 42, 43, 50, 51, 71, 74	F <sub>DL_low</sub>	-	F <sub>DL_high</sub>	-50	1	
	E-UTRA Bands 4, 10, 41, 48, 66, 70, NR Band n77	F <sub>DL_low</sub>	-	F <sub>DL_high</sub>	-50	1	2
	E-UTRA Band 12, 85	F <sub>DL_low</sub>	-	F <sub>DL_high</sub>	-50	1	5
DC_5_n38	E-UTRA Band 1, 2, 3, 4, 5, 8, 10, 12, 13, 14, 17, 28, 29, 30, 31, 34, 40, 42, 43, 50, 51, 65, 66, 74, 85	F <sub>DL_low</sub>	-	F <sub>DL_high</sub>	-50	1	
	E-UTRA Band 52	F <sub>DL_low</sub>	-	F <sub>DL_high</sub>	-50	1	2
DC_5_n40	E-UTRA Band 1, 3, 5, 7, 8, 28, 31, 34, 38, 42, 43, 45, 65, 73	F <sub>DL_low</sub>	-	F <sub>DL_high</sub>	-50	1	
	E-UTRA Band 26	859	-	869	-27	1	

EN-DC Configuration	Spurious emission						
	Protected band	Frequency range (MHz)		Maximum Level (dBm)	MBW (MHz)	NOTE	
	E-UTRA Band 41, 52 Frequency range	F <sub>DL_low</sub> 1884.5	-	F <sub>DL_high</sub> 1915.7	-50 -41	1 0.3	3
DC_5A_n48A	E-UTRA Band 2, 4, 5, 12, 13, 14, 17, 24, 25, 26, 29, 30, 41, 50, 51, 66, 70, 71, 74, 85	F <sub>DL_low</sub>	-	F <sub>DL_high</sub>	-50	1	
	E-UTRA Band 26	859	-	869	-27	1	
	E-UTRA Band 41 Frequency range	F <sub>DL_low</sub> 1884.5	-	F <sub>DL_high</sub> 1915.7	-50 -41	1 0.3	2 3
DC_5_n66	E-UTRA Band 1, 2, 3, 4, 5, 6, 7, 8, 10, 12, 13, 14, 17, 24, 25, 28, 29, 30, 34, 38, 40, 43, 45, 50, 51, 65, 66, 70, 71, 85	F <sub>DL_low</sub>	-	F <sub>DL_high</sub>	-50	1	
	E-UTRA Band 26	859	-	869	-27	1	
	E-UTRA Band 41, 42, 48, 52, NR Band n77	F <sub>DL_low</sub>	-	F <sub>DL_high</sub>	-50	1	2
	E-UTRA Band 18, 19	F <sub>DL_low</sub>	-	F <sub>DL_high</sub>	-40	1	
	E-UTRA Band 11, 21 Frequency range	F <sub>DL_low</sub> 1884.5	-	F <sub>DL_high</sub> 1915.7	-50 -41	1 0.3	
							3
DC_5_n71	E-UTRA Band 4, 5, 12, 13, 14, 17, 24, 26, 30, 48, 66, 85	F <sub>DL_low</sub>	-	F <sub>DL_high</sub>	-50	1	
	E-UTRA Band 2, 25, 41, 70, NR Band n77	F <sub>DL_low</sub>	-	F <sub>DL_high</sub>	-50	1	2
	E-UTRA Band 29	F <sub>DL_low</sub>	-	F <sub>DL_high</sub>	-38	1	5
	E-UTRA Band 71	F <sub>DL_low</sub>	-	F <sub>DL_high</sub>	-50	1	5
DC_5_n78	E-UTRA Band 1, 2, 3, 4, 5, 7, 8, 10, 12, 13, 14, 17, 24, 25, 28, 29, 30, 31, 34, 38, 40, 45, 65, 66, 70	F <sub>DL_low</sub>	-	F <sub>DL_high</sub>	-50	1	
	E-UTRA Band 26	859	-	869	-27	1	
	Frequency range	945	-	960	-50	1	
	Frequency range	1884.5	-	1915.7	-41	0.3	3, 4
	Frequency range	2545	-	2575	-50	1	
	Frequency range	2595	-	2645	-50	1	
	E-UTRA Band 41	F <sub>DL_low</sub>	-	F <sub>DL_high</sub>	-50	1	7
	E-UTRA Band 18, 19	F <sub>DL_low</sub>	-	F <sub>DL_high</sub>	-40	1	4
E-UTRA Band 11, 21	F <sub>DL_low</sub>	-	F <sub>DL_high</sub>	-50	1	4	
DC_5_n79	Bands 1, 2, 3, 4, 5, 7, 8, 10, 12, 13, 14, 17, 24, 25, 28, 29, 30, 31, 34, 38, 40, 42, 43, 45, 48, 50, 51, 65, 66, 70, 71, 73, 74, 85	F <sub>DL_low</sub>	-	F <sub>DL_high</sub>	-50	1	
	E-UTRA Band 26	859	-	869	-27	1	
	Bands 41, 52, NR Band n77	F <sub>DL_low</sub>	-	F <sub>DL_high</sub>	-50	1	2
	E-UTRA Band 18, 19	F <sub>DL_low</sub>	-	F <sub>DL_high</sub>	-40	1	4
	E-UTRA Band 11, 21 Frequency range	F <sub>DL_low</sub> 1884.5	-	F <sub>DL_high</sub> 1915.7	-50 -41	1 0.3	4 3, 4
DC_7_n1	Band 1, 5, 7, 8, 20, 22, 26, 27, 28, 31, 32, 40, 42, 43, 50, 51, 52, 65, 67, 72, 74, 75, 76, n78, n79	F <sub>DL_low</sub>	-	F <sub>DL_high</sub>	-50	1	
	band n77	F <sub>DL_low</sub>	-	F <sub>DL_high</sub>	-50	1	2
	band 3, 34	F <sub>DL_low</sub>	-	F <sub>DL_high</sub>	-50	1	5
	Frequency range	1880		1895	-40	1	5, 16
	Frequency range	1895		1915	-15.5	5	5, 7, 16
	Frequency range	1915		1920	+1.6	5	5, 7, 16
	Frequency range	2570	-	2575	+1.6	5	5, 6, 7
	Frequency range	2575	-	2595	-15.5	5	5, 6, 7
Frequency range	2595	-	2620	-40	1	5, 6	
DC_7_n3	E-UTRA Band 1, 5, 7, 8, 20, 26, 27, 28, 31, 32, 33, 34, 40, 43, 50, 51, 65, 67, 68, 72, 74, 75, 76	F <sub>DL_low</sub>	-	F <sub>DL_high</sub>	-50	1	
	E-UTRA band 3	F <sub>DL_low</sub>	-	F <sub>DL_high</sub>	-50	1	5
	E-UTRA band 22, 42, 52 NR band n78, n77	F <sub>DL_low</sub>	-	F <sub>DL_high</sub>	-50	1	2
	Frequency range	2570	-	2575	+1.6	5	5, 6, 7
	Frequency range	2575	-	2595	-15.5	5	5, 6, 7
	Frequency range	2595	-	2620	-40	1	5, 6
DC_7_n5	E-UTRA Band 1, 2, 3, 4, 5, 7, 8, 10, 12, 13, 14, 17, 22, 26, 28, 29, 30, 31, 40, 42, 43, 50, 51, 65, 66, 74, 85	F <sub>DL_low</sub>	-	F <sub>DL_high</sub>	-50	1	

EN-DC Configuration	Spurious emission						
	Protected band	Frequency range (MHz)		Maximum Level (dBm)	MBW (MHz)	NOTE	
	E-UTRA Band 52 NR Band n77, n78	F <sub>DL_low</sub>	-	F <sub>DL_high</sub>	-50	1	2
	Frequency range	2570	-	2575	+1.6	5	5, 7, 6
	Frequency range	2575	-	2595	-15.5	5	5, 7, 6
	Frequency range	2595	-	2620	-40	1	5, 14
DC_7_n8	E-UTRA Band 1, 10, 20, 28, 31, 32, 33, 34, 40, 50, 51, 65, 67, 68, 72, 74, 75, 76	F <sub>DL_low</sub>	-	F <sub>DL_high</sub>	-50	1	
	E-UTRA band 3, 7, 22, 42, 43, 52 NR Band n77, n78	F <sub>DL_low</sub>	-	F <sub>DL_high</sub>	-50	1	2
	E-UTRA Band 8	F <sub>DL_low</sub>	-	F <sub>DL_high</sub>	-50	1	5
	Frequency range	2570	-	2575	+1.6	5	5, 6, 7
	Frequency range	2575	-	2595	-15.5	5	5, 6, 7
DC_7_n20	Frequency range	2595	-	2620	-40	1	5, 6
	E-UTRA Band 1, 3, 7, 8, 22, 31, 32, 33, 34, 40, 43, 50, 51, 65, 67, 68, 72, 74, 75, 76	F <sub>DL_low</sub>	-	F <sub>DL_high</sub>	-50	1	
DC_7_n28	E-UTRA Band 42, 52 NR band n78, n77	F <sub>DL_low</sub>	-	F <sub>DL_high</sub>	-50	1	2
	E-UTRA Band 20	F <sub>DL_low</sub>	-	F <sub>DL_high</sub>	-50	1	5
	E-UTRA Band 2, 3, 5, 7, 8, 20, 26, 27, 31, 34, 40, 72	F <sub>DL_low</sub>	-	F <sub>DL_high</sub>	-50	1	
DC_7_n40	E-UTRA Band 1, 4, 10, 42, 43, 50, 51, 65, 66, 74, 75, 76 NR band n78	F <sub>DL_low</sub>	-	F <sub>DL_high</sub>	-50	1	2
	E-UTRA band 1	F <sub>DL_low</sub>	-	F <sub>DL_high</sub>	-50	1	9, 10
	Frequency range	758	-	773	-32	1	5
	Frequency range	773	-	803	-50	1	
	Frequency range	2570	-	2575	+1.6	5	5, 6, 7
	Frequency range	2575	-	2595	-15.5	5	5, 6, 7
	Frequency range	2595	-	2620	-40	1	5, 6
DC_7_n51	E-UTRA Band 1, 3, 5, 7, 8, 20, 22, 26, 27, 28, 31, 32, 33, 34, 42, 43, 50, 51, 52, 65, 67, 68, 72, 74, 75, 76, 77, 78	F <sub>DL_low</sub>	-	F <sub>DL_high</sub>	-50	1	
	Frequency range	2570	-	2575	+1.6	5	5, 6, 7
	Frequency range	2575	-	2595	-15.5	5	5, 6, 7
	Frequency range	2595	-	2620	-40	1	5, 6
DC_7_n66	E-UTRA Band 2, 3, 5, 8, 26, 30, 31, 32, 33, 34, 40, 48, 72	F <sub>DL_low</sub>	-	F <sub>DL_high</sub>	-50	1	
	Frequency range	2570	-	2575	+1.6	5	5, 7, 16
	Frequency range	2575	-	2595	-15.5	5	5, 7, 16
	Frequency range	2595	-	2620	-40	1	5
DC_7_n71	E-UTRA Band 1, 4, 10, 12, 13, 14, 17, 20, 22, 23, 27, 28, 29, 42, 43, 44, 46, 65, 66, 67, 68 NR Band n77, n78, n79,	F <sub>DL_low</sub>	-	F <sub>DL_high</sub>	-50	1	2
	E-UTRA Band 2, 4, 5, 7, 10, 12, 13, 14, 17, 26, 27, 28, 29, 30, 43, 50, 51, 66, 74, 85	F <sub>DL_low</sub>	-	F <sub>DL_high</sub>	-50	1	
	E-UTRA Band 42	F <sub>DL_low</sub>	-	F <sub>DL_high</sub>	-50	1	2
	Frequency range	2570	-	2575	+1.6	5	5, 6, 7
	Frequency range	2575	-	2595	-15.5	5	5, 6, 7
DC_7_n77	Frequency range	2595	-	2620	-40	1	5, 6
	E-UTRA Band 4, 5, 12, 13, 14, 17, 26, 30, 66, 85	F <sub>DL_low</sub>	-	F <sub>DL_high</sub>	-50	1	
	E-UTRA Band 2, 70	F <sub>DL_low</sub>	-	F <sub>DL_high</sub>	-50	1	2
	E-UTRA Band 29	F <sub>DL_low</sub>	-	F <sub>DL_high</sub>	-38	1	5
	Frequency range	2570	-	2575	1.6	5	5, 6, 7
DC_7_n77	Frequency range	2575	-	2595	-15.5	5	5, 6, 7
	Frequency range	2595	-	2620	-40	1	5, 6
	E-UTRA Band 1, 2, 3, 4, 5, 7, 8, 10, 11, 18, 19, 20, 21, 26, 27, 28, 31, 32, 33, 34, 40, 50, 51, 65, 66, 67, 68, 72, 74, 75, 76	F <sub>DL_low</sub>	-	F <sub>DL_high</sub>	-50	1	
	Frequency range	2570	-	2575	+1.6	5	5, 6, 7
	Frequency range	2575	-	2595	-15.5	5	5, 6, 7
	Frequency range	2595	-	2620	-40	1	5, 6

EN-DC Configuration	Spurious emission						
	Protected band	Frequency range (MHz)		Maximum Level (dBm)	MBW (MHz)	NOTE	
DC_7_n78	E-UTRA Band 1, 2, 3, 4, 5, 7, 8, 10, 11, 18, 19, 20, 21, 26, 27, 28, 31, 32, 33, 34, 40, 50, 51, 65, 66, 67, 68, 72, 74, 75, 76	F <sub>DL_low</sub>	-	F <sub>DL_high</sub>	-50	1	
	Frequency range	2570	-	2575	+1.6	5	5, 6, 7
	Frequency range	2575	-	2595	-15.5	5	5, 6, 7
	Frequency range	2595	-	2620	-40	1	5, 6
DC_8_n1	E-UTRA Band 20, 28, 31, 32, 38, 40, 50, 51, 65, 67, 72, 73, 74, 75, 76	F <sub>DL_low</sub>	-	F <sub>DL_high</sub>	-50	1	
	E-UTRA band 3, 7, 22, 41, 42, 43, 52 NR Band n77, n78, n79	F <sub>DL_low</sub>	-	F <sub>DL_high</sub>	-50	1	2
	E-UTRA Band 1, 8, 34	F <sub>DL_low</sub>	-	F <sub>DL_high</sub>	-50	1	5
	E-UTRA band 11, 21	F <sub>DL_low</sub>	-	F <sub>DL_high</sub>	-50	1	12
	Frequency range	860	-	890	-40	1	5, 12
	Frequency range	1884.5	-	1915.7	-41	0.3	12, 15
	Frequency range	1880	-	1895	-40	1	5, 16
	Frequency range	1895	-	1915	-15.5	5	5, 7, 16
Frequency range	1915	-	1920	+1.6	5	5, 7, 16	
DC_8_n3	E-UTRA Band 1, 20, 28, 31, 32, 33, 34, 38, 39, 40, 44, 50, 51, 65, 67, 72, 73, 74, 75, 76	F <sub>DL_low</sub>	-	F <sub>DL_high</sub>	-50	1	
	E-UTRA band 3, 8	F <sub>DL_low</sub>	-	F <sub>DL_high</sub>	-50	1	2, 5
	E-UTRA band 11, 21	F <sub>DL_low</sub>	-	F <sub>DL_high</sub>	-50	1	12
	E-UTRA band 7, 22, 41, 42, 43, 52 NR Band n77, n78, n79	F <sub>DL_low</sub>	-	F <sub>DL_high</sub>	-50	1	2
	Frequency range	1884.5	-	1915.7	-41	0.3	3, 12
	Frequency range	860	-	890	-40	1	5, 12
DC_7_n80	E-UTRA Band 1, 5, 7, 8, 20, 26, 27, 28, 31, 32, 33, 34, 40, 42, 43, 50, 51, 65, 67, 68, 72, 74, 75, 76. NR Band n79	F <sub>DL_low</sub>	-	F <sub>DL_high</sub>	-50	1	
	E-UTRA Band 3, 34	F <sub>DL_low</sub>	-	F <sub>DL_high</sub>	-50	1	5
	E-UTRA Band 22, 42, NR Band n77, n78	F <sub>DL_low</sub>	-	F <sub>DL_high</sub>	-50	1	2
	Frequency range	2570	-	2575	+1.6	5	5, 6, 7
	Frequency range	2575	-	2595	-15.5	5	5, 6, 7
	Frequency range	2595	-	2620	-40	1	5, 6
DC_8_n20	E-UTRA Band 1, 31, 32, 33, 34, 40, 50, 51, 65, 67, 68, 72, 74, 75, 76	F <sub>DL_low</sub>	-	F <sub>DL_high</sub>	-50	1	
	E-UTRA Band 3, 7, 22, 38, 42, 43, 52, 69 NR band n77, n78	F <sub>DL_low</sub>	-	F <sub>DL_high</sub>	-50	1	2
	E-UTRA Band 8, 20	F <sub>DL_low</sub>	-	F <sub>DL_high</sub>	-50	1	5
	Frequency range	758	-	788	-50	1	
DC_8_n28	E-UTRA Band 20, 31, 34, 38, 40, 72	F <sub>DL_low</sub>	-	F <sub>DL_high</sub>	-50	1	
	E-UTRA band 3, 7, 22, 41, 42, 43, 50, 51, 65, 73, 74, 75, 76 NR Band n77, n78, n79	F <sub>DL_low</sub>	-	F <sub>DL_high</sub>	-50	1	2
	E-UTRA Band 1	F <sub>DL_low</sub>	-	F <sub>DL_high</sub>	-50	1	2, 9, 10
	E-UTRA Band 8	F <sub>DL_low</sub>	-	F <sub>DL_high</sub>	-50	1	5
	E-UTRA Band 11, 21	F <sub>DL_low</sub>	-	F <sub>DL_high</sub>	-50	1	9, 11, 12
	Frequency range	470	-	694	-42	8	5, 17
	Frequency range	470	-	710	-26.2	6	14
	Frequency range	662	-	694	-26.2	6	5
	Frequency range	758	-	773	-32	1	5
	Frequency range	773	-	803	-50	1	
Frequency range	860	-	890	-40	1	5, 12	
Frequency range	1884.5	-	1915.7	-41	0.3	3, 9, 12	
DC_8_n34	E-UTRA Band 1, 20, 28, 31, 32, 33, 38, 39, 40, 45, 50, 51, 65, 67, 69, 72, 73, 74, 75, 76	F <sub>DL_low</sub>	-	F <sub>DL_high</sub>	-50	1	
	E-UTRA Band 3, 7, 22, 41, 42, 43, 52 NR Band n78, n79	F <sub>DL_low</sub>	-	F <sub>DL_high</sub>	-50	1	2
	E-UTRA Band 8	F <sub>DL_low</sub>	-	F <sub>DL_high</sub>	-50	1	5
	E-UTRA Band 11, 21	F <sub>DL_low</sub>	-	F <sub>DL_high</sub>	-50	1	12
	Frequency range	1884.5	-	1915.7	-41	0.3	3, 12
	Frequency range	860	-	890	-40	1	5, 12



EN-DC Configuration	Spurious emission						
	Protected band	Frequency range (MHz)			Maximum Level (dBm)	MBW (MHz)	NOTE
DC_8_n39	E-UTRA Band 1, 28, 34, 40, 45, 50, 51, 73, 74	F <sub>DL_low</sub>	-	F <sub>DL_high</sub>	-50	1	
	E-UTRA Band 22, 41, 42, 52 NR Band n77, n78, n79	F <sub>DL_low</sub>	-	F <sub>DL_high</sub>	-50	1	2
	E-UTRA Band 8	F <sub>DL_low</sub>	-	F <sub>DL_high</sub>	-50	1	5
DC_8_n40	E-UTRA Band 1, 20, 28, 31, 32, 33, 34, 38, 39, 45, 50, 51, 65, 67, 68, 69, 72, 73, 74, 75, 76	F <sub>DL_low</sub>	-	F <sub>DL_high</sub>	-50	1	
	E-UTRA Band 3, 7, 22, 41, 42, 43, 52	F <sub>DL_low</sub>	-	F <sub>DL_high</sub>	-50	1	2
	E-UTRA Band 8	F <sub>DL_low</sub>	-	F <sub>DL_high</sub>	-50	1	5
	E-UTRA Band 11, 21	F <sub>DL_low</sub>	-	F <sub>DL_high</sub>	-50	1	12
	Frequency range	860	-	890	-40	1	5, 12
	Frequency range	1884.5	-	1915.7	-41	0.3	3, 12
DC_8_n41	E-UTRA Band 1, 28, 34, 39, 40, 45, 50, 51, 65, 73, 74, n77, 78, 79	F <sub>DL_low</sub>	-	F <sub>DL_high</sub>	-50	1	
	E-UTRA band 3, 42, 52	F <sub>DL_low</sub>	-	F <sub>DL_high</sub>	-50	1	2
	E-UTRA band 11, 21	F <sub>DL_low</sub>	-	F <sub>DL_high</sub>	-50	1	
	Frequency range	1884.5	-	1915.7	-41	0.3	3
DC_8_n41, DC_8_n81_ULSUP -TDM	E-UTRA Band 1, 28, 34, 39, 40, 45, 50, 51, 65, 73, 74	F <sub>DL_low</sub>	-	F <sub>DL_high</sub>	-50	1	
	E-UTRA band 3, 42	F <sub>DL_low</sub>	-	F <sub>DL_high</sub>	-50	1	2
	E-UTRA Band 8	F <sub>DL_low</sub>	-	F <sub>DL_high</sub>	-50	1	5
	E-UTRA Band 11, 21	F <sub>DL_low</sub>	-	F <sub>DL_high</sub>	-50	1	13
	Frequency range	1884.5	-	1915.7	-41	0.3	3
DC_8_n77	E-UTRA Band 1, 20, 28, 31, 32, 33, 34, 38, 39, 40, 44, 45, 50, 51, 65, 67, 68, 69, 72, 73, 74, 75, 76	F <sub>DL_low</sub>	-	F <sub>DL_high</sub>	-50	1	
	E-UTRA band 3, 7, 41	F <sub>DL_low</sub>	-	F <sub>DL_high</sub>	-50	1	2
	E-UTRA Band 8	F <sub>DL_low</sub>	-	F <sub>DL_high</sub>	-50	1	5
	E-UTRA Band 11, 21	F <sub>DL_low</sub>	-	F <sub>DL_high</sub>	-50	1	12
	Frequency range	860	-	890	-40	1	5, 12
	Frequency range	1884.5	-	1915.7	-41	0.3	3, 12
DC_8_n78 DC_8_n81_ULSUP -TDM_n78	E-UTRA Band 1, 8, 20, 28, 34, 39, 40, 65	F <sub>DL_low</sub>	-	F <sub>DL_high</sub>	-50	1	
	E-UTRA Band 3, 7, 41	F <sub>DL_low</sub>	-	F <sub>DL_high</sub>	-50	1	2
	E-UTRA Band 11, 21	F <sub>DL_low</sub>	-	F <sub>DL_high</sub>	-50	1	12
	Frequency range	860	-	890	-40	1	5, 12
	Frequency range	1884.5	-	1915.7	-41	0.3	3, 12
DC_8_n79	E-UTRA Band 1, 8, 28, 34, 39, 40, 65	F <sub>DL_low</sub>	-	F <sub>DL_high</sub>	-50	1	

EN-DC Configuration	Spurious emission						
	Protected band	Frequency range (MHz)		Maximum Level (dBm)	MBW (MHz)	NOTE	
DC_8_n81_ULSU -TDM_n79	E-UTRA Band 3,41,42	F <sub>DL_low</sub>	-	F <sub>DL_high</sub>	-50	1	2
	E-UTRA Band 11, 21	F <sub>DL_low</sub>	-	F <sub>DL_high</sub>	-50	1	12
	Frequency range	860	-	890	-40	1	5, 12
	Frequency range	1884.5	-	1915.7	-41	0.3	3
DC_8_n80	E-UTRA Band 1, 20, 28, 31, 32, 33, 34, 38, 39, 40, 45, 50, 51, 65, 67, 68, 69, 72, 73, 74, 75, 76 NR Band n79	F <sub>DL_low</sub>	-	F <sub>DL_high</sub>	-50	1	
	E-UTRA Band 3, 8	F <sub>DL_low</sub>	-	F <sub>DL_high</sub>	-50	1	5
	E-UTRA Band 3, 7, 22, 41, 42, 43, 52 NR Band n77, n78	F <sub>DL_low</sub>	-	F <sub>DL_high</sub>	-50	1	2
	E-UTRA Band 11, 21	F <sub>DL_low</sub>	-	F <sub>DL_high</sub>	-50	1	13
	Frequency range	1884.5	-	1915.7	-41	0.3	3
DC_8A_93A_ULSU P-TDM, DC_8A_94A_ULSU P-TDM	E-UTRA Band 1, 20, 28, 31, 32, 33, 34, 38, 39, 40, 45, 50, 51, 65, 67, 68, 69, 72, 73, 74, 75, 76	F <sub>DL_low</sub>	-	F <sub>DL_high</sub>	-50	1	2
	E-UTRA band 3, 7, 22, 41, 42, 43, 52, NR Band n77, n78	F <sub>DL_low</sub>	-	F <sub>DL_high</sub>	-50	1	5
	E-UTRA 8	F <sub>DL_low</sub>	-	F <sub>DL_high</sub>	-50	1	2
	E-UTRA Band 1, 28, 34, 65 NR band n79	F <sub>DL_low</sub>	-	F <sub>DL_high</sub>	-50	1	
DC_11_n3	E-UTRA band 3	F <sub>DL_low</sub>	-	F <sub>DL_high</sub>	-50	1	5
	E-UTRA Band 11, 18, 19, 21	F <sub>DL_low</sub>	-	F <sub>DL_high</sub>	-50	1	13
	E-UTRA Band 42 NR band n77, n78	F <sub>DL_low</sub>	-	F <sub>DL_high</sub>	-50	1	2
	Frequency range	945	-	960	-50	1	
	Frequency range	1884.5	-	1915.7	-41	0.3	3, 13
	Frequency range	2545	-	2575	-50	1	
	Frequency range	2595	-	2645	-50	1	
DC_11_28	E-UTRA Band 3, 18, 19, 34 NR band n79	F <sub>DL_low</sub>	-	F <sub>DL_high</sub>	-50	1	
	E-UTRA band 1, 42, 65 NR band n77, n78	F <sub>DL_low</sub>	-	F <sub>DL_high</sub>	-50	1	2
	E-UTRA band 1	F <sub>DL_low</sub>	-	F <sub>DL_high</sub>	-50	1	9, 10
	E-UTRA Band 11, 21	F <sub>DL_low</sub>	-	F <sub>DL_high</sub>	-50	1	9, 11
	Frequency range	470	-	710	-26.2	6	14
	Frequency range	773	-	803	-50	1	
	Frequency range	945	-	960	-50	1	
	Frequency range	1884.5	-	1915.7	-41	0.3	3, 9
	Frequency range	2545	-	2575	-50	1	
DC_11_n77	E-UTRA Band 1, 3, 18, 19, 28, 34, 65	F <sub>DL_low</sub>	-	F <sub>DL_high</sub>	-50	1	
	Frequency range	945	-	960	-50	1	
	Frequency range	1884.5	-	1915.7	-41	0.3	3
	Frequency range	2545	-	2575	-50	1	
	Frequency range	2595	-	2645	-50	1	
DC_11_n78	E-UTRA Band 1, 3, 18, 19, 28, 34, 65	F <sub>DL_low</sub>	-	F <sub>DL_high</sub>	-50	1	
	Frequency range	945	-	960	-50	1	
	Frequency range	1884.5	-	1915.7	-41	0.3	3
	Frequency range	2545	-	2575	-50	1	
	Frequency range	2595	-	2645	-50	1	
DC_11_n79	E-UTRA Band 1, 3, 18, 19, 28, 34, 42, 65	F <sub>DL_low</sub>	-	F <sub>DL_high</sub>	-50	1	
	Frequency range	945	-	960	-50	1	
	Frequency range	1884.5	-	1915.7	-41	0.3	3
	Frequency range	2545	-	2575	-50	1	
	Frequency range	2595	-	2645	-50	1	
DC_12_n2	E-UTRA Band 5, 13, 14, 17, 24, 26, 27, 30, 41, 50, 53, 71, 74	F <sub>DL_low</sub>	-	F <sub>DL_high</sub>	-50	1	
	E-UTRA Band 12, 25, 85	F <sub>DL_low</sub>	-	F <sub>DL_high</sub>	-50	1	3
	E-UTRA Band 2	F <sub>DL_low</sub>	-	F <sub>DL_high</sub>	-50	1	5
	E-UTRA Band 4, 10, 51, 66, 70, NR Band n77	F <sub>DL_low</sub>	-	F <sub>DL_high</sub>	-50	1	2
	E-UTRA Band 2, 5, 12, 13, 14, 17, 24, 25, 26, 30, 42, 43 50, 51, 71, 74	F <sub>DL_low</sub>	-	F <sub>DL_high</sub>	-50	1	

EN-DC Configuration	Spurious emission						
	Protected band	Frequency range (MHz)			Maximum Level (dBm)	MBW (MHz)	NOTE
DC_12_n66	E-UTRA Bands 4, 10, 41, 48, 66, 70, NR Band n77	F <sub>DL_low</sub>	-	F <sub>DL_high</sub>	-50	1	2
	E-UTRA Band 12, 85	F <sub>DL_low</sub>	-	F <sub>DL_high</sub>	-50	1	
	E-UTRA Band 2, 4, 5, 13, 14, 17, 24, 25, 26, 27, 30, 41, 50, 51, 70, 71, 74	F <sub>DL_low</sub>	-	F <sub>DL_high</sub>	-50	1	
DC_12_n7	E-UTRA Band 4, 10, 48, NR Band n77	F <sub>DL_low</sub>	-	F <sub>DL_high</sub>	-50	1	2
	E-UTRA Band 12, 85	F <sub>DL_low</sub>	-	F <sub>DL_high</sub>	-50	1	5
	E-UTRA Band 2, 5, 12, 13, 14, 17, 24, 25, 30, 42, 43 50, 51, 71, 74	F <sub>DL_low</sub>	-	F <sub>DL_high</sub>	-50	1	
	E-UTRA Band 2, 5, 7, 13, 14, 17, 26, 27, 30, 74, NR Band n78	F <sub>DL_low</sub>	-	F <sub>DL_high</sub>	-50	1	
	E-UTRA Band 4, 10, 50, 51,66	F <sub>DL_low</sub>	-	F <sub>DL_high</sub>	-50	1	2
DC_12_n25	E-UTRA Band 12, 85	F <sub>DL_low</sub>	-	F <sub>DL_high</sub>	-50	1	5
	Frequency range	2570	-	2575	+1.6	5	5, 6, 7
	Frequency range	2575	-	2595	-15.5	5	5, 6, 7
	Frequency range	2595	-	2620	-40	1	5, 6
	E-UTRA Band 5, 13, 14, 17, 24, 26, 27, 30, 41, 48, 53, 71	F <sub>DL_low</sub>	-	F <sub>DL_high</sub>	-50	1	
	E-UTRA Band 4, 10, 66, 70. NR Band n77	F <sub>DL_low</sub>	-	F <sub>DL_high</sub>	-50	1	2
DC_12_n38	E-UTRA Band 2, 12, 25, 85	F <sub>DL_low</sub>	-	F <sub>DL_high</sub>	-50	1	15
	Frequency range	470	-	710	-26.2	6	14
	Frequency range	1884.5	-	1915.7	-41	0.3	16
	Frequency range	1880	-	1895	-40	1	5,17
	Frequency range	1895	-	1915	-15.5	5	5, 7, 17
	E-UTRA Band 2, 5, 13, 14, 17, 27, 30, 74 NR band n38	F <sub>DL_low</sub>	-	F <sub>DL_high</sub>	-50	1	
	E-UTRA band 4, 10, 50, 51, 66	F <sub>DL_low</sub>	-	F <sub>DL_high</sub>	-50	1	2
DC_12_n41	E-UTRA band 12, 85	F <sub>DL_low</sub>	-	F <sub>DL_high</sub>	-50	1	5
	E-UTRA Band 2, 5, 13, 14, 17, 24, 25, 26, 27, 30, 48, 71, 74	F <sub>DL_low</sub>	-	F <sub>DL_high</sub>	-50	1	
	E-UTRA band 4, 10, 50, 51, 66, 70	F <sub>DL_low</sub>	-	F <sub>DL_high</sub>	-50	1	2
DC_12_n78	E-UTRA band 12, 85	F <sub>DL_low</sub>	-	F <sub>DL_high</sub>	-50	1	5
	E-UTRA Band 2, 5, 7, 13, 17, 25, 26, 41, 71	F <sub>DL_low</sub>	-	F <sub>DL_high</sub>	-50	1	
	E-UTRA Band 4, 66	F <sub>DL_low</sub>	-	F <sub>DL_high</sub>	-50	1	2
	E-UTRA band 12	F <sub>DL_low</sub>	-	F <sub>DL_high</sub>	-50	1	5
DC_13_n2	Frequency range	1884.5	-	1915.7	-41	0.3	3
	E-UTRA Band 4, 5,12,13,17, 26, 29, 41, 48, 66, 70, 71	F <sub>DL_low</sub>	-	F <sub>DL_high</sub>	-50	1	
	E-UTRA Band 2,14, 25	F <sub>DL_low</sub>	-	F <sub>DL_high</sub>	-50	1	5
	E-UTRA Band 30	F <sub>DL_low</sub>	-	F <sub>DL_high</sub>	-50	1	2
	Frequency range	769	-	775	-35	0.0062 5	5
DC_13_n5	Frequency range	799	-	805	-35	0.0062 5	5
	E-UTRA Band 2, 4, 5, 10, 12, 13, 17, 25, 26, 29, 48, 50, 51, 53, 66, 70, 71, 85	F <sub>DL_low</sub>	-	F <sub>DL_high</sub>	-50	1	
	E-UTRA Band 26	859	-	869	-27	1	
	E-UTRA Band 24, 30, 41	F <sub>DL_low</sub>	-	F <sub>DL_high</sub>	-50	1	2
	E-UTRA Band 14	F <sub>DL_low</sub>	-	F <sub>DL_high</sub>	-50	1	5
	Frequency range	769	-	775	-35	0.0062 5	5
DC_13_n7	Frequency range	799	-	805	-35	0.0062 5	5
	E-UTRA Band 2, 4, 5, 7, 10, 12, 13, 17,25. 26, 27, 29, 50, 51, 66. 74, 85 NR Band n78	F <sub>DL_low</sub>	-	F <sub>DL_high</sub>	-50	1	
	E-UTRA Band 30	F <sub>DL_low</sub>	-	F <sub>DL_high</sub>	-50	1	2
	E-UTRA Band 14	F <sub>DL_low</sub>	-	F <sub>DL_high</sub>	-50	1	5
	Frequency range	769	-	775	-35	0.0062 5	5
	Frequency range	799	-	805	-35	0.0062 5	5
DC_13_n7	Frequency range	2570	-	2575	+1.6	5	5, 6, 7

EN-DC Configuration	Spurious emission						
	Protected band	Frequency range (MHz)		Maximum Level (dBm)	MBW (MHz)	NOTE	
	Frequency range	2575	-	2595	-15.5	5	5, 6, 7
Frequency range	2595	-	2620	-40	1	5, 6	
DC_13A_n48A	E-UTRA Band 2, 4, 5, 10, 12, 13, 14, 17, 25, 26, 27, 29, 30, 41, 50, 51, 66, 70, 71, 74, 85	F <sub>DL_low</sub>	-	F <sub>DL_high</sub>	-50	1	
	E-UTRA Band 14	F <sub>DL_low</sub>	-	F <sub>DL_high</sub>	-50	1	5
	E-UTRA Band 24, 30	F <sub>DL_low</sub>	-	F <sub>DL_high</sub>	-50	1	2
	Frequency range	769	-	775	-35	0.0062 5	5
	Frequency range	799	-	805	-35	0.0062 5	5
DC_13_n66	Bands 2, 4, 5, 7, 10, 12, 13, 17, 25, 26, 27, 29, 41, 53, 66, 70, 71, 85	F <sub>DL_low</sub>	-	F <sub>DL_high</sub>	-50	1	
	E-UTRA Band 14	F <sub>DL_low</sub>	-	F <sub>DL_high</sub>	-50	1	5
	E-UTRA Band 24, 30, 46, 48, NR Band n77	F <sub>DL_low</sub>	-	F <sub>DL_high</sub>	-50	1	2
	Frequency range	769	-	775	-35	0.0062 5	5
	Frequency range	799	-	805	-35	0.0062 5	5
DC_13A_n71A	E-UTRA Band 4, 5, 12, 13, 17, 26, 48, 66, 85	F <sub>DL_low</sub>	-	F <sub>DL_high</sub>	<u>-50</u>	1	
	E-UTRA Band 2, 24, 25, 30, 41, 70, NR Band n77	F <sub>DL_low</sub>	-	F <sub>DL_high</sub>	-50	1	2
	E-UTRA Band 29	F <sub>DL_low</sub>	-	F <sub>DL_high</sub>	-38	1	5
	E-UTRA Band 14, 71	F <sub>DL_low</sub>	-	F <sub>DL_high</sub>	-50	1	5
	Frequency range	769	-	775	-35	0.0062 5	5
	Frequency range	799	-	805	-35	0.0062 5	5
DC_13_n78	E-UTRA Band 2, 5, 7, 12, 13, 25, 26, 41, 66 NR Band n78	F <sub>DL_low</sub>	-	F <sub>DL_high</sub>	-50	1	
	Frequency range	769	-	775	-35	0.0062 5	5
	Frequency range	799	-	805	-35	0.0062 5	5
DC_18_n3	E-UTRA Band 1, 3, 11, 18, 19, 21, 28, 34, 42, 65 NR Band n79	F <sub>DL_low</sub>	-	F <sub>DL_high</sub>	-50	1	
	NR Band n77, n78	F <sub>DL_low</sub>	-	F <sub>DL_high</sub>	-50	1	2
	Frequency range	945	-	960	-50	1	
	Frequency range	1884.5	-	1915.7	-41	0.3	3
	Frequency range	2545	-	2575	-50	1	
DC_18_n77	E-UTRA Band 1, 3, 11, 21, 28, 34, 65	F <sub>DL_low</sub>	-	F <sub>DL_high</sub>	-50	1	
	Frequency range	945	-	960	-50	1	
	Frequency range	1884.5	-	1915.7	-41	0.3	3
	Frequency range	2545	-	2575	-50	1	
	Frequency range	2595	-	2645	-50	1	
DC_18_n78	E-UTRA Band 1, 3, 11, 21, 28, 34, 65	F <sub>DL_low</sub>	-	F <sub>DL_high</sub>	-50	1	
	Frequency range	945	-	960	-50	1	
	Frequency range	1884.5	-	1915.7	-41	0.3	3
	Frequency range	2545	-	2575	-50	1	
	Frequency range	2595	-	2645	-50	1	
DC_18_n79	E-UTRA Band 1, 3, 11, 21, 28, 34, 42, 65	F <sub>DL_low</sub>	-	F <sub>DL_high</sub>	-50	1	
	Frequency range	945	-	960	-50	1	
	Frequency range	1884.5	-	1915.7	-41	0.3	3
	Frequency range	2545	-	2575	-50	1	
	Frequency range	2595	-	2645	-50	1	
DC_19_n77	E-UTRA Band 1, 3, 11, 21, 28, 34, 65	F <sub>DL_low</sub>	-	F <sub>DL_high</sub>	-50	1	
	Frequency range	945	-	960	-50	1	
	Frequency range	1884.5	-	1915.7	-41	0.3	3
	Frequency range	2545	-	2575	-50	1	
	Frequency range	2595	-	2645	-50	1	

EN-DC Configuration	Spurious emission						
	Protected band	Frequency range (MHz)			Maximum Level (dBm)	MBW (MHz)	NOTE
DC_19_n78	E-UTRA Band 1, 3, 11, 21, 28, 34, 65	F <sub>DL_low</sub>	-	F <sub>DL_high</sub>	-50	1	
	Frequency range	945	-	960	-50	1	
	Frequency range	1884.5	-	1915.7	-41	0.3	3
	Frequency range	2545	-	2575	-50	1	
	Frequency range	2595	-	2645	-50	1	
DC_19_n79	E-UTRA Band 1, 3, 11, 21, 28, 34, 42, 65	F <sub>DL_low</sub>	-	F <sub>DL_high</sub>	-50	1	
	Frequency range	945	-	960	-50	1	
	Frequency range	1884.5	-	1915.7	-41	0.3	3
	Frequency range	2545	-	2575	-50	1	
	Frequency range	2595	-	2645	-50	1	
DC_20_n1	E-UTRA Band 1, 3, 7, 8, 20, 22, 31, 32, 33, 34, 40, 42, 43, 50, 51, 65, 67, 68, 72, 75, 76	F <sub>DL_low</sub>	-	F <sub>DL_high</sub>	-50	1	
	E-UTRA Band 1	F <sub>DL_low</sub>	-	F <sub>DL_high</sub>	-50	1	5
	E-UTRA Band 38, 69 NR Band n77, n78	F <sub>DL_low</sub>	-	F <sub>DL_high</sub>	-50	1	2
	Frequency range	758	-	788	-50	1	
DC_20_n3	E-UTRA Band 1, 7, 8, 31, 32, 33, 34, 40, 43, 50, 51, 65, 67, 72, 74, 75, 76	F <sub>DL_low</sub>	-	F <sub>DL_high</sub>	-50	1	
	E-UTRA Band 20 E-UTRA Band 3	F <sub>DL_low</sub>	-	F <sub>DL_high</sub>	-50	1	5
	E-UTRA Band 22, 38, 42, 52	F <sub>DL_low</sub>	-	F <sub>DL_high</sub>	-50	1	2
	Frequency range	758	-	788	-50	1	
DC_20_n7	E-UTRA Band 1, 3, 7, 8, 22, 31, 32, 33, 34, 40, 43, 50, 51, 65, 67, 68, 72, 74, 75, 76	F <sub>DL_low</sub>	-	F <sub>DL_high</sub>	-50	1	
	E-UTRA Band 42, 52 NR band n78, n77	F <sub>DL_low</sub>	-	F <sub>DL_high</sub>	-50	1	2
	E-UTRA Band 20	F <sub>DL_low</sub>	-	F <sub>DL_high</sub>	-50	1	5
DC_20_n8	E-UTRA Band 1, 3, 7, 22, 28, 31, 32, 34, 38, 42, 43, 65, 75, 76 NR band n78	F <sub>DL_low</sub>	-	F <sub>DL_high</sub>	-50	1	
DC_20_n38	E-UTRA Band 1, 3, 8, 22, 31, 32, 33, 34, 40, 43, 50, 51, 65, 67, 68, 72, 74, 75, 76	F <sub>DL_low</sub>	-	F <sub>DL_high</sub>	-50	1	
	E-UTRA Band 42, 52	F <sub>DL_low</sub>	-	F <sub>DL_high</sub>	-50	1	2
	E-UTRA Band 20	F <sub>DL_low</sub>	-	F <sub>DL_high</sub>	-50	1	5
DC_20_n41	E-UTRA Band 1, 2, 4, 10, 24, 25, 30, 31, 32, 33, 34, 39, 40, 43, 48, 50, 51, 65, 66, 70, 72, 73, 74, 75, 76	F <sub>DL_low</sub>	-	F <sub>DL_high</sub>	-50	1	
	E-UTRA Band 3, 8, 12, 13, 14, 17, 38, 42, 44, 45, 52, 67, 68, 69, 71, 85 NR Band n77, n78, n79	F <sub>DL_low</sub>	-	F <sub>DL_high</sub>	-50	1	2
	Frequency range	758	-	788	-50	1	
	E-UTRA Band 9, 11, 21	F <sub>DL_low</sub>	-	F <sub>DL_high</sub>	-50	1	19
	Frequency range	1884.5	-	1915.7	-41	0.3	3, 19
DC_20_n28 DC_20_n83	E-UTRA Band 1, 3, 7, 8, 22, 31, 32, 34, 38, 42, 43, 65, 75, 76	F <sub>DL_low</sub>	-	F <sub>DL_high</sub>	-50	1	
DC_20A_n50A	E-UTRA Band 2, 3, 7, 12, 17, 31, 33, 38, 39, 41, 43, 48, 52, 65, 66, 67, 68, 69, 72, 85	F <sub>DL_low</sub>	-	F <sub>DL_high</sub>	-50	1	
	Frequency range	1400	-	1427	-42	27	
	E-UTRA Band 1, 4, 5, 8, 13, 34, 38, 40, 42, 43, 65, 66, 67, 68 NR Band n77, n78	F <sub>DL_low</sub>	-	F <sub>DL_high</sub>	-50	1	2
DC_20_n51	Frequency range	758	-	788	-50	1	
	E-UTRA Band 1, 3, 4, 8, 17, 22, 28, 29, 31, 40, 43, 48, 65, 66, 68, 72	F <sub>DL_low</sub>	-	F <sub>DL_high</sub>	-50	1	
	E-UTRA Band 20	F <sub>DL_low</sub>	-	F <sub>DL_high</sub>	-50	1	5
DC_20_n51	Frequency range	758	-	788	-50	1	
	E-UTRA Band 2, 7, 25, 32, 33, 34, 35, 36, 37, 38, 39, 41, 42, 46, 69, 70 NR Band n77, n78, n79,	F <sub>DL_low</sub>	-	F <sub>DL_high</sub>	-50	1	2
DC_20_n77	E-UTRA Band 1, 3, 7, 8, 31, 32, 33, 34, 40, 50, 51, 65, 67, 68, 72, 74, 75, 76	F <sub>DL_low</sub>	-	F <sub>DL_high</sub>	-50	1	
	E-UTRA Band 20	F <sub>DL_low</sub>	-	F <sub>DL_high</sub>	-50	1	5
	E-UTRA Band 38, 69	F <sub>DL_low</sub>	-	F <sub>DL_high</sub>	-50	1	2

EN-DC Configuration	Spurious emission						
	Protected band	Frequency range (MHz)			Maximum Level (dBm)	MBW (MHz)	NOTE
DC_20_n78,	E-UTRA Band 1, 3, 7, 8, 31, 32, 33, 34, 40, 50, 51, 65, 67, 68, 72, 74, 75, 76	F <sub>DL_low</sub>	-	F <sub>DL_high</sub>	-50	1	

EN-DC Configuration	Spurious emission						
	Protected band	Frequency range (MHz)		Maximum Level (dBm)	MBW (MHz)	NOTE	
DC_20_n82_ULS UP-TDM_n78	E-UTRA Band 20	F <sub>DL_low</sub>	-	F <sub>DL_high</sub>	-50	1	5
	E-UTRA Band 38, 69	F <sub>DL_low</sub>	-	F <sub>DL_high</sub>	-50	1	2
DC_20_n80	E-UTRA Band 1, 7, 8, 27, 28, 31, 32, 33, 34, 40, 43, 50, 51, 65, 67, 68, 72, 74, 75, 76, NR Band n79	F <sub>DL_low</sub>	-	F <sub>DL_high</sub>	-50	1	
	E-UTRA Band 3, 20	F <sub>DL_low</sub>	-	F <sub>DL_high</sub>	-50	1	5
	E-UTRA Band 22, 42, NR Band n77, n78	F <sub>DL_low</sub>	-	F <sub>DL_high</sub>	-50	1	2
DC_20A_91A_ULS UP-TDM, DC_20A_92A_ULS UP-TDM	E-UTRA Band 1, 3, 7, 8, 22, 31, 32, 33, 34, 40, 42, 43, 50, 51, 65, 67, 68, 72, 74, 75, 76	F <sub>DL_low</sub>	-	F <sub>DL_high</sub>	-50	1	
	E-UTRA Band 20	F <sub>DL_low</sub>	-	F <sub>DL_high</sub>	-50	1	5
	E-UTRA Band 38, 42, 69, NR Band n77, n78	F <sub>DL_low</sub>	-	F <sub>DL_high</sub>	-50	1	2
	Frequency range	758	-	788	-50	1	
DC_21_n77	E-UTRA Band 1, 3, 18, 19, 21, 28, 34, 65	F <sub>DL_low</sub>	-	F <sub>DL_high</sub>	-50	1	
	Frequency range	945	-	960	-50	1	
	Frequency range	1884.5	-	1915.7	-41	0.3	3
	Frequency range	2545	-	2575	-50	1	
	Frequency range	2595	-	2645	-50	1	
DC_21_n78	E-UTRA Band 1, 3, 18, 19, 21, 28, 34, 65	F <sub>DL_low</sub>	-	F <sub>DL_high</sub>	-50	1	
	Frequency range	945	-	960	-50	1	
	Frequency range	1884.5	-	1915.7	-41	0.3	3
	Frequency range	2545	-	2575	-50	1	
	Frequency range	2595	-	2645	-50	1	
DC_21_n79	E-UTRA Band 1, 3, 18, 19, 21, 28, 34, 42, 65	F <sub>DL_low</sub>	-	F <sub>DL_high</sub>	-50	1	
	Frequency range	945	-	960	-50	1	
	Frequency range	1884.5	-	1915.7	-41	0.3	3
	Frequency range	2545	-	2575	-50	1	
	Frequency range	2595	-	2645	-50	1	
DC_25_n41	E-UTRA Band 4, 5, 10, 12, 13, 14, 17, 24, 26, 27, 28, 29, 30, 42, 45, 48, 66, 70, 71	F <sub>DL_low</sub>	-	F <sub>DL_high</sub>	-50	1	
	E-UTRA Band 2, 25, NR Band n77	F <sub>DL_low</sub>	-	F <sub>DL_high</sub>	-50	1	5
DC_26A_n25A	4, 5, 10, 12, 13, 14, 17, 24, 26, 29, 30, 42, 48, 53, 66, 70, 71, 85	F <sub>DL_low</sub>	-	F <sub>DL_high</sub>	-50	1	
	2, 25	F <sub>DL_low</sub>	-	F <sub>DL_high</sub>	-50	1	5
	41, 43	F <sub>DL_low</sub>	-	F <sub>DL_high</sub>	-50	1	2
DC_26_n41	E-UTRA Band 1, 2, 3, 4, 5, 10, 11, 12, 13, 14, 17, 18, 19, 21, 24, 25, 26, 29, 30, 31, 34, 39, 42, 43, 48, 50, 51, 65, 66, 70, 71, 74	F <sub>DL_low</sub>	-	F <sub>DL_high</sub>	-50	1	
	E-UTRA Band 9, 11, 18, 19, 21	F <sub>DL_low</sub>	-	F <sub>DL_high</sub>	-50	1	19
	Frequency range	1884.5	-	1915.7	-41	0.3	3, 19
	Frequency range	703	-	799	-50	1	
	Frequency range	799	-	803	-40	1	5
	Frequency range	945	-	960	-50	1	
DC_26_n77	E-UTRA Band 1, 3, 5, 11, 18, 19, 21, 26, 34, 39, 40, 41, 65	F <sub>DL_low</sub>	-	F <sub>DL_high</sub>	-50	1	
	Frequency range	703	-	799	-50	1	
	Frequency range	799	-	803	-40	1	5
	Frequency range	945	-	960	-50	1	
	Frequency range	1884.5	-	1915.7	-41	0.3	3
	Frequency range	2545	-	2575	-50	1	
	Frequency range	2595	-	2645	-50	1	
DC_26_n78	E-UTRA Band 1, 3, 5, 11, 18, 19, 21, 26, 34, 39, 40, 41, 42, 65	F <sub>DL_low</sub>	-	F <sub>DL_high</sub>	-50	1	
	Frequency range	703	-	799	-50	1	
	Frequency range	799	-	803	-40	1	5
	Frequency range	945	-	960	-50	1	
	Frequency range	1884.5	-	1915.7	-41	0.3	3
	Frequency range	2545	-	2575	-50	1	
	Frequency range	2595	-	2645	-50	1	

EN-DC Configuration	Spurious emission						
	Protected band	Frequency range (MHz)			Maximum Level (dBm)	MBW (MHz)	NOTE
DC_26_n79	E-UTRA Band 1, 3, 5, 11, 18, 19, 21, 26, 34, 39, 40, 41, 65	F <sub>DL_low</sub>	-	F <sub>DL_high</sub>	-50	1	
	Frequency range	703	-	799	-50	1	
	Frequency range	799	-	803	-40	1	5
	Frequency range	945	-	960	-50	1	
	Frequency range	1884.5	-	1915.7	-41	0.3	3
	Frequency range	2545	-	2575	-50	1	
DC_28_n3	E-UTRA Band 1, 22, 42, 43, 50, 51, 65, 74, 75, 76, NR Band n77, n78	F <sub>DL_low</sub>	-	F <sub>DL_high</sub>	-50	1	2
	E-UTRA Band 1	F <sub>DL_low</sub>	-	F <sub>DL_high</sub>	-50	1	9, 11
	E-UTRA Band 3, 5, 7, 8, 18, 19, 20, 26, 27, 31, 34, 38, 40, 41, 72, 73 NR Band n79	F <sub>DL_low</sub>	-	F <sub>DL_high</sub>	-50	1	
	E-UTRA Band 11, 21	F <sub>DL_low</sub>	-	F <sub>DL_high</sub>	-50	1	9, 10
	Frequency range	470	-	710	-26.2	6	14
	Frequency range	758	-	773	-32	1	5
	Frequency range	773	-	803	-50	1	
DC_28_n5	E-UTRA Band 2, 3, 5, 7, 8, 12, 13, 14, 17, 18, 19, 24, 25, 26, 28, 29, 30, 31, 34, 38, 40, 45, 48, 70, 71, 85	F <sub>DL_low</sub>	-	F <sub>DL_high</sub>	-50		
	E-UTRA Band 1, 4, 10, 22, 32, 41, 42, 43, 50, 51, 52, 65, 66, 73, 74, 75, 76 NR Band n77, n78, n79	F <sub>DL_low</sub>	-	F <sub>DL_high</sub>	-50	1	2
	E-UTRA Band 11, 21	F <sub>DL_low</sub>	-	F <sub>DL_high</sub>	-50	1	4
	Frequency range	1884.5	-	1915.7	-41	0.3	3, 4
	Frequency range	470	-	694	-42	8	5, 17
	Frequency range	470	-	710	-26.2	6	14
	Frequency range	662	-	694	-26.2	6	5
	Frequency range	758	-	773	-32	1	5
DC_28A_n7A DC_28A_n7B	E-UTRA Band 2, 3, 5, 8, 20, 26, 27, 31, 34, 40, 72 NR band n7	F <sub>DL_low</sub>	-	F <sub>DL_high</sub>	-50	1	
	E-UTRA Band 4, 10, 22, 32, 42, 43, 50, 51, 52, 65, 66, 74, 75, 76 NR band n77, n78	F <sub>DL_low</sub>	-	F <sub>DL_high</sub>	-50	1	2
	E-UTRA band 1	F <sub>DL_low</sub>	-	F <sub>DL_high</sub>	-50	1	9, 10
	Frequency range	758	-	773	-32	1	5
	Frequency range	773	-	803	-50	1	
	Frequency range	2570	-	2575	+1.6	5	5, 6, 7
	Frequency range	2575	-	2595	-15.5	5	5, 6, 7
	Frequency range	2595	-	2620	-40	1	5, 6
DC_28_n8	E-UTRA Band 20, 31, 34, 38, 40, 72	F <sub>DL_low</sub>	-	F <sub>DL_high</sub>	-50	1	
	E-UTRA band 3, 7, 22, 41, 42, 43, 50, 51, 52, 65, 73, 74, 75, 76 NR Band n77, n78, n79	F <sub>DL_low</sub>	-	F <sub>DL_high</sub>	-50	1	2
	E-UTRA Band 8	F <sub>DL_low</sub>	-	F <sub>DL_high</sub>	-50	1	5
	E-UTRA Band 11, 21	F <sub>DL_low</sub>	-	F <sub>DL_high</sub>	-50	1	12
	E-UTRA Band 1	F <sub>DL_low</sub>	-	F <sub>DL_high</sub>	-50	1	9, 10
	Frequency range	470	-	694	-42	8	5, 17
	Frequency range	470	-	710	-26.2	6	14
	Frequency range	662	-	694	-26.2	6	5
	Frequency range	758	-	773	-32	1	5
	Frequency range	773	-	803	-50	1	
	Frequency range	860	-	890	-40	1	5, 12
DC_28_n40	E-UTRA Band 3, 5, 7, 8, 20, 26, 27, 31, 34, 38, 41, 72	F <sub>DL_low</sub>	-	F <sub>DL_high</sub>	-50	1	
	E-UTRA band 22, 32, 42, 43, 50, 51, 52, 65, 73, 74, 75, 76 NR Band n8, n77, n78, n79	F <sub>DL_low</sub>	-	F <sub>DL_high</sub>	-50	1	2



EN-DC Configuration	Spurious emission						
	Protected band	Frequency range (MHz)		Maximum Level (dBm)	MBW (MHz)	NOTE	
DC_28_n41	E-UTRA Band 4, 10, 12, 13, 14, 17, 18, 19, 20, 26, 27, 29, 39, 42, 43, 50, 51, 52, 65, 66, 71, 73, 85 NR Band n77, n78, n79	F <sub>DL_low</sub>	-	F <sub>DL_high</sub>	-50	1	2
	E-UTRA Band 1	F <sub>DL_low</sub>	-	F <sub>DL_high</sub>	-50	1	9, 10
	E-UTRA Band 2, 3, 5, 8, 24, 25, 30, 31, 34, 40, 44, 48, 70, 72	F <sub>DL_low</sub>	-	F <sub>DL_high</sub>	-50	1	
	E-UTRA Band 11, 21, 74, 75, 76	F <sub>DL_low</sub>	-	F <sub>DL_high</sub>	-50	1	9, 11
	Frequency range	470	-	694	-42	8	5, 17
	Frequency range	470	-	710	-26.2	6	14
	Frequency range	662	-	694	-26.2	6	5
	Frequency range	758	-	773	-32	1	5
	Frequency range	773	-	803	-50	1	
Frequency range	1884.5	-	1915.7	-41	0.3	3, 9	
DC_28_n50	E-UTRA Band 4, 10, 29, 40, 42, 43, 52, 65, 66, 73, 85 NR Band n77, n78, n79	F <sub>DL_low</sub>	-	F <sub>DL_high</sub>	-50	1	2
	E-UTRA Band 1	F <sub>DL_low</sub>	-	F <sub>DL_high</sub>	-50	1	9, 10
	E-UTRA Band 2, 3, 5, 7, 8, 18, 19, 25, 26, 27, 31, 34, 38, 39, 41, 48, 52, 72	F <sub>DL_low</sub>	-	F <sub>DL_high</sub>	-50	1	
	Frequency range	470	-	694	-42	8	5, 17
	Frequency range	470	-	710	-26.2	6	14
	Frequency range	662	-	694	-26.2	6	5
	Frequency range	758	-	773	-32	1	5
	Frequency range	773	-	803	-50	1	
	Frequency range	1884.5	-	1915.7	-41	0.3	3, 9
Frequency range	1400	-	1427	-32	27		
DC_28_n51	E-UTRA Band 2, 3, 5, 7, 8, 25, 26, 31, 34, 38, 40, 41, 66, 72	F <sub>DL_low</sub>	-	F <sub>DL_high</sub>	-50	1	
	E-UTRA Band 4, 10, 20, 22, 24, 32, 42, 43, 45, 46, 65, 66, 71, 73 NR band n78, n79	F <sub>DL_low</sub>	-	F <sub>DL_high</sub>	-50	1	2
	E-UTRA Band 1	F <sub>DL_low</sub>	-	F <sub>DL_high</sub>	-50	1	2, 9, 10
	Frequency range	470	-	694	-42	8	5, 17
	Frequency range	470	-	710	-26.2	6	14
	Frequency range	662	-	694	-26.2	6	5
	Frequency range	758	-	773	-32	1	5
Frequency range	773	-	803	-50	1		
DC_28_n77	E-UTRA Band 3, 5, 7, 8, 18, 19, 20, 26, 34, 39, 40, 41	F <sub>DL_low</sub>	-	F <sub>DL_high</sub>	-50	1	
	E-UTRA Band 1, 65	F <sub>DL_low</sub>	-	F <sub>DL_high</sub>	-50	1	2
	E-UTRA Band 1	F <sub>DL_low</sub>	-	F <sub>DL_high</sub>	-50	1	9, 10
	E-UTRA Band 11, 21	F <sub>DL_low</sub>	-	F <sub>DL_high</sub>	-50	1	9, 11
	Frequency range	758	-	773	-32	1	
	Frequency range	773	-	803	-50	1	
Frequency range	1884.5	-	1915.7	-41	0.3	3	
DC_28_n78	E-UTRA Band 3, 5, 7, 8, 18, 19, 20, 26, 34, 39, 40, 41	F <sub>DL_low</sub>	-	F <sub>DL_high</sub>	-50	1	

EN-DC Configuration	Spurious emission							
	Protected band	Frequency range (MHz)		Maximum Level (dBm)	MBW (MHz)	NOTE		
DC_28_n83_ULSU P-TDM_n78	E-UTRA Band 1, 65	F <sub>DL_low</sub>	-	F <sub>DL_high</sub>	-50	1	2	
	E-UTRA Band 1	F <sub>DL_low</sub>	-	F <sub>DL_high</sub>	-50	1	9, 10	
	E-UTRA Band 11, 21	F <sub>DL_low</sub>	-	F <sub>DL_high</sub>	-50	1	9, 11	
	Frequency range	758	-	773	-32	1		
	Frequency range	773	-	803	-50	1		
	Frequency range	1884.5	-	1915.7	-41	0.3	3	
DC_28_n79	E-UTRA Band 3, 5, 8, 18, 19, 34, 39, 40, 41, 42	F <sub>DL_low</sub>	-	F <sub>DL_high</sub>	-50	1		
	E-UTRA Band 1, 65	F <sub>DL_low</sub>	-	F <sub>DL_high</sub>	-50	1	2	
	E-UTRA Band 1	F <sub>DL_low</sub>	-	F <sub>DL_high</sub>	-50	1	9, 10	
	E-UTRA Band 11, 21	F <sub>DL_low</sub>	-	F <sub>DL_high</sub>	-50	1	9, 11	
	Frequency range	758	-	773	-32	1		
	Frequency range	773	-	803	-50	1		
DC_30_n2	E-UTRA Band 4, 5, 10, 12, 13, 14, 17, 24, 26, 27, 28, 29, 30, 41, 42, 48, 50, 51, 53, 66, 70, 71, 74, 85	F <sub>DL_low</sub>	-	F <sub>DL_high</sub>	-50	1		
	E-UTRA Band 25	F <sub>DL_low</sub>	-	F <sub>DL_high</sub>	-50	1	5	
	E-UTRA Band 2	F <sub>DL_low</sub>	-	F <sub>DL_high</sub>	-50	1	5	
	E-UTRA Band 43, NR Band n77	F <sub>DL_low</sub>	-	F <sub>DL_high</sub>	-50	1	2	
	DC_30_n5	E-UTRA Band 1, 2, 3, 4, 5, 7, 8, 10, 12, 13, 14, 17, 24, 25, 26, 28, 29, 30, 31, 34, 38, 42, 43, 45, 48, 50, 51, 65, 66, 70, 71, 73, 74, 85	F <sub>DL_low</sub>	-	F <sub>DL_high</sub>	-50	1	
		E-UTRA Band 41, 48, 52, NR Band n77	F <sub>DL_low</sub>	-	F <sub>DL_high</sub>	-50	1	2
E-UTRA Band 18, 19		F <sub>DL_low</sub>	-	F <sub>DL_high</sub>	-40	1		
E-UTRA Band 11, 21		F <sub>DL_low</sub>	-	F <sub>DL_high</sub>	-50	1		
Frequency range		1884.5	-	1915.7	-41	0.3	3	
DC_30_n66		E-UTRA Band 2, 4, 5, 10, 12, 13, 14, 17, 24, 25, 26, 27, 29, 30, 38, 41, 66, 70, 71	F <sub>DL_low</sub>	-	F <sub>DL_high</sub>	-50	1	
	E-UTRA Band 48, NR Band n77	F <sub>DL_low</sub>	-	F <sub>DL_high</sub>	-50	1	2	
DC_38_n78	N/A							
DC_39_n40	E-UTRA Band 1, 8, 22, 26, 28, 34, 41, 42, 44, 45, 50, 51, 52, 73, 74	F <sub>DL_low</sub>	-	F <sub>DL_high</sub>	-50	1		
	NR Band n77, n78, n79	F <sub>DL_low</sub>	-	F <sub>DL_high</sub>	-50	1	2	
	Frequency range	1805	-	1855	-40	1	18	
	Frequency range	1855	-	1880	-15.5	5	5, 7, 18	
DC_39_n41	E-UTRA Band 1, 8, 26, 28, 34, 40, 42, 44, 45, 50, 51, 74	F <sub>DL_low</sub>	-	F <sub>DL_high</sub>	-50	1		
	NR Band n77, n78, n79	F <sub>DL_low</sub>	-	F <sub>DL_high</sub>	-50	1	2	
	Frequency range	1805	-	1855	-40	1	5	
	Frequency range	1855	-	1880	-15.5	5	5, 7, 19	
DC_39_n78	E-UTRA Band 1, 8, 28, 34, 40, 41, 44, 45	F <sub>DL_low</sub>	-	F <sub>DL_high</sub>	-50	1		
	Frequency range	1805	-	1855	-40	1	18	
	Frequency range	1855	-	1880	-15.5	5	18	
DC_39_n79	E-UTRA Band 1, 8, 28, 34, 40, 41, 44, 45	F <sub>DL_low</sub>	-	F <sub>DL_high</sub>	-50	1		
	Frequency range	1805	-	1855	-40	1	18	
	Frequency range	1855	-	1880	-15.5	5	18	
DC_40_n1	E-UTRA Band 1, 3, 5, 7, 8, 20, 22, 26, 27, 28, 31, 32, 38, 41, 42, 43, 44, 45, 50, 51, 52, 65, 67, 68, 69, 72, 73, 74, 75, 76 NR Band n78	F <sub>DL_low</sub>	-	F <sub>DL_high</sub>	-50	1		
	E-UTRA Band 34	F <sub>DL_low</sub>	-	F <sub>DL_high</sub>	-50	1	5	
	NR Band n77, n79	F <sub>DL_low</sub>	-	F <sub>DL_high</sub>	-50	1	2	
DC_40_n41	Bands 1, 3, 5, 8, 26, 27, 28, 34, 39, 42, 44, 45, 50, 51, 65, 73, 74, NR Band n77, n78	F <sub>DL_low</sub>	-	F <sub>DL_high</sub>	-50	1		
	NR Band n79	F <sub>DL_low</sub>	-	F <sub>DL_high</sub>	-50	1	2	
	Frequency range	1884.5	-	1915.7	-41	0.3	3, 19	
DC_40_n77	N/A							

EN-DC Configuration	Spurious emission						
	Protected band	Frequency range (MHz)		Maximum Level (dBm)	MBW (MHz)	NOTE	
DC_40_n78	E-UTRA Band 1, 3, 5, 7, 8, 20, 22, 26, 27, 28, 31, 32, 33, 34, 38, 39, 41, 42, 43, 44, 45, 50, 51, 52, 65, 67, 68, 69, 72, 73, 74, 75, 76 NR Band n77, n78	F <sub>DL_low</sub>	-	F <sub>DL_high</sub>	-50	1	
	NR Band n79	F <sub>DL_low</sub>	-	F <sub>DL_high</sub>	-50	1	2
DC_40_n79	Bands 1, 3, 5, 8, 28, 34, 39, 41, 42, 65	F <sub>DL_low</sub>	-	F <sub>DL_high</sub>	-50	1	
	Frequency range	1884.5	-	1915.7	-41	0.3	3, 19
DC_41_n3	E-UTRA Band 1, 5, 8, 26, 27, 28, 34, 39, 40, 44, 45, 50, 51, 65, 73, 74	F <sub>DL_low</sub>	-	F <sub>DL_high</sub>	-50	1	
	E-UTRA Band 3	F <sub>DL_low</sub>	-	F <sub>DL_high</sub>	-50	1	5
	E-UTRA Band 11, 18, 19, 21	F <sub>DL_low</sub>	-	F <sub>DL_high</sub>	-50	1	13, 19
	E-UTRA Band 42, 52 NR Band n77, n78, n79	F <sub>DL_low</sub>	-	F <sub>DL_high</sub>	-50	1	2
	Frequency range	1884.5	-	1915.7	-41	0.3	3, 19
DC_41_n28	E-UTRA Band 4, 10, 12, 13, 14, 17, 18, 19, 20, 26, 27, 29, 39, 42, 43, 50, 51, 52, 65, 66, 71, 73, 85 NR Band n77, n78, n79	F <sub>DL_low</sub>	-	F <sub>DL_high</sub>	-50	1	2
	E-UTRA Band 1	F <sub>DL_low</sub>	-	F <sub>DL_high</sub>	-50	1	9,10
	E-UTRA Band 2, 3, 5, 8, 24, 25, 30, 31, 34, 40, 44, 48, 70, 72	F <sub>DL_low</sub>	-	F <sub>DL_high</sub>	-50	1	
	E-UTRA Band 11, 21, 74, 75, 76	F <sub>DL_low</sub>	-	F <sub>DL_high</sub>	-50	1	9, 11
	Frequency range	470	-	694	-42	8	5, 17
	Frequency range	470	-	710	-26.2	6	14
	Frequency range	662	-	694	-26.2	6	5
	Frequency range	758	-	773	-32	1	5
	Frequency range	773	-	803	-50	1	
	Frequency range	1884.5	-	1915.7	-41	0.3	3, 9
DC_41_n77	E-UTRA Band 1, 3, 5, 8, 26, 28, 33, 34, 39, 40, 44, 45, 73, 74	F <sub>DL_low</sub>	-	F <sub>DL_high</sub>	-50	1	
	E-UTRA Band 9, 11, 18, 19, 21	F <sub>DL_low</sub>	-	F <sub>DL_high</sub>	-50	1	19
	Frequency range	1884.5	-	1915.7	-41	0.3	3, 19
DC_41_n78	E-UTRA Band 1, 3, 8, 34, 39, 40, 44, 45	F <sub>DL_low</sub>	-	F <sub>DL_high</sub>	-50	1	
	Frequency range	1884.5	-	1915.7	-41	0.3	3, 19
DC_41_n79	E-UTRA Band 1, 3, 5, 8, 9, 11, 18, 19, 21, 28, 34, 40, 42, 44, 45, 65	F <sub>DL_low</sub>	-	F <sub>DL_high</sub>	-50	1	
	Frequency range	1884.5	-	1915.7	-41	0.3	3
DC_42_n51	E-UTRA Band 3, 8, 20, 25, 30, 31, 34, 39, 41, 73	F <sub>DL_low</sub>	-	F <sub>DL_high</sub>	-50	1	
	E-UTRA Band 1, 2, 4, 5, 6, 7, 10, 12, 13, 14, 17, 23, 24, 26, 27, 28, 29, 32, 38, 40, 44, 46, 65, 66, 67, 68, 70, 71	F <sub>DL_low</sub>	-	F <sub>DL_high</sub>	-50	1	2
DC_42_n77	N/A						
DC_42_n78	N/A						
DC_42_n79	N/A						
DC_48_n5	E-UTRA Band 2, 4, 5, 12, 13, 14, 17, 24, 25, 26, 29, 30, 41, 50, 51, 66, 70, 71, 74, 85	F <sub>DL_low</sub>	-	F <sub>DL_high</sub>	-50	1	
	E-UTRA Band 26	859	-	869	-27	1	
	E-UTRA Band 41	F <sub>DL_low</sub>	-	F <sub>DL_high</sub>	e	1	2
	Frequency range	1884.5	-	1915.7	-41	0.3	3
DC_48_n12	E-UTRA Band 2, 5, 13, 14, 17, 24, 25, 26, 30, 41, 71, 74	F <sub>DL_low</sub>	-	F <sub>DL_high</sub>	-50	1	
	E-UTRA Band 4, 50, 51, 66, 70	F <sub>DL_low</sub>	-	F <sub>DL_high</sub>	-50	1	2
	E-UTRA Band 12, 85	F <sub>DL_low</sub>	-	F <sub>DL_high</sub>	-50	1	5
DC_48_n66	E-UTRA Band 2, 4, 5, 12, 13, 14, 17, 24, 25, 26, 29, 30, 41, 50, 51, 66, 70, 71, 74, 85	F <sub>DL_low</sub>	-	F <sub>DL_high</sub>	-50	1	
DC_48_n71	E-UTRA Band 4, 5, 12, 13, 14, 17, 24, 26, 30, 48, 50, 51, 53, 66, 74, 85	F <sub>DL_low</sub>	-	F <sub>DL_high</sub>	-50	1	
	E-UTRA Band 2, 25, 41, 70	F <sub>DL_low</sub>	-	F <sub>DL_high</sub>	-50	1	2
	E-UTRA Band 29	F <sub>DL_low</sub>	-	F <sub>DL_high</sub>	-38	1	5
	E-UTRA Band 71	F <sub>DL_low</sub>	-	F <sub>DL_high</sub>	-50	1	5
DC_66_n2	E-UTRA Band 4, 5, 10, 12, 13, 14, 17, 22, 24, 26, 27, 28, 29, 30, 41, 50, 51, 53, 66, 70, 71, 74, 85	F <sub>DL_low</sub>	-	F <sub>DL_high</sub>	-50	1	

EN-DC Configuration	Spurious emission						
	Protected band	Frequency range (MHz)		Maximum Level (dBm)	MBW (MHz)	NOTE	
	E-UTRA Band 25	F <sub>DL_low</sub>	-	F <sub>DL_high</sub>	-50	1	5
	E-UTRA Band 2	F <sub>DL_low</sub>	-	F <sub>DL_high</sub>	-50	1	5
	E-UTRA Band 42, 43, NR Band n77	F <sub>DL_low</sub>	-	F <sub>DL_high</sub>	-50	1	2
DC_66_n5	E-UTRA Band 1, 2, 3, 4, 5, 6, 7, 8, 10, 12, 13, 14, 17, 24, 25, 26, 28, 29, 30, 34, 38, 40, 43, 45, 50, 51, 65, 66, 70, 71, 85	F <sub>DL_low</sub>	-	F <sub>DL_high</sub>	-50	1	
	E-UTRA Band 41, 42, 48, 52, NR Band n77	F <sub>DL_low</sub>	-	F <sub>DL_high</sub>	-50	1	2
	E-UTRA Band 18, 19	F <sub>DL_low</sub>	-	F <sub>DL_high</sub>	-40	1	
	E-UTRA Band 11, 21	F <sub>DL_low</sub>	-	F <sub>DL_high</sub>	-50	1	
	Frequency range	1884.5	-	1915.7	-41	0.3	3
DC_66_n7	E-UTRA Band 2, 4, 5, 7, 10, 12, 13, 14, 17, 26, 27, 28, 29, 30, 43, 50, 51, 66, 74, 85	F <sub>DL_low</sub>	-	F <sub>DL_high</sub>	-50	1	
	E-UTRA Band 42	F <sub>DL_low</sub>	-	F <sub>DL_high</sub>	-50	1	2
	Frequency range	2570	-	2575	+1.6	5	5, 6, 7
	Frequency range	2575	-	2595	-15.5	5	5, 6, 7
DC_66_n12	E-UTRA Band 2, 5, 13, 14, 17, 24, 25, 26, 27, 30, 41, 48, 50, 53, 66, 70, 71, 74	F <sub>DL_low</sub>	-	F <sub>DL_high</sub>	-50	1	
	E-UTRA Band 4, 10, 51, 66, 48, NR Band n77	F <sub>DL_low</sub>	-	F <sub>DL_high</sub>	-50	1	2
	E-UTRA Band 12, 85	F <sub>DL_low</sub>	-	F <sub>DL_high</sub>	-50	1	5
DC_66_n25	E-UTRA Band 4, 5, 7, 10, 12, 13, 14, 17, 24, 26, 27, 28, 29, 30, 38, 41, 50, 51, 53, 66, 70, 71, 74, 85	F <sub>DL_low</sub>	-	F <sub>DL_high</sub>	-50	1	
	E-UTRA Band 42, 48, NR Band n77	F <sub>DL_low</sub>	-	F <sub>DL_high</sub>	-50	1	2
	E-UTRA Band 2	F <sub>DL_low</sub>	-	F <sub>DL_high</sub>	-50	1	5
	E-UTRA Band 25	F <sub>DL_low</sub>	-	F <sub>DL_high</sub>	-50	1	5
	E-UTRA Band 43	F <sub>DL_low</sub>	-	F <sub>DL_high</sub>	-50	1	2
DC_66_n41	E-UTRA Band 2, 4, 5, 7, 10, 12, 13, 14, 17, 24, 25, 26, 27, 28, 29, 30, 43, 50, 51, 53, 66, 70, 71, 74, 85	F <sub>DL_low</sub>	-	F <sub>DL_high</sub>	-50	1	
	E-UTRA Band 42, 48, NR Band n77	F <sub>DL_low</sub>	-	F <sub>DL_high</sub>	-50	1	2
DC_66_n38	E-UTRA Band 2, 4, 5, 10, 12, 13, 14, 17, 25, 27, 28, 29, 30, 43, 50, 51, 66, 74, 85	F <sub>DL_low</sub>	-	F <sub>DL_high</sub>	-50	1	
	E-UTRA Band 42	F <sub>DL_low</sub>	-	F <sub>DL_high</sub>	-50	1	2
	Frequency range	2620	-	2645	-15.5	5	5, 7, 22
	Frequency range	2645	-	2690	-40	1	5, 22
DC_66A_n48A	E-UTRA Band 2, 4, 5, 12, 13, 14, 17, 24, 25, 26, 29, 30, 41, 50, 51, 66, 70, 71, 74, 85	F <sub>DL_low</sub>	-	F <sub>DL_high</sub>	-50	1	
DC_66_n71	E-UTRA Band 4, 5, 7, 10, 13, 14, 17, 22, 24, 26, 27, 29, 30, 43, 50, 51, 66, 74	F <sub>DL_low</sub>	-	F <sub>DL_high</sub>	-50	1	
	E-UTRA Band 2, 25, 41, 42, 48, 70, NR Band n77	F <sub>DL_low</sub>	-	F <sub>DL_high</sub>	-50	1	2
	E-UTRA Band 71	F <sub>DL_low</sub>	-	F <sub>DL_high</sub>	-50	1	5
DC_66_n78, DC_66_n86_ULSU P-TDM_n78	E-UTRA Band 1, 3, 5, 7, 8, 20, 26, 28, 34, 39, 40, 41, 65	F <sub>DL_low</sub>	-	F <sub>DL_high</sub>	-50	1	
DC_71_n5	E-UTRA Band 4, 12, 13, 14, 17, 24, 26, 30, 48, 66, 85 NR Band n5	F <sub>DL_low</sub>	-	F <sub>DL_high</sub>	-50	1	
	E-UTRA Band 2, 25, 41, 70, NR Band n77	F <sub>DL_low</sub>	-	F <sub>DL_high</sub>	-50	1	2
	E-UTRA Band 29	F <sub>DL_low</sub>	-	F <sub>DL_high</sub>	-38	1	5
	E-UTRA Band 71	F <sub>DL_low</sub>	-	F <sub>DL_high</sub>	-50	1	5
DC_71_n38	E-UTRA Band 4, 5, 12, 13, 14, 17, 30, 66, 85	F <sub>DL_low</sub>	-	F <sub>DL_high</sub>	-50	1	
	E-UTRA Band 2	F <sub>DL_low</sub>	-	F <sub>DL_high</sub>	-50	1	2
	E-UTRA band 29	F <sub>DL_low</sub>	-	F <sub>DL_high</sub>	-50	1	5

EN-DC Configuration	Spurious emission						
	Protected band	Frequency range (MHz)		Maximum Level (dBm)	MBW (MHz)	NOTE	
DC_71_n48	E-UTRA Band 2, 4, 5, 12, 13, 14, 17, 24, 25, 26, 29, 30, 41, 50, 51, 66, 70, 71, 74, 85	F <sub>DL_low</sub>	-	F <sub>DL_high</sub>	-50	1	
DC_71_n66	E-UTRA Band 4, 5, 7, 10, 13, 14, 17, 22, 24, 26, 27, 29, 30, 43, 50, 51, 66, 74	F <sub>DL_low</sub>	-	F <sub>DL_high</sub>	-50	1	
	E-UTRA Band 2, 25, 41, 42, 48, 70, NR Band n77	F <sub>DL_low</sub>	-	F <sub>DL_high</sub>	-50	1	2
	E-UTRA Band 71	F <sub>DL_low</sub>	-	F <sub>DL_high</sub>	-50	1	5
DC_71_n78	E-UTRA Band 5, 26	F <sub>DL_low</sub>	-	F <sub>DL_high</sub>	-50	1	
	E-UTRA Band 41	F <sub>DL_low</sub>	-	F <sub>DL_high</sub>	-50	1	2

NOTE 1: F<sub>DL\_low</sub> and F<sub>DL\_high</sub> refer to each E-UTRA frequency band specified in Table 5.5-1 in TS 36.101 [4].

NOTE 2: As exceptions, measurements with a level up to the applicable requirements defined in Table 6.6.3.1-2 are permitted for each assigned E-UTRA carrier used in the measurement due to 2<sup>nd</sup>, 3<sup>rd</sup>, 4<sup>th</sup> or 5<sup>th</sup> harmonic spurious emissions. Due to spreading of the harmonic emission the exception is also allowed for the first 1 MHz frequency range immediately outside the harmonic emission on both sides of the harmonic emission. This results in an overall exception interval centred at the harmonic emission of (2 MHz + N x L<sub>CRB</sub> x 180 kHz), where N is 2, 3, 4, 5 for the 2<sup>nd</sup>, 3<sup>rd</sup>, 4<sup>th</sup> or 5<sup>th</sup> harmonic respectively. The exception is allowed if the measurement bandwidth (MBW) totally or partially overlaps the overall exception interval.

NOTE 3: Applicable when co-existence with PHS system operating in 1884.5 - 1915.7 MHz

NOTE 4: Applicable only when the assigned E-UTRA carrier is confined within 824 MHz and 849 MHz for UE category M1, M2 and UE category NB1 and NB2.

NOTE 5: These requirements also apply for the frequency ranges that are less than F<sub>OOB</sub> (MHz) in Table 6.6.3.1-1 and Table 6.6.3.1A-1 from the edge of the channel bandwidth.

NOTE 6: This requirement is applicable for any channel bandwidths within the range 2500 - 2570 MHz with the following restriction: for carriers of 15 MHz bandwidth when carrier centre frequency is within the range 2560.5 - 2562.5 MHz and for carriers of 20 MHz bandwidth when carrier centre frequency is within the range 2552 - 2560 MHz the requirement is applicable only for an uplink transmission bandwidth less than or equal to 54 RB.

NOTE 7: For these adjacent bands, the emission limit could imply risk of harmful interference to UE(s) operating in the protected operating band.

NOTE 8: This requirement is applicable for any channel bandwidths within the range 1920 - 1980 MHz with the following restriction: for carriers of 15 MHz bandwidth when carrier centre frequency is within the range 1927.5 - 1929.5 MHz and for carriers of 20 MHz bandwidth when carrier centre frequency is within the range 1930 - 1938 MHz the requirement is applicable only for an uplink

NOTE 9: Applicable when the assigned E-UTRA carrier is confined within 718 MHz and 748 MHz and when the channel bandwidth used is 5 or 10 MHz.

NOTE 10: As exceptions, measurements with a level up to the applicable requirement of -36 dBm/MHz is permitted for each assigned E-UTRA carrier used in the measurement due to 2nd harmonic spurious emissions. An exception is allowed if there is at least one individual RB within the transmission bandwidth (see Figure 5.6-1) for which the 2nd harmonic totally or partially overlaps the measurement bandwidth (MBW).

NOTE 11: As exceptions, measurements with a level up to the applicable requirement of -38 dBm/MHz is permitted for each assigned E-UTRA carrier used in the measurement due to 3rd harmonic spurious emissions. An exception is allowed if there is at least one individual RB within the transmission bandwidth (see Figure 5.6-1) for which the 3rd harmonic totally or partially overlaps the measurement bandwidth (MBW).

NOTE 12: This requirement is applicable only for the following cases: A: for carriers of 5 MHz channel bandwidth when carrier centre frequency (Fc) is within the range 902.5 MHz ≤ Fc < 907.5 MHz with an uplink transmission bandwidth less than or equal to 20 RB; B: for carriers of 5 MHz channel bandwidth when carrier centre frequency (Fc) is within the range 907.5 MHz ≤ Fc ≤ 912.5 MHz without any restriction on uplink transmission bandwidth; C: for carriers of 10 MHz channel bandwidth when carrier centre frequency (Fc) is Fc = 910 MHz with an uplink transmission bandwidth less than or equal to 32 RB with RB<sub>start</sub> > 3.

NOTE 13: This requirement applies for 5, 10, 15 and 20 MHz E-UTRA channel bandwidth allocated within 1744.9MHz and 1784.9MHz.

NOTE 14: This requirement is applicable for 5 and 10 MHz E-UTRA channel bandwidth allocated within 718-728MHz. For carriers of 10 MHz bandwidth, this requirement applies for an uplink transmission bandwidth less than or equal to 30 RB with RB<sub>start</sub> > 1 and RB<sub>start</sub> < 48.

NOTE 15: Applicable when NS\_05 in clause 6.6.3.3.1 is signalled by the network.

NOTE 16: This requirement is applicable for any channel bandwidths within the range 1920 - 1980 MHz with the following restriction: for carriers of 15 MHz bandwidth when carrier centre frequency is within the range 1927.5 - 1929.5 MHz and for carriers of 20 MHz bandwidth when carrier centre frequency is within the range 1930 - 1938 MHz the requirement is applicable only for an uplink transmission bandwidth less than or equal to 54 RB.

NOTE 17: This requirement is applicable in the case of a 10 MHz E-UTRA carrier confined within 703 MHz and 733 MHz, otherwise the requirement of -25 dBm with a measurement bandwidth of 8 MHz applies.

EN-DC Configuration	Spurious emission				
	Protected band	Frequency range (MHz)	Maximum Level (dBm)	MBW (MHz)	NOTE
NOTE 18: This requirement is only applicable for E-UTRA carriers with bandwidth confined within 1885 - 1920 MHz (requirement for carriers with at least 1RB confined within 1880 - 1885 MHz is not specified). This requirement applies for an uplink transmission bandwidth less than or equal to 54 RB for E-UTRA carriers of 15 MHz bandwidth when carrier center frequency is within the range 1892.5 - 1894.5 MHz and for E-UTRA carriers of 20 MHz bandwidth when carrier center frequency is within the range 1895 - 1903 MHz.					
NOTE 19: This requirement applies when the E-UTRA and NR carriers are confined within 2545 – 2575 MHz or 2595 - 2645 MHz and the channel bandwidth is 10 or 20 MHz					
NOTE 20: For category NB1 and NB2 UE when carrier centre frequency is 1920.1 MHz, in case of single-tone uplink transmission the requirement is applicable only for sub-carrier index > 2.					
NOTE 21: Void					
NOTE 22: This requirement is applicable for power class 3 UE for any channel bandwidths within the range 2570 - 2615 MHz with the following restriction: for carriers of 15 MHz bandwidth when carrier centre frequency is within the range 2605.5 - 2607.5 MHz and for carriers of 20 MHz bandwidth when carrier centre frequency is within the range 2597 - 2605 MHz the requirement is applicable only for an uplink transmission bandwidth less than or equal to 54 RB.					

NOTE: To simplify the above Table, E-UTRA band numbers are listed for bands which are specified only for E-UTRA operation or both E-UTRA and NR operation. NR band numbers are listed for bands which are specified only for NR operation.

### 6.5B.3.3a Inter-band NE-DC within FR1

#### 6.5B.3.3a.1 General spurious emissions

The general spurious emissions requirements specified in clause 6.6.3.1 of TS 36.101 [4], clause 6.5.3.1 of TS 38.101-1 [2] and TS 38.101-2 [3] apply for each component carrier.

#### 6.5B.3.3a.2 Spurious emission band UE co-existence

This clause specifies the requirements for the specified NE-DC configurations that do not have a corresponding defined EN-DC, for coexistence with protected bands. For the NE-DC configurations that have a corresponding specified EN-DC configuration, the requirements in Table 6.5B.3.3.2-1 apply on each component carrier with all component carriers are active.

### 6.5B.3.4 Inter-band EN-DC including FR2

General spurious requirement for E-UTRA single carrier and CA operation specified in clauses 6.6.3.1 and 6.6.3.1A of TS 36.101 [4] and for NR single carrier and CA operation specified in clause 6.5.3, 6.5A.3 and 6.5D.3 of TS 38.101-2 [3] apply.

#### 6.5B.3.4.1 Spurious emission band UE co-existence

This clause specifies the requirements for the specified EN-DC, for coexistence with protected bands. Unless otherwise stated, for inter-band EN-DC configurations defined in table 5.5B.5.1-1, no requirements for FR2 NR bands to protect E-UTRA and FR1 NR bands are applied to the constituent FR2 NR bands. Spurious emission band UE co-existence requirements specified in TS 36.101 [4] are applied to the constituent E-UTRA bands for the EN-DC configuration.

Spurious emission band UE co-existence requirement for E-UTRA single carrier and CA operation specified in clauses 6.6.3.2 and 6.6.3.2A of TS 36.101 [4] and for NR single carrier and CA operation specified in clause 6.5.3.1, 6.5A.3.1 and 6.5D.3.1 of TS 38.101-2 [3] apply.

**Table 6.5B.3.4.1-1: Void****6.5B.3.5 Inter-band EN-DC including both FR1 and FR2**

General spurious requirement for E-UTRA single carrier and CA operation specified in clauses 6.6.3.1 and 6.6.3.1A of TS 36.101 [4] and for NR single carrier and CA operation specified in clause 6.5.3.1 of TS 38.101-1 [2] and clause 6.5.3, 6.5A.3 and 6.5D.3 of TS 38.101-2 [3] apply.

**6.5B.3.5.1 Spurious emission band UE co-existence**

This clause specifies the requirements for the specified EN-DC, for coexistence with protected bands. Unless otherwise stated, for inter-band EN-DC configurations defined in clause 5.5B.6, no requirements for FR2 NR bands to protect E-UTRA and FR1 NR bands are applied to the constituent FR2 NR bands. Spurious emission band UE co-existence requirements for constituent E-UTRA and FR1 NR bands for the inter-band EN-DC are the same as those for the corresponding EN-DC configuration without the FR2 bands specified in 6.5B.3.2.2.

Spurious emission band UE co-existence requirement for E-UTRA single carrier and CA operation specified in clauses 6.6.3.2 and 6.6.3.2A of TS 36.101 [4] and for NR single carrier and CA operation specified in clause 6.5.3.2 of TS 38.101-1 [2] and clause 6.5.3.1, 6.5A.3.1 and 6.5D.3.1 of TS 38.101-2 [3] apply.

**Table 6.5B.3.5.1-1: Void****6.5B.4 Additional spurious emissions****6.5B.4.1 General**

These requirements are specified in terms of an additional spectrum emission requirement. Additional spurious emission requirements are signalled by the network to indicate that the UE shall meet an additional requirement for a specific deployment scenario as part of the cell handover/broadcast message.

**NOTE:** For measurement conditions at the edge of each frequency range, the lowest frequency of the measurement position in each frequency range should be set at the lowest boundary of the frequency range plus MBW/2. The highest frequency of the measurement position in each frequency range should be set at the highest boundary of the frequency range minus MBW/2. MBW denotes the measurement bandwidth defined for the protected band.

**6.5B.4.1.1 Minimum requirement (network signalled value "NS\_04")**

When "NS 04" is indicated in the cell, the power of any UE emission shall not exceed the levels specified in Table 6.5B.4.1.1-1. This requirement also applies for the frequency ranges that are less than  $F_{\text{OoB}}$  (MHz) in Table 6.6.3.1-1 from the edge of the channel bandwidth.

**Table 6.5B.4.1.1-1: Additional requirements**

Frequency band (MHz)	Channel bandwidth / Spectrum emission limit (dBm)	Measurement bandwidth
$2495 \leq f < 2496$	-13	1 % of Channel BW for contiguous BW up to 100 MHz, 1 MHz for contiguous BW > 100 MHz
$2490.5 \leq f < 2495$	-13	1 MHz
$0 < f < 2490.5$	-25	1 MHz

**6.5B.5 Transmit intermodulation for DC****6.5B.5.1 Intra-band contiguous EN-DC**

Unless otherwise stated, no transmit intermodulation requirements are applied for intra band contiguous EN DC.

### 6.5B.5.2 Intra-band non-contiguous EN-DC

Unless otherwise stated, no transmit intermodulation requirements are applied for intra band non contiguous EN DC.

### 6.5B.5.3 Inter-band EN-DC within FR1

The transmit intermodulation requirement specified in clauses 6.7.1 of TS 36.101 [4] and clauses 6.5.4 and 6.5A.4 of TS 38.101-1 [2] apply for each component carrier in E-UTRA bands and NR bands, respectively.

### 6.5B.5.3a Inter-band NE-DC within FR1

The transmit intermodulation requirement specified in clauses 6.7.1 and 6.7.1A of TS 36.101 [4] and clauses 6.5.4 and 6.5A.4 of TS 38.101-1 [2] apply for each component carrier in E-UTRA bands and NR bands, respectively.

### 6.5B.5.4 Inter-band EN-DC including FR2

Transmit intermodulation requirements specified in clause 6.7.1 and 6.7.1A of TS 36.101 [4] apply for each component carrier in E-UTRA bands.

### 6.5B.5.5 Inter-band EN-DC including both FR1 and FR2

Transmit intermodulation requirement specified in clauses 6.7.1 and 6.7.1A of TS 36.101 [4] and clauses 6.5.4 and 6.5A.4 of TS 38.101-1 [2] apply for each component carrier in E-UTRA bands and NR bands, respectively.

## 6.5C Output RF spectrum emissions for V2X operation in FR1

### 6.5C.1 Occupied bandwidth

#### 6.5C.1.1 Intra-band V2X

For intra-band V2X, the occupied bandwidth specified in clause 6.6.1G in TS 36.101 [4] and specified in clause 6.5C.1 in TS 38.101-1 [2] apply for each frequency range respectively.

#### 6.5C.1.2 inter-band V2X con-current operation

For the inter-band con-current NR V2X operation, the requirements specified in subclause 6.6.1 of TS 36.101 [4] shall apply for the E-UTRA uplink in licensed band and the requirements specified in subclause 6.5C.1 of TS 38.101-1 [2] shall apply for the sidelink in NR Band n47.

### 6.5C.2 Out-of-band emissions

#### 6.5C.2.1 Intra-band V2X

For intra-band V2X, out-of-band emissions specified in clause 6.6.2G in TS 36.101 [4] and specified in clause 6.5C.2 in TS 38.101-1 [2] apply for each frequency range respectively.

#### 6.5C.2.2 Inter-band V2X con-current operation

For the inter-band con-current NR V2X operation, the general SEM/additional SEM requirements and ACLR specified in subclause 6.6.2 of TS 36.101 [4] shall apply for the E-UTRA uplink in licensed band and the general SEM/additional SEM and ACLR requirements specified in subclause 6.5C.2 of TS 38.101-1 [2] shall apply for the sidelink in NR Band n47.



## 6.5C.3 Spurious emissions

### 6.5C.3.1 Intra-band V2X

#### 6.5C.3.1.1 General spurious emissions

For intra-band V2X, the general spurious emissions requirements specified in clause 6.6.3.1 of TS 36.101 [4] and clause 6.5C.3.1 of TS 38.101-1 [2] apply for each frequency range respectively.

#### 6.5C.3.1.2 Spurious emission band UE co-existence

For intra-band V2X, the spurious emissions band UE co-existence requirements specified in clause 6.6.3.2 of TS 36.101 [4] and clause 6.5C.3.2 of TS 38.101-1 [2] apply for each frequency range respectively.

### 6.5C.3.2 Inter-band V2X con-current operation

#### 6.5C.3.2.1 General spurious emissions

For inter-band V2X, the general spurious emissions requirements specified in clause 6.6.3.1 of TS 36.101 [4] and clause 6.5C.3.1 of TS 38.101-1 [2] apply for each frequency range respectively.

#### 6.5C.3.2.2 Spurious emission band UE co-existence

For the inter-band con-current NR V2X operation, the UE-coexistence requirements in Table 6.5C.3.2.2-1 apply for the corresponding inter-band con-current operation with transmission assigned to both E-UTRA uplink in licensed band and sidelink in NR Band n47.

**Table 6.5C.3.2.2-1: Requirements for inter-band con-current V2X operation**

V2X con-current operating band configuration	Spurious emission						
	Protected band	Frequency range (MHz)			Maximum Level (dBm)	MBW (MHz)	NOTE
V2X_20_n38	E-UTRA Band 1, 3, 8, 22, 31, 32, 33, 34, 40, 43, 50, 51, 65, 67, 68, 72, 74, 75, 76	F <sub>DL_low</sub>	-	F <sub>DL_high</sub>	-50	1	
	E-UTRA Band 42, 52	F <sub>DL_low</sub>	-	F <sub>DL_high</sub>	-50	1	1
	E-UTRA Band 20	F <sub>DL_low</sub>	-	F <sub>DL_high</sub>	-50	1	2
V2X_n71_47 –	E-UTRA Band 4, 5, 12, 13, 14, 17, 24, 26, 30, 48, 53, 66, 85	F <sub>DL_low</sub>	-	F <sub>DL_high</sub>	-50	1	
	E-UTRA Band 2, 25, 41, 70	F <sub>DL_low</sub>	-	F <sub>DL_high</sub>	-50	1	1
	E-UTRA Band 29	F <sub>DL_low</sub>	-	F <sub>DL_high</sub>	-38	1	2
	E-UTRA Band 71	F <sub>DL_low</sub>	-	F <sub>DL_high</sub>	-50	1	2
	Frequency range	5925	-	5950	-30	1	3, 4
	Frequency range	5815	-	5855	-30	1	3
<p>NOTE 1: As exceptions, measurements with a level up to the applicable requirements defined in Table 6.6.3.1-2 are permitted for each assigned E-UTRA carrier used in the measurement due to 2<sup>nd</sup>, 3<sup>rd</sup>, 4<sup>th</sup> [or 5<sup>th</sup>] harmonic spurious emissions. In case the exceptions are allowed due to spreading of the harmonic emission the exception is also allowed for the first 1 MHz frequency range immediately outside the harmonic emission on both sides of the harmonic emission. This results in an overall exception interval centred at the harmonic emission of (2MHz + N x L<sub>CRB</sub> x 180kHz), where N is 2, 3 or 4 for the 2<sup>nd</sup>, 3<sup>rd</sup> or 4<sup>th</sup> harmonic respectively. The exception is allowed if the measurement bandwidth (MBW) totally or partially overlaps the overall exception interval.</p> <p>NOTE 2: These requirements also apply for the frequency ranges that are less than F<sub>00B</sub> (MHz) in Table 6.6.3.1-1 and Table 6.6.3.1A-1 from the edge of the aggregated channel bandwidth.</p> <p>NOTE 3: Applicable when NS_XX is configured by the pre-configured radio parameters for power class 3 V2X UE.</p> <p>NOTE 4: In the frequency range x-5950MHz, SE requirement of -30dBm/MHz should be applied; where x = max (5925, fc + 15), where fc is the channel centre frequency.</p>							

## 6.5C.4 Transmit intermodulation

### 6.5C.4.1 Intra-band V2X

For intra-band V2X, transmit intermodulation requirements specified in clause 6.7.1G of TS 36.101 [4] and clause 6.5C.4 of TS 38.101-1 [2] apply for each frequency range respectively.

### 6.5C.4.2 Inter-band V2X con-current operation

For the inter-band con-current NR V2X operation, the requirements specified in subclause 6.7.1 of TS 36.101 [4] shall apply for the E-UTRA uplink in licensed band and the requirements specified in subclause 6.5C.4 of TS 38.101-1 [2] shall apply for the sidelink in NR Band n47.

## 6.6B Beam correspondence for DC

### 6.6B.1 Void

### 6.6B.2 Void

### 6.6B.3 Void

### 6.6B.4 Inter-band EN-DC including FR2

Beam correspondence requirement specified in clause 6.6 and 6.6A of TS 38.101-2 [3] apply for NR FR2 bands.

### 6.6B.5 Inter-band EN-DC including both FR1 and FR2

Beam correspondence requirement specified in clause 6.6 and 6.6A of TS 38.101-2 [3] apply for NR FR2 bands.

---

# 7 Receiver characteristics

## 7.1 General

Unless otherwise stated the receiver characteristics are specified at the antenna connector(s) of the UE for the bands operating on frequency range 1 and over the air of the UE for the bands operating on frequency range 2. The requirements for frequency range 1 and frequency range 2 can be verified separately. For the carrier in frequency range 1, requirements can be verified with NR FR2 link disabled. For the carrier in frequency range 2, requirements can be verified in OTA mode with E-UTRA connecting to the network by OTA without calibration.

The requirements defined in this clause are the extra requirements compared with the single carrier requirements defined in TS 38.101-1 [2] and TS 38.101-2 [3].

Unless otherwise stated, the UL and DL reference measurement channels are the same with the configurations specified in TS 38.101-1 [2] and TS 38.101-2 [3].

Unless otherwise stated, requirements for NR receiver written in TS 38.101-1 [2] and TS 38.101-2 [3] apply and are assumed anchor agnostic. Requirements are verified under conditions where anchor resources do not interfere NR operation.

For intra-band non-contiguous EN-DC, the output power is configured as follows:

- One E-UTRA uplink carrier with the output power set to 4dB Below  $P_{\text{CMAX,L}}$  and the NR band whose downlink is being tested has its uplink carrier output power set to minimum output power as defined in clause 6.3.1 of TS 38.101-1 [2].

- One NR uplink carrier with the output power set to 4dB Below  $P_{\text{CMAX}_L}$  and the E-UTRA band whose downlink is being tested has its uplink carrier output power set to minimum output power as defined in clause 6.3.2.1 of TS 36.101 [4].

For the additional requirements for intra-band non-contiguous EN-DC of two sub-blocks, an in-gap test refers to the case when the interfering signal is located at a negative offset with respect to the assigned lowest channel frequency of the highest sub-block and located at a positive offset with respect to the assigned highest channel frequency of the lowest sub-block.

For the additional requirements for intra-band non-contiguous EN-DC of two sub-blocks, an out-of-gap test refers to the case when the interfering signal(s) is (are) located at a positive offset with respect to the assigned channel frequency of the highest carrier frequency or located at a negative offset with respect to the assigned channel frequency of the lowest carrier frequency.

For the additional requirements for intra-band non-contiguous EN-DC of two sub-blocks with channel bandwidth larger than or equal to 5 MHz, the existing adjacent channel selectivity requirements, in-band blocking requirements (for each case), and narrow band blocking requirements apply for in-gap tests only if the corresponding interferer frequency offsets with respect to the two measured carriers satisfy the following condition in relation to the sub-block gap size  $W_{\text{gap}}$  for at least one of the E-UTRA or NR sub-blocks, so that the interferer frequency position does not change the nature of the core requirement tested:

$$W_{\text{gap}} \geq 2 \cdot |F_{\text{Interferer (offset)}}| - BW_{\text{Channel}}$$

For the E-UTRA sub-block, the  $F_{\text{Interferer (offset)}}$ , for a sub-block with a single component carrier is the interferer frequency offset with respect to carrier as specified in clause 7.5.1, clause 7.6.1 and clause 7.6.3 for the respective requirement in TS 36.101 [4] and  $BW_{\text{Channel}}$ .  $F_{\text{Interferer (offset)}}$  for the E-UTRA sub-block with two or more contiguous component carriers is the interference frequency offset with respect to the carrier adjacent to the gap is specified in clause 7.5.1A, 7.6.1A and 7.6.3A in TS 36.101 [4].

For the NR sub-block, the  $F_{\text{Interferer (offset)}}$ , for a sub-block with a single component carrier is the interferer frequency offset with respect to carrier as specified in clause 7.5.1, clause 7.6.1 and clause 7.6.3 for the respective requirement in TS 38.101-1 [2] and  $BW_{\text{Channel}}$ .

The interferer frequency offsets for adjacent channel selectivity, each in-band blocking case and narrow-band blocking shall be tested separately with a single in-gap interferer at a time.

For sub-clauses with suffix A or B: the minimum requirements for band combinations including Band n41 also apply for the corresponding band combinations with Band n90 replacing Band n41 but with otherwise identical parameters. For brevity the said band combinations with Band n90 are not listed in the tables below but are covered by this specification.

7.2 Void

7.3 Void

7.3A Reference sensitivity for CA

7.3A.1 General

For NR CA operation NR single carrier REFSENS requirements defined in TS 38.101-1 [2] and TS 38.101-2 [3] apply to all downlink bands part of NR CA configurations listed in Table 5.2A.1-1 unless sensitivity degradation is allowed as defined in clause 7.3A.

## 7.3A.2 Reference sensitivity power level for CA

### 7.3A.3 $\Delta R_{IB,c}$ for CA

For the UE which supports inter-band NR CA configuration, the minimum requirement for reference sensitivity in clause 7.3.2, 7.3A2 in TS 38.101-1 [2] and clause 7.3.2, 7.3A.2 in TS 38.101-2 [3] shall be increased by the amount given in  $\Delta R_{IB,c}$  in Tables below. Unless otherwise stated,  $\Delta R_{IB,c}$  is set to zero.

In case the UE supports more than one of band combinations for CA, SUL or DC, and an operating band belongs to more than one band combinations then

- When the operating band frequency range is  $\leq 1$ GHz, the applicable additional  $\Delta R_{IB,c}$  shall be the average value for all band combinations defined in clause 7.3A, 7.3B, 7.3C in this specification and 7.3A, 7.3B in TS 38.101-3 [3], truncated to one decimal place that apply for that operating band among the supported band combinations. In case there is a harmonic relation between low band UL and high band DL, then the maximum  $\Delta R_{IB,c}$  among the different supported band combinations involving such band shall be applied
- When the operating band frequency range is  $> 1$  GHz, the applicable additional  $\Delta R_{IB,c}$  shall be the maximum value for all band combinations defined in clause 7.3A, 7.3B, 7.3C in this specification and 7.3A, 7.3B in TS 38.101-3 [3] for the applicable operating bands.

#### 7.3A.3.1 $\Delta R_{IB,c}$ for Inter-band CA between FR1 and FR2

$\Delta R_{IB,c}$  is independent between FR1 and FR2. For inter-band CA between FR1 and FR2,  $\Delta R_{IB,c}$  for the FR1 band(s) from TS 38.101-1 [2] applies and  $\Delta R_{IB,c}$  for the FR2 NR band(s) is set to zero. Otherwise  $\Delta R_{IB,c}$  is set to zero.

**Table 7.3A.3.1-1: Void**

**Table 7.3A.3.1-2: Void**

**Table 7.3A.3.1-3: Void**

#### 7.3A.4 Void

## 7.3B Reference sensitivity level for DC

### 7.3B.1 General

For EN-DC, E-UTRA and NR single carrier, CA, and MIMO operation of REFSENS requirements defined in TS 38.101-1 [2], TS 38.101-2 [3] and TS 36.101 [4] apply to all downlink bands of EN-DC configurations listed in clause 5.5B, unless sensitivity degradation exception is allowed in this clause of this specification, clause 7.3 in TS 38.101-1 [2], clause 7.3 in TS 38.101-2 [3] or clause 7.3 in TS 36.101 [4]. Allowed exceptions specified in this clause also apply to any higher order EN-DC configuration combination containing one of the band combinations that exception is allowed for. Reference sensitivity exceptions are specified by applying maximum sensitivity degradation (MSD) into applicable REFSENS requirement. EN-DC REFSENS requirements shall be met for NR uplink transmissions using QPSK DFT-s-OFDM waveforms as defined in clause 7.3.2 [2]. Unless otherwise specified UL allocation uses the lowest SCS allowable for a given channel BW. Limits on configured maximum output power for the uplink according to clause 6.2B.4 shall apply.

In case of interband EN-DC the receiver REFSENS requirements in this clause do not apply for 1.4 and 3 MHz E-UTRA carriers. For the case of inter-band EN-DC with a single carrier per cell group and multi carrier per cell group, in addition to the E-UTRA and NR single carrier, CA, and MIMO operation of REFSENS requirements defined in TS 38.101-1 [2], TS 38.101-2 [3], and TS 36.101 [4], the REFSENS requirements specified therein also apply with both downlink carriers and both uplink carriers active unless sensitivity exceptions are allowed in this clause of this specification, clause 7.3 in TS 38.101-1 [2] or clause 7.3 in TS 36.101 [4].

NOTE: For inter-band EN-DC, the reference sensitivity requirement with both uplink carriers active is allowed to be verified for only a single inter-band EN-DC configuration per NR band.

## 7.3B.2 Reference sensitivity for DC

### 7.3B.2.1 Intra-band contiguous EN-DC

For intra-band contiguous EN-DC configurations, the reference sensitivity power level REFSENS is the minimum mean power applied to each one of the UE antenna ports at which the throughput for the carrier(s) of the E-UTRA and NR CGs shall meet or exceed the requirements for the specified E-UTRA and NR reference measurement channels. The reference sensitivity requirements apply with all uplink carriers and all downlink carriers active for EN-DC configuration and Uplink EN-DC configuration listed in Table 5.5B.2-1 and Table 5.5B.3-1, as supported by the UE. For EN-DC configurations where uplink is not available in either the MCG or the SCG or for EN-DC configurations where the UE only supports single uplink operation, reference sensitivity requirements apply with single uplink transmission. The downlink carrier(s) from the cell group with uplink shall be configured closer to the uplink operating band than any of the downlink carriers from the cell group without uplink.

Sensitivity degradation is allowed for Intra-band contiguous EN-DC configurations listed in Table 7.3B.2.1-1 the reference sensitivity is defined only for the specific uplink and downlink test points which are specified in Table 7.3B.2.1-1 and E-UTRA and NR single carrier requirements do not apply.

Table 7.3B.2.1-1: Reference sensitivity (MSD) for intra-band contiguous EN-DC

EN-DC configuration / channel allocations /MSD								
EN-DC configuration	E-UTRA/NR band	F <sub>c</sub> (UL) (MHz)	Channel bandwidth (MHz)	UL allocation (LCRB)	F <sub>c</sub> (DL) (MHz)	MSD (dB)	Duplex mode	
DC_(n)5AA	5	826.5	5	N/A	871.5	5.2	FDD	
	n5	839	20	20 (RB <sub>end</sub> = 105)	884	0		
DC_(n)5AA	5	829	10	N/A	874	5.2		
	n5	841.5	15	20 (RB <sub>end</sub> = 78)	886.5	0		
DC_(n)5AA	5	844	10	25 (RB <sub>end</sub> = 49)	889	0		
	n5	831.5	15	N/A	876.5	3.1		
DC_(n)5AA	5	831.5	5	N/A	876.5	5.2		
	n5	841.5	15	20 (RB <sub>end</sub> = 78)	886.5	0		
DC_(n)5AA	5	846.5	5	25	891.5	0		
	n5	836.5	15	N/A	881.5	1		
DC_(n)5AA	5	834	10	N/A	879	1.5		
	n5	844	10	25 (RB <sub>end</sub> = 51)	889	0		
DC_(n)5AA	5	844	10	25 (RB <sub>end</sub> = 49)	889	0		
	n5	834	10	N/A	879	1.4		
DC_(n)12AA	12	703.5	5	N/A	733.5	4.5		FDD
	n12	711	10	20 (RB <sub>end</sub> = 51)	741	0		
DC_(n)12AA	12	711	10	20 (RB <sub>end</sub> = 49)	741	0		
	n12	703.5	5	N/A	733.5	4.5		
DC_(n)71AA	71	665.5	5	5 (RB <sub>end</sub> =24)	619.5	0	FDD	
	n71	675.5	15	15 (RB <sub>start</sub> = 0)	629.5	1.8		
DC_(n)71AA	71	670.5	15	15 (RB <sub>end</sub> = 74)	624.5	0		
	n71	680.5	5	5 (RB <sub>start</sub> = 0)	634.5	1.6		
DC_(n)71AA	71	668	10	10 (RB <sub>end</sub> = 49)	622	0		
	n71	678	10	10 (RB <sub>start</sub> = 0)	632	1.7		
DC_(n)71AA	71	668	10	10 (RB <sub>start</sub> = 0)	622	17.2		
	n71	678	10	10 (RB <sub>end</sub> = 51)	632	29.4		
DC_(n)71AA	71	665.5	5	5 (RB <sub>end</sub> =24)	619.5	0	FDD	
	n71	675.5	15 <sup>1</sup>	15 (RB <sub>start</sub> = 0)	6321	2.5		
DC_(n)71AA	71	670.5	15	15 (RB <sub>end</sub> = 74)	624.5	0		
	n71	680.5	5 <sup>1</sup>	5 (RB <sub>start</sub> = 0)	6371	2.2		
DC_(n)71AA	71	668	10	10 (RB <sub>end</sub> = 49)	622	0		
	n71	678	10 <sup>1</sup>	10 (RB <sub>start</sub> = 0)	634.51	2.5		
DC_(n)71AA	71	668	10	10 (RB <sub>start</sub> = 0)	622	17.2		
	n71	678	10 <sup>1</sup>	10 (RB <sub>end</sub> = 51)	634.51	29.1		
NOTE 1: In accordance to BCS1, the NR uplink bandwidth is specified as in this table, but the corresponding NR downlink bandwidth is 5 MHz larger.								
NOTE 2: The transmitters powers shall be set to P <sub>UMAX</sub> , as defined in TS 38.101-1 [2], TS 38.101-2 [3], and TS 36.101 [4], with additional limits on configured maximum output power for the uplink according to clause 6.2B.4.								

### 7.3B.2.2 Intra-band non-contiguous EN-DC

For intra-band non-contiguous EN-DC configurations, the reference sensitivity power level REFSENS is the minimum mean power applied to each one of the UE antenna ports at which the throughput for the carrier(s) of the E-UTRA and NR CGs shall meet or exceed the requirements for the specified E-UTRA and NR reference measurement channels.

Sensitivity degradation is allowed for Intra-band non-contiguous EN-DC configurations listed in Table 7.3B.2.2-1, the reference sensitivity is defined only for the specific uplink and downlink test points which are specified in Table 7.3B.2.2-1 and E-UTRA and NR single carrier requirements do not apply.

For UE supporting Intra-band non-contiguous EN-DC configurations with single switched UL, no MSD is specified and E-UTRA and NR single carrier requirements apply.

Table 7.3B.2.2-1: Reference sensitivity (MSD) for intra-band non-contiguous EN-DC

MSD / DC bandwidth class A + A								
DC configuration	E-UTRA/NR band	F <sub>c</sub> (UL) (MHz)	Channel bandwidth (MHz)	UL allocation (LCRB)	F <sub>c</sub> (DL) (MHz)	MSD (dB)	Duplex mode	
DC_3A_n3A	3	1782.5	5	12 (RB <sub>start</sub> =0)	1877.5	0 <sup>1</sup> 1 <sup>2</sup>	FDD	
	n3	1772.5	5	12 (RB <sub>end</sub> = 24)	1867.5	0 <sup>1</sup> 1.5 <sup>2</sup>		
DC_3A_n3A	3	1782.5	5	12 (RB <sub>start</sub> = 9)	1877.5	3 <sup>1</sup> 29 <sup>2</sup>		
	n3	1752.5	5	12 (RB <sub>start</sub> = 0)	1847.5	15 <sup>1</sup> 31 <sup>2</sup>		
DC_3A_n3A	3	1782.5	5	12 (RB <sub>start</sub> = 12)	1877.5	16 <sup>1,3</sup>		
	n3	1737.5	5	12 (RB <sub>start</sub> = 0)	1832.5	33 <sup>1,3</sup>		
DC_3A_n3A	3	1737.5	5	12 (RB <sub>start</sub> = 0)	1832.5	33 <sup>1,3,4</sup>		
	n3	1782.5	5	12 (RB <sub>start</sub> = 12)	1877.5	16 <sup>1,3,4</sup>		
NOTE 1: Applicable for UE signaling with dual PA capability.								
NOTE 2: Applicable for UE signaling without dual PA capability.								
NOTE 3: The IMD also impacts Rx received blocks for UE signaling without dual PA capability but the requirements are not specified.								
NOTE 4: The test point is not applicable for BCS0 of DC_3A_n3A in Table 5.3B.1.3-1.								

### 7.3B.2.3 Inter-band EN-DC within FR1

Reference sensitivity exceptions are specified for the condition when there is uplink transmission only in the aggressor band.

#### 7.3B.2.3.1 Reference sensitivity exceptions due to UL harmonic interference for EN-DC in NR FR1

Sensitivity degradation is allowed for a band if it is impacted by UL harmonic interference from another band part of the same EN-DC configuration. Reference sensitivity exceptions for the victim band (high) are specified in Table 7.3B.2.3.1-1 with uplink configuration of the aggressor band (low) specified in Table 7.3B.2.3.1-2.

**Table 7.3B.2.3.1-1: Reference sensitivity exceptions (MSD) due to UL harmonic for EN-DC in NR FR1**



E-UTRA or NR Band / Channel bandwidth of the affected DL band / MSD													
UL band	DL band	5 MHz (dB)	10 MHz (dB)	15 MHz (dB)	20 MHz (dB)	25 MHz (dB)	30 MHz (dB)	40 MHz (dB)	50 MHz (dB)	60 MHz (dB)	80 MHz (dB)	90 MHz (dB)	100 MHz (dB)
1, 3	n77 <sup>2,13</sup>		23.9	22.1	20.9			17.9	16.8	16.0	14.8	14.3	13.8
	n77 <sup>3</sup>		1.1	0.8	0.3								
2	n48 <sup>2,13</sup>	27.3	24.4	22.4	21.2			18	17.1	16.3	15	14.5	14
	n48 <sup>3</sup>	1.9	1.4	0.9	0.4			0	0	0	0	0	0
2	n78 <sup>2,13</sup>		23.9	22.1	20.9			17.9	16.8	16.0	14.8	14.3	13.8
	n78 <sup>3</sup>		1.1	0.8	0.3								
3	n78 <sup>2,13</sup>		23.9	22.1	20.9			17.9	16.8	16.0	14.8	14.3	13.8
	n78 <sup>3</sup>		1.1	0.8	0.3								
4	n78 <sup>2,13</sup>		23.9	22.1	20.9			17.9	16.8	16.0	14.8	14.3	13.8
	n78 <sup>3</sup>		1.1	0.8	0.3								
5	n78 <sup>6,7</sup>		10.5	8.9	7.8			5.4	4.2	3.5	2.3	2.1	1.4
8	n41 <sup>8,9</sup>	N/A	13	11.3	10.1			7.0	6.1	5.5	4.3	3.9	3.5
8	n77 <sup>6,7</sup> n78 <sup>6,7</sup>		10.8	9.1	8			5.1	4.2	3.5	2.3	2.1	1.4
	n79 <sup>4,5</sup>							6.8	6.2	5.6	4.9		4.4
n8	3 <sup>14</sup>	N/A	N/A	N/A	N/A								
n8	7 <sup>8,9,10</sup>	10	7.6	6.2	5.3								
12	n66 <sup>8,9,10</sup>	10	7.5	6.2	5.5			2.4					
12	n78 <sup>4,5</sup>		10.4	8.9	7.8			4.7	3.7	3	1.7	1.2	0.7
n12	48 <sup>4,5</sup>	13	10.4	8.9	7.8								
n12	66 <sup>8,9,10</sup>	10	7.5	6.2	5.5								
18, 19	n77 <sup>4,5</sup>		10.4	8.9	7.8			4.7	3.7	3	1.7	1.2	0.7
28	n50 <sup>2,13</sup>	27.8	24.6	22.8	21.6			18.5	17.5	16.7	15.4		
	n50 <sup>3</sup>	1.9	1.4	0.9	0.4								
28	n51 <sup>2,13</sup>	27.8											
	n51 <sup>3</sup>	1.9											
28	n77 <sup>4,5</sup> n78 <sup>4,5</sup>		10.4	8.9	7.8			4.7	3.7	3	1.7	1.2	0.7
20	n38 <sup>8,9</sup>	12.9	10.3	8.4	7.4								
20	n41	12.9	10.3	8.4	7.4			5	4.3	3.9	3.1	2.7	
20	n77 <sup>6,7</sup> n78 <sup>6,7</sup>		10.8	9.1	8			6	4.0	3.2	2.0	1.5	1.0
26	n41 <sup>8,9</sup>		10.3	8.4	7.4			5	4.3	3.9	3.1	2.9	2.7
26	n77 <sup>6,7</sup> n78 <sup>6,7</sup>		10.8	9.1	8			6	4.0	3.2	2.0	1.5	1.0
n28	1 <sup>8,9,10</sup>	10.2	7.6	6.2	5.3								
n28	n75	28.1	25.3	24.0	22.8								
n28	11 <sup>2,10,13</sup>	24.8	21.8										
n28	42 <sup>4,5,10</sup>	14.1	10.4	8.9	7.9								
28	n50 <sup>2,13</sup>	27.8	24.6	22.8	21.6			18.5	17.5	16.7	15.4		
	n50 <sup>3</sup>	1.9	1.4	0.9	0.4								
n71	2 <sup>11</sup>	4.6	1.0	0.7	0.6								
	2 <sup>12</sup>	1.7	1.0	0.7	0.6								
n71	7 <sup>6,7</sup>	14.6	11.7	10.1	9								
66	n48 <sup>2,13</sup>	27.3	24.4	22.4	21.2			18	17.1	16.3	15	14.5	14
	n48 <sup>3</sup>	1.9	1.4	0.9	0.4			0	0	0	0	0	0
66	n78 <sup>2,13</sup>		23.9	22.1	20.9			17.9	16.8	16.0	14.8	14.3	13.8

E-UTRA or NR Band / Channel bandwidth of the affected DL band / MSD													
UL band	DL band	5 MHz (dB)	10 MHz (dB)	15 MHz (dB)	20 MHz (dB)	25 MHz (dB)	30 MHz (dB)	40 MHz (dB)	50 MHz (dB)	60 MHz (dB)	80 MHz (dB)	90 MHz (dB)	100 MHz (dB)
	n78 <sup>3</sup>		1.1	0.8	0.3								
n66	48 <sup>2,13</sup>	27.3	24.4	22.4	21.2								
	48 <sup>3</sup>	1.9	1.4	0.9	0.4								
71	n78 <sup>4,5</sup>		10.4	8.9	7.8			4.7	3.7	3	1.7	1.2	0.7

- NOTE 1: Void
- NOTE 2: The requirements should be verified for UL EARFCN or NR ARFCN of the aggressor (lower) band (superscript LB) such that  $f_{UL}^{LB} = \lfloor f_{DL}^{HB} / 0.2 \rfloor \cdot 0.1$  in MHz and  $F_{UL\_low}^{LB} + BW_{Channel}^{LB} / 2 \leq f_{UL}^{LB} \leq F_{UL\_high}^{LB} - BW_{Channel}^{LB} / 2$  with carrier frequency in the victim (higher) band in MHz and the channel bandwidth configured in the lower band.
- NOTE 3: The requirements are only applicable to channel bandwidths no larger than 20 MHz and with a carrier frequency at  $\pm (20 + BW_{Channel}^{HB} / 2)$  MHz offset from  $2f_{UL}^{LB}$  in the victim (higher) band) with  $F_{UL\_low}^{LB} + BW_{Channel}^{LB} / 2 \leq f_{UL}^{LB} \leq F_{UL\_high}^{LB} - BW_{Channel}^{LB} / 2$ , whereand  $BW_{Channel}^{HB}$  are the channel bandwidths configured in the aggressor (lower) and victim (higher) bands in MHz, respectively.
- NOTE 4: These requirements apply when there is at least one individual RE within the uplink transmission bandwidth of the aggressor (lower) band for which the 5<sup>th</sup> transmitter harmonic is within the downlink transmission bandwidth of a victim (higher) band.
- NOTE 5: The requirements should be verified for UL EARFCN of the aggressor (lower) band (superscript LB) such that  $f_{UL}^{LB} = \lfloor f_{DL}^{HB} / 0.5 \rfloor \cdot 0.1$  in MHz and  $F_{UL\_low}^{LB} + BW_{Channel}^{LB} / 2 \leq f_{UL}^{LB} \leq F_{UL\_high}^{LB} - BW_{Channel}^{LB} / 2$  with carrier frequency in the victim (higher) band in MHz and the channel bandwidth configured in the lower band.
- NOTE 6: These requirements apply when there is at least one individual RE within the uplink transmission bandwidth of the aggressor (lower) band for which the 4<sup>th</sup> transmitter harmonic is within the downlink transmission bandwidth of a victim (higher) band.
- NOTE 7: The requirements should be verified for UL EARFCN of the aggressor (lower) band (superscript LB) such that  $f_{UL}^{LB} = \lfloor f_{DL}^{HB} / 0.4 \rfloor \cdot 0.1$  in MHz and  $F_{UL\_low}^{LB} + BW_{Channel}^{LB} / 2 \leq f_{UL}^{LB} \leq F_{UL\_high}^{LB} - BW_{Channel}^{LB} / 2$  with carrier frequency in the victim (higher) band in MHz and the channel bandwidth configured in the lower band.
- NOTE 8: These requirements apply when there is at least one individual RE within the uplink transmission bandwidth of the aggressor (lower) for which the 3<sup>rd</sup> transmitter harmonic is within the downlink transmission bandwidth of a victim (higher) band.
- NOTE 9: The requirements should be verified for UL EARFCN of the aggressor (lower) band (superscript LB) such that  $f_{UL}^{LB} = \lfloor f_{DL}^{HB} / 0.3 \rfloor \cdot 0.1$  in MHz and  $F_{UL\_low}^{LB} + BW_{Channel}^{LB} / 2 \leq f_{UL}^{LB} \leq F_{UL\_high}^{LB} - BW_{Channel}^{LB} / 2$  with  $f_{DL}^{HB}$  the carrier frequency in the victim (higher) band in MHz and  $BW_{Channel}^{LB}$  the channel bandwidth configured in the low band.
- NOTE 10: Applicable for the operations with 2 or 4 antenna ports supported in the band with carrier aggregation configured.
- NOTE 11: These requirements apply when the lower edge frequency of the 5 MHz uplink channel in Band 71 is located at or below 668 MHz and the downlink channel in Band 2 is located with its upper edge at 1990 MHz.
- NOTE 12: These requirements apply when the lower edge frequency of the 10 MHz, 15 MHz, or 20 MHz uplink channel in Band 71 is located at or below 668 MHz and the downlink channel in Band 2 is located with its upper edge at 1990 MHz.
- NOTE 13: These requirements apply when there is at least one individual RE within the uplink transmission bandwidth of the aggressor (lower) band for which the 2<sup>nd</sup> transmitter harmonic is within the downlink transmission bandwidth of a victim (higher) band and a range  $\Delta F_{HD}$  above and below the edge of this downlink transmission bandwidth. The value  $\Delta F_{HD}$  depends on the EN-DC band combination:  $\Delta F_{HD} = 10$  MHz for DC\_1\_n77, DC\_2\_n48, DC\_2\_n77, DC\_48\_n66, DC\_66\_n48, DC\_66\_n77, DC\_3\_n77, DC\_3\_n78, DC\_11\_n28 and DC\_28\_n50
- NOTE 14: No requirements apply when there is at least one individual RE within the uplink transmission bandwidth of the low band for which the 2<sup>nd</sup> transmitter harmonic is within the downlink transmission bandwidth of the high band. The reference sensitivity for all active downlink component carriers is only verified when this is not the case (the requirements specified in clause 7.3.1 from TS 36.101-1 apply unless otherwise specified).

**Table 7.3B.2.3.1-2: Uplink configuration for reference sensitivity exceptions due to UL harmonic interference for EN-DC in NR FR1**

E-UTRA or NR Band / Channel bandwidth of the affected DL band / UL RB allocation of the aggressor band													
UL band	DL band	5 MHz (LCRB)	10 MHz (LCRB)	15 MHz (LCRB)	20 MHz (LCRB)	25 MHz (LCRB)	30 MHz (LCRB)	40 MHz (LCRB)	50 MHz (LCRB)	60 MHz (LCRB)	80 MHz (LCRB)	90 MHz (LCRB)	100 MHz (LCRB)
1	n77		25	36	50			100	100	100	100	100	100
2	n48	12	25	36	50			100	100	100	100	100	100
2	n78		25	36	50			50	50	50	50	50	50
3	n77, n78		25	36	50			50	50	50	50	50	50
4	n78		25	36	50			100	100	100	100	100	100
5	n78	8	16	25	25			25	25	25	25	25	25
8	n41		16	25	25			25	25	25	25	25	25
8	n77 n78		16	25	25			25	25	25	25	25	25
8	n79							25	25	25	25		25
n8	7	8	16	25	25								
12	n66	8	16	20	20			20					
12	n78		10	15	20			25	25	25	25	25	25
n12	48	5	10	15	20								
n12	66	8	16	20	20								
18	n77		16	25	25			25	25	25	25	25	25
19	n77		16	25	25			25	25	25	25	25	25
20	n38	8	16	25	25								
20	n41	8	16	25	25			25	25	25	25	25	
20	n77, n78		16	25	25			25	25	25	25	25	25
26	n41		16	25	25			25	25	25	25	25	25
26	n77, n78		16	25	25			25	25	25	25	25	25
n28	1	8	16	25	25								
n28	n75	8	16	25	25								
28	n50	12	25	25	25			25	25	25	25		
28	n51	12											
n28	11	12	25										
n28	42	5	10	15	20								
28	n50	12	25	25	25			25	25	25	25		
28	n77, n78		10	15	20			25	25	25	25	25	25
66	n48	12	25	36	50			100	100	100	100	100	100
66	n78		25	36	50			100	100	100	100	100	100
n66	48	12	25	36	50								
n71	2	25 <sup>4</sup> 8 <sup>5</sup>	25 <sup>4</sup> 8 <sup>5</sup>	20 <sup>4</sup> 8 <sup>5</sup>	20 <sup>4</sup> 8 <sup>5</sup>								
n71	7	8	16	25	25								
71	n78		10	15	20			25	25	25	25	25	25

NOTE 1: The UL configuration applies regardless of the channel bandwidth of the UL band unless the UL resource blocks exceed that specified in Table 7.3.1-2 in TS 36.101 [4] or Table 7.3.2-3 in TS 38.101-1 [2] for the uplink bandwidth in which case the allocation according to Table 7.3.1-2 in TS 36.101 [4] or Table 7.3.2-3 in TS 38.101-1 [2] applies

NOTE 2: Void

NOTE 3: Unless stated otherwise, UL resource blocks shall be centred within the transmission bandwidth configuration for the channel bandwidth.

NOTE 4: These requirements apply when the lower edge frequency of the 5 MHz uplink channel in Band 71 is located at or below 668 MHz and the downlink channel in Band 2 is located with its upper edge at 1990 MHz.

NOTE 5: These requirements apply when the lower edge frequency of the 10 MHz, 15 MHz, or 20 MHz uplink channel in Band 71 is located at or below 668 MHz and the downlink channel in Band 2 is located with its upper edge at 1990 MHz.

7.3B.2.3.2 Reference sensitivity exceptions due to receiver harmonic mixing for EN-DC in NR FR1

Sensitivity degradation is allowed for a band if it is impacted by receiver harmonic mixing due to another band part of the same EN-DC configuration. Reference sensitivity exceptions for the victim band (low) are specified in Table 7.3B.2.3.2-1 with uplink configuration of the aggressor band (high) specified in Table 7.3B.2.3.2-2.

**Table 7.3B.2.3.2-1: Reference sensitivity exceptions (MSD) due to receiver harmonic mixing for EN-DC in NR FR1**

**DC in NR FR1**

E-UTRA or NR Band / Channel bandwidth of the affected DL band / MSD												
UL band	DL band	5 MHz (dB)	10 MHz (dB)	15 MHz (dB)	20 MHz (dB)	25 MHz (dB)	40 MHz (dB)	50 MHz (dB)	60 MHz (dB)	80 MHz (dB)	90 MHz (dB)	100 MHz (dB)
1	n71 <sup>4</sup>	26.8	23.6	21.2	15.6							
2	n71 <sup>4</sup>	26.8	23.6	21.2	15.6							
n38	5 <sup>9</sup>	N/A	N/A									
n40	28 <sup>4</sup>	37.8	34.8	33	30.3							
n41	26 <sup>4</sup>	24.3	24.3	22.5	N/A							
n77	3	5.7	4.0	3.0	2.7							
n78	3	5.7	4.0	3.0	2.7							
n77	7 <sup>8</sup>	10.4	10.4	10.4	10.4							
n77	41 <sup>8</sup>	10.4	10.4	10.4	10.4							
n77	28 <sup>2</sup>	28	25	23.2	22							
n78	40 <sup>8</sup>	10.4	10.4	10.4	10.4							
n78	41 <sup>8</sup>	10.4	10.4	10.4	10.4							
n79	11 <sup>4</sup>	39.3	36.3	34.5								
n79	19 <sup>2</sup>	29.5	26.5	24.7								
n79	21 <sup>4</sup>	39.3	36.3	34.5								
n79	26 <sup>2</sup>	27	24	22.2								

NOTE 1: These requirements apply when there is at least one individual RE within the uplink transmission bandwidth of the aggressor (higher) band for which the mixing product due to harmonic of victim (lower) band LO with leakage of aggressor (higher) band is within the downlink transmission bandwidth of a victim (lower) band.

NOTE 2: The requirements should be verified for DL EARFCN of the victim (lower) band (superscript LB) such that  $f_{DL}^{LB} = \lfloor f_{UL}^{HB} / 0.5 \rfloor \cdot 0.1$  with  $f_{DL}^{LB}$  the DL carrier frequency in the lower band and  $f_{UL}^{HB}$  the UL carrier frequency in the higher band, both in MHz.

NOTE 3: Void.

NOTE 4: The requirements should be verified for DL EARFCN or NR ARFCN of the victim (lower) band (superscript LB) such that  $f_{DL}^{LB} = \lfloor f_{UL}^{HB} / 0.3 \rfloor \cdot 0.1$  with  $f_{DL}^{LB}$  the DL carrier frequency in the lower band and  $f_{UL}^{HB}$  the UL carrier frequency in the higher band, both in MHz.

NOTE 5: Void

NOTE 6: Void

NOTE 7: Void

NOTE 8: The requirements should be verified for DL EARFCN of the victim (lower) band (superscript LB) such that  $f_{DL}^{LB} = \lfloor f_{UL}^{HB} / 0.15 \rfloor \cdot 0.1$  with  $f_{DL}^{LB}$  the DL carrier frequency in the lower band and  $f_{UL}^{HB}$  the UL carrier frequency in the higher band, both in MHz.

NOTE 9: No requirements apply for the case that there is at least one individual RE within the uplink transmission bandwidth of the relative higher band and when the frequency range of relative higher band's uplink channel bandwidth or uplink 1<sup>st</sup> adjacent channel bandwidth is fully or partially overlapped with the 3 times of the frequency range of the relative lower band's downlink channel bandwidth. The reference sensitivity is only verified when this is not the case.

**Table 7.3B.2.3.2-2: Uplink configuration for reference sensitivity exceptions due to receiver harmonic mixing for EN-DC in NR FR1**

E-UTRA or NR Band / SCS / Channel bandwidth of the affected DL band / UL RB allocation of the aggressor band													
UL band	DL band	SCS of UL band (kHz)	5 MHz (LCRB)	10 MHz (LCRB)	15 MHz (LCRB)	20 MHz (LCRB)	25 MHz (LCRB)	40 MHz (LCRB)	50 MHz (LCRB)	60 MHz (LCRB)	80 MHz (LCRB)	90 MHz (LCRB)	100 MHz (LCRB)
1	n71	15	25	50	75	100							
2	n71	15	25	50	50	50							
n40	28	15	25	50	75	100							
n41	26	15	25	50	75								
n77	3	15	25	50	75	100							
n78	3	15	25	50	75	100							
n77	7	15	12	25	36	50							
n77	28	15	25	50	75	100							
n77	41	15	12	25	36	50							
n78	40	15	12	25	36	50							
n78	41	15	12	25	36	50							
n79	11	15	25	50	75								
n79	19	15	25	50	75								
n79	21	15	25	50	75								
n79	26	15	25	50	75								

NOTE 1: Void  
NOTE 2: Void  
NOTE 3: The UL configuration applies regardless of the channel bandwidth of the UL band. UL resource blocks allocation in the table shall be further limited to that specified in Table 7.3.1-2 in TS 36.101 [4] or Table 7.3.2-3 in TS 38.101-1 [2].  
NOTE 4: Unless otherwise stated, the UL resource blocks allocation is applied at the center of the channel bandwidth. The note applies to the entire table

7.3B.2.3.3 Void

7.3B.2.3.4 Reference sensitivity exceptions due to cross band isolation for EN-DC in NR FR1

Sensitivity degradation is allowed for a band if it is impacted by UL of another band part of the same EN-DC configuration due to cross band isolation issues. Reference sensitivity exceptions for the victim band are specified in Table 7.3B.2.3.4-1 with uplink configuration of the aggressor band specified in Table 7.3B.2.3.4-2.

**Table 7.3B.2.3.4-1: Reference sensitivity exceptions (MSD) due to cross band isolation for EN-DC in NR FR1**

UL band	DL band	E-UTRA or NR Band / Channel bandwidth of the affected DL band / MSD											
		5 MHz (dB)	10 MHz (dB)	15 MHz (dB)	20 MHz (dB)	25 MHz (dB)	30 MHz (dB)	40 MHz (dB)	50 MHz (dB)	60 MHz (dB)	80 MHz (dB)	90 MHz (dB)	100 MHz (dB)
n1 <sup>3</sup>	3		2.3	2	1.8								
n1	40	6.6	6.6	6.6	6.6								
1 <sup>3</sup>	n3	3	2.2	1.9	1.7	1.6	1.5						
1	n40	6.6	6.6	6.6	6.6	6.6	6.6	6.6	6.6	6.6	6.6	6.6	6.6
1	n41		6.1	6.1	6.1			6.1	6.1	6.1	6.1	6.1	6.1
n3	11	6.4	6.1										
3	n41		0.7	0.7	0.7			0.7	0.7	0.7	0.7	0.7	0.7
3	n51	6.4											
30	n66	8.3	8.3	8.3	8.3			8.3					
n3	41	0.7	0.7	0.7	0.7								
n5	28	4.5	3	2.2	0.3								
7	n40	3.7	3.4	3.2	3.1			3.1	3.1	3.1	3.1		
n38	1	1.9	1.9	1.9	1.9								
n38	2	0.6	0.6	0.6	0.6								
n38	4	1.9	1.9	1.9	1.9								
n38	66	1.9	1.9	1.9	1.9								
n40	1	8.3	8.3	8.3	8.3								
n41	4	3.5	3.5	3.5	3.5								
40	n1	8.3	8.3	8.3	8.3								
n40	7	3.7	3.7	3.7	3.7								
n41	1	9.1	9.1	9.1	9.1								
n41	2	0.6	0.6	0.6	0.6								
n41	3	0.6	0.6	0.6	0.6								
41	n3	0.6	0.6	0.6	0.6	0.6	0.6						
n41	66 <sup>1</sup>	3.5	3.5	3.5	3.5								
n41	25	0.6	0.6	0.6	0.6								
n50	3	2.5	1.9	1.6	1.5								
n77	7 <sup>1</sup>	4.5	4.5	4.5	4.5								
n77	41 <sup>1</sup>	4.5	4.5	4.5	4.5								
41	n77		8.3	8.3	8.3			6.3	5.3	4.5	4.0	3.9	3.8
n78	7 <sup>1</sup>	4.5	4.5	4.5	4.5								
n78	38	3.3	3.3	3.3	3.3								
n78	41 <sup>1</sup>	4.5	4.5	4.5	4.5								
n78	46				7								
41	n78		8.3	8.3	8.3			6.3	5.3	4.5	4.0	3.9	3.8
n84 <sup>3</sup>	3	3	2.3	2	1.8								

NOTE 1: Applicable only when harmonic mixing MSD for this combination is not applied.

NOTE 2: The B41 requirements are modified by -0.5dB when carrier frequency of the assigned E-UTRA channel bandwidth is within 2515 – 2690 MHz.

NOTE 3: These requirements apply when the uplink is active in Band n1, n84 and the separation between the lower edge of the uplink channel in Band n1, n84 and the upper edge of the downlink channel in Band 3 is < 60 MHz. For each channel bandwidth in Band 3, the requirement applies regardless of channel bandwidth in Band n1, n84.

NOTE 4: The DL victim band should be configured using the lowest SCS that is compatible with the highest CBW for which an MSD is specified

**Table 7.3B.2.3.4-2: Uplink configuration for reference sensitivity exceptions due to cross band isolation for EN-DC in NR FR1**

E-UTRA or NR Band / SCS / Channel bandwidth of the affected DL band / UL RB allocation of the agressor band														
UL band	DL band	SCS of UL band (kHz)	5 MHz (L <sub>CRB</sub> )	10 MHz (L <sub>CRB</sub> )	15 MHz (L <sub>CRB</sub> )	20 MHz (L <sub>CRB</sub> )	25 MHz (L <sub>CRB</sub> )	30 MHz (L <sub>CRB</sub> )	40 MHz (L <sub>CRB</sub> )	50 MHz (L <sub>CRB</sub> )	60 MHz (L <sub>CRB</sub> )	80 MHz (L <sub>CRB</sub> )	90 MHz (L <sub>CRB</sub> )	100 MHz (L <sub>CRB</sub> )
n1	3	15	25	25	25	25								
n1	40	15	25	50	75	100								
1	n3	15	25	25	25	25	25	25						
1	n40	15	25	50	75	100	100	100	100	100	100	100		
1	n41	15		100	100	100			100	100	100	100	100	100
n3	11	15	25	50										
3	n41	15		50	50	50			50	50	50	50	50	50
3	n51	15	25											
30	n66	15	25	25	25	25			25					
n3	41	15	25	50 <sup>2</sup>	50 <sup>2</sup>	50 <sup>2</sup>								
n5	28	15	25	25	20	20								
7	n40	15	25	50	75	75			100	100	100	100		
n38	1	15	100	100	100	100								
n38	2	15	100	100	100	100								
n38	4	15	100	100	100	100								
n38	66	15	100	100	100	100								
40	n1	15	25	50	75	100								
n40	1	15	25	50	75	100								
n40	7	30	216	216	216	216								
n41	1	30	128	128	128	128								
n41	2	30	160	160	160	160								
n41	3	30	160	160	160	160								
41	n3	15	25	50	75	100	100	100						
n41	4	30	128	128	128	128								
n41	25	30	160	160	160	160								
n41	66	30	128	128	128	128								
n50	3	30	160	160	160	160								
n77	7	30	270	270	270	270								
n77	41	30	270	270	270	270								
41	n77	15		100	100	100			100	100	100	100	100	100
n78	7	30	270	270	270	270								
n78	38	30	270	270	270	270								
n78	41	30	270	270	270	270								
n78	46	30				270								
41	n78	15		100	100	100			100	100	100	100	100	100
n84	3	15	25	25	25	25								

NOTE 1: The UL configuration applies regardless of the channel bandwidth of the UL band. UL resource blocks allocation in the table shall be further limited to that specified in Table 7.3.1-2 in TS 36.101 [4] or Table 7.3.2-3 in TS 38.101-1 [2].

NOTE 2: The UL resource blocks shall be located as close as possible to the downlink operating band but confined within the transmission bandwidth configuration for the channel bandwidth.

NOTE 3: When the maximum UL RB allocation "L<sub>CRB</sub>" value is less than the maximum transmission bandwidth configuration "N<sub>RB</sub>" defined in Table 5.3.2-1 in 38.101-1 [2] for the specified UL band SCS, the UL band should be configured using the lowest CBW that is compatible with the maximum specified L<sub>CRB</sub> value.



### 7.3B.2.3.5 MSD for intermodulation interference due to dual uplink operation for EN-DC in NR FR1

For EN-DC configurations in NR FR1 the UE may indicate capability of not supporting simultaneous dual uplink operation due to possible intermodulation interference overlapping in frequency to its own primary downlink channel bandwidth if

- the intermodulation order is 2;
- the intermodulation order is 3 when both operating bands are between 450 MHz – 960 MHz or between 1427 MHz – 2690 MHz

In the case for EN-DC configurations in NR FR1 for which the intermodulation products caused by dual uplink operation do not interfere with its own primary downlink channel bandwidth as defined in Annex I the UE is mandated to operate in dual and triple uplink mode.

For EN-DC configurations in NR FR1 with uplink and downlink assigned to E-UTRA and NR FR1 bands given in Table 7.3B.2.3.5.1-1, Table 7.3B.2.3.5.2-0 and Table 7.3B.2.3.5.2-1 the reference sensitivity is defined only for the specific uplink and downlink test points specified in Table 7.3B.2.3.5.1-1, Table 7.3B.2.3.5.2-0 and Table 7.3B.2.3.5.2-1. For these test points the reference sensitivity levels specified in clause 7.3.1 in TS 36.101 [4] and 7.3.2 of TS 38.101-1 [2] for the corresponding channel bandwidths or in clause 7.3.1 of TS 36.101 [4] are relaxed by the amount of the parameter MSD given in Table 7.3B.2.3.5.1-1, Table 7.3B.2.3.5.2-0 and Table 7.3B.2.3.5.2-1.

The throughput on each of the CGs shall be  $\geq 95\%$  of the maximum throughput of the respective reference measurement channels as specified in Annex A of TS 38.101-1 [2] and Annex A of TS 36.101 [4], with parameters specified in Table 7.3B.2.3.5.1-1, Table 7.3B.2.3.5.2-0 and Table 7.3B.2.3.5.2-1 with dual UL transmissions overlapping in time unless otherwise stated.

7.3B.2.3.5.1 MSD test points for intermodulation interference due to dual uplink operation for EN-DC in NR FR1 involving two bands

**Table 7.3B.2.3.5.1-1: MSD test points for PCell due to dual uplink operation for EN-DC in NR FR1 (two bands)**

NR or E-UTRA Band / Channel bandwidth / N <sub>RB</sub> / MSD							
EN-DC Configuration	EUTRA or NR band	UL F <sub>c</sub> (MHz)	UL/DL BW (MHz)	UL L <sub>CRB</sub>	DL F <sub>c</sub> (MHz)	MSD (dB)	IMD order
DC_1_n3	1	1950	5	25	2140	23	IMD3
	n3	1760	5	25	1855	N/A	N/A
DC_1A-n5A	1	1965	5	25	2155	6	IMD4
	n5	836.5	5	25	876.5	N/A	N/A
DC_1A_n8A	1	1965	5	25	2155	6.0	IMD4
	n8	887.5	5	25	932.5	N/A	N/A
DC_1A_n71A	1	1958	5	25	2148	N/A	N/A
DC_1A_n71B	n71	668	5	25	622	15.1	IMD3
DC_1A_n77A, DC_1A_SUL_n77A- n84A, DC_1A_n77(2A),	1	1950	5	25	2140	29.8	IMD2 <sup>3</sup>
	n77	4090	10	50	4090	32.5 <sup>4</sup>	
DC_1A_n77A, DC_1A_SUL_n77A- n84A, DC_1A_n77(2A), DC_1A_n78A, DC_1A_SUL_n78A- n84A, DC_1A_n78(2A)	1	1950	5	25	2140	8.0	IMD4 <sup>3</sup>
	n77	3710	10	50	3710	10.7 <sup>4</sup>	
DC_2A_n48A	2	1852.5	5	25	1932.5	12	IMD4
	n48	3625	20	100	3625	N/A	N/A
DC_2A_n66A, DC_2A-2A_n66A	2	1855	5	25	1935	20	IMD3
	n66	1775	5	25	2175	N/A	N/A
DC_2A_n66A, DC_2A-2A_n66A	2	1883.3	5	25	1963.3	N/A	N/A
	n66	1750	5	25	2150	4	IMD5
DC_2A_n78A DC_2A_n78(2A)	2	1855	5	25	1935	26	IMD2 <sup>3</sup>
	n78	3790	10	50	3790	28.7 <sup>4</sup>	
DC_2A_n78A DC_2A_n78(2A)	2	1885	5	25	1965	8.0	IMD4 <sup>3</sup>
	n78	3690	10	50	3690	10.7 <sup>4</sup>	
DC_3_n1	3	1760	5	25	1855	N/A	N/A
	n1	1950	5	25	2140	23	IMD3
DC_3_n5	3	1771	10	50	1866	4	IMD4
	n5	838	5	25	883	N/A	N/A
	3	1721	10	50	1816	N/A	N/A
DC_3A_n7A DC_3C_n7A	n5	838	5	25	883	24	IMD2 <sup>3</sup>
	3	1730	5	25	1825	N/A	N/A
DC_3_n8	n7	2535	10	50	2655	10.2	IMD4
	n8	900	5	25	945	8	IMD4 <sup>3</sup>
	3	1755	10	50	1850	N/A	N/A
	n8	897.5	5	25	942.5	N/A	N/A
DC_3A-n20A	3	1747.5	10	50	1842.5	6.4	IMD5
	3	1775	5	25	1870	4	IMD4
	n20	840	5	25	799	N/A	N/A
	3	1735	5	25	1830	N/A	N/A
DC_3A_n38A	n20	847	5	25	806	9	IMD4
	3	1713	5	25	1808	8.2	IMD4
DC_3A_n41A DC_3C_n41A DC_3A_SUL_n41A- n80A, DC_3C_SUL_n41A- n80A	n38	2617	5	25	2617	N/A	N/A
	3	1740	5	25	1835	8.2	IMD4
	n41	2657.5	10	50	2657.5	N/A	N/A
	3	1740	5	25	1835	26	IMD2 <sup>3</sup>
					28.7 <sup>4</sup>		

NR or E-UTRA Band / Channel bandwidth / N <sub>RB</sub> / MSD							
EN-DC Configuration	EUTRA or NR band	UL F <sub>c</sub> (MHz)	UL/DL BW (MHz)	UL L <sub>CRB</sub>	DL F <sub>c</sub> (MHz)	MSD (dB)	IMD order
DC_3A_n77A, DC_3A_n77(2A), DC_3A_SUL_n77A-n80A, DC_3A_n78A, DC_3A_SUL_n78A-n80A, DC_3A_n78(2A), DC_3C_n78A DC_3C_n78(2A)	n77, n78	3575	10	50	3575	N/A	N/A
DC_3A_n77A, DC_3A_n77(2A), DC_3A_SUL_n77A-n80A, DC_3A_n78A, DC_3A_SUL_n78A-n80A, DC_3A_n78(2A), DC_3C_n78A DC_3C_n78(2A)	3	1765	5	25	1860	8.0 10.7 <sup>4</sup>	IMD4 <sup>3</sup>
	n77, n78	3435	10	50	3435	N/A	N/A
DC_5_n7	n7	2547	10	50	2667	N/A	N/A
	5	834	5	25	879	12	IMD3 <sup>3</sup>
DC_5_n38	5	844	5	25	889	12	IMD3 <sup>3</sup>
	n38	2577	10	50	2577	N/A	N/A
DC_5A_n66A	5	838	5	25	883	30	IMD2 <sup>3</sup>
	n66	1721	5	25	2121	N/A	N/A
DC_5A_n78A DC_5A_n78(2A)	5	844	5	25	889	8.3	IMD4
	n78	3421	10	50	3421	N/A	N/A
DC_7_n3	7	2535	10	50	2655	13	IMD4
	n3	1730	5	25	1825	N/A	N/A
DC_7_n5	7	2547	10	50	2667	N/A	N/A
	n5	834	5	25	879	12	IMD3 <sup>3</sup>
DC_7A_n20A	7	2512	10	50	2632	N/A	N/A
	n20	851	5	25	810	12	IMD3 <sup>3</sup>
DC_7_n40	7	2510	5	25	2630	23	IMD3
	n40	2390	5	25	2390	N/A	N/A
DC_7A_n66A DC_7A-7A_n66A DC_7C_n66A	7	2535	10	50	2655	15	4 <sup>th</sup> IMD
	n66	1730	5	25	2130	N/A	N/A
DC_7A_n77A	7	2540	5	25	2660	7.1	IMD4
	n77	3870	10	50	3870	N/A	N/A
DC_8A_n1A	8	887.5	5	25	932.5	N/A	N/A
	n1	1965	5	25	2155	6	IMD4
DC_8A_n3A	8	900	5	25	945	8	IMD4 <sup>3</sup>
	n3	1755	10	50	1850	N/A	N/A
	8	897.5	5	25	942.5	N/A	N/A
	n3	1747.5	10	50	1842.5	6.4	IMD5
DC_8A_n20A	n20	849.5	5	25	808.5	25	IMD3 <sup>3</sup>
	8	890.5	5	25	935.5	N/A	N/A
	n20	847.5	5	25	806.5	N/A	N/A
	8	892.5	5	25	937.5	25	IMD3 <sup>3</sup>
DC_8A_n41A DC_8A_SUL_n41A-n81A	8	882.5	5	25	927.5	12.1	IMD3 <sup>3</sup>
	n41	2685	10	50	2685	N/A	N/A
DC_8A_n77A, DC_8A_n78A, DC_8A_SUL_n78A-n81A	8	897.5	5	25	942.5	8.3	IMD4
	n77, n78	3635	10	50	3635	N/A	N/A
DC_8A_n79A, DC_8A-n79C, DC_8A_SUL_n79A-n81A	8	897.5	5	25	942.5	4.8	IMD5
	n79	4532.5	40	216	4532.5	N/A	N/A
DC_11A_n28A	11	1430.5	5	25	1478.5	N/A	N/A

NR or E-UTRA Band / Channel bandwidth / N <sub>RB</sub> / MSD							
EN-DC Configuration	EUTRA or NR band	UL F <sub>c</sub> (MHz)	UL/DL BW (MHz)	UL L <sub>CRB</sub>	DL F <sub>c</sub> (MHz)	MSD (dB)	IMD order
	n28	743	5	25	798	10.4	IMD4
DC_12_n78	12	710	5	25	740	5.5	IMD5
	n78	3580	10	50	3580	N/A	N/A
DC_13_n5	13	783	5	25	752	N/A	N/A
	n5	828	5	25	873	25	IMD3
DC_13A_n7A DC_13A_n7(2A)	13	784.5	5	25	753.5	N/A	N/A
	n7	2520	40	216	2640	2.5	IMD5
DC_18A_n3A	18	823	5	25	868	N/A	N/A
	n3	1721	5	25	1816	4	IMD4
DC_20A_n3A	20	840	5	25	799	N/A	N/A
	n3	1775	5	25	1870	4	IMD4
	20	847	5	25	806	9	IMD4
	n3	1735	5	25	1830	N/A	N/A
DC_20A_n38A	20	N/A	N/A	N/A	N/A	N/A	IMD5
	n38	N/A	N/A	N/A	N/A	N/A	N/A
DC_20_n7	20	851	5	25	810	12	IMD3 <sup>3</sup>
	n7	2512	10	50	2632	N/A	N/A
DC_20A_n8A	20	849.5	5	25	808.5	25	IMD3
	n8	892.5	5	25	937.5	25	IMD3
DC_20_n41	20	851	5	25	810	12.1	IMD3
	n41	2512	10	50	2512	N/A	N/A
DC_20_n41	20	841	5	25	800	8.1	IMD5
	n41	2564	10	50	2564	N/A	N/A
DC_20A_n77A, DC_20A_n78A, DC_20A_n78(2A), DC_20A_SUL_n78A- n82A	20	850	5	25	809	11	IMD4
	n77, n78	3359	10	50	3359	N/A	N/A
DC_20A_n77A	20	840	5	25	799	6.5	IMD5
	n77	4159	10	50	4159	N/A	N/A
DC_21A_n79A	21	1457.5	5	25	1505.5	18.4	IMD3
	n79	4420.5	40	216	4420.5	N/A	N/A
DC_26A_n41A	26	839	5	25	884	15.6	IMD3 <sup>3</sup>
	n41	2562	10	50	2562	N/A	N/A
DC_28_n50	28	730	10	50	775	15.3	IMD 2
	n50	1500	10	50	1500	N/A	N/A
	28	740	10	50	785	6	IMD 4
	n50	1500	10	50	1500	N/A	N/A
	28	740	10	50	785	0.5	IMD 5
	n50	1500	10	50	1500	N/A	N/A
DC_28A_n51A	28	742.3	5	25	797.3	5	IMD4
	n51	1429.5	5	25	1429.5	N/A	N/A
DC_26A_n77A, DC_26A_n78A	26	836.5	5	25	881.5	11.1	IMD4
	n77, n78	3391	10	50	3391	N/A	N/A
DC_28A_n77A, DC_28A_n78A, DC_28A_n78(2A), DC_28A_SUL_n78A- n83A	28	705.5	5	25	760.5	5.5	IMD5
	n77, n78	3582.5	10	50	3582.5	N/A	N/A
DC_41A_n3A DC_41C_n3A	n3	1740	5	25	1835	8.2	IMD4
	41	2657.5	5	25	2657.5	N/A	N/A
DC_42_n28	42	3582.5	10	50	3582.5	N/A	N/A
	n28	705.5	5	25	760.5	5.5	IMD5
DC_48A_n12A	48	3557.5	10	50	3557.5	N/A	N/A
	n12	705.5	5	25	735.5	5.5	IMD5
DC_48A_n66A	48	3630	20	100	3630	N/A	N/A
	n66	1715	5	25	2115	4	IMD5
DC_66A_n2A, DC_66A-66A_n2A	66	1775	5	25	2175	N/A	N/A
	n2	1855	5	25	1935	20	IMD3
	66	1750	5	25	2150	4	IMD5
	n2	1883.3	5	25	1963.3	N/A	N/A

NR or E-UTRA Band / Channel bandwidth / N <sub>RB</sub> / MSD							
EN-DC Configuration	EUTRA or NR band	UL F <sub>c</sub> (MHz)	UL/DL BW (MHz)	UL L <sub>CRB</sub>	DL F <sub>c</sub> (MHz)	MSD (dB)	IMD order
DC_66A_n5A	n5	838	5	25	883	30	IMD2 <sup>3</sup>
	66	1721	5	25	2121	N/A	N/A
DC_66A_n7A DC_66A-66A_n7A DC_66A_n7(2A) DC_66A-66A_n7(2A)	66	1730	5	25	2130	N/A	N/A
	n7	2535	10	50	2655	15	IMD4
DC_66A_n25A	66	1775	5	25	2175	N/A	N/A
	n25	1855	5	25	1935	20	IMD3
	66	1712.5	5	25	2112.5	23	IMD3
	n25	1912.5	5	25	1992.5	N/A	N/A
	66	1750	5	25	2150	4	IMD5
	n25	1883.3	5	25	1963.3	N/A	N/A
DC_66A_n48A	66	1715	5	25	2115	4	IMD5
	n48	3630	20	100	3630	N/A	N/A
DC_66A_n71A	66	1750	5	25	2150	5	IMD4
	n71	675	5	25	629	N/A	N/A
DC_71A_n38A	71	665	5	25	619	11	IMD4
	n38	2614	5	25	2614	N/A	N/A
DC_71A_n66A	71	675	5	25	629	N/A	N/A
	n66	1750	5	25	2150	5	IMD4
DC_71A_n78A	71	681.5	5	25	635.5	5.5	IMD5
	n78	3361.5	10	50	3582.5	N/A	N/A

NOTE 1: Both of the transmitters shall be set min(+20 dBm, P<sub>C<sub>MAX</sub>L,c</sub>) as defined in clause 6.2.5A.  
 NOTE 2: RB<sub>start</sub> = 0  
 NOTE 3: This band is subject to IMD5 also which MSD is not specified.  
 NOTE 4: Applicable only if operation with 4 antenna ports is supported in the band with EN-DC configured.  
 NOTE 5: Void

7.3B.2.3.5.2 MSD test points for intermodulation interference due to dual uplink operation for EN-DC in NR FR1 involving three bands

Table 7.3B.2.3.5.2-0: MSD test points for Pcell due to dual uplink operation for EN-DC in NR FR1 (three bands)

NR or E-UTRA Band / Channel bandwidth / N <sub>RB</sub> / MSD							
EN-DC Configuration	EUTRA/NR band	UL F <sub>c</sub> (MHz)	UL/DL BW (MHz)	UL L <sub>CRB</sub>	DL F <sub>c</sub> (MHz)	MSD (dB)	IMD order
DC_66A_(n)71AA	66	1750	5	25	2150	5	IMD4
	n71	678	10	10 (RB <sub>start</sub> =0)	632	N/A	N/A

**Table 7.3B.2.3.5.2-1: MSD test points for Scell due to dual uplink operation for EN-DC in NR FR1 (three bands)**

NR or E-UTRA Band / Channel bandwidth / NRB / MSD							
EN-DC Configuration	EUTRA / NR band	UL F <sub>c</sub> (MHz)	UL/DL BW (MHz)	UL L <sub>CRB</sub>	DL F <sub>c</sub> (MHz)	MSD (dB)	IMD order
DC_1A-3A_n28A DC_1A-3C_n28A	1	1975	5	25	2165	N/A	N/A
	n28	710.5	5	25	765.5	N/A	N/A
	3	1723.5	5	25	1818.5	4.0	IMD5
DC_1A_n3A-n28A	1	1975	5	25	2165	N/A	N/A
	n28	710.5	5	25	765.5	N/A	N/A
	n3	1723.5	5	25	1818.5	4.0	IMD5
DC_1A-3A_n28A DC_1A-3C_n28A	3	1780	5	25	1875	N/A	N/A
	n28	710.5	5	25	765.5	N/A	N/A
	1	1949	5	25	2139	11.0	IMD4
DC_1A-3A_n71A DC_1A-3A_n71B	1	1960	5	25	2150	5	IMD4
	3	1750	5	25	1845	N/A	N/A
	n71	675	5	25	629	N/A	N/A
DC_1A-7A_n28A DC_1A-7C_n28A	1	1935	5	25	2125	N/A	N/A
	n28	718	5	25	773	N/A	N/A
	7	2533	10	50	2653	30.0	IMD2
DC_1A-7A_n40A	1	1970	5	25	2160	N/A	N/A
	7	2510	5	25	2630	23	IMD3
	n40	2390	5	25	2390	N/A	N/A
	1	1930	5	25	2120	16.4	IMD3
	7	2530	5	25	2650	N/A	N/A
	n40	2310	5	25	2310	N/A	N/A
DC_1A-3A_n77A	1	1950	5	25	2140	N/A	N/A
	3	1712.5	5	25	1807.5	31.5	IMD2
	n77	3757.5	10	50	3757.5	N/A	N/A
	1	1950	5	25	2140	N/A	N/A
	3	1775	5	25	1870	8.5	IMD4
	n77	3980	10	50	3980	N/A	N/A
	1	1950	5	25	2140	31.0	IMD2
	3	1775	5	25	1870	N/A	N/A
DC_1A-3A_n78A DC_1A-3C_n78A DC_1A-3A_n78(2A) DC_1A-3C_n78(2A)	n77	3915	10	50	3915	N/A	N/A
	1	1950	5	25	2140	N/A	N/A
	3	1712.5	5	25	1807.5	31.2	IMD2
	n78	3757.5	10	50	3757.5	N/A	N/A
	1	1935	5	25	2125	2.8	IMD5
DC_1A_n3A-n78A	3	1775	5	25	1870	N/A	N/A
	n78	3725	10	50	3725	N/A	N/A
	1	1950	5	25	2140	N/A	N/A
	n3	1750	5	25	1845	N/A	N/A
	n78	3700	10	50	3700	28.4	IMD2
	1	1950	5	25	2140	N/A	N/A
DC_1A-5A_n78A	n3	1735	5	25	1830	27.9	IMD2
	n78	3780	10	50	3780	N/A	N/A
	1	1932	5	25	2122	18.1	IMD3
	5	829	5	25	874	N/A	N/A
	n78	3780	10	50	3780	N/A	N/A
	1	1975	5	25	2165	N/A	N/A
DC_1A-7A_n78A DC_1A-7C_n78A DC_1A-7A_n78(2A) DC_1A-7C_n78(2A)	5	840	5	25	885	3.1	IMD5
	n78	3405	10	50	3405	N/A	N/A
	1	1977.5	5	25	2167.5	N/A	N/A
	7	2507.5	5	25	2627.5	9.1	IMD4
	n78	3305	10	50	3305	N/A	N/A
DC_1A-7A_n78A DC_1A-7C_n78A DC_1A-7A_n78(2A) DC_1A-7C_n78(2A)	1	1950	5	25	2140	8.7	IMD4
	7	2510	10	50	2630	N/A	N/A
	n78	3580	10	50	3580	N/A	N/A
	7	2510	10	50	2630	N/A	N/A



NR or E-UTRA Band / Channel bandwidth / NRB / MSD							
EN-DC Configuration	EUTRA / NR band	UL F <sub>c</sub> (MHz)	UL/DL BW (MHz)	UL L <sub>CRB</sub>	DL F <sub>c</sub> (MHz)	MSD (dB)	IMD order
DC_1A_n7A-n78A DC_1A_n7B-n78A	1	1977.5	5	25	2167.5	N/A	N/A
	n7	2507.5	5	25	2627.5	9.1	IMD4
	n78	3305	10	50	3305	N/A	N/A
	1	1970	5	25	2160	N/A	N/A
	n7	2520	5	25	2640	N/A	N/A
	n78	3390	10	50	3390	10.1	IMD4
DC_1A-3A_n79A	1	1950	5	25	2140	3.6	IMD5
	3	1750	5	25	1845	N/A	N/A
	n79	4860	40	216	4860	N/A	N/A
DC_1A-5A_n79A	1	1950	5	25	2140	N/A	N/A
	5	837.5	5	25	882.5	18.3	IMD3
	n79	4782.5	40	216	4782.5	N/A	N/A
	1	1930	5	25	2120	N/A	N/A
	5	837.5	5	25	882.5	8.9	IMD4
	n79	4907.5	40	216	4907.5	N/A	N/A
	1	1950	5	25	2140	8.1	IMD4
	5	837.5	5	25	882.5	N/A	N/A
DC_1A-8A_n28A	1	1970	5	25	2160	N/A	N/A
	n28	730	5	25	785	N/A	N/A
	8	905	5	25	950	3.3	IMD5
DC_1A_n8A-n40A	1	1930	5	25	2120	N/A	N/A
	n8	885	5	25	930	8.0	IMD4 [2*f <sub>B1</sub> -2*f <sub>n40</sub> ]
	n40	2395	5	25	2395	N/A	N/A
DC_1A-8A_n77A	1	1955	5	25	2145	N/A	N/A
	n77	3410	10	50	3410	N/A	N/A
	8	910	5	25	955	3.3	IMD5
DC_1A-8A_n77A	8	910	5	25	955	N/A	N/A
	n77	3960	10	50	3960	N/A	N/A
	1	1950	5	25	2140	14.4	IMD3
DC_1A_n8A-n78A	1	1945	5	25	2135	N/A	N/A
	n8	900	5	25	945	N/A	N/A
	n78	3745	10	52	3745	14.9	IMD3
	1	1940	5	25	2130	N/A	N/A
	n8	895	5	25	940	3.3	IMD5
	n78	3380	10	52	3330	N/A	N/A
DC_1A-8A_n79A	1	1935	5	25	2125	N/A	N/A
	n79	4815	40	216	4815	N/A	N/A
	8	900	5	25	945	15.8	IMD3
DC_1A-8A_n79A	8	900	5	25	945	N/A	N/A
	n79	4845	40	216	4845	N/A	N/A
	1	1955	5	25	2145	8.2	IMD4
DC_1A-11A_n3A	1	1960	5	25	2150	N/A	N/A
	n3	1720	5	25	1815	N/A	N/A
	11	1432	5	25	1480	15.2	IMD3
DC_1A-11A_n77A	1	1955	5	25	2145	N/A	N/A
	n77	3441	10	50	3441	N/A	N/A
	11	1438	5	25	1486	31.4	IMD2
DC_1A-11A_n77A	11	1438	5	25	1486	N/A	N/A
	n77	3578	10	50	3578	N/A	N/A
	1	1950	5	25	2140	30.8	IMD2
DC_1A-11A_n78A	1	1955	5	25	2145	N/A	N/A
	n78	3441	10	50	3441	N/A	N/A
	11	1438	5	25	1486	31.4	IMD2
DC_1A-11A_n78A	11	1438	5	25	1486	N/A	N/A
	n78	3578	10	50	3578	N/A	N/A
	1	1950	5	25	2140	30.8	IMD2

NR or E-UTRA Band / Channel bandwidth / NRB / MSD							
EN-DC Configuration	EUTRA / NR band	UL F <sub>c</sub> (MHz)	UL/DL BW (MHz)	UL L <sub>CRB</sub>	DL F <sub>c</sub> (MHz)	MSD (dB)	IMD order
DC_1A-18A_n77A	1	1930	5	25	2120	16.4	IMD3
	18	825	5	25	870	N/A	N/A
	n77	3770	10	50	3770	N/A	N/A
DC_1A-18A_n78A	1	1930	5	25	2120	16.4	IMD3
	18	819	5	25	864	N/A	N/A
	n78	3758	10	50	3758	N/A	N/A
DC_1A-18A_n79A	1	1935	5	25	2125	N/A	N/A
	18	822.5	5	25	867.5	18.3	IMD3
	n79	4737.5	40	216	4737.5	N/A	N/A
	1	1930	5	25	2120	N/A	N/A
	18	820	5	25	865	8.9	IMD4
	n79	4925	40	216	4925	N/A	N/A
	1	1935	5	25	2125	8.1	IMD4
	18	822.5	5	25	867.5	N/A	N/A
	n79	4592.5	40	216	4592.5	N/A	N/A
DC_1A-19A_n77A DC_1A-19A_n78A	1	1940	5	25	2130	17.8	IMD3
	19	832.5	5	25	877.5	N/A	N/A
	n77, n78	3795	10	50	3795	N/A	N/A
DC_1A-20A_n8A	1	1925	5	25	2115	N/A	N/A
	n8	910	5	25	955	N/A	N/A
	20	846	5	25	805	11.5	IMD4
DC_1A-20A_n38A	1	N/A	N/A	N/A	N/A	N/A	N/A
	20	N/A	N/A	N/A	N/A	N/A	IMD5
	n38	N/A	N/A	N/A	N/A	N/A	N/A
DC_1A-28A_n3A	28	710.5	5	25	765.5	N/A	N/A
	n3	1780	5	25	1875	N/A	N/A
	1	1949	5	25	2139	11.0	IMD4
DC_1A-28A_n7A DC_1A-1A-28A_n7A DC_1A-28A_n7B DC_1A-1A-28A_n7B	1	1935	5	25	2125	N/A	N/A
	28	730	10	50	785	4.5	IMD5
	n7	2510	10	50	2630	N/A	N/A
	1	1950	5	25	2140	N/A	N/A
DC_1A-19A_n79A	19	837.5	5	25	882.5	18.3	IMD3
	n79	4782.5	40	216	4782.5	N/A	N/A
	1	1950	5	25	2140	8.1	IMD4
	19	837.5	5	25	882.5	N/A	N/A
	n79	4652.5	40	216	4652.5	N/A	N/A
	1	1930	5	25	2120	20.3	IMD3
DC_1A-20A_n78A	20	835	5	25	794	N/A	N/A
	n78	3790	10	50	3790	N/A	N/A
	1	1950	5	25	2140	N/A	N/A
DC_1A-20A_n78A	20	851	5	25	810	3.0	IMD5
	n78	3330	10	50	3330	N/A	N/A
	1	1964.6	5	25	2154.6	30.6	IMD2
DC_1A-21A_n77A DC_1A-21A_n78A	21	1450.4	5	25	1498.4	N/A	N/A
	n77, n78	3605	10	50	3605	N/A	N/A
	1	1950	5	25	2140	N/A	N/A
	21	1452	5	25	1500	2.9	IMD5
	n77, n78	3675	10	50	3675	N/A	N/A
	1	1930	5	25	2120	N/A	N/A
DC_1A_n28A-n40A	n28	743	5	25	798	N/A	N/A
	n40	2374	5	25	2374	10.1	IMD4
	1	1930	5	25	2120	N/A	N/A
	n28	713	5	25	768	8.6	IMD4
	n40	2314	5	25	2314	N/A	N/A
	1	1950	5	25	2140	N/A	N/A
DC_1A-28A_n40A	28	725	5	25	780	8.9	IMD4
	n40	2340	5	25	2340	N/A	N/A
	1	1960	5	25	2150	15.8	IMD3

NR or E-UTRA Band / Channel bandwidth / NRB / MSD								
EN-DC Configuration	EUTRA / NR band	UL F <sub>c</sub> (MHz)	UL/DL BW (MHz)	UL L <sub>CRB</sub>	DL F <sub>c</sub> (MHz)	MSD (dB)	IMD order	
	28	740	5	25	795	N/A	N/A	
	n77	3630	10	50	3630	N/A	N/A	
DC_1A-28A_n77A	1	1960	5	25	2150	N/A	N/A	
	28	725	5	25	780	4.3	IMD5	
	n77	3330	10	50	3330	N/A	N/A	
DC_1A-28A_n77A DC_1A-28A_n78A	1	1960	5	25	2150	15.7	IMD3	
	28	740	5	25	795	N/A	N/A	
	n77/n78	3630	10	50	3630	N/A	N/A	
DC_1A-28A_n77A DC_1A-28A_n78A	1	1970	5	25	2160	N/A	N/A	
	28	739	5	25	794	4.2	IMD5	
	n77/n78	3352	10	50	3352	N/A	N/A	
DC_1A_n28A-n78A	1	1950	5	25	2140	N/A	N/A	
	n28	733	5	25	788	N/A	N/A	
	n78	3416	10	50	3416	15.7	IMD3	
	1	1950	5	25	2140	N/A	N/A	
	n78	3320	10	50	3320	N/A	N/A	
	n28	735	5	25	790	3.3	IMD5	
DC_1A-28A_n79A	1	1930	5	25	2120	N/A	N/A	
	28	733	5	25	788	15.2	IMD3	
	n79	4648	40	216	4648	N/A	N/A	
	1	1925	5	25	2115	N/A	N/A	
	28	740	5	25	795	10.0	IMD4	
	n79	4980	40	216	4980	N/A	N/A	
	1	1977.5	5	25	2167.5	1.2	IMD4	
	28	745.5	5	25	800.5	N/A	N/A	
	n79	4420	40	216	4420	N/A	N/A	
	1	1935	5	25	2125	4.5	IMD5	
DC_1A-32A_n78A DC_1A-32A_n78(2A)	28	718	5	25	773	N/A	N/A	
	n79	4807	40	216	4807	N/A	N/A	
	1	1930	5	25	2120	N/A	N/A	
	32	N/A	5	25	1470	31.8	IMD2	
	n78	3400	10	50	3400	N/A	N/A	
	1	1930	5	25	2120	N/A	N/A	
	32	N/A	5	25	1470	0	IMD5	
	n78	3630	10	50	3630	N/A	N/A	
	DC_1A_n40A-n78A DC_1A_n40A-n78(2A)	1	1930	5	25	2120	N/A	N/A
		n40	2340	5	25	2340	N/A	N/A
n78		3450	10	50	3450	9.8	IMD4	
1		1960	5	25	2150	N/A	N/A	
n40		2360	5	25	2360	10.6	IMD4	
n78		3520	10	50	3520	N/A	N/A	
DC_1A-41A_n3A DC_1A-41C_n3A	1	1977.5	5	25	2167.5	N/A	N/A	
	n3	1712.5	5	25	1807.5	N/A	N/A	
	41	2507.5	5	25	2507.5	5.0	IMD5 [3*f <sub>B1</sub> -2*f <sub>n3</sub> ]	
DC_1A-41A_n28A	1	1935	5	25	2125	N/A	N/A	
	n28	718	5	25	773	N/A	N/A	
	41	2653	10	50	2653	30	IMD2 [f <sub>B1</sub> +f <sub>Bn28</sub> ]	
DC_1A-41A_n77A DC_1A-41C_n77A DC_1A-41A_n77(2A) DC_1A-41C_n77(2A)	1	1970	5	25	2160	N/A	N/A	
	n77	3400	10	50	3400	N/A	N/A	
	41	2510	5	25	2510	N/A	IMD4	
	1	1930	5	25	2120	11.0	N/A	
	n77	4150	10	50	4150	N/A	N/A	
	41	2510	5	25	2510	N/A	IMD5	
DC_1A-41A_n78A DC_1A-41C_n78A DC_1A-41A_n78(2A) DC_1A-41C_n78(2A)	1	1975	5	25	2165	N/A	N/A	
	41	2515	5	25	2515	12	IMD4	
	n78	3410	10	50	3410	N/A	N/A	
	DC_1A_n41A-n78A	1	1975	5	25	2165	N/A	N/A
n41		2515	10	50	2515	11.5	IMD4	

NR or E-UTRA Band / Channel bandwidth / NRB / MSD							
EN-DC Configuration	EUTRA / NR band	UL F <sub>c</sub> (MHz)	UL/DL BW (MHz)	UL L <sub>CRB</sub>	DL F <sub>c</sub> (MHz)	MSD (dB)	IMD order
	n78	3410	10	50	3410	N/A	N/A
	1	1970	5	25	2160	N/A	N/A
	n41	2650	10	25	2650	N/A	N/A
	n78	3330	10	50	3330	19.6	IMD3
DC_1A-41A_n79A	1	1970	5	25	2160	N/A	N/A
	n79	4500	40	216	4500	N/A	
	41	2530	5	25	2530	29.4	IMD2
DC_1A_n75A-n78A DC_1A_n75A-n78(2A)	1	1930	5	25	2120	N/A	N/A
	n78	3400	10	50	3400	N/A	N/A
	n75	-	-	-	1470	30.4	IMD2
DC_1A-42A_n28A	1	1950	5	25	2140	N/A	N/A
	n28	733	5	25	788	N/A	N/A
	42	3416	5	25	3416	15.7	IMD3
DC_1A-42A_n28A	42	3580	5	25	3580	N/A	N/A
	n28	723	5	25	778	N/A	N/A
	1	1944	5	25	2134	15.7	IMD3
DC_1A-42A_n79A	1	1977.5	5	25	2167.5	N/A	N/A
	n79	4420	40	216	4420	N/A	N/A
	42	3490	5	25	3490	4.8	IMD5
	42	3402.5	5	25	3402.5	N/A	N/A
	n79	4640	40	216	4640	N/A	N/A
	1	1975	5	25	2165	15.5	IMD3
	42	3450	5	25	3450	N/A	N/A
	n79	4520	40	216	4520	N/A	N/A
DC_1A_SUL_n77A-n80A	1	1950	5	25	2140	23	IMD3
	n80	1760	5	25		N/A	N/A
DC_1A_SUL_n77A-n80A	1	1922.5	5	25	2112.5	N/A	N/A
	n80	1782.5	5	25		N/A	N/A
	n78	3425	10	50	3425	13.0	IMD4
DC_1A_n78A-n79A	1	1950	5	25	2140	N/A	N/A
	n78	3410	10	50	3410	N/A	N/A
	n79	4870	40	216	4870	15.9	IMD3
	1	1950	5	25	2140	N/A	N/A
	n79	4670	40	216	4670	N/A	N/A
	n78	3490	10	50	3490	4.6	IMD5
DC_1A_SUL_n78A-n80A	1	1950	5	25	2140	23	IMD3
	n80	1760	5	25		N/A	N/A
	1	1922.5	5	25	2112.5	N/A	N/A
	n80	1782.5	5	25		N/A	N/A
	n78	3425	10	50	3425	13.0	IMD4
DC_2A-4A_n41A	2	1860	5	25	1940	11.0	IMD4
	4	1715	5	25	2115	N/A	N/A
	n41	2685	10	50	2685	N/A	N/A
DC_2A-5A_n71A	2	1855	5	25	1935	N/A	N/A
	n71	686.5	5	25	640.5	N/A	N/A
	5	846.5	5	25	891.5	4.2	IMD5
DC_2A-7A_n78A DC_2A-7C_n78A DC_2A-7A-7A_n78A DC_2A-7A_n78(2A) DC_2A-7C_n78(2A) DC_2A-7A-7A_n78(2A)	2	1870	5	25	1950	8.6	IMD4
	7	2550	5	25	2685	N/A	N/A
	n78	3525	10	50	3475	N/A	N/A
DC_2A_n7A-n78A, DC_2A_n7(2A)-n78A DC_2A_n7A-n78(2A) DC_2A_n7(2A)-n78(2A)	2	1900	5	25	1980	N/A	N/A
	n7	2525	5	25	2645	N/A	N/A
	n78	3775	10	50	3775	4.2	IMD5
DC_2A-13A_n66A DC_2A-2A-13A_n66A	2	1860	5	25	1940	6.2	IMD4
	13	780	10	50	749	N/A	N/A

NR or E-UTRA Band / Channel bandwidth / NRB / MSD							
EN-DC Configuration	EUTRA / NR band	UL F <sub>c</sub> (MHz)	UL/DL BW (MHz)	UL L <sub>CRB</sub>	DL F <sub>c</sub> (MHz)	MSD (dB)	IMD order
DC_2A_n38A-n78A	n66	1750	5	25	2150	N/A	N/A
	2	1870	5	25	1950	N/A	N/A
	n38	2610	5	25	2610	N/A	N/A
	n78	3350	10	50	3350	14.8	IMD3
DC_2A-14A_n66A	2	1874	5	25	1954	7.2	IMD4
	14	793	5	25	763	N/A	N/A
	66	1770	5	25	2170	N/A	N/A
DC_2A_n41A-n71A	2	1900	5	25	1980	N/A	N/A
	n41	2530	10	50	2530	N/A	N/A
	n71	676	5	50	630	28.7	IMD2
	2	1900	5	25	1980	N/A	N/A
	n41	2586	10	50	2586	29.2	IMD2
	n71	686	5	50	640	N/A	N/A
DC_2A-46A_n66A <sup>5</sup> DC_2A-46C_n66A <sup>5</sup> DC_2A-46D_n66A <sup>5</sup>	2	N/A	N/A	N/A	N/A	N/A	N/A
	46	N/A	N/A	N/A	N/A	N/A	IMD3, IMD5
	n66	N/A	N/A	N/A	N/A	N/A	N/A
DC_2A-48A_n66A	2	1880	5	25	1960	N/A	N/A
	48	3620	10	50	3620	29.4	IMD2  f <sub>B2</sub> +f <sub>Bn66</sub>
	n66	1740	5	25	2140	N/A	N/A
	2	1880	5	25	1960	28.3	IMD2  f <sub>Bn48</sub> -f <sub>B66</sub>
	48	3695	5	25	3695	N/A	N/A
	n66	1735	5	25	2135	N/A	N/A
DC_2A-66A_n5A	2	1900	5	25	1980	N/A	N/A
	66	1740	5	25	2140	7.2	IMD4
	n5	830	5	25	875	N/A	N/A
DC_2A-66A_n25A	2	1855	5	25	1935	20	IMD3
	66	1775	5	25	2175	N/A	N/A
	n25	1855	5	25	1935	20	IMD3
	2	1883.3	5	25	1963.3	N/A	N/A
	66	1750	5	25	2150	4	IMD5
	n25	1883.3	5	25	1963.3	N/A	N/A
	2	1883.3	5	25	1963.3	N/A	N/A
	66	1712.5	5	25	2112.5	23	IMD3
	n25	1912.5	5	25	1992.5	N/A	N/A
DC_2A-66A_n41A DC_2A-66A_n41C DC_2A-66A_n41(2A)	2	1860	5	25	1940	11.0	IMD4
	66	1715	5	25	2115	N/A	N/A
	n41	2685	5	25	2685	N/A	N/A
DC_2A-66A_n48A DC_2A-66A_n48B DC_2A-66A-66A_n48A DC_2A-66A-66A_n48B	2	1905	5	25	1985	N/A	N/A
	66	1755	5	25	2155	12.1	IMD4
	n48	3560	5	25	3560	N/A	N/A
DC_2A-66A_n48A DC_2A-66A_n48B DC_2A-66A-66A_n48A DC_2A-66A-66A_n48B	2	1880	5	25	1960	28.3	IMD5
	66	1735	5	25	2135	N/A	N/A
	n48	3695	5	25	3695	N/A	N/A
DC_2A-66A_n78A DC_2A-66A_n78(2A) DC_2A-66A-66A_n78A DC_2A-66A- 66A_n78(2A) DC_2A_n66A-n78A	2	1880	5	25	1960	N/A	N/A
	66/n66	1760	5	25	2160	10.3	IMD4
	n78	3480	10	50	3480	N/A	N/A
DC_2A-66A_n78A DC_2A-66A_n78(2A) DC_2A-66A-66A_n78A DC_2A-66A- 66A_n78(2A)	2	1880	5	25	1960	32.1	IMD2
	66	1740	5	25	2140	N/A	N/A
	n78	3700	10	50	3700	N/A	N/A
	2	1880	5	25	1960	9.1	IMD4

NR or E-UTRA Band / Channel bandwidth / NRB / MSD							
EN-DC Configuration	EUTRA / NR band	UL F <sub>c</sub> (MHz)	UL/DL BW (MHz)	UL L <sub>CRB</sub>	DL F <sub>c</sub> (MHz)	MSD (dB)	IMD order
DC_2A-66A_n78A	66	1770	5	25	2170	N/A	N/A
DC_2A-66A_n78(2A) DC_2A-66A-66A_n78A DC_2A-66A-66A_n78(2A)	n78	3350	10	50	3350	N/A	N/A
DC_2A-66A_n78A DC_2A-66A_n78(2A) DC_2A-66A-66A_n78A DC_2A-66A-66A_n78(2A)	2	1880	5	25	1960	2.1	IMD5
	66	1760	5	25	2160	N/A	N/A
	n78	3620	10	50	3620	N/A	N/A
DC_2A_n66A-n78A	2	1880	5	25	1960	N/A	N/A
	n66	1740	5	25	2140	N/A	N/A
	n78	3620	10	50	3620	29.4	IMD2
	2	1880	5	25	1960	N/A	N/A
	n66	1740	5	25	2140	N/A	N/A
	n78	3340	10	50	3340	8.9	IMD4
DC_2A-71A_n38A DC_2A-2A-71A_n38A	2	1862	5	25	1942	26	IMD2
	71	668	5	25	622	N/A	N/A
	n38	2610	10	50	2610	N/A	N/A
DC_2A-71A_n78A DC_2A-2A-71A_n78A	2	1874	5	25	1954	16.5	IMD3
	71	693	5	25	647	N/A	N/A
	n78	3340	10	50	3340	N/A	N/A
DC_3A_n1A-n28A DC_3C_n1A-n28A	3	1780	5	25	1875	N/A	N/A
	n28	710.5	5	25	765.5	N/A	N/A
	n1	1949	5	25	2139	11.0	IMD4
DC_3A_n1A-n40A	n1	1950	5	25	2140	N/A	N/A
	3	1735	5	25	1830	N/A	N/A
	40	2380	5	25	2380	8.0	IMD5
DC_3A_n1A-n77A	3	1750	5	25	1845	N/A	N/A
	n1	1950	5	25	2140	N/A	N/A
	n77	3700	10	50	3700	28.4	IMD2
	3	1775	5	25	1870	N/A	N/A
	n1	1950	5	25	2140	31.0	IMD2
	n77	3915	10	50	3915	N/A	N/A
DC_3A_n1A-n78A DC_3C_n1A-n78A	3	1750	5	25	1845	N/A	N/A
	n1	1950	5	25	2140	N/A	N/A
	n78	3700	10	50	3700	28.4	IMD2
	3	1770	5	25	1865	N/A	N/A
	n1	1940	5	25	2130	3.5	IMD5
	n78	3720	10	50	3720	N/A	N/A
DC_3A-5A_n79A	3	1775	5	25	1870	N/A	N/A
	5	840	5	25	885	18.5	IMD3
	n79	4435	40	216	4435	N/A	N/A
	3	1782.5	5	25	1877.5	0.2	IMD4
	5	842.5	5	25	887.5	N/A	N/A
	n79	4420	40	216	4420	N/A	N/A
DC_3A-7A_n5A	3	1780	10	50	1875	N/A	N/A
	7	2505	10	50	2625	30.0	IMD2 <sup>1</sup>
	n5	845	5	25	890	N/A	N/A
DC_3A-7A_n8A	3	1780	5	25	1875	N/A	N/A
	n8	890	5	25	935	N/A	N/A
	7	2550	10	50	2670	29.0	IMD2 IMD3 <sup>3</sup>
	3	1712.5	5	25	1807.5	N/A	N/A
	n28	743	5	25	798	N/A	N/A
	7	2562	10	50	2682	16.9	IMD3

NR or E-UTRA Band / Channel bandwidth / NRB / MSD							
EN-DC Configuration	EUTRA / NR band	UL F <sub>c</sub> (MHz)	UL/DL BW (MHz)	UL L <sub>CRB</sub>	DL F <sub>c</sub> (MHz)	MSD (dB)	IMD order
DC_3A-7A_n28A	7	2543	10	50	2663	N/A	N/A
DC_3A-7C_n28A	n28	710.5	5	25	765.5	N/A	N/A
DC_3C-7A_n28A	3	1737.5	5	25	1832.5	26.0	IMD2
DC_3C-7C_n28A							IMD2
DC_3A-18A_n77A	3	N/A	N/A	N/A	N/A	N/A	IMD3

NR or E-UTRA Band / Channel bandwidth / NRB / MSD							
EN-DC Configuration	EUTRA / NR band	UL F <sub>c</sub> (MHz)	UL/DL BW (MHz)	UL L <sub>CRB</sub>	DL F <sub>c</sub> (MHz)	MSD (dB)	IMD order
DC_3A-18A_n78A	18	N/A	N/A	N/A	N/A	N/A	N/A
	n77, n78	N/A	N/A	N/A	N/A	N/A	N/A
DC_3A_n7A-n28A	3	1747	5	25	1842	N/A	N/A
	n7	2543	5	25	2663	N/A	N/A
	n28	741	5	25	796.0	20.0	IMD2
	3	1712.5	5	25	1807.5	N/A	N/A
	n7	2562	5	25	2682	17.0	IMD3
DC_3A-7A_n40A	n28	743	5	25	798	N/A	N/A
	3	1771.6	5	25	1866.6	3.4	IMD5
	7	2530	5	25	2650	N/A	N/A
DC_3A-7A_n77A	n40	2310	5	25	2310	N/A	N/A
	3	1725	5	25	1820	17.6	IMD3
	7	2565	5	25	2685	N/A	N/A
DC_3A-7A_n77A	n77	3310	10	50	3310	N/A	N/A
	3	1725	5	25	1820	8.6	IMD4
	7	2565	5	25	2685	N/A	N/A
DC_3A-7A_n77A	n77	3475	10	50	3475	N/A	N/A
	3	1715	5	25	1810	N/A	N/A
	7	2550	5	25	2670	5.2	IMD5
DC_3A-7A_n77A	n77	4190	10	50	4190	N/A	N/A
	3	1720	5	25	1815	N/A	N/A
	7	2520	5	25	2640	3.4	IMD5
DC_3A-7A_n77A	n77	3900	10	50	3900	N/A	N/A
	3	1725	5	25	1820	17.6	IMD3
	7	2565	5	25	2685	N/A	N/A
DC_3A-7A_n78A DC_3C-7A_n78A DC_3C-7C_n78A DC_3A-3A-7A_n78A DC_3A-3A-7A-7A_n78A DC_3A-7A_SUL_n78A-n80A DC_3C-7A_SUL_n78A-n80A DC_3A-7A_n78(2A) DC_3C-7A_n78(2A) DC_3A-7C_n78(2A) DC_3C-7C_n78(2A)	n78	3310	10	50	3310	N/A	N/A
	3	1725	5	25	1820	8.6	IMD4
	7	2565	5	25	2685	N/A	N/A
DC_3A-8A_n77A	n78	3475	10	50	3475	N/A	N/A
	3	1715	5	25	1810	N/A	N/A
	n77	4190	10	50	4190	N/A	N/A
DC_3A-8A_n77A	8	910	5	25	955	9.7	IMD4
	8	910	5	25	955	N/A	N/A
	n77	3640	10	50	3640	N/A	N/A
DC_3A-8A_n77A	3	1725	5	25	1820	16.5	IMD3
	8	910	5	25	955	N/A	N/A
	n78	3640	10	50	3640	N/A	N/A
DC_3A-8A_n78A DC_3A-3A-8A_n78A	3	1725	5	25	1820	16.5	IMD3
	3	1740	5	25	1835	N/A	N/A
	n8	900	5	25	945	N/A	N/A
DC_3A_n8A-n78A	n78	3540	10	50	3540	16.3	IMD3
	3	1755	5	25	1850	N/A	N/A
	n79	4465	40	216	4465	N/A	N/A
DC_3A-8A_n79A	8	910	5	25	955	15.3	IMD3
	8	910	5	25	955	N/A	N/A
	n79	4580	40	216	4580	N/A	N/A
DC_3A-8A_n79A	3	1755	5	25	1850	8.8	IMD4
	3	1730	5	25	1825	N/A	N/A
	n7	2560	5	25	2680	N/A	N/A



NR or E-UTRA Band / Channel bandwidth / NRB / MSD							
EN-DC Configuration	EUTRA / NR band	UL F <sub>c</sub> (MHz)	UL/DL BW (MHz)	UL L <sub>CRB</sub>	DL F <sub>c</sub> (MHz)	MSD (dB)	IMD order
DC_3A_n7A-n78A DC_3A_n7B-n78A DC_3C_n7A-n78A DC_3C_n7B-n78A	n78	3390	10	50	3390	16.1	IMD3
DC_3A-19A_n79A	3	1775	5	25	1870	N/A	N/A
	19	840	5	25	885	18.5	IMD3
	n79	4435	40	216	4435	N/A	N/A
	3	1782.5	5	25	1877.5	0.2	IMD4
	19	842.5	5	25	887.5	N/A	N/A
	n79	4420	40	216	4420	N/A	N/A
DC_3A-20A_n7A DC_3C-20A_n7A	3	1737	5	25	1832	N/A	N/A
	20	847	10	20	806	10.5	IMD2
	n7	2543	10	50	2663	N/A	N/A
DC_3A-20A_n8A	3	1720	5	25	1815	N/A	N/A
	n8	910	5	25	955	N/A	N/A
	20	851	5	25	810	27	IMD2
DC_3A-20A_n8A	3	1765	5	25	1860	14.5	IMD4
	n8	900	5	25	945	N/A	N/A
	20	840	5	25	799	N/A	N/A
DC_3A-20A_n28A DC_3C-20A_n28A	20	852	5	25	811	N/A	N/A
	n28	738	5	25	793	N/A	N/A
	3	1723	5	25	1818	9.4	IMD4
DC_3A-20A_n38A	3	1779	5	25	1874	N/A	N/A
	20	852	10	20	811	26.0	IMD2 <sup>1</sup>
	n38	2590	10	50	2590	N/A	N/A
DC_3A-20A_n41A DC_3C-20A_n41A	3	1744	5	25	1839	26.0	IMD 2
	n41	2680	10	52	2680	N/A	N/A
	20	841	10	50	800	N/A	N/A
DC_3A-20A_n41A DC_3C-20A_n41A	3	1779	5	25	1874	N/A	N/A
	n41	2590	10	52	2590	N/A	N/A
	20	852	10	50	811	26.0	IMD 2
DC_3A-20A_n41A DC_3C-20A_n41A	3	1730	5	25	1825	N/A	N/A
	n41	2660	10	52	2660	N/A	N/A
	20	841	5	25	800	12.5	IMD 3
DC_3A_20A_SUL_n78A- n80A DC_3C_20A_SUL_n78A- n80A	3	1725	5	25	1820	17.3	IMD3
	20	845	5	25	804	N/A	N/A
	n78	3510	10	50	3510	N/A	N/A
DC_3A_n20A-n78A	3	1730	5	25	1825	N/A	N/A
	n20	845	5	25	804	N/A	N/A
	n78	3420	10	50	3420	16.1	IMD3
DC_3A-20A_n78A DC_3C-20A_n78A	3	1725	5	25	1820	17.3	IMD3
	20	845	5	25	804	N/A	N/A
	n78	3510	10	50	3510	N/A	N/A
DC_3A-21A_n77A DC_3A-21A_n78A	3	1767.5	5	25	1862.5	N/A	N/A
	21	1459.5	5	25	1507.5	8.8	IMD4
	n77, n78	3795	10	50	3795	N/A	N/A
DC_3A-21A_n77A	3	1771.6	5	25	1866.6	3.4	IMD5
	21	1450.4	5	25	1498.4	N/A	N/A
	n77	3935	10	50	3935	N/A	N/A
DC_3A-21A_n79A	3	1774.2	5	25	1869.2	17.8	IMD3
	21	1450.4	5	25	1498.4	N/A	N/A
	n79	4770	40	216	4770	N/A	N/A
DC_3A-28A_n5A DC_3C-28A_n5A	3	1735	5	25	1830	8.7	IMD4
	28	705	5	25	798	N/A	N/A
	n5	845	5	25	874	N/A	N/A
	3	1750	5	25	1845	N/A	N/A

NR or E-UTRA Band / Channel bandwidth / NRB / MSD							
EN-DC Configuration	EUTRA / NR band	UL F <sub>c</sub> (MHz)	UL/DL BW (MHz)	UL L <sub>CRB</sub>	DL F <sub>c</sub> (MHz)	MSD (dB)	IMD order
	28	730	5	25	785	9.4	IMD4
	n5	845	5	25	874	N/A	N/A
DC_3A-28A_n7A	3	1737.5	5	25	1832.5	26.0	IMD2
DC_3C-28A_n7A	28	710.5	5	25	765.5	N/A	N/A
DC_3A-3A-28A_n7A	n7	2543	10	50	2663	N/A	N/A
DC_3A-28A_n7B	3	1747	5	25	1842	N/A	N/A
DC_3C-28A_n7B	28	741	5	25	796.0	20.0	IMD2
DC_3A-3A-28A_n7B	n7	2543	5	25	2663	N/A	N/A
DC_3A-28A_n77A	3	1712.5	5	25	1807.5	N/A	N/A
	28	715	5	25	770	15.3	IMD3
	n77	4195	10	50	4195	N/A	N/A
	3	1755	5	25	1850	17.0	IMD3
	28	735	5	25	790	N/A	N/A
	n77	3320	10	50	3320	N/A	N/A
DC_3A_n28A-n77A	3	1720	5	25	1815	N/A	N/A
	28	733	5	25	788	N/A	N/A
	n77	4173	10	50	4173	15.9	IMD3
	3	1712.5	5	25	1807.5	N/A	N/A
	28	715	5	25	770	15.3	IMD3
	n77	4195	10	50	4195	N/A	N/A
DC_3A-28A_n41A	3	1720	5	25	1815	N/A	N/A
	n41	2510	5	25	2510	N/A	N/A
	28	735	5	25	790	26.0	IMD2 <sup>1</sup>
DC_3A-28A_n78A	3	1775	5	25	1870	17.3	IMD3
DC_3C-28A_n78A	28	740	5	25	760	N/A	N/A
DC_3A-3A-28A_n78A	n78	3350	10	25	3350	N/A	N/A
DC_3A-28A_n79A	3	1770	5	25	1865	N/A	N/A
	28	725	5	25	780	10.3	IMD4
	n79	4530	40	216	4530	N/A	N/A
	3	1775	5	25	1870	5.7	IMD5
	28	725	5	25	780	N/A	N/A
	n79	4770	40	216	4770	N/A	N/A
DC_3A_n28A-n78A DC_3C_n28A-n78A	3	1750	5	25	1845	N/A	N/A
	n28	743	5	25	798	N/A	N/A
	n78	3764	10	50	3764	4.5	IMD5
DC_3A_SUL_n77A-n84A	3	1782.5	5	25	1877.5	N/A	N/A
	n84	1922.5	5	25		N/A	N/A
	n77	3425	10	50	3425	13.0	IMD4
DC_3A_n40A-n78A	3	1730	5	25	1825	N/A	N/A
	n40	2360	5	25	2360	N/A	N/A
	n78	3620	10	50	3620	4.8	IMD5
	3	1720	5	25	1815	N/A	N/A
	n40	2360	5	25	2360	4.4	IMD5
	n78	3760	10	50	3760	N/A	N/A
DC_3A_n40A-n79A	3	1720	5	25	1815	N/A	N/A
	n40	2330	5	25	2330	N/A	N/A
	n79	4550	40	216	4550	4.7	IMD5 $ 4*f_{B3}-f_{n40} $
	3	1720	5	25	1815	N/A	N/A
	n40	2330	5	25	2330	3.2	IMD5 $ 4*f_{B3}-f_{n79} $
	n79	4550	40	216	4550	N/A	N/A
DC_3A_n41A-n79A	3	1770	5	25	1865	N/A	N/A
	n41	2670	10	50	2670	N/A	N/A
	n79	4440	40	216	4440	30.8	IMD2 <sup>4</sup> $ f_{B3}-f_{n41} $
DC_3A_n75A-n78A DC_3A_n75A-n78(2A)	3	1782.5	5	25	1877.5	N/A	N/A
	n78	3305	10	50	3305	N/A	N/A
	n75	-	-	-	1514.5	10.0	IMD2

NR or E-UTRA Band / Channel bandwidth / NRB / MSD							
EN-DC Configuration	EUTRA / NR band	UL F <sub>c</sub> (MHz)	UL/DL BW (MHz)	UL L <sub>CRB</sub>	DL F <sub>c</sub> (MHz)	MSD (dB)	IMD order
DC_3A_n78A-n79A	3	1770	5	25	1865	N/A	N/A
	n78	3340	10	50	3340	N/A	N/A
	n79	4910	40	216	4910	16.3	IMD3
	3	1770	5	25	1865	N/A	N/A
	n79	4510	40	216	4510	N/A	N/A
	n78	3710	10	50	3710	4.2	IMD5
DC_3A_SUL_n78A-n82A	3	1775	5	25	1870	4	IMD4
	n82	840	5	25		N/A	N/A
DC_3A_SUL_n78A-n84A	3	1782.5	5	25	1877.5	N/A	N/A
	n84	1922.5	5	25		N/A	N/A
	n78	3425	10	50	3425	13.0	IMD4
DC_3A-21A_n79A	3	1774.2	5	25	1869.2	17.8	IMD3
	21	1450.4	5	25	1498.4	N/A	N/A
	n79	4770	40	216	4770	N/A	N/A
DC_3A-32A_n78A DC_3A-32A_n78(2A)	3	1730	5	25	1825	N/A	N/A
	32	N/A	5	25	1470	4.9	IMD4
	n78	3720	10	50	3720	N/A	N/A
	3	1775	5	25	1870	N/A	N/A
	32	N/A	5	25	1475	0	IMD5
DC_3A-40A_n1A	n78	3400	10	50	3400	N/A	N/A
	n1	1950	5	25	2140	N/A	N/A
	3	1735	5	25	1830	N/A	N/A
DC_3A-41A_n1A	40	2380	5	25	2380	8.0	IMD5
	41	2543	10	50	2543	N/A	N/A
	n28	710.5	5	25	765.5	N/A	N/A
DC_3A-41A_n28A DC_3A-41C_n28A	3	1737.5	5	25	1832.5	26	IMD2  f <sub>B41</sub> -f <sub>n28</sub>
	3	1780	5	25	1875	N/A	N/A
	n28	738	5	25	793	N/A	N/A
	41	2518	5	25	2518	27.4	IMD2  f <sub>B3</sub> +f <sub>n28</sub>
	3	1715	5	25	1810	N/A	N/A
	n28	743	5	25	798	N/A	N/A
	41	2687	5	25	2687	15.9	IMD3  2*f <sub>B3</sub> -f <sub>n28</sub>
	41	2543	10	50	2543	N/A	N/A
DC_3A-41A_n77A DC_3A-41C_n77A DC_3A-41A_n77(2A) DC_3A-41C_n77(2A)	3	1720	5	25	1815	N/A	N/A
	n77	3900	10	50	3900	N/A	N/A
	41	2640	5	25	2640	5.3	IMD5
	41	2620	5	25	2620	N/A	N/A
	n77	3400	10	50	3400	N/A	N/A
	3	1745	5	25	1840	16.4	IMD3
DC_3A-41A_n78A DC_3A-41C_n78A DC_3A-41A_n78(2A) DC_3A-41C_n78(2A)	41	2620	5	25	2620	N/A	N/A
	n78	3400	10	52	3400	N/A	N/A
	3	1745	5	25	1840	16.4	IMD3
DC_3A_n41A-n78A	3	1730	5	25	1825	N/A	N/A
	n41	2560	10	50	2560	N/A	N/A
	n78	3390	10	50	3390	16.4	IMD3  2*f <sub>n41</sub> -f <sub>B3</sub>
DC_3A-41A_n79A	3	1770	5	25	1865	N/A	N/A
	n79	4440	40	216	4440	N/A	N/A
	41	2670	5	25	2670	30.2	IMD2
	41	2570	5	25	2570	N/A	N/A
	n79	4420	40	216	4420	N/A	N/A
	3	1755	5	25	1850	29.4	IMD2
DC_5A-7A_n71A	5	835	5	25	880	N/A	N/A
	7	2540	5	25	2660	6.5	IMD5

NR or E-UTRA Band / Channel bandwidth / NRB / MSD							
EN-DC Configuration	EUTRA / NR band	UL F <sub>c</sub> (MHz)	UL/DL BW (MHz)	UL L <sub>CRB</sub>	DL F <sub>c</sub> (MHz)	MSD (dB)	IMD order
DC_5A-7A_n78A	n71	680	5	25	634	N/A	N/A
	5	844	5	25	889	N/A	N/A
	7	2525	5	25	2645	30.1	IMD2
	n78	3489	10	50	3489	N/A	N/A
	5	834	5	25	879	30.2	IMD2
	7	2550	5	25	2670	N/A	N/A
	n78	3429	10	50	3429	N/A	N/A
	5	830	5	25	875	3.3	IMD5
	7	2525	5	25	2645	N/A	N/A
DC_5A_n7A-n78A, DC_5A_n7(2A)-n78A DC_5A_n7A-n78(2A) DC_5A_n7(2A)-n78(2A)	n78	3350	10	50	3350	N/A	N/A
	5	844	5	25	889	N/A	N/A
	n7	2525	5	25	2645	30.1	IMD2
	n78	3489	10	50	3489	N/A	N/A
	5	835	5	25	880	N/A	N/A
DC_5A_41A_n78A	n7	2540	5	25	2660	N/A	N/A
	n78	3375	10	50	3375	29.7	IMD2 $ f_{B7} + f_{n5} $
	5	860	5	25	885	30.2	IMD2
	41	2615	5	25	2615	N/A	N/A
	n78	3500	10	50	3500	N/A	N/A
	5	856.5	5	25	881.5	3.1	IMD5
DC_5A-41A_n79A	41	2620.5	5	25	2620.5	N/A	N/A
	n78	3490	10	50	3490	N/A	N/A
	5	835	5	25	880	23.9	IMD3
	41	2665	5	25	2665	N/A	N/A
	n79	4450	40	216	4450	N/A	N/A
	5	826.5	5	25	871.5	N/A	N/A
DC_5A-66A_n2A DC_5BA-66A_n2A DC_5A-5A-66A_n2A DC_5A-66A-66A_n2A DC_5B-66A-66A_n2A DC_5A-5A-66A-66A_n2A	41	2517.5	5	25	2517.5	1.8	IMD4
	n79	4980	40	216	4980	N/A	N/A
	5	834	5	25	879	N/A	N/A
DC_5A-66A_n71A	66	1712	5	25	2132	7.2	IMD4
	n2	1900	5	25	1980	N/A	N/A
	5	830	5	25	875	N/A	N/A
	66	1761	5	25	2161	13	IMD3
	n71	665.5	5	25	619.5	N/A	N/A
	5	846.5	5	25	891.5	4.2	IMD5
DC_5A-66A_n78A DC_5A-66A_n78(2A)	66	1770	5	25	2170	N/A	N/A
	n71	665.5	5	25	619.5	N/A	N/A
	5	826.5	5	25	871.5	N/A	N/A
DC_7A_n1A-n40A	66	1742	5	25	2142	13.2	IMD3
	n78	3795	10	50	3795	N/A	N/A
	7	2540	5	25	2660	N/A	N/A
DC_7A_n1A-n78A DC_7C_n1A-n78A	n40	2335	5	25	2335	N/A	N/A
	n1	1940	5	25	2130	15.2	IMD3
	7	2520	5	25	2640	N/A	N/A
	n1	1970	5	25	2160	N/A	N/A
	n78	3390	10	50	3390	10.1	IMD4
	7	2530	5	25	2650	N/A	N/A
DC_7A_n3A-n78A	n1	1970	5	25	2160	9.0	IMD4
	n78	3610	10	50	3610	N/A	N/A
	7	2560	5	25	2680	N/A	N/A
DC_7A_n3A-n78A	n3	1730	5	25	1825	N/A	N/A
	n78	3390	10	50	3390	16.1	IMD3

NR or E-UTRA Band / Channel bandwidth / NRB / MSD							
EN-DC Configuration	EUTRA / NR band	UL F <sub>c</sub> (MHz)	UL/DL BW (MHz)	UL L <sub>CRB</sub>	DL F <sub>c</sub> (MHz)	MSD (dB)	IMD order
	7	2565	5	25	2685	N/A	N/A
	n3	1725	5	25	1820	15.6	IMD3
	n78	3310	10	50	3310	N/A	N/A
DC_7A_n8A-n40A	7	2530	5	25	2650	N/A	N/A
	n8	905	5	25	950	N/A	N/A
	n40	2345	5	25	2345	3.0	IMD5
DC_7A-8A_n3A	n3	1735	5	25	1830	N/A	N/A
	7	2530	10	50	2650	N/A	N/A
	8	895	5	25	940	18.0	IMD3
DC_7A-8A_n3A	n3	1780	5	25	1875	N/A	N/A
	8	890	5	25	935	N/A	N/A
	7	2550	10	50	2670	29.0	IMD2+IMD3 <sup>3</sup>
DC_7A-8A_n77A	7	2530	5	25	2650	N/A	N/A
	8	895	5	25	940	30.5	IMD2
	n77	3470	10	50	3470	N/A	N/A
DC_7A-8A_n77A	7	2520	5	25	2640	N/A	N/A
	8	895	5	25	940	3.1	IMD5
	n77	3310	10	50	3310	N/A	N/A
DC_7A-8A_n77A	7	2530	5	25	2650	28	IMD2
	8	895	5	25	940	N/A	N/A
	n77	3545	10	50	3545	N/A	N/A
DC_7A-8A_n78A	7	2530	5	25	2650	N/A	N/A
	8	895	5	25	940	30.5	IMD2
	n78	3470	10	50	3470	N/A	N/A
DC_7A-8A_n78A	7	2520	5	25	2640	N/A	N/A
	8	895	5	25	940	3.1	IMD5
	n78	3310	10	50	3310	N/A	N/A
DC_7A-8A_n78A	7	2530	5	25	2650	28	IMD2
	8	895	5	25	940	N/A	N/A
	n78	3545	10	50	3545	N/A	N/A
DC_7A_n8A-n78A	7	2555	5	25	2675	N/A	N/A
	n8	900	5	25	945	N/A	N/A
	n78	3455	10	50	3455	28.5	IMD2
	7	2555	5	25	2675	N/A	N/A
	n8	900	5	25	945	29.7	IMD2
	n78	3500	10	50	3500	N/A	N/A
DC_7A-13A_n66A	7	2520	5	25	2640	N/A	N/A
	13	781	5	25	750	31	IMD2
	n66	1770	5	25	2170	N/A	N/A
DC_7A-13A_n66A	7	2540	5	25	2660	18	IMD3
	13	780	5	25	749	N/A	N/A
	n66	1720	5	25	2120	N/A	N/A
DC_7A-20A_n1A DC_7C-20A_n1A	7	2510	10	50	2630	N/A	N/A
	20	841	10	50	800	4.5	IMD5
	n1	1940	5	25	2130	N/A	N/A
DC_7A-20A_n3A	7	2543	10	50	2663	N/A	N/A
	20	847	10	20	806	10.5	IMD2
	n3	1737	5	25	1832	N/A	N/A
	7	2510	10	50	2630	26.0	IMD2 <sup>1</sup>
	20	855	5	25	896	N/A	N/A
	n3	1775	10	50	1870	N/A	N/A
DC_7A-20A_n8A	7	2565	5	25	2685	N/A	N/A
	n8	885	5	25	930	N/A	N/A

NR or E-UTRA Band / Channel bandwidth / NRB / MSD							
EN-DC Configuration	EUTRA / NR band	UL F <sub>c</sub> (MHz)	UL/DL BW (MHz)	UL L <sub>CRB</sub>	DL F <sub>c</sub> (MHz)	MSD (dB)	IMD order
	20	836	5	25	795	17.4	IMD3
DC_7A-20A_n8A	7	2520	5	25	2640	21.1	IMD3
	n8	900	5	25	945	N/A	N/A
	20	840	5	25	799	N/A	N/A
DC_7A-20A_n8A	7	2504	5	25	2624	18.8	IMD3
	n8	910	5	25	955	N/A	N/A
	20	857	5	25	816	N/A	N/A
DC_7A-20A_n28A	20	852	5	25	811	N/A	N/A
	n28	738	5	25	793	N/A	N/A
	7	2550	10	50	2670	5.9	IMD5
DC_7A-20A_n78A	7	2560	5	25	2680	N/A	N/A
	20	851	5	25	810	30.5	IMD2
	n78	3370	10	50	3370	N/A	N/A
DC_7A-20A_n78A	7	2560	5	25	2680	N/A	N/A
	20	851	5	25	810	3.0	IMD5
	n78	3435	10	50	3435	N/A	N/A
DC_7A-20A_n78A	7	2555	5	25	2675	30.8	IMD2
	20	845	5	25	804	N/A	N/A
	n78	3520	10	50	3520	N/A	N/A
DC_7A-28A_n3A DC_7C-28A_n3A	7	2543	5	25	2663	N/A	N/A
	28	741	5	25	796.0	20.0	IMD2
	n3	1747	5	25	1842	N/A	N/A
	7	2540	5	25	2685	18	IMD3
	28	745	5	25	800	N/A	N/A
	n3	1715	5	25	1810	N/A	N/A
DC_7A-28A_n5A DC_7C-28A_n5A	7	2540	5	25	2725	N/A	N/A
	28	721	5	25	776	4.4	IMD5
	n5	829	5	25	854	N/A	N/A
	7	2510	5	25	2630	5.9	IMD5
	28	730	5	25	785	N/A	N/A
	n5	840	5	25	874	N/A	N/A
DC_7A-28A_n40A	7	2510	5	25	2630	5.9	IMD5
	28	743	5	25	798	N/A	N/A
	n40	2310	5	25	2310	N/A	N/A
DC_7A-28A_n78A	7	2567.5	5	25	2687.5	N/A	N/A
	28	727.5	5	25	782.5	8.3	IMD2
	n78	3350	10	50	3350	N/A	N/A
	7	2567.5	5	25	2687.5	N/A	N/A
	28	727.5	5	25	782.5	3.0	IMD5
	n78	3460	10	50	3460	N/A	N/A
	7	2530	5	25	2650	30.5	IMD2
	28	740	5	25	795	N/A	N/A
	n78	3390	10	50	3390	N/A	N/A
DC_7A_n28A-n78A DC_7C_n28A-n78A	7	2565	5	25	2685	N/A	N/A
	n28	745	5	25	800	N/A	N/A
	n78	3310	10	50	3310	29.7	IMD2
	7	2565	5	25	2685	N/A	N/A
	n78	3365	10	50	3365	N/A	N/A
	n28	745	5	25	800	28.8	IMD2
DC_7A-40A_n1A	n1	1970	5	25	2160	N/A	N/A
	7	2530	5	25	2650	32.1	IMD3
	40	2310	5	25	2310	N/A	N/A
DC_7A-46A_n78A <sup>6</sup>	7	N/A	N/A	N/A	N/A	N/A	N/A
	46	N/A	N/A	N/A	N/A	N/A	IMD2, IMD5

NR or E-UTRA Band / Channel bandwidth / NRB / MSD														
EN-DC Configuration	EUTRA / NR band	UL F <sub>c</sub> (MHz)	UL/DL BW (MHz)	UL L <sub>CRB</sub>	DL F <sub>c</sub> (MHz)	MSD (dB)	IMD order							
	n78	N/A	N/A	N/A	N/A	N/A	N/A							
DC_7A-66A_n78A	7	2550	5	25	2685	N/A	N/A							
DC_7C-66A_n78A	66/n66	1750	5	25	2150	8.7	IMD4							
DC_7A-7A-66A_n78A														
DC_7A-66A-66A_n78A	n78	3625	10	50	3475	N/A	N/A							
DC_7A-7A-66A-66A_n78A														
DC_7C-66A-66A_n78A														
DC_7A_n66A-n78A														
DC_7A-7A_n66A-n78A														
DC_7C_n66A-n78A														
DC_7A-66A_n78(2A)														
DC_7C-66A_n78(2A)														
DC_7A-7A-66A_n78(2A)														
DC_7A-66A-66A_n78(2A)														
DC_7A-7A-66A-66A_n78(2A)														
DC_7C-66A-66A_n78(2A)														
DC_7A_n66A-n78A								7	2542	5	25	2662	N/A	N/A
DC_7A-7A_n66A-n78A								n66	1740	5	25	2140	N/A	N/A
DC_7C_n66A-n78A	n78	3344	10	50	3344	16.0	IMD3							
DC_7A_SUL_n78A-n80A	n80	1730	5	25		N/A	N/A							
	7	2535	10	50	2655	13	IMD4							
DC_8A_n1A-n78A	8	900	5	25	945	N/A	N/A							
	n1	1945	5	25	2135	N/A	N/A							
	n78	3745	10	50	3745	14.9	IMD3							
DC_8A_n3A-n28A	8	912.5	5	25	957.5	N/A	N/A							
	n3	1712.5	5	25	1807.5	N/A	N/A							
	n28	745	5	25	800	30.4	IMD2							
DC_8A-11A_n77A	8	910	5	25	955	N/A	N/A							
	n77	3311	10	50	3311	N/A	N/A							
	11	1443	5	25	1491	18.8	IMD3							
DC_8A-11A_n77A	11	1430.5	5	25	1478.5	N/A	N/A							
	n77	3791	10	50	3791	N/A	N/A							
	8	885	5	25	930	18.2	IMD3							
DC_8A-11A_n78A	8	910	5	25	955	N/A	N/A							
	n78	3311	10	50	3311	N/A	N/A							
	11	1443	5	25	1491	18.8	IMD3							
DC_8A-11A_n78A	11	1430.5	5	25	1478.5	N/A	N/A							
	n78	3791	10	50	3791	N/A	N/A							
	8	885	5	25	930	18.2	IMD3							
DC_8A-20A_n78A	8	890	5	25	935	N/A	N/A							
	n78	3470	10	50	3470	N/A	N/A							
	20	841	5	25	800	12.1	IMD4							
	8	895	5	25	940	12.1	IMD4							
	n78	3481	10	50	3481	N/A	N/A							
	20	847	5	25	806	N/A	N/A							
DC_8A_n28A-n77A	8	910	5	25	955	N/A	N/A							
	n28	743	5	25	798	N/A	N/A							
	n77	3473	10	50	3473	10.3	IMD4							
	8	910	5	25	955	N/A	N/A							
	n28	710	5	25	765	11.6	IMD4							
	n77	3495	10	50	3495	N/A	N/A							
DC_8A_n40A-n79A	8	885	5	25	930	N/A	N/A							
	n40	2305	5	25	2305	N/A	N/A							
	n79	4960	40	216	4960	10.7	IMD4  3*f <sub>B8+f<sub>n40</sub></sub>							
	8	885	5	25	930	N/A	N/A							

NR or E-UTRA Band / Channel bandwidth / NRB / MSD							
EN-DC Configuration	EUTRA / NR band	UL F <sub>c</sub> (MHz)	UL/DL BW (MHz)	UL L <sub>CRB</sub>	DL F <sub>c</sub> (MHz)	MSD (dB)	IMD order
	n40	2305	5	25	2305	9.2	IMD4 $ 3*f_{B8}-f_{n79} $
	n79	4960	40	216	4960	N/A	N/A
DC_8A_n41A-n79A	8	910	5	25	955	N/A	N/A
	n41	2650	10	50	2650	N/A	N/A
	n79	4470	40	216	4470	16.3	IMD3 $ 2*f_{B8}+f_{n41} $
	8	910	5	25	955	N/A	N/A
	n41	2650	10	50	2650	15.5	IMD3 $ 2*f_{B8}-f_{n79} $
	n79	4470	40	216	4470	N/A	N/A
DC_8A-42A_n28A	8	900	5	25	945	N/A	N/A
	n28	743	5	25	798	N/A	N/A
	42	3443	5	25	3443	8.7	IMD4
DC_8A_SUL_n78A-n80A	n80	1755	10	50		N/A	N/A
	8	900	5	25	945	8	IMD4
	n80	1750	10	50		N/A	N/A
	8	900	5	25	945	N/A	N/A
	n78	3550	10	50	3550	8	IMD3 <sup>3</sup>
DC_11A-18A_n77A	11	1443	5	25	1491	N/A	N/A
	n77	3706	10	50	3706	N/A	N/A
	18	820	5	25	865	18.7	IMD3 $ f_{Bn77}-2*f_{B11} $
DC_11A-18A_n78A	11	1443	5	25	1491	N/A	N/A
	n78	3706	10	50	3706	N/A	N/A
	18	820	5	25	865	18.7	IMD3 $ f_{Bn77}-2*f_{B11} $
DC_12A_n7A-n78A, DC_12A_n7(2A)-n78A DC_12A_n7A-n78(2A) DC_12A_n7(2A)-n78(2A)	12	708	5	25	738	N/A	N/A
	n7	2520	5	25	2640	N/A	N/A
	n78	3624	10	50	3624	9	IMD4
	12	708	5	25	738	N/A	N/A
	n78	3370	10	50	3370	N/A	N/A
	n7	2542	5	25	2662	29.6	IMD2
DC_12A-30A_n2A	12	708.5	5	25	738.5	N/A	N/A
	30	2308	5	25	2353	12.0	IMD4
	n2	1885	5	25	1965	N/A	N/A
DC_13A-66A_n2A DC_13A-66A-66A_n2A	13	782	5	25	751	N/A	N/A
	66	1736	5	25	2156	7..2	IMD4
	n2	1860	5	25	1940	N/A	N/A
DC_12A-66A_n25A	12	708.5	5	25	738.5	N/A	N/A
	66	1775	5	25	2175	N/A	N/A
	n25	1855	5	25	1935	20	IMD3
	12	708.5	5	25	738.5	N/A	N/A
	66	1750	5	25	2150	4	IMD5
	n25	1883.3	5	25	1963.3	N/A	N/A
	12	708.5	5	25	738.5	N/A	N/A
	66	1712.5	5	25	2112.5	23	IMD3
DC_13A-66A_n48A DC_13A-66A_n48B DC_13A-66A-66A_n48A DC_13A-66A-66A_n48B	13	782	5	25	751	N/A	N/A
	66	1731	5	25	2131	17.1	IMD3
	n48	3695	5	25	3695	N/A	N/A
	18	820	5	25	865	N/A	N/A
DC_18A_n3A-n77A	n3	1770	5	25	1865	N/A	N/A
	n77	3410	10	50	3410	16.3	IMD3
	18	820	5	25	865	N/A	N/A
	n3	1770	5	25	1865	15.7	IMD3
	n77	3505	10	50	3505	N/A	N/A
	14	793	5	25	763	N/A	N/A
DC_14A-66A_n2A DC_14A-66A-66A_n2A	66	1762	5	25	2162	7.6	IMD4



NR or E-UTRA Band / Channel bandwidth / NRB / MSD							
EN-DC Configuration	EUTRA / NR band	UL F <sub>c</sub> (MHz)	UL/DL BW (MHz)	UL L <sub>CRB</sub>	DL F <sub>c</sub> (MHz)	MSD (dB)	IMD order
DC_18A_n3A-n78A	n2	1874	5	25	1954	N/A	N/A
	18	820	5	25	865	N/A	N/A
	n3	1750	5	25	1845	N/A	N/A
	n78	3390	10	50	3390	15.2	IMD3 <sup>3</sup>
DC_18A-28A_n77A	18	820	5	25	865	N/A	N/A
	28	723	5	25	778	4.4	IMD5
	n77	4058	10	50	4058	N/A	N/A
DC_18A-28A_n77A	18	820	5	25	865	3.9	IMD5
	28	723	5	25	778	N/A	N/A
	n77	3757	10	50	3757	N/A	N/A
DC_18A-28A_n78A	18	819	5	25	864	3.8	IMD5
	28	723	5	25	778	N/A	N/A
	n78	3756	10	50	3756	N/A	N/A
DC_18A-41A_n3A DC_18A-41C_n3A	18	820	5	25	865	N/A	N/A
	n3	1725	5	25	1820	N/A	N/A
	41	2630	5	25	2630	16.0	IMD3 $[2*f_{B18}-f_{Bn3}]$
	18	820	5	25	865	28.9	IMD2 <sup>1</sup> $[f_{B41}-f_{Bn3}]$
	n3	1765	5	25	1860	N/A	N/A
	41	2630	5	25	2630	N/A	N/A
DC_18A-41A_n77A DC_18A-41C_n77A	18	820	5	25	865	3.4	IMD5 $[2*f_{n77}-3*f_{B41}]$
	n77	3527.5	10	50	3527.5	N/A	N/A
	41	2640	5	25	2640	N/A	N/A
DC_18A-41A_n78A DC_18A-41C_n78A	18	820	5	25	865	3.4	IMD5 $[2*f_{n78}-3*f_{B41}]$
	n78	3527.5	10	50	3527.5	N/A	N/A
	41	2640	5	25	2640	N/A	N/A
DC_19A-21A_n77A DC_19A-21A_n78A	19	837.5	5	25	882.5	18.7	IMD3
	21	1450.4	5	25	1498.4	N/A	N/A
	n77, n78	3783.3	10	50	3783.3	N/A	N/A
DC_19A-21A_n77A	19	837.5	5	25	882.5	N/A	N/A
	21	1454.5	5	25	1502.5	9.0	IMD4
	n77	4015	10	50	4015	N/A	N/A
DC_19A-21A_n79A	19	837.5	5	25	882.2	N/A	N/A
	21	1452	5	25	1500	3.8	IMD5
	n79	4850	40	216	4850	N/A	N/A
DC_20A_n1A-n78A	20	845	5	25	804	N/A	N/A
	n1	1940	5	25	2130	N/A	N/A
	n78	3630	10	50	3630	16.0	IMD3
	20	835	5	25	794	N/A	N/A
	n1	1930	5	25	2120	15.3	IMD3
	n78	3790	10	50	3790	N/A	N/A
DC_20A_n3A-n78A	20	845	5	25	804	N/A	N/A
	n3	1730	5	25	1825	N/A	N/A
	n78	3420	10	50	3420	16.1	IMD3
	20	845	5	25	804	N/A	N/A
	n3	1765	5	25	1860	15.7	IMD3
	n78	3550	10	50	3550	N/A	N/A
DC_20A_38A-n78A	20	N/A	N/A	N/A	N/A	N/A	IMD2
	38	N/A	N/A	N/A	N/A	N/A	N/A
	n78	N/A	N/A	N/A	N/A	N/A	N/A
	20	N/A	N/A	N/A	N/A	N/A	N/A
	38	N/A	N/A	N/A	N/A	N/A	IMD2
	n78	N/A	N/A	N/A	N/A	N/A	N/A
DC_20A_n7A-n28A	20	857	5	25	816	N/A	N/A
	n7	2512	5	25	2632	N/A	N/A
	n28	743	5	25	798	13.9	IMD3
	20	852	5	25	811	N/A	N/A
	n7	2550	10	50	2670	5.9	IMD5

NR or E-UTRA Band / Channel bandwidth / NRB / MSD							
EN-DC Configuration	EUTRA / NR band	UL F <sub>c</sub> (MHz)	UL/DL BW (MHz)	UL L <sub>CRB</sub>	DL F <sub>c</sub> (MHz)	MSD (dB)	IMD order
DC_20A_SUL_n78A-n80A	n28	738	5	25	793	N/A	N/A
	20	847	5	25	806	9	IMD4
	n80	1735	5	25		N/A	N/A
DC_20A_n41A-n78A	20	845	5	25	804	N/A	N/A
	n41	2675	10	50	2675	29.8	IMD2 $ f_{n78}-f_{B20} $
	n78	3520	10	50	3520	N/A	N/A
	20	850	5	25	809	N/A	N/A
	n41	2550	10	50	2550	N/A	N/A
	n78	3400	10	50	3400	28.8	IMD2 $ f_{B20}+f_{n41} $
DC_21A-28A_n77A	21	1452	5	25	1500	N/A	N/A
	28	730.5	5	25	785.5	16.9	IMD3
	n77	3689.5	10	50	3689.5	N/A	N/A
	21	1450.5	5	25	1498.5	9.9	IMD4
	28	730.5	5	25	785.5	N/A	N/A
	n77	3690	10	50	3690	N/A	N/A
DC_21A-28A_n79A	21	1450	5	25	1498	5.2	IMD5
	28	730.5	5	25	785.5	N/A	N/A
	n79	4420	40	216	4420	N/A	N/A
DC_28A_n3A-n77A	28	735	5	25	790	N/A	N/A
	n3	1755	5	25	1850	17.0	IMD3
	n77	3320	10	52	3320	N/A	N/A
	28	733	5	25	788	N/A	N/A
	n3	1720	5	25	1815	N/A	N/A
	n77	4173	10	50	4173	15.9	IMD3
DC_28A_n7A-n78A DC_28A_n7B-n78A	28	745	5	25	800	N/A	N/A
	n7	2565	5	25	2685	N/A	N/A
	n78	3310	10	50	3310	29.7	IMD2
	28	740	5	25	795	N/A	N/A
	n7	2530	5	25	2650	30.5	IMD2
	n78	3390	10	50	3390	N/A	N/A
DC_28A-41A_n77A	28	738	5	25	793	N/A	N/A
	n77	3380	10	50	3380	N/A	N/A
	41	2642	5	25	2642	29.5	IMD2
DC_28A-41A_n77A	41	2642	5	25	2642	N/A	N/A
	n77	3440	10	50	3440	N/A	N/A
	28	743	5	25	798	30.8	IMD2
DC_28A-41A_n78A	28	738	5	25	793	N/A	N/A
	n78	3380	10	50	3380	N/A	N/A
	41	2642	5	25	2642	29.5	IMD2
DC_28A-41A_n78A	41	2642	5	25	2642	N/A	N/A
	n78	3440	10	50	3440	N/A	N/A
	28	743	5	25	798	30.8	IMD2
DC_28A-41A_n79A	28	743	5	25	798	N/A	N/A
	n79	4739	40	216	4739	N/A	N/A
	41	2510	5	25	2510	8.6	IMD4
DC_28A-41A_n79A	41	2650	5	25	2650	N/A	N/A
	n79	4502	40	216	4502	N/A	N/A
	28	743	5	25	798	15.9	IMD3
DC_28A-42A_79A	28	730	5	25	785	N/A	N/A
	42	3420	5	25	3420	15.3	IMD3
	n79	4880	40	216	4880	N/A	N/A
	28	745	5	25	800	16.2	IMD2
	42	3597.5	5	25	3597.5	N/A	N/A
	n79	4420	40	216	4420	N/A	N/A
DC_19A_n78A-n79A	19	835	5	25	880	N/A	N/A
	n78	3680	10	50	3680	N/A	N/A
	n79	4515	40	216	4515	29.3	IMD2

NR or E-UTRA Band / Channel bandwidth / NRB / MSD							
EN-DC Configuration	EUTRA / NR band	UL F <sub>c</sub> (MHz)	UL/DL BW (MHz)	UL L <sub>CRB</sub>	DL F <sub>c</sub> (MHz)	MSD (dB)	IMD order
	19	835	5	25	880	N/A	N/A
	n79	4550	40	216	4550	N/A	N/A
	n78	3715	10	50	3715	28.8	IMD2
DC_20A_n28A-n78A, DC_20A_SUL_n78A-n83A	20	857	5	25	816	N/A	N/A
	n28, n83	743	5	25	798	N/A	N/A
	n78	3314	10	50	3314	8.7	IMD4
	20	837	5	25	796	N/A	N/A
	n78	3310	10	50	3310	N/A	N/A
	n28	744	5	25	799	9.4	IMD4
DC_21A_n78A-n79A	21	1453	5	25	1501	N/A	N/A
	n78	3420	10	50	3420	N/A	N/A
	n79	4873	40	216	4873	30.1	IMD2
	21	1453	5	25	1501	N/A	N/A
	n79	4940	40	216	4940	N/A	N/A
	n78	3487	10	50	3487	29.8	IMD2
DC_28A_n8A-n78A	28	728	5	25	783	N/A	N/A
	n8	910	5	25	955	N/A	N/A
	n78	3458	10	50	3458	9.1	IMD4
	28	713	5	25	768	N/A	N/A
	n8	890	5	25	935	4.3	IMD5
	n78	3787	10	50	3787	N/A	N/A
DC_30A-66A_n5A, DC_30A-66A-66A_n5A, DC_30A-66A-66A-66A_n5A	30	2310	5	25	2355	N/A	N/A
	66	1730	5	25	2130	2.5	IMD5
	n5	830	5	25	875	N/A	N/A
	n5	830	5	25	875	N/A	N/A
DC_39A_n40A-n79A	39	1917.5	5	25	1917.5	N/A	N/A
	n40	2302.5	5	25	2302.5	N/A	N/A
	n79	4980	40	216	4980	5.8	IMD4 $ f_{B39}-3*f_{n40} $
DC_39A_n41A-n79A	39	1900	5	25	1900	N/A	N/A
	n41	2620	10	50	2620	N/A	N/A
	n79	4520	40	216	4520	29.8	IMD2 <sup>4</sup> $ f_{B39}-f_{n41} $
	39	1900	5	25	1900	N/A	N/A
	n41	2620	10	50	2620	30.2	IMD2 <sup>4</sup> $ f_{B39}-f_{n79} $
	n79	4520	40	216	4520	N/A	N/A
DC_41A_n3A-n77A, DC_41C_n3A-n77A, DC_41A_n3A-n78A, DC_41C_n3A-n78A	41	2620	5	25	2620	N/A	N/A
	n3	1745	5	25	1840	16.4	IMD3 $ 2*f_{B41}-f_{n77} $
	n77/n78	3400	10	50	3400	N/A	N/A
	41	2580	5	25	2580	N/A	N/A
	n3	1720	5	25	1815	N/A	N/A
	n77/n78	3440	10	50	3440	16.8	IMD3 <sup>4</sup> $ 2*f_{B41}-f_{n3} $
DC_41A_n28A-n77A, DC_41C_n28A-n77A, DC_41A_n28A-n78A, DC_41C_n28A-n78A	41	2580	5	25	2580	N/A	N/A
	n28	743	5	25	798	N/A	N/A
	n77/n78	3323	10	50	3323	28.2	IMD2 <sup>1</sup> $ f_{B41}+f_{n28} $
	41	2642	5	25	2642	N/A	N/A
	n28	743	5	25	798	30.8	IMD2 <sup>1</sup> $ f_{B41}-f_{n77} $
	n77/n78	3440	10	50	3440	N/A	N/A
DC_46A-66A_n5A	46	5163	10	50	5163	9.0	IMD4
	66	1775	5	25	2175	N/A	N/A
	n5	847	5	25	892	N/A	N/A
	46	5505	10	50	5505	16.1	IMD3

NR or E-UTRA Band / Channel bandwidth / NRB / MSD							
EN-DC Configuration	EUTRA / NR band	UL F <sub>c</sub> (MHz)	UL/DL BW (MHz)	UL L <sub>CRB</sub>	DL F <sub>c</sub> (MHz)	MSD (dB)	IMD order
DC_46A-66A_n25A <sup>4</sup> DC_46C-66A_n25A <sup>4</sup> DC_46D-66A_n25A <sup>4</sup>	66	1775	5	25	2175	N/A	N/A
	n25	1855	5	25	1935	20	IMD3
	46	5505	10	50	5505	16.1	IMD3
	66	1750	5	25	2150	4	IMD5
	n25	1883.3	5	25	1963.3	N/A	N/A
	46	5505	10	50	5505	16.1	IMD3
	66	1712.5	5	25	2112.5	23	IMD3
	n25	1912.5	5	25	1992.5	N/A	N/A
DC_48A-66A_n12A	48	3580	5	25	3580	N/A	N/A
	66	1760	5	25	2160	17.1	IMD3
	n12	710	5	25	740	N/A	N/A
DC_48A-66A_n71A	48	3560	5	25	3560	N/A	N/A
	66	1774	5	25	2174	15.8	IMD3
	n71	693	5	25	647	N/A	N/A
	48	3697.5	5	25	3697.5	13.0	IMD4
	66	1712.5	5	25	2112.5	N/A	N/A
	n71	665.5	5	25	619.5	N/A	N/A
DC_66A_n7A-n78A, DC_66A-66A_n7A-n78 DC_66A_n7(2A)-n78A DC_66A-66A_n7(2A)- n78A DC_66A_n7A-n78(2A) DC_66A-66A_n7A- n78(2A) DC_66A-66A_n7(2A)- n78(2A)	66	1730	5	25	1825	N/A	N/A
	n7	2560	5	25	2680	N/A	N/A
	n78	3390	10	50	3390	16.1	IMD3
DC_66A_n25A-n41A	66	1715	5	25	2115	N/A	N/A
	n41	2685	10	50	2685	N/A	N/A
	n25	1860	5	25	1940	5	11.0
DC_66A_n38A-n78A	66	1760	5	25	2160	N/A	N/A
	n38	2610	5	25	2610	N/A	N/A
	n78	3460	10	50	3460	15.0	IMD3
DC_66A_n66A-n78A	66	1775	5	25	2175	N/A	N/A
	n66	1725	5	25	2125	2.8	IMD5
	n78	3725	10	50	3725	N/A	N/A

NOTE 1: This band is subject to IMD3 also which MSD is not specified.  
 NOTE 2: For DC\_3A\_n3A-n77A, DC\_3A\_n3A-n78A paired with UL\_DC\_3A\_n3A, the 3rd DL bands n77/n78 are subject to IMD2 which MSD is not specified  
 NOTE 3: This MSD requirement apply with both IMD2 and IMD3 products should be generated.  
 NOTE 4: This band is subject to IMD5 also which MSD is not specified.  
 NOTE 5: When Band 46 have self-interference problems by dual uplink CA/EN-DC, then the requirements do not apply in exclusion zone which is frequency range within (harmonics frequency region + ΔF<sub>HD</sub>) and IMD frequency region as follow.

IMD frequency range

DL_CA configuration	UL_CA configuration	Exclusion zone center frequency	Exclusion zone BW
DC_2A-46A_n66A	DC_2A_n66A	2*fc_2A + fc_n66A	2*BW_2A + BW_n66A
DC_2A-46A_n66A	DC_2A_n66A	fc_2A + 2*fc_n66A	BW_2A + 2*BW_n66A

7.3B.2.3.5.3 Void

7.3B.2.3.5.4 MSD test points for intermodulation interference due to dual uplink operation for EN-DC in NR FR1 involving four bands

**Table 7.3B.2.3.5.4-1: MSD test points for Scell due to dual uplink operation for EN-DC in NR FR1 (four bands)**

NR or E-UTRA Band / Channel bandwidth / NRB / MSD							
EN-DC Configuration	EUTRA / NR band	UL F <sub>c</sub> (MHz)	UL/DL BW (MHz)	UL L <sub>CRB</sub>	DL F <sub>c</sub> (MHz)	MSD (dB)	IMD order
DC_1A-7A_n7A-n78A	1	1950	5	25	2140	8.7	IMD4
	7, n7	2510	10	50	2630	N/A	N/A
	n78	3580	10	50	3580	N/A	N/A
	1	1977.5	5	25	2167.5	N/A	N/A
	7, n7	2507.5	5	25	2627.5	9.1	IMD4
	n78	3305	10	50	3305	N/A	N/A
	1	1970	5	25	2160	N/A	N/A
	7, n7	2520	5	25	2640	N/A	N/A
DC_3A-7A_n7A-n78A DC_3A-3A-7A_n7A-n78A DC_3C-7A_n7A-n78A	n78	3390	10	50	3390	10.1	IMD4
	3	1725	5	25	1820	17.6	IMD3
	7, n7	2565	5	25	2685	N/A	N/A
	n78	3310	10	50	3310	N/A	N/A
	3	1725	5	25	1820	8.6	IMD4
	7, n7	2565	5	25	2685	N/A	N/A
	n78	3475	10	50	3475	N/A	N/A
	3	1730	5	25	1825	N/A	N/A
DC_7A-28A_n7A-n78A	n7, n7	2560	5	25	2680	N/A	N/A
	n78	3390	10	50	3390	16.1	IMD3
	7, n7	2565	5	25	2685	N/A	N/A
	28	745	5	25	800	28.8	IMD2
	n78	3365	10	50	3365	N/A	N/A
	7, n7	2570	5	25	2670	N/A	N/A
	28	720	5	25	790	3.0	IMD5
	n78	3460	10	50	3421	N/A	N/A
	7, n7	2570	5	25	2650	30.5	IMD2
	28	740	5	25	768	N/A	N/A
	n78	3390	10	50	3421	N/A	N/A
	7, n7	2565	5	25	2685	N/A	N/A
28	745	5	25	800	N/A	N/A	
n78	3310	10	50	3310	29.7	IMD2	

**7.3B.2.3a Inter-band NE-DC within FR1**

Reference sensitivity exceptions are specified for the condition when there is uplink transmission only in the aggressor band. This clause addresses directly only NE-DC configurations that don't have a corresponding specified EN-DC configuration or specific NE-DC exceptions.

**7.3B.2.3a.1 Reference sensitivity exceptions due to UL harmonic interference for NE-DC in NR FR1**

Sensitivity degradation is allowed for a band if it is impacted by UL harmonic interference from another band part of the same NE-DC configuration. For the NE-DC configurations that have an EN-DC defined configuration, the reference sensitivity exceptions for the victim band (high) are specified in Table 7.3B.2.3.1-1 with uplink configuration of the aggressor band (low) specified in Table 7.3B.2.3.1-2 are applicable.

### 7.3B.2.4 Inter-band EN-DC including FR2

#### 7.3B.2.4.1 Void

### 7.3B.2.5 Inter-band EN-DC including both FR1 and FR2

#### 7.3B.2.5.1 Reference sensitivity exceptions due to UL harmonic interference for EN-DC including both FR1 and FR2

For inter-band EN-DC of E-UTRA and NR in both FR1 and FR2, the UE is allowed to apply each sensitivity degradation for EN-DC in FR1 specified in clause 7.3B.2.3 TS 38.101-3 and for EN-DC including FR2 specified in clause 7.3B.2.3 of TS 38.101-3 independently.

## 7.3B.3 $\Delta R_{IB,c}$ , $\Delta R_{IBNC}$ for DC

### 7.3B.3.0 General

For the UE which supports inter-band EN-DC or NE-DC configuration, the minimum requirement for reference sensitivity in Table 7.3.1-1 and Table 7.3.1-1a in TS 36.101 [4], clause 7.3.2, 7.3A.2, 7.3C.2 in TS 38.101-1 [2] and clause 7.3.2, 7.3A.2 in TS 38.101-2 [3] shall be increased by the amount given in  $\Delta R_{IB,c}$ ,  $\Delta R_{IBNC}$  in Tables below where unless otherwise stated, the same  $\Delta R_{IB,c}$ ,  $\Delta R_{IBNC}$  are applicable to NR band(s) part for DC configurations which have the same NR operating band combination. Unless otherwise stated,  $\Delta R_{IB,c}$  or  $\Delta R_{IBNC}$  is set to zero.

In case the UE supports more than one of band combinations for CA, SUL or DC, and an operating band belongs to more than one band combinations then

- When the operating band frequency range is  $\leq 1$  GHz, the applicable additional  $\Delta R_{IB,c}$  shall be the average value for all band combinations defined in clause 7.3A, 7.3B, 7.3C in this specification and 7.3A, 7.3B in TS 38.101-3 [3], truncated to one decimal place that apply for that operating band among the supported band combinations. In case there is a harmonic relation between low band UL and high band DL, then the maximum  $\Delta R_{IB,c}$  among the different supported band combinations involving such band shall be applied
- When the operating band frequency range is  $> 1$  GHz, the applicable additional  $\Delta R_{IB,c}$  shall be the maximum value for all band combinations defined in clause 7.3A, 7.3B, 7.3C in this specification and 7.3A, 7.3B in TS 38.101-3 [3] for the applicable operating bands.

Unless  $\Delta R_{IB,c}$  is specified for the NE-DC configuration, the specified  $\Delta R_{IB,c}$  for the EN-DC configuration including same bands as the corresponding NE-DC configuration is applicable for the NE-DC configuration.

7.3B.3.1 Intra-band contiguous EN-DC

7.3B.3.2 Intra-band non-contiguous EN-DC

**Table 7.3B.3.2-1: Intra-band non-contiguous EN-DC with one uplink configuration on E-UTRA for reference sensitivity (E-UTRA carrier is higher than the NR carrier)**

DC configuration	Aggregated channel bandwidth		$W_{gap}$ / (MHz)	UL E-UTRA allocation	$\Delta R_{IBNC}$ (dB)	Duplex mode
	E-UTRA	NR				
DC_3A_n3A	5 MHz	5 MHz	$45.0 < W_{gap} \leq 65.0$	12 <sup>1</sup>	4.7	FDD
			$0.0 < W_{gap} \leq 45.0$	25 <sup>1</sup>	0	
	5 MHz	10 MHz	$40.0 < W_{gap} \leq 60.0$	12 <sup>1</sup>	3.8	
			$0.0 < W_{gap} \leq 40.0$	25 <sup>1</sup>	0	
	5 MHz	15 MHz	$35.0 < W_{gap} \leq 55.0$	12 <sup>1</sup>	3.6	
			$0.0 < W_{gap} \leq 35.0$	25 <sup>1</sup>	0	
	5 MHz	20 MHz	$30.0 < W_{gap} \leq 50.0$	12 <sup>1</sup>	3.4	
			$0.0 < W_{gap} \leq 30.0$	25 <sup>1</sup>	0	
	5 MHz	25 MHz	$25.0 < W_{gap} \leq 45.0$	12 <sup>1</sup>	3.2	
			$0.0 < W_{gap} \leq 25.0$	25 <sup>1</sup>	0	
	5 MHz	30 MHz	$20.0 < W_{gap} \leq 40.0$	12 <sup>1</sup>	3.0	
			$0.0 < W_{gap} \leq 20.0$	25 <sup>1</sup>	0	
	10 MHz	5 MHz	$30.0 < W_{gap} \leq 60.0$	12 <sup>5</sup>	5.1	
			$0.0 < W_{gap} \leq 30.0$	32 <sup>1</sup>	0	
	10 MHz	10MHz	$25.0 < W_{gap} \leq 55.0$	12 <sup>5</sup>	4.3	
			$0.0 < W_{gap} \leq 25.0$	32 <sup>1</sup>	0	
	10 MHz	15 MHz	$20.0 < W_{gap} \leq 50.0$	12 <sup>5</sup>	3.8	
			$0.0 < W_{gap} \leq 20.0$	32 <sup>1</sup>	0	
	10 MHz	20 MHz	$15.0 < W_{gap} \leq 45.0$	12 <sup>5</sup>	3.5	
			$0.0 < W_{gap} \leq 15.0$	32 <sup>1</sup>	0	
	10 MHz	25 MHz	$10.0 < W_{gap} \leq 40.0$	12 <sup>5</sup>	3.2	
			$0.0 < W_{gap} \leq 10.0$	32 <sup>1</sup>	0	
	10 MHz	30 MHz	$5.0 < W_{gap} \leq 35.0$	12 <sup>5</sup>	2.8	
			$0.0 < W_{gap} \leq 5.0$	32 <sup>1</sup>	0	
	15 MHz	5 MHz	$25.0 < W_{gap} \leq 55.0$	12 <sup>6</sup>	6.0	
			$0.0 < W_{gap} \leq 25.0$	32 <sup>1</sup>	0	
	15 MHz	10 MHz	$20.0 < W_{gap} \leq 50.0$	12 <sup>6</sup>	4.7	
			$0.0 < W_{gap} \leq 20.0$	32 <sup>1</sup>	0	
	15 MHz	15 MHz	$15.0 < W_{gap} \leq 45.0$	12 <sup>6</sup>	4.2	
			$0.0 < W_{gap} \leq 15.0$	32 <sup>1</sup>	0	
	15 MHz	20 MHz	$10.0 < W_{gap} \leq 40.0$	12 <sup>6</sup>	3.8	
			$0.0 < W_{gap} \leq 10.0$	32 <sup>1</sup>	0	
15 MHz	25 MHz	$5.0 < W_{gap} \leq 35.0$	12 <sup>6</sup>	3.5		
		$0.0 < W_{gap} \leq 5.0$	32 <sup>1</sup>	0		
15 MHz	30 MHz	$0.0 < W_{gap} \leq 30.0$	12 <sup>6</sup>	3.3		
20 MHz	5 MHz	$15.0 < W_{gap} \leq 50.0$	16 <sup>7</sup>	6.5		
		$0.0 < W_{gap} \leq 15.0$	32 <sup>1</sup>	0		
20 MHz	10 MHz	$10.0 < W_{gap} \leq 45.0$	16 <sup>7</sup>	5.1		
		$0.0 < W_{gap} \leq 10.0$	32 <sup>1</sup>	0		
20 MHz	15 MHz	$5.0 < W_{gap} \leq 40.0$	16 <sup>7</sup>	4.5		
		$0.0 < W_{gap} \leq 5.0$	32 <sup>1</sup>	0		
20 MHz	20 MHz	$0.0 < W_{gap} \leq 35.0$	16 <sup>7</sup>	4.1		
20 MHz	25 MHz	$0.0 < W_{gap} \leq 30.0$	16 <sup>7</sup>	3.8		
20 MHz	30 MHz	$0.0 < W_{gap} \leq 25.0$	16 <sup>7</sup>	3.6		
DC_66A_n66A	NOTE 4	NOTE 8	NOTE 9	0	FDD	
<p>NOTE 1: UL resource blocks shall be located as close as possible to the downlink operating band but confined within the transmission.</p> <p>NOTE 2: <math>W_{gap}</math> is the sub-block gap between the two sub-blocks.</p> <p>NOTE 3: The table only applies when the center frequency of E-UTRA carrier is higher than the NR carrier, and the <math>\Delta R_{IBNC}</math> applies to the NR DL carrier only</p> <p>NOTE 4: All combinations of channel bandwidths defined in Table 5.3B.1.3-1.</p> <p>NOTE 5: UL resource blocks shall be located at <math>RB_{start} = 25</math>.</p> <p>NOTE 6: UL resource blocks shall be located at <math>RB_{start} = 35</math>.</p> <p>NOTE 7: UL resource blocks shall be located at <math>RB_{start} = 50</math>.</p> <p>NOTE 8: All applicable sub-block gap sizes.</p> <p>NOTE 9: The UL LTE allocation is same as Transmission bandwidth configuration <math>N_{RB}</math> as defined in Table 5.6-1 in TS 36.101 [4].</p>						



**Table 7.3B.3.2-2: Intra-band non-contiguous EN-DC with one uplink configuration on NR for reference sensitivity (NR carrier is higher than the E-UTRA carrier)**

DC configuration	Aggregated bandwidth		$W_{gap}$ / (MHz)	UL NR allocation	$\Delta R_{IBNC}$ (dB)	Duplex mode
	NR	E-UTRA				
DC_2A_n2A	5MHz	5MHz	$30.0 < W_{gap} \leq 50.0$	$12^1$	5.3	FDD
			$0.0 < W_{gap} \leq 30.0$	$25^1$	0	
	5MHz	10MHz	$25.0 < W_{gap} \leq 45.0$	$12^1$	4.4	
			$0.0 < W_{gap} \leq 25.0$	$25^1$	0	
	5MHz	15MHz	$20.0 < W_{gap} \leq 40.0$	$12^1$	4.2	
			$0.0 < W_{gap} \leq 20.0$	$25^1$	0	
	5MHz	20MHz	$15.0 < W_{gap} \leq 35.0$	$12^1$	3.8	
			$0.0 < W_{gap} \leq 15.0$	$25^1$	0	
	10MHz	5MHz	$15.0 < W_{gap} \leq 45.0$	$12^1$	5.9	
			$0.0 < W_{gap} \leq 15.0$	$32^1$	0	
	10MHz	10MHz	$10.0 < W_{gap} \leq 40.0$	$12^1$	4.6	
			$0.0 < W_{gap} \leq 10.0$	$32^1$	0	
	10MHz	15MHz	$5.0 < W_{gap} \leq 35.0$	$12^1$	4.1	
			$0.0 < W_{gap} \leq 5.0$	$32^1$	0	
	10MHz	20MHz	$0.0 < W_{gap} \leq 30.0$	$12^1$	4.0	
	15MHz	5MHz	$10.0 < W_{gap} \leq 40.0$	$12^{11}$	6.7	
			$0.0 < W_{gap} \leq 10.0$	$36^1$	0	
	15MHz	10MHz	$5.0 < W_{gap} \leq 35.0$	$12^{11}$	5.4	
			$0.0 < W_{gap} \leq 5.0$	$36^1$	0	
	15MHz	15MHz	$0.0 < W_{gap} \leq 30.0$	$12^{11}$	4.6	
15MHz	20MHz	$0.0 < W_{gap} \leq 25.0$	$12^{11}$	4.2		
20MHz	5MHz	$0.0 < W_{gap} \leq 35.0$	$16^{12}$	7.2		
20MHz	10MHz	$0.0 < W_{gap} \leq 30.0$	$16^{12}$	5.8		
20MHz	15MHz	$0.0 < W_{gap} \leq 25.0$	$16^{12}$	5.0		
20MHz	20MHz	$0.0 < W_{gap} \leq 20.0$	$16^{12}$	4.6		
DC_3A_n3A	5MHz	5MHz	$45.0 < W_{gap} \leq 65.0$	$12^1$	4.7	FDD
			$0.0 < W_{gap} \leq 45.0$	$25^1$	0	
	5MHz	10MHz	$40.0 < W_{gap} \leq 60.0$	$12^1$	3.8	
			$0.0 < W_{gap} \leq 40.0$	$25^1$	0	
	5MHz	15MHz	$35.0 < W_{gap} \leq 55.0$	$12^1$	3.6	
			$0.0 < W_{gap} \leq 35.0$	$25^1$	0	
	5MHz	20MHz	$30.0 < W_{gap} \leq 50.0$	$12^1$	3.4	
			$0.0 < W_{gap} \leq 30.0$	$25^1$	0	
	10MHz	5MHz	$30.0 < W_{gap} \leq 60.0$	$12^5$	5.1	
			$0.0 < W_{gap} \leq 30.0$	$32^1$	0	
	10MHz	10MHz	$25.0 < W_{gap} \leq 55.0$	$12^5$	4.3	
			$0.0 < W_{gap} \leq 25.0$	$32^1$	0	
	10MHz	15MHz	$20.0 < W_{gap} \leq 50.0$	$12^5$	3.8	
			$0.0 < W_{gap} \leq 20.0$	$32^1$	0	
	10MHz	20MHz	$15.0 < W_{gap} \leq 45.0$	$12^5$	3.5	
			$0.0 < W_{gap} \leq 15.0$	$32^1$	0	
	15MHz	5MHz	$25.0 < W_{gap} \leq 55.0$	$12^6$	6.0	
			$0.0 < W_{gap} \leq 25.0$	$32^1$	0	
	15MHz	10MHz	$20.0 < W_{gap} \leq 50.0$	$12^6$	4.7	
			$0.0 < W_{gap} \leq 20.0$	$32^1$	0	
	15MHz	15MHz	$15.0 < W_{gap} \leq 45.0$	$12^6$	4.2	
			$0.0 < W_{gap} \leq 15.0$	$32^1$	0	
	15MHz	20MHz	$10.0 < W_{gap} \leq 40.0$	$12^6$	3.8	
			$0.0 < W_{gap} \leq 10.0$	$32^1$	0	
	20MHz	5MHz	$15.0 < W_{gap} \leq 50.0$	$16^7$	6.5	
			$0.0 < W_{gap} \leq 15.0$	$32^1$	0	
	20MHz	10MHz	$10.0 < W_{gap} \leq 45.0$	$16^7$	5.1	
			$0.0 < W_{gap} \leq 10.0$	$32^1$	0	
	20MHz	15MHz	$5.0 < W_{gap} \leq 40.0$	$16^7$	4.5	
			$0.0 < W_{gap} \leq 5.0$	$32^1$	0	
20MHz	20MHz	$0.0 < W_{gap} \leq 35.0$	$16^7$	4.1		
25MHz	5MHz	$10.0 < W_{gap} \leq 45.0$	$16^8$	7.4		
		$0.0 < W_{gap} \leq 10.0$	$32^1$	0		
25MHz	10MHz	$5.0 < W_{gap} \leq 40.0$	$16^8$	5.5		
		$0.0 < W_{gap} \leq 5.0$	$32^1$	0		
25MHz	15MHz	$0.0 < W_{gap} \leq 35.0$	$16^8$	4.9		
25MHz	20MHz	$0.0 < W_{gap} \leq 30.0$	$16^8$	4.6		

DC configuration	Aggregated bandwidth		$W_{gap}$ / (MHz)	UL NR allocation	$\Delta R_{IBNC}$ (dB)	Duplex mode
	NR	E-UTRA				
	30MHz	5MHz	$5.0 < W_{gap} \leq 40.0$	16 <sup>9</sup>	8.3	
			$0.0 < W_{gap} \leq 5.0$	32 <sup>1</sup>	0	
	30MHz	10MHz	$0.0 < W_{gap} \leq 35.0$	16 <sup>9</sup>	5.9	
	30MHz	15MHz	$0.0 < W_{gap} \leq 30.0$	16 <sup>9</sup>	5.5	
	30MHz	20MHz	$0.0 < W_{gap} \leq 25.0$	16 <sup>9</sup>	4.9	
DC_5A_n5A	5 MHz	5 MHz	NOTE 10	12 <sup>1</sup>	5.3	FDD
	10 MHz	5 MHz			4.4	
	15 MHz	5 MHz			6.1	
	5 MHz	10 MHz			5.9	
	10 MHz	10 MHz			4.6	
DC_7A_n7A	5MHz	5MHz	$0 < W_{gap} \leq 60$	25	0.0	FDD
			$0 < W_{gap} \leq 55$	25	0.0	
	5MHz	10MHz	$0 < W_{gap} \leq 50$	25	0.0	
			$0 < W_{gap} \leq 45$	25	0.0	
	5MHz	20MHz	$0 < W_{gap} \leq 45$	25	0.0	
			$0 < W_{gap} \leq 40$	25	0.0	
	10MHz	5MHz	$30 < W_{gap} \leq 55$	32 <sup>1</sup>	0.0	
			$0 < W_{gap} \leq 30$	50	0.0	
	10MHz	10MHz	$25.0 < W_{gap} \leq 50.0$	32 <sup>1</sup>	0.0	
			$0.0 < W_{gap} \leq 25.0$	50	0.0	
	10MHz	15MHz	$20 < W_{gap} \leq 45$	32 <sup>1</sup>	0.0	
			$0 < W_{gap} \leq 20$	50	0.0	
	10MHz	20MHz	$15 < W_{gap} \leq 40$	32 <sup>1</sup>	0.0	
			$0 < W_{gap} \leq 15$	50	0.0	
	15MHz	5MHz	$20.0 < W_{gap} \leq 50.0$	32 <sup>1</sup>	0.0	
			$0.0 < W_{gap} \leq 20.0$	50 <sup>1</sup>	0.0	
	15MHz	10MHz	$20.0 < W_{gap} \leq 45.0$	32 <sup>1</sup>	0.0	
			$0.0 < W_{gap} \leq 20.0$	50 <sup>1</sup>	0.0	
	15MHz	15MHz	$15.0 < W_{gap} \leq 40.0$	32 <sup>1</sup>	0.0	
			$0.0 < W_{gap} \leq 15.0$	50 <sup>1</sup>	0.0	
	15MHz	20MHz	$10 < W_{gap} \leq 35$	32 <sup>1</sup>	0.0	
			$0 < W_{gap} \leq 10$	50 <sup>1</sup>	0.0	
	20MHz	5MHz	$25 < W_{gap} \leq 45$	32 <sup>1</sup>	0.0	
			$0 < W_{gap} \leq 25$	45 <sup>1</sup>	0.0	
20MHz	10MHz	$20 < W_{gap} \leq 40$	32 <sup>1</sup>	0.0		
		$0 < W_{gap} \leq 20$	45 <sup>1</sup>	0.0		
20MHz	15MHz	$15.0 < W_{gap} \leq 35.0$	36 <sup>1</sup>	0.0		
		$0.0 < W_{gap} \leq 15.0$	50 <sup>1</sup>	0.0		
20MHz	20MHz	$15.0 < W_{gap} \leq 30.0$	32 <sup>1</sup>	0.0		
		$0.0 < W_{gap} \leq 15.0$	45 <sup>1</sup>	0.0		

NOTE 1: <sup>1</sup> refers to the UL resource blocks shall be located as close as possible to the downlink operating band but confined within the transmission.

NOTE 2:  $W_{gap}$  is the sub-block gap between the two sub-blocks.

NOTE 3: The table only applies when the center frequency of NR carrier is higher than the E-UTRA carrier, and the  $\Delta R_{IBNC}$  applies to the E-UTRA DL carrier only.

NOTE 4: All combinations of channel bandwidths defined in Table 5.3B.1.3-1.

NOTE 5: <sup>5</sup> refers to the UL resource blocks shall be located at  $RB_{start}=25$ .

NOTE 6: <sup>6</sup> refers to the UL resource blocks shall be located at  $RB_{start}=35$ .

NOTE 7: <sup>7</sup> refers to the UL resource blocks shall be located at  $RB_{start}=50$ .

NOTE 8: <sup>8</sup> refers to the UL resource blocks shall be located at  $RB_{start}=60$ .

NOTE 9: <sup>9</sup> refers to the UL resource blocks shall be located at  $RB_{start}=75$ .

NOTE 10: All applicable sub-block gap sizes.

NOTE 11: <sup>11</sup> refers to the UL resource blocks shall be located at  $RB_{start}=39$ .

NOTE 12: <sup>12</sup> refers to the UL resource blocks shall be located at  $RB_{start}=57$ .

## 7.3B.3.3 Inter-band EN-DC within FR1

7.3B.3.3.1  $\Delta R_{IB,c}$  for EN-DC in two bandsTable 7.3B.3.3.1-1:  $\Delta R_{IB,c}$  due to EN-DC(two bands)

Inter-band EN-DC configuration	E-UTRA or NR Band	$\Delta R_{IB,c}$ (dB)
DC_1_n28	n28	0.2
DC_1_n51	n51	0.1
DC_1_n77	1	0.2
	n77	0.5
DC_1_n78	n78	0.5
DC_2_n48	2	0.2
	n48	0.5
DC_2_n66	2	0.3
	n66	0.3
DC_2_n78	2	0.2
	n78	0.5
DC_3_n41	n41	0 <sup>3</sup>
		0.5 <sup>4</sup>
DC_3_n51	3	0.2
	n51	0.2
DC_3_n77, DC_3-3_n77	3	0.2
	n77	0.5
DC_3_n78, DC_3-3_n78	3	0.2
	n78	0.5
DC_5_n78	5	0.2
	n78	0.5
DC_4_n38	4	0.5
	n38	0.5
DC_4_n41	4	0.5
	n41	0.5 <sup>1</sup>
DC_4_n78	4	1 <sup>2</sup>
	n78	0.2
DC_5_n12	5	0.5
	n12	0.3
DC_7_n8	n8	0.2
DC_7_n40	n40	0.5
DC_7_n51	n51	0.2
DC_7_n66, DC_7-7_n66	7	0.5
	n66	0.5
DC_7_n71	n71	0.2
DC_7_n77, DC_7-7_n77	n77	0.5
DC_7_n78, DC_7-7_n78	n78	0.5
DC_8_n28	8	0.2
	n28	0.1
DC_8_n77	8	0.2
	n77	0.5
DC_8_n78	8	0.2
	n78	0.5
DC_11_n3	11	0.3
	n3	0.5
DC_11_n28	n28	0.2
DC_11_n77	n77	0.5
DC_11_n78	n78	0.5
DC_12_n5	12	0.3
	n5	0.5
DC_12_n66	12	0.5
DC_12_n78	12	0.2
	n78	0.5
DC_13_n7	13	0.5
	n7	0.5

Inter-band EN-DC configuration	E-UTRA or NR Band	$\Delta R_{IB,c}$ (dB)
DC_13_n78	13	0.2
	n78	0.5
DC_18_n77	n77	0.5
DC_19_n77	n77	0.5
DC_19_n78	n78	0.5
DC_20_n51	n51	0.2
DC_20_n77	n77	0.5
DC_20_n78	n78	0.5
DC_21_n77	n77	0.5
DC_21_n78	n78	0.5
DC_25_n41, DC_25-25_n41	n41	0 <sup>1</sup>
		0.5 <sup>2</sup>
DC_26_n77	n77	0.5
DC_26_n78	n78	0.5
DC_28_n8	28	0.1
	n8	0.2
DC_28A_n51	n51	0.2
DC_28_n77	28	0.2
	n77	0.5
DC_28_n78	28	0.2
	n78	0.5
DC_30_n66	30	0.5
	n66	0.4
DC_38_n78	38	0.4
	n78	0.5
DC_39_n40	39	0.3
	n40	0.3
DC_39-n41	39	0.2
	n41	0.2
DC_39_n78	n78	0.5
DC_39_n79	n79	0.5
DC_40_n77	40	0.4
	n77	0.5
DC_40_n78	40	0.4 <sup>5</sup>
	n78	0.5 <sup>5</sup>
DC_40_n79	n79	0.5
DC_41_n3	41	0 <sup>3</sup>
		0.5 <sup>4</sup>
DC_42_n28	42	0.2
	n28	0.5
DC_41_n77	n77	0.5
DC_41_n78	n78	0.5
DC_41_n79	n79	0.5
DC_42_n51	n51	0.2
DC_48_n66	48	0.5
	n66	0.2
DC_66_n2	66	0.3
	n2	0.3
DC_66_n7	66	0.5
	n7	0.5
DC_66_n12	66	0.5
DC_66_n25	66	0.3
	n25	0.3
DC_66_n38	66	0.5
	n38	0.5
DC_66_n41	n41	0.5
		0.5 <sup>1</sup>
DC_66_n48, DC_66-66_n48	66	0.2
	n48	0.5
DC_66_n78	66	0.2
	n78	0.5

Inter-band EN-DC configuration	E-UTRA or NR Band	$\Delta R_{IB,c}$ (dB)
DC_71_n38	71	0.2
DC_71_n78	71	0.2
	n78	0.5
NOTE 1: The requirement is applied for UE transmitting on the frequency range of 2545 – 2690 MHz.		
NOTE 2: The requirement is applied for UE transmitting on the frequency range of 2496 – 2545 MHz.		
NOTE 3: Applicable for the frequency range of 2515 – 2690 MHz.		
NOTE 4: Applicable for the frequency range of 2496 – 2515 MHz.		
NOTE 5: Only applicable for UE supporting inter-band carrier aggregation with uplink in one E-UTRA band and without simultaneous Rx/Tx.		

7.3B.3.3.2  $\Delta R_{IB,c}$  for EN-DC three bandsTable 7.3B.3.3.2-1:  $\Delta R_{IB,c}$  due to EN-DC (three bands)

Inter-band EN-DC configuration	E-UTRA or NR Band	$\Delta R_{IB,c}$ (dB)
DC_1-3_n28	n28	0.2
DC_1_n3-n28	n28	0.2
DC_1-3_n41 DC_1-41_n3	n41 or 41	0 <sup>1</sup>
		0.5 <sup>2</sup>
DC_1-3_n77	1	0.2
	3	0.2
	n77	0.5
DC_1-3_n78	1	0.2
	3	0.2
	n78	0.5
DC_1_n3-n78	1	0.2
	n3	0.2
	n78	0.5
DC_1-5_n78	1	0.2
	5	0.2
	n78	0.5
DC_1-7_n8	n8	0.2
DC_1-7_n28	n28	0.2
DC_1-7_n40	7	0.3
	n40	0.8
DC_1-7_n78	1	0.2
DC_1-7-7_n78	7 or n7	0.2
DC_1_n7-n78	n78	0.5
DC_1-8_n28	8	0.2
	n28	0.2
DC_1_n8-n40	n8	0.2
	n40	0.5
DC_1-8_n77	8	0.2
	n77	0.5
DC_1-8_n78	8	0.2
	n78	0.5
DC_1_n8-n78	1	0.2
	n8	0.2
	n78	0.5
DC_1-11_n3	11	0.3
	n3	0.5
DC_1-11_n77	1	0.2
	n77	0.5
DC_1-11_n78	n78	0.5
DC_1-18_n77	n77	0.5
DC_1-18_n78	n78	0.5
DC_1-19_n77	n77	0.5
DC_1-19_n78	n78	0.5
DC_1-19_n79	1	0.3
	19	0.3
DC_1-20_n28	20	0.2

Inter-band EN-DC configuration	E-UTRA or NR Band	$\Delta R_{IB,c}$ (dB)
	n28	0.2
DC_1-20_n78	n78	0.5
DC_1-21_n77	n77	0.5
DC_1-21_n78	1	0.2
	n78	0.5
DC_1-28-n3	28	0.2
DC_1-28_n7	28	0.2
DC_1_n28-n40	n28	0.2
DC_1-28_n40	28	0.2
DC_1-28_n77	28	0.2
	n77	0.5
DC_1_n28-n77	1	0.2
	n28	0.2
	n77	0.5
DC_1-28_n78	28 or n28	0.2
DC_1_n28-n78	n78	0.5
DC_1_n28-n79	1	0.3
	28	0.3
DC_1-32_n78	n78	0.5
DC_1-41_n78	n78	0.5
DC_1_n41-n78		
DC_1-41_n3	41	0 <sup>1</sup> /0.5 <sup>2</sup>
DC_1-41_n28	n28	0.2
DC_1-41_n77	n77	0.5
DC_1-41_n78	n78	0.5
DC_1-42_n28	42	0.5
	n28	0.5
DC_1-42_n77	1	0.2
	42	0.5
	n77	0.5
DC_1-42_n78	1	0.2
	42	0.5
	n78	0.5
DC_1-42_n79	42	0.5
DC_1_n75-n78	n78	0.5
DC_1_n77-n79	1	0.2
	n77	0.5
DC_1_SUL_n77-n80	1	0.2
	n77	0.5
DC_1_SUL_n77-n84	1	0.2
	n77	0.5
DC_1_n78-n79	n78	0.5
DC_1_SUL_n78-n80	1	0.2
	n78	0.5
DC_1-SUL_n78-n84	n78	0.5
DC_2-4_n38	2	0.3
	4	0.5
	n38	0.5
DC_2-4_n41	2	0.3
	4	0.5
	n41	0.5
DC_2-5_n66	2	0.3
DC_2-5-5_n66	n66	0.3
DC_2-7_n38	n38	0.2
DC_2-2-7_n38		
DC_2-7_n66	2	0.3
	7	0.5
	n66	0.5
DC_2-7_n71	n71	0.2
DC_2_n7-n78	2	0.2
	n7	0.5
	n78	0.5
	2	0.3

Inter-band EN-DC configuration	E-UTRA or NR Band	$\Delta R_{IB,c}$ (dB)	
DC_2-12_n66, DC_2-2-12_n66	12	0.5	
	n66	0.3	
DC_2-13_n66 DC_2-2-13_n66	2	0.3	
	n66	0.3	
DC_2-14_n66 DC_2-2-14_n66	2	0.3	
	n66	0.3	
DC_2-29_n66 DC_2-2-29_n66	2	0.3	
	n66	0.3	
DC_2-30_n5, DC_2-2-30_n5	2	0.4	
	30	0.5	
DC_2-30_n66, DC_2-2-30_n66	2	0.4	
	30	0.5	
	n66	0.4	
DC_2_n38-n78	2	0.5	
	n7	0.5	
	n78	0.5	
DC_2_n41-n66	2	0.3	
	n41	0.5	
	n66	0.5	
DC_2-48_n12	2	0.2	
	48	0.5	
DC_2-48_n66	2	0.3	
	48	0.5	
	n66	0.3	
DC_2-48_n71	2	0.2	
	48	0.5	
DC_2-66_n5 DC_2-2-66_n5 DC_2-66-66_n5 DC_2-2-66-66_n5 DC_2-66-66-66_n5	2	0.3	
	66	0.3	
		2	0.3
		66	0.3
		n12	0.5
DC_2-66_n25	2	0.3	
	66	0.3	
	n25	0.3	
DC_2-66_n38 DC_2-2-66_n38 DC_2-66-66_n38	2	0.3	
	66	0.5	
	n38	0.5	
DC_2-66_n41	2	0.3	
	66	0.5	
	n41	0.5 <sup>1</sup> 1 <sup>2</sup>	
DC_2-66_n48 DC_2-66-66_n48	2	0.3	
	66	0.3	
	n48	0.5	
DC_2-66_n66	2	0.3	
	66	0.3	
	n66	0.3	
DC_2-66_n71 DC_2_n66-n71	2	0.3	
	66	0.3	
	66	0.3	
DC_2-66_n78 DC_2-66-66_n78 DC_2_n66-n78	2	0.3	
	66	0.3	
	n78	0.5	
DC_2-71_n66 DC_2-2-71_n66	2	0.3	
	n66	0.3	
DC_2-71_n78 DC_2-2-71_n78	2	0.2	
	71	0.2	
	n78	0.5	
DC_3_n1-n28	n28	0.2	
DC_3_n1-n77	3	0.2	
	n1	0.2	
	n77	0.5	



Inter-band EN-DC configuration	E-UTRA or NR Band	$\Delta R_{IB,c}$ (dB)
DC_3_n1-n78	3	0.2
	n1	0.2
	n78	0.5
DC_3_n3-n77	3	0.2
	n3	0.2
	n77	0.5
DC_3_n3-n78	3	0.2
	n3	0.2
	n78	0.5
DC_3-5_n78	3	0.2
	5	0.2
	n78	0.5
DC_3-7_n40	7	0.3
	n40	0.8
DC_3-7_n77	3	0.2
DC_3-3-7_n77	7	0.2
DC_3-7-7_n77	n77	0.5
DC_3-3-7-7_n77		
DC_3-7_n8	n8	0.2
DC_3-7_n78	3	0.2
DC_3-7-7_n78	7 or n7	0.2
DC_3-3-7_n78	n78	0.5
DC_3-3-7-7_n78		
DC_3_n7-n78		
DC_3-8_n28	8	0.2
	n28	0.1
DC_3-8_n77	3	0.2
	8	0.2
	n77	0.5
DC_3-8_n78	3	0.2
DC_3-3-8_n78	8 or n8	0.2
DC_3_n8-n78	n78	0.5
DC_3-18-n77	3	0.2
	18	0
	n77	0.5
DC_3-18-n78	3	0.2
	n78	0.5
DC_3-19_n77	3	0.2
	n77	0.5
DC_3-19_n78	3	0.2
	n78	0.5
DC_3-20_n28	20	0.1
	n28	0.1
DC_3-20_n78	3	0.2
	n78	0.5
DC_3_n20-n78	3	0.2
	n78	0.5
DC_3-21_n77	3	0.3
	21	0.5
	n77	0.5
DC_3-21_n78	3	0.3
	21	0.5
	n78	0.5
DC_3-21_n79	3	0.3
	21	0.5
DC_3-28_n5	28	0.1
	n5	0.1
DC_3-28_n41	n41	0 <sup>1</sup> /0.5 <sup>2</sup>
DC_3-28_n77	3	0.2
	28 or n28	0.2
	n77	0.5
DC_3-28_n78	3	0.2
DC_3_n28-n78	n78	0.5
DC_3-32_n78	3	0.2

Inter-band EN-DC configuration	E-UTRA or NR Band	$\Delta R_{IB,c}$ (dB)
	n78	0.5
DC_3-38_n78	3	0.2
	38	0.4
	n78	0.5
DC_3_n40-n41	n41	0 <sup>4</sup>
		0.5 <sup>3</sup>
DC_3-41_n28	3	0
	41	0 <sup>1</sup> /0.5 <sup>2</sup>
	n28	0
DC_3-41_n41	41	0 <sup>3</sup>
		0.5 <sup>4</sup>
	n41	0 <sup>3</sup>
		0.5 <sup>4</sup>
DC_3-(n)41	41	0 <sup>3</sup>
		0.5 <sup>4</sup>
	n41	0 <sup>3</sup>
		0.5 <sup>4</sup>
DC_3-41-n77	3	0.2
	41	0 <sup>1</sup>
	n77	0.5 <sup>2</sup>
		0.5
DC_3-41_n78 DC_3_n41-n78	3	0.2
	41 or n41	0 <sup>1</sup>
	n78	0.5 <sup>2</sup>
DC_3-41-n79, DC_3_n41-n79	3	0.2
	41 or n41	0 <sup>1</sup>
		0.5 <sup>2</sup>
DC_3_SUL_n41-n80	n41	0.5 <sup>3</sup>
DC_3-42_n28	3	0.2
	42	0.5
	n28	0.5
DC_3-42_n77	3	0.2
	42	0.5
	n77	0.5
DC_3-42_n78	3	0.2
	42	0.5
	n78	0.5
DC_3-42_n79	3	0.2
	42	0.5
DC_3_n75-n78	3	0.2
	n78	0.5
DC_3_n77-n79	3	0.2
	n77	0.5
DC_3_SUL_n77-n80	3	0.2
	n77	0.5
DC_3_SUL_n77-n84	3	0.2
	n77	0.5
DC_3_n78-n79	3	0.2
	n78	0.5
DC_3-SUL_n78-n80	3	0.2
	n78	0.5
DC_3-SUL_n78-n82	3	0.2
	n78	0.5
DC_3_SUL_n78-n84	3	0.2
	n78	0.5
DC_5-7_n71	n71	0.2
DC_5-7_n78, DC_5-7- 7_n78, DC_5_n7-n78	5	0.2
	7 or n7	0.2
	n78	0.5

Inter-band EN-DC configuration	E-UTRA or NR Band	$\Delta R_{IB,c}$ (dB)
DC_5_(n)12	5	0.5
	12	0.3
	n12	0.3
DC_5_30_n66	30	0.5
	n66	0.4
DC_5-66_n2 DC_5-5-66_n2 DC_5-66-66_n2 DC_5-5-66-66_n2	66	0.3
	n2	0.3
	5	0.2
	66	0.2
DC_5-66_n78	n78	0.5
	7	0.2
	n1	0.2
DC_7_n1-n78	n78	0.5
	7	0.2
	n1	0.2
DC_7_n3-n78	n78	0.5
	7	0.2
	n3	0.2
DC_7_n7-n78	n78	0.5
	7	0.5
	n7	0.5
DC_7-8_n1 DC_7-7-8_n1	8	0.2
	n8	0.2
DC_7_n8-n40	n40	0.5
	n8	0.2
DC_7-8_n3	8	0.2
DC_7-8_n77	8	0.2
	n77	0.5
DC_7-8_n78 DC_7-7-8_n78 DC_7_n8-n78	8 or n8	0.2
	n78	0.5
	7	0.5
DC_7-13_n66	n66	0.5
	7	0.5
DC_7-20_n28	n28	0.2
	20	0.2
DC_7-20_n78	n78	0.5
DC_7_n28-n40	n40	0.5
DC_7-28_n40	n40	0.5
DC_7-28_n78	n78	0.5
DC_7_n28-n78	n78	0.5
DC_7-40_n1 DC_7_n1-n40	7	0.3
	40 or n40	0.8
DC_7-46_n78	n78	0.5
DC_7-66_n38	n38	0.2
DC_7-66_n66 DC_7-7-66_n66	7	0.5
	66	0.5
	n66	0.5
DC_7_n66-n78 DC_7-7_n66-n78	7	0.5
	n66	0.5
	n78	0.5
DC_7-66_n71 DC_7-66-66_n71	7	0.5
	66	0.5
	n71	0.1
DC_7_SUL_n78-n80	7	0.2
	n78	0.5
DC_8_n1-n78	8	0.2
	n78	0.5
DC_8_n3-n28	8	0.2
	n28	0.1
DC_8-11_n3	11	0.3
	n3	0.5
DC_8-11_n77	8	0.2
	n77	0.5
DC_8-11_n78	8	0.2

Inter-band EN-DC configuration	E-UTRA or NR Band	$\Delta R_{IB,c}$ (dB)
	n78	0.2
DC_8-20_n78	8	0.2
	n78	0.5
DC_8-42_n28	8	0.2
	42	0.5
	n28	0.5
DC_8-42_n77	8	0.2
	42	0.5
	n77	0.5
DC_8_SUL_n78-n80	8	0.2
	n78	0.5
DC_8_n28-n77	8	0.2
	n28	0.2
	n77	0.5
DC_8A-SUL_n78-n81	8	0.2
	n78	0.2
DC_11-18_n77	n77	0.5
DC_11-18_n78	n78	0.5
DC_12_(n)5	5	0.5
	12	0.3
	n5	0.5
DC_12_n7-n78	12	0.2
	n7	0.5
	n78	0.5
DC_12-30_n2	30	0.5
	n2	0.4
DC_12-30_n66	12	0.5
	30	0.5
	n66	0.4
DC_12-66_n2	12	0.5
	66	0.3
	n2	0.3
DC_12-66_n25	12	0.5
	66	0.3
	n25	0.3
DC_13-48_n2	48	0.5
	n2	0.2
DC_13-48_n66	48	0.5
	n66	0.2
DC_13-66_n2	66	0.3
	n2	0.3
DC_13-66_n48	66	0.2
	n48	0.5
DC_18_n3-n77	n3	0.2
	n77	0.5
DC_14-66_n2	66	0.3
	n2	0.3
DC_18_n3-n78	18	0
	n3	0.2
	n78	0.5
DC_18-28_n77	n77	0.5
DC_18-28_n78	n78	0.5
DC_18-41_n3	41	0 <sup>1/0.5</sup> 2
DC_18-41_n77	n77	0.5
DC_18-41_n78	n78	0.5
DC_18-42_n77	42	0.5
	n77	0.5
DC_18-42_n78	42	0.5
	n78	0.5
DC_18-42_n79	42	0.5
DC_19-21_n77	n77	0.5
DC_19-21_n78	n78	0.5
DC_19-42_n77	42	0.5

Inter-band EN-DC configuration	E-UTRA or NR Band	$\Delta R_{IB,c}$ (dB)
	n77	0.5
DC_19-42_n78	42	0.5
	n78	0.5
DC_19-42_n79	42	0.5
DC_19_n77-n79	n77	0.5
DC_19_n78-n79	n78	0.5
DC_20_n1-n28	n1	0.2
	n28	0.2
DC_20_n1-n78	n78	0.5
DC_20_n3-n78	n3	0.2
	n78	0.5
DC_20_n7-n28	20	0.2
	n28	0.2
DC_20_n28-n75	n28	0.2
DC_20_n28-n78	20	0.2
	n28	0.2
	n78	0.5
DC_20-32_n78	n78	0.5
DC_20-38_n78	38	0.4
	n78	0.5
DC_20_n41-n78	n78	0.5
DC_20-(n)41	20	0.3
	41	0.3
	n41	0.3
DC_20_n75-n78	n78	0.5
DC_20_n76-n78	n78	0.5
DC_20_SUL_n78-n80	n78	0.5
DC_20-SUL_n78-n82	n78	0.5
DC_20-SUL_n78-n83	20	0.2
	n78	0.5
DC_20_n78-n92	n78	0.5
DC_21-42_n77	42	0.5
	n77	0.5
DC_21-42_n78	42	0.5
	n78	0.5
DC_21-42_n79	42	0.5
DC_21_n77-n79	n77	0.5
DC_21_n78-n79	n78	0.5
DC_25-41_n41	41	0 <sup>1</sup>
		0.5 <sup>2</sup>
DC_25-25-41_n41	n41	0 <sup>1</sup>
DC_25-25_(n)41		0.5 <sup>2</sup>
DC_28-SUL_n78-n83	28	0.2
	n78	0.5
DC_28_n3-n77	28	0.2
	n3	0.2
	n77	0.5
DC_28_n3-n78	28	0
	n3	0.2
	n78	0.5
DC_28_n7-n78	n78	0.5
DC_28_n40-n78	28	0.2
	n40	0.4 <sup>5</sup>
	n78	0.5 <sup>5</sup>
DC_28-41_n77	28	0.2
	n77	0.5
DC_28-41_n78	28	0.2
	n78	0.5
DC_28-41_n79	n79	0.5
DC_28-42_n77	28	0.2
	42	0.5
	n77	0.5
DC_28-42_n78	28	0.2

Inter-band EN-DC configuration	E-UTRA or NR Band	$\Delta R_{IB,c}$ (dB)
	42	0.5
	n78	0.5
DC_28-42_n79	28	0.2
	42	0.5
DC_29-66_n2 DC_29-66-66_n2	66	0.3
	n2	0.3
DC_30-66_n2	30	0.5
	66	0.4
	n2	0.4
DC_30-66_n5 DC_30-66-66_n5 DC_30-66-66-66_n5	66	0.4
	n5	0.5
DC_39_n40-n79	39	0.3
	n40	0.3
	n79	0.5
DC_39_n41-n79	39	0.2
	n41	0.2
	n79	0.5
DC_41_n3-n77	41	0 <sup>3</sup> /0.5 <sup>4</sup>
	n3	0.2
	n77	0.5
DC_41_n3-n78	41	0 <sup>3</sup> /0.5 <sup>4</sup>
	n3	0.2
	n78	0.5
DC_41_n28-n77	n28	0.2
	n77	0.5
DC_41_n28-n78	n28	0.2
	n78	0.5
DC_(n)41-n78	n78	0.5
DC_41-42_n77	42	0.5
	n77	0.5
DC_41-42_n78	42	0.5
	n78	0.5
DC_41-42_n79	42	0.5
DC_42_n28-n77	42	0.2
	n28	0.5
	n77	0.5
DC_46-66_n41	66	0.5
	n41	0.5 <sup>1</sup> 1 <sup>2</sup>
DC_48-66_n5	48	0.5
	66	0.2
DC_48-66_n12	48	0.5
	66	0.2
DC_48-66_n71	48	0.5
	66	0.2
DC_66_n7-n78	66	0.2
	n7	0.5
	n78	0.5
DC_66_n25-n41	66	0.5
	n25	0.5
	n41	0.5 <sup>1</sup> 1 <sup>2</sup>
DC_66_n25-n71	66	0.3
	n25	0.5
DC_66_n38-n78	66	0.5
	n38	0.5
	n78	0.5
DC_66_n41-n71	66	0.5
	n41	0.5 <sup>1</sup> 1 <sup>2</sup>
	n71	0.5
DC_66_n66-n78	66	0.2

Inter-band EN-DC configuration	E-UTRA or NR Band	$\Delta R_{IB,c}$ (dB)
	n66	0.2
	n78	0.5
DC_66-71_n38	66	0.5
	71	0.5
	n38	0.5
DC_66-71_n78	66	0.2
	71	0.2
	n78	0.5
DC_66-SUL_n78-n86	66	0.2
	n78	0.5
NOTE 1: The requirement is applied for UE transmitting on the frequency range of 2545 – 2690 MHz.		
NOTE 2: The requirement is applied for UE transmitting on the frequency range of 2496 – 2545 MHz.		
NOTE 3: The requirement is applied for UE transmitting on the frequency range of 2515 - 2690 MHz.		
NOTE 4: The requirement is applied for UE transmitting on the frequency range of 2496 – 2515 MHz.		
NOTE 5: Only applicable for UE supporting inter-band carrier aggregation with uplink in one NR band and without simultaneous Rx/Tx.		

7.3B.3.3.3  $\Delta R_{IB,c}$  for EN-DC four bands

Table 7.3B.3.3.3-1:  $\Delta R_{IB,c}$  due to EN-DC (four bands)

Inter-band EN-DC configuration	E-UTRA or NR Band	$\Delta R_{IB,c}$ (dB)
DC_1-3-5_n78	1	0.2
	3	0.2
	n78	0.5
DC_1-3-7_n28	n28	0.2
DC_1-3-7_n40	7	0.3
	n40	0.8
DC_1-3-7_n78 DC_1-3-7-7_n78 DC_1-3_n7-n78	1	0.3
	3	0.3
	7 or n7	0.3
	n78	0.5
DC_1-3-8_n28	8	0.2
	n28	0.2
DC_1-3-8_n77	1	0.2
	3	0.2
	8	0.2
	n77	0.5
DC_1-3-8_n78	1	0.2
	3	0.2
	8	0.2
	n78	0.5
DC_1-3-28_n5	28	0.2
	n5	0.2
DC_1-3-28_n7	28	0.2
DC_1-3-28_n40	28	0.2
DC_1-3-28_n77 DC_1-3_n28-n77	1	0.2
	3	0.2
	28 or n28	0.2
	n77	0.5
DC_1-3-28_n78 DC_1-3_n28-n78	1	0.2
	3	0.2
	28 or n28	0.2
	n78	0.5
DC_1-3-28_n79	1	0.2
	3	0.2
	28	0.2

Inter-band EN-DC configuration	E-UTRA or NR Band	$\Delta R_{IB,c}$ (dB)
DC_1-3-18_n77	1	0.2
	3	0.2
	n77	0.5
DC_1-3-18_n78	1	0.2
	3	0.2
	n78	0.5
DC_1-3-19_n78	1	0.2
	3	0.2
	n78	0.5
DC_1-3-20_n28	20	0.2
	n28	0.2
DC_1-3-20_n41	n41	0 <sup>1</sup>
		0.5 <sup>2</sup>
DC_1-3-20_n78	1	0.2
	3	0.2
	n78	0.5
DC_1-3-21_n77	1	0.2
	3	0.3
	21	0.5
	n77	0.5
DC_1-3-21_n78	1	0.2
	3	0.3
	21	0.5
	n78	0.5
DC_1-3-21_n79	3	0.3
	21	0.5
DC_1-3-32_n78	n78	0.5
DC_1-3-28_n77	1	0.2
	3	0.2
	28	0.2
	n77	0.5
DC_1-3-28_n78 DC_1-3_n28-n78	1	0.2
	3	0.2
	28 or n28	0.2
DC_1-3-28_n79	n78	0.5
	1	0.2
	3	0.2
DC_1-3-28_n79	28	0.2
	3	0.2
	n78	0.5
DC_1-3_n38-n78	3	0.2
	n78	0.5
	3	0.2
DC_1-3_n40-n78	n40	0.4 <sup>5</sup>
	n78	0.5 <sup>5</sup>
	41	0 <sup>3</sup> /0.5 <sup>4</sup>
DC_1-3-41_n28	n28	0.2
	1	0.2
	3	0.2
DC_1-3-41_n77	n77	0.5
	1	0.2
	3	0.2
DC_1-3-41_n78 DC_1-3_n41-n78	n78	0.5
	41	0 <sup>3</sup> /0.5 <sup>4</sup>
	1	0.2
DC_1-3-42_n77	3	0.2
	42	0.5
	n77	0.5
	1	0.2
DC_1-3-42_n78	3	0.2
	42	0.5
	n78	0.5
	1	0.2
DC_1-3-42_n79	3	0.2
	42	0.5
	42	0.5



Inter-band EN-DC configuration	E-UTRA or NR Band	$\Delta R_{IB,c}$ (dB)
DC_1-3_n77-n79	1	0.2
	3	0.2
	n77	0.5
DC_1-3_n78-n79	1	0.2
	3	0.2
	n78	0.5
DC_1-3_SUL_n78-n80	1	0.2
	3	0.2
	n78	0.5
DC_1-5-7_n78 DC_1-5-7-7_n78	1	0.2
	5	0.2
	7	0.2
	n78	0.5
DC_1-7_n3-n78	n78	0.5
DC_1-7_n7-n78	1	0.2
	7	0.2
	n7	0.2
	n78	0.5
DC_1-7-8_n78	1	0.2
	7	0.2
	8	0.2
	n78	0.5
DC_1-7-20_n28	20	0.2
	n28	0.2
DC_1-7-20_n78	1	0.2
	7	0.2
	20	0.2
	n78	0.5
DC_1-7-28_n5	28	0.2
DC_1-7-28_n5	n5	0.2
DC_1-7-28_n7	28	0.2
DC_1-7-28_n40	7	0.3
	28	0.2
	n40	0.8
DC_1-7-28_n78	1	0.2
	7	0.2
	28	0.2
	n78	0.5
DC_1-7_n28-n78	1	0.2
	7	0.2
	n28	0.2
	n78	0.5
DC_1-8_n3-n28	8	0.2
	n28	0.2
DC_1-8-11_n77	1	0.2
	8	0.2
	n77	0.5
DC_1-8-11_n78	8	0.2
	n78	0.5
DC_1-8-20_n78	8	0.2
	n78	0.5
DC_1-8_n28-n77	1	0.2
	8	0.2
	n28	0.2
	n77	0.5
DC_1-8-42_n77	1	0.2
	8	0.2
	42	0.5
	n77	0.5
DC_1-18_n3-n77	1	0.2
	n3	0.2
	n77	0.5
DC_1-18_n3-n78	1	0.2

Inter-band EN-DC configuration	E-UTRA or NR Band	$\Delta R_{IB,c}$ (dB)
	n3	0.2
	n78	0.5
DC_1-11-18_n77	1	0.2
	n77	0.5
DC_1-11-18_n78	n78	0.5
DC_1-18-28_n77	n77	0.5
DC_1-18-28_n78	n78	0.5
DC_1-18-41_n3	41	0 <sup>3</sup> /0.5 <sup>4</sup>
DC_1-18-41_n3	41	0 <sup>6</sup> /0.5 <sup>7</sup>
DC_1-18-41_n77	1	0.2
	n77	0.5
DC_1-18-41_n78	n78	0.5
DC_1-18-42_n77	42	0.5
	n77	0.5
DC_1-18-42_n78	42	0.5
	n78	0.5
DC_1-18-42_n79	42	0.5
DC_1-19-42_n77	1	0.2
	42	0.5
	n77	0.5
DC_1-19-42_n78	42	0.5
	n78	0.5
DC_1-19-42_n79	42	0.5
DC_1-19_n77-n79	1	0.3
	19	0.3
	n77	0.5
DC_1-19_n78-n79	1	0.3
	19	0.3
	n78	0.5
DC_1-20_n3-n78	n78	0.5
DC_1-20_n28-n78	20	0.2
	n28	0.2
	n78	0.5
DC_1-20-38_n78	38	0.4
	n78	0.5
DC_1-20_n41-n78	n78	0.5
DC_1-21-42_n77	1	0.2
	42	0.5
	n77	0.5
DC_1-21-42_n78	42	0.5
	n78	0.5
DC_1-21-42_n79	42	0.5
DC_1-21_n77-n79	n77	0.5
DC_1-21_n78-n79	n78	0.5
DC_1-28_n3-n77	1	0.2
	28	0.2
	n3	0.2
	n77	0.5
DC_1-28_n3-n78	1	0.2
	28	0.2
	n3	0.2
	n78	0.5
DC_1-28_n40-n78	28	0.2
	n40	0.4 <sup>5</sup>
	n78	0.5 <sup>5</sup>
DC_1-28-42_n77	1	0.2
	28	0.2
	42	0.5
	n77	0.5
DC_1-28-42_n78	28	0.2
	42	0.5
	n78	0.5
DC_1-28_n7-n78	1	0.2

Inter-band EN-DC configuration	E-UTRA or NR Band	$\Delta R_{IB,c}$ (dB)
	28	0.2
	n7	0.2
	n78	0.5
DC_1-28-42_n79	28	0.2
	42	0.5
DC_1-41_n3-n77	1	0.2
	41	0 <sup>3</sup> /0.5 <sup>4</sup>
	n3	0.2
	n77	0.5
DC_1-41_n3-n78	1	0.2
	41	0 <sup>3</sup> /0.5 <sup>4</sup>
	n3	0.2
	n78	0.5
DC_1-41_n28-n77	1	0.2
	n28	0.2
	n77	0.5
DC_1-41_n28-n78	n28	0.2
	n78	0.5
DC_1-41-42_n77	42	0.5
	n77	0.5
DC_1-41-42_n78	42	0.5
	n78	0.5
DC_1-41-42_n79	42	0.5
DC_1-41-42_n79	42	0.5
DC_1-42_n77-n79	1	0.2
	42	0.5
	n77	0.5
DC_1-42_n78-n79	1	0.2
	42	0.5
	n78	0.5
DC_2-5_(n)12	5	0.5
	12	0.3
	n12	0.3
DC_2-12_(n)5	5	0.5
	12	0.5
DC_2-5-48_n12	2	0.2
	5	0.5
	48	0.5
	n12	0.3
DC_2-5-48_n71	2	0.2
	48	0.5
DC_2-5-66_n2	2	0.3
	66	0.3
	n2	0.3
DC_2-5-66_n5	2	0.3
	66	0.3
DC_2-5-66_n12	2	0.2
	5	0.5
	66	0.5
	n12	0.3
DC_2-5-66_n66	2	0.3
	66	0.3
	n66	0.3
DC_2-5-66_n71	2	0.3
	66	0.3
DC_2-7-13_n66	2	0.3
	7	0.5
	n66	0.5
DC_2-7_n38-n78	2	0.2
DC_2-7-7_n38-n78	n78	0.5
DC_2-7-66_n38	2	0.3
DC_2-2-7-66_n38	7	0.5
	66	0.5

Inter-band EN-DC configuration	E-UTRA or NR Band	$\Delta R_{IB,c}$ (dB)
DC_2-7-66_n66, DC_2-7-7-66_n66	n38	0.5
	2	0.3
	7	0.5
	66	0.5
DC_2-7-66_n71	n66	0.5
	2	0.3
	7	0.5
DC_2-7-66_n78	66	0.5
	2	0.3
	66	0.3
DC_2-7_n66-n78 DC_2-7-7_n66-n78	n78	0.5
	2	0.3
	7	0.5
	n66	0.5
DC_2-12-30_n2	n78	0.5
	2	0.4
	30	0.5
DC_2-12-30_n66	n2	0.4
	2	0.4
	12	0.5
	30	0.5
DC_2-12-48_n5	n66	0.4
	2	0.3
	12	0.3
	48	0.5
DC_2-12-66_n5	n5	0.5
	2	0.3
	12	0.5
	66	0.5
DC_2-12-66_n2	n5	0.3
	2	0.3
	12	0.5
	66	0.3
DC_2-12-66_n66	n2	0.3
	2	0.3
	12	0.5
	66	0.3
DC_2-13-66_n2	n66	0.3
	2	0.3
	66	0.3
DC_2-13-66_n5	n2	0.3
	2	0.3
	66	0.3
DC_2-13-66_n48	2	0.3
	66	0.3
	n48	0.5
DC_2-13-66_n66	2	0.3
	66	0.3
	n66	0.3

Inter-band EN-DC configuration	E-UTRA or NR Band	$\Delta R_{IB,c}$ (dB)
DC_2-14-66_n2 DC_2-14-66-66_n2	2	0.3
	66	0.3
	n2	0.3
DC_2-14-66_n66 DC_2-2-14-66_n66	2	0.3
	66	0.3
	n66	0.3
DC_2-29-30_n2	2	0.4
	30	0.5
	n2	0.4
DC_2-29-66_n2 DC_2-29-66-66_n2	2	0.3
	66	0.3
	n2	0.3
DC_2-29-66_n66	2	0.3
	66	0.3
	n66	0.3
DC_2-30-66_n2 DC_2-30-66-66_n2	2	0.4
	30	0.5
	66	0.4
	n2	0.4
DC_2-30-66_n5	2	0.4
	30	0.5
	66	0.4
DC_2-30-66_n66	2	0.4
	30	0.5
	66	0.4
	n66	0.4
DC_2-46_n41-n66	2	0.3
	n41	0.5
	n66	0.5
DC_2-46_n41-n71	n71	0.2
DC_2-46-48_n5	2	0.2
	48	0.5
DC_2-46-48_n66	2	0.3
	48	0.5
	n66	0.3
DC_2-46-66_n41	2	0.3
	66	0.5
	n41	0.5 <sup>1</sup> 1 <sup>2</sup>
DC_2-48_(n)5		0.2
		0.5
DC_2-48-66_n5	2	0.3
	48	0.5
	66	0.3
DC_2-48-66_n12	2	0.3
	48	0.5
	66	0.3
DC_2-48-66_n71	2	0.3
	48	0.5
	66	0.3
DC_2-66_(n)5		0.3
		0.3
DC_2-66_n38-n78	2	0.5
	66	0.5
	n38	0.5
	n78	0.5
DC_2-66-71_n38 DC_2-2-66-71_n38	2	0.3
	66	0.5
	n38	0.5
DC_2-66-71_n66	2	0.3
	66	0.3
	n66	0.3
	2	0.3

Inter-band EN-DC configuration	E-UTRA or NR Band	$\Delta R_{IB,c}$ (dB)
DC_2-66-71_n78	66	0.5
	n78	0.5
DC_2-66-(n)71	2	0.3
	66	0.3
DC_2-66_n41-n71	2	0.3
	66	0.3
	n41	0.5 <sup>1</sup>
	n71	1 <sup>2</sup>
DC_2-66_n66-n78	2	0.3
	66	0.3
	n66	0.3
	n78	0.5
DC_3-5-7_n78	3	0.2
	5	0.2
	7	0.2
	n78	0.5
DC_3-5-41_n79	41	0 <sup>3</sup> /0.5 <sup>3</sup>
DC_3-7_n1-n78	3	0.3
	7	0.3
	n1	0.3
	n78	0.5
DC_3-7-7_n78	3	0.2
	7	0.2
	n78	0.5
DC_3-7-8_n1	8	0.2
	3	0.2
	7	0.2
	n77	0.2
DC_3-7-8_n78	3	0.2
	7	0.2
	8	0.2
	n78	0.5
DC_3-7_n7-n78	3	0.2
	7	0.2
	n7	0.2
	n78	0.5
DC_3-7-20_n28	20	0.2
	n28	0.1
DC_3-7-20_n78	3	0.2
	7	0.2
	n78	0.5
DC_3-7-28_n40	7	0.3
	n40	0.8
DC_3-7-28_n78	3	0.2
	7	0.2
	28 or n28	0.2
	n78	0.5
DC_3-7-40_n1	7	0.3
	40	0.8
DC_3-7_SUL_n78-n80	7	0.2
	3	0.2
	n78	0.5
DC_3-8_n1-n78	3	0.2
	8	0.2
	n1	0.2
	n78	0.5
DC_3-8-20_n78	3	0.2
	8	0.2

Inter-band EN-DC configuration	E-UTRA or NR Band	$\Delta R_{IB,c}$ (dB)
	n78	0.5
DC_3-8_n28-n77	3	0.2
	8	0.2
	n28	0.2
	n77	0.5
DC_3-8-42_n77	3	0.2
	8	0.2
	42	0.5
	n77	0.5
DC_3-8_SUL_n78-n80	3	0.2
	8	0.2
	n78	0.5
DC_3-18-42_n77	42	0.5
	n77	0.5
DC_3-18-42_n78	42	0.5
	n78	0.5
DC_3-18-42_n79	3	0.2
	42	0.5
DC_3-19-21_n77	3	0.3
	21	0.5
	n77	0.5
DC_3-19-21_n78	3	0.3
	21	0.5
	n78	0.5
DC_3-19-21_n79	3	0.3
	21	0.5
DC_3-19-42_n77	3	0.2
	42	0.5
	n77	0.5
DC_3-19-42_n78	3	0.2
	42	0.5
	n78	0.5
DC_3-19-42_n79	3	0.2
	42	0.5
DC_3-19_n77-n79	3	0.2
	n77	0.5
DC_3-19_n78-n79	3	0.2
	n78	0.5
DC_3-20_n1-n28	n1	0.2
	n28	0.2
DC_3-20_n7-n28	20	0.1
	n28	0.1
DC_3-20_n28-n78	3	0.2
	20	0.2
	n28	0.2
	n78	0.5
DC_3-20-38_n78 DC_3-20_n38-n78	3	0.2
	38 or n38	0.4
DC_3-20_n41-n78	n78	0.5
	n78	0.5
DC_3_20_SUL_n78-n80	3	0.2
	n78	0.5
DC_3-21-42_n77	3	0.3
	21	0.5
	42	0.5
	n77	0.5
DC_3-21-42_n78	3	0.3
	21	0.5
	42	0.5
	n78	0.5
DC_3-21-42_n79	3	0.3
	21	0.5
	42	0.5

Inter-band EN-DC configuration	E-UTRA or NR Band	$\Delta R_{IB,c}$ (dB)
DC_3-21_n77-n79	3	0.3
	21	0.5
	n77	0.5
DC_3-21_n78-n79	3	0.3
	21	0.5
	n78	0.5
DC_3-28_n7-n78 DC_3-3-28_n7-n78	3	0.5
	28	0.2
	n7	0.4
	n78	0.5
DC_3-28_n40-n78	3	0.2
	28	0.2
	n40	0.4 <sup>5</sup>
	n78	0.5 <sup>5</sup>
DC_3-28-41_n78	3	0.5
	28	0.2
	41	0.4 <sup>3</sup> /0.5 <sup>4</sup>
	n78	0.5
DC_3-28-42_n77	3	0.2
	28	0.2
	42	0.5
	n77	0.5
DC_3-28-42_n78	3	0.2
	28	0.2
	42	0.5
	n78	0.5
DC_3-28-42_n79	3	0.2
	28	0.2
	42	0.5
DC_3-41_n28-n77	3	0.2
	41	0 <sup>3</sup> /0.5 <sup>4</sup>
	n28	0.2
	n77	0.5
DC_3-41_n28-n78	3	0.5
	41	0.4 <sup>3</sup> /0.5 <sup>4</sup>
	n28	0.2
	n78	0.5
DC_3-41-42_n77	3	0.5
	41	0 <sup>3</sup> /0.5 <sup>4</sup>
	42	0.5
	n77	0.5
DC_3-41-42_n78	3	0.5
	41	0 <sup>3</sup> /0.5 <sup>4</sup>
	42	0.5
	n78	0.5
DC_3-41-42_n79	3	0.5
	41	0 <sup>3</sup> /0.5 <sup>4</sup>
	42	0.5
DC_3-42_n77-n79	3	0.2
	42	0.5
	n77	0.5
DC_3-42_n78-n79	3	0.2
	42	0.5
	n78	0.5
DC_5-7-7_n78	5	0.2
	7	0.2
	n78	0.5
DC_5-48_(n)12	5	0.5
	12	0.3
	n12	0.5
DC_5-48-66_n12	5	0.5
	48	0.5
	66	0.2



Inter-band EN-DC configuration	E-UTRA or NR Band	$\Delta R_{IB,c}$ (dB)
	n12	0.3
DC_5-48-66_n71	48	0.5
	66	0.2
	12	0.5
DC_5-66_(n)12	66	0.5
	n12	0.5
	7	0.5
DC_7-13-66_n66	66	0.5
	n66	0.5
	7	0.2
DC_7-8_n1-n78 DC_7-7-8_n1-n78	8	0.2
	n1	0.2
	n78	0.5
	n78	0.5
DC_7-20_n3-n78	20	0.2
	n28	0.2
	n78	0.5
DC_7-20_n28-n78	7	0.5
	28	0.2
	n3	0.5
	n78	0.5
DC_7-28_n3-n78	n78	0.5
	7	0.5
	66	0.5
	n66	0.5
DC_7-28_n7-n78	7	0.5
	66	0.5
	n66	0.5
	n78	0.5
DC_7-66_n66-n78 DC_7-7-66_n66-n78	12	0.5
	30	0.5
	66	0.4
	n2	0.4
DC_12-30-66_n2	12	0.5
	30	0.5
	66	0.4
	n66	0.4
DC_12-30-66_n66	5	0.5
	12	0.3
	n5	0.5
	2	0.5
DC_12-48_(n)5	48	0.5
	66	0.5
	12	0.5
DC_12-48-66_n5	66	0.5
	12	0.5
	66	0.5
DC_12-66_(n)5	18	0.2
	41	$0^3/0.5^4$
	n3	0.2
DC_18-41_n3-n77	n77	0.5
	18	0.2
	41	$0^3/0.5^4$
	n3	0.2
DC_18-41_n3-n78	n78	0.5
	42	0.5
	n77	0.5
	42	0.5
DC_19-21-42_n77	n78	0.5
	42	0.5
	n79	0.5
DC_19-21-42_n78	n77	0.5
	42	0.5
	n79	0.5
DC_19-21-42_n79	n78	0.5
	42	0.5
	n77	0.5
DC_19-21_n77-n79	n78	0.5
	42	0.5
	n77	0.5
DC_19-21_n78-n79	42	0.5
	n77	0.5
	42	0.5
DC_19-42_n77-n79	42	0.5
	n78	0.5
	28	0.2
DC_19-42_n78-n79	42	0.5
	42	0.5
DC_21-28-42_n77	28	0.2
	42	0.5

Inter-band EN-DC configuration	E-UTRA or NR Band	$\Delta R_{IB,c}$ (dB)
	n77	0.5
DC_21-28-42_n78	28	0.2
	42	0.5
	n78	0.5
DC_21-28-42_n79	28	0.2
	42	0.5
DC_21-42_n77-n79	42	0.5
	n77	0.5
DC_21-42_n78-n79	42	0.5
	n78	0.5
DC_28-41-42_n78	28	0.2
	41	0.4
	42	0.5
	n78	0.5
DC_29-30-66_n2 DC_29-30-66-66_n2	30	0.5
	66	0.4
	n2	0.4
DC_29-30-66_n66	30	0.5
	66	0.3
	n66	0.3
DC_46-66_n25-n41	66	0.3
	n25	0.3
	n41	0.5 <sup>1</sup>
		1 <sup>2</sup>
DC_46-66_n41-n71	66	0.3
	n41	0.5 <sup>1</sup>
		1 <sup>2</sup>
	n71	0.2

NOTE 1: The requirement is applied for UE transmitting on the frequency range of 2545 - 2690 MHz.

NOTE 2: The requirement is applied for UE transmitting on the frequency range of 2496 - 2545 MHz.

NOTE 3: The requirement is applied for UE transmitting on the frequency range of 2515 - 2690 MHz

NOTE 4: The requirement is applied for UE transmitting on the frequency range of 2496 – 2515 MHz.

NOTE 5: Only applicable for UE supporting inter-band carrier aggregation with uplink in one E-UTRA band and without simultaneous Rx/Tx.

NOTE 6: The requirement is applied for UE transmitting on the frequency range of 2515 - 2690 MHz.

NOTE 7: The requirement is applied for UE transmitting on the frequency range of 2496 - 2515 MHz.

#### 7.3B.3.3.4 $\Delta R_{IB,c}$ for EN-DC five bands

**Table 7.3B.3.3.4-1:  $\Delta R_{IB,c}$  due to EN-DC (five bands)**

Inter-band EN-DC configuration	E-UTRA or NR Band	$\Delta R_{IB,c}$ (dB)
DC_1-3-5-7_n78, DC_1-3-5-7-7_n78	1	0.2
	3	0.2
	5	0.2
	7	0.2
	n78	0.5
DC_1-3-5-41_n79	41	0 <sup>3</sup>
		0.5 <sup>4</sup>
DC_1-3-7_n7-n78	1	0.3
	3	0.3
	7	0.3
	n7	0.3
	n78	0.5
DC_1-3-7-8_n78	1	0.2
	3	0.2

Inter-band EN-DC configuration	E-UTRA or NR Band	$\Delta R_{IB,c}$ (dB)
	7	0.2
	8	0.2
	n78	0.5
DC_1-3-7-20_n28	20	0.2
	n28	0.2
DC_1-3-7-20_n78	1	0.2
	3	0.2
	7	0.2
	n78	0.5
DC_1-3-7-28_n5	28	0.2
DC_1-3-7-28_n7	n5	0.2
DC_1-3-7-28_n40	28	0.2
	7	0.3
	n40	0.8
DC_1-3-7-28_n78	1	0.2
	3	0.2
	7	0.2
	28	0.2
	n78	0.5
DC_1-3-7_n28-n78	1	0.2
	3	0.2
	7	0.2
	n28	0.2
	n78	0.5
DC_1-3-8-42_n77	1	0.2
	3	0.2
	8	0.2
	42	0.5
	n77	0.5
DC_1-3-18-42_n77	1	0.2
	3	0.2
	42	0.5
	n77	0.5
DC_1-3-18-42_n78	1	0.2
	3	0.2
	42	0.5
	n78	0.5
DC_1-3-18-42_n79	1	0.2
	3	0.2
	42	0.5
DC_1-3-19-21_n77	1	0.2
	3	0.3
	21	0.5
	n77	0.5
DC_1-3-19-21_n78	1	0.2
	3	0.3
	21	0.5
	n78	0.5
DC_1-3-19-21_n79	3	0.3
	21	0.5
DC_1-3-19-42_n77	1	0.2
	3	0.2
	42	0.5
	n77	0.5
DC_1-3-19-42_n78	1	0.2
	3	0.2
	42	0.5
	n78	0.5
DC_1-3-19-42_n79	1	0.2
	3	0.2
	42	0.5
DC_1-3-20-38_n78 DC_1-3-20_n38-n78	3	0.2
	38 or n38	0.4

Inter-band EN-DC configuration	E-UTRA or NR Band	$\Delta R_{IB,c}$ (dB)
	n78	0.5
DC_1-3-20_n41-n78	n78	0.5
DC_1-3-21_n77-n79	1	0.2
	3	0.3
	21	0.5
	n77	0.5
DC_1-3-21_n78-n79	1	0.2
	3	0.3
	21	0.5
	n78	0.5
DC_1-3-28_n7-n78	1	0.2
	3	0.2
	28	0.2
	n7	0.2
DC_1-3-28_n40-n78	n78	0.5
	3	0.2
	28	0.2
	n40	0.4 <sup>5</sup>
DC_1-3-28-42_n77	n78	0.5 <sup>5</sup>
	1	0.2
	3	0.2
	28	0.2
DC_1-3-28-42_n78	42	0.5
	n77	0.5
	1	0.2
	3	0.2
DC_1-3-28-42_n79	28	0.2
	42	0.5
	n78	0.5
	1	0.2
DC_1-3-41_n28-n77	3	0.2
	41	0 <sup>3</sup> /0.5 <sup>4</sup>
	n28	0.2
	n77	0.5
DC_1-3-41_n28-n78	3	0.2
	41	0 <sup>3</sup> /0.5 <sup>4</sup>
	n28	0.2
	n78	0.5
DC_1-3-20_n28-n78	1	0.2
	3	0.2
	20	0.2
	n28	0.2
DC_1-7-28_n7-n78	n78	0.5
	1	0.2
	7	0.2
	28	0.2
DC_1-18-41_n3-n77	n7	0.2
	1	0.2
	41	0 <sup>3</sup> /0.5 <sup>4</sup>
	n3	0.2
DC_1-18-41_n3-n78	n77	0.5
	1	0.2
	41	0 <sup>3</sup> /0.5 <sup>4</sup>
	n3	0.2
DC_1-3-21-42_n77	n78	0.5
	1	0.2
	3	0.3
	21	0.5
	42	0.5

Inter-band EN-DC configuration	E-UTRA or NR Band	$\Delta R_{IB,c}$ (dB)
	n77	0.2
DC_1-3-21-42_n78	1	0.2
	3	0.3
	21	0.5
	42	0.5
	n78	0.2
DC_1-3-21-42_n79	1	0.2
	3	0.3
	21	0.5
	42	0.5
DC_1-3-41-42_n77	1	0.2
	3	0.2
	42	0.5
	n77	0.5
DC_1-3-41-42_n78	1	0.2
	3	0.2
	42	0.5
	n78	0.5
DC_1-3-41-42_n79	1	0.2
	3	0.2
	42	0.5
DC_1-7-20_n3-n78	n78	0.5
DC_1-7-20_n28-n78	1	0.2
	7	0.2
	20	0.2
	n28	0.2
DC_1-19-21-42_n77	n78	0.5
	1	0.2
	42	0.5
	n77	0.5
DC_1-19-21-42_n78	42	0.5
	n78	0.5
DC_1-19-21-42_n79	42	0.5
	42	0.5
DC_1-19-42_n77-n79	1	0.2
	42	0.5
	n77	0.5
DC_1-19-42_n78-n79	42	0.5
	n78	0.5
DC_1-20-38_n3-n78	n3	0.2
	n78	0.5
DC_1-21-28-42_n77	1	0.2
	28	0.2
	42	0.5
	n77	0.5
DC_1-21-28-42_n78	28	0.2
	42	0.5
	n78	0.5
DC_1-21-28-42_n79	28	0.2
	42	0.5
DC_1-21-42_n77-n79	1	0.2
	21	0.2
	42	0.5
	n77	0.5
DC_1-21-42_n78-n79	21	0.2
	42	0.5
	n78	0.5
DC_2-7-13-66_n66	2	0.3
	7	0.5
	66	0.5
	n66	0.5
DC_2-7-66_n66-n78 DC_2-7-7-66_n66-n78	2	0.3
	7	0.5
	66	0.5
	n66	0.5

Inter-band EN-DC configuration	E-UTRA or NR Band	$\Delta R_{IB,c}$ (dB)
	n78	0.5
DC_2-12-30-66_n2	2	0.4
	12	0.5
	30	0.5
	66	0.4
	n2	0.4
DC_2-12-30-66_n66	2	0.4
	12	0.5
	30	0.5
	66	0.4
	n66	0.4
DC_2-29-30-66_n2	2	0.4
	30	0.5
	66	0.4
	n2	0.4
DC_2-46-66_n41-n71	2	0.3
	66	0.3
	n41	0.5 <sup>1</sup>
	n71	0.5
DC_3-7-8_n1-n78 DC_3-3-7-8_n1-n78, DC_3-7-7-8_n1-n78, DC_3-3-7-7-8_n1-n78	3	0.2
	7	0.2
	8	0.2
	n1	0.2
	n78	0.5
DC_3-7-20_n28-n78	3	0.2
	7	0.2
	20	0.2
	n28	0.2
DC_3-7-28_n7-n78	3	0.2
	7	0.2
	28	0.2
	n7	0.2
DC_3-19-21-42_n77	n78	0.5
	3	0.3
	21	0.5
	42	0.5
DC_3-19-21-42_n78	n77	0.5
	3	0.3
	21	0.5
	42	0.5
DC_3-19-21-42_n79	n78	0.5
	3	0.3
	21	0.5
	42	0.5
DC_3-28-41-42_n78	n79	0.5
	3	0.5
	28	0.2
	41	0.4 <sup>1</sup>
	42	0.5 <sup>2</sup>
DC_19-21-42_n77-n79	42	0.5
	n78	0.5
	n77	0.5
DC_19-21-42_n78-n79	42	0.5
	n78	0.5

Inter-band EN-DC configuration	E-UTRA or NR Band	$\Delta R_{IB,c}$ (dB)
NOTE 1: The requirement is applied for UE transmitting on the frequency range of 2545 – 2690 MHz.		
NOTE 2: The requirement is applied for UE transmitting on the frequency range of 2496 – 2545 MHz.		
NOTE 3: The requirement is applied for UE transmitting on the frequency range of 2515 - 2690 MHz		
NOTE 4: The requirement is applied for UE transmitting on the frequency range of 2496 – 2515 MHz.		
NOTE 5: Only applicable for UE supporting inter-band carrier aggregation with uplink in one E-UTRA band and without simultaneous Rx/Tx.		

### 7.3B.3.3.5 $\Delta R_{IB,c}$ for EN-DC six bands

**Table 7.3B.3.3.5-1:  $\Delta R_{IB,c}$  due to EN-DC (six bands)**

Inter-band EN-DC configuration	E-UTRA or NR Band	$\Delta R_{IB,c}$ (dB)
DC_1-3-7-20_n28-n78	1	0.2
	3	0.2
	7	0.2
	20	0.2
	n28	0.2
	n78	0.5
DC_1-3-7-28_n7-n78	1	0.2
	3	0.2
	7	0.2
	28	0.2
	n7	0.2
	n78	0.5

### 7.3B.3.3a Inter-band NE-DC within FR1

Unless  $\Delta R_{IB,c}$  is specified in this clause, the value of  $\Delta R_{IB,c}$  for the correspondingly specified EN-DC configuration in clause 7.3B.3.3 is applicable.

### 7.3B.3.4 Inter-band EN-DC including FR2

#### 7.3B.3.4.1 $\Delta R_{IB,c}$ for EN-DC in two bands

Unless otherwise stated,  $\Delta R_{IB,c}$  for E-UTRA and FR2 NR bands of inter-band EN-DC combinations defined in table 5.5B.5.1-1 is set to zero.

**Table 7.3B.3.4.1-1: Void**

#### 7.3B.3.4.2 $\Delta R_{IB,c}$ for EN-DC three bands

Unless otherwise stated,  $\Delta R_{IB,c}$  for FR2 NR bands is set to zero, and  $\Delta R_{IB,c}$  for constituent E-UTRA bands for inter-band EN-DC defined in table 5.5B.5.3-1 is the same as those for the corresponding E-UTRA CA configuration specified in TS 36.101 [4], without the FR2 NR bands.

**Table 7.3B.3.4.2-1: Void**

#### 7.3B.3.4.3 $\Delta R_{IB,c}$ for EN-DC four bands

Unless otherwise stated,  $\Delta R_{IB,c}$  for FR2 NR bands is set to zero, and  $\Delta R_{IB,c}$  for constituent E-UTRA bands for inter-band EN-DC defined in table 5.5B.5.3-1 is the same as those for the corresponding E-UTRA CA configuration specified in TS 36.101 [4], without the FR2 NR bands.

**Table 7.3B.3.4.3-1: Void****7.3B.3.4.4  $\Delta R_{IB,c}$  for EN-DC five bands**

Unless otherwise stated,  $\Delta R_{IB,c}$  for FR2 NR bands is set to zero, and  $\Delta R_{IB,c}$  for constituent E-UTRA bands for inter-band EN-DC defined in table 5.5B.5.4-1 is the same as those for the corresponding E-UTRA CA configuration specified in TS 36.101 [4], without the FR2 NR bands.

**Table 7.3B.3.4.4-1: Void****7.3B.3.4.5 Void****7.3B.3.5 Inter-band EN-DC including both FR1 and FR2****7.3B.3.5.2  $\Delta R_{IB,c}$  for EN-DC three bands**

Unless otherwise stated, for inter-band EN-DC configurations defined in table 5.5B.6.2-1,  $\Delta R_{IB,c}$  for constituent FR2 NR bands is set to zero, and  $\Delta R_{IB,c}$  for constituent E-UTRA and FR1 NR bands is the same as those for the corresponding inter band EN-DC configuration without the FR2 bands specified in 7.3B.3.3.

**Table 7.3B.3.5.2-1: Void****7.3B.3.5.3  $\Delta R_{IB,c}$  for EN-DC four bands**

Unless otherwise stated, for inter-band EN-DC configurations defined in table 5.5B.6.3-1,  $\Delta R_{IB,c}$  for constituent FR2 NR bands is set to zero, and  $\Delta R_{IB,c}$  for constituent E-UTRA and FR1 NR bands is the same as those for the corresponding inter band EN-DC configuration without the FR2 bands specified in 7.3B.3.3.

**7.3B.3.5.4  $\Delta R_{IB,c}$  for EN-DC five bands**

Unless otherwise stated, for a certain inter-band EN-DC configurations defined in table 5.5B.6.4-1,  $\Delta R_{IB,c}$  for constituent FR2 NR bands is set to zero, and  $\Delta R_{IB,c}$  for constituent E-UTRA and FR1 NR bands is the same as those for the corresponding inter band EN-DC configuration without the FR2 bands specified in 7.3B.3.3.

**7.3B.3.5.5  $\Delta R_{IB,c}$  for EN-DC six bands**

Unless otherwise stated, for inter-band EN-DC configurations defined in table 5.5B.6.5-1,  $\Delta R_{IB,c}$  for constituent FR2 NR bands is set to zero, and  $\Delta R_{IB,c}$  for constituent E-UTRA and FR1 NR bands is the same as those for the corresponding inter band EN-DC configuration without the FR2 bands specified in 7.3B.3.3.

**7.3C Reference sensitivity for V2X operation in FR1****7.3C.1 General**

For V2X operation, REFSSENS requirements defined in TS 38.101-1 [2] and TS 36.101 [4] apply to all downlink bands of V2X configurations listed in clause 5.5C, unless sensitivity degradation exception is allowed in this clause of this specification, clause 7.3C in TS 38.101-1 [2] or clause 7.3.1G in TS 36.101 [4].

**7.3C.2 Reference sensitivity for V2X****7.3C.2.1 Intra-band contiguous V2X**

For intra-band contiguous V2X listed in Table 5.5C.2-1, the each REFSSENS requirements specified in clause 7.3.1G of TS 36.101 [4] and clause 7.3C.2 of TS 38.101-1 [2] apply when all SL reception CCs are activated at same time.



### 7.3C.2.2 Intra-band non-contiguous V2X

For intra-band non-contiguous V2X listed in Table 5.5C.3-1, the each REFSENS requirements specified in clause 7.3.1G of TS 36.101 [4] and clause 7.3C.2 of TS 38.101-1 [2] apply when all SL reception CCs are activated at same time.

### 7.3C.2.3 Inter-band V2X con-current operation

When UE is configured for NR V2X reception on V2X carrier con-current with E-UTRA uplink and downlink, NR V2X sidelink throughput for the carrier shall be  $\geq 95\%$  of the maximum throughput of the reference measurement channels as specified in Annexes A.8. Also the E-UTRA downlink throughput shall be  $\geq 95\%$  of the maximum throughput of the reference measurement channels as specified in Annexes A.3.

For the inter-band con-current NR V2X operation, and the UE also supports a E-UTRA downlink inter-band con-current configuration in Table 5.5C.4.1-1, the minimum requirement for reference sensitivity of each band according to TS 36.101 [4] and TS 38.101-1 [2] shall be increased by the amount of  $\Delta R_{IB,c}$  for the corresponding NR V2X/E-UTRA band.

The reference sensitivity is defined to be met with Uu uplink assigned to one band (that differs from the V2X operating band) and all E-UTRA downlink carriers active. The Uu uplink resource blocks shall be located as close as possible to V2X operating band but confined within the transmission bandwidth configuration for the channel.

## 7.4 Void

### 7.4A Maximum input level for CA

For inter-band NR CA between FR1 and FR2, the maximum input level specified in TS 38.101-1 [2] and TS 38.101-2 [3] apply for FR1 and FR2 respectively.

### 7.4B Maximum input level for DC in FR1

#### 7.4B.1 Intra-band contiguous EN-DC in FR1

Intra-band contiguous EN-DC maximum input level requirement and parameters are defined in Table 7.4B.1-1.

**Table 7.4B.1-1: Maximum Input**

Power in Largest CC, E-UTRA or NR, dBm	$X^1$
Power in each other CC, dBm	$X^1 - 10 \cdot \log_{10}(N_x \text{SCS}_x / N_y \text{SCS}_y)$
NOTE 1: Power in Largest E-UTRA or NR bandwidth CC, listed in Table 7.4-1 [2]	
NOTE 2: $N_x, \text{SCS}_x$ is the number of RB's and Sub carrier spacing in the largest carrier bandwidth and could be E-UTRA or NR carrier	
NOTE 3: $N_y, \text{SCS}_y$ is the number of RB's in any other carrier.	
NOTE 4: For NR carrier, the transmitter shall be set to 4dB below $P_{\text{CMAX\_L,f,c,NR}}$ at the minimum uplink configuration specified in Table 7.3.2-3 [2] with $P_{\text{CMAX\_L,f,c,NR}}$ as defined in subclause 6.2B.4.	
NOTE 5: For E-UTRA carrier, the transmitter shall be set to 4dB below $P_{\text{CMAX\_L,E-UTRA,c}}$ at the minimum uplink configuration specified in Table 7.3.1-2 [4] with $P_{\text{CMAX\_L,E-UTRA,c}}$ as defined in subclause 6.2B.4 for single carrier.	

#### 7.4B.2 Intra-band non-contiguous EN-DC in FR1

For the E-UTRA sub-block containing one or multiple CC's, the requirement is defined in clause 7.4.1 for single carrier operation and in clause 7.4.1A for CA in TS 36.101 [4].

For the NR sub-block, the requirement is defined in clause 7.4 in TS 38.101-1 [2].

### 7.4B.3 Inter-band EN-DC within FR1

Maximum input level requirement for E-UTRA single carrier and CA operation specified in clauses 7.4.1 and 7.4.1A of TS 36.101 [4] and for NR single carrier and CA operation specified in clauses 7.4 and 7.4A of TS 38.101-1 [2] apply.

### 7.4B.3a Inter-band NE-DC within FR1

Maximum input level requirement for E-UTRA single carrier and CA operation specified in clauses 7.4.1 and 7.4.1A of TS 36.101 [4] and for NR single carrier and CA operation specified in clauses 7.4 and 7.4A of TS 38.101-1 [2] apply.

### 7.4B.4 Inter-band EN-DC including FR2

Maximum input level requirement for E-UTRA single carrier and CA operation specified in clauses 7.4.1 and 7.4.1A of TS 36.101 [4] and for NR single carrier and CA operation specified in clauses 7.4, 7.4A and 7.4B of TS 38.101-2 [3] apply.

### 7.4B.5 Inter-band EN-DC including both FR1 and FR2

Maximum input level requirement for E-UTRA single carrier and CA operation specified in clauses 7.4.1 and 7.4.1A of TS 36.101 [4] and for NR single carrier and CA operation specified in clauses 7.4, 7.4A and 7.4B of TS 38.101-1 [2] and TS 38.101-2 [3] apply.

## 7.4C Maximum input level for V2X operation in FR1

For intra-band V2X UE, the maximum input requirements specified in clause 7.4.1G of TS 36.101 [4] and clause 7.4C.2 of TS 38.101-1 [2] apply when all SL reception CCs are activated at same time.

For the inter-band con-current NR V2X operation, the requirements specified in subclause 7.4C of TS 38.101-1 [2] shall apply for the NR sidelink reception in Band n47 and the requirements specified in subclause 7.4.1 of TS 36.101 [4] shall apply for the E-UTRA downlink reception in licensed band while all downlink carriers are active.

## 7.5 Void

### 7.5A Adjacent channel selectivity for CA

For inter-band NR CA between FR1 and FR2, the adjacent channel selectivity specified in TS 38.101-1 [2] and TS 38.101-2 [3] apply for FR1 and FR2 respectively.

### 7.5B Adjacent channel selectivity for DC in FR1

#### 7.5B.1 Intra-band contiguous EN-DC in FR1

Intra-band contiguous EN-DC ACS requirement and parameters are defined for test case 1 in Table 7.5B.1-1 and for test case 2 in Table 7.5B.1-2.

Table 7.5B.1-1: ACS test case 1

EN-DC Aggregated Bandwidth, MHz	<=100	>100, <=120	>120, <=140	>140, <=160
ACS, dB	X <sup>1</sup>	19.2	18.5	17.9
P <sub>interferer</sub> , dBm	P <sub>i</sub> <sup>2</sup>	Aggregated power + 17.7 dB	Aggregated power + 17 dB	Aggregated power + 16.4dB
P <sub>w</sub> in Transmission BW configuration, per CC, dBm	REFSENS +14dB			
NOTE 1: X is ACS level at the specified EN-DC aggregated bandwidth from Table 7.5.1A-1 in TS 36.101 [4]				
NOTE 2: P <sub>i</sub> is from Table 7.5.1A-2 in TS 36.101 [4]				
NOTE 3: Jammer BW and offset is from Table 7.5.1A-2 [4] and is applied from the lowest edge of the lowest carrier and the highest edge of the highest carrier				
NOTE 4: For NR carrier, the transmitter shall be set to 4dB below P <sub>C<sub>MAX</sub>_L,f,c,NR</sub> at the minimum uplink configuration specified in Table 7.3.2-3 [2] with P <sub>C<sub>MAX</sub>_L,f,c,NR</sub> as defined in clause 6.2B.4.				
NOTE 5: For E-UTRA carrier, the transmitter shall be set to 4 dB below P <sub>C<sub>MAX</sub>_L,E-UTRA,c</sub> at the minimum uplink configuration specified in Table 7.3.1-2 [4] with P <sub>C<sub>MAX</sub>_L,E-UTRA,c</sub> as defined in clause 6.2B.4 for single carrier.				

Table 7.5B.1-2: ACS test case 2

EN-DC Aggregated Bandwidth, ENBW, MHz	≤100	>100, ≤120	>120, ≤140	>140, ≤160
P <sub>w</sub> in Transmission Bandwidth Configuration, perCC, dBm	P <sub>w</sub> <sup>1</sup>	-42.7 +10log <sub>10</sub> (N <sub>RB,c</sub> /N <sub>RB_agg</sub> )	-42 +10log <sub>10</sub> (N <sub>RB,c</sub> /N <sub>RB_agg</sub> )	-41.4 +10log <sub>10</sub> (N <sub>RB,c</sub> /N <sub>RB_agg</sub> )
P <sub>interferer</sub> , dBm	-25			
NOTE 1: P <sub>w</sub> is wanted signal power level at the specified EN-DC aggregated Bandwidth from Table 7.5.1A-3 in TS 36.101 [4]				
NOTE 2: Jammer BW and offset is from Table 7.5.1A-3 [4] and is applied from the lowest edge of the lowest carrier and the highest edge of the highest carrier				
NOTE 3: For NR carrier, the transmitter shall be set to 4dB below P <sub>C<sub>MAX</sub>_L,f,c,NR</sub> at the minimum uplink configuration specified in Table 7.3.2-3 [2] with P <sub>C<sub>MAX</sub>_L,f,c,NR</sub> as defined in clause 6.2B.4.				
NOTE 4: For E-UTRA carrier, the transmitter shall be set to 4 dB below P <sub>C<sub>MAX</sub>_L,E-UTRA,c</sub> at the minimum uplink configuration specified in Table 7.3.1-2 [4] with P <sub>C<sub>MAX</sub>_L,E-UTRA,c</sub> as defined in clause 6.2B.4 for single carrier.				

## 7.5B.2 Intra-band non-contiguous EN-DC in FR1

For the E-UTRA sub-block containing one or multiple CC's, the requirement is defined in clause 7.5.1 for single carrier operation and in clause 7.5.1A for CA in TS 36.101 [4].

For the NR sub-block, the requirement is defined in clause 7.5 in TS 38.101-1 [2].

The blocker configuration is defined in the general clause 7.1.

## 7.5B.3 Inter-band EN-DC within FR1

Adjacent channel selectivity requirement for E-UTRA single carrier and CA operation specified in clauses 7.5.1 and 7.5.1A of TS 36.101 [4] and for NR single carrier and CA operation specified in clauses 7.5 and 7.5A of TS 38.101-1 [2] apply.

### 7.5B.3a Inter-band NE-DC within FR1

Adjacent channel selectivity requirement for E-UTRA single carrier and CA operation specified in clauses 7.5.1 and 7.5.1A of TS 36.101 [4] and for NR single carrier and CA operation specified in clauses 7.5 and 7.5A of TS 38.101-1 [2] apply.

## 7.5B.4 Inter-band EN-DC including FR2

Adjacent channel selectivity requirement for E-UTRA single carrier and CA operation specified in clauses 7.5.1 and 7.5.1A of TS 36.101 [4] and for NR single carrier and CA operation specified in clauses 7.5, 7.5A and 7.5B of TS 38.101-2 [3] apply.

## 7.5B.5 Inter-band EN-DC including both FR1 and FR2

Adjacent channel selectivity requirement for E-UTRA single carrier and CA operation specified in clauses 7.5.1 and 7.5.1A of TS 36.101 [4] and for NR single carrier and CA operation specified in clauses 7.5, 7.5A and 7.5B of TS 38.101-1 [2] and TS 38.101-2 [3] apply.

## 7.5C Adjacent channel selectivity for V2X operation in FR1

For intra-band V2X operation, the adjacent channel selectivity specified in clause 7.5.1G in TS 36.101 [4] and specified in clause 7.5C in TS 38.101-1 [2] apply when all SL reception CCs are activated at same time.

For the inter-band con-current NR V2X operation, the requirements specified in subclause 7.5C of TS 38.101-1 [2] shall apply for the NR sidelink reception in Band n47 and the requirements specified in subclause 7.5.1 of TS 36.101 [4] shall apply for the E-UTRA downlink reception in licensed band while all downlink carriers are active.

## 7.6 Void

### 7.6A Blocking characteristics for CA

For inter-band NR CA between FR1 and FR2, the in-band blocking characteristics specified in TS 38.101-1 [2] and TS 38.101-2 [3] apply for FR1 and FR2 respectively. The narrow band blocking and out-of-band blocking specified in TS 38.101-1 [2] apply for FR1.

### 7.6B Blocking characteristics for DC in FR1

#### 7.6B.1 General

#### 7.6B.2 In-band blocking for DC in FR1

##### 7.6B.2.1 Intra-band contiguous EN-DC in FR1

Intra-band contiguous EN-DC in-band blocking requirement and parameters are defined in Table 7.6B.2.1-1.

**Table 7.6B.2.1-1: In-band blocking**

EN-DC Aggregated Bandwidth, MHz	≤100	>100, ≤120	>120, ≤140	>140, ≤160
P <sub>w</sub> in Transmission Bandwidth Configuration, perCC, dBm		REFSENS + Aggregated BW specific value below		
	P <sub>w</sub> <sup>1</sup>	16.8	17.5	18
NOTE 1: P <sub>w</sub> is wanted signal power level at the specified EN-DC aggregated Bandwidth from Table 7.6.1.1A-1 in TS 36.101 [4]				
NOTE 2: Interferer values are specified from Table 7.6.1.1A-2 in TS 36.101 [4]				
NOTE 3: Jammer BW and offset is from Table 7.6.1.1A-1 [4] and is applied from the lowest edge of the lowest carrier and the highest edge of the highest carrier				
NOTE 4: For NR carrier, the transmitter shall be set to 4dB below P <sub>C<sub>MAX</sub>_L<sub>f,c,NR</sub></sub> at the minimum uplink configuration specified in Table 7.3.2-3 [2] with P <sub>C<sub>MAX</sub>_L<sub>f,c,NR</sub></sub> as defined in clause 6.2B.4.				
NOTE 5: For E-UTRA carrier, the transmitter shall be set to 4dB below P <sub>C<sub>MAX</sub>_L<sub>E-UTRA,c</sub></sub> at the minimum uplink configuration specified in Table 7.3.1-2 [4] with P <sub>C<sub>MAX</sub>_L<sub>E-UTRA,c</sub></sub> as defined in clause 6.2B.4 for single carrier.				

##### 7.6B.2.2 Intra-band non-contiguous EN-DC in FR1

For the E-TRA sub-block containing one or multiple CC's, the requirement is defined in clause 7.6.1.1 for single carrier operation and in clause 7.6.1.1A for CA in TS 36.101 [4].

For the NR sub-block, the requirement is defined in clause 7.6.2 in TS 38.101-1 [2].

The blocker configuration is defined in the general clause 7.1.

### 7.6B.2.3 Inter-band EN-DC within FR1

Inband blocking requirement for E-UTRA single carrier and CA operation specified in clauses 7.6.1.1 and 7.6.1.1A of TS 36.101 [4] and for NR single carrier and CA operation specified in clauses 7.6.2 and 7.6A.2 of TS 38.101-1 [2] apply.

### 7.6B.2.3a Inter-band NE-DC within FR1

Inband blocking requirement for E-UTRA single carrier and CA operation specified in clauses 7.6.1.1 and 7.6.1.1A of TS 36.101 [4] and for NR single carrier and CA operation specified in clauses 7.6.2 and 7.6A.2 of TS 38.101-1 [2] apply.

### 7.6B.2.4 Inter-band EN-DC including FR2

Inband blocking requirement for E-UTRA single carrier and CA operation specified in clauses 7.6.1.1 and 7.6.1.1A of TS 36.101 [4] and for NR single carrier and CA operation specified in clauses 7.6.2, 7.6A.2 and 7.6B.2 of TS 38.101-1 [3] apply.

### 7.6B.2.5 Inter-band EN-DC including both FR1 and FR2

Inband blocking requirement for E-UTRA single carrier and CA operation specified in clauses 7.6.1.1 and 7.6.1.1A of TS 36.101 [4] and for NR single carrier and CA operation specified in clauses 7.6.2, 7.6A.2 and 7.6B.2 of TS 38.101-1 [2] and TS 38.101-2 [3] apply.

## 7.6B.3 Out-of-band blocking for DC in FR1

### 7.6B.3.1 Intra-band contiguous EN-DC in FR1

Intra-band contiguous EN-DC out-of-band requirement and parameters are defined in Table 7.6B.3.1-1.

**Table 7.6B.3.1-1: Out-of-band blocking**

EN-DC Aggregated Bandwidth, MHz	≤100	>100, ≤120	>120, ≤140	>140, ≤160
Pw in Transmission Bandwidth Configuration, perCC, dBm	REFSENS + Aggregated BW specific value below			
	9			
NOTE 1: Interferer values and offsets are specified from Table 7.6.2.1A-2 in TS 36.101 [4]				
NOTE 2: For NR carrier, the transmitter shall be set to 4dB below $P_{\text{CMAX\_L,f,c,NR}}$ at the minimum uplink configuration specified in Table 7.3.2-3 [2] with $P_{\text{CMAX\_L,f,c,NR}}$ as defined in clause 6.2B.4.				
NOTE 3: For E-UTRA carrier, the transmitter shall be set to 4dB below $P_{\text{CMAX\_L,E-UTRA,c}}$ at the minimum uplink configuration specified in Table 7.3.1-2 [4] with $P_{\text{CMAX\_L,E-UTRA,c}}$ as defined in clause 6.2B.4 for single carrier.				

### 7.6B.3.2 Intra-band non-contiguous EN-DC in FR1

For the E-UTRA sub-block containing one or multiple CC's, the requirement is defined in clause 7.6.2.1 for single carrier operation and in clause 7.6.2.1A for CA in TS 36.101 [4].

For the NR sub-block, the requirement is defined in clause 7.6.3 is [2].

### 7.6B.3.3 Inter-band EN-DC within FR1

Out-of band blocking requirements for E-UTRA single carrier and CA operation specified in clauses 7.6.2.1 and 7.6.2.1A of TS 36.101 [4] and for NR single carrier and CA operation specified in clauses 7.6.3 and 7.6A.3 of TS 38.101-1 [2] apply for lowest level EN-DC fallbacks (two bands) in clause 5.5.B.4.1 with following conditions

- one E-UTRA uplink carrier with the output power set to 4 dB below  $P_{\text{CMAX\_L}}$  and the NR band whose downlink is being tested has its uplink carrier output power set to minimum output power as defined in clause 6.3.1 of TS 38.101-1 [2]

one NR uplink carrier with the output power set to 4 dB below  $P_{\text{CMAX}_L}$  on the NR band with both E-UTRA and NR downlinks being tested with E-UTRA output power set to minimum output power as defined in clause 6.3.2.1 of TS 36.101 [4].

If CW interferer falls in a gap between  $F_{\text{DL\_high}}$  of the E-UTRA or NR band and  $F_{\text{DL\_low}}$  of the NR or EUTRA band, where the corresponding OOB ranges 1 and 2 overlap, then the lower level interferer limit of the overlapping OOB ranges applies.

If  $F_{\text{DL\_high}}$  of the lower E-UTRA or NR band is greater than or equal to the  $F_{\text{DL\_low}}$  of the upper NR or E-UTRA band as in overlapping RX frequency ranges, then the OOB range shall start from the  $F_{\text{DL\_low}}$  of the lower E-UTRA or NR band, and from the  $F_{\text{DL\_high}}$  of the upper NR or E-UTRA band.

For EN-DC combination listed in Table 7.6B.3.3-1 under the first test condition above, exceptions to the requirement specified in Table 7.6B.3.3-2 are allowed when the second order intermodulation product of the lower frequency band UL carrier and the CW interfering signal fully or partially overlaps with the higher frequency band DL carrier.

**Table 7.6B.3.3-1: EN-DC combination with exceptions allowed**

EN-DC combination
DC_5_n78
DC_8_n77
DC_8_n78
DC_8_n79
DC_11_n77
DC_18_n77
DC_18_n78
DC_18_n79
DC_19_n77
DC_19_n78
DC_19_n79
DC_20_n77
DC_20_n78
DC_21_n77
DC_26_n77
DC_26_n78
DC_26_n79
DC_28_n77
DC_28_n78
DC_28_n79

Parameter	Unit	Level
$P_{\text{Interferer (CW)}}$	dBm	-44 <sup>1</sup>
NOTE 1: The requirement applies when $ f_{\text{Interferer}} \pm f_{\text{UL}}^{\text{LB}} - f_{\text{DL}}^{\text{HB}}  \leq (BW_{\text{UL}}^{\text{LB}} + BW_{\text{DL}}^{\text{HB}})/2$ , where $f_{\text{UL}}^{\text{LB}}$ and $f_{\text{DL}}^{\text{HB}}$ are the carrier frequencies for lower frequency band UL and higher frequency band DL, respectively. $BW_{\text{UL}}^{\text{LB}}$ and $BW_{\text{DL}}^{\text{HB}}$ are the channel bandwidths configured for lower frequency band UL carrier and higher frequency band DL carrier in MHz, respectively.		

For each of the two test cases in clauses 7.6.2.1 and 7.6.2.1A of TS 36.101 [4] and for NR single carrier and CA operation specified in clauses 7.6.3 and 7.6A.3 of TS 38.101-1 [2] for all interferer frequency ranges a maximum of

$$\lfloor \max\{24,6 \cdot \lceil n \cdot N_{\text{RB}} / 6 \rceil\} / \min\{\lfloor n \cdot N_{\text{RB}} / 10 \rfloor, 5\} \rfloor$$

exceptions are allowed for spurious response frequencies in each assigned frequency channel when measured using a step size of  $\min(\lfloor CBW / 2 \rfloor, 5)$  MHz with  $N_{RB}$  the number of resource blocks in the downlink transmission bandwidth configuration,  $CBW$  the bandwidth of the frequency channel in MHz and  $n = 1, 2, 3$  for SCS = 15, 30, 60 kHz, respectively. For these exceptions, the requirements in clause 7.7 apply.

### 7.6B.3.3a Inter-band NE-DC within FR1

Out-of band blocking requirements for E-UTRA single carrier and CA operation specified in clauses 7.6.2.1 and 7.6.2.1A of TS 36.101 [4] and for NR single carrier and CA operation specified in clauses 7.6.3 and 7.6A.3 of TS 38.101-1 [2] apply for lowest level NE-DC fallbacks (two bands) in clause 5.5.B.4a.1 with following conditions

one E-UTRA uplink carrier with the output power set to 4 dB below  $P_{CMAX,L}$  and the NR band whose downlink is being tested has its uplink carrier output power set to minimum output power as defined in clause 6.3.1 of TS 38.101-1 [2]

one NR uplink carrier with the output power set to 4 dB below  $P_{CMAX,L}$  on the NR band with both E-UTRA and NR downlinks being tested with E-UTRA output power set to minimum output power as defined in clause 6.3.2.1 of TS 36.101 [4].

### 7.6B.3.4 Inter-band EN-DC including FR2

Out-of band blocking requirements specified for E-UTRA single carrier and CA operation specified in clauses 7.6.2.1 and 7.6.2.1A of TS 36.101 [4] apply for lowest level EN-DC fallbacks (two bands) in clause 5.5B.5.1 with only E-UTRA UL with output power as in TS 36.101 [4] (4 dB below  $P_{CMAX,L}$ ).

### 7.6B.3.5 Inter-band EN-DC including both FR1 and FR2

Out-of band blocking requirements specified for E-UTRA single carrier and CA operation specified in clauses 7.6.2.1 and 7.6.2.1A of TS 36.101 [4] and for NR single carrier and CA operation specified in clauses 7.6.3 and 7.6A.3 of TS 38.101-1 [2] apply for lowest level EN-DC fallbacks (three bands) in clause 5.5B.6.2 with only E-UTRA UL with output power as in TS 36.101 [4] (4 dB below  $P_{CMAX,L}$ ).

## 7.6B.4 Narrow band blocking for DC in FR1

### 7.6B.4.1 Intra-band contiguous EN-DC in FR1

Intra-band contiguous EN-DC narrow band blocking requirement and parameters are defined in Table 7.6B.4.1-1.

**Table 7.6B.4.1-1: Narrow band blocking parameters**

EN-DC Aggregated Bandwidth, MHz	≤100	>100, ≤120	>120, ≤140	>140, ≤160
Pw in Transmission Bandwidth Configuration, perCC, dBm	REFSENS + Aggregated BW specific value below			
P <sub>UW</sub> , dBm (CW)	16			
	-55			
NOTE 1: Jammer offset is from Table 7.6.3.1A-1 [4] and is applied from the lowest edge of the lowest carrier and the highest edge of the highest carrier				
NOTE 2: For NR carrier, the transmitter shall be set to 4dB below $P_{CMAX,L,f,c,NR}$ at the minimum uplink configuration specified in Table 7.3.2-3 [2] with $P_{CMAX,L,f,c,NR}$ as defined in clause 6.2.4 from TS 38.101-1 [2].				
NOTE 3: For E-UTRA carrier, the transmitter shall be set to 4dB below $P_{CMAX,L,E-UTRA,c}$ at the minimum uplink configuration specified in Table 7.3.1-2 [4] with $P_{CMAX,L,E-UTRA,c}$ as defined in clause 6.2B.4 for single carrier.				
NOTE 4: If NR carrier BW > 40 MHz, no narrow band blocking requirements apply when blocker is applied at the edge of the NR carrier.				

### 7.6B.4.2 Intra-band non-contiguous EN-DC in FR1

For the E-TRA sub-block containing one or multiple CC's, the requirement is defined in clause 7.6.3.1 for single carrier operation and in clause 7.6.3.1A for CA in TS 36.101 [4].



For the NR sub-block, the requirement is defined in clause 7.6.4 in TS 38.101-1 [2].

The blocker configuration is defined in the general clause 7.1.

### 7.6B.4.3 Inter-band EN-DC within FR1

Narrow band blocking requirement for E-UTRA single carrier and CA operation specified in clauses 7.6.3.1 and 7.6.3.1A of TS 36.101 [4] and for NR single carrier and CA operation specified in clauses 7.6.4 and 7.6A.4 of TS 38.101-1 [2] apply.

### 7.6B.4.3a Inter-band NE-DC within FR1

Narrow band blocking requirement for E-UTRA single carrier and CA operation specified in clauses 7.6.3.1 and 7.6.3.1A of TS 36.101 [4] and for NR single carrier and CA operation specified in clauses 7.6.4 and 7.6A.4 of TS 38.101-1 [2] apply.

### 7.6B.4.4 Inter-band EN-DC including FR2

Narrow band blocking requirement for E-UTRA single carrier and CA operation specified in clauses 7.6.3.1 and 7.6.3.1A of TS 36.101 [4] apply.

### 7.6B.4.5 Inter-band EN-DC including both FR1 and FR2

Narrow band blocking requirement for E-UTRA single carrier and CA operation specified in clauses 7.6.3.1 and 7.6.3.1A of TS 36.101 [4] and for NR single carrier and CA operation specified in clauses 7.6.4 and 7.6A.4 of TS 38.101-1 [2] apply.

## 7.6C Blocking characteristics for V2X in FR1

For intra-band V2X operation, the blocking characteristics specified in clause 7.6.1.1G in TS 36.101 [4] and specified in clause 7.6C in TS 38.101-1 [2] apply when all SL reception CCs are activated at same time.

For inter-band con-current NR V2X operation, the in-band blocking and out of band blocking requirement specified in clause 7.6C in TS 38.101-1 [2] shall apply on NR V2X carrier and the requirement specified in clause 7.6 in TS 36.101 [4] shall apply for the E-UTRA downlink reception in licensed band while all downlink carriers are active.  $P_{\text{Interferer}}$  power is increased by  $\Delta R_{\text{B,c}}$  in the requirement.

No narrow band blocking requirement applied for NR V2X carrier.

## 7.7 Void

### 7.7A Spurious response for CA

For inter-band NR CA between FR1 and FR2, the spurious response specified in TS 38.101-1 [2] apply for FR1.

### 7.7B Spurious response for DC in FR1

#### 7.7B.1 Intra-band contiguous EN-DC in FR1

Intra-band contiguous EN-DC spurious response requirement and parameters are defined in Table 7.7B.1-1.

Table 7.7B.1-1: Spurious Response Parameters

EN-DC Aggregated Bandwidth, MHz	≤100	>100, ≤120	>120, ≤140	>140, ≤160
P <sub>w</sub> in Transmission Bandwidth Configuration, perCC, dBm	REFSENS + Aggregated BW specific value below			
	9			
P <sub>interferer</sub> , dBm (CW)	-44			
NOTE 1: For NR carrier, the transmitter shall be set to 4 dB below P <sub>C<sub>MAX</sub>L,f,c,NR</sub> at the minimum uplink configuration specified in Table 7.3.2-3 [2] with P <sub>C<sub>MAX</sub>L,f,c,NR</sub> as defined in clause 6.2B.4.				
NOTE 2: For E-UTRA carrier, the transmitter shall be set to 4 dB below P <sub>C<sub>MAX</sub>L_E-UTRA,c</sub> at the minimum uplink configuration specified in Table 7.3.1-2 [4] with P <sub>C<sub>MAX</sub>L_E-UTRA,c</sub> as defined in clause 6.2B.4 for single carrier.				

## 7.7B.2 Intra-band non-contiguous EN-DC in FR1

For the E-UTRA sub-block containing one or multiple CC's, the requirement is defined in clause 7.7.1 for single carrier operation and in clause 7.7.1A for CA in TS 36.101 [4].

For the NR sub-block, the requirement is defined in clause 7.7 is [2].

## 7.7B.3 Inter-band EN-DC within FR1

Spurious response requirement for E-UTRA single carrier and CA operation specified in clauses 7.7.1 and 7.7.1A of TS 36.101 [4] and for NR single carrier and CA operation specified in clauses 7.7 and 7.7A of TS 38.101-1 [2] apply for lowest level EN-DC fallbacks (two bands) in clause 5.5.B.4.1 with following conditions

- one E-UTRA uplink carrier with the output power set to 4 dB below P<sub>C<sub>MAX</sub>L</sub> and the NR band whose downlink is being tested has its uplink carrier output power set to minimum output power as defined in clause 6.3.1 of TS 38.101-1 [2]
- one NR uplink carrier with the output power set to 4 dB below P<sub>C<sub>MAX</sub>L</sub> on the NR band with both E-UTRA and NR downlinks being tested with E-UTRA output power set to minimum output power as defined in clause 6.3.2.1 of TS 36.101 [4].

### 7.7B.3a Inter-band NE-DC within FR1

Spurious response requirement for E-UTRA single carrier and CA operation specified in clauses 7.7.1 and 7.7.1A of TS 36.101 [4] and for NR single carrier and CA operation specified in clauses 7.7 and 7.7A of TS 38.101-1 [2] apply.

## 7.7B.4 Inter-band EN-DC including FR2

Spurious response requirement for E-UTRA single carrier and CA operation specified in clauses 7.7.1 and 7.7.1A of TS 36.101 [4] apply for lowest level EN-DC fallbacks (two bands) in clause 5.5B.5.1 with only E-UTRA UL with output power as in TS 36.101 [4] (4 dB below P<sub>C<sub>MAX</sub>L</sub>).

## 7.7B.5 Inter-band EN-DC including both FR1 and FR2

Spurious response requirement for E-UTRA single carrier and CA operation specified in clauses 7.7.1 and 7.7.1A of TS 36.101 [4] and for NR single carrier and CA operation specified in clauses 7.7 and 7.7A of TS 38.101-1 [2] apply for lowest level EN-DC fallbacks (three bands) in clause 5.5B.6.2 with only E-UTRA UL with output power as in TS 36.101 [4] (4 dB below P<sub>C<sub>MAX</sub>L</sub>).

## 7.7C Spurious response for V2X in FR1

For intra-band V2X operation, the spurious response specified in clause 7.7.1G in TS 36.101 [4] and specified in clause 7.7C in TS 38.101-1 [2] apply when all SL reception CCs are activated at same time.

For the inter-band con-current NR V2X operation, the requirements specified in subclause 7.7C of TS 38.101-1 [2] shall apply for the NR sidelink reception in Band n47 and the requirements specified in subclause 7.7.1 of TS 36.101 [4] shall apply for the E-UTRA downlink reception in licensed band while all downlink carriers are active.

## 7.8 Void

### 7.8A Intermodulation characteristics for CA

For inter-band NR CA between FR1 and FR2, the intermodulation characteristics specified in TS 38.101-1 [2] apply for FR1.

### 7.8B Intermodulation characteristics for DC in FR1

#### 7.8B.1 General

#### 7.8B.2 Wide band Intermodulation

##### 7.8B.2.1 Intra-band contiguous EN-DC in FR1

Intra-band contiguous EN-DC wide band intermodulation requirement and parameters are defined in Table 7.8B.2.1-1.

**Table 7.8B.2.1-1: Wide band intermodulation**

EN-DC Aggregated Bandwidth, MHz	<=100	>100, <=120	>120, <=140	>140, <=160
P <sub>w</sub> in Transmission Bandwidth Configuration, perCC, dBm	P <sub>w</sub> <sup>1</sup>	REFSENS + Aggregated BW specific value below		
P <sub>interferer 1</sub> , dBm (CW) <sup>2</sup>		16.8	17.5	18.0
P <sub>interferer 2</sub> , dBm (Modulated) <sup>2</sup>		-46		
NOTE 1: P <sub>w</sub> is wanted signal power level from Table 7.8.1A-1 in TS 36.101 [4]				
NOTE 2: Jammer BW and offsets is from Table 7.8.1A-1 [4] and is applied from the lowest edge of the lowest carrier and the highest edge of the highest carrier				
NOTE 3: For NR carrier, the transmitter shall be set to 4dB below P <sub>C<sub>MAX</sub>_L,f,c,NR</sub> at the minimum uplink configuration specified in Table 7.3.2-3 [2] with P <sub>C<sub>MAX</sub>_L,f,c,NR</sub> as defined in clause 6.2B.4.				
NOTE 4: For E-UTRA carrier, the transmitter shall be set to 4dB below P <sub>C<sub>MAX</sub>_L,E-UTRA,c</sub> at the minimum uplink configuration specified in Table 7.3.1-2 [4] with P <sub>C<sub>MAX</sub>_L,E-UTRA,c</sub> as defined in clause 6.2B.4 for single carrier.				

##### 7.8B.2.2 Intra-band non-contiguous EN-DC in FR1

For the E-UTRA sub-block containing one or multiple CC's, the requirement is defined in clause 7.8.1 for single carrier operation and in clause 7.8.1A for CA in TS 36.101 [4].

For the NR sub-block, the requirement is defined in clause 7.8.2 in TS 38.101-1 [2].

The blocker configuration is defined in the general clause 7.1 and the requirement only apply for out of gap interferers.

##### 7.8B.2.3 Inter-band EN-DC within FR1

Wide band Intermodulation requirement for E-UTRA single carrier and CA operation specified in clauses 7.8.1 and 7.8.1A of TS 36.101 [4] and for NR single carrier and CA operation specified in clauses 7.8.2 and 7.8A.2 of TS 38.101-1 [2] apply.

##### 7.8B.2.3a Inter-band NE-DC within FR1

Wide band Intermodulation requirement for E-UTRA single carrier and CA operation specified in clauses 7.8.1 and 7.8.1A of TS 36.101 [4] and for NR single carrier and CA operation specified in clauses 7.8.2 and 7.8A.2 of TS 38.101-1 [2] apply.

#### 7.8B.2.4 Inter-band EN-DC including FR2

Wide band Intermodulation requirement for E-UTRA single carrier and CA operation specified in clauses 7.8.1 and 7.8.1A of TS 36.101 [4] apply.

#### 7.8B.2.5 Inter-band EN-DC including both FR1 and FR2

Wide band Intermodulation requirement for E-UTRA single carrier and CA operation specified in clauses 7.8.1 and 7.8.1A of TS 36.101 [4] and for NR single carrier and CA operation specified in clauses 7.8.2 and 7.8A.2 of TS 38.101-1 [2] apply.

### 7.8C Intermodulation characteristics for V2X operation in FR1

For intra-band V2X operation, the intermodulation characteristics specified in clause 7.8.1G in TS 36.101 [4] and specified in clause 7.8C in TS 38.101-1 [2] apply when all SL reception CCs are activated at same time.

For inter-band NR V2X con-current operation, the wideband inter-modulation requirement specified in clause 7.8C in TS 38.101-1 [2] shall apply on NR V2X carrier and the requirement specified in clause 7.8.1 in TS 36.101 [4] shall apply on E-UTRA downlink reception in licensed band while all downlink carriers are active.  $P_{\text{Interferer}}$  power is increased by  $\Delta R_{\text{B,c}}$  in the requirement.

## 7.9 Void

### 7.9A Spurious emissions for CA

For inter-band NR CA between FR1 and FR2, the spurious emission specified in TS 38.101-1 [2] and TS 38.101-2 [3] apply for FR1 and FR2 respectively.

### 7.9B Spurious emissions for DC in FR1

#### 7.9B.1 Intra-band contiguous EN-DC in FR1

The requirement is defined in clause 7.9A.1 in TS 38.101-1 [2].

#### 7.9B.2 Intra-band non-contiguous EN-DC in FR1

Spurious emissions requirement for E-UTRA single carrier and CA operation specified in clauses 7.9.1 and 7.9.1A of TS 36.101 [4] and for NR single carrier and CA operation specified in clauses 7.9 and 7.9A of TS 38.101-1 [2] apply.

#### 7.9B.3 Inter-band EN-DC within FR1

E-UTRA requirements from TS 36.101 [4] and NR requirements from TS 38.101-1 [2] apply.

#### 7.9B.3a Inter-band NE-DC within FR1

E-UTRA requirements from TS 36.101 [4] and NR requirements from TS 38.101-1 [2] apply.

#### 7.9B.4 Inter-band EN-DC including FR2

Spurious emissions requirement for E-UTRA single carrier and CA operation specified in clauses 7.9.1 and 7.9.1A of TS 36.101 [4] and for NR single carrier and CA operation specified in clause 7.9 of TS 38.101-2 [3] apply.

## 7.9B.5 Inter-band EN-DC including both FR1 and FR2

Spurious emissions requirement for E-UTRA single carrier and CA operation specified in clauses 7.9.1 and 7.9.1A of TS 36.101 [4] and for NR single carrier and CA operation specified in clauses 7.9 and 7.9A of TS 38.101-1 [2] and TS 38.101-2 [3] apply.

---

# Annex A (normative): Measurement channels

---

---

## A.1 General

The throughput values defined in the measurement channels specified in Annex A, are calculated and are valid per datastream (codeword). For multi-stream (more than one codeword) transmissions, the throughput referenced in the minimum requirements is the sum of throughputs of all datastreams (codewords).

The UE category entry in the definition of the reference measurement channel in Annex A is only informative and reveals the UE categories, which can support the corresponding measurement channel. Whether the measurement channel is used for testing a certain UE category or not is specified in the individual minimum requirements.

---

## A.2 UL reference measurement channels for E-UTRA TDD Config 2

### A.2.1 General

The measurement channels in the following clauses are defined to derive the requirements in clause 6 (Transmitter Characteristics) and clause 7 (Receiver Characteristics). The measurement channels represent example configurations of physical channels for different data rates.

## A.2.2 Reference measurement channels for E-UTRA

### A.2.2.1 Full RB allocation

#### A.2.2.1.1 QPSK

**Table A.2.2.1.1-1: Reference Channels for QPSK with full RB allocation**

Parameter	Unit	Value					
		1.4	3	5	10	15	20
Channel bandwidth	MHz	1.4	3	5	10	15	20
Allocated resource blocks		6	15	25	50	75	100
Uplink-Downlink Configuration (NOTE 2)		2	2	2	2	2	2
Special subframe configuration (NOTE 3)		7	7	7	7	7	7
DFT-OFDM Symbols per Sub-Frame		12	12	12	12	12	12
Modulation		QPSK	QPSK	QPSK	QPSK	QPSK	QPSK
Target Coding rate		1/3	1/3	1/3	1/3	1/5	1/6
Payload size							
For Sub-Frame 2,7	Bits	600	1544	2216	5160	4392	4584
Transport block CRC	Bits	24	24	24	24	24	24
Number of code blocks per Sub-Frame (NOTE 1)							
For Sub-Frame 2,7		1	1	1	1	1	1
Total number of bits per Sub-Frame							
For Sub-Frame 2,7	Bits	1728	4320	7200	14400	21600	28800
Total symbols per Sub-Frame							
For Sub-Frame 2,7		864	2160	3600	7200	10800	14400
UE Category		≥ 1	≥ 1	≥ 1	≥ 1	≥ 1	≥ 1
NOTE 1: If more than one Code Block is present, an additional CRC sequence of L = 24 Bits is attached to each Code Block (otherwise L = 0 Bit)							
NOTE 2: As per Table 4.2-2 in TS 36.211 [7]							
NOTE 3: As per Table 4.2-1 in TS 36.211 [7]							

## A.2.2.1.2 16-QAM

Table A.2.2.1.2-1: Reference Channels for 16-QAM with full RB allocation

Parameter	Unit	Value					
Channel bandwidth	MHz	1.4	3	5	10	15	20
Allocated resource blocks		6	15	25	50	75	100
Uplink-Downlink Configuration (NOTE 2)		2	2	2	2	2	2
Special subframe configuration (NOTE 3)		7	7	7	7	7	7
DFT-OFDM Symbols per Sub-Frame		12	12	12	12	12	12
Modulation		16QAM	16QAM	16QAM	16QAM	16QAM	16QAM
Target Coding rate		3/4	1/2	1/3	3/4	1/2	1/3
Payload size							
For Sub-Frame 2,7	Bits	2600	4264	4968	21384	21384	19848
Transport block CRC	Bits	24	24	24	24	24	24
Number of code blocks per Sub-Frame (NOTE 1)							
For Sub-Frame 2,7		1	1	1	4	4	4
Total number of bits per Sub-Frame							
For Sub-Frame 2,7	Bits	3456	8640	14400	28800	43200	57600
Total symbols per Sub-Frame							
For Sub-Frame 2,7		864	2160	3600	7200	10800	14400
UE Category		≥ 1	≥ 1	≥ 1	≥ 2	≥ 2	≥ 2
NOTE 1: If more than one Code Block is present, an additional CRC sequence of L = 24 Bits is attached to each Code Block (otherwise L = 0 Bit)							
NOTE 2: As per Table 4.2-2 in TS 36.211 [7]							
NOTE 3: As per Table 4.2-1 in TS 36.211 [7]							



## A.2.2.1.3 64-QAM

Table A.2.2.1.3-1: Reference Channels for 64-QAM with full RB allocation

Parameter	Unit	Value					
		1.4	3	5	10	15	20
Channel bandwidth	MHz	1.4	3	5	10	15	20
Allocated resource blocks		6	15	25	50	75	100
Uplink-Downlink Configuration (NOTE 2)		2	2	2	2	2	2
Special subframe configuration (NOTE 3)		7	7	7	7	7	7
DFT-OFDM Symbols per Sub-Frame		12	12	12	12	12	12
Modulation		64QAM	64QAM	64QAM	64QAM	64QAM	64QAM
Target Coding rate		3/4	3/4	3/4	3/4	3/4	3/4
Payload size							
For Sub-Frame 2,7	Bits	3752	9528	15840	31704	46888	63776
Transport block CRC	Bits	24	24	24	24	24	24
Number of code blocks per Sub-Frame (NOTE 1)							
For Sub-Frame 2,7		1	2	3	6	8	11
Total number of bits per Sub-Frame							
For Sub-Frame 2,7	Bits	5184	12960	21600	43200	64800	86400
Total symbols per Sub-Frame							
For Sub-Frame 2,7		864	2160	3600	7200	10800	14400
UE Category (NOTE 4)		5, 8	5, 8	5, 8	5, 8	5, 8	5, 8
UE UL Category (NOTE 4)		5, 8, 13, 14	5, 8, 13, 14	5, 8, 13, 14	5, 8, 13, 14	5, 8, 13, 14	5, 8, 13, 14
NOTE 1: If more than one Code Block is present, an additional CRC sequence of L = 24 Bits is attached to each Code Block (otherwise L = 0 Bit)							
NOTE 2: As per Table 4.2-2 in TS 36.211 [7]							
NOTE 3: As per Table 4.2-1 in TS 36.211 [7]							
NOTE 4: If UE does not report UE UL category, then the applicability of reference channel is determined by UE category. If UE reports UE UL category, then the applicability of reference channel is determined by UE UL category.							

## A.2.2.1.4 256 QAM

Table A.2.2.1.4-1: Reference Channels for 256 QAM with full RB allocation

Parameter	Unit	Value					
Channel bandwidth	MHz	1.4	3	5	10	15	20
Allocated resource blocks		6	15	25	50	75	100
Uplink-Downlink Configuration (NOTE 2)		2	2	2	2	2	2
Special subframe configuration (NOTE 3)		7	7	7	7	7	7
DFT-OFDM Symbols per Sub-Frame		12	12	12	12	12	12
Modulation		256QAM	256QAM	256QAM	256QAM	256QAM	256QAM
Target Coding rate		3/4	3/4	3/4	3/4	3/4	3/4
Payload size							
For Sub-Frame 2,7	Bits	5160	12960	21384	42368	63776	84760
Transport block CRC	Bits	24	24	24	24	24	24
Number of code blocks per Sub-Frame (NOTE 1)							
For Sub-Frame 2,7		1	3	4	8	11	15
Total number of bits per Sub-Frame							
For Sub-Frame 2,7	Bits	6912	17280	28800	57600	86400	115200
Total symbols per Sub-Frame							
For Sub-Frame 2,7		864	2160	3600	7200	10800	14400
UE UL Category		≥ 15	≥ 15	≥ 15	≥ 15	≥ 15	≥ 15
NOTE 1: If more than one Code Block is present, an additional CRC sequence of L = 24 Bits is attached to each Code Block (otherwise L = 0 Bit)							
NOTE 2: As per Table 4.2-2 in TS 36.211 [7]							
NOTE 3: As per Table 4.2-1 in TS 36.211 [7]							

## A.2.2.2 Partial RB allocation

### A.2.2.2.1 QPSK

**Table A.2.2.2.1-1: Reference Channels for QPSK with partial RB allocation**

Parameter	Ch BW	Allocated RBs	UL-DL Configuration (NOTE 2)	Special subframe configuration (NOTE 3)	DFT-OFDM Symbols per Sub-Frame	Mod'n	Target Coding rate	Payload size for Sub-Frame 2, 7	Transport block CRC	Number of code blocks per Sub-Frame (NOTE 1)	Total number of bits per Sub-Frame for Sub-Frame 2, 7	Total symbols per Sub-Frame for Sub-Frame 2, 7	UE Category
Unit	MHz							Bits	Bits		Bits		
	1.4 - 20	1	2	7	12	QPSK	1/3	72	24	1	288	144	≥ 1
	1.4 - 20	2	2	7	12	QPSK	1/3	176	24	1	576	288	≥ 1
	1.4 - 20	3	2	7	12	QPSK	1/3	256	24	1	864	432	≥ 1
	1.4 - 20	4	2	7	12	QPSK	1/3	392	24	1	1152	576	≥ 1
	1.4 - 20	5	2	7	12	QPSK	1/3	424	24	1	1440	720	≥ 1
	3-20	6	2	7	12	QPSK	1/3	600	24	1	1728	864	≥ 1
	3-20	8	2	7	12	QPSK	1/3	808	24	1	2304	1152	≥ 1
	3-20	9	2	7	12	QPSK	1/3	776	24	1	2592	1296	≥ 1
	3-20	10	2	7	12	QPSK	1/3	872	24	1	2880	1440	≥ 1
	3-20	12	2	7	12	QPSK	1/3	1224	24	1	3456	1728	≥ 1
	5-20	15	2	7	12	QPSK	1/3	1320	24	1	4320	2160	≥ 1
	5-20	16	2	7	12	QPSK	1/3	1384	24	1	4608	2304	≥ 1
	5-20	18	2	7	12	QPSK	1/3	1864	24	1	5184	2592	≥ 1
	5-20	20	2	7	12	QPSK	1/3	1736	24	1	5760	2880	≥ 1
	5-20	24	2	7	12	QPSK	1/3	2472	24	1	6912	3456	≥ 1
	10-20	25	2	7	12	QPSK	1/3	2216	24	1	7200	3600	≥ 1
	10-20	27	2	7	12	QPSK	1/3	2792	24	1	7776	3888	≥ 1
	10-20	30	2	7	12	QPSK	1/3	2664	24	1	8640	4320	≥ 1
	10-20	32	2	7	12	QPSK	1/3	2792	24	1	9216	4608	≥ 1
	10-20	36	2	7	12	QPSK	1/3	3752	24	1	10368	5184	≥ 1
	10-20	40	2	7	12	QPSK	1/3	4136	24	1	11520	5760	≥ 1
	10-20	45	2	7	12	QPSK	1/3	4008	24	1	12960	6480	≥ 1
	10-20	48	2	7	12	QPSK	1/3	4264	24	1	13824	6912	≥ 1
	15 - 20	50	2	7	12	QPSK	1/3	5160	24	1	14400	7200	≥ 1
	15 - 20	54	2	7	12	QPSK	1/3	4776	24	1	15552	7776	≥ 1
	15 - 20	60	2	7	12	QPSK	1/4	4264	24	1	17280	8640	≥ 1
	15 - 20	64	2	7	12	QPSK	1/4	4584	24	1	18432	9216	≥ 1
	15 - 20	72	2	7	12	QPSK	1/4	5160	24	1	20736	10368	≥ 1
	20	75	2	7	12	QPSK	1/5	4392	24	1	21600	10800	≥ 1
	20	80	2	7	12	QPSK	1/5	4776	24	1	23040	11520	≥ 1
	20	81	2	7	12	QPSK	1/5	4776	24	1	23328	11664	≥ 1
	20	90	2	7	12	QPSK	1/6	4008	24	1	25920	12960	≥ 1
	20	96	2	7	12	QPSK	1/6	4264	24	1	27648	13824	≥ 1

NOTE 1: If more than one Code Block is present, an additional CRC sequence of L = 24 Bits is attached to each Code Block (otherwise L = 0 Bit)

NOTE 2: As per Table 4.2-2 in TS 36.211 [7]

NOTE 3: As per Table 4.2-1 in TS 36.211 [7]

## A.2.2.2.2 16-QAM

Table A.2.2.2-1: Reference Channels for 16QAM with partial RB allocation

Parameter	Ch BW	Allocated RBs	UL-DL Configuration (NOTE 2)	Special subframe configuration (NOTE 3)	DFT-OFDM Symbols per Sub-Frame	Mod'n	Target Coding rate	Payload size for Sub-Frame 2, 7	Transport block CRC	Number of code blocks per Sub-Frame (NOTE 1)	Total number of bits per Sub-Frame for Sub-Frame 2, 7	Total symbols per Sub-Frame for Sub-Frame 2, 7	UE Category
Unit	MHz							Bits	Bits		Bits		
	1.4 - 20	1	2	7	12	16QAM	3/4	408	24	1	576	144	≥ 1
	1.4 - 20	2	2	7	12	16QAM	3/4	840	24	1	1152	288	≥ 1
	1.4 - 20	3	2	7	12	16QAM	3/4	1288	24	1	1728	432	≥ 1
	1.4 - 20	4	2	7	12	16QAM	3/4	1736	24	1	2304	576	≥ 1
	1.4 - 20	5	2	7	12	16QAM	3/4	2152	24	1	2880	720	≥ 1
	3-20	6	2	7	12	16QAM	3/4	2600	24	1	3456	864	≥ 1
	3-20	8	2	7	12	16QAM	3/4	3496	24	1	4608	1152	≥ 1
	3-20	9	2	7	12	16QAM	3/4	3880	24	1	5184	1296	≥ 1
	3-20	10	2	7	12	16QAM	3/4	4264	24	1	5760	1440	≥ 1
	3-20	12	2	7	12	16QAM	3/4	5160	24	1	6912	1728	≥ 1
	5-20	15	2	7	12	16QAM	1/2	4264	24	1	8640	2160	≥ 1
	5-20	16	2	7	12	16QAM	1/2	4584	24	1	9216	2304	≥ 1
	5-20	18	2	7	12	16QAM	1/2	5160	24	1	10368	2592	≥ 1
	5-20	20	2	7	12	16QAM	1/3	4008	24	1	11520	2880	≥ 1
	5-20	24	2	7	12	16QAM	1/3	4776	24	1	13824	3456	≥ 1
	10-20	25	2	7	12	16QAM	1/3	4968	24	1	14400	3600	≥ 1
	10-20	27	2	7	12	16QAM	1/3	4776	24	1	15552	3888	≥ 1
	10-20	30	2	7	12	16QAM	3/4	12960	24	3	17280	4320	≥ 2
	10-20	32	2	7	12	16QAM	3/4	13536	24	3	18432	4608	≥ 2
	10-20	36	2	7	12	16QAM	3/4	15264	24	3	20736	5184	≥ 2
	10-20	40	2	7	12	16QAM	3/4	16992	24	3	23040	5760	≥ 2
	10-20	45	2	7	12	16QAM	3/4	19080	24	4	25920	6480	≥ 2
	10-20	48	2	7	12	16QAM	3/4	20616	24	4	27648	6912	≥ 2
	15 - 20	50	2	7	12	16QAM	3/4	21384	24	4	28800	7200	≥ 2
	15 - 20	54	2	7	12	16QAM	3/4	22920	24	4	31104	7776	≥ 2
	15 - 20	60	2	7	12	16QAM	2/3	23688	24	4	34560	8640	≥ 2
	15 - 20	64	2	7	12	16QAM	2/3	25456	24	4	36864	9216	≥ 2
	15 - 20	72	2	7	12	16QAM	1/2	20616	24	4	41472	10368	≥ 2
	20	75	2	7	12	16QAM	1/2	21384	24	4	43200	10800	≥ 2
	20	80	2	7	12	16QAM	1/2	22920	24	4	46080	11520	≥ 2
	20	81	2	7	12	16QAM	1/2	22920	24	4	46656	11664	≥ 2
	20	90	2	7	12	16QAM	2/5	20616	24	4	51840	12960	≥ 2
	20	96	2	7	12	16QAM	2/5	22152	24	4	55296	13824	≥ 2

NOTE 1: If more than one Code Block is present, an additional CRC sequence of L = 24 Bits is attached to each Code Block (otherwise L = 0 Bit)

NOTE 2: As per Table 4.2-2 in TS 36.211 [7]

NOTE 3: As per Table 4.2-1 in TS 36.211 [7]

## A.2.2.2.3 64-QAM

Table A.2.2.2.3-1: Reference Channels for 64-QAM with partial RB allocation

Parameter	Ch BW	Allocated RBs	UL-DL Configuration (NOTE 2)	Special subframe configuration (NOTE 3)	DFT-OFDM Symbols per Sub-Frame	Mod'n	Target Coding rate	Payload size for Sub-Frame 2, 7	Transport block CRC	Number of code blocks per Sub-Frame (NOTE 1)	Total number of bits per Sub-Frame for Sub-Frame 2, 7	Total symbols per Sub-Frame for Sub-Frame 2, 7	UE Category (NOTE 4)
Unit	MHz							Bits	Bits		Bits		
	1.4 - 20	1	2	7	12	64QAM	3/4	616	24	1	864	144	5,8
	1.4 - 20	2	2	7	12	64QAM	3/4	1256	24	1	1728	288	5,8
	1.4 - 20	3	2	7	12	64QAM	3/4	1864	24	1	2592	432	5,8
	1.4 - 20	4	2	7	12	64QAM	3/4	2536	24	1	3456	576	5,8
	1.4 - 20	5	2	7	12	64QAM	3/4	3112	24	1	4320	720	5,8
	3-20	6	2	7	12	64QAM	3/4	3752	24	1	5184	864	5,8
	3-20	8	2	7	12	64QAM	3/4	5160	24	1	6912	1152	5,8
	3-20	9	2	7	12	64QAM	3/4	5736	24	1	7776	1296	5,8
	3-20	10	2	7	12	64QAM	3/4	6200	24	2	8640	1440	5,8
	3-20	12	2	7	12	64QAM	3/4	7480	24	2	10368	1728	5,8
	5-20	15	2	7	12	64QAM	3/4	9528	24	2	12960	2160	5,8
	5-20	16	2	7	12	64QAM	3/4	10296	24	2	13824	2304	5,8
	5-20	18	2	7	12	64QAM	3/4	11448	24	2	15552	2592	5,8
	5-20	20	2	7	12	64QAM	3/4	12576	24	3	17280	2880	5,8
	5-20	24	2	7	12	64QAM	3/4	15264	24	3	20736	3456	5,8
	10-20	25	2	7	12	64QAM	3/4	15840	24	3	21600	3600	5,8
	10-20	27	2	7	12	64QAM	3/4	16992	24	3	23328	3888	5,8
	10-20	30	2	7	12	64QAM	3/4	19080	24	4	25920	4320	5,8
	10-20	32	2	7	12	64QAM	3/4	20616	24	4	27648	4608	5,8
	10-20	36	2	7	12	64QAM	3/4	22920	24	4	31104	5184	5,8
	10-20	40	2	7	12	64QAM	3/4	25456	24	5	34560	5760	5,8
	10-20	45	2	7	12	64QAM	3/4	28336	24	5	38880	6480	5,8
	10-20	48	2	7	12	64QAM	3/4	30576	24	5	41472	6912	5,8
	15 - 20	50	2	7	12	64QAM	3/4	31704	24	6	43200	7200	5,8
	15 - 20	54	2	7	12	64QAM	3/4	34008	24	6	46656	7776	5,8
	15 - 20	60	2	7	12	64QAM	3/4	37888	24	7	51840	8640	5,8
	15 - 20	64	2	7	12	64QAM	3/4	40576	24	7	55296	9216	5,8
	1.4 - 20	1	2	7	12	64QAM	3/4	616	24	1	864	144	5,8
	1.4 - 20	2	2	7	12	64QAM	3/4	1256	24	1	1728	288	5,8
	1.4 - 20	3	2	7	12	64QAM	3/4	1864	24	1	2592	432	5,8
	1.4 - 20	4	2	7	12	64QAM	3/4	2536	24	1	3456	576	5,8
	1.4 - 20	5	2	7	12	64QAM	3/4	3112	24	1	4320	720	5,8
	3-20	6	2	7	12	64QAM	3/4	3752	24	1	5184	864	5,8
	3-20	8	2	7	12	64QAM	3/4	5160	24	1	6912	1152	5,8
	3-20	9	2	7	12	64QAM	3/4	5736	24	1	7776	1296	5,8
	3-20	10	2	7	12	64QAM	3/4	6200	24	2	8640	1440	5,8
	3-20	12	2	7	12	64QAM	3/4	7480	24	2	10368	1728	5,8
	5-20	15	2	7	12	64QAM	3/4	9528	24	2	12960	2160	5,8
	5-20	16	2	7	12	64QAM	3/4	10296	24	2	13824	2304	5,8
	5-20	18	2	7	12	64QAM	3/4	11448	24	2	15552	2592	5,8
	5-20	20	2	7	12	64QAM	3/4	12576	24	3	17280	2880	5,8
	5-20	24	2	7	12	64QAM	3/4	15264	24	3	20736	3456	5,8
	10-20	25	2	7	12	64QAM	3/4	15840	24	3	21600	3600	5,8
	10-20	27	2	7	12	64QAM	3/4	16992	24	3	23328	3888	5,8
	10-20	30	2	7	12	64QAM	3/4	19080	24	4	25920	4320	5,8
	15 - 20	50	2	7	12	64QAM	3/4	31704	24	6	43200	7200	5,8
	15 - 20	54	2	7	12	64QAM	3/4	34008	24	6	46656	7776	5,8
	15 - 20	60	2	7	12	64QAM	3/4	37888	24	7	51840	8640	5,8
	15 - 20	64	2	7	12	64QAM	3/4	40576	24	7	55296	9216	5,8
	15 - 20	72	2	7	12	64QAM	3/4	45352	24	8	62208	10368	5,8
	20	75	2	7	12	64QAM	3/4	46888	24	8	64800	10800	5,8
	20	80	2	7	12	64QAM	3/4	51024	24	9	69120	11520	5,8
	20	81	2	7	12	64QAM	3/4	51024	24	9	69984	11664	5,8
	20	90	2	7	12	64QAM	3/4	51024	24	9	77760	12960	5,8
	20	96	2	7	12	64QAM	3/4	61664	24	11	82944	13824	5,8

NOTE 1: If more than one Code Block is present, an additional CRC sequence of L = 24 Bits is attached to each Code Block (otherwise L = 0 Bit)

NOTE 2: As per Table 4.2-2 in TS 36.211 [7].

NOTE 3: As per Table 4.2-1 in TS 36.211 [7].

NOTE 4: If UE does not report UE UL category, then the applicability of reference channel is determined by UE category. If UE reports UE UL category, then the applicability of reference channel is determined by UE UL category.

## A.2.2.2.4 256 QAM

Table A.2.2.2.4-1: Reference Channels for 256 QAM with partial RB allocation

Parameter	Ch BW	Allocated RBs	UL-DL Configuration (NOTE 2)	Special Slot Configuration (NOTE 3)	DFT-OFDM Symbols per Sub-Frame	Mod'n	Target Coding rate	Payload size for Sub-Frame 2, 7	Transport block CRC	Number of code blocks per Sub-Frame (NOTE 1)	Total number of bits per Sub-Frame for Sub-Frame 2, 7	Total symbols per Sub-Frame for Sub-Frame 2, 7	UE UL Category
Unit	MHz							Bits	Bits		Bits		
	1.4 - 20	1	2	7	12	256QAM	3/4	840	24	1	1152	144	≥ 15
	1.4 - 20	2	2	7	12	256QAM	3/4	1672	24	1	2304	288	≥ 15
	1.4 - 20	3	2	7	12	256QAM	3/4	2536	24	1	3456	432	≥ 15
	1.4 - 20	4	2	7	12	256QAM	3/4	3368	24	1	4608	576	≥ 15
	1.4 - 20	5	2	7	12	256QAM	3/4	4264	24	1	5760	720	≥ 15
	3-20	6	2	7	12	256QAM	3/4	5160	24	1	6912	864	≥ 15
	3-20	8	2	7	12	256QAM	3/4	6712	24	2	9216	1152	≥ 15
	3-20	9	2	7	12	256QAM	3/4	7736	24	2	10368	1296	≥ 15
	3-20	10	2	7	12	256QAM	3/4	8504	24	2	11520	1440	≥ 15
	3-20	12	2	7	12	256QAM	3/4	10296	24	2	13824	1728	≥ 15
	5-20	15	2	7	12	256QAM	3/4	12960	24	3	17280	2160	≥ 15
	5-20	16	2	7	12	256QAM	3/4	13536	24	3	18432	2304	≥ 15
	5-20	18	2	7	12	256QAM	3/4	15264	24	3	20736	2592	≥ 15
	5-20	20	2	7	12	256QAM	3/4	16992	24	3	23040	2880	≥ 15
	5-20	24	2	7	12	256QAM	3/4	20616	24	4	27648	3456	≥ 15
	10-20	25	2	7	12	256QAM	3/4	21384	24	4	28800	3600	≥ 15
	10-20	27	2	7	12	256QAM	3/4	22920	24	4	31104	3888	≥ 15
	10-20	30	2	7	12	256QAM	3/4	25456	24	5	34560	4320	≥ 15
	10-20	32	2	7	12	256QAM	3/4	27376	24	5	36864	4608	≥ 15
	10-20	36	2	7	12	256QAM	3/4	30576	24	6	41472	5184	≥ 15
	10-20	40	2	7	12	256QAM	3/4	34008	24	6	46080	5760	≥ 15
	10-20	45	2	7	12	256QAM	3/4	37888	24	7	51840	6480	≥ 15
	10-20	48	2	7	12	256QAM	3/4	40576	24	8	55296	6912	≥ 15
	15 - 20	50	2	7	12	256QAM	3/4	42368	24	8	57600	7200	≥ 15
	15 - 20	54	2	7	12	256QAM	3/4	46888	24	8	62208	7776	≥ 15
	15 - 20	60	2	7	12	256QAM	3/4	51024	24	9	69120	8640	≥ 15
	15 - 20	64	2	7	12	256QAM	3/4	55056	24	9	73728	9216	≥ 15
	15 - 20	72	2	7	12	256QAM	3/4	61664	24	11	82944	10368	≥ 15
	20	75	2	7	12	256QAM	3/4	63776	24	11	86400	10800	≥ 15
	20	80	2	7	12	256QAM	3/4	68808	24	12	92160	11520	≥ 15
	20	81	2	7	12	256QAM	3/4	68808	24	12	93312	11664	≥ 15
	20	90	2	7	12	256QAM	3/4	76208	24	13	103680	12960	≥ 15
	20	96	2	7	12	256QAM	3/4	81176	24	14	110592	13824	≥ 15

NOTE 1: If more than one Code Block is present, an additional CRC sequence of L = 24 Bits is attached to each Code Block (otherwise L = 0 Bit)  
NOTE 2: As per Table 4.2-2 in TS 36.211 [7]  
NOTE 3: As per Table 4.2-1 in TS 36.211 [7]

## A.3 DL reference measurement channels for E-UTRA

### A.3.1 General

The number of available channel bits varies across the sub-frames due to PBCH and PSS/SSS overhead. The payload size per sub-frame is varied in order to keep the code rate constant throughout a frame.

Unless otherwise stated, no user data is scheduled on subframes #5 in order to facilitate the transmission of system information blocks (SIB).

The algorithm for determining the payload size  $A$  is as follows; given a desired coding rate  $R$  and radio block allocation  $N_{RB}$

1. Calculate the number of channel bits  $N_{ch}$  that can be transmitted during the first transmission of a given sub-frame.
2. Find  $A$  such that the resulting coding rate is as close to  $R$  as possible, that is,

$$\min \left| R - (A + 24 * (N_{CB} + 1)) / N_{ch} \right|, \text{ where } N_{CB} = \begin{cases} 0, & \text{if } C = 1 \\ C, & \text{if } C > 1 \end{cases}$$

subject to

- a) A is a valid TB size according to clause 7.1.7 of TS 36.213 [6] assuming an allocation of  $N_{RB}$  resource blocks.
  - b) C is the number of Code Blocks calculated according to clause 5.1.2 of TS 36.212 [5].
3. If there is more than one A that minimizes the equation above, then the larger value is chosen per default and the chosen code rate should not exceed 0.93.
  4. For TDD, the measurement channel is based on DL/UL configuration ratio of 3DL+DwPTS (10 OFDM symbol SSF7): 1UL

### A.3.1.1 QPSK

**Table A.3.1.1-1: Fixed Reference Channel for Receiver Requirements (TDD)**

Parameter	Unit	Value					
		1.4	3	5	10	15	20
Channel Bandwidth	MHz	1.4	3	5	10	15	20
Allocated resource blocks		6	15	25	50	75	100
Uplink-Downlink Configuration (NOTE 5)		2	2	2	2	2	2
Special subframe configuration (NOTE 6)		7	7	7	7	7	7
Allocated subframes per Radio Frame (D+S)		3	3+2	3+2	3+2	3+2	3+2
Number of HARQ Processes	Processes	7	7	7	7	7	7
Maximum number of HARQ transmission		1	1	1	1	1	1
Modulation		QPSK	QPSK	QPSK	QPSK	QPSK	QPSK
Target coding rate		1/3	1/3	1/3	1/3	1/3	1/3
Information Bit Payload per Sub-Frame	Bits						
For Sub-Frame 3, 4, 8, 9		408	1320	2216	4392	6712	8760
For Sub-Frame 1, 6		N/A	776	1288	2664	4008	5352
For Sub-Frame 5		N/A	N/A	N/A	N/A	N/A	N/A
For Sub-Frame 0		208	1064	1800	4392	6712	8760
Transport block CRC	Bits	24	24	24	24	24	24
Number of Code Blocks per Sub-Frame (NOTE 4)							
For Sub-Frame 3, 4, 8, 9		1	1	1	1	2	2
For Sub-Frame 1, 6		N/A	1	1	1	1	1
For Sub-Frame 5		N/A	N/A	N/A	N/A	N/A	N/A
For Sub-Frame 0		1	1	1	1	2	2
Binary Channel Bits Per Sub-Frame	Bits						
For Sub-Frame 3, 4, 8, 9		1368	3780	6300	13800	20700	27600
For Sub-Frame 1, 6		N/A	2616	4456	9056	13656	18256
For Sub-Frame 5		N/A	N/A	N/A	N/A	N/A	N/A
For Sub-Frame 0		672	3084	5604	13104	20004	26904
Max. Throughput averaged over 1 frame	kbps	102.4	564	932	1965.6	3007.2	3970.4
UE Category		≥ 1	≥ 1	≥ 1	≥ 1	≥ 1	≥ 1
NOTE 1: For normal subframes(0,3,4,5,8,9), 2 symbols allocated to PDCCH for 20 MHz, 15 MHz and 10 MHz channel BW; 3 symbols allocated to PDCCH for 5 MHz and 3 MHz; 4 symbols allocated to PDCCH for 1.4 MHz. For special subframe (1&6), only 2 OFDM symbols are allocated to PDCCH for all BWs.							
NOTE 2: For 1.4MHz, no data shall be scheduled on special subframes(1&6) to avoid problems with insufficient PDCCH performance							
NOTE 3: Reference signal, Synchronization signals and PBCH allocated as per TS 36.211 [7]							
NOTE 4: If more than one Code Block is present, an additional CRC sequence of L = 24 Bits is attached to each Code Block (otherwise L = 0 Bit).							
NOTE 5: As per Table 4.2-2 in TS 36.211 [7]							
NOTE 6: As per Table 4.2-1 in TS 36.211 [7]							

## A.3.1.2 64-QAM

Table A.3.1.2-1: Fixed Reference Channel for Maximum input level for UE Categories  $\geq 3$  (TDD)

Parameter	Unit	Value					
		1.4	3	5	10	15	20
Channel bandwidth	MHz	1.4	3	5	10	15	20
Allocated resource blocks		6	15	25	50	75	100
Subcarriers per resource block		12	12	12	12	12	12
Uplink-Downlink Configuration (NOTE 5)		2	2	2	2	2	2
Special subframe configuration (NOTE 6)		7	7	7	7	7	7
Allocated subframes per Radio Frame		2	3+2	3+2	3+2	3+2	3+2
Modulation		64QAM	64QAM	64QAM	64QAM	64QAM	64QAM
Target Coding Rate		$\frac{3}{4}$	$\frac{3}{4}$	$\frac{3}{4}$	$\frac{3}{4}$	$\frac{3}{4}$	$\frac{3}{4}$
Number of HARQ Processes	Processes	7	7	7	7	7	7
Maximum number of HARQ transmissions		1	1	1	1	1	1
Information Bit Payload per Sub-Frame							
For Sub-Frames 3, 4, 8, 9	Bits	2984	8504	14112	30576	46888	61664
For Sub-Frames 1,6	Bits	N/A	5544	9528	19848	30576	40576
For Sub-Frame 5	Bits	N/A	N/A	N/A	N/A	N/A	N/A
For Sub-Frame 0	Bits	N/A	6968	12576	30576	45352	61664
Transport block CRC	Bits	24	24	24	24	24	24
Number of Code Blocks per Sub-Frame (NOTE 4)							
For Sub-Frames 3, 4, 8, 9		1	2	3	5	8	11
For Sub-Frames 1,6		N/A	2	2	4	6	8
For Sub-Frame 5		N/A	N/A	N/A	N/A	N/A	N/A
For Sub-Frame 0		N/A	2	3	5	8	11
Binary Channel Bits per Sub-Frame							
For Sub-Frames 3, 4, 8, 9	Bits	4104	11340	18900	41400	62100	82800
For Sub-Frames 1,6		N/A	7848	13368	27168	40968	54768
For Sub-Frame 5	Bits	N/A	N/A	N/A	N/A	N/A	N/A
For Sub-Frame 0	Bits	N/A	9252	16812	39312	60012	80712
Max. Throughput averaged over 1 frame	kbps	596.8	3791.2	6369.6	13910	20945	27877
NOTE 1: For normal subframes(0,3,4,5,8,9), 2 symbols allocated to PDCCH for 20 MHz, 15 MHz and 10 MHz channel BW; 3 symbols allocated to PDCCH for 5 MHz and 3 MHz; 4 symbols allocated to PDCCH for 1.4 MHz. For special subframe (1&6), only 2 OFDM symbols are allocated to PDCCH for all BWs.							
NOTE 2: For 1.4MHz, no data shall be scheduled on special subframes(1&6) to avoid problems with insufficient PDCCH performance.							
NOTE 3: Reference signal, Synchronization signals and PBCH allocated as per TS 36.211 [7].							
NOTE 4: If more than one Code Block is present, an additional CRC sequence of L = 24 Bits is attached to each Code Block (otherwise L = 0 Bit).							
NOTE 5: As per Table 4.2-2 in TS 36.211 [7].							
NOTE 6: As per Table 4.2-1 in TS 36.211 [7]							



### A.3.1.3 256-QAM

**Table A.3.1.3-1: Fixed Reference Channel for Maximum input level for UE Categories 11/12 and UE DL categories  $\geq 11$  (TDD)**

Parameter	Unit	Value					
		1.4	3	5	10	15	20
Channel bandwidth	MHz	1.4	3	5	10	15	20
Allocated resource blocks		6	15	25	50	75	100
Subcarriers per resource block		12	12	12	12	12	12
Uplink-Downlink Configuration (NOTE 5)		2	2	2	2	2	2
Special subframe configuration (NOTE 6)		7	7	7	7	7	7
Allocated subframes per Radio Frame		2	3+2	3+2	3+2	3+2	3+2
Modulation		256QAM	256QAM	256QAM	256QAM	256QAM	256QAM
Target Coding Rate		4/5	4/5	4/5	4/5	4/5	4/5
Number of HARQ Processes	Processes	7	7	7	7	7	7
Maximum number of HARQ transmissions		1	1	1	1	1	1
Information Bit Payload per Sub-Frame							
For Sub-Frames 3,4,8,9	Bits	4392	12216	19848	42368	63776	84760
For Sub-Frames 1,6	Bits	N/A	10464	17824	36224	54624	73024
For Sub-Frame 5	Bits	N/A	N/A	N/A	N/A	N/A	N/A
For Sub-Frame 0	Bits	N/A	9912	17568	42368	63776	84760
Transport block CRC	Bits	24	24	24	24	24	24
Number of Code Blocks per Sub-Frame (NOTE 4)							
For Sub-Frames 3,4,8,9		1	2	4	7	11	14
For Sub-Frames 1,6		N/A	2	3	6	9	13
For Sub-Frame 5		N/A	N/A	N/A	N/A	N/A	N/A
For Sub-Frame 0		N/A	2	3	7	11	14
Binary Channel Bits per Sub-Frame							
For Sub-Frames 3,4,8,9	Bits	5472	15120	25200	55200	82800	110400
For Sub-Frames 1,6		N/A	8248	13536	27376	40576	55056
For Sub-Frame 5	Bits	N/A	N/A	N/A	N/A	N/A	N/A
For Sub-Frame 0	Bits	N/A	12336	22416	52416	80016	107616
Max. Throughput averaged over 1 frame	kbps	878.4	5570.4	9240	20049.6	30144	40503.2
NOTE 1: For normal subframes(0,3,4,5,8,9), 2 symbols allocated to PDCCH for 20 MHz, 15 MHz and 10 MHz channel BW; 3 symbols allocated to PDCCH for 5 MHz and 3 MHz; 4 symbols allocated to PDCCH for 1.4 MHz. For special subframe (1&6), only 2 OFDM symbols are allocated to PDCCH for all BWs.							
NOTE 2: For 1.4MHz, no data shall be scheduled on special subframes(1&6) to avoid problems with insufficient PDCCH performance.							
NOTE 3: Reference signal, Synchronization signals and PBCH allocated as per TS 36.211 [7].							
NOTE 4: If more than one Code Block is present, an additional CRC sequence of L = 24 Bits is attached to each Code Block (otherwise L = 0 Bit).							
NOTE 5: As per Table 4.2-2 in TS 36.211 [7].							
NOTE 6: As per Table 4.2-1 in TS 36.211 [7].							

---

Annex B: Void

---

Annex C: Void

---

Annex D: Void

---

## Annex E: Void

---

## Annex F: Void

---

## Annex G: Void

---

## Annex H (normative): Modified MPR behavior

The definitions of the bits in the modifiedMPRbehavior field have been moved to Annex H of 38.101-1[2].

---

## Annex I (normative): Dual uplink interferer

UE is mandated to support operation in dual and triple uplink mode for EN-DC configuration in NR FR1 listed in Table 5.5B.2-1, Table 5.5B.3-1, and Table 5.5B.4.1-1 and indicated by column single uplink allowed, Table 7.3B.2.3.5.1-1, Table 7.3B.2.3.5.2-0, Table 7.3B.2.3.5.2-1 or NE-DC configuration in NR FR1 listed in Table 5.5B.4a.1-1 and indicated by column single uplink allowed if the intermodulation products caused by the dual uplink operation do not interfere with its own primary downlink transmission channel bandwidth of PCell or PSCell. For intermodulation products falling into any secondary downlink channel bandwidth, UE single UL capability is not considered.

Formula for determining if the EN-DC in NR FR1 configuration with dual uplink operation interferes with its own downlink reception.

Interference bandwidth:  $IBW = |a| * CBW1 + |b| * CBW2$

- $|a| + |b| = 2$  (or 3)
- CBW1 and CBW2 are the transmission bandwidth configurations of the UL channels

Center frequency of IBW:  $f_{IBW} = |a * f1 + b * f2|$

- f1 and f2 are center frequency of the transmission bandwidth configurations of each UL channel

The range of IMD 2 (or 3):  $[f_{IBW} - IBW/2, f_{IBW} + IBW/2]$

NOTE 1: UE shall be able to apply operations which are configured by RRC reconfiguration and corresponding HARQ timing on the transmission bandwidth.

NOTE 2: For identified difficult band combination, during two adjacent RRC reconfiguration, the changing of transmission bandwidth should not introduce IM2 and IM3, which will result in UE changing from 2Tx to 1Tx. Otherwise, UE behavior is not specified.

For DC\_3A\_n3A intra-band non-contiguous EN-DC combination, only single switched UL is supported in Rel-15.

For DC\_2A\_n2A, DC\_5A\_n5A, DC\_7A\_n7A, DC\_48A\_n48A, DC\_66A\_n66A intra-band non-contiguous EN-DC combination, and DC\_(n)5AA, DC\_(n)12AA, DC\_(n)38AA, DC\_(n)48AA intra-band contiguous EN-DC combination, only single switched UL is supported.

---

## Annex J: Void

## Annex K: Void

## Annex L (informative): Change history

Change history							
Date	Meeting	TDoc	CR	Rev	Cat	Subject/Comment	New version
2017-08	RAN4#84					Initial Skeleton	0.0.1
2017-11	RAN4#84 Bis	R4-1711980				Number TPs from editors	0.1.0
2017-12	RAN4#85	R4-1713807				Approved TPs in RAN4#85 R4-1714444, CA BW classes, TP, Ericsson R4-1714170, How to list DC configurations into TS 38.101-3, Nokia R4-1714530, TP on introducing operating bands for NR-LTE DC including SUL band combinations in 38.101-3, Qualcomm R4-1714098, TP to TS 38.101-3: UE RF requirements for non-standalone SUL, Huawei R4-1713206, TP on general parts for 38.101-3 NR interwork, Ericsson R4-1714443, TP to TS 38.101-3: On dual uplink operation for EN-DC in NR FR1 and single uplink, Nokia R4-1714450, TP to 38.101-3: maximum output power and unwanted emissions for EN-DC, Ericsson R4-1714346, TP to 38.101-3: REFSSENS for intra-band EN-DC, Ericsson R4-1714345, TP for TS 36.101-3: clause 7 receiver requirements, Huawei  Band list according to R4-1714542, List of bands and band combinations to be introduced into RAN4 NR core requirements by December 2017, RAN4 Chairmen	0.2.0
2017-12	RAN4#85	R4-1714571				Further corrections after email review	0.3.0
2017-12	RAN#78	RP-172477				v1.0.0 submitted for plenary approval. Contents same as 0.3.0	1.0.0
2017-12	RAN#78					Approved by plenary – Rel-15 spec under change control	15.0.0
2018-03	RAN#79	RP-180264	0005		F	Implementation of endorsed CRs to 38.101-3 Endorsed draft CR F: R4-1801267, Draft CR on UE RF requirements for SUL in TS 38.101-3, Huawei B: R4-1801111, Draft CR for completed LTE 1CC + NR 1band for TS 38.101-3, NTT DOCOMO, INC. B: R4-1800716, Draft CR for introduction of completed band combinations from 37.863-03-01 into 38.101-3, Ericsson B: R4-1800063, Draft CR for completed EN-DC of LTE 4CC + NR 1band for TS 38.101-3, Nokia B: R4-1800717, Draft CR for introduction of completed band combinations from 37.865-01-01 into 38.101-3, Ericsson F: R4-1800049, Modification for TS38.101-3, CATT F: R4-1800287, 38.101-3 DC_(n)71B draft CR for clause 6.2.4.1 - A-MPR for intra-band EN-DC - NS value, T-Mobile USA Inc. F: R4-1800288, 38.101-3 DC_(n)71B draft CR for clause 7.3.3 Reference sensitivity for DC_(n)71B - MSD values, T-Mobile USA Inc. F: R4-1801139 Draft CR to 38.101-3: MSD for inter-band EN-DC, Ericsson	15.1.0
2018-06	RAN#80	RP-181374	0013	1	F	CR to TS 38.101-3: Implementation of endorsed draft CRs from RAN4 #87 <b>Missing figures (Figure 6.3B.1.1-1, Figure 6.3B.1.1-2, Figure 6.3B.1.1-3 and Figure 6.3B.1.1-4) from the endorsed draftCR (R4-1807235) were added during the CR implementation.</b>	15.2.0
2018-09	RAN#81	RP-182129	0020	2	F	Big CR for 38.101-3  Draft CRs from RAN4#88: R4-1809960 Draft CR to TS 38.101-3: to introduce new NR inter-band DC band combinations Samsung,KDDI,SKT,KT,LGU+ R4-1809991 CR to 38.101-3:Corrections on UE coexistence table for Table 6.5B.3.3.1-1 MediaTek Inc. R4-1810054 Pcmx for Rel-15 inter-band EN-DC for FR1 and NR in FR2 InterDigital, Inc. R4-1810111 Single UL allowed corrections for DC_28A-n51A EN-DC in 38.101-3 Skyworks Solutions Inc.	15.3.0

					<p>R4-1810125 Draft CR to 38.101-3 Single UL allowed corrections for DC_28A_51A EN-DC Skyworks Solutions Inc.</p> <p>R4-1810128 Draft CR to 38.101-3 Single UL allowed corrections for EN-DC operation in NR FR1 (two bands) Skyworks Solutions Inc.</p> <p>R4-1810167 TP for TR 37.863-01-01: MSD for DC_5A_n78A due to the 4th harmonic MediaTek Inc.</p> <p>R4-1810410 Draft CR to 38.101-3: Corrections on symbols and abbreviations in clause 3 ZTE Corporation</p> <p>R4-1810417 Correction to DC_(n)71B MSD definition Nokia</p> <p>R4-1810433 Correction on EN-DC 8A_n79A SoftBank Corp.,ZTE</p> <p>R4-1810476 Draft CR to TS 38.101-3 correction for DC_3_n3-n77, DC_3_n3-n78 CHTTL</p> <p>R4-1810976 Annex lettering change for 38.101-3 Qualcomm Incorporated</p> <p>R4-1811461 Clarification and corrections of EN-DC REFSENS exceptions requirement Nokia, Nokia Shanghai Bell</p> <p>R4-1811462 Correction to DC_(n)71B scs restriction for NR Nokia</p> <p>R4-1811466 EN DC_41-79 CATT</p> <p>R4-1811467 Draft CR TS 38.101-3 Corrections to Single UL Allowed Criteria for Mid-Band EN-DC in FR1 Skyworks Solutions Inc.</p> <p>R4-1811484 Pcmx for inter-band EN-DC FR1 draft CR InterDigital, Inc.</p> <p>R4-1811525 Draft CR TS 38.101-3 on missing requirements for FR1 EN-DC Skyworks Solutions, Inc.</p> <p>R4-1811542 Draft CR to 38.101-3 on correction on some errors Huawei, HiSilicon</p> <p>R4-1811796 Draft CR to 38.101-3 Corrections to Single UL allowed criteria for EN-DC Skyworks Solutions Inc.</p> <p>R4-1811800 DRAFT CR for PCmax FR2 correction Qualcomm Incorporated</p> <p>R4-1811810 Draft CR TS 38.101-3: Corrections for B41/n41 SPRINT Corporation</p>	
2018-12	RAN#82	RP-182359	0030	F	<p>Endorced draft CRs from RAN4#88Bis :</p> <p>R4-1812057, Introduction of Intra-band contiguous EN-DC bandwidth classes, Nokia</p> <p>R4-1812290 Draft CR on MSD for EN-DC including Band 66 and n78 Huawei, HiSilicon</p> <p>R4-1812293 Draft CR on switching time mask for EN-DC Huawei, HiSilicon</p> <p>R4-1812298 Draft CR to TS 38.101-3: to add missing requirements for inter-band CA between FR1 and FR2. Samsung</p> <p>R4-1812360 Draft CR to 38.101-3: Correction to UL configuration for EN-DC reference sensitivity exceptions Skyworks Solutions Inc.</p> <p>R4-1812361 Draft CR to 38.101-3: NR uplink DFT-S-OFDM waveforms for EN-DC reference sensitivity Skyworks Solutions Inc.</p> <p>R4-1812362 Draft CR to 38.101-3: Editorial and RB allocation corrections to table 7.3B.2.3.4-2 Skyworks Solutions Inc.</p> <p>R4-1812363 Draft CR to 38.101-3: Single UL allowed operation corrections in clause 7.3B.2.3.5 Skyworks Solutions Inc.</p> <p>R4-1812404 Non-contiguous intra-band EN-DC emission requirements Qualcomm Incorporated</p> <p>R4-1812410 Correction on REFSENS exception for EN-DC 41A-n77A/n78A SoftBank Corp.</p> <p>R4-1812670 Correction on REFSENS exceptions of DC_5A-7A_n78A to TS 38.101-3 LG Uplus</p> <p>R4-1813471 draft CR on applicability of TDD configuratiin for CA in TS 38.101-3 Huawei</p> <p>R4-1813796 Draft CR for 38.101-3: Intra-band Pcmx for Type 2 UEs Sprint Corporation</p> <p>R4-1813816 Renaming of DC_(n)71B into DC_(n)71AA Nokia</p> <p>R4-1813817 Correction to EN-DC operating bands and configurations Nokia</p> <p>R4-1813818 Draft CR on correction REFSENS exceptions due to dual uplink operation for inter-band EN-DC to TS 38.101-3 Samsung</p> <p>R4-1813822 Draft CR for 38.101-3: Single UL allowed criteria in Annex I Vodafone España SA</p> <p>R4-1814157 Draft CR for UE-to-UE coexistence requirements for intra-band EN-DC in TS38.101-3 LG Electronics France</p>	15.4.0

						<p>R4-1814167 Draft CR on Single UL for some EN-DC combinations Huawei</p> <p>Endorsed draft CRs from Ran4#89:  R4-1815952 dCR on TS38.101-3 merging draft CRs from RAN4#(88Bis) Qualcomm Incorporated  R4-1814803 Draft CR on editorial error for EN-DC band combinations to TS 38.101-3 Huawei, HiSilicon  R4-1815802 draft CR editorial correction in 38.101-3 Ericsson  R4-1814425 Simplification of requirements for EN-DC configuration including FR2 NTT DOCOMO, INC.  R4-1814512 Draft CR to TS38.101-3_Corrections on MSD requirements for EN-DC combinations of band 8 and n77 n78(Clause 7.3B.2.3.1) ZTE Corporation  R4-1814938 Draft CR to 38.101-3 on operating bands for CA and DC ZTE Corporation Zhifeng Ma  R4-1814976 Correction for Maximum output power for inter-band EN-DC (two bands) Nokia, Nokia Shanghai Bell  R4-1814977 Correction for ?TIB,c for EN-DC Nokia, Nokia Shanghai Bell  R4-1814978 MPR and A-MPR for interband EN-DC Nokia, Nokia Shanghai Bell  R4-1814980 Correction for intra-band EN-DC bandwidth class Nokia, Nokia Shanghai Bell  R4-1815065 draft CR for adding missing transmit signal quality for inter band EN-DC for TS 38.101-3 NTT DOCOMO, INC.  R4-1815811 draft Rel-15 CR to 38.101-3 to correct n260 BW class Ericsson, AT&amp;T  R4-1815865 Draft CR for 38.101-3 Intra-band EN-DC nominal carrier spacing for 30 kHz raster SPRINT Corporation  R4-1815973 Draft CR to 38.101-3 rel. 15 to fix MSD issues for higher order EN-DC combinations  R4-1816227 Draft CR on Power Class for inter band EN-DC within FR1 OPPO  R4-1816233 Receiver requirements for intra-band EN-DC Qualcomm Incorporated  R4-1816621 Introduction of maxUplinkDutyCycle to ENDC HPUE in FR1 OPPO  R4-1816638 Pcmx computation and evaluation for inter band ENDC Qualcomm  R4-1816178 Draft CR for correction for missing agreed DC combinations in Rel-15 for TS 38.101-3 NTT DOCOMO, INC.  R4-1816197 Draft CR to TS38.101-3_Clarifications on MSD and UL configuration tables for EN-DC ZTE Corporation  R4-1816198 Simplification of EN-DC and CA between FR1 and FR2 UE to UE co-ex table by adopting CA band approach Nokia, Nokia Shanghai Bell  R4-1816202 Correction to interband EN-DC OOB emission requirements Nokia, Nokia Shanghai Bell  R4-1816203 Receiver requirements for interband EN-DC Nokia, Nokia Shanghai Bell  R4-1816207 Draft CR to 38.101-3 rel. 15 to fix MPR issue Apple GmbH  R4-1816224 Draft CR for 38.101-3 NS_04 applicability for intra-band EN-DC SPRINT Corporation  R4-1816231 Draft CR on output power dynamic for DC OPPO  R4-1816237 Correction for Intra-band contiguous EN-DC A-MPR definition Nokia, Nokia Shanghai Bell  R4-1816246 Draft CR to TS38.101-3: Corrections on TS for MSD calculations based on ENDC bands combination including of bands 1,3,8, n77, and n78 MediaTek Inc.  R4-1816247 Draft CR 38-101-3 Corrections for EN-DC Single Uplink allowed Operation Skyworks Solutions Inc.  R4-1816250 draft CR for adding note about the fallback of EN-DC in Applicability of minimum requirements for TS 38.101-3 NTT DOCOMO, INC.  R4-1816608 Draft CR on LTE RMC for TDD EN-DC UE RF Tests Qualcomm Incorporated  R4-1816613 Draft CR for reducing AMPR for DC_(n)71AA without Dynamic Power Sharing" Motorola Mobility, T-Mobile"</p>	
2018-12	RAN#82	RP-182773	0033	1	F	Completion of configured maximum output power for intra-band contiguous EN-DC	15.4.0
2018-12	RAN#82	RP-182774	0034	1	F	Configured maximum output power for intra-band non-contiguous EN-DC	15.4.0

2019-03	RAN#83	RP-190403	0035	F	<p>CR to TS 38.101-3: Implementation of endorsed draft CRs from RAN4#90</p> <p>Endorced draft CRs from RAN4#90  R4-1900034, Editorial corrections for 38.101-3, Qualcomm Incorporated  R4-1900460, Draft CR to TS38.101-3_corrections on MSD, ZTE Corporation  R4-1900461, Draft CR to TS38.101-3_inter-band NR DC between FR1 and FR2, ZTE Corporation  R4-1900524, Draft CR to TS 38.101-3 on inter-band CA &amp; inter-band EN-DC configurations, ZTE Corporation  R4-1900529, Draft CR to TS 38.101-3 on Single Uplink Allowed for EN-DC combinations of order 3 or higher, ZTE Corporation  R4-1900726, Editorial corrections to delta Tib for EN-DC, Rohde &amp; Schwarz  R4-1901359, draft CR for correction for missing operating band for EN-DC, NTT DOCOMO INC.  R4-1901428, draft CR to make editorial corrections in 38-101-3 Rel-15, Ericsson  R4-1901848, Draft CR for 38.101-3: Addition of default power class, Sprint Corporation  R4-1901850, Draft CR for 38.101-3: Intra-band P<sub>cmx</sub> P<sub>EN-DC</sub>_Total for non-DPS UEs, Sprint Corporation  R4-1901851, Draft CR for 38.101-3: Intra-band P<sub>cmx</sub> Editorial corrections, Sprint Corporation  R4-1901874, Guardband for harmonic exception to reference sensitivity, Qualcomm Incorporated  R4-1901878, Non-simultaneous Tx/Rx for TDD intra-band EN-DC, Qualcomm Incorporated  R4-1901890, A-MPR for DC<sub>(n)</sub>71AA without Dynamic Power Sharing, Motorola Mobility France S.A.S  R4-1901926, Draft CR to 38.101-3 to clarify ACS2 wanted level, Qualcomm Incorporated  R4-1901997, draft_CR TS 38.101-3 type 2 UE DC<sub>(n)</sub>41 and DC_41_n41 NS04 AMPR correction, Skyworks Solutions Inc.  R4-1902002, Draft CR to 38.101-3 on DC<sub>n</sub>41-41 – B40 coexistence, Qualcomm Incorporated  R4-1902154, Draft CR to TS38.101-3_clean up on inter-band CA between FR1 and FR2, ZTE Corporation  R4-1902155, Draft CR for TS 38.101-3: Corrections to Table 7.3B.2.3.5.1-1 for reference sensitivity exceptions (two bands), MediaTek Inc.  R4-1902156, draftCR corrections for TS 38.101-3, Huawei  R4-1902157, CR on intraband ENDC channel configurations, Intel Corporation  R4-1902160, Draft CR on some errors to TS 38.101-3, Huawei  R4-1902161, CR to 38.101-3 to clarify non-simultaneous RXTX capability for co-bands, Qualcomm Incorporated  R4-1902163, Draft CR to 38.101-3 to clarify DL carrier levels for bands in close frequency proximity, Qualcomm Incorporated  R4-1902164, Draft CR to reflect agreed MSD analysis of DC_25A-n41A for TS 38.101-3, MediaTek Inc.  R4-1902169, draft CR for inter-band EN-DC P<sub>cmx</sub>, Huawei  R4-1902172, Draft CR ACLR for NC intra-band EN-DC, Skyworks Solutions Inc.  R4-1902176, Draft CR for 38.101-3 modification of requirements for intra-band non-contiguous EN-DC SEM, Huawei  R4-1902179, draft CR for introduction of Tx IM for Inter-band EN-DC in TS38.101-3, NTT DOCOMO, INC.  R4-1902182, Clarification for OOB boundary for intra-band contiguous and non-contiguous EN-DC, vivo  R4-1902195, draft_CR TS 38.101-3 Footnote correction in Table 7.3B.2.3.1-2, Skyworks Solutions Inc.  R4-1902232, Draft CR on SUL band combinations to TS 38.101-3, Huawei  R4-1902478, Addition of power class 2 EN-DC ACLR requirement, Nokia  R4-1902481, draftCR on inter-band EN-DC Rx requirement for TS 38.101-3, Huawei  R4-1902486, Draft CR for 38.101-3 modification of requirements for network signalled value NS_04, Huawei  R4-1902496, Draft CR for TS 38.101-3: Switching time for intra-band EN-DC upon dual PA UE capability, Huawei  R4-1902500, Draft CR for 38.101-3: adding MPR for intra-band ENDC, Skyworks Solutions Inc  R4-1902660, Introduction of modified MPR for 38.101-3, Nokia</p>	15.5.0
---------	--------	-----------	------	---	--	--------

					Editorial changes after RAN#83 To align the annex numbering with other specifications (TS 38.101-x series), 'Modified MPR behavior' was moved to annex H.	
2019-06	RAN#84	RP-191240	0041	F	<p>CR to TS 38.101-3: Implementation of endorsed draft CRs from RAN4#90bis and RAN4#91</p> <p>Endorced draft CRs from RAN4#90Bis  R4-1902829, Draft CR for 38.101-3 editorial correction for editorial correction for intra-band contiguous EN-DC uplink configuration when Rx requirements are measured, Huawei  R4-1903074 Draft CR to 38.101-3 rel. 15 to fix missing SUO note Apple Inc.  R4-1903090 Pcmx for Rel-15 intra-band EN-DC within FR1 wrong references - fixes InterDigital Communications  R4-1903150 Draft CR to TS 38.101-3_Spurious emission and Tx IM for inter-band CA between FR1 and FR2 ZTE Corporation  R4-1903302 Draft CR to TS 38.101-3 correction for the DC_3_n3 delta R IBNC table CHTTL  R4-1903426 draft CR for 38.101-3: Reflect the agreed MSD for DC_5_n78 China Telecom  R4-1903515 Removal of reference sensitivity exception due to close proximity of bands for EN-DC in NR FR1 clause Nokia  R4-1903958 Completion of defintions of EN-DC configured power Ericsson  R4-1904639 Draft CR to 38.101-3 on DC_n41-41 – B40 coexistence, Qualcomm Incorporated  R4-1904934 Harmonization of reference sensitivity level for DC clause Nokia  R4-1904935 Change description 4.2(e) in Applicability of minimum requirements for TS 38.101-3 vivo  R4-1904945 Draft CR to TS38.101-3_adding some exclusion frequencies for SEM and spurious emission for EN-DC ZTE Corporation  R4-1904946 Draft CR to TS 38.101-3 on some minor corrections ZTE Corporation  R4-1904951 Draft CR for 38.101-3 intra-band EN-DC AMPR Huawei  R4-1904953 Draft CR for 38.101-3: NS_04 A-MPR power class relationship clarification Sprint Corporation  R4-1904959 Draft CR on UE to UE coexistence for TS 38.101-3 Huawei  R4-1904988 Draft CR to 38.101-1. Clarify EN-DC category for requirements of carrier imbalance Qualcomm Incorporated  R4-1904995 draft CR to 38.101-3 Configured output power for inter-band EN-DC including both FR1 and FR2 Intel Corporation  R4-1905085 Draft CR for TR 38.101-3 NE-DC RF requirement Huawei  R4-1904925 Draft CR for improving EN-DC configuration tables in TS38.101-3 CATT</p> <p>Endorced draft CRs from RAN4#91  R4-1905628 Draft CR to TS38.101-3_Frequency error for intra-band for EN-DC ZTE Corporation  R4-1905629 Draft CR to TS 38.101-3_removal of the reference sensitivity exception for NR CA between FR1 and FR2 ZTE Corporation  R4-1905767 draft CR to 38.101-3 Correction of DeltaTIB,c in configured output power for EN-DC Intel Corporation  R4-1905774 Draft CR to TS38.101-3 Correction to intra-band and inter-band EN-DC Pcmx Intel Corporation  R4-1905793 CR for TS 38.101-3 (Rel-15): Support of n257D-F for DC_1-42_n257 and DC_3-42_n257 SoftBank Corp.  R4-1905799 Correction of LTE anchor condition to Spurious response for EN-DC Anritsu Corporation  R4-1907057 Draft CR for 38.101-3: Further UE coexistence table clean-up Sprint Corporation  R4-1907063 Draft CR for 38.101-3: Global replacement of LTE with E-UTRA Sprint Corporation  R4-1907136 Draft CR to 38.101-3 rel. 15 to fix missing Exceptions for Out-of-band Blocking Apple  R4-1907137 Draft CR to 38.101-3 rel. 15 to fix missing SUO note Apple  R4-1907181 Draft CR for 38.101-3: Removal of unnecessary ACLR notes Sprint Corporation  R4-1907422 Draft CR for TS 38.101-1 Correction of channel bandwidth set for NR CA Huawei</p>	15.6.0



						R4-1907424 Draft CR for clarification of note for B42_n77 and B42_n78 NTT DOCOMO, INC. R4-1907425 DraftCR TS 38.101-3 Corrections to Intra-band ENDC MPR text Skyworks Solutions Inc. R4-1907426 Definition of BCS support in inter-band EN-DC mode Qualcomm Incorporated R4-1907448 Correction to EN-DC spurious emissions ROHDE & SCHWARZ R4-1907476 draft CR for TS 38.101-3 intra-band EN-DC P <sub>cm</sub> ax Huawei R4-1907482 Correction of RefSens exceptions due to UL harmonic interference for EN-DC in 38.101-3 vivo R4-1907483 [Rx]Draft CR for 38.101-3 defining Reference sensitivity for intra-band non-contiguous, Huawei R4-1907485 Corrections to MPR/A-MPR and additional requirements for intra-band EN-DC Ericsson R4-1907489 Draft CR to 38.101-3. Revise MSD for DC_20A-n8A Qualcomm Incorporated R4-1907492 Modification of reference sensitivity and general spurious emissions in 38.101-3 Qualcomm Incorporated R4-1907594 draft CR of modification on reference for inter-band EN-DC including FR2 for TS 38.101-3 NTT DOCOMO INC. R4-1907808 Draft CR to 38.101-3 NE-DC introduction InterDigital Communications	
2019-06	RAN#84	RP-191241	0036		B	CR to REL-16 TS 38.101-3: Implementation of endorsed draft CRs on NR combinations and dual Connectivity combinations	16.0.0
2019-06	RAN#84	RP-191241	0037		B	CR on introduction of completed EN-DC of 2 bands LTE and 1 band NR from RAN4#91 into TS 38.101-3	16.0.0
2019-06	RAN#84	RP-191241	0039		B	Introducing CR on new EN-DC LTE(xDL/1UL)+ NR(2DL/1UL) DC in rel-16	16.0.0
2019-06	RAN#84	RP-191252	0040	1	B	Introduction of band combinations and requirements for Band n87 (LTE/NR sharing)	16.0.0
2019-06	RAN#84	RP-191241	0042	1	B	Big CR for agreed DC band combo of 1 LTE band + 1 NR band	16.0.0
2019-06	RAN#84	RP-191241	0043		B	CR introduction completed band combinations 37.716-31-11 -> 38.101-3	16.0.0
2019-06	RAN#84	RP-191241	0044		B	CR to reflect the completed NR inter band CA DC combinations for 2 bands DL with up to 2 bands UL into Rel16 TS 38.101-3	16.0.0
2019-09	RAN#85	RP-192049	0064		A	CR to TS 38.101-3: Implementation of endorsed draft CRs from RAN4#92 (Rel-16) - Mirror changes from R4-1910354 from RAN4#92	16.1.0
2019-09	RAN#85	RP-192028	0045	2	B	CR to correct 7.3B.2.3.2 and 7.3B.2.3.4 for EN-DC DC_7_n77 and DC_7_n78	16.1.0
2019-09	RAN#85	RP-192028	0046	2	F	Correction on EN-DC grouping in Rel-16 spec	16.1.0
2019-09	RAN#85	RP-192028	0047	1	F	CR to TS 38.101-3 correction for the UL RB allocations of the MSD table	16.1.0
2019-09	RAN#85	RP-192027	0049	1	F	[SUL] CR on SUL band combinations into Rel-16 TS 38.101-3	16.1.0
2019-09	RAN#85	RP-192028	0051		B	CR on introduction of completed EN-DC of 2 bands LTE and 1 band NR from RAN4#92 into TS 38.101-3	16.1.0
2019-09	RAN#85	RP-192033	0053		C	CR for 38.101-3: B41 n41 EN-DC allocation based A-MPR	16.1.0
2019-09	RAN#85	RP-192028	0054	1	F	CR 38.101-3 Rel 16 Addition of footnote 3 to DC_40A_n41A	16.1.0
2019-09	RAN#85	RP-192028	0056	1	F	CR for 38.101-3: Correction of n5 combinations protection for B26	16.1.0
2019-09	RAN#85	RP-192027	0057		B	CR on introducing NR intra-band CA for 3DL Bands and 1UL band for 38.101-3	16.1.0
2019-09	RAN#85	RP-192027	0058		B	CR to reflect the completed NR inter band CA DC combinations for 2 bands DL with up to 2 bands UL into Rel16 TS 38.101-3	16.1.0
2019-09	RAN#85	RP-192028	0059		F	Big CR for EN-DC of LTE 1band + NR 1band	16.1.0
2019-09	RAN#85	RP-192028	0060		B	CR introduction completed band combinations 37.716-31-11 -> 38.101-3	16.1.0
2019-09	RAN#85	RP-192028	0061		B	CR to introduce new combinations of LTE 4band + NR 1band for TS 38.101-3	16.1.0
2019-09	RAN#85	RP-192035	0062		F	CR for 38.101-3 P <sub>cm</sub> ax for EN-DC with 3CC uplink	16.1.0
2019-09	RAN#85	RP-192027	0065		B	CR to reflect the completed NR inter band CA DC combinations for 3 bands DL with 2 bands UL into Rel16 TS 38.101-3	16.1.0
2019-09	RAN#85	RP-192028	0066		B	CR on introduction of completed EN-DC of x bands LTE and 2 band NR from RAN4#92 into TS 38.101-3	16.1.0
2019-12	RAN#86	RP-193032	0075		A	CR for 38.101-3 EN-DC RX Out-of-Band Blocking for shared bands and bands in close proximity	16.2.0
2019-12	RAN#86	RP-193032	0077		A	CR to 38.101-3 Missing Harmonic Mixing MSD for DC_3_n77/n78	16.2.0
2019-12	RAN#86	RP-193032	0079		A	CR for 38.101-3 EN-DC DL Synchronous Carriers	16.2.0
2019-12	RAN#86	RP-193032	0085		A	CR for 38.101-3: Correction to DC Config and dual UL interferer (Rel-16)	16.2.0
2019-12	RAN#86	RP-193032	0087		A	CR for 38.101-3: Correction to EN-DC and NE-DC Configurations (Rel-16)	16.2.0
2019-12	RAN#86	RP-193032	0090		A	CR to TS38.101-3: Correction on channel spacing for intra-band EN-DC carriers (section 5.4B.1)	16.2.0

2019-12	RAN#86	RP-193012	0091		B	CR to reflect the completed NR inter band CA DC combinations for 2 bands DL with up to 2 bands UL into Rel16 TS 38.101-3	16.2.0
2019-12	RAN#86	RP-193012	0092		B	CR to reflect the completed NR inter band CA DC combinations for 3 bands DL with 2 bands UL into Rel16 TS 38.101-3	16.2.0
2019-12	RAN#86	RP-193012	0093	1	B	CR to reflect the completed ENDC combinations for 3 bands DL with 3 bands UL into Rel16 TS 38.101-3	16.2.0
2019-12	RAN#86	RP-193021	0094		F	CR to remove square brackets for n90 in TS38.101-3	16.2.0
2019-12	RAN#86	RP-193019	0095	1	B	CR for adding solution for addressing SAR issue for EN-DC PC2 UE	16.2.0
2019-12	RAN#86	RP-193012	0097		B	Introducing NR inter-band CA for 3DL Bands and 1UL band for 38.101-3	16.2.0
2019-12	RAN#86	RP-193012	0099		F	CR to TS 38.101-3 on single UL allowed for inter-band CA configurations (Rel-16)	16.2.0
2019-12	RAN#86	RP-193012	0102		B	CR on introduction of completed EN-DC of 1 band LTE and 1 band NR	16.2.0
2019-12	RAN#86	RP-193032	0106		A	CR for TS 38.101-3: Removing MSD requirements for EN-DC combinations due to receiver even order harmonic mixing with UL 3rd harmonic	16.2.0
2019-12	RAN#86	RP-193032	0107		A	CR to TS 38.101-3: clarification for MPR statement	16.2.0
2019-12	RAN#86	RP-193032	0108		A	CR to TS 38.101-3 on inter-band CA, EN-DC, NE-DC and NR-DC configurations (Rel-16)	16.2.0
2019-12	RAN#86	RP-193012	0109		F	CR for TS 38.101-3: Removing MSD requirements for EN-DC combinations due to receiver even order harmonic mixing with UL 3rd harmonic	16.2.0
2019-12	RAN#86	RP-193033	0111		A	CR to TS 38.101-3: adding missing 90MHz channel BW support for n77, n78 related CA	16.2.0
2019-12	RAN#86	RP-193012	0112		B	Introducing CR on new EN-DC LTE(xDL/1UL)+ NR(2DL/1UL) DC in rel-16	16.2.0
2019-12	RAN#86	RP-193033	0114		F	Removal of brackets from MPR and MSD 38.101-3 REL16	16.2.0
2019-12	RAN#86	RP-193033	0120		A	Pcmax for EN-DC: applicability of NS values and removal of a duty-cycle capability	16.2.0
2019-12	RAN#86	RP-193012	0123	1	B	CR for TS 38.101-3: MSD due to cross band isolation	16.2.0
2019-12	RAN#86	RP-193033	0125		A	CR for TS 38.101-3: Additional out-of-band blocking exceptions for inter-band EN-DC	16.2.0
2019-12	RAN#86	RP-193012	0126		B	CR for 38.101-3 introduce SUL band combination DC_66A_n78(2A)_SUL_n78A-n86A	16.2.0
2019-12	RAN#86	RP-193033	0128		A	CR for 38.101-3: correct MSD exception for DC_2_n78(Rel-16)	16.2.0
2019-12	RAN#86	RP-193012	0129		B	CR to introduce new combinations of LTE 4band + NR 1band for TS 38.101-3	16.2.0
2019-12	RAN#86	RP-193012	0130		B	CR on introduction of completed EN-DC of 2 bands LTE and 1 band NR from RAN4#92bis and RAN4#93 into TS 38.101-3	16.2.0
2019-12	RAN#86	RP-193012	0131		B	CR introduction completed band combinations 37.716-31-11 -> 38.101-3	16.2.0
2019-12	RAN#86	RP-193012	0132		B	CR introduction completed band combinations 38.716-04-01 -> 38.101-3	16.2.0
2019-12	RAN#86	RP-193012	0133	1	F	CR to 38.101-3 to remove duplicate combinations	16.2.0
2019-12	RAN#86	RP-193012	0134		F	CR to 38.101-3 to add missing ?TIB and ?RIB values for DC_12-30_n66	16.2.0
2019-12	RAN#86	RP-193033	0136		A	Mirror CR for 38.101-3: Clarification of the notation for intra-band EN-DC combinations	16.2.0
2019-12	RAN#86	RP-193008	0140	2	B	CR to 38.101-3 on uplink power control for non synchronous NR-DC between FR1 and FR2	16.2.0
2019-12	RAN#86	RP-193032	0148		A	CR to TS 38.101-3 on inter-band EN-DC configurations including FR2 for five bands (Rel-16)	16.2.0
2019-12	RAN#86	RP-193033	0152	1	A	CR for 38.101-3 correction for intra-band EN-DC Pcmax	16.2.0
2019-12	RAN#86	RP-193033	0153	1	A	CR for 38.101-3 intra-band EN-DC MPR/AMPR	16.2.0
2019-12	RAN#86	RP-193032	0154		F	EN-DC grouping correction for FR1 only configurations REL-16	16.2.0
2019-12	RAN#86					Change history corrected	16.2.1
2020-03	RAN#87	RP-200388	0159	1	F	CR on SAR solution for TDD&TDD EN-DC PC2 UE	16.3.0
2020-03	RAN#87	RP-200396	0164		A	Mirror CR for 38.101-3: Correction of MOP tolerance for B41/n41 EN-DC	16.3.0
2020-03	RAN#87	RP-200380	0165	1	F	CR for 38.101-3: Remove delta Tib and delta Rib for FR1+FR2 CA	16.3.0
2020-03	RAN#87	RP-200380	0166		F	CR for 38.101-3: DC_25-41_n41 correction	16.3.0
2020-03	RAN#87	RP-200396	0172		A	CR to TS 38.101-3: corrections on ACS for intra-band contiguous EN-DC	16.3.0
2020-03	RAN#87	RP-200396	0174		A	CR to TS 38.101-3: editorial corrections on Rx requirements for intra-band contiguous EN-DC	16.3.0
2020-03	RAN#87	RP-200380	0175	1	F	CR to TS 38.101-3: Updated the MSD values for ENDC 3-n41	16.3.0
2020-03	RAN#87	RP-200396	0177		A	CR to TS 38.101-3: Correct the intra-band ENDC channel spacing	16.3.0
2020-03	RAN#87	RP-200380	0178		B	CR to reflect the completed NR inter band CA DC combinations for 2 bands DL with up to 2 bands UL into Rel16 TS 38.101-3	16.3.0
2020-03	RAN#87	RP-200380	0179		B	CR to reflect the completed NR inter band CA DC combinations for 3 bands DL with 2 bands UL into Rel16 TS 38.101-3	16.3.0

2020-03	RAN#87	RP-200380	0180		B	CR to reflect the completed ENDC combinations for 3 bands DL with 3 bands UL into Rel16 TS 38.101-3	16.3.0
2020-03	RAN#87	RP-200380	0181		F	Correction to remedy missing implementation of approved CR0093r1	16.3.0
2020-03	RAN#87	RP-200396	0182		F	CR for TS38.101-3, Correction of IE RF-Parameters name of maxUplinkDutyCycle	16.3.0
2020-03	RAN#87	RP-200384	0184		B	UE co-existence requirements for band n28 into 38.101-3	16.3.0
2020-03	RAN#87	RP-200380	0186		F	CR for 38.101-3: Correction of MOP tolerance for DC_39_n41	16.3.0
2020-03	RAN#87	RP-200380	0187		B	CR on introduction of completed EN-DC of 2 bands LTE and 1 band NR from RAN4#94-e into TS 38.101-3	16.3.0
2020-03	RAN#87	RP-200380	0190		B	CR on introduction of completed EN-DC of 1 band LTE and 1 band NR	16.3.0
2020-03	RAN#87	RP-200396	0193		A	CR to TS 38.101-3: editorial correction for output power dynamics for intra-band EN-DC	16.3.0
2020-03	RAN#87	RP-200380	0195		B	CR to TS 38.101-3: adding 90MHz channel BW support for Rel.16 CA_n78A-n257 configurations	16.3.0
2020-03	RAN#87	RP-200380	0196		B	Introducing CR on new EN-DC LTE (x bands DL/1UL)+NR(2 bands DL/1UL) band combinations in rel-16	16.3.0
2020-03	RAN#87	RP-200396	0199		A	CR on correction of 38.101-3 NEDC Ppowerclass (Rel-16)	16.3.0
2020-03	RAN#87	RP-200380	0200		D	CR to introduce new combinations of LTE 4band + NR 1band for TS 38.101-3	16.3.0
2020-03	RAN#87	RP-200380	0206		B	CR to add 3 LTE bands and 1 NR band EN-DC combinations	16.3.0
2020-03	RAN#87	RP-200380	0207		B	CR to add NR Inter-band CA for 4 bands in TS 38.101-3	16.3.0
2020-03	RAN#87	RP-200380	0208	1	F	Editorial corrections	16.3.0
2020-03	RAN#87	RP-200396	0211		F	CR to 38.101-3 R16 to remove FDM ULSUP combinations	16.3.0
2020-03	RAN#87	RP-200396	0213	1	A	CR for inter-band ENDC Tx requirement	16.3.0
2020-03	RAN#87	RP-200380	0215	1	F	CR to 38.101-3 on EN-DC band combination with SUL	16.3.0
2020-03	RAN#87	RP-200378	0217		A	EN-DC configuration table corrections	16.3.0
2020-03	RAN#87	RP-200380	0218		B	CR for introduce new EN-DC of LTE 2,3,4 band + NR FR1 1UL1DL band + NR FR2 1UL1DL band for TS 38.101-3	16.3.0

2020-06	RAN#88	RP-200880	0223	3	B	CR to TS 38.101-3: Switching time mask between two uplink carriers in EN-DC	16.4.0
2020-06	RAN#88	RP-200960	0228		F	CR for TS38.101-3, Aligned IE RF-Parameters name of maxUplinkDutyCycle with RAN2	16.4.0
2020-06	RAN#88	RP-200959	0229		B	Introducing NR inter-band CA for 3DL Bands and 1UL band for 38.101-3	16.4.0
2020-06	RAN#88	RP-200959	0232		A	CR Coexistence cleanup for 38101-3 Rel16	16.4.0
2020-06	RAN#88	RP-200985	0234		A	CR to TS 38.101-3 R16: corrections on ACS for intra-band contiguous EN-DC	16.4.0
2020-06	RAN#88	RP-200985	0240		A	CR for TS 38.101-3: MSD due to UL harmonic	16.4.0
2020-06	RAN#88	RP-200959	0241		F	CR for TS 38.101-3: Adding missing MSD due to UL harmonic for DC_28_n50	16.4.0
2020-06	RAN#88	RP-200985	0245		A	MOP for interband EN-DC including both FR1 and FR2 REL16	16.4.0
2020-06	RAN#88	RP-200985	0248		A	CR to 38.101-3 MSD due to UL harmonics and intermodulation interference R16	16.4.0
2020-06	RAN#88	RP-200985	0251		A	Mirror CR for 38.101-3: Corrections for Ppowerclass and referenced sections	16.4.0
2020-06	RAN#88	RP-200959	0252		B	Introducing CR on new EN-DC LTE(xDL/1UL)+ NR(2DL/1UL) DC in Rel-16	16.4.0
2020-06	RAN#88	RP-200959	0255		B	Big CR on introduction of completed EN-DC of 1 band LTE and 1 band NR	16.4.0
2020-06	RAN#88	RP-200985	0259		A	CR to TS 38.101-3 on configured output power relaxation due to EN-DC (Rel-16)	16.4.0
2020-06	RAN#88	RP-200985	0261		A	CR to TS 38.101-3 on REFSENS relaxation due to EN-DC (Rel-16)	16.4.0
2020-06	RAN#88	RP-200959	0264		F	Correction to EN-DC coexistence requirements	16.4.0
2020-06	RAN#88	RP-200985	0267		A	CR to TS 38.101-3: Clean up the MSD test point for ENDC(three band)	16.4.0
2020-06	RAN#88	RP-200959	0268		B	CR to reflect the completed NR inter band CA DC combinations for 2 bands DL with up to 2 bands UL into Rel16 TS 38.101-3	16.4.0
2020-06	RAN#88	RP-200959	0269		B	CR to reflect the completed ENDC combinations for 3 bands DL with 3 bands UL into Rel16 TS 38.101-3	16.4.0
2020-06	RAN#88	RP-200959	0274		B	CR to introduce new combinations of LTE 4band + NR 1band for TS 38.101-3	16.4.0
2020-06	RAN#88	RP-200959	0275		B	CR on introduction of completed EN-DC of 2 bands LTE and 1 band NR from RAN4#94bis-e and RAN4#95-e into TS 38.101-3	16.4.0
2020-06	RAN#88	RP-200959	0276		B	CR to reflect the completed NR inter band CA DC combinations for 3 bands DL with 2 bands UL into Rel16 TS 38.101-3	16.4.0
2020-06	RAN#88	RP-200959	0277		B	CR introduction completed band combinations 37.716-31-11 -	16.4.0
2020-06	RAN#88	RP-200959	0279		F	CR Rel-16 for editorial corrections TS 38.101-3	16.4.0
2020-06	RAN#88	RP-200959	0280		F	CR for 38.101-3: to clean up for SUL band combinations	16.4.0
2020-06	RAN#88	RP-200985	0238	1	A	CR for TS 38.101-3: Missing MSD due to cross band isolation	16.4.0
2020-06	RAN#88	RP-200985	0243	1	F	FR1+FR2 CA interband CA BCS support REL16	16.4.0
2020-06	RAN#88	RP-201045	0282	1	B	Addition of UE coexistence between US DC combinations and NR Band n77	16.4.0
2020-06	RAN#88	RP-200965	0249	1	B	CR for 38.101-3: Introduction of Power Class 1.5	16.4.0
2020-06	RAN#88	RP-200985	0236	1	A	CR to TS 38.101-3: editorial corrections on wide band Intermodulation for intra-band contiguous EN-DC in FR1	16.4.0
2020-06	RAN#88	RP-200988	0296		F	CR to remove TBD in 38.101-3	16.4.0
2020-06	RAN#88	RP-201055	0281	2	B	CR to 38.101-3 MSD due to UL harmonics and intermodulation interference R16	16.4.0
2020-06	RAN#88	RP-200958	0287	2	B	CR for TS 38.101-3: NR V2X con-current operation	16.4.0
2020-06	RAN#88	RP-200985	0272	1	A	Removal of the Annex modifiedMPR-Behaviour from the NSA specification	16.4.0

---

# History

<b>Document history</b>		
V16.4.0	July 2020	Publication