

ETSI TS 138 115-2 V17.4.0 (2024-01)



**5G;
NR;
Repeater conformance testing -
Part 2: Radiated conformance testing
(3GPP TS 38.115-2 version 17.4.0 Release 17)**



Reference

RTS/TSGR-0438115-1vh40

Keywords

5G

ETSI

650 Route des Lucioles
F-06921 Sophia Antipolis Cedex - FRANCE

Tel.: +33 4 92 94 42 00 Fax: +33 4 93 65 47 16

Siret N° 348 623 562 00017 - APE 7112B
Association à but non lucratif enregistrée à la
Sous-Préfecture de Grasse (06) N° w061004871

Important notice

The present document can be downloaded from:

<https://www.etsi.org/standards-search>

The present document may be made available in electronic versions and/or in print. The content of any electronic and/or print versions of the present document shall not be modified without the prior written authorization of ETSI. In case of any existing or perceived difference in contents between such versions and/or in print, the prevailing version of an ETSI deliverable is the one made publicly available in PDF format at www.etsi.org/deliver.

Users of the present document should be aware that the document may be subject to revision or change of status.

Information on the current status of this and other ETSI documents is available at

<https://portal.etsi.org/TB/ETSIDeliverableStatus.aspx>

If you find errors in the present document, please send your comment to one of the following services:

<https://portal.etsi.org/People/CommitteeSupportStaff.aspx>

If you find a security vulnerability in the present document, please report it through our
Coordinated Vulnerability Disclosure Program:

<https://www.etsi.org/standards/coordinated-vulnerability-disclosure>

Notice of disclaimer & limitation of liability

The information provided in the present deliverable is directed solely to professionals who have the appropriate degree of experience to understand and interpret its content in accordance with generally accepted engineering or other professional standard and applicable regulations.

No recommendation as to products and services or vendors is made or should be implied.

No representation or warranty is made that this deliverable is technically accurate or sufficient or conforms to any law and/or governmental rule and/or regulation and further, no representation or warranty is made of merchantability or fitness for any particular purpose or against infringement of intellectual property rights.

In no event shall ETSI be held liable for loss of profits or any other incidental or consequential damages.

Any software contained in this deliverable is provided "AS IS" with no warranties, express or implied, including but not limited to, the warranties of merchantability, fitness for a particular purpose and non-infringement of intellectual property rights and ETSI shall not be held liable in any event for any damages whatsoever (including, without limitation, damages for loss of profits, business interruption, loss of information, or any other pecuniary loss) arising out of or related to the use of or inability to use the software.

Copyright Notification

No part may be reproduced or utilized in any form or by any means, electronic or mechanical, including photocopying and microfilm except as authorized by written permission of ETSI.

The content of the PDF version shall not be modified without the written authorization of ETSI.

The copyright and the foregoing restriction extend to reproduction in all media.

© ETSI 2024.
All rights reserved.

Intellectual Property Rights

Essential patents

IPRs essential or potentially essential to normative deliverables may have been declared to ETSI. The declarations pertaining to these essential IPRs, if any, are publicly available for **ETSI members and non-members**, and can be found in ETSI SR 000 314: "*Intellectual Property Rights (IPRs); Essential, or potentially Essential, IPRs notified to ETSI in respect of ETSI standards*", which is available from the ETSI Secretariat. Latest updates are available on the ETSI Web server (<https://ipr.etsi.org/>).

Pursuant to the ETSI Directives including the ETSI IPR Policy, no investigation regarding the essentiality of IPRs, including IPR searches, has been carried out by ETSI. No guarantee can be given as to the existence of other IPRs not referenced in ETSI SR 000 314 (or the updates on the ETSI Web server) which are, or may be, or may become, essential to the present document.

Trademarks

The present document may include trademarks and/or tradenames which are asserted and/or registered by their owners. ETSI claims no ownership of these except for any which are indicated as being the property of ETSI, and conveys no right to use or reproduce any trademark and/or tradename. Mention of those trademarks in the present document does not constitute an endorsement by ETSI of products, services or organizations associated with those trademarks.

DECT™, **PLUGTESTS™**, **UMTS™** and the ETSI logo are trademarks of ETSI registered for the benefit of its Members. **3GPP™** and **LTE™** are trademarks of ETSI registered for the benefit of its Members and of the 3GPP Organizational Partners. **oneM2M™** logo is a trademark of ETSI registered for the benefit of its Members and of the oneM2M Partners. **GSM®** and the GSM logo are trademarks registered and owned by the GSM Association.

Legal Notice

This Technical Specification (TS) has been produced by ETSI 3rd Generation Partnership Project (3GPP).

The present document may refer to technical specifications or reports using their 3GPP identities. These shall be interpreted as being references to the corresponding ETSI deliverables.

The cross reference between 3GPP and ETSI identities can be found under <https://webapp.etsi.org/key/queryform.asp>.

Modal verbs terminology

In the present document "**shall**", "**shall not**", "**should**", "**should not**", "**may**", "**need not**", "**will**", "**will not**", "**can**" and "**cannot**" are to be interpreted as described in clause 3.2 of the [ETSI Drafting Rules](#) (Verbal forms for the expression of provisions).

"**must**" and "**must not**" are **NOT** allowed in ETSI deliverables except when used in direct citation.

Contents

Intellectual Property Rights	2
Legal Notice	2
Modal verbs terminology.....	2
Foreword.....	8
1 Scope	10
2 References	10
3 Definitions of terms, symbols and abbreviations	11
3.1 Terms.....	11
3.2 Symbols.....	13
3.3 Abbreviations	14
4 General radiated test conditions and declarations	15
4.1 Measurement uncertainties and test requirements	15
4.1.1 General.....	15
4.1.2 Acceptable uncertainty of Test System.....	15
4.1.2.1 General	15
4.1.2.2 Radiated characteristics measurements	15
4.1.3 Interpretation of measurement results	16
4.2 Radiated requirement reference points	17
4.3 Repeater classes.....	17
4.3.1 Repeater class for downlink.....	17
4.3.2 Repeater class for uplink.....	18
4.4 Regional requirements.....	18
4.5 Repeater configurations.....	18
4.5.1 Downlink configurations	18
4.5.2 Uplink configurations	19
4.5.3 Power supply options.....	19
4.6 Manufacturer's declarations.....	19
4.7 Test configurations	23
4.7.1 General.....	23
4.7.2 Test signal configurations.....	23
4.7.2.1 Test signal used to build Test Configurations	23
4.7.2.2 RTC1: Contiguous spectrum operation.....	24
4.7.2.2.1 RTC1 generation	24
4.7.2.2.2 RTC1 power allocation.....	24
4.7.2.4 RTC2: Non-contiguous spectrum operation.....	24
4.7.2.4.1 RTC2 generation	24
4.7.2.4.2 RTC2 power allocation.....	25
4.8 Applicability of requirements.....	25
4.9 RF channels and test models	26
4.9.1 RF channels	26
4.9.2 Test models	27
4.9.2.1 General	27
4.9.2.2 FR2 test models for repeater type 2-O for DL	27
4.9.2.3 FR2 test models for repeater type 2-O for UL	27
4.9.2.3.1 FR2 test model 1.1 (RUL-FR2-TM1.1).....	28
4.9.2.3.2 FR2 test model 2 (RUL-FR2-TM2).....	29
4.9.2.3.2a FR2 test model 2a (RUL-FR2-TM2a)	29
4.9.2.3.3 FR2 test model 3.1 (RUL-FR2-TM3.1).....	29
4.9.2.3.4 FR2 test model 3.1a (RUL-FR2-TM3.1a)	30
4.9.2.4 Data content of physical channels and signals for RUL-FR2-TM	30
4.9.2.3.1 PUSCH	30
4.10 Requirements for contiguous and non-contiguous spectrum.....	31
4.11 Format and interpretation of tests.....	31
4.12 Reference coordinate system.....	32

5	Operating bands and channel arrangement.....	33
6	Radiated characteristics.....	33
6.1	General.....	33
6.2	OTA output power.....	34
6.2.1	General.....	34
6.2.2	OTA output power (EIRP).....	34
6.2.2.1	Definition and applicability.....	34
6.2.2.2	Minimum requirement.....	35
6.2.2.3	Test purpose.....	35
6.2.2.4	Method of test.....	35
6.2.2.4.1	Initial conditions.....	35
6.2.2.4.2	Procedure.....	36
6.2.2.5	Test requirement.....	37
6.2.3	OTA repeater output power (TRP).....	37
6.2.3.1	Definition and applicability.....	37
6.2.3.2	Minimum requirement.....	37
6.2.3.3	Test purpose.....	37
6.2.3.4	Method of test.....	38
6.2.3.4.1	Initial conditions.....	38
6.2.3.4.2	Procedure.....	38
6.2.3.5	Test requirement.....	39
6.3	OTA frequency stability.....	39
6.3.1	Definition and applicability.....	39
6.3.2	Minimum Requirement.....	39
6.3.3	Test purpose.....	39
6.3.4	Method of test.....	39
6.3.5	Test Requirements.....	39
6.4	OTA out of band gain.....	40
6.4.1	Definition and applicability.....	40
6.4.2	Minimum Requirement.....	40
6.4.3	Test purpose.....	40
6.4.4	Method of test.....	40
6.4.4.1	Initial conditions.....	40
6.4.4.2	Procedure.....	40
6.4.5	Test Requirements.....	41
6.5	OTA unwanted emissions.....	41
6.5.1	General.....	41
6.5.2	OTA Adjacent Channel Leakage Power Ratio (ACLR).....	42
6.5.2.1	Definition and applicability.....	42
6.5.2.2	Minimum requirement.....	42
6.5.2.3	Test purpose.....	42
6.5.2.4	Method of test.....	42
6.5.2.4.1	Initial conditions.....	42
6.5.2.4.2	Procedure.....	42
6.5.2.5	Test requirements.....	43
6.5.3	OTA operating band unwanted emissions.....	47
6.5.3.1	Definition and applicability.....	47
6.5.3.2	Minimum requirement.....	48
6.5.3.3	Test purpose.....	48
6.5.3.4	Method of test.....	48
6.5.3.4.1	Initial conditions.....	48
6.5.3.4.2	Procedure.....	48
6.5.3.4	Test requirements.....	49
6.5.3.4.1	OTA operating band unwanted emission limits (Category A).....	49
6.5.3.4.2	OTA operating band unwanted emission limits (Category B).....	50
6.5.3.4.3	Additional OTA operating band unwanted emission requirements.....	51
6.5.3.4.3.1	Protection of Earth Exploration Satellite Service.....	51
6.5.4	OTA transmitter spurious emissions.....	51
6.5.4.1	Definition and applicability.....	51
6.5.4.2	Minimum requirement.....	51
6.5.4.3	Test purpose.....	52

6.5.4.4	Method of test	52
6.5.4.4.1	Initial conditions	52
6.5.4.4.2	Procedure	52
6.5.4.5	Test requirements	53
6.5.4.5.1	General	53
6.5.4.5.2	OTA transmitter spurious emissions (Category A)	53
6.5.4.5.3	OTA transmitter spurious emissions (Category B)	53
6.5.4.5.4	Additional OTA transmitter spurious emissions requirements	54
6.5.4.5.4.1	Limits for protection of Earth Exploration Satellite Service	54
6.6	OTA Repeater Error Vector Magnitude	54
6.6.1	Downlink repeater error vector magnitude	54
6.6.1.1	General	54
6.6.1.2	Minimum requirements	55
6.6.1.3	Test purpose	55
6.6.1.4	Method of test	55
6.6.1.4.1	Initial conditions	55
6.6.1.4.2	Procedure	56
6.6.1.5	Test requirement	57
6.6.2	Uplink Repeater error vector magnitude	57
6.6.2.1	General	57
6.6.2.2	Minimum requirement	58
6.6.2.3	Test purpose	58
6.6.2.4	Method of test	58
6.6.2.4.1	Initial conditions	58
6.6.2.4.2	Procedure	58
6.6.2.5	Test requirement	59
6.7	OTA input intermodulation	59
6.7.1	Definition and applicability	59
6.7.1.1	General	59
6.7.1.2	Minimum requirements	60
6.7.1.3	Test purpose	60
6.7.1.4	Method of test	60
6.7.1.4.1	Initial conditions	60
6.7.1.4.2	Procedure	60
6.7.1.5	Test requirements	60
6.8	OTA Adjacent Channel Rejection Ratio (ACRR)	61
6.8.1	Definitions and applicability	61
6.8.2	Co-existence with NR	61
6.8.2.1	Minimum requirements	61
6.8.2.2	Test purpose	61
6.8.2.3	Method of test	61
6.8.2.3.1	Initial conditions	61
6.8.2.3.2	Procedure	62
6.8.2.3.3	Test Requirements	62
6.9	OTA transmit ON/OFF power	64
6.9.1	OTA transmitter OFF power	64
6.9.1.1	Definition and applicability	64
6.9.1.2	Minimum requirement	64
6.9.1.3	Test purpose	64
6.9.1.4	Method of test	64
6.9.1.5	Test requirements	64
6.9.2	OTA transient period	64
6.9.2.1	Definition and applicability	64
6.9.2.2	Minimum requirement	65
6.9.2.3	Test purpose	65
6.9.2.4	Method of test	65
6.9.2.4.1	Initial conditions	65
6.9.2.4.2	Procedure	65
6.9.2.5	Test requirements	66
Annex A (normative):	Repeater stimulus signals	67

A.1	Repeater stimulus signal 1.....	67
A.2	Repeater stimulus signal 2.....	67
A.3	Repeater stimulus signal spectral purity requirements.....	67
Annex B (normative): Environmental requirements for the Repeater equipment.....		68
B.1	General.....	69
B.2	Normal test environment.....	69
B.3	Extreme test environment.....	69
B.3.1	Extreme temperature.....	69
B.4	Vibration.....	70
B.5	Power supply.....	70
B.6	Measurement of test environments.....	70
Annex C (informative): Test tolerances and derivation of test requirements.....		71
C.1	Measurement of radiated characteristics.....	72
Annex D (normative): Calibration.....		74
Annex E (informative): OTA measurement system set-up.....		74
E.1	OTA output power EIRP, OTA Frequency stability, OTA Error Vector Magnitude and OTA Transmit ON/OFF power.....	75
E.2	Out of band gain.....	76
E.3	Unwanted emission: Operating band unwanted emission and ACLR.....	77
E.4	Input intermodulation.....	78
E.5	Adjacent Channel Rejection Ratio.....	79
Annex F (normative): In-channel TX tests.....		79
F.1	General.....	79
F.2	Basic principles.....	80
F.2.1	Output signal of the TX under test.....	80
F.2.2	Ideal signal.....	80
F.2.3	Measurement results.....	81
F.2.4	Measurement points.....	81
F.3	Pre-FFT minimization process.....	82
F.4	Timing of the FFT window.....	82
F.5	Resource element TX power.....	84
F.6	Post-FFT equalisation.....	84
F.7	EVM.....	87
F.7.0	General.....	87
F.7.1	Averaged EVM.....	87
Annex G (normative): TRP measurement procedures.....		89
G.1	General.....	89
G.2	Spherical equal angle grid.....	89
G.2.1	General.....	89
G.2.2	Reference angular step criteria.....	90
G.3	Spherical equal area grid.....	92

G.4	Spherical Fibonacci grid.....	93
G.5	Orthogonal cut grid	93
G.5.1	General	93
G.5.2	Operating band unwanted emissions	95
G.5.3	Spurious unwanted emissions.....	95
G.6	Wave vector space grid	95
G.7	Full sphere with sparse sampling	96
G.8	Beam-based directions	97
G.9	Peak method	97
G.10	Equal sector with peak average	97
G.11	Pre-scan	98
Annex H (informative):	Change history	99
History		101

Foreword

This Technical Specification has been produced by the 3rd Generation Partnership Project (3GPP).

The contents of the present document are subject to continuing work within the TSG and may change following formal TSG approval. Should the TSG modify the contents of the present document, it will be re-released by the TSG with an identifying change of release date and an increase in version number as follows:

Version x.y.z

where:

x the first digit:

1 presented to TSG for information;

2 presented to TSG for approval;

3 or greater indicates TSG approved document under change control.

y the second digit is incremented for all changes of substance, i.e. technical enhancements, corrections, updates, etc.

z the third digit is incremented when editorial only changes have been incorporated in the document.

In the present document, modal verbs have the following meanings:

shall indicates a mandatory requirement to do something

shall not indicates an interdiction (prohibition) to do something

The constructions "shall" and "shall not" are confined to the context of normative provisions, and do not appear in Technical Reports.

The constructions "must" and "must not" are not used as substitutes for "shall" and "shall not". Their use is avoided insofar as possible, and they are not used in a normative context except in a direct citation from an external, referenced, non-3GPP document, or so as to maintain continuity of style when extending or modifying the provisions of such a referenced document.

should indicates a recommendation to do something

should not indicates a recommendation not to do something

may indicates permission to do something

need not indicates permission not to do something

The construction "may not" is ambiguous and is not used in normative elements. The unambiguous constructions "might not" or "shall not" are used instead, depending upon the meaning intended.

can indicates that something is possible

cannot indicates that something is impossible

The constructions "can" and "cannot" are not substitutes for "may" and "need not".

will indicates that something is certain or expected to happen as a result of action taken by an agency the behaviour of which is outside the scope of the present document

will not indicates that something is certain or expected not to happen as a result of action taken by an agency the behaviour of which is outside the scope of the present document

might indicates a likelihood that something will happen as a result of action taken by some agency the behaviour of which is outside the scope of the present document

might not indicates a likelihood that something will not happen as a result of action taken by some agency the behaviour of which is outside the scope of the present document

In addition:

is (or any other verb in the indicative mood) indicates a statement of fact

is not (or any other negative verb in the indicative mood) indicates a statement of fact

The constructions "is" and "is not" do not indicate requirements.

1 Scope

The present document specifies the Radio Frequency (RF) test methods and conformance requirements for NR *Repeater type 2-O*. These have been derived from, and are consistent with the radiated requirements for *Repeater type 2-O* in Repeater specification defined in TS 38.106 [2].

A repeater type 1-C only has conducted requirements so it does not require compliance to this specification.

Repeater type 2-O have only radiated requirements so they require compliance to this specification only.

2 References

The following documents contain provisions which, through reference in this text, constitute provisions of the present document.

- References are either specific (identified by date of publication, edition number, version number, etc.) or non-specific.
- For a specific reference, subsequent revisions do not apply.
- For a non-specific reference, the latest version applies. In the case of a reference to a 3GPP document (including a GSM document), a non-specific reference implicitly refers to the latest version of that document *in the same Release as the present document*.

- [1] 3GPP TR 21.905: "Vocabulary for 3GPP Specifications"
- [2] 3GPP TS 38.106: "NR repeater radio transmission and reception"
- [3] Recommendation ITU-R M.1545: "Measurement uncertainty as it applies to test limits for the terrestrial component of International Mobile Telecommunications-2000"
- [4] ITU-R Recommendation SM.329: "Unwanted emissions in the spurious domain"
- [5] 3GPP TS 38.104: "NR Base Station (BS) radio transmission and reception"
- [6] 3GPP TS 38.141-2: "NR; Base Station (BS) conformance testing; Part 2: Radiated conformance testing"
- [7] IEC 60 721-3-3: "Classification of environmental conditions - Part 3-3: Classification of groups of environmental parameters and their severities - Stationary use at weather protected locations"
- [8] IEC 60 721-3-4: "Classification of environmental conditions - Part 3: Classification of groups of environmental parameters and their severities - Clause 4: Stationary use at non-weather protected locations"
- [9] IEC 60 721: "Classification of environmental conditions"
- [10] IEC 60 068-2-1 (2007): "Environmental testing - Part 2: Tests. Tests A: Cold"
- [11] IEC 60 068-2-2: (2007): "Environmental testing - Part 2: Tests. Tests B: Dry heat"

- [12] IEC 60 068-2-6: (2007): "Environmental testing - Part 2: Tests - Test Fc: Vibration (sinusoidal)"
- [13] 3GPP TR 37.941: "Radio Frequency (RF) conformance testing background for radiated Base Station (BS) requirements"
- [14] 3GPP TS 38.101-2: "NR; User Equipment (UE) radio transmission and reception; Part 2: Range 2 Standalone".

3 Definitions of terms, symbols and abbreviations

3.1 Terms

For the purposes of the present document, the terms given in 3GPP TR 21.905 [1] and the following apply. A term defined in the present document takes precedence over the definition of the same term, if any, in 3GPP TR 21.905 [1].

Beam: beam (of the antenna) is the main lobe of the radiation pattern of an *antenna array*

Beam centre direction: direction equal to the geometric centre of the half-power contour of the beam

Beam direction pair: data set consisting of the *beam centre direction* and the related *beam peak direction*

Beam peak direction: direction where the maximum EIRP is found

Beamwidth: beam which has a half-power contour that is essentially elliptical, the half-power beamwidths in the two pattern cuts that respectively contain the major and minor axis of the ellipse

directional requirement: requirement which is applied in a specific direction within the *OTA coverage*

range.**Equivalent isotropic radiated power:** equivalent power radiated from an isotropic directivity device producing the same field intensity at a point of observation as the field intensity radiated in the direction of the same point of observation by the discussed device

Fractional bandwidth: *fractional bandwidth* FBW is defined as $FBW = 200 \cdot \frac{F_{FBW\ high} - F_{FBW\ low}}{F_{FBW\ high} + F_{FBW\ low}} \%$

gap between passbands: frequency gap between two consecutive passbands that belong to the same *operating band*, where the RF requirements in the gap are based on co-existence for un-coordinated operation

Inter-passband gap: The frequency gap between two supported consecutive *passbands* that belong to different operating bands.

Maximum passband TRP output power: mean power level measured per passband during the *transmitter ON state* in a specified reference condition and corresponding to the declared *rated passband TRP output power* ($P_{\text{rated,p,TRP}}$)

Measurement bandwidth: RF bandwidth in which an emission level is specified

Nominal channel bandwidth: Bandwidth calculated as $\min(100\text{MHz}, BW_{\text{passband}})$ in FR1 or $\min(400\text{MHz}, BW_{\text{passband}})$ in FR2. If this bandwidth is not defined for BS channel bandwidth for the operating band, *nominal channel bandwidth* shall be defined as the widest BS channel bandwidth for the operating band which is narrower than BW_{passband} .

Non-contiguous spectrum: spectrum consisting of two or more *passbands* separated by *inter-passband gap(s)*.

Operating band: frequency range in which NR operates (paired or unpaired), that is defined with a specific set of technical requirements

OTA coverage range: a common range of directions within which OTA requirements that are neither specified in the *OTA peak directions sets* nor as *TRP requirement* are intended to be met

OTA peak directions set: set(s) of *beam peak directions* within which certain OTA requirements are intended to be met, where all *OTA peak directions set(s)* are subsets of the *OTA coverage range*
Passband: The frequency range in which the repeater operates in with operational configuration, this frequency range can correspond to one or several consecutive nominal channels, if they are not consecutive each subset of channels shall be considered as an individual *passband*, a repeater can have one or several *passbands*, all channels within the *passband(s)* shall belong to a single operator or collaborating operators.

passband edge: Frequency at the edge of the passband

Repeater RF Bandwidth: RF bandwidth in which a repeater transmits and/or receives single or multiple passband(s) within a supported operating band

NOTE: In single passband operation, the Repeater RF Bandwidth is equal to the passband bandwidth.

Radiated interface boundary: *operating band* specific radiated requirements reference where the radiated requirements apply

Rated beam EIRP: For a declared beam and *beam direction pair*, the *rated beam EIRP* level is the maximum power that the repeater is declared to radiate at the associated *beam peak direction* during the *transmitter ON state*

Rated passband TRP output power: mean power level declared by the manufacturer per passband, that the manufacturer has declared to be available at the RIB during the *transmitter ON state*

Rated total TRP output power: mean power level associated with a particular *operating band*, that the manufacturer has declared to be available at the RIB during the *transmitter ON state* in a specified reference condition

Reference beam direction pair: Beam direction pair in the reference direction declared by the manufacturer.

Repeater type 2-O: Repeater operating at FR2 with a requirement set consisting only of OTA requirements defined at the RIB

Requirement set: one of the NR requirements set as defined for *NR repeater*

Sub-band: A *sub-band* of an operating band contains a part of the uplink and downlink frequency range of the operating band.

sub-block: one contiguous allocated block of spectrum for transmission and reception by the repeater.

Superseding-band: A *superseding-band* of an operating band includes the whole of the uplink and downlink frequency range of the operating band.

Total radiated power: is the total power radiated by the antenna

NOTE: The *total radiated power* is the power radiating in all direction for two orthogonal polarizations. *Total radiated power* is defined in both the near-field region and the far-field region

Transmitter OFF state: Time period during which the repeater downlink or uplink is not allowed to transmit in the corresponding direction.

Transmitter ON state: Time period during which the repeater is transmitting downlink or uplink signals in the corresponding direction.

Transmitter transient period: Time period during which the repeater is changing from the OFF state to the ON state or vice versa.

3.2 Symbols

For the purposes of the present document, the following symbols apply:

BW_{Config}	Transmission bandwidth configuration, where $BW_{\text{Config}} = N_{\text{RB}} \times \text{SCS} \times 12$
BW_{Nominal}	Nominal channel bandwidth
BW_{Passband}	<i>Passband</i> bandwidth
Δf	Separation between the <i>passband edge</i> frequency and the nominal -3 dB point of the measuring filter closest to the carrier frequency
Δf_{max}	$f_{\text{offset}_{\text{max}}}$ minus half of the bandwidth of the measuring filter
Δf_{OBUE}	Maximum offset of the <i>operating band</i> unwanted emissions mask from the <i>operating band edge</i> $F_{\text{DL},\text{low}}$ The lowest frequency of the downlink <i>operating band</i>
$F_{\text{DL},\text{high}}$	The highest frequency of the downlink <i>operating band</i>
$F_{\text{FBW},\text{high}}$	Highest supported frequency within supported <i>operating band</i> , for which <i>fractional bandwidth</i> support was declared
$F_{\text{FBW},\text{low}}$	Lowest supported frequency within supported <i>operating band</i> , for which <i>fractional bandwidth</i> support was declared
F_{filter}	Filter centre frequency
$F_{\text{offset},\text{high}}$	Frequency offset from $F_{\text{C},\text{high}}$ to the upper <i>passband edge</i>
$F_{\text{offset},\text{low}}$	Frequency offset from $F_{\text{C},\text{low}}$ to the lower <i>passband edge</i>
f_{offset}	Separation between the <i>passband edge</i> frequency and the centre of the measuring
$f_{\text{offset}_{\text{max}}}$	The offset to the frequency Δf_{OBUE} outside the <i>operating band</i>
$F_{\text{step},\text{X}}$	Frequency steps for the OTA transmitter spurious emissions (Category B)
$F_{\text{UL},\text{low}}$	The lowest frequency of the uplink <i>operating band</i>
$F_{\text{UL},\text{high}}$	The highest frequency of the uplink <i>operating band</i>
$P_{\text{EM},\text{n}50/\text{n}75,\text{ind}}$	Declared emission level for Band n50/n75; ind = a, b
$P_{\text{rated},\text{in}}$	Rated pass band input power to the repeater for the test
$P_{\text{rated},\text{p},\text{EIRP}}$	Rated passband EIRP output power
$P_{\text{rated},\text{p},\text{TRP}}$	Rated passband TRP output power declared per RIB
$P_{\text{rated},\text{t},\text{TRP}}$	Rated total TRP output power declared per RIB
$P_{\text{in},\text{p},\text{EIRP}}$	Input power intended to produce the maximum rated output power ($P_{\text{rated},\text{p},\text{TRP}}$) at the RIB $P_{\text{rated},\text{out},\text{FBW},\text{high}}$ The rated output EIRP for the higher supported frequency range within supported <i>operating band</i> , for which <i>fractional bandwidth</i> support was declared
$P_{\text{rated},\text{out},\text{FBW},\text{low}}$	The rated output EIRP for the lower supported frequency range within supported <i>operating band</i> , for which <i>fractional bandwidth</i> support was declared $P_{\text{max},\text{p},\text{EIRP}}$ Maximum passband EIRP output power when repeater is configured at the rated passband TRP output power ($P_{\text{rated},\text{p},\text{TRP}}$)
$P_{\text{max},\text{p},\text{TRP}}$	Maximum passband TRP output power measured per RIB

W_{gap} *Inter passband Bandwidth gap size*

3.3 Abbreviations

For the purposes of the present document, the abbreviations given in 3GPP TR 21.905 [1] and the following apply. An abbreviation defined in the present document takes precedence over the definition of the same abbreviation, if any, in 3GPP TR 21.905 [1].

ACLR	Adjacent Channel Leakage Ratio
AoA	Angle of Arrival
BW	Bandwidth
CACLR	Cumulative ACLR
CP-OFDM	Cyclic Prefix-OFDM
DFT-s-OFDM	Discrete Fourier Transform-spread-OFDM
DL	Downlink
EIRP	Effective Isotropic Radiated Power
EVM	Error Vector Magnitude
FBW	Fractional Bandwidth
FR	Frequency Range
ITU-R	Radiocommunication Sector of the International Telecommunication Union
LA	Local Area
MR	Medium Range
NR	New Radio
OBUE	Operating Band Unwanted Emissions
OOB	Out-of-band
OTA	Over-The-Air
QAM	Quadrature Amplitude Modulation
RF	Radio Frequency
RIB	Radiated Interface Boundary
RX	Receiver
SCS	Sub-Carrier Spacing
TX	Transmitter
TRP	Total Radiated Power
UL	Uplink
WA	Wide Area

4 General radiated test conditions and declarations

4.1 Measurement uncertainties and test requirements

4.1.1 General

The requirements of this clause apply to all applicable tests in part 2 of this specification, i.e. to all radiated tests defined for FR2. The FR2 frequency range is defined in clause 5.1 of TS 38.106 [2].

The minimum requirements are given in TS 38.106 [2]. Test Tolerances for the radiated test requirements explicitly stated in the present document are given in annex C of the present document.

Test Tolerances are individually calculated for each test. The Test Tolerances are used to relax the minimum requirements to create test requirements.

When a test requirement differs from the corresponding minimum requirement, then the Test Tolerance applied for the test is non-zero. The Test Tolerance for the test and the explanation of how the minimum requirement has been relaxed by the Test Tolerance are given in annex C.

4.1.2 Acceptable uncertainty of Test System

4.1.2.1 General

The maximum acceptable uncertainty of the Test System is specified below for each test defined explicitly in the present specification, where appropriate. The maximum acceptable uncertainty of the Test System for test requirements included by reference is defined in the respective referred test specification.

The Test System shall enable the stimulus signals in the test case to be adjusted to within the specified tolerance and the equipment under test to be measured with an uncertainty not exceeding the specified values. All tolerances and uncertainties are absolute values, and are valid for a confidence level of 95 %, unless otherwise stated.

A confidence level of 95 % is the measurement uncertainty tolerance interval for a specific measurement that contains 95 % of the performance of a population of test equipment.

4.1.2.2 Radiated characteristics measurements

The maximum OTA Test System uncertainty for radiated characteristics measurements are given in tables 4.1.2.2-1. Details for derivation of OTA Test System uncertainty are given in corresponding clauses in TR 37.941 [13].

Table 4.1.2.2-1: Maximum Test System uncertainty for radiated characteristics tests

Clause	Maximum Test System Uncertainty	Derivation of Test System Uncertainty
6.2 Radiated transmit power (EIRP)	Normal condition: ±1.7 dB (24.25 – 29.5 GHz) ±2.0 dB (37 – 43.5 GHz) ±2.2 dB (43.5 GHz < f ≤ 48.2 GHz)	
	Extreme condition: ±3.1 dB (24.25 – 29.5 GHz) ±3.3 dB (37 – 43.5 GHz) ±3.5 dB (43.5 GHz < f ≤ 48.2 GHz)	
6.3 OTA repeater output power (TRP)	±2.1 dB (24.25 – 29.5 GHz) ±2.4 dB (37 – 43.5 GHz) ±2.6 dB (43.5 GHz < f ≤ 48.2 GHz)	
6.4 OTA frequency stability	±1] Hz Measurement results of ± [5000] Hz	
6.5 OTA out of band gain	±2.1 dB, 24.25GHz < f □ 29.5GHz ±2.4 dB, 37GHz < f □ 43,5GHz ±2.6 dB, 43.5GHz < f □ 48.2GHz	
6.6.2 OTA ACLR	Relative ACLR: ±2.3 dB (24.25 – 29.5 GHz) ±2.6 dB (37 – 43.5 GHz) ±2.8 dB (43.5 GHz < f ≤ 48.2 GHz)	
	Absolute ACLR: ±2.7 dB (24.25 – 29.5 GHz) ±2.7 dB (37 – 43.5 GHz) ±2.9 dB (43.5 GHz < f ≤ 48.2 GHz)	
6.6.3 OTA operating band unwanted emission	±2.7 dB (24.25 – 29.5 GHz) ±2.7 dB (37 – 43.5 GHz) ±2.9 dB (43.5 GHz < f ≤ 48.2 GHz)	
6.6.4 OTA spurious emissions	±2.3 dB, 30 MHz ≤ f ≤ 6 GHz ±2.7 dB, 6 GHz < f ≤ 40 GHz ±5.0 dB, 40 GHz < f ≤ 60 GHz	
6.7 OTA EVM	1.25% signal analyser 2% stimulus signal	
6.8 OTA input intermodulation	±2.0 dB, f ≤ 3.0 GHz ±2.6 dB, 3.0 GHz < f ≤ 4.2 GHz ±3.2 dB, 4.2 GHz < f ≤ 6.0 GHz	
6.9 OTA ACRR	±2.7 dB (24.25 – 29.5 GHz) ±2.7 dB (37 – 43.5 GHz) ±2.9 dB (43.5 GHz < f ≤ 48.2 GHz)	
6.10.1 OTA transmitter OFF power	±2.9 dB (24.25 – 29.5 GHz) ±3.3 dB (37 – 43.5 GHz) ±3.6 dB (43.5 GHz < f ≤ 48.2 GHz)	
6.10.2 OTA transient period	N/A	

4.1.3 Interpretation of measurement results

The measurement results returned by the Test System are compared - without any modification - against the test requirements as defined by the Shared Risk principle.

The Shared Risk principle is defined in Recommendation ITU-R M.1545 [3].

The actual measurement uncertainty of the Test System for the measurement of each parameter shall be included in the test report.

The recorded value for the Test System uncertainty shall be, for each measurement, equal to or lower than the appropriate figure in clause 4.1.2 of the present document.

If the Test System for a test is known to have a measurement uncertainty greater than that specified in clause 4.1.2, it is still permitted to use this apparatus provided that an adjustment is made as follows.

Any additional uncertainty in the Test System over and above that specified in clause 4.1.2 shall be used to tighten the test requirement, making the test harder to pass. For some tests e.g. receiver tests, this may require modification of stimulus signals. This procedure will ensure that a Test System not compliant with clause 4.1.2 does not increase the chance of passing a device under test where that device would otherwise have failed the test if a Test System compliant with clause 4.1.2 had been used.

4.2 Radiated requirement reference points

For *repeater type 2-O*, the radiated characteristics are defined over the air (OTA), where the operating band specific radiated interface is referred to as the Radiated Interface Boundary (RIB). Radiated requirements are also referred to as OTA requirements. The (spatial) characteristics in which the OTA requirements apply are detailed for each requirement.

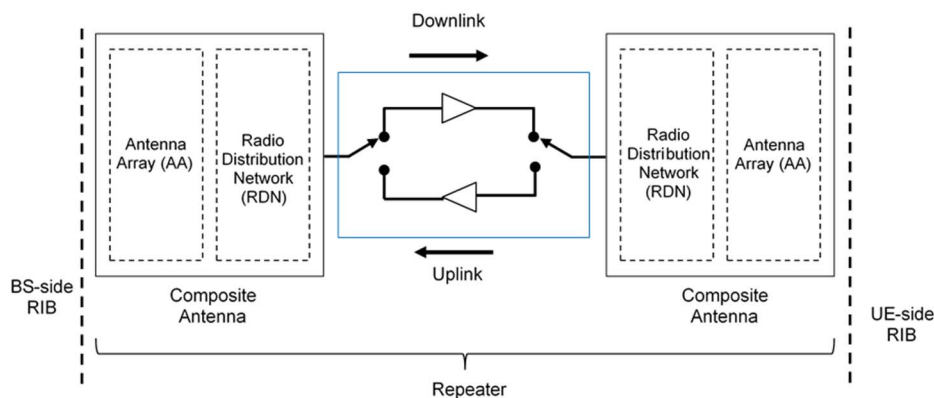

Figure 4.2-1: Radiated reference points for *repeater type 2-O*

4.3 Repeater classes

4.3.1 Repeater class for downlink

The requirements in this specification apply to downlink Wide Area repeaters, downlink Medium Range repeaters and downlink Local Area repeaters unless otherwise stated. The associated deployment scenarios for each class are exactly the same for repeater with and without connectors.

For *repeater type 2-O*, repeater downlink classes are defined as indicated below:

- Wide Area repeaters are characterised by requirements derived from Macro Cell scenarios with a repeater to UE minimum distance along the ground equal to 35 m.
- Medium Range repeaters are characterised by requirements derived from Micro Cell scenarios with a repeater to UE minimum distance along the ground equal to 5 m.

- Local Area repeaters are characterised by requirements derived from Pico Cell scenarios with a repeater to UE minimum distance along the ground equal to 2 m.

4.3.2 Repeater class for uplink

The requirements in this specification apply to uplink Wide Area repeaters and uplink Local Area repeaters unless otherwise stated. The associated deployment scenarios for each class are exactly the same for repeater with and without connectors.

For *repeater type 2-O*, repeater uplink classes are defined as indicated below:

- Wide Area repeaters are characterised by requirements derived from Macro Cell and/or Micro Cell scenarios.
- Local Area repeaters are characterised by requirements derived from Pico Cell and/or Micro Cell scenarios.

4.4 Regional requirements

Some requirements in the present document may only apply in certain regions either as optional requirements, or as mandatory requirements set by local and regional regulation. It is normally not stated in the 3GPP specifications under what exact circumstances the regional requirements apply, since this is defined by local or regional regulation.

Table 4.4-1 lists all requirements in the present specification that may be applied differently in different regions.

Table 4.4-1: List of regional requirements

Clause number	Requirement	Comments
5.2	<i>Operating bands</i>	Some NR <i>operating bands</i> may be applied regionally.
7.3.4	OTA repeater output power: Additional requirements	These requirements may be applied regionally as additional repeater output power requirements.
7.5.3.2	OTA operating band unwanted emissions	Category A or Category B operating band unwanted emissions limits may be applied regionally.
7.5.4.2	OTA Tx spurious emissions	Category A or Category B spurious emission limits, as defined in ITU-R Recommendation SM.329 [4], may apply regionally.
7.5.4.2.3	OTA Tx spurious emissions: additional requirements	These requirements may be applied for the protection of system operating in frequency ranges other than the repeater <i>operating band</i> .

4.5 Repeater configurations

4.5.1 Downlink configurations

Unless otherwise stated, the radiated downlink characteristics in clause 6 are specified at RIB, with a full complement of transceiver units for the configuration in normal operating conditions.

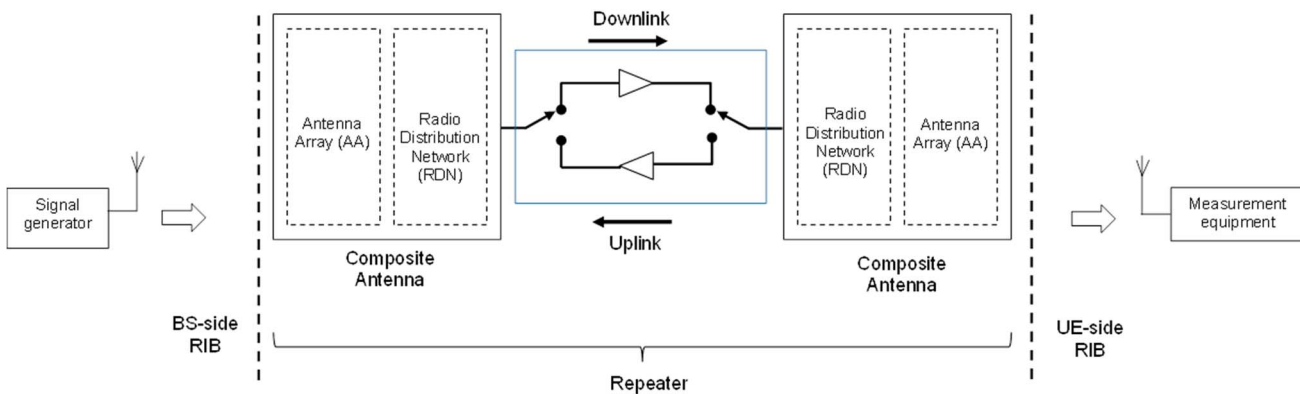

Figure 4.5.1-1: Test interface for downlink

4.5.2 Uplink configurations

Unless otherwise stated, the radiated downlink characteristics in clause 6 are specified at RIB, with a full complement of transceiver units for the configuration in normal operating conditions.

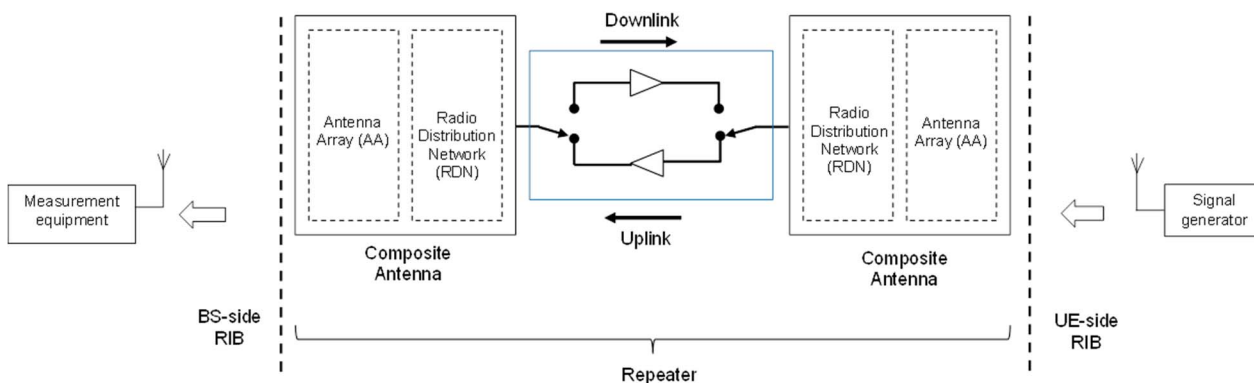

Figure 4.5.2-1: Test interface for uplink

4.5.3 Power supply options

If the repeater is supplied with a number of different power supply configurations, it may not be necessary to test RF parameters for each of the power supply options, provided that it can be demonstrated that the range of conditions over which the equipment is tested is at least as great as the range of conditions due to any of the power supply configurations.

4.6 Manufacturer's declarations

The following repeater manufacturer's declarations listed in table 4.6-1, when applicable to the BS under test, are required to be provided by the manufacturer for radiated requirements testing for *repeater type 2-0*. Declarations can be made independently for UL and DL.

Table 4.6-1: Manufacturers declarations for *repeater type 2-O* radiated test requirements

Declaration identifier	Declaration	Description
D.1	Coordinate system reference point	Location of coordinated system reference point in reference to an identifiable physical feature of the repeater enclosure.
D.2	Coordinate system orientation	Orientation of the coordinate system in reference to an identifiable physical feature of the repeater enclosure.
D.3	Beam identifier	A unique title to identify a beam, e.g. a, b, c or 1, 2, 3. The vendor may declare any number of beams with unique identifiers. The minimum set to declare for conformance, corresponds to the beams at the reference beam direction with the highest intended EIRP, and covering the properties listed below: 1) A beam with the narrowest intended BeW_{θ} and narrowest intended BeW_{ϕ} possible when narrowest intended BeW_{θ} is used. 2) A beam with the narrowest intended BeW_{ϕ} and narrowest intended BeW_{θ} possible when narrowest intended BeW_{ϕ} is used. 3) A beam with the widest intended BeW_{θ} and widest intended BeW_{ϕ} possible when widest intended BeW_{θ} is used. 4) A beam with the widest intended BeW_{ϕ} and widest intended BeW_{θ} possible when widest intended BeW_{ϕ} is used. 5) A beam which provides the highest intended EIRP of all possible beams. When selecting the above five beam widths for declaration, all beams that the repeater is intended to produce shall be considered, including beams that during operation may be identified by any kind of cell or UE specific reference signals, with the exception of any type of beam that is created from a group of transmitters that are not all phase synchronised. (Note 1)
D.4	Operating bands and passband frequency ranges	List of NR <i>operating band(s)</i> supported by the repeater and passband frequency range(s) within the <i>operating band(s)</i> that the repeater can operate in. Supported bands declared for every beam (D.3). (Note 2)
D.5	Repeater class	Declared as Wide Area repeater, Medium Range repeater, or Local Area repeater.
D.6	OTA peak directions set reference beam direction pair	The beam direction pair, describing the reference beam peak direction and the reference beam centre direction. Declared for every beam (D.3).
D.7	OTA peak directions set	The OTA peak directions set for each beam. Declared for every beam (D.3).
D.8	OTA peak directions set maximum steering direction(s)	The <i>beam direction pair(s)</i> corresponding to the following points: 1) The beam peak direction corresponding to the maximum steering from the reference beam centre direction in the positive Φ direction, while the θ value being the closest possible to the reference beam centre direction. 2) The beam peak direction corresponding to the maximum steering from the reference beam centre direction in the negative Φ direction, while the θ value being the closest possible to the reference beam centre direction. 3) The beam peak direction corresponding to the maximum steering from the reference beam centre direction in the positive θ direction, while the Φ value being the closest possible to the reference beam centre direction. 4) The beam peak direction corresponding to the maximum steering from the reference beam centre direction in the negative θ direction, while the Φ value being the closest possible to the reference beam centre direction. The maximum steering direction(s) may coincide with <i>the reference beam centre direction</i> . Declared for every beam (D.3).
D.9	Rated beam EIRP	The rated EIRP level per passband ($P_{rated,p,EIRP}$) at the <i>beam peak direction</i> associated with a particular <i>beam direction pair</i> for each of the declared maximum steering directions (D.8), as well as the reference <i>beam direction pair</i> (D.8). Declared for every beam (D.3). (Note 5, 6, 7)
D.10	Beamwidth	The <i>beamwidth</i> for the reference <i>beam direction pair</i> and the four maximum steering directions. Declared for every beam (D.3).
D.11	Equivalent beams	List of beams which are declared to be equivalent. Equivalent beams imply that the beams are expected to have identical <i>OTA peak directions sets</i> and intended to have identical spatial properties at all steering directions within the <i>OTA peak directions set</i> when presented with identical signals. All declarations (D.4 – D.10) made for the beams are identical and the transmitter unit, RDN and antenna array responsible for generating the beam are of identical design.
D.12	Parallel beams	List of beams which have been declared equivalent (D.11) and can be generated in parallel using independent RF power resources. Independent power resources mean that the beams are transmitted from mutually exclusive transmitter units.

Declaration identifier	Declaration	Description
D.13	OTA coverage range	Declared as a single range of directions within which selected TX OTA requirements are intended to be met. (Note 3)
D.14	OTA coverage range reference direction	The direction describing the reference direction of the <i>OTA coverage range</i> (D.13). (Note 4)
D.15	OTA coverage range maximum directions	The directions corresponding to the following points: 1) The direction determined by the maximum φ value achievable inside the <i>OTA coverage range</i> , while θ value being the closest possible to the <i>OTA coverage range</i> reference direction. 2) The direction determined by the minimum φ value achievable inside the <i>OTA coverage range</i> , while θ value being the closest possible to the <i>OTA coverage range</i> reference direction. 3) The direction determined by the maximum θ value achievable inside the <i>OTA coverage range</i> , while φ value being the closest possible to the <i>OTA coverage range</i> reference direction. 4) The direction determined by the minimum θ value achievable inside the <i>OTA coverage range</i> , while φ value being the closest possible to the <i>OTA coverage range</i> reference direction.
D.16	The rated passband OTA repeater power, $P_{\text{rated,p,TRP}}$	$P_{\text{rated,p,TRP}}$ is declared as TRP OTA power per passband, declared per supported operating band. (Note 5, 7)
D.17	Rated transmitter TRP, $P_{\text{rated,t,TRP}}$	Rated total radiated output power. Declared per supported <i>operating band</i> . (Note 5, 7)
D.18	Spurious emission category	Declare the repeater spurious emission category as either category A or B with respect to the limits for spurious emissions, as defined in Recommendation ITU-R SM.329 [4].
D.19	Additional operating band unwanted emissions	The manufacturer shall declare whether the repeater under test is intended to operate in geographic areas where the additional operating band unwanted emission limits defined in clause 6.7.4 apply.
D.20	Co-existence with other systems	The manufacturer shall declare whether the repeater under test is intended to operate in geographic areas where one or more of the systems GSM850, GSM900, DCS1800, PCS1900, UTRA FDD, UTRA TDD, E-UTRA and/or PHS operating in another operating band are deployed.
D.21	Supported frequency range of the NR <i>operating band</i>	List of supported frequency ranges representing <i>fractional bandwidths</i> (FBW) of <i>operating bands</i> with FBW larger than 6%.
D.22	Rated beam EIRP at lower end of the <i>fractional bandwidth</i> ($P_{\text{rated,out,FBWlow}}$)	The rated EIRP level per passband at lower frequency range of the <i>fractional bandwidth</i> ($P_{\text{rated,out,FBWlow}}$), at the <i>beam peak direction</i> associated with a particular <i>beam direction pair</i> for each of the declared maximum steering directions (D.10), as well as the reference <i>beam direction pair</i> (D.6). Declared per beam for all supported frequency ranges (D.21). (Note 5, 6, 7)
D.23	Rated beam EIRP at higher frequency range of the <i>fractional bandwidth</i> ($P_{\text{rated,out,FBWhigh}}$)	The rated EIRP level per passband at higher frequency range of the <i>fractional bandwidth</i> ($P_{\text{rated,out,FBWhigh}}$), at the <i>beam peak direction</i> associated with a particular <i>beam direction pair</i> for each of the declared maximum steering directions (D.10), as well as the reference <i>beam direction pair</i> (D.6). Declared per beam for all supported frequency ranges in (D.21). (Note 5, 6, 7)]
D.24	Long delay repeater	Declared only if the repeater internal delay between the input and output for this repeater does not fit within the TDD transient time. The repeater is intended for situations in which it will not cause interference to other nodes. This is achieved by RF isolation or by reservation of longer guard periods, which degrades frame utilization. The length of repeaters internal delay is declared using this declaration.
D.25	Input signal EIRP for maximum output power	Declaration of input signal EIRP required to reach maximum output power. Declared per passband.
D.26	Repeater radiating direction	Declaration on whether the repeater is intended to radiate in DL, UL or both. Testing shall be performed only for the direction(s) in which the repeater radiates.
D.27	Maximum repeater RF Bandwidth	Maximum <i>repeater RF Bandwidth</i> in the <i>operating band</i> for single-band operation. Declared per supported <i>operating band</i> . (Note 8)

Declaration identifier	Declaration	Description
NOTE 1:	Depending on the capability of the system some of these beams may be the same. For those same beams, testing is not repeated.	
NOTE 2:	These <i>operating bands</i> are related to their respective single-band RIBs.	
NOTE 3:	<i>OTA coverage range</i> is used for conformance testing of such TX OTA requirements as frequency error or EVM.	
NOTE 4:	The <i>OTA coverage range</i> reference direction may be the same as the Reference beam direction pair (D.8) but does not have to be.	
NOTE 5:	If a <i>Repeater type 2-O</i> is capable of 64QAM operation but not capable of 256QAM operation, then up to two rated output power declarations may be made. One declaration is applicable when configured for 64QAM operation and the other declaration is applicable when not configured for 64QAM operation.	
NOTE 6:	If D.22 and D.23 are declared for certain frequency range (D.21), there shall be no "Rated beam EIRP" declaration (D.9) for the <i>operating band</i> containing that particular frequency range.	
NOTE 7:	If a BS type 2-O is capable of 256QAM operation, then up to three rated output power declarations may be made. One declaration is applicable when configured for 256QAM operation, a different declaration is applicable when configured for 64QAM operation and the other declaration is applicable when not configured neither for 256QAM nor 64QAM operation.	
NOTE 8:	Parameters for contiguous or non-contiguous spectrum operation in the operating band are assumed to be the same unless they are separately declared. When separately declared, they shall still use the same declaration identifier.	

4.7 Test configurations

4.7.1 General

Test configurations in this specification refer to the configuration of test signals from test equipment that are provided to the repeater input.

The test configurations shall be constructed using the methods defined below subject to the parameters declared by the manufacturer as listed in clause 4.6.

The applicable test models for generation of the carrier transmit test signal are defined in clause 4.9.2.

NOTE: If required, carriers are shifted to align with the channel raster.

4.7.2 Test signal configurations

4.7.2.1 Test signal used to build Test Configurations

The signal's channel bandwidth and subcarrier spacing used to build NR Test Configurations shall be selected according to tables 4.7.2.1-1.

Table 4.7.2.1-1: Signal to be used to build NR TCs

Operating band characteristics		$F_{DL_high} - F_{DL_low} \leq 3250$ MHz
TC signal characteristics	$BW_{channel}$	100 MHz (Note 1, Note 2)
	Subcarrier spacing	Smallest supported subcarrier spacing declared per operating band (D.7)
NOTE 1: Repeater vendor can decide to test with 50 MHz channel bandwidth and smallest supported SCS declared per <i>operating band</i> (D.7) instead of 100 MHz channel bandwidth in certain regions, where spectrum allocation and regulation require testing with 50 MHz.		
NOTE 2: The narrowest specified <i>BS channel bandwidth</i> for the <i>operating band</i> (D.7) shall be used if 100MHz channel bandwidth is not specified for the band.		

4.7.2.2 RTC1: Contiguous spectrum operation

The purpose of test configuration RTC1 is to test all repeater requirements that need an input signal in the *passband* when there is only one *passband* per *operating band*.

4.7.2.2.1 RTC1 generation

RTC1 shall be constructed on a per band basis using the following method:

- Declared maximum repeater RF Bandwidth supported shall be used (D.27);
- Select the carrier to be tested according to 4.7.2 and place it adjacent to the lower *passband* edge. If the width of the *passband* is at least twice the bandwidth of the signal to be tested then place a second signal adjacent to the upper *passband* edge. Otherwise reposition the carrier to be tested according to the single carrier test frequencies described in section 4.9.1.

The test configuration should be constructed sequentially on a per band basis. All configured component carriers are transmitted simultaneously in the tests where the repeater should be ON.

4.7.2.2.2 RTC1 power allocation

Set the TRP of each carrier to the same level so that the sum of the carrier powers equals the expected input power to the repeater for the test (i.e., either $P_{rated,in}$ or $P_{rated,in} + 10dB$) according to the manufacturer's declaration in clause 4.6.

4.7.2.4 RTC2: Non-contiguous spectrum operation

The purpose of RTC2 is to test all repeater requirements that need an input signal in the *passband* when there is more than one *passband* per *operating band*.

4.7.2.4.1 RTC2 generation

RTC2 is constructed on a per band basis using the following method:

- The repeater *passband* bandwidths shall be the declared maximum repeater RF Bandwidth supported for multiple *passbands* (D.27). The repeater RF Bandwidth consists of one sub-block gap and the two highest and lowest declared *passbands*.
- For each *passband*, select the carrier to be tested according to 4.7.2. If the the width of the *passband* is at least twice that of the carrier to be tested then place a carrier adjacent to the upper *passband* edge and another carrier

(as described in 4.7.2) adjacent to the lower *passband* edge. Otherwise, tests shall be applied with one carrier adjacent to the lower sub-block edge and one carrier adjacent to the upper sub-block edge for each sub-block gap.

- The sub-block edges adjacent to the sub-block gap shall be determined using the specified $F_{\text{offset_high}}$ and $F_{\text{offset_low}}$ for the carriers adjacent to the sub-block gap.

4.7.2.4.2 RTC2 power allocation

Set the power of each carrier to the same level so that the sum of the carrier powers equals the expected input power to the repeater for the test (i.e., either $P_{\text{in,p,EIRP}}$ or $P_{\text{in,p,EIRP}} + 10\text{dB}$) according to the manufacturer's declaration in clause 4.6.

4.8 Applicability of requirements

4.8.1 Applicability of test configurations

be declared according to clause 4.6. The generation and power allocation for each test configuration is defined in clause 4.7. This clause contains the test configurations for a repeater capable of single carrier, and/or multi-carrier operation in both contiguous and non-contiguous spectrum in single band.

For a repeater declared to support a single *passband* within a single band, the test configurations in the second column of table 4.8.1-1 shall be used for testing.

For a repeater declared to support more than one *passband* within a single band (D.4) and where the parameters in the manufacture's declaration according to clause 4.6 are identical for all passbands, the test configurations in the third column of table 4.8.1-1 shall be used for testing.

For a repeater declared to support more than one *passband* within a single band (D.4) and where the parameters in the manufacture's declaration according to clause 4.6 are not identical for all passbands, the test configurations in the fourth column of table 4.8.1-1 shall be used for testing.

Table 4.8.1-1: Test configurations for a repeater capable of single or multiple *passbands* in a single band

Test case	Single passband repeater	Multiple passband capable repeater with identical parameters per passband	Multiple passband capable repeater with different parameters per passband
Repeater output power	RTC1	RTC1	RTC1, RTC2
Frequency stability	Tested with Error Vector Magnitude	Tested with Error Vector Magnitude	Tested with Error Vector Magnitude
Out of band gain	N/A	N/A	N/A
Transmit ON/OFF power (only applied for NR TDD repeater)	RTC1	RTC1	RTC1, RTC2
Error Vector Magnitude	RTC1	RTC1	RTC1, RTC2
Adjacent Channel Leakage power Ratio (ACLR)	RTC1	RTC1, RTC2	RTC1, RTC2
Cumulative ACLR requirement in non-contiguous spectrum	-	RTC2	RTC2
Operating band unwanted emissions	RTC1	RTC1, RTC2	RTC1, RTC2
Transmitter spurious emissions	RTC1	RTC1, RTC2	RTC1, RTC2
Output intermodulation	RTC1	RTC1, RTC2	RTC1, RTC2
Input intermodulation	N/A	N/A	N/A
Adjacent Channel Rejection Ratio (ACRR)	RTC1	RTC2	RTC1, RTC2
Receiver spurious emissions	RTC1	RTC1, RTC2	RTC1, RTC2

4.9 RF channels and test models

4.9.1 RF channels

For the single passband testing many tests in the present document are performed with appropriate frequencies in the bottom, middle and top channels of the supported frequency range of the repeater. These are denoted as RF channels B (bottom), M (middle) and T (top).

Unless otherwise stated, the test shall be performed with a single passband at each of the RF channels B, M and T.

Many tests in the present document are performed with the maximum *repeater RF Bandwidth* located at the bottom, middle and top of the supported frequency range in the operating band. These are denoted as B_{RFBW} (bottom), M_{RFBW} (middle) and T_{RFBW} (top).

Unless otherwise stated, the test shall be performed at B_{RFBW} , M_{RFBW} and T_{RFBW} defined as following:

- B_{RFBW} : maximum *repeater RF Bandwidth* located at the bottom of the supported frequency range in the operating band.
- M_{RFBW} : maximum *repeater RF Bandwidth* located in the middle of the supported frequency range in the operating band.
- T_{RFBW} : maximum *repeater RF Bandwidth* located at the top of the supported frequency range in the operating band.

When a test is performed by a test laboratory, the position of B, M and T for single passband, B_{RFBW} , M_{RFBW} and T_{RFBW} for single band operation shall be specified by the laboratory. The laboratory may consult with operators, the manufacturer or other bodies.

4.9.2 Test models

4.9.2.1 General

The following clauses will describe the test models needed for *repeater type 2-O*.

4.9.2.2 FR2 test models for repeater type 2-O for DL

FR2 test model in clause 4.9.2.2 in TS 38.141-2 [6] applies to *repeater type 2-O* as below:

- NR-FR2-TM1.1 applies to RDL-FR2-TM1.1
- NR-FR2-TM2 applies to RDL-FR2-TM2
- NR-FR2-TM2a applies to RDL-FR2-TM2a
- NR-FR2-TM3.1 applies to RDL-FR2-TM3.1
- NR-FR2-TM3.1a applies to RDL-FR2-TM3.1a

4.9.2.3 FR2 test models for repeater type 2-O for UL

The set-up of physical channels for transmitter tests shall be according to one of the test models (R-FR2-TMs) below. A reference to the applicable test model is made within each test.

The following general parameters are used by all NR test models:

- Duration is 2 radio frames for TDD (20 ms)
- The slots are numbered 0 to $10 \times 2^\mu - 1$ where μ is the numerology corresponding to the subcarrier spacing
- N_{RB} is the maximum transmission bandwidth configuration seen in table 5.3.2-2 in TS 38.106 [x].
- Normal CP
- Virtual resource blocks of localized type

For FR2 TDD, repeater test models are derived based on the uplink/downlink configuration as shown in the table 4.9.2.3-1 using information element *TDD-UL-DL-ConfigCommon* as defined in TS 38.331 [z].

Table 4.9.2.3-1: Configurations of TDD for repeater type 2-O test models

Field name	Value	
referenceSubcarrierSpacing (kHz)	60	120
Periodicity (ms) for dl-UL-TransmissionPeriodicity	1.25	1.25
nrofDownlinkSlots	3	7
nrofDownlinkSymbols	10	6
nrofUplinkSlots	1	2
nrofUplinkSymbols	2	4

Common physical channel parameters for all FR2 test models are specified in table 4.9.2.3-2 and table 4.9.2.3-3 for PUSCH. Specific physical channel parameters for FR2 test models are described in clauses 4.9.2.3.1 to 4.9.2.3.3.

Table 4.9.2.3-2: Common physical channel parameters for repeater type 2-O PUSCH

Parameter	Value
mapping type	PUSCH mapping type A
<i>dmrs-TypeA-Position</i> for the first DM-RS symbol	'pos2'
<i>dmrs-AdditionalPosition</i> for additional DM-RS symbol(s)	'pos0'
<i>dmrs-Type</i> for comb pattern	Configuration type 1
maxLength	1
Ratio of PUSCH EPRE to DM-RS EPRE	0 dB
PTRS configuration and density	L _{PT-RS} = 4 K _{PT-RS} = 2 k _{ref} ^{RE} = 00
Ratio of PT-RS EPRE to DM-RS EPRE	0 dB

Table 4.9.2.3-3: Common physical channel parameters for PUSCH by RNTI for repeater type 2-O test models

Parameter	Value
PUSCH $n_{\text{RNTI}} = 0$	

4.9.2.3.1 FR2 test model 1.1 (RUL-FR2-TM1.1)

This model shall be used for tests on:

- OTA output power (EIRP)- OTA Repeater output power (TRP)
- OTA out of band gain
- OTA Unwanted emissions
- OTA ACLR
- OTA operating band unwanted emissions
- OTA transmitter spurious emissions
- OTA input intermodulation
- OTA ACRR
- OTA transmit ON/OFF power

Common physical channel parameters are defined in clause 4.9.2.3. Specific physical channel parameters for RUL-FR2-TM1.1 are defined in table 4.9.2.3.1-1.

Table 4.9.2.3.1-1: Specific physical channel parameters of RUL-FR2-TM1.1

Parameter	Value
# of PRBs PUSCH $n_{\text{RNTI}} = 0$	N_{RB}
Modulation PUSCH $n_{\text{RNTI}} = 0$	QPSK

4.9.2.3.2 FR2 test model 2 (RUL-FR2-TM2)

This model shall be used for tests on:

- Uplink OTA repeater EVM of single PRB allocation (at lower PSD TX power limit at min power)
- OTA frequency stability (at lower PSD TX power limit at min power)

Common physical channel parameters are defined in clause 4.9.2.3. Specific physical channel parameters for RUL-FR2-TM2 are defined in table 4.9.2.3.2-1 for 64QAM. For 16QAM and QPSK, specific physical channel parameters for RUL-FR2-TM2 are defined in table 4.9.2.3.2-1 with 64QAM PUSCH PRB replaced with selected modulation order PUSCH PRB according to the corresponding test procedure.

Table 4.9.2.3.2-1: Specific physical channel parameters of RUL-FR2-TM2

Parameter	Value												
# of 64QAM PUSCH PRBs	1												
Level of boosting (dB)	0												
Location of 64QAM PRB	<table border="0"> <tr> <td>Slot</td> <td>RB</td> <td>n</td> </tr> <tr> <td>$3n$</td> <td>0</td> <td>$n = 0, \dots, \left\lfloor \frac{10 \times 2^\mu}{3} \right\rfloor - 1$</td> </tr> <tr> <td>$3n+1$</td> <td>$\left\lfloor \frac{N_{\text{RB}}}{2} \right\rfloor$</td> <td>$n = 0, \dots, \left\lfloor \frac{10 \times 2^\mu - 1}{3} \right\rfloor - 1$</td> </tr> <tr> <td>$3n+2$</td> <td>$N_{\text{RB}} - 1$</td> <td>$n = 0, \dots, \left\lfloor \frac{10 \times 2^\mu - 2}{3} \right\rfloor - 1$</td> </tr> </table>	Slot	RB	n	$3n$	0	$n = 0, \dots, \left\lfloor \frac{10 \times 2^\mu}{3} \right\rfloor - 1$	$3n+1$	$\left\lfloor \frac{N_{\text{RB}}}{2} \right\rfloor$	$n = 0, \dots, \left\lfloor \frac{10 \times 2^\mu - 1}{3} \right\rfloor - 1$	$3n+2$	$N_{\text{RB}} - 1$	$n = 0, \dots, \left\lfloor \frac{10 \times 2^\mu - 2}{3} \right\rfloor - 1$
Slot	RB	n											
$3n$	0	$n = 0, \dots, \left\lfloor \frac{10 \times 2^\mu}{3} \right\rfloor - 1$											
$3n+1$	$\left\lfloor \frac{N_{\text{RB}}}{2} \right\rfloor$	$n = 0, \dots, \left\lfloor \frac{10 \times 2^\mu - 1}{3} \right\rfloor - 1$											
$3n+2$	$N_{\text{RB}} - 1$	$n = 0, \dots, \left\lfloor \frac{10 \times 2^\mu - 2}{3} \right\rfloor - 1$											
# of PUSCH PRBs which are not allocated	$N_{\text{RB}} - 1$												

4.9.2.3.2a FR2 test model 2a (RUL-FR2-TM2a)

This model shall be used for tests on:

- Uplink OTA repeater EVM of single PRB allocation (at lower PSD TX power limit at min power)
- OTA frequency stability (at lower PSD TX power limit at min power)

Common physical channel parameters are defined in clause 4.9.2.3. Specific physical channel parameters for RUL-FR2-TM2a are defined in table 4.9.2.3.2-1 with all 64QAM PUSCH PRBs replaced by 256QAM PUSCH PRBs.

4.9.2.3.3 FR2 test model 3.1 (RUL-FR2-TM3.1)

This model shall be used for tests on:

- Transmitted signal quality
- OTA frequency stability (at max power)

- Uplink OTA repeater EVM for modulation (at max power)

Common physical channel parameters are defined in clause 4.9.2.3. Specific physical channel parameters for RUL-FR2-TM3.1 are defined in table 4.9.2.3.1-1 with all QPSK PUSCH PRBs replaced with selected modulation order PUSCH PRBs according to the corresponding test procedure.

4.9.2.3.4 FR2 test model 3.1a (RUL-FR2-TM3.1a)

This model shall be used for tests on:

- Transmitted signal quality
- OTA frequency stability (at max power)
- Uplink OTA repeater EVM for 256QAM modulation (at max power)

Common physical channel parameters are defined in clause 4.9.2.3. Specific physical channel parameters for RUL-FR2-TM3.1a shall be defined in table 4.9.2.3.1-1 with all QPSK PUSCH PRBs replaced by 256QAM.

4.9.2.4 Data content of physical channels and signals for RUL-FR2-TM

Randomisation of the data content is obtained by utilizing a PN sequence generator and the length-31 Gold sequence scrambling of TS 38.211 [x], clause 5.2.1 which is invoked by all physical channels prior to modulation and mapping to the RE grid.

Initialization of the scrambler and RE-mappers as defined in TS 38.211 [x] use the following additional parameters:

- $N_{ID}^{cell} = 1$
- $q = 0$ (single code word)
- Rank 1, single layer

4.9.2.3.1 PUSCH

- Generate the required amount of bits from the output of the PN23 sequence generator [28]. The PN sequence generator is initialized with a starting seed of "all ones" in the first allocated slot of each frame. The PN sequence is continuous over the slot boundaries.
- Perform user specific scrambling according to TS 38.211 [x], clause 6.3.1.1.
- $n_{ID} = N_{ID}^{cell}$
- Perform modulation of the scrambled bits with the modulation scheme defined for each user according to TS 38.211 [x], clause 6.3.1.3.
- Perform mapping of the complex-valued symbols to layer according to TS 38.211 [x], clause 6.3.1.3.
- Perform PDSCH mapping type A according to TS 38.211 [x].
- DM-RS sequence generation according to TS 38.211 [x], clause 6.4.1.1.1 where l is the OFDM symbol number within the slot with symbols indicated by table 4.9.2.3-3.
- $N_{ID}^{n_{SCID}} = N_{ID}^{cell}$

- $n_{\text{SCID}} = 0$
- DM-RS mapping according to TS 38.211 [7], clause 6.4.1.1.3 with parameters listed in table 4.9.2.3-3.
- For RUL-FR2-TM PT-RS sequence generation according to TS 38.211 [7], clause 6.4.1.2.1, with parameters listed in table 4.9.2.3-3.
- For RUL-FR2-TM PT-RS mapping according to TS 38.211 [7], clause 6.4.1.2.2, with parameters listed in table 4.9.2.3-3.

4.10 Requirements for contiguous and non-contiguous spectrum

A spectrum allocation where a repeater operates can either be contiguous or non-contiguous. Unless otherwise stated, the requirements in the present specification apply for repeater configured for both contiguous spectrum operation and non-contiguous spectrum operation.

For repeater operation in non-contiguous spectrum, some requirements apply both at the repeater *passband* edges and inside the sub-block gaps. For each such requirement, it is stated how the limits apply relative to the repeater *passband* edges and the sub-block edges respectively.

4.11 Format and interpretation of tests

Each test has a standard format:

X Title

All tests are applicable to all equipment within the scope of the present document, unless otherwise stated.

X.1 Definition and applicability

This clause gives the general definition of the parameter under consideration and specifies whether the test is applicable to all equipment or only to a certain subset. Required manufacturer declarations may be included here.

X.2 Minimum requirement

This clause contains the reference to the clause to the 3GPP reference (or core) specification which defines the minimum requirement.

X.3 Test purpose

This clause defines the purpose of the test.

X.4 Method of test

X.4.1 General

In some cases there are alternative test procedures or initial conditions. In such cases, guidance for which initial conditions and test procedures can be applied are stated here. In the case only one test procedure is applicable, that is stated here.

X.4.2y First test method

X.4.2y.1 Initial conditions

This clause defines the initial conditions for each test, including the test environment, the RF channels to be tested and the basic measurement set-up. The OTA Test System is assumed to be correctly calibrated as part of the initial conditions. Calibration is not explicitly mentioned.

X.4.2y.2 Procedure

This clause describes the steps necessary to perform the test and provides further details of the test definition like domain (e.g. frequency-span), range, weighting (e.g. bandwidth), and algorithms (e.g. averaging). The procedure may comprise data processing of the measurement result before comparison with the test requirement (e.g. average result from several measurement positions).

X.4.3y Alternative test method (if any)

If there are alternative test methods, each is described with its initial conditions and procedures.

X.5 Test requirement

This clause defines the pass/fail criteria for the equipment under test, see clause 4.1.3 (Interpretation of measurement results). Test requirements for every minimum requirement referred in clause X.2 are listed here. Cases where minimum requirements do not apply need not be mentioned.

4.12 Reference coordinate system

Radiated requirements are stated in terms of electromagnetic characteristics (e.g. EIRP) at certain angles with respect to the repeater. To be able to declare radiated characteristics part of radiated requirements a reference coordinate system is required. The reference coordinate system should be associated to an identifiable physical feature on the repeater enclosure. The location of the origin and the orientation of the reference coordinate system are for the repeater manufacturer to declare.

The reference coordinate system is created of a Cartesian coordinate system with rectangular axis (x , y , z) and spherical angles (θ , ϕ) as showed in figure 4.12-1.

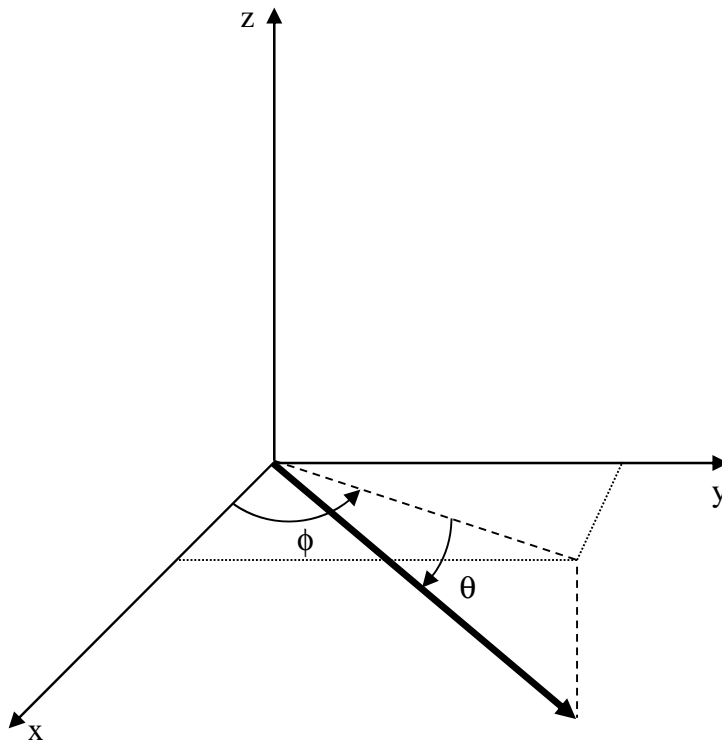

Figure 4.12-1: Reference coordinate system

ϕ is the angle in the x/y plane, between the x-axis and the projection of the radiating vector onto the x/y plane and is defined between -180° and $+180^\circ$, inclusive. θ is the angle between the projection of the vector in the x/y plane and the radiating vector and is defined between -90° and $+90^\circ$, inclusive. Note that θ is defined as positive along the down-tilt angle.

5 Operating bands and channel arrangement

For the NR operation in NR operating bands specification, their channel bandwidth configurations, channel spacing and raster, as well as synchronization raster specification, refer to TS 38.106 [2], clause 5 and its relevant clauses.

For the radiated testing purposes in this specification, only FR2-1 operating bands are considered.

6 Radiated characteristics

6.1 General

Unless otherwise stated, the radiated characteristics are specified at RIB for *repeater type 2-0* configuration in normal operating conditions.

Requirements apply in both DL and UL unless otherwise stated, or declared.

- For the DL the BS-side RIB is the input and the UE-side RIB is the output.

- For the UL the UE-side RIB is the input and the BS-side RIB is the output.

General test conditions for radiated tests of the *repeater type 2-O* are given in clause 4, including interpretation of measurement results and configurations for testing. Repeater configurations for the tests are defined in clause 4.5.

If a number of *single-band RIB* have been declared equivalent (D.x), only a representative one is necessary to be tested to demonstrate conformance.

6.2 OTA output power

6.2.1 General

OTA output power include both OTA output EIRP power and OTA output TRP.

6.2.2 OTA output power (EIRP)

6.2.2.1 Definition and applicability

Radiated transmit power is defined as the EIRP level for a declared beam at a specific *beam peak direction*.

For each declared beam, the requirement is based on declarations captured in clause 4.6 for a beam identifier (D.3), *reference beam direction pair* (D.6), *rated beam EIRP* (D.9) at the beam's reference direction pair, *OTA peak directions set* (D.7), the *beam direction pairs* at the maximum steering directions (D.8) and their associated *rated beam EIRP* and *beamwidth(s)* for reference *beam direction pair* and maximum steering directions (D.10).

For a declared beam and *beam direction pair*, the *rated beam EIRP* level is the maximum power that the repeater is declared to radiate at the associated *beam peak direction*.

For each *beam peak direction* associated with a *beam direction pair* within the *OTA peak directions set*, a specific *rated beam EIRP* level may be claimed. Any claimed value shall be met within the accuracy requirement as described below. *Rated beam EIRP* is only required to be declared for the *beam direction pairs* subject to conformance testing as detailed in clause 6.2.4.

NOTE 1: *OTA peak directions set* is set of *beam peak directions* for which the EIRP accuracy requirement is intended to be met. The *beam peak directions* are related to a corresponding contiguous range or discrete list of *beam centre directions* by the *beam direction pairs* included in the set.

NOTE 2: A *beam direction pair* is data set consisting of the *beam centre direction* and the related *beam peak direction*.

NOTE 3: A declared EIRP value is a value provided by the manufacturer for verification according to the conformance specification declaration requirements, whereas a claimed EIRP value is provided by the manufacturer to the equipment user for normal operation of the equipment and is not subject to formal conformance testing.

For *passbands* where the supported *fractional bandwidth* (FBW) is larger than 6%, two rated beam EIRP may be declared by manufacturer:

- $P_{\text{rated,out,FBWlow}}$ for lower supported frequency range, and
- $P_{\text{rated,out,FBWhigh}}$ for higher supported frequency range.

For frequencies in between F_{FBWlow} and F_{FBWhigh} the rated beam EIRP is:

- $P_{\text{rated,out,FBWlow}}$, for the output whose frequency is within frequency range $F_{\text{FBWlow}} \leq f < (F_{\text{FBWlow}} + F_{\text{FBWhigh}}) / 2$,
- $P_{\text{rated,out,FBWhigh}}$, for the output whose frequency is within frequency range $(F_{\text{FBWlow}} + F_{\text{FBWhigh}}) / 2 \leq f \leq F_{\text{FBWhigh}}$.

The repeater radiated transmit power requirements are specified at *single-band RIB*.

If beams have been declared equivalent and parallel (D.11, D.12), only a representative beam is necessary to be tested to demonstrate conformance.

The *repeater rated beam EIRP output power* for *repeater type 2-O* UL transmission shall be within limits as specified in table 6.2.2.1-1.

Table 6.2.2.1-1: Repeater rated beam EIRP output power limits for repeater type 2-O UL transmission

Repeater class	$P_{\text{rated,p,EIRP}}$
Wide Area	(note 1)
Local Area	$\leq + 55 + X$ dBm, Note 2
NOTE1: There is no upper limit for the $P_{\text{rated,p,EIRP}}$ of the <i>repeater type 2-O</i> UL transmission.	
NOTE2: $X = 10 \cdot \log(\text{ceil}(\text{passband bandwidth}/100\text{MHz}))$	

6.2.2.2 Minimum requirement

The minimum requirement applies per *single-band RIB* supporting transmission in the *operating band*.

The minimum requirement for *repeater type 2-O* is defined for normal and extreme conditions in TS 38.106 [2], clause 7.2.2.

6.2.2.3 Test purpose

The test purpose is to verify the ability to accurately generate and direct radiated power per beam, across the frequency range, for all declared beams.

6.2.2.4 Method of test

6.2.2.4.1 Initial conditions

Test environment:

- Normal, see annex A.2,
- Extreme, see annexes A.3 and A.5.

A measurement system set-up is shown in annex E.

RF channels to be tested for single carrier: B, M and T; see clause 4.9.1.

RF channels positions to be tested for multi-carrier and/or CA:

- B_{RFBW} , M_{RFBW} and T_{RFBW} for *single-band RIB*, see clause 4.9.1.

Under extreme test environment, it is sufficient to test on one NR-ARFCN or one RF bandwidth position, and with one applicable test configuration defined in clauses 4.7 and 4.8. Testing shall be performed under extreme power supply conditions, as defined in annex B.5.

NOTE: Tests under extreme power supply conditions also test extreme temperatures.

Directions to be tested:

- OTA peak directions set reference beam direction pair (D.6), and
- OTA peak directions set maximum steering directions (D.8).

Beams to be tested: Declared beam with the highest intended EIRP for the narrowest intended beam corresponding to the smallest $BeW\theta$, or for the narrowest intended beam corresponding to the smallest $BeW\phi$ (D.3, D.9).

Power levels to be tested:

- The lowest input power ($P_{\text{p,in,EIRP}}$) that produces the *rated passband TRP output power* ($P_{\text{rated,p,TRP}}$).
- The lowest input power ($P_{\text{p,in,EIRP}}$) that produces the *rated passband TRP output power* ($P_{\text{rated,p,TRP}}$), plus 10 dB.

6.2.2.4.2 Procedure

For normal test environment conditions in OTA domain, the test procedure is as follows:

- 1) Place the DUT at the positioner.
- 2) Align the manufacturer declared coordinate system orientation (D.2) of the DUT with the test system.
- 3) Orient the positioner (and repeater and test signal generator) in order that the direction to be tested aligns with the test antenna and the correct angle of arrival for the input signal is achieved.
- 4) Configure the *beam peak direction* of the DUT according to the declared *beam direction pair* if necessary.
- 5) Set the test signal generator power at the RIB as shown in annex E with a power equivalent to the power level to be tested, according to the applicable test configuration in clause 4.8 using the corresponding test model(s) in clause 4.9.2, in the correct direction in respect to the repeater.
- 6) Measure EIRP for any two orthogonal polarizations (denoted p1 and p2) and calculate total radiated transmit power for particular *beam direction pair* as $EIRP = EIRP_{p1} + EIRP_{p2}$.
- 7) Test steps 3 to 6 are repeated for all declared beams (D.7) and their reference *beam direction pairs* and *maximum steering directions* (D.6 and D.8), and for all applicable power levels.

For extreme conditions tests the methods in TS 38.141-2 [6], annex B.7 may be used.

6.2.2.5 Test requirement

For each *single-band RIB* under test, the power measured in clause 6.2.2.4.2 in step 6 shall remain within the values provided in table 6.2.2.5-1 for normal and extreme test environments, relative to the manufacturer's declared $P_{\text{rated,p,EIRP}}$ (D.9) for *repeater type 2-O*:

Table 6.2.2.5-1: Test requirements for radiated transmit power accuracy

Normal test environment	Extreme test environment
24.25 GHz < f ≤ 29.5 GHz: ± 5.1 dB	24.25 GHz < f ≤ 29.5 GHz: ± 7.6 dB
37 GHz < f ≤ 43.5 GHz: ± 5.4 dB	37 GHz < f ≤ 43.5 GHz: ± 7.8 dB
43.5 GHz < f ≤ 48.2 GHz: ± 5.6 dB	43.5 GHz < f ≤ 48.2 GHz: ± 8.0 dB

6.2.3 OTA repeater output power (TRP)

6.2.3.1 Definition and applicability

OTA repeater output power is declared as rated carrier TRP, with the output power accuracy requirement defined at the RIB.

The repeater *rated TRP output power* for *repeater type 2-O* UL transmission shall be within limits as specified in table 6.2.3.1-1.

Table 6.2.3.1-1: Repeater *rated TRP output power* limits for *repeater type 2-O* UL transmission

Repeater class	$P_{\text{rated,p,TRP}}$
Wide Area	(note 1)
Local Area	≤ + 35 + X dBm (note 2)
NOTE 1: There is no upper limit for the $P_{\text{rated,p,TRP}}$ of the <i>repeater type 2-O</i> UL transmission.	
NOTE 2: $X = 10 \cdot \log(\text{ceil}(\text{passband bandwidth}/100\text{MHz}))$	

The output power limit for the respective repeater classes in table 6.2.3.1-1 shall be compared to the rated output power and the declared repeater class. It is not subject to testing.

6.2.3.2 Minimum requirement

The minimum requirement applies per *single-band RIB* supporting transmission in the *operating band*.

The minimum requirement for *repeater type 2-O* is defined for normal conditions in TS 38.106 [2], clause 7.2.2.

6.2.3.3 Test purpose

The test purpose is to verify the accuracy of the *maximum passband TRP output power* ($P_{\text{max,p,TRP}}$) across the frequency range for all *RIBs*.

6.2.3.4 Method of test

6.2.3.4.1 Initial conditions

Test environment: Normal, see annex A.2.

A measurement system set-up is shown in annex E.

RF channels to be tested for single carrier: B, M, T; see clause 4.9.1.

Base Station RF Bandwidth positions to be tested for multi-carrier and/or CA:

- B_{RFBW} , M_{RFBW} and T_{RFBW} in single band operation; see clause 4.9.1.

Beams to be tested: As the requirement is TRP the beam pattern(s) may be set up to optimise the TRP measurement procedure (see annex G) as long as the required TRP level is achieved.

Power levels to be tested:

- The lowest input power ($P_{\text{p,in,EIRP}}$) that produces the *rated passband TRP output power* ($P_{\text{rated,p,TRP}}$).
- The lowest input power ($P_{\text{p,in,EIRP}}$) that produces the *rated passband TRP output power* ($P_{\text{rated,p,TRP}}$), plus 10 dB.

6.2.3.4.2 Procedure

The following procedure for measuring TRP is based on the directional power measurements as described in annex G. An alternative method to measure TRP is to use a characterized and calibrated reverberation chamber if so follow steps 1, 3, 5, and 7.

- 1) Place the DUT at the positioner.
- 2) Align the manufacturer declared coordinate system orientation (D.2) of the DUT with the test system.
- 3) Orient the positioner (and repeater and test signal generator) in order that the direction to be tested aligns with the test antenna and the correct angle of arrival for the input signal is achieved.
- 4) Configure the DUT such that the beam peak direction(s) applied during the power measurement step 6 are consistent with the grid and measurement approach for the TRP test.
- 5) Set the test signal generator power at the RIB as shown in annex G with a power equivalent to the tested input power level, transmit according to the applicable test configuration in clause 4.8 using the corresponding test model(s) in clause 4.9.2, in the correct direction in respect to the repeater.
- 6) Orient the positioner (and DUT) in order that the direction to be tested aligns with the test antenna such that measurements to determine TRP can be performed (see annex G) whilst maintaining the correct direction of arrival for the test signal.
- 7) Measure the radiated power for any two orthogonal polarizations (denoted p1 and p2) and calculate total radiated transmit power for particular beam direction pair as $\text{EIRP} = \text{EIRP}_{\text{p1}} + \text{EIRP}_{\text{p2}}$.

- 8) Repeat step 6-7 for all directions in the appropriated TRP measurement grid needed for full TRP estimation (see annex G).
- 9) Calculate TRP using the EIRP measurements.

6.2.3.5 Test requirement

The final TRP measurement result in clause 6.2.3.4.2 shall remain:

- within +5.1 dB and -5.1 dB of the manufacturer's declared *rated TRP output power* $P_{\text{rated,p,TRP}}$ for carrier frequency $24.25 \text{ GHz} < f \leq 29.5 \text{ GHz}$.
- within +5.4 dB and -5.4 dB of the manufacturer's declared *rated TRP output power* $P_{\text{rated,p,TRP}}$ for carrier frequency $37 \text{ GHz} < f \leq 43.5 \text{ GHz}$.
- within +5.6 dB and -5.6 dB of the manufacturer's declared *rated TRP output power* $P_{\text{rated,p,TRP}}$ for carrier frequency $43.5 \text{ GHz} < f \leq 48.2 \text{ GHz}$.

6.3 OTA frequency stability

6.3.1 Definition and applicability

Frequency stability is the ability to maintain the same frequency on the output signal with respect to the input signal.

6.3.2 Minimum Requirement

The minimum requirement is in TS 38.106 [2], clause 7.3.2.

6.3.3 Test purpose

The test purpose is to verify that frequency stability is within the limit specified by the minimum requirement.

6.3.4 Method of test

Requirement is tested together with modulation quality test, as described in clause 7.6.

6.3.5 Test Requirements

The frequency deviation of the output signal with respect to the input signal shall be accurate to within $\pm(0.01 \text{ ppm} + 12 \text{ Hz})$ observed over 1 ms.

6.4 OTA out of band gain

6.4.1 Definition and applicability

Out of band gain refers to the gain of the repeater outside the *passband*.

6.4.2 Minimum Requirement

The minimum requirement is in TS 38.106 [2], clause 7.4.2.

6.4.3 Test purpose

The test purpose is to verify that out of band gain is within the limit specified by the minimum requirement.

6.4.4 Method of test

6.4.4.1 Initial conditions

Test environment:

- Normal, see annex B.2,

6.4.4.2 Procedure

For normal test environment conditions in OTA domain, the test procedure is as follows:

- 1) Place the repeater at the positioner.
- 2) Align the manufacturer declared coordinate system orientation (D.2) of the repeater with the test system.
- 3) Orient the positioner (and repeater and test signal generator) in order that the direction to be tested aligns with the test antenna and the correct angle of arrival for the input signal is achieved..
- 4) Set the CW generator power at the RIB as shown in annex E with a power equivalent to $P_{in,p,EIRP}$, in the correct direction in respect to the repeater.
- 5) Orient the positioner (and repeater and test signal source) in order that the direction to be tested aligns with the test antenna such that measurements to determine TRP can be performed (see annex G) whilst maintaining the correct direction of arrival for the test signal.
- 6) Measure the radiated power for any two orthogonal polarizations (denoted p1 and p2) and calculate total radiated transmit power for particular beam direction pair as $EIRP = EIRP_{p1} + EIRP_{p2}$.
- 7) Repeat step 6-7 for all directions in the appropriated TRP measurement grid needed for full TRP estimation (see annex G), whilst maintaining the input signal in the correct direction with respect to the repeater.

- 8) Calculate TRP using the EIRP measurements. The out of band gain at the frequency under test is given by the difference in dB between the measured output TRP and the EIRP of the input signal.
- 9) Repeat steps 2-8, shifting the offset frequency of the CW from the edge of the *passband* from 200kHz to 10MHz in steps of 200kHz for each *passband*.

6.4.5 Test Requirements

The gain outside the *passband* shall not exceed the maximum level specified in table 6.4.5-1, where:

- $f_{\text{offset_CW}}$ is the offset between the outer channel edge frequency of the outer channel in the *passband* and a CW signal.

Table 6.4.5-1: Out of band gain limits

Frequency offset, $f_{\text{offset_CW}}$	Maximum gain
$0.1 \cdot \text{Minimum}\{400\text{MHz}, \text{passband BW}\} \leq f_{\text{offset_CW}} < 150$ MHz	70.1 dB (NOTE 1) 70.4 dB (NOTE 2) 70.6 dB (NOTE 3)
$150 \text{ MHz} \leq f_{\text{offset_CW}} < 400 \text{ MHz}$	57.1 dB (NOTE 1) 57.4 dB (NOTE 2) 57.6 dB (NOTE 3)
$400 \text{ MHz} \leq f_{\text{offset_CW}} < f_{\text{offset_max}}$	37.1 dB (NOTE 1) 37.4 dB (NOTE 2) 37.6 dB (NOTE 3)
NOTE 1: Applicable to bands defined within the frequency spectrum range of 24.25–29.5 GHz NOTE 2: Applicable to bands defined within the frequency spectrum range of 37–43.5GHz NOTE 3: Applicable to bands defined within the frequency spectrum range of 43.5–48.2 GHz	

6.5 OTA unwanted emissions

6.5.1 General

Unwanted emissions consist of so-called out-of-band emissions and spurious emissions according to ITU definitions ITU-R SM.329 [4]. In ITU terminology, out of band emissions are unwanted emissions immediately outside the *passband* resulting from the modulation process and non-linearity in the transmitter but excluding spurious emissions. Spurious emissions are emissions which are caused by unwanted transmitter effects such as harmonics emission, parasitic emission, intermodulation products and frequency conversion products, but exclude out of band emissions.

The OTA out-of-band emissions requirement for the *repeater type 2-O* transmitter is specified both in terms of Adjacent Channel Leakage power Ratio (ACLR) and operating band unwanted emissions (OBUE). OTA Unwanted emissions outside of this frequency range are limited by an OTA spurious emissions requirement.

The maximum offset of the operating band unwanted emissions mask from the *operating band* edge is Δf_{OBUE} . The value of Δf_{OBUE} is defined in table 6.5.1-1 for *repeater type 2-O* for NR *operating bands*.

Table 6.5.1-1: Maximum offset Δf_{OBUE} outside the downlink *operating band* for *repeater type 2-O*

Repeater type	Operating band characteristics	Δf_{OBUE} (MHz)
<i>Repeater type 2-O</i>	$F_{\text{DL,high}} - F_{\text{DL,low}} \leq 4000 \text{ MHz}$	1500

The unwanted emission requirements are applied per cell for all the configurations. Requirements for OTA unwanted emissions are captured using TRP, *directional requirements* as described per requirement.

6.5.2 OTA Adjacent Channel Leakage Power Ratio (ACLR)

6.5.2.1 Definition and applicability

OTA Adjacent Channel Leakage power Ratio (ACLR) is the ratio of the filtered mean power centred on the assigned channel frequency to the filtered mean power centred on an adjacent channel frequency. The measured power is TRP.

The requirement shall be applied per RIB during the *transmitter ON state*.

6.5.2.2 Minimum requirement

The minimum requirement in TS 38.106 [2], clause 7.5.2.2.

6.5.2.3 Test purpose

To verify that the adjacent channel leakage power ratio requirement shall be met as specified by the minimum requirement.

6.5.2.4 Method of test

6.5.2.4.1 Initial conditions

Test environment: Normal; see annex B.2.

RF channels to be tested for single carrier: B, M and T; see clause 4.9.1.

6.5.2.4.2 Procedure

The following procedure for measuring TRP is based on the directional power measurements as described in annex G.

- 1) Place the repeater at the positioner.
- 2) Align the manufacturer declared coordinate system orientation (D.2) of the repeater with the test system.
- 3) The measurement devices characteristics shall be:
 - measurement filter bandwidth: defined in clause 6.5.2.5.
 - detection mode: true RMS voltage or true power averaging.
- 4a) Set the input signal at the RIB according to the applicable test configuration and direction in clause 4.8 using the corresponding test models RDL-FR2-TM1.1 and RUL-FR2-TM1.1 in clause 4.9.2 at the input power intended to produce the maximum rated output power, $P_{in,p,EIRP} + 10\text{dB}$.
- 4b) Verify measurement impact from feeding test signal by generating a signal for repeater input with repeater to be turned off. Verify measured result is enough below requirement limit.

- 5) Orient the positioner (and repeater and test signal source) in order that the direction to be tested aligns with the test antenna such that measurements to determine TRP can be performed (see annex G) whilst maintaining the correct direction of arrival for the test signal.
- 6) Measure the absolute power of the assigned channel frequency and the (adjacent channel frequency).
- 7) Repeat step 5-6 for all directions in the appropriated TRP measurement grid needed for $TRP_{Estimate}$ (see annex G).
- 8) Calculate $TRP_{Estimate}$ for the absolute total radiated power of the wanted channel and the adjacent channel using the measurements made in Step 7.
- 9) Calculate relative ACLR estimate.

NOTE 1: ACLR is calculated by the ratio of the absolute TRP of the assigned channel frequency and the absolute TRP of the adjacent frequency channel.

- 10) Measure OTA ACLR for the frequency offsets both side of the passband edge as specified in table 6.5.2.5-1. In multiple carrier case only offset frequencies below the lowest and above the highest carrier frequency used shall be measured.
- 11) For the OTA ACLR requirement applied inside *gap between passbands*:
 - a) Measure OTA ACLR inside *gap between passbands*, if applicable.
 - b) Measure OTA CACLR inside *gap between passbands*, if applicable.

6.5.2.5 Test requirements

The OTA ACLR limit is specified in table 6.5.2.5-1 for DL and UL for Wide Area class and DL for Local Area class.

The OTA ACLR limit is specified in table 6.5.2.5-1a for UL for Local Area class.

The OTA ACLR absolute limit is specified in table 6.5.2.5-2.

The OTA ACLR (CACLR) absolute limit in table 6.5.2.5-2 or 6.5.2.5-5 or the ACLR (CACLR) limit in table 6.5.2.5-1, 6.5.2.5-3 or 6.5.2.5-4, whichever is less stringent, shall apply.

For a RIB operating in *non-contiguous spectrum*, the OTA ACLR requirement in table 6.5.2.5-3 shall apply in *gaps between passbands* for the frequency ranges defined in the table, while the OTA CACLR requirement in table 6.5.2.5-4 shall apply in *gaps between passbands* for the frequency ranges defined in the table.

The CACLR in a *gap between passbands* is the ratio of:

- a) the sum of the filtered mean power centred on the assigned channel frequencies for the two carriers adjacent to each side of the *gap between passbands*, and
- b) the filtered mean power centred on a frequency channel adjacent to one of the respective passband edges.

The assumed filter for the adjacent channel frequency is defined in table 6.5.2.5-4 and the filters on the assigned channels are defined in table 6.5.2.5-6.

For operation in *non-contiguous spectrum*, the CACLR for NR carriers located on either side of the *gap between passbands* shall be higher than the value specified in table 6.5.2.5-4.

For repeater type 2-O nominal repeater channel bandwidth is calculated as $\min(400\text{MHz}, BW_{\text{passband}})$.

Table 6.5.2.5-1: Repeater type 2-O ACLR limit for DL and UL for WA class and DL for LA class

Repeater nominal channel bandwidth BW_{Nominal} (MHz)	Repeater adjacent channel centre frequency offset below or above passband edge	Assumed adjacent channel carrier	Filter on the adjacent channel frequency and corresponding filter bandwidth	ACLR limit (dB)
50, 100, 200, 400	$BW_{\text{Nominal}}/2$	NR of same BW (Note 2)	Square (BW_{Config})	25.7 (Note 3) 23.4 (Note 4) 23.2 (Note 5)
NOTE 1: BW_{Nominal} is the <i>nominal channel bandwidth</i> . BW_{Config} is the <i>transmission bandwidth configuration</i> assumed for the adjacent channel.				
NOTE 2: With SCS that provides the largest <i>transmission bandwidth configuration</i> (BW_{Config}).				
NOTE 3: Applicable to bands defined within the frequency spectrum range of 24.25 – 33.4 GHz				
NOTE 4: Applicable to bands defined within the frequency spectrum range of 37 – 43.5 GHz				
NOTE 5: Applicable to bands defined within the frequency spectrum range of 43.5 – 48.2 GHz				

Table 6.5.2.5-1a: Repeater type 2-O ACLR limit for UL LA class

Repeater nominal channel bandwidth BW_{Nominal} (MHz)	Repeater adjacent channel centre frequency offset below or above passband edge	Assumed adjacent channel carrier	Filter on the adjacent channel frequency and corresponding filter bandwidth	ACLR limit (dB)
50, 100, 200, 400	$BW_{\text{Nominal}}/2$	NR of same BW (Note 2)	Square (BW_{Config})	14.7 (Note 3) 13.4 (Note 4) 13.2 (Note 5)
NOTE 1: BW_{Nominal} is the <i>nominal channel bandwidth</i> . BW_{Config} is the <i>transmission bandwidth configuration</i> assumed for the adjacent channel.				
NOTE 2: With SCS that provides the largest <i>transmission bandwidth configuration</i> (BW_{Config}).				
NOTE 3: Applicable to bands defined within the frequency spectrum range of 24.25 – 33.4 GHz				
NOTE 4: Applicable to bands defined within the frequency spectrum range of 37 – 43.5 GHz				
NOTE 5: Applicable to bands defined within the frequency spectrum range of 43.5 – 48.2 GHz				

Table 6.5.2.5-2: Repeater type 2-O ACLR absolute limit

Repeater class	ACLR absolute limit (Note 1)	ACLR absolute limit (Note 2)
Wide-area DL and UL	-10.3 dBm/MHz	-10.1 dBm/MHz
Medium-range DL	-17.3 dBm/MHz	-17.1 dBm/MHz
Local-area DL	-17.3 dBm/MHz	-17.1 dBm/MHz
NOTE 1: Applicable to bands defined within the frequency spectrum range of 24.25 – 43.5 GHz		
NOTE 2: Applicable to bands defined within the frequency spectrum range of 43.5 – 48.2 GHz		

Table 6.5.2.5-3: Repeater type 2-O ACLR limit in non-contiguous spectrum for DL and UL for WA class and DL for LA class

Repeater nominal channel bandwidth BW_{Nominal} (MHz)	Gap between passbands size (W_{gap}) where the limit applies (MHz)	Repeater adjacent channel centre frequency offset below or above passband edge (inside the gap)	Assumed adjacent channel carrier	Filter on the adjacent channel frequency and corresponding filter bandwidth	ACLR limit
50, 100, 200, 400	$W_{\text{gap}} \geq 100$ (Note 6) $W_{\text{gap}} \geq 250$ (Note 7)	25 MHz	50 MHz NR (Note 2)	Square (BW_{Config})	25.7 (Note 3) 23.4 (Note 4) 23.2 (Note 5)
50, 100, 200, 400	$W_{\text{gap}} \geq 400$ (Note 7) $W_{\text{gap}} \geq 250$ (Note 6)	100 MHz	200 MHz NR (Note 2)	Square (BW_{Config})	25.7 (Note 3) 23.4 (Note 4) 23.2 (Note 5)

NOTE 1: BW_{Config} is the *transmission bandwidth configuration* assumed for the adjacent channel.
NOTE 2: With SCS that provides the largest *transmission bandwidth configuration* (BW_{Config}).
NOTE 3: Applicable to bands defined within the frequency spectrum range of 24.25 – 33.4 GHz.
NOTE 4: Applicable to bands defined within the frequency spectrum range of 37 – 43.5 GHz.
NOTE 5: Applicable to bands defined within the frequency spectrum range of 43.5 – 52.6 GHz.
NOTE 6: Applicable in case the *nominal channel bandwidth* at the other edge of the gap is ≤ 100 MHz.
NOTE 7: Applicable in case the *nominal channel bandwidth* at the other edge of the gap is > 100 MHz.

Table 6.5.2.2-3a: Repeater type 2-O ACLR limit in non-contiguous spectrum for UL for LA class

Repeater nominal channel bandwidth BW_{Nominal} (MHz)	Gap between passbands size (W_{gap}) where the limit applies (MHz)	Repeater adjacent channel centre frequency offset below or above the passband edge (inside the gap)	Assumed adjacent channel carrier	Filter on the adjacent channel frequency and corresponding filter bandwidth	ACLR limit
50, 100, 200, 400	$W_{\text{gap}} \geq 100$ (Note 6) $W_{\text{gap}} \geq 250$ (Note 7)	25 MHz	50 MHz NR (Note 2)	Square (BW_{Config})	14.7 (Note 3) 13.4 (Note 4) 13.2 (Note 5)
50, 100, 200, 400	$W_{\text{gap}} \geq 400$ (Note 7) $W_{\text{gap}} \geq 250$ (Note 6)	100 MHz	200 MHz NR (Note 2)	Square (BW_{Config})	14.7 (Note 3) 13.4 (Note 4) 13.2 (Note 5)

NOTE 1: BW_{Config} is the *transmission bandwidth configuration* assumed for the adjacent channel.
NOTE 2: With SCS that provides the largest *transmission bandwidth configuration* (BW_{Config}).
NOTE 3: Applicable to bands defined within the frequency spectrum range of 24.25 – 33.4 GHz.
NOTE 4: Applicable to bands defined within the frequency spectrum range of 37 – 43.5 GHz.
NOTE 5: Applicable to bands defined within the frequency spectrum range of 43.5 – 52.6 GHz.
NOTE 6: Applicable in case the *nominal channel bandwidth* at the other edge of the gap is ≤ 100 MHz.
NOTE 7: Applicable in case the *nominal channel bandwidth* at the other edge of the gap is > 100 MHz.

Table 6.5.2.5-4: Repeater type 2-O CA CLR limit in non-contiguous spectrum for DL and UL for WA class and DL for LA class

Repeater nominal channel bandwidth BW_{Nominal} (MHz)	Gap between passbands size (W_{gap}) where the limit applies (MHz)	Repeater adjacent channel centre frequency offset below or above passband edge (inside the gap)	Assumed adjacent channel carrier	Filter on the adjacent channel frequency and corresponding filter bandwidth	CA CLR limit
50, 100, 200, 400	$50 \leq W_{\text{gap}} < 100$ (Note 6) $50 \leq W_{\text{gap}} < 250$ (Note 7)	25 MHz	50 MHz NR (Note 2)	Square (BW_{Config})	25.7 (Note 3) 23.4 (Note 4) 23.2 (Note 5)
50, 100, 200, 400	$200 \leq W_{\text{gap}} < 400$ (Note 7) $200 \leq W_{\text{gap}} < 250$ (Note 6)	100 MHz	200 MHz NR (Note 2)	Square (BW_{Config})	25.7 (Note 3) 23.4 (Note 4) 23.2 (Note 5)

NOTE 1: BW_{Config} is the nominal bandwidth configuration of the assumed adjacent channel carrier.
NOTE 2: With SCS that provides nominal bandwidth configuration (BW_{Config}).
NOTE 3: Applicable to bands defined within the frequency spectrum range of 24.25 – 33.4 GHz.
NOTE 4: Applicable to bands defined within the frequency spectrum range of 37 – 43.5 GHz.
NOTE 5: Applicable to bands defined within the frequency spectrum range of 43.5 – 52.6 GHz.
NOTE 6: Applicable in case the *nominal channel bandwidth* at the other edge of the gap is ≤ 100 MHz.
NOTE 7: Applicable in case the *nominal channel bandwidth* at the other edge of the gap is > 100 MHz.

Table 6.5.2.5-4a: Repeater type 2-O CA CLR limit in non-contiguous spectrum for UL for LA class

Repeater channel bandwidth BW_{Nominal} (MHz)	Gap between passbands size (W_{gap}) where the limit applies (MHz)	Repeater adjacent channel centre frequency offset below or above the passband edge (inside the gap)	Assumed adjacent channel carrier	Filter on the adjacent channel frequency and corresponding filter bandwidth	CA CLR limit
50, 100, 200, 400	$50 \leq W_{\text{gap}} < 100$ (Note 6) $50 \leq W_{\text{gap}} < 250$ (Note 7)	25 MHz	50 MHz NR (Note 2)	Square (BW_{Config})	14.7 (Note 3) 13.4 (Note 4) 13.2 (Note 5)
50, 100, 200, 400	$200 \leq W_{\text{gap}} < 400$ (Note 7) $200 \leq W_{\text{gap}} < 250$ (Note 6)	100 MHz	200 MHz NR (Note 2)	Square (BW_{Config})	14.7 (Note 3) 13.4 (Note 4) 13.2 (Note 5)

NOTE 1: BW_{Config} is the *transmission bandwidth configuration* assumed for the adjacent channel.
NOTE 2: With SCS that provides the largest *transmission bandwidth configuration* (BW_{Config}).
NOTE 3: Applicable to bands defined within the frequency spectrum range of 24.25 – 33.4 GHz.
NOTE 4: Applicable to bands defined within the frequency spectrum range of 37 – 43.5 GHz.
NOTE 5: Applicable to bands defined within the frequency spectrum range of 43.5 – 52.6 GHz.
NOTE 6: Applicable in case the *nominal channel bandwidth* at the other edge of the gap is ≤ 100 MHz.
NOTE 7: Applicable in case the *nominal channel bandwidth* at the other edge of the gap is > 100 MHz.

Table 6.5.2.5-5: Repeater type 2-O CA CLR absolute limit

Repeater class	CA CLR absolute limit (Note 1)	CA CLR absolute limit (Note 2)
Wide-area DL and UL	-10.3 dBm/MHz	-10.1 dBm/MHz
Medium-range DL	-17.3 dBm/MHz	-17.1 dBm/MHz
Local-area DL	-17.3 dBm/MHz	-17.1 dBm/MHz

NOTE 1: Applicable to bands defined within the frequency spectrum range of 24.25 – 43.5 GHz
NOTE 2: Applicable to bands defined within the frequency spectrum range of 43.5 – 48.2 GHz

Table 6.5.2.5-6: Filter parameters for the assigned channel

RAT of the carrier adjacent to the <i>gap between passbands</i>	Filter on the assigned channel frequency and corresponding filter bandwidth
NR	NR of same BW with SCS that provides largest <i>transmission bandwidth configuration</i>

6.5.3 OTA operating band unwanted emissions

6.5.3.1 Definition and applicability

The requirements of either clause 6.5.3.4.1 (Category A limits) or clause 6.5.3.4.2 (Category B limits) shall apply. The application of either Category A or Category B limits shall be the same as for General OTA transmitter spurious emissions requirements (*repeater type 2-O*) in clause 6.5.4. In addition, the limits in clause 6.5.3.4.3 may also apply.

Out-of-band emissions in FR2 are limited by OTA operating band unwanted emission limits.

For *repeater type 2-O*, unless otherwise stated, the OTA operating band unwanted emission limits in FR2 are defined from Δf_{OBUE} below the lowest frequency of each supported downlink *operating band* up to Δf_{OBUE} above the highest frequency of each supported downlink *operating band*.

The values of Δf_{OBUE} are defined in table 6.5.1-1 for the NR *operating bands*.

The requirements shall apply whatever the type of transmitter considered and for all transmission modes foreseen by the manufacturer's specification. For a *RIB* operating in contiguous CA, the requirements apply to the frequencies (Δf_{OBUE}) starting from the edge of the *passband*. In addition, for a *RIB* operating in *non-contiguous spectrum*, the requirements apply inside any *gap between passbands*.

Emissions shall not exceed the maximum levels specified in the tables below, where:

- Δf is the separation between the *passband* edge frequency and the nominal -3dB point of the measuring filter closest to the *passband* edge.
- f_{offset} is the separation between the *passband* edge frequency and the centre of the measuring filter.
- $f_{\text{offset}_{\text{max}}}$ is the offset to the frequency Δf_{OBUE} outside the downlink *operating band*, where Δf_{OBUE} is defined in table 6.5.1-1.
- Δf_{max} is equal to $f_{\text{offset}_{\text{max}}}$ minus half of the bandwidth of the measuring filter.

In addition, inside any *gap between passbands* for a *RIB* operating in *non-contiguous spectrum*, emissions shall not exceed the cumulative sum of the limits specified for the adjacent *sub-blocks* on each side of the *gap between passbands*. The limit for each *sub-block* is specified in clauses 6.5.3.4.1 and 6.5.3.4.2 below, where in this case:

- Δf is the separation between the *sub-block* edge frequency and the nominal -3 dB point of the measuring filter closest to the *sub-block* edge.
- f_{offset} is the separation between the *sub-block* edge frequency and the centre of the measuring filter.
- $f_{\text{offset}_{\text{max}}}$ is equal to the *gap between passbands* bandwidth minus half of the bandwidth of the measuring filter.

- Δf_{\max} is equal to $f_{\text{offset}_{\max}}$ minus half of the bandwidth of the measuring filter.

6.5.3.2 Minimum requirement

The minimum requirement is defined in TS 38.106 [2], clause 7.5.3.2

6.5.3.3 Test purpose

This test measures the emissions close to the assigned channel bandwidth of the wanted signal, while the transmitter is in operation.

6.5.3.4 Method of test

6.5.3.4.1 Initial conditions

Test environment: Normal; see annex B.2.

RF channels to be tested for single carrier: B, M and T; see clause 4.9.1.

6.5.3.4.2 Procedure

The following procedure for measuring TRP is based on the directional power measurements as described in annex I.

- 1) Place the repeater at the positioner.
- 2) Align the manufacturer declared coordinate system orientation (D.2) of the repeater with the test system.
- 3) The measurement devices characteristics shall be:
 - detection mode: true RMS.
 - As a general rule, the resolution bandwidth of the measuring equipment should be equal to the measurement bandwidth. However, to improve measurement accuracy, sensitivity, efficiency and avoiding e.g. carrier leakage, the resolution bandwidth may be smaller than the measurement bandwidth. When the resolution bandwidth is smaller than the measurement bandwidth, the result should be integrated over the measurement bandwidth in order to obtain the equivalent noise bandwidth of the measurement bandwidth.
- 4a) Set the input signal at the RIB according to the applicable test configuration and direction in clause 4.8 using the corresponding test models RDL-FR2-TM1.1 and RUL-FR2-TM1.1 in clause 4.9.2 at the input power intended to produce the maximum rated output power, $P_{\text{in,p,EIRP}} + 10\text{dB}$.
- 4b) Verify measurement impact from feeding test signal by generating a signal for repeater input with repeater to be turned off. Verify measured result is enough below requirement limit.
- 5) Orient the positioner (and repeater and test signal source) in order that the direction to be tested aligns with the test antenna such that measurements to determine TRP can be performed (see annex G) whilst maintaining the correct direction of arrival for the test signal.
- 6) Step the centre frequency of the measurement filter in contiguous steps and measure the emission within the specified frequency ranges with the specified measurement bandwidth. For connector under test declared to

operate in non-contiguous spectrum, the emission within the *sub-block gap* shall be measured using the specified measurement bandwidth from the closest sub block edge.

- 7) Repeat step 5-6 for all directions in the appropriated TRP measurement grid needed for $TRP_{Estimate}$ (see annex G).
- 8) Calculate $TRP_{Estimate}$ using the measurements made in Step 7.

6.5.3.4 Test requirements

6.5.3.4.1 OTA operating band unwanted emission limits (Category A)

Repeater type 2-O unwanted emissions shall not exceed the maximum levels specified in table 6.5.3.4.1-1 or 6.5.3.4.1-2 or 6.5.3.4.1-3.

Table 6.5.3.4.1-1: OBUE limits applicable in the frequency range 24.25 – 33.4 GHz

Frequency offset of measurement filter -3B point, Δf	Frequency offset of measurement filter centre frequency, f_{offset}	Limit	Measurement bandwidth
$0 \text{ MHz} \leq \Delta f < 0.1 * BW_{contiguous}$	$0.5 \text{ MHz} \leq f_{offset} < 0.1 * BW_{contiguous} + 0.5 \text{ MHz}$	Min(-2.3 dBm, Max($P_{rated,t,TRP} - 32.3 \text{ dB}$, -9.3 dBm))	1 MHz
$0.1 * BW_{contiguous} \leq \Delta f < \Delta f_{max}$	$0.1 * BW_{contiguous} + 0.5 \text{ MHz} \leq f_{offset} < f_{offset_{max}}$	Min(-13 dBm, Max($P_{rated,t,TRP} - 43 \text{ dB}$, -20 dBm))	1 MHz
NOTE 1: For <i>non-contiguous spectrum</i> operation within any <i>operating band</i> the limit within <i>gaps between passbands</i> is calculated as a cumulative sum of contributions from adjacent <i>sub-blocks</i> on each side of the <i>gap between passbands</i> .			

Table 6.5.3.4.1-2: OBUE limits applicable in the frequency range 37 – 43.5 GHz

Frequency offset of measurement filter -3B point, Δf	Frequency offset of measurement filter centre frequency, f_{offset}	Limit	Measurement bandwidth
$0 \text{ MHz} \leq \Delta f < 0.1 * BW_{contiguous}$	$0.5 \text{ MHz} \leq f_{offset} < 0.1 * BW_{contiguous} + 0.5 \text{ MHz}$	Min(-2.3 dBm, Max($P_{rated,t,TRP} - 30.3 \text{ dB}$, -9.3 dBm))	1 MHz
$0.1 * BW_{contiguous} \leq \Delta f < \Delta f_{max}$	$0.1 * BW_{contiguous} + 0.5 \text{ MHz} \leq f_{offset} < f_{offset_{max}}$	Min(-13 dBm, Max($P_{rated,t,TRP} - 41 \text{ dB}$, -20 dBm))	1 MHz
NOTE 1: For <i>non-contiguous spectrum</i> operation within any <i>operating band</i> the limit within <i>gaps between passbands</i> is calculated as a cumulative sum of contributions from adjacent <i>sub-blocks</i> on each side of the <i>gap between passbands</i> .			

Table 6.5.3.4.1-3: OBUE limits applicable in the frequency range 43.5 – 48.2 GHz

Frequency offset of measurement filter -3B point, Δf	Frequency offset of measurement filter centre frequency, f_{offset}	Limit	Measurement bandwidth
$0 \text{ MHz} \leq \Delta f < 0.1 * BW_{\text{contiguous}}$	$0.5 \text{ MHz} \leq f_{\text{offset}} < 0.1 * BW_{\text{contiguous}} + 0.5 \text{ MHz}$	Min(-2.1 dBm, Max($P_{\text{rated,t,TRP}} - 30.1 \text{ dB}$, -9.1 dBm))	1 MHz
$0.1 * BW_{\text{contiguous}} \leq \Delta f < \Delta f_{\text{max}}$	$0.1 * BW_{\text{contiguous}} + 0.5 \text{ MHz} \leq f_{\text{offset}} < f_{\text{offsetmax}}$	Min(-13 dBm, Max($P_{\text{rated,t,TRP}} - 41 \text{ dB}$, -20 dBm))	1 MHz
NOTE 1: For <i>non-contiguous spectrum</i> operation within any <i>operating band</i> the limit within <i>gaps between passbands</i> is calculated as a cumulative sum of contributions from adjacent <i>sub-blocks</i> on each side of the <i>gap between passbands</i> .			

6.5.3.4.2 OTA operating band unwanted emission limits (Category B)

Repeater type 2-O unwanted emissions shall not exceed the maximum levels specified in table 6.5.3.4.2-1 or 6.5.3.4.2-2 or 6.5.3.4.2-3.

Table 6.5.3.4.2-1: OBUE limits applicable in the frequency range 24.25 – 33.4 GHz

Frequency offset of measurement filter -3 dB point, Δf	Frequency offset of measurement filter centre frequency, f_{offset}	Limit	Measurement bandwidth
$0 \text{ MHz} \leq \Delta f < 0.1 * BW_{\text{contiguous}}$	$0.5 \text{ MHz} \leq f_{\text{offset}} < 0.1 * BW_{\text{contiguous}} + 0.5 \text{ MHz}$	Min(-2.3 dBm, Max($P_{\text{rated,t,TRP}} - 32.3 \text{ dB}$, -9.3 dBm))	1 MHz
$0.1 * BW_{\text{contiguous}} \leq \Delta f < \Delta f_{\text{B}}$	$0.1 * BW_{\text{contiguous}} + 0.5 \text{ MHz} \leq f_{\text{offset}} < \Delta f_{\text{B}} + 0.5 \text{ MHz}$	Min(-13 dBm, Max($P_{\text{rated,t,TRP}} - 43 \text{ dB}$, -20 dBm))	1 MHz
$\Delta f_{\text{B}} \leq \Delta f < \Delta f_{\text{max}}$	$\Delta f_{\text{B}} + 5 \text{ MHz} \leq f_{\text{offset}} < f_{\text{offsetmax}}$	Min(-5 dBm, Max($P_{\text{rated,t,TRP}} - 33 \text{ dB}$, -10 dBm))	10 MHz
NOTE 1: For non-contiguous spectrum operation within any <i>operating band</i> the limit within <i>gaps between passbands</i> is calculated as a cumulative sum of contributions from adjacent <i>sub-blocks</i> on each side of the <i>gap between passbands</i> .			
NOTE 2: $\Delta f_{\text{B}} = 2 * BW_{\text{contiguous}}$ when $BW_{\text{contiguous}} \leq 500 \text{ MHz}$, otherwise $\Delta f_{\text{B}} = BW_{\text{contiguous}} + 500 \text{ MHz}$.			

Table 6.5.3.4.2-2: OBUE limits applicable in the frequency range 37 – 43.5 GHz

Frequency offset of measurement filter -3 dB point, Δf	Frequency offset of measurement filter centre frequency, f_{offset}	Limit	Measurement bandwidth
$0 \text{ MHz} \leq \Delta f < 0.1 * BW_{\text{contiguous}}$	$0.5 \text{ MHz} \leq f_{\text{offset}} < 0.1 * BW_{\text{contiguous}} + 0.5 \text{ MHz}$	Min(-2.3 dBm, Max($P_{\text{rated,t,TRP}} - 30.3 \text{ dB}$, -9.3 dBm))	1 MHz
$0.1 * BW_{\text{contiguous}} \leq \Delta f < \Delta f_{\text{B}}$	$0.1 * BW_{\text{contiguous}} + 0.5 \text{ MHz} \leq f_{\text{offset}} < \Delta f_{\text{B}} + 0.5 \text{ MHz}$	Min(-13 dBm, Max($P_{\text{rated,t,TRP}} - 41 \text{ dB}$, -20 dBm))	1 MHz
$\Delta f_{\text{B}} \leq \Delta f < \Delta f_{\text{max}}$	$\Delta f_{\text{B}} + 5 \text{ MHz} \leq f_{\text{offset}} < f_{\text{offsetmax}}$	Min(-5 dBm, Max($P_{\text{rated,t,TRP}} - 31 \text{ dB}$, -10 dBm))	10 MHz
NOTE 1: For non-contiguous spectrum operation within any <i>operating band</i> the limit within <i>gaps between passbands</i> is calculated as a cumulative sum of contributions from adjacent <i>sub-blocks</i> on each side of the <i>gap between passbands</i> .			
NOTE 2: $\Delta f_{\text{B}} = 2 * BW_{\text{contiguous}}$ when $BW_{\text{contiguous}} \leq 500 \text{ MHz}$, otherwise $\Delta f_{\text{B}} = BW_{\text{contiguous}} + 500 \text{ MHz}$.			

Table 6.5.3.4.2-2: OBUE limits applicable in the frequency range 43.5 - 48.2 GHz

Frequency offset of measurement filter -3 dB point, Δf	Frequency offset of measurement filter centre frequency, f_{offset}	Limit	Measurement bandwidth
$0 \text{ MHz} \leq \Delta f < 0.1 * BW_{\text{contiguous}}$	$0.5 \text{ MHz} \leq f_{\text{offset}} < 0.1 * BW_{\text{contiguous}} + 0.5 \text{ MHz}$	Min(-2.3 dBm, Max($P_{\text{rated,t,TRP}} - 30.3 \text{ dB}$, -9.3 dBm))	1 MHz
$0.1 * BW_{\text{contiguous}} \leq \Delta f < \Delta f_{\text{B}}$	$0.1 * BW_{\text{contiguous}} + 0.5 \text{ MHz} \leq f_{\text{offset}} < \Delta f_{\text{B}} + 0.5 \text{ MHz}$	Min(-13 dBm, Max($P_{\text{rated,t,TRP}} - 41 \text{ dB}$, -20 dBm))	1 MHz
$\Delta f_{\text{B}} \leq \Delta f < \Delta f_{\text{max}}$	$\Delta f_{\text{B}} + 5 \text{ MHz} \leq f_{\text{offset}} < f_{\text{offset}_{\text{max}}}$	Min(-5 dBm, Max($P_{\text{rated,t,TRP}} - 31 \text{ dB}$, -10 dBm))	10 MHz
NOTE 1: For non-contiguous spectrum operation within any <i>operating band</i> the limit within gaps between <i>passbands</i> is calculated as a cumulative sum of contributions from adjacent sub-blocks on each side of the gap between <i>passbands</i> .			
NOTE 2: $\Delta f_{\text{B}} = 2 * BW_{\text{contiguous}}$ when $BW_{\text{contiguous}} \leq 500 \text{ MHz}$, otherwise $\Delta f_{\text{B}} = BW_{\text{contiguous}} + 500 \text{ MHz}$.			

6.5.3.4.3 Additional OTA operating band unwanted emission requirements

6.5.3.4.3.1 Protection of Earth Exploration Satellite Service

For repeater operating in the frequency range 24.25 – 27.5 GHz, the power of unwanted emission shall not exceed the limits in table 6.5.3.4.3.1-1 for DL and in table 6.5.3.4.3.1-2 for UL.

Table 6.5.3.4.3.1-1: OBUE limits for protection of Earth Exploration Satellite Service for DL

Frequency range	Limit	Measurement Bandwidth
23.6 – 24 GHz	-3 dBm (Note 1)	200 MHz
23.6 – 24 GHz	-9 dBm (Note 2)	200 MHz
NOTE 1: This limit applies to repeater brought into use on or before 1 September 2027.		
NOTE 2: This limit applies to repeater brought into use after 1 September 2027.		

Table 6.5.3.4.3.1-2: OBUE limits for protection of Earth Exploration Satellite Service for UL

Frequency range	Limit	Measurement Bandwidth
23.6 – 24 GHz	1 dBm	200 MHz

6.5.4 OTA transmitter spurious emissions

6.5.4.1 Definition and applicability

For *repeater type 2-O*, the OTA transmitter spurious emission limits apply from 30 MHz to 2nd harmonic of the upper frequency edge of the downlink *operating band*, excluding the frequency range from Δf_{OBUE} below the lowest frequency of the downlink *operating band*, up to Δf_{OBUE} above the highest frequency of the downlink *operating band*, where the Δf_{OBUE} is defined in table 6.5.1-1.

6.5.4.2 Minimum requirement

The minimum requirement is defined in TS 38.106 [2], clause 7.5.4.2.2.

6.5.4.3 Test purpose

This test measures conducted spurious emissions while the transmitter is in operation.

6.5.4.4 Method of test

6.5.4.4.1 Initial conditions

Test environment: Normal; see annex B.2.

RF channels to be tested for single carrier:

- B when testing the spurious emissions below $F_{DL_low} - \Delta f_{OBUE}$,
- T when testing the spurious emissions above $F_{DL_high} + \Delta f_{OBUE}$; see clause 4.9.1.

6.5.4.4.2 Procedure

The following procedure for measuring TRP is based on the directional power measurements as described in annex.

- 1) Place the repeater at the positioner.
- 2) Align the manufacturer declared coordinate system orientation (D.2) of the repeater with the test system.
- 3) The measurement devices characteristics shall be:
 - detection mode: true RMS.
- 4a) Set the input signal at the RIB according to the applicable test configuration and direction in clause 4.8 using the corresponding test models RDL-FR2-TM1.1 and RUL-FR2-TM1.1 in clause 4.9.2 at the input power intended to produce the maximum rated output power, $P_{in,p,EIRP} + 10dB$.
- 4b) Verify measurement impact from feeding test signal by generating a signal for repeater input with repeater to be turned off. Verify measured result is enough below requirement limit.
- 5) Orient the positioner (and repeater and test signal source) in order that the direction to be tested aligns with the test antenna such that measurements to determine TRP can be performed with the specified measurement bandwidth (see annex I) whilst maintaining the correct direction of arrival for the test signal.
- 7) Repeat step 5-6 for all directions in the appropriated TRP measurement grid needed for $TRP_{Estimate}$ (see annex G).
- 8) Calculate $TRP_{Estimate}$ using the measurements made in Step 7.

6.5.4.5 Test requirements

6.5.4.5.1 General

The requirements of either clause 6.5.4.5.2 (Category A limits) or clause 6.5.4.5.3 (Category B limits) shall apply. The application of either Category A or Category B limits shall be the same as for Operating band unwanted emissions in clause 6.5.3.

6.5.4.5.2 OTA transmitter spurious emissions (Category A)

The power of any spurious emission shall not exceed the limits in table 6.5.4.5.2-1

Table 6.5.4.5.2-1: Repeater radiated Tx spurious emission limits in FR2

Frequency range	Limit	Measurement Bandwidth	Note
30 MHz – 1 GHz	-13 dBm	100 kHz	Note 1
1 GHz – 2 nd harmonic of the upper frequency edge of the <i>passband</i>		1 MHz	Note 1, Note 2
NOTE 1: Bandwidth as in ITU-R SM.329 [4], s4.1			
NOTE 2: Upper frequency as in ITU-R SM.329 [4], s2.5 table 1.			

6.5.4.5.3 OTA transmitter spurious emissions (Category B)

The power of any spurious emission shall not exceed the limits in table 6.5.4.5.3-1.

Table 6.5.4.5.3-1: Repeater radiated Tx spurious emission limits in FR2 (Category B)

Frequency range (Note 4)	Limit	Measurement Bandwidth	Note
30 MHz ↔ 1 GHz	-36 dBm	100 kHz	Note 1
1 GHz ↔ 18 GHz	-30 dBm	1 MHz	Note 1
18 GHz ↔ $F_{\text{step},1}$	-20 dBm	10 MHz	Note 2
$F_{\text{step},1}$ ↔ $F_{\text{step},2}$	-15 dBm	10 MHz	Note 2
$F_{\text{step},2}$ ↔ $F_{\text{step},3}$	-10 dBm	10 MHz	Note 2
$F_{\text{step},4}$ ↔ $F_{\text{step},5}$	-10 dBm	10 MHz	Note 2
$F_{\text{step},5}$ ↔ $F_{\text{step},6}$	-15 dBm	10 MHz	Note 2
$F_{\text{step},6}$ ↔ 2 nd harmonic of the upper frequency edge of the <i>passband</i>	-20 dBm	10 MHz	Note 2, Note 3
NOTE 1: Bandwidth as in ITU-R SM.329 [5], s4.1			
NOTE 2: Limit and bandwidth as in ERC Recommendation 74-01 [9], Annex 2.			
NOTE 3: Upper frequency as in ITU-R SM.329 [5], s2.5 table 1.			
NOTE 4: The step frequencies $F_{\text{step},X}$ are defined in Table 6.5.4.5.3-2.			

Table 6.5.4.5.3-2: Step frequencies for defining the Repeater radiated Tx spurious emission limits in FR2 (Category B)

Operating band	F _{step,1} (GHz)	F _{step,2} (GHz)	F _{step,3} (GHz) (Note 2)	F _{step,4} (GHz) (Note 2)	F _{step,5} (GHz)	F _{step,6} (GHz)
n258	18	21	22.75	29	30.75	40.5
n259	23.5	35.5	38	45	47.5	59.5
NOTE 1: F _{step,X} are based on ERC Recommendation 74-01 [9], Annex 2.						
NOTE 2: F _{step,3} and F _{step,4} are aligned with the values for Δf _{OBUE} in Table 6.5.1-1						

6.5.4.5.4 Additional OTA transmitter spurious emissions requirements

These requirements may be applied for the protection of systems operating in frequency ranges other than the repeater-Node. The limits may apply as an optional protection of such systems that are deployed in the same geographical area as the repeater-Node, or they may be set by local or regional regulation as a mandatory requirement for an NR *operating band*. It is in some cases not stated in the present document whether a requirement is mandatory or under what exact circumstances that a limit applies, since this is set by local or regional regulation.

6.5.4.5.4.1 Limits for protection of Earth Exploration Satellite Service

For repeater operating in the frequency range 24.25 – 27.5 GHz, the power of any spurious emissions shall not exceed the limits in Table 6.5.4.5.4.1-1 and Table 6.5.4.5.4.1-2.

Table 6.5.4.5.4.1-1: Limits for protection of Earth Exploration Satellite Service for DL

Frequency range	Limit	Measurement Bandwidth	Note
23.6 – 24 GHz	-3 dBm	200 MHz	Note 1
23.6 – 24 GHz	-9 dBm	200 MHz	Note 2
NOTE 1: This limit applies to Repeater brought into use on or before 1 September 2027.			
NOTE 2: This limit applies to Repeater brought into use after 1 September 2027.			

Table 6.5.4.5.4.1-2: OBUE limits for protection of Earth Exploration Satellite Service for UL

Frequency range	Limit	Measurement Bandwidth
23.6 – 24 GHz	1 dBm	200 MHz

6.6 OTA Repeater Error Vector Magnitude

6.6.1 Downlink repeater error vector magnitude

6.6.1.1 General

The Repeater Error Vector Magnitude (EVM) is a measure of the difference between the symbols provided at the input of the repeater and the measured signal symbols at the output of the repeater after the equalization by the measurement equipment. This difference is called the error vector. Details about how the repeater EVM is determined are the same as

specified in TS 38.104 [5] Annex [C] for FR2. The repeater EVM result is defined as the square root of the ratio of the mean error vector power to the mean reference power expressed in percent. The accuracy of the input symbols is counted in the measurement uncertainty.

OTA modulation quality requirement is defined as a *directional requirement* at the RIB and shall be met within the *OTA coverage range* on the transmit side and the AoA of the incident wave of the received signal is in the reference direction at the receive side.

The repeater EVM requirement is applicable when the repeater is operating with an input power level within the range from what is required to reach the rated beam EIRP output power ($P_{\text{rated,p,EIRP}}$) to the minimum power levels in table 6.6.1.1-1.

Table 6.6.1.1-1: Minimum input power for repeater EVM

BS class	Minimum input power (dBm/MHz)					
	24.25 – 33.4 GHz			37 – 52.6 GHz		
	Up to 16 QAM	64QAM ¹	256QAM ²	Up to 16 QAM	64QAM ¹	256QAM ²
WA, MR, LA	-77- $G_{\text{RX_ANT}}$	-73- $G_{\text{RX_ANT}}$	-66- $G_{\text{RX_ANT}}$	-75- $G_{\text{RX_ANT}}$	-71- $G_{\text{RX_ANT}}$	-64- $G_{\text{RX_ANT}}$
Note 1: support of 64QAM is based on the declaration						
Note 2: support of 256QAM is based on the declaration						

Where $G_{\text{RX_ANT}}$ is the gain of the receive side antennas and is based on EIRP and TRP declaration.

6.6.1.2 Minimum requirements

The minimum requirement is in TS 38.106 [2] clause 7.6.1.2.

6.6.1.3 Test purpose

To verify that the downlink repeater EVM deterioration is within the limit specified by the minimum requirements after the signal passed through the Repeater.

6.6.1.4 Method of test

6.6.1.4.1 Initial conditions

Test environment: normal; see Annex [B.2]

RF channels to be tested for single carrier:

- B and T; see clause 4.9.1.

Passband positions to be tested for multi-carrier:

- B_{RFBW} and T_{RFBW} in single-band operation, see clause 4.9.1;

Directions to be tested:

- The OTA coverage range reference direction (D.14).
- The OTA coverage range maximum directions (D.15).

Polarizations to be tested: For dual polarized systems the requirement shall be tested and met for both polarizations.

6.6.1.4.2 Procedure

- 1a) Place the repeater at the positioner.
- 1b) Verify measurement impact from feeding test signal by generating a signal for repeater input with repeater to be turned off. Verify measured result is enough below requirement limit.
- 2) Align the manufacturer declared coordinate system orientation (D.2) of the repeater with the test system.
- 3) Orient the positioner (and repeater) in order that the direction to be tested aligns with the test antenna.

For *repeater type 2-O* declared to be capable of single carrier operation only, set the repeater to transmit a signal according to the applicable test signal configuration and corresponding power setting specified in clause 4.7.2 and 4.8 using the corresponding test models on all carriers configured:

- RDL-FR2-TM3.1a with 256QAM signal if 256QAM is supported by repeater without power back off, or
- RDL-FR2-TM3.1a at manufacturer's declared rated output power if 256QAM is supported by repeater with power back off, and RDL-FR2-TM3.1 with highest modulation order supported without power back off, or
- RDL-FR2-TM3.1 with 64QAM signal if 64QAM is supported by repeater without power back off, or
- RDL-FR2-TM3.1 with highest modulation order without power back off if 64QAM is not supported by repeater, or
- if 64 QAM is supported by repeater with power back off, RDL-FR2-TM 3.1 with 64QAM at manufacturer's declared rated output power ($P_{\text{rated,c,EIRP}}$) and RDL-FR2-TM3.1 with highest modulation order supported at maximum power.

For *repeater type 2-O* declared to be capable of multi-carrier, set the repeater to transmit according to:

- RDL-FR2-TM3.1a with 256QAM signal if 256QAM is supported by repeater without power back off, or
- RDL-FR2-TM3.1a at manufacturer's declared rated output power if 256QAM is supported by repeater with power back off, and RDL-FR2-TM3.1 at maximum power, or
- RDL-FR2-TM3.1 with 64QAM signal if 64QAM is supported by repeater without power back off, or
- RDL-FR2-TM3.1 with highest modulation order supported without power back off if 64QAM is not supported by repeater, or
- if 64QAM is supported by repeater with power back off, RDL-FR2-TM3.1 with 64QAM signal at manufacturer's declared rated output power ($P_{\text{rated,c,EIRP}}$) and RDL-FR2-TM3.1 with highest supported modulation order at maximum power

For RDL-FR1-TM 3.1a and RDL-FR2-TM 3.1, power back-off shall be applied if it is declared.

- 5) For each carrier, measure the repeater EVM and frequency error as defined in annex L.
- 6) Adjust the input power to the Repeater to create the maximum nominal Repeater output power at maximum gain.
- 7) Measure the repeater EVM and frequency error as defined in TS 38.141-2 [6] Annex [F].

8) Repeat the procedure with all the narrower bandwidths.

6.6.1.5 Test requirement

The downlink of the Repeater EVM levels for different modulation schemes shall not exceed values in table 6.6.1.5-1.

Table 6.6.1.5-1: Repeater EVM test requirements

Parameter	Required EVM
Up to 16QAM	13.9 %
64QAM	9.5 % ¹
256QAM	5.3 % ²
Note 1: support of 64QAM is based on the declaration	
Note 2: support of 256QAM is based on the declaration.	

6.6.2 Uplink Repeater error vector magnitude

6.6.2.1 General

The Repeater Error Vector Magnitude is a measure of the difference between the reference waveform provided at the input of the repeater and the measured waveform at the output of the repeater. This difference is called the error vector. Details about how the repeater EVM is determined are the same as specified in TS 38.101-2 [14] Annex F. Before calculating the repeater EVM, the measured waveform is corrected by the sample timing offset and RF frequency offset. Then the carrier leakage shall be removed from the measured waveform before calculating the repeater EVM.

The measured waveform is further equalised using the channel estimates subjected to the repeater EVM equaliser spectrum flatness requirement specified in TS 38.101-2 [14] sub-clauses 6.4.2.4 and 6.4.2.5. For DFT-s-OFDM waveforms, the repeater EVM result is defined after the front-end FFT and IDFT as the square root of the ratio of the mean error vector power to the mean reference power expressed as a %. For CP-OFDM waveforms, the repeater EVM result is defined after the front-end FFT as the square root of the ratio of the mean error vector power to the mean reference power expressed as a %. The accuracy of the input waveform is counted in the measurement uncertainty.

The basic repeater EVM measurement interval is one slot in the time domain. The repeater EVM measurement interval is reduced by any symbols that contains an allowable power transient in the measurement interval as defined in TS 38.101-2 clause 6.3.3 for EVM for UE.

All the parameters defined in clause 6.6.2 are defined using the measurement methodology specified in TS 38.101-2 [14] Annex F.

OTA modulation quality requirement is defined as a *directional requirement* at the RIB and shall be met within the *OTA coverage range* on the transmit side and the AoA of the incident wave of the received signal is in the reference direction at the receive side.

The repeater EVM requirement is applicable when the repeater is operating with an input power level within the range from what is required to reach the rated beam EIRP output power ($P_{\text{rated,p,EIRP}}$) to the minimum input power levels in table 6.6.2.1-1.

Table 6.6.2.1-1: Minimum input power for repeater EVM

BS class	Minimum input power (dBm/MHz)			
	24.25 – 33.4 GHz		37 – 52.6 GHz	
	Up to 16 QAM	64QAM ¹	Up to 16 QAM	64QAM ¹
WA, MR, LA	$-77 - G_{RX_ANT}$	$-73 - G_{RX_ANT}$	$-75 - G_{RX_ANT}$	$-71 - G_{RX_ANT}$
Note 1: support of 64QAM is based on the declaration				

Where G_{RX_ANT} is the gain of the receive side antennas and is calculated from EIRP and TRP declaration.

6.6.2.2 Minimum requirement

The minimum requirement is in TS 38.106 [2] clause 7.6.2.2.

6.6.2.3 Test purpose

To verify that the uplink repeater EVM deterioration is within the limit specified by the minimum requirements after the signal passed through the Repeater.

6.6.2.4 Method of test

6.6.2.4.1 Initial conditions

RF channels to be tested for single carrier:

- B and T; see clause 4.9.1.

Passband positions to be tested for multi-carrier:

- B_{RFBW} and T_{RFBW} in single-band operation, see clause 4.9.1;

Directions to be tested:

- The OTA coverage range reference direction [(D.14)].
- The OTA coverage range maximum directions [(D.15)].

Polarizations to be tested: For dual polarized systems the requirement shall be tested and met for both polarizations.

6.6.2.4.2 Procedure

- 1a) Place the repeater at the positioner.
- 1b) Verify measurement impact from feeding test signal by generating a signal for repeater input with repeater to be turned off. Verify measured result is enough below requirement limit.
- 2) Align the manufacturer declared coordinate system orientation [(D.2)] of the repeater with the test system.

- 3) Orient the positioner (and repeater) in order that the direction to be tested aligns with the test antenna.

For *repeater type 2-0* declared to be capable of multi-carrier operation, set the repeater to transmit according to:

- RUL-FR2-TM3.1 with 64QAM signal if 64QAM is supported by repeater without power back off, or
- RUL-FR2-TM3.1 with highest modulation order supported without power back off if 64QAM is not supported by repeater, or
- if 64QAM is supported by repeater with power back off, RUL-FR2-TM3.1 with 64QAM signal at manufacturer's declared rated output power ($P_{\text{rated,c,EIRP}}$) and RUL-FR2-TM3.1 with highest supported modulation order at maximum power

For RUL-FR1-TM 3.1a and RUL-FR2-TM 3.1, power back-off shall be applied if it is declared.

- 6) For each carrier, measure the repeater EVM and frequency error as defined in annex L.
- 7) Repeat steps 5 and 6 for RUL-FR2-TM2 if 256QAM is not supported by *repeater* or for RUL-FR1-TM2a if 256QAM is supported by repeater. For RUL-FR1-TM2 and RUL-FR1-TM2a the OFDM symbol power (in the conformance direction) shall be at the lower limit of the dynamic range according to the test procedure in clause 6.4.3.4.2 and test requirements in clause 6.4.3.5.1.

6.6.2.5 Test requirement

The uplink of the Repeater EVM levels for different modulation schemes shall not exceed values in table 6.6.2.5-1.

Table 6.6.2.5-1: Repeater EVM test requirements

Parameter	Unit	Average repeater EVM level
Up to 16 QAM	%	13.9
64 QAM	%	9.5 ¹
Note 1: support of 64QAM is based on the declaration		

6.7 OTA input intermodulation

6.7.1 Definition and applicability

6.7.1.1 General

The input intermodulation is a measure of the capability of the repeater to inhibit the generation of interference in the passband, in the presence of interfering signals on frequencies other than the passband.

Third and higher order mixing of the two interfering RF signals can produce an interfering signal in the band of the desired channel. Intermodulation response rejection is a measure of the capability of the repeater to maintain the wanted frequency free of internally created interference.

The measurements shall apply to both uplink and downlink paths of the repeater, during the *transmitter ON state* at maximum gain.

6.7.1.2 Minimum requirements

The minimum requirement is in TS 38.106 [2] clause 7.7.2.

6.7.1.3 Test purpose

The purpose of this test is to verify that the repeater meets the intermodulation characteristics requirements as specified by the minimum requirements.

6.7.1.4 Method of test

6.7.1.4.1 Initial conditions

Test environment: normal; see Annex B

A measurement system set-up is shown in Annex E.

6.7.1.4.2 Procedure

- 1a) Verify measurement impact from feeding test signal by generating a signal for repeater input with repeater to be turned off. Verify measured result is enough below requirement limit.
- 1b) Set the repeater to maximum gain.
- 2) Place the repeater with its manufacturer declared coordinate system reference point in the same place as calibrated point in the test system, as shown in Annex E.
- 3) Align the test antennas and repeater both in input and output directions of the repeater.
- 4) Align the repeater and test antennas so that repeater antennas are polarization matched with the test antenna(s)
- 5) Configure the beam peak direction of the repeater according to declared reference beam direction pair for the appropriate beam identifier.
- 6) Adjust the frequency of the input signals, either below or above the passband, so that one carrier, f_1 , is 1 MHz outside the channel edge frequency of the first or last channel in the passband, and the lowest order intermodulation product from the two carriers is positioned in the centre of the passband.
- 7) Measure the increase in output power in the passband when the interferer is applied
- 8) Repeat the measurement for all supported polarizations and all specified measurement directions.
- 9) Repeat the measurement for the opposite path of the repeater.

6.7.1.5 Test requirements

For the parameters specified in table 6.7.1.5-1, the power in the *passband* shall not increase with more than $[10+TT]$ dB at the output of the repeater as measured with 1 MHz measurement bandwidth, compared to the level obtained without interfering signals applied.

Table 6.7.1.5-1 specifies the parameters for two interfering signals, where:

- f_1 offset is the offset from the channel edge frequency of the first or last channel in the *passband* of the closer carrier.
- G_{RX_ANT} is the gain of the receive side antennas and is calculated from EIRP and TRP declaration.

Table 6.7.1.5-1: Input intermodulation requirement

f_1 offset	Interfering signal levels	Type of signals	Measurement bandwidth
1 MHz	-53dBm – G_{RX_ANT}	2 CW carriers	1 MHz

6.8 OTA Adjacent Channel Rejection Ratio (ACRR)

6.8.1 Definitions and applicability

OTA Adjacent Channel Rejection Ratio (ACRR) is the ratio of the average gain over a carrier of the repeater in the *passband* to the average gain of the repeater over an adjacent channel outside the repeater *passband*. The requirement shall apply to the uplink and downlink of the Repeater. The bandwidth of the channel inside the *passband* and the adjacent channel shall be of the same type (reference carrier) with bandwidths as defined by *nominal channel bandwidth*.

The requirement is differentiated between downlink and uplink.

The requirement shall apply during the *transmitter ON state*.

The ACRR is a ratio of gain in the adjacent channel to gain in the wanted channel. The gain in each case is defined as the ratio of TRP output power to directional input power.

6.8.2 Co-existence with NR

This requirement shall be applied for the protection of NR signals in geographic areas in which NR Repeater and NR BS are deployed so that they serve adjacent channels. The reference carrier is a NR carrier.

6.8.2.1 Minimum requirements

The minimum requirement is in TS 38.106 [2] sub-clause 7.8.1.1.

6.8.2.2 Test purpose

To verify that the Repeater OTA ACRR requirement is met as specified in sub-clause 6.8.2.1.

6.8.2.3 Method of test

6.8.2.3.1 Initial conditions

Test environment: normal; see Annex B.2.

RF channels to be tested for single carrier: B, M, T; see clause 4.9.1.

Beams to be tested:

As the requirement is TRP the beam pattern(s) may be set up to optimise the TRP measurement procedure (see annex G) as long as the required TRP level is achieved.

6.8.2.3.2 Procedure

- 1a) Place the repeater with its manufacturer declared coordinate system reference point in the same place as calibrated point in the test system, as shown in annex E.2.7.
- 1b) Verify measurement impact from feeding test signal by generating a signal for repeater input with repeater to be turned off. Verify measured result is enough below requirement limit.
- 2) Align the manufacturer declared coordinate system orientation of the repeater with the test system.
- 3) Align the repeater with the test antenna in the declared direction to be tested.
- 4) Align the repeater to that the wanted signal and interferer signal is *polarization matched* with the test antenna(s).
- 5) Set the signal generator to transmit a signal modulated with test model RDL-FR2-TM1.1 for downlink and test model RUL-FR2-TM1.1 for uplink as defined in section 4.9 at the first or last channel with channel offset from frequency range of passband defined in section 6.8.2.3.3 within the pass band.
- 6) Adjust the input power to the Repeater to create the maximum nominal Repeater output power at maximum gain
- 7) Orient the positioner (and repeater) in order that the direction to be tested aligns with the test antenna such that measurements to determine TRP can be performed (see annex G).
- 8) Measure the absolute power of the assigned channel frequency.
- 9) Repeat step 7-8 for all directions in the appropriated TRP measurement grid needed for $TRP_{Estimate}$ (see annex G).
- 10) Calculate $TRP_{Estimate}$ for the absolute total radiated power of a carrier of the repeater in the *passband* and using the measurements made in Step 9.
- 11) Set the signal generator to transmit the same signal and the same input power at one of the channel offsets outside the repeater pass band according to Tables in section 6.8.2.3.3.
- 12) Repeat step 7) to 9) for the measurement of the input signal outside the repeater pass-band.;
- 13) Calculate $TRP_{Estimate}$ for the absolute total radiated power of a carrier over an adjacent channel outside the repeater *passband* and using the measurements made in Step 9.
- 14) Calculate relative ACRR estimate.
- 15) Repeat step 5) to 14) until all channel offsets in Tables in section 6.8.2.3.3 are measured.

6.8.2.3.3 Test Requirements

The requirement shall apply at the RIB when the AoA of the incident wave of a received signal in the *passband* and a received signal on an adjacent channel outside repeater *passband* is from the same direction and are the same as the TX reference direction for the opposite DL/UL setting.

For a repeater operating at passband operating in FR2, the ACRR requirements in table 6.8.2.3.3-1 shall apply in downlink. In normal conditions the ACRR for downlink shall be higher than the value specified in the Table 6.8.2.3.3-1.

Table 6.8.2.3.3-1: Repeater Downlink ACRR

Co-existence with other systems	Repeater Class	Channel offset from frequency edge of <i>passband</i> (MHz)	Filter on the adjacent channel frequency and corresponding filter bandwidth	ACRR limit (dB)
NR	Wide Area repeater	$BW_{Nominal}/2$	Square (BW_{Config})	25.3 (Note 2) 23.3 (Note 3) 23.1 (Note 4)
	Medium Range repeater	$BW_{Nominal}/2$	Square (BW_{Config})	25.3 (Note 2) 23.3 (Note 3) 23.1 (Note 4)
	Local Area repeater	$BW_{Nominal}/2$	Square (BW_{Config})	25.3 (Note 1,2) 23.3 (Note 1,3) 23.1 (Note 1,4)
NOTE 1: This requirement is not applicable if the <i>passband</i> occupies the entire <i>operating band</i> . NOTE 2: Applicable to bands defined within the frequency spectrum range of 24.25-29.5GHz. NOTE 3: Applicable to bands defined within the frequency spectrum range of 37-43.5 GHz. NOTE 4: Applicable to bands defined within the frequency spectrum range of 43.5-48.2GHz. NOTE 5: $BW_{Nominal}$ is the <i>nominal channel bandwidth</i> . BW_{Config} is the <i>transmission bandwidth configuration</i> assumed for the adjacent channel. NOTE 6: With SCS that provides largest <i>transmission bandwidth configuration</i> (BW_{Config}).				

For a repeater operating at passband operating in FR2, the ACRR requirements in table 6.8.2.3.3-2 shall apply in uplink. In normal conditions the ACRR for uplink shall be higher than the value specified in the Table 6.8.2.3.3-2.

Table 6.8.2.3.3-2: Repeater Uplink ACRR

Co-existence with other systems	Repeater Class	Channel offset from frequency edge of <i>passband</i> (MHz)	Filter on the adjacent channel frequency and corresponding filter bandwidth	ACRR limit (dB)
NR	Wide Area repeater	$BW_{Nominal}/2$	Square (BW_{Config})	25.3 (Note 2) 23.3 (Note 3) 23.1 (Note 4)
	Local Area repeater	$BW_{Nominal}/2$	Square (BW_{Config})	14.3 (Note 1, 2) 13.3 (Note 1, 3) 13.1 (Note 1, 4)
NOTE 1: This requirement is not applicable if the <i>passband</i> occupies the entire <i>operating band</i> . NOTE 2: Applicable to bands defined within the frequency spectrum range of 24.25-29.5GHz. NOTE 3: Applicable to bands defined within the frequency spectrum range of 37-43.5 GHz. NOTE 4: Applicable to bands defined within the frequency spectrum range of 43.5-48.2GHz. NOTE 5: $BW_{Nominal}$ is the <i>nominal channel bandwidth</i> . BW_{Config} is the <i>transmission bandwidth configuration</i> assumed for the adjacent channel. NOTE 6: With SCS that provides largest <i>transmission bandwidth configuration</i> (BW_{Config}).				

6.9 OTA transmit ON/OFF power

6.9.1 OTA transmitter OFF power

6.9.1.1 Definition and applicability

OTA transmitter OFF power is defined as the mean power measured over $70/N$ μ s filtered with a square filter of bandwidth equal to the *passband bandwidth* of the repeater (BW_{passband}) centred on the assigned channel frequency during the *transmitter OFF state*. $N = \text{SCS}/15$, where SCS is Sub Carrier Spacing in kHz of the input signal. The OTA transmitter OFF power is defined as TRP.

6.9.1.2 Minimum requirement

The minimum requirement is in TS 38.106 [2], clause 7.9.2.2.

6.9.1.3 Test purpose

The purpose of this test is to verify the OTA transmitter OFF power is within the limits of the minimum requirements.

6.9.1.4 Method of test

Requirement is tested together with transmitter transient period, as described in clause 6.9.2.4.

6.9.1.5 Test requirements

The conformance testing of transmit OFF power is included in the conformance testing of transmitter transient period; therefore, see clause 6.9.2.5 for test requirements.

6.9.2 OTA transient period

6.9.2.1 Definition and applicability

The OTA *transmitter transient period* is the time period during which the transmitter is changing from the *transmitter OFF state* to the *transmitter ON state* or vice versa. The *transmitter transient period* is illustrated in figure 6.9.2.1-1.

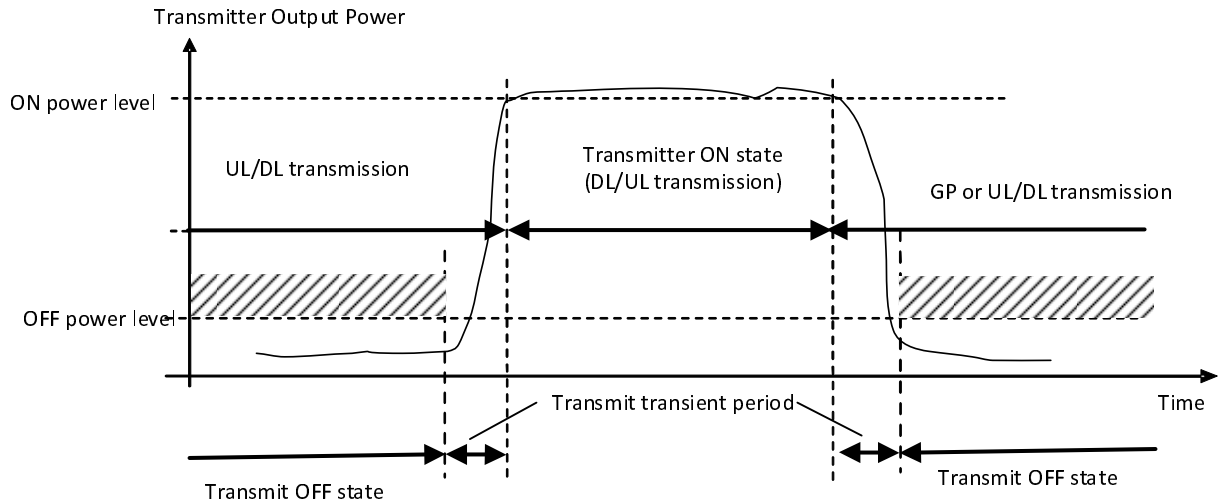

Figure 6.9.2.1-1: Example of relations between transmitter *ON state*, transmitter *OFF state* and transmitter *transient period*

This requirement shall be applied at each RIB supporting transmission in the *operating band*.

For a repeater that is not declared to be a long delay repeater (D.24), the beginning and end point of downlink and uplink bursts are referenced to the slot timing at the input.

For a repeater that is declared to be a long delay repeater (D.24), the beginning and end point of downlink and uplink bursts are referenced to the slot timing at the input plus the declared repeater delay.

6.9.2.2 Minimum requirement

The minimum requirement is in TS 38.106 [2], clause 7.9.3.2.

6.9.2.3 Test purpose

The purpose of this test is to verify the OTA transmitter transient periods are within the limits of the minimum requirements.

6.9.2.4 Method of test

6.9.2.4.1 Initial conditions

Test environment: Normal; see annex B.2.

RF channels to be tested: M; see clause 4.9.1.

Directions to be tested:

- The requirement is verified by an EIRP measurement at a direction corresponding to the OTA peak directions set reference beam direction pair (D.6) for the beam identifier (D.3) which provides the highest intended EIRP.

6.9.2.4.2 Procedure

- 1a) Place the repeater at the positioner.

- 1b) Verify measurement impact from feeding test signal by generating a signal for repeater input with repeater to be turned off. Verify measured result is enough below requirement limit.
- 2) Align the manufacturer declared coordinate system orientation (D.2) of the repeater with the test system.
- 4a) For transient period measurement, set the input signal at the RIB according to the applicable test configuration and direction in clause 4.8 using the corresponding test models RDL-FR2-TM 1.1 and RUL-FR2-TM 1.1 in clause 4.9.2 at the input power intended to produce the maximum rated output power, $P_{\text{rated,in, EIRP}} + 10\text{dB}$.
- 4b) For OFF power measurement, set the signal generator RF output turned off for not to generate input signal.
- 5) Orient the positioner (and repeater and test signal source) in order that the direction to be tested aligns with the test antenna such that measurements to determine TRP can be performed (see annex G) whilst maintaining the correct direction of arrival for the test signal.
- 6) Measure the mean EIRP spectral density as the power sum over two orthogonal polarizations over $70/N \mu\text{s}$ filtered with a square filter of bandwidth equal to the *passband* bandwidth of the repeater centred on the central frequency of the *passband*. $70/N \mu\text{s}$ average window centre is set from $35/N \mu\text{s}$ after end of one transmitter ON state + $3 \mu\text{s}$ to $35/N \mu\text{s}$ before start of next transmitter ON state - $3 \mu\text{s}$. $N = \text{SCS}/15$, where SCS is Sub Carrier Spacing in kHz.

NOTE: Make sure that the measurement receiver is not overloaded.

6.9.2.5 Test requirements

The measured mean EIRP spectral density shall be less than $-33.1 + P_{\text{rated,c,EIRP}} - P_{\text{rated,c,TRP}}$ dBm/MHz for carrier frequency $24.15 \text{ GHz} < f \leq 29.5 \text{ GHz}$, where $P_{\text{rated,c,EIRP}}$ is the value declared for the *reference beam direction pair* (D.6) for the beam identifier (D.3) which provides the highest intended EIRP.

The measured mean EIRP spectral density shall be less than $-32.7 + P_{\text{rated,c,EIRP}} - P_{\text{rated,c,TRP}}$ dBm/MHz for carrier frequency $37 \text{ GHz} < f \leq 43.5 \text{ GHz}$, where $P_{\text{rated,c,EIRP}}$ is the value declared for the *reference beam direction pair* (D.6) for the beam identifier (D.3) which provides the highest intended EIRP.

The measured mean EIRP spectral density shall be less than $-32.4 + P_{\text{rated,c,EIRP}} - P_{\text{rated,c,TRP}}$ dBm/MHz for carrier frequency $43.5 \text{ GHz} < f \leq 48.2 \text{ GHz}$, where $P_{\text{rated,c,EIRP}}$ is the value declared for the *reference beam direction pair* (D.6) for the beam identifier (D.3) which provides the highest intended EIRP.

Annex A (normative):

Repeater stimulus signals

A.1 Repeater stimulus signal 1

This repeater stimulus signal shall be used for tests on:

- Uplink maximum output power
- Uplink operating band unwanted emissions
- Uplink spurious emissions

Two uplink fixed reference channels for performance requirements (16QAM $\frac{3}{4}$) for FDD according to the TS38.141-2 [x], [A.4 table A.4-1, channel reference A4-3 of 50 MHz] bandwidth generated on separate centre frequencies with equal power and combined with a time difference of [266,7 us (4 OFDM symbols)].

The PUSCH data payload shall contain only zeroes (0000 0000)

Each reference channel shall be subjected to time windowing and filtering so that it fulfils the spectral purity requirements defined in A.3

A.2 Repeater stimulus signal 2

This repeater stimulus signal shall be used for tests on:

- Downlink operating band unwanted emissions
- Downlink spurious emissions

Two NR-FR2-TM1.1 channels according to the TS38.141-2 [x] of 50 MHz bandwidth generated on separate centre frequencies with equal power and combined with a time difference of [1400 us (21 OFDM symbols)].

Each NR-FR2-TM1.1 channel shall be subjected to time windowing and filtering so that it fulfils the spectral purity requirements defined in A.3.

A.3 Repeater stimulus signal spectral purity requirements

The reference channels or test models constituting the repeater stimulus signal shall fulfil the spectral purity requirements defined by tables A.3-1 , A.3-2 and A.3-3, where;

Table A.3-1: Repeater stimulus signal spectral purity requirements for frequency range 24.25 GHz ~ 33.4 GHz

Center frequency of measurement filter	Minimum requirements	Measurement filter type and filter bandwidth	Integration bandwidth
0.5 MHz outside from channel edge	28.7 dBc (Note 1)	Square (1 MHz)	1 MHz
Center of adjacent channel frequency with same nominal channel BW	28.7 dBc (Note 2)	Square (nominal channel BW)	Nominal channel BW
NOTE 1: the reference spectral density shall be taken at the carrier center frequency with an integration bandwidth of 1 MHz.			
NOTE 2: the reference spectral density shall be taken at the carrier center frequency with an integration bandwidth of nominal carrier BW			

Table A.3-2: Repeater stimulus signal spectral purity requirements for frequency range 37.0 GHz ~ 43.5 GHz

Center frequency of measurement filter	Minimum requirements	Measurement filter type and filter bandwidth	Integration bandwidth
0.5 MHz outside from channel edge	26.4 dBc (Note 1)	Square (1 MHz)	1 MHz
Center of adjacent channel frequency with same nominal channel BW	26.4 dBc (Note 2)	Square (nominal channel BW)	Nominal channel BW
NOTE 1: the reference spectral density shall be taken at the carrier center frequency with an integration bandwidth of 1 MHz.			
NOTE 2: the reference spectral density shall be taken at the carrier center frequency with an integration bandwidth of nominal carrier BW			

Table A.3-3: Repeater stimulus signal spectral purity requirements for frequency range 43.5 GHz ~ 48.2 GHz

Center frequency of measurement filter	Minimum requirements	Measurement filter type and filter bandwidth	Integration bandwidth
0.5 MHz outside from channel edge	26.2 dBc (Note 1)	Square (1 MHz)	1 MHz
Center of adjacent channel frequency with same nominal channel BW	26.2 dBc (Note 2)	Square (nominal channel BW)	Nominal channel BW
NOTE 1: the reference spectral density shall be taken at the carrier center frequency with an integration bandwidth of 1 MHz.			
NOTE 2: the reference spectral density shall be taken at the carrier center frequency with an integration bandwidth of nominal carrier BW			

Annex B (normative):

Environmental requirements for the Repeater equipment

B.1 General

For each test in the present document, the environmental conditions under which the repeater is to be tested are defined.

B.2 Normal test environment

When a normal test environment is specified for a test, the test should be performed within the minimum and maximum limits of the conditions stated in table B.2.1.

Table B.2-1: Limits of conditions for normal test environment

Condition	Minimum	Maximum
Barometric pressure	86 kPa	106 kPa
Temperature	15 °C	30 °C
Relative humidity	20 %	85 %
Power supply	Nominal, as declared by the manufacturer	
Vibration	Negligible	

The ranges of barometric pressure, temperature and humidity represent the maximum variation expected in the uncontrolled environment of a test laboratory. If it is not possible to maintain these parameters within the specified limits, the actual values shall be recorded in the test report.

NOTE: This may, for instance, be the case for measurements of radiated emissions performed on an open field test site.

B.3 Extreme test environment

The manufacturer shall declare one of the following:

- 1) The equipment class for the equipment under test, as defined in the IEC 60 721-3-3 [7];
- 2) The equipment class for the equipment under test, as defined in the IEC 60 721-3-4 [8];
- 3) The equipment that does not comply with the mentioned classes, the relevant classes from IEC 60 721 [9] documentation for temperature, humidity and vibration shall be declared.

NOTE: Reduced functionality for conditions that fall outside of the standard operational conditions is not tested in the present document. These may be stated and tested separately.

B.3.1 Extreme temperature

When an extreme temperature test environment is specified for a test, the test shall be performed at the standard minimum and maximum operating temperatures defined by the manufacturer's declaration for the equipment under test.

Minimum temperature:

The test shall be performed with the environment test equipment and methods including the required environmental phenomena into the equipment, conforming to the test procedure of IEC 60 068-2-1 [10].

Maximum temperature:

The test shall be performed with the environmental test equipment and methods including the required environmental phenomena into the equipment, conforming to the test procedure of IEC 60 068-2-2 [11].

NOTE: It is recommended that the equipment is made fully operational prior to the equipment being taken to its lower operating temperature.

B.4 Vibration

When vibration conditions are specified for a test, the test shall be performed while the equipment is subjected to a vibration sequence as defined by the manufacturer's declaration for the equipment under test. This shall use the environmental test equipment and methods of inducing the required environmental phenomena in to the equipment, conforming to the test procedure of IEC 60 068-2-6 [12]. Other environmental conditions shall be within the ranges specified in annex A.2.

NOTE: The higher levels of vibration may induce undue physical stress in to equipment after a prolonged series of tests. The testing body should only vibrate the equipment during the RF measurement process.

B.5 Power supply

When extreme power supply conditions are specified for a test, the test shall be performed at the standard upper and lower limits of operating voltage defined by manufacturer's declaration for the equipment under test.

Upper voltage limit:

The equipment shall be supplied with a voltage equal to the upper limit declared by the manufacturer (as measured at the input terminals to the equipment). The tests shall be carried out at the steady state minimum and maximum temperature limits declared by the manufacturer for the equipment, to the methods described in IEC 60 068-2-1 [10] Test Ab/Ad and IEC 60 068-2-2 [11] Test Bb/Bd: Dry heat.

Lower voltage limit:

The equipment shall be supplied with a voltage equal to the lower limit declared by the manufacturer (as measured at the input terminals to the equipment). The tests shall be carried out at the steady state minimum and maximum temperature limits declared by the manufacturer for the equipment, to the methods described in IEC 60 068-2-1 [10] Test Ab/Ad and IEC 60 068-2-2 [11] Test Bb/Bd: Dry heat.

B.6 Measurement of test environments

The measurement accuracy of the repeater test environments defined in annex A shall be:

Pressure: ± 5 kPa

Temperature: ± 2 degrees

Relative humidity: ± 5 %

DC voltage: ± 1.0 %

AC voltage: ± 1.5 %

Vibration: 10 %

Vibration frequency: 0.1 Hz

The above values shall apply unless the test environment is otherwise controlled and the specification for the control of the test environment specifies the uncertainty for the parameter.

Annex C (informative):

Test tolerances and derivation of test requirements

C.1 Measurement of radiated characteristics

Table C.1-1: Derivation of test requirements (radiated tests)

Test	Minimum requirement in TS 38.106 [2]	Test Tolerance (TT)	Test requirement in the present document
6.2 Radiated transmit power (EIRP)	See TS 38.106 [2], clause 7.2	Normal conditions: 1.7 dB, 24.25GHz < f ≤ 29.5GHz 2.0 dB, 37GHz < f ≤ 43.5GHz 2.2 dB, 43.5GHz < f ≤ 48.2GHz Extreme conditions: 3.1 dB, 24.25GHz < f ≤ 29.5GHz 3.3 dB, 37GHz < f ≤ 43.5GHz 3.5 dB, 43.5GHz < f ≤ 48.2GHz	Formula: Upper limit + TT, Lower limit – TT
6.3 OTA repeater output power (TRP)		2.1 dB, 24.25GHz < f ≤ 29.5GHz 2.4 dB, 37GHz < f ≤ 43.5GHz 2.6 dB, 43.5GHz < f ≤ 48.2GHz	Formula: Upper limit + TT, Lower limit – TT
6.4 OTA frequency stability	See TS 38.106 [2], clause 7.3	12 Hz	Formula: Frequency Error limit + TT
6.5 OTA out of band gain	See TS 38.106 [2], clause 7.4	±2.1 dB, 24.25GHz < f □ 29.5GHz ±2.4 dB, 37GHz < f □ 43.5GHz ±2.6 dB, 43.5GHz < f □ 48.2GHz	Formula: Minimum Requirement + TT
6.6.2 OTA ACLR	See TS 38.106 [2], clause 7.5.2	Relative: 2.3 dB, 24.25GHz < f ≤ 29.5GHz 2.6 dB, 37GHz < f ≤ 43.5GHz 2.8 dB, 43.5GHz < f ≤ 48.2GHz Absolute: 2.7 dB, 24.25GHz < f ≤ 29.5GHz 2.7 dB, 37GHz < f ≤ 43.5GHz 2.9 dB, 43.5GHz < f ≤ 48.2GHz	Formula: Relative limit - TT Absolute limit +TT
6.6.3 OTA operating band unwanted emission	See TS 38.106 [2], clause 7.5.3	0 MHz ≤ Δf < 0.1*BW _{contiguous} 2.7 dB, 24.25GHz < f ≤ 29.5GHz 2.7 dB, 37GHz < f ≤ 43.5GHz 2.9 dB, 43.5GHz < f ≤ 48.2GHz 0.1*BW _{contiguous} ≤ Δf < Δf _{max} 0 dB	Formula: Minimum Requirement + TT
6.6.4 OTA spurious emissions	See TS 38.106 [2], clause 7.5.4	0 dB	Formula: Minimum Requirement + TT
6.7 OTA EVM	See TS 38.106 [2], clause 7.6	1.4%, Up to 16QAM 1.5%, 64QAM NOTE 2 1.8%, 256QAM Note 3	Test requirement limit shifted by RSS of minimum requirement and stimulus signal EVM. Analyser error added to requirement limit. Formula: EVM limit + TT

6.7 OTA input intermodulation	See TS 38.106 [2], clause 7.7	± 2.0 dB, $f \leq 3.0$ GHz ± 2.6 dB, 3.0 GHz $< f \leq 4.2$ GHz ± 3.2 dB, 4.2 GHz $< f \leq 6.0$ GHz	Formula: Minimum Requirement + TT
6.9 OTA ACRR	See TS 38.106 [2], clause 7.8	± 2.7 dB (24.25 – 29.5 GHz) ± 2.7 dB (37 – 43.5 GHz) ± 2.9 dB (43.5 GHz $< f \leq 48.2$ GHz)	Formula: Minimum Requirement – TT
6.10.1 OTA transmitter OFF power	See TS 38.106 [2], clause 7.9.2	2.9 dB, 24.25GHz $< f \leq 29.5$ GHz 3.3 dB, 37GHz $< f \leq 43.5$ GHz 3.6 dB, 43.5GHz $< f \leq 48.2$ GHz	Formula: Minimum Requirement + TT
6.10.2 OTA transient period	See TS 38.106 [2], clause 7.9.3	N/A	
NOTE 1: TT values are applicable for normal condition unless otherwise stated. NOTE 2: Support of 64QAM is based on the declaration NOTE 3: Support of 256QAM is based on the declaration.			

Annex D (normative):

Calibration

OTA test requirements specific and OTA measurement chamber specific calibration (and measurement) procedures were captured in [13] for the following requirements sets:

- TX directional requirements
- within passband and out-of-passband TRP requirements.

Annex E (informative):

OTA measurement system set-up

E.1 OTA output power EIRP, OTA Frequency stability, OTA Error Vector Magnitude and OTA Transmit ON/OFF power

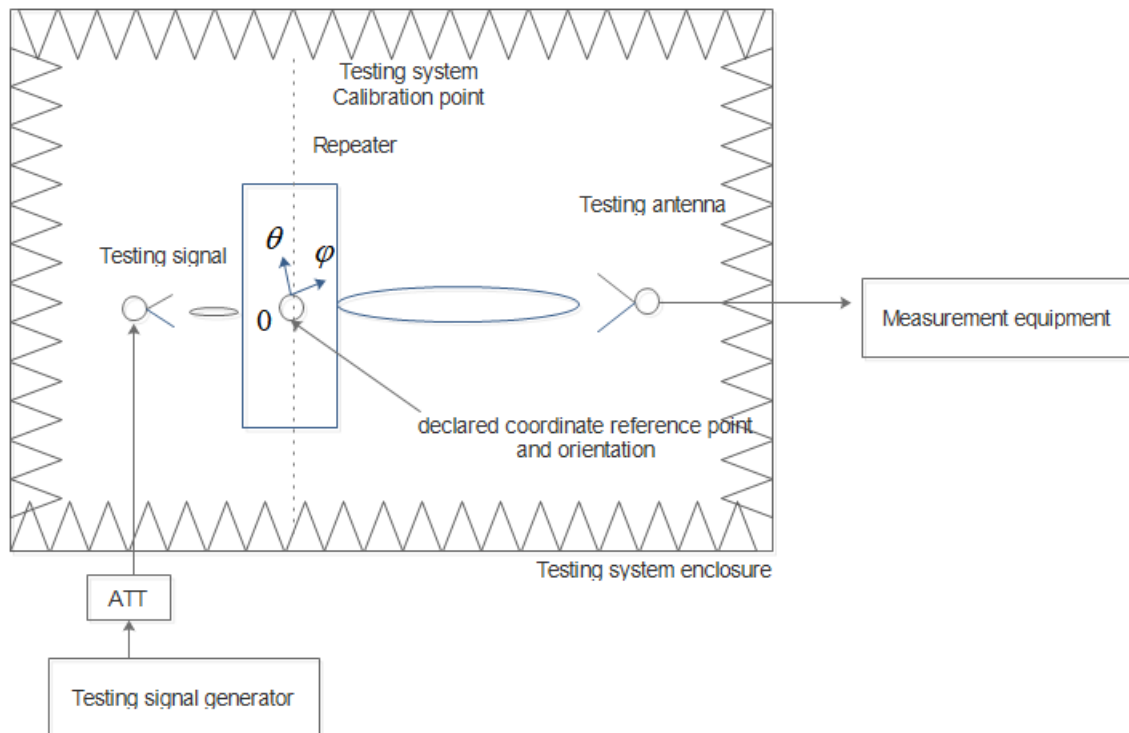

Figure E.1-1: Measuring system set-up for maximum EIRP testing

Note 1: The repeater is a bi-directional device. The signal generator may need protection.

Note 2: The OTA chamber shown in figure E.1-1 is intended to be generic and can be replaced with any suitable OTA chamber (Far field anechoic chamber, etc.)

Note 3: UL/DL timing can be provided to the repeater.

E.2 Out of band gain

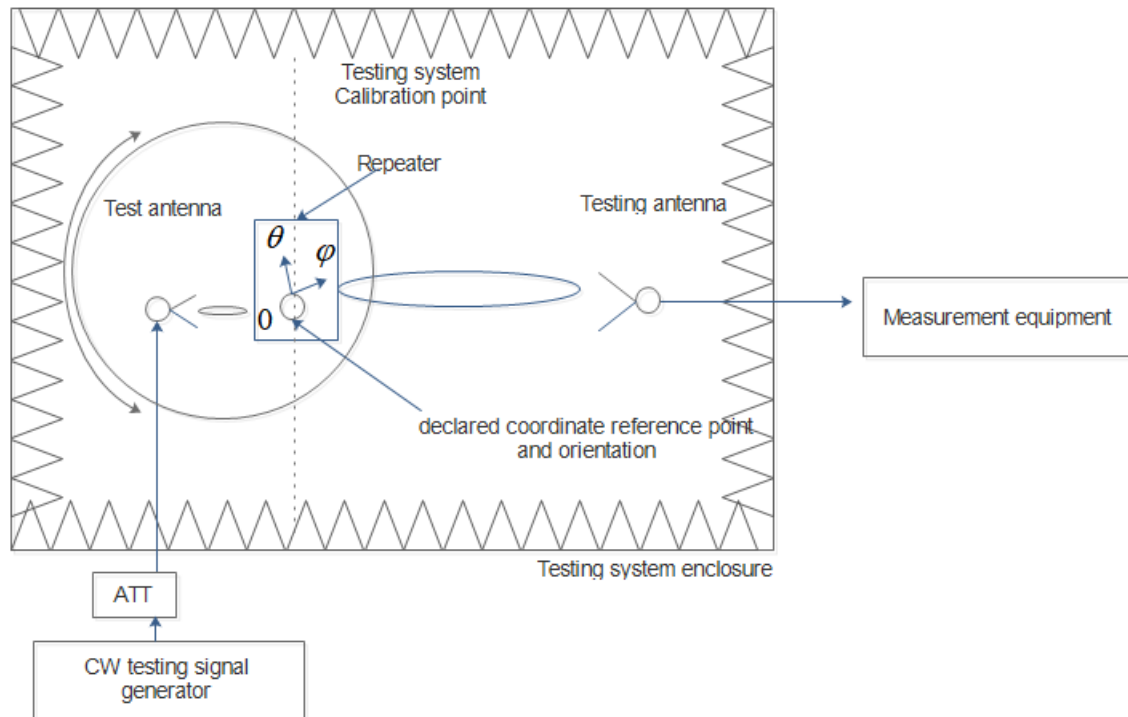

Figure E.2-1: Measuring system set-up for out of band gain

- Note 1: That repeater is a bi-directional device. The signal generator may need protection.
- Note 2: The OTA chamber shown in figure E.2-1 is intended to be generic and can be replaced with any suitable OTA chamber (Far field anechoic chamber, etc.)
- Note 3: It is possible to keep the repeater static but move the measurement probes or use multiple probe.

E.3 Unwanted emission: Operating band unwanted emission and ACLR

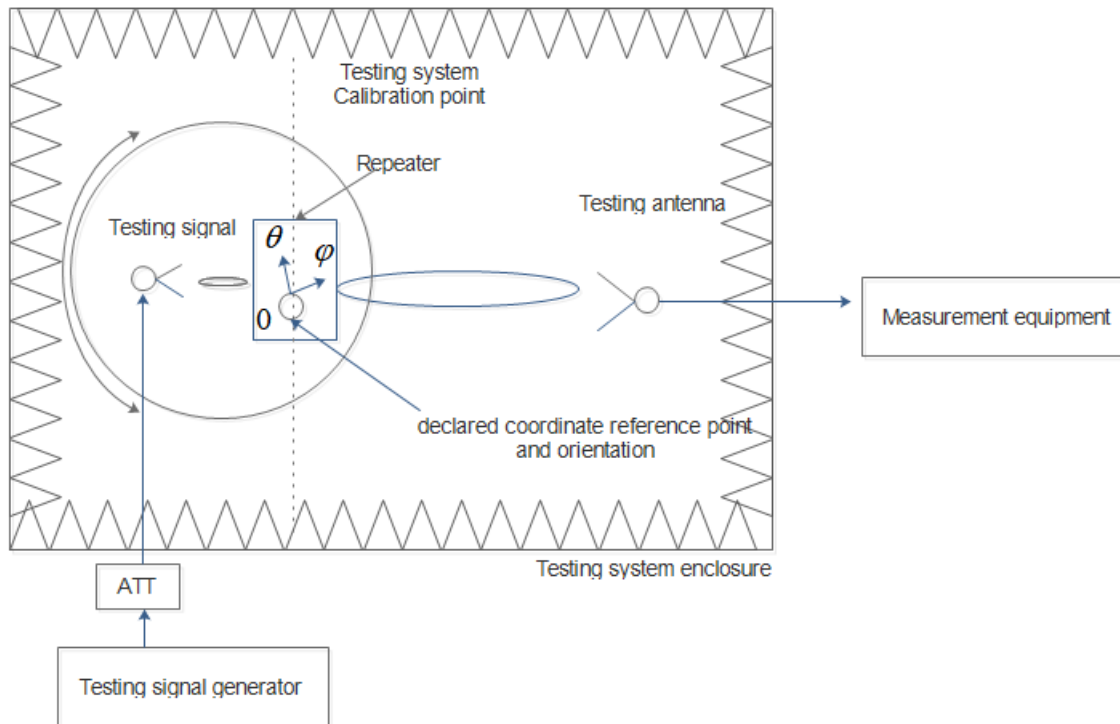

Figure E.3-1: Measuring system set-up for unwanted emission: ACLR, Operating band unwanted emission and spurious emission requirement

Note 1: That repeater is a bi-directional device. The signal generator may need protection.

Note 2: The OTA chamber shown in figure E.3-1 is intended to be generic and can be replaced with any suitable OTA chamber (Far field anechoic chamber, etc.)

Note 3: It is possible to keep the repeater static but move the measurement probes or use multiple probe.

Note 4: UL/DL timing can be provided to the repeater.

E.4 Input intermodulation

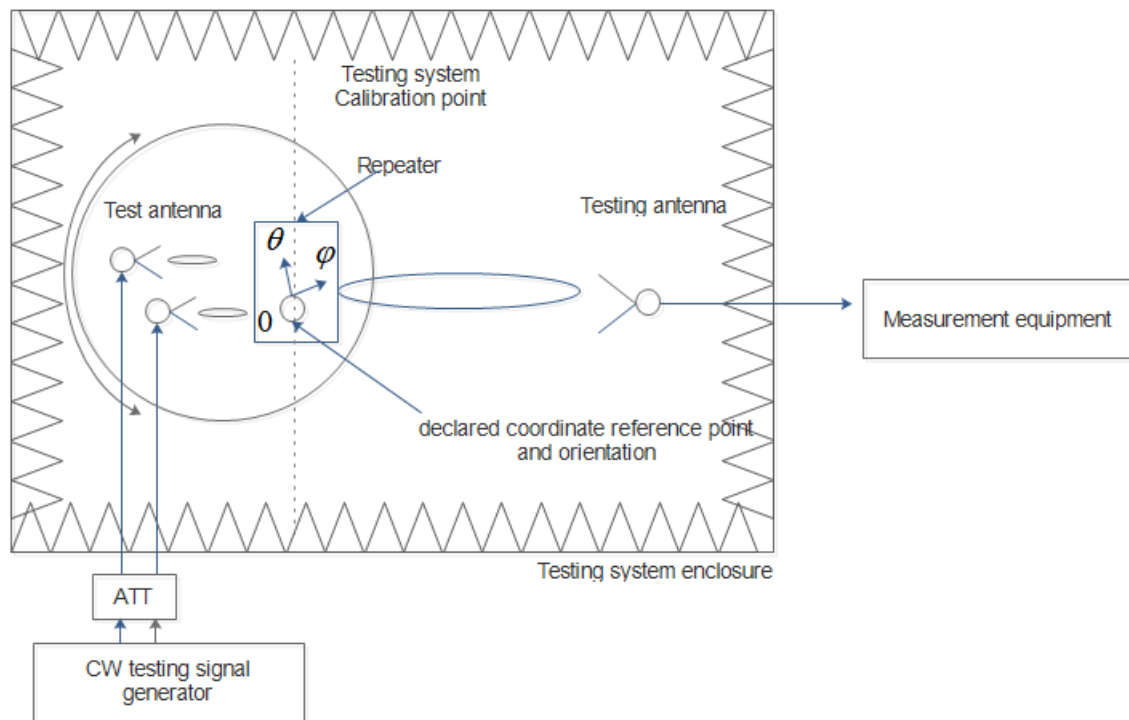

Figure E.4-1: Measuring system set-up for input intermodulation.

- Note 1: That repeater is a bi-directional device. The signal generator may need protection.
- Note 2: The OTA chamber shown in figure E.4-1 is intended to be generic and can be replaced with any suitable OTA chamber (Far field anechoic chamber, etc.)
- Note 3: It is possible to keep the repeater static but move the measurement probes or use multiple probe.

E.5 Adjacent Channel Rejection Ratio

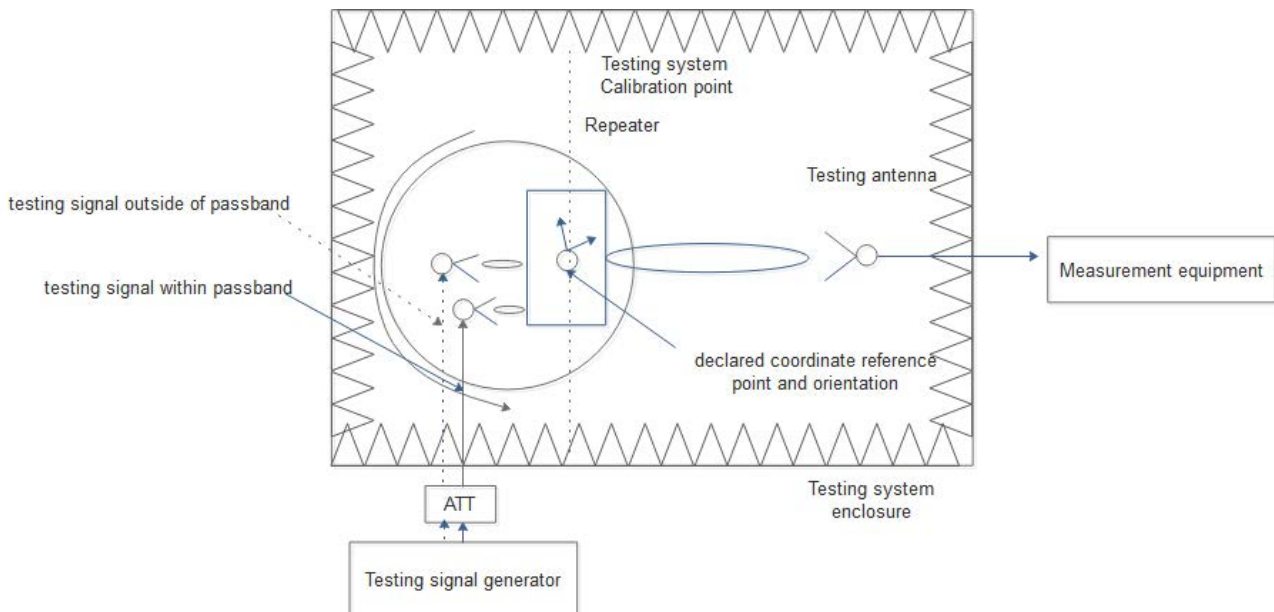

Figure E.5-1: Measuring system set-up for Adjacent Channel Rejection Ratio

- Note 1: That repeater is a bi-directional device. The signal generator may need protection.
- Note 2: The OTA chamber shown in figure E.5-1 is intended to be generic and can be replaced with any suitable OTA chamber (Far field anechoic chamber, etc.)
- Note 3: It is possible to keep the repeater static but move the measurement probes or use multiple probe.
- Note 4: UL/DL timing can be provided to the repeater.

Annex F (normative):

In-channel TX tests

F.1 General

The in-channel TX test enables the measurement of all relevant parameters that describe the in-channel quality of the output signal of the repeater under test in a single measurement process.

The parameters describing the in-channel quality of a transmitter, however, are not necessarily independent. The algorithm chosen for description inside this annex places particular emphasis on the exclusion of all interdependencies among the parameters.

F.2 Basic principles

The process is based on the comparison of the actual output signal of the TX under test, received by an ideal receiver, with an ideal signal, that is generated by the measuring equipment and represents an ideal error free received signal. All signals are represented as equivalent (generally complex) baseband signals.

The description below uses numbers and illustrations as examples only. These numbers are taken from a TDD frame structure with normal CP length, 120 kHz SCS and a transmission bandwidth configuration of 400 MHz ($N_{RB} = 264$). The application of the text below, however, is not restricted to this parameter set.

F.2.1 Output signal of the TX under test

The output signal of the TX under test is acquired by the measuring equipment and stored for further processing. It is sampled at a sampling rate which is the product of the SCS and the *FFT size*, and it is named $z(v)$.

For FR2, *FFT size* is determined by the transmission bandwidth in table 6.6.3.5-2 for 60 kHz SCS, and table 6.6.3.5-3 in [5] for 120 kHz SCS. In the time domain it comprises at least 10 ms. It is modelled as a signal with the following parameters:

- demodulated data content,
- carrier frequency,
- amplitude and phase for each subcarrier.

For the example in the annex, the *FFT size* is 4096 based on table 6.6.3.5-3 in [5]. The sampling rate of 491.52 Msps is the product of the *FFT size* and SCS.

F.2.2 Ideal signal

Two types of ideal signals are defined:

The first ideal signal $i_1(v)$ is constructed by the measuring equipment according to the relevant TX specifications, using the following parameters:

- demodulated data content,
- nominal carrier frequency,
- nominal amplitude and phase for each subcarrier.

It is represented as a sequence of samples at the sampling rate determined from annex F.2.1 in the time domain. The structure of the signal is described in the test models.

The second ideal signal $i_2(v)$ is constructed by the measuring equipment according to the relevant TX specifications, using the following parameters for FR1 and FR2:

- nominal demodulation reference signal and nominal PT-RS if present (all other modulation symbols are set to 0 V),

- nominal carrier frequency,
- nominal amplitude and phase for each applicable subcarrier,
- nominal timing.

It is represented as a sequence of samples at the sampling rate determined from annex F.2.1 in the time domain.

F.2.3 Measurement results

The measurement results, achieved by the in-channel TX test are the following:

- Carrier frequency stability.
- EVM.

Other side results are: residual amplitude- and phase response of the TX chain after equalisation.

F.2.4 Measurement points

The EVM shall be measured at the point after the FFT and a zero-forcing (ZF) equalizer in the receiver, as depicted in figure G.2.4-1. The FFT window of $FFT\ size$ samples out of $(FFT\ size + \text{cyclic prefix length})$ samples in the time domain is selected in the "Remove CP" box.

For FR2, $FFT\ size$ and the cyclic prefix length is determined from table 6.6.3.5-2 for 60 kHz SCS, and table 6.6.3.5-3 in [5] for 120 kHz SCS.

In one subframe, there are two symbols with the length of the cyclic prefix larger than the values listed in tables 6.6.3.5-2 and table 6.6.3.5-3 in [5]. Table F.2.4-1 lists the slot number and the symbol number and the formula how to compute the length of cyclic prefix for those two symbols according to the sampling rate.

Table F.2.4-1: Slot number and symbol number identifying the longer CP length for normal CP

SCS (kHz)	Frequency Range	# slots in subframe	Symbol # and slot # with longer CP	Longer CP length
15	FR1	1	(symbol 0, slot 0) (symbol 7, slot 0)	CP length + $FFT\ size / 128$
30		2	(symbol 0, slot 0) (symbol 0, slot 1)	CP length + $FFT\ size / 64$
60		4	(symbol 0, slot 0) (symbol 0, slot 2)	CP length + $FFT\ size / 32$
60	FR2	4	(symbol 0, slot 0) (symbol 0, slot 2)	CP length + $FFT\ size / 32$
120		8	(symbol 0, slot 0) (symbol 0, slot 4)	CP length + $FFT\ size / 16$

For the example used in the annex, the "Remove CP" box selects 4096 samples out of 4384 samples. Symbol 0 of slot 0 and slot 4 has 256 more samples in the cyclic prefix than the other symbols (the longer CP length = 544).

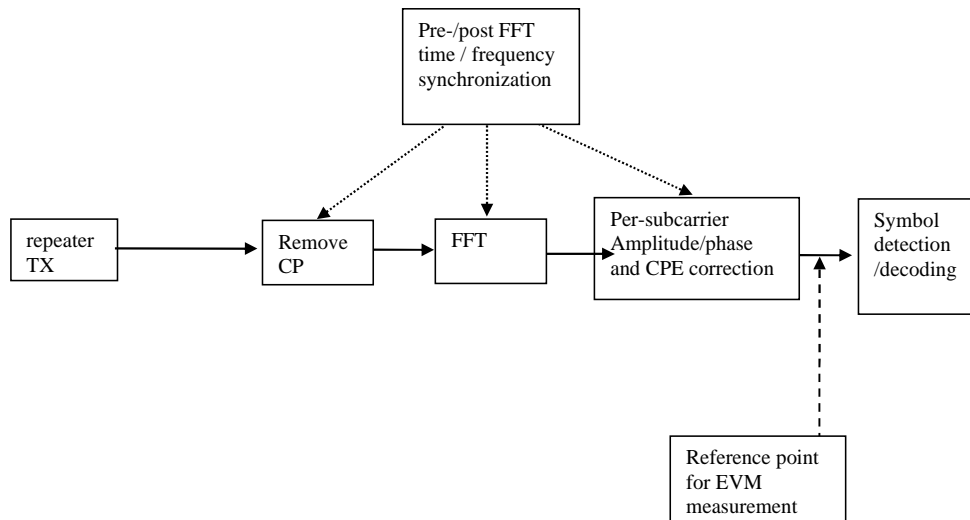

Figure F.2.4-1: Reference point for FR2 EVM measurements

F.3 Pre-FFT minimization process

Sample timing, carrier frequency in $z(v)$ are varied in order to minimise the difference between $z(v)$ and $i_1(v)$, after the amplitude ratio of $z(v)$ and $i_1(v)$ has been scaled. Best fit (minimum difference) is achieved when the RMS difference value between $z(v)$ and $i_1(v)$ is an absolute minimum.

The carrier frequency variation is the measurement result: carrier frequency error.

From the acquired samples, one value of carrier frequency error can be derived.

NOTE 1: The minimisation process, to derive the RF error can be supported by post-FFT operations. However the minimisation process defined in the pre-FFT domain comprises all acquired samples (i.e. it does not exclude the samples inbetween the FFT widths and it does not exclude the bandwidth outside the transmission bandwidth configuration).

NOTE 2: The algorithm would allow to derive carrier frequency error and sample frequency error of the TX under test separately. However there are no requirements for sample frequency error. Hence the algorithm models the RF and the sample frequency commonly (not independently). It returns one error and does not distinguish between both.

After this process the samples $z(v)$ are called $z^0(v)$.

F.4 Timing of the FFT window

The FFT window length is *FFT size* samples per OFDM symbol. For TDD, the number of FFTs performed is the number of downlink symbols in the measurement interval.

The position in time for the FFT shall be determined.

For the example used in the annex, the FFT window length is 4096 samples per OFDM symbol. 832 FFTs (i.e. 3,407,872 samples) cover less than the acquired number of samples (i.e. 3,651,584 samples in 10 ms). There are 816 symbols with 4384 samples and 16 symbols with 4640 samples.

In an ideal signal, the FFT may start at any instant within the cyclic prefix without causing an error. The TX filter, however, reduces the window. The EVM requirements shall be met within a window $W < CP$. There are three different instants for FFT:

- Centre of the reduced window, called $\Delta\tilde{c}$,
- $\Delta c - W/2$, and
- $\Delta c + W/2$.

The value of EVM window length W is obtained from the transmission bandwidth and table 6.6.3.5-2 for 60 kHz SCS, and table 6.6.3.5-3 [5] for 120 kHz SCS.

The repeater shall transmit a signal according to the test models intended for EVM. The demodulation reference signal of the second ideal signal shall be used to find the centre of the FFT window.

The timing of the measured signal is determined in the pre FFT domain as follows, using $z^0(v)$ and $i_2(v)$:

1. The measured signal is delay spread by the TX filter. Hence the distinct borders between the OFDM symbols and between data and CP are also spread and the timing is not obvious.
2. In the ideal signal $i_2(v)$, the timing is known.

Correlation between bullet (1) and (2) will result in a correlation peak. The meaning of the correlation peak is approximately the "impulse response" of the TX filter.
3. The meaning of "impulse response" assumes that the autocorrelation of the ideal signal $i_2(v)$ is a Dirac peak and that the correlation between the ideal signal $i_2(v)$ and the data in the measured signal is 0. The correlation peak, (the highest, or in case of more than one highest, the earliest) indicates the timing in the measured signal.

The number of samples, used for FFT is reduced compared to $z^0(v)$. This subset of samples is called $z'(v)$.

From the acquired samples one timing can be derived.

The timing of the centre $\Delta\tilde{c}$ is determined according to the cyclic prefix length of the OFDM symbols. For normal CP, there are two values for $\Delta\tilde{c}$ in a 1 ms period:

- $\Delta\tilde{c} = \text{length of cyclic prefix} / 2$,
- $\Delta\tilde{c} = \text{Longer CP length} - \text{length of cyclic prefix} / 2$,

Where the length of cyclic prefix is obtained from table 6.6.3.5-2 for 60 kHz SCS, and table 6.6.3.5-3 [5] for 120 kHz SCS, and the longer CP length is obtained from table F.2.4-1.

As per the example values.

- $\Delta\tilde{c} = 144$ within the CP of length 288 for most OFDM symbols in 1 ms,
- $\Delta\tilde{c} = 400 (= 544 - 144)$ within the CP of length 544 for OFDM symbol 0 of slot 0 and slot 4.

F.5 Resource element TX power

Perform FFT on $z'(v)$ with the FFT window timing $\Delta\tilde{c}$.

The result is called $Z'(t, f)$. The RE TX (RETP) power is then defined as:

$$RETP = |Z'(t, f)|^2 SCS$$

where SCS is the subcarrier spacing in Hz.

From RETP, the OFDM symbol TX power (OSTP) is derived as follows:

$$OSTP = \frac{1}{N_{sym}} \hat{a} RETP$$

Where the summation accumulates $N_{RB} N_{sc}^{RB}$ values of all N_{sym} OFDM symbols that carry PDSCH and not containing PDCCH, RS or SSB within a slot.

$$N_{sc}^{RB} = 12.$$

From the acquired samples N_{dl} values for each OSTP can be obtained and averaged where N_{dl} is the number of slots with downlink symbols in a 10 ms measurement interval and is computed according to the values in table 4.9.2.2-1 in [5].

For the example used in the annex, $N_{dl} = 64$ and $N_{RB} = 264$.

F.6 Post-FFT equalisation

Perform $14N_{dl}$ FFTs on $z'(v)$, one for each OFDM symbol within 10 ms measurement interval with the FFT window timing to produce an array of samples, $14N_{dl}$ in the time axis t by *FFT size* in the frequency axis f .

For the example in the annex, 1120 FFTs are performed on $z'(v)$. The result is an array of samples, 1120 in the time axis by 4096 in the frequency axis.

The equalizer coefficients $\tilde{a}(f)$ and $\tilde{\varphi}(f)$ are determined as follows:

1. Calculate the complex ratios (amplitude and phase) of the post-FFT acquired signal $Z'(t, f)$ and the post-FFT ideal signal $I_2(t, f)$, for each demodulation reference signal, over 10 ms measurement interval. This process creates a set of complex ratios:

$$a(t, f)e^{j\varphi(t, f)} = \frac{Z'(t, f)}{I_2(t, f)}$$

2. Perform time averaging at each demodulation reference signal subcarrier of the complex ratios, the time-averaging length is 10 ms measurement interval. Prior to the averaging of the phases $\varphi(t_i, f)$ an unwrap operation must be performed according to the following definition:

- The unwrap operation corrects the radian phase angles of $\varphi(t_i, f)$ by adding multiples of $2 * \pi$ when absolute phase jumps between consecutive time instances t_i are greater than or equal to the jump tolerance of π radians.
- This process creates an average amplitude and phase for each demodulation reference signal subcarrier (i.e. every second subcarrier).

$$a(f) = \frac{\sum_{i=1}^N a(t_i, f)}{N}$$

$$\varphi(f) = \frac{\sum_{i=1}^N \varphi(t_i, f)}{N}$$

- Where N is the number of demodulation reference signal time-domain locations t_i from $Z'(t, f)$ for each demodulation reference signal subcarrier f .
3. The equalizer coefficients for amplitude and phase $\hat{a}(f)$ and $\hat{\varphi}(f)$ at the demodulation reference signal subcarriers are obtained by computing the moving average in the frequency domain of the time-averaged demodulation reference signal subcarriers. The moving average window size is 19 and averaging is over the DM-RS subcarriers in the allocated RBs. For DM-RS subcarriers at or near the edge of the channel, or when the number of available DM-RS subcarriers within a set of contiguously allocated RBs is smaller than the moving average window size, the window size is reduced accordingly as per figure F.6-1.
 4. Perform linear interpolation from the equalizer coefficients $\hat{a}(f)$ and $\hat{\varphi}(f)$ to compute coefficients $\tilde{a}(f)$, $\tilde{\varphi}(f)$ for each subcarrier.

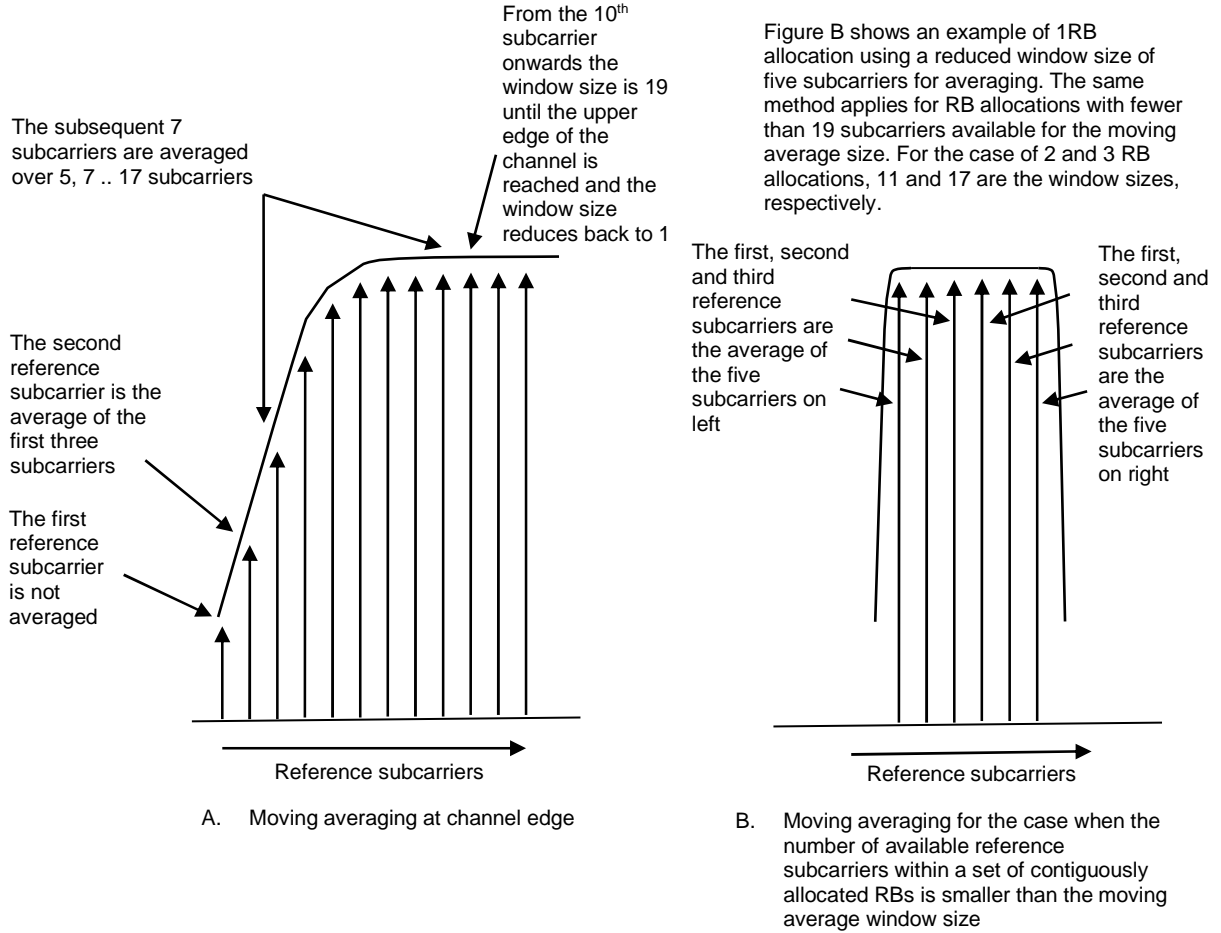

Figure F.6-1: Reference subcarrier smoothing in the frequency domain

- a) To account for the common phase error (CPE) experienced in millimetre wave frequencies, $\bar{\varphi}(f)$, in the estimated coefficients contain phase rotation due to the CPE, θ , in addition to the phase of the equalizer coefficient $\tilde{\varphi}(f)$, that is:

$$\bar{\varphi}(f) = \tilde{\varphi}(f) + \theta(t)$$

For OFDM symbols where PT-RS does not exist, $\theta(t)$ can be estimated by performing linear interpolation from neighboring symbols where PT-RS is present.

In order to separate component of the CPE, θ , contained in, $\bar{\varphi}(f)$, estimation and compensation of the CPE needs to follow. $\theta(t)$ is the common phase error (CPE), that rotates all the subcarriers of the OFDM symbol at time t .

Estimate of the CPE, $\theta(t)$, at OFDM symbol time, t , can then be obtained from using the PT-RS employing the expression:

$$\tilde{\theta}(t) = \text{arg} \left\{ \sum_{f \in f^{ptrs}} \left(\frac{z'(t,f)}{I_{ptrs}(t,f)} \right) (\tilde{a}(f) e^{-j\tilde{\varphi}(f)}) \right\}$$

In the above equation, f^{ptrs} is the set of subcarriers where PT-RS are mapped, $t \in t^{ptrs}$ where t^{ptrs} is the set of OFDM symbols where PT-RS are mapped while $Z'(t, f)$ and $I_{ptrs}(t, f)$ are the post-FFT acquired signal and the ideal PT-RS signal respectively. That is, estimate of the CPE at a given OFDM

symbol is obtained from frequency correlation of the complex ratios at the PT-RS positions with the conjugate of the estimated equalizer complex coefficients. The estimated CPE can be subtracted from $\bar{\varphi}(f)$ to remove influence of the CPE, and obtain estimate of the complex coefficient's phase:

$$\tilde{\varphi}(f) = \bar{\varphi}(f) - \tilde{\theta}(t)$$

F.7 EVM

F.7.0 General

For EVM create two sets of $Z_{eq}'(t, f)$, according to the timing $(\Delta c - W/2)$ and $(\Delta c + W/2)$, using the equalizer coefficients from G.6.

The equivalent ideal samples are calculated from $i_1(v)$ (annex G.2.2) and are called $I(t, f)$.

The EVM is the difference between the ideal signal and the equalized measured signal.

$$EVM = \sqrt{\frac{\sum_{t \in T} \sum_{f \in F(i)} |Z_{eq}'(t, f) - I(t, f)|^2}{\sum_{t \in T} \sum_{f \in F(i)} |I(t, f)|^2}}$$

Where:

- T is the set of symbols with the considered modulation scheme being active within the slot,
- $F(t)$ is the set of subcarriers within the resource blocks with the considered modulation scheme being active in symbol t ,
- $I(t, f)$ is the ideal signal reconstructed by the measurement equipment in accordance with relevant test models,
- $Z_{eq}'(t, f)$ is the equalized signal under test.

NOTE: Although the basic unit of measurement is one slot, the equalizer is calculated over the entire 10 ms measurement interval to reduce the impact of noise in the reference signals.

F.7.1 Averaged EVM

Let N_{dl}^{TDD} be the number of slots with downlink symbols within a 10 ms measurement interval. For TDD, the averaging in the time domain can be calculated from N_{dl}^{TDD} slots of different 10 ms measurement intervals and should have a minimum of N_{dl} slots averaging length where N_{dl} is the number of slots in a 10 ms measurement interval.

$\overline{EVM}_{\text{frame}}$ is derived by: Square the EVM results in each 10 ms measurement interval. Sum the squares, divide the sum by the number of EVM relevant locations, square-root the quotient (RMS).

$$\overline{EVM}_{\text{frame}} = \sqrt{\frac{1}{\sum_{i=1}^{N_{dt}^{TDD}} N_i} \sum_{i=1}^{N_{dt}^{TDD}} \sum_{j=1}^{N_i} EVM_{i,j}^2}$$

Where N_i is the number of resource blocks with the considered modulation scheme in slot i .

The EVM_{frame} is calculated, using the maximum of $\overline{EVM}_{\text{frame}}$ at the window W extremities. Thus $\overline{EVM}_{\text{frame},l}$ is calculated using $\tilde{t} = \Delta\tilde{t}_l$ and $\overline{EVM}_{\text{frame},h}$ is calculated using $\tilde{t} = \Delta\tilde{t}_h$ (l and h , low and high; where low is the timing $(\Delta c - W/2)$ and high is the timing $(\Delta c + W/2)$).

$$EVM_{\text{frame}} = \max(\overline{EVM}_{\text{frame},l}, \overline{EVM}_{\text{frame},h})$$

In order to unite at least N_{dt} slots, consider the minimum integer number of 10 ms measurement intervals, where N_{frame} is determined by

$$N_{\text{frame}} = \left\lceil \frac{10 \times N_{\text{slot}}}{N_{dt}^{TDD}} \right\rceil$$

And $N_{\text{slot}} = 4$ for 60 kHz SCS and $N_{\text{slot}} = 8$ for 120 kHz SCS.

Unite by RMS.

$$\overline{EVM} = \sqrt{\frac{1}{N_{\text{frame}}} \sum_{k=1}^{N_{\text{frame}}} EVM_{\text{frame},k}^2}$$

The resulting \overline{EVM} is compared against the limit.

Annex G (normative):

TRP measurement procedures

G.1 General

The annex describes various procedures for NR Repeater OTA TRP measurements. These procedures can provide either an accurate or an over-estimate of TRP values. The procedures for an accurate estimate can be applied to all TRP requirements. However, if a TRP requirement does not need accurate TRP estimate then the procedures for over-estimate of TRP may be used in order to have a reasonable OTA test time. Pre-scan does not provide an accurate TRP estimate or over-estimate of TRP. Pre-scan is a fast but coarse method that is used to identify the spurious emission frequencies with emission power as described in annex G.13. A sequential measurement is then made at the emission frequencies, to assess the TRP as described in annex G.2 to annex G.7.

When making TRP measurements for a repeater, it is important to ensure that a stimulus signal is maintained at the correct power level and direction with respect to the repeater for the whole of the measurement duration. This may be achieved by calibrated rotation of the signal generation equipment together with the repeater, or by means of the movement of probes within the measurement chamber around the repeater whilst the repeater and signal generation equipment are maintained static.

When making TRP measurements the alignment between EUT and measurement antenna is important to achieve expected measurement uncertainty:

1. The measurement antenna needs to be aligned tangential to the measurement surface forming a sphere around the EUT, in order to correctly measure the TRP properly.
2. Test methods described in clauses G.5.1, G.5.2, G.10, G.11 and G.12 require angular alignment between the selected measurement grid and EUT radiation pattern in order to measure peak values in the main beams. Angular misalignment can lead to differences in the actual and measured angular positions of the intended maximum EIRP.
3. Test methods described in clause G.5.3, and G.6 are designed to be independent of rotations of the angular grid, and hence angular alignment between the measurement grid and EUT is not needed.

G.2 Spherical equal angle grid

G.2.1 General

TRP_{Estimate} is defined as

$$TRP_{Estimate} = \frac{\pi}{2NM} \sum_{n=0}^{N-1} \sum_{m=0}^{M-1} EIRP(\theta_n, \phi_m) \sin \theta_n$$

when EIRP measurements is used or as

$$TRP_{Estimate} = 4\pi d^2 \frac{\pi}{2NM} \sum_{n=1}^{N-1} \sum_{m=0}^{M-1} P_D(\theta_n, \phi_m) \sin \theta_n$$

when power density measurements are used, and d is the test distance. N and M are the number of samples in the θ and ϕ angles. Each (θ_n, ϕ_m) is a sampling point. The sampling angular intervals for θ and ϕ angles are $\Delta\theta = \frac{\pi}{N}$ and $\Delta\phi = \frac{2\pi}{M}$. The sampling intervals $\Delta\theta$ and $\Delta\phi$ are described in G.2.2.

G.2.2 Reference angular step criteria

The reference angular steps $\Delta\phi_{ref}$ and $\Delta\theta_{ref}$ in degrees are defined as:

$$\Delta\phi_{ref} = \min\left(\frac{180^\circ}{\pi} \frac{\lambda}{D_{cyl}}, 15^\circ\right)$$

$$\Delta\theta_{ref} = \min\left(\frac{180^\circ}{\pi} \frac{\lambda}{D}, 15^\circ\right)$$

The upper limit for these reference angular steps of 15° ensures a low Summation Error (SE) when λ is large compared to the EUT dimensions.

D_{cyl} and D are calculated as:

$$D_{cyl} = \sqrt{d^2 + w^2}$$

$$D = \sqrt{d^2 + w^2 + h^2}$$

The definition of d , w and h is shown in figure G.2.2-1. The radiation source can be EUT antenna array or the whole of EUT.

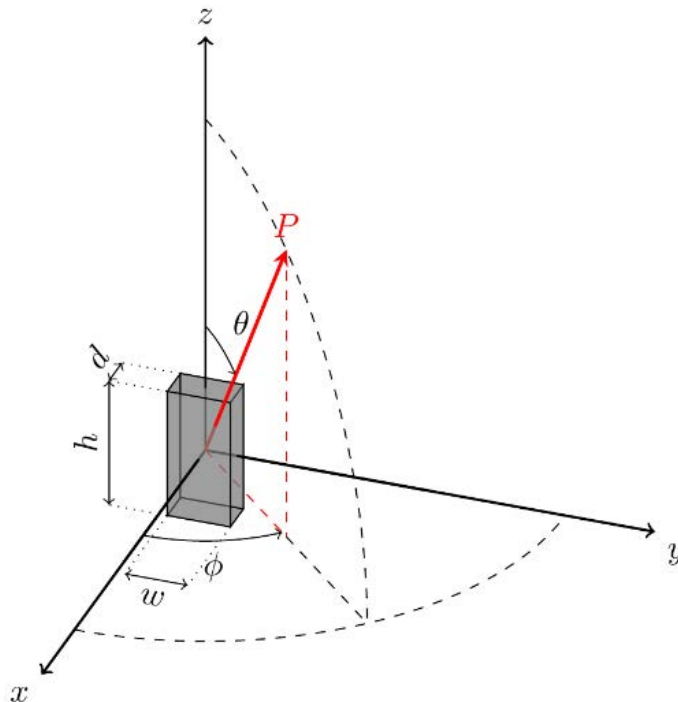

Figure G.2.2-1: Dimensions of a radiation source: depth (d), width (w) and height (h)

Optionally, in the case of Uniform Linear Array (ULA), when d is negligible ($d \approx 0$) and the EUT is mounted along the yz plane as shown in figure G.2.2-2, the reference angular steps, in degrees, can be determined by

$$\Delta\theta_{ref} = \min\left(\frac{180^\circ}{\pi} \arcsin\left(\frac{\lambda}{D_z}\right), 15^\circ\right)$$

$$\Delta\phi_{ref} = \min\left(\frac{180^\circ}{\pi} \arcsin\left(\frac{\lambda}{D_y}\right), 15^\circ\right)$$

Where D_y is the length of radiating parts of EUT along y-axis, D_z is the length of radiating parts of EUT along the z-axis and λ is wavelength for the measured frequency.

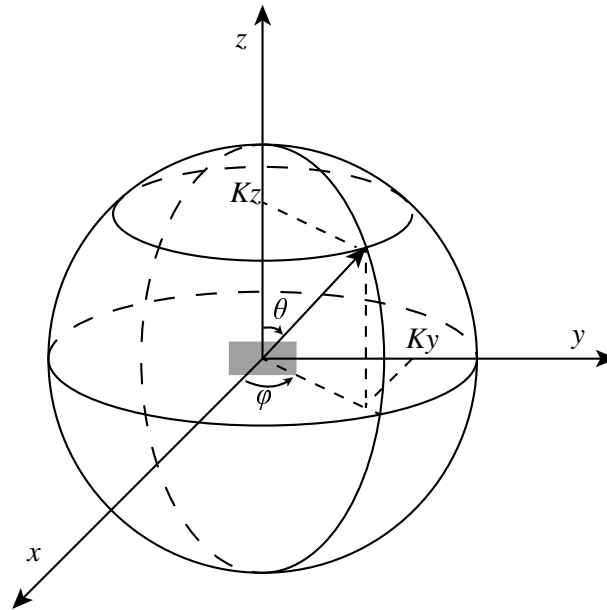

Figure G.2.2-2: Spherical coordinate for OTA conformance testing of EUT

Where due to practical reasons such as time constraints or turn-table precision, measurement with the reference steps is not practical, sparser grids can be used. Use of sparse grids can lead to errors in TRP assessment. In order to characterize these errors, the SF (sparsity factor) of the grid is defined as

$$SF = \max\left(\frac{\Delta\theta_{grid}}{\Delta\theta_{ref}}, \frac{\Delta\phi_{grid}}{\Delta\phi_{ref}}\right)$$

Where $\Delta\theta_{grid}$ and $\Delta\phi_{grid}$ are the actual angular steps used in the measurement.

Alternatively, when EUT radiating dimensions are not known, for each frequency within the *downlink operating band* including Δf_{OBUe} , the reference angular steps can be specified in terms of the *beamwidth* of the wanted signal as

$$\Delta\phi_{ref} = \frac{\lambda}{\lambda_0} BeW_{\phi}$$

$$\Delta\theta_{ref} = \frac{\lambda}{\lambda_0} BeW_{\theta}$$

where λ_0 is the wavelength of the wanted signal, and BeW_{ϕ} and BeW_{θ} are the *beamwidth* of the wanted signal in the ϕ -axis and θ -axis, respectively.

BeW_{ϕ} and BeW_{θ} may be set to *beamwidth* declared for the OTA Repeater radiated transmit power requirement provided the same *beam* is applied to test in-band TRP requirements.

NOTE: *Beamwidth* is approximately equal to half the first-null beam width.

G.3 Spherical equal area grid

TRP_{Estimate} is defined as

$$TRP_{Estimate} = \frac{1}{N} \sum_{n=1}^N EIRP(\theta_n, \phi_n)$$

N is the total number of samples and specified as

$$N \geq \frac{4\pi}{\Delta\theta_{ref} \Delta\phi_{ref}}$$

The sampling intervals $\Delta\theta_{ref}$ and $\Delta\phi_{ref}$ are described in annex G.2.2. Each (θ_n, ϕ_n) is a sampling point.

G.4 Spherical Fibonacci grid

$TRP_{Estimate}$ is defined as

$$TRP_{Estimate} = \frac{1}{N} \sum_{n=0}^{N-1} EIRP(\theta_n, \phi_n)$$

N is the total number of samples and specified as

$$N \geq \frac{4\pi}{\Delta\theta_{ref} \Delta\phi_{ref}}$$

The sampling intervals $\Delta\theta_{ref}$ and $\Delta\phi_{ref}$ are described in annex G.2.2. Each (θ_n, ϕ_n) is a sampling point, where θ_n and ϕ_n , in degrees, are defined as:

$$\theta_n = \cos^{-1} \left(1 - \frac{2n+1}{N} \right)$$

$$\phi_n = \frac{360^\circ n}{\Psi}, \quad \Psi = \frac{1 + \sqrt{5}}{2}$$

G.5 Orthogonal cut grid

G.5.1 General

Here, at least two cuts (default) shall be used, an optional third cut can be used. The alignment of the cuts must be along the symmetry planes of the antenna array. No alignment is required for spurious emissions.

When alignment is required:

- 1) The first mandatory cut is a horizontal cut passing through the peak direction of the main beam.
- 2) The second mandatory is a vertical cut passing through the peak direction of the main beam. Using the data from these two mandatory cuts, a conditional pattern multiplication can be used.

3) The third optional cut is a vertical cut orthogonal to the first and the second cut.

When alignment is not required, the cuts can be aligned arbitrarily.

Once the number and the orientation of the cuts are decided, the total EIRP is measured on the orthogonal cuts and the TRP is then calculated as follows: First the contributions from each cut is calculated as

$$EIRP_{av, cut-n} = \frac{1}{P} \sum_{j=1}^P EIRP(j)$$

where P is the number of sampling points in the cut. The final contribution for all cuts is calculated as

$$TRP_{Estimate} = \frac{1}{N} \sum_{n=1}^N EIRP_{av, cut-n}$$

where N is the number of cuts. Note that when orthogonal cuts are measured, the interclause points are measured multiple times and the repeated values can be removed from the samples before averaging.

When two cuts measurements are used, a conditional pattern multiplication can be applied. The following are the conditions for applying pattern multiplication:

- i. The vertical cut (and the main beam) is in the xz -plane
- ii. The frequency of the emission is within the downlink operating band.
- iii. The bandwidth of the emission is the same as the bandwidth of the in-band modulated signal
- iv. The emission appears/disappears when the Tx power is turned on/off.
- v. The antenna arrays of the EUT
 - 1) Have rectangular grids of antenna element positions
 - 2) Have symmetry planes that are vertical and horizontal.
 - 3) Have parallel antenna planes

The antenna array is here assumed to be placed in the yz -plane. The pattern multiplication is performed in uv -coordinates and the data in the two cuts are denoted $EIRP_{cut1}(\phi)$ at $\theta = \theta_H$ and a vertical cut with data $EIRP_{cut2}(\theta)$ at $\phi = 0$. The data is split in two parts corresponding to the forward and backward hemispheres. The uv -coordinates are the projections of the angular directions onto the antenna plane, here the yz -plane. Using the spherical coordinates as depicted in figure G.2.2-1 the u and v coordinates are defined as:

$$\begin{cases} u = \sin \theta \sin \phi \\ v = \cos \theta \end{cases}$$

Note that only the data on the cuts are measured.

Calculate power density/EIRP values outside the two cardinal cuts as

$$EIRP(u, v) = \frac{EIRP_{cut1}(u)EIRP_{cut2}(v)}{EIRP(0, v_H)}$$

The pattern multiplication is applied separately for the forward (fwd) and backward (bwd) hemisphere. The TRP is then calculated as

$$\text{TRP} = \frac{1}{4\pi} \left[\iint_{\text{fwd}} \text{EIRP}_{\text{fwd}}(u, v) \frac{dudv}{\sqrt{1-u^2-v^2}} + \iint_{\text{bwd}} \text{EIRP}_{\text{bwd}}(u, v) \frac{dudv}{\sqrt{1-u^2-v^2}} \right]$$

NOTE: The numerical singularity at $u^2 + v^2 = 1$ must be treated with care, e.g. by change of variables.

G.5.2 Operating band unwanted emissions

The procedure is as follows:

- 1) Follow steps described in annex G.5.1 for the first two mandatory cuts and calculate the $\text{TRP}_{\text{Estimate}}$.
- 2) Compare the $\text{TRP}_{\text{Estimate}}$ to the limit.
- 3) If the $\text{TRP}_{\text{Estimate}}$ is above the limit, perform the measurement on an additional third cut and repeat steps 1 to 2.

G.5.3 Spurious unwanted emissions

The procedure is as follows:

- 1) Follow steps described in annex G.5.1 for two cuts and calculate the preliminary $\text{TRP}_{\text{Estimate}}$.
- 2) Add the appropriate correction factor ΔTRP according to table G.5.3-1 to ensure overestimation with 95% confidence.
- 3) Compare the corrected $\text{TRP}_{\text{Estimate}}$ (including ΔTRP) to the limit.
- 4) If the corrected $\text{TRP}_{\text{Estimate}}$ is above the limit, perform the measurement on an additional third cut and repeat steps 1 to 3.

Table G.5.3-1: The correction factor for two or three cuts dense sampling

	Three cuts	Two cuts
Correction factor ΔTRP (dB)	2.0	2.5

G.6 Wave vector space grid

If EUT is mounted along the yz plane as shown in figure G.2.2-1, the reference step in wave vector space can be determined by

$$\Delta u_{\text{ref}} = \frac{\lambda}{D_y}$$

$$\Delta v_{\text{ref}} = \frac{\lambda}{D_z}$$

where D_y is the length of radiating parts of EUT along y-axis, D_z is the length of radiating parts of EUT along the z-axis.

According to the relationship between the normalized wave vector and spherical coordinate, the wave vector can be represented as following:

$$u = \sin(\theta) \sin(\phi), v = \cos(\theta)$$

The total radiated power (TRP) in the wave vector space is determined by:

$$\text{TRP}_{estimate} = \frac{\Delta u_{ref} \Delta v_{ref}}{4\pi} \left(\sum_{\substack{u^2+v^2 < 1 \\ \cos\phi > 0}} \frac{\text{EIRP}(\theta_n, \phi_{m,n})}{\sin\theta_n |\cos\phi_{m,n}|} + \sum_{\substack{u^2+v^2 < 1 \\ \cos\phi < 0}} \frac{\text{EIRP}(\theta_n, \phi_{m,n})}{\sin\theta_n |\cos\phi_{m,n}|} \right)$$

For spurious Tx or Rx emissions and where due to practical reasons such as time constraints or turn-table precision, measurement with the reference steps is not practical, sparser grids can be used. Use of sparse grids can lead to errors in TRP assessment. In order to characterize these errors, the SF (sparsity factor) of the grid is defined as

$$SF = \max\left(\frac{\Delta u_{grid}}{\Delta u_{ref}}, \frac{\Delta v_{grid}}{\Delta v_{ref}}\right)$$

Where Δu_{grid} and Δv_{grid} are the actual steps used in the wave vector space in the measurement and the upper bound of their value is 1/12, corresponding to 15 degree steps close to boresight.

G.7 Full sphere with sparse sampling

The procedure is as follows:

- 1) Set the angular grid:
 - a. Non-harmonic frequencies: choose the angular steps $\Delta\phi$ and $\Delta\theta$ smaller than or equal to 15 degrees. Calculate the sparsity factor (SF) as

$$SF = \max\left(\frac{\Delta\phi}{\Delta\phi_{ref}}, \frac{\Delta\theta}{\Delta\theta_{ref}}\right)$$

and the correction factor as:

$$\Delta\text{TRP} = \frac{SF-1}{SF_{max}-1} \cdot 1.0 \text{ dB},$$

where SF_{max} corresponds to 15 degrees angular step. If the sparsity factor is smaller than 1, the correction factor ΔTRP is 0 dB.

Harmonic frequencies with fixed beam test signal: choose the angular steps smaller than or equal to the reference angular steps $\Delta\phi_{ref}$ and $\Delta\theta_{ref}$. Correction factor ΔTRP is 0 dB.

Harmonic frequencies with beam sweeping test signal: set the angular steps to 15 degrees. Correction factor is ΔTRP 0 dB.

- 2) Apply a suitable numerical integration to calculate the preliminary $\text{TRP}_{Estimate}$.

- 3) Add the appropriate correction factor ΔTRP according to step 1 to ensure an overestimation with 95 % confidence.
- 4) Compare the corrected $TRP_{Estimate}$ (including ΔTRP) with the limit. If the corrected $TRP_{Estimate}$ is above the limit, choose a smaller angular step and repeat steps 2-4. If the sparsity factor is less than one, no significant improvement of accuracy is expected.

G.8 Beam-based directions

Beam-based direction can be used in the base station *operating band* only if the directivity of the radiation pattern of the emissions being measured is known. $TRP_{Estimate}$ is defined as

$TRP_{Estimate} = \frac{EIRP_{peak}}{D_{EUT}}$, where $EIRP_{peak}$ is the maximum EIRP in the beam peak direction within a particular beam direction pair and D_{EUT} is the directivity of the EUT.

G.9 Peak method

The peak method can be used when frequencies with unwanted peak emissions are identified during pre-scan. The method does not provide an estimate of TRP.

For each peak emission frequency identified during pre-scan, measure peak EIRP or power density as follows:

- 1) Move EUT and test antenna to the same position where the peak emission is recorded during the pre-scan.
- 2) Move the EUT around the position and test antenna orientation to find the final peak EIRP or power density.
- 3) The measured peak power density or EIRP shall be used to demonstrate conformance.

NOTE: Peak EIRP is the linear sum of two orthogonal polarized components.

G.10 Equal sector with peak average

Equal sector with peak average can be performed on frequencies with unwanted peak emission, which are considered by the peak method for further measurements.

The spherical angle ϕ is divided into K equal sectors. If the largest dimension of EUT is less than 60 cm, then each sector is a half quadrant of 45°.

For each peak emission frequency, measure peak EIRP of beams belonging to different sectors of the sphere as follows:

- 1) Move EUT and test antenna to the same position where the emission peak is recorded during the pre-scan.
- 2) Move EUT around the position and test antenna orientation to find the final peak EIRP.
- 3) Repeat Steps 1 to 2 until all sectors are covered.

4) Calculate $TRP_{Estimate}$ as

$$TRP_{Estimate} = \frac{1}{K} \sum_{k=1}^K EIRP_k, \text{ where } EIRP_k \text{ is the peak EIRP in the } k\text{th sector}$$

NOTE: Peak EIRP is the linear sum of two orthogonal polarized components.

G.11 Pre-scan

Pre-scan is used to identify frequencies with unwanted emission power levels above a certain threshold. The pre-scan does not provide an estimate of TRP. An emission frequency identified by a pre-scan may be further investigated by any of the TRP measurement methods in this annex.

The procedure for pre-scan is as follows:

- 1) Scan the entire surface around EUT.
- 2) Rotate test antenna to cover all possible polarizations of emissions to detect maximum emissions.
- 3) Record the list of frequencies and corresponding unwanted emission power levels, EUT spatial positions, and test antenna polarization for which the maximum emission levels occur.
- 4) Emissions which 20 dB or more below the specified limit shall not require further measurements.

Annex H (informative):

Change history

Change history							
Date	Meeting	TDoc	CR	Rev	Cat	Subject/Comment	New version
2022-05	RAN4#10 3e	R4-2210846				TS skeleton	0.0.1
2022-08	RAN4#10 4e	R4-2214368				Added approved TPs in RAN4#104-e including R4-2211703,TP for TS 38.115-2: Clause 4.2-4.5 R4-2211704,TP for TS 38.115-2: Clause 5 operating bands R4-2213722,TP for TS 38.115-2: section 4.10~4.12 R4-2213977,TP to TS 38.115-2 Annex A Repeater stimulus signals (OTA) R4-2214742,TP for TS 38.115-2: Clause 3 definitions R4-2214788,TP to TS 38.115-2: Frequency Stability, Out of band gain, unwanted emissions R4-2214792,TP to TS 38.115-2: TDD Switching R4-2214802,TP to TS 38.115-2 Manufacturer declarations for NR FR2 repeaters R4-2214804,TP to TS 38.115-2 clause 6.7 OTA Input intermodulation R4-2214842,TP for TS 38.115-2: section 6.8 R4-2214843,TP for TS 38.115-2: Annex D and E R4-2214868,TP to TS 38.115-2 clause 6.6 OTA EVM	0.1.0
2022-10	RAN4#10 4bis-e	R4-2216568				Added approved TPs in RAN4#104-e including R4-2214786,TP to TS 38.115-2: Test Configurations and Requirement applicability R4-2214790,TP to TS 38.115-2: In-band measurements Annex R4-2214866,TP to TS 38.115-2 clause 4.9 RF channels and test models Added approved TPs in RAN4#104bis-e including R4-2217302,TP to TS 38.115-2 – Annex I TRP measurement procedures R4-2217300,TP for TS 38.115-2: Scope, reference and editorial changes R4-2217308,TP to TS 38.115-2: Measurement uncertainties and test requirements (4.1) R4-2217310,TP to TS 38.115-2: OTA output power (6.1, 6.2) R4-2217309,TP to TS 38.115-2: Annex B: Test tolerances and derivation of test requirements R4-2216844,TP to TS 38.115-2: Annex A: Environmental requirements for the repeater	0.2.0
2022-11	RAN4#10 5	R4-2219348				Added approved TPs in RAN4#105 including R4-2220215 TP to 38.115-2: OTA ACLR requirement R4-2220218 TP to 38.115-2: OTA EVM requirement R4-2220271 TP to 38.115-2: OTA ACRR requirement R4-2220227 Draft CR to 38.115-2: Spectrum purity R4-2220228 TP for TS 38.115-2 OTA Out of band gain requirements R4-2220289 Maintenance TP for TS 38.115-2	0.3.0
2022-12	RAN#98e	RP-223091				Draft version for approval to RAN Plenary meeting: RP-223091, TS 38.115-2 v1.0.0 NR; Repeater conformance testing - Part 2: Radiated conformance testing	1.0.0

Change history							
Date	Meeting	TDoc	CR	Rev	Cat	Subject/Comment	New version
2022-12	RAN#98-e					Approved by plenary – Rel-17 spec under change control	17.0.0
2023-03	RAN#99	RP-230518	0001	1	F	CR for TS 38.115-2: Correction of some errors	17.1.0
2023-03	RAN#99	RP-230518	0002		F	CR to 38.115-2: Correction on OTA repeater EVM test requirements	17.1.0
2023-03	RAN#99	RP-230518	0003		F	CR to 38.115-2: Correction on derivation of test requirements	17.1.0
2023-03	RAN#99	RP-230518	0004		F	CR to 38.115-2: Correction of repeater ACLR test procedure	17.1.0
2023-06	RAN#100	RP-231339	0005	1	F	CR for TS 38.115-2, Add manufacturer declarations for test configurations and RF channels	17.2.0
2023-06	RAN#100	RP-231339	0006		F	CR to 38.115-2: Corrections on repeater output power requirements	17.2.0
2023-06	RAN#100	RP-231339	0007	1	F	CR to TS 38.115-2: Clarifications for repeater test models	17.2.0
2023-09	RAN#101	RP-232496	0008	1	F	[NR_repeaters] CR to 38.115-2: Input intermodulation	17.3.0
2023-12	RAN#102	RP-233350	0009		F	CR for TS 38.115-2, Remove multi-band related content for repeater type 2-O	17.4.0
2023-12	RAN#102	RP-233350	0010	1	F	CR to 38.115-2: Correction of terminologies for NR repeaters	17.4.0

History

Document history		
V17.0.0	January 2023	Publication
V17.1.0	May 2023	Publication
V17.2.0	July 2023	Publication
V17.3.0	October 2023	Publication
V17.4.0	January 2024	Publication