

ETSI TS 138 133 V15.5.0 (2019-07)



**5G;
NR;
Requirements for support of radio resource management
(3GPP TS 38.133 version 15.5.0 Release 15)**



Reference

RTS/TSGR-0438133vf50

Keywords

5G

ETSI

650 Route des Lucioles
F-06921 Sophia Antipolis Cedex - FRANCE

Tel.: +33 4 92 94 42 00 Fax: +33 4 93 65 47 16

Siret N° 348 623 562 00017 - NAF 742 C
Association à but non lucratif enregistrée à la
Sous-Préfecture de Grasse (06) N° 7803/88

Important notice

The present document can be downloaded from:

<http://www.etsi.org/standards-search>

The present document may be made available in electronic versions and/or in print. The content of any electronic and/or print versions of the present document shall not be modified without the prior written authorization of ETSI. In case of any existing or perceived difference in contents between such versions and/or in print, the prevailing version of an ETSI deliverable is the one made publicly available in PDF format at www.etsi.org/deliver.

Users of the present document should be aware that the document may be subject to revision or change of status.

Information on the current status of this and other ETSI documents is available at

<https://portal.etsi.org/TB/ETSIDeliverableStatus.aspx>

If you find errors in the present document, please send your comment to one of the following services:

<https://portal.etsi.org/People/CommiteeSupportStaff.aspx>

Copyright Notification

No part may be reproduced or utilized in any form or by any means, electronic or mechanical, including photocopying and microfilm except as authorized by written permission of ETSI.

The content of the PDF version shall not be modified without the written authorization of ETSI.

The copyright and the foregoing restriction extend to reproduction in all media.

© ETSI 2019.

All rights reserved.

DECT™, **PLUGTESTS™**, **UMTS™** and the ETSI logo are trademarks of ETSI registered for the benefit of its Members.

3GPP™ and **LTE™** are trademarks of ETSI registered for the benefit of its Members and of the 3GPP Organizational Partners.

oneM2M™ logo is a trademark of ETSI registered for the benefit of its Members and of the oneM2M Partners.

GSM® and the GSM logo are trademarks registered and owned by the GSM Association.

Intellectual Property Rights

Essential patents

IPRs essential or potentially essential to normative deliverables may have been declared to ETSI. The information pertaining to these essential IPRs, if any, is publicly available for **ETSI members and non-members**, and can be found in ETSI SR 000 314: *"Intellectual Property Rights (IPRs); Essential, or potentially Essential, IPRs notified to ETSI in respect of ETSI standards"*, which is available from the ETSI Secretariat. Latest updates are available on the ETSI Web server (<https://ipr.etsi.org/>).

Pursuant to the ETSI IPR Policy, no investigation, including IPR searches, has been carried out by ETSI. No guarantee can be given as to the existence of other IPRs not referenced in ETSI SR 000 314 (or the updates on the ETSI Web server) which are, or may be, or may become, essential to the present document.

Trademarks

The present document may include trademarks and/or tradenames which are asserted and/or registered by their owners. ETSI claims no ownership of these except for any which are indicated as being the property of ETSI, and conveys no right to use or reproduce any trademark and/or tradename. Mention of those trademarks in the present document does not constitute an endorsement by ETSI of products, services or organizations associated with those trademarks.

Legal notice

This Technical Specification (TS) has been produced by the ETSI 3rd Generation Partnership Project (3GPP).

The present document may refer to technical specifications or reports using their 3GPP identities. These shall be interpreted as being references to the corresponding ETSI deliverables.

The cross reference between 3GPP and ETSI identities can be found under <http://webapp.etsi.org/key/queryform.asp>.

Modal verbs terminology

In the present document "**shall**", "**shall not**", "**should**", "**should not**", "**may**", "**need not**", "**will**", "**will not**", "**can**" and "**cannot**" are to be interpreted as described in clause 3.2 of the [ETSI Drafting Rules](#) (Verbal forms for the expression of provisions).

"**must**" and "**must not**" are **NOT** allowed in ETSI deliverables except when used in direct citation.

Contents

Intellectual Property Rights	2
Legal notice	2
Modal verbs terminology.....	2
Foreword.....	20
1 Scope	20
2 References	20
3 Definitions, symbols and abbreviations	21
3.1 Definitions	21
3.2 Symbols.....	22
3.3 Abbreviations	22
3.4 Test tolerances.....	24
3.5 Frequency bands grouping	24
3.5.1 Introduction.....	24
3.5.2 NR operating bands in FR1	24
3.5.3 NR operating bands in FR2	24
3.6 Applicability of requirements in this specification version	25
3.6.1 RRC connected state requirements in DRX.....	25
3.6.2 Number of serving carriers	26
3.6.2.1 Number of serving carriers for SA	26
3.6.2.2 Number of serving carriers for EN-DC.....	26
3.6.2.3 Number of serving carriers for NE-DC.....	26
3.6.2.4 Number of serving carriers for NR-DC.....	26
3.6.3 Applicability for SSB Rx beam in intra-band FR2	26
3.6.4 Applicability for FR2 UE power classes.....	27
3.6.5 Applicability of requirements for NGEN-DC operation.....	27
4 SA: RRC_IDLE state mobility.....	27
4.1 Cell Selection	27
4.2 Cell Re-selection	27
4.2.1 Introduction.....	27
4.2.2 Requirements	27
4.2.2.1 UE measurement capability	27
4.2.2.5 Measurements of inter-RAT E-UTRAN cells.....	30
4.2.2.6 Maximum interruption in paging reception.....	31
4.2.2.7 General requirements	32
5 SA: RRC_INACTIVE state mobility	33
5.1 Cell Re-selection	33
5.1.1 Introduction.....	33
5.1.2 Requirements	33
5.1.2.1 UE measurement capability	33
5.1.2.2 Measurement and evaluation of serving cell.....	33
5.1.2.3 Measurements of intra-frequency NR cells.....	33
5.1.2.4 Measurements of inter-frequency NR cells.....	33
5.1.2.5 Measurements of inter-RAT E-UTRAN cells.....	33
5.1.2.6 Maximum interruption in paging reception.....	33
5.1.2.7 General requirements	33
5.2 RRC_INACTIVE Mobility Control	33
6 RRC_CONNECTED state mobility	34
6.1 Handover	34
6.1.1 NR Handover	34
6.1.1.1 Introduction.....	34
6.1.1.2 NR FR1 - NR FR1 Handover.....	34
6.1.1.2.1 Handover delay.....	34

6.1.1.2.2	Interruption time	34
6.1.1.3	NR FR2- NR FR1 Handover	35
6.1.1.3.1	Handover delay	35
6.1.1.3.2	Interruption time	35
6.1.1.4	NR FR2- NR FR2 Handover	35
6.1.1.4.1	Handover delay	35
6.1.1.4.2	Interruption time	36
6.1.1.5	NR FR1- NR FR2 Handover	36
6.1.1.5.1	Handover delay	36
6.1.1.5.2	Interruption time	36
6.1.2	NR Handover to other RATs	37
6.1.2.1	NR – E-UTRAN Handover	37
6.1.2.1.1	Introduction	37
6.1.2.1.2	Handover delay	37
6.1.2.1.3	Interruption time	37
6.2	RRC Connection Mobility Control	38
6.2.1	SA: RRC Re-establishment	38
6.2.1.1	Introduction	38
6.2.1.2	Requirements	38
6.2.1.2.1	UE Re-establishment delay requirement	38
6.2.2	Random access	40
6.2.2.1	Introduction	40
6.2.2.2	Requirements	40
6.2.2.2.1	Contention based random access	40
6.2.2.2.2	Non-Contention based random access	41
6.2.2.2.3	UE behaviour when configured with supplementary UL	42
6.2.3	SA: RRC Connection Release with Redirection	42
6.2.3.1	Introduction	42
6.2.3.2	Requirements	42
6.2.3.2.1	RRC connection release with redirection to NR	42
6.2.3.2.2	RRC connection release with redirection to E-UTRAN	43
7	Timing	44
7.1	UE transmit timing	44
7.1.1	Introduction	44
7.1.2	Requirements	44
7.2	UE timer accuracy	45
7.2.1	Introduction	45
7.2.2	Requirements	45
7.3	Timing advance	46
7.3.1	Introduction	46
7.3.2	Requirements	46
7.3.2.1	Timing Advance adjustment delay	46
7.3.2.2	Timing Advance adjustment accuracy	46
7.4	Cell phase synchronization accuracy	46
7.4.1	Definition	46
7.4.2	Minimum requirements	46
7.5	Maximum Transmission Timing Difference	47
7.5.1	Introduction	47
7.5.2	Minimum Requirements for inter-band EN-DC	47
7.5.3	Minimum Requirements for intra-band EN-DC	47
7.5.4	Minimum Requirements for NR Carrier Aggregation	47
7.5.5	Minimum Requirements for inter-band NE-DC	48
7.5.6	Minimum Requirements for inter-band NR-NR DC	48
7.6	Maximum Receive Timing Difference	49
7.6.1	Introduction	49
7.6.2	Minimum Requirements for inter-band EN-DC	49
7.6.3	Minimum Requirements for intra-band EN-DC	50
7.6.4	Minimum Requirements for NR Carrier Aggregation	50
7.6.5	Minimum Requirements for inter-band NE-DC	50
7.6.6	Minimum Requirements for inter-band NR-NR DC	51
7.7	deriveSSB-IndexFromCell tolerance	51

7.7.1	Minimum requirements.....	51
7.8	Maximum Allowed UE Transition Times for TDD Intra-band Carrier Aggregation.....	52
7.8.1	Requirements	52
8	Signalling characteristics.....	52
8.1	Radio Link Monitoring.....	52
8.2	Interruption.....	60
8.2.1.2	Requirements	60
8.2.1.2.1	Interruptions at transitions between active and non-active during DRX	60
8.2.1.2.3	Interruptions at SCell addition/release.....	61
8.2.1.2.6	Interruptions at UL carrier RRC reconfiguration	63
8.2.1.2.7	Interruption due to Active BWP switching Requirement.....	64
8.2.2.2.1	Interruptions at SCell addition/release.....	65
8.2.2.2.2	Interruptions at SCell activation/deactivation.....	65
8.2.2.2.3	Interruptions during measurements on SCC for intra-band CA	66
8.2.2.2.5	Interruption due to Active BWP switching Requirement	67
8.2.3	NE-DC Interruptions.....	68
8.2.3.1	Introduction.....	68
8.2.3.2	Requirements	68
8.2.3.2.1	Interruptions at transitions between active and non-active during DRX	68
8.2.3.2.3	Interruptions at PSCell/SCell addition/release	69
8.2.3.2.6	Interruptions at UL carrier RRC reconfiguration	71
8.2.3.2.7	Interruption due to Active BWP switching Requirement.....	71
8.2.4	NR-NR DC: Interruptions.....	71
8.2.4.1	Introduction.....	71
8.2.4.2	Requirements	72
8.2.4.2.1	Interruptions at PSCell/SCell addition/release	72
8.2.4.2.2	Interruptions at SCell activation/deactivation.....	72
8.2.4.2.3	Interruptions during measurements on SCC.....	73
8.2.4.2.5	Interruption due to Active BWP switching Requirement.....	74
8.3	SCell Activation and Deactivation Delay.....	74
8.3.1	Introduction.....	74
8.3.2	SCell Activation Delay Requirement for Deactivated SCell	74
8.3.3	SCell Deactivation Delay Requirement for Activated SCell	75
8.4	UE UL carrier RRC reconfiguration Delay.....	76
8.4.1	Introduction.....	76
8.4.2	UE UL carrier configuration Delay Requirement.....	76
8.4.3	UE UL carrier deconfiguration Delay Requirement	76
8.5.7	Scheduling availability of UE during beam failure detection	84
8.6	Active BWP switch delay.....	86
8.6.1	Introduction.....	86
8.6.2	DCI and timer based BWP switch delay.....	86
8.6.3	RRC based BWP switch delay.....	87
8.7	Void.....	87
8.8	NE-DC: E-UTRAN PSCell Addition and Release Delay	87
8.8.1	Introduction.....	87
8.8.2	E-UTRAN PSCell Addition Delay Requirement.....	87
8.8.3	E-UTRAN PSCell Release Delay Requirement	88
9	Measurement Procedure	89
9.1	General measurement requirement.....	89
9.1.1	Introduction.....	89
9.1.2	Measurement gap.....	89
9.1.2.1	NSA: Measurement Gap Sharing	97
9.1.2.1a	SA: Measurement Gap Sharing.....	97
9.1.2.1b	NE-DC: Measurement Gap Sharing.....	98
9.1.2.1c	NR-DC: Measurement Gap Sharing	98
9.1.3	UE Measurement capability.....	98
9.1.3.1	NSA: Monitoring of multiple layers using gaps.....	98
9.1.3.1b	NE-DC: Monitoring of multiple layers using gaps	99
9.1.3.2	NSA: Maximum allowed layers for multiple monitoring	100
9.1.3.2a	SA: Maximum allowed layers for multiple monitoring	101

9.1.3.2b	NE-DC: Maximum allowed layers for multiple monitoring	101
9.1.4	Capabilities for Support of Event Triggering and Reporting Criteria	102
9.1.4.1	Introduction	102
9.1.4.2	Requirements	102
9.1.5	Carrier-specific scaling factor	103
9.1.5.1	Monitoring of multiple layers outside gaps	103
9.1.5.1.1	NSA mode: carrier-specific scaling factor for SSB-based measurements performed outside gaps	103
9.1.5.1.2	SA mode: carrier-specific scaling factor for SSB-based measurements performed outside gaps without NR-DC operation	104
9.1.5.1.3	SA mode: carrier-specific scaling factor for SSB-based measurements performed outside gaps with NR-DC operation	104
9.1.5.2	Monitoring of multiple layers within gaps	105
9.1.5.2.1	NSA mode: carrier-specific scaling factor for SSB-based measurements performed within gaps	105
9.1.5.2.2	SA mode: carrier-specific scaling factor for SSB-based measurements performed within gaps... ..	106
9.1.6	Minimum requirement at transitions	107
9.2	NR intra-frequency measurements	107
9.2.1	Introduction	107
9.2.2	Requirements applicability	108
9.2.3	Number of cells and number of SSB	108
9.2.4	Measurement Reporting Requirements	109
9.2.5	Intrafrequency measurements without measurement gaps	109
9.2.5.3.1	Scheduling availability of UE performing measurements with a same subcarrier spacing as PDSCH/PDCCH on FR1	113
9.2.6	Intrafrequency measurements with measurement gaps	114
9.3	NR inter-frequency measurements	116
9.3.2	Requirements applicability	116
9.3.2.1	Void	116
9.3.2.2	Void	116
9.3.3	Number of cells and number of SSB	116
9.3.4	Inter frequency cell identification	117
9.3.4.1	Void	118
9.3.4.2	Void	118
9.3.5	Inter frequency measurements	118
9.3.5.1	Void	119
9.3.5.2	Void	119
9.3.5.3	Void	119
9.3.6	NR Inter frequency measurements reporting requirements	119
9.3.7	Void	120
9.4	Inter-RAT measurements	120
9.4.1	Introduction	120
9.4.2	SA: NR – E-UTRAN FDD measurements	121
9.4.3	SA: NR – E-UTRAN TDD measurements	123
9.4.4	SA: Inter-RAT RSTD measurements	125
9.4.5	SA: Inter-RAT E-CID measurements	132
10	Measurement Performance requirements	139
10.1.1	Introduction	139
10.1.2.1	SFTD accuracy requirements	168
10.1.2.1.1	SFTD accuracy requirements for NE-DC	168
10.2	E-UTRAN measurements	169
10.2.1	Introduction	169
10.2.2	E-UTRAN RSRP measurements	170
10.2.3	E-UTRAN RSRQ measurements	170
10.2.4	E-UTRAN RSTD measurements	170
10.2.5	E-UTRAN RS-SINR measurements	170
11	Measurements Performance Requirements for NR network	170
Annex A (normative):	Test Cases	171
A.1	Purpose of annex	171

A.2	Requirement classification for statistical testing.....	171
A.2.1	Types of requirements in TS 38.133	171
A.2.1.1	Time and delay requirements on UE higher layer actions	171
A.2.1.2	Measurements of power levels, relative powers and time	171
A.2.1.3	Implementation requirements	172
A.2.1.4	Physical layer timing requirements.....	172
A.3	RRM test configurations	173
A.3.1	Reference measurement channels.....	173
A.3.1.1	PDSCH	173
A.3.1.1.1	FDD.....	173
A.3.1.1.2	TDD	174
A.3.1.2	CORESET for RMSI scheduling	177
A.3.1.2.1	FDD.....	177
A.3.1.2.2	TDD	178
A.3.1.3	CORESET for RMC scheduling	181
A.3.1.3.1	FDD.....	181
A.3.1.3.2	TDD	182
A.3.1.4	TDD UL/DL configuration	184
A.3.2	OFDMA channel noise generator (OCNG).....	185
A.3.2.1	Generic OFDMA Channel Noise Generator (OCNG)	185
A.3.2.1.1	OCNG pattern 1: Generic OCNG pattern for all unused REs	185
A.3.2.2	Void	186
A.3.3	Reference DRX configurations	186
A.3.3.1	DRX Configuration 1: DRX cycle = 40 ms and TAT = 500 ms.....	186
A.3.3.2	DRX Configuration 2: DRX cycle = 640 ms and TAT = 500 ms.....	186
A.3.3.3	DRX Configuration 3: DRX cycle = 40 ms and TAT = Infinity	186
A.3.3.4	DRX Configuration 4: DRX cycle = 160 ms.....	187
A.3.3.5	DRX Configuration 5: DRX cycle = 320 ms.....	187
A.3.3.6	DRX Configuration 6: DRX cycle = 320 ms and TAT = Infinity	187
A.3.3.7	DRX Configuration 7: DRX cycle = 640 ms and TAT = Infinity	188
A.3.3.8	DRX Configuration 8: DRX cycle = 320 ms and TAT = Infinity	188
A.3.4	Test Cases with Different Channel Bandwidths.....	188
A.3.4.1	Test Cases with Different E-UTRA Channel Bandwidths.....	188
A.3.4.1.1	Introduction.....	188
A.3.4.1.2	Principle of testing	188
A.3.5	Test Cases for Synchronous and Asynchronous DC Operations.....	189
A.3.5.1	EN-DC Test Cases for Synchronous and Asynchronous EN-DC Operations	189
A.3.5.1.1	Introduction.....	189
A.3.5.1.2	Principle of Testing.....	189
A.3.6	Antenna configurations	189
A.3.6.1	Antenna configurations for FR1	189
A.3.6.1.1	Antenna connection for 4 Rx capable UEs	189
A.3.6.1.1.1	Introduction	189
A.3.6.1.1.2	Principle of testing.....	189
A.3.6.2	Antenna configurations for FR2	191
A.3.7	EN-DC test setup.....	191
A.3.7.1	Introduction.....	191
A.3.7.2	E-UTRAN Serving Cell Parameters	191
A.3.7.2.1	E-UTRAN Serving Cell Parameters for Tests with NR Cell(s) in FR1	191
A.3.7.2.2	E-UTRAN Serving Cell Parameters for Tests with NR Cell(s) in FR2	193
A.3.8	PRACH configurations.....	194
A.3.8.1	Introduction.....	194
A.3.8.2	PRACH configurations in FR1	194
A.3.8.2.1	FR1 PRACH configuration 1	194
A.3.8.2.2	FR1 PRACH configuration 2	195
A.3.8.2.3	FR1 PRACH configuration 3	195
A.3.8.2.4	FR1 PRACH configuration 4	196
A.3.8.3	PRACH configurations in FR2	197
A.3.8.3.1	FR2 PRACH configuration 1	197
A.3.8.3.2	FR2 PRACH configuration 2	198
A.3.8.3.3	FR2 PRACH configuration 3	199

A.3.8.3.4	FR2 PRACH configuration 4	200
A.3.9	BWP configurations	201
A.3.9.1	Introduction.....	201
A.3.9.2	Downlink BWP configurations.....	202
A.3.9.2.1	Initial BWP	202
A.3.9.2.2	Dedicated BWP.....	202
A.3.9.3	Uplink BWP configurations.....	202
A.3.9.3.1	Initial BWP	202
A.3.9.3.2	Dedicated BWP.....	203
A.3.10	SSB Configurations.....	203
A.3.10.1	SSB Configurations for FR1	203
A.3.10.1.1	SSB pattern 1 in FR1: SSB for SSB SCS=15 KHz in 10 MHz.....	203
A.3.11	SMTC Configurations	206
A.3.11.1	SMTC pattern 1: SMTC period = 20 ms with SMTC duration = 1 ms.....	206
A.3.11.2	SMTC pattern 2: SMTC period = 20 ms with SMTC duration = 5 ms.....	206
A.3.11.3	SMTC pattern 3: SMTC period = 160 ms with SMTC duration = 1 ms.....	206
A.3.12	Test Cases with Different CC Configurations	207
A.3.12.1	EN-DC Test Cases with Different EN-DC Configurations	207
A.3.12.1.1	Introduction	207
A.3.12.1.2	Principle of testing	207
A.3.12.2	Carrier Aggregation Test Cases with Different CA Configurations	207
A.3.12.2.1	Introduction	207
A.3.12.2.2	Principle of testing	207
A.3.13	Test Cases in Standalone and Non-Standalone Operations	207
A.3.13.1	Introduction.....	207
A.3.13.2	Principle of Testing.....	207
A.3.14	CSI-RS configurations	208
A.3.14.1	FDD	208
A.3.14.2	TDD.....	210
A.3.15	Angle of Arrival (AoA) for FR2 RRM test cases.....	213
A.3.15.1	Setup 1: Single AoA in Rx beam peak direction	213
A.3.16	TCI State Configuration	213
A.3.16.1	Introduction.....	213
A.3.16.2	TCI states	213
A.3.17	Configurations of CSI-RS for tracking.....	214
A.3.17.1	Configuration of CSI-RS for tracking for FR1	214
A.3.17.1.1	FDD.....	214
A.3.17.1.2	TDD	215
A.3.17.2	Configuration of CSI-RS for tracking for FR2	216
A.3.17.2.1	TDD	216
A.4	EN-DC tests with all NR cells in FR1.....	216
A.4.1	Void.....	216
A.4.2	Void.....	216
A.4.3	RRC_CONNECTED state mobility	216
A.4.3.1	Void	216
A.4.3.2	RRC Connection Mobility Control.....	216
A.4.3.2.1	Void.....	216
A.4.3.2.3	Void.....	223
A.4.4	Timing	223
A.4.4.1	UE transmit timing	223
A.4.4.1.1	NR UE Transmit Timing Test for FR1	223
A.4.4.1.1.1	Test Purpose and environment	223
A.4.4.1.1.2	Test requirements	225
A.4.4.2	UE timer accuracy	226
A.4.4.3	Timing advance	226
A.4.4.3.1	EN-DC FR1 timing advance adjustment accuracy.....	226
A.4.4.3.1.1	Test Purpose and Environment.....	226
A.4.4.3.1.2	Test Parameters	226
A.4.4.3.1.3	Test Requirements	228
A.4.5	Signaling characteristics.....	229
A.4.5.1	Radio link Monitoring	229

A.4.5.1.1	Radio Link Monitoring Out-of-sync Test for FR1 PSCell configured with SSB-based RLM RS in non-DRX mode	229
A.4.5.1.1.1	Test Purpose and Environment.....	229
A.4.5.1.1.2	Test Requirements	232
A.4.5.1.2	Radio Link Monitoring In-sync Test for FR1 PSCell configured with SSB-based RLM RS in non-DRX mode	232
A.4.5.1.2.1	Test Purpose and Environment.....	232
A.4.5.1.2.2	Test Requirements	236
A.4.5.1.3	Radio Link Monitoring Out-of-sync Test for FR1 PSCell configured with SSB-based RLM RS in DRX mode	236
A.4.5.1.3.1	Test Purpose and Environment.....	236
A.4.5.1.3.2	Test Requirements	239
A.4.5.1.4	Radio Link Monitoring In-sync Test for FR1 PSCell configured with SSB-based RLM RS in DRX mode	239
A.4.5.1.4.1	Test Purpose and Environment.....	239
A.4.5.1.4.2	Test Requirements	242
A.4.5.1.5	EN-DC Radio Link Monitoring Out-of-sync Test for FR1 PSCell configured with CSI-RS-based RLM in non-DRX mode	242
A.4.5.1.5.1	Test Purpose and Environment.....	242
A.4.5.1.5.2	Test Requirements	245
A.4.5.1.6	EN-DC Radio Link Monitoring In-sync Test for FR1 PSCell configured with CSI-RS-based RLM in non-DRX mode	246
A.4.5.1.6.1	Test Purpose and Environment.....	246
A.4.5.1.6.2	Test Requirements	249
A.4.5.1.7	EN-DC Radio Link Monitoring Out-of-sync Test for FR1 PSCell configured with CSI-RS-based RLM in DRX mode.....	249
A.4.5.1.7.1	Test Purpose and Environment.....	249
A.4.5.1.7.2	Test Requirements	254
A.4.5.1.8	EN-DC Radio Link Monitoring In-sync Test for FR1 PSCell configured with CSI-RS-based RLM in DRX mode.....	254
A.4.5.1.8.1	Test Purpose and Environment.....	254
A.4.5.1.8.2	Test Requirements	259
A.4.5.2	Interruption	259
A.4.5.2.1	E-UTRAN – NR FR1 interruptions at transitions between active and non-active during DRX in synchronous EN-DC	259
A.4.5.2.1.2	Test Requirements	261
A.4.5.2.2	E-UTRAN – NR FR1 interruptions at transitions between active and non-active during DRX in asynchronous EN-DC.....	262
A.4.5.2.2.1	Test Purpose and Environment.....	262
A.4.5.2.2.2	Test Requirements	264
A.4.5.2.3	E-UTRAN – NR FR1 interruptions during measurements on deactivated NR SCC in synchronous EN-DC	264
A.4.5.2.3.1	Test Purpose and Environment.....	264
A.4.5.2.3.2	Test Requirements	266
A.4.5.2.4	E-UTRAN – NR FR1 interruptions during measurements on deactivated NR SCC in asynchronous EN-DC.....	267
A.4.5.2.5	E-UTRAN – NR FR1 interruptions during measurements on deactivated E-UTRAN SCC in synchronous EN-DC	270
A.4.5.2.6	E-UTRAN – NR FR1 interruptions during measurements on deactivated E-UTRAN SCC in asynchronous EN-DC.....	272
A.4.5.2.7	Void.....	275
A.4.5.4	UE UL carrier RRC reconfiguration Delay	283
A.4.5.4.1	UE UL carrier RRC reconfiguration Delay.....	283
A.4.5.4.1.1	Test Purpose and Environment.....	283
A.4.5.4.1.2	Test Requirements	288
A.4.5.5	Beam Failure Detection and Link recovery procedures.....	288
A.4.5.5.1	EN-DC Beam Failure Detection and Link Recovery Test for FR1 PSCell configured with SSB-based BFD and LR in non-DRX mode	288
A.4.5.5.1.1	Test Purpose and Environment.....	288
A.4.5.5.1.2	Test Requirements	292
A.4.5.5.2	EN-DC Beam Failure Detection and Link Recovery Test for FR1 PSCell configured with SSB-based BFD and LR in DRX mode.....	292

A.4.5.5.2.1	Test Purpose and Environment.....	292
A.4.5.5.2.2	Test Requirements	296
A.4.5.5.3	EN-DC Beam Failure Detection and Link Recovery Test for FR1 PSCell configured with CSI- RS-based BFD and LR in non-DRX mode	297
A.4.5.5.3.1	Test Purpose and Environment.....	297
A.4.5.5.3.2	Test Requirements	301
A.4.5.5.4	EN-DC Beam Failure Detection and Link Recovery Test for FR1 PSCell configured with CSI- RS-based BFD and LR in DRX mode.....	302
A.4.5.5.4.1	Test Purpose and Environment.....	302
A.4.5.5.4.2	Test Requirements	307
A.4.5.6	Active BWP switch delay	308
A.4.5.6.1	DCI-based and Timer-based Active BWP Switch	308
A.4.5.6.1.1	E-UTRAN – NR PSCell FR1 DL active BWP switch in non-DRX in synchronous EN-DC	308
A.4.5.6.1.1.1	Test Purpose and Environment	308
A.4.5.6.1.1.2	Test Requirements	311
A.4.5.6.2	RRC-based Active BWP Switch	312
A.4.5.6.2.1	E-UTRAN – NR PSCell FR1 DL active BWP switch in non-DRX in synchronous EN-DC	312
A.4.5.6.2.1.1	Test Purpose and Environment	312
A.4.5.6.2.2.2	Test Requirements	314
A.4.5.7	PSCell addition and release delay.....	314
A.4.5.7.1	Addition and Release Delay of known NR PSCell	314
A.4.5.7.1.1	Test purpose and environment.....	314
A.4.5.7.1.2	Test Requirements	318
A.4.6	Measurement procedure	318
A.4.6.1	Intra-frequency Measurements	318
A.4.6.1.1	EN-DC event triggered reporting tests without gap under non-DRX	318
A.4.6.1.1.1	Test purpose and Environment	318
A.4.6.1.1.2	Test parameters.....	318
A.4.6.1.1.3	Test Requirements	320
A.4.6.1.2	EN-DC event triggered reporting tests without gap under DRX.....	320
A.4.6.1.2.1	Test purpose and Environment	320
A.4.6.1.2.2	Test parameters.....	321
A.4.6.1.2.2	Test Requirements	323
A.4.6.1.3	EN-DC event triggered reporting tests with per-UE gaps under non-DRX	323
A.4.6.1.3.1	Test purpose and Environment	323
A.4.6.1.3.2	Test parameters.....	323
A.4.6.1.3.3	Test Requirements	325
A.4.6.1.4	EN-DC event triggered reporting tests with per-UE gaps under DRX	325
A.4.6.1.4.1	Test purpose and Environment	325
A.4.6.1.4.2	Test parameters.....	326
A.4.6.1.4.3	Test Requirements	328
A.4.6.1.5	EN-DC event triggered reporting tests without gap under non-DRX with SSB index reading	328
A.4.6.1.5.1	Test purpose and Environment	328
A.4.6.1.5.2	Test parameters.....	328
A.4.6.1.5.3	Test Requirements	330
A.4.6.1.6	EN-DC event triggered reporting tests with SSB index reading with per-UE gaps	331
A.4.6.1.6.1	Test purpose and Environment	331
A.4.6.1.6.2	Test parameters.....	331
A.4.6.1.6.3	Test Requirements	332
A.4.6.2	Inter-frequency Measurements	333
A.4.6.2.1	EN-DC event triggered reporting tests for FR1 cell without SSB time index detection when DRX is not used	333
A.4.6.2.1.1	Test Purpose and Environment.....	333
A.4.6.2.1.2	Test Requirements	336
A.4.6.2.2	EN-DC event triggered reporting tests for FR1 cell without SSB time index detection when DRX is used.....	336
A.4.6.2.2.1	Test Purpose and Environment.....	336
A.4.6.2.2.2	Test Requirements	339
A.4.6.2.3	Void.....	340
A.4.6.2.4	Void.....	340
A.4.6.2.5	EN-DC event triggered reporting tests for FR1 cell with SSB time index detection when DRX is not used	340

A.4.6.2.5.1	Test Purpose and Environment.....	340
A.4.6.2.5.2	Test Requirements.....	343
A.4.6.2.6	EN-DC event triggered reporting tests for FR1 cell with SSB time index detection when DRX is used.....	343
A.4.6.2.6.1	Test Purpose and Environment.....	343
A.4.6.2.6.2	Test Requirements.....	346
A.4.6.2.7	Void.....	347
A.4.6.2.8	Void.....	347
A.4.7	Measurement Performance requirements.....	347
A.4.7.1	SS-RSRP.....	347
A.4.7.1.1	EN-DC Intra-frequency measurement accuracy with FR1 serving cell and FR1 target cell.....	347
A.4.7.1.1.1	Test Purpose and Environment.....	347
A.4.7.1.1.2	Test parameters.....	347
A.4.7.1.1.3	Test Requirements.....	350
A.4.7.1.3	Void.....	353
A.4.7.2	SS-RSRQ.....	353
A.4.7.2.1	EN-DC Intra-frequency measurement accuracy with FR1 serving cell and FR1 target cell.....	353
A.4.7.2.1.1	Test Purpose and Environment.....	353
A.4.7.2.1.2	Test Parameters.....	353
A.4.7.2.1.3	Test Requirements.....	356
A.4.7.2.2	EN-DC Inter-frequency measurement accuracy with FR1 serving cell and FR1 target cell.....	356
A.4.7.2.2.1	Test Purpose and Environment.....	356
A.4.7.2.2.2	Test Parameters.....	356
A.4.7.2.2.3	Test Requirements.....	359
A.4.7.3	SS-SINR.....	359
A.4.7.3.1	EN-DC Intra-frequency measurement accuracy with FR1 serving cell and FR1 target cell.....	359
A.4.7.3.1.1	Test Purpose and Environment.....	359
A.4.7.3.1.2	Test Parameters.....	359
A.4.7.3.1.3	Test Requirements.....	362
A.4.7.3.2	EN-DC Inter-frequency measurement accuracy with FR1 serving cell and FR1 target cell.....	362
A.4.7.3.2.1	Test Purpose and Environment.....	362
A.4.7.3.2.2	Test Parameters.....	362
A.4.7.3.2.3	Test Requirements.....	365
A.4.7.4	L1-RSRP measurement for beam reporting.....	366
A.4.7.4.1	SSB based L1-RSRP measurement.....	366
A.4.7.4.1.1	Test Purpose and Environment.....	366
A.4.7.4.1.2	Test parameters.....	366
A.4.7.4.1.3	Test Requirements.....	368
A.4.7.4.2	CSI-RS based L1-RSRP measurement on resource set with repetition off.....	369
A.4.7.4.2.1	Test Purpose and Environment.....	369
A.4.7.4.2.2	Test parameters.....	369
A.4.7.4.2.3	Test Requirements.....	371
A.4.7.5	SFTD accuracy.....	371
A.4.7.5.1	Test Purpose and Environment.....	371
A.4.7.5.2	Test Requirements.....	372
A.4.7.5.3	Test Requirements.....	374
A.4.8	Void.....	374
A.5	EN-DC tests with one or more NR cells in FR2.....	375
A.5.1	Void.....	375
A.5.2	Void.....	375
A.5.3	RRC_CONNECTED state mobility.....	375
A.5.3.1	Void.....	375
A.5.3.2	RRC Connection Mobility Control.....	375
A.5.3.2.1	Void.....	375
A.5.3.2.2	Random Access.....	375
A.5.3.2.2.1	Contention based random access test in FR2 for PSCell/SCell in EN-DC.....	375
A.5.3.2.2.2	Non-contention based random access test in FR2 for PSCell/SCell in EN-DC.....	379
A.5.3.2.3	Void.....	383
A.5.4	Timing.....	383
A.5.4.1	UE transmit timing.....	383
A.5.4.1.1	NR UE Transmit Timing Test for FR2.....	383

A.5.4.1.1.1	Test Purpose and environment	383
A.5.4.1.1.2	Test requirements	385
A.5.4.2	UE timer accuracy	386
A.5.4.3	Timing advance	386
A.5.4.3.1	EN-DC FR2 timing advance adjustment accuracy	386
A.5.4.3.1.1	Test Purpose and Environment	386
A.5.4.3.1.2	Test Parameters	386
A.5.4.3.1.3	Test Requirements	389
A.5.5	Signaling characteristics	389
A.5.5.1	Radio link Monitoring	389
A.5.5.1.1	Radio Link Monitoring Out-of-sync Test for FR2 PSCell configured with SSB-based RLM RS in non-DRX mode	389
A.5.5.1.1.1	Test Purpose and Environment	389
A.5.5.1.1.2	Test Requirements	392
A.5.5.1.2	Radio Link Monitoring In-sync Test for FR2 PSCell configured with SSB-based RLM RS in non-DRX mode	392
A.5.5.1.2.1	Test Purpose and Environment	392
A.5.5.1.2.2	Test Requirements	395
A.5.5.1.3	Radio Link Monitoring Out-of-sync Test for FR2 PSCell configured with SSB-based RLM RS in DRX mode	395
A.5.5.1.3.1	Test Purpose and Environment	395
A.5.5.1.3.2	Test Requirements	398
A.5.5.1.4	Radio Link Monitoring In-sync Test for FR2 PSCell configured with SSB-based RLM RS in DRX mode	398
A.5.5.1.4.1	Test Purpose and Environment	398
A.5.5.1.4.2	Test Requirements	402
A.5.5.2	Interruption	420
A.5.5.2.1	E-UTRAN – NR FR2 interruptions at transitions between active and non-active during DRX in synchronous EN-DC	420
A.5.5.2.1.1	Test Purpose and Environment	420
A.5.5.2.1.2	Test Requirements	422
A.5.5.2.2	E-UTRAN – NR FR2 interruptions at transitions between active and non-active during DRX in asynchronous EN-DC	423
A.5.5.2.2.1	Test Purpose and Environment	423
A.5.5.2.2.2	Test Requirements	425
A.5.5.2.3	E-UTRAN – NR FR2 interruptions during measurements on deactivated NR SCC in synchronous EN-DC	425
A.5.5.2.3.1	Test Purpose and Environment	425
A.5.5.2.3.2	Test Requirements	428
A.5.5.2.4	E-UTRAN – NR FR2 interruptions during measurements on deactivated NR SCC in asynchronous EN-DC	428
A.5.5.2.4.1	Test Purpose and Environment	428
A.5.5.2.4.2	Test Requirements	431
A.5.5.2.5	E-UTRAN – NR FR2 interruptions during measurements on deactivated E-UTRAN SCC in synchronous EN-DC	431
A.5.5.2.5.1	Test Purpose and Environment	431
A.5.5.2.5.2	Test Requirements	434
A.5.5.2.6	E-UTRAN – NR FR2 interruptions during measurements on deactivated E-UTRAN SCC in asynchronous EN-DC	434
A.5.5.2.6.1	Test Purpose and Environment	434
A.5.5.2.6.2	Test Requirements	437
A.5.5.4	UE UL carrier RRC reconfiguration Delay	442
A.5.5.5	Beam Failure Detection and Link recovery procedures	442
A.5.5.5.1	EN-DC Beam Failure Detection and Link Recovery Test for FR2 PSCell configured with SSB-based BFD and LR in non-DRX mode	442
A.5.5.5.1.1	Test Purpose and Environment	442
A.5.5.5.1.2	Test Requirements	446
A.5.5.5.2	EN-DC Beam Failure Detection and Link Recovery Test for FR2 PSCell configured with SSB-based BFD and LR in DRX mode	446
A.5.5.5.2.1	Test Purpose and Environment	446
A.5.5.5.2.2	Test Requirements	450

A.5.5.5.3	EN-DC Beam Failure Detection and Link Recovery Test for FR2 PSCell configured with CSI-RS-based BFD and LR in non-DRX mode	451
A.5.5.5.3.1	Test Purpose and Environment.....	451
A.5.5.5.3.2	Test Requirements	455
A.5.5.5.4	EN-DC Beam Failure Detection and Link Recovery Test for FR2 PSCell configured with CSI-RS-based BFD and LR in DRX mode.....	456
A.5.5.5.4.1	Test Purpose and Environment.....	456
A.5.5.5.4.2	Test Requirements	460
A.5.5.6	Active BWP switch delay	461
A.5.5.6.1	DCI-based and Timer-based Active BWP Switch	461
A.5.5.6.1.1	E-UTRAN – NR PSCell FR2 DL active BWP switch with non-DRX in synchronous EN-DC ...	461
A.5.5.6.1.1.1	Test Purpose and Environment	461
A.5.5.6.1.1.2	Test Requirements	464
A.5.5.6.1.2	E-UTRAN – NR PSCell FR2 DL active BWP switch with FR2 SCell in non-DRX in synchronous EN-DC.....	465
A.5.5.6.1.2.1	Test Purpose and Environment	465
A.5.5.6.1.2.2	Test Requirements	468
A.5.5.6.2	RRC-based Active BWP Switch	468
A.5.5.6.2.1.1	Test Purpose and Environment	468
A.5.5.6.2.1.2	Test Requirements	470
A.5.6	Measurement procedure	471
A.5.6.1	Intra-frequency Measurements	471
A.5.6.1.1	EN-DC event triggered reporting test without gap under non-DRX.....	471
A.5.6.1.1.1	Test purpose and Environment	471
A.5.6.1.1.2	Test Requirements	473
A.5.6.1.2	EN-DC event triggered reporting test without gap under DRX	473
A.5.6.1.2.1	Test purpose and Environment	473
A.5.6.1.2.2	Test Requirements	476
A.5.6.1.3	EN-DC event triggered reporting test with per-UE gaps under non-DRX.....	476
A.5.6.1.3.1	Test purpose and Environment	476
A.5.6.1.3.2	Test Requirements	479
A.5.6.1.4	EN-DC event triggered reporting test with per-UE gaps under DRX.....	479
A.5.6.1.4.1	Test purpose and Environment	479
A.5.6.1.4.2	Test Requirements	482
A.5.6.2	Inter-frequency Measurements	482
A.5.6.2.1	EN-DC event triggered reporting tests for FR2 cell without SSB time index detection when DRX is not used	482
A.5.6.2.1.1	Test Purpose and Environment.....	482
A.5.6.2.1.2	Test Requirements	485
A.5.6.2.2	EN-DC event triggered reporting tests for FR2 cell without SSB time index detection when DRX is used.....	485
A.5.6.2.2.1	Test Purpose and Environment.....	485
A.5.6.2.2.2	Test Requirements	488
A.5.6.2.3	EN-DC event triggered reporting tests for FR2 cell with SSB time index detection when DRX is not used	488
A.5.6.2.3.1	Test Purpose and Environment.....	488
A.5.6.2.3.2	Test Requirements	492
A.5.6.2.4	EN-DC event triggered reporting tests for FR2 cell with SSB time index detection when DRX is used	492
A.5.6.2.4.1	Test Purpose and Environment.....	492
A.5.6.2.2.4	Test Requirements	495
A.5.6.2.5	EN-DC event triggered reporting tests for FR2 cell without SSB time index detection when DRX is not used	495
A.5.6.2.5.1	Test Purpose and Environment.....	495
A.5.6.2.5.2	Test Requirements	499
A.5.6.2.6	EN-DC event triggered reporting tests for FR2 cell without SSB time index detection when DRX is used.....	500
A.5.6.2.6.1	Test Purpose and Environment.....	500
A.5.6.2.6.2	Test Requirements	503
A.5.6.2.7	EN-DC event triggered reporting tests for FR2 cell with SSB time index detection when DRX is not used	504
A.5.6.2.7.1	Test Purpose and Environment.....	504

A.5.6.2.7.2	Test Requirements	507
A.5.6.2.8	EN-DC event triggered reporting tests for FR2 cell with SSB time index detection when DRX is used	508
A.5.6.2.8.1	Test Purpose and Environment.....	508
A.5.6.2.8.2	Test Requirements	511
A.5.7	Measurement Performance requirements	512
A.5.7.1	SS-RSRP.....	512
A.5.7.1.1	EN-DC intra-frequency case measurement accuracy with FR2 serving cell and FR2 target cell	512
A.5.7.1.1.1	Test Purpose and Environment.....	512
A.5.7.1.1.2	Test parameters.....	512
A.5.7.1.1.3	Test Requirements	514
A.5.7.1.2	EN-DC inter-frequency case measurement accuracy with FR2 serving cell and FR2 target cell	514
A.5.7.1.2.1	Test Purpose and Environment.....	514
A.5.7.1.2.2	Test parameters.....	514
A.5.7.1.2.3	Test Requirements	516
A.5.7.1.3	EN-DC inter-frequency measurement accuracy with FR1 serving cell and FR2 target cell	516
A.5.7.1.3.1	Test Purpose and Environment.....	516
A.5.7.2	SS-RSRQ	520
A.5.7.2.1	EN-DC Intra-frequency measurement accuracy with FR2 serving cell and FR2 TDD target cell.....	520
A.5.7.2.1.1	Test Purpose and Environment	520
A.5.7.2.1.2	Test Parameters	520
A.5.7.2.1.3	Test Requirements	522
A.5.7.2.2	EN-DC Inter-frequency measurement accuracy with FR2 serving cell and FR2 TDD target cell.....	523
A.5.7.2.2.1	Test Purpose and Environment.....	523
A.5.7.2.2.2	Test Parameters	523
A.5.7.2.2.3	Test Requirements	525
A.5.7.3	SS-SINR	525
A.5.7.3.1	Intra-frequency case	525
A.5.7.3.1.1	Test Purpose and Environment.....	525
A.5.7.3.1.2	Test Parameters	525
A.5.7.3.1.3	Test Requirements	527
A.5.7.3.2	EN-DC Inter-frequency measurement accuracy with FR2 serving cell and FR2 TDD target cell.....	527
A.5.7.3.2.1	Test Purpose and Environment.....	527
A.5.7.3.2.2	Test Parameters	527
A.5.7.3.2.3	Test Requirements	529
A.5.7.4	L1-RSRP measurement for beam reporting.....	530
A.5.7.4.1	SSB based L1-RSRP measurement.....	530
A.5.7.4.1.1	Test Purpose and Environment.....	530
A.5.7.4.1.2	Test parameters.....	530
A.5.7.4.1.3	Test Requirements	532
A.5.7.4.2	CSI-RS based L1-RSRP measurement on resource set with repetition off.....	532
A.5.7.4.2.1	Test Purpose and Environment.....	532
A.5.7.4.2.2	Test parameters.....	533
A.5.7.4.2.3	Test Requirements	535
A.5.8	PSCell addition and release delay	535
A.5.8.1	Addition and Release Delay of NR PSCell.....	535
A.5.8.1.1	Test purpose and environment	535
A.5.8.1.2	Test Requirements.....	537
A.6	NR standalone tests with all NR cells in FR1	539
A.6.1	SA: RRC_IDLE state mobility.....	539
A.6.1.1	Cell re-selection to NR	539
A.6.1.1.1	Cell reselection to FR1 intra-frequency NR case	539
A.6.1.1.1.1	Test Purpose and Environment.....	539
A.6.1.1.1.2	Test Parameters	539
A.6.1.1.1.3	Test Requirements	542
A.6.1.1.2	Cell reselection to FR1 inter-frequency NR case	542
A.6.1.1.2.1	Test Purpose and Environment.....	542
A.6.1.1.2.2	Test Parameters	542
A.6.1.1.2.3	Test Requirements	544
A.6.1.2	Inter-RAT E-UTRAN cell re-selection.....	545
A.6.1.2.1	Cell reselection to higher priority E-UTRAN	545

A.6.1.2.1.1	Test Purpose and Environment.....	545
A.6.1.2.1.2	Test Parameters	545
A.6.1.2.1.3	Test Requirements	548
A.6.1.2.2	Cell reselection to lower priority E-UTRAN	548
A.6.1.2.2.1	Test Purpose and Environment.....	548
A.6.1.2.2.2	Test Parameters	548
A.6.1.2.2.3	Test Requirements	551
A.6.2	SA: RRC_INACTIVE state mobility	552
A.6.3	RRC_CONNECTED state mobility	552
A.6.3.1	Handover	552
A.6.3.1.1	Intra-frequency handover from FR1 to FR1; known target cell	552
A.6.3.1.1.1	Test Purpose and Environment.....	552
A.6.3.1.1.2	Test Parameters	552
A.6.3.1.1.3	Test Requirements	554
A.6.3.1.2	Intra-frequency handover from FR1 to FR1; unknown target cell	554
A.6.3.1.2.1	Test Purpose and Environment.....	554
A.6.3.1.2.2	Test Parameters	554
A.6.3.1.2.3	Test Requirements	556
A.6.3.1.3	Inter-frequency handover from FR1 to FR1; unknown target cell	556
A.6.3.1.3.1	Test Purpose and Environment.....	556
A.6.3.1.3.2	Test Parameters	556
A.6.3.1.3.3	Test Requirements	558
A.6.3.1.4	SA NR - E-UTRAN handover	558
A.6.3.1.4.1	Test Purpose and Environment.....	558
A.6.3.1.4.2	Test Requirements	562
A.6.3.1.5	SA NR - E-UTRAN handover with unknown target cell	562
A.6.3.1.5.1	Test Purpose and Environment.....	562
A.6.3.1.5.2	Test Requirements	565
A.6.3.2	RRC Connection Mobility Control.....	566
A.6.3.2.1	SA: RRC Re-establishment	566
A.6.3.2.1.1	Intra-frequency RRC Re-establishment in FR1	566
A.6.3.2.1.1.1	Test Purpose and Environment	566
A.6.3.2.1.1.2	Test Requirements	568
A.6.3.2.1.2	Inter-frequency RRC Re-establishment in FR1	568
A.6.3.2.1.2.1	Test Purpose and Environment	568
A.6.3.2.1.2.2	Test Requirements	570
A.6.3.2.2	Random Access	571
A.6.3.2.2.1	Contention based random access test in FR1 for NR standalone	571
A.6.3.2.2.2	Non-Contention based random access test in FR1 for NR standalone	574
A.6.3.2.3	SA: RRC Connection Release with Redirection	577
A.6.3.2.3.1	Redirection from NR in FR1 to NR in FR1	577
A.6.3.2.3.1.1	Test Purpose and Environment	577
A.6.3.2.3.1.2	Test Parameters.....	577
A.6.3.2.3.1.3	Test Requirements	579
A.6.3.2.3.2	Redirection from NR in FR1 to E-UTRAN.....	580
A.6.3.2.3.2.1	Test Purpose and Environment	580
A.6.3.2.3.2.2	Test Parameters.....	580
A.6.3.2.3.2.3	Test Requirements	583
A.6.4	Timing	584
A.6.4.1	UE transmit timing	584
A.6.4.1.1	NR UE Transmit Timing Test for FR1	584
A.6.4.1.1.1	Test Purpose and environment	584
A.6.4.1.1.2	Test requirements	586
A.6.4.2	UE timer accuracy	587
A.6.4.3	Timing advance	587
A.6.4.3.1	SA FR1 timing advance adjustment accuracy.....	587
A.6.4.3.1.1	Test Purpose and Environment.....	587
A.6.4.3.1.2	Test Parameters	587
A.6.4.3.1.3	Test Requirements	590
A.6.5	Signaling characteristics.....	590
A.6.5.1	Radio link Monitoring	590

A.6.5.1.1	Radio Link Monitoring Out-of-sync Test for FR1 PCell configured with SSB-based RLM RS in non-DRX mode	591
A.6.5.1.1.1	Test Purpose and Environment.....	591
A.6.5.1.1.2	Test Requirements	594
A.6.5.1.2	Radio Link Monitoring In-sync Test for FR1 PCell configured with SSB-based RLM RS in non-DRX mode	594
A.6.5.1.2.1	Test Purpose and Environment.....	594
A.6.5.1.2.2	Test Requirements	598
A.6.5.1.3	Radio Link Monitoring Out-of-sync Test for FR1 PCell configured with SSB-based RLM RS in DRX mode	598
A.6.5.1.3.1	Test Purpose and Environment.....	598
A.6.5.1.3.2	Test Requirements	601
A.6.5.1.4	Radio Link Monitoring In-sync Test for FR1 PCell configured with SSB-based RLM RS in DRX mode.....	601
A.6.5.1.4.1	Test Purpose and Environment.....	601
A.6.5.1.4.2	Test Requirements	605
A.6.5.1.5	Radio Link Monitoring Out-of-sync Test for FR1 PCell configured with CSI-RS-based RLM in non-DRX mode	605
A.6.5.1.5.1	Test Purpose and Environment.....	605
A.6.5.1.5.2	Test Requirements	608
A.6.5.1.6	Radio Link Monitoring In-sync Test for FR1 PCell configured with CSI-RS-based RLM in non-DRX mode	609
A.6.5.1.6.1	Test Purpose and Environment.....	609
A.6.5.1.6.2	Test Requirements	612
A.6.5.1.7	Radio Link Monitoring Out-of-sync Test for FR1 PCell configured with CSI-RS-based RLM in DRX mode	612
A.6.5.1.7.1	Test Purpose and Environment.....	612
A.6.5.1.7.2	Test Requirements	617
A.6.5.1.8	Radio Link Monitoring In-sync Test for FR1 PCell configured with CSI-RS-based RLM in DRX mode.....	617
A.6.5.1.8.1	Test Purpose and Environment.....	617
A.6.5.1.8.2	Test Requirements	622
A.6.5.3	SCell Activation and Deactivation Delay	625
A.6.5.4	UE UL carrier RRC reconfiguration Delay	630
A.6.5.4.1	UE UL carrier RRC reconfiguration Delay.....	630
A.6.5.4.1.1	Test Purpose and Environment.....	630
A.6.5.4.1.2	Test Requirements	634
A.6.5.4.2	Test Requirements.....	635
A.6.5.5	Beam Failure Detection and Link recovery procedures.....	635
A.6.5.5.1	Beam Failure Detection and Link Recovery Test for FR1 PCell configured with SSB-based BFD and LR in non-DRX mode	635
A.6.5.5.1.1	Test Purpose and Environment.....	635
A.6.5.5.1.2	Test Requirements	639
A.6.5.5.2	Beam Failure Detection and Link Recovery Test for FR1 PCell configured with SSB-based BFD and LR in DRX mode	639
A.6.5.5.2.1	Test Purpose and Environment.....	639
A.6.5.5.2.2	Test Requirements	643
A.6.5.5.3	Beam Failure Detection and Link Recovery Test for FR1 PCell configured with CSI-RS-based BFD and LR in non-DRX mode	643
A.6.5.5.3.1	Test Purpose and Environment.....	643
A.6.5.5.3.2	Test Requirements	647
A.6.5.5.4	Beam Failure Detection and Link Recovery Test for FR1 PCell configured with CSI-RS-based BFD and LR in DRX mode.....	648
A.6.5.5.4.1	Test Purpose and Environment.....	648
A.6.5.5.4.2	Test Requirements	652
A.6.5.6	Active BWP switch delay	653
A.6.5.6.1	DCI-based and Timer-based Active BWP Switch	653
A.6.5.6.1.1	NR FR1- NR FR1 DL active BWP switch of PCell with non-DRX in SA	653
A.6.5.6.1.1.1	Test Purpose and Environment	653
A.6.5.6.1.1.2	Test Requirements	656
A.6.5.6.1.2	NR FR1 DL active BWP switch with non-DRX in SA	656
A.6.5.6.1.2.1	Test Purpose and Environment	656

A.6.5.6.1.2.2	Test Requirements	659
A.6.5.6.2	RRC-based Active BWP Switch	659
A.6.5.6.2.1	NR FR1- NR FR1 DL active BWP switch of PCell with non-DRX in SA	659
A.6.6	Measurement procedure	662
A.6.6.1	Intra-frequency Measurements	662
A.6.6.1.1	SA event triggered reporting tests without gap under non-DRX	662
A.6.6.1.1.1	Test purpose and Environment	662
A.6.6.1.1.2	Test parameters.....	662
A.6.6.1.1.3	Test Requirements	664
A.6.6.1.2	SA event triggered reporting tests without gap under DRX.....	664
A.6.6.1.2.1	Test purpose and Environment	664
A.6.6.1.2.2	Test parameters.....	664
A.6.6.1.2.3	Test Requirements	666
A.6.6.1.3	SA event triggered reporting tests with per-UE gaps under non-DRX	666
A.6.6.1.3.1	Test purpose and Environment	666
A.6.6.1.3.2	Test parameters.....	666
A.6.6.1.3.3	Test Requirements	668
A.6.6.1.4	SA event triggered reporting tests with per-UE gaps under DRX.....	668
A.6.6.1.4.1	Test purpose and Environment	668
A.6.6.1.4.2	Test parameters.....	669
A.6.6.1.4.3	Test Requirements	671
A.6.6.1.5	SA event triggered reporting tests without gap under non-DRX with SSB index reading.....	671
A.6.6.1.5.1	Test purpose and Environment	671
A.6.6.1.5.2	Test parameters.....	671
A.6.6.1.5.3	Test Requirements	673
A.6.6.1.6	SA event triggered reporting tests with per-UE gaps under non-DRX with SSB index reading	673
A.6.6.1.6.1	Test purpose and Environment	673
A.6.6.1.6.2	Test parameters.....	673
A.6.6.1.6.3	Test Requirements	675
A.6.6.2	Inter-frequency Measurements	675
A.6.6.2.1	SA event triggered reporting tests for FR1 without SSB time index detection when DRX is not used	675
A.6.6.2.1.1	Test Purpose and Environment.....	675
A.6.6.2.1.2	Test Requirements	678
A.6.6.2.2	SA event triggered reporting tests for FR1 without SSB time index detection when DRX is used ...	678
A.6.6.2.2.1	Test Purpose and Environment.....	678
A.6.6.2.2.2	Test Requirements	681
A.6.6.2.3	SA event triggered reporting tests for FR1 with SSB time index detection when DRX is not used ..	682
A.6.6.2.3.1	Test Purpose and Environment.....	682
A.6.6.2.3.2	Test Requirements	685
A.6.6.2.4	SA event triggered reporting tests for FR1 with SSB time index detection when DRX is used	685
A.6.6.2.4.1	Test Purpose and Environment.....	685
A.6.6.2.4.2	Test Requirements	688
A.6.6.3	Inter-RAT Measurements	688
A.6.6.3.1	SA NR - E-UTRAN event-triggered reporting in non-DRX in FR1	688
A.6.6.3.1.2	Test Requirements	691
A.6.6.3.2	SA NR - E-UTRAN event-triggered reporting in DRX in FR1	692
A.6.7	Measurement Performance requirements	696
A.6.7.1	SS-RSRP.....	696
A.6.7.1.1	SA: intra-frequency case measurement accuracy with FR1 serving cell and FR1 target cell	696
A.6.7.1.1.1	Test Purpose and Environment.....	696
A.6.7.1.1.2	Test parameters.....	696
A.6.7.1.1.3	Test Requirements	699
A.6.7.1.2	SA inter-frequency case measurement accuracy with FR1 serving cell and FR1 target cell	699
A.6.7.1.2.1	Test Purpose and Environment.....	699
A.6.7.1.2.2	Test parameters.....	699
A.6.7.1.2.3	Test Requirements	701
A.6.7.1.3	Void.....	701
A.6.7.2	SS-RSRQ.....	701
A.6.7.2.1	SA: Intra-frequency measurement accuracy with FR1 serving cell and FR1 target cell	701
A.6.7.2.1.1	Test Purpose and Environment.....	701
A.6.7.2.1.2	Test Parameters	702

A.6.7.2.1.3	Test Requirements	704
A.6.7.2.2	SA Inter-frequency measurement accuracy with FR1 serving cell and FR1 target cell	705
A.6.7.2.2.1	Test Purpose and Environment	705
A.6.7.2.2.2	Test Parameters	705
A.6.7.2.2.3	Test Requirements	708
A.6.7.3	SS-SINR	708
A.6.7.3.1	Intra-frequency case	708
A.6.7.3.1.1	Test Purpose and Environment	708
A.6.7.3.1.2	Test Parameters	708
A.6.7.3.1.3	Test Requirements	711
A.6.7.3.2	SA Inter-frequency measurement accuracy with FR1 serving cell and FR1 target cell	711
A.6.7.3.2.1	Test Purpose and Environment	711
A.6.7.3.2.2	Test Parameters	711
A.6.7.3.2.3	Test Requirements	714
A.6.7.4.2.2	Test parameters	717
A.7.3.1	Handover	726
A.7.3.1.1	Inter-frequency handover from FR1 to FR2; unknown target cell	726
A.7.3.1.1.1	Test Purpose and Environment	726
A.7.3.1.1.2	Test Parameters	726
A.7.3.1.1.3	Test Requirements	729
A.7.3.1.2	Intra-frequency handover from FR2 to FR2; unknown target cell	729
A.7.3.1.2.1	Test Purpose and Environment	729
A.7.3.1.2.2	Test Parameters	729
A.7.3.1.2.3	Test Requirements	731
A.7.3.1.3	Inter-frequency handover from FR2 to FR2; unknown target cell	731
A.7.3.1.3.1	Test Purpose and Environment	731
A.7.3.1.3.2	Test Parameters	731
A.7.3.1.3.3	Test Requirements	733
A.7.3.2.1.2	Inter-frequency RRC Re-establishment in FR2	736
A.7.6.2	Inter-frequency Measurements	829
A.7.7.1.3	SA inter-frequency measurement accuracy with FR1 serving cell and FR2 target cell	859
A.7.7.1.3.1	Test Purpose and Environment	859
A.7.7.3	SS-SINR	866
A.8	E-UTRA standalone tests for NR RRM	876
A.8.1	E-UTRA – NR Inter-RAT SFTD Measurement Delay	876
A.8.1.1	E-UTRA – NR Inter-RAT SFTD Measurement Delay in non-DRX	876
A.8.1.1.1	Test Purpose and Environment	876
A.8.1.1.2	Test Requirements	879
A.8.1.2	E-UTRA – NR Inter-RAT SFTD Measurement Delay in DRX	879
A.8.1.2.1	Test Purpose and Environment	879
A.8.1.2.2	Test Requirements	880
A.8.1.3	SFTD accuracy	881
A.8.1.3.1	Test Purpose and Environment	881
A.8.1.3.2	Test Requirements	881
A.8.1.3.3	Test Requirements	884
Annex B (normative): Conditions for RRM requirements applicability for operating bands ...886		
B.1	Conditions for NR RRC_IDLE state mobility	886
B.1.1	Introduction	886
B.1.2	Conditions for measurements on NR intra-frequency cells for cell re-selection	886
B.1.3	Conditions for measurements on NR inter-frequency cells for cell re-selection	887
B.2	Conditions for UE measurements procedures and performance requirements in RRC_CONNECTED state	887
B.2.1	Introduction	887
B.2.2	Conditions for NR intra-frequency measurements	887
B.2.3	Conditions for NR inter-frequency measurements	888
B.2.4	Conditions for NR L1-RSRP reporting	888
B.2.4.1	Conditions for SSB based L1-RSRP reporting	888
B.2.4.2	Conditions for CSI-RS based L1-RSRP reporting	889
B.2.5	Conditions for RRC connection release with redirection to NR	890

B.3	RRM Requirements Exceptions	890
B.3.1	Introduction	890
B.3.2	Receiver sensitivity relaxation for CA	891
B.3.2.1	Receiver sensitivity relaxation for UE supporting CA in FR1	891
B.3.2.2	Receiver sensitivity relaxation for UE configured with CA in FR1	891
B.3.2.2.1	Inter-band carrier aggregation	891
B.3.2.2.2	Reference sensitivity exceptions due to UL harmonic interference for CA	891
B.3.2.2.3	Reference sensitivity exceptions due to intermodulation interference due to 2UL CA	891
B.3.2.3	Receiver sensitivity relaxation for UE supporting CA in FR2	892
B.3.2.4	Receiver sensitivity relaxation for UE configured with CA in FR2	892
B.3.2.4.1	Intra-band contiguous carrier aggregation	892
B.3.2.4.2	Intra-band non-contiguous carrier aggregation	892
B.3.3	Receiver sensitivity relaxation for DC	892
B.3.4	Receiver sensitivity relaxation for SUL	892
B.3.4.1	Receiver sensitivity relaxation for UE supporting SUL in FR1	892
B.3.4.2	Receiver sensitivity relaxation for UE configured with SUL in FR1	892
B.3.4.2.1	Reference sensitivity exceptions due to UL harmonic interference for SUL	892
Annex C (informative):	Change history	893
History		894

Foreword

This Technical Specification has been produced by the 3rd Generation Partnership Project (3GPP).

The contents of the present document are subject to continuing work within the TSG and may change following formal TSG approval. Should the TSG modify the contents of the present document, it will be re-released by the TSG with an identifying change of release date and an increase in version number as follows:

Version x.y.z

where:

- x the first digit:
 - 1 presented to TSG for information;
 - 2 presented to TSG for approval;
 - 3 or greater indicates TSG approved document under change control.
- y the second digit is incremented for all changes of substance, i.e. technical enhancements, corrections, updates, etc.
- z the third digit is incremented when editorial only changes have been incorporated in the document.

1 Scope

The present document specifies requirements for support of Radio Resource Management for the FDD and TDD modes of New Radio(NR). These requirements include requirements on measurements in NR and the UE as well as requirements on node dynamical behaviour and interaction, in terms of delay and response characteristics.

2 References

The following documents contain provisions which, through reference in this text, constitute provisions of the present document.

- References are either specific (identified by date of publication, edition number, version number, etc.) or non-specific.
- For a specific reference, subsequent revisions do not apply.
- For a non-specific reference, the latest version applies. In the case of a reference to a 3GPP document (including a GSM document), a non-specific reference implicitly refers to the latest version of that document *in the same Release as the present document*.

- [1] 3GPP TS 38.304: "NR; User Equipment (UE) procedures in idle mode".
- [2] 3GPP TS 38.331: "NR; Radio Resource Control (RRC); Protocol specification".
- [3] 3GPP TS 38.213: "NR; Physical layer procedures for control".
- [4] 3GPP TS 38.215: "NR; Physical layer measurements".
- [5] 3GPP TS 38.533: "NR; User Equipment (UE) conformance specification; Radio Resource Management (RRM)".
- [6] 3GPP TS 38.211: "NR; Physical channels and modulation".
- [7] 3GPP TS 38.321: "NR; Medium Access Control (MAC) protocol specification".

- [8] 3GPP TS 38.212 "NR; Multiplexing and channel coding".
- [9] 3GPP TS 38.202: "NR; Physical layer services provided by the physical layer".
- [10] 3GPP TS 38.300: "NR; Overall description; Stage-2".
- [11] 3GPP TR 21.905: "Vocabulary for 3GPP Specifications".
- [12] 3GPP TS 38.423: "NG-RAN; Xn Application Protocol (XnAP)".
- [13] 3GPP TS 38.104: "NR; Base Station (BS) radio transmission and reception".
- [14] 3GPP TS 38.306: "NR; User Equipment (UE) radio access capabilities".
- [15] 3GPP TS 36.133: "Evolved Universal Terrestrial Radio Access (E-UTRA); Requirements for support of radio resource management".
- [16] 3GPP TS 36.331: "Evolved Universal Terrestrial Radio Access (E-UTRA); Radio Resource Control (RRC) protocol specification".
- [17] 3GPP TS 37.340: "Evolved Universal Terrestrial Radio Access (E-UTRA) and NR; Multi-connectivity", Stage 2.
- [18] 3GPP TS 38.101-1: "NR; User Equipment (UE) radio transmission and reception; Part 1: Range 1 Standalone".
- [19] 3GPP TS 38.101-2: "NR; User Equipment (UE) radio transmission and reception; Part 2: Range 2 Standalone".
- [20] 3GPP TS 38.101-3: "NR; User Equipment (UE) radio transmission and reception; Part 3: Range 1 and Range 2 Interworking operation with other radios".
- [21] 3GPP TS 38.101-4: "NR; User Equipment (UE) radio transmission and reception; Part 4: Performance requirements".
- [22] 3GPP TS 38.305: "NG Radio Access Network (NG-RAN); Stage 2 functional specification of User Equipment (UE) positioning in NG-RAN".
- [23] 3GPP TS 36.211: "Evolved Universal Terrestrial Radio Access (E-UTRA); Physical Channels and Modulation".
- [24] 3GPP TS 36.300: "Evolved Universal Terrestrial Radio Access (E-UTRA); Overall description".
- [25] 3GPP TS 36.101: "Technical Specification Group Radio Access Network; Evolved Universal Terrestrial Radio Access (E-UTRA); User Equipment (UE) radio transmission and reception".

3 Definitions, symbols and abbreviations

3.1 Definitions

For the purposes of the present document, the terms and definitions given in TR 21.905 [11] and the following apply. A term defined in the present document takes precedence over the definition of the same term, if any, in TR 21.905 [11].

Active DL BWP: Active DL bandwidth part as defined in TS 38.213 [3].

Blackbox Approach: Testing methodology, in which the UE internal implementation of certain specific UE functionality involved in the test, is unknown.

DL BWP: DL bandwidth part as defined in TS 38.213 [3].

EN-DC: E-UTRA-NR Dual Connectivity as defined in clause 4.1.2 of TS 37.340 [17].

en-gNB: As defined in TS 37.340 [17].

FR1: Frequency range 1 as defined in clause 5.1 of TS 38.104 [13].

FR2: Frequency range 2 as defined in clause 5.1 of TS 38.104 [13].

gNB: as defined in in TS 38.300 [10].

Master Cell Group: As defined in TS 38.331 [2].

Multi-Radio Dual Connectivity: Dual Connectivity between E-UTRA and NR nodes, or between two NR nodes, as defined in TS 37.340 [17].

ng-eNB: As defined in TS 38.300 [10].

NE-DC: NR-E-UTRA Dual Connectivity as defined in clause 4.1.3.2 of TS 37.340 [17].

NGEN-DC: NG-RAN E-UTRA-NR Dual Connectivity as defined in clause 4.1.3.1 of TS 37.340 [17].

NR-DC: NR-NR Dual Connectivity as defined in clause 4.1.3.3 of TS 37.340 [17].

Primary Cell: As defined in TS 38.331 [2].

RLM-RS resource: A resource out of the set of resources configured for RLM by higher layer parameter RLM-RS-List [2] as defined in TS 38.213 [3].

SA operation mode: Operation mode when the UE is configured with at least PCell and not any MR-DC.

Secondary Cell: As defined in TS 38.331 [2].

Secondary Cell Group: As defined in TS 38.331 [2].

Serving Cell: As defined in TS 38.331 [2].

SMTC: An SSB-based measurement timing configuration configured by *SSB-MeasurementTimingConfiguration* as specified in TS 38.331 [2].

SSB: SS/PBCH block as defined in clause 7.8.3 of TS 38.211 [6].

Timing Advance Group: As defined in TS 38.331 [2].

3.2 Symbols

For the purposes of the present document, the following symbols apply:

[...]	Values included in square bracket must be considered for further studies, because it means that a decision about that value was not taken.
T_c	Basic time unit, defined in clause 4.1 of TS 38.211 [6].
T_s	Reference time unit, defined in clause 4.1 of TS 38.211 [6].

3.3 Abbreviations

For the purposes of the present document, the abbreviations given in TR 21.905 [11] and the following apply. An abbreviation defined in the present document takes precedence over the definition of the same abbreviation, if any, in TR 21.905 [11].

BFD	Beam Failure Detection
BWP	Bandwidth Part
CA	Carrier Aggregation
CBD	Candidate Beam Detection
CC	Component Carrier
CP	Cyclic Prefix
CSI	Channel-State Information
CSI-RS	CSI Reference Signal
DC	Dual Connectivity
DL	Downlink

DMRS	Demodulation Reference Signal
DRX	Discontinuous Reception
E-CID	Enhanced Cell ID
E-UTRA	Evolved UTRA
E-UTRAN	Evolved UTRAN
EN-DC	E-UTRA-NR Dual Connectivity
FDD	Frequency Division Duplex
FR	Frequency Range
HARQ	Hybrid Automatic Repeat Request
HO	Handover
MAC	Medium Access Control
MCG	Master Cell Group
MGL	Measurement Gap Length
MGRP	Measurement Gap Repetition Period
MIB	Master Information Block
MR-DC	Multi-Radio Dual Connectivity
NE-DC	NR-E-UTRA Dual Connectivity
NGEN-DC	NG-RAN E-UTRA-NR Dual Connectivity
NR	New Radio
NR-DC	NR-NR Dual Connectivity
NSA	Non-Standalone operation mode
OFDM	Orthogonal Frequency Division Multiplexing
OFDMA	Orthogonal Frequency Division Multiple Access
OTDOA	Observed Time Difference Of Arrival
PBCH	Physical Broadcast Channel
PCell	Primary Cell
PLMN	Public Land Mobile Network
PRACH	Physical RACH
PSCell	Primary SCell
PSS	Primary Synchronization Signal
PUCCH	Physical Uplink Control Channel
PUSCH	Physical Uplink Shared Channel
RACH	Random Access Channel
RAT	Radio Access Technology
RLM	Radio Link Monitoring
RLM-RS	Reference Signal for RLM
RRC	Radio Resource Control
RRM	Radio Resource Management
RSSI	Received Signal Strength Indicator
RSTD	Reference Signal Time Difference
SA	Standalone operation mode
SCell	Secondary Cell
SCG	Secondary Cell Group
SCS	Subcarrier Spacing
SCS _{SSB}	SSB subcarrier spacing
SDL	Supplementary Downlink
SFN	System Frame Number
SI	System Information
SIB	System Information Block
SMTC	SSB-based Measurement Timing configuration
SRS	Sounding Reference Signal
SS-RSRP	Synchronization Signal based Reference Signal Received Power
SS-RSRQ	Synchronization Signal based Reference Signal Received Quality
SS-SINR	Synchronization Signal based Signal to Noise and Interference Ratio
SSB	Synchronization Signal Block
SSB_RP	Received (linear) average power of the resource elements that carry NR SSB signals and channels, measured at the UE antenna connector.
SSS	Secondary Synchronization Signal
SUL	Supplementary Uplink
TA	Timing Advance
TAG	Timing Advance Group
TDD	Time Division Duplex

TTI	Transmission Time Interval
UE	User Equipment
UL	Uplink

3.4 Test tolerances

The requirements given in the present document make no allowance for measurement uncertainty. The test specification 38.5xx [x] defines the test tolerances.

Editor's note: intended to capture test tolerances. OTA test tolerance or margin will be captured in this section if needed.

3.5 Frequency bands grouping

3.5.1 Introduction

The intention with the frequency band grouping below is to increase the readability of the specification.

The frequency bands grouping is derived based on UE REFSENS requirements specified in [18, 19, 20] and assuming 0.5 dB step between the neighbour groups. The groups are defined in the order of increasing REFSENS, i.e., the group A has the smallest REFSENS among the groups. For the same SCS and a given bandwidth, the bands within the same group have the same I_0 conditions in a corresponding requirement in this specification, provided the bands support this SCS. For different SCSs supported by a frequency band and the same bandwidth, different I_0 conditions may apply for the frequency band in the requirements, while the band group is the same, based on the lowest REFSENS requirement normalized by the number of subcarriers among its supported SCSs for this bandwidth. For the same SCS but different supported bandwidths, the group for a band is determined based on the lowest REFSENS requirement normalized by the number of subcarriers among its supported bandwidths.

3.5.2 NR operating bands in FR1

NR frequency bands grouping for FR1 is specified in Table 3.5.2-1.

Table 3.5.2-1: NR frequency band groups for FR1

Group	NR FDD		NR TDD		NR SDL	
	Band group notation	Operating bands	Band group notation	Operating bands	Band group notation	Operating bands
A	NR_FDD_FR1_A	n1, n70, n74 ⁴	NR_TDD_FR1_A	n34, n38, n39, n40, n50, n51	NR_SDL_FR1_A	n75, n76
B	NR_FDD_FR1_B	n65, n66, n74 ³	NR_TDD_FR1_B	-	NR_SDL_FR1_B	-
C	NR_FDD_FR1_C	-	NR_TDD_FR1_C	n48, n77 ¹ , n78, n79	NR_SDL_FR1_C	-
D	NR_FDD_FR1_D	n28	NR_TDD_FR1_D	n77 ²	NR_SDL_FR1_D	-
E	NR_FDD_FR1_E	n2, n5, n7	NR_TDD_FR1_E	n41	NR_SDL_FR1_E	-
F	NR_FDD_FR1_F	-	NR_TDD_FR1_F	-	NR_SDL_FR1_F	-
G	NR_FDD_FR1_G	n3, n8, n12, n20, n71	NR_TDD_FR1_G	-	NR_SDL_FR1_G	-
H	NR_FDD_FR1_H	n25	NR_TDD_FR1_H	-	NR_SDL_FR1_H	-

NOTE 1: Except 3.8 GHz to 4.2 GHz.

NOTE 2: Only 3.8 GHz to 4.2 GHz.

NOTE 3: Except 1475.9 MHz to 1510.9 MHz.

NOTE 4: Only when the band is confined in 1475.9 MHz to 1510.9 MHz.

3.5.3 NR operating bands in FR2

NR frequency bands grouping for FR2 is specified in Table 3.5.3-1.

Table 3.5.3-1: NR frequency band groups for FR2

Group	Band group notation	Operating bands
A	NR_TDD_FR2_A	n257 ¹ , n258 ¹ , n261 ¹
B	NR_TDD_FR2_B	n257 ⁴ , n258 ⁴ , n261 ⁴
C	NR_TDD_FR2_C	
D	NR_TDD_FR2_D	
E	NR_TDD_FR2_E	
F	NR_TDD_FR2_F	n260 ⁴
G	NR_TDD_FR2_G	n257 ² , n258 ² , n260 ¹ , n261 ²
H	NR_TDD_FR2_H	
I	NR_TDD_FR2_I	
J	NR_TDD_FR2_J	
K	NR_TDD_FR2_K	
L	NR_TDD_FR2_L	
M	NR_TDD_FR2_M	
N	NR_TDD_FR2_N	
O	NR_TDD_FR2_O	
P	NR_TDD_FR2_P	
Q	NR_TDD_FR2_Q	
R	NR_TDD_FR2_R	
S	NR_TDD_FR2_S	
T	NR_TDD_FR2_T	n257 ³ , n258 ³ , n261 ³
U	NR_TDD_FR2_U	
V	NR_TDD_FR2_V	
W	NR_TDD_FR2_W	
X	NR_TDD_FR2_X	
Y	NR_TDD_FR2_Y	n260 ³
NOTE 1: UE power class 1. NOTE 2: UE power class 2. NOTE 3: UE power class 3. NOTE 4: UE power class 4.		

3.6 Applicability of requirements in this specification version

In this specification,

- ‘cell’, ‘PCell’, ‘PSCell’ and ‘SCell’ refer to NR cell, NR PCell, NR PSCell and NR SCell,
- E-UTRA cells are referred to as ‘E-UTRA cell’, ‘E-UTRA PCell’ and ‘E-UTRA SCell’,
- E-UTRA-NR dual connectivity where E-UTRA is the master is referred to as ‘E-UTRA-NR dual connectivity’ or ‘EN-DC’.
- NR-NR dual connectivity which involves two gNB acting as Master gNB and Secondary gNB is referred to as “NR-NR dual connectivity” or “NR-DC”. NR-DC in Rel-15 only includes the scenarios where all serving cells in MCG in FR1 and all serving cells in SCG in FR2.

For UE configured with supplementary UL, the requirements in section 7.1 and 7.3 shall also apply to uplink transmissions on supplementary UL.

3.6.1 RRC connected state requirements in DRX

For the requirements in RRC connected state specified in this version of the specification, the UE shall assume that no DRX is used provided the following conditions are met:

- DRX parameters are not configured or
- DRX parameters are configured and
 - drx-InactivityTimer is running or
 - drx-RetransmissionTimerDL is running or
 - drx-RetransmissionTimerUL is running or

- ra-ContentionResolutionTimer is running or
- a Scheduling Request sent on PUCCH is pending or
- a PDCCH indicating a new transmission addressed to the C-RNTI of the MAC entity has not been received after successful reception of a Random Access Response for the preamble not selected by the MAC entity

Otherwise the UE shall assume that DRX is used.

3.6.2 Number of serving carriers

3.6.2.1 Number of serving carriers for SA

Requirements for standalone NR with NR PCell are applicable for the UE configured with the following number of serving NR CCs:

- up to 8 NR DL CCs in total, with 1 UL (or 2 UL if SUL is configured) in PCell and up to 1 UL (or 2 UL if SUL is configured) in SCell.
- SUL may be configured together with one of the UL

3.6.2.2 Number of serving carriers for EN-DC

Requirements for EN-DC operation of E-UTRA and NR with E-UTRA PCell and NR PSCell are applicable for the UE configured with the following number of serving NR CCs:

- up to 7 NR DL CCs in total, with 1 UL (or 2 UL if SUL is configured) in PSCell and up to 1 UL (or 2 UL if SUL is configured) in SCell.
- SUL may be configured together with one of the UL

The applicable number of E-UTRA CC for EN-DC in the MCG for both UL and DL is specified in TS 36.133 [15].

3.6.2.3 Number of serving carriers for NE-DC

Requirements for NE-DC operation of NR and E-UTRA with NR PCell and E-UTRA PSCell are applicable for the UE configured with the following number of serving NR CCs:

- up to 7 NR DL CCs in total, with 1 UL (or 2 UL if SUL is configured) in PCell and up to 1 UL (or 2 UL if SUL is configured) in SCell.
- SUL may be configured together with one of the UL

The applicable number of E-UTRA CC for NE-DC in the SCG for both UL and DL is specified in TS 36.133 [15].

3.6.2.4 Number of serving carriers for NR-DC

Requirements for NR-DC are applicable for the UE configured with the following number of serving NR CCs:

- up to TBD NR DL CCs in total in MCG, up to TBD NR DL CCs in total in SCG, with 1 UL (or 2 UL if SUL is configured) in PCell, TBD UL CCs in SCG, and up to 1 UL (or 2 UL if SUL is configured) in each SCell.
- SUL may be configured together with one of the UL.

3.6.3 Applicability for SSB Rx beam in intra-band FR2

For the requirements in RRC connected state specified in this version of the specification, UE shall assume that the SSBs from the serving cells should have the same downlink spatial domain transmission filter in the same band in FR2. If the SSBs don't have same downlink spatial domain transmission filter the UE is not supposed to satisfy any requirements for SCell.

3.6.4 Applicability for FR2 UE power classes

For the requirements of each FR2 power class specified in this version of the specification, certain UE types with specific device architectures are assumed. The UE types can be found in TS 38.101-2 [19].

3.6.5 Applicability of requirements for NGEN-DC operation

All the requirements in this specification applicable for EN-DC are also applicable for NGEN-DC.

4 SA: RRC_IDLE state mobility

Editor's note: intended to capture the RRM requirements for RRC_IDLE state in stand-alone operation.

4.1 Cell Selection

After a UE has switched on and a PLMN has been selected, the Cell selection process takes place, as described in TS 38.304. This process allows the UE to select a suitable cell where to camp on in order to access available services. In this process, the UE can use stored information (*Stored information cell selection*) or not (*Initial cell selection*).

4.2 Cell Re-selection

4.2.1 Introduction

The cell reselection procedure allows the UE to select a more suitable cell and camp on it.

When the UE is in either *Camped Normally* state or *Camped on Any Cell* state on a cell, the UE shall attempt to detect, synchronise, and monitor intra-frequency, inter-frequency and inter-RAT cells indicated by the serving cell. For intra-frequency and inter-frequency cells the serving cell may not provide explicit neighbour list but carrier frequency information and bandwidth information only. UE measurement activity is also controlled by measurement rules defined in TS 38.304, allowing the UE to limit its measurement activity.

In the requirements of Section 4.2, the exceptions for side conditions apply as follows:

- for the UE capable of CA, the applicable exceptions for side conditions are specified in Annex B, Section B.3.2.1, B.3.2.3, or B.3.2.5 for UE supporting CA in FR1, CA in FR2 and CA between FR1 and FR2, respectively;
- for the UE capable of SUL, the applicable exceptions for side conditions are specified in Annex B, Section B.3.4.1 for UE supporting SUL in FR1.

4.2.2 Requirements

4.2.2.1 UE measurement capability

For idle mode cell re-selection purposes, the UE shall be capable of monitoring at least:

- Intra-frequency carrier, and
- Depending on UE capability, 7 NR inter-frequency carriers, and
- Depending on UE capability, 7 FDD E-UTRA inter-RAT carriers, and
- Depending on UE capability, 7 TDD E-UTRA inter-RAT carriers.

In addition to the requirements defined above, a UE supporting E-UTRA measurements in RRC_IDLE state shall be capable of monitoring a total of at least 14 carrier frequency layers, which includes serving layer, comprising of any above defined combination of E-UTRA FDD, E-UTRA TDD and NR layers.

4.2.2.2 Measurement and evaluation of serving cell

The UE shall measure the SS-RSRP and SS-RSRQ level of the serving cell and evaluate the cell selection criterion S defined in [1] for the serving cell at least once every $M1 \cdot N1$ DRX cycle; where:

$M1=2$ if SMTC periodicity (T_{SMTC}) > 20 ms and DRX cycle \leq 0.64 second,

otherwise $M1=1$.

The UE shall filter the SS-RSRP and SS-RSRQ measurements of the serving cell using at least 2 measurements. Within the set of measurements used for the filtering, at least two measurements shall be spaced by, at least DRX cycle/2.

If the UE has evaluated according to Table 4.2.2.2-1 in N_{serv} consecutive DRX cycles that the serving cell does not fulfil the cell selection criterion S, the UE shall initiate the measurements of all neighbour cells indicated by the serving cell, regardless of the measurement rules currently limiting UE measurement activities.

If the UE in RRC_IDLE has not found any new suitable cell based on searches and measurements using the intra-frequency, inter-frequency and inter-RAT information indicated in the system information for 10 s, the UE shall initiate cell selection procedures for the selected PLMN as defined in TS 38.304 [1].

Table 4.2.2.2-1: N_{serv}

DRX cycle length [s]	Scaling Factor (N1)		N_{serv} [number of DRX cycles]
	FR1	FR2 ^{Note1}	
0.32	1	8	$M1 \cdot N1 \cdot 4$
0.64		5	$M1 \cdot N1 \cdot 4$
1.28		4	$N1 \cdot 2$
2.56		3	$N1 \cdot 2$
Note 1: Applies for UE supporting power class 2&3&4. For UE supporting power class 1, $N1 = 8$ for all DRX cycle length.			

4.2.2.3 Measurements of intra-frequency NR cells

The UE shall be able to identify new intra-frequency cells and perform SS-RSRP and SS-RSRQ measurements of the identified intra-frequency cells without an explicit intra-frequency neighbour list containing physical layer cell identities.

The UE shall be able to evaluate whether a newly detectable intra-frequency cell meets the reselection criteria defined in TS38.304 within T_{detect,NR_Intra} when that $T_{reselection} = 0$. An intra frequency cell is considered to be detectable according to the conditions defined in Annex B.1.2 for a corresponding Band.

The UE shall measure SS-RSRP and SS-RSRQ at least every $T_{measure,NR_Intra}$ (see table 4.2.2.3-1) for intra-frequency cells that are identified and measured according to the measurement rules.

The UE shall filter SS-RSRP and SS-RSRQ measurements of each measured intra-frequency cell using at least 2 measurements. Within the set of measurements used for the filtering, at least two measurements shall be spaced by at least $T_{measure,NR_Intra}/2$.

The UE shall not consider a NR neighbour cell in cell reselection, if it is indicated as not allowed in the measurement control system information of the serving cell.

For an intra-frequency cell that has been already detected, but that has not been reselected to, the filtering shall be such that the UE shall be capable of evaluating that the intra-frequency cell has met reselection criterion defined [1] within $T_{evaluate,NR_Intra}$ when $T_{reselection} = 0$ as specified in table 4.2.2.3-1 provided that:

- when *rangeToBestCell* is not configured, the cell has at least [3]dB in FR1 or [TBD]dB in FR2 better ranked or
- when *rangeToBestCell* is configured, the cell which has the highest number of beams above the threshold *absThreshSS-BlocksConsolidation* among the cells whose cell-ranking criterion R value as specified in TS 38.304 [1, Section 5.2.4.6] is within *rangeToBestCell* of the R value of the best cell where the best cell has at least [TBD] in FR1 or [TBD]dB in FR2 better ranked, and if there are multiple such cells the UE shall perform cell reselection to the highest ranked cell among them.

When evaluating cells for reselection, the SSB side conditions apply to both serving and non-serving intra-frequency cells.

If $T_{\text{reselection}}$ timer has a non zero value and the intra-frequency cell is satisfied with the reselection criteria which are defined in TS38.304 [1], the UE shall evaluate this intra-frequency cell for the $T_{\text{reselection}}$ time. If this cell remains satisfied with the reselection criteria within this duration, then the UE shall reselect that cell.

Table 4.2.2.3-1: $T_{\text{detect,NR_Intra}}$, $T_{\text{measure,NR_Intra}}$ and $T_{\text{evaluate,NR_Intra}}$

DRX cycle length [s]	Scaling Factor (N1)		$T_{\text{detect,NR_Intra}}$ [s] (number of DRX cycles)	$T_{\text{measure,NR_Intra}}$ [s] (number of DRX cycles)	$T_{\text{evaluate,NR_Intra}}$ [s] (number of DRX cycles)
	FR1	FR2 ^{Note1}			
0.32	1	8	$11.52 \times N1 \times M2$ (36 x N1 x M2)	$1.28 \times N1 \times M2$ (4 x N1 x M2)	$5.12 \times N1 \times M2$ (16 x N1 x M2)
0.64		5	$17.92 \times N1$ (28 x N1)	$1.28 \times N1$ (2 x N1)	$5.12 \times N1$ (8 x N1)
1.28		4	$32 \times N1$ (25 x N1)	$1.28 \times N1$ (1 x N1)	$6.4 \times N1$ (5 x N1)
2.56		3	$58.88 \times N1$ (23 x N1)	$2.56 \times N1$ (1 x N1)	$7.68 \times N1$ (3 x N1)
Note 1: Applies for UE supporting power class 2&3&4. For UE supporting power class 1, N1 = 8 for all DRX cycle length.					
Note 2: M2 = 1.5 if SMTC periodicity of measured intra-frequency cell > 20 ms; otherwise M2=1.					

4.2.2.4 Measurements of inter-frequency NR cells

The UE shall be able to identify new inter-frequency cells and perform SS-RSRP or SS-RSRQ measurements of identified inter-frequency cells if carrier frequency information is provided by the serving cell, even if no explicit neighbour list with physical layer cell identities is provided.

If $S_{\text{rxlev}} > S_{\text{nonIntraSearchP}}$ and $S_{\text{qual}} > S_{\text{nonIntraSearchQ}}$ then the UE shall search for inter-frequency layers of higher priority at least every $T_{\text{higher_priority_search}}$ where $T_{\text{higher_priority_search}}$ is described in clause 4.2.2.7.

If $S_{\text{rxlev}} \leq S_{\text{nonIntraSearchP}}$ or $S_{\text{qual}} \leq S_{\text{nonIntraSearchQ}}$ then the UE shall search for and measure inter-frequency layers of higher, equal or lower priority in preparation for possible reselection. In this scenario, the minimum rate at which the UE is required to search for and measure higher priority layers shall be the same as that defined below in this subclause.

The UE shall be able to evaluate whether a newly detectable inter-frequency cell meets the reselection criteria defined in TS38.304 within $K_{\text{carrier}} * T_{\text{detect,NR_Inter}}$ if at least carrier frequency information is provided for inter-frequency neighbour cells by the serving cells when $T_{\text{reselection}} = 0$ provided that the reselection criteria is met by a margin of at least [5] dB in FR1 or [TBD]dB in FR2 for reselections based on ranking or [6]dB in FR1 or [TBD] dB in FR2 for SS-RSRP reselections based on absolute priorities or [4]dB in FR1 and [TBD] in FR2 for SS-RSRQ reselections based on absolute priorities. The parameter K_{carrier} is the number of NR inter-frequency carriers indicated by the serving cell. An inter-frequency cell is considered to be detectable according to the conditions defined in Annex B.1.3 for a corresponding Band.

When higher priority cells are found by the higher priority search, they shall be measured at least every $T_{\text{measure,NR_Inter}}$. If, after detecting a cell in a higher priority search, it is determined that reselection has not occurred then the UE is not required to continuously measure the detected cell to evaluate the ongoing possibility of reselection. However, the minimum measurement filtering requirements specified later in this section shall still be met by the UE before it makes any determination that it may stop measuring the cell. If the UE detects on a NR carrier a cell whose physical identity is indicated as not allowed for that carrier in the measurement control system information of the serving cell, the UE is not required to perform measurements on that cell.

The UE shall measure SS-RSRP or SS-RSRQ at least every $K_{\text{carrier}} * T_{\text{measure,NR_Inter}}$ (see table 4.2.2.4-1) for identified lower or equal priority inter-frequency cells. If the UE detects on a NR carrier a cell whose physical identity is indicated as not allowed for that carrier in the measurement control system information of the serving cell, the UE is not required to perform measurements on that cell.

The UE shall filter SS-RSRP or SS-RSRQ measurements of each measured higher, lower and equal priority inter-frequency cell using at least 2 measurements. Within the set of measurements used for the filtering, at least two measurements shall be spaced by at least $T_{\text{measure,NR_Inter}}/2$.

The UE shall not consider a NR neighbour cell in cell reselection, if it is indicated as not allowed in the measurement control system information of the serving cell.

For an inter-frequency cell that has been already detected, but that has not been reselected to, the filtering shall be such that the UE shall be capable of evaluating that the inter-frequency cell has met reselection criterion defined TS 38.304 within $K_{\text{carrier}} * T_{\text{evaluate,NR_Inter}}$ when $T_{\text{reselection}} = 0$ as specified in table 4.2.2.4-1 provided that the reselection criteria is met by

- the condition when performing equal priority reselection and
 - when *rangeToBestCell* is not configured, the cell has at least [5]dB in FR1 or [TBD]dB in FR2 better ranked or
 - when *rangeToBestCell* is configured, the cell which has the highest number of beams above the threshold *absThreshSS-BlocksConsolidation* among the cells whose cell-ranking criterion R value as specified in TS 38.304 [1, Section 5.2.4.6] is within *rangeToBestCell* of the R value of the best cell where the best cell has at least [TBD] in FR1 or [TBD]dB in FR2 better ranked, and if there are multiple such cells the UE shall perform cell reselection to the highest ranked cell among them or
- [6]dB in FR1 or [TBD]dB in FR2 for SS-RSRP reselections based on absolute priorities or
- [4]dB in FR1 or [TBD] in FR2 for SS-RSRQ reselections based on absolute priorities.

When evaluating cells for reselection, the SSB side conditions apply to both serving and inter-frequency cells.

If $T_{\text{reselection}}$ timer has a non zero value and the inter-frequency cell is satisfied with the reselection criteria, the UE shall evaluate this inter-frequency cell for the $T_{\text{reselection}}$ time. If this cell remains satisfied with the reselection criteria within this duration, then the UE shall reselect that cell.

The UE is not expected to meet the measurement requirements for an inter-frequency carrier under DRX cycle=320 ms defined in Table 4.2.2.4-1 under the following conditions:

- $T_{\text{SMTC_intra}} = T_{\text{SMTC_inter}} = 160$ ms; where $T_{\text{SMTC_intra}}$ and $T_{\text{SMTC_inter}}$ are periodicities of the SMTC occasions configured for the intra-frequency carrier and the inter-frequency carrier respectively,
- SMTC occasions configured for the inter-frequency carrier occur up to TBD ms before the start or up to TBD ms after the end of the SMTC occasions configured for the intra-frequency carrier and
- SMTC occasions configured for the intra-frequency carrier and for the inter-frequency carrier occur up to TBD ms before the start or up to TBD ms after the end of the paging occasion [1].

Table 4.2.2.4-1: $T_{\text{detect,NR_Inter}}$, $T_{\text{measure,NR_Inter}}$ and $T_{\text{evaluate,NR_Inter}}$

DRX cycle length [s]	Scaling Factor (N1)		$T_{\text{detect,NR_Inter}}$ [s] (number of DRX cycles)	$T_{\text{measure,NR_Inter}}$ [s] (number of DRX cycles)	$T_{\text{evaluate,NR_Inter}}$ [s] (number of DRX cycles)
	FR1	FR2 ^{Note1}			
0.32	1	8	$11.52 \times N1 \times 1.5$ (36 x N1 x 1.5)	$1.28 \times N1 \times 1.5$ (4 x N1 x 1.5)	$5.12 \times N1 \times 1.5$ (16 x N1 x 1.5)
0.64		5	$17.92 \times N1$ (28 x N1)	$1.28 \times N1$ (2 x N1)	$5.12 \times N1$ (8 x N1)
1.28		4	$32 \times N1$ (25 x N1)	$1.28 \times N1$ (1 x N1)	$6.4 \times N1$ (5 x N1)
2.56		3	$58.88 \times N1$ (23 x N1)	$2.56 \times N1$ (1 x N1)	$7.68 \times N1$ (3 x N1)
Note 1: Applies for UE supporting power class 2&3&4. For UE supporting power class 1, N1 = 8 for all DRX cycle length.					

4.2.2.5 Measurements of inter-RAT E-UTRAN cells

If $S_{\text{rxlev}} > S_{\text{nonIntraSearchP}}$ and $S_{\text{qual}} > S_{\text{nonIntraSearchQ}}$ then the UE shall search for inter-RAT E-UTRAN layers of higher priority at least every $T_{\text{higher_priority_search}}$ where $T_{\text{higher_priority_search}}$ is described in clause 4.2.2

If $S_{\text{rxlev}} \leq S_{\text{nonIntraSearchP}}$ or $S_{\text{qual}} \leq S_{\text{nonIntraSearchQ}}$ then the UE shall search for and measure inter-RAT E-UTRAN layers of higher, lower priority in preparation for possible reselection. In this scenario, the minimum rate at which the UE is required to search for and measure higher priority inter-RAT E-UTRAN layers shall be the same as that defined below for lower priority RATs.

The requirements in this section apply for inter-RAT E-UTRAN FDD measurements and E-UTRA TDD measurements. When the measurement rules indicate that inter-RAT E-UTRAN cells are to be measured, the UE shall measure RSRP and RSRQ of detected E-UTRA cells in the neighbour frequency list at the minimum measurement rate specified in this

section. The parameter $N_{\text{EUTRA_carrier}}$ is the total number of configured E-UTRA carriers in the neighbour frequency list. The UE shall filter RSRP and RSRQ measurements of each measured E-UTRA cell using at least 2 measurements. Within the set of measurements used for the filtering, at least two measurements shall be spaced by at least $T_{\text{measure,EUTRAN}}/2$.

An inter-RAT E-UTRA cell is considered to be detectable provided the following conditions are fulfilled:

- the same conditions as for inter-frequency RSRP measurements specified in TS 36.133 [15, Annex B.1.2] are fulfilled for a corresponding Band, and
- the same conditions as for inter-frequency RSRQ measurements specified in TS 36.133 [15, Annex B.1.2] are fulfilled for a corresponding Band.
- SCH conditions specified in TS 36.133 [15, Annex B.1.2] are fulfilled for a corresponding Band

The UE shall be able to evaluate whether a newly detectable inter-RAT E-UTRAN cell meets the reselection criteria defined in TS38.304 within $(N_{\text{EUTRA_carrier}}) * T_{\text{detect,EUTRAN}}$ when $S_{\text{rxlev}} \leq S_{\text{nonIntraSearchP}}$ or $S_{\text{qual}} \leq S_{\text{nonIntraSearchQ}}$ when $T_{\text{reselection}} = 0$ provided that the reselection criteria is met by a margin of at least 6dB for RSRP reselections based on absolute priorities or 4dB for RSRQ reselections based on absolute priorities.

Cells which have been detected shall be measured at least every $(N_{\text{EUTRA_carrier}}) * T_{\text{measure,EUTRAN}}$ when $S_{\text{rxlev}} \leq S_{\text{nonIntraSearchP}}$ or $S_{\text{qual}} \leq S_{\text{nonIntraSearchQ}}$.

When higher priority cells are found by the higher priority search, they shall be measured at least every $T_{\text{measure,EUTRAN}}$. If, after detecting a cell in a higher priority search, it is determined that reselection has not occurred then the UE is not required to continuously measure the detected cell to evaluate the ongoing possibility of reselection. However, the minimum measurement filtering requirements specified later in this section shall still be met by the UE before it makes any determination that it may stop measuring the cell.

If the UE detects on an inter-RAT E-UTRAN carrier a cell whose physical identity is indicated as not allowed for that carrier in the measurement control system information of the serving cell, the UE is not required to perform measurements on that cell.

The UE shall not consider an inter-RAT E-UTRA cell in cell reselection, if it is indicated as not allowed in the measurement control system information of the serving cell.

For a cell that has been already detected, but that has not been reselected to, the filtering shall be such that the UE shall be capable of evaluating that an already identified inter-RAT E-UTRA cell has met reselection criterion defined in TS 38.304 [1] within $(N_{\text{EUTRA_carrier}}) * T_{\text{evaluate,EUTRAN}}$ when $T_{\text{reselection}} = 0$ as specified in table 4.2.2.5-1 provided that the reselection criteria is met by a margin of at least 6dB for RSRP reselections based on absolute priorities or 4dB for RSRQ reselections based on absolute priorities.

If $T_{\text{reselection}}$ timer has a non zero value and the inter-RAT E-UTRA cell is satisfied with the reselection criteria which are defined in [1], the UE shall evaluate this E-UTRA cell for the $T_{\text{reselection}}$ time. If this cell remains satisfied with the reselection criteria within this duration, then the UE shall reselect that cell.

Table 4.2.2.5-1: $T_{\text{detect,EUTRAN}}$, $T_{\text{measure,EUTRAN}}$, and $T_{\text{evaluate,EUTRAN}}$

DRX cycle length [s]	$T_{\text{detect,EUTRAN}}$ [s] (number of DRX cycles)	$T_{\text{measure,EUTRAN}}$ [s] (number of DRX cycles)	$T_{\text{evaluate,EUTRAN}}$ [s] (number of DRX cycles)
0.32	11.52 (36)	1.28 (4)	5.12 (16)
0.64	17.92 (28)	1.28 (2)	5.12 (8)
1.28	32(25)	1.28 (1)	6.4 (5)
2.56	58.88 (23)	2.56 (1)	7.68 (3)

4.2.2.6 Maximum interruption in paging reception

UE shall perform the cell re-selection with minimum interruption in monitoring downlink channels for paging reception.

At intra-frequency and inter-frequency cell re-selection, the UE shall monitor the downlink of serving cell for paging reception until the UE is capable to start monitoring downlink channels of the target intra-frequency and inter-frequency cell for paging reception. The interruption time shall not exceed $T_{SI-NR} + 2 * T_{target_cell_SMTC_period}$ ms.

At inter-RAT cell re-selection, the UE shall monitor the downlink of serving cell for paging reception until the UE is capable to start monitoring downlink channels for paging reception of the target inter-RAT cell. For NR to E-UTRAN cell re-selection the interruption time must not exceed $T_{SI-EUTRA} + 55$ ms.

T_{SI-NR} is the time required for receiving all the relevant system information data according to the reception procedure and the RRC procedure delay of system information blocks defined in TS 38.331 [2] for an NR cell.

$T_{SI-EUTRA}$ is the time required for receiving all the relevant system information data according to the reception procedure and the RRC procedure delay of system information blocks defined in TS 36.331 [16] for an E-UTRAN cell.

These requirements assume sufficient radio conditions, so that decoding of system information can be made without errors and does not take into account cell re-selection failure.

4.2.2.7 General requirements

The UE shall search every layer of higher priority at least every $T_{higher_priority_search} = ([60] * N_{layers})$ seconds, where N_{layers} is the total number of higher priority NR and E-UTRA carrier frequencies broadcasted in system information.

5 SA: RRC_INACTIVE state mobility

5.1 Cell Re-selection

5.1.1 Introduction

The cell reselection procedure allows the UE to select a more suitable cell and camp on it.

When the UE is in *Camped Normally* state on a cell, the UE shall attempt to detect, synchronise, and monitor intra-frequency, inter-frequency and inter-RAT cells indicated by the serving cell. For intra-frequency and inter-frequency cells the serving cell may not provide explicit neighbour list but carrier frequency information and bandwidth information only. UE measurement activity is also controlled by measurement rules defined in TS38.304, allowing the UE to limit its measurement activity.

5.1.2 Requirements

5.1.2.1 UE measurement capability

The requirements in sub-clause 4.2.2.1 shall apply.

5.1.2.2 Measurement and evaluation of serving cell

The requirements in sub-clause 4.2.2.2 shall apply.

5.1.2.3 Measurements of intra-frequency NR cells

The requirements in sub-clause 4.2.2.3 shall apply.

5.1.2.4 Measurements of inter-frequency NR cells

The requirements in sub-clause 4.2.2.4 shall apply.

5.1.2.5 Measurements of inter-RAT E-UTRAN cells

The requirements in sub-clause 4.2.2.5 shall apply.

5.1.2.6 Maximum interruption in paging reception

The requirements in sub-clause 4.2.2.6 shall apply.

5.1.2.7 General requirements

The requirements in sub-clause 4.2.2.7 shall apply.

5.2 RRC_INACTIVE Mobility Control

Editor's note: intended to capture requirements which applies for the transition between INACTIVE and IDLE state. This section might be removed if unnecessary.

6 RRC_CONNECTED state mobility

6.1 Handover

6.1.1 NR Handover

6.1.1.1 Introduction

The purpose of NR handover is to change the NR PCell to another NR cell. The requirements in this clause are applicable to SA NR, NE-DC and NR-DC.

6.1.1.2 NR FR1 - NR FR1 Handover

The requirements in this clause are applicable to both intra-frequency and inter-frequency handovers from NR FR1 cell to NR FR1 cell.

6.1.1.2.1 Handover delay

Procedure delays for all procedures that can command a handover are specified in TS 38.331 [2].

When the UE receives a RRC message implying handover the UE shall be ready to start the transmission of the new uplink PRACH channel within D_{handover} seconds from the end of the last TTI containing the RRC command.

Where:

D_{handover} equals the maximum RRC procedure delay to be defined in clause 12 in TS 38.331 [2] plus the interruption time stated in clause 6.1.1.2.2.

6.1.1.2.2 Interruption time

The interruption time is the time between end of the last TTI containing the RRC command on the old PDSCH and the time the UE starts transmission of the new PRACH, excluding the RRC procedure delay.

When intra-frequency or inter-frequency handover is commanded, the interruption time shall be less than $T_{\text{interrupt}}$

$$T_{\text{interrupt}} = T_{\text{search}} + T_{\text{IU}} + 20 + T_{\Delta} \text{ ms}$$

Where:

T_{search} is the time required to search the target cell when the target cell is not already known when the handover command is received by the UE. If the target cell is known, then $T_{\text{search}} = 0$ ms. If the target cell is an unknown intra-frequency cell and the target cell $E_s/I_{\text{ot}} \geq -\text{TBD}$ dB, then $T_{\text{search}} = T_{\text{rs}} + 2$ ms. If the target cell is an unknown inter-frequency cell and the target cell $E_s/I_{\text{ot}} \geq -\text{TBD}$ dB, then $T_{\text{search}} = [3 * T_{\text{rs}} + 2]$ ms. Regardless of whether DRX is in use by the UE, T_{search} shall still be based on non-DRX target cell search times.

T_{Δ} is time for fine time tracking and acquiring full timing information of the target cell. $T_{\Delta} = T_{\text{rs}}$.

T_{IU} is the interruption uncertainty in acquiring the first available PRACH occasion in the new cell. T_{IU} can be up to $x * 10 + 10$ ms. x is defined in the table 6.3.3.2-2 of TS 38.211 [6].

T_{rs} is the SMTC periodicity of the target NR cell if the UE has been provided with an SMTC configuration for the target cell in the handover command, otherwise T_{rs} is the SMTC configured in the measObjectNR having the same SSB frequency and subcarrier spacing. If the UE is not provided SMTC configuration or measurement object on this frequency, the requirement in this section is applied with $T_{\text{rs}} = [5]$ ms assuming the SSB transmission periodicity is 5 ms. There is no requirements if the SSB transmission periodicity is not 5 ms.

NOTE 1: The actual value of T_{IU} shall depend upon the PRACH configuration used in the target cell.

In the interruption requirement a cell is known if it has been meeting the relevant cell identification requirement during the last 5 seconds otherwise it is unknown. Relevant cell identification requirements are described in Clause 9.2.5 for intra-frequency handover and Clause 9.3.1 for inter-frequency handover.

6.1.1.3 NR FR2- NR FR1 Handover

The requirements in this clause are applicable to inter-frequency handovers from NR FR2 cell to NR FR1 cell.

6.1.1.3.1 Handover delay

Procedure delays for all procedures that can command a handover are specified in TS 38.331 [2].

When the UE receives a RRC message implying handover the UE shall be ready to start the transmission of the new uplink PRACH channel within D_{handover} seconds from the end of the last TTI containing the RRC command.

Where:

D_{handover} equals the maximum RRC procedure delay to be defined in clause 12 in TS 38.331 [2] plus the interruption time stated in clause 6.1.1.3.2.

6.1.1.3.2 Interruption time

The interruption time is the time between end of the last TTI containing the RRC command on the old PDSCH and the time the UE starts transmission of the new PRACH, excluding the RRC procedure delay.

When intra-frequency or inter-frequency handover is commanded, the interruption time shall be less than $T_{\text{interrupt}}$

$$T_{\text{interrupt}} = T_{\text{search}} + T_{\text{IU}} + 40 + T_{\Delta} \text{ ms}$$

Where:

T_{search} is the time required to search the target cell when the target cell is not already known when the handover command is received by the UE. If the target cell is known, then $T_{\text{search}} = 0$ ms. If the target cell is an unknown inter-frequency cell and the target cell $E_s/I_{\text{ot}} \geq -\text{TBD}$ dB, then $T_{\text{search}} = [3 * T_{\text{rs}} + 2]$ ms. Regardless of whether DRX is in use by the UE, T_{search} shall still be based on non-DRX target cell search times.

T_{Δ} is time for fine time tracking and acquiring full timing information of the target cell. $T_{\Delta} = T_{\text{rs}}$.

T_{IU} is the interruption uncertainty in acquiring the first available PRACH occasion in the new cell. T_{IU} can be up to $x * 10 + 10$ ms. x is defined in the table 6.3.3.2-2 of [6].

T_{rs} is the SMTC periodicity of the target NR cell if the UE has been provided with an SMTC configuration for the target cell in the handover command, otherwise T_{rs} is the SMTC configured in the *measObjectNR* having the same SSB frequency and subcarrier spacing. If the UE is not provided SMTC configuration or measurement object on this frequency, the requirement in this section is applied with $T_{\text{rs}} = [5]$ ms assuming the SSB transmission periodicity is 5 ms. There is no requirement if the SSB transmission periodicity is not 5ms. If the UE has been provided with higher layer in TS 38.331 [2] signaling of *smtc2* prior to the handover command, T_{rs} follows *smtc1* or *smtc2* according to the physical cell ID of the target cell.

NOTE 1: The actual value of T_{IU} shall depend upon the PRACH configuration used in the target cell.

In the interruption requirement a cell is known if it has been meeting the relevant cell identification requirement during the last 5 seconds otherwise it is unknown. Relevant cell identification requirements are described in Clause 9.2.5 for intra-frequency handover and Clause 9.3.1 for inter-frequency handover.

6.1.1.4 NR FR2- NR FR2 Handover

The requirements in this clause are applicable to both intra-frequency and inter-frequency handovers from NR FR2 cell to NR FR2 cell.

6.1.1.4.1 Handover delay

Procedure delays for all procedures that can command a handover are specified in TS 38.331 [2].

When the UE receives a RRC message implying handover the UE shall be ready to start the transmission of the new uplink PRACH channel within D_{handover} seconds from the end of the last TTI containing the RRC command.

Where:

D_{handover} equals the maximum RRC procedure delay to be defined in clause 12 in TS 38.331 [2] plus the interruption time stated in clause 6.1.1.4.2.

6.1.1.4.2 Interruption time

The interruption time is the time between end of the last TTI containing the RRC command on the old PDSCH and the time the UE starts transmission of the new PRACH, excluding the RRC procedure delay.

When intra-frequency or inter-frequency handover is commanded, the interruption time shall be less than $T_{\text{interrupt}}$

$$T_{\text{interrupt}} = T_{\text{search}} + T_{\text{IU}} + T_{\text{processing}} + T_{\Delta} \text{ ms}$$

Where:

T_{search} is the time required to search the target cell when the handover command is received by the UE. If the target cell is an intra-frequency cell and the target cell $E_s/I_{ot} \geq -\text{TBD}$ dB, then $T_{\text{search}} = [8 * T_{rs} + 2]$ ms. If the target cell is an inter-frequency cell and the target cell $E_s/I_{ot} \geq -\text{TBD}$ dB, then $T_{\text{search}} = [8 * 3 * T_{rs} + 2]$ ms. Regardless of whether DRX is in use by the UE, T_{search} shall still be based on non-DRX target cell search times.

$T_{\text{processing}}$ is time for UE processing. $T_{\text{processing}}$ can be up to 20ms.

T_{Δ} is time for fine time tracking and acquiring full timing information of the target cell. $T_{\Delta} = [1] * T_{rs}$.

T_{IU} is the interruption uncertainty in acquiring the first available PRACH occasion in the new cell. T_{IU} can be up to $x * 10 + 10$ ms. x is defined in the table 6.3.3.2-2 of [6].

T_{rs} is the SMTC periodicity of the target NR cell if the UE has been provided with an SMTC configuration for the target cell in the handover command, otherwise T_{rs} is the SMTC configured in the measObjectNR having the same SSB frequency and subcarrier spacing. If the UE is not provided SMTC configuration or measurement object on this frequency, the requirement in this section is applied with $T_{rs} = [5]$ ms assuming the SSB transmission periodicity is 5 ms. There is no requirements if the SSB transmission periodicity is not 5 ms. If the UE has been provided with higher layer in TS 38.331 [2] signaling of *smtc2* prior to the handover command, T_{rs} follows *smtc1* or *smtc2* according to the physical cell ID of the target cell.

NOTE 1: The actual value of T_{IU} shall depend upon the PRACH configuration used in the target cell.

NOTE 2: Void

6.1.1.5 NR FR1- NR FR2 Handover

The requirements in this clause are applicable to inter-frequency handovers from NR FR1 cell to NR FR2 cell.

6.1.1.5.1 Handover delay

Procedure delays for all procedures that can command a handover are specified in TS 38.331 [2].

When the UE receives a RRC message implying handover the UE shall be ready to start the transmission of the new uplink PRACH channel within D_{handover} seconds from the end of the last TTI containing the RRC command.

Where:

D_{handover} equals the maximum RRC procedure delay to be defined in clause 12 in TS 38.331 [2] plus the interruption time stated in clause 6.1.1.5.2.

6.1.1.5.2 Interruption time

The interruption time is the time between end of the last TTI containing the RRC command on the old PDSCH and the time the UE starts transmission of the new PRACH, excluding the RRC procedure delay.

When intra-frequency or inter-frequency handover is commanded, the interruption time shall be less than $T_{\text{interrupt}}$

$$T_{\text{interrupt}} = T_{\text{search}} + T_{\text{IU}} + T_{\text{processing}} + T_{\Delta} \text{ ms}$$

Where:

T_{search} is the time required to search the target cell when the handover command is received by the UE. If the target cell is an intra-frequency cell and the target cell $E_s/I_{ot} \geq -\text{TBD dB}$, then $T_{\text{search}} = [8 * T_{\text{rs}} + 2]$ ms. If the target cell is an inter-frequency cell and the target cell $E_s/I_{ot} \geq -\text{TBD dB}$, then $T_{\text{search}} = [8 * 3 * T_{\text{rs}} + 2]$ ms. Regardless of whether DRX is in use by the UE, T_{search} shall still be based on non-DRX target cell search times.

$T_{\text{processing}}$ is time for UE processing. $T_{\text{processing}}$ can be up to 40ms.

T_{Δ} is time for fine time tracking and acquiring full timing information of the target cell. $T_{\Delta} = [1] * T_{\text{rs}}$.

T_{IU} is the interruption uncertainty in acquiring the first available PRACH occasion in the new cell. T_{IU} can be up to $x * 10 + 10$ ms. x is defined in the table 6.3.3.2-2 of [6].

T_{rs} is the SMTC periodicity of the target NR cell if the UE has been provided with an SMTC configuration for the target cell in the handover command, otherwise T_{rs} is the SMTC configured in the measObjectNR having the same SSB frequency and subcarrier spacing. If the UE is not provided SMTC configuration or measurement object on this frequency, the requirement in this section is applied with $T_{\text{rs}} = [5]$ ms assuming the SSB transmission periodicity is 5 ms. There is no requirements if the SSB transmission periodicity is not 5 ms. If the UE has been provided with higher layer in TS 38.331 [2] signaling of *smtc2* prior to the handover command, T_{rs} follows *smtc1* or *smtc2* according to the physical cell ID of the target cell.

NOTE 1: The actual value of T_{IU} shall depend upon the PRACH configuration used in the target cell.

NOTE 2: Void

6.1.2 NR Handover to other RATs

6.1.2.1 NR – E-UTRAN Handover

6.1.2.1.1 Introduction

The purpose of inter-RAT handover from NR to E-UTRAN is to change the radio access mode of PCell from NR to E-UTRAN. The handover procedure is initiated from NR with a RRC message that implies a handover as described in TS 38.331 [2]. The requirements in this clause are applicable to SA NR, NE-DC and NR-DC.

6.1.2.1.2 Handover delay

When the UE receives a RRC message implying handover to E-UTRAN the UE shall be ready to start the transmission of the uplink PRACH channel in E-UTRA within D_{handover} seconds from the end of the last TTI containing the RRC command. D_{handover} is defined as

$$D_{\text{handover}} = T_{\text{RRC_procedure_delay}} + T_{\text{interrupt}}$$

Where:

$T_{\text{RRC_procedure_delay}}$: it is the RRC procedure delay, which is 50ms

$T_{\text{interrupt}}$: it is the time between end of the last TTI containing the RRC command on the NR PDSCH and the time the UE starts transmission of the PRACH in E-UTRAN, excluding $T_{\text{RRC_procedure_delay}}$. $T_{\text{interrupt}}$ is defined in clause 6.1.2.1.3.

6.1.2.1.3 Interruption time

When the inter-RAT handover to E-UTRAN is commanded, the interruption time shall be less than $T_{\text{interrupt}}$

$$T_{\text{interrupt}} = T_{\text{search}} + T_{\text{IU}} + 20 \text{ ms}$$

Where:

T_{search} is the time required to search the target cell when the target cell is not already known when the handover command is received by the UE. If the target cell is known, then $T_{\text{search}} = 0$ ms. If the target cell is unknown and signal quality is sufficient for successful cell detection on the first attempt, then $T_{\text{search}} = 80$ ms. Regardless of whether DRX is in use by the UE, T_{search} shall still be based on non-DRX target cell search times.

T_{IU} is the interruption uncertainty in acquiring the first available PRACH occasion in the new cell. T_{IU} can be up to 30 ms.

NOTE: The actual value of T_{IU} shall depend upon the PRACH configuration used in the target cell.

In the interruption requirement a cell is known if it has been meeting the relevant cell identification requirement during the last 5 seconds otherwise it is unknown. Relevant E-UTRAN cell identification requirements are described in clause [9.4.1].

6.2 RRC Connection Mobility Control

6.2.1 SA: RRC Re-establishment

6.2.1.1 Introduction

This clause contains requirements on the UE regarding RRC connection re-establishment procedure. RRC connection re-establishment is initiated when a UE in RRC_CONNECTED state loses RRC connection due to any of failure cases, including radio link failure, handover failure, and RRC connection reconfiguration failure. The RRC connection re-establishment procedure is specified in clause 5.3.7 of TS 38.331 [2].

The requirements in this clause are applicable for RRC connection re-establishment to NR cell.

6.2.1.2 Requirements

In RRC connected mode the UE shall be capable of sending *RRCReestablishmentRequest* message within $T_{\text{re-establish_delay}}$ seconds from the moment it detects a loss in RRC connection. The total RRC connection delay ($T_{\text{re-establish_delay}}$) shall be less than:

$$T_{\text{re-establish_delay}} = T_{\text{UE_re-establish_delay}} + T_{\text{UL_grant}}$$

$T_{\text{UL_grant}}$: It is the time required to acquire and process uplink grant from the target PCell. The uplink grant is required to transmit *RRCReestablishmentRequest* message.

The UE re-establishment delay ($T_{\text{UE_re-establish_delay}}$) is specified in clause 6.2.1.2.1.

6.2.1.2.1 UE Re-establishment delay requirement

The UE re-establishment delay ($T_{\text{UE_re-establish_delay}}$) is the time between the moments when any of the conditions requiring RRC re-establishment as defined in clause 5.3.7 in TS 38.331 [2] is detected by the UE and when the UE sends PRACH to the target PCell. The UE re-establishment delay ($T_{\text{UE_re-establish_delay}}$) requirement shall be less than:

$$T_{\text{UE_re-establish_delay}} = 50 + T_{\text{identify_intra_NR}} + \sum_{i=1}^{N_{\text{freq}}-1} T_{\text{identify_inter_NR},i} + T_{\text{SI-NR}} + T_{\text{PRACH}}$$

The intra-frequency target NR cell shall be considered detectable when for each relevant SSB:

- SS-RSRP related side conditions given in Section 10.1.2 and 10.1.3 are fulfilled for a corresponding NR Band for FR1 and FR2, respectively,
- SSB_{RP} and SSB \hat{E}_s/I_{ot} according to Annex B.2.2 for a corresponding NR Band.

The inter-frequency target NR cell shall be considered detectable when for each relevant SSB:

- SS-RSRP related side conditions given in Section 10.1.4 and 10.1.5 are fulfilled for a corresponding NR Band for FR1 and FR2, respectively,
- SSB_{RP} and SSB \hat{E}_s/I_{ot} according to Annex B.2.2 for a corresponding NR Band.

$T_{\text{identify_intra_NR}}$: It is the time to identify the target intra-frequency NR cell and it depends on whether the target NR cell is known cell or unknown cell and on the frequency range (FR) of the target NR cell. If the UE is not configured with intra-frequency NR carrier for RRC re-establishment then $T_{\text{identify_intra_NR}}=0$; otherwise $T_{\text{identify_intra_NR}}$ shall not exceed the values defined in table 6.2.1.2.1-1.

$T_{\text{identify_inter_NR},i}$: It is the time to identify the target inter-frequency NR cell on inter-frequency carrier i configured for RRC re-establishment and it depends on whether the target NR cell is known cell or unknown cell and on the frequency range (FR) of the target NR cell. $T_{\text{identify_inter_NR},i}$ shall not exceed the values defined in table 6.2.1.2.1-2.

T_{SMTC} : It is the periodicity of the SMTC occasion configured for the intra-frequency carrier. If the UE has been provided with higher layer in TS 38.331 [2] signaling of smtc2 , T_{smtc} follows smtc1 or smtc2 according to the physical cell ID of the target cell.

$T_{\text{SMTC},i}$: It is the periodicity of the SMTC occasion configured for the inter-frequency carrier i .

$T_{\text{SI-NR}}$ = It is the time required for receiving all the relevant system information according to the reception procedure and the RRC procedure delay of system information blocks defined in TS 38.331 [2] for the target NR cell.

T_{PRACH} = It is the delay caused due to the random access procedure when sending random access to the target NR cell. The delay depends on the PRACH configuration defined in Table 6.3.3.2-2 [6] or Table 6.3.3.2-3 [6] for FR1 and in Table 6.3.3.2-4 [6] for FR2.

N_{freq} : It is the total number of NR frequencies to be monitored for RRC re-establishment; $N_{\text{freq}} = 1$ if the target intra-frequency NR cell is known, else $N_{\text{freq}} = 2$ and $T_{\text{identify_intra_NR}} = 0$ if the target inter-frequency NR cell is known.

There is no requirement if the target cell does not contain the UE context.

In the requirement defined in the below tables, the target FR1 cell is known if it has been meeting the relevant cell identification requirement during the last [5] seconds otherwise it is unknown.

Table 6.2.1.2.1-1: Time to identify target NR cell for RRC connection re-establishment to NR intra-frequency cell

Serving cell SSB \hat{E}_s/lot (dB)	Frequency range (FR) of target NR cell	$T_{\text{identify_intra_NR}}$ [ms]	
		Known NR cell	Unknown NR cell
$\geq [-8]$	FR1	MAX (200 ms, [5] x T_{SMTC})	MAX (800 ms, [10] x T_{SMTC})
$\geq [-8]$	FR2	N/A	MAX (1000 ms, [80] x T_{SMTC})
$< [-8]$	FR1	N/A	800 ^{Note1}
$< [-8]$	FR2	N/A	3520 ^{Note1}

Note 1: The UE is not required to successfully identify a cell on any NR frequency layer when $T_{\text{SMTC}} > 20$ ms and serving cell SSB $\hat{E}_s/\text{lot} < [-8]$ dB.

Table 6.2.1.2.1-2: Time to identify target NR cell for RRC connection re-establishment to NR inter-frequency cell

Serving cell SSB \hat{E}_s/lot (dB)	Frequency range (FR) of target NR cell	$T_{\text{identify_inter_NR},i}$ [ms]	
		Known NR cell	Unknown NR cell
$\geq [-8]$	FR1	MAX (200 ms, [6] x $T_{\text{SMTC},i}$)	MAX (800 ms, [13] x $T_{\text{SMTC},i}$)
$\geq [-8]$	FR2	N/A	MAX (1000 ms, [104] x $T_{\text{SMTC},i}$)
$< [-8]$	FR1	N/A	800 ^{Note1}
$< [-8]$	FR2	N/A	4000 ^{Note1}

Note 1: The UE is not required to successfully identify a cell on any NR frequency layer when $T_{\text{SMTC},i} > 20$ ms and serving cell SSB $\hat{E}_s/\text{lot} < [-8]$ dB.

6.2.2 Random access

6.2.2.1 Introduction

This clause contains requirements on the UE regarding random access procedure. The random access procedure is initiated to establish uplink time synchronization for a UE which either has not acquired or has lost its uplink synchronization, or to convey UE's request Other SI, or for beam failure recovery. The random access is specified in clause 8 of TS 38.213 [3] and the control of the RACH transmission is specified in clause 5.1 of TS 38.321 [7].

6.2.2.2 Requirements

The UE shall have capability to calculate PRACH transmission power according to the PRACH power formula defined in TS 38.213 [3] and apply this power level at the first preamble or additional preambles. The absolute power applied to the first preamble shall have an accuracy as specified in Table 6.3.4.2-1 of TS 38.101-1 [18] for frequency range 1 and in Table 6.3.4.2-1 of TS 38.101-2 [19] for frequency range 2. The relative power applied to additional preambles shall have an accuracy as specified in Table 6.3.4.3-1 of TS 38.101-1 [18] for frequency range 1 and clause 6.3.4.3 of TS 38.101-2 [19] for frequency range 2.

The UE shall indicate a Random Access problem to upper layers if the maximum number of preamble transmission counter has been reached for the random access procedure on PCell or PSCell as specified in clause 5.1.4 in TS 38.321 [7].

The requirements in this section apply for UE in SA operation mode or any MR-DC operation mode.

6.2.2.2.1 Contention based random access

6.2.2.2.1.1 Correct behaviour when transmitting Random Access Preamble

With the UE selected SSB with SS-RSRP above *rsrp-ThresholdSSB*, UE shall have the capability to select a Random Access Preamble randomly with equal probability from the Random Access Preambles associated with the selected SSB if the association between Random Access Preambles and SS blocks is configured, as specified in clause 5.1.2 in TS 38.321 [7].

With the UE selected SSB with SS-RSRP above *rsrp-ThresholdSSB*, UE shall have the capability to transmit Random Access Preamble on the next available PRACH occasion from the PRACH occasions corresponding to the selected SSB permitted by the restrictions given by the *ra-ssb-OccasionMaskIndex* if configured, if the association between PRACH occasions and SSBs is configured, and PRACH occasion shall be randomly selected with equal probability amongst the selected SSB associated PRACH occasions occurring simultaneously but on different subcarriers, as specified in clause 5.1.2 in TS 38.321 [7].

6.2.2.2.1.2 Correct behaviour when receiving Random Access Response

The UE may stop monitoring for Random Access Response(s) and shall transmit the msg3 if the Random Access Response contains a Random Access Preamble identifier corresponding to the transmitted Random Access Preamble.

The UE shall again perform the Random Access Resource selection procedure defined in clause 5.1.2 in TS 38.321 [7], and transmit with the calculated PRACH transmission power when the backoff time expires if all received Random Access Responses contain Random Access Preamble identifiers that do not match the transmitted Random Access Preamble.

6.2.2.2.1.3 Correct behaviour when not receiving Random Access Response

The UE shall again perform the Random Access Resource selection procedure defined in clause 5.1.2 in TS 38.321 [7], and transmit with the calculated PRACH transmission power when the backoff time expires if no Random Access Response is received within the RA Response window defined in clause 5.1.4 in TS 38.321 [7].

6.2.2.2.1.4 Correct behaviour when receiving a NACK on msg3

The UE shall re-transmit the msg3 upon the reception of a NACK on msg3.

6.2.2.2.1.5 Correct behaviour when receiving a message over Temporary C-RNTI

The UE shall send ACK if the Contention Resolution is successful.

The UE shall again perform the Random Access Resource selection procedure defined in clause 5.1.2 in TS 38.321 [7], and transmit with the calculated PRACH transmission power when the backoff time expires unless the received message includes a UE Contention Resolution Identity MAC control element and the UE Contention Resolution Identity included in the MAC control element matches the CCCH SDU transmitted in the uplink message.

6.2.2.2.1.6 Correct behaviour when contention Resolution timer expires

The UE shall re-select a preamble and transmit with the calculated PRACH transmission power when the backoff time expires if the Contention Resolution Timer expires.

6.2.2.2.2 Non-Contention based random access

6.2.2.2.2.1 Correct behaviour when transmitting Random Access Preamble

If the contention-free Random Access Resources and the contention-free PRACH occasions associated with SSBs is configured, with the UE selected SSB with SS-RSRP above *rsrp-ThresholdSSB* amongst the associated SSBs, UE shall have the capability to select the Random Access Preamble corresponding to the selected SSB, and to transmit Random Access Preamble on the next available PRACH occasion from the PRACH occasions corresponding to the selected SSB permitted by the restrictions given by the *ra-ssb-OccasionMaskIndex* if configured, and PRACH occasion shall be randomly selected with equal probability amongst the selected SSB associated PRACH occasions occurring simultaneously but on different subcarriers, as specified in clause 5.1.2 in TS 38.321 [7].

If the contention-free Random Access Resources and the contention-free PRACH occasions associated with CSI-RSs is configured, with the UE selected CSI-RS with CSI-RSRP above *cfra-csirs-DedicatedRACH-Threshold* amongst the associated CSI-RSs, UE shall have the capability to select the Random Access Preamble corresponding to the selected CSI-RS, and to transmit Random Access Preamble on the next available PRACH occasion from the PRACH occasions in *ra-OccasionList* corresponding to the selected CSI-RS, and PRACH occasion shall be randomly selected with equal probability amongst the selected CSI-RS associated PRACH occasions occurring simultaneously but on different subcarriers, as specified in clause 5.1.2 in TS 38.321 [7].

If the random access procedure is initialized for beam failure recovery and if the contention-free Random Access Resources and the contention-free PRACH occasions for beam failure recovery request associated with any of the SSBs and/or CSI-RSs is configured, UE shall have the capability to select the Random Access Preamble corresponding to the selected SSB with SS-RSRP above *rsrp-ThresholdSSB* amongst the associated SSBs or the selected CSI-RS with CSI-RSRP above *cfra-csirs-DedicatedRACH-Threshold* amongst the associated CSI-RSs, and to transmit Random Access Preamble on the next available PRACH occasion from the PRACH occasions corresponding to the selected SSB permitted by the restrictions given by the *ra-ssb-OccasionMaskIndex* if configured, or from the PRACH occasions in *ra-OccasionList* corresponding to the selected CSI-RS, and PRACH occasion shall be randomly selected with equal probability amongst the selected SSB associated PRACH occasions or the selected CSI-RS associated PRACH occasions occurring simultaneously but on different subcarriers, as specified in clause 5.1.2 in TS 38.321 [7].

6.2.2.2.2.2 Correct behaviour when receiving Random Access Response

The UE may stop monitoring for Random Access Response(s), if the Random Access Response contains a Random Access Preamble identifier corresponding to the transmitted Random Access Preamble, unless the random access procedure is initialized for Other SI request from UE.

The UE may stop monitoring for Random Access Response(s) and shall monitor the Other SI transmission if the Random Access Response only contains a Random Access Preamble identifier which is corresponding to the transmitted Random Access Preamble and the random access procedure is initialized for SI request from UE, as specified in clause 5.1.4 in TS 38.321 [7].

The UE may stop monitoring for Random Access Response(s), if the contention-free Random Access Preamble for beam failure recovery request was transmitted and if the PDCCH addressed to UE's C-RNTI is received, as specified in clause 5.1.4 in TS 38.321 [7].

The UE shall again perform the Random Access Resource selection procedure defined in clause 5.1.2 in TS 38.321 [7] for the next available PRACH occasion, and transmit the preamble with the calculated PRACH transmission power if

all received Random Access Responses contain Random Access Preamble identifiers that do not match the transmitted Random Access Preamble.

6.2.2.2.3 Correct behaviour when not receiving Random Access Response

The UE shall again perform the Random Access Resource selection procedure defined in clause 5.1.2 in TS 38.321 [7] for the next available PRACH occasion, and transmit the preamble with the calculated PRACH transmission power, if no Random Access Response is received within the RA Response window configured in *RACH-ConfigCommon* or if no PDCCH addressed to UE's C-RNTI is received within the RA Response window configured in *BeamFailureRecoveryConfig*, as defined in clause 5.1.4 in TS 38.321 [7].

6.2.2.2.3 UE behaviour when configured with supplementary UL

In addition to the requirements defined in clause 6.2.2.2.1 and 6.2.2.2.2, a UE configured with supplementary UL carrier shall use RACH configuration for the supplementary UL carrier contained in RMSI and RRC dedicated signalling. If the cell for the random access procedure is configured with supplementary UL, the UE shall transmit or re-transmit PRACH preamble on the supplementary UL carrier if the SS-RSRP measured by the UE on the DL carrier is lower than the *rsrp-ThresholdSSB-SUL* as defined in TS 38.331 [2].

6.2.3 SA: RRC Connection Release with Redirection

6.2.3.1 Introduction

This clause contains requirements on the UE regarding RRC connection release with redirection procedure. RRC connection release with redirection is initiated by the *RRCConnectionRelease* message with redirection to E-UTRAN or NR from NR specified in TS 38.331 [2]. The RRC connection release with redirection procedure is specified in clause 5.3.8 of TS 38.331 [2].

6.2.3.2 Requirements

6.2.3.2.1 RRC connection release with redirection to NR

The UE shall be capable of performing the RRC connection release with redirection to the target NR cell within $T_{\text{connection_release_redirect_NR}}$.

The time delay ($T_{\text{connection_release_redirect_NR}}$) is the time between the end of the last slot containing the RRC command, "*RRCRelease*" (TS 38.331 [2]) on the NR PDSCH and the time the UE starts to send random access to the target NR cell. The time delay ($T_{\text{connection_release_redirect_NR}}$) shall be less than:

$$T_{\text{connection_release_redirect_NR}} = T_{\text{RRC_procedure_delay}} + T_{\text{identify-NR}} + T_{\text{SI-NR}} + T_{\text{RACH}}$$

The target NR cell shall be considered detectable when for each relevant SSB, the side conditions should be met that,

- SSB_{RP} and SSB \hat{E}_s/I_{ot} according to Annex B.2.5 for a corresponding NR Band.

$T_{\text{RRC_procedure_delay}}$: It is the RRC procedure delay for processing the received message "*RRCRelease*" as defined in clause 6.2.2 of TS 38.331 [2].

$T_{\text{identify-NR}}$: It is the time to identify the target NR cell and depend on the frequency range (FR) of the target NR cell. It is defined in table 6.2.3.2.1-1. Note that $T_{\text{identify-NR}} = T_{\text{PSS/SSS-sync}} + T_{\text{meas}}$, in which $T_{\text{PSS/SSS-sync}}$ is the cell search time and T_{meas} is the measurement time due to cell selection criteria evaluation.

$T_{\text{SI-NR}}$: It is the time required for acquiring all the relevant system information of the target NR cell. This time depends upon whether the UE is provided with the relevant system information of the target NR cell or not by the old NR cell before the RRC connection is released. $T_{\text{SI-NR}} = 0$ provided the UE is provided with the SI (including MIB and all relevant SIBs) of the target NR cell before the RRC connection is released by the old NR cell.

T_{RACH} : It is the delay caused due to the random access procedure when sending random access to the target NR cell. This delay depends on the PRACH configuration defined in Table 6.3.3.2-2 [6] or Table 6.3.3.2-3 [6] for FR1 and in Table 6.3.3.2-4 [6] for FR2.

T_{rs} is the SMTC periodicity of the target NR cell if the UE has been provided with an SMTC configuration for the target cell in the redirection command, otherwise T_{rs} is the SMTC configured in the measObjectNR having the same SSB frequency and subcarrier spacing configured for the RRC connection release with redirection. If the UE is not provided with SMTC configuration or measurement object for the frequency which is also configured for the RRC connection release with redirection then:

- the requirement in this section is applied with $T_{rs} = 20$ ms assuming the SSB transmission periodicity is not larger than 20 ms,
- there is no requirement if the SSB transmission periodicity is larger than 20ms.

Table 6.2.3.2.1-1: Time to identify target NR cell for RRC connection release with redirection to NR

Frequency range (FR) of target NR cell	$T_{\text{identify-NR}}$
FR1	MAX (680 ms, [11] x T_{rs})
FR2	MAX (880 ms, 8x[11] x T_{rs})
Note :	If the UE has been provided with higher layer in TS 38.331 [2] signaling of <i>smtc2</i> prior to the redirection command, SMTC follows <i>smtc1</i> or <i>smtc2</i> according to the physical cell ID of the target cell.

6.2.3.2.2 RRC connection release with redirection to E-UTRAN

The UE shall be capable of performing the RRC connection release with redirection to the target E-UTRAN cell within $T_{\text{connection_release_redirect_E-UTRA}}$.

The time delay ($T_{\text{connection_release_redirect_E-UTRA}}$) is the time between the end of the last slot containing the RRC command, “*RRCRelease*” (TS 38.331 [2]) on the PDSCH and the time the UE starts to send random access to the target E-UTRA cell. The time delay ($T_{\text{connection_release_redirect_E-UTRA}}$) shall be less than:

$$T_{\text{connection_release_redirect_E-UTRA}} = T_{\text{RRC_procedure_delay}} + T_{\text{identify-E-UTRA}} + T_{\text{SI-E-UTRA}} + T_{\text{RACH}}$$

The target E-UTRA FDD or TDD cell shall be considered detectable when for each relevant SSB:

- RSRP related conditions in the accuracy requirements in Section 10.2.2 are fulfilled for a corresponding Band, together with the corresponding side conditions in Annex B.2 and Annex B.3 of TS 36.133 [15],
- RSRQ related conditions in the accuracy requirements in Section 10.2.3 are fulfilled for a corresponding Band, together with the corresponding side conditions in Annex B.2 and Annex B.3 of TS 36.133 [15],
- RS-SINR related conditions in the accuracy requirements in Section 10.2.5 are fulfilled for a corresponding Band, together with the corresponding side conditions in Annex B.2 and Annex B.3 of TS 36.133 [15].

$T_{\text{RRC_procedure_delay}}$: It is the RRC procedure delay for processing the received message “*RRCRelease*” as defined in clause 6.2.2 of TS 38.331 [2].

$T_{\text{identify-E-UTRA}}$: It is the time to identify the target E-UTRA cell. It shall be less than 320 ms.

$T_{\text{SI-E-UTRA}}$: It is the time required for acquiring all the relevant system information of the target E-UTRA cell. This time depends upon whether the UE is provided with the relevant system information (SI) of the target E-UTRA cell or not by the old NR cell before the RRC connection is released. $T_{\text{SI-E-UTRA}} = 0$ provided the UE is provided with the SI (including MIB and all relevant SIBs) of the target E-UTRA cell before the RRC connection is released by the old NR cell.

T_{RACH} : It is the delay caused due to the random access procedure when sending random access to the target E-UTRA cell.

7 Timing

7.1 UE transmit timing

7.1.1 Introduction

The UE shall have capability to follow the frame timing change of the reference cell in connected state. The uplink frame transmission takes place $(N_{TA} + N_{TA\ offset}) \times T_c$ before the reception of the first detected path (in time) of the corresponding downlink frame from the reference cell. If the UE is configured with a pTAG containing the PCell, UE shall use the PCell as the reference cell for deriving the UE transmit timing for cells in the pTAG. If the UE is configured with a psTAG containing the PSCell, UE shall use the PSCell as the reference cell for deriving the UE transmit timing for cells in the psTAG. UE initial transmit timing accuracy, maximum amount of timing change in one adjustment, minimum and maximum adjustment rate are defined in the following requirements.

7.1.2 Requirements

The UE initial transmission timing error shall be less than or equal to $\pm T_e$ where the timing error limit value T_e is specified in Table 7.1.2-1. This requirement applies:

- when it is the first transmission in a DRX cycle for PUCCH, PUSCH and SRS or it is the PRACH transmission.

The UE shall meet the T_e requirement for an initial transmission provided that at least one SSB is available at the UE during the last 160 ms. The reference point for the UE initial transmit timing control requirement shall be the downlink timing of the reference cell minus $(N_{TA} + N_{TA\ offset}) \times T_c$. The downlink timing is defined as the time when the first detected path (in time) of the corresponding downlink frame is received from the reference cell. N_{TA} for PRACH is defined as 0.

$(N_{TA} + N_{TA\ offset}) \times T_c$ (in T_c units) for other channels is the difference between UE transmission timing and the downlink timing immediately after when the last timing advance in clause 7.3 was applied. N_{TA} for other channels is not changed until next timing advance is received. The value of $N_{TA\ offset}$ depends on the duplex mode of the cell in which the uplink transmission takes place and the frequency range (FR). $N_{TA\ offset}$ is defined in Table 7.1.2-2.

Table 7.1.2-1: T_e Timing Error Limit

Frequency Range	SCS of SSB signals (KHz)	SCS of uplink signals s(KHz)	T_e
1	15	15	$12 \cdot 64 \cdot T_c$
		30	$10 \cdot 64 \cdot T_c$
		60	$10 \cdot 64 \cdot T_c$
	30	15	$8 \cdot 64 \cdot T_c$
		30	$8 \cdot 64 \cdot T_c$
		60	$7 \cdot 64 \cdot T_c$
2	120	60	$3.5 \cdot 64 \cdot T_c$
		120	$3.5 \cdot 64 \cdot T_c$
	240	60	$3 \cdot 64 \cdot T_c$
		120	$3 \cdot 64 \cdot T_c$
Note 1: T_c is the basic timing unit defined in TS 38.211 [6]			

Table 7.1.2-2: The Value of $N_{TA\ offset}$

Frequency range and band of cell used for uplink transmission	$N_{TA\ offset}$ (Unit: T_c)
FR1 FDD band without LTE-NR coexistence case or FR1 TDD band without LTE-NR coexistence case	25600 (Note 1)
FR1 FDD band with LTE-NR coexistence case	0 (Note 1)
FR1 TDD band with LTE-NR coexistence case	39936 (Note 1)
FR2	13792
Note 1: The UE identifies $N_{TA\ offset}$ based on the information n-TimingAdvanceOffset according to [2]. If UE is not provided with the information n-TimingAdvanceOffset, the default value of $N_{TA\ offset}$ is set as 25600 for FR1 band. In case of multiple UL carriers in the same TAG, UE expects that the same value of n-TimingAdvanceOffset is provided for all the UL carriers according to section 4.2 in [3] and the value 39936 of $N_{TA\ offset}$ can also be provided for a FDD serving cell. Note 2: Void	

When it is not the first transmission in a DRX cycle or there is no DRX cycle, and when it is the transmission for PUCCH, PUSCH and SRS transmission, the UE shall be capable of changing the transmission timing according to the received downlink frame of the reference cell except when the timing advance in clause 7.3 is applied.

When the transmission timing error between the UE and the reference timing exceeds $\pm T_e$, the UE is required to adjust its timing to within $\pm T_e$. The reference timing shall be $(N_{TA} + N_{TA\ offset}) \times T_c$ before the downlink timing of the reference cell. All adjustments made to the UE uplink timing shall follow these rules:

- 1) The maximum amount of the magnitude of the timing change in one adjustment shall be T_q .
- 2) The minimum aggregate adjustment rate shall be T_p per second.
- 3) The maximum aggregate adjustment rate shall be T_q per 200ms.

where the maximum autonomous time adjustment step T_q and the aggregate adjustment rate T_p are specified in Table 7.1.2-3.

Table 7.1.2-3: T_q Maximum Autonomous Time Adjustment Step and T_p Minimum Aggregate Adjustment rate

Frequency Range	SCS of uplink signals (KHz)	T_q	T_p
1	15	$5.5 \cdot 64 \cdot T_c$	$5.5 \cdot 64 \cdot T_c$
	30	$5.5 \cdot 64 \cdot T_c$	$5.5 \cdot 64 \cdot T_c$
	60	$5.5 \cdot 64 \cdot T_c$	$5.5 \cdot 64 \cdot T_c$
2	60	$2.5 \cdot 64 \cdot T_c$	$2.5 \cdot 64 \cdot T_c$
	120	$2.5 \cdot 64 \cdot T_c$	$2.5 \cdot 64 \cdot T_c$
NOTE 1: T_c is the basic timing unit defined in TS 38.211 [6]			

7.2 UE timer accuracy

7.2.1 Introduction

UE timers are used in different protocol entities to control the UE behaviour.

7.2.2 Requirements

For UE timers specified in TS 38.331 [2], the UE shall comply with the timer accuracies according to Table 7.2.2-1.

The requirements are only related to the actual timing measurements internally in the UE. They do not include the following:

- Inaccuracy in the start and stop conditions of a timer (e.g. UE reaction time to detect that start and stop conditions of a timer is fulfilled), or
- Inaccuracies due to restrictions in observability of start and stop conditions of a UE timer (e.g. slot alignment when UE sends messages at timer expiry).

Table 7.2.2-1

Timer value [s]	Accuracy
timer value < 4	$\pm 0.1\text{s}$
timer value ≥ 4	$\pm 2.5\%$

7.3 Timing advance

7.3.1 Introduction

The timing advance is initiated from PSCell in EN-DC and NR-DC operation modes, and from PCell in SA, NE-DC, or NR-DC operation modes, with MAC message that implies and adjustment of the timing advance, as defined in clause 5.2 of TS 38.321 [7].

7.3.2 Requirements

7.3.2.1 Timing Advance adjustment delay

UE shall adjust the timing of its uplink transmission timing at time slot $n+k$ for a timing advance command received in time slot n , and the value of k is defined in section 4.2 in TS 38.213 [3]. The same requirement applies also when the UE is not able to transmit a configured uplink transmission due to the channel assessment procedure.

7.3.2.2 Timing Advance adjustment accuracy

The UE shall adjust the timing of its transmissions with a relative accuracy better than or equal to the UE Timing Advance adjustment accuracy requirement in Table 7.3.2.2-1, to the signalled timing advance value compared to the timing of preceding uplink transmission. The timing advance command step is defined in TS 38.213 [3].

Table 7.3.2.2-1: UE Timing Advance adjustment accuracy

Sub Carrier Spacing, SCS kHz	15	30	60	120
UE Timing Advance adjustment accuracy	$\pm 256 T_c$	$\pm 256 T_c$	$\pm 128 T_c$	$\pm 32 T_c$

7.4 Cell phase synchronization accuracy

7.4.1 Definition

Cell phase synchronization accuracy for TDD is defined as the maximum absolute deviation in frame start timing between any pair of cells on the same frequency that have overlapping coverage areas.

7.4.2 Minimum requirements

The cell phase synchronization accuracy measured at BS antenna connectors shall be better than 3 μs .

7.5 Maximum Transmission Timing Difference

7.5.1 Introduction

A UE shall be capable of handling a relative transmission timing difference between subframe timing boundary of E-UTRA PCell and slot timing boundary of PSCell to be aggregated for EN-DC operation.

A UE shall be capable of handling a relative transmission timing difference among slot timing boundaries of different carriers to be aggregated in NR carrier aggregation.

7.5.2 Minimum Requirements for inter-band EN-DC

The UE shall be capable of handling a maximum uplink transmission timing difference between E-UTRA PCell and PSCell as shown in Table 7.5.2-1.

Table 7.5.2-1 Maximum uplink transmission timing difference requirement for asynchronous EN-DC

Sub-carrier spacing in E-UTRA PCell (kHz)	UL Sub-carrier spacing for data in PSCell (kHz)	Maximum uplink transmission timing difference (μ s)
15	15	500
15	30	250
15	60	125
15	120 ^{Note1}	62.5
NOTE 1: For E-UTRA FDD-NR FDD and E-UTRA TDD-NR TDD intra-band EN-DC, for which the requirement is defined in Section 7.5.3 and this Table 7.5.2-1 is also applicable, the scenario with 120kHz PSCell does not exist.		

The UE shall be capable of handling a maximum uplink transmission timing difference between E-UTRA PCell and PSCell as shown in Table 7.5.2-2. The requirements for synchronous EN-DC are applicable for E-UTRA TDD-NR TDD, E-UTRA FDD-NR FDD, E-UTRA TDD-NR FDD and E-UTRA FDD-NR TDD inter-band EN-DC.

Table 7.5.2-2 Maximum uplink transmission timing difference requirement for inter-band synchronous EN-DC

Sub-carrier spacing in E-UTRA PCell (kHz)	UL Sub-carrier spacing for data in PSCell (kHz)	Maximum uplink transmission timing difference (μ s)
15	15	35.21
15	30	35.21
15	60	35.21
15	120	35.21
NOTE 1: Void		

Editor Note: It is FFS the necessity of inter-band EN-DC synchronous requirement for MTTD.

7.5.3 Minimum Requirements for intra-band EN-DC

For intra-band EN-DC, only collocated deployment is applied.

The UE shall be capable of handling a maximum uplink transmission timing difference between E-UTRA PCell and PSCell as shown in Table 7.5.2-1 for E-UTRA FDD-NR FDD intra-band EN-DC provided the UE indicates that it is capable of asynchronous EN-DC operation [16]. No requirement on maximum uplink transmission timing difference is applicable for synchronous E-UTRA FDD-NR FDD and E-UTRA TDD-NR TDD intra-band EN-DC.

7.5.4 Minimum Requirements for NR Carrier Aggregation

The UE shall be capable of handling at least a relative transmission timing difference between slot timing of different TAGs as shown in Table 7.5.4-1, provided that the UE is:

- configured with the pTAG and the sTAG for inter-band NR carrier aggregation in SA mode. or
- configured with more than one sTAG for inter-band NR carrier aggregation in NSA mode.

Table 7.5.4-1: Maximum transmission timing difference requirement for inter-band NR carrier aggregation

Frequency Range	Maximum transmission timing difference (μs)
FR1	34.6
FR2	8.5
Between FR1 and FR2	26.1

7.5.5 Minimum Requirements for inter-band NE-DC

The UE shall be capable of handling a maximum uplink transmission timing difference between NR PCell and PSCell as shown in Table 7.5.5-1.

Table 7.5.5-1: Maximum uplink transmission timing difference requirement for asynchronous NE-DC

Sub-carrier spacing in NR PCell (kHz)	UL Sub-carrier spacing for data in PSCell (kHz)	Maximum uplink transmission timing difference (μs)
15	15	500
30	15	250
60	15	125
120 ^{Note1}	15	62.5
NOTE 1: For NR FDD- E-UTRA FDD and NR TDD- E-UTRA TDD intra-band NE-DC, for which the requirement is defined in Section [7.5.X] and this Table 7.5.5-1 is also applicable, the scenario with 120kHz PCell does not exist.		

The UE shall be capable of handling a maximum uplink transmission timing difference between NR PCell and PSCell as shown in Table 7.5.5-2. The requirements for synchronous NE-DC are applicable for NR TDD- E-UTRA TDD, NR FDD- E-UTRA FDD, NR TDD- E-UTRA FDD and NR FDD- E-UTRA TDD inter-band NE-DC.

Table 7.5.5-2: Maximum uplink transmission timing difference requirement for inter-band synchronous NE-DC

Sub-carrier spacing in NR PCell (kHz)	UL Sub-carrier spacing for data in PSCell (kHz)	Maximum uplink transmission timing difference (μs)
15	15	35.21
30	15	35.21
60	15	35.21
120	15	35.21
NOTE 1: Void		

Editor Note: It is FFS the necessity of inter-band NE-DC synchronous requirement for MTTD.

7.5.6 Minimum Requirements for inter-band NR-NR DC

The UE shall be capable of handling a maximum uplink transmission timing difference between PCell and PSCell as shown in Table 7.5.6-1 provided that the UE indicates that it is capable of synchronous NR-NR DC [16].

Table 7.5.6-1: Maximum transmission timing difference requirement for inter-band NR-NR synchronous dual connectivity

Frequency Range		Maximum transmission timing difference (μ s)
PCell	PSCell	
FR1	FR2	34.1

7.6 Maximum Receive Timing Difference

7.6.1 Introduction

A UE shall be capable of handling a relative receive timing difference between subframe timing boundary of E-UTRA PCell and slot timing boundary of PSCell to be aggregated for EN-DC operation.

A UE shall be capable of handling a relative receive timing difference among slot timing boundaries of different carriers to be aggregated in NR carrier aggregation.

7.6.2 Minimum Requirements for inter-band EN-DC

The UE shall be capable of handling at least a relative receive timing difference between subframe timing of signal from E-UTRA PCell and slot timing of signal from PSCell at the UE receiver as shown in Table 7.6.2-1.

Table 7.6.2-1: Maximum receive timing difference requirement for asynchronous EN-DC

Sub-carrier spacing in E-UTRA PCell (kHz)	DL Sub-carrier spacing in PSCell (kHz) (Note 1)	Maximum receive timing difference (μ s)
15	15	500
15	30	250
15	60	125
15	120 ^{Note2}	62.5
NOTE 1: DL Sub-carrier spacing is $\min\{SCS_{SS}, SCS_{DATA}\}$.		
NOTE 2: For E-UTRA FDD-NR FDD and E-UTRA TDD-NR TDD intra-band EN-DC, for which the requirement is defined in Section 7.6.3 and this Table 7.6.2-1 is also applicable, the scenario with 120kHz does not exit.		

The UE shall be capable of handling at least a relative receive timing difference between subframe timing of signal from E-UTRA PCell and slot timing of signal from PSCell at the UE receiver as shown in Table 7.6.2-2. The requirements for synchronous EN-DC are applicable for E-UTRA TDD-NR TDD, E-UTRA FDD-NR FDD, E-UTRA TDD-NR FDD and E-UTRA FDD-NR TDD inter-band EN-DC.

Table 7.6.2-2: Maximum receive timing difference requirement for inter-band synchronous EN-DC

Sub-carrier spacing in E-UTRA PCell (kHz)	DL Sub-carrier spacing in PSCell (kHz) (Note1)	Maximum receive timing difference (μ s)
15	15	33
15	30	
15	60	
15	120	
NOTE 1: DL Sub-carrier spacing is $\min\{SCS_{SS}, SCS_{DATA}\}$.		
NOTE 2: Void		

Editor Note: It is FFS the necessity of inter-band EN-DC synchronous requirement for MRTD.

Table 7.6.2-3 Void

7.6.3 Minimum Requirements for intra-band EN-DC

For intra-band EN-DC, only collocated deployment is applied.

The UE shall be capable of handling at least a relative receive timing difference between subframe timing of signal from E-UTRA PCell and slot timing of signal from PSCell as shown in Table 7.6.2-1 for E-UTRA FDD-NR FDD intra-band EN-DC provided the UE indicates that it is capable of asynchronous EN-DC operation[16].

The UE shall be capable of handling at least a relative receive timing difference between subframe timing of signal from E-UTRA PCell and slot timing of signal from PSCell as shown in Table 7.6.3-1. The requirements for synchronous EN-DC are applicable for E-UTRA TDD-NR TDD and E-UTRA FDD-NR FDD intra-band EN-DC.

Table 7.6.3-1 Maximum receive timing difference requirement for intra-band synchronous EN-DC

Sub-carrier spacing in E-UTRA PCell (kHz)	DL Sub-carrier spacing in PSCell (kHz) ^{Note1}	Maximum receive timing difference (μs)
15	15	3
15	30	3
15	60	3
NOTE 1: DL Sub-carrier spacing is $\min\{SCS_{SS}, SCS_{DATA}\}$.		

Table 7.6.3-2 Void

7.6.4 Minimum Requirements for NR Carrier Aggregation

For intra-band CA, only collocated deployment is applied. For intra-band non-contiguous NR carrier aggregation, the UE shall be capable of handling at least a relative receive timing difference between slot timing of different carriers to be aggregated at the UE receiver as shown in Table 7.6.4-1 below.

Table 7.6.4-1: Maximum receive timing difference requirement for intra-band non-contiguous NR carrier aggregation

Frequency Range	Maximum receive timing difference (μs)
FR1	3
FR2	3

For inter-band NR carrier aggregation, the UE shall be capable of handling at least a relative receive timing difference between slot timing of different carriers to be aggregated at the UE receiver as shown in Table 7.6.4-2 below.

Table 7.6.4-2: Maximum receive timing difference requirement for inter-band NR carrier aggregation

Frequency Range	Maximum receive timing difference (μs)
FR1	33
FR2	8
Between FR1 and FR2	25

7.6.5 Minimum Requirements for inter-band NE-DC

The UE shall be capable of handling at least a relative receive timing difference between subframe timing of signal from NR PCell and slot timing of signal from PSCell at the UE receiver as shown in Table 7.6.5-1.

Table 7.6.5-1: Maximum receive timing difference requirement for asynchronous NE-DC

Sub-carrier spacing in NR PCell (kHz)	DL Sub-carrier spacing in PSCell (kHz) (Note 1)	Maximum receive timing difference (μ s)
15	15	500
30	15	250
60	15	125
120 ^{Note2}	15	62.5
NOTE 1: DL Sub-carrier spacing is $\min\{SCS_{SS}, SCS_{DATA}\}$. NOTE 2: For NR FDD- E-UTRA FDD and NR TDD- E-UTRA TDD intra-band NE-DC, for which the requirement is defined in Section [7.6.X] and this Table 7.6.5-1 is also applicable, the scenario with 120kHz does not exist.		

The UE shall be capable of handling at least a relative receive timing difference between subframe timing of signal from NR PCell and slot timing of signal from PSCell at the UE receiver as shown in Table 7.6.5-2. The requirements for synchronous NE-DC are applicable for NR TDD- E-UTRA TDD, NR FDD- E-UTRA FDD, NR TDD- E-UTRA FDD and NR FDD- E-UTRA TDD inter-band NE-DC.

Table 7.6.5-2: Maximum receive timing difference requirement for inter-band synchronous NE-DC

Sub-carrier spacing in NR PCell (kHz)	DL Sub-carrier spacing in PSCell (kHz) (Note1)	Maximum receive timing difference (μ s)
15	15	33
30	15	
60	15	
120	15	
NOTE 1: DL Sub-carrier spacing is $\min\{SCS_{SS}, SCS_{DATA}\}$. NOTE 2: Void		

Editor Note: It is FFS the necessity of inter-band NE-DC synchronous requirement for MRTD.

7.6.6 Minimum Requirements for inter-band NR-NR DC

The UE shall be capable of handling at least a relative receive timing difference between subframe timing of signal from PCell and slot timing of signal from PSCell at the UE receiver as shown in Table 7.6.6-1 provided that the UE indicates that it is capable of synchronous NR-NR DC [16].

Table 7.6.6-1: Maximum receive timing difference requirement for inter-band NR-NR synchronous dual connectivity

Frequency Range		Maximum receive timing difference (μ s)
PCell	PSCell	
FR1	FR2	33

7.7 deriveSSB-IndexFromCell tolerance

7.7.1 Minimum requirements

When *deriveSSB-IndexFromCell* is enabled, the UE assumes frame boundary alignment (including half frame, subframe and slot boundary alignment) across cells on the same frequency carrier is within a tolerance not worse than $\min(2 \text{ SSB symbols}, 1 \text{ PDSCH symbol})$ and the SFN of all cells on the same frequency carrier are the same.

7.8 Maximum Allowed UE Transition Times for TDD Intra-band Carrier Aggregation

7.8.1 Requirements

A UE is not expected to transmit in the uplink to a cell earlier than $N_{\text{Rx-Tx}} T_C$ after the end of the last received downlink symbol from the any cell in the same TDD band where $N_{\text{Rx-Tx}}$ is given by Table 4.3.2-3 in TS 38.211 [6].

A UE is not expected to receive in the downlink from a cell earlier than $N_{\text{Tx-Rx}} T_C$ after the end of the last transmitted uplink symbol toward any cell in the same TDD band where $N_{\text{Tx-Rx}}$ is given by Table 4.3.2-3 in TS 38.211 [6].

8 Signalling characteristics

8.1 Radio Link Monitoring

8.1.1 Introduction

The requirements in section 8.1 apply for radio link monitoring on any of:

- PCell in SA NR, NR-DC and NE-DC operation mode,
- PSCell in NR-DC and EN-DC operation mode.

The UE shall monitor the downlink link quality based on the reference signal in the configured RLM-RS resource(s) in order to detect the downlink radio link quality of the PCell and PSCell as specified in [3]. The configured RLM-RS resources can be all SSBs, or all CSI-RSs, or a mix of SSBs and CSI-RSs. UE is not required to perform RLM outside the active DL BWP.

On each RLM-RS resource, the UE shall estimate the downlink radio link quality and compare it to the thresholds Q_{out} and Q_{in} for the purpose of monitoring downlink radio link quality of the cell.

The threshold Q_{out} is defined as the level at which the downlink radio link cannot be reliably received and shall correspond to the out-of-sync block error rate (BLER_{out}) as defined in Table 8.1.1-1. For SSB based radio link monitoring, $Q_{\text{out_SSB}}$ is derived based on the hypothetical PDCCH transmission parameters listed in Table 8.1.2.1-1. For CSI-RS based radio link monitoring, $Q_{\text{out_CSI-RS}}$ is derived based on the hypothetical PDCCH transmission parameters listed in Table 8.1.3.1-1.

The threshold Q_{in} is defined as the level at which the downlink radio link quality can be significantly more reliably received than at Q_{out} and shall correspond to the in-sync block error rate (BLER_{in}) as defined in Table 8.1.1-1. For SSB based radio link monitoring, $Q_{\text{in_SSB}}$ is derived based on the hypothetical PDCCH transmission parameters listed in Table 8.1.2.1-2. For CSI-RS based radio link monitoring, $Q_{\text{in_CSI-RS}}$ is derived based on the hypothetical PDCCH transmission parameters listed in Table 8.1.3.1-2.

The out-of-sync block error rate (BLER_{out}) and in-sync block error rate (BLER_{in}) are determined from the network configuration via parameter *rlmInSyncOutOfSyncThreshold* signalled by higher layers. When UE is not configured with *RLM-IS-OOS-thresholdConfig* from the network, UE determines out-of-sync and in-sync block error rates from Configuration #0 in Table 8.1.1-1 as default. All requirements in Section 8.1 are applicable for BLER Configuration #0 in Table 8.1.1-1.

Table 8.1.1-1: Out-of-sync and in-sync block error rates

Configuration	BLER_{out}	BLER_{in}
0	10%	2%

UE shall be able to monitor up to N_{RLM} RLM-RS resources of the same or different types in each corresponding carrier frequency range, depending on a maximum number L_{max} of candidate SSBs per half frame according to TS 38.213 [3], where N_{RLM} is specified in Table 8.1.1-2, and meet the requirements as specified in section 8.1.

Table 8.1.1-2: Maximum number of RLM-RS resources N_{RLM}

Maximum number of RLM-RS resources, N_{RLM}	L_{max}	Carrier frequency range of PCell/PSCell
2	4	FR1, ≤ 3 GHz ^{Note}
4	8	FR1, > 3 GHz ^{Note}
8	64	FR2
NOTE: for unpaired spectrum operation with Case C - 30 kHz SCS, 3GHz is replaced by 2.4GHz, as specified in clause 4.1 in TS 38.213 [3].		

If different SCS is used for CSI-RS based RLM-RS and SSB, then CSI-RS based RLM-RS and SSB shall be TDMed. If same SCS is used for CSI-RS based RLM-RS and SSB, then CSI-RS based RLM-RS and SSB can be FDMed or TDMed.

8.1.2 Requirements for SSB based radio link monitoring

8.1.2.1 Introduction

The requirements in this section apply for each SSB based RLM-RS resource configured for PCell or PSCell, provided that the SSB configured for RLM are actually transmitted within UE active DL BWP during the entire evaluation period specified in section 8.1.2.2.

Table 8.1.2.1-1: PDCCH transmission parameters for out-of-sync

Attribute	Value for BLER Configuration #0
DCI format	1-0
Number of control OFDM symbols	2
Aggregation level (CCE)	8
Ratio of hypothetical PDCCH RE energy to average SSS RE energy	4dB
Ratio of hypothetical PDCCH DMRS energy to average SSS RE energy	4dB
Bandwidth (MHz)	TBD
Sub-carrier spacing (kHz)	TBD
DMRS precoder granularity	REG bundle size
REG bundle size	6
CP length	Normal
Mapping from REG to CCE	Distributed

Table 8.1.2.1-2: PDCCH transmission parameters for in-sync

Attribute	Value for BLER Configuration #0
DCI payload size	1-0
Number of control OFDM symbols	2
Aggregation level (CCE)	4
Ratio of hypothetical PDCCH RE energy to average SSS RE energy	0dB
Ratio of hypothetical PDCCH DMRS energy to average SSS RE energy	0dB
Bandwidth (MHz)	TBD
Sub-carrier spacing (kHz)	TBD
DMRS precoder granularity	REG bundle size
REG bundle size	6
CP length	Normal
Mapping from REG to CCE	Distributed

8.1.2.2 Minimum requirement

UE shall be able to evaluate whether the downlink radio link quality on the configured RLM-RS resource estimated over the last $T_{\text{Evaluate_out_SSB}}$ [ms] period becomes worse than the threshold $Q_{\text{out_SSB}}$ within $T_{\text{Evaluate_out_SSB}}$ [ms] evaluation period.

UE shall be able to evaluate whether the downlink radio link quality on the configured RLM-RS resource estimated over the last $T_{\text{Evaluate_in_SSB}}$ [ms] period becomes better than the threshold $Q_{\text{in_SSB}}$ within $T_{\text{Evaluate_in_SSB}}$ [ms] evaluation period.

$T_{\text{Evaluate_out_SSB}}$ and $T_{\text{Evaluate_in_SSB}}$ are defined in Table 8.1.2.2-1 for FR1.

$T_{\text{Evaluate_out_SSB}}$ and $T_{\text{Evaluate_in_SSB}}$ are defined in Table 8.1.2.2-2 for FR2 with

- $N=1$,
if the SSB configured for RLM is QCL-Type D and TDMed to CSI-RS resources configured for L1-RSRP reporting, and the QCL association is known to UE;
- $N=8$, otherwise.

For FR1,

- $P=1/(1 - T_{\text{SSB}}/\text{MGRP})$, when in the monitored cell there are measurement gaps configured for intra-frequency, inter-frequency or inter-RAT measurements, which are overlapping with some but not all occasions of the SSB; and
- $P=1$ when in the monitored cell there are no measurement gaps overlapping with any occasion of the SSB.

For FR2,

- $P=1/(1 - T_{\text{SSB}}/T_{\text{SMTCperiod}})$, when RLM-RS is not overlapped with measurement gap and RLM-RS is partially overlapped with SMTC occasion ($T_{\text{SSB}} < T_{\text{SMTCperiod}}$).
- P is 3, when RLM-RS is not overlapped with measurement gap and RLM-RS is fully overlapped with SMTC period ($T_{\text{SSB}} = T_{\text{SMTCperiod}}$).
- P is $1/(1 - T_{\text{SSB}}/\text{MGRP} - T_{\text{SSB}}/T_{\text{SMTCperiod}})$, when RLM-RS is partially overlapped with measurement gap and RLM-RS is partially overlapped with SMTC occasion ($T_{\text{SSB}} < T_{\text{SMTCperiod}}$) and SMTC occasion is not overlapped with measurement gap and
 - $T_{\text{SMTCperiod}} \neq \text{MGRP}$ or
 - $T_{\text{SMTCperiod}} = \text{MGRP}$ and $T_{\text{SSB}} < 0.5 * T_{\text{SMTCperiod}}$

- P is $1/(1 - T_{SSB}/MGRP)*3$, when RLM-RS is partially overlapped with measurement gap and RLM-RS is partially overlapped with SMTC occasion ($T_{SSB} < T_{SMTCperiod}$) and SMTC occasion is not overlapped with measurement gap and $T_{SMTCperiod} = MGRP$ and $T_{SSB} = 0.5*T_{SMTCperiod}$
- P is $1/\{1 - T_{SSB}/\min(T_{SMTCperiod}, MGRP)\}$, when RLM-RS is partially overlapped with measurement gap and RLM-RS is partially overlapped with SMTC occasion ($T_{SSB} < T_{SMTCperiod}$) and SMTC occasion is partially or fully overlapped with measurement gap
- P is $1/(1 - T_{SSB}/MGRP)*3$, when RLM-RS is partially overlapped with measurement gap and RLM-RS is fully overlapped with SMTC occasion ($T_{SSB} = T_{SMTCperiod}$) and SMTC occasion is partially overlapped with measurement gap ($T_{SMTCperiod} < MGRP$)

If the high layer in TS 38.331 [2] signaling of *smtc2* is present, $T_{SMTCperiod}$ follows *smtc2*; Otherwise $T_{SMTCperiod}$ follows *smtc1*.

Longer evaluation period would be expected if the combination of RLM-RS, SMTC occasion and measurement gap configurations does not meet previous conditions.

Table 8.1.2.2-1: Evaluation period $T_{Evaluate_out}$ and $T_{Evaluate_in}$ for FR1

Configuration	$T_{Evaluate_out}$ (ms)	$T_{Evaluate_in}$ (ms)
no DRX	$\max(200, \text{ceil}(10*P)*T_{SSB})$	$\max(100, \text{ceil}(5*P)*T_{SSB})$
DRX cycle ≤ 320	$\max(200, \text{ceil}(15*P)*\max(T_{DRX}, T_{SSB}))$	$\max(100, \text{ceil}(7.5*P)*\max(T_{DRX}, T_{SSB}))$
DRX cycle > 320	$\text{ceil}(10*P)*T_{DRX}$	$\text{ceil}(5*P)*T_{DRX}$

NOTE: T_{SSB} is the periodicity of SSB configured for RLM. T_{DRX} is the DRX cycle length.

Table 8.1.2.2-2: Evaluation period $T_{Evaluate_out}$ and $T_{Evaluate_in}$ for FR2

Configuration	$T_{Evaluate_out}$ (ms)	$T_{Evaluate_in}$ (ms)
no DRX	$\max(200, \text{ceil}(10*P*N)*T_{SSB})$	$\max(100, \text{ceil}(5*P*N)*T_{SSB})$
DRX cycle ≤ 320	$\max(200, \text{ceil}(15*P*N)*\max(T_{DRX}, T_{SSB}))$	$\max(100, \text{ceil}(7.5*P*N)*\max(T_{DRX}, T_{SSB}))$
DRX cycle > 320	$\text{ceil}(10*P*N)*T_{DRX}$	$\text{ceil}(5*P*N)*T_{DRX}$

NOTE: T_{SSB} is the periodicity of SSB configured for RLM. T_{DRX} is the DRX cycle length.

8.1.3 Requirements for CSI-RS based radio link monitoring

8.1.3.1 Introduction

The requirements in this section apply for each CSI-RS based RLM-RS resource configured for PCell or PSCell, provided that the CSI-RS configured for RLM are actually transmitted within UE active DL BWP during the entire evaluation period specified in section 8.1.3.2. UE is not expected to perform radio link monitoring measurements on the CSI-RS configured as RLM-RS if the CSI-RS is not QCL-ed with any CORESET configured in the UE active BWP.

Editor's Note: FFS if the configured TCI state or the active TCI state of the CORESET should be considered.

Table 8.1.3.1-1: PDCCH transmission parameters for out-of-sync

Attribute	Value for BLER Configuration #0
DCI format	1-0
Number of control OFDM symbols	2
Aggregation level (CCE)	8
Ratio of hypothetical PDCCH RE energy to average CSI-RS RE energy	4dB
Ratio of hypothetical PDCCH DMRS energy to average CSI-RS RE energy	4dB
Bandwidth (MHz)	TBD
Sub-carrier spacing (kHz)	TBD
DMRS precoder granularity	REG bundle size
REG bundle size	6
CP length	Normal
Mapping from REG to CCE	Distributed

Table 8.1.3.1-2: PDCCH transmission parameters for in-sync

Attribute	Value for BLER Configuration #0
DCI payload size	1-0
Number of control OFDM symbols	2
Aggregation level (CCE)	4
Ratio of hypothetical PDCCH RE energy to average CSI-RS RE energy	0dB
Ratio of hypothetical PDCCH DMRS energy to average CSI-RS RE energy	[0]dB
Bandwidth (MHz)	TBD
Sub-carrier spacing (kHz)	TBD
DMRS precoder granularity	REG bundle size
REG bundle size	6
CP length	Normal
Mapping from REG to CCE	Distributed

8.1.3.2 Minimum requirement

UE shall be able to evaluate whether the downlink radio link quality on the configured RLM-RS resource estimated over the last $T_{\text{Evaluate_out_CSI-RS}}$ [ms] period becomes worse than the threshold $Q_{\text{out_CSI-RS}}$ within $T_{\text{Evaluate_out_CSI-RS}}$ [ms] evaluation period.

UE shall be able to evaluate whether the downlink radio link quality on the configured RLM-RS resource estimated over the last $T_{\text{Evaluate_in_CSI-RS}}$ [ms] period becomes better than the threshold $Q_{\text{in_CSI-RS}}$ within $T_{\text{Evaluate_in_CSI-RS}}$ [ms] evaluation period.

- $T_{\text{Evaluate_out_CSI-RS}}$ and $T_{\text{Evaluate_in_CSI-RS}}$ are defined in Table 8.1.3.2-1 for FR1.
- $T_{\text{Evaluate_out_CSI-RS}}$ and $T_{\text{Evaluate_in_CSI-RS}}$ are defined in Table 8.1.3.2-2 for FR2, where
 - $N=1$,
 - if the CSI-RS resource configured for RLM is QCL-Type D and TDMed to CSI-RS resources configured for L1-RSRP reporting or SSBs configured for L1-RSRP reporting, all CSI-RS resources configured for RLM are mutually TDMed, and the QCL association is known to UE;
 - $N=8$, otherwise.

For FR1,

- $P=1/(1 - T_{\text{CSI-RS}}/\text{MGRP})$, when in the monitored cell there are measurement gaps configured for intra-frequency, inter-frequency or inter-RAT measurements, which are overlapping with some but not all occasions of the CSI-RS; and
- $P=1$ when in the monitored cell there are no measurement gaps overlapping with any occasion of the CSI-RS.

For FR2,

- $P=1$, when RLM-RS is not overlapped with measurement gap and also not overlapped with SMTC occasion.
- $P=1/(1 - T_{\text{CSI-RS}}/\text{MGRP})$, when RLM-RS is partially overlapped with measurement gap and RLM-RS is not overlapped with SMTC occasion ($T_{\text{CSI-RS}} < \text{MGRP}$)
- $P=1/(1 - T_{\text{CSI-RS}}/T_{\text{SMTCperiod}})$, when RLM-RS is not overlapped with measurement gap and RLM-RS is partially overlapped with SMTC occasion ($T_{\text{CSI-RS}} < T_{\text{SMTCperiod}}$).
- P is 3, when RLM-RS is not overlapped with measurement gap and RLM-RS is fully overlapped with SMTC occasion ($T_{\text{CSI-RS}} = T_{\text{SMTCperiod}}$).
- P is $1/(1 - T_{\text{CSI-RS}}/\text{MGRP} - T_{\text{CSI-RS}}/T_{\text{SMTCperiod}})$, when RLM-RS is partially overlapped with measurement gap and RLM-RS is partially overlapped with SMTC occasion ($T_{\text{CSI-RS}} < T_{\text{SMTCperiod}}$) and SMTC occasion is not overlapped with measurement gap and
 - $T_{\text{SMTCperiod}} \neq \text{MGRP}$ or
 - $T_{\text{SMTCperiod}} = \text{MGRP}$ and $T_{\text{CSI-RS}} < 0.5 * T_{\text{SMTCperiod}}$
- P is $1/(1 - T_{\text{CSI-RS}}/\text{MGRP}) * 3$, when RLM-RS is partially overlapped with measurement gap and RLM-RS is partially overlapped with SMTC occasion ($T_{\text{CSI-RS}} < T_{\text{SMTCperiod}}$) and SMTC occasion is not overlapped with measurement gap and $T_{\text{SMTCperiod}} = \text{MGRP}$ and $T_{\text{CSI-RS}} = 0.5 * T_{\text{SMTCperiod}}$
- P is $1/\{1 - T_{\text{CSI-RS}}/\min(T_{\text{SMTCperiod}}, \text{MGRP})\}$, when RLM-RS is partially overlapped with measurement gap and RLM-RS is partially overlapped with SMTC occasion ($T_{\text{CSI-RS}} < T_{\text{SMTCperiod}}$) and SMTC occasion is partially or fully overlapped with measurement gap
- P is $1/(1 - T_{\text{CSI-RS}}/\text{MGRP}) * 3$, when RLM-RS is partially overlapped with measurement gap and RLM-RS is fully overlapped with SMTC occasion ($T_{\text{CSI-RS}} = T_{\text{SMTCperiod}}$) and SMTC occasion is partially overlapped with measurement gap ($T_{\text{SMTCperiod}} < \text{MGRP}$)

If the high layer in TS 38.331 [2] signaling of *smtc2* is present, $T_{\text{SMTCperiod}}$ follows *smtc2*; Otherwise $T_{\text{SMTCperiod}}$ follows *smtc1*.

Note: The overlap between CSI-RS RLM and SMTC means that CSI-RS based RLM is within the SMTC window duration. Longer evaluation period would be expected if the combination of RLM-RS, SMTC occasion and measurement gap configurations does not meet previous conditions.

The values of M_{out} and M_{in} used in Table 8.1.3.2-1 and Table 8.1.3.2-2 are defined as:

- $M_{\text{out}} = 20$ and $M_{\text{in}} = 10$, if the CSI-RS resource configured for RLM is transmitted with Density = 3.

Table 8.1.3.2-1: Evaluation period $T_{\text{Evaluate_out}}$ and $T_{\text{Evaluate_in}}$ for FR1

Configuration	$T_{\text{Evaluate_out}}$ (ms)	$T_{\text{Evaluate_in}}$ (ms)
no DRX	$\max(200, \text{ceil}(M_{\text{out}} \times P) \times T_{\text{CSI-RS}})$	$\max(100, \text{ceil}(M_{\text{in}} \times P) \times T_{\text{CSI-RS}})$
$\text{DRX} \leq 320\text{ms}$	$\max(200, \text{ceil}(1.5 \times M_{\text{out}} \times P) \times \max(T_{\text{DRX}}, T_{\text{CSI-RS}}))$	$\max(100, \text{ceil}(1.5 \times M_{\text{in}} \times P) \times \max(T_{\text{DRX}}, T_{\text{CSI-RS}}))$
$\text{DRX} > 320\text{ms}$	$\text{ceil}(M_{\text{out}} \times P) \times T_{\text{DRX}}$	$\text{ceil}(M_{\text{in}} \times P) \times T_{\text{DRX}}$

NOTE: $T_{\text{CSI-RS}}$ is the periodicity of CSI-RS resource configured for RLM. T_{DRX} is the DRX cycle length.

Table 8.1.3.2-2: Evaluation period $T_{\text{Evaluate_out}}$ and $T_{\text{Evaluate_in}}$ for FR2

Configuration	$T_{\text{Evaluate_out}}$ (ms)	$T_{\text{Evaluate_in}}$ (ms)
no DRX	$\max(200, \text{ceil}(M_{\text{out}} \times P \times N) \times T_{\text{CSI-RS}})$	$\max(100, \text{ceil}(M_{\text{in}} \times P \times N) \times T_{\text{CSI-RS}})$
$\text{DRX} \leq 320\text{ms}$	$\max(200, \text{ceil}(1.5 \times M_{\text{out}} \times P \times N) \times \max(T_{\text{DRX}}, T_{\text{CSI-RS}}))$	$\max(100, \text{ceil}(1.5 \times M_{\text{in}} \times P \times N) \times \max(T_{\text{DRX}}, T_{\text{CSI-RS}}))$
$\text{DRX} > 320\text{ms}$	$\text{ceil}(M_{\text{out}} \times P \times N) \times T_{\text{DRX}}$	$\text{ceil}(M_{\text{in}} \times P \times N) \times T_{\text{DRX}}$
NOTE:	$T_{\text{CSI-RS}}$ is the periodicity of CSI-RS resource configured for RLM. T_{DRX} is the DRX cycle length.	

8.1.4 Minimum requirement at transitions

When the UE transitions between DRX and no DRX or when DRX cycle periodicity changes, for each RLM-RS resource, for a duration of time equal to the evaluation period corresponding to the second mode after the transition occurs, the UE shall use an evaluation period that is no less than the minimum of evaluation period corresponding to the first mode and the second mode. Subsequent to this duration, the UE shall use an evaluation period corresponding to the second mode for each RLM-RS resource. This requirement shall be applied to both out-of-sync evaluation and in-sync evaluation of the monitored cell.

When the UE transitions from a first configuration of RLM-RS resources to a second configuration of RLM-RS resources that is different from the first configuration, for each RLM-RS resource present in the second configuration, for a duration of time equal to the evaluation period corresponding to the second configuration after the transition occurs, the UE shall use an evaluation period that is no less than the minimum of evaluation periods corresponding to the first configuration and the second configuration. Subsequent to this duration, the UE shall use an evaluation period corresponding to the second configuration for each RLM-RS resource present in the second configuration. This requirement shall be applied to both out-of-sync evaluation and in-sync evaluation of the monitored cell.

8.1.5 Minimum requirement for UE turning off the transmitter

The transmitter power of the UE in the monitored cell shall be turned off within 40ms after expiry of T310 timer as specified in TS 38.331 [2].

8.1.6 Minimum requirement for L1 indication

When the downlink radio link quality on all the configured RLM-RS resources is worse than Q_{out} , Layer 1 of the UE shall send an out-of-sync indication for the cell to the higher layers. A Layer 3 filter shall be applied to the out-of-sync indications as specified in TS 38.331 [2].

When the downlink radio link quality on at least one of the configured RLM-RS resources is better than Q_{in} , Layer 1 of the UE shall send an in-sync indication for the cell to the higher layers. A Layer 3 filter shall be applied to the in-sync indications as specified in TS 38.331 [2].

The out-of-sync and in-sync evaluations for the configured RLM-RS resources shall be performed as specified in clause 5 in TS 38.213 [3]. Two successive indications from Layer 1 shall be separated by at least $T_{\text{Indication_interval}}$.

When DRX is not used $T_{\text{Indication_interval}}$ is $\max(10\text{ms}, T_{\text{RLM-RS,M}})$, where $T_{\text{RLM-RS,M}}$ is the shortest periodicity of all configured RLM-RS resources for the monitored cell, which corresponds to T_{SSB} specified in section 8.1.2 if the RLM-RS resource is SSB, or $T_{\text{CSI-RS}}$ specified in section 8.1.3 if the RLM-RS resource is CSI-RS.

In case DRX is used, $T_{\text{Indication_interval}}$ is $\max(10\text{ms}, 1.5 \times \text{DRX_cycle_length}, 1.5 \times T_{\text{RLM-RS,M}})$ if DRX cycle_length is less than or equal to 320ms, and $T_{\text{Indication_interval}}$ is DRX_cycle_length if DRX cycle_length is greater than 320ms. Upon start of T310 timer as specified in TS 38.331 [2], the UE shall monitor the configured RLM-RS resources for recovery using the evaluation period and Layer 1 indication interval corresponding to the no DRX mode until the expiry or stop of T310 timer.

8.1.7 Scheduling availability of UE during radio link monitoring

When the reference signal to be measured for RLM has different subcarrier spacing than PDSCH/PDCCH and on frequency range FR2, there are restrictions on the scheduling availability as described in the following clauses.

8.1.7.1 Scheduling availability of UE performing radio link monitoring with a same subcarrier spacing as PDSCH/PDCCH on FR1

There are no scheduling restrictions due to radio link monitoring performed with a same subcarrier spacing as PDSCH/PDCCH on FR1.

8.1.7.2 Scheduling availability of UE performing radio link monitoring with a different subcarrier spacing than PDSCH/PDCCH on FR1

For UE which support *simultaneousRxDataSSB-DiffNumerology* [14] there are no restrictions on scheduling availability due to radio link monitoring based on SSB as RLM-RS. For UE which do not support *simultaneousRxDataSSB-DiffNumerology* [14] the following restrictions apply due to radio link monitoring based on SSB as RLM-RS.

- The UE is not expected to transmit PUCCH/PUSCH or receive PDCCH/PDSCH on SSB symbols to be measured for radio link monitoring.

When intra-band carrier aggregation is performed, the scheduling restrictions apply to all serving cells on the band due to radio link monitoring performed on FR1 serving PCell or PSCell in the same band. When inter-band carrier aggregation within FR1 is performed, there are no scheduling restrictions on FR1 serving cell(s) in the bands due to radio link monitoring performed on FR1 serving PCell or PSCell in different bands.

8.1.7.3 Scheduling availability of UE performing radio link monitoring on FR2

The following scheduling restriction applies due to radio link monitoring on an FR2 serving PCell and/or PSCell.

- If the RLM-RS is type-D QCLed with active TCI state for PDCCH/PDSCH, and $N=1$ applies for the RLM-RS as specified in section 8.1.2.2 if the RLM-RS is SSB and in section 8.1.3.2 if the RLM-RS is CSI-RS
- There are no scheduling restrictions due to radio link monitoring based on SSB or CSI-RS with a same subcarrier spacing as PDSCH/PDCCH.
- When performing radio link monitoring based on SSB with a different subcarrier spacing than PDSCH/PDCCH, for UE which support *simultaneousRxDataSSB-DiffNumerology* [14] there are no restrictions on scheduling availability due to radio link monitoring. For UE which do not support *simultaneousRxDataSSB-DiffNumerology* [14] the UE is not expected to transmit PUCCH/PUSCH or receive PDCCH/PDSCH on SSB symbols to be measured for radio link monitoring.
- Otherwise
 - The UE is not expected to transmit PUCCH/PUSCH or receive PDCCH/PDSCH on RLM-RS symbols to be measured for radio link monitoring.

When intra-band carrier aggregation is performed, the scheduling restrictions apply to all serving cells on the band due to radio link monitoring performed on FR2 serving PCell or PSCell in the same band.

Editor's Note: FFS scheduling restrictions for inter-band carrier aggregation will be defined depending on band combination in future.

8.1.7.4 Scheduling availability of UE performing radio link monitoring on FR1 or FR2 in case of FR1-FR2 inter-band CA and NR-DC

There are no scheduling restrictions on FR1 serving cell(s) due to radio link monitoring performed on FR2 serving PCell and/or PSCell.

There are no scheduling restrictions on FR2 serving cell(s) due to radio link monitoring performed on FR1 serving PCell and/or PSCell.

Editor's Note: NR-DC in Rel-15 only includes the scenarios where all serving cells in MCG in FR1 and all serving cells in SCG in FR2.

8.2 Interruption

8.2.1 NSA: Interruptions with EN-DC

8.2.1.1 Introduction

This section contains the requirements related to the interruptions on PSCell, and SCell, when

E-UTRA PCell transitions between active and non-active during DRX, or

E-UTRA PCell transitions from non-DRX to DRX, or

E-UTRA SCell in MCG or SCell in SCG is added or released, or

E-UTRA SCell in MCG or SCell in SCG is activated or deactivated, or

measurements on SCC with deactivated SCell in either E-UTRA MCG or NR SCG

This section also contains the requirements related to the interruptions on other active serving cells in the same frequency range wherein the UE is performing BWP switching.

The requirements shall apply for E-UTRA-NR DC with an E-UTRA PCell.

This section contains interruptions where victim cell is PSCell or SCell belonging to SCG. Requirements for interruptions requirements when the victim cell is E-UTRA PCell or E-UTRA SCell belonging to MCG are specified in [15].

For a UE which does not support per-FR measurement gaps, interruptions to the PSCell or active SCG SCells may be caused by EUTRA PCell, EUTRA SCells or SCells on any frequency range. For UE which support per-FR gaps, interruptions to the PSCell or active SCG SCells may be caused by EUTRA PCell, EUTRA SCells or SCells on the same frequency range as the victim cell.

8.2.1.2 Requirements

8.2.1.2.1 Interruptions at transitions between active and non-active during DRX

Interruption on PSCell and the activated SCell if configured due to E-UTRA PCell transitions between active and non-active during DRX when PSCell or SCell is in non-DRX are allowed with up to 1% probability of missed ACK/NACK when the configured E-UTRA PCell DRX cycle is less than 640 ms, and 0.625% probability of missed ACK/NACK is allowed when the configured E-UTRA PCell DRX cycle is 640 ms or longer. Each interruption shall not exceed X slot as defined in table 8.2.1.2.1-1.

Each interruption shall not exceed X slot as defined in table 8.2.1.2.1-1.

Table 8.2.1.2.1-1: Interruption length X at transition between active and non-active during DRX

μ	NR Slot length (ms)	Interruption length X	
		Sync	Async
0	1	1	2
1	0.5	1	2
2	0.25	3	
3	0.125	5	

When both E-UTRA PCell and PSCell are in DRX, no interruption is allowed.

8.2.1.2.2 Interruptions at transitions from non-DRX to DRX

Interruption on PSCell and the activated SCell if configured due to E-UTRA PCell transitions from non-DRX to DRX when PSCell or SCell is in non-DRX shall not exceed X slot as defined in table 8.2.1.2.1-1.

When PSCell and the activated SCell are in DRX, no interruption due to E-UTRA PCell transitions from non-DRX to DRX is allowed.

8.2.1.2.3 Interruptions at SCell addition/release

The requirements in this clause shall apply for the UE configured with PSCell.

When one E-UTRA SCell is added or released:

- an interruption on any activated serving cell in SCG:
 - of up to X1 slot, if the activated serving cell is not in the same band as any of the E-UTRA SCells being added or released, or
 - of up to $\max\{Y1 \text{ slot} + T_{\text{SMTC_duration}}, 5\text{ms}\}$ if the activated serving cells are in the same band as any of the E-UTRA SCells being added or released, provided the cell specific reference signals from the activated serving cells and the E-UTRA SCells being added or released are available in the same slot, where $T_{\text{SMTC_duration}}$ is the longest SMTC duration among all above activated serving cells in SCG;

Where X1 and Y1 are specified in in Table 8.2.1.2.3-1.

When one SCell is added or released:

- an interruption on any activated serving cell in SCG:
 - of up to X1 slot, if the activated serving cell is not in the same band as any of the SCells being added or released, or
 - of up to $Y1 \text{ slot} + T_{\text{SMTC_duration}}$ if the activated serving cells are in the same band as any of the SCells being added or released, provided the cell specific reference signals from the activated serving cells and the SCells being added or released are available in the same slot, where, $T_{\text{SMTC_duration}}$ is
 - the longest SMTC duration among all above activated serving cells in SCG and the SCell being added when one SCell is added;
 - the longest SMTC duration among all above activated serving cells in SCG when one SCell is released.

Where X1 and Y1 are specified in in Table 8.2.1.2.3-2.

Table 8.2.1.2.3-1: Interruption length X1 and Y1 at SCell addition/Release

μ	NR Slot length (ms)	Interruption length X1 slot		Interruption length Y1 slot ^{Note 1}	
		Sync	Async	Sync	Async
0	1	1	2	1	2
1	0.5	2	3	2	3
2	0.25	5		4	5
3	0.125	9		8	9

Table 8.2.1.2.3-2: Interruption length X1 and Y1 at SCell addition/Release

μ	NR Slot length (ms) of victim cell	Interruption length X1 slot		Interruption length Y1 slot ^{Note}
		Aggressor cell is on FR2	Aggressor cell is on FR1	
0	1	1		1
1	0.5	2		2
2	0.25	Aggressor cell is on FR2	4	4
		Aggressor cell is on FR1	5	
3	0.125	Aggressor cell is on FR2	8	8
		Aggressor cell is on FR1	9	

8.2.1.2.4 Interruptions at SCell activation/deactivation

The requirements in this clause shall apply for the UE configured with PSCell and one SCell.

When one E-UTRA SCell is activated or deactivated:

- an interruption on any activated serving cell in SCG:
 - of up to X2 slot, if the activated serving cell is not in the same band as any of the E-UTRA SCells being activated or deactivated, or
 - of up to $\max\{Y2 \text{ slot} + T_{\text{SMTC_duration}}, 5\text{ms}\}$ if the activated serving cells are in the same band as any of the E-UTRA SCells being activated or deactivated, provided the cell specific reference signals from the activated serving cells and the E-UTRA SCells being activated or deactivated are available in the same slot, where $T_{\text{SMTC_duration}}$ is the longest SMTC duration among all above activated serving cells in SCG.

Where X2 and Y2 are specified in in Table 8.2.1.2.4-1.

When one SCell is activated or deactivated:

- an interruption on any serving cell in SCG:
 - of up to X2 slot, if the activated serving cell is not in the same band as any of the SCells being activated or deactivated, or
 - of up to $Y2 \text{ slot} + T_{\text{SMTC_duration}}$ if the activated serving cells are in the same band as any of the SCells being activated or deactivated, provided the cell specific reference signals from the activated serving cells and the SCells being activated or deactivated are available in the same slot, where, $T_{\text{SMTC_duration}}$ is
 - the longest SMTC duration among all above activated serving cells in SCG and the SCell being activated when one SCell is activated;
 - the longest SMTC duration among all above activated serving cells in SCG when one SCell is deactivated.

Where X2 and Y2 are specified in in Table 8.2.1.2.4-2.

Table 8.2.1.2.4-1: Interruption length X2 and Y2 at SCell activation/deactivation

μ	NR Slot length (ms)	Interruption length X2 slot		Interruption length Y2 slot ^{Note 1}	
		Sync	Async	Sync	Async
0	1	1	2	1	2
1	0.5	1	2	1	2
2	0.25	3		2	3
3	0.125	5		4	5

Table 8.2.1.2.4-2: Interruption length X2 and Y2 at SCell activation/deactivation

μ	NR Slot length (ms) of victim cell	Interruption length X2 slot		Interruption length Y2 slot ^{Note}
0	1	1		1
1	0.5	1		1
2	0.25	Aggressor cell is on FR2	2	2
		Aggressor cell is on FR1	3	
3	0.125	Aggressor cell is on FR2	4	4
		Aggressor cell is on FR1	5	

8.2.1.2.5 Interruptions during measurements on SCC

8.2.1.2.5.1 Interruptions during measurements on deactivated NR SCC

Interruption on PSCell and other active NR SCell(s) during measurement on the deactivated NR SCC shall meet requirements in clause 8.2.2.2.3, where the term PCell in clause 8.2.2.2.3 shall be deemed to be replaced with PSCell.

8.2.1.2.5.2 Interruptions during measurements on deactivated E-UTRAN SCC

When one E-UTRA SCell in MCG is deactivated, the UE is allowed due to measurements on the E-UTRA SCC with the deactivated E-UTRA SCell:

- an interruption on PSCell or any activated SCell with up to 0.5% probability of missed ACK/NACK when any of the configured *measCycleSCell* [2] for the deactivated E-UTRA SCells is 640 ms or longer.
- an interruption on PSCell or any activated SCell with up to 0.5% probability of missed ACK/NACK regardless of the configured *measCycleSCell* [2] for the deactivated E-UTRA SCells if indicated by the network using IE *allowInterruptions* [2].

Each interruption shall not exceed

- X3 slot, if the PSCell or activated SCell is not in the same band as the E-UTRA deactivated SCC being measured, or
- Y3 slot + SMTC duration, if the PSCell or activated SCell is in the same band as the E-UTRA deactivated SCC being measured, provided the cell specific reference signals from the PSCell or activated SCell and the E-UTRA deactivated SCC being measured are available in the same slot.

Table 8.2.1.2.5.2-1: Interruption length X3 and Y3 at measurements on deactivated E-UTRA SCC

μ	NR Slot length (ms)	Interruption length X3 slot		Interruption length Y3 slot ^{Note 1}	
		Sync	Async	Sync	Async
0	1	1	2	1	2
1	0.5	1	2	1	2
2	0.25	3		2	3
3	0.125	5		4	5

8.2.1.2.6 Interruptions at UL carrier RRC reconfiguration

The requirements in this clause shall apply when a supplementary UL carrier or an UL carrier is configured or de-configured in NR non-standalone operation as defined in [2].

When an UL carrier or supplementary UL carrier is configured or deconfigured, an interruption on E-UTRA PCell, all activated E-UTRA SCells, PSCell and all activated SCells within the same FR as the reconfigured uplink carrier of up to X4 slot, is allowed during the RRC reconfiguration procedure [2]. The interruption is for both uplink and downlink of E-UTRA PCell, all activated E-UTRA SCells, PSCell and all activated SCells within the same FR as the configured or de-configured UL.

Table 8.2.1.2.6-1: Interruption length X4 at UL carrier RRC reconfiguration

μ	NR Slot length (ms)	Interruption length X4 slot	
		Sync	Async
0	1	1	2
1	0.5	2	3
2	0.25	5	
3	0.125	9	

8.2.1.2.7 Interruption due to Active BWP switching Requirement

When UE receives a DCI indicating UE to switch its active BWP involving changes in any of the parameters listed in Table 8.2.1.2.7-2, the UE is allowed to cause interruption of up to X slot to other active serving cells if the UE is not capable of per-FR gap, or if the BWP switching involves SCS changing. When the BWP switch imposes changes in any of the parameters listed in Table 8.2.1.2.7-2 and the UE is capable of per-FR gap, the UE is allowed to cause interruption of up to X slot to other active serving cells in the same frequency range wherein the UE is performing BWP switching. X is defined in Table 8.2.1.2.7-1. The starting time of interruption is only allowed within the BWP switching delay $T_{\text{BWPswitchDelay}}$ as defined in clause 8.6.2. Interruptions are not allowed during BWP switch involving other parameter change.

When a BWP timer *bwp-InactivityTimer* defined in [2] expires, UE is allowed to cause interruption of up to X slot to other active serving cells due to switching its active BWP involving changes in any of the parameters listed in Table 8.2.1.2.7-2 if the UE is not capable of per-FR gap, or if the BWP switching involves SCS changing. When the BWP switch imposes changes in any of the parameters listed in Table 8.2.1.2.7-2 and the UE is capable of per-FR gap the UE is allowed to cause interruption of up to X slot to other active serving cells in the same frequency range wherein the UE is performing BWP switching. X is defined in Table 8.2.1.2.7-1. The starting time of interruption is only allowed within the BWP switching delay $T_{\text{BWPswitchDelay}}$ as defined in clause 8.6.2. Interruptions are not allowed during BWP switch involving other parameter change.

Editor's note: FFS if RAN4 will specify interruption requirements for RRC-based BWP switch.

Table 8.2.1.2.7-1: interruption length X

μ	NR Slot length (ms)	Interruption length X (slots ^{note 1})
0	1	1
1	0.5	1
2	0.25	3
3	0.125	5
Note1: If the BWP switch involves changing of SCS, the interruption due to BWP switch is determined by the larger one between the SCS before BWP switch and the SCS after the BWP switch.		

Table 8.2.1.2.7-2: Parameters which cause interruption other than SCS

Parameters	Comment
<i>locationAndBandwidth</i>	From TS 38.331 [2]
<i>nrofSRS-Ports</i>	
<i>Editor's note: More parameters can be added if identified</i>	

8.2.2 SA: Interruptions with Standalone NR Carrier Aggregation

8.2.2.1 Introduction

This section contains the requirements related to the interruptions on PCell and activated SCell if configured, when up to 7 SCells are configured, deconfigured, activated or deactivated.

Note: interruptions at SCell addition/release, activation/deactivation and during measurements on SCC may not be required by all UEs.

Editor's Note: The interruptions shall not interrupt RRC signalling or ACK/NACKs related to RRC reconfiguration procedure [2] for SCell addition/release or MAC control signalling [17] for SCell activation/deactivation command. How to specify this is FFS.

This section also contains the requirements related to the interruptions on other active serving cells in the same frequency range wherein the UE is performing BWP switching.

For a UE which does not support per-FR measurement gaps, interruptions to the PCell and activated SCell may be caused by SCells on any frequency range. For UE which support per-FR gaps, interruptions to PCell and activated SCell may be caused by SCells on the same frequency range as the victim cell.

8.2.2.2 Requirements

8.2.2.2.1 Interruptions at SCell addition/release

When any number of SCells between one and 7 is added or released using the same *RRConnectionReconfiguration* message as defined in [2], the UE is allowed an interruption on any activated serving cell during the RRC reconfiguration procedure as follows:

- an interruption on any activated serving cell:
 - of up to the duration shown in table 8.2.2.2.1-1, if the activated serving cell is not in the same band as any of the SCells being added or released, or
 - of up to the duration shown in table 8.2.2.2.1-2, if the activated serving cells are in the same band as any of the SCells being added or released, provided the cell specific reference signals from the activated serving cells and the SCells being added or released are available in the same slot.

Table 8.2.2.2.1-1: Interruption duration for SCell addition/release for inter-band CA

μ	NR Slot length (ms) of victim cell	Interruption length (slot)	
0	1	1	
1	0.5	2	
2	0.25	Aggressor cell is on FR2	4
		Aggressor cell is on FR1	5
3	0.125	Aggressor cell is on FR2	8
		Aggressor cell is on FR1	9
Note: $T_{\text{SMTC_duration}}$ is <ul style="list-style-type: none"> - the longest SMTC duration among all above activated serving cells and the SCell being added when one SCell is added; - the longest SMTC duration among all activated serving cells in the same band when one SCell is released. 			

Table 8.2.2.2.1-2: Interruption duration for SCell addition/release for intra-band CA

μ	NR Slot length (ms)	Interruption length (slot)
0	1	$1 + T_{\text{SMTC_duration}}$
1	0.5	$2 + T_{\text{SMTC_duration}}$
2	0.25	$4 + T_{\text{SMTC_duration}}$
3	0.125	$8 + T_{\text{SMTC_duration}}$
Note: $T_{\text{SMTC_duration}}$ is <ul style="list-style-type: none"> - the longest SMTC duration among all above activated serving cells and the SCell being added when one SCell is added; - the longest SMTC duration among all activated serving cells in the same band when one SCell is released. 		

8.2.2.2.2 Interruptions at SCell activation/deactivation

When an intra-band SCell is activated or deactivated as defined in [17], the UE is allowed

- an interruption on any activated serving cell:

- of up to the duration shown in table 8.2.2.2.2-1, if the activated serving cell is not in the same band as any of the SCells being activated or deactivated, or
- of up to the duration shown in table 8.2.2.2.2-2, if the activated serving cells are in the same band as any of the SCells being activated or deactivated provided the cell specific reference signals from the activated serving cells and the SCells being activated or deactivated are available in the same slot.

Table 8.2.2.2.2-1: Interruption duration for SCell activation/deactivation for inter-band CA

μ	NR Slot length (ms) of victim cell	Interruption length (slot)	
0	1		1
1	0.5		1
2	0.25	Aggressor cell is on FR2	2
		Aggressor cell is on FR1	3
3	0.125	Aggressor cell is on FR2	4
		Aggressor cell is on FR1	5
Note: $T_{\text{SMTC_duration}}$ is - the longest SMTC duration among all above activated serving cells and the SCell being added when one SCell is added; - the longest SMTC duration among all activated serving cells in the same band when one SCell is released.			

Table 8.2.2.2.2-2: Interruption duration for SCell activation/deactivation for intra-band CA

μ	NR Slot length (ms)	Interruption length
0	1	$1 + T_{\text{SMTC_duration}}$
1	0.5	$1 + T_{\text{SMTC_duration}}$
2	0.25	$2 + T_{\text{SMTC_duration}}$
3	0.125	$4 + T_{\text{SMTC_duration}}$
Note: $T_{\text{SMTC_duration}}$ is - the longest SMTC duration among all above activated serving cells and the SCell being activated when one SCell is activated; - the longest SMTC duration among all activated serving cells in the same band when one SCell is deactivated.		

8.2.2.2.3 Interruptions during measurements on SCC for intra-band CA

Interruptions on PCell due to measurements when an SCell is deactivated are allowed with up to 0.5% probability of missed ACK/NACK when the configured *measCycleSCell* [2] is 640 ms or longer. The UE is only allowed to cause interruptions immediately before and immediately after an SMTC. Each interruption shall not exceed requirement in Table 8.2.2.2.2-1 if the PCell is not in the same band as the deactivated SCell. Each interruption shall not exceed requirement in Table 8.2.2.2.2-2 if the PCell is in the same band as the deactivated SCell.

Interruptions on active SCells due to measurements when an SCell is deactivated are allowed with up to 0.5% probability of missed ACK/NACK when the configured *measCycleSCell* [2] is 640 ms or longer. The UE is only allowed to cause interruptions immediately before and immediately after an SMTC. Each interruption shall not exceed requirement in Table 8.2.2.2.2-1 if the active SCell is not in the same band as the deactivated SCell. Each interruption shall not exceed requirement in Table 8.2.2.2.2-2 if the active SCell is in the same band as the deactivated SCell.

8.2.2.2.4 Interruptions at UL carrier RRC reconfiguration

The requirements in this clause shall apply when a supplementary UL carrier or an UL carrier is configured or de-configured in NR standalone carrier aggregation as defined in [2].

When an UL carrier or supplementary UL carrier is configured or deconfigured, an interruption on PCell and all activated SCells within the same FR as the reconfigured uplink carrier of up to the duration shown in table 8.2.2.2.4-1,

is allowed during the RRC reconfiguration procedure [2]. The interruption is for both uplink and downlink of PCell and all the activated SCells within the same FR as the configured or de-configured UL.

Table 8.2.2.2.4-1: Interruption duration for UL carrier RRC reconfiguration μ	NR Slot length (ms)	Interruption length
0	1	1
1	0.5	2
2	0.25	4
3	0.125	8

8.2.2.2.5 Interruption due to Active BWP switching Requirement

When UE receives a DCI indicating UE to switch its active BWP involving changes in any of the parameters listed in Table 8.2.2.2.5-2, the UE is allowed to cause interruption of up to X slot to other active serving cells if the UE is not capable of per-FR gap, or if the BWP switching involves SCS changing. When the BWP switch imposes changes in any of the parameters listed in Table 8.2.2.2.5-2 and the UE is capable of per-FR gap the UE is allowed to cause interruption of up to X slot to other active serving cells in the same frequency range wherein the UE is performing BWP switching. X is defined in Table 8.2.2.2.5-1. The starting time of interruption is only allowed within the BWP switching delay $T_{\text{BWPswitchDelay}}$ as defined in clause 8.6.2. Interruptions are not allowed during BWP switch involving other parameter change.

When a BWP timer *bwp-InactivityTimer* defined in [2] expires, UE is allowed to cause interruption of up to X slot to other active serving cells due to switching its active BWP involving changes in any of the parameters listed in Table 8.2.2.2.5-2 if the UE is not capable of per-FR gap, or if the BWP switching involves SCS changing. When the BWP switch imposes changes in any of the parameters listed in Table 8.2.2.2.5-2 and the UE is capable of per-FR gap the UE is allowed to cause interruption of up to X slot to other active serving cells in the same frequency range wherein the UE is performing BWP switching. X is defined in Table 8.2.2.2.5-1. The starting time of interruption is only allowed within the BWP switching delay $T_{\text{BWPswitchDelay}}$ as defined in clause 8.6.2. Interruptions are not allowed during BWP switch involving other parameter change.

Editor's note: FFS if RAN4 will specify interruption requirements for RRC-based BWP switch.

Table 8.2.2.2.5-1: Interruption length X

μ	NR Slot length (ms)	Interruption length X (slots ^{note 1})
0	1	1
1	0.5	1
2	0.25	3
3	0.125	5
Note1:	If the BWP switch involves changing of SCS, the interruption due to BWP switch is determined by the larger one between the SCS before BWP switch and the SCS after the BWP switch.	

Table 8.2.2.2.5-2: Parameters which cause interruption other than SCS

Parameters	Comment
<i>locationAndBandwidth</i>	From TS 38.331 [2]
<i>nrofSRS-Ports</i>	
<i>Editor's note: More parameters can be added if identified</i>	

8.2.3 NE-DC Interruptions

8.2.3.1 Introduction

This section contains the requirements related to the interruptions on PCell and SCell, when

E-UTRA PSCell transitions between active and non-active during DRX, or

E-UTRA PSCell transitions from non-DRX to DRX, or

E-UTRA PSCell/SCell in SCG or SCell in MCG is added or released, or

E-UTRA PSCell/SCell in SCG or SCell in MCG is activated or deactivated, or

measurements on SCC with deactivated SCell in either E-UTRA SCG or NR MCG or

PUSCH/PUCCH carrier configuration and deconfiguration in NR MCG.

This section also contains the requirements related to the interruptions on other active serving cells in the same frequency range wherein the UE is performing BWP switching.

The requirements shall apply for NE-DC with an NR PCell.

This section contains interruptions where victim cell is PCell or SCell belonging to MCG, or E-UTRA PSCell or E-UTRA SCell belonging to SCG. Requirements for interruptions requirements when the victim cell is E-UTRA PSCell or E-UTRA SCell belonging to SCG are specified in [15].

For a UE which does not support per-FR measurement gaps, interruptions to the PCell, E-UTRA PSCell or active MCG SCells may be caused by EUTRA PSCell, EUTRA SCells or SCells on any frequency range. For UE which support per-FR gaps, interruptions to the PCell, E-UTRA PSCell or active MCG SCells may be caused by EUTRA PSCell, EUTRA SCells or SCells on the same frequency range as the victim cell.

8.2.3.2 Requirements

8.2.3.2.1 Interruptions at transitions between active and non-active during DRX

Interruption on PCell and the activated SCell if configured due to E-UTRA PSCell transitions between active and non-active during DRX when PCell or SCell is in non-DRX are allowed with up to 1% probability of missed ACK/NACK when the configured E-UTRA PSCell DRX cycle is less than 640 ms, and 0.625% probability of missed ACK/NACK is allowed when the configured E-UTRA PCell DRX cycle is 640 ms or longer. Each interruption shall not exceed X slot as defined in table 8.2.3.2.1-1.

Each interruption shall not exceed X slot as defined in table 8.2.3.2.1-1.

Table 8.2.3.2.1-1: Interruption length X at transition between active and non-active during DRX

μ	NR Slot length (ms)	Interruption length X	
		Sync	Async
0	1	1	2
1	0.5	1	2
2	0.25	3	
3	0.125	5	

When both PCell and E-UTRA PSCell are in DRX, no interruption is allowed.

8.2.3.2.2 Interruptions at transitions from non-DRX to DRX

Interruption on PCell and the activated SCell if configured due to E-UTRA PSCell transitions from non-DRX to DRX when PCell or SCell is in non-DRX shall not exceed X slot as defined in table 8.2.3.2.1-1.

8.2.3.2.3 Interruptions at PSCell/SCell addition/release

The requirements in this clause shall apply for the UE configured with E-UTRA PSCell.

When one E-UTRA PSCell/SCell is added or released:

- an interruption on any activated serving cell in MCG:
 - of up to X1 slot, if the activated serving cell is not in the same band as any of the E-UTRA PSCell/SCells being added or released, or
 - of up to $\max\{Y1 \text{ slot} + T_{\text{SMTC_duration}}, 5\text{ms}\}$ if the activated serving cells are in the same band as any of the E-UTRA PSCell/SCells being added or released, provided the cell specific reference signals from the activated serving cells and the E-UTRA PSCell/SCells being added or released are available in the same slot, where $T_{\text{SMTC_duration}}$ is the longest SMTC duration among all above activated serving cells in MCG;

Where X1 and Y1 are specified in in Table 8.2.3.2.3-1.

When one SCell is added or released:

- an interruption on any activated serving cell in MCG:
 - of up to X1 slot, if the activated serving cell is not in the same band as any of the SCells being added or released, or
 - of up to $Y1 \text{ slot} + T_{\text{SMTC_duration}}$ if the activated serving cells are in the same band as any of the SCells being added or released, provided the cell specific reference signals from the activated serving cells and the SCells being added or released are available in the same slot, where, $T_{\text{SMTC_duration}}$ is
 - the longest SMTC duration among all above activated serving cells in MCG and the SCell being added when one SCell is added;
 - the longest SMTC duration among all above activated serving cells in MCG when one SCell is released.

Where X1 and Y1 are specified in in Table 8.2.3.2.3-2.

Table 8.2.3.2.3-1: Interruption length X1 and Y1 at SCell/E-UTRA PSCell addition/release

μ	NR Slot length (ms)	Interruption length X1 slot		Interruption length Y1 slot ^{Note 1}
		Sync	Async	
0	1	1	2	1
1	0.5	2	3	2
2	0.25	5		4
3	0.125	9		8

Table 8.2.3.2.3-2: Interruption length X1 and Y1 at SCell addition/Release

μ	NR Slot length (ms)	Interruption length X1 slot	Interruption length Y1 slot ^{Note}
0	1	1	1
1	0.5	2	2
2	0.25	4	4
3	0.125	8	8

8.2.3.2.4 Interruptions at SCell activation/deactivation

The requirements in this clause shall apply for the UE configured with E-UTRA PSCell and one SCell.

When one E-UTRA SCell is activated or deactivated:

- an interruption on any activated serving cell in MCG:
 - of up to X2 slot, if the activated serving cell is not in the same band as any of the E-UTRA SCells being activated or deactivated, or

- of up to $\max\{Y2 \text{ slot} + T_{\text{SMTC_duration}}, 5\text{ms}\}$ if the activated serving cells are in the same band as any of the E-UTRA SCells being activated or deactivated, provided the cell specific reference signals from the activated serving cells and the E-UTRA SCells being activated or deactivated are available in the same slot, where $T_{\text{SMTC_duration}}$ is the longest SMTC duration among all above activated serving cells in MCG.

Where X2 and Y2 are specified in in Table 8.2.3.2.4-1.

When one SCell is activated or deactivated:

- an interruption on any serving cell in MCG:
 - of up to X2 slot, if the activated serving cell is not in the same band as any of the SCells being activated or deactivated, or
 - of up to $Y2 \text{ slot} + T_{\text{SMTC_duration}}$ if the activated serving cells are in the same band as any of the SCells being activated or deactivated, provided the cell specific reference signals from the activated serving cells and the SCells being activated or deactivated are available in the same slot, where, $T_{\text{SMTC_duration}}$ is
 - the longest SMTC duration among all above activated serving cells in MCG and the SCell being activated when one SCell is activated;
 - the longest SMTC duration among all above activated serving cells in MCG when one SCell is deactivated.

Where X2 and Y2 are specified in in Table 8.2.3.2.4-2.

Table 8.2.3.2.4-1: Interruption length X2 and Y2 at SCell activation/deactivation

μ	NR Slot length (ms)	Interruption length X2 slot		Interruption length Y2 slot
		Sync	Async	
0	1	1	2	1
1	0.5	1	2	1
2	0.25	3		2
3	0.125	5		4

Table 8.2.3.2.4-2: Interruption length X2 and Y2 at SCell activation/deactivation

μ	NR Slot length (ms)	Interruption length X2 slot	Interruption length Y2 slot
0	1	1	1
1	0.5	1	1
2	0.25	2	2
3	0.125	4	4

8.2.3.2.5 Interruptions during measurements on SCC

8.2.3.2.5.1 Interruptions during measurements on deactivated NR SCC

Interruption on PCell and other active SCell(s) during measurement on the deactivated NR SCC shall meet requirements in clause 8.2.2.2.3.

8.2.3.2.5.2 Interruptions during measurements on deactivated E-UTRAN SCC

When one E-UTRA SCell in SCG is deactivated, the UE is allowed due to measurements on the E-UTRA SCC with the deactivated E-UTRA SCell:

- an interruption on PCell or any activated SCell with up to 0.5% probability of missed ACK/NACK when any of the configured *measCycleSCell* [2] for the deactivated E-UTRA SCells is 640 ms or longer.
- an interruption on PCell or any activated SCell with up to 0.5% probability of missed ACK/NACK regardless of the configured *measCycleSCell* [2] for the deactivated E-UTRA SCells if indicated by the network using IE *allowInterruptions* [2].

Each interruption shall not exceed

- X3 slot, if the PCell or activated SCell is not in the same band as the E-UTRA deactivated SCC being measured, or
- Y3 slot + SMTC duration, if the PCell or activated SCell is in the same band as the E-UTRA deactivated SCC being measured, provided the cell specific reference signals from the PCell or activated SCell and the E-UTRA deactivated SCC being measured are available in the same slot.

Where X3 and Y3 are specified in in Table 8.2.3.2.5-1

Table 8.2.3.2.5-1: Interruption length X3 and Y3 at measurements on deactivated E-UTRA SCC

μ	NR Slot length (ms)	Interruption length X3 slot	Interruption length Y3 slot
0	1	1	1
1	0.5	1	1
2	0.25	2	2
3	0.125	4	4

8.2.3.2.6 Interruptions at UL carrier RRC reconfiguration

The requirements in this clause shall apply when a supplementary UL carrier or an UL carrier is configured or de-configured in NE-DC.

When an UL carrier or supplementary UL carrier is configured or deconfigured, an interruption on PCell, all activated SCells within the same FR as the reconfigured uplink carrier of up to X4 slot as specified in Table 8.2.3.2.6-1, is allowed during the RRC reconfiguration procedure [2]. The interruption is for both uplink and downlink of PCell, all activated within the same FR as the configured or de-configured UL.

Table 8.2.3.2.6-1: Interruption length X4 at UL carrier RRC reconfiguration

μ	NR Slot length (ms)	Interruption length X4 slot	
		Sync	Async
0	1	1	2
1	0.5	2	3
2	0.25	5	
3	0.125	9	

8.2.3.2.7 Interruption due to Active BWP switching Requirement

When UE receives a DCI indicating the UE to switch its active BWP, or when a BWP timer *bwp-InactivityTimer* defined in [2] expires, or when the UE receives an RRC command indicating the UE to switch its active BWP, the UE is allowed an interruption on PCell and any activated SCells as defined in section 8.2.2.2.5.

8.2.4 NR-NR DC: Interruptions

8.2.4.1 Introduction

This section contains the requirements related to the interruptions on PCell, PSCell and activated SCell if configured, when up to TBD SCells are configured, deconfigured, activated or deactivated.

Note: interruptions at SCell addition/release, activation/deactivation and during measurements on SCC may not be required by all UEs.

Editor's Note: The interruptions shall not interrupt RRC signalling or ACK/NACKs related to RRC reconfiguration procedure [2] for SCell addition/release or MAC control signalling [17] for SCell activation/deactivation command. How to specify this is FFS.

The requirements shall apply for NR-NR DC with a NR PCell, PSCell or SCell.

This section also contains the requirements related to the interruptions on other active serving cells in the same frequency range wherein the UE is performing BWP switching.

For a UE which does not support per-FR measurement gaps, interruptions to the PCell and activated SCell may be caused by SCells on any frequency range. For UE which support per-FR gaps, interruptions to PCell, PSCell and activated SCell may be caused by SCells on the same frequency range as the victim cell.

8.2.4.2 Requirements

8.2.4.2.1 Interruptions at PSCell/SCell addition/release

When PSCell or any number of SCells between one and TBD is added or released using the same *RRCConnectionReconfiguration* message as defined in [2], the UE is allowed an interruption on any activated serving cell during the RRC reconfiguration procedure as follows:

- an interruption on any activated serving cell:
 - of up to the duration shown in table 8.2.4.2.1-1, if the activated serving cell is not in the same band as any of the SCells being added or released, or
 - of up to the duration shown in table 8.2.4.2.1-2, if the activated serving cells are in the same band as any of the SCells being added or released, provided the cell specific reference signals from the activated serving cells and the SCells being added or released are available in the same slot.

Table 8.2.4.2.1-1: Interruption duration for PSCell/SCell addition/release

μ	NR Slot length (ms)	Interruption length (slot)
0	1	1
1	0.5	2
2	0.25	4
3	0.125	8

Table 8.2.4.2.1-2: Interruption duration for SCell addition/release

μ	NR Slot length (ms)	Interruption length (slot)
0	1	$1 + T_{SMTC_duration}$
1	0.5	$2 + T_{SMTC_duration}$
2	0.25	$4 + T_{SMTC_duration}$
3	0.125	$8 + T_{SMTC_duration}$
Note: $T_{SMTC_duration}$ is <ul style="list-style-type: none"> - the longest SMTC duration among all above activated serving cells and the SCell being added when one SCell is added; - the longest SMTC duration among all activated serving cells in the same band when one SCell is released. 		

8.2.4.2.2 Interruptions at SCell activation/deactivation

When a SCell is activated or deactivated as defined in [17], the UE is allowed

- an interruption on any activated serving cell:
 - of up to the duration shown in table 8.2.4.2.2-1, if the activated serving cell is not in the same band as any of the SCells being activated or deactivated, or

- of up to the duration shown in table 8.2.4.2.2-2, if the activated serving cells are in the same band as any of the SCells being activated or deactivated provided the cell specific reference signals from the activated serving cells and the SCells being activated or deactivated are available in the same slot.

Table 8.2.4.2.2-1: Interruption duration for SCell activation/deactivation for inter-band CA

μ	NR Slot length (ms)	Interruption length
0	1	1
1	0.5	1
2	0.25	2
3	0.125	4

Table 8.2.4.2.2-2: Interruption duration for SCell activation/deactivation for intra-band CA

μ	NR Slot length (ms)	Interruption length
0	1	$1 + T_{\text{SMTC_duration}}$
1	0.5	$1 + T_{\text{SMTC_duration}}$
2	0.25	$2 + T_{\text{SMTC_duration}}$
3	0.125	$4 + T_{\text{SMTC_duration}}$
Note: $T_{\text{SMTC_duration}}$ is - the longest SMTC duration among all above activated serving cells and the SCell being activated when one SCell is activated; - the longest SMTC duration among all activated serving cells in the same band when one SCell is deactivated.		

8.2.4.2.3 Interruptions during measurements on SCC

Interruptions on PCell due to measurements when an SCell is deactivated are allowed with up to 0.5% probability of missed ACK/NACK when the configured *measCycleSCell* [2] is 640 ms or longer. The UE is only allowed to cause interruptions immediately before and immediately after an SMTC. Each interruption shall not exceed requirement in Table 8.2.2.2.2-1 if the PCell is not in the same band as the deactivated SCell. Each interruption shall not exceed requirement in Table 8.2.2.2.2-2 if the PCell is in the same band as the deactivated SCell.

Interruptions on active SCell due to measurements when an SCell is deactivated are allowed with up to 0.5% probability of missed ACK/NACK when the configured *measCycleSCell* [2] is 640 ms or longer. The UE is only allowed to cause interruptions immediately before and immediately after an SMTC. Each interruption shall not exceed requirement in Table 8.2.2.2.2-1 if the active SCell is not in the same band as the deactivated SCell. Each interruption shall not exceed requirement in Table 8.2.2.2.2-2 if the active SCell is in the same band as the deactivated SCell.

8.2.4.2.4 Interruptions at UL carrier RRC reconfiguration

The requirements in this clause shall apply when a supplementary UL carrier or an UL carrier is configured or de-configured in NR-DC as defined in [2].

When an UL carrier or supplementary UL carrier is configured or deconfigured, an interruption on all the other activated serving cells within the same FR as the reconfigured uplink carrier of up to the duration shown in table 8.2.4.2.4-1, is allowed during the RRC reconfiguration procedure [2]. The interruption is for both uplink and downlink of all the other serving cells within the same FR as the configured or de-configured UL.

Table 8.2.4.2.4-1: Interruption duration for UL carrier RRC reconfiguration

μ	NR Slot length (ms)	Interruption length
0	1	1
1	0.5	2
2	0.25	4
3	0.125	8

8.2.4.2.5 Interruption due to Active BWP switching Requirement

When UE receives a DCI indicating the UE to switch its active BWP, or when a BWP timer `bwp-InactivityTimer` defined in [2] expires, or when the UE receives an RRC command indicating the UE to switch its active BWP, the UE is allowed to cause an interruption on any other serving cells as defined in section 8.2.2.2.5.

8.3 SCell Activation and Deactivation Delay

8.3.1 Introduction

This section defines requirements for the delay within which the UE shall be able to activate a deactivated SCell and deactivate an activated SCell in EN-DC, or in standalone NR carrier aggregation, or in NE-DC, or in NR-DC.

The requirements shall apply for EN-DC, standalone NR carrier aggregation, NE-DC, and NR-DC.

8.3.2 SCell Activation Delay Requirement for Deactivated SCell

The requirements in this section shall apply for the UE configured with one downlink SCell in EN-DC, or in standalone NR carrier aggregation or in NE-DC or in NR-DC and when one SCell is being activated.

The delay within which the UE shall be able to activate the deactivated SCell depends upon the specified conditions.

Upon receiving SCell activation command in slot n , the UE shall be capable to transmit valid CSI report and apply actions related to the activation command for the SCell being activated no later than in slot $n + [T_{\text{HARQ}} + T_{\text{activation_time}} + T_{\text{CSI_Reporting}}]$, where:

T_{HARQ} is the timing between DL data transmission and acknowledgement as specified in [7].

$T_{\text{activation_time}}$ is the SCell activation delay. If the SCell is known and belongs to FR1, $T_{\text{activation_time}}$ is:

- $[T_{\text{SMTC_SCell}} + 5\text{ms}]$, if the SCell measurement cycle is equal to or smaller than [160ms].
- $[T_{\text{SMTC_MAX}} + T_{\text{SMTC_SCell}} + 5\text{ms}]$, if the SCell measurement cycle is larger than [160ms].

If the SCell is unknown and belongs to FR1, $T_{\text{activation_time}}$ is:

- $[2 * T_{\text{SMTC_MAX}} + 2 * T_{\text{SMTC_SCell}} + 5\text{ms}]$ provided the SCell can be successfully detected on the first attempt.

If the SCell being activated belongs to FR2, $T_{\text{activation_time}}$ is:

- $[T_{\text{SMTC_SCell}} + 5\text{ms}]$ if there is at least one active serving cell on that FR2 band, provided that the SSBs in the serving cell(s) and the SSBs in the SCell fulfil the condition defined in section 3.6.3.
- $[T_{\text{BD}} * T_{\text{SMTC_SCell}} + 5\text{ms}]$ if there is no active serving cell on that FR2 band provided that PCell or PSCell is FR1.

Where,

$T_{\text{SMTC_MAX}}$:

- In FR1, in case of intra-band SCell activation, $T_{\text{SMTC_MAX}}$ is the longer SMTC periodicity between active serving cells and SCell being activated provided the cell specific reference signals from the active serving cells and the SCells being activated or released are available in the same slot; in case of inter-band SCell activation, $T_{\text{SMTC_MAX}}$ is the SMTC periodicity of SCell being activated.
- In FR2, $T_{\text{SMTC_MAX}}$ is the longer SMTC periodicity between active serving cells and SCell being activated provided that in Rel-15 only support FR2 intra-band CA.
- $T_{\text{SMTC_MAX}}$ is bounded to a minimum value of 10ms.

$T_{\text{SMTC_SCell}}$: SMTC periodicity of SCell being activated and the minimum value is 10ms.

$T_{\text{CSI_reporting}}$ is the delay including uncertainty in acquiring the first available downlink CSI reference resource, UE processing time for CSI reporting and uncertainty in acquiring the first available CSI reporting resources as specified in [2].

SCell in FR1 is known if it has been meeting the following conditions:

- During the period equal to $\max([5] \text{ measCycleSCell}, [5] \text{ DRX cycles})$ for FR1 before the reception of the SCell activation command:
 - the UE has sent a valid measurement report for the SCell being activated and
 - the SSB measured remains detectable according to the cell identification conditions specified in section 9.2 and 9.3.
- the SSB measured during the period equal to $\max([5] \text{ measCycleSCell}, [5] \text{ DRX cycles})$ also remains detectable during the SCell activation delay according to the cell identification conditions specified in section 9.2 and 9.3.

Otherwise SCell in FR1 is unknown.

If the UE has been provided with higher layer in TS 38.331 [2] signaling of *smtc2* prior to the activation command, $T_{\text{SMTC_SCell}}$ follows *smtc1* or *smtc2* according to the physical cell ID of the target cell being activated. $T_{\text{SMTC_MAX}}$ follows *smtc1* or *smtc2* according to the physical cell IDs of the target cells being activated and the active serving cells.

In addition to CSI reporting defined above, UE shall also apply other actions related to the activation command specified in [2] for an SCell at the first opportunities for the corresponding actions once the SCell is activated.

The interruption on PSCell or any activated SCell in SCG for EN-DC mode specified in section 8.2 shall not occur before slot $n+1+[T_{\text{HARQ}}]$ and not occur after slot $n+1+[T_{\text{HARQ}}+3\text{ms} + T_{\text{SMTC_MAX}} + T_{\text{SMTC_duration}}]$.

The interruption on PCell or any activated SCell in MCG for NR standalone mode specified in section 8.2 shall not occur before slot $n+1+[T_{\text{HARQ}}]$ and not occur after slot $n+1+[T_{\text{HARQ}}+3\text{ms} + T_{\text{SMTC_MAX}} + T_{\text{SMTC_duration}}]$.

The interruption on PCell or any activated SCell in MCG for NE-DC specified in section 8.2 and the interruption on E-UTRA PSCell or any activated E-UTRA SCell in SCG for NE-DC specified in section 7.36 of [15] shall not occur before slot $n+1+[T_{\text{HARQ}}]$ and not occur after slot $n+1+[T_{\text{HARQ}}+3\text{ms} + T_{\text{SMTC_MAX}} + T_{\text{SMTC_duration}}]$.

The interruption on PCell, PSCell or any activated SCell in MCG or SCG for NR-DC specified in section 8.2 shall not occur before slot $n+1+[T_{\text{HARQ}}]$ and not occur after slot $n+1+[T_{\text{HARQ}}+3\text{ms} + T_{\text{SMTC_MAX}} + T_{\text{SMTC_duration}}]$.

Starting from the slot specified in section 4.3 of [3] (timing for secondary Cell activation/deactivation) and until the UE has completed the SCell activation, the UE shall report out of range if the UE has available uplink resources to report CQI for the SCell.

8.3.3 SCell Deactivation Delay Requirement for Activated SCell

The requirements in this section shall apply for the UE configured with one downlink SCell in EN-DC, or in standalone NR carrier aggregation, or in NE-DC, or in NR-DC.

Upon receiving SCell deactivation command or upon expiry of the *sCellDeactivationTimer* in slot n , the UE shall accomplish the deactivation actions for the SCell being deactivated no later than in slot $n+[T_{\text{HARQ}}+3\text{ms}]$.

The interruption on PSCell or any activated SCell in SCG for EN-DC mode specified in section 8.2 shall not occur before slot $n+1+[T_{\text{HARQ}}]$ and not occur after slot $n+1+[T_{\text{HARQ}}+3\text{ms}]$.

The interruption on PCell or any activated SCell in MCG for NR standalone mode specified in section 8.2 shall not occur before slot $n+1+[T_{\text{HARQ}}]$ and not occur after slot $n+1+[T_{\text{HARQ}}+3\text{ms}]$.

The interruption on PCell or any activated SCell in MCG for NE-DC specified in section 8.2 and the interruption on E-UTRA PCell or any activated E-UTRA SCell in SCG for NE-DC specified in section -7.36 of [15] shall not occur before slot $n+1+[T_{\text{HARQ}}]$ and not occur after slot $n+1+[T_{\text{HARQ}}+3\text{ms}]$.

The interruption on PCell, PSCell or any activated SCell in MCG or SCG for NR standalone mode specified in section 8.2 shall not occur before slot $n+1+[T_{\text{HARQ}}]$ and not occur after slot $n+1+[T_{\text{HARQ}}+3\text{ms}]$.

8.4 UE UL carrier RRC reconfiguration Delay

8.4.1 Introduction

The requirements in this section apply for a UE being configured or deconfigured with a supplementary UL carrier or NR UL carrier.

8.4.2 UE UL carrier configuration Delay Requirement

When the UE receives a RRC message implying NR UL or Supplementary UL carrier configuration, the UE shall be ready to start transmission on the newly configured carrier within $T_{\text{UL_carrier_config}}$ from the end of the last slot containing the RRC command.

$T_{\text{UL_carrier_config}}$ equals the maximum RRC procedure delay defined in section 12 in TS 38.331 [2].

8.4.3 UE UL carrier deconfiguration Delay Requirement

When the UE receives a RRC message implying NR UL or Supplementary UL carrier deconfiguration RRC signalling, the UE shall stop UL signalling on the deconfigured UL carrier within $T_{\text{UL_carrier_deconfig}}$ from the end of the last slot containing the RRC command.

$T_{\text{UL_carrier_deconfig}}$ equals the maximum RRC procedure delay defined in section 12 in TS 38.331 [2].

8.5 Link Recovery Procedures

8.5.1 Introduction

The UE shall assess the downlink link quality of a serving cell based on the reference signal in the set \bar{q}_0 as specified in TS 38.213 [3] in order to detect beam failure instance for any of:

- PCell in SA, NR-DC, or NE-DC operation mode,
- PSCell in NR-DC and EN-DC operation mode,
- FFS: SCell when the UE is configured with NR CA in any operation mode.

The RS resources in the set \bar{q}_0 can be periodic CSI-RS resources and/or SSBs. UE is not required to perform beam failure detection outside the active DL BWP.

On each RS resource in the set \bar{q}_0 , the UE shall estimate the radio link quality and compare it to the threshold $Q_{\text{out_LR}}$ for the purpose of accessing downlink radio link quality of the serving cell.

The threshold $Q_{\text{out_LR}}$ is defined as the level at which the downlink radio level link cannot be reliably received and shall correspond to the $\text{BLER}_{\text{out}}=10\%$ block error rate of a hypothetical PDCCH transmission. For SSB based beam failure detection, $Q_{\text{out_LR_SSB}}$ is derived based on the hypothetical PDCCH transmission parameters listed in Table 8.5.2.1-1. For CSI-RS based beam failure detection, $Q_{\text{out_LR_CSI-RS}}$ is derived based on the hypothetical PDCCH transmission parameters listed in Table 8.5.3.1-1.

The UE shall perform L1-RSRP measurements based on the reference signal in the set \bar{q}_1 as specified in TS 38.213 [3] in order to detect candidate beam with L1-RSRP measurement that is better than the threshold indicated by higher layer parameter rsrp-ThresholdSSB and $\text{rsrp-ThresholdCSI-rs}$ ($\text{rsrp-ThresholdSSB} + \text{powerControlOffsetSS}$). The RS resources in the set \bar{q}_1 can be periodic CSI-RS resources or SSBs or both SSB and CSI-RS. UE is not required to perform candidate beam detection outside the active DL BWP.

On each RS resource in the set \bar{q}_1 , the UE shall perform L1-RSRP measurements and compare it to the threshold rsrp-ThresholdSSB or $\text{rsrp-ThresholdCSI-rs}$ for the purpose of selecting new beam(s) for beam failure recovery.

UE is not expected to perform beam failure detection measurements if the SCS of the CSI-RS used for beam failure detection and the SCS of the SSB used for beam failure detection are different, and the CSI-RS and SSB are FDM-ed in the same OFDM symbol.

Editor's Note: FFS: whether UE supporting simultaneousRxDataSSB-DiffNumerology can perform BFD on SSB and CSI-RS simultaneously.

8.5.2 Requirements for SSB based beam failure detection

8.5.2.1 Introduction

The requirements in this section apply for each SSB resource in the set \bar{q}_0 configured for a serving cell, provided that the SSB configured for beam failure detection are actually transmitted within the UE active DL BWP during the entire evaluation period specified in section 8.5.2.2.

Table 8.5.2.1-1: PDCCH transmission parameters for beam failure instance

Attribute	Value for BLER
DCI format	1-0
Number of control OFDM symbols	2
Aggregation level (CCE)	8
Ratio of hypothetical PDCCH RE energy to average SSS RE energy	0dB
Ratio of hypothetical PDCCH DMRS energy to average SSS RE energy	0dB
Bandwidth (MHz)	TBD
Sub-carrier spacing (kHz)	Same as the SCS of RMSI CORESET
DMRS precoder granularity	REG bundle size
REG bundle size	6
CP length	Normal
Mapping from REG to CCE	Distributed

8.5.2.2 Minimum requirement

UE shall be able to evaluate whether the downlink radio link quality on the configured SSB resource in set \bar{q}_0 estimated over the last $T_{\text{Evaluate_BFD_SSB}}$ [ms] period becomes worse than the threshold $Q_{\text{out_LR_SSB}}$ within $T_{\text{Evaluate_BFD_SSB}}$ [ms] period.

The value of $T_{\text{Evaluate_BFD_SSB}}$ is defined in Table 8.5.2.2-1 for FR1.

The value of $T_{\text{Evaluate_BFD_SSB}}$ is defined in Table 8.5.2.2-2 for FR2 with $N=8$

For FR1,

- $P=1/(1 - T_{\text{SSB}}/M_{\text{GRP}})$, when in the monitored cell there are measurement gaps configured for intra-frequency, inter-frequency or inter-RAT measurements, which are overlapping with some but not all occasions of the SSB; and

- $P=1$ when in the monitored cell there are no measurement gaps overlapping with any occasion of the SSB.

For FR2,

- $P=1/(1 - T_{SSB}/T_{SMTCperiod})$, when BFD-RS is not overlapped with measurement gap and BFD-RS is partially overlapped with SMTC occasion ($T_{SSB} < T_{SMTCperiod}$).
- P is $P_{sharing\ factor}$, when BFD-RS is not overlapped with measurement gap and BFD-RS is fully overlapped with SMTC period ($T_{SSB} = T_{SMTCperiod}$).
- P is $1/(1 - T_{SSB}/MGRP - T_{SSB}/T_{SMTCperiod})$, when BFD-RS is partially overlapped with measurement gap and BFD-RS is partially overlapped with SMTC occasion ($T_{SSB} < T_{SMTCperiod}$) and SMTC occasion is not overlapped with measurement gap and
 - $T_{SMTCperiod} \neq MGRP$ or
 - $T_{SMTCperiod} = MGRP$ and $T_{SSB} < 0.5 * T_{SMTCperiod}$
- P is $1/(1 - T_{SSB}/MGRP) * P_{sharing\ factor}$, when BFD-RS is partially overlapped with measurement gap and BFD-RS is partially overlapped with SMTC occasion ($T_{SSB} < T_{SMTCperiod}$) and SMTC occasion is not overlapped with measurement gap and $T_{SMTCperiod} = MGRP$ and $T_{SSB} = 0.5 * T_{SMTCperiod}$
- P is $1/\{1 - T_{SSB}/\min(T_{SMTCperiod}, MGRP)\}$, when BFD-RS is partially overlapped with measurement gap ($T_{SSB} < MGRP$) and BFD-RS is partially overlapped with SMTC occasion ($T_{SSB} < T_{SMTCperiod}$) and SMTC occasion is partially or fully overlapped with measurement gap.
- P is $1/(1 - T_{SSB}/MGRP) * P_{sharing\ factor}$, when BFD-RS is partially overlapped with measurement gap and BFD-RS is fully overlapped with SMTC occasion ($T_{SSB} = T_{SMTCperiod}$) and SMTC occasion is partially overlapped with measurement gap ($T_{SMTCperiod} < MGRP$)
- $P_{sharing\ factor} = 3$.

If the high layer in TS 38.331 [2] signaling of *smtc2* is configured, $T_{SMTCperiod}$ corresponds to the value of higher layer parameter *smtc2*; Otherwise $T_{SMTCperiod}$ corresponds to the value of higher layer parameter *smtc1*.

Longer evaluation period would be expected if the combination of BFD-RS, SMTC occasion and measurement gap configurations does not meet pervious conditions.

Table 8.5.2.2-1: Evaluation period $T_{Evaluate_BFD_SSB}$ for FR1

Configuration	$T_{Evaluate_BFD_SSB}$ (ms)
no DRX	$\max([50], \text{ceil}(5 * P) * T_{SSB})$
DRX cycle ≤ 320 ms	$\max([50], \text{ceil}(7.5 * P) * \max(T_{DRX}, T_{SSB}))$
DRX cycle > 320 ms	$\text{ceil}(5 * P) * T_{DRX}$
Note: T_{SSB} is the periodicity of SSB in the set \bar{q}_0 . T_{DRX} is the DRX cycle length.	

Table 8.5.2.2-2: Evaluation period $T_{Evaluate_BFD_out}$ for FR2

Configuration	$T_{Evaluate_BFD_SSB}$ (ms)
no DRX	$\max([50], \text{ceil}(5 * P * N) * T_{SSB})$
DRX cycle ≤ 320 ms	$\max([50], \text{ceil}(7.5 * P * N) * \max(T_{DRX}, T_{SSB}))$
DRX cycle > 320 ms	$\text{ceil}(5 * P * N) * T_{DRX}$
Note: T_{SSB} is the periodicity of SSB in the set \bar{q}_0 . T_{DRX} is the DRX cycle length.	

8.5.3 Requirements for CSI-RS based beam failure detection

8.5.3.1 Introduction

The requirements in this section apply for each CSI-RS resource in the set \bar{q}_0 configured for a serving cell, provided that the CSI-RS resource configured for beam failure detection are actually transmitted within the UE active DL BWP

during the entire evaluation period specified in section 8.5.3.2. UE is not expected to perform beam failure detection measurements on the CSI-RS configured as BFD-RS if the CSI-RS is not QCL-ed with the RS in the active TCI state of any CORESET configured in the UE active BWP.

Table 8.5.3.1-1: PDCCH transmission parameters for beam failure instance

Attribute	Value for BLER
DCI format	1-0
Number of control OFDM symbols	2
Aggregation level (CCE)	8
Ratio of hypothetical PDCCH RE energy to average CSI-RS RE energy	0dB
Ratio of hypothetical PDCCH DMRS energy to average CSI-RS RE energy	0dB
Bandwidth (PRBs)	48
Sub-carrier spacing (kHz)	SCS of the active DL BWP
DMRS precoder granularity	REG bundle size
REG bundle size	6
CP length	Normal
Mapping from REG to CCE	Distributed

8.5.3.2 Minimum requirement

UE shall be able to evaluate whether the downlink radio link quality on the configured CSI-RS resource in set \bar{q}_0 estimated over the last $T_{\text{Evaluate_BFD_CSI-RS}}$ [ms] period becomes worse than the threshold $Q_{\text{out_LR_CSI-RS}}$ within $T_{\text{Evaluate_BFD_CSI-RS}}$ [ms] period.

The value of $T_{\text{Evaluate_BFD_CSI-RS}}$ is defined in Table 8.5.3.2-1 for FR1.

The value of $T_{\text{Evaluate_BFD_CSI-RS}}$ is defined in Table 8.5.3.2-2 for FR2 with $N=1$

Editor's Note: It is FFS if a CSI-RS resource in the resource set with repetition "ON" can be configured as a BFD-RS. If CSI-RS for BFD can be in the resource set with repetition "ON", $N=8$ may apply.

Editor's Note: FFS if there are other conditions with $N=8$.

For FR1,

- $P=1/(1 - T_{\text{CSI-RS}}/\text{MGRP})$, when in the monitored cell there are measurement gaps configured for intra-frequency, inter-frequency or inter-RAT measurements, which are overlapping with some but not all occasions of the CSI-RS; and
- $P=1$ when in the monitored cell there are no measurement gaps overlapping with any occasion of the CSI-RS.

For FR2,

- $P=1$, when BFD-RS is not overlapped with measurement gap and also not overlapped with SMTC occasion.
- $P=1/(1 - T_{\text{CSI-RS}}/\text{MGRP})$, when BFD-RS is partially overlapped with measurement gap and BFD-RS is not overlapped with SMTC occasion ($T_{\text{CSI-RS}} < \text{MGRP}$)
- $P=1/(1 - T_{\text{CSI-RS}}/T_{\text{SMTCperiod}})$, when BFD-RS is not overlapped with measurement gap and BFD-RS is partially overlapped with SMTC occasion ($T_{\text{CSI-RS}} < T_{\text{SMTCperiod}}$).
- P is $P_{\text{sharing factor}}$, when BFD-RS is not overlapped with measurement gap and BFD-RS is fully overlapped with SMTC occasion ($T_{\text{CSI-RS}} = T_{\text{SMTCperiod}}$).
- P is $1/(1 - T_{\text{CSI-RS}}/\text{MGRP} - T_{\text{CSI-RS}}/T_{\text{SMTCperiod}})$, when BFD-RS is partially overlapped with measurement gap and BFD-RS is partially overlapped with SMTC occasion ($T_{\text{CSI-RS}} < T_{\text{SMTCperiod}}$) and SMTC occasion is not overlapped with measurement gap and

- $T_{\text{SMTCperiod}} \neq \text{MGRP}$ or
- $T_{\text{SMTCperiod}} = \text{MGRP}$ and $T_{\text{CSI-RS}} < 0.5 * T_{\text{SMTCperiod}}$
- P is $1/(1 - T_{\text{CSI-RS}}/\text{MGRP}) * P_{\text{sharing factor}}$, when BFD-RS is partially overlapped with measurement gap and BFD-RS is partially overlapped with SMTC occasion ($T_{\text{CSI-RS}} < T_{\text{SMTCperiod}}$) and SMTC occasion is not overlapped with measurement gap and $T_{\text{SMTCperiod}} = \text{MGRP}$ and $T_{\text{CSI-RS}} = 0.5 * T_{\text{SMTCperiod}}$
- P is $1/\{1 - T_{\text{CSI-RS}}/\min(T_{\text{SMTCperiod}}, \text{MGRP})\}$, when BFD-RS is partially overlapped with measurement gap ($T_{\text{CSI-RS}} < \text{MGRP}$) and BFD-RS is partially overlapped with SMTC occasion ($T_{\text{CSI-RS}} < T_{\text{SMTCperiod}}$) and SMTC occasion is partially or fully overlapped with measurement gap.
- P is $1/(1 - T_{\text{CSI-RS}}/\text{MGRP}) * P_{\text{sharing factor}}$, when BFD-RS is partially overlapped with measurement gap and BFD-RS is fully overlapped with SMTC occasion ($T_{\text{CSI-RS}} = T_{\text{SMTCperiod}}$) and SMTC occasion is partially overlapped with measurement gap ($T_{\text{SMTCperiod}} < \text{MGRP}$)
- $P_{\text{sharing factor}}$ is 3.

If the high layer in TS 38.331 [2] signaling of *smtc2* is configured, $T_{\text{SMTCperiod}}$ corresponds to the value of higher layer parameter *smtc2*; Otherwise $T_{\text{SMTCperiod}}$ corresponds to the value of higher layer parameter *smtc1*.

Note: The overlap between CSI-RS for BFD and SMTC means that CSI-RS for BFD is within the SMTC window duration.

Longer evaluation period would be expected if the combination of BFD-RS, SMTC occasion and measurement gap configurations does not meet previous conditions.

The values of M_{BFD} used in Table 8.5.3.2-1 and Table 8.5.3.2-2 are defined as

- $M_{\text{BFD}} = 10$, if the CSI-RS resource configured for BFD is transmitted with Density = 3.

Table 8.5.3.2-1: Evaluation period $T_{\text{Evaluate_BFD_CSI-RS}}$ for FR1

Configuration	$T_{\text{Evaluate_BFD_CSI-RS}}$ (ms)
no DRX	$\max([50], [M_{\text{BFD}} * P] * T_{\text{CSI-RS}})$
DRX cycle ≤ 320 ms	$\max([50], [1.5 * M_{\text{BFD}} * P] * \max(T_{\text{DRX}}, T_{\text{CSI-RS}}))$
DRX cycle > 320 ms	$[M_{\text{BFD}} * P] * T_{\text{DRX}}$
Note: $T_{\text{CSI-RS}}$ is the periodicity of CSI-RS resource in the set \bar{q}_0 . T_{DRX} is the DRX cycle length.	

Table 8.5.3.2-2: Evaluation period $T_{\text{Evaluate_BFD_CSI-RS}}$ for FR2

Configuration	$T_{\text{Evaluate_BFD_CSI-RS}}$ (ms)
no DRX	$\max([50], [M_{\text{BFD}} * P * N] * T_{\text{CSI-RS}})$
DRX cycle ≤ 320 ms	$\max([50], [1.5 * M_{\text{BFD}} * P * N] * \max(T_{\text{DRX}}, T_{\text{CSI-RS}}))$
DRX cycle > 320 ms	$[M_{\text{BFD}} * P * N] * T_{\text{DRX}}$
Note: $T_{\text{CSI-RS}}$ is the periodicity of CSI-RS resource in the set \bar{q}_0 . T_{DRX} is the DRX cycle length.	

8.5.4 Minimum requirement for L1 indication

When the radio link quality on all the configured RS resources in set \bar{q}_0 is worse than $Q_{\text{out_LR}}$, Layer 1 of the UE shall send a beam failure instance indication to the higher layers. A Layer 3 filter may be applied to the beam failure instance indications as specified in [2].

The beam failure instance evaluation for the configured RS resources in set \bar{q}_0 shall be performed as specified in section 6 in [3]. Two successive indications from Layer 1 shall be separated by at least $T_{\text{Indication_interval_BFD}}$.

When DRX is not used, $T_{\text{Indication_interval_BFD}}$ is $\max(2\text{ms}, T_{\text{BFD-RS,M}})$, where $T_{\text{BFD-RS,M}}$ is the shortest periodicity of all configured RS resources in set \bar{q}_0 for the accessed cell, corresponding to either the shortest periodicity of the SSB in the set \bar{q}_0 or CSI-RS resource in the set \bar{q}_0 .

When DRX is used, $T_{\text{Indication_interval_BFD}}$ is $\max(1.5 \cdot \text{DRX_cycle_length}, 1.5 \cdot T_{\text{BFD-RS,M}})$ if DRX cycle_length is less than or equal to 320ms, and $T_{\text{Indication_interval}}$ is DRX_cycle_length if DRX cycle_length is greater than 320ms.

8.5.5 Requirements for SSB based candidate beam detection

8.5.5.1 Introduction

The requirements in this section apply for each SSB resource in the set \bar{q}_1 configured for a serving cell, provided that the SSBs configured for candidate beam detection are actually transmitted within UE active DL BWP during the entire evaluation period specified in section 8.5.5.2.

8.5.5.2 Minimum requirement

UE shall be able to evaluate whether the L1-RSRP measured on the configured SSB resource in set \bar{q}_1 estimated over the last $T_{\text{Evaluate_CBD_SSB}}$ [ms] period becomes better than the threshold $Q_{\text{in_LR}}$ provided SSB_RP and SSB \hat{E}_s/I_{ot} are according to Annex Table B.2.4.1 for a corresponding band.

The value of $T_{\text{Evaluate_CBD_SSB}}$ is defined in Table 8.5.5.2-1 for FR1.

The value of $T_{\text{Evaluate_CBD_SSB}}$ is defined in Table 8.5.5.2-2 for FR2 with $N=8$.

Where,

For FR1,

- $P=1/(1 - T_{\text{SSB}}/\text{MGRP})$, when in the monitored cell there are measurement gaps configured for intra-frequency, inter-frequency or inter-RAT measurements, which are overlapping with some but not all occasions of the SSB; and
- $P=1$ when in the monitored cell there are no measurement gaps overlapping with any occasion of the SSB.

For FR2,

- $P=1/(1 - T_{\text{SSB}}/T_{\text{SMTCperiod}})$, when candidate beam detection RS is not overlapped with measurement gap and candidate beam detection RS is partially overlapped with SMTC occasion ($T_{\text{SSB}} < T_{\text{SMTCperiod}}$).
- P is 3, when candidate beam detection RS is not overlapped with measurement gap and candidate beam detection RS is fully overlapped with SMTC period ($T_{\text{SSB}} = T_{\text{SMTCperiod}}$).
- P is $1/(1 - T_{\text{SSB}}/\text{MGRP} - T_{\text{SSB}}/T_{\text{SMTCperiod}})$, when candidate beam detection RS is partially overlapped with measurement gap and candidate beam detection RS is partially overlapped with SMTC occasion ($T_{\text{SSB}} < T_{\text{SMTCperiod}}$) and SMTC occasion is not overlapped with measurement gap and
 - $T_{\text{SMTCperiod}} \neq \text{MGRP}$ or
 - $T_{\text{SMTCperiod}} = \text{MGRP}$ and $T_{\text{SSB}} < 0.5 \cdot T_{\text{SMTCperiod}}$
- P is $1/(1 - T_{\text{SSB}}/\text{MGRP}) \cdot 3$, when candidate beam detection RS is partially overlapped with measurement gap and candidate beam detection RS is partially overlapped with SMTC occasion ($T_{\text{SSB}} < T_{\text{SMTCperiod}}$) and SMTC occasion is not overlapped with measurement gap and $T_{\text{SMTCperiod}} = \text{MGRP}$ and $T_{\text{SSB}} = 0.5 \cdot T_{\text{SMTCperiod}}$
- P is $1/\{1 - T_{\text{SSB}}/\min(T_{\text{SMTCperiod}}, \text{MGRP})\}$, when candidate beam detection RS is partially overlapped with measurement gap and candidate beam detection RS is partially overlapped with SMTC occasion ($T_{\text{SSB}} < T_{\text{SMTCperiod}}$) and SMTC occasion is partially or fully overlapped with measurement gap
- P is $1/(1 - T_{\text{SSB}}/\text{MGRP}) \cdot 3$, when candidate beam detection RS is partially overlapped with measurement gap and candidate beam detection RS is fully overlapped with SMTC occasion ($T_{\text{SSB}} = T_{\text{SMTCperiod}}$) and SMTC occasion is partially overlapped with measurement gap ($T_{\text{SMTCperiod}} < \text{MGRP}$)

In both FR1 and FR2, if different SCS is used for SSB and CSI-RS, and the UE does not support *simultaneousRxDataSSB-DiffNumerology*, it is assumed that the SSB configured for candidate beam detection and each CSI-RS resource shall be TDMed transmitted.

In FR2, it is assumed that the SSB configured for candidate beam detection and each CSI-RS resource shall be TDMed transmitted.

Table 8.5.5.2-1: Evaluation period $T_{\text{Evaluate_CBD_SSB}}$ for FR1

Configuration	$T_{\text{Evaluate_CBD_SSB}}$ (ms)
non-DRX	$\text{ceil}([3]^P) * T_{\text{SSB}}$
DRX cycle $\leq 320\text{ms}$	$\text{ceil}([3]^P * 1.5) * \max(T_{\text{DRX}}, T_{\text{SSB}})$
DRX cycle $> 320\text{ms}$	$\text{ceil}([3]^P) * T_{\text{DRX}}$
Note: T_{SSB} is the periodicity of SSB in the set \bar{q}_1 . T_{DRX} is the DRX cycle length.	

Table 8.5.5.2-2: Evaluation period $T_{\text{Evaluate_CBD_out}}$ for FR2

Configuration	$T_{\text{Evaluate_CBD_SSB}}$ (ms)
non-DRX	$\text{ceil}([3]^P * N) * T_{\text{SSB}}$
DRX cycle $\leq 320\text{ms}$	$\text{ceil}([3]^P * N * 1.5) * \max(T_{\text{DRX}}, T_{\text{SSB}})$
DRX cycle $> 320\text{ms}$	$\text{ceil}([3]^P * N) * T_{\text{DRX}}$
Note: T_{SSB} is the periodicity of SSB in the set \bar{q}_1 . T_{DRX} is the DRX cycle length.	

8.5.6 Requirements for CSI-RS based candidate beam detection

8.5.6.1 Introduction

The requirements in this section apply for each CSI-RS resource in the set \bar{q}_1 configured for a serving cell, provided that the CSI-RS resources configured for candidate beam detection are actually transmitted within UE active DL BWP during the entire evaluation period specified in section 8.5.6.2.

8.5.6.2 Minimum requirement

UE shall be able to evaluate whether the L1-RSRP measured on the configured CSI-RS resource in set \bar{q}_1 estimated over the last $T_{\text{Evaluate_CBD_CSI-RS}}$ [ms] period becomes better than the threshold $Q_{\text{in_LR}}$ within $T_{\text{Evaluate_CBD_CSI-RS}}$ [ms] period provided CSI-RS \hat{E}_s/Iot is according to Annex Table B.2.4.2 for a corresponding band.

The value of $T_{\text{Evaluate_CBD_CSI-RS}}$ is defined in Table 8.5.6.2-1 for FR1.

The value of $T_{\text{Evaluate_CBD_CSI-RS}}$ is defined in Table 8.5.6.2-2 for FR2 with $N=8$.

Editor's Note: FFS whether $N=1$ need to be applied for CSI-RS based candidate beam detection in FR2.

For FR1,

- $P=1/(1 - T_{\text{CSI-RS}}/\text{MGRP})$, when in the monitored cell there are measurement gaps configured for intra-frequency, inter-frequency or inter-RAT measurements, which are overlapping with some but not all occasions of the CSI-RS; and
- $P=1$ when in the monitored cell there are no measurement gaps overlapping with any occasion of the CSI-RS.

For FR2,

- $P=1$, when candidate beam detection RS is not overlapped with measurement gap and also not overlapped with SMTC occasion.
- $P=1/(1 - T_{\text{CSI-RS}}/\text{MGRP})$, when candidate beam detection RS is partially overlapped with measurement gap and candidate beam detection RS is not overlapped with SMTC occasion ($T_{\text{CSI-RS}} < \text{MGRP}$)

- $P=1/(1 - T_{CSI-RS} / T_{SMTCperiod})$, when candidate beam detection RS is not overlapped with measurement gap and candidate beam detection RS is partially overlapped with SMTC occasion ($T_{CSI-RS} < T_{SMTCperiod}$).
- P is 3, when candidate beam detection RS is not overlapped with measurement gap and candidate beam detection RS is fully overlapped with SMTC occasion ($T_{CSI-RS} = T_{SMTCperiod}$).
- P is $1/(1 - T_{CSI-RS} / MGRP - T_{CSI-RS} / T_{SMTCperiod})$, when candidate beam detection RS is partially overlapped with measurement gap and candidate beam detection RS is partially overlapped with SMTC occasion ($T_{CSI-RS} < T_{SMTCperiod}$) and SMTC occasion is not overlapped with measurement gap and
 - $T_{SMTCperiod} \neq MGRP$ or
 - $T_{SMTCperiod} = MGRP$ and $T_{CSI-RS} < 0.5 * T_{SMTCperiod}$
- P is $1/(1 - T_{CSI-RS} / MGRP) * 3$, when candidate beam detection RS is partially overlapped with measurement gap and candidate beam detection RS is partially overlapped with SMTC occasion ($T_{CSI-RS} < T_{SMTCperiod}$) and SMTC occasion is not overlapped with measurement gap and $T_{SMTCperiod} = MGRP$ and $T_{CSI-RS} = 0.5 * T_{SMTCperiod}$
- P is $1/\{1 - T_{CSI-RS} / \min(T_{SMTCperiod}, MGRP)\}$, when candidate beam detection RS is partially overlapped with measurement gap and candidate beam detection RS is partially overlapped with SMTC occasion ($T_{CSI-RS} < T_{SMTCperiod}$) and SMTC occasion is partially or fully overlapped with measurement gap
- P is $1/(1 - T_{CSI-RS} / MGRP) * 3$, when candidate beam detection RS is partially overlapped with measurement gap and candidate beam detection RS is fully overlapped with SMTC occasion ($T_{CSI-RS} = T_{SMTCperiod}$) and SMTC occasion is partially overlapped with measurement gap ($T_{SMTCperiod} < MGRP$) [Longer evaluation period would be expected if the CSI-RS is on the same OFDM symbols with RLM/BFD/BM-RS, or other CBD-RS, according to the measurement restrictions defined in section TBD.]

In both FR1 and FR2, if different SCS is used for SSB and CSI-RS, and the UE does not support *simultaneousRxDataSSB-DiffNumerology*, it is assumed that the CSI-RS configured for candidate beam detection and each SSB shall be TDMed transmitted.

In FR2, It is assumed that the CSI-RS configured for candidate beam detection with N=1 shall be TDMed with any RS resources configured for RLM/BFD/CBD/L1-RSRP reporting which is not is QCL-Type D with this CSI-RS resource or under the conditions of N>1 as specified in section 8.1.2.2, 8.1.2.3, 8.5.2.2, 8.5.2.3, 8.5.2.5, 8.5.2.6, 9.5.4.1 and 9.5.4.2.

The values of M_{CBD} used in Table 8.5.6.2-1 and Table 8.5.6.2-2 are defined as

- $M_{CBD} = 3$, if the CSI-RS resource configured in the set \bar{q}_1 is transmitted with Density = 3.

Table 8.5.6.2-1: Evaluation period $T_{Evaluate_CBD_CSI-RS}$ for FR1

Configuration	$T_{Evaluate_CBD_CSI-RS}$ (ms)
non-DRX	$\max([25], \text{ceil}(M_{CBD} * P) * T_{CSI-RS})$
DRX cycle ≤ 320 ms	$\text{ceil}(M_{CBD} * P) * \max(T_{DRX}, T_{CSI-RS})$
DRX cycle > 320 ms	$\text{ceil}(M_{CBD} * P) * T_{DRX}$
Note:	T_{CSI-RS} is the periodicity of CSI-RS resource in the set \bar{q}_1 . T_{DRX} is the DRX cycle length.

Table 8.5.6.2-2: Evaluation period $T_{Evaluate_CBD_CSI-RS}$ for FR2

Configuration	$T_{Evaluate_CBD_CSI-RS}$ (ms)
non-DRX	$\max([25], \text{ceil}(M_{CBD} * P * N) * T_{CSI-RS})$
DRX cycle ≤ 320 ms	$\text{ceil}(M_{CBD} * P * N * 1.5) * \max(T_{DRX}, T_{CSI-RS})$
DRX cycle > 320 ms	$\text{ceil}(M_{CBD} * P * N) * T_{DRX}$
Note:	T_{CSI-RS} is the periodicity of CSI-RS resource in the set \bar{q}_1 . T_{DRX} is the DRX cycle length.

8.5.7 Scheduling availability of UE during beam failure detection

Scheduling availability restrictions when the UE is performing beam failure detection are described in the following clauses.

8.5.7.1 Scheduling availability of UE performing beam failure detection with a same subcarrier spacing as PDSCH/PDCCH on FR1

There are no scheduling restrictions due to beam failure detection performed on SSB and CSI-RS configured as BFD-RS with the same SCS as PDSCH/PDCCH in FR1.

8.5.7.2 Scheduling availability of UE performing beam failure detection with a different subcarrier spacing than PDSCH/PDCCH on FR1

For UEs which support *simultaneousRxDataSSB-DiffNumerology* [14] there are no restrictions on scheduling availability due to beam failure detection based on SSB as BFD-RS. For UEs which do not support *simultaneousRxDataSSB-DiffNumerology* [14] the following restrictions apply due to beam failure detection based on SSB configured as BFD-RS.

- The UE is not expected to transmit PUCCH/PUSCH/SRS or receive PDCCH/PDSCH/TRS/CSI-RS for CQI on SSB symbols to be measured for beam failure detection.

When intra-band carrier aggregation in FR1 is configured, the scheduling restrictions apply to all SCells that are aggregated in the same band as the PCell or PSCell. When inter-band carrier aggregation within FR1 is configured, there are no scheduling restrictions on FR1 serving cell(s) configured in other bands than the bands in which PCell or PSCell is configured.

8.5.7.3 Scheduling availability of UE performing beam failure detection on FR2

The following scheduling restriction applies due to beam failure detection.

- For the case where no RSs are provided for BFD, or where BFD-RS is explicitly configured and is QCLed with active TCI state for PDCCH/PDSCH, and $N=1$ applies for the BFD-RS as specified in section 8.5.2.2 if the BFD-RS is SSB and in section 8.5.3.2 if the BFD-RS is CSI-RS
 - There are no scheduling restrictions due to beam failure detection performed based on SSB or CSI-RS with a same SCS as PDSCH/PDCCH.
 - When performing beam failure detection based on SSB with a different SCS than PDSCH/PDCCH, for UEs which support *simultaneousRxDataSSB-DiffNumerology* [14] there are no restrictions on scheduling availability due to beam failure detection. For UEs which do not support *simultaneousRxDataSSB-DiffNumerology* [14] the UE is not expected to transmit PUCCH/PUSCH/SRS or receive PDCCH/PDSCH/TRS/CSI-RS for CQI on SSB symbols to be measured for beam failure detection.
- Otherwise
 - The UE is not expected to transmit PUCCH/PUSCH/SRS or receive PDCCH/PDSCH/TRS/CSI-RS for CQI on BFD-RS symbols to be measured for beam failure detection.

When intra-band carrier aggregation is performed, the scheduling restrictions apply to all serving cells on the band due to beam failure detection performed on FR2 PCell or PSCell in the same band.

Editor's Note: FFS scheduling restrictions for inter-band carrier aggregation will be defined depending on band combination in future.

8.5.7.4 Scheduling availability of UE performing beam failure detection on FR1 or FR2 in case of FR1-FR2 inter-band CA and NR DC

There are no scheduling restrictions on FR1 serving cell(s) due to beam failure detection performed on FR2 serving PCell and/or PSCell.

There are no scheduling restrictions on FR2 serving cell(s) due to beam failure detection performed on FR1 serving PCell and/or PSCell.

Editor's Note: NR-DC in Rel-15 only includes the scenarios where all serving cells in MCG in FR1 and all serving cells in SCG in FR2.

8.5.8 Scheduling availability of UE during candidate beam detection

Scheduling availability restrictions when the UE is performing L1-RSRP measurement for candidate beam detection are described in the following clauses.

8.5.8.1 Scheduling availability of UE performing L1-RSRP measurement with a same subcarrier spacing as PDSCH/PDCCH on FR1

There are no scheduling restrictions due to L1-RSRP measurement performed on SSB and CSI-RS configured as link recovery detection resource with the same SCS as PDSCH/PDCCH in FR1.

8.5.8.2 Scheduling availability of UE performing L1-RSRP measurement with a different subcarrier spacing than PDSCH/PDCCH on FR1

For UEs which support *simultaneousRxDataSSB-DiffNumerology* [14] there are no restrictions on scheduling availability due to L1-RSRP measurement based on SSB as link recovery detection resource. For UEs which do not support *simultaneousRxDataSSB-DiffNumerology* [14] the following restrictions apply due to L1-RSRP measurement based on SSB configured as link recovery detection resource.

- The UE is not expected to transmit PUCCH/PUSCH/SRS or receive PDCCH/PDSCH/TRS/CSI-RS for CQI on SSB symbols to be measured for L1-RSRP.

When intra-band carrier aggregation in FR1 is configured, the scheduling restrictions apply to all serving cells that are aggregated in the same band as the cell where L1-RSRP measurement is performed. When inter-band carrier aggregation within FR1 is configured, there are no scheduling restrictions on FR1 serving cell(s) configured in other bands.

8.5.8.3 Scheduling availability of UE performing L1-RSRP measurement on FR2

The following scheduling restriction applies due to beam failure detection

- For the case where no RSs are provided for beam failure detection, or where beam failure detection RS is explicitly configured and is QCLed with active TCI state for PDCCH/PDSCH, and N=1 applies for the beam failure detection RS as specified in section 8.5.2.2 if the beam failure detection RS is SSB and in section 8.5.3.2 if the beam failure detection RS is CSI-RS
 - There are no scheduling restrictions due to beam failure detection performed based on SSB or CSI-RS with a same SCS as PDSCH/PDCCH.
 - When performing beam failure detection based on SSB with a different SCS than PDSCH/PDCCH, for UEs which support *simultaneousRxDataSSB-DiffNumerology* [14] there are no restrictions on scheduling availability due to beam failure detection. For UEs which do not support *simultaneousRxDataSSB-DiffNumerology* [14] the UE is not expected to transmit PUCCH/PUSCH or receive PDCCH/PDSCH on SSB symbols to be measured for beam failure detection.
- Otherwise
 - The UE is not expected to transmit PUCCH/PUSCH or receive PDCCH/PDSCH on BFD-RS symbols to be measured for beam failure detection.

When intra-band carrier aggregation is configured, the scheduling restrictions apply to all serving cells that are aggregated in the same band as the serving cell where L1-RSRP measurement for candidate beam detection is performed.

Editor's Note: FFS scheduling restrictions for inter-band carrier aggregation will be defined depending on band combination in future.

8.5.8.4 Scheduling availability of UE performing L1-RSRP measurement on FR1 or FR2 in case of FR1-FR2 inter-band CA and NR-DC

There are no scheduling restrictions on FR1 serving cell(s) due to L1-RSRP measurement performed on FR2 serving cell(s).

There are no scheduling restrictions on FR2 serving cell(s) due to L1-RSRP measurement performed on FR1 serving cell(s).

Editor's Note: NR-DC in Rel-15 only includes the scenarios where all serving cells in MCG in FR1 and all serving cells in SCG in FR2.

8.6 Active BWP switch delay

8.6.1 Introduction

The requirements in this section apply for a UE configured with more than one BWP on PCell or any activated SCell in standalone NR or NE-DC, PCell, PSCell or any activated SCell in MCG or SCG in NR-DC, or PSCell or any activated SCell in SCG in EN-DC. UE shall complete the switch of active DL and/or UL BWP within the delay defined in this section.

8.6.2 DCI and timer based BWP switch delay

For DCI-based BWP switch, after the UE receives BWP switching request at DL slot n on a serving cell, UE shall be able to receive PDSCH (for DL active BWP switch) or transmit PUSCH (for UL active BWP switch) on the new BWP on the serving cell on which BWP switch on the first DL or UL slot occurs right after the beginning of DLslot $n + T_{\text{BWPswitchDelay}}$.

The UE is not required to follow the requirements defined in this section when performing a DCI-based BWP switch between the BWPs in disjoint channel bandwidths or in partially overlapping channel bandwidths.

For timer-based BWP switch, the UE shall start BWP switch at DL slot n , where n is the beginning of a DL subframe (FR1) or DL half-subframe (FR2) immediately after a BWP-inactivity timer *bwp-InactivityTimer* [2] expires on a serving cell, and the UE shall be able to receive PDSCH (for DL active BWP switch) or transmit PUSCH (for UL active BWP switch) on the new BWP on the serving cell on which BWP switch on the first DL or UL slot occurs right after the beginning of DLslot $n + T_{\text{BWPswitchDelay}}$.

The UE is not required to transmit UL signals or receive DL signals during time duration $T_{\text{BWPswitchDelay}}$ on the cell where DCI-based BWP switch or timer-based BWP switch occurs.

Depending on UE capability *bwp-SwitchingDelay* [2], UE shall finish BWP switch within the time duration $T_{\text{BWPswitchDelay}}$ defined in Table 8.6.2-1.

Table 8.6.2-1: BWP switch delay

μ	NR Slot length (ms)	BWP switch delay $T_{\text{BWPswitchDelay}}$ (slots)	
		Type 1 ^{Note 1}	Type 2 ^{Note 1}
0	1	1	3
1	0.5	2	5
2	0.25	3	9
3	0.125	6	17
Note 1: Depends on UE capability. Note 2: If the BWP switch involves changing of SCS, the BWP switch delay is determined by the larger one between the SCS before BWP switch and the SCS after BWP switch.			

8.6.3 RRC based BWP switch delay

For RRC-based BWP switch, after the UE receives BWP switching request, UE shall be able to receive PDSCH (for DL active BWP switch) or transmit PUSCH (for UL active BWP switch) on the new BWP on the serving cell on which BWP switch on the first DL or UL slot right after the beginning of DLslot $n + T_{\text{RRCprocessingDelay}} + T_{\text{BWPswitchDelayRRC}}$, where DL slot n is the last slot containing the RRC command, and $T_{\text{RRCprocessingDelay}}$ is the length of the RRC procedure delay in slots defined in clause 12 in TS 38.331 [2], and $T_{\text{BWPswitchDelayRRC}}$ is the BWP switching delay for RRC based BWP switch.

Editor's Note: $T_{\text{BWPswitchDelayRRC}}$ is going to be defined based one of the following options: Option 1) single requirement based on the worst scenario, Option 2) two sets of requirement. One set of requirement would be same as option1 and the other requirement might be tightened.

8.7 Void

8.8 NE-DC: E-UTRAN PSCell Addition and Release Delay

8.8.1 Introduction

This section defines requirements for the delay within which the UE shall be able to configure an E-UTRAN PSCell in NR - E-UTRA dual connectivity. The requirements are applicable to an NR - E-UTRA dual connectivity capable UE.

8.8.2 E-UTRAN PSCell Addition Delay Requirement

The requirements in this section shall apply for the UE which is configured with PCell, and may also be configured with one or more SCells.

Upon receiving E-UTRAN PSCell addition in subframe n , the UE shall be capable to transmit PRACH preamble towards E-UTRAN PSCell no later than in subframe $n + T_{\text{config_EUTRAN-PSCell}}$:

Where:

$$T_{\text{config_EUTRAN-PSCell}} = 20\text{ms} + T_{\text{activation_time}} + 50\text{ms} + T_{\text{PCell_DU}} + T_{\text{E-UTRAN-PSCell_DU}}$$

$T_{\text{activation_time}}$ is the E-UTRAN PSCell activation delay. If the E-UTRAN PSCell is known, then $T_{\text{activation_time}}$ is 20ms. If the E-UTRAN PSCell is unknown, then $T_{\text{activation_time}}$ is 30ms provided the E-UTRAN PSCell can be successfully detected on the first attempt.

$T_{\text{PCell_DU}}$ is the delay uncertainty due to PCell PRACH preamble transmission. $T_{\text{PCell_DU}}$ is up to 20ms if E-UTRAN PSCell activation is interrupted by a PCell PRACH preamble transmission, otherwise it is 0.

$T_{\text{E-UTRAN-PSCell_DU}}$ is the delay uncertainty in acquiring the first available PRACH occasion in the E-UTRAN PSCell. $T_{\text{E-UTRAN-PSCell_DU}}$ is up to 30ms.

E-UTRAN PSCell is known if it has been meeting the following conditions:

During the last [5] seconds before the reception of the E-UTRAN PSCell configuration command:

- the UE has sent a valid measurement report for the E-UTRAN PSCell being configured and
- the E-UTRAN PSCell being configured remains detectable according to the cell identification conditions specified in section 8.8 of [15],
- E-UTRAN PSCell being configured also remains detectable during the E-UTRAN PSCell configuration delay according to the cell identification conditions specified in section 8.8 of [15].

otherwise it is unknown.

The PCell interruption specified in section 8.2 is allowed only during the RRC reconfiguration procedure [2].

8.8.3 E-UTRAN PSCell Release Delay Requirement

The requirements in this section shall apply for a UE which is configured with PCell and E-UTRAN PSCell, and may also be configured with one or more SCells and/or E-UTRAN SCells.

Upon receiving E-UTRAN PSCell release in subframe n , the UE shall accomplish the release actions specified in [2] no later than in subframe $n+20$.

The PCell interruption specified in section 8.2 is allowed only during the RRC reconfiguration procedure [2].

8.9 NR-DC: PSCell Addition and Release Delay

8.9.1 Introduction

This section defines requirements for the delay within which the UE shall be able to configure an PSCell in NR dual connectivity. The requirements are applicable to an NR dual connectivity capable UE.

8.9.2 PSCell Addition Delay Requirement

The requirements in this section shall apply for the UE configured with only PCell.

Upon receiving PSCell addition in subframe n , the UE shall be capable to transmit PRACH preamble towards PSCell no later than in subframe $n + T_{\text{config PSCell}}$:

Where:

$$T_{\text{config PSCell}} = T_{\text{RRC_delay}} + T_{\text{processing}} + T_{\text{search}} + T_{\Delta} + T_{\text{PSCell_DU}} + 2 \text{ ms}$$

$T_{\text{RRC_delay}}$ is the RRC procedure delay as specified in [2].

$T_{\text{processing}}$ is the SW processing time needed by UE, including RF warm up period. $T_{\text{processing}} = 20$ ms if PSCell is in FR1, $T_{\text{processing}} = 40$ ms if PSCell is in FR2.

T_{search} is the time for AGC settling and PSS/SSS detection.

- For PSCell in FR1: if the target cell is known, then $T_{\text{search}} = 0$ ms. If the target cell is an unknown intra-frequency cell and signal quality is sufficient for successful cell detection on the first attempt, then $T_{\text{search}} = \text{SMTC periodicity} + 5$ ms. If the target cell is an unknown inter-frequency cell and signal quality is sufficient for successful cell detection on the first attempt, then $T_{\text{search}} = [\text{TBD} * \text{SMTC periodicity} + 5]$ ms;
- For PSCell in FR2: if the target cell is an unknown intra-frequency cell and signal quality is sufficient for successful cell detection on the first attempt, then $T_{\text{search}} = [N1 * \text{SMTC periodicity} + 5]$ ms. If the target cell is an unknown inter-frequency cell and signal quality is sufficient for successful cell detection on the first attempt, then $T_{\text{search}} = [N1 * \text{TBD} * \text{SMTC periodicity} + 5]$ ms, else $T_{\text{search}} = [\text{TBD} * \text{SMTC periodicity} + 5]$ ms.

T_{Δ} is time for fine time tracking and acquiring full timing information of the target cell. $T_{\Delta} = 1$ SMTC periodicity ms.

$T_{\text{PSCell_DU}}$ is the delay uncertainty in acquiring the first available PRACH occasion in the PSCell. $T_{\text{PSCell_DU}}$ is up to $x * 10 + 10$ ms. x is defined in the table 6.3.3.2-2 of [6].

In FR1, the PSCell is known if it has been meeting the following conditions:

During the last 5 seconds before the reception of the PSCell configuration command:

- the UE has sent a valid measurement report for the PSCell being configured and
- One of the SSBs measured from the PSCell being configured remains detectable according to the cell identification conditions specified in section 9.3,
- One of the SSBs measured from PSCell being configured also remains detectable during the PSCell configuration delay according to the cell identification conditions specified in section 9.3.

otherwise it is unknown.

The PCell interruption specified in section 8.2 is allowed only during the RRC reconfiguration procedure [2].

Editor's note: The definition of known cell in FR2 is TBD.

Editor's note: It is FFS whether SRS carrier based switching during PSCell addition procedure impacts PSCell addition delay requirement.

Editor's note: It is FFS whether delay uncertainty due to PCell PRACH preamble transmission has an impact on $T_{\text{config_PSCell}}$.

8.9.3 PSCell Release Delay Requirement

The requirements in this section shall apply for a UE which is configured with PCell and one PSCell.

Upon receiving PSCell release in subframe n , the UE shall accomplish the release actions specified in [2] no later than in subframe $n + T_{\text{RRC_delay}}$:

Where

$T_{\text{RRC_delay}}$ is the RRC procedure delay as specified in [2].

The PCell interruption specified in section 8.2 is allowed only during the RRC reconfiguration procedure [2].

Editor's note: It is FFS whether SRS carrier based switching during PSCell release procedure impacts PSCell release delay requirement.

9 Measurement Procedure

9.1 General measurement requirement

9.1.1 Introduction

This clause contains general requirements on the UE regarding measurement reporting in RRC_CONNECTED state. The requirements are split in intra-frequency, inter-frequency, inter-RAT E-UTRAN FDD, inter-RAT E-UTRAN TDD, and L1-RSRP measurements requirements. These measurements may be used by the NG-RAN. The measurement quantities are defined in TS38.215[4], the measurement model is defined in TS38.300[10], TS37.340[17] and measurement accuracies are specified in clause 10. Control of measurement reporting is specified in [16].

In the requirements of Section 9, the exceptions for side conditions apply as follows:

- for the UE capable of CA but not configured with any SCell, the applicable exceptions for side conditions are specified in Annex B, Section B.3.2.1 for UE supporting CA in FR1, and Section B.3.2.3 for UE supporting CA in FR2, respectively;
- for the UE capable of CA and configured with at least one SCell, the applicable exceptions for side conditions are specified in Annex B, Section B.3.2.2 for UE configured with CA in FR1, and Section B.3.2.4 for UE supporting CA in FR2 respectively;
- for the UE capable of SUL but not configured with SUL, the applicable exceptions for side conditions are specified in Annex B, Section B.3.4.1 for UE supporting SUL in FR1;
- for the UE capable of SUL and configured with at least one SUL, the applicable exceptions for side conditions are specified in Annex B, Section B.3.4.2 for UE configured with SUL in FR1.

9.1.2 Measurement gap

If the UE requires measurement gaps to identify and measure intra-frequency cells and/or inter-frequency cells and/or inter-RAT E-UTRAN cells, and the UE does not support independent measurement gap patterns for different frequency

ranges as specified in Table 5.1-1 in [18, 19, 20], in order for the requirements in the following subsections to apply the network must provide a single per-UE measurement gap pattern for concurrent monitoring of all frequency layers.

If the UE requires measurement gaps to identify and measure intra-frequency cells and/or inter-frequency cells and/or inter-RAT E-UTRAN cells, and the UE supports independent measurement gap patterns for different frequency ranges as specified in Table 5.1-1 in [18, 19, 20], in order for the requirements in the following subsections to apply the network must provide either per-FR measurement gap patterns for frequency range where UE requires per-FR measurement gap for concurrent monitoring of all frequency layers of each frequency range independently, or a single per-UE measurement gap pattern for concurrent monitoring of all frequency layers of all frequency ranges.

During the per-UE measurement gaps the UE:

- is not required to conduct reception/transmission from/to the corresponding E-UTRAN PCell, E-UTRAN SCell(s) and NR serving cells for E-UTRA-NR dual connectivity except the reception of signals used for RRM measurement
- is not required to conduct reception/transmission from/to the corresponding NR serving cells for SA (with single carrier or CA configured) except the reception of signals used for RRM measurement
- is not required to conduct reception/transmission from/to the corresponding PCell, SCell(s) and E-UTRAN serving cells for NR-E-UTRA dual connectivity except the reception of signals used for RRM measurement
- is not required to conduct reception/transmission from/to the corresponding NR serving cells for NR-DC except the reception of signals used for RRM measurement

During the per-FR measurement gaps the UE:

- is not required to conduct reception/transmission from/to the corresponding E-UTRAN PCell, E-UTRAN SCell(s) and NR serving cells in the corresponding frequency range for E-UTRA-NR dual connectivity except the reception of signals used for RRM measurement
- is not required to conduct reception/transmission from/to the corresponding NR serving cells in the corresponding frequency range for SA (with single carrier or CA configured) except the reception of signals used for RRM measurement
- is not required to conduct reception/transmission from/to the corresponding PCell, SCell(s) and E-UTRAN serving cells in the corresponding frequency range for NR-E-UTRA dual connectivity except the reception of signals used for RRM measurement
- is not required to conduct reception/transmission from/to the corresponding NR serving cells in the corresponding frequency range for NR-DC except the reception of signals used for RRM measurement

UEs shall support the measurement gap patterns listed in Table 9.1.2-1 based on the applicability specified in table 9.1.2-2 and 9.1.2-3. UE determines measurement gap timing based on gap offset configuration and measurement gap timing advance configuration provided by higher layer signalling as specified in [2] and [16].

Table 9.1.2-1: Gap Pattern Configurations

Gap Pattern Id	Measurement Gap Length (MGL, ms)	Measurement Gap Repetition Period (MGRP, ms)
0	6	40
1	6	80
2	3	40
3	3	80
4	6	20
5	6	160
6	4	20
7	4	40
8	4	80
9	4	160
10	3	20
11	3	160
12	5.5	20
13	5.5	40
14	5.5	80
15	5.5	160
16	3.5	20
17	3.5	40
18	3.5	80
19	3.5	160
20	1.5	20
21	1.5	40
22	1.5	80
23	1.5	160

Table 9.1.2-2: Applicability for Gap Pattern Configurations supported by the E-UTRA-NR dual connectivity UE or NR-E-UTRA dual connectivity UE

Measurement gap pattern configuration	Serving cell	Measurement Purpose	Applicable Gap Pattern Id
Per-UE measurement gap	E-UTRA + FR1, or E-UTRA + FR2, or E-UTRA + FR1 + FR2	non-NR RAT ^{Note1,2}	0,1,2,3
		FR1 and/or FR2	0-11
		non-NR RAT ^{Note1,2} and FR1 and/or FR2	0, 1, 2, 3, 4, 6, 7, 8,10
Per FR measurement gap	E-UTRA and, FR1 if configured	non-NR RAT ^{Note1,2}	0,1,2,3
	FR2 if configured		No gap
	E-UTRA and, FR1 if configured	FR1 only	0-11
	FR2 if configured		No gap
	E-UTRA and, FR1 if configured	FR2 only	No gap
	FR2 if configured		12-23
	E-UTRA and, FR1 if configured	non-NR RAT ^{Note1,2} and FR1	0, 1, 2, 3, 4, 6, 7, 8,10
	FR2 if configured		No gap
	E-UTRA and, FR1 if configured	FR1 and FR2	0-11
	FR2 if configured		12-23
	E-UTRA and, FR1 if configured	non-NR RAT ^{Note1,2} and FR2	0, 1, 2, 3, 4, 6, 7, 8,10
	FR2 if configured		12-23
	E-UTRA and, FR1 if configured	non-NR RAT ^{Note1,2} and FR1 and FR2	0, 1, 2, 3, 4, 6, 7, 8,10
FR2 if configured	12-23		

Note: In E-UTRA-NR dual connectivity mode, if GSM or UTRA TDD or UTRA FDD inter-RAT frequency layer is configured to be monitored, only measurement gap pattern #0 and #1 can be used for per-FR gap in E-UTRA and FR1 if configured, or for per-UE gap.

NOTE 1: In E-UTRA-NR dual connectivity mode, non-NR RAT includes E-UTRA, UTRA and/or GSM.

In NR-E-UTRA dual connectivity mode, non-NR RAT means E-UTRA.

NOTE 2: In E-UTRA-NR dual connectivity mode, the gap patterns with short MGL (gap pattern #2, 3, 6, 7, 8, 10) are supported by UEs which support shortMeasurementGap-r14. In NR-E-UTRA dual connectivity mode, the measurement gap pattern #2, 3, 6, 7, 8, 10 are supported by the UEs which indicate the capability signalling of supportedGapPattern to network.

NOTE 3: When E-UTRA inter-frequency RSTD measurements are configured and the UE requires measurement gaps for performing such measurements, only Gap Pattern #0 can be used.

In E-UTRA-NR dual connectivity mode,

- if per-UE measurement gap is configured with MG timing advance of T_{MG} ms, the measurement gap starts at time T_{MG} ms advanced to the end of the latest E-UTRA subframe occurring immediately before the configured measurement gap among MCG serving cells subframes.
- if per-FR measurement gap for FR1 is configured with MG timing advance of T_{MG} ms, the measurement gap for FR1 starts at time T_{MG} ms advanced to the end of the latest E-UTRA subframe occurring immediately before the configured measurement gap among MCG serving cells subframes.
- if per-FR measurement gap for FR2 is configured with MG timing advance of T_{MG} ms, the measurement gap for FR2 starts at time T_{MG} ms advanced to the end of the latest NR subframe occurring immediately before the configured measurement gap among SCG serving cells subframes in FR2.

In NR-E-UTRA dual connectivity mode,

- if per-UE measurement gap is configured with MG timing advance of T_{MG} ms, the measurement gap starts at time T_{MG} ms advanced to the end of the latest NR subframe occurring immediately before the configured measurement gap among MCG serving cells subframes.
- if per-FR measurement gap for FR1 is configured with MG timing advance of T_{MG} ms and UE has NR serving cell in FR1, the measurement gap for FR1 starts at time T_{MG} ms advanced to the end of the latest NR subframe occurring immediately before the configured measurement gap among MCG serving cells subframes in FR1.
- if per-FR measurement gap for FR1 is configured with MG timing advance of T_{MG} ms and UE doesn't have NR serving cell in FR1, the measurement gap for FR1 starts at time T_{MG} ms advanced to the end of the latest E-UTRA subframe occurring immediately before the configured measurement gap among SCG serving cells subframes.
- if per-FR measurement gap for FR2 is configured with MG timing advance of T_{MG} ms, the measurement gap for FR2 starts at time T_{MG} ms advanced to the end of the latest NR subframe occurring immediately before the configured measurement gap among MCG serving cells subframes in FR2.

T_{MG} is the MG timing advance value provided in *mgta* according to [2].

In determining the measurement gap starting point, UE shall use the DL timing of the latest E-UTRA or NR subframe occurring immediately before the configured measurement gap among E-UTRA or NR serving cells.

In NR-NR dual connectivity mode,

- If per-UE measurement gap is configured with MG timing advance of T_{MG} ms, the measurement gap starts at time T_{MG} ms advanced to the end of the latest MCG subframe occurring immediately before the configured measurement gap among MCG serving cells subframes.
- If per-FR measurement gap for FR1 is configured with MG timing advance of T_{MG} ms, the measurement gap for FR1 starts at time T_{MG} ms advanced to the end of the latest MCG subframe occurring immediately before the configured measurement gap among MCG serving cells subframes.
- If per-FR measurement gap for FR2 is configured with MG timing advance of T_{MG} ms, the measurement gap for FR2 starts at time T_{MG} ms advanced to the end of the latest SCG subframe occurring immediately before the configured measurement gap among SCG serving cells subframes in FR2.

Editor's Note: NR-DC in Rel-15 only includes the scenarios where all serving cells in MCG in FR1 and all serving cells in SCG in FR2.

For per-FR measurement gap capable UE configured with E-UTRA-NR dual connectivity or NR-E-UTRA dual connectivity, when serving cells are in E-UTRA and FR1, measurement objects are in both E-UTRA /FR1 and FR2,

- If MN indicates UE that the measurement gap from MN applies to E-UTRA/FR1/FR2 serving cells, UE fulfils the per-UE measurement requirements for both E-UTRA/FR1 and FR2 measurement objects based on the measurement gap pattern configured by MN;
- If MN indicates UE that the measurement gap from MN applies to only LTE/FR1 serving cell(s),
 - UE fulfils the measurement requirements for FR1/LTE measurement objects based on the configured measurement gap pattern;
 - UE fulfils the requirements for FR2 measurement objects based on effective MGRP=20ms;

For per-FR measurement gap capable configured with E-UTRA-NR dual connectivity, NR-E-UTRA dual connectivity or NR-NR dual connectivity, when serving cells are in E-UTRA, FR1 and FR2, or in E-UTRA and FR2, or in FR1 and FR2, measurement objects are in both E-UTRA /FR1 and FR2,

- If MN indicates UE that the measurement gap from MN applies to E-UTRA/FR1/FR2 serving cells, UE fulfils the per-UE measurement requirements for both E-UTRA/FR1 and FR2 measurement objects based on the measurement gap pattern configured by MN.

Table 9.1.2-3: Applicability for Gap Pattern Configurations supported by the UE with NR standalone operation (with single carrier, NR CA and NR-DC configuration)

Measurement gap pattern configuration	Serving cell	Measurement Purpose ^{NOTE 2}	Applicable Gap Pattern Id	
Per-UE measurement gap	FR1 ^{NOTE5} , or FR1 + FR2	E-UTRA only ^{NOTE3}	0,1,2,3	
		FR1 and/or FR2	0-11	
		E-UTRAN and FR1 and/or FR2 ^{NOTE3}	0, 1, 2, 3, 4, 6, 7, 8,10	
	FR2 ^{NOTE5}	E-UTRA only ^{NOTE3}	0,1,2,3	
		FR1 only	0-11	
		FR1 and FR2	0-11	
		E-UTRAN and FR1 and/or FR2 ^{NOTE3}	0, 1, 2, 3, 4, 6, 7, 8,10	
		FR2 only	12-23	
	Per FR measurement gap	FR1 if configured	E-UTRA only ^{NOTE3}	0,1,2,3
		FR2 if configured		No gap
FR1 if configured		FR1 only	0-11	
FR2 if configured			No gap	
FR1 if configured		FR2 only	No gap	
FR2 if configured			12-23	
FR1 if configured		E-UTRA and FR1 ^{NOTE3}	0, 1, 2, 3, 4, 6, 7, 8,10	
FR2 if configured			No gap	
FR1 if configured		FR1 and FR2	0-11	
FR2 if configured			12-23	
FR1 if configured		E-UTRA and FR2 ^{NOTE3}	0, 1, 2, 3, 4, 6, 7, 8,10	
FR2 if configured			12-23	
FR1 if configured		E-UTRA and FR1 and FR2 ^{NOTE3}	0, 1, 2, 3, 4, 6, 7, 8,10	
FR2 if configured	12-23			

- NOTE 1: When E-UTRA inter-RAT RSTD measurements are configured and the UE requires measurement gaps for performing such measurements, only Gap Pattern #0 can be used.
- NOTE 2: Measurement purpose which includes E-UTRA measurements includes also inter-RAT E-UTRA RSRP and RSRQ measurements for E-CID
- NOTE 3: The measurement gap pattern #2, 3, 6, 7, 8, 10 are supported by the UEs which indicate the capability signalling of supportedGapPattern to network.
- NOTE 4: If per-UE measurement gap is configured with MG timing advance of T_{MG} ms, the measurement gap starts at time T_{MG} ms advanced to the end of the latest subframe occurring immediately before the configured measurement gap among all serving cells subframes.
 If per-FR measurement gap for FR1 is configured with MG timing advance of T_{MG} ms, the measurement gap for FR1 starts at time T_{MG} ms advanced to the end of the latest subframe occurring immediately before the configured measurement gap among serving cells subframes in FR1.
 If per-FR measurement gap for FR2 is configured with MG timing advance of T_{MG} ms, the measurement gap for FR2 starts at time T_{MG} ms advanced to the end of the latest subframe occurring immediately before the configured measurement gap among serving cells subframes in FR2.
 T_{MG} is the MG timing advance value provided in *mgta* according to [2].
 In determining the measurement gap starting point, UE shall use the DL timing of the latest subframe occurring immediately before the configured measurement gap among serving cells.
- NOTE 5: NR-DC in Rel-15 only includes the scenarios where all serving cells in MCG in FR1 and all serving cells in SCG in FR2.

For per-FR measurement gap capable UE in NR standalone operation (with single carrier, NR CA and NR-DC configuration), for per-FR gap based measurement, when there is no serving cell in a particular FR, where measurement objects are configured, regardless if explicit per-FR measurement gap is configured in this FR, the effective MGRP in this FR used to determine requirements;

- 20ms for FR2 NR measurements
- 40ms for FR1 NR measurements
- 40ms for LTE measurements
- 40ms for FR1+LTE measurements

For per-FR measurement gap capable UE in NR standalone operation (with single carrier, NR CA and NR-DC configuration), when serving cells are in FR1 or FR2, measurement objects are in both E-UTRA /FR1 and FR2,

- If MN indicates UE that the measurement gap from MN applies to E-UTRA/FR1/FR2 serving cells, UE fulfils the per-UE measurement requirements for both E-UTRA/FR1 and FR2 measurement objects based on the measurement gap pattern configured by MN;

If measurement gap is configured in one FR but measurement object is not configured in the FR, the scheduling opportunity in the FR depends on the configured measurement gap pattern.

For E-UTRA-NR dual connectivity, if UE is not capable of per-FR-gap, total interruption time on SCG during MGL is defined only when $MGL(N) = 6ms, 4ms$ and $3ms$. And if UE is capable of per-FR-gap, total interruption time on FR1 serving cells in SCG during MGL is defined only when $MGL(N) = 6ms, 4ms$ and $3ms$, and total interruption time on FR2 serving cells in SCG during MGL is defined only when $MGL(N) = 5.5ms, 3.5ms$ and $1.5ms$, given that the reference time for per-FR gap in FR2 is based on an FR2 serving cell.

For NR standalone operation (with single carrier, NR CA and NR-DC configuration), if UE is not capable of per-FR-gap, total interruption time on a serving cell during MGL is defined when $MGL(N) = 6ms, 5.5ms, 4ms, 3.5ms, 3ms,$ and $1.5ms$. And if UE is capable of per-FR-gap, total interruption time on FR1 serving cells during MGL is defined only when $MGL(N) = 6ms, 4ms$ and $3ms$, and total interruption time on FR2 serving cells during MGL is defined only when $MGL(N) = 5.5ms, 3.5ms$ and $1.5ms$, given that the reference time for per-FR gap in FR2 is based on an FR2 serving cell.

For NR-E-UTRA dual connectivity, if UE is not capable of per-FR-gap, total interruption time on MCG during MGL is defined only when $MGL(N) = 6ms, 4ms$ and $3ms$. And if UE is capable of per-FR-gap, total interruption time on FR1 serving cells in MCG during MGL is defined only when $MGL(N) = 6ms, 4ms$ and $3ms$, and total interruption time on FR2 serving cells in MCG during MGL is defined only when $MGL(N) = 5.5ms, 3.5ms$ and $1.5ms$, given that the reference time for per-FR gap in FR2 is based on an FR2 serving cell.

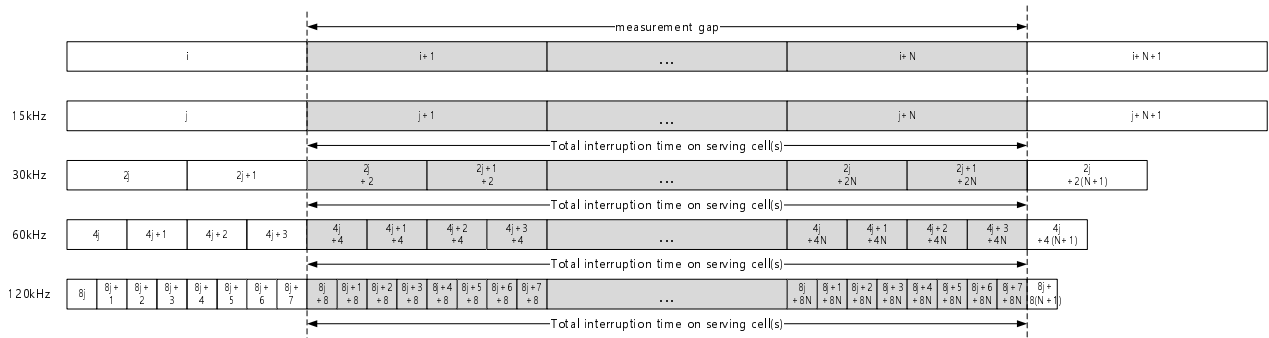

(a) Measurement gap with MGL = N (ms) with MG timing advance of 0ms for synchronous EN-DC, NR standalone operation (with single carrier, NR CA and NR-DC configuration) and synchronous NE-DC

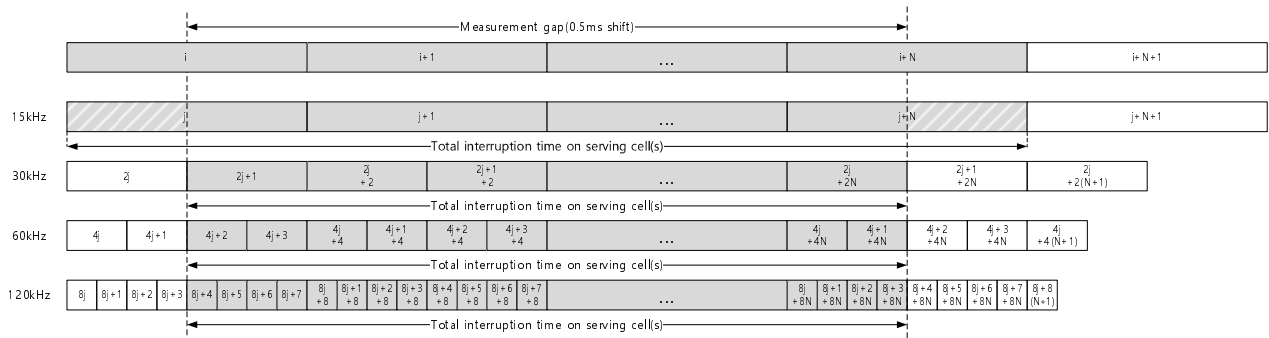

(b) Measurement gap with MGL = N (ms) with MG timing advance of 0.5ms for synchronous EN-DC, NR standalone operation (with single carrier, NR CA and NR-DC configuration) and synchronous NE-DC

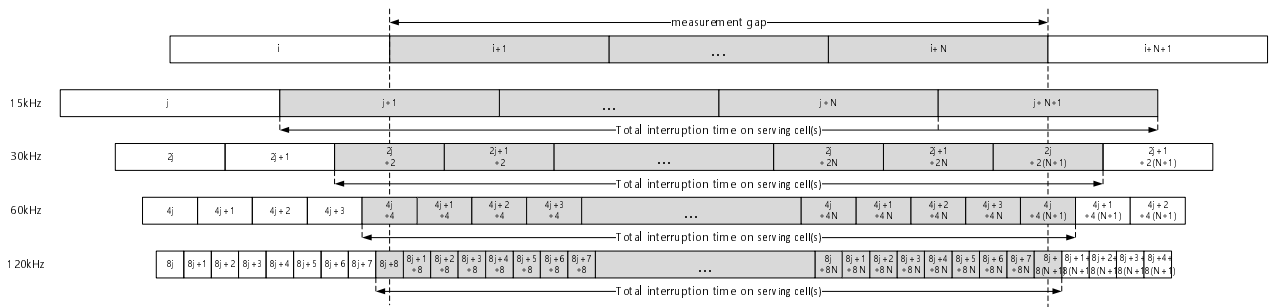

(c) Measurement gap with MGL = N (ms) with MG timing advance of 0ms for asynchronous EN-DC and asynchronous NE-DC

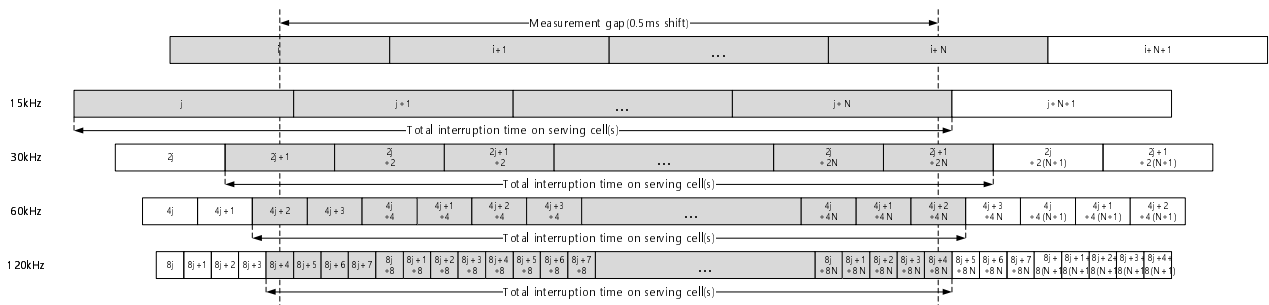

(d) Measurement gap with MGL = N (ms) with MG timing advance of 0.5ms for asynchronous EN-DC and asynchronous NE-DC

Figure 9.1.2-1: Measurement GAP and total interruption time on serving cells for EN-DC, NR standalone operation (with single carrier, NR CA and NR-DC configuration) and NE-DC

The corresponding total number of interrupted slots on serving cells is listed in Table9.1.2-4 and Table9.1.2-4a for synchronous EN-DC, NR standalone and synchronous NE-DC, and asynchronous EN-DC and asynchronous NE-DC respectively.

Table 9.1.2-4: Total number of interrupted slots on serving cells during MGL for Synchronous EN-DC ,NR standalone operation (with single carrier, NR CA and NR-DC configuration) and Synchronous NE-DC with per-UE measurement gap or per-FR measurement gap for FR1

NR SCS (kHz)	Total number of interrupted slots on serving cells					
	When MG timing advance of 0ms is applied			When MG timing advance of 0.5ms is applied		
	MGL=6ms	MGL=4ms	MGL=3ms	MGL=6ms	MGL=4ms	MGL=3ms
15	6	4	3	7 ^{Note3}	5 ^{Note3}	4 ^{Note3}
30	12	8	6	12	8	6
60	24	16	12	24	16	12
120	48	32	24	48	32	24
NOTE 1: For Gap Pattern ID 0, 1, 2 and 3, total number of interrupted subframes on MCG is MGL subframes when MG timing advance of 0ms is applied, and (MGL+1) subframes when MG timing advance of 0.5ms is applied.						
NOTE 2: NR SCS of 120 kHz is only applicable to the case with per-UE measurement gap.						
NOTE 3: Non-overlapped half-slots occur before and after the measurement gap. Whether a Rel-15 UE can receive and/or transmit in those half-slots is up to UE implementation.						

Table 9.1.2-4a: Total number of interrupted slots on serving cells during MGL for Asynchronous EN-DC and Asynchronous NE-DC with per-UE measurement gap or per-FR measurement gap for FR1

NR SCS (kHz)	Total number of interrupted slots on serving cells					
	When MG timing advance of 0ms is applied			When MG timing advance of 0.5ms is applied		
	MGL=6ms	MGL=4ms	MGL=3ms	MGL=6ms	MGL=4ms	MGL=3ms
15	7	5	4	7	5	4
30	13	9	7	13	9	7
60	25	17	13	25	17	13
120	49	33	25	49	33	25
NOTE 1: For Gap Pattern ID 0, 1, 2 and 3, total number of interrupted subframes on MCG is MGL subframes when MG timing advance of 0ms is applied, and (MGL+1) subframes when MG timing advance of 0.5ms is applied.						
NOTE 2: NR SCS of 120 kHz is only applicable to the case with per-UE measurement gap.						

In case that UE capable of per-FR measurement gap is configured with per-FR measurement gap for FR2 serving cells, total number of interrupted slots on FR2 serving cells during MGL is listed in Table9.1.2-4b.

Table 9.1.2-4b: Total number of interrupted slots on FR2 serving cells during MGL for EN-DC, NR standalone operation (with single carrier, NR CA and NR-DC configuration) and NE-DC with per-UE measurement gap or per-FR measurement gap for FR2

NR SCS (kHz)	Total number of interrupted slots on FR2 serving cells					
	When MG timing advance of 0ms is applied			When MG timing advance of 0.25ms is applied		
	MGL=5.5ms	MGL=3.5ms	MGL=1.5ms	MGL=5.5ms	MGL=3.5ms	MGL=1.5ms
60	22	14	6	22	14	6
120	44	28	12	44	28	12

When MGTA is not applied, in the slot with respect to the SCS of each UL carrier occurring immediately after measurement gap and fully non-overlapped with measurement gap, or

When MGTA is applied, in the slot with respect to the SCS of each UL carrier occurring immediately after the slot partially overlapped with measurement gap,

- It is up to UE implementation whether or not the UE is able to conduct transmission if all the symbols in the slot are uplink symbols.

Editor notes: FFS if very large TA is applied.

Table 9.1.2-5: (Void)

9.1.2.1 NSA: Measurement Gap Sharing

For E-UTRA-NR dual connectivity UE configured with per-UE measurement gap, measurement gap sharing shall be applied when UE requires measurement gaps to identify and measure cells on intra-frequency carriers or when SMTC configured for intra-frequency measurement are fully overlapping with per-UE measurement gaps, and when UE is configured to identify and measure cells on inter-frequency carriers, E-UTRA gap-needed inter-frequency carriers and inter-RAT UTRAN carriers and/or inter-RAT GSM carriers.

For E-UTRA-NR dual connectivity UE configured with per-FR1 measurement gap, measurement gap sharing shall be applied when UE requires measurement gaps to identify and measure cells on FR1 intra-frequency carriers or when SMTC configured for FR1 intra-frequency measurement are fully overlapping with per-FR1 measurement gaps, and when UE is configured to identify and measure cells on FR1 inter-frequency carriers, E-UTRA gap-needed inter-frequency carriers, inter-RAT UTRAN carriers and/or inter-RAT GSM carriers.

For E-UTRA-NR dual connectivity UE configured with per-FR2 measurement gap, measurement gap sharing shall be applied when UE requires measurement gaps to identify and measure cells on FR2 intra-frequency carriers or when SMTC configured for FR2 intra-frequency measurement are fully overlapping with per-FR2 measurement gaps, and when UE is configured to identify and measure cells on FR2 inter-frequency carriers.

When network signals “01”, “10” or “11” with RRC parameter *MeasGapSharingScheme* [2][16] and the value of X is defined as in Table 9.1.2.1-1, and

- $K_{\text{intra}} = 1 / X * 100$,
- $K_{\text{inter}} = 1 / (100 - X) * 100$,

When network signals “00” indicating equal splitting gap sharing, X is not applied.

The RRC parameter *MeasGapSharingScheme* shall be applied to the calculation of carrier specific scaling factor as specified in clause 9.1.5.2.1.

Table 9.1.2.1-1: Value of parameter X for EN-DC measurement gap sharing

<i>measGapSharingScheme</i>	Value of X (%)
'00'	Equal splitting
'01'	25
'10'	50
'11'	75

9.1.2.1a SA: Measurement Gap Sharing

For NR standalone UE without NR-DC operation and configured with per-UE measurement gap, measurement gap sharing shall be applied when UE requires measurement gaps to identify and measure cells on intra-frequency carriers or when SMTC configured for intra-frequency measurement are fully overlapping with per-UE measurement gaps, and when UE is configured to identify and measure cells on inter-frequency carriers, and/or inter-RAT E-UTRAN carriers.

For NR standalone UE without NR-DC operation and configured with per-FR1 measurement gap, measurement gap sharing shall be applied when UE requires measurement gaps to identify and measure cells on FR1 intra-frequency carriers or when SMTC configured for FR1 intra-frequency measurement are fully overlapping with per-FR1 measurement gaps, and when UE is configured to identify and measure cells on FR1 inter-frequency carriers and/or inter-RAT E-UTRAN carriers.

For NR standalone UE without NR-DC operation and configured with per-FR2 measurement gap, measurement gap sharing shall be applied when UE requires measurement gaps to identify and measure cells on FR2 intra-frequency

carriers or when SMTC configured for FR2 intra-frequency measurement are fully overlapping with per-FR2 measurement gaps, and when UE is configured to identify and measure cells on FR2 inter-frequency carriers.

When network signals “01”, “10” or “11” with RRC parameter *MeasGapSharingScheme* [2] and the value of X is defined as in Table 9.1.2.1a-1, and

- $K_{\text{intra}} = 1 / X * 100$,
- $K_{\text{inter}} = 1 / (100 - X) * 100$,

When network signals “00” indicating equal splitting gap sharing, X is not applied.

The RRC parameter *MeasGapSharingScheme* shall be applied to the calculation of carrier specific scaling factor as specified in clause 9.1.5.2.2.

Table 9.1.2.1a-1: Value of parameter X for NR standalone measurement gap sharing

<i>measGapSharingScheme</i>	Value of X (%)
'00'	Equal splitting
'01'	25
'10'	50
'11'	75

9.1.2.1b NE-DC: Measurement Gap Sharing

Editor notes: the measurement gap mechanism for NE-DC is FFS.

9.1.2.1c NR-DC: Measurement Gap Sharing

Editor notes: the measurement gap mechanism for NR-DC is FFS.

9.1.3 UE Measurement capability

9.1.3.1 NSA: Monitoring of multiple layers using gaps

The requirements in this section are applicable for UE capable of and configured with the EN-DC operation mode.

When monitoring of multiple inter-frequency E-UTRAN, inter-RAT NR, GSM, UTRA FDD and UTRA TDD carriers as configured by E-UTRA PCell, and inter-frequency NR carriers as configured by PSCell using gaps (or without using gaps provided the UE supports such capability) is configured, the UE shall be capable of performing one measurement of the configured measurement type (SS-RSRP, SS-RSRQ, SS-SINR, SFTD, E-UTRAN RSRP, E-UTRAN RSRQ, E-UTRAN RS-SINR measurements, UTRAN TDD P-CCPCH RSCP, UTRAN FDD CPICH measurements, GSM carrier RSSI, etc.) of detected cells on all the layers.

For UE configured with the EN-DC operation, the effective total number of frequencies excluding the frequencies of the PSCell, SCells, E-UTRA PCell, and E-UTRA SCells being monitored is $N_{\text{freq, EN-DC}}$, which is defined as:

$$N_{\text{freq, EN-DC}} = N_{\text{freq, EN-DC, NR}} + N_{\text{freq, EN-DC, E-UTRA}} + N_{\text{freq, EN-DC, UTRA}} + M_{\text{EN-DC, GSM}},$$

where

$N_{\text{freq, EN-DC, E-UTRA}}$ is the number of E-UTRA inter-frequency carriers being monitored (FDD and TDD) as configured by E-UTRA PCell or via LPP [22],

$$N_{\text{freq, EN-DC, NR}} \leq N_{\text{freq, EN-DC, NR, inter-RAT}} + N_{\text{freq, EN-DC, NR, inter-freq}}$$

where

$N_{\text{freq, EN-DC, NR, inter-RAT}}$ is the number of NR inter-RAT carriers excluding NR serving carrier(s) being monitored as configured by E-UTRA PCell [15],

$N_{\text{freq, EN-DC, NR, inter-freq}}$ is the number of NR inter-frequency carriers being monitored as configured by PSCell,

$N_{\text{freq, EN-DC, UTRA}}$ is the number of UTRA inter-RAT carriers being monitored as configured by E-UTRA PCell (FDD and TDD).

$M_{\text{EN-DC, GSM}}$ is an integer which is a function of the number of GSM inter-RAT carriers as configured by E-UTRA PCell on which measurements are being performed. $M_{\text{EN-DC, GSM}}$ is equal to 0 if no GSM carrier is being monitored. For a MGRP of 40 ms, $M_{\text{EN-DC, GSM}}$ is equal to 1 if cells on up to 32 GSM carriers are being measured. For a MGRP of 80 ms, $M_{\text{EN-DC, GSM}}$ is equal to $\text{ceil}(N_{\text{carriers, GSM}}/20)$ where $N_{\text{carriers, GSM}}$ is the number of GSM carriers on which cells are being measured.

9.1.3.1a SA: Monitoring of multiple layers using gaps

The requirements in this section are applicable for UE configured with SA NR operation mode.

When monitoring of multiple inter-RAT E-UTRAN carriers and inter-frequency NR carriers using gaps (or without using gaps provided the UE supports such capability) is configured by PCell, the UE shall be capable of performing one measurement of the configured measurement type (SS-RSRP, SS-RSRQ, SS-SINR, E-UTRAN RSRP, E-UTRAN RSRQ, E-UTRAN RS-SINR measurements, etc.) of detected cells on all the layers.

For UE configured with the NR SA operation, the effective total number of frequencies, excluding the frequencies of the PCell, PSCell and SCells being monitored, is $N_{\text{freq, SA}}$, which is defined as:

$$N_{\text{freq, SA}} = N_{\text{freq, SA, NR}} + N_{\text{freq, SA, E-UTRA}},$$

where

$N_{\text{freq, SA, E-UTRA}}$ is the number of E-UTRA inter-RAT carriers being monitored (FDD and TDD) as configured by PCell or via LPP [22],

$N_{\text{freq, SA, NR}}$ is the number of NR inter-frequency carriers being monitored as configured by PCell.

9.1.3.1b NE-DC: Monitoring of multiple layers using gaps

The requirements in this section are applicable for UE capable of and configured with the NE-DC operation mode.

When monitoring of multiple inter-frequency E-UTRAN carriers as configured by E-UTRA PSCell, inter-RAT E-UTRAN carriers as configured by PCell, and inter-frequency NR carriers as configured by PCell using gaps (or without using gaps provided the UE supports such capability) is configured, the UE shall be capable of performing one measurement of the configured measurement type (SS-RSRP, SS-RSRQ, SS-SINR, SFTD, E-UTRAN RSRP, E-UTRAN RSRQ, and E-UTRAN RS-SINR measurements, etc.) of detected cells on all the layers.

For UE configured with the NE-DC operation, the effective total number of frequencies excluding the frequencies of the PCell, SCells, E-UTRA PSCell, and E-UTRA SCells being monitored is $N_{\text{freq, NE-DC}}$, which is defined as:

$$N_{\text{freq, NE-DC}} = N_{\text{freq, NE-DC, NR}} + N_{\text{freq, NE-DC, E-UTRA}},$$

where

$N_{\text{freq, NE-DC, NR}}$ is the number of NR inter-frequency carriers being monitored as configured by PCell,

$$N_{\text{freq, NE-DC, E-UTRA}} \leq N_{\text{freq, NE-DC, E-UTRA, inter-RAT}} + N_{\text{freq, NE-DC, E-UTRA, inter-freq}}$$

where

$N_{\text{freq, NE-DC, E-UTRA, inter-RAT}}$ is the number of E-UTRA inter-RAT carriers (FDD and TDD) excluding E-UTRA serving carrier(s) being monitored as configured by E-UTRA PSCell [15] or via LPP [22],

$N_{\text{freq, NE-DC, E-UTRA, inter-freq}}$ is the number of E-UTRA inter-frequency carriers (FDD and TDD) being monitored as configured by PCell or via LPP [22].

9.1.3.1c NR-DC: Monitoring of multiple layers using gaps

The requirements in this section are applicable for UE configured with NR-DC operation mode.

When monitoring of multiple inter-RAT E-UTRAN carriers and inter-frequency NR carriers using gaps (or without using gaps provided the UE supports such capability) is configured by PCell, the UE shall be capable of performing one measurement of the configured measurement type (SS-RSRP, SS-RSRQ, SS-SINR, E-UTRAN RSRP, E-UTRAN RSRQ, E-UTRAN RS-SINR measurements, etc.) of detected cells on all the layers.

For UE configured with the NR-DC operation, the effective total number of frequencies, excluding the frequencies of the PCell, PSCell and SCells being monitored, is $N_{\text{freq, NR-DC}}$, which is defined as:

$$N_{\text{freq, NR-DC}} = N_{\text{freq, NR-DC, NR}} + N_{\text{freq, NR-DC, E-UTRA}},$$

where

$N_{\text{freq, NR-DC, E-UTRA}}$ is the number of E-UTRA inter-RAT carriers being monitored (FDD and TDD) as configured by PCell or via LPP [22].

$N_{\text{freq, NR-DC, NR}}$ is the number of NR inter-frequency carriers being monitored as configured by PCell and PSCell.

9.1.3.2 NSA: Maximum allowed layers for multiple monitoring

If a UE is configured with EN-DC operation, the UE shall be capable of monitoring at least:

- Depending on UE capability, 7 NR inter-frequency carriers configured by PSCell, and
- Depending on UE capability, 7 NR inter-RAT carriers excluding NR serving carrier(s) configured by E-UTRA PCell [15], and
- Depending on UE capability, 6 E-UTRA TDD inter-frequency carriers configured by E-UTRA PCell [15], and
- Depending on UE capability, 6 E-UTRA FDD inter-frequency carriers configured by E-UTRA PCell [15], and
- Depending on UE capability, 3 FDD UTRA carriers, and
- Depending on UE capability, 3 TDD UTRA carriers, and
- Depending on UE capability, 32 GSM carriers (one GSM layer corresponds to 32 carriers), and
- Depending on UE capability, 1 E-UTRA FDD inter-frequency carrier for RSTD measurements configured via LPP [22], and
- Depending on UE capability, 1 E-UTRA TDD inter-frequency carrier for RSTD measurements configured via LPP [22].

In addition to the requirements defined above, the UE shall be capable of monitoring a total of at least 13 effective carrier frequency layers comprising of any above defined combination of NR, E-UTRA FDD, E-UTRA TDD, UTRA FDD, UTRA TDD and GSM (one GSM layer corresponds to 32 carriers) layers. The UE shall be capable of monitoring a total of at least 7 effective NR carrier frequency layers excluding NR serving carrier(s), comprising of any above defined combination of NR inter-RAT carriers excluding NR serving carrier(s) configured by E-UTRA PCell and NR inter-frequency carriers configured by PSCell.

When the E-UTRA PCell and PSCell configure the same NR carrier frequency layer to be monitored by the UE in synchronous intra-band EN-DC, this layer shall be counted only once to the total number of effective carrier frequency layers provided that the SFN-s and slot boundaries are aligned, unless the configured NR carrier frequency layers to be monitored have

- different RSSI measurement resources or
- different deriveSSB-IndexFromCell indications or
- different SMTC configurations.

Note 1: The E-UTRA-NR dual connectivity capable UE configured with PSCell shall fulfil the requirements defined in only one of Section 9.1.3.2 and Section 8.1.2.1.1b.1 of [15].

Editor's note: FFS when the E-UTRA PCell and PSCell configure the same NR carrier frequency layer to be monitored, whether this layer shall be counted only once under the condition that the UE is configured with differences in SMTC configurations or different useServingCellTimingForSync indications.

9.1.3.2a SA: Maximum allowed layers for multiple monitoring

If a UE is configured with SA NR operation mode, the UE shall be capable of monitoring at least:

- Depending on UE capability, 7 NR inter-frequency carriers configured by PCell, and
- Depending on UE capability, 7 E-UTRA TDD inter-RAT carriers configured by PCell, and
- Depending on UE capability, 7 E-UTRA FDD inter-RAT carriers configured by PCell, and
- Depending on UE capability, 1 E-UTRA FDD inter-RAT carrier for RSTD measurements configured via LPP [22], and
- Depending on UE capability, 1 E-UTRA TDD inter-RAT carrier for RSTD measurements configured via LPP [22].

In addition to the requirements defined above, the UE shall be capable of monitoring a total of at least [13] effective carrier frequency layers comprising of any above defined combination of NR, E-UTRA FDD and E-UTRA TDD layers.

9.1.3.2b NE-DC: Maximum allowed layers for multiple monitoring

If a UE is configured with NE-DC operation mode, the UE shall be capable of monitoring at least:

- Depending on UE capability, 7 NR inter-frequency carriers configured by PCell, and
- Depending on UE capability, 6 E-UTRA TDD inter-frequency carriers configured by E-UTRA PSCell [15], and
- Depending on UE capability, 6 E-UTRA FDD inter-frequency carriers configured by E-UTRA PSCell [15], and
- Depending on UE capability, 1 E-UTRA FDD inter-frequency carrier for RSTD measurements configured via LPP [22], and
- Depending on UE capability, 1 E-UTRA TDD inter-frequency carrier for RSTD measurements configured via LPP [22].

In addition to the requirements defined above, the UE shall be capable of monitoring a total of at least 13 effective carrier frequency layers comprising of any above defined combination of NR, E-UTRA FDD, and E-UTRA TDD layers. The UE shall be capable of monitoring a total of at least 6 effective E-UTRA carrier frequency layers, excluding E-UTRA serving carrier(s), comprising of any above defined combination of E-UTRA inter-RAT carriers excluding E-UTRA serving carrier(s) configured by PCell and E-UTRA inter-frequency carriers configured by E-UTRA PSCell.

Editor's note: FFS when the PCell and E-UTRA PSCell configure the same E-UTRA carrier frequency layer to be monitored.

9.1.3.2c NR-DC: Maximum allowed layers for multiple monitoring

If a UE is configured with PCell and PSCell, the UE shall be capable of monitoring at least:

- Depending on UE capability, 7 NR inter-frequency carriers configured by PCell, and
- Depending on UE capability, 7 NR inter-frequency carriers configured by PSCell, and
- Depending on UE capability, 7 E-UTRA TDD inter-RAT carriers configured by PCell, and
- Depending on UE capability, 7 E-UTRA FDD inter-RAT carriers configured by PCell, and
- Depending on UE capability, 1 E-UTRA FDD inter-RAT carrier for RSTD measurements configured via LPP [22], and
- Depending on UE capability, 1 E-UTRA TDD inter-RAT carrier for RSTD measurements configured via LPP [22].

In addition to the requirements defined above, the UE shall be capable of monitoring a total of at least [TBD] effective carrier frequency layers comprising of any above defined combination of NR, E-UTRA FDD and E-UTRA TDD layers.

Editor's note: FFS when the PCell and PSCell configure the same carrier frequency layer to be monitored.

9.1.4 Capabilities for Support of Event Triggering and Reporting Criteria

9.1.4.1 Introduction

This clause contains requirements on UE capabilities for support of event triggering and reporting criteria. As long as the measurement configuration does not exceed the requirements stated in Section 9.1.4.2, the UE shall meet all other performance requirements defined in Section 9 and Section 10.

The UE can be requested to make measurements under different measurement identities defined in TS 38.331 [2]. Each measurement identity corresponds to either event based reporting, periodic reporting, or no reporting. In case of event based reporting, each measurement identity is associated with an event triggering criterion. In case of periodic reporting, a measurement identity is associated with one periodic reporting criterion. In case of no reporting, a measurement identity is associated with one no reporting criterion.

The purpose of this clause is to set some limits on the number of different event triggering, periodic, and no reporting criteria the UE may be requested to track in parallel.

9.1.4.2 Requirements

In this section a reporting criterion corresponds to either one event (in the case of event based reporting), or one periodic reporting criterion (in case of periodic reporting), or one no reporting criterion (in case of no reporting). For event based reporting, each instance of event, with the same or different event identities, is counted as separate reporting criterion in Table 9.1.4.2-1.

The UE shall be able to support in parallel per category up to E_{cat} reporting criteria according to Table 9.1.4.2-1. For the measurement categories belonging to intra-frequency, inter-frequency, and inter-RAT measurements (i.e. without counting other categories that the UE shall always support in parallel), the UE need not support more than the total number of reporting criteria as follows:

- For UE configured with EN-DC: $E_{cat,NSA,NR} + E_{cat,NSA,E-UTRA}$, where

$E_{cat,NSA,NR} = 10 + 9 \times n$ is the total number of NR reporting criteria applicable for UE configured with EN-DC according to Table 9.1.4.2-1, and n is the number of configured NR serving frequencies, including PCell and SCells carrier frequencies,

$E_{cat,NSA,E-UTRA}$ is the total number of reporting criteria for E-UTRA PCell as specified in TS 36.133 [15] for UE configured with EN-DC,

- For UE configured with NE-DC: $E_{cat,NE-DC,NR} + E_{cat,NE-DC,E-UTRA}$, where

$E_{cat,NE-DC,NR} = 10 + 9 \times n$ is the total number of NR reporting criteria according to Table 9.1.4.2-1, and n is the number of configured NR serving frequencies, including PCell and SCells carrier frequencies,

$E_{cat,NE-DC,E-UTRA} = E_{cat,NE-DC,E-UTRA,inter-RAT} + E_{cat,NE-DC,E-UTRA,inter-freq}$,

$E_{cat,NE-DC,E-UTRA,inter-RAT}$ is the total number of E-UTRA inter-RAT reporting criteria for PCell according to Table 9.1.4.2-1,

$E_{cat,NE-DC,E-UTRA,inter-freq}$ is the total number of reporting criteria for E-UTRA PCell as specified in TS 36.133 [15] for UE configured with NE-DC,

- For UE not configured of EN-DC or NE-DC: $E_{cat,SA,NR} + E_{cat,SA,E-UTRA}$, where

$E_{cat,SA,NR} = 10 + 9 \times n$ is the total number of NR reporting criteria according to Table 9.1.4.2-1, and n is the number of configured NR serving frequencies, including PCell, PSCell and SCells carrier frequencies,

$E_{cat,SA,E-UTRA}$ is the total number of E-UTRA inter-RAT reporting criteria according to Table 9.1.4.2-1.

Table 9.1.4.2-1: Requirements for reporting criteria per measurement category

Measurement category	E _{cat}	Note
Intra-frequency ^{Note 1}	9	Events for any one or a combination of intra-frequency SS-RSRP, SS-RSRQ, and SS-SINR for NG-RAN intra-frequency cells
Inter-frequency	10	Events for any one or a combination of inter-frequency SS-RSRP, SS-RSRQ, and SS-SINR for NG-RAN inter-frequency cells
Inter-RAT (E-UTRA FDD, E-UTRA TDD)	10	Only applicable for UE with this (inter-RAT) capability when the UE is not configured with EN-DC operation.
Inter-RAT (E-UTRA FDD, E-UTRA TDD) RSTD	1	Inter-RAT RSTD measurement reporting for UE supporting OTDOA; 1 report capable of minimum 16 inter-RAT cell measurements. Only applicable for UE with this (inter-RAT RSTD via LPP [22]) capability and when the UE is not configured with EN-DC or NE-DC operation.
Inter-RAT (E-UTRA FDD, E-UTRA TDD) RSRP and RSRQ measurements for E-CID	1	Inter-RAT RSRP and RSRQ measurements for E-CID reported to E-SMLC via LPP [22]. One report capable of at least in total 10 inter-RAT RSRP and RSRQ measurements. Applicable to UE capable of reporting inter-RAT RSRP and RSRQ to E-SMLC via LPP and when the UE is not configured with EN-DC operation.
NOTE 1: When the UE is configured with PCell and SCell carrier frequencies, E _{cat} for Intra-frequency is applied per serving frequency.		

9.1.5 Carrier-specific scaling factor

This clause specifies the derivation of carrier-specific scaling factor (CSSF) values, which scale the measurement delay requirements given in Section 9.2, 9.3 and 9.4 when UE is configured to monitor multiple measurement objects. The CSSF values are categorized into $CSSF_{\text{outside_gap},i}$ and $CSSF_{\text{within_gap},i}$, for the measurements conducted outside measurement gaps and within measurement gaps, respectively.

9.1.5.1 Monitoring of multiple layers outside gaps

The carrier-specific scaling factor $CSSF_{\text{outside_gap},i}$ for measurement object i derived in this chapter is applied to following measurement types:

- Intra-frequency measurement with no measurement gap in Section 9.2.5, when none of the SMTC occasions of this intra-frequency measurement object are overlapped by the measurement gap.
- Intra-frequency measurement with no measurement gap in Section 9.2.5, when part of the SMTC occasions of this intra-frequency measurement object are overlapped by the measurement gap.

UE is expected to conduct the measurement of this measurement object i only outside the measurement gaps.

If the higher layer signaling in TS 38.331 [2] signaling of *smtc2* is present and *smtc1* is fully overlapping with measurement gaps and *smtc2* is partially overlapping with measurement gaps, $CSSF_{\text{outside_gap},i}$ and requirements derived from $CSSF_{\text{outside_gap},i}$ are not specified.

9.1.5.1.1 NSA mode: carrier-specific scaling factor for SSB-based measurements performed outside gaps

For UE configured with the E-UTRA-NR dual connectivity operation, the carrier-specific scaling factor $CSSF_{\text{outside_gap},i}$ for intra-frequency SSB-based measurements performed outside measurements gaps will be as specified in Table 9.1.5.1.1-1.

Table 9.1.5.1.1-1: $CSSF_{outside_gap,i}$ scaling factor in NSA mode

Scenario	$CSSF_{outside_gap,p,i}$ for FR1 PSCC	$CSSF_{outside_gap,i}$ for FR1 SCC	$CSSF_{outside_gap,i}$ for FR2 PSCC	$CSSF_{outside_gap,i}$ for FR2 SCC where neighbour cell measurement is required ^{Note 2}	$CSSF_{outside_gap,i}$ for FR2 SCC where neighbour cell measurement is not required
EN-DC with FR1 only CA	1	Number of configured FR1 SCell(s)	N/A	N/A	N/A
EN-DC with FR2 only intra band CA	N/A	N/A	1	N/A	Number of configured FR2 SCells
EN-DC with FR1 +FR2 CA (FR1 PSCell) ^{Note 1}	1	2x(Number of configured SCell(s)-1)	N/A	2	2x(Number of configured SCell(s)-1)
EN-DC with FR1 +FR2 CA (FR2 PSCell) ^{Note 1}	N/A	Number of configured SCell(s)	1	N/A	Number of configured SCell(s)

Note 1: Only one NR FR1 operating band and one NR FR2 operating band are included for FR1+FR2 inter-band EN-DC.
Note 2: Selection of FR2 SCC where neighbour cell measurement is required follows section 9.2.3.2.

9.1.5.1.2 SA mode: carrier-specific scaling factor for SSB-based measurements performed outside gaps without NR-DC operation

For UE not configured with NR-DC operation in SA mode, the carrier-specific scaling factor $CSSF_{outside_gap,i}$ for intra-frequency SSB-based measurements performed outside measurements gaps will be as specified in Table 9.1.5.1.2-1, which shall also be applied for a UE configured with NE-DC operation.

Table 9.1.5.1.2-1: $CSSF_{outside_gap,i}$ scaling factor without NR-DC operation in SA mode

Scenario	$CSSF_{outside_gap,i}$ for FR1 PCC	$CSSF_{outside_gap,i}$ for FR1 SCC	$CSSF_{outside_gap,p,i}$ for FR2 PCC	$CSSF_{outside_gap,i}$ for FR2 SCC where neighbour cell measurement is required	$CSSF_{outside_gap,i}$ for FR2 SCC where neighbour cell measurement is not required
FR1 only CA	1	Number of configured FR1 SCell(s)	N/A	N/A	N/A
FR2 only intra band CA	N/A	N/A	1	N/A	Number of configured FR2 SCell(s)
FR1 +FR2 CA (FR1 PCell) ^{Note 1}	1	2x(Number of configured SCell(s)-1)	N/A	2	2x(Number of configured SCell(s)-1)

Note 1: Only one FR1 operating band and one FR2 operating band are included for FR1+FR2 inter-band CA.
Note 2: Selection of FR2 SCC where neighbour cell measurement is required follows section 9.2.3.2.

9.1.5.1.3 SA mode: carrier-specific scaling factor for SSB-based measurements performed outside gaps with NR-DC operation

For UE configured with NR-DC operation in SA mode, the carrier-specific scaling factor $CSSF_{outside_gap,i}$ for intra-frequency SSB-based measurements performed outside measurements gaps will be as specified in Table 9.1.5.1.3-1.

Table 9.1.5.1.3-1: $CSSF_{outside_gap,i}$ scaling factor with NR-DC operation in SA mode

Scenario	$CSSF_{outside_gap,i}$ for FR1 PCC	$CSSF_{outside_gap,i}$ for FR1 SCC	$CSSF_{outside_gap,i}$ for FR2 PSCC	$CSSF_{outside_gap,i}$ for FR2 SCC where neighbour cell measurement is not required
FR1 + FR2 NR-DC (FR1 PCell and FR2 PSCell) Note 1	1	2×(Number of configured SCell(s))	2	2×(Number of configured SCell(s))
Note 1: NR-DC in Rel-15 only includes the scenarios where all serving cells in MCG in FR1 and all serving cells in SCG in FR2.				

9.1.5.2 Monitoring of multiple layers within gaps

The carrier-specific scaling factor $CSSF_{within_gap,i}$ for measurement object i derived in this chapter is applied to following measurement types:

- Intra-frequency measurement with no measurement gap in Section 9.2.5, when all of the SMTC occasions of this intra-frequency measurement object are overlapped by the measurement gap.
- Intra-frequency measurement with measurement gap in Section 9.2.6.
- Inter-frequency measurement in Section 9.3
- Inter-RAT measurement in Section 9.4

UE is expected to conduct the measurement of this measurement object i only within the measurement gaps.

If the higher layer signaling in TS 38.331 [2] signaling of *smtc2* is present and *smtc1* is fully overlapping with measurement gaps and *smtc2* is partially overlapping with measurement gaps, $CSSF_{within_gap,i}$ and requirements derived from $CSSF_{outside_gap,i}$ are not specified.

9.1.5.2.1 NSA mode: carrier-specific scaling factor for SSB-based measurements performed within gaps

Editor's note: The scaling value $CSSF_{within_gap,i}$ below has been derived without considering GSM inter-RAT carriers.

When one or more measurement objects are monitored within measurement gaps, the carrier specific scaling factor for a target measurement object with index i is designated as $CSSF_{within_gap,i}$ and is derived as described in this section.

If measurement object i refers to an RSTD measurement with periodicity $T_{prs} > 160\text{ms}$ or with periodicity $T_{prs} = 160\text{ms}$ but *prs-MutingInfo-r9* is configured, $CSSF_{within_gap,i} = 1$. Otherwise, the the $CSSF_{within_gap,i}$ for other measurement objects (including RSTD measurement with periodicity $T_{prs} = 160\text{ms}$) participate in the gap competition are derived as below.

For each measurement gap j not used for an RSTD measurement with periodicity $T_{prs} > 160\text{ms}$ or with periodicity $T_{prs} = 160\text{ms}$ but *prs-MutingInfo-r9* is configured within an arbitrary 160ms period, count the total number of intrafrequency measurement objects and interfrequency/interRAT measurement objects which are candidates to be measured within the gap j .

- An NR carrier is a candidate to be measured in a gap if its SMTC duration is fully covered by the MGL excluding RF switching time. For intrafrequency NR carriers, if the high layer in TS 38.331 [2] signaling of *smtc2* is configured, the assumed periodicity of SMTC occasions corresponds to the value of higher layer parameter *smtc2*; Otherwise the assumed periodicity of SMTC occasions corresponds to the value of higher layer parameter *smtc1*.
- An interRAT measurement object is a candidate to be measured in all measurement gaps.

R_i is the maximal ratio of the number of measurement gap where measurement object i is a candidate to be measured over the number of measurement gap where measurement object i is a candidate and not used for RSTD measurement with periodicity $T_{prs} > 160\text{ms}$ or with periodicity $T_{prs} = 160\text{ms}$ but *prs-MutingInfo-r9* is configured within an arbitrary 1280ms period.

For UEs which support and are configured with per FR gaps, the counting is done on a per FR basis, and for UEs which are configured with per UE gaps the counting is done on a per UE basis.

Per gap j :

$M_{\text{intra},i,j}$: Number of intrafrequency measurement objects which are candidates to be measured in gap j where the measurement object i is also a candidate. Otherwise $M_{\text{intra},i,j}$ equals 0.

$M_{\text{inter},i,j}$: Number of NR interfrequency measurement objects or NR interRAT measurement objects configured by E-UTRA PCell, EUTRA interfrequency measurement objects configured by E-UTRA PCell, UTRA inter-RAT measurement objects and GSM interRAT measurement objects configured by E-UTRA PCell which are candidates to be measured in gap j where the measurement object i is also a candidate. Otherwise $M_{\text{inter},i,j}$ equals 0.

$M_{\text{tot},i,j} = M_{\text{intra},i,j} + M_{\text{inter},i,j}$: Total number of intrafrequency, interfrequency and interRAT measurement objects which are candidates to be measured in gap j where the measurement object i is also a candidate. Otherwise $M_{\text{tot},i,j}$ equals 0.

The carrier specific scaling factor $\text{CSSF}_{\text{within_gap},i}$ is given by:

If *measGapSharingScheme* is equal sharing, $\text{CSSF}_{\text{within_gap},i} = \max(\text{ceil}(R_i \times M_{\text{tot},i,j}))$, where $j=0 \dots (160/\text{MGRP})-1$

If *measGapSharingScheme* is not equal sharing and

- measurement object i is an intrafrequency measurement object, $\text{CSSF}_{\text{within_gap},i}$ is the maximum among
 - $\text{ceil}(R_i \times K_{\text{intra}} \times M_{\text{intra},i,j})$ in gaps where $M_{\text{inter},i,j} \neq 0$, where $j=0 \dots (160/\text{MGRP})-1$
 - $\text{ceil}(R_i \times M_{\text{intra},i,j})$ in gaps where $M_{\text{inter},i,j} = 0$, where $j=0 \dots (160/\text{MGRP})-1$
- measurement object i is an interfrequency or interRAT measurement object, $\text{CSSF}_{\text{within_gap},i}$ is the maximum among
 - $\text{ceil}(R_i \times K_{\text{inter}} \times M_{\text{inter},i,j})$ in gaps where $M_{\text{intra},i,j} \neq 0$, where $j=0 \dots (160/\text{MGRP})-1$
 - $\text{ceil}(R_i \times M_{\text{inter},i,j})$ in gaps where $M_{\text{intra},i,j} = 0$, where $j=0 \dots (160/\text{MGRP})-1$

9.1.5.2.2 SA mode: carrier-specific scaling factor for SSB-based measurements performed within gaps

When one or more measurement objects are monitored within measurement gaps, the carrier specific scaling factor for a target measurement object with index i is designated as $\text{CSSF}_{\text{within_gap},i}$ and is derived as described in this section.

If measurement object i refers to an RSTD measurement with periodicity $T_{\text{prs}} > 160\text{ms}$ or with periodicity $T_{\text{prs}} = 160\text{ms}$ but *prs-MutingInfo-r9* is configured, $\text{CSSF}_{\text{within_gap},i} = 1$. Otherwise, the the $\text{CSSF}_{\text{within_gap},i}$ for other measurement objects (including RSTD measurement with periodicity $T_{\text{prs}} = 160\text{ms}$) participate in the gap competition and the $\text{CSSF}_{\text{within_gap},i}$ are derived as below.

For each measurement gap j not used for an RSTD measurement with periodicity $T_{\text{prs}} > 160\text{ms}$ or with periodicity $T_{\text{prs}} = 160\text{ms}$ but *prs-MutingInfo-r9* is configured within an arbitrary 160ms period, count the total number of intrafrequency measurement objects and interfrequency/interRAT measurement objects which are candidates to be measured within the gap j .

- An NR carrier is a candidate to be measured in a gap if its SMTC duration is fully covered by the MGL excluding RF switching time. For intrafrequency NR carriers, if the high layer in TS 38.331 [2] signaling of *smtc2* is configured, the assumed periodicity of SMTC occasions corresponds to the value of higher layer parameter *smtc2*; Otherwise the assumed periodicity of SMTC occasions corresponds to the value of higher layer parameter *smtc1*.
- An interRAT measurement object is a candidate to be measured in all measurement gaps.

R_i is the maximal ratio of the number of measurement gap where measurement object i is a candidate to be measured over the number of measurement gap where measurement object i is a candidate and not used for RSTD measurement with periodicity $T_{\text{prs}} > 160\text{ms}$ or with periodicity $T_{\text{prs}} = 160\text{ms}$ but *prs-MutingInfo-r9* is configured within an arbitrary 1280ms period.

For UEs which support and are configured with per FR gaps, the counting is done on a per FR basis, and for UEs which are configured with per UE gaps the counting is done on a per UE basis.

Per gap j :

$M_{\text{intra},i,j}$: Number of intrafrequency measurement objects which are candidates to be measured in gap j where the measurement object i is also a candidate. Otherwise $M_{\text{intra},i,j}$ equals 0.

$M_{\text{inter},i,j}$: Number of NR interfrequency and EUTRA interRAT measurement objects which are candidates to be measured in gap j where the measurement object i is also a candidate. Otherwise $M_{\text{inter},i,j}$ equals 0.

$M_{\text{tot},i,j} = M_{\text{intra},i,j} + M_{\text{inter},i,j}$: Total number of intrafrequency, interfrequency and interRAT measurement objects which are candidates to be measured in gap j where the measurement object i is also a candidate. Otherwise $M_{\text{tot},i,j}$ equals 0.

The carrier specific scaling factor $\text{CSSF}_{\text{within_gap},i}$ is given by:

If *measGapSharingScheme* is equal sharing, $\text{CSSF}_{\text{within_gap},i} = \max(\text{ceil}(R_i \times M_{\text{tot},i,j}))$, where $j=0 \dots (160/\text{MGRP})-1$

If *measGapSharingScheme* is not equal sharing and

- measurement object i is an intrafrequency measurement object, $\text{CSSF}_{\text{within_gap},i}$ is the maximum among
 - $\text{ceil}(R_i \times K_{\text{intra}} \times M_{\text{intra},i,j})$ in gaps where $M_{\text{inter},i,j} \neq 0$, where $j=0 \dots (160/\text{MGRP})-1$
 - $\text{ceil}(R_i \times M_{\text{intra},i,j})$ in gaps where $M_{\text{inter},i,j} = 0$, where $j=0 \dots (160/\text{MGRP})-1$
- measurement object i is an interfrequency or interRAT measurement object, $\text{CSSF}_{\text{within_gap},i}$ is the maximum among
 - $\text{ceil}(R_i \times K_{\text{inter}} \times M_{\text{inter},i,j})$ in gaps where $M_{\text{intra},i,j} \neq 0$, where $j=0 \dots (160/\text{MGRP})-1$
 - $\text{ceil}(R_i \times M_{\text{inter},i,j})$ in gaps where $M_{\text{intra},i,j} = 0$, where $j=0 \dots (160/\text{MGRP})-1$

9.1.6 Minimum requirement at transitions

When the measurement on one intra-frequency measurement object transitions from measurements performed outside gaps to measurements performed within gaps or vice versa during one measurement period, the cell identification and measurement period requirements with the longer delay apply.

The carrier-specific scaling factor specified in Section 9.1.5 that applies to the other impacted measurement objects will also apply based on the longer measurement or cell identification delay before or after the transition.

When the UE transitions between DRX and non-DRX or when DRX cycle periodicity changes, the cell identification and measurement period requirements apply based on the longer delay before or after the transition.

Subsequent to this measurement period, the cell identification and measurement period requirements on each measurement object are corresponding to the second mode after transition.

9.2 NR intra-frequency measurements

9.2.1 Introduction

A measurement is defined as a SSB based intra-frequency measurement provided the centre frequency of the SSB of the serving cell indicated for measurement and the centre frequency of the SSB of the neighbour cell are the same, and the subcarrier spacing of the two SSB are also the same.

The UE shall be able to identify new intra-frequency cells and perform SS-RSRP, SS-RSRQ, and SS-SINR measurements of identified intra-frequency cells if carrier frequency information is provided by PCell or the PSCell, even if no explicit neighbour list with physical layer cell identities is provided.

The UE can perform intra-frequency SSB based measurements without measurement gaps if

- the SSB is completely contained in the active BWP of the UE, or
- the active downlink BWP is initial BWP[3].

For intra-frequency SSB based measurements without measurement gaps, UE may cause scheduling restriction as specified in section 9.2.5.3.

SSB based measurements are configured along with one or two measurement timing configuration(s) (SMTC) which provides periodicity, duration and offset information on a window of up to 5ms where the measurements are to be performed. For intra-frequency connected mode measurements, up to two measurement window periodicities may be configured. A single measurement window offset and measurement duration are configured per intra-frequency measurement object.

When measurement gaps are needed, the UE is not expected to detect SSB which start earlier than the gap starting time + switching time, nor detect SSB which end later than the gap end – switching time. Switching time is 0.5ms for frequency range FR1 and 0.25ms for frequency range FR2.

9.2.2 Requirements applicability

The requirements in Section 9.2 apply, provided:

- The cell being identified or measured is detectable.

An intra-frequency cell shall be considered detectable when for each relevant SSB:

- SS-RSRP related side conditions given in Sections 10.1.2 and 10.1.3 for FR1 and FR2, respectively, for a corresponding Band,
- SS-RSRQ related side conditions given in Sections 10.1.7 and 10.1.8 for FR1 and FR2, respectively, for a corresponding Band,
- SS-SINR related side conditions given in Sections 10.1.12 and 10.1.13 for FR1 and FR2, respectively, for a corresponding Band,
- SSB_{RP} and SSB \hat{E}_s/I_{ot} according to Annex B.2.2 for a corresponding Band.

9.2.3 Number of cells and number of SSB

9.2.3.1 Requirements for FR1

For each intra-frequency layer, during each layer 1 measurement period, the UE shall be capable of performing SS-RSRP, SS-RSRQ, and SS-SINR measurements for at least:

- 8 identified cells, and
- 14 SSBs with different SSB index and/or PCI on the intra-frequency layer, where the number of SSBs in the serving cell (except for the SCell) is no smaller than the number of configured RLM-RS SSB resources.

9.2.3.2 Requirements for FR2

For each intra-frequency layer, during each Layer 1 measurement period, the UE shall be capable of performing SS-RSRP, SS-RSRQ, and SS-SINR measurements for at least:

- 6 identified cells, and
- 24 SSBs with different SSB index and/or PCI,

where the single serving carrier shall be:

- PCC when UE is configured with SA NR operation mode with PCC in the band; or
- PSCC when UE is configured with EN-DC with PSCC in the band; or
- One of the SCCs on which UE is configured to report SSB based measurements when neither PCC nor PSCC is in the same band, so that the selected SCC shall be an SCC where the UE is configured with SS-RSRP measurement reporting if such SCC exists, otherwise the selected SCC is up to the UE

UE shall also be capable of performing SS-RSRP, SS-RSRQ, and SS-SINR measurements for at least 2 SSBs on serving cell for each of the other serving carrier(s) in the same band.

9.2.4 Measurement Reporting Requirements

9.2.4.1 Periodic Reporting

Reported RSRP, RSRQ, and RS-SINR measurements contained in periodically triggered measurement reports shall meet the requirements in sections 10.1.2.1, 10.1.3.1, 10.1.7.1, 10.1.8.1, 10.1.12.1 and 10.1.13.1, respectively.

9.2.4.2 Event-triggered Periodic Reporting

Reported RSRP, RSRQ, and RS-SINR measurements contained in periodically triggered measurement reports shall meet the requirements in sections 10.1.2.1, 10.1.3.1, 10.1.7.1, 10.1.8.1, 10.1.12.1 and 10.1.13.1, respectively.

The first report in event triggered periodic measurement reporting shall meet the requirements specified in clause 9.2.4.3.

9.2.4.3 Event Triggered Reporting

Reported RSRP, RSRQ, and RS-SINR measurements contained in periodically triggered measurement reports shall meet the requirements in sections 10.1.2.1, 10.1.3.1, 10.1.7.1, 10.1.8.1, 10.1.12.1 and 10.1.13.1, respectively.

The UE shall not send any event triggered measurement reports as long as no reporting criteria are fulfilled.

The measurement reporting delay is defined as the time between an event that will trigger a measurement report and the point when the UE starts to transmit the measurement report over the air interface. This requirement assumes that the measurement report is not delayed by other RRC signalling on the DCCH. This measurement reporting delay excludes a delay uncertainty resulted when inserting the measurement report to the TTI of the uplink DCCH. The delay uncertainty is: $2 \times TTI_{DCCH}$. This measurement reporting delay excludes a delay which caused by no UL resources for UE to send the measurement report.

The event triggered measurement reporting delay, measured without L3 filtering shall be less than $T_{\text{identify intra with index}}$ or $T_{\text{identify intra without index}}$ defined in clause 9.2.5.1 or clause 9.2.6.2. When L3 filtering is used an additional delay can be expected.

If a cell which has been detectable at least for the time period $T_{\text{identify intra without index}}$ or $T_{\text{identify intra with index}}$ defined in clause 9.2.5.1 or clause 9.2.6.2 becomes undetectable for a period and then the cell becomes detectable again and triggers an event, the event triggered measurement reporting delay shall be less than $T_{\text{Measurement_Period, Intra}}$ provided the timing to that cell has not changed more than $\pm 3200 T_c$ while the measurement gap has not been available and the L3 filter has not been used. When L3 filtering is used, an additional delay can be expected.

9.2.5 Intrafrequency measurements without measurement gaps

9.2.5.1 Intrafrequency cell identification

The UE shall be able to identify a new detectable intra frequency cell within $T_{\text{identify_intra_without_index}}$ if UE is not indicated to report SSB based RRM measurement result with the associated SSB index (*reportQuantityRsIndexes* or *maxNrofRSIndexesToReport* is not configured), or the UE is indicated that the neighbour cell is synchronous with the serving cell (*deriveSSB-IndexFromCell* is enabled). Otherwise UE shall be able to identify a new detectable intra frequency cell within $T_{\text{identify_intra_with_index}}$. The UE shall be able to identify a new detectable intra frequency SS block of an already detected cell within $T_{\text{identify_intra_without_index}}$. It is assumed that *deriveSSB-IndexFromCell* is always enabled for FR1 TDD and FR2.

$$T_{\text{identify_intra_without_index}} = (T_{\text{PSS/SSS_sync_intra}} + T_{\text{SSB_measurement_period_intra}}) \text{ ms}$$

$$T_{\text{identify_intra_with_index}} = (T_{\text{PSS/SSS_sync_intra}} + T_{\text{SSB_measurement_period_intra}} + T_{\text{SSB_time_index_intra}}) \text{ ms}$$

Where:

$T_{\text{PSS/SSS_sync_intra}}$: it is the time period used in PSS/SSS detection given in table 9.2.5.1-1, 9.2.5.1-2, 9.2.5.1-4 (deactivated Scell) or 9.2.5.1-5 (deactivated SCell)

$T_{SSB_time_index_intra}$: it is the time period used to acquire the index of the SSB being measured given in table 9.2.5.1-3 or 9.2.5.1-6 (deactivated SCell)

$T_{SSB_measurement_period_intra}$: equal to a measurement period of SSB based measurement given in table 9.2.5.2-1, table 9.2.5.2-2 table 9.2.5.2-3 (deactivated SCell) or 9.2.5.2-4(deactivated SCell)

$CSSF_{intra}$: it is a carrier specific scaling factor and is determined

- according to $CSSF_{outside_gap,i}$ in section 9.1.5.1 for measurement conducted outside measurement gaps, i.e. when intrafrequency SMTC is fully non overlapping or partially overlapping with measurement gaps, or according to $CSSF_{within_gap,i}$ in section 9.1.5.2 for measurement conducted within measurement gaps, i.e. when intrafrequency SMTC is fully overlapping with measurement gaps.
- if the high layer in TS 38.331 [2] signaling of *smtc2* is configured, the assumed periodicity of intrafrequency SMTC occasions corresponds to the value of higher layer parameter *smtc2*; Otherwise the assumed periodicity of intrafrequency SMTC occasions corresponds to the value of higher layer parameter *smtc1*.

$M_{pss/sss_sync_w/o_gaps}$: For a UE supporting FR2 power class 1, $M_{pss/sss_sync}=40$. For a UE supporting power class 2, $M_{pss/sss_sync_w/o_gaps}=24$. For a UE supporting FR2 power class 3, $M_{pss/sss_sync_w/o_gaps}=24$. For a UE supporting FR2 power class 4, $M_{pss/sss_sync_w/o_gaps}=24$

$M_{meas_period_w/o_gaps}$: For a UE supporting power class 1, $M_{meas_period_w/o_gaps}=40$. For a UE supporting FR2 power class 2, $M_{meas_period_w/o_gaps}=24$. For a UE supporting power class 3, $M_{meas_period_w/o_gaps}=24$. For a UE supporting power class 4, $M_{meas_period_w/o_gaps}=24$.

When intrafrequency SMTC is fully non overlapping with measurement gaps or intrafrequency SMTC is fully overlapping with MGs, $K_p=1$

When intrafrequency SMTC is partially overlapping with measurement gaps, $K_p = 1/(1 - (SMTC\ period / MGRP))$, where $SMTC\ period < MGRP$

If the higher layer signaling in TS38.331 [2] signaling of *smtc2* is present and *smtc1* is fully overlapping with measurement gaps and *smtc2* is partially overlapping with measurement gaps, requirements are not specified for $T_{identify_intra_without_index}$ or $T_{identify_intra_with_index}$

For FR2 when any of the reference signals configured for RLM, BFD, CBD or L1-RSRP for beam reporting outside measurement gap is fully overlapping with intra-frequency SMTC, $K_{layer1_measurement}= 1.5$, otherwise $K_{layer1_measurement}=1$.

If SCG DRX is in use, intrafrequency cell identification requirements specified in Table 9.2.5.1-1, Table 9.2.5.1-2, Table 9.2.5.1-3, Table 9.2.5.1-4, Table 9.2.5.1-5 and Table 9.2.5.1-6 shall depend on the SCG DRX cycle. Otherwise, the requirements for when DRX is not in use shall apply.

Table 9.2.5.1-1: Time period for PSS/SSS detection, (Frequency range FR1)

DRX cycle	T_{PSS/SSS_sync_intra}
No DRX	$\max[600ms, \text{ceil}(5 \times K_p) \times SMTC\ period]^{Note\ 1} \times CSSF_{intra}$
$DRX\ cycle \leq 320ms$	$\max[600ms, \text{ceil}(1.5 \times 5 \times K_p) \times \max(SMTC\ period, DRX\ cycle)] \times CSSF_{intra}$
$DRX\ cycle > 320ms$	$\text{ceil}[5] \times K_p \times DRX\ cycle \times CSSF_{intra}$
NOTE 1: If different SMTC periodicities are configured for different cells, the SMTC period in the requirement is the one used by the cell being identified	

Table 9.2.5.1-2: Time period for PSS/SSS detection, (Frequency range FR2)

DRX cycle	T_{PSS/SSS_sync_intra}
No DRX	$\max(600\text{ms}, \text{ceil}(M_{pss/sss_sync_w/o_gaps} \times K_p \times K_{layer1_measurement}) \times \text{SMTC period})^{Note 1} \times \text{CSSF}_{intra}$
DRX cycle \leq 320ms	$\max(600\text{ms}, \text{ceil}(1.5 \times M_{pss/sss_sync_w/o_gaps} \times K_p \times K_{layer1_measurement}) \times \max(\text{SMTC period}, \text{DRX cycle})) \times \text{CSSF}_{intra}$
DRX cycle > 320ms	$\text{ceil}(M_{pss/sss_sync_w/o_gaps} \times K_p \times K_{layer1_measurement}) \times \text{DRX cycle} \times \text{CSSF}_{intra}$

NOTE 1: If different SMTC periodicities are configured for different cells, the SMTC period in the requirement is the one used by the cell being identified

Table 9.2.5.1-3: Time period for time index detection (Frequency range FR1)

DRX cycle	$T_{SSB_time_index_intra}$
No DRX	$\max(120\text{ms}, \text{ceil}(3 \times K_p) \times \text{SMTC period})^{Note 1} \times \text{CSSF}_{intra}$
DRX cycle \leq 320ms	$\max(120\text{ms}, \text{ceil}(1.5 \times 3 \times K_p) \times \max(\text{SMTC period}, \text{DRX cycle})) \times \text{CSSF}_{intra}$
DRX cycle > 320ms	$\text{Ceil}(3 \times K_p) \times \text{DRX cycle} \times \text{CSSF}_{intra}$

NOTE 1: If different SMTC periodicities are configured for different cells, the SMTC period in the requirement is the one used by the cell being identified

Table 9.2.5.1-4: Time period for PSS/SSS detection, deactivated SCell (Frequency range FR1)

DRX cycle	T_{PSS/SSS_sync_intra}
No DRX	$5 \times \text{measCycleSCell} \times \text{CSSF}_{intra}$
DRX cycle \leq 320ms	$5 \times \max(\text{measCycleSCell}, 1.5 \times \text{DRX cycle}) \times \text{CSSF}_{intra}$
DRX cycle > 320ms	$5 \times \max(\text{measCycleSCell}, \text{DRX cycle}) \times \text{CSSF}_{intra}$

Table 9.2.5.1-5: Time period for PSS/SSS detection, deactivated SCell (Frequency range FR2)

DRX cycle	T_{PSS/SSS_sync_intra}
No DRX	$M_{pss/sss_sync_w/o_gaps} \times \text{measCycleSCell} \times \text{CSSF}_{intra}$
DRX cycle \leq 320ms	$M_{pss/sss_sync_w/o_gaps} \times \max(\text{measCycleSCell}, 1.5 \times \text{DRX cycle}) \times \text{CSSF}_{intra}$
DRX cycle > 320ms	$M_{pss/sss_sync_w/o_gaps} \times \max(\text{measCycleSCell}, \text{DRX cycle}) \times \text{CSSF}_{intra}$

Table 9.2.5.1-6: Time period for time index detection, deactivated SCell (Frequency range FR1)

DRX cycle	$T_{SSB_time_index_intra}$
No DRX	$3 \times \text{measCycleSCell} \times \text{CSSF}_{intra}$
DRX cycle \leq 320ms	$3 \times \max(\text{measCycleSCell}, 1.5 \times \text{DRX cycle}) \times \text{CSSF}_{intra}$
DRX cycle > 320ms	$3 \times \max(\text{measCycleSCell}, \text{DRX cycle}) \times \text{CSSF}_{intra}$

Table 9.2.5.1-7: Void**Table 9.2.5.1-8: Void**

9.2.5.2 Measurement period

The measurement period for intrafrequency measurements without gaps is as shown in table 9.2.5.2-1, 9.2.5.2-2, 9.2.5.2-3 (deactivated SCell) or 9.2.5.2-4 (deactivated SCell). If the higher layer signaling in TS38.331 [2] signaling of *smtc2* is present and *smtc1* is fully overlapping with measurement and *smtc2* is partially overlapping with measurement gaps, requirements are not specified for $T_{SSB_measurement_period_intra}$

If SCG DRX is in use, intrafrequency measurement period requirements specified in Table 9.2.5.2-1, Table 9.2.5.2-2, Table 9.2.5.2-3 and Table 9.2.5.2-4 shall depend on the SCG DRX cycle. Otherwise, the requirements for when DRX is not in use shall apply.

Table 9.2.5.2-1: Measurement period for intrafrequency measurements without gaps(Frequency FR1)

DRX cycle	$T_{SSB_measurement_period_intra}$
No DRX	$\max(200\text{ms}, \text{ceil}(5 \times K_p) \times \text{SMTC period})^{\text{Note 1}} \times \text{CSSF}_{intra}$
DRX cycle $\leq 320\text{ms}$	$\max(200\text{ms}, \text{ceil}(1.5 \times 5 \times K_p) \times \max(\text{SMTC period}, \text{DRX cycle})) \times \text{CSSF}_{intra}$
DRX cycle $> 320\text{ms}$	$\text{ceil}(5 \times K_p) \times \text{DRX cycle} \times \text{CSSF}_{intra}$
NOTE 1: If different SMTC periodicities are configured for different cells, the SMTC period in the requirement is the one used by the cell being identified	

Table 9.2.5.2-2: Measurement period for intrafrequency measurements without gaps(Frequency FR2)

DRX cycle	$T_{SSB_measurement_period_intra}$
No DRX	$\max(400\text{ms}, \text{ceil}(M_{meas_period_w/o_gaps} \times K_p \times K_{layer1_measurement}) \times \text{SMTC period})^{\text{Note 1}} \times \text{CSSF}_{intra}$
DRX cycle $\leq 320\text{ms}$	$\max(400\text{ms}, \text{ceil}(1.5 \times M_{meas_period_w/o_gaps} \times K_p \times K_{layer1_measurement}) \times \max(\text{SMTC period}, \text{DRX cycle})) \times \text{CSSF}_{intra}$
DRX cycle $> 320\text{ms}$	$\text{ceil}(M_{meas_period_w/o_gaps} \times K_p \times K_{layer1_measurement}) \times \text{DRX cycle} \times \text{CSSF}_{intra}$
NOTE 1: If different SMTC periodicities are configured for different cells, the SMTC period in the requirement is the one used by the cell being identified	

Table 9.2.5.2-3: Measurement period for intrafrequency measurements without gaps (deactivated SCell) (Frequency range FR1)

DRX cycle	$T_{SSB_measurement_period_intra}$
No DRX	$5 \times \text{measCycleSCell} \times \text{CSSF}_{intra}$
DRX cycle $\leq 320\text{ms}$	$5 \times \max(\text{measCycleSCell}, 1.5 \times \text{DRX cycle}) \times \text{CSSF}_{intra}$
DRX cycle $> 320\text{ms}$	$5 \times \max(\text{measCycleSCell}, \text{DRX cycle}) \times \text{CSSF}_{intra}$

Table 9.2.5.2-4: Measurement period for intrafrequency measurements without gaps (deactivated SCell) (Frequency range FR2)

DRX cycle	$T_{SSB_measurement_period_intra}$
No DRX	$M_{meas_period_with_gaps} \times \text{measCycleSCell} \times \text{CSSF}_{intra}$
DRX cycle $\leq 320\text{ms}$	$M_{meas_period_with_gaps} \times \max(\text{measCycleSCell}, 1.5 \times \text{DRX cycle}) \times \text{CSSF}_{intra}$
DRX cycle $> 320\text{ms}$	$M_{meas_period_with_gaps} \times \max(\text{measCycleSCell}, \text{DRX cycle}) \times \text{CSSF}_{intra}$

9.2.5.3 Scheduling availability of UE during intra-frequency measurements

UE are required to be capable of measuring without measurement gaps when the SSB is completely contained in the active bandwidth part of the UE. When the measurement signal has different subcarrier spacing than PDSCH/PDCCH or on frequency range FR2, there are restrictions on the scheduling availability as described in the following clauses. Note that the SSB symbols to be measured in the following clauses are the SSB symbols indicated by *SSB-ToMeasure* [2], if it is configured; otherwise, all *L* SSB symbols within SMTC window duration defined in Section 4.1 of [3] are included.

9.2.5.3.1 Scheduling availability of UE performing measurements with a same subcarrier spacing as PDSCH/PDCCH on FR1

There are no scheduling restrictions due to measurements performed with a same subcarrier spacing as PDSCH/PDCCH on FR1.

9.2.5.3.2 Scheduling availability of UE performing measurements with a different subcarrier spacing than PDSCH/PDCCH on FR1

For UE which support *simultaneousRxDataSSB-DiffNumerology* [14] there are no restrictions on scheduling availability due to measurements. For UE which do not support *simultaneousRxDataSSB-DiffNumerology* [14] the following restrictions apply due to SS-RSRP/RSRQ/SINR measurement

- If *deriveSSB_IndexFromCell* is enabled the UE is not expected to transmit PUCCH/PUSCH/SRS or receive PDCCH/PDSCH/TRS/CSI-RS for CQI on SSB symbols to be measured, and on 1 data symbol before each consecutive SSB symbols to be measured and 1 data symbol after each consecutive SSB symbols to be measured within SMTC window duration. If the high layer in TS 38.331 [2] signaling of *smtc2* is configured, the SMTC periodicity follows *smtc2*; Otherwise SMTC periodicity follows *smtc1*.
- If *deriveSSB_IndexFromCell* is not enabled the UE is not expected to transmit PUCCH/PUSCH/SRS or receive PDCCH/PDSCH/TRS/CSI-RS for CQI on all symbols within SMTC window duration. If the high layer in TS 38.331 [2] signaling of *smtc2* is configured, the SMTC periodicity follows *smtc2*; Otherwise SMTC periodicity follows *smtc1*.

When intra-band carrier aggregation is performed, the scheduling restrictions due to one serving cell should also apply to all other serving cells in the same band on the symbols that fully or partially overlap with aforementioned restricted symbols. When inter-band carrier aggregation within FR1 is performed, there are no scheduling restrictions on FR1 serving cell(s) in the bands due to measurements performed on FR1 serving cell frequency layer in different bands.

9.2.5.3.3 Scheduling availability of UE performing measurements on FR2

The following scheduling restriction applies due to SS-RSRP or SS-SINR measurement on an FR2 intra-frequency cell

The UE is not expected to transmit PUCCH/PUSCH/SRS or receive PDCCH/PDSCH/TRS/CSI-RS for CQI on SSB symbols to be measured, and on 1 data symbol before each consecutive SSB symbols to be measured and 1 data symbol after each consecutive SSB symbols to be measured within SMTC window duration (The signaling *deriveSSB_IndexFromCell* is always enabled for FR2). If the high layer in TS 38.331 [2] signaling of *smtc2* is configured, the SMTC periodicity follows *smtc2*; Otherwise SMTC periodicity follows *smtc1*.

The following scheduling restriction applies to SS-RSRQ measurement on an FR2 intra-frequency cell

- UE is not expected to transmit PUCCH/PUSCH/SRS or receive PDCCH/PDSCH/TRS/CSI-RS for CQI on SSB symbols to be measured, RSSI measurement symbols, and on 1 data symbol before each consecutive SSB to be measured/RSSI symbols and 1 data symbol after each consecutive SSB to be measured/RSSI symbols within SMTC window duration (The signaling *deriveSSB_IndexFromCell* is always enabled for FR2). If the high layer in TS 38.331 [2] signaling of *smtc2* is configured, the SMTC periodicity follows *smtc2*; Otherwise SMTC periodicity follows *smtc1*.

When intra-band carrier aggregation is performed, the scheduling restrictions due to one serving cell should also apply to all other serving cells in the same band on the symbols that fully or partially overlap with aforementioned restricted symbols. When inter-band carrier aggregation within FR2 is performed, the scheduling restrictions apply to all the other serving cells.

Editor's Note: FFS scheduling restrictions for inter-band carrier aggregation will be defined depending on band combination in future.

9.2.5.3.4 Scheduling availability of UE performing measurements on FR1 or FR2 in case of FR1-FR2 inter-band CA

There are no scheduling restrictions on FR1 serving cell(s) due to measurements performed on FR2 serving cell frequency layer.

There are no scheduling restrictions on FR2 serving cell(s) due to measurements performed on FR1 serving cell frequency layer.

9.2.6 Intrafrequency measurements with measurement gaps

9.2.6.1 Void

9.2.6.2 Intrafrequency cell identification

The UE shall be able to identify a new detectable intra frequency cell within $T_{\text{identify_intra_without_index}}$ if UE is not indicated to report SSB based RRM measurement result with the associated SSB index (*reportQuantityRsIndexes* or *maxNrofRSIndexesToReport* is not configured), or the UE has been indicated that the neighbour cell is synchronous with the serving cell (*deriveSSB-IndexFromCell* is enabled). Otherwise UE shall be able to identify a new detectable intra frequency cell within $T_{\text{identify_intra_with_index}}$. The UE shall be able to identify a new detectable intra frequency SS block of an already detected cell within $T_{\text{identify_intra_without_index}}$. It is assumed that *deriveSSB-IndexFromCell* is always enabled for FR1 TDD and FR2.

$$T_{\text{identify_intra_without_index}} = T_{\text{PSS/SSS_sync_intra}} + T_{\text{SSB_measurement_period_intra}} \text{ ms}$$

$$T_{\text{identify_intra_with_index}} = T_{\text{PSS/SSS_sync_intra}} + T_{\text{SSB_measurement_period_intra}} + T_{\text{SSB_time_index_intra}}$$

Where:

$T_{\text{PSS/SSS_sync_intra}}$: it is the time period used in PSS/SSS detection given in table 9.2.6.2-1 or 9.2.6.2-2.

$T_{\text{SSB_time_index_intra}}$: it is the time period used to acquire the index of the SSB being measured given in table 9.2.6.2-3.

$T_{\text{SSB_measurement_period_intra}}$: equal to a measurement period of SSB based measurement given in table 9.2.6.2-1 or 9.2.6.2-2.

$\text{CSSF}_{\text{intra}}$: it is a carrier specific scaling factor and is determined according to $\text{CSSF}_{\text{within_gap},i}$ in section 9.1.5.2 for measurement conducted within measurement gaps.

$M_{\text{pss/sss_sync_with_gaps}}$: For a UE supporting FR2 power class 1, $M_{\text{pss/sss_sync_with_gaps}}=40$. For a UE supporting FR2 power class 2, $M_{\text{pss/sss_sync_with_gaps}}=24$. For a UE supporting FR2 power class 3, $M_{\text{pss/sss_sync_with_gaps}}=24$. For a UE supporting power class 4, $M_{\text{pss/sss_sync_with_gaps}}=24$.

$M_{\text{meas_period_with_gaps}}$: For a UE supporting power class 1, $M_{\text{meas_period_with_gaps}}=40$. For a UE supporting power class 2, $M_{\text{meas_period_with_gaps}}=24$. For a UE supporting power class 3, $M_{\text{meas_period_with_gaps}}=24$. For a UE supporting power class 4, $M_{\text{meas_period_with_gaps}}=24$.

If the higher layer signaling in TS 38.331 [2] signaling of *smtc2* is present and *smtc1* is fully overlapping with measurement gaps and *smtc2* is partially overlapping with measurement gaps, requirements are not specified for $T_{\text{identify_intra_without_index}}$ Or $T_{\text{identify_intra_with_index}}$.

If SCG DRX is in use, intrafrequency cell identification requirements specified in Table 9.2.6.1-1, Table 9.2.6.1-2, and Table 9.2.5.1-3 shall depend on the SCG DRX cycle. Otherwise, the requirements for when DRX is not in use shall apply.

Table 9.2.6.2-1: Time period for PSS/SSS detection (Frequency range FR1)

DRX cycle	$T_{\text{PSS/SSS_sync_intra}}$
No DRX	$\max(600\text{ms}, 5 \times \max(\text{MGRP}, \text{SMTC period})) \times \text{CSSF}_{\text{intra}}$
$\text{DRX cycle} \leq 320\text{ms}$	$\max(600\text{ms}, \text{ceil}(1.5 \times 5) \times \max(\text{MGRP}, \text{SMTC period}, \text{DRX cycle})) \times \text{CSSF}_{\text{intra}}$
$\text{DRX cycle} > 320\text{ms}$	$5 \times \max(\text{MGRP}, \text{DRX cycle}) \times \text{CSSF}_{\text{intra}}$

Table 9.2.6.2-2: Time period for PSS/SSS detection (Frequency range FR2)

DRX cycle	$T_{\text{PSS/SSS_sync_intra}}$
No DRX	$\max(600\text{ms}, M_{\text{pss/sss_sync_with_gaps}} \times \max(\text{MGRP}, \text{SMTC period})) \times \text{CSSF}_{\text{intra}}$
DRX cycle $\leq 320\text{ms}$	$\max(600\text{ms}, \text{ceil}(1.5 \times M_{\text{pss/sss_sync_with_gaps}}) \times \max(\text{MGRP}, \text{SMTC period}, \text{DRX cycle})) \times \text{CSSF}_{\text{intra}}$
DRX cycle $> 320\text{ms}$	$M_{\text{pss/sss_sync_with_gaps}} \times \max(\text{MGRP}, \text{DRX cycle}) \times \text{CSSF}_{\text{intra}}$

Table 9.2.6.2-3: Time period for time index detection (Frequency range FR1)

DRX cycle	$T_{\text{SSB_time_index_intra}}$
No DRX	$\max(120\text{ms}, 3 \times \max(\text{MGRP}, \text{SMTC period})) \times \text{CSSF}_{\text{intra}}$
DRX cycle $\leq 320\text{ms}$	$\max(120\text{ms}, \text{ceil}(1.5 \times 3) \times \max(\text{MGRP}, \text{SMTC period}, \text{DRX cycle})) \times \text{CSSF}_{\text{intra}}$
DRX cycle $> 320\text{ms}$	$3 \times \max(\text{MGRP}, \text{DRX cycle}) \times \text{CSSF}_{\text{intra}}$

Table 9.2.6.2-7: Void**Table 9.2.6.2-8: Void**

9.2.6.3 Intrafrequency Measurement Period

The measurement period for FR1 intrafrequency measurements with gaps is as shown in table 9.2.6.3-1.

The measurement period for FR2 intrafrequency measurements with gaps is as shown in table 9.2.6.3-2 .

If SCG DRX is in use, intrafrequency measurement period requirements specified in Table 9.2.6.3-1 and Table 9.2.6.3-2, shall depend on the SCG DRX cycle. Otherwise, the requirements for when DRX is not in use shall apply.

Table 9.2.6.3-1: Measurement period for intrafrequency measurements with gaps(Frequency Range FR1)

DRX cycle	$T_{\text{SSB_measurement_period_intra}}$
No DRX	$\max(200\text{ms}, 5 \times \max(\text{MGRP}, \text{SMTC period})) \times \text{CSSF}_{\text{intra}}$
DRX cycle $\leq 320\text{ms}$	$\max(200\text{ms}, \text{ceil}(1.5 \times 5) \times \max(\text{MGRP}, \text{SMTC period}, \text{DRX cycle})) \times \text{CSSF}_{\text{intra}}$
DRX cycle $> 320\text{ms}$	$5 \times \max(\text{MGRP}, \text{DRX cycle}) \times \text{CSSF}_{\text{intra}}$

Table 9.2.6.3-2: Measurement period for intrafrequency measurements with gaps(Frequency Range FR2)

DRX cycle	$T_{\text{SSB_measurement_period_intra}}$
No DRX	$\max(400\text{ms}, M_{\text{meas_period_with_gaps}} \times \max(\text{MGRP}, \text{SMTC period})) \times \text{CSSF}_{\text{intra}}$
DRX cycle $\leq 320\text{ms}$	$\max(400\text{ms}, \text{ceil}(1.5 \times M_{\text{meas_period_with_gaps}}) \times \max(\text{MGRP}, \text{SMTC period}, \text{DRX cycle})) \times \text{CSSF}_{\text{intra}}$ ^{Note 1}
DRX cycle $> 320\text{ms}$	$M_{\text{meas_period_with_gaps}} \times \max(\text{MGRP}, \text{DRX cycle}) \times \text{CSSF}_{\text{intra}}$

9.3 NR inter-frequency measurements

9.3.1 Introduction

A measurement is defined as a SSB based inter-frequency measurement provided it is not defined as in intra-frequency measurement according to section 9.2.

The UE shall be able to identify new inter-frequency cells and perform SS-RSRP, SS-RSRQ, and SS-SINR measurements of identified inter-frequency cells if carrier frequency information is provided by PCell or the PSCell, even if no explicit neighbour list with physical layer cell identities is provided.

SSB based measurements are configured along with a measurement timing configuration (SMTC) per carrier, which provides periodicity, duration and offset information on a window of up to 5ms where the measurements on the configured inter-frequency carrier are to be performed. For inter-frequency connected mode measurements, one measurement window periodicity may be configured per inter-frequency measurement object.

When measurement gaps are needed, the UE is not expected to detect SSB on an inter-frequency measurement object which start earlier than the gap starting time + switching time, nor detect SSB which end later than the gap end – switching time. When the inter-frequency cells are in FR2 and the per-FR gap is configured to the UE in EN-DC, SA NR, NE-DC and NR-DC, or the serving cells are in FR2, the inter-frequency cells are in FR2 and the per-UE gap is configured to the UE in SA NR and NR-DC, the switching time is 0.25ms. Otherwise the switching time is 0.5ms.

9.3.2 Requirements applicability

The requirements in Section 9.3 apply, provided:

- The cell being identified or measured is detectable.

An inter-frequency cell shall be considered detectable when for each relevant SSB:

- SS-RSRP related side conditions given in Sections 10.1.4 and 10.1.5 for FR1 and FR2, respectively, for a corresponding Band,
- SS-RSRQ related side conditions given in Sections 10.1.9 and 10.1.10 for FR1 and FR2, respectively, for a corresponding Band,
- SS-SINR related side conditions given in Sections 10.1.14 and 10.1.15 for FR1 and FR2, respectively, for a corresponding Band,
- SSB_{RP} and SSB \hat{E}_s/I_{ot} according to Annex B.2.3 for a corresponding Band.

9.3.2.1 Void

9.3.2.2 Void

9.3.3 Number of cells and number of SSB

9.3.3.1 Requirements for FR1

For each inter-frequency layer, during each layer 1 measurement period, the UE shall be capable of performing SS-RSRP, SS-RSRQ, and SS-SINR measurements for at least:

- 4 identified cells, and
- 7 SSBs with different SSB index and/or PCI on the inter-frequency layer.

9.3.3.2 Requirements for FR2

For each inter-frequency layer, during each layer 1 measurement period, the UE shall be capable of performing SS-RSRP, SS-RSRQ, and SS-SINR measurements for at least:

- 4 identified cells, and
- 10 SSBs with different SSB index and/or PCI on the inter-frequency layer, and
- one SSB per identified cell.

9.3.4 Inter frequency cell identification

When measurement gaps are provided, or the UE supports capability of conducting such measurements without gaps, the UE shall be able to identify a new detectable inter frequency cell within $T_{\text{identify_inter_without_index}}$ if UE is not indicated to report SSB based RRM measurement result with the associated SSB index (*reportQuantityRSIndexes* or *maxNrofRSIndexesToReport* is not configured). Otherwise UE shall be able to identify a new detectable inter frequency cell within $T_{\text{identify_inter_with_index}}$. The UE shall be able to identify a new detectable inter frequency SS block of an already detected cell within $T_{\text{identify_inter_without_index}}$.

$$T_{\text{identify_inter_without_index}} = (T_{\text{PSS/SSS_sync_inter}} + T_{\text{SSB_measurement_period_inter}}) \text{ ms}$$

$$T_{\text{identify_inter_with_index}} = (T_{\text{PSS/SSS_sync_inter}} + T_{\text{SSB_measurement_period_inter}} + T_{\text{SSB_time_index_inter}}) \text{ ms}$$

Where:

$T_{\text{PSS/SSS_sync_inter}}$: it is the time period used in PSS/SSS detection given in table 9.3.4-1 and table 9.3.4-2.

$T_{\text{SSB_time_index_inter}}$: it is the time period used to acquire the index of the SSB being measured given in table 9.3.4-3 and table 9.3.4-4.

$T_{\text{SSB_measurement_period_inter}}$: equal to a measurement period of SSB based measurement given in table 9.3.5-1 and table 9.3.5-2.

$M_{\text{pss/sss_sync_inter}}$: For a UE supporting FR2 power class 1, $M_{\text{pss/sss_sync_inter}} = 64$ samples. For a UE supporting FR2 power class 2, $M_{\text{pss/sss_sync_inter}} = 40$ samples. For a UE supporting FR2 power class 3, $M_{\text{pss/sss_sync_inter}} = 40$ samples. For a UE supporting FR2 power class 4, $M_{\text{pss/sss_sync}} = 40$ samples.

$M_{\text{SSB_index_inter}}$: For a UE supporting power class 1, $M_{\text{SSB_index_inter}} = 40$ samples. For a vehicle mounted UE supporting power class 2, $M_{\text{pss/sss_sync_inter}} = 24$ samples. For a UE supporting power class 3, $M_{\text{SSB_index_inter}} = 24$ samples. For a UE supporting power class 4, $M_{\text{meas_period_inter}} = 24$ samples.

$M_{\text{meas_period_inter}}$: For a UE supporting FR2 power class 1, $M_{\text{meas_period_inter}} = 64$ samples. For a vehicle mounted UE supporting FR2 power class 2, $M_{\text{pss/sss_sync_inter}} = 40$ samples. For a UE supporting FR2 power class 3, $M_{\text{meas_period_inter}} = 40$ samples. For a UE supporting FR2 power class 4, $M_{\text{meas_period_inter}} = 40$ samples.

$\text{CSSF}_{\text{inter}}$: it is a carrier specific scaling factor and is determined according to $\text{CSSF}_{\text{within_gap},i}$ in section 9.1.5.2 for measurement conducted within measurement gaps.

Table 9.3.4-1: Time period for PSS/SSS detection, (Frequency range FR1)

Condition ^{NOTE1,2}	$T_{\text{PSS/SSS_sync_inter}}$
No DRX	$\max[600\text{ms}, [8] \times \max(\text{MGRP}, \text{SMTC period})] \times \text{CSSF}_{\text{inter}}$
DRX cycle $\leq 320\text{ms}$	$\max[600\text{ms}, \text{ceil}(8 \times 1.5) \times \max(\text{MGRP}, \text{SMTC period}, \text{DRX cycle})] \times \text{CSSF}_{\text{inter}}$
DRX cycle $> 320\text{ms}$	$[8] \times \text{DRX cycle} \times \text{CSSF}_{\text{inter}}$
NOTE 1: DRX or non DRX requirements apply according to the conditions described in section 3.6.1	
NOTE 2: In EN-DC operation, the parameters, timers and scheduling requests referred to in section 3.6.1 are for the secondary cell group. The DRX cycle is the DRX cycle of the secondary cell group.	

Table 9.3.4-2: Time period for PSS/SSS detection, (Frequency range FR2)

Condition ^{NOTE1,2}	$T_{\text{PSS/SSS_sync_inter}}$
No DRX	$\max[600\text{ms}, M_{\text{pss/sss_sync_inter}} \times \max(\text{MGRP, SMTC period})] \times \text{CSSF}_{\text{inter}}$
DRX cycle \leq 320ms	$\max[600\text{ms}, (1.5 \times M_{\text{pss/sss_sync_inter}}) \times \max(\text{MGRP, SMTC period, DRX cycle})] \times \text{CSSF}_{\text{inter}}$
DRX cycle > 320ms	$M_{\text{pss/sss_sync_inter}} \times \text{DRX cycle} \times \text{CSSF}_{\text{inter}}$
NOTE 1: DRX or non DRX requirements apply according to the conditions described in section 3.6.1	
NOTE 2: In EN-DC operation, the parameters, timers and scheduling requests referred to in section 3.6.1 are for the secondary cell group. The DRX cycle is the DRX cycle of the secondary cell group.	

Table 9.3.4-3: Time period for time index detection (Frequency range FR1)

Condition ^{NOTE1,2}	$T_{\text{SSB_time_index_inter}}$
No DRX	$\max[120\text{ms}, [3] \times \max(\text{MGRP, SMTC period})] \times \text{CSSF}_{\text{inter}}$
DRX cycle \leq 320ms	$\max[120\text{ms}, \text{ceil}(3 \times 1.5) \times \max(\text{MGRP, SMTC period, DRX cycle})] \times \text{CSSF}_{\text{inter}}$
DRX cycle > 320ms	$[3] \times \text{DRX cycle} \times \text{CSSF}_{\text{inter}}$
NOTE 1: DRX or non DRX requirements apply according to the conditions described in section 3.6.1	
NOTE 2: In EN-DC operation, the parameters, timers and scheduling requests referred to in section 3.6.1 are for the secondary cell group. The DRX cycle is the DRX cycle of the secondary cell group.	

Table 9.3.4-4: Time period for time index detection (Frequency range FR2)

Condition ^{NOTE1,2}	$T_{\text{SSB_time_index_inter}}$
No DRX	$\max[200\text{ms}, M_{\text{SSB_index_inter}} \times \max(\text{MGRP, SMTC period})] \times \text{CSSF}_{\text{inter}}$
DRX cycle \leq 320ms	$\max[200\text{ms}, (1.5 \times M_{\text{SSB_index_inter}}) \times \max(\text{MGRP, SMTC period, DRX cycle})] \times \text{CSSF}_{\text{inter}}$
DRX cycle > 320ms	$M_{\text{SSB_index_inter}} \times \text{DRX cycle} \times \text{CSSF}_{\text{inter}}$
NOTE 1: DRX or non DRX requirements apply according to the conditions described in section 3.6.1	
NOTE 2: In EN-DC operation, the parameters, timers and scheduling requests referred to in section 3.6.1 are for the secondary cell group. The DRX cycle is the DRX cycle of the secondary cell group.	

9.3.4.1 Void

9.3.4.2 Void

9.3.5 Inter frequency measurements

When measurement gaps are provided for inter frequency measurements, or the UE supports capability of conducting such measurements without gaps, the UE physical layer shall be capable of reporting SS-RSRP, SS-RSRQ and SS-SINR measurements to higher layers with measurement accuracy as specified in sub-clauses 10.1.4, 10.1.5, 10.1.9, 10.1.10, 10.1.14 and 10.1.15, respectively, as shown in table 9.3.5-1 and 9.3.5-2:

Table 9.3.5-1: Measurement period for inter-frequency measurements with gaps (Frequency FR1)

Condition ^{NOTE1,2}	$T_{\text{SSB_measurement_period_inter}}$
No DRX	$\max[200\text{ms}, [8] \times \max(\text{MGRP, SMTC period})] \times \text{CSSF}_{\text{inter}}$
DRX cycle \leq 320ms	$\max[200\text{ms}, \text{ceil}(8 \times 1.5) \times \max(\text{MGRP, SMTC period, DRX cycle})] \times \text{CSSF}_{\text{inter}}$
DRX cycle > 320ms	$[8] \times \text{DRX cycle} \times \text{CSSF}_{\text{inter}}$
NOTE 1: DRX or non DRX requirements apply according to the conditions described in section 3.6.1	
NOTE 2: In EN-DC operation, the parameters, timers and scheduling requests referred to in section 3.6.1 are for the secondary cell group. The DRX cycle is the DRX cycle of the secondary cell group.	

Table 9.3.5-2: Measurement period for inter-frequency measurements with gaps (Frequency FR2)

Condition ^{NOTE1,2}	$T_{SSB_measurement_period_inter}$
No DRX	$\max[400\text{ms}, M_{meas_period_inter} \times \max(\text{MGRP}, \text{SMTC period})] \times \text{CSSF}_{inter}$
DRX cycle \leq 320ms	$\max[400\text{ms}, (1.5 \times M_{meas_period_inter}) \times \max(\text{MGRP}, \text{SMTC period}, \text{DRX cycle})] \times \text{CSSF}_{inter}$
DRX cycle $>$ 320ms	$M_{meas_period_inter} \times \text{DRX cycle} \times \text{CSSF}_{inter}$
NOTE 1: DRX or non DRX requirements apply according to the conditions described in section 3.6.1	
NOTE 2: In EN-DC operation, the parameters, timers and scheduling requests referred to in section 3.6.1 are for the secondary cell group. The DRX cycle is the DRX cycle of the secondary cell group.	

9.3.5.1 Void

9.3.5.2 Void

9.3.5.3 Void

9.3.6 NR Inter frequency measurements reporting requirements

9.3.6.1 Periodic Reporting

Reported SS-RSRP, SS-RSRQ, and SS-SINR measurements contained in periodically triggered measurement reports shall meet the requirements in sections 10.1.4.1, 10.1.5.1, 10.1.9.1, 10.1.10.1, 10.1.14.1 and 10.1.15.1, respectively.

9.3.6.2 Event-triggered Periodic Reporting

Reported SS-RSRP, SS-RSRQ, and SS-SINR measurements contained in event triggered periodic measurement reports shall meet the requirements in sections 10.1.4.1, 10.1.5.1, 10.1.9.1, 10.1.10.1, 10.1.14.1 and 10.1.15.1, respectively.

The first report in event triggered periodic measurement reporting shall meet the requirements specified in clause 9.3.6.3.

9.3.6.3 Event-triggered Reporting

Reported SS-RSRP, SS-RSRQ, and SS-SINR measurements contained in event triggered measurement reports shall meet the requirements in sections 10.1.4.1, 10.1.5.1, 10.1.9.1, 10.1.10.1, 10.1.14.1 and 10.1.15.1, respectively.

The UE shall not send any event triggered measurement reports, as long as no reporting criteria are fulfilled.

The measurement reporting delay is defined as the time between an event that will trigger a measurement report and the point when the UE starts to transmit the measurement report over the air interface. This requirement assumes that the measurement report is not delayed by other RRC signalling on the DCCH. This measurement reporting delay excludes a delay uncertainty resulted when inserting the measurement report to the TTI of the uplink DCCH. The delay uncertainty is: $2 \times TTI_{DCCH}$. This measurement reporting delay excludes a delay which caused by no UL resources for UE to send the measurement report.

The event triggered measurement reporting delay, measured without L3 filtering shall be within $T_{identify_inter_without_index}$ if UE is not indicated to report SSB based RRM measurement result with the associated SSB index. Otherwise UE shall be able to identify a new detectable inter frequency cell within $T_{identify_inter_with_index}$. Both $T_{identify_inter_without_index}$ and $T_{identify_inter_with_index}$ are defined in clause 9.3.4. When L3 filtering is used an additional delay can be expected.

If a cell which has been detectable at least for the time period $T_{identify_inter_without_index}$ or $T_{identify_inter_with_index}$ defined in clause 9.3.4 and then triggers the measurement report as per TS 38.331 [2], the event triggered measurement reporting delay shall be less than $T_{SSB_measurement_period_inter}$ defined in clause 9.3.5 provided the timing to that cell has not changed more than $\pm 3200 T_c$ while measurement gap has not been available and the L3 filter has not been used. When L3 filtering is used an additional delay can be expected.

9.3.7 Void

9.4 Inter-RAT measurements

9.4.1 Introduction

The requirements in this section are specified for NR–E-UTRAN FDD and NR–E-UTRAN TDD measurements and are applicable without an explicit E-UTRAN neighbour cell list containing physical layer cell identities, for a UE:

- in RRC_CONNECTED state, and
- configured with at least PCell, and
- configured with an appropriate measurement gap pattern according to Table 9.1.2-3.

Parameter T_{inter1} used in inter-RAT requirements in Section 9.4 is specified in Table 9.4.1-1.

Table 9.4.1-1: Minimum available time for inter-RAT measurements

Gap Pattern Id	MeasurementGap Length (MGL, ms)	Measurement Gap Repetition Period (MGRP, ms)	Minimum available time for inter-frequency and inter-RAT measurements during 480ms period (T_{inter1} , ms)
0	6	40	60
1	6	80	30
2	3	40	24 ^{Note 1}
3	3	80	12 ^{Note 1}
4	6	20	120 ^{Note 1}
6	4	20	72 ^{Note 1,3,6}
7	4	40	36 ^{Note 1,4,6}
8	4	80	18 ^{Note 1,5,6}
10	3	20	48 ^{Note 1}

NOTE 1: When determining UE requirements using T_{inter1} for GP2, 3, 4, 6, 7, 8, 10, $T_{\text{inter1}} = 60$ for GP2, GP4, GP6, GP7, GP10 and $T_{\text{inter1}} = 30$ for GP3 and GP8 shall be used.

NOTE 2: Measurement gaps pattern configurations applicability is as specified in Table 9.1.2-1.

NOTE 3: When this gap pattern is used, the T_{inter} for E-UTRA inter-frequency measurements is 48 ms corresponding to the first 3 ms of the 4 ms gap

NOTE 4: When this gap pattern is used, the T_{inter} for E-UTRA inter-frequency measurements is 24 ms corresponding to the first 3 ms of the 4 ms gap

NOTE 5: When this gap pattern is used, the T_{inter} for E-UTRA inter-frequency measurements is 12 ms corresponding to the first 3 ms of the 4 ms gap

NOTE 6: This gap pattern is applicable for E-UTRA inter-frequency measurements only if gap based NR measurements are also configured.

Editor's note: a note to be added in Table 9.4.1-1 on that measurement gap patterns #2 #3, #6, #7, #8, #10 are supported only by the UEs which have a corresponding capability once RAN2 specifies the capability.

A UE configured with gap pattern Id 2, 3 or 10, shall be able to detect a target cell if the E-UTRA subframe #0 or #5 of the target E-UTRAN cell begins no earlier than 500 μs from the start of the measurement gap and if the E-UTRA subframe #0 or #5 of the target E-UTRAN cell ends no later than 500 μs before the end of the measurement gap in case of FDD, and no later than 750 μs before the end of measurement gap in case of TDD.

A UE configured with gap pattern Id 6, 7 or 8 shall be able to detect a target cell if the E-UTRA subframe #0 or #5 of the target E-UTRAN cell begins no earlier than 500 μs from the start of the measurement gap and if the E-UTRA subframe #0 or #5 of the target E-UTRAN cell ends no later than 1500 μs before the end of the measurement gap in case of FDD, and no later than 1750 μs before the end of measurement gap in case of TDD.

9.4.2 SA: NR – E-UTRAN FDD measurements

9.4.2.1 Introduction

The requirements are applicable for NR–E-UTRAN FDD RSRP, RSRQ, and RS-SINR measurements.

In the requirements, an E-UTRAN FDD cell is considered to be detectable when:

- RSRP related conditions in the accuracy requirements in Section 10.2.2 are fulfilled for a corresponding Band, together with the corresponding side conditions in Annex B.2.3 and Annex B.3.3 of TS 36.133 [15],
- RSRQ related conditions in the accuracy requirements in Section 10.2.3 are fulfilled for a corresponding Band, together with the corresponding side conditions in Annex B.2.3 and Annex B.3.3 of TS 36.133 [15],
- RS-SINR related conditions in the accuracy requirements in Section 10.2.5 are fulfilled for a corresponding Band, together with the corresponding side conditions in Annex B.2.3 and Annex B.3.19 of TS 36.133 [15].

9.4.2.2 Requirements when no DRX is used

When the UE requires measurement gaps to identify and measure inter-RAT cells and an appropriate measurement gap pattern is scheduled, the UE shall be able to identify a new detectable FDD cell within $T_{\text{Identify, E-UTRAN FDD}}$ according to the following expression:

$$T_{\text{Identify, E-UTRAN FDD}} = T_{\text{BasicIdentify}} * \frac{480}{T_{\text{Inter1}}} * K \quad \text{ms,}$$

where:

$$T_{\text{BasicIdentify}} = 480 \text{ ms,}$$

T_{Inter1} is defined in Section 9.4.1,

$\text{CSSF}_{\text{interRAT}} = \text{CSSF}_{\text{within_gap_i}}$ is the scaling factor for the measured inter-RAT E-UTRA carrier i which is calculated as specified in Section 9.1.5.2.

Identification of a cell shall include detection of the cell and additionally performing a single measurement with measurement period of $T_{\text{Measure, E-UTRAN FDD}}$ defined in Table 9.4.2.2-1.

Table 9.4.2.2-1: Measurement period and measurement bandwidth

Configuration	Physical Layer Measurement period: $T_{\text{Measure, E-UTRAN FDD}}$ [ms]	Measurement bandwidth [RB]
0	$480 \times \text{CSSF}_{\text{interRAT}}$	6
1 (Note 1)	$240 \times \text{CSSF}_{\text{interRAT}}$	50
NOTE 1: This configuration is optional.		

The UE shall be capable of identifying and performing NR – E-UTRAN FDD RSRP, RSRQ, and RS-SINR measurements of at least 4 identified E-UTRAN FDD cells per E-UTRA FDD carrier frequency layer during each layer 1 measurement period, for up to 7 E-UTRA FDD carrier frequency layers.

If higher layer filtering is used, an additional cell identification delay can be expected.

The NR – E-UTRAN FDD RSRP measurement accuracy for all measured cells shall be as specified in Section 10.2.2. The NR – E-UTRAN FDD RSRQ measurement accuracy for all measured cells shall be as specified in Section 10.2.3. The NR – E-UTRAN FDD RS-SINR measurement accuracy for all measured cells shall be as specified in Section 10.2.5.

9.4.2.3 Requirements when DRX is used

When DRX is in use and measurement gaps are configured, the UE shall be able to identify a new detectable E-UTRAN FDD cell within $T_{\text{Identify, E-UTRAN FDD}}$ specified in Table 9.4.2.3-1.

Table 9.4.2.3-1: Requirement to identify a newly detectable E-UTRAN FDD cell

DRX cycle length (s)	T _{Identify, E-UTRAN FDD} (s) (DRX cycles)	
	Gap period = 40 ms, 20 ms	Gap period = 80 ms
≤0.16	Non-DRX requirements in Section 9.4.2.2 apply	Non-DRX requirements in Section 9.4.2.2 apply
0.256	5.12*K (20*CSSF _{interRAT})	7.68*K (30*CSSF _{interRAT})
0.32	6.4*K (20*CSSF _{interRAT})	7.68*K (24*CSSF _{interRAT})
0.32 < DRX-cycle ≤ 10.24	Note1 (20*CSSF _{interRAT})	Note1 (20*CSSF _{interRAT})
NOTE 1: The time depends on the DRX cycle length.		
NOTE 2: CSSF _{interRAT} is as defined in Section 9.4.2.2.		

When DRX is in use, the UE shall be capable of performing NR – E-UTRAN FDD RSRP, RSRQ, and RS-SINR measurements of at least 4 identified E-UTRAN FDD cells per E-UTRA FDD frequency layer during each layer 1 measurement period, for up to 7 E-UTRA FDD carrier frequency layers, and the UE physical layer shall be capable of reporting NR – E-UTRAN FDD RSRP, RSRQ, and RS-SINR measurements to higher layers with the measurement period T_{measure, E-UTRAN FDD} specified in Table 9.4.2.3-2.

Table 9.4.2.3-2: Requirement to measure E-UTRAN FDD cells

DRX cycle length (s)	T _{measure, E-UTRAN FDD} (s) (DRX cycles)
≤0.08	Non-DRX requirements in Section 9.4.2.2 apply
0 < DRX-cycle ≤ 10.24	Note1 (5* CSSF _{interRAT})
NOTE 1: The time depends on the DRX cycle length.	
NOTE 2: CSSF _{interRAT} is as defined in Section 9.4.2.2.	

If higher layer filtering is used, an additional cell identification delay can be expected.

The NR – E-UTRAN FDD RSRP measurement accuracy for all measured cells shall be as specified in Section 10.2.2. The NR – E-UTRAN FDD RSRQ measurement accuracy for all measured cells shall be as specified in Section 10.2.3. The NR – E-UTRAN FDD RS-SINR measurement accuracy for all measured cells shall be as specified in Section 10.2.5.

9.4.2.4 Measurement reporting requirements

9.4.2.4.1 Periodic Reporting

The reported NR – E-UTRAN FDD RSRP, RSRQ, and RS-SINR measurements contained in periodically triggered measurement reports shall meet the requirements in Sections 10.2.2, 10.2.3, and 10.2.5, respectively.

9.4.2.4.2 Event-Triggered Periodic Reporting

The reported NR – E-UTRAN FDD RSRP, RSRQ, and RS-SINR measurements contained in event-triggered periodic measurement reports shall meet the requirements in Sections 10.2.2, 10.2.3, and 10.2.5, respectively.

The first report in event-triggered periodic measurement reporting shall meet the requirements specified in Section 9.4.2.4.3.

9.4.2.4.3 Event-Triggered Reporting

The reported NR – E-UTRAN FDD RSRP, RSRQ, and RS-SINR measurements contained in event-triggered measurement reports shall meet the requirements in Sections 10.2.2, 10.2.3, and 10.2.5, respectively.

The UE shall not send any event-triggered measurement reports, as long as no reporting criteria are fulfilled.

The measurement reporting delay is defined as the time between an event that will trigger a measurement report and the point when the UE starts to transmit the measurement report over the air interface. This requirement assumes that the measurement report is not delayed by other RRC signalling on the DCCH. This measurement reporting delay excludes a delay uncertainty resulted when inserting the measurement report to the TTI of the uplink DCCH. The delay

uncertainty is: $2 \times T_{\text{TTI}_{\text{DCCH}}}$ where $T_{\text{TTI}_{\text{DCCH}}}$ is the duration of subframe or slot or subslot when the measurement report is transmitted on the PUSCH with subframe or slot or subslot duration. This measurement reporting delay excludes a delay which caused by no UL resources for UE to send the measurement report.

The event triggered measurement reporting delay, measured without L3 filtering shall be less than $T_{\text{Identify, E-UTRAN FDD}}$ defined in Sections 9.4.2.2 and 9.4.2.3 without DRX and with DRX, respectively. When L3 filtering is used, an additional delay can be expected.

If a cell which has been detectable at least for the time period $T_{\text{Identify, E-UTRAN FDD}}$ becomes undetectable for a period $\leq [5]$ seconds and then the cell becomes detectable again and triggers an event as per TS 38.331 [2], the event triggered measurement reporting delay shall be less than $T_{\text{Measure, E-UTRAN FDD}}$ provided the timing to that cell has not changed more than $\pm 50 T_s$ while measurement gap has not been available and the L3 filter has not been used.

9.4.3 SA: NR – E-UTRAN TDD measurements

9.4.3.1 Introduction

The requirements are applicable for NR–E-UTRAN TDD RSRP, RSRQ, and RS-SINR measurements.

In the requirements, an E-UTRAN TDD cell is considered to be detectable when:

- RSRP related conditions in the accuracy requirements in Section 10.2.2 are fulfilled for a corresponding Band, together with the corresponding side conditions in Annex B.2.3 and Annex B.3.3 of TS 36.133 [15],
 - RSRQ related conditions in the accuracy requirements in Section 10.2.3 are fulfilled for a corresponding Band, together with the corresponding side conditions in Annex B.2.3 and Annex B.3.3 of TS 36.133 [15],
- RS-SINR related conditions in the accuracy requirements in Section 10.2.5 are fulfilled for a corresponding Band, together with the corresponding side conditions in Annex B.2.3 and Annex B.3.19 of TS 36.133 [15].-

9.4.3.2 Requirements when no DRX is used

When the UE requires measurement gaps to identify and measure inter-RAT cells and an appropriate measurement gap pattern is scheduled, the UE shall be able to identify a new detectable TDD cell within $T_{\text{Identify, E-UTRAN TDD}}$ according to the following expression:

- When configuration 0 or configuration 1 in Table 9.4.3.2-1 is applied,
- $$T_{\text{Identify, E-UTRAN TDD}} \leq T_{\text{BasicIdentify}} + T_{\text{Inter1}} \cdot \text{CSSF}_{\text{interRAT}}$$
- When configuration 2 or configuration 3 in Table 9.4.3.2-1 is applied,
- $$T_{\text{Identify, E-UTRAN TDD}} \leq T_{\text{BasicIdentify}} + T_{\text{Inter1}} \cdot \text{CSSF}_{\text{interRAT}} + T_{\text{Inter1}}$$

where:

$T_{\text{BasicIdentify}} = 480 \text{ ms}$,

T_{Inter1} is defined in Section 9.4.1,

$\text{CSSF}_{\text{interRAT}} = \text{CSSF}_{\text{within_gap}_i}$ is the scaling factor for the measured inter-RAT E-UTRA carrier i which is calculated as specified in Section 9.1.5.2.

Identification of a cell shall include detection of the cell and additionally performing a single measurement with measurement period of $T_{\text{Measure, E-UTRAN TDD}}$ defined in Table 9.4.3.2-1.

Table 9.4.3.2-1: $T_{\text{Measure, E-UTRAN TDD}}$ for different configurations

Configuration	Measurement bandwidth [RB]	Number of UL/DL sub-frames per half frame (5 ms)		DwPTS		$T_{\text{Measure, E-UTRAN TDD}}$ [ms]
		DL	UL	Normal CP	Extended CP	
0	6	2	2	$19760 \cdot T_s$	$20480 \cdot T_s$	$480 \times \text{CSSF}_{\text{interRAT}}$
1 (Note 1)	50	2	2	$19760 \cdot T_s$	$20480 \cdot T_s$	$240 \times \text{CSSF}_{\text{interRAT}}$

NOTE 1: This configuration is optional. NOTE 2: Void

The UE shall be capable of identifying and performing NR – E-UTRAN TDD RSRP, RSRQ, and RS-SINR measurements of at least 4 identified E-UTRAN TDD cells per E-UTRA TDD carrier frequency layer during each layer 1 measurement period, for up to 7 E-UTRA TDD carrier frequency layers.

If higher layer filtering is used, an additional cell identification delay can be expected.

The NR – E-UTRAN TDD RSRP measurement accuracy for all measured cells shall be as specified in Section 10.2.2. The NR – E-UTRAN TDD RSRQ measurement accuracy for all measured cells shall be as specified in Section 10.2.3. The NR – E-UTRAN TDD RS-SINR measurement accuracy for all measured cells shall be as specified in Section 10.2.5.

9.4.3.3 Requirements when DRX is used

When DRX is in use and measurement gaps are configured, the UE shall be able to identify a new detectable E-UTRAN TDD cell within $T_{\text{Identify, E-UTRAN TDD}}$ specified in Table 9.4.3.3-1.

Table 9.4.3.3-1: Requirement to identify a newly detectable E-UTRAN TDD cell

DRX cycle length (s)	$T_{\text{Identify, E-UTRAN TDD}}$ (s) (DRX cycles)	
	Gap period = 40 ms, 20 ms	Gap period = 80 ms
≤ 0.16	Non-DRX requirements in Section 9.4.3.2 apply	Non-DRX requirements in Section 9.4.3.2 apply
0.256	$5.12 \cdot K (20 \cdot \text{CSSF}_{\text{interRAT}})$	$7.68 \cdot K (30 \cdot \text{CSSF}_{\text{interRAT}})$
0.32	$6.4 \cdot K (20 \cdot \text{CSSF}_{\text{interRAT}})$	$7.68 \cdot K (24 \cdot \text{CSSF}_{\text{interRAT}})$
$0.32 < \text{DRX-cycle} \leq 10.24$	Note1 ($20 \cdot \text{CSSF}_{\text{interRAT}}$)	Note1 ($20 \cdot \text{CSSF}_{\text{interRAT}}$)

NOTE 1: The time depends on the DRX cycle length.
NOTE 2: $\text{CSSF}_{\text{interRAT}}$ is as defined in Section 9.4.3.2.

When DRX is in use, the UE shall be capable of performing NR – E-UTRAN TDD RSRP, RSRQ, and RS-SINR measurements of at least 4 identified E-UTRAN TDD cells per E-UTRA TDD frequency layer during each layer 1 measurement period, for up to 7 E-UTRA TDD carrier frequency layers, and the UE physical layer shall be capable of reporting NR – E-UTRAN TDD RSRP, RSRQ, and RS-SINR measurements to higher layers with the measurement period $T_{\text{measure, E-UTRAN TDD}}$ specified in Table 9.4.3.3-2.

Table 9.4.3.3-2: Requirement to measure E-UTRAN TDD cells

DRX cycle length (s)	$T_{\text{measure, E-UTRAN TDD}}$ (s) (DRX cycles)
≤ 0.08	Non-DRX Requirements in Section 9.4.3.2 apply
0.128	For configuration 2, non-DRX requirements in section 9.4.3.2 apply, Otherwise: Note1 ($5 \cdot \text{CSSF}_{\text{interRAT}}$)
$0.128 < \text{DRX-cycle} \leq 10.24$	Note1 ($5 \cdot \text{CSSF}_{\text{interRAT}}$)

NOTE 1: The time depends on the DRX cycle length.
NOTE 2: $\text{CSSF}_{\text{interRAT}}$ is as defined in Section 9.4.3.2.

If higher layer filtering is used, an additional cell identification delay can be expected.

The NR – E-UTRAN TDD RSRP measurement accuracy for all measured cells shall be as specified in Section 10.2.2.
 The NR – E-UTRAN TDD RSRQ measurement accuracy for all measured cells shall be as specified in Section 10.2.3.
 The NR – E-UTRAN TDD RS-SINR measurement accuracy for all measured cells shall be as specified in Section 10.2.5.

9.4.3.4 Measurement reporting requirements

9.4.3.4.1 Periodic Reporting

The reported NR – E-UTRAN TDD RSRP, RSRQ, and RS-SINR measurements contained in periodically triggered measurement reports shall meet the requirements in Sections 10.2.2, 10.2.3, and 10.2.5, respectively.

9.4.3.4.2 Event-Triggered Periodic Reporting

The reported NR – E-UTRAN TDD RSRP, RSRQ, and RS-SINR measurements contained in event-triggered periodic measurement reports shall meet the requirements in Sections 10.2.2, 10.2.3, and 10.2.5, respectively.

The first report in event-triggered periodic measurement reporting shall meet the requirements specified in Section 9.4.3.4.3.

9.4.3.4.3 Event-Triggered Reporting

The reported NR – E-UTRAN TDD RSRP, RSRQ, and RS-SINR measurements contained in event-triggered measurement reports shall meet the requirements in Sections 10.2.2, 10.2.3, and 10.2.5, respectively.

The UE shall not send any event-triggered measurement reports, as long as no reporting criteria are fulfilled.

The measurement reporting delay is defined as the time between an event that will trigger a measurement report and the point when the UE starts to transmit the measurement report over the air interface. This requirement assumes that the measurement report is not delayed by other RRC signalling on the DCCH. This measurement reporting delay excludes a delay uncertainty resulted when inserting the measurement report to the TTI of the uplink DCCH. The delay uncertainty is: $2 \times TTI_{DCCH}$ where TTI_{DCCH} is the duration of subframe or slot or subslot when the measurement report is transmitted on the PUSCH with subframe or slot or subslot duration. This measurement reporting delay excludes a delay which caused by no UL resources for UE to send the measurement report.

The event triggered measurement reporting delay, measured without L3 filtering shall be less than $T_{Identify, E-UTRAN TDD}$ defined in Sections 9.4.3.2 and 9.4.3.3 without DRX and with DRX, respectively. When L3 filtering is used, an additional delay can be expected.

If a cell which has been detectable at least for the time period $T_{Identify, E-UTRAN TDD}$ becomes undetectable for a period $\leq [5]$ seconds and then the cell becomes detectable again and triggers an event as per TS 38.331 [2], the event triggered measurement reporting delay shall be less than $T_{Measure, E-UTRAN TDD}$ provided the timing to that cell has not changed more than $\pm 50 T_s$ while measurement gap has not been available and the L3 filter has not been used.

9.4.4 SA: Inter-RAT RSTD measurements

9.4.4.1 SA: NR – E-UTRAN FDD RSTD measurements

9.4.4.1.1 Introduction

The requirements are applicable for NR–E-UTRAN FDD RSTD measurements requested via LPP [22, 24].

The requirements in section 9.4.4.1 apply when:

- the UE is provided with the LTE timing information via LPP [24], including both *nr-LTE-SFN-Offset* and *nr-LTE-fineTiming-Offset*, or
- the UE is not provided with *nr-LTE-SFN-Offset* or *nr-LTE-fineTiming-Offset*, or
- the UE is provided with *nr-LTE-SFN-Offset* but not with *nr-LTE-fineTiming-Offset*.

When the UE is not aware of the SFN of at least one LTE cell in the OTDOA assistance data, the UE may be using autonomous gaps in FR1 to acquire SFN of the OTDOA assistance data reference cell prior to requesting measurement gaps for performing the requested E-UTRA RSTD measurements before the

$T_{\text{RSTD InterRAT, E-UTRAN FDD}}$ time period starts while meeting all the requirements in Section 9.4.4.1.2, provided that the OTDOA assistance data is provided to allow sufficient time for the UE to acquire the SFN before the $T_{\text{RSTD InterRAT, E-UTRAN FDD}}$ starts.

When the UE is not aware of and cannot derive the subframe timing difference between the NR serving cell and the OTDOA assistance data reference cell, the UE may need to request measurement gaps in FR1 to perform cell detection for the OTDOA assistance data reference cell prior to requesting measurement gaps for performing the requested E-UTRA RSTD measurements before the $T_{\text{RSTD InterRAT, E-UTRAN FDD}}$ time period starts while meeting all the requirements in Section 9.4.4.1.2, provided that the OTDOA assistance data is provided to allow sufficient time for the UE to detect the cell before the $T_{\text{RSTD InterRAT, E-UTRAN FDD}}$ starts.

9.4.4.1.2 Requirements

When the physical layer cell identities of neighbour cells together with the OTDOA assistance data are provided, the UE shall be able to detect and measure inter-RAT E-UTRAN FDD RSTD, specified in TS 38.215 [4], for at least $n=16$ cells, including the reference cell, within $T_{\text{RSTD InterRAT, E-UTRAN FDD}}$ ms as given below:

$$T_{\text{RSTD InterRAT, E-UTRAN FDD}} = T_{\text{PRS}} \cdot (M - 1) + \Delta \quad \text{ms},$$

where

$T_{\text{RSTD InterRAT, E-UTRAN FDD}}$ is the total time for detecting and measuring at least n cells,

T_{PRS} is the largest value of the cell-specific positioning subframe configuration period, defined in TS 36.211 [23], among the measured n cells including the reference cell,

M is the number of PRS positioning occasions as defined in Table 9.4.4.1.2-1, where each PRS positioning occasion comprises of N_{PRS} ($1 \leq N_{\text{PRS}} \leq 6$) consecutive downlink positioning subframes defined in TS 36.211 [23],

$\text{CSSF}_{\text{interRAT}} = \text{CSSF}_{\text{within_gap}_i}$ is the scaling factor determined by the gap sharing scheme for the RSTD measurements on the carrier frequency i as defined in Section 9.1.5.2,

$\Delta = 160 \cdot \left\lceil \frac{n}{M} \right\rceil$ ms is the measurement time for a single PRS positioning occasion which includes the sampling time and the processing time, and

the n cells are distributed on up to two E-UTRAN FDD carrier frequencies.

Table 9.4.4.1.2-1: Number of PRS positioning occasions within $T_{\text{RSTD InterRAT, E-UTRAN FDD}}$

Positioning subframe configuration period T_{PRS}	Number of PRS positioning occasions M	
	f2 <small>Note1</small>	f1 and f2 <small>Note2</small>
160 ms	$16 \times \text{CSSF}_{\text{interRAT}}$	$32 \times \text{CSSF}_{\text{interRAT}}$
>160 ms	$8 \times \text{CSSF}_{\text{interRAT}}$	$16 \times \text{CSSF}_{\text{interRAT}}$
NOTE 1: When inter-RAT E-UTRAN FDD RSTD measurements are performed over the reference cell and neighbour cells, which belong to the E-UTRAN FDD carrier frequency f2.		
NOTE 2: When inter-RAT E-UTRAN FDD RSTD measurements are performed over the reference cell and the neighbour cells, which belong to the E-UTRAN FDD carrier frequency f1 and the E-UTRAN FDD carrier frequency f2 respectively.		

The UE physical layer shall be capable of reporting RSTD for the reference cell and all the neighbor cells i out of at least $(n-1)$ neighbor cells within $T_{\text{RSTD InterRAT, E-UTRAN FDD}}$ provided:

$$\left(\text{PRS } \hat{E}_s / I_{\text{ot}} \right)_{\text{ref}} \geq -6 \text{ dB for all Frequency Bands for the reference cell,}$$

$(\text{PRS } \hat{E}_s / \text{Iot})_i \geq -13$ dB for all Frequency Bands for neighbour cell i ,

$(\text{PRS } \hat{E}_s / \text{Iot})_{ref}$ and $(\text{PRS } \hat{E}_s / \text{Iot})_i$ conditions apply for all subframes of at least $L = \frac{M}{2}$ PRS positioning

occasions,

PRP 1,2|dBm according to TS 36.133 [15, Annex B.2.6] for a corresponding Band

$\text{PRS } \hat{E}_s / \text{Iot}$ is defined as the ratio of the average received energy per PRS RE during the useful part of the symbol to the average received power spectral density of the total noise and interference for this RE, where the ratio is measured over all REs which carry PRS.

The time $T_{\text{RSTD InterRAT, E-UTRAN FDD}}$ starts from the first subframe of the PRS positioning occasion closest in time after both the *OTDOA-RequestLocationInformation* message and the OTDOA assistance data in the *OTDOA-ProvideAssistanceData* message via LPP as specified in TS 38.305 [22], are delivered to the physical layer of the UE.

The RSTD measurement accuracy for all measured neighbor cells i shall be fulfilled according to the accuracy as specified in Section 10.2.4.

9.4.4.1.2.1 RSTD Measurement Reporting Delay

This requirement assumes that the measurement report is not delayed by other LPP signalling on the DCCH. This measurement reporting delay excludes a delay uncertainty resulted when inserting the measurement report to the TTI of the uplink DCCH. The delay uncertainty is: $2 \times \text{TTI}_{\text{DCCH}}$ where TTI_{DCCH} is the duration of subframe or slot or subslot when the measurement report is transmitted on the PUSCH with subframe or slot or subslot duration. This measurement reporting delay excludes any delay caused by no UL resources for UE to send the measurement report.

9.4.4.1.2.2 Requirements for acquiring the timing of the E-UTRA OTDOA reference cell

When the UE is not aware of the SFN of at least one LTE cell in the OTDOA assistance data, the UE supporting per-FR gaps may make autonomous gaps in downlink reception and uplink transmission of the PCell and each of the SCells in FR1 for acquiring SFN of the reference cell in the E-UTRA OTDOA assistance data. No autonomous gaps in downlink reception or uplink transmission are allowed in any of the UE serving cells in FR2. The UE, which are only supporting per-UE gaps, may make autonomous gaps in downlink reception and uplink transmission of the PCell and each of the SCells for acquiring the SFN of the reference cell in the E-UTRA OTDOA assistance data.

When the UE is not aware of and cannot derive the subframe timing difference between the NR serving cell and the OTDOA assistance data reference cell, the UE may need to request measurement gaps while indicating *utra-FineTimingDetection* according to TS 38.331 [2] for detecting the reference cell in the E-UTRA OTDOA assistance data.

When the UE is performing one or both of SFN acquisition or cell detection as specified above, the UE shall be able to determine the timing of the E-UTRA OTDOA assistance data reference cell during the time period

$$T_{\text{RefCell,E-UTRAN}} = T_{\text{Detect, E-UTRAN FDD}} + T_{\text{MIB}} + T_{\text{ECGI}},$$

where

$T_{\text{Detect, E-UTRAN FDD}} = T_{\text{Identify, E-UTRAN FDD}} - T_{\text{measure, E-UTRAN FDD}}$ is according to Section 9.4.2 assuming $\text{CSSF}_{\text{interRAT}}=1$ and it is the time needed to detect the E-UTRA OTDOA assistance data reference cell when the UE needs to acquire the subframe and slot timing of the cell, provided the UE is configured with measurement gaps ($T_{\text{Detect, E-UTRAN FDD}}=0$ when both *nr-LTE-SFN-Offset* and *nr-LTE-fineTiming-Offset* are provided in the E-UTRA OTDOA assistance data or the E-UTRA OTDOA assistance data reference cell is known to the UE), and

$T_{\text{MIB}} = 50$ ms is the time required to acquire SFN of the E-UTRA OTDOA assistance data reference cell provided the OTDOA assistance data reference cell is decodable and at least all E-UTRA subframes #0 during T_{MIB} are available at the UE receiver ($T_{\text{MIB}}=0$ when *nr-LTE-SFN-Offset* is provided in the E-UTRA OTDOA assistance data), and

$T_{\text{ECGI}} = 100$ ms is the time required to acquire ECGI of the E-UTRA OTDOA assistance data reference cell when *cellGlobalId* is included in *OTDOA-ReferenceCellInfo* and the UE is not aware of the ECGI of this cell ($T_{\text{ECGI}} = 0$ when *cellGlobalId* is not included in *OTDOA-ReferenceCellInfo* or the UE is aware of the ECGI of the E-UTRA OTDOA assistance data reference cell).

When detecting the E-UTRAN OTDOA reference cell, the requirements in this section shall be met, provided the conditions for the detectable cell are fulfilled according to Section 9.4.2.1. In addition, the MIB of the E-UTRA OTDOA reference cell whose SFN is acquired shall be considered decodable by the UE provided the PBCH demodulation requirements are met according to TS 36.101 [25].

The requirement for acquiring the timing of the E-UTRA OTDOA reference cell within $T_{\text{RefCell,E-UTRAN}}$ is applicable when no DRX is used as well as when any of the DRX cycles specified in TS 38.331 [2] is used.

When $T_{\text{MIB}} > 0$ and UE is using autonomous gaps during T_{MIB} , the UE shall transmit at least $N_{\text{ACK/NACK, MIB, FDD, FR1}}$ ACK/NACKs on PCell in FR1 or each of activated SCell(s) in the same frequency range, specified in Table 9.4.4.1.2.2-1. When $T_{\text{ECGI}} > 0$ and UE is using autonomous gaps during T_{ECGI} , the UE shall transmit at least $N_{\text{ACK/NACK, ECGI, FDD, FR1}}$ ACK/NACKs on PCell in FR1 or each of activated SCell(s) in the same frequency range, specified in Table 9.4.4.1.2.2-2. The requirements in Tables 9.4.4.1.2.2-1 and 9.4.4.1.2.2-2 apply, provided that:

- there is continuous DL data allocation,
- no DRX cycle is used,
- no measurement gaps are configured,
- only one code word is transmitted in each slot,
- 2 slot ACK/NACK feedback is configured,
- 20 ms SMTC period is configured.

Table 9.4.4.1.2.2-1: Number of ACK/NACKs transmitted by the UE during T_{MIB}

NACK/NACK, MIB, FDD, FR1	Configuration of the serving cell in which the transmitted ACK/NACKs are counted	
	Duplex mode configuration	SCS
[15]	FDD	15 kHz
[39]	FDD	30 kHz
[85]	FDD	60 kHz
[2]	TDD ^{Note 1}	15 kHz
[4]	TDD ^{Note 1}	30 kHz
[44]	TDD ^{Note 1}	60 kHz

NOTE 1: TDD UL-DL configuration is as specified in Table A.3.3.1-1 of TS 38.101-1 [18].

Table 9.4.4.1.2.2-2: Number of ACK/NACKs transmitted by the UE during T_{ECGI}

NACK/NACK, ECGI, FDD, FR1	Configuration of the serving cell in which the transmitted ACK/NACKs are counted	
	Duplex mode configuration	SCS
TBD	FDD	15 kHz
TBD	FDD	30 kHz
TBD	FDD	60 kHz
TBD	TDD ^{Note 1}	15 kHz
TBD	TDD ^{Note 1}	30 kHz
TBD	TDD ^{Note 1}	60 kHz

NOTE 1: TDD UL-DL configuration is as specified in Table A.3.3.1-1 of TS 38.101-1 [18].

9.4.4.2 SA: NR – E-UTRAN TDD RSTD measurements

9.4.4.2.1 Introduction

The requirements are applicable for NR–E-UTRAN TDD RSTD measurements requested via LPP [22, 24].

The requirements in section 9.4.4.1 apply when:

- the UE is provided with the LTE timing information via LPP [24], including both *nr-LTE-SFN-Offset* and *nr-LTE-fineTiming-Offset*, or
- the UE is not provided with *nr-LTE-SFN-Offset* or *nr-LTE-fineTiming-Offset*, or
- the UE is provided with *nr-LTE-SFN-Offset* but not with *nr-LTE-fineTiming-Offset*.

When the UE is not aware of the SFN of at least one LTE cell in the OTDOA assistance data, the UE may be using autonomous gaps in FR1 to acquire SFN of the OTDOA assistance data reference cell prior to requesting measurement gaps for performing the requested E-UTRA RSTD measurements before the

$T_{\text{RSTD InterRAT,E-UTRAN TDD}}$ time period starts while meeting all the requirements in Section 9.4.4.2.2, provided that the OTDOA assistance data is provided to allow sufficient time for the UE to acquire the SFN before the

$T_{\text{RSTD InterRAT,E-UTRAN TDD}}$ starts. When the UE is not aware of and cannot derive the subframe timing difference between the NR serving cell and the OTDOA assistance data reference cell, the UE may need to request measurement gaps in FR1 to perform cell detection for the OTDOA assistance data reference cell prior to requesting measurement gaps for performing the requested E-UTRA RSTD measurements before the

$T_{\text{RSTD InterRAT,E-UTRAN TDD}}$ time period starts while meeting all the requirements in Section 9.4.4.2.2, provided that the OTDOA assistance data is provided to allow sufficient time for the UE to detect the cell before the

$T_{\text{RSTD InterRAT,E-UTRAN TDD}}$ starts.

9.4.4.2.2 Requirements

When the physical layer cell identities of neighbour cells together with the OTDOA assistance data are provided, the UE shall be able to detect and measure inter-RAT -UTRAN TDD RSTD, specified in TS 38.215 [4], for at least $n=16$ cells, including the reference cell, within $T_{\text{RSTD InterRAT,E-UTRAN TDD}}$ ms as given below:

$$T_{\text{RSTD InterRAT,E-UTRAN TDD}} = T_{\text{PRS}} \cdot (M - 1) + \Delta \quad \text{ms} \quad ,$$

where

$T_{\text{RSTD InterRAT,E-UTRAN TDD}}$ is the total time for detecting and measuring at least n cells,

T_{PRS} is the largest value of the cell-specific positioning subframe configuration period, defined in TS 36.211 [23], among the measured n cells including the reference cell,

M is the number of PRS positioning occasions as defined in Table 9.4.4.2.2-1, where a PRS positioning occasion is as defined in clause 9.4.4.1.2,

$\text{CSSF}_{\text{interRAT}} = \text{CSSF}_{\text{within_gap_i}}$ is the scaling factor determined by the gap sharing scheme for the RSTD measurements on the carrier frequency i as defined in Section 9.1.5.2,

$\Delta = 160 \cdot \left\lceil \frac{n}{M} \right\rceil$ ms is the measurement time for a single PRS positioning occasion which includes the sampling time and the processing time, and

the n cells are distributed on up to two E-UTRAN TDD carrier frequencies.

Table 9.4.4.2.2-1: Number of PRS positioning occasions within $T_{\text{RSTD InterRAT,E-UTRAN TDD}}$

Positioning subframe configuration period T_{PRS}	Number of PRS positioning occasions M	
	f2 ^{Note1}	f1 and f2 ^{Note2}
160 ms	16 × $\text{CSSF}_{\text{interRAT}}$	32 × $\text{CSSF}_{\text{interRAT}}$
>160 ms	8 × $\text{CSSF}_{\text{interRAT}}$	16 × $\text{CSSF}_{\text{interRAT}}$
NOTE 1: When inter-RAT E-UTRAN TDD RSTD measurements are performed over the reference cell and neighbour cells, which belong to the E-UTRAN TDD carrier frequency f2.		
NOTE 2: When inter-RAT E-UTRAN TDD RSTD measurements are performed over the reference cell and the neighbour cells, which belong to the E-UTRAN TDD carrier frequency f1 and the E-UTRAN TDD carrier frequency f2 respectively.		

The requirements in this section shall apply for all TDD special subframe configurations specified in TS 36.211 [23] and for the TDD uplink-downlink configurations as specified in Table 9.4.4.2.2-2 for UE requiring measurement gaps for these measurements. For UEs capable of performing inter-RAT RSTD measurements without measurement gaps, TDD uplink-downlink subframe configurations as specified in Table 9.4.4.2.2-3 shall apply.

Table 9.4.4.2.2-2: TDD uplink-downlink subframe configurations applicable for inter-RAT RSTD requirements

PRS Transmission Bandwidth [RB]	Applicable TDD uplink-downlink configurations
6, 15	3, 4 and 5
25	1, 2, 3, 4, 5 and 6
50, 75, 100	0, 1, 2, 3, 4, 5 and 6
NOTE 1: Uplink-downlink configurations are specified in Table 4.2-2 in TS 36.211 [23].	

Table 9.4.4.2.2-3: TDD uplink-downlink subframe configurations applicable for inter-RAT RSTD requirements without gaps

PRS Transmission Bandwidth [RB]	Applicable TDD uplink-downlink configurations
6, 15	1, 2, 3, 4 and 5
25, 50, 75, 100	0, 1, 2, 3, 4, 5 and 6
NOTE: Uplink-downlink configurations are specified in Table 4.2-2 in TS 36.211 [23].	

The UE physical layer shall be capable of reporting RSTD for the reference cell and all the neighbor cells i out of at least $(n-1)$ neighbor cells within $T_{\text{RSTD InterRAT,E-UTRAN TDD}}$ provided:

$$\left(\text{PRS } \hat{E}_s / \text{Iot} \right)_{\text{ref}} \geq -6 \text{ dB for all Frequency Bands for the reference cell,}$$

$$\left(\text{PRS } \hat{E}_s / \text{Iot} \right)_i \geq -13 \text{ dB for all Frequency Bands for neighbour cell } i,$$

$$\left(\text{PRS } \hat{E}_s / \text{Iot} \right)_{\text{ref}} \text{ and } \left(\text{PRS } \hat{E}_s / \text{Iot} \right)_i \text{ conditions apply for all subframes of at least } L = \frac{M}{2} \text{ PRS positioning}$$

occasions,

PRP 1,2_{dBm} according to TS 36.133 [15, Annex B.2.6] for a corresponding Band

$\text{PRS } \hat{E}_s / \text{Iot}$ is as defined in Section 9.4.4.1.2.

The time $T_{\text{RSTD InterRAT,E-UTRAN TDD}}$ starts from the first subframe of the PRS positioning occasion closest in time after both the OTDOA-RequestLocationInformation message and the OTDOA assistance data in the OTDOA-ProvideAssistanceData message via LPP as specified in TS 38.305 [22], are delivered to the physical layer of the UE.

The RSTD measurement accuracy for all measured neighbor cells i shall be fulfilled according to the accuracy as specified in Section 10.2.4.

9.4.4.2.2.1 RSTD Measurement Reporting Delay

This requirement assumes that the measurement report is not delayed by other LPP signalling on the DCCH. This measurement reporting delay excludes a delay uncertainty resulted when inserting the measurement report to the TTI of the uplink DCCH. The delay uncertainty is: $2 \times \text{TTI}_{\text{DCCH}}$ where TTI_{DCCH} is the duration of subframe or slot or subslot when the measurement report is transmitted on the PUSCH with subframe or slot or subslot duration. This measurement reporting delay excludes any delay caused by no UL resources for UE to send the measurement report.

9.4.4.2.2.2 Requirements for acquiring the timing of the E-UTRA OTDOA reference cell

When the UE is not aware of the SFN of at least one LTE cell in the OTDOA assistance data, the UE supporting per-FR gaps may make autonomous gaps in downlink reception and uplink transmission of the PCell and each of the SCells in FR1 for acquiring SFN of the reference cell in the E-UTRA OTDOA assistance data. No autonomous gaps in downlink reception or uplink transmission are allowed in any of the UE serving cells in FR2. The UE, which are only supporting

per-UE gaps, may make autonomous gaps in downlink reception and uplink transmission of the PCell and each of the SCells for acquiring the SFN of the reference cell in the E-UTRA OTDOA assistance data.

When the UE is not aware of and cannot derive the subframe timing difference between the NR serving cell and the OTDOA assistance data reference cell, the UE may need to request measurement gaps while indicating *eutra-FineTimingDetection* according to TS 38.331 [2] for detecting the reference cell in the E-UTRA OTDOA assistance data.

When the UE is performing one or both of SFN acquisition or cell detection as specified above, the UE shall be able to determine the timing of the E-UTRA OTDOA assistance data reference cell during the time period

$$T_{\text{RefCell,E-UTRAN}} = T_{\text{Detect, E-UTRAN TDD}} + T_{\text{MIB}} + T_{\text{ECGI}},$$

where

$T_{\text{Detect, E-UTRAN TDD}} = T_{\text{Identify, E-UTRAN TDD}} - T_{\text{measure, E-UTRAN TDD}}$ is according to Section 9.4.3 assuming $\text{CSSF}_{\text{interRAT}}=1$ and it is the time needed to detect the E-UTRA OTDOA assistance data reference cell when the UE needs to acquire the subframe and slot timing of the cell, provided the UE is configured with measurement gaps ($T_{\text{Detect, E-UTRAN TDD}}=0$ when both *nr-LTE-SFN-Offset* and *nr-LTE-fineTiming-Offset* are provided in the E-UTRA OTDOA assistance data or the E-UTRA OTDOA assistance data reference cell is known to the UE), and

$T_{\text{MIB}} = 50$ ms is the time required to acquire SFN of the E-UTRA OTDOA assistance data reference cell provided the OTDOA assistance data reference cell is decodable and at least all E-UTRA subframes #0 during T_{MIB} are available at the UE receiver ($T_{\text{MIB}}=0$ when *nr-LTE-SFN-Offset* is provided in the E-UTRA OTDOA assistance data), and

$T_{\text{ECGI}} = 100$ ms is the time required to acquire ECGI of the E-UTRA OTDOA assistance data reference cell when *cellGlobalId* is included in *OTDOA-ReferenceCellInfo* and the UE is not aware of the ECGI of this cell ($T_{\text{ECGI}} = 0$ when *cellGlobalId* is not included in *OTDOA-ReferenceCellInfo* or the UE is aware of the ECGI of the E-UTRA OTDOA assistance data reference cell).

When detecting the E-UTRAN OTDOA reference cell, the requirements in this section shall be met, provided the conditions for the detectable cell are fulfilled according to Section 9.4.3.1. In addition, the MIB of an the E-UTRA OTDOA reference cell whose SFN is acquired shall be considered decodable by the UE provided the PBCH demodulation requirements are met according to TS 36.101 [25].

The requirement for acquiring the timing of the E-UTRA OTDOA reference cell within $T_{\text{RefCell,E-UTRAN}}$ is applicable when no DRX is used as well as when any of the DRX cycles specified in TS 38.331 [2] is used.

When $T_{\text{MIB}}>0$ and UE is using autonomous gaps during T_{MIB} , the UE shall transmit at least $N_{\text{ACK/NACK, MIB, TDD, FR1}}$ ACK/NACKs on PCell in FR1 or each of activated SCell(s) in the same frequency range, specified in Table 9.4.4.2.2.2-1. When $T_{\text{ECGI}}>0$ and UE is using autonomous gaps during T_{ECGI} , the UE shall transmit at least $N_{\text{ACK/NACK, ECGI, TDD, FR1}}$ ACK/NACKs on PCell in FR1 or each of activated SCell(s) in the same frequency range, specified in Table 9.4.4.2.2.2-2. The requirements in Tables 9.4.4.2.2.2-1 and 9.4.4.2.2.2-2 apply, provided that:

- there is continuous DL data allocation,
- no DRX cycle is used,
- no measurement gaps are configured,
- only one code word is transmitted in each slot,
- 2 slot ACK/NACK feedback is configured,
- 20 ms SMTC period is configured.

Table 9.4.4.2.2-1: Minimum number of ACK/NACKs transmitted by the UE during T_{MIB}

NACK/NACK, MIB, TDD, FR1	Configuration of the serving cell in which the transmitted ACK/NACKs are counted	
	Duplex mode configuration	SCS
[15]	FDD	15 kHz
[39]	FDD	30 kHz
[85]	FDD	60 kHz
[2]	TDD ^{Note 1}	15 kHz
[4]	TDD ^{Note 1}	30 kHz
[44]	TDD ^{Note 1}	60 kHz

NOTE 1: TDD UL-DL configuration is as specified in Table A.3.3.1-1 of TS 38.101-1 [18].

Table 9.4.4.2.2-2: Number of ACK/NACKs transmitted by the UE during T_{ECGI}

NACK/NACK, ECGI, TDD, FR1	Configuration of the serving cell in which the transmitted ACK/NACKs are counted	
	Duplex mode configuration	SCS
TBD	FDD	15 kHz
TBD	FDD	30 kHz
TBD	FDD	60 kHz
TBD	TDD ^{Note 1}	15 kHz
TBD	TDD ^{Note 1}	30 kHz
TBD	TDD ^{Note 1}	60 kHz

NOTE 1: TDD UL-DL configuration is as specified in Table A.3.3.1-1 of TS 38.101-1 [18].

9.4.5 SA: Inter-RAT E-CID measurements

9.4.5.1 NR-E-UTRAN FDD E-CID RSRP and RSRQ measurements

9.4.5.1.1 Introduction

The requirements in Section 9.4.5.1 shall apply provided the UE has received *ECID-RequestLocationInformation* message from LMF via LPP requesting the UE to report inter-RAT E-UTRAN FDD E-CID RSRP and RSRQ measurements [22].

9.4.5.1.2 Requirements

The requirements in Section 9.4.2 also apply for this section except the measurement reporting requirements. The measurement reporting requirements for E-CID RSRP and RSRQ are defined in Section 9.4.5.1.3.

9.4.5.1.3 Measurement Reporting Delay

This requirement assumes that the measurement report is not delayed by other LPP signalling on the DCCH. This measurement reporting delay excludes a delay uncertainty resulted when inserting the measurement report to the TTI of the uplink DCCH. The delay uncertainty is: $2 \times TTI_{DCCH}$ where TTI_{DCCH} is the duration of subframe or slot or subslot when the measurement report is transmitted on the PUSCH with subframe or slot or subslot duration. This measurement reporting delay excludes any delay caused by no UL resources for UE to send the measurement report.

Reported RSRP and RSRQ measurements contained in periodically triggered measurement reports shall meet the requirements in Sections 10.2.2 and 10.2.3, respectively.

9.4.5.2 NR–E-UTRAN TDD E-CID RSRP and RSRQ measurements

9.4.5.2.1 Introduction

The requirements in Section 9.4.5.2. shall apply provided the UE has received *ECID-RequestLocationInformation* message from LMF via LPP requesting the UE to report inter-RAT E-UTRAN TDD E-CID RSRP and RSRQ measurements [22].

9.4.5.2.2 Requirements

The requirements in Section 9.4.3 also apply for this section except the measurement reporting requirements. The measurement reporting requirements for E-CID RSRP and RSRQ are defined in Section 9.4.5.2.3.

9.4.5.2.3 Measurement Reporting Delay

This requirement assumes that the measurement report is not delayed by other LPP signalling on the DCCH. This measurement reporting delay excludes a delay uncertainty resulted when inserting the measurement report to the TTI of the uplink DCCH. The delay uncertainty is: $2 \times TTI_{DCCH}$ where TTI_{DCCH} is the duration of subframe or slot or subslot when the measurement report is transmitted on the PUSCH with subframe or slot or subslot duration. This measurement reporting delay excludes any delay caused by no UL resources for UE to send the measurement report.

Reported RSRP and RSRQ measurements contained in periodically triggered measurement reports shall meet the requirements in Sections 10.2.2 and 10.2.3, respectively.

9.5 L1-RSRP measurements for Reporting

9.5.1 Introduction

When configured by the network, the UE shall be able to perform L1-RSRP measurements of configured CSI-RS, SSB or CSI-RS and SSB resources for L1-RSRP. The measurements shall be performed for a serving cell, including PCell, PSCell, or SCell, on the resources configured for L1-RSRP measurements within the active BWP.

The UE shall be able to measure all CSI-RS resources and/or SSB resources of the CSI Resource set(s) within the CSI Resource settings configured for L1-RSRP for the active BWP, provided that the number of resources does not exceed the UE capability indicated by *beamManagementSSB-CSI-RS*.

Unless the reporting quantity is set to 'none', the UE shall report the quantity for the CSI reporting configuration associated by the reporting quantity.

9.5.2 Requirements applicability

The requirements in Section 9.5 apply, provided:

- The CSI-RS or SSB or CSI-RS and SSB resources configured for L1-RSRP measurements are measurable.

An SSB resource configured for L1-RSRP shall be considered measurable when for each relevant SSB the following conditions are met:

- L1-RSRP related side conditions given in Sections 10.1.19.1. and 10.1.20.1 for FR1 and FR2, respectively, for a corresponding band,
- SSB_RP and $SSB \hat{E}_s/I_{ot}$ according to Annex B.2.4.1 for a corresponding band.

A CSI-RS resource configured for L1-RSRP shall be considered measurable when for each relevant CSI-RS the following conditions are met:

- L1-RSRP related side conditions given in Sections 10.1.19.2 and 10.1.20.2 for FR1 and FR2, respectively, for a corresponding band,
- $CSI-RS_RP$ and $CSI-RS \hat{E}_s/I_{ot}$ according to Annex B.2.4.2 for a corresponding band.

A CSI-RS and SSB resource configured for L1-RSRP shall be considered measurable when the measurable resource conditions are met for both CSI-RS resource and SSB resource.

Requirements are defined for periodic, semi-persistent and aperiodic resources.

9.5.3 Measurement Reporting Requirements

The UE shall only send L1-RSRP reports for report configurations configured for the active BWP.

The UE shall report the L1-RSRP value as a 7-bit value in the range [-140, -44] dBm with 1dB step size according to section 10.1.x if *nrofReportedRS* is configured to one. Otherwise, and additionally if *groupBasedBeamReporting* is enabled the UE shall use differential L1-RSRP based reporting as defined in section 10.1.x.

9.5.3.1 Periodic Reporting

Reported L1-RSRP measurements contained in periodic L1-RSRP reports shall meet the requirements in sections 10.x, 10.y and 10.z, respectively.

The UE shall not send any periodic L1-RSRP reports for a non-active BWP.

The L1-RSRP reporting delay is FFS.

The periodic L1-RSRP reporting delay shall be less than [TBD].

9.5.3.2 Semi-Persistent Reporting

Reported L1-RSRP measurements contained in Semi-Persistent L1-RSRP reports shall meet the requirements in sections 10.x, 10.y and 10.z, respectively. This requirement applies for semi-persistent L1-RSRP reports send on PUSCH or PUCCH.

The UE shall not send any semi-persistent L1-RSRP reports on PUSCH, as long as no DCI request have been received.

The UE shall not send any semi-persistent L1-RSRP reports on PUCCH, as long as no activation command [38.321] have been received.

The L1-RSRP reporting delay is defined as the time between a request or command that will trigger an L1-RSRP report is received by the UE and the point when the UE starts to transmit the L1-RSRP report over the air interface.

The Semi-persistent L1-RSRP reporting delay shall be less than [TBD] for a DCI requested semi-persistent L1-RSRP report and less than [TBD] for an L1-RSRP requested by activation command [36.321].

9.5.3.3 Aperiodic Reporting

Reported L1-RSRP measurements contained in Aperiodic triggered, Aperiodic triggered periodic and Aperiodic triggered semi-persistent L1-RSRP reports shall meet the requirements in sections 10.x, 10.y and 10.z, respectively.

The UE shall not send any aperiodic L1-RSRP reports, as long as no DCI trigger have been received.

The L1-RSRP reporting delay is defined as the time between a DCI request that will trigger an L1-RSRP report and the point when the UE starts to transmit the L1-RSRP report over the air interface.

The aperiodic L1-RSRP reporting delay shall be less than [TBD].

9.5.4 L1-RSRP measurement requirements

9.5.4.1 SSB based L1-RSRP Reporting

The UE shall be capable of performing L1-RSRP measurements based on the configured SSB resource for L1-RSRP computation, and the UE physical layer shall be capable of reporting L1-RSRP measured over the measurement period of $T_{\text{BM_Measurement_Period_SSB}}$.

The value of $T_{\text{BM_Measurement_Period_SSB}}$ is defined in Table 9.5.4.1-1 for FR1 and Table 9.5.4.1-2 for FR2, where

- $M=1$ if higher layer parameter *timeRestrictionForChannelMeasurement* is configured, and $M=3$ otherwise
- $N=8$.

For FR1,

- $P=1/(1 - T_{SSB}/MGRP)$, when in the monitored cell there are measurement gaps configured for intra-frequency, inter-frequency or inter-RAT measurements, which are overlapping with some but not all occasions of the SSB; and
- $P=1$ when in the monitored cell there are no measurement gaps overlapping with any occasion of the SSB.

For FR2,

- $P=1/(1 - T_{SSB}/T_{SMTCperiod})$, when BM-RS is not overlapped with measurement gap and BM-RS is partially overlapped with SMTC occasion ($T_{SSB} < T_{SMTCperiod}$).
- P is $P_{sharing}$ factor, when BM-RS is not overlapped with measurement gap and BM-RS is fully overlapped with SMTC period ($T_{SSB} = T_{SMTCperiod}$).
- P is $1/(1 - T_{SSB}/MGRP - T_{SSB}/T_{SMTCperiod})$, when BM-RS is partially overlapped with measurement gap and BM-RS is partially overlapped with SMTC occasion ($T_{SSB} < T_{SMTCperiod}$) and SMTC occasion is not overlapped with measurement gap and
 - $T_{SMTCperiod} \neq MGRP$ or
 - $T_{SMTCperiod} = MGRP$ and $T_{SSB} < 0.5 * T_{SMTCperiod}$
- P is $1/(1 - T_{SSB}/MGRP) * P_{sharing}$ factor, when BM-RS is partially overlapped with measurement gap and BM-RS is partially overlapped with SMTC occasion ($T_{SSB} < T_{SMTCperiod}$) and SMTC occasion is not overlapped with measurement gap and $T_{SMTCperiod} = MGRP$ and $T_{SSB} = 0.5 * T_{SMTCperiod}$
- P is $1/\{1 - T_{SSB}/\min(T_{SMTCperiod}, MGRP)\}$, when BM-RS is partially overlapped with measurement gap ($T_{SSB} < MGRP$) and BM-RS is partially overlapped with SMTC occasion ($T_{SSB} < T_{SMTCperiod}$) and SMTC occasion is partially or fully overlapped with measurement gap.
- P is $1/(1 - T_{SSB}/MGRP) * P_{sharing}$ factor, when BM-RS is partially overlapped with measurement gap and BM-RS is fully overlapped with SMTC occasion ($T_{SSB} = T_{SMTCperiod}$) and SMTC occasion is partially overlapped with measurement gap ($T_{SMTCperiod} < MGRP$)
- $P_{sharing}$ factor = 3.

If the high layer in TS 38.331 [2] signaling of *smtc2* is configured, $T_{SMTCperiod}$ corresponds to the value of higher layer parameter *smtc2*; Otherwise $T_{SMTCperiod}$ corresponds to the value of higher layer parameter *smtc1*.

Longer evaluation period would be expected if the combination of BM-RS, SMTC occasion and measurement gap configurations does not meet previous conditions.

Editor's Note: FFS what evaluation period would be expected if BM-RS are in the same OFDM symbols with RLM/BFD/CBD-RS, or other BM-RS.

Table 9.5.4.1-1: Measurement period $T_{BM_Measurement_Period_SSB}$ for FR1

Configuration	$T_{BM_Measurement_Period_SSB}$ (ms)
non-DRX	$\max(T_{Report}, \text{ceil}(M * P) * T_{SSB})$
DRX cycle ≤ 320 ms	$\max(T_{Report}, \text{ceil}(1.5 * M * P) * \max(T_{DRX}, T_{SSB}))$
DRX cycle > 320 ms	$\text{ceil}(M * P) * T_{DRX}$
Note:	T_{SSB} is the periodicity of SSB configured for L1-RSRP measurement. T_{DRX} is the DRX cycle length. T_{Report} is configured periodicity for reporting.

Table 9.5.4.1-2: Measurement period $T_{\text{BM_Measurement_Period_SSB}}$ for FR2

Configuration	$T_{\text{BM_Measurement_Period_SSB}}$ (ms)
non-DRX	$\max(T_{\text{Report}}, \text{ceil}(M \cdot P \cdot N) \cdot T_{\text{SSB}})$
DRX cycle $\leq 320\text{ms}$	$\max(T_{\text{Report}}, \text{ceil}(1.5 \cdot M \cdot P \cdot N) \cdot \max(T_{\text{DRX}}, T_{\text{SSB}}))$
DRX cycle $> 320\text{ms}$	$\text{ceil}(1.5 \cdot M \cdot P \cdot N) \cdot T_{\text{DRX}}$
Note:	T_{SSB} is the periodicity of SSB configured for L1-RSRP measurement. T_{DRX} is the DRX cycle length. T_{Report} is configured periodicity for reporting.

9.5.4.2 CSI-RS based L1-RSRP Reporting

The UE shall be capable of performing L1-RSRP measurements based on the configured CSI-RS resource for L1-RSRP computation, and the UE physical layer shall be capable of reporting L1-RSRP measured over the measurement period of $T_{\text{BM_Measurement_Period_CSI-RS}}$.

The value of $T_{\text{BM_Measurement_Period_CSI-RS}}$ is defined in Table 9.5.4.2-1 for FR1 and in Table 9.5.4.2-2 for FR2, where

- For periodic and semi-persistent CSI-RS resources, $M=1$ if higher layer parameter *timeRestrictionForChannelMeasurement* is configured, and $M=3$ otherwise
- For aperiodic CSI-RS resources $M=1$
- $N=\text{TBD}$

For FR1,

- $P=1/(1 - T_{\text{CSI-RS}}/\text{MGRP})$, when in the monitored cell there are measurement gaps configured for intra-frequency, inter-frequency or inter-RAT measurements, which are overlapping with some but not all occasions of the CSI-RS; and
- $P=1$ when in the monitored cell there are no measurement gaps overlapping with any occasion of the CSI-RS.

For FR2,

- $P=1$, when BM-RS is not overlapped with measurement gap and also not overlapped with SMTC occasion.
- $P=1/(1 - T_{\text{CSI-RS}}/\text{MGRP})$, when BM-RS is partially overlapped with measurement gap and BM-RS is not overlapped with SMTC occasion ($T_{\text{CSI-RS}} < \text{MGRP}$)
- $P=1/(1 - T_{\text{CSI-RS}}/T_{\text{SMTCperiod}})$, when BM-RS is not overlapped with measurement gap and BM-RS is partially overlapped with SMTC occasion ($T_{\text{CSI-RS}} < T_{\text{SMTCperiod}}$).
- P is $P_{\text{sharing factor}}$, when BM-RS is not overlapped with measurement gap and BM-RS is fully overlapped with SMTC occasion ($T_{\text{CSI-RS}} = T_{\text{SMTCperiod}}$).
- P is $1/(1 - T_{\text{CSI-RS}}/\text{MGRP} - T_{\text{CSI-RS}}/T_{\text{SMTCperiod}})$, when BM-RS is partially overlapped with measurement gap and BM-RS is partially overlapped with SMTC occasion ($T_{\text{CSI-RS}} < T_{\text{SMTCperiod}}$) and SMTC occasion is not overlapped with measurement gap and
 - $T_{\text{SMTCperiod}} \neq \text{MGRP}$ or
 - $T_{\text{SMTCperiod}} = \text{MGRP}$ and $T_{\text{CSI-RS}} < 0.5 \cdot T_{\text{SMTCperiod}}$
- P is $1/(1 - T_{\text{CSI-RS}}/\text{MGRP}) \cdot P_{\text{sharing factor}}$, when BM-RS is partially overlapped with measurement gap and BM-RS is partially overlapped with SMTC occasion ($T_{\text{CSI-RS}} < T_{\text{SMTCperiod}}$) and SMTC occasion is not overlapped with measurement gap and $T_{\text{SMTCperiod}} = \text{MGRP}$ and $T_{\text{CSI-RS}} = 0.5 \cdot T_{\text{SMTCperiod}}$
- P is $1/\{1 - T_{\text{CSI-RS}}/\min(T_{\text{SMTCperiod}}, \text{MGRP})\}$, when BM-RS is partially overlapped with measurement gap ($T_{\text{CSI-RS}} < \text{MGRP}$) and BM-RS is partially overlapped with SMTC occasion ($T_{\text{CSI-RS}} < T_{\text{SMTCperiod}}$) and SMTC occasion is partially or fully overlapped with measurement gap.
- P is $1/(1 - T_{\text{CSI-RS}}/\text{MGRP}) \cdot P_{\text{sharing factor}}$, when BM-RS is partially overlapped with measurement gap and BM-RS is fully overlapped with SMTC occasion ($T_{\text{CSI-RS}} = T_{\text{SMTCperiod}}$) and SMTC occasion is partially overlapped with measurement gap ($T_{\text{SMTCperiod}} < \text{MGRP}$)

- P_{sharing} factor is 3.

If the high layer in TS 38.331 [2] signaling of *smtc2* is configured, $T_{\text{SMTCPeiod}}$ corresponds to the value of higher layer parameter *smtc2*; Otherwise $T_{\text{SMTCPeiod}}$ corresponds to the value of higher layer parameter *smtc1*.

Note: The overlap between CSI-RS for L1-RSRP measurement and SMTC means that CSI-RS for L1-RSRP measurement is within the SMTC window duration.

Longer evaluation period would be expected if the combination of BM-RS, SMTC occasion and measurement gap configurations does not meet pervious conditions.

Editor's Note: FFS what evaluation period would be expected if BM-RS are in the same OFDM symbols with RLM/BFD/CBD-RS, or other BM-RS.

Table 9.5.4.2-1: Measurement period $T_{\text{BM_Measurement_Period_CSI-RS}}$ for FR1

Configuration	$T_{\text{BM_Measurement_Period_CSI-RS}}$ (ms)
non-DRX	$\max(T_{\text{Report}}, \text{ceil}(M \cdot P) \cdot T_{\text{CSI-RS}})$
DRX cycle $\leq 320\text{ms}$	$\max(T_{\text{Report}}, \text{ceil}(1.5 \cdot M \cdot P) \cdot \max(T_{\text{DRX}}, T_{\text{CSI-RS}}))$
DRX cycle $> 320\text{ms}$	$\text{ceil}(M \cdot P) \cdot T_{\text{DRX}}$
Note 1:	$T_{\text{CSI-RS}}$ is the periodicity of CSI-RS configured for L1-RSRP measurement. T_{DRX} is the DRX cycle length. T_{Report} is configured periodicity for reporting.
Note 2:	the requirements are applicable provided that the CSI-RS resource configured for L1-RSRP measurement is transmitted with Density = 3.

Table 9.5.4.2-2: Measurement period $T_{\text{BM_Measurement_Period_CSI-RS}}$ for FR2

Configuration	$T_{\text{BM_Measurement_Period_CSI-RS}}$ (ms)
non-DRX	$\max(T_{\text{Report}}, \text{ceil}(M \cdot P \cdot N) \cdot T_{\text{CSI-RS}})$
DRX cycle $\leq 320\text{ms}$	$\max(T_{\text{Report}}, \text{ceil}(1.5 \cdot M \cdot P \cdot N) \cdot \max(T_{\text{DRX}}, T_{\text{CSI-RS}}))$
DRX cycle $> 320\text{ms}$	$\text{ceil}(M \cdot P \cdot N) \cdot T_{\text{DRX}}$
Note 1:	$T_{\text{CSI-RS}}$ is the periodicity of CSI-RS configured for L1-RSRP measurement. T_{DRX} is the DRX cycle length. T_{Report} is configured periodicity for reporting.
Note 2:	the requirements are applicable provided that the CSI-RS resource configured for L1-RSRP measurement is transmitted with Density = 3.

9.5.5 Measurement restriction for CSI-RS and SSB for L1-RSRP measurement

The UE is required to be capable of measuring CSI-RS for L1-RSRP without measurement gaps. The UE is required to perform the CSI-RS measurements as described in the following clauses.

9.5.5.1 UE performing CSI-RS measurements with a same subcarrier spacing as SSB on FR1

When the SSB is within the active BWP and has same SCS than CSI-RS, the UE shall be able to perform CSI-RS measurement without restrictions when CSI-RS measurement are performed with same subcarrier spacing as the SSB on FR1.

9.5.5.2 CSI-RS measurement restrictions of UE performing CSI-RS measurements with a different subcarrier spacing than SSB on FR1

When the SSB is within the active BWP and has different SCS than CSI-RS, the UE shall be able to perform CSI-RS measurement with restrictions according to its capabilities:

- If CSI-RS and SSB are FDM'ed, the UE measurement capability depends on the whether the UE supports *simultaneousRxDataSSB-DiffNumerology*.
- If the UE supports *simultaneousRxDataSSB-DiffNumerology* the UE shall be able to perform CSI-RS measurement without restrictions.
- If the UE does not support *simultaneousRxDataSSB-DiffNumerology* the UE is not expected to perform simultaneous FDM'ed SSB and CSI-RS measurements,
- If CSI-RS and SSB are TDM'ed, the UE shall be able to perform CSI-RS measurement with restrictions: the UE is not expected to measure CSI-RS on symbols on 1 data symbol before each consecutive SSB symbols and 1 data symbol after each consecutive SSB symbols within the SMTC window duration.

9.5.6 Scheduling availability of UE during L1-RSRP measurement

Scheduling availability restrictions when the UE is performing L1-RSRP measurement are described in the following clauses.

9.5.6.1 Scheduling availability of UE performing L1-RSRP measurement with a same subcarrier spacing as PDSCH/PDCCH on FR1

There are no scheduling restrictions due to L1-RSRP measurement performed on SSB and CSI-RS configured as RS for L1-RSRP measurement with the same SCS as PDSCH/PDCCH in FR1.

9.5.6.2 Scheduling availability of UE performing L1-RSRP measurement with a different subcarrier spacing than PDSCH/PDCCH on FR1

For UEs which support *simultaneousRxDataSSB-DiffNumerology* [14] there are no restrictions on scheduling availability due to L1-RSRP measurement based on SSB as RS for L1-RSRP measurement. For UEs which do not support *simultaneousRxDataSSB-DiffNumerology* [14] the following restrictions apply due to L1-RSRP measurement based on SSB configured as RS for L1-RSRP measurement.

- The UE is not expected to transmit PUCCH/PUSCH/SRS or receive PDCCH/PDSCH/TRS/CSI-RS for CQI on SSB symbols to be measured for L1-RSRP measurement.

When intra-band carrier aggregation in FR1 is configured, the scheduling restrictions apply to all SCells that are aggregated in the same band as the PCell or PSCell. When inter-band carrier aggregation within FR1 is configured, there are no scheduling restrictions on FR1 serving cell(s) configured in other bands than the bands in which PCell or PSCell is configured.

9.5.6.3 Scheduling availability of UE performing L1-RSRP measurement on FR2

The following scheduling restriction applies due to L1-RSRP measurement.

- For the case where RS for L1-RSRP measurement is QCLed with active TCI state for PDCCH/PDSCH, and N=1 applies for the RS for L1-RSRP measurement as specified in section 9.4.5.1 if the reference signal is SSB and in section 9.4.5.2 if the reference signal is CSI-RS
 - There are no scheduling restrictions due to L1-RSRP measurement performed based on SSB or CSI-RS with a same SCS as PDSCH/PDCCH.
 - When performing L1-RSRP measurement based on SSB with a different SCS than PDSCH/PDCCH, for UEs which support *simultaneousRxDataSSB-DiffNumerology* [14] there are no restrictions on scheduling availability due to L1-RSRP measurement. For UEs which do not support *simultaneousRxDataSSB-DiffNumerology* [14] the UE is not expected to transmit PUCCH/PUSCH/SRS or receive PDCCH/PDSCH/TRS/CSI-RS for CQI on SSB symbols to be measured for L1-RSRP measurement.
- Otherwise
 - The UE is not expected to transmit PUCCH/PUSCH/SRS or receive PDCCH/PDSCH/TRS/CSI-RS for CQI on RS for L1-RSRP measurement symbols to be measured for L1-RSRP measurement.

When intra-band carrier aggregation is performed, the scheduling restrictions apply to all serving cells on the band due to L1-RSRP measurement performed on any serving cell in the same band.

Editor's Note: FFS scheduling restrictions for inter-band carrier aggregation will be defined depending on band combination in future.

9.5.6.4 Scheduling availability of UE performing L1-RSRP measurement on FR1 or FR2 in case of FR1-FR2 inter-band CA

There are no scheduling restrictions on FR1 serving cell(s) due to L1-RSRP measurement performed on FR2 serving PCell and/or PSCell.

There are no scheduling restrictions on FR2 serving cell(s) due to L1-RSRP measurement performed on FR1 serving PCell and/or PSCell.

10 Measurement Performance requirements

Editor's note: Accuracy requirement might be an individual top-level chapter to maintain since it is the performance part.

10.1 NR measurements

10.1.1 Introduction

Editor's note: new measurement metrics may be added according to the RAN4 discussion. Absolute/relative accuracy requirement, mapping table of RSRP/RSRQ may be specified in this section. The numerology and BW combinations might be reflected in the accuracy requirement table.

The requirements in Section 10.1 apply as follows:

- intra-frequency requirements apply for PCell measurements in SA, NR-DC, or NE-DC operation mode,
- intra-frequency requirements apply for PSCell measurements in NR-DC or EN-DC operation mode,
- intra-frequency requirements apply for SCell measurements in SA operation mode with NR CA or any MR-DC operation mode with NR CA,
- inter-frequency requirements apply for non-serving cell measurements on NR carrier frequencies.

In the requirements of Section 10.1, the exceptions for side conditions apply as follows:

- for the UE capable of CA but not configured with any SCell, the applicable exceptions for side conditions are specified in Annex B, Section B.3.2.1 for UE supporting CA in FR1, and Section B.3.2.3 for UE supporting CA in FR2, respectively;
- for the UE capable of CA and configured with at least one SCell, the applicable exceptions for side conditions are specified in Annex B, Section B.3.2.2 for UE configured with CA in FR1, and Section B.3.2.4 for UE supporting CA in FR2 respectively;
- for the UE capable of SUL but not configured with SUL, the applicable exceptions for side conditions are specified in Annex B, Section B.3.4.1 for UE supporting SUL in FR1;
- for the UE capable of SUL and configured with at least one SUL, the applicable exceptions for side conditions are specified in Annex B, Section B.3.4.2 for UE configured with SUL in FR1.

10.1.2 Intra-frequency RSRP accuracy requirements for FR1

10.1.2.1 Intra-frequency SS-RSRP accuracy requirements

10.1.2.1.1 Absolute SS-RSRP Accuracy

Unless otherwise specified, the requirements for absolute accuracy of SS-RSRP in this clause apply to a cell on the same frequency as that of the serving cell in FR1.

The accuracy requirements in Table 10.1.2.1.1-1 are valid under the following conditions:

- Conditions defined in 38.101-1 [18] Clause 7.3 for reference sensitivity are fulfilled.
- Conditions for intra-frequency measurements are fulfilled according to Annex B.2.2 for a corresponding Band for each relevant SSB.

Table 10.1.2.1.1-1: SS-RSRP Intra frequency absolute accuracy in FR1

Accuracy		Conditions					
Normal condition	Extreme condition	SSB $\hat{\epsilon}$ s/lot	I_o ^{Note 1} range				
			NR operating band groups <small>Note 2</small>	Minimum I_o		Maximum I_o	
dB	dB	dB		dBm / SCS_{SSB}		dBm/ $BW_{Channel}$	dBm/ $BW_{Channel}$
				$SCS_{SSB} = 15$ kHz	$SCS_{SSB} = 30$ kHz		
± 4.5	± 9	≥ 6 dB	NR_FDD_FR1_A, NR_TDD_FR1_A	-121	-118	N/A	-70
			NR_FDD_FR1_B	-120.5	-117.5	N/A	-70
			NR_TDD_FR1_C	-120	-117	N/A	-70
			NR_FDD_FR1_D, NR_TDD_FR1_D	-119.5	-116.5	N/A	-70
			NR_FDD_FR1_E, NR_TDD_FR1_E	-119	-116	N/A	-70
			NR_FDD_FR1_G	-118	-115	N/A	-70
			NR_FDD_FR1_H	-117.5	-114.5	N/A	-70
± 8	± 11	≥ 6 dB	ANR_FDD_FR1_A, NR_TDD_FR1_A, NR_FDD_FR1_B, NR_TDD_FR1_C, NR_FDD_FR1_D, NR_TDD_FR1_D, NR_FDD_FR1_E, NR_TDD_FR1_E, NR_FDD_FR1_G, NR_FDD_FR1_H,	N/A	N/A	-70	-50

NOTE 1: I_o is assumed to have constant EPRE across the bandwidth.
 NOTE 2: NR operating band groups in FR1 are as defined in Section 3.5.2.

10.1.2.1.2 Relative SS-RSRP Accuracy

The relative accuracy of SS-RSRP is defined as the SS-RSRP measured from one cell compared to the SS-RSRP measured from another cell on the same frequency, or between any two SS RSRP levels measured on the same cell in FR1.

The accuracy requirements in Table 10.1.2.1.2-1 are valid under the following conditions:

- Conditions defined in 38.101-1 [18] Clause 7.3 for reference sensitivity are fulfilled.
- Conditions for intra-frequency measurements are fulfilled according to Annex B.2.2 for a corresponding Band for each relevant SSB.

Table 10.1.2.1.2-1: SS-RSRP Intra frequency relative accuracy in FR1

Accuracy		Conditions					
Normal condition	Extreme condition	SSB \hat{E}_s/lot Note 2	NR operating band groups Note 4	I_o Note 1 range			
				Minimum I_o		Maximum I_o	
dB	dB	dB		dBm / SCS_{SSB}		dBm/ BW_{Channel}	dBm/ BW_{Channel}
				$SCS_{SSB} = 15 \text{ kHz}$	$SCS_{SSB} = 30 \text{ kHz}$		
± 2	± 3	$\geq -3 \text{ dB}$	NR_FDD_FR1_A, NR_TDD_FR1_A	-121	-118	N/A	-50
			NR_FDD_FR1_B	-120.5	-117.5	N/A	-50
			NR_TDD_FR1_C	-120	-117	N/A	-50
			NR_FDD_FR1_D, NR_TDD_FR1_D	-119.5	-116.5	N/A	-50
			NR_FDD_FR1_E, NR_TDD_FR1_E	-119	-116	N/A	-50
			NR_FDD_FR1_G	-118	-115	N/A	-50
			NR_FDD_FR1_H	-117.5	-114.5	N/A	-50
± 3	± 3	$\geq -6 \text{ dB}$	Note 3	Note 3	Note 3	N/A	Note 3

NOTE 1: I_o is assumed to have constant EPRE across the bandwidth.
 NOTE 2: The parameter SSB \hat{E}_s/lot is the minimum SSB \hat{E}_s/lot of the pair of cells to which the requirement applies.
 NOTE 3: The same bands and the same I_o conditions for each band apply for this requirement as for the corresponding highest accuracy requirement.
 NOTE 4: NR operating band groups in FR1 are as defined in Section 3.5.2.

10.1.2.2 Intra-frequency [CSI-RS RSRP] accuracy requirements

10.1.3 Intra-frequency RSRP accuracy requirements for FR2

10.1.3.1 Intra-frequency SS-RSRP accuracy requirements

10.1.3.1.1 Absolute SS-RSRP Accuracy

Unless otherwise specified, the requirements for absolute accuracy of SS-RSRP in this clause apply to a cell on the same frequency as that of the serving cell in FR2.

The accuracy requirements in Table 10.1.3.1.1-1 are valid under the following conditions:

- Conditions defined in 38.101-2 [19] Clause 7.3 for reference sensitivity are fulfilled.
- Conditions for intra-frequency measurements are fulfilled according to Annex B.2.2 for a corresponding Band for each relevant SSB.

Table 10.1.3.1.1-1: SS-RSRP Intra frequency absolute accuracy in FR2

Accuracy		Conditions					
Normal condition	Extreme condition	SSB \dot{E}_s/lot	I_o ^{Note 1} range				
			NR operating band groups ^{Note 2}	Minimum I_o		Maximum I_o	
dB	dB	dB		dBm / SCS_{SSB}		dBm/ $BW_{Channel}$	dBm/ $BW_{Channel}$
			$SCS_{SSB} = 120\text{kHz}$	$SCS_{SSB} = 240\text{kHz}$			
$\pm[6]$	$\pm[9]$	TBD	NR_TDD_FR2_A	TBD	TBD	N/A	-70
			NR_TDD_FR2_B	TBD	TBD	N/A	-70
			NR_TDD_FR2_F	TBD	TBD	N/A	-70
			NR_TDD_FR2_G	TBD	TBD	N/A	-70
			NR_TDD_FR2_T	TBD	TBD	N/A	-70
			NR_TDD_FR2_Y	TBD	TBD	N/A	-70
$\pm[8]$	$\pm[11]$	TBD	TNR_TDD_FR2_A, NR_TDD_FR2_B, NR_TDD_FR2_F, NR_TDD_FR2_G, NR_TDD_FR2_T, NR_TDD_FR2_Y	N/A	N/A	-70	-50

NOTE 1: I_o is assumed to have constant EPRE across the bandwidth.
 NOTE 2: NR operating band groups in FR2 are as defined in Section 3.5.3.

10.1.3.1.2 Relative SS-RSRP Accuracy

The relative accuracy of SS-RSRP is defined as the SS-RSRP measured from one cell compared to the SS-RSRP measured from another cell on the same frequency, or between any two SS RSRP levels measured on the same cell in FR2.

The accuracy requirements in Table 10.1.3.1.2-1 are valid under the following conditions:

- Conditions defined in 38.101-2 [19] Clause 7.3 for reference sensitivity are fulfilled.
- Conditions for intra-frequency measurements are fulfilled according to Annex B.2.2 for a corresponding Band for each relevant SSB.

Table 10.1.3.1.2-1: SS-RSRP Intra frequency relative accuracy in FR2

Accuracy		Conditions					
Normal condition	Extreme condition	SSB \dot{E}_s/lot ^{Note 2}	I_o ^{Note 1} range				
			NR operating band groups ^{Note 3}	Minimum I_o		Maximum I_o	
dB	dB	dB		dBm / SCS_{SSB}		dBm/ $BW_{Channel}$	dBm/ $BW_{Channel}$
			$SCS_{SSB} = 120\text{kHz}$	$SCS_{SSB} = 240\text{kHz}$			
$\pm[6]$	$\pm[9]$	TBD	NR_TDD_FR2_A	TBD	TBD	N/A	TBD
			NR_TDD_FR2_B	TBD	TBD	N/A	TBD
			NR_TDD_FR2_F	TBD	TBD	N/A	TBD
			NR_TDD_FR2_G	TBD	TBD	N/A	TBD
			NR_TDD_FR2_T	TBD	TBD	N/A	TBD
			NR_TDD_FR2_Y	TBD	TBD	N/A	TBD

NOTE 1: I_o is assumed to have constant EPRE across the bandwidth.
 NOTE 2: The parameter SSB \dot{E}_s/lot is the minimum SSB \dot{E}_s/lot of the pair of cells to which the requirement applies.
 NOTE 3: NR operating band groups in FR2 are as defined in Section 3.5.3.

10.1.3.2 Intra-frequency [CSI-RS RSRP] accuracy requirements

10.1.4 Inter-frequency RSRP accuracy requirements for FR1

10.1.4.1 Inter-frequency SS-RSRP accuracy requirements

10.1.4.1.1 Absolute Accuracy of SS-RSRP in FR1

The requirements for absolute accuracy of SS-RSRP in this clause apply to a cell on a frequency in FR1 that has different carrier frequency from the serving cell.

The accuracy requirements in Table 10.1.4.1.1-1 are valid under the following conditions:

- Conditions defined in 38.101-1 [18] Clause 7.3 for reference sensitivity are fulfilled.
- Conditions for inter-frequency measurements are fulfilled according to Annex B.2.3 for a corresponding Band for each relevant SSB.

Table 10.1.4.1.1-1: SS-RSRP Inter frequency Absolute accuracy in FR1

Accuracy		Conditions					
Normal condition	Extreme condition	SSB \hat{E}_s/lot Note 2	I_o Note 1 range				
			NR operating band groups Note 3	Minimum I_o		Maximum I_o	
dB	dB	dB		dBm / SCS_{SSB}			dBm/ BW_{Channel}
			$SCS_{SSB} = 15 \text{ kHz}$	$SCS_{SSB} = 30 \text{ kHz}$			
± 4.5	± 6	$\geq -6 \text{ dB}$	NR_FDD_FR1_A, NR_TDD_FR1_A	-121	-118	N/A	-70
			NR_FDD_FR1_B	-120.5	-117.5	N/A	-70
			NR_TDD_FR1_C	-120	-117	N/A	-70
			NR_FDD_FR1_D, NR_TDD_FR1_D	-119.5	-116.5	N/A	-70
			NR_FDD_FR1_E, NR_TDD_FR1_E	-119	-116	N/A	-70
			NR_FDD_FR1_G	-118	-115	N/A	-70
			NR_FDD_FR1_H	-117.5	-114.5	N/A	-70
± 8	± 11	$\geq -6 \text{ dB}$	NR_FDD_FR1_A, NR_TDD_FR1_A, NR_FDD_FR1_B, NR_TDD_FR1_C, NR_FDD_FR1_D, NR_TDD_FR1_D, NR_FDD_FR1_E, NR_TDD_FR1_E, NR_FDD_FR1_G, NR_FDD_FR1_H,	N/A	N/A	-70	-50

NOTE 1: I_o is assumed to have constant EPRE across the bandwidth.
 NOTE 2: The parameter SSB \hat{E}_s/lot is the minimum SSB \hat{E}_s/lot of the pair of cells to which the requirement applies.
 NOTE 3: NR operating band groups in FR1 are as defined in Section 3.5.2.

10.1.4.1.2 Relative Accuracy of SS-RSRP in FR1

The relative accuracy of SS-RSRP in inter frequency case is defined as the RSRP measured from one cell on a frequency in FR1 compared to the RSRP measured from another cell on a different frequency in FR1.

The accuracy requirements in Table 10.1.4.1.2-1 are valid under the following conditions:

- Conditions defined in 38.101-1 [18] Clause 7.3 for reference sensitivity are fulfilled.
- Conditions for inter-frequency measurements are fulfilled according to Annex B.2.3 for a corresponding Band for each relevant SSB.

- $|RSRP1|_{dBm} - RSRP2|_{dBm}| \leq 27dB$
- $|Channel\ 1_{Io} - Channel\ 2_{Io}| \leq 20\ dB$

Table 10.1.4.1.2-1: SS-RSRP Inter frequency relative accuracy in FR1

Accuracy		Conditions					
Normal condition	Extreme condition	SSB \hat{E}_s/lot Note 2	Io ^{Note 1} range				
			NR operating band groups Note 3	Minimum Io		Maximum Io	
dB	dB	dB		dBm / SCS_{SSB}		dBm/ $BW_{Channel}$	dBm/ $BW_{Channel}$
			$SCS_{SSB} = 15\ kHz$	$SCS_{SSB} = 30\ kHz$			
±4.5	±6	≥-6 dB	NR_FDD_FR1_A, NR_TDD_FR1_A	-121	-118	N/A	-50
			NR_FDD_FR1_B	-120.5	-117.5	N/A	-50
			NR_TDD_FR1_C	-120	-117	N/A	-50
			NR_FDD_FR1_D, NR_TDD_FR1_D	-119.5	-116.5	N/A	-50
			NR_FDD_FR1_E, NR_TDD_FR1_E	-119	-116	N/A	-50
			NR_FDD_FR1_G	-118	-115	N/A	-50
			NR_FDD_FR1_H	-117.5	-114.5	N/A	-50

NOTE 1: Io is assumed to have constant EPRE across the bandwidth.
 NOTE 2: The parameter SSB \hat{E}_s/lot is the minimum SSB \hat{E}_s/lot of the pair of cells to which the requirement applies.
 NOTE 3: NR operating band groups in FR1 are as defined in Section 3.5.2.

10.1.4.2 Inter-frequency [CSI-RS RSRP] accuracy requirements

10.1.5 Inter-frequency RSRP accuracy requirements for FR2

10.1.5.1 Inter-frequency SS-RSRP accuracy requirements

10.1.5.1.1 Absolute SS-RSRP Accuracy

Unless otherwise specified, the requirements for absolute accuracy of SS-RSRP in this clause apply to a cell on a frequency in FR2 that is on a different frequency than the serving cell.

The accuracy requirements in Table 10.1.5.1.1-1 are valid under the following conditions:

- Conditions defined in 38.101-2 [19] Clause 7.3 for reference sensitivity are fulfilled.
- Conditions for inter-frequency measurements are fulfilled according to Annex B.2.3 for a corresponding Band for each relevant SSB.

Table 10.1.5.1.1-1: SS-RSRP Inter frequency absolute accuracy in FR2

Accuracy		Conditions					
Normal condition	Extreme condition	SSB \hat{E}_s/lot	NR operating band groups <small>Note 2</small>	I_o <small>Note 1</small> range			
				Minimum I_o			Maximum I_o
dB	dB	dB		dBm / SCS_{SSB}		dBm/ $BW_{Channel}$	dBm/ $BW_{Channel}$
				$SCS_{SSB} = 120\text{kHz}$	$SCS_{SSB} = 240\text{kHz}$		
$\pm[6]$	$\pm[9]$	TBD	NR_TDD_FR2_A	TBD	TBD	N/A	-70
			NR_TDD_FR2_B	TBD	TBD	N/A	-70
			NR_TDD_FR2_F	TBD	TBD	N/A	-70
			NR_TDD_FR2_G	TBD	TBD	N/A	-70
			NR_TDD_FR2_T	TBD	TBD	N/A	-70
			NR_TDD_FR2_Y	TBD	TBD	N/A	-70
$\pm[8]$	$\pm[11]$	TBD	TNR_TDD_FR2_A, NR_TDD_FR2_B, NR_TDD_FR2_F, NR_TDD_FR2_G, NR_TDD_FR2_T, NR_TDD_FR2_Y	N/A	N/A	-70	-50

NOTE 1: I_o is assumed to have constant EPRE across the bandwidth.

NOTE 2: NR operating band groups in FR2 are as defined in Section 3.5.3.

10.1.5.1.2 Relative SS-RSRP Accuracy

The relative accuracy of SS-RSRP is defined as the SS-RSRP measured from one cell on a frequency in FR2 compared to the SS-RSRP measured from another cell on another frequency in FR2.

The accuracy requirements in Table 10.1.5.1.2-1 are valid under the following conditions:

- Conditions defined in 38.101-2 [19] Clause 7.3 for reference sensitivity are fulfilled.
- Conditions for inter-frequency measurements are fulfilled according to Annex B.2.3 for a corresponding Band for each relevant SSB.

$$|RSRP1|_{dBm} - |RSRP2|_{dBm} \leq 27dB$$

$$|Channel\ 1\ I_o - Channel\ 2\ I_o| \leq 20\ dB$$

Table 10.1.5.1.2-1: SS-RSRP Inter frequency relative accuracy in FR2

Accuracy		Conditions					
Normal condition	Extreme condition	SSB \hat{E}_s/lot <small>Note 2</small>	NR operating band groups <small>Note 3</small>	I_o <small>Note 1</small> range			
				Minimum I_o			Maximum I_o
dB	dB	dB		dBm / SCS_{SSB}		dBm/ $BW_{Channel}$	dBm/ $BW_{Channel}$
				$SCS_{SSB} = 120\text{kHz}$	$SCS_{SSB} = 240\text{kHz}$		
$\pm[6]$	$\pm[9]$	TBD	NR_TDD_FR2_A	TBD	TBD	N/A	TBD
			NR_TDD_FR2_B	TBD	TBD	N/A	TBD
			NR_TDD_FR2_F	TBD	TBD	N/A	TBD
			NR_TDD_FR2_G	TBD	TBD	N/A	TBD
			NR_TDD_FR2_T	TBD	TBD	N/A	TBD
			NR_TDD_FR2_Y	TBD	TBD	N/A	TBD

NOTE 1: I_o is assumed to have constant EPRE across the bandwidth.

NOTE 2: The parameter SSB \hat{E}_s/lot is the minimum SSB \hat{E}_s/lot of the pair of cells to which the requirement applies.

NOTE 3: NR operating band groups in FR2 are as defined in Section 3.5.3.

10.1.5.2 Inter-frequency [CSI-RS RSRP] accuracy requirements

10.1.6 RSRP Measurement Report Mapping

The reporting range of SS-RSRP for L3 reporting is defined from -156 dBm to -31 dBm with 1 dB resolution. The reporting range of SS-RSRP and CSI-RSRP for L1 reporting is defined from -140 to -40dBm with 1dB resolution.

The mapping of measured quantity is defined in Table 10.1.6.1-1. The range in the signalling may be larger than the guaranteed accuracy range.

The reporting range of differential SS-RSRP and CSI-RSRP for L1 reporting is defined from 0 dBm to -30 dB with 2 dB resolution.

The mapping of measured quantity is defined in Table 10.1.6.1-2. The range in the signalling may be larger than the guaranteed accuracy range.

Table 10.1.6.1-1: SS-RSRP and CSI-RSRP measurement report mapping

Reported value	Measured quantity value(L3 SS-RSRP)	Measured quantity value(L1 SS-RSRP and CSI-RSRP)	Unit
RSRP_0	SS-RSRP<-156	Not valid	dBm
RSRP_1	-156 ≤ SS-RSRP<-155	Not valid	dBm
RSRP_2	-155 ≤ SS-RSRP<-154	Not valid	dBm
RSRP_3	-154 ≤ SS-RSRP<-153	Not valid	dBm
RSRP_4	-153 ≤ SS-RSRP<-152	Not valid	dBm
RSRP_5	-152 ≤ SS-RSRP<-151	Not valid	dBm
RSRP_6	-151 ≤ SS-RSRP<-150	Not valid	dBm
RSRP_7	-150 ≤ SS-RSRP<-149	Not valid	dBm
RSRP_8	-149 ≤ SS-RSRP<-148	Not valid	dBm
RSRP_9	-148 ≤ SS-RSRP<-147	Not valid	dBm
RSRP_10	-147 ≤ SS-RSRP<-146	Not valid	dBm
RSRP_11	-146 ≤ SS-RSRP<-145	Not valid	dBm
RSRP_12	-145 ≤ SS-RSRP<-144	Not valid	dBm
RSRP_13	-144 ≤ SS-RSRP<-143	Not valid	dBm
RSRP_14	-143 ≤ SS-RSRP<-142	Not valid	dBm
RSRP_15	-142 ≤ SS-RSRP<-141	Not valid	dBm
RSRP_16	-141 ≤ SS-RSRP<-140	RSRP<-140	dBm
RSRP_17	-140 ≤ SS-RSRP<-139	-140 ≤ RSRP<-139	dBm
RSRP_18	-139 ≤ SS-RSRP<-138	-139 ≤ RSRP<-138	dBm
...
RSRP_111	-46 ≤ SS-RSRP<-45	-46 ≤ RSRP<-45	dBm
RSRP_112	-45 ≤ SS-RSRP<-44	-45 ≤ RSRP<-44	dBm
RSRP_113	-44 ≤ SS-RSRP<-43	-44 ≤ RSRP	dBm
RSRP_114	-43 ≤ SS-RSRP<-42	Not valid	dBm
RSRP_115	-42 ≤ SS-RSRP<-41	Not valid	dBm
RSRP_116	-41 ≤ SS-RSRP<-40	Not valid	dBm
RSRP_117	-40 ≤ SS-RSRP<-39	Not valid	dBm
RSRP_118	-39 ≤ SS-RSRP<-38	Not valid	dBm
RSRP_119	-38 ≤ SS-RSRP<-37	Not valid	dBm
RSRP_120	-37 ≤ SS-RSRP<-36	Not valid	dBm
RSRP_121	-36 ≤ SS-RSRP<-35	Not valid	dBm
RSRP_122	-35 ≤ SS-RSRP<-34	Not valid	dBm
RSRP_123	-34 ≤ SS-RSRP<-33	Not valid	dBm
RSRP_124	-33 ≤ SS-RSRP<-32	Not valid	dBm
RSRP_125	-32 ≤ SS-RSRP<-31	Not valid	dBm
RSRP_126	-31 ≤ SS-RSRP	Not valid	dBm
RSRP_127 (Note)	Infinity	Infinity	dBm
Note:	The value of RSRP_127 is applicable for RSRP threshold configured by the network as defined in TS 38.331 [2], but not for the purpose of measurement reporting.		

Table 10.1.6.1-2: Differential SS-RSRP and CSI-RSRP measurement report mapping

Reported value	Measured quantity value(difference in measured RSRP from strongest RSRP)	Unit
DIFFRSRP_0	$0 \geq \Delta \text{RSRP} > -2$	dB
DIFFRSRP_1	$-2 \geq \Delta \text{RSRP} > -4$	dB
DIFFRSRP_2	$-4 \geq \Delta \text{RSRP} > -6$	dB
DIFFRSRP_3	$-6 \geq \Delta \text{RSRP} > -8$	dB
DIFFRSRP_4	$-8 \geq \Delta \text{RSRP} > -10$	dB
DIFFRSRP_5	$-10 \geq \Delta \text{RSRP} > -12$	dB
DIFFRSRP_6	$-12 \geq \Delta \text{RSRP} > -14$	dB
DIFFRSRP_7	$-14 \geq \Delta \text{RSRP} > -16$	dB
DIFFRSRP_8	$-16 \geq \Delta \text{RSRP} > -18$	dB
DIFFRSRP_9	$-18 \geq \Delta \text{RSRP} > -20$	dB
DIFFRSRP_10	$-20 \geq \Delta \text{RSRP} > -22$	dB
DIFFRSRP_11	$-22 \geq \Delta \text{RSRP} > -24$	dB
DIFFRSRP_12	$-24 \geq \Delta \text{RSRP} > -26$	dB
DIFFRSRP_13	$-26 \geq \Delta \text{RSRP} > -28$	dB
DIFFRSRP_14	$-28 \geq \Delta \text{RSRP} > -30$	dB
DIFFRSRP_15	$-30 \geq \Delta \text{RSRP}$	dB

10.1.7 Intra-frequency RSRQ accuracy requirements for FR1

10.1.7.1 Intra-frequency SS-RSRQ accuracy requirements in FR1

10.1.7.1.1 Absolute SS-RSRQ Accuracy in FR1

Unless otherwise specified, the requirements for absolute accuracy of SS-RSRQ in this clause apply to a cell on the same frequency as that of the serving cell in FR1.

The accuracy requirements in Table 10.1.7.1.1-1 are valid under the following conditions:

- Conditions defined in 38.101-1 [18] Clause 7.3 for reference sensitivity are fulfilled.
- Conditions for intra-frequency measurements are fulfilled according to Annex B.2.2 for a corresponding Band for each relevant SSB.

Table 10.1.7.1.1-1: SS-RSRQ Intra frequency absolute accuracy in FR1

Accuracy		Conditions					
Normal condition	Extreme condition	SSB Es/lot	NR operating band groups Note 3	Io ^{Note 1} range			
				Minimum Io		Maximum Io	
dB	dB	dB		dBm / SCS _{SSB}		dBm/BW _{Channel}	dBm/BW _{Channel}
				SCS _{SSB} = 15 kHz	SCS _{SSB} = 30 kHz		
±2.5	±4	≥-3 dB	NR_FDD_FR1_A, NR_TDD_FR1_A	-121	-118	N/A	-50
			NR_FDD_FR1_B	-120.5	-117.5	N/A	-50
			NR_TDD_FR1_C	-120	-117	N/A	-50
			NR_FDD_FR1_D, NR_TDD_FR1_D	-119.5	-116.5	N/A	-50
			NR_FDD_FR1_E, NR_TDD_FR1_E	-119	-116	N/A	-50
			NR_FDD_FR1_G	-118	-115	N/A	-50
			NR_FDD_FR1_H	-117.5	-114.5	N/A	-50
±3.5	±4	≥-6 dB	Note 2	Note 2	Note 2	Note 2	Note 2

NOTE 1: Io is assumed to have constant EPRE across the bandwidth.
NOTE 2: The same bands and the same Io conditions for each band apply for this requirement as for the corresponding highest accuracy requirement.
NOTE 3: NR operating band groups in FR1 are as defined in Section 3.5.2.

10.1.8 Intra-frequency RSRQ accuracy requirements for FR2

10.1.8.1 Intra-frequency SS-RSRQ accuracy requirements in FR2

10.1.8.1.1 Absolute SS-RSRQ Accuracy in FR2

Unless otherwise specified, the requirements for absolute accuracy of SS-RSRQ in this clause apply to a cell on the same frequency as that of the serving cell in FR2.

The accuracy requirements in Table 10.1.8.1.1-1 are valid under the following conditions:

- Conditions defined in 38.101-2 [19] Clause 7.3 for reference sensitivity are fulfilled.
- Conditions for intra-frequency measurements are fulfilled according to Annex B.2.2 for a corresponding Band for each relevant SSB.

Table 10.1.8.1.1-1: SS-RSRQ Intra frequency absolute accuracy in FR2

Accuracy		Conditions					
Normal condition	Extreme condition	SSB \dot{E}_s/lot	l_o ^{Note 1} range				
			NR operating band groups ^{Note 3}	Minimum l_o		Maximum l_o	
dB	dB	dB		dBm / SCS_{SSB}		dBm/ BW_{Channel}	dBm/ BW_{Channel}
			$SCS_{SSB} = 120 \text{ kHz}$	$SCS_{SSB} = 240 \text{ kHz}$			
$\pm[2.5]$	$\pm[4]$	$\geq[\text{TBD}]$ dB	NR_TDD_FR2_A	TBD	TBD	N/A	-50
			NR_TDD_FR2_B	TBD	TBD	N/A	-50
			NR_TDD_FR2_F	TBD	TBD	N/A	-50
			NR_TDD_FR2_G	TBD	TBD	N/A	-50
			NR_TDD_FR2_T	TBD	TBD	N/A	-50
			NR_TDD_FR2_Y	TBD	TBD	N/A	-50
$\pm[3.5]$	$\pm[4]$	$\geq[\text{TBD}]$ dB	Note 2	Note 2	Note 2	Note 2	Note 2

NOTE 1: l_o is assumed to have constant EPRE across the bandwidth.
NOTE 2: The same bands and the same l_o conditions for each band apply for this requirement as for the corresponding highest accuracy requirement.
NOTE 3: NR operating band groups in FR2 are as defined in Section 3.5.3.

10.1.9 Inter-frequency RSRQ accuracy requirements for FR1

10.1.9.1 Inter-frequency SS-RSRQ accuracy requirements in FR1

10.1.9.1.1 Absolute Accuracy of SS-RSRQ in FR1

The requirements for absolute accuracy of SS-RSRQ in this clause apply to a cell on a frequency in FR1 that has different carrier frequency from the serving cell.

The accuracy requirements in Table 10.1.9.1.1-1 are valid under the following conditions:

- Conditions defined in 38.101-1 [18] Clause 7.3 for reference sensitivity are fulfilled.
- Conditions for inter-frequency measurements are fulfilled according to Annex B.2.3 for a corresponding Band for each relevant SSB.

Table 10.1.9.1.1-1: SS-RSRQ Inter frequency absolute accuracy in FR1

Accuracy		Conditions					
Normal condition	Extreme condition	SSB Es/lot	Io ^{Note 1} range				
			NR operating band groups ^{Note 3}	Minimum Io		Maximum Io	
dB	dB	dB		dBm / SCS _{SSB}			dBm/BW _{Channel}
			SCS _{SSB} = 15 kHz	SCS _{SSB} = 30 kHz			
±2.5	±4	≥-3 dB	NR_FDD_FR1_A, NR_TDD_FR1_A	-121	-118	N/A	-50
			NR_FDD_FR1_B	-120.5	-117.5	N/A	-50
			NR_TDD_FR1_C	-120	-117	N/A	-50
			NR_FDD_FR1_D, NR_TDD_FR1_D	-119.5	-116.5	N/A	-50
			NR_FDD_FR1_E, NR_TDD_FR1_E	-119	-116	N/A	-50
			NR_FDD_FR1_G	-118	-115	N/A	-50
			NR_FDD_FR1_H	-117.5	-114.5	N/A	-50
±3.5	±4	≥-6 dB	Note 2	Note 2	Note 2	Note 2	Note 2

NOTE 1: Io is assumed to have constant EPRE across the bandwidth.
NOTE 2: The same bands and the same Io conditions for each band apply for this requirement as for the corresponding highest accuracy requirement.
NOTE 3: NR operating band groups in FR1 are as defined in Section 3.5.2.

10.1.9.1.2 Relative Accuracy of SS-RSRQ in FR1

The relative accuracy of SS-RSRQ in inter frequency case is defined as the RSRQ measured from one cell on a frequency in FR1 compared to the RSRP measured from another cell on a different frequency in FR1.

The accuracy requirements in Table 10.1.9.1.2-1 are valid under the following conditions:

- Conditions defined in 38.101-1 [18] Clause 7.3 for reference sensitivity are fulfilled.
- Conditions for inter-frequency measurements are fulfilled according to Annex B.2.3 for a corresponding Band for each relevant SSB.

$$- \left| RSRP1 \Big|_{dBm} - RSRP2 \Big|_{dBm} \right| \leq 27dB$$

$$- | \text{Channel 1_Io} - \text{Channel 2_Io} | \leq 20 \text{ dB}$$

Table 10.1.9.1.2-1: SS-RSRQ Inter frequency relative accuracy in FR1

Accuracy		Conditions					
Normal condition	Extreme condition	SSB \hat{E}_s/lot Note 2	NR operating band groups Note 4	I_o Note 1 range			
				Minimum I_o		Maximum I_o	
dB	dB	dB		dBm / SCS_{SSB}		dBm/ $BW_{Channel}$	dBm/ $BW_{Channel}$
				$SCS_{SSB} = 15\text{ kHz}$	$SCS_{SSB} = 30\text{ kHz}$		
± 3	± 4	$\geq -3\text{ dB}$	NRFDD_FR1_A, NRTDD_FR1_A	TBD	TBD	N/A	-50
			NRFDD_FR1_B	TBD	TBD	N/A	-50
			NRTDD_FR1_C	TBD	TBD	N/A	-50
			NRFDD_FR1_E, NRTDD_FR1_E	TBD	TBD	N/A	-50
			NRFDD_FR1_G	TBD	TBD	N/A	-50
			NRFDD_FR1_H	TBD	TBD	N/A	-50
± 4	± 4	$\geq -6\text{ dB}$	Note 3	Note 3	Note 3	Note 3	

NOTE 1: I_o is assumed to have constant EPRE across the bandwidth.
 NOTE 2: The parameter SSB \hat{E}_s/lot is the minimum SSB \hat{E}_s/lot of the pair of cells to which the requirement applies.
 NOTE 3: The same bands and the same I_o conditions for each band apply for this requirement as for the corresponding highest accuracy requirement.
 NOTE 4: NR operating band groups in FR1 are as defined in Section 3.5.2.

10.1.10 Inter-frequency RSRQ accuracy requirements for FR2

10.1.10.1 Inter-frequency SS-RSRQ accuracy requirements in FR2

10.1.10.1.1 Absolute Accuracy of SS-RSRQ in FR2

The requirements for absolute accuracy of SS-RSRQ in this clause apply to a cell on a frequency in FR2 that has different carrier frequency from the serving cell.

The accuracy requirements in Table 10.1.10.1.1-1 are valid under the following conditions:

- Conditions defined in 38.101-2 [19] Clause 7.3 for reference sensitivity are fulfilled.
- Conditions for inter-frequency measurements are fulfilled according to Annex B.2.3 for a corresponding Band for each relevant SSB.

Table 10.1.10.1.1-1: SS-RSRQ Inter frequency absolute accuracy in FR2

Accuracy		Conditions					
Normal condition	Extreme condition	SSB \hat{E}_s/lot	NR operating band groups Note 3	I_o Note 1 range			
				Minimum I_o		Maximum I_o	
dB	dB	dB		dBm / SCS_{SSB}		dBm/ $BW_{Channel}$	dBm/ $BW_{Channel}$
				$SCS_{SSB} = 120\text{ kHz}$	$SCS_{SSB} = 240\text{ kHz}$		
$\pm[2.5]$	$\pm[4]$	$\geq[\text{TBD}]\text{ dB}$	NR_TDD_FR2_A	TBD	TBD	N/A	-50
			NR_TDD_FR2_B	TBD	TBD	N/A	-50
			NR_TDD_FR2_F	TBD	TBD	N/A	-50
			NR_TDD_FR2_G	TBD	TBD	N/A	-50
			NR_TDD_FR2_T	TBD	TBD	N/A	-50
			NR_TDD_FR2_Y	TBD	TBD	N/A	-50
$\pm[3.5]$	$\pm[4]$	$\geq[\text{TBD}]\text{ dB}$	Note 2	Note 2	Note 2	Note 2	

NOTE 1: I_o is assumed to have constant EPRE across the bandwidth.
 NOTE 2: The same bands and the same I_o conditions for each band apply for this requirement as for the corresponding highest accuracy requirement.
 NOTE 3: NR operating band groups in FR2 are as defined in Section 3.5.3.

10.1.10.1.2 Relative Accuracy of SS-RSRQ in FR2

The relative accuracy of SS-RSRQ in inter frequency case is defined as the RSRQ measured from one cell on a frequency in FR2 compared to the RSRP measured from another cell on a different frequency in FR2.

The accuracy requirements in Table 10.1.10.1.2-1 are valid under the following conditions:

- Conditions defined in 38.101-2 [19] Clause 7.3 for reference sensitivity are fulfilled.
- Conditions for inter-frequency measurements are fulfilled according to Annex B.2.3 for a corresponding Band for each relevant SSB.

$$|RSRP1|_{dBm} - RSRP2|_{dBm} \leq 27dB$$

$$|Channel\ 1_Io - Channel\ 2_Io| \leq 20\ dB$$

Table 10.1.10.1.2-1: SS-RSRQ Inter frequency relative accuracy in FR2

Accuracy		Conditions					
Normal condition	Extreme condition	SSB \hat{E}_s/lot Note 2	Io Note 1 range				
			NR operating band groups Note 4	Minimum Io		Maximum Io	
dB	dB	dB		dBm / SCS_{SSB}			dBm/ $BW_{Channel}$
			$SCS_{SSB} = 120\ kHz$	$SCS_{SSB} = 240\ kHz$			
$\pm[3]$	$\pm[4]$	$\geq[TBD]$ dB	NR_TDD_FR2_A	TBD	TBD	N/A	-50
			NR_TDD_FR2_B	TBD	TBD	N/A	-50
			NR_TDD_FR2_F	TBD	TBD	N/A	-50
			NR_TDD_FR2_G	TBD	TBD	N/A	-50
			NR_TDD_FR2_T	TBD	TBD	N/A	-50
			NR_TDD_FR2_Y	TBD	TBD	N/A	-50
$\pm[4]$	$\pm[4]$	$\geq[TBD]$ dB	Note 3	Note 3	Note 3	Note 3	Note 3

NOTE 1: Io is assumed to have constant EPRE across the bandwidth.
 NOTE 2: The parameter SSB \hat{E}_s/lot is the minimum SSB \hat{E}_s/lot of the pair of cells to which the requirement applies.
 NOTE 3: The same bands and the same Io conditions for each band apply for this requirement as for the corresponding highest accuracy requirement.
 NOTE 4: NR operating band groups in FR2 are as defined in Section 3.5.3.

10.1.11 RSRQ report mapping

10.1.11.1 SS-RSRQ measurement report mapping

The reporting range of SS-RSRQ is defined from -43 dB to 20 dB with 0.5 dB resolution. The mapping of measured quantity is defined in Table 10.1.11.1-1. The range in the signalling may be larger than the guaranteed accuracy range.

Table 10.1.11.1-1: SS-RSRQ measurement report mapping

Reported value	Measured quantity value	Unit
SS-RSRQ_0	$SS-RSRQ < -43$	dB
SS-RSRQ_1	$-43 \leq SS-RSRQ < -42.5$	dB
SS-RSRQ_2	$-42.5 \leq SS-RSRQ < -42$	dB
SS-RSRQ_3	$-42 \leq SS-RSRQ < -41.5$	dB
SS-RSRQ_4	$-41.5 \leq SS-RSRQ < -41$	dB
..
SS-RSRQ_122	$17.5 \leq SS-RSRQ < 18$	dB
SS-RSRQ_123	$18 \leq SS-RSRQ < 18.5$	dB
SS-RSRQ_124	$18.5 \leq SS-RSRQ < 19$	dB
SS-RSRQ_125	$19 \leq SS-RSRQ < 19.5$	dB
SS-RSRQ_126	$19.5 \leq SS-RSRQ < 20$	dB
SS-RSRQ_127	$20 \leq SS-RSRQ$	dB

10.1.12 Intra-frequency SINR accuracy requirements for FR1

10.1.12.1 Intra-frequency SS-SINR accuracy requirements in FR1

10.1.12.1.1 Absolute SS-SINR Accuracy in FR1

Unless otherwise specified, the requirements for absolute accuracy of SS-SINR in this clause apply to a cell on the same frequency as that of the serving cell in FR1.

The accuracy requirements in Table 10.1.12.1.1-1 are valid under the following conditions:

- Conditions defined in 38.101-1 [18] Clause 7.3 for reference sensitivity are fulfilled.
- Conditions for intra-frequency measurements are fulfilled according to Annex B.2.2 for a corresponding Band.

Table 10.1.12.1.1-1: SS-SINR Intra frequency absolute accuracy in FR1

Accuracy		Conditions					
Normal condition	Extreme condition	SSB \hat{E}_s/lot Note 3	NR operating band groups Note 4	I_o Note 1 range			
				Minimum I_o		Maximum I_o	
dB	dB	dB		dBm / SCS_{SSB}		dBm/ $BW_{Channel}$	dBm/ $BW_{Channel}$
				$SCS_{SSB} = 15 \text{ kHz}$	$SCS_{SSB} = 30 \text{ kHz}$		
± 3.0	± 4	$\geq -3 \text{ dB}$	NR_FDD_FR1_A, NR_TDD_FR1_A	-121	-118	N/A	-50
			NR_FDD_FR1_B	-120.5	-117.5	N/A	-50
			NR_TDD_FR1_C	-120	-117	N/A	-50
			NR_FDD_FR1_D, NR_TDD_FR1_D	-119.5	-116.5	N/A	-50
			NR_FDD_FR1_E, NR_TDD_FR1_E	-119	-116	N/A	-50
			NR_FDD_FR1_G	-118	-115	N/A	-50
			NR_FDD_FR1_H	-117.5	-114.5	N/A	-50
± 3.5	± 4	$\geq -6 \text{ dB}$	Note 2	Note 2	Note 2	Note 2	Note 2

NOTE 1: I_o is assumed to have constant EPRE across the bandwidth.
 NOTE 2: The same bands and the same I_o conditions for each band apply for this requirement as for the corresponding highest accuracy requirement.
 NOTE 3: The requirements apply for SSB $\hat{E}_s/\text{lot} \leq 25 \text{ dB}$.
 NOTE 4: NR operating band groups in FR1 are as defined in Section 3.5.2.

10.1.13 Intra-frequency SINR accuracy requirements for FR2

10.1.13.1 Intra-frequency SS-SINR accuracy requirements in FR2

10.1.13.1.1 Absolute SS-SINR Accuracy in FR2

Unless otherwise specified, the requirements for absolute accuracy of SS-SINR in this clause apply to a cell on the same frequency as that of the serving cell in FR2.

The accuracy requirements in Table 10.1.13.1.1-1 are valid under the following conditions:

- Conditions defined in 38.101-2 [19] Clause 7.3 for reference sensitivity are fulfilled.
- Conditions for intra-frequency measurements are fulfilled according to Annex B.2.2 for a corresponding Band.

Table 10.1.13.1.1-1: SS-SINR Intra frequency absolute accuracy in FR2

Accuracy		Conditions					
Normal condition	Extreme condition	SSB \hat{E}_s/lot Note 3	I_o Note 1 range				
			NR operating band groups Note 4	Minimum I_o		Maximum I_o	
dB	dB	dB		dBm / SCS_{SSB}		dBm/ $BW_{Channel}$	dBm/ $BW_{Channel}$
			$SCS_{SSB} = 120 \text{ kHz}$	$SCS_{SSB} = 240 \text{ kHz}$			
$\pm[3.0]$	$\pm[4]$	$\geq[\text{TBD}]$ dB	NR_TDD_FR2_A	TBD	TBD	N/A	-50
			NR_TDD_FR2_B	TBD	TBD	N/A	-50
			NR_TDD_FR2_F	TBD	TBD	N/A	-50
			NR_TDD_FR2_G	TBD	TBD	N/A	-50
			NR_TDD_FR2_T	TBD	TBD	N/A	-50
			NR_TDD_FR2_Y	TBD	TBD	N/A	-50
$\pm[3.5]$	$\pm[4]$	$\geq[\text{TBD}]$ dB	Note 2	Note 2	Note 2	Note 2	Note 2

NOTE 1: I_o is assumed to have constant EPRE across the bandwidth.
 NOTE 2: The same bands and the same I_o conditions for each band apply for this requirement as for the corresponding highest accuracy requirement.
 NOTE 3: The requirements apply for $SSB \hat{E}_s/\text{lot} \leq [25]$ dB.
 NOTE 4: NR operating band groups in FR2 are as defined in Section 3.5.3.

10.1.14 Inter-frequency SINR accuracy requirements for FR1

10.1.14.1 Inter-frequency SS-SINR accuracy requirements in FR1

10.1.14.1.1 Absolute Accuracy of SS-SINR in FR1

The requirements for absolute accuracy of SS-SINR in this clause apply to a cell on a frequency in FR1 that has different carrier frequency from the serving cell.

The accuracy requirements in Table 10.1.14.1.1-1 are valid under the following conditions:

- Conditions defined in 38.101-1 [18] Clause 7.3 for reference sensitivity are fulfilled.
- Conditions for inter-frequency measurements are fulfilled according to Annex B.2.3 for a corresponding Band.

Table 10.1.14.1.1-1: SS-SINR Inter frequency absolute accuracy in FR1

Accuracy		Conditions					
Normal condition	Extreme condition	SSB \hat{E}_s/lot Note 3	NR operating band groups Note 4	I_o Note 1 range			
				Minimum I_o		Maximum I_o	
dB	dB	dB		dBm / SCS_{SSB}		dBm/ BW_{Channel}	dBm/ BW_{Channel}
				$SCS_{SSB} = 15 \text{ kHz}$	$SCS_{SSB} = 30 \text{ kHz}$		
± 3.0	± 4	$\geq -3 \text{ dB}$	NR_FDD_FR1_A, NR_TDD_FR1_A	-121	-118	N/A	-50
			NR_FDD_FR1_B	-120.5	-117.5	N/A	-50
			NR_TDD_FR1_C	-120	-117	N/A	-50
			NR_FDD_FR1_D, NR_TDD_FR1_D	-119.5	-116.5	N/A	-50
			NR_FDD_FR1_E, NR_TDD_FR1_E	-119	-116	N/A	-50
			NR_FDD_FR1_G	-118	-115	N/A	-50
			NR_FDD_FR1_H	-117.5	-114.5	N/A	-50
± 3.5	± 4	$\geq -6 \text{ dB}$	Note 2	Note 2	Note 2	Note 2	Note 2

NOTE 1: I_o is assumed to have constant EPRE across the bandwidth.
NOTE 2: The same bands and the same I_o conditions for each band apply for this requirement as for the corresponding highest accuracy requirement.
NOTE 3: The requirements apply for SSB $\hat{E}_s/\text{lot} \leq 25 \text{ dB}$.
NOTE 4: NR operating band groups in FR1 are as defined in Section 3.5.2.

10.1.14.1.2 Relative Accuracy of SS-SINR in FR1

The relative accuracy of SS-SINR in inter frequency case is defined as the SS-SINR measured from one cell on a frequency in FR1 compared to the SS-SINR measured from another cell on a different frequency in FR1.

The accuracy requirements in Table 10.1.14.1.2-1 are valid under the following conditions:

- Conditions defined in 38.101-1 [18] Clause 7.3 for reference sensitivity are fulfilled.
- Conditions for inter-frequency measurements are fulfilled according to Annex B.2.3 for a corresponding Band.

$$- \left| RSRP1_{dBm} - RSRP2_{dBm} \right| \leq 27 \text{ dB}$$

$$- | \text{Channel 1}_{I_o} - \text{Channel 2}_{I_o} | \leq 20 \text{ dB}$$

Table 10.1.14.1.2-1: SS-SINR Inter frequency relative accuracy in FR1

Accuracy		Conditions					
Normal condition	Extreme condition	SSB \hat{E}_s/lot Note 2,4	NR operating band groups Note 5	I_o Note 1 range			
				Minimum I_o		Maximum I_o	
dB	dB	dB		dBm / SCS_{SSB}		dBm/ BW_{Channel}	dBm/ BW_{Channel}
				$SCS_{SSB} = 120$ kHz	$SCS_{SSB} = 240$ kHz		
± 3.5	± 4	≥ -3 dB	NR_FDD_FR1_A, NR_TDD_FR1_A	-121	-118	N/A	-50
			NR_FDD_FR1_B	-120.5	-117.5	N/A	-50
			NR_TDD_FR1_C	-120	-117	N/A	-50
			NR_FDD_FR1_D, NR_TDD_FR1_D	-119.5	-116.5	N/A	-50
			NR_FDD_FR1_E, NR_TDD_FR1_E	-119	-116	N/A	-50
			NR_FDD_FR1_G	-118	-115	N/A	-50
			NR_FDD_FR1_H	-117.5	-114.5	N/A	-50
± 4	± 4	≥ -6 dB	Note 3	Note 3	Note 3	Note 3	Note 3

NOTE 1: I_o is assumed to have constant EPRE across the bandwidth.
NOTE 2: The parameter SSB \hat{E}_s/lot is the minimum SSB \hat{E}_s/lot of the pair of cells to which the requirement applies.
NOTE 3: The same bands and the same I_o conditions for each band apply for this requirement as for the corresponding highest accuracy requirement.
NOTE 4: The requirements apply for SSB $\hat{E}_s/\text{lot} \leq [25]$ dB.
NOTE 5: NR operating band groups in FR1 are as defined in Section 3.5.2.

10.1.15 Inter-frequency SINR accuracy requirements for FR2

10.1.15.1 Inter-frequency SS-SINR accuracy requirements in FR2

10.1.15.1.1 Absolute Accuracy of SS-SINR in FR2

The requirements for absolute accuracy of SS-SINR in this clause apply to a cell on a frequency in FR2 that has different carrier frequency from the serving cell.

The accuracy requirements in Table 10.1.15.1.1-1 are valid under the following conditions:

- Conditions defined in 38.101-2 [19] Clause 7.3 for reference sensitivity are fulfilled.
- Conditions for inter-frequency measurements are fulfilled according to Annex B.2.3 for a corresponding Band.

Table 10.1.15.1.1-1: SS-SINR Inter frequency absolute accuracy in FR2

Accuracy		Conditions					
Normal condition	Extreme condition	SSB \hat{E}_s/lot Note 3	I_o Note 1 range				
			NR operating band groups Note 4	Minimum I_o		Maximum I_o	
dB	dB	dB		dBm / SCS_{SSB}		dBm/ BW_{Channel}	dBm/ BW_{Channel}
			$SCS_{SSB} = 120 \text{ kHz}$	$SCS_{SSB} = 240 \text{ kHz}$			
$\pm[3.0]$	$\pm[4]$	$\geq[\text{TBD}]$ dB	NR_TDD_FR2_A	TBD	TBD	N/A	-50
			NR_TDD_FR2_B	TBD	TBD	N/A	-50
			NR_TDD_FR2_F	TBD	TBD	N/A	-50
			NR_TDD_FR2_G	TBD	TBD	N/A	-50
			NR_TDD_FR2_T	TBD	TBD	N/A	-50
			NR_TDD_FR2_Y	TBD	TBD	N/A	-50
$\pm[3.5]$	$\pm[4]$	$\geq[\text{TBD}]$ dB	Note 2	Note 2	Note 2	Note 2	Note 2

NOTE 1: I_o is assumed to have constant EPRE across the bandwidth.
 NOTE 2: The same bands and the same I_o conditions for each band apply for this requirement as for the corresponding highest accuracy requirement.
 NOTE 3: The requirements apply for $SSB \hat{E}_s/\text{lot} \leq [25]$ dB.
 NOTE 4: NR operating band groups in FR2 are as defined in Section 3.5.3.

10.1.15.1.2 Relative Accuracy of SS-SINR in FR2

The relative accuracy of SS-SINR in inter frequency case is defined as the SS-SINR measured from one cell on a frequency in FR2 compared to the SS-SINR measured from another cell on a different frequency in FR2.

The accuracy requirements in Table 10.1.15.1.2-1 are valid under the following conditions:

- Conditions defined in 38.101-2 [19] Clause 7.3 for reference sensitivity are fulfilled.
- Conditions for inter-frequency measurements are fulfilled according to Annex B.2.3 for a corresponding Band.

$$- \left| RSRP1 \Big|_{dBm} - RSRP2 \Big|_{dBm} \right| \leq 27dB$$

$$- | \text{Channel 1}_I_o - \text{Channel 2}_I_o | \leq 20 \text{ dB}$$

Table 10.1.15.1.2-1: SS-SINR Inter frequency relative accuracy in FR2

Accuracy		Conditions					
Normal condition	Extreme condition	SSB \hat{E}_s/lot Note 2, Note 4	I_o ^{Note 1} range				
			NR operating band groups Note 5	Minimum I_o		Maximum I_o	
dB	dB	dB		dBm / SCS_{SSB}		dBm/ $BW_{Channel}$	dBm/ $BW_{Channel}$
			$SCS_{SSB} = 120$ kHz	$SCS_{SSB} = 240$ kHz			
$\pm[3.5]$	$\pm[4]$	$\geq[\text{TBD}]$ dB	NR_TDD_FR2_A	TBD	TBD	N/A	-50
			NR_TDD_FR2_B	TBD	TBD	N/A	-50
			NR_TDD_FR2_F	TBD	TBD	N/A	-50
			NR_TDD_FR2_G	TBD	TBD	N/A	-50
			NR_TDD_FR2_T	TBD	TBD	N/A	-50
			NR_TDD_FR2_Y	TBD	TBD	N/A	-50
$\pm[4]$	$\pm[4]$	$\geq[\text{TBD}]$ dB	Note 3	Note 3	Note 3	Note 3	Note 3

NOTE 1: I_o is assumed to have constant EPRE across the bandwidth.
NOTE 2: The parameter SSB \hat{E}_s/lot is the minimum SSB \hat{E}_s/lot of the pair of cells to which the requirement applies.
NOTE 3: The same bands and the same I_o conditions for each band apply for this requirement as for the corresponding highest accuracy requirement.
NOTE 4: The requirements apply for SSB $\hat{E}_s/\text{lot} \leq [25]$ dB.
NOTE 5: NR operating band groups in FR2 are as defined in Section 3.5.3.

10.1.16 SINR report mapping

10.1.16.1 SS-SINR measurement report mapping

The reporting range of SS-SINR is defined from -23 dB to 40 dB with 0.5 dB resolution. The mapping of measured quantity is defined in Table 10.1.16.1-1. The range in the signalling may be larger than the guaranteed accuracy range.

Table 10.1.16.1-1: SS-SINR measurement report mapping

Reported value	Measured quantity value	Unit
SS-SINR_0	$SS-SINR < -23$	dB
SS-SINR_1	$-23 \leq SS-SINR < -22.5$	dB
SS-SINR_2	$-22.5 \leq SS-SINR < -22$	dB
SS-SINR_3	$-22 \leq SS-SINR < -21.5$	dB
SS-SINR_4	$-21.5 \leq SS-SINR < -21$	dB
..
SS-SINR_123	$38 \leq SS-SINR < 38.5$	dB
SS-SINR_124	$38.5 \leq SS-SINR < 39$	dB
SS-SINR_125	$39 \leq SS-SINR < 39.5$	dB
SS-SINR_126	$39.5 \leq SS-SINR < 40$	dB
SS-SINR_127	$40 \leq SS-SINR$	dB

10.1.17 Power Headroom

10.1.17.1 Power Headroom Report

10.1.17.1.1 Power Headroom Report Mapping

The power headroom reporting range is from -32 ...+38 dB. Table 10.1.17.1-1 defines the report mapping.

Table 10.1.17.1-1: Power headroom report mapping

Reported value	Measured quantity value (dB)
POWER_HEADROOM_0	PH < -32
POWER_HEADROOM_1	-32 ≤ PH < -31
POWER_HEADROOM_2	-31 ≤ PH < -30
POWER_HEADROOM_3	-30 ≤ PH < -29
...	...
POWER_HEADROOM_53	20 ≤ PH < 21
POWER_HEADROOM_54	21 ≤ PH < 22
POWER_HEADROOM_55	22 ≤ PH < 24
POWER_HEADROOM_56	24 ≤ PH < 26
POWER_HEADROOM_57	26 ≤ PH < 28
POWER_HEADROOM_58	28 ≤ PH < 30
POWER_HEADROOM_59	30 ≤ PH < 32
POWER_HEADROOM_60	32 ≤ PH < 34
POWER_HEADROOM_61	34 ≤ PH < 36
POWER_HEADROOM_62	36 ≤ PH < 38
POWER_HEADROOM_63	PH ≥ 38

10.1.18 $P_{\text{CMAX},c,f}$

The UE is required to report the UE configured maximum output power ($P_{\text{CMAX},c,f}$) together with the power headroom. This clause defines the requirements for the $P_{\text{CMAX},c,f}$ reporting.

10.1.18.1 Report Mapping

The $P_{\text{CMAX},c,f}$ reporting range is defined from -29dBm to 33 dBm with 1 dB resolution. Table 10.1.18.1-1 defines the reporting mapping.

Table 10.1.18.1-1 Mapping of $P_{\text{CMAX},c,f}$

Reported value	Measured quantity value	Unit
PCMAX_C_00	$P_{\text{CMAX},c,f} < -29$	dBm
PCMAX_C_01	$-29 \leq P_{\text{CMAX},c,f} < -28$	dBm
PCMAX_C_02	$-28 \leq P_{\text{CMAX},c,f} < -27$	dBm
...
PCMAX_C_61	$31 \leq P_{\text{CMAX},c,f} < 32$	dBm
PCMAX_C_62	$32 \leq P_{\text{CMAX},c,f} < 33$	dBm
PCMAX_C_63	$33 \leq P_{\text{CMAX},c,f}$	dBm

10.1.19 L1-RSRP accuracy requirements for FR1

10.1.19.1 SSB based L1-RSRP accuracy requirements

10.1.19.1.1 Absolute Accuracy

Unless otherwise specified, the requirements for absolute accuracy of SSB based L1-RSRP in this clause apply to all SSBs of the serving cell configured for L1-RSRP measurement.

The accuracy requirements in Table 10.1.19.1.1-1 are valid under the following conditions:

Conditions for L1-RSRP measurements are fulfilled according to Annex B.2.4.1 for a corresponding Band for each relevant SSB-.

Table 10.1.19.1.1-1: SSB based L1-RSRP absolute accuracy in FR1

Accuracy		Conditions					
Normal condition	Extreme condition	SSB \hat{E}_s/lot	I_o ^{Note 1} range				
			NR operating band groups ^{Note 2}	Minimum I_o		Maximum I_o	
dB	dB	dB		dBm / SCS_{SSB}			dBm/ $BW_{Channel}$
			$SCS_{SSB} = 15 \text{ kHz}$	$SCS_{SSB} = 30 \text{ kHz}$			
TBD	TBD	$\geq -3\text{dB}$	NR_FDD_FR1_A, NR_TDD_FR1_A	-121	-118	N/A	-70
			NR_FDD_FR1_B	-120.5	-117.5	N/A	-70
			NR_TDD_FR1_C	-120	-117	N/A	-70
			NR_FDD_FR1_D, NR_TDD_FR1_D	-119.5	-116.5	N/A	-70
			NR_FDD_FR1_E, NR_TDD_FR1_E	-119	-116	N/A	-70
			NR_FDD_FR1_G	-118	-115	N/A	-70
			NR_FDD_FR1_H	-117.5	-114.5	N/A	-70
TBD	TBD	TBD	NR_FDD_FR1_A, NR_TDD_FR1_A, NR_FDD_FR1_B, NR_TDD_FR1_C, NR_FDD_FR1_D, NR_TDD_FR1_D, NR_FDD_FR1_E, NR_TDD_FR1_E, NR_FDD_FR1_G, NR_FDD_FR1_H,	N/A	N/A	-70	-50

NOTE 1: I_o is assumed to have constant EPRE across the bandwidth.
 NOTE 2: NR operating band groups in FR1 are as defined in Section 3.5.2.

10.1.19.1.2 Relative Accuracy

The relative accuracy of SSB based L1-RSRP is defined as the L1-RSRP measured from one SSB compared to the largest measured value of L1-RSRP among all SSBs of the serving cell.

The accuracy requirements in Table 10.1.19.1.2-1 are valid under the following conditions:

Conditions for L1-RSRP measurements are fulfilled according to Annex B.2.4.1 for a corresponding Band for each relevant SSB.

Table 10.1.19.1.2-1: SSB based L1-RSRP relative accuracy in FR1

Accuracy		Conditions					
Normal condition	Extreme condition	SSB \hat{E}_s/I_{ot} Note 2	NR operating band groups Note 4	I_o Note 1 range			
				Minimum I_o		Maximum I_o	
dB	dB	dB		dBm / SCS_{SSB}		dBm/ $BW_{Channel}$	dBm/ $BW_{Channel}$
				$SCS_{SSB} = 15$ kHz	$SCS_{SSB} = 30$ kHz		
TBD	TBD	≥ 3 dB	NR_FDD_FR1_A, NR_TDD_FR1_A	-121	-118	N/A	-50
			NR_FDD_FR1_B	-120.5	-117.5	N/A	-50
			NR_TDD_FR1_C	-120	-117	N/A	-50
			NR_FDD_FR1_D, NR_TDD_FR1_D	-119.5	-116.5	N/A	-50
			NR_FDD_FR1_E, NR_TDD_FR1_E	-119	-116	N/A	-50
			NR_FDD_FR1_G	-118	-115	N/A	-50
			NR_FDD_FR1_H	-117.5	-114.5	N/A	-50
TBD	TBD	TBD	Note 3	Note 3	Note 3	N/A	Note 3

NOTE 1: I_o is assumed to have constant EPRE across the bandwidth.
 NOTE 2: The parameter SSB \hat{E}_s/I_{ot} is the minimum SSB \hat{E}_s/I_{ot} of the pair of SSBs to which the requirement applies.
 NOTE 3: The same bands and the same I_o conditions for each band apply for this requirement as for the corresponding highest accuracy requirement.
 NOTE 4: NR operating band groups in FR1 are as defined in Section 3.5.2.

10.1.19.2 CSI-RS based L1-RSRP accuracy requirements

10.1.19.2.1 Absolute Accuracy

Unless otherwise specified, the requirements for absolute accuracy of CSI-RS based L1-RSRP in this clause apply to all CSI-RS resources of the serving cell configured for L1-RSRP measurement.

The accuracy requirements in Table 10.1.19.2.1-1 are valid under the following conditions:

Conditions for L1-RSRP measurements are fulfilled according to Annex B.2.4.2 for a corresponding Band for each relevant CSI-RS.

Table 10.1.19.2.1-1: CSI-RS based L1-RSRP absolute accuracy in FR1

Accuracy		Conditions					
Normal condition	Extreme condition	CSI-RS \hat{E}_s/lot	NR operating band groups <small>Note 2</small>	I_o <small>Note 1</small> range			
				Minimum I_o		Maximum I_o	
dB	dB	dB		dBm / $SCS_{\text{CSI-RS}}$		dBm/BW _{Channel}	dBm/BW _{Channel}
				$SCS_{\text{CSI-RS}} = 15 \text{ kHz}$	$SCS_{\text{CSI-RS}} = 30 \text{ kHz}$		
TBD	TBD	$\geq -3\text{dB}$	NR_FDD_FR1_A, NR_TDD_FR1_A	-121	-118	N/A	-70
			NR_FDD_FR1_B	-120.5	-117.5	N/A	-70
			NR_TDD_FR1_C	-120	-117	N/A	-70
			NR_FDD_FR1_D, NR_TDD_FR1_D	-119.5	-116.5	N/A	-70
			NR_FDD_FR1_E, NR_TDD_FR1_E	-119	-116	N/A	-70
			NR_FDD_FR1_G	-118	-115	N/A	-70
			NR_FDD_FR1_H	-117.5	-114.5	N/A	-70
TBD	TBD	TBD	NR_FDD_FR1_A, NR_TDD_FR1_A, NR_FDD_FR1_B, NR_TDD_FR1_C, NR_FDD_FR1_D, NR_TDD_FR1_D, NR_FDD_FR1_E, NR_TDD_FR1_E, NR_FDD_FR1_G, NR_FDD_FR1_H,	N/A	N/A	-70	-50

NOTE 1: I_o is assumed to have constant EPRE across the bandwidth.
 NOTE 2: NR operating band groups in FR1 are as defined in Section 3.5.2.

10.1.19.2.2 Relative Accuracy

The relative accuracy of CSI-RS based L1-RSRP is defined as the L1-RSRP measured from one CSI-RS compared to the largest measured value of L1-RSRP among all CSI-RS resources of the serving cell.

The accuracy requirements in Table 10.1.19.2.2-1 are valid under the following conditions:

Conditions for L1-RSRP measurements are fulfilled according to Annex B.2.4.2 for a corresponding Band for each relevant CSI-RS.

Table 10.1.19.2.2-1: CSI-RS based L1-RSRP relative accuracy in FR1

Accuracy		Conditions					
Normal condition	Extreme condition	CSI-RS \hat{E}_s/lot Note 2	NR operating band groups Note 4	I_o Note 1 range			
				Minimum I_o		Maximum I_o	
dB	dB	dB		dBm / $SCS_{\text{CSI-RS}}$		dBm/BW _{Channel}	dBm/BW _{Channel}
				$SCS_{\text{CSI-RS}} = 15 \text{ kHz}$	$SCS_{\text{CSI-RS}} = 30 \text{ kHz}$		
TBD	TBD	$\geq -3\text{dB}$	NR_FDD_FR1_A, NR_TDD_FR1_A	-121	-118	N/A	-50
			NR_FDD_FR1_B	-120.5	-117.5	N/A	-50
			NR_TDD_FR1_C	-120	-117	N/A	-50
			NR_FDD_FR1_D, NR_TDD_FR1_D	-119.5	-116.5	N/A	-50
			NR_FDD_FR1_E, NR_TDD_FR1_E	-119	-116	N/A	-50
			NR_FDD_FR1_G	-118	-115	N/A	-50
			NR_FDD_FR1_H	-117.5	-114.5	N/A	-50
TBD	TBD	TBD	Note 3	Note 3	Note 3	N/A	Note 3

NOTE 1: I_o is assumed to have constant EPRE across the bandwidth.
NOTE 2: The parameter CSI-RS \hat{E}_s/lot is the minimum SSB \hat{E}_s/lot of the pair of CSI-RS resources to which the requirement applies.
NOTE 3: The same bands and the same I_o conditions for each band apply for this requirement as for the corresponding highest accuracy requirement.
NOTE 4: NR operating band groups in FR1 are as defined in Section 3.5.2.

10.1.20 L1-RSRP accuracy requirements for FR2

10.1.20.1 SSB based L1-RSRP accuracy requirements

10.1.20.1.1 Absolute Accuracy

Unless otherwise specified, the requirements for absolute accuracy of SSB based L1-RSRP in this clause apply to all SSBs of the serving cell configured for L1-RSRP measurement.

The accuracy requirements in Table 10.1.20.1.1-1 are valid under the following conditions:

Conditions for L1-RSRP measurements are fulfilled according to Annex B.2.4.1 for a corresponding Band for each relevant SSB.

Table 10.1.20.1.1-1: SSB based L1-RSRP absolute accuracy in FR2

Accuracy		Conditions					
Normal condition	Extreme condition	SSB \hat{E}_s/lot	NR operating band groups <small>Note 2</small>	Io <small>Note 1</small> range			
				Minimum Io		Maximum Io	
dB	dB	dB		dBm / SCS _{SSB}		dBm/BW _{Channel}	
				SCS _{SSB} = 120kHz	SCS _{SSB} = 240kHz		
TBD	TBD	$\geq -3\text{dB}$	NR_TDD_FR2_A	TBD	TBD	N/A	-70
			NR_TDD_FR2_B	TBD	TBD	N/A	-70
			NR_TDD_FR2_F	TBD	TBD	N/A	-70
			NR_TDD_FR2_G	TBD	TBD	N/A	-70
			NR_TDD_FR2_T	TBD	TBD	N/A	-70
			NR_TDD_FR2_Y	TBD	TBD	N/A	-70
TBD	TBD	TBD	NR_TDD_FR2_A, NR_TDD_FR2_B, NR_TDD_FR2_F, NR_TDD_FR2_G, NR_TDD_FR2_T, NR_TDD_FR2_Y	N/A	N/A	-70	-50

NOTE 1: Io is assumed to have constant EPRE across the bandwidth.
 NOTE 2: NR operating band groups in FR2 are as defined in Section 3.5.3.

10.1.20.1.2 Relative Accuracy

The relative accuracy of SSB based L1-RSRP is defined as the L1-RSRP measured from one SSB compared to the largest measured value of L1-RSRP among all SSBs of the serving cell.

The accuracy requirements in Table 10.1.20.1.2-1 are valid under the following conditions:

Conditions for L1-RSRP measurements are fulfilled according to Annex B.2.4.1 for a corresponding Band for each relevant SSB.

Table 10.1.20.1.2-1: SSB based L1-RSRP relative accuracy in FR2

Accuracy		Conditions					
Normal condition	Extreme condition	SSB \hat{E}_s/lot <small>Note 2</small>	NR operating band groups <small>Note 3</small>	Io <small>Note 1</small> range			
				Minimum Io		Maximum Io	
dB	dB	dB		dBm / SCS _{SSB}		dBm/BW _{Channel}	
				SCS _{SSB} = 120kHz	SCS _{SSB} = 240kHz		
TBD	TBD	$\geq -3\text{dB}$	NR_TDD_FR2_A	TBD	TBD	N/A	TBD
			NR_TDD_FR2_B	TBD	TBD	N/A	TBD
			NR_TDD_FR2_F	TBD	TBD	N/A	TBD
			NR_TDD_FR2_G	TBD	TBD	N/A	TBD
			NR_TDD_FR2_T	TBD	TBD	N/A	TBD
			NR_TDD_FR2_Y	TBD	TBD	N/A	TBD

NOTE 1: Io is assumed to have constant EPRE across the bandwidth.
 NOTE 2: The parameter SSB \hat{E}_s/lot is the minimum SSB \hat{E}_s/lot of the pair of SSBs to which the requirement applies.
 NOTE 3: NR operating band groups in FR2 are as defined in Section 3.5.3.

10.1.20.2 CSI-RS based L1-RSRP accuracy requirements

10.1.20.2.1 Absolute Accuracy

Unless otherwise specified, the requirements for absolute accuracy of CSI-RS based L1-RSRP in this clause apply to all CSI-RS resources of the serving cell configured for L1-RSRP measurement.

The accuracy requirements in Table 10.1.20.2.1-1 are valid under the following conditions:

Conditions for L1-RSRP measurements are fulfilled according to Annex B.2.4.2 for a corresponding Band for each relevant CSI-RS.

Table 10.1.20.2.1-1: CSI-RS based L1-RSRP absolute accuracy in FR2

Accuracy		Conditions					
Normal condition	Extreme condition	CSI-RS \hat{E}_s/I_{ot}	I_o ^{Note 1} range				
			NR operating band groups ^{Note 2}	Minimum I_o		Maximum I_o	
dB	dB	dB		dBm / SCS_{CSI-RS}			dBm/ $BW_{Channel}$
			$SCS_{CSI-RS} = 60kHz$	$SCS_{CSI-RS} = 120kHz$			
TBD	TBD	$\geq -3dB$	NR_TDD_FR2_A	TBD	TBD	N/A	-70
			NR_TDD_FR2_B	TBD	TBD	N/A	-70
			NR_TDD_FR2_F	TBD	TBD	N/A	-70
			NR_TDD_FR2_G	TBD	TBD	N/A	-70
			NR_TDD_FR2_T	TBD	TBD	N/A	-70
			NR_TDD_FR2_Y	TBD	TBD	N/A	-70
TBD	TBD	TBD	NR_TDD_FR2_A, NR_TDD_FR2_B, NR_TDD_FR2_F, NR_TDD_FR2_G, NR_TDD_FR2_T, NR_TDD_FR2_Y	N/A	N/A	-70	-50

NOTE 1: I_o is assumed to have constant EPRE across the bandwidth.
 NOTE 2: NR operating band groups in FR2 are as defined in Section 3.5.3.

10.1.20.2.2 Relative Accuracy

The relative accuracy of CSI-RS based L1-RSRP is defined as the L1-RSRP measured from one CSI-RS compared to the largest measured value of L1-RSRP among all CSI-RS resources of the serving cell.

The accuracy requirements in Table 10.1.20.2.2-1 are valid under the following conditions:

Conditions for L1-RSRP measurements are fulfilled according to Annex B.2.4.2 for a corresponding Band for each relevant CSI-RS.

Table 10.1.20.2.2-1: CSI-RS based L1-RSRP relative accuracy in FR2

Accuracy		Conditions					
Normal condition	Extreme condition	CSI-RS \hat{E}_s/I_{ot} ^{Note 2}	I_o ^{Note 1} range				
			NR operating band groups ^{Note 3}	Minimum I_o		Maximum I_o	
dB	dB	dB		dBm / SCS_{CSI-RS}			dBm/ $BW_{Channel}$
			$SCS_{CSI-RS} = 60kHz$	$SCS_{CSI-RS} = 120kHz$			
TBD	TBD	$\geq -3dB$	NR_TDD_FR2_A	TBD	TBD	N/A	TBD
			NR_TDD_FR2_B	TBD	TBD	N/A	TBD
			NR_TDD_FR2_F	TBD	TBD	N/A	TBD
			NR_TDD_FR2_G	TBD	TBD	N/A	TBD
			NR_TDD_FR2_T	TBD	TBD	N/A	TBD
			NR_TDD_FR2_Y	TBD	TBD	N/A	TBD

NOTE 1: I_o is assumed to have constant EPRE across the bandwidth.
 NOTE 2: The parameter CSI-RS \hat{E}_s/I_{ot} is the minimum CSI-RS \hat{E}_s/I_{ot} of the pair of CSI-RS resources to which the requirement applies.
 NOTE 3: NR operating band groups in FR2 are as defined in Section 3.5.3.

10.1.21 SFTD accuracy requirements

10.1.21.1 SFTD accuracy requirements for NE-DC

The SFN and frame timing difference (SFTD) is measured between PCell and E-UTRAN PSCell under NE-DC.

The accuracy requirements in Table 10.1.21.1-4 are applicable under the following conditions:

For PCell SFN and frame timing measurement:

Conditions defined in TS 38.101-1 [18] Clause 7.3 for reference sensitivity are fulfilled.

Conditions defined in TS 38.101-2 [19] Clause 7.3 for reference sensitivity are fulfilled.

Io range defined in Table 10.1.21.1-1 for FR1.

Io range defined in Table 10.1.21.1-2 for FR2.

Other conditions are TBD

Table 10.1.21.1-1: PCell Io range conditions in FR1

Parameter	Io ^{Note 1} range				
	NR operating band groups ^{Note 2}	Minimum Io		Maximum Io	
Conditions		dBm/ SCS _{SSB}		dBm/BW _{Channel}	
		SCS _{SSB} = 15 kHz	SCS _{SSB} = 30 kHz		
		NR_FDD_FR1_A, NR_TDD_FR1_A	-121	-118	-50
		NR_FDD_FR1_B	-120.5	-117.5	-50
		NR_TDD_FR1_C	-120	-117	-50
		NR_FDD_FR1_D, NR_TDD_FR1_D	-119.5	-116.5	-50
		NR_FDD_FR1_E, NR_TDD_FR1_E	-119	-116	-50
		NR_FDD_FR1_G	-118	-115	-50
		NR_FDD_FR1_H	-117.5	-114.5	-50

NOTE 1: Io is assumed to have constant EPRE across the bandwidth.
NOTE 2: NR operating band groups are as defined in Section 3.5.2.

Table 10.1.21.1-2: PCell Io range conditions in FR2

Parameter	Io ^{Note 1} range				
	NR operating band groups ^{Note 2}	Minimum Io		Maximum Io	
Conditions		dBm/ SCS _{SSB}		dBm/BW _{Channel}	
		SCS _{SSB} = 120 kHz	SCS _{SSB} = 240 kHz		
		NR_TDD_FR2_A	TBD	TBD	-50
		NR_TDD_FR2_B	TBD	TBD	-50
		NR_TDD_FR2_F	TBD	TBD	-50
		NR_TDD_FR2_G	TBD	TBD	-50
		NR_TDD_FR2_T	TBD	TBD	-50
	NR_TDD_FR2_Y	TBD	TBD	-50	

NOTE 1: Io is assumed to have constant EPRE across the bandwidth.
NOTE 2: NR operating band groups are as defined in Section 3.5.3.

For E-UTRA PSCell SFN and frame timing measurement:

Cell specific reference signals are transmitted either from one, two or four antenna ports.

Conditions defined in TS 36.101 [25] Clause 7.3 for reference sensitivity are fulfilled.

No changes to the uplink transmission timing are applied during the measurement period.

RSRP_{dBm} according to Annex B.3.5 in TS 36.101 [25] for a corresponding Band.

Io range defined in Table 10.1.21.1-3.

Table 10.1.21.1-3: E-UTRA PSCell Io range conditions

Parameter	Io ^{Note 1} range		
	E-UTRA operating band groups ^{Note 3}	Minimum Io dBm/15kHz ^{Note 2}	Maximum Io dBm/BW _{Channel}
Conditions	FDD_A, TDD_A	-121	-50
	FDD_C, TDD_C	-120	-50
	FDD_D	-119.5	-50
	FDD_E, TDD_E	-119	-50
	FDD_F	-118.5	-50
	FDD_G	-118	-50
	FDD_H	-117.5	-50
	FDD_N	-114.5	-50

NOTE 1: When in dBm/15kHz, the minimum Io condition is expressed as the average Io per RE over all REs in that symbol. Io may be different in different symbols within a subframe.
NOTE 2: The condition level is increased by $\Delta > 0$, when applicable, as described in Sections B.4.2 and B.4.3 in TS36.133 [15].
NOTE 3: E-UTRA operating band groups are as defined in Section 3.5 in TS 36.133 [15].

Table 10.1.21.1-4: SFTD measurement accuracy

Accuracy	Conditions	
	$\hat{E}s/lot$ ^{Note 2}	Frequency range
Ts ^{Note 1}	dB	
[40]*64*Tc	$\geq [-3]$ dB	FR1
[40]*64*Tc		FR2

NOTE 1: Tc is the basic timing unit defined in TS 38.211 [6].
NOTE 2: The parameter $\hat{E}s/lot$ is the minimum $\hat{E}s/lot$ of the pair of cells to which the requirement applies.

10.2 E-UTRAN measurements

10.2.1 Introduction

Accuracy requirements for measurements on E-UTRAN carrier frequencies are specified in Section 10.2 and apply for UE in SA or NR-DC operation mode.

The requirements in Section 10.2 are applicable for a UE:

- in RRC_CONNECTED state
- performing measurements with appropriate measurement gaps according to section 9.1.2.
- that is synchronised to the cell that is measured.

The reported measurement result after layer 1 filtering shall be an estimate of the average value of the measured quantity over the measurement period. The reference point for the measurement result after layer 1 filtering is referred to as point B in the measurement model described in TS 36.300 [24].

The accuracy requirements of E-UTRA measurements in this clause are valid for the reported measurement result after layer 1 filtering. The accuracy requirements are verified from the measurement report at point D in the measurement model having the layer 3 filtering disabled.

If the UE needs measurement gaps to perform the inter-RAT NR — E-UTRAN FDD and NR — E-UTRAN TDD measurements, the relevant measurement procedure and measurement gap patterns stated in Section 9.1.2 shall apply.

10.2.2 E-UTRAN RSRP measurements

NOTE: This measurement is for handover between NR and E-UTRAN.

The measurement period of E-UTRA RSRP in RRC_CONNECTED state is specified in section 9.4.2 and 9.4.3.

The accuracy requirements of E-UTRA RSRP measurements in RRC_CONNECTED state and the corresponding side conditions shall be the same as the inter-frequency RSRP Accuracy Requirements in TS 36.133 [15, Section 9.1.3].

The reporting range and mapping specified for RSRP measurements in TS 36.133 [15, Section 9.1.4] shall apply.

10.2.3 E-UTRAN RSRQ measurements

NOTE: This measurement is for handover between NR and E-UTRAN.

The measurement period of E-UTRA RSRQ in RRC_CONNECTED state is specified in section 9.4.2 and 9.4.3.

The accuracy requirements of E-UTRA RSRQ measurements in RRC_CONNECTED state and the corresponding side conditions shall be the same as the inter-frequency RSRQ Accuracy Requirements in TS 36.133 [15, Section 9.1.6].

The requirements for accuracy of E-UTRA RSRQ measurements in RRC_CONNECTED state and the corresponding side conditions shall be the same as the inter-frequency RSRQ Accuracy Requirements in TS 36.133 [15, Section 9.1.6].

The reporting range and mapping specified for RSRQ measurements in TS 36.133 [15, Section 9.1.7] shall apply.

10.2.4 E-UTRAN RSTD measurements

The requirements in this section are valid for UE supporting this capability.

The measurement period is specified in Sections 9.4.4.1 and 9.4.4.2 for inter-RAT NR — E-UTRAN FDD and inter-RAT NR — E-UTRAN TDD RSTD measurements, respectively.

The accuracy requirements and the corresponding side conditions shall be the same as the inter-frequency measurement accuracy requirements for RSTD measurements in RRC_CONNECTED in TS 36.133 [15, Section 9.1.10.2].

If the UE needs measurement gaps to perform the inter-RAT NR — E-UTRAN FDD and NR — E-UTRAN TDD RSTD measurements, the relevant measurement procedure and measurement gap patterns stated in Section 9.1.2 shall apply.

The reporting range and mapping for the inter-RAT NR — E-UTRAN FDD and NR — E-UTRAN TDD RSTD measurements is the same as specified for RSTD measurements in TS 36.133 [15, Sections 9.1.10.3 and 9.1.10.4].

10.2.5 E-UTRAN RS-SINR measurements

NOTE: This measurement is for handover between NR and E-UTRAN.

The measurement period of E-UTRA RS-SINR in RRC_CONNECTED state is specified in section 9.4.2 and 9.4.3.

The accuracy requirements of E-UTRA RS-SINR measurements in RRC_CONNECTED state and the corresponding side conditions shall be the same as the inter-frequency RS-SINR Accuracy Requirements in TS 36.133 [15, Section 9.1.17.3].

The reporting range and mapping for E-UTRA RS-SINR measurements shall be the same as specified for RS-SINR measurements in TS 36.133 [15, 9.1.17.1].

11 Measurements Performance Requirements for NR network

Editor's note: network side measurement and mapping tables may be specified in this section. If RAN4 decides to move NR network requirements to gNodeB specification, this section might be removed.

Annex A (normative): Test Cases

A.1 Purpose of annex

A.2 Requirement classification for statistical testing

Requirements in this specification are either expressed as absolute requirements with a single value stating the requirement, or expressed as a success rate. There are no provisions for the statistical variations that will occur when the parameter is tested.

Annex A outlines the tests in more detail and lists the test parameters needed. The test will result in an outcome of a test variable value for the device under test (DUT) inside or outside the test limit. Overall, the probability of a "good" DUT being inside the test limit(s) and the probability of a "bad" DUT being outside the test limit(s) should be as high as possible. For this reason, when selecting the test variable and the test limit(s), the statistical nature of the test is accounted for.

The statistical nature depends on the type of requirement. Some have large statistical variations, while others are not statistical in nature at all. When testing a parameter with a statistical nature, a confidence level is set. This establishes the probability that a DUT passing the test actually meets the requirements and determines how many times a test has to be repeated and what the pass and fail criteria are. Those aspects are not covered by TS 38.133. The details of the tests on how many times to run it and how to establish confidence in the tests are described in TS 38.533 [5]. This Annex establishes the variable to be used in the test and whether it can be viewed as statistical in nature or not.

A.2.1 Types of requirements in TS 38.133

A.2.1.1 Time and delay requirements on UE higher layer actions

A very large part of the RRM requirements are delay requirements:

- In RRC_IDLE state mobility (clause A.4.x, A.5.x, A.6.x and A.7.x) there is cell re-selection delay.
- In RRC_CONNECTED state mobility (clauses A.4.3, A.4.6, A.5.3, A.5.6, A.6.3, A.6.6, A.7.3 and A.7.6) there is handover delay, cell search delay and measurement reporting delay.
- In RRC Connection Control (clauses A.4.3.2, A.5.3.2, A.6.3.2 and A.7.3.2) there is RRC re-establishment delay.

All have in common that the UE is required to perform an action observable in higher layers (e.g. camp on the correct cell) within a certain time after a specific event (e.g. when a new strong pilot or reference signal appears). The delay time is statistical in nature for several reasons, among others that several of the measurements are performed by the UE in a fading radio environment.

The variations make a strict limit unsuitable for a test. Instead there is a condition set for a correct action by the UE, e.g. that the UE shall camp on the correct cell within X seconds. Then the rate of correct events is observed during repeated tests and a limit is set on the rate of correct events, usually 90% correct events are required. How the limit is applied in the test depends on the confidence required, further detailed are in TS 38.533 [5].

A.2.1.2 Measurements of power levels, relative powers and time

A very large number of requirements are on measurements that the UE performs:

- In RRC_CONNECTED state mobility (clauses A.4.3, A.5.3, A.6.3 and A.7.3) there are measurement reports.
- In Measurement Performance Requirements (clauses A.4.7, A.5.7, A.6.7 and A.7.7) there are requirements for all type of measurements.

The accuracy requirements on measurements are expressed in this specification as a fixed limit (e.g. +/-X dB), but the measurement error will have a distribution that is not easily confined in fixed limits. Assuming a Gaussian distribution of the error, the limits will have to be set at $\pm 3.29\sigma$ if the probability of failing a "good DUT" in a single test is to be kept at 0.1%. It is more reasonable to set the limit tighter and test the DUT by counting the rate of measurements that are within the limits, in a way similar to the requirements on delay.

A.2.1.3 Implementation requirements

A few requirements are strict actions the UE should take or capabilities the UE should have, without any allowance for deviations. These requirements are absolute and should be tested as such. Examples are:

- "Event triggered report rate" in RRC_CONNECTED state mobility (clauses A.4.3, A.4.6, A.5.3, A.5.6, A.6.3, A.6.6, A.7.3 and A.7.6)
- "Correct behaviour at time-out" in RRC connection control (clauses A.4.3.2, A.5.3.2, A.6.3.2 and A.7.3.2)

A.2.1.4 Physical layer timing requirements

There are requirements on Timing (clauses A.4.4, A.5.4, A.6.4 and A.7.4). There are both absolute and relative limits on timing accuracy depending upon the type of requirement. Examples are:

- Initial Transmit Timing (clauses A.4.4.1, A.5.4.1, A.6.4.1 and A.7.4.1) has an absolute limit on timing accuracy.
- Timing Advance (clauses A.4.4.2, A.5.4.2, A.6.4.2 and A.7.4.2) has a relative limit on timing accuracy.

A.3 RRM test configurations

A.3.1 Reference measurement channels

A.3.1.1 PDSCH

A.3.1.1.1 FDD

Table A.3.1.1.1-1: PDSCH Reference Measurement Channels for SCS=15kHz

Parameter	Unit	Value						
Reference channel		SR.1.1 FDD						
Channel bandwidth	MHz	10						
Number of transmitter antennas		1						
Allocated resource blocks for PDSCH ^{Note 1}		24						
Allocated slots per Radio Frame		10						
Radio frame containing SSB	slots	Note 5						
Radio frame not containing SSB	slots	[10]						
MCS index		4						
Modulation		QPSK						
Target Coding Rate		1/3						
Number of control symbols		2						
PDSCH mapping type		Type A						
Information Bit Payload								
For slots with RMSI ^{Note 2}	Bits	[1864]						
Number of Code Blocks per slot		1						
Binary Channel Bits Per slot								
For slots with RMSI ^{Note 2, Note 4}	Bits	[6048]						
<p>Note 1: Allocated outside the SMTC duration in time and in resource blocks which do not overlap with the resource blocks allocated for SS/PBCH block.</p> <p>Note 2: PDSCH is scheduled on the slots with RMSI.</p> <p>Note 3: If necessary the information bit payload size can be adjusted to facilitate the test implementation. The payload sizes are defined in TS 38.213 [3].</p> <p>Note 4: Derived based on the PDSCH DMRS assumption: dmrs-TypeA-Position=2, dmrs-Type=1, dmrs-AdditionalPositions=2, maxLength=1, Antenna port index: 1000, and Number of PDSCH DMRS CDM group(s) without data: 1.</p> <p>Note 5: PDSCH is not scheduled in slots containing SSB according to the SSB configuration used in the test. SSB configurations are defined in section A.3.10.</p>								

A.3.1.1.2 TDD

Table A.3.1.1.2-1: PDSCH Reference Measurement Channels for SCS=15kHz

Parameter	Unit	Value					
Reference channel		SR.1.1 TDD					
Channel bandwidth	MHz	10					
Number of transmitter antennas		1					
Allocated resource blocks for PDSCH ^{Note 1}		24					
Allocated slots per Radio Frame							
Radio frame containing SSB	slots	Note 5					
Radio frame not containing SSB	slots	[4]					
MCS table		64QAM					
MCS index		4					
Modulation		QPSK					
Target Coding Rate		1/3					
Number of control symbols		2					
PDSCH mapping type		Type A					
Information Bit Payload							
For slots with RMSI ^{Note 2}	Bits	[1864]					
Number of Code Blocks per slot		1					
Binary Channel Bits Per slot							
For slots with RMSI ^{Note 2, Note 4}	Bits	[6048]					
<p>Note 1: Allocated outside the SMTC duration in time and in resource blocks which do not overlap with the resource blocks allocated for SS/PBCH block.</p> <p>Note 2: PDSCH is scheduled on the slots with RMSI.</p> <p>Note 3: If necessary the information bit payload size can be adjusted to facilitate the test implementation. The payload sizes are defined in TS 38.213 [3].</p> <p>Note 4: Derived based on the PDSCH DMRS assumption: dmrs-TypeA-Position=2, dmrs-Type=1, dmrs-AdditionalPositions=2, maxLength=1, Antenna port index: 1000, and Number of PDSCH DMRS CDM group(s) without data: 1.</p> <p>Note 5: PDSCH is not scheduled in slots containing SSB according to the SSB configuration used in the test. SSB configurations are defined in section A.3.10.</p>							

Table A.3.1.1.1-2: PDSCH Reference Measurement Channels for SCS=30kHz

Parameter	Unit	Value						
Reference channel		SR.2.1 TDD						
Channel bandwidth	MHz	40						
Number of transmitter antennas		1						
Allocated resource blocks for PDSCH ^{Note 1}		24						
Allocated slots per Radio Frame								
Radio frame containing SSB	slots	Note 5						
Radio frame not containing SSB	slots	[10]						
MCS table		64QAM						
MCS index		4						
Modulation		QPSK						
Target Coding Rate		1/3						
Number of control symbols		2						
PDSCH mapping type		Type A						
Information Bit Payload								
For slots with RMSI ^{Note 2}	Bits	[1864]						
Number of Code Blocks per slot		1						
Binary Channel Bits Per slot								
For slots with RMSI ^{Note 2, Note 4}	Bits	[6048]						
<p>Note 1: Allocated outside the SMTC duration in time and in resource blocks which do not overlap with the resource blocks allocated for SS/PBCH block.</p> <p>Note 2: PDSCH is scheduled on the slots with RMSI.</p> <p>Note 3: If necessary the information bit payload size can be adjusted to facilitate the test implementation. The payload sizes are defined in TS 38.213 [3].</p> <p>Note 4: Derived based on the PDSCH DMRS assumption: dmrs-TypeA-Position=2, dmrs-Type=1, dmrs-AdditionalPositions=2, maxLength=1, Antenna port index: 1000, and Number of PDSCH DMRS CDM group(s) without data: 1.</p> <p>Note 5: PDSCH is not scheduled in slots containing SSB according to the SSB configuration used in the test. SSB configurations are defined in section A.3.10.</p>								

Table A.3.1.1.1-3: PDSCH Reference Measurement Channels for SCS=120kHz

Parameter	Unit	Value						
Reference channel		SR.3.1 TDD						
Channel bandwidth	MHz	100						
Number of transmitter antennas		1						
Allocated resource blocks for PDSCH ^{Note 1}		24						
Allocated slots per Radio Frame								
Radio frame containing SSB	slots	Note 5						
Radio frame not containing SSB	slots	[48]						
MCS table		64QAM						
MCS index		4						
Modulation		QPSK						
Target Coding Rate		1/3						
Number of control symbols		2						
PDSCH mapping type		Type A						
Information Bit Payload								
For slots with RMSI ^{Note 2}	Bits	[1864]						
Number of Code Blocks per slot		1						
Binary Channel Bits Per slot								
For slots with RMSI ^{Note 2, Note 4}	Bits	[6048]						
<p>Note 1: Allocated outside the SMTTC duration in time and in resource blocks which do not overlap with the resource blocks allocated for SS/PBCH block</p> <p>Note 2: PDSCH is scheduled on the slots with RMSI.</p> <p>Note 3: If necessary the information bit payload size can be adjusted to facilitate the test implementation. The payload sizes are defined in TS 38.213 [3].</p> <p>Note 4: Derived based on the PDSCH DMRS assumption: dmrs-TypeA-Position=2, dmrs-Type=1, dmrs-AdditionalPositions=2, maxLength=1, Antenna port index: 1000, and Number of PDSCH DMRS CDM group(s) without data: 1.</p> <p>Note 5: PDSCH is not scheduled in slots containing SSB according to the SSB configuration used in the test. SSB configurations are defined in section A.3.10.</p>								

A.3.1.2 CORESET for RMSI scheduling

A.3.1.2.1 FDD

Table A.3.1.2.1-1: RMSI CORESET Reference Channel for FDD with SCS=15KHz

Parameter	Unit	Value					
Reference channel		CR.1.1 FDD					
Channel bandwidth	MHz	10					
Subcarrier spacing for RMSI CORESET	KHz	15					
Allocated resource blocks for RMSI CORESET ^{Note 7}		24					
Subcarrier spacing for SSB	KHz	15					
SSB and RMSI CORESET multiplexing configuration ^{Note 7}		Pattern 1					
Offset between SSB and RMSI CORESET ^{Note 3, 7}	RB	0 (Note8)					
Configuration of PDCCH monitoring occasions for RMSI CORESET ^{Note 4}		Index 4					
Number of transmitter antennas		1					
Duration of RMSI CORESET ^{Note 7}	symbols	2					
DCI Format ^{Note 1}		Note 2					
Aggregation level	CCE	8					
DMRS precoder granularity		6					
REG bundle size		6					
Mapping from REG to CCE		Distributed					
Cell ID		Note 5					
Payload (without CRC)	Bits	Note 6					
<p>Note 1: DCI formats are defined in TS 38.212.</p> <p>Note 2: DCI format shall depend upon the test configuration.</p> <p>Note 3: The offset is defined with respect to the subcarrier spacing of the CORESET from the smallest RB index of RMSI CORESET to the smallest RB index of the common RB overlapping with the first RB of the SS/PBCH block.</p> <p>Note 4: The configuration of PDCCH monitoring occasions for RMSI CORESET is defined in Table 13-11 in TS 38.213 [3].</p> <p>Note 5: Cell ID shall depend upon the test configuration.</p> <p>Note 6: Payload size shall depend upon the test configuration.</p> <p>Note 7: The configuration of set of resource blocks and slot symbols of control resource set for Type0-PDCCH search space corresponds to index 0 in Table 13-1 in TS 38.213</p> <p>Note 8: Other values can be used to align with GSCN [13] as long as SSB does not overlap the RMC.</p>							

A.3.1.2.2 TDD

Table A.3.1.2.2-1: RMSI CORESET Reference Channel for TDD with SCS=15KHz

Parameter	Unit	Value					
Reference channel		CR.1.1 TDD					
Channel bandwidth	MHz	10					
Subcarrier spacing	KHz	15					
Allocated resource blocks for RMSI CORESET ^{Note 7}		24					
Index of transmitted SSB within an SS-Burst		#0					
SSB and RMSI CORESET multiplexing configuration ^{Note 7}		Pattern 1					
Offset between SSB and RMSI CORESET ^{Note 3, 7}	RB	0 (Note 8)					
Configuration of PDCCH monitoring occasions for RMSI CORESET ^{Note 4}		Index 4					
Number of transmitter antennas		1					
Duration of RMSI CORESET ^{Note 7}	symbols	2					
DCI Format ^{Note 1}		Note 2					
Aggregation level	CCE	8					
DMRS precoder granularity		6					
REG bundle size		6					
Mapping from REG to CCE		Distributed					
Cell ID		Note 5					
Payload (without CRC)	Bits	Note 6					
<p>Note 1: DCI formats are defined in TS 38.212.</p> <p>Note 2: DCI format shall depend upon the test configuration.</p> <p>Note 3: The offset is defined with respect to the subcarrier spacing of the CORESET from the smallest RB index of RMSI CORESET to the smallest RB index of the common RB overlapping with the first RB of the SS/PBCH block.</p> <p>Note 4: The configuration of PDCCH monitoring occasions for RMSI CORESET is defined in Table 13-11 in TS 38.213 [3].</p> <p>Note 5: Cell ID shall depend upon the test configuration.</p> <p>Note 6: Payload size shall depend upon the test configuration.</p> <p>Note 7: The configuration of set of resource blocks and slot symbols of control resource set for Type0-PDCCH search space corresponds to index 0 in Table 13-1 in TS 38.213</p> <p>Note 8: Other values can be used to align with GSCN [13] as long as SSB does not overlap the RMC.</p>							

Table A.3.1.2.2-2: RMSI CORESET Reference Channel for TDD with SCS=30KHz

Parameter	Unit	Value					
Reference channel		CR.2.1 TDD					
Channel bandwidth	MHz	40					
Subcarrier spacing	KHz	30					
Allocated resource blocks for RMSI CORESET ^{Note 7}		24					
Index of transmitted SSB within an SS-Burst		#0					
SSB and RMSI CORESET multiplexing configuration ^{Note 7}		Pattern 1					
Offset between SSB and RMSI CORESET ^{Note 3, 7}	RB	0 (Note 8)					
Configuration of PDCCH monitoring occasions for RMSI CORESET ^{Note 4}		Index 4					
Number of transmitter antennas		1					
Duration of RMSI CORESET ^{Note 7}	symbols	2					
DCI Format ^{Note 1}		Note 2					
Aggregation level	CCE	8					
DMRS precoder granularity		6					
REG bundle size		6					
Mapping from REG to CCE		Distributed					
Cell ID		Note 5					
Payload (without CRC)	Bits	Note 6					
<p>Note 1: DCI formats are defined in TS 38.212.</p> <p>Note 2: DCI format shall depend upon the test configuration.</p> <p>Note 3: The offset is defined with respect to the subcarrier spacing of the CORESET from the smallest RB index of RMSI CORESET to the smallest RB index of the common RB overlapping with the first RB of the SS/PBCH block.</p> <p>Note 4: The configuration of PDCCH monitoring occasions for RMSI CORESET is defined in Table 13-11 in TS 38.213 [3].</p> <p>Note 5: Cell ID shall depend upon the test configuration.</p> <p>Note 6: Payload size shall depend upon the test configuration.</p> <p>Note 7: The configuration of set of resource blocks and slot symbols of control resource set for Type0-PDCCH search space corresponds to index 0 in Table 13-6 in TS 38.213</p> <p>Note 8: Other values can be used to align with GSCN [13] as long as SSB does not overlap the RMC.</p>							

Table A.3.1.2.2-3: RMSI CORESET Reference Channel for TDD with SCS=120KHz

Parameter	Unit	Value					
Reference channel		CR.3.1 TDD					
Channel bandwidth	MHz	100					
Subcarrier spacing	KHz	120					
Allocated resource blocks for RMSI CORESET ^{Note 7}		24					
Subcarrier spacing for SSB	KHz	120					
SSB and RMSI CORESET multiplexing configuration ^{Note 7}		Pattern 1					
Offset between SSB and RMSI CORESET ^{Note 3, 7}	RB	0 (Note 8)					
Configuration of PDCCH monitoring occasions for RMSI CORESET ^{Note 4}		Index 4					
Number of transmitter antennas		1					
Duration of RMSI CORESET ^{Note 7}	symbols	2					
DCI Format ^{Note 1}		Note 2					
Aggregation level	CCE	8					
DMRS precoder granularity		6					
REG bundle size		6					
Mapping from REG to CCE		Distributed					
Cell ID		Note 5					
Payload (without CRC)	Bits	Note 6					
<p>Note 1: DCI formats are defined in TS 38.212.</p> <p>Note 2: DCI format shall depend upon the test configuration.</p> <p>Note 3: The offset is defined with respect to the subcarrier spacing of the CORESET from the smallest RB index of RMSI CORESET to the smallest RB index of the common RB overlapping with the first RB of the SS/PBCH block.</p> <p>Note 4: The configuration of PDCCH monitoring occasions for RMSI CORESET is defined in Table 13-12 in TS 38.213 [3].</p> <p>Note 5: Cell ID shall depend upon the test configuration.</p> <p>Note 6: Payload size shall depend upon the test configuration.</p> <p>Note 7: The configuration of set of resource blocks and slot symbols of control resource set for Type0-PDCCH search space corresponds to index 0 in Table 13-8 in TS 38.213</p> <p>Note 8: Other values can be used to align with GSCN [13] as long as SSB does not overlap the RMC.</p>							

A.3.1.3 CORESET for RMC scheduling

A.3.1.3.1 FDD

Table A.3.1.3.1-1: Control Channel RMC for FDD with SCS=15KHz

Parameter	Unit	Value					
Reference channel		[CCR.1.1] FDD					
Channel bandwidth	MHz	10					
Subcarrier spacing	KHz	15					
Allocated resource blocks for CORESET ^{Note 3}		24					
Number of transmitter antennas		1					
Duration of CORESET	symbols	2					
REG bundle size		6					
DMRS precoder granularity		Same as REG bundle size					
CCE to REG mapping		Interleaved					
Interleave n_shift		0					
Interleave size		2					
Beamforming Pre-Coder		N/A					
Aggregation level	CCE	8					
DCI formats		Note 1					
Payload size (without CRC)	bits	Note 2					
Note 1: DCI format shall depend upon the test configuration. Note 2: Payload size shall depend upon the test configuration Note 3: Allocated in the same resource blocks where the associated RMC is scheduled.							

A.3.1.3.2 TDD

Table A.3.1.3.2-1: Control Channel RMC for TDD with SCS=15KHz

Parameter	Unit	Value					
Reference channel		[CCR.1.1] TDD					
Channel bandwidth	MHz	10					
Subcarrier spacing	KHz	15					
Allocated resource blocks for CORESET ^{Note 3}		24					
Number of transmitter antennas		1					
Duration of CORESET	symbols	2					
REG bundle size		6					
DMRS precoder granularity		Same as REG bundle size					
CCE to REG mapping		Interleaved					
Interleave n_shift		0					
Interleave size		2					
Beamforming Pre-Coder		N/A					
Aggregation level	CCE	8					
DCI formats		Note 1					
Payload size (without CRC)	bits	Note 2					
Note 1: DCI format shall depend upon the test configuration. Note 2: Payload size shall depend upon the test configuration Note 3: Allocated in the same resource blocks where the associated RMC is scheduled.							

Table A.3.1.3.2-2: Control Channel RMC for TDD with SCS=30KHz

Parameter	Unit	Value					
Reference channel		[CCR.2.1] TDD					
Channel bandwidth	MHz	40					
Subcarrier spacing	KHz	30					
Allocated resource blocks for CORESET ^{Note 3}		24					
Number of transmitter antennas		1					
Duration of CORESET	symbols	2					
REG bundle size		6					
DMRS precoder granularity		Same as REG bundle size					
CCE to REG mapping		Interleaved					
Interleave n_shift		0					
Interleave size		2					
Beamforming Pre-Coder		N/A					
Aggregation level	CCE	8					
DCI formats		Note 1					
Payload size (without CRC)	bits	Note 2					
Note 1: DCI format shall depend upon the test configuration.							
Note 2: Payload size shall depend upon the test configuration							
Note 3: Allocated in the same resource blocks where the associated RMC is scheduled.							

Table A.3.1.3.2-3: Control Channel RMC for TDD with SCS=120KHz

Parameter	Unit	Value					
Reference channel		[CCR.3.1] TDD					
Channel bandwidth	MHz	100					
Subcarrier spacing	KHz	120					
Allocated resource blocks for CORESET ^{Note 3}		24					
Number of transmitter antennas		1					
Duration of CORESET	symbols	2					
REG bundle size		6					
DMRS precoder granularity		Same as REG bundle size					
CCE to REG mapping		Interleaved					
Interleave n_shift		0					
Interleave size		2					
Beamforming Pre-Coder		N/A					
Aggregation level	CCE	8					
DCI formats		Note 1					
Payload size (without CRC)	bits	Note 2					
Note 1: DCI format shall depend upon the test configuration.							
Note 2: Payload size shall depend upon the test configuration							
Note 3: Allocated in the same resource blocks where the associated RMC is scheduled.							

A.3.1.4 TDD UL/DL configuration

Table A.3.1.4-1: TDD UL/DL configuration for SCS=15kHz

Parameter	Unit	Value	
Reference channel		TDDConf.1.1	
<i>referenceSubcarrierSpacing</i>	kHz	15	
TDD UL/DL pattern 1 ^{Note 2}		'DSUU' S='10DL:2GP:2UL'	
<i>dl-UL-TransmissionPeriodicity</i>	ms	4	
<i>nrofDownlinkSlots</i>		1	
<i>nrofDownlinkSymbols</i>		9	
<i>nrofUplinkSlot</i>		2	
<i>nrofUplinkSymbols</i>		2	
TDD UL/DL pattern 2 ^{Note 2}		'D'	
<i>dl-UL-TransmissionPeriodicity</i>	ms	1	
<i>nrofDownlinkSlots</i>		1	
<i>nrofDownlinkSymbols</i>		0	
<i>nrofUplinkSlot</i>		0	
<i>nrofUplinkSymbols</i>		0	
Note 1:	As specified in TS 38.213 [3] and TS 38.331 [2].		
Note 2:	For information		

Table A.3.1.4-2: TDD UL/DL configuration for SCS=30kHz

Parameter	Unit	Value	
Reference channel		TDDConf.2.1	
<i>referenceSubcarrierSpacing</i>	kHz	30	
TDD UL/DL pattern 1 ^{Note 2}		'3D1S4U' S='6DL:4GP:4UL'	
<i>dl-UL-TransmissionPeriodicity</i>	ms	4	
<i>nrofDownlinkSlots</i>		3	
<i>nrofDownlinkSymbols</i>		4	
<i>nrofUplinkSlot</i>		4	
<i>nrofUplinkSymbols</i>		4	
TDD UL/DL pattern 2 ^{Note 2}		'DD'	
<i>dl-UL-TransmissionPeriodicity</i>	ms	1	
<i>nrofDownlinkSlots</i>		2	
<i>nrofDownlinkSymbols</i>		0	
<i>nrofUplinkSlot</i>		0	
<i>nrofUplinkSymbols</i>		0	
Note 1:	As specified in TS 38.213 [3] and TS 38.331 [2].		
Note 2:	For information		

Table A.3.1.4-3: TDD UL/DL configuration for SCS=120kHz

Parameter	Unit	Value	
Reference channel		TDDConf.3.1	
<i>referenceSubcarrierSpacing</i>	kHz	120	
TDD UL/DL pattern 1 ^{Note 2}		'DDDSU' S='10DL:2GP:2UL'	
<i>dl-UL-TransmissionPeriodicity</i>	ms	0.625	
<i>nrofDownlinkSlots</i>		3	
<i>nrofDownlinkSymbols</i>		9	
<i>nrofUplinkSlot</i>		1	
<i>nrofUplinkSymbols</i>		2	
TDD UL/DL pattern 2 ^{Note 2}		Not configured	
<i>dl-UL-TransmissionPeriodicity</i>	ms	Not configured	
<i>nrofDownlinkSlots</i>		Not configured	
<i>nrofDownlinkSymbols</i>		Not configured	
<i>nrofUplinkSlot</i>		Not configured	
<i>nrofUplinkSymbols</i>		Not configured	
Note 1: As specified in TS 38.213 [3] and TS 38.331 [2].			
Note 2: For information			

A.3.2 OFDMA channel noise generator (OCNG)

A.3.2.1 Generic OFDMA Channel Noise Generator (OCNG)

The OCNG pattern is used in a test for modelling allocations of unused resources in the channel bandwidth to virtual UEs (which are not under test). The OCNG pattern comprises PDCCH and PDSCH transmissions to the virtual UEs.

A.3.2.1.1 OCNG pattern 1: Generic OCNG pattern for all unused REs

Table A.3.2.1.1-1: OP.1: Generic OCNG pattern for all unused REs

OCNG Parameters	Control Region	Data Region
Resource allocation	Unused REs (Note 1)	Unused REs (Note 2)
Channel	PDCCH	PDSCH
Contents	Virtual UE IDs	Uncorrelated pseudo random QPSK modulated data
Antenna transmission scheme	Same as used in PDCCH RMC	Same as used in PDSCH RMC
Subcarrier spacing	Same as used in PDCCH RMC	Same as used in PDSCH RMC
Aggregation level	Same as used in PDCCH RMC	N/A
Code rate	Same as used in PDCCH RMC	Same as used in PDSCH RMC
Transmit Power	Same as used in PDCCH RMC	Same as used in PDSCH RMC
CP length	Same as used in PDCCH RMC	Same as used in PDSCH RMC
Note 1: REs not used in the active CORESETs where PDCCH is scheduled for the UE under test.		
Note 2: REs not allocated to any physical channels, CORESET, SSB or any other reference signal within the channel bandwidth of the cell.		

A.3.2.2 Void

A.3.3 Reference DRX configurations

A.3.3.1 DRX Configuration 1: DRX cycle = 40 ms and TAT = 500 ms

Table A.3.3.1-1: DRX.1: DRX cycle = 40 ms and time alignment timer (TAT) = 500 ms

Field	Value
drx-onDurationTimer	1 ms
drx-InactivityTimer	1 ms
drx-RetransmissionTimerDL	1 slot
drx-RetransmissionTimerUL	1 slot
drx-LongCycleStartOffset	40 ms
shortDRX	disable
TimeAlignmentTimer	500 ms
Note:	The DRX cycle and time alignment timer parameters are specified in clause 6.3.2 in TS 38.331 [2]

A.3.3.2 DRX Configuration 2: DRX cycle = 640 ms and TAT = 500 ms

Table A.3.3.2-1: DRX.2: DRX cycle = 640 ms and time alignment timer (TAT) = 500 ms

Field	Value
drx-onDurationTimer	1 ms
drx-InactivityTimer	1 ms
drx-RetransmissionTimerDL	1 slot
drx-RetransmissionTimerUL	1 slot
drx-LongCycleStartOffset	640 ms
shortDRX	disable
TimeAlignmentTimer	500 ms
Note:	The DRX cycle and time alignment timer parameters are specified in clause 6.3.2 in TS 38.331 [2]

A.3.3.3 DRX Configuration 3: DRX cycle = 40 ms and TAT = Infinity

Table A.3.3.3-1: DRX.3: DRX cycle = 40 ms and time alignment timer (TAT) = Infinity

Field	Value
drx-onDurationTimer	6 ms
drx-InactivityTimer	1 ms
drx-RetransmissionTimerDL	1 slot
drx-RetransmissionTimerUL	1 slot
drx-LongCycleStartOffset	40 ms
shortDRX	disable
TimeAlignmentTimer	Infinity
Note:	The DRX cycle and time alignment timer parameters are specified in clause 6.3.2 in TS 38.331 [2]

A.3.3.4 DRX Configuration 4: DRX cycle = 160 ms

Table A.3.3.4-1: DRX.4: DRX cycle = 160 ms and time alignment timer (TAT) = Infinity

Field	Value
drx-onDurationTimer	psf2
drx-InactivityTimer	psf2
drx-RetransmissionTimer	Psf16
longDRX-CycleStartOffset	Sf160, 0
shortDRX	disable
TimeAlignmentTimer	Infinity
Note:	For further information see clause 6.3.2 in TS 36.331 [16].

A.3.3.5 DRX Configuration 5: DRX cycle = 320 ms

Table A.3.3.5-1: DRX.5: DRX cycle = 320 ms and time alignment timer (TAT) = Infinity

Field	Value
drx-onDurationTimer	psf6
drx-InactivityTimer	psf1920
drx-RetransmissionTimer	psf16
longDRX-CycleStartOffset	Sf320, 0
shortDRX	disable
TimeAlignmentTimer	Infinity
Note:	For further information see clause 6.3.2 in TS 36.331 [16].

A.3.3.6 DRX Configuration 6: DRX cycle = 320 ms and TAT = Infinity

Table A.3.3.6-1: DRX.6: DRX cycle = 320 ms and time alignment timer (TAT) = Infinity

Field	Value
drx-onDurationTimer	1 ms
drx-InactivityTimer	1 ms
drx-RetransmissionTimerDL	1 slot
drx-RetransmissionTimerUL	1 slot
drx-LongCycleStartOffset	640 ms
shortDRX	disable
TimeAlignmentTimer	500 ms
Note:	The DRX cycle and time alignment timer parameters are specified in clause 6.3.2 in TS 38.331 [2]

A.3.3.7 DRX Configuration 7: DRX cycle = 640 ms and TAT = Infinity

Table A.3.3.7-1: DRX.7: DRX cycle = 640 ms and time alignment timer (TAT) = Infinity

Field	Value
drx-onDurationTimer	6 ms
drx-InactivityTimer	1 ms
drx-RetransmissionTimerDL	1 slot
drx-RetransmissionTimerUL	1 slot
drx-LongCycleStartOffset	640 ms
shortDRX	disable
TimeAlignmentTimer	Infinity
Note:	The DRX cycle and time alignment timer parameters are specified in clause 6.3.2 in TS 38.331 [2]

A.3.3.8 DRX Configuration 8: DRX cycle = 320 ms and TAT = Infinity

Table A.3.3.8-1: DRX.8: DRX cycle = 320 ms and time alignment timer (TAT) = Infinity

Field	Value
drx-onDurationTimer	6 ms
drx-InactivityTimer	1 ms
drx-RetransmissionTimerDL	1 slot
drx-RetransmissionTimerUL	1 slot
drx-LongCycleStartOffset	320 ms
shortDRX	disable
TimeAlignmentTimer	Infinity
Note:	The DRX cycle and time alignment timer parameters are specified in clause 6.3.2 in TS 38.331 [2]

A.3.4 Test Cases with Different Channel Bandwidths

A.3.4.1 Test Cases with Different E-UTRA Channel Bandwidths

A.3.4.1.1 Introduction

In Annex A test cases involving E-UTRA cell(s) may be defined with different E-UTRA channel bandwidths to verify the same type of RRM requirement.

A.3.4.1.2 Principle of testing

If multiple test cases involving E-UTRA cell(s) are defined with different E-UTRA channel bandwidths to verify the same type of RRM requirement that is E-UTRA channel bandwidth independent, then the UE needs to be tested with only one channel bandwidth in each E-UTRA cell and with the same bandwidth in all the E-UTRA cells used in the test case.

A.3.5 Test Cases for Synchronous and Asynchronous DC Operations

A.3.5.1 EN-DC Test Cases for Synchronous and Asynchronous EN-DC Operations

A.3.5.1.1 Introduction

This clause defines a principle which is applicable to test cases verifying RRM requirements for EN-DC operation in synchronous and asynchronous scenarios.

In Annex A test cases may be defined in both synchronous EN-DC and asynchronous EN-DC scenarios to verify the same type of RRM requirement.

A.3.5.1.2 Principle of Testing

If EN-DC test cases are defined in both synchronous and asynchronous EN-DC scenarios to verify the same type of RRM requirement then the UE capable of both synchronous and asynchronous EN-DC operations needs to be tested with one of the tests in either synchronous or asynchronous EN-DC scenarios.

A.3.6 Antenna configurations

A.3.6.1 Antenna configurations for FR1

Unless otherwise specified, NR FDD or NR TDD cells in all RRM Test cases in AWGN propagation condition are configured with Antenna Configuration 1x2.

A.3.6.1.1 Antenna connection for 4 Rx capable UEs

A.3.6.1.1.1 Introduction

All tests in section A.4 and A.6 are specified for UEs supporting 2RX. In this section, the antenna connection method for applying 2RX tests to UEs supporting 4RX antenna ports is specified. No tests are currently specified in section A.4 or A.6 which are applicable only to 4RX antenna ports, so 4RX capable UEs are always tested by reusing tests which were originally specified for 2RX UEs.

A.3.6.1.1.2 Principle of testing

A.3.6.1.1.2.1 Single carrier tests

For 4RX capable UEs supporting at least one 2RX band, the, all single carrier tests specified in section A.4 and A.6 except those in A.4.7 and A.6.7 shall be tested on any band where 2RX is supported with the antenna connection specified in A.6.3.1.2.4. For single carrier tests specified in section A.4.7 or A.6.7, all tests shall be tested with the antenna connection specified in A.3.6.1.1.2.4 for bands where 2RX is supported, and the antenna connection specified in A.3.6.1.1.2.5 for bands where 4RX is supported.

For 4RX capable UEs which do not support any 2RX band, all tests specified in sections A.4 and A.6 shall be tested using the antenna connection specified in section A.3.6.1.1.2.5. For radio link monitoring tests, the SNR levels are modified according to table A.3.6.1.1.2.1-1 and table A.3.6.1.1.2.1-2

Table A.3.6.1.1.2.1-1: Modified parameters for RLM out of sync testing with 4 RX antenna connection

Test case	SNR during T3 (dB)			
	Test 1	Test 2	Test 3	Test 4
A.4.5.1.1	[-18]	[-18]	N/A	N/A
A.4.5.1.3	[-18]	[-18]	N/A	N/A
A.4.5.1.5	TBD	TBD	N/A	N/A
A.4.5.1.7	TBD	TBD	N/A	N/A
A.5.5.1.1	[-18]	[-18]	N/A	N/A
A.5.5.1.3	[-18]	[-18]	N/A	N/A
A.5.5.1.5	TBD	TBD	N/A	N/A
A.5.5.1.7	TBD	TBD	N/A	N/A
A.6.5.1.1	[-18]	[-18]	N/A	N/A
A.6.5.1.3	[-18]	[-18]	N/A	N/A
A.6.5.1.5	TBD	TBD	N/A	N/A
A.6.5.1.7	TBD	TBD	N/A	N/A
A.7.5.1.1	[-18]	[-18]	N/A	N/A
A.7.5.1.3	[-18]	[-18]	N/A	N/A
A.7.5.1.5	TBD	TBD	N/A	N/A
A.7.5.1.7	TBD	TBD	N/A	N/A

Table A.3.6.1.1.2.1-2: Modified parameters for RLM in sync single carrier testing with 4 RX antenna connection

Test case	SNR during T3 (dB)		SNR during T4 (dB)	
	Test 1	Test 2	Test 1	Test 2
A.4.5.1.2	[-18]	[-18]	[-8]	[-8]
A.4.5.1.4	[-18]	[-18]	[-8]	[-8]
A.4.5.1.6	TBD	TBD	TBD	TBD
A.4.5.1.8	TBD	TBD	TBD	TBD
A.5.5.1.2	[-18]	[-18]	[-8]	[-8]
A.5.5.1.4	[-18]	[-18]	[-8]	[-8]
A.5.5.1.6	TBD	TBD	TBD	TBD
A.5.5.1.8	TBD	TBD	TBD	TBD
A.6.5.1.2	[-18]	[-18]	[-8]	[-8]
A.6.5.1.4	[-18]	[-18]	[-8]	[-8]
A.6.5.1.6	TBD	TBD	TBD	TBD
A.6.5.1.8	TBD	TBD	TBD	TBD
A.7.5.1.2	[-18]	[-18]	[-8]	[-8]
A.7.5.1.4	[-18]	[-18]	[-8]	[-8]
A.7.5.1.6	TBD	TBD	TBD	TBD
A.7.5.1.8	TBD	TBD	TBD	TBD

A.3.6.1.1.2.2 Carrier aggregation tests

All carrier aggregation tests are performed using the antenna connection in section A.3.6.1.1.2.4 for the PCell antenna connection if the PCell is on a band where 2RX is supported or the antenna connection in A.3.6.1.1.2.5 for the PCell antenna connection if the PCell is on a band where 4RX is supported.

All carrier aggregation tests are performed using the antenna connection in section A.3.6.1.1.2.4 for the SCell antenna connection if an SCell is on band where 2RX is supported or the testing procedure in A.3.6.1.1.2.5 for the SCell antenna connection if an SCell is on a band where 4RX is supported.

A.3.6.1.1.2.3 EN-DC tests

All carrier aggregation tests are performed using the antenna connection in section A.3.6.1.1.2.6 for the PCell antenna connection if the PCell is on a band where 2RX is supported or the antenna connection in A.3.6.1.1.2.7 for the PCell antenna connection if the PCell is on a band where 4RX is supported.

All carrier aggregation tests are performed using the antenna connection in section A.3.6.1.1.2.4 for the PSCell or SCell antenna connection if an SCell is on band where 2RX is supported or the testing procedure in A.3.6.1.1.2.5 for the SCell antenna connection if an SCell or PSCell is on a band where 4RX is supported.

A.3.6.1.1.2.4 Antenna connection for bands where 2RX is supported

For bands where 2RX is supported, it is left to the UE declaration and AP configuration to decide which 2 of the 4 Rx ports are connected with data source from system simulator. The remaining 2 Rx ports shall be connected with zero input. No test parameters or requirements are modified.

A.3.6.1.1.2.5 Antenna connection for bands where 4RX is supported

For bands where 4RX is supported, all 4 Rx are connected with data source from system simulator. The system simulator shall provide independent noise and fading (low correlation) for each antenna port. Except for the modifications to radio link monitoring thresholds described in sections A.3.8.1.2.1 and A.3.8.1.2.2, no test parameters or requirements are modified.

A.3.6.1.1.2.6 EN-DC LTE Antenna connection for bands where 2RX is supported

For bands where LTE 2RX is supported, it is left to the UE declaration and AP configuration to decide which 2 of the 4 Rx ports are connected with data source from system simulator. The remaining 2 Rx ports shall be connected with zero input. No test parameters or requirements are modified.

A.3.6.1.1.2.7 EN-DC LTE Antenna connection for bands where 4RX is supported

For bands where LTE 4RX is supported, all 4 Rx are connected with data source from system simulator. The system simulator shall provide independent noise and fading (low correlation) for each antenna port. Except for the modifications to radio link monitoring thresholds described in sections A.3.8.1.2.1 and A.3.8.1.2.2, no test parameters or requirements are modified.

A.3.6.2 Antenna configurations for FR2

Unless otherwise specified, Downlink Antenna Configuration 2x2 for NR RRM FR2 requirements implies the following for the test configuration:

- The downlink signal is transmitted over the two polarizations (V and H) of the dual polarized antenna of the test equipment.
- The downlink signal is received assuming 2 UE baseband receivers. As the UE is tested following the Blackbox Approach with regard to the UE Rx antennas, the exact UE Rx antenna configuration is not relevant for the test configuration and has no impact on the test implementation.

A.3.7 EN-DC test setup

A.3.7.1 Introduction

A.3.7.2 E-UTRAN Serving Cell Parameters

A.3.7.2.1 E-UTRAN Serving Cell Parameters for Tests with NR Cell(s) in FR1

Table A.3.7.2.1-1 defines cell specific test parameters for E-UTRAN cell which can be used in EN-DC test cases with all NR cells in FR1. Unless otherwise stated within the test, all measurements in Annex A.4 and A.5 are

performed only on the NR carrier. The E-UTRA PCell shall be configured to not interfere with NR operation and the E-UTRA PCell signal power shall not be critical to the test purpose.

Table A.3.7.2.1-1: E-UTRAN cell specific test parameters for tests with all NR cells in FR1

Parameter	Unit	E-UTRAN Cell1
E-UTRA RF Channel Number		1
Duplex mode		FDD or TDD
TDD special subframe configuration ^{Note1}		6
TDD uplink-downlink configuration ^{Note1}		1
BW _{channel}		5MHz: N _{RB,c} = 25 10MHz: N _{RB,c} = 50 20MHz: N _{RB,c} = 100
PDSCH parameters: DL Reference Measurement Channel ^{Note2}		5MHz: R.7 FDD 10MHz: R.3 FDD 20MHz: R.6 FDD 5MHz: R.4 TDD 10MHz: R.0 TDD 20MHz: R.3 TDD
PCFICH/PDCCH/PHICH parameters: DL Reference Measurement Channel ^{Note2}		5MHz: R.11 FDD 10MHz: R.6 FDD 20MHz: R.10 FDD 5MHz: R.11 TDD 10MHz: R.6 TDD 20MHz: R.10 TDD
OCNG Patterns ^{Note2}		5MHz: OP.20 FDD 10MHz: OP.10 FDD 20MHz: OP.17 FDD 5MHz: OP.9 TDD 10MHz: OP.1 TDD 20MHz: OP.7 TDD
PBCH_RA	dB	0
PBCH_RB	dB	
PSS_RA	dB	
SSS_RA	dB	
PCFICH_RB	dB	
PHICH_RA	dB	
PHICH_RB	dB	
PDCCH_RA	dB	
PDCCH_RB	dB	
PDSCH_RA	dB	
PDSCH_RB	dB	
OCNG_RA ^{Note3}	dB	
OCNG_RB ^{Note3}	dB	
N _{oc} ^{Note4}	dBm/15 kHz	
\bar{E}_s/N_{oc}	dB	
\bar{E}_s/I_{ot}	dB	
RSRP ^{Note5}	dBm/15 kHz	
SCH_RP ^{Note5}	dBm/15 kHz	
I _o ^{Note5}	dBm/Ch BW	-59.13 +10log (N _{RB,c} /50)
Propagation Condition		AWGN
Antenna Configuration		1x2

Note 1:	Special subframe and uplink-downlink configurations are specified in table 4.2-1 in TS 36.211.
Note 2:	DL RMCs and OCNG patterns are specified in sections A 3.1 and A 3.2 of TS 36.133 respectively.
Note 3:	OCNG shall be used such that all cells are fully allocated and a constant total transmitted power spectral density is achieved for all OFDM symbols.
Note 4:	Interference from other cells and noise sources not specified in the test is assumed to be constant over subcarriers and time and shall be modelled as AWGN of appropriate power for N_{oc} to be fulfilled.
Note 5:	E_s/lot , RSRP, SCH_RP and I_o levels have been derived from other parameters for information purposes. They are not settable parameters themselves.

A.3.7.2.2 E-UTRAN Serving Cell Parameters for Tests with NR Cell(s) in FR2

Table A.3.7.2.2-1 defines cell specific test parameters for E-UTRAN cell which can be used in EN-DC test cases with one or more NR cells in FR2.

Table A.3.7.2.2-1: E-UTRAN cell specific test parameters for tests with one or more NR cells in FR2

Parameter	Unit	E-UTRAN Cell1
E-UTRA RF Channel Number		1
Duplex mode		FDD or TDD
TDD special subframe configuration ^{Note1}		6
TDD uplink-downlink configuration ^{Note1}		1
$BW_{channel}$	MHz	5MHz: $N_{RB,c} = 25$ 10MHz: $N_{RB,c} = 50$ 20MHz: $N_{RB,c} = 100$
PDSCH parameters: DL Reference Measurement Channel ^{Note2}		5MHz: R.7 FDD 10MHz: R.3 FDD 20MHz: R.6 FDD 5MHz: R.4 TDD 10MHz: R.0 TDD 20MHz: R.3 TDD
PCFICH/PDCCH/PHICH parameters: DL Reference Measurement Channel ^{Note2}		5MHz: R.11 FDD 10MHz: R.6 FDD 20MHz: R.10 FDD 5MHz: R.11 TDD 10MHz: R.6 TDD 20MHz: R.10 TDD
OCNG Patterns ^{Note2}		5MHz: OP.20 FDD 10MHz: OP.10 FDD 20MHz: OP.17 FDD 5MHz: OP.9 TDD 10MHz: OP.1 TDD 20MHz: OP.7 TDD
PBCH_RA	dB	0
PBCH_RB	dB	
PSS_RA	dB	
SSS_RA	dB	
PCFICH_RB	dB	
PHICH_RA	dB	
PHICH_RB	dB	
PDCCH_RA	dB	
PDCCH_RB	dB	
PDSCH_RA	dB	
PDSCH_RB	dB	
OCNG_RA ^{Note3}	dB	
OCNG_RB ^{Note3}	dB	

Note 1:	Special subframe and uplink-downlink configurations are specified in table 4.2-1 in TS 36.211.
Note 2:	DL RMCs and OCNG patterns are specified in sections A 3.1 and A 3.2 of TS 36.133 respectively.
Note 3:	OCNG shall be used such that all cells are fully allocated and a constant total transmitted power spectral density is achieved for all OFDM symbols.
Note 4:	The E-UTRA signal is required only to ensure the E-UTRA link to the DUT in the EN-DC operation. The Test System shall provide a stable and noise-free E-UTRA signal without need of precise propagation modelling, path loss and polarization control. Further details of the E-UTRA signal configuration are not defined as part of the cell specific test parameters, since the E-UTRA link is not under performance verification and is not expected to influence the NR FR2 requirement.

A.3.8 PRACH configurations

A.3.8.1 Introduction

This section provides the typical PRACH configurations used for RRM test cases defined in Annex A. To note that for other parameters not listed in this section, either it can be derived from the set up of each test or it is subjected to RAN5 specifications.

A.3.8.2 PRACH configurations in FR1

A.3.8.2.1 FR1 PRACH configuration 1

FR1 PRACH configuration 1 in this section provides the typical PRACH configuration for SSB-based contention based random access in FR1.

Table A.3.8.2.1-1: Parameters for FR1 PRACH configuration 1

Field	Value	Comment
<i>prach-ConfigurationIndex</i>	87	160ms PRACH periodicity, and other detailed configuration defined in table 6.3.3.2-2 and table 6.3.3.2-3 in TS 38.211 [6].
<i>msg1-SubcarrierSpacing</i>	Same as UL carrier SCS	
<i>totalNumberOfRA-Preambles</i>	48	Total number of preambles used for contention based and contention free random access
<i>numberOfRA-PreamblesGroupA</i>	48	No group B.
<i>prach-RootSequenceIndex</i>	0	Logic equence index = 0, resulting in root sequence = 1.
<i>ssb-perRACH-OccasionAndCB-PreamblesPerSSB</i>	oneFourth, n48	OneFourth: 1 SSB associated with 4 RACH occasions n48: 48 contention based preambles per SSB
<i>msg1-FDM</i>	One	One PRACH transmission occasions FDMed in one time instance.
<i>rsrp-ThresholdSSB</i>	RSRP_51	The actual value of the threshold is -105dBm, as defined in TS 38.331 [2].
<i>ra-ContentionResolutionTimer</i>	sf48	48 sub-frames
<i>powerRampingStep</i>	dB2	
<i>preambleReceivedTargetPower</i>	dBm-120	
<i>preambleTransMax</i>	n6	Max number of RA preamble transmission performed before declaring a failure is 6
<i>ra-ResponseWindow</i>	sl10	10 slots
<i>zeroCorrelationZoneConfig</i>	11	N-CS configuration, N _{CS} = 23
Backoff Parameter Index	2	20ms, as defined in table 7.2-1 in TS 38.321 [7].
Note:	For further information see Clause 6.3.2 in TS 38.331 [2].	

A.3.8.2.2 FR1 PRACH configuration 2

FR1 PRACH configuration 2 in this section provides the typical PRACH configuration for SSB based non-contention based random access in FR1.

Table A.3.8.2.2-1: Parameters for FR1 PRACH configuration 2

Field	Value	Comment
<i>prach-ConfigurationIndex</i>	87	160ms PRACH periodicity, and other detailed configuration defined in table 6.3.3.2-2 and table 6.3.3.2-3 in TS 38.211 [6].
<i>msg1-SubcarrierSpacing</i>	Same as UL carrier SCS	
<i>totalNumberOfRA-Preambles</i>	48	Total number of preambles used for contention based and contention free random access
<i>numberOfRA-PreamblesGroupA</i>	48	No group B.
<i>prach-RootSequenceIndex</i>	0	Logic sequence index = 0, resulting in root sequence = 1.
<i>ssb-perRACH-Occasion</i>	oneFourth	OneFourth: 1 SSB associated with 4 RACH occasions
<i>msg1-FDM</i>	One	One PRACH transmission occasions FDMed in one time instance.
<i>powerRampingStep</i>	dB2	
<i>preambleReceivedTargetPower</i>	dBm-120	
<i>preambleTransMax</i>	n6	Max number of RA preamble transmission performed before declaring a failure is 6
<i>ra-ResponseWindow</i>	sl10	10 slots
<i>zeroCorrelationZoneConfig</i>	11	N-CS configuration, $N_{CS} = 23$
Backoff Parameter Index	2	20ms, as defined in table 7.2-1 in TS 38.321 [7].
<i>ssb-ResourceList</i>	ra-PreambleIndex = 50	Associated with SSB index 0
<i>ra-ssb-OccasionMaskIndex</i>	1	PRACH occasion index 1 is allowed
<i>rsrp-ThresholdSSB</i>	RSRP_51	The actual value of the threshold is -105dBm, as defined in TS 38.331 [2].
Note: For further information see Clause 6.3.2 in TS 38.331 [2].		

A.3.8.2.3 FR1 PRACH configuration 3

FR1 PRACH configuration 3 in this section provides the typical PRACH configuration for CSI-RS based non-contention based random access in FR1.

Table A.3.8.2.3-1: Parameters for FR1 PRACH configuration 3

Field	Value	Comment
<i>prach-ConfigurationIndex</i>	87	160ms PRACH periodicity, and other detailed configuration defined in table 6.3.3.2-2 and table 6.3.3.2-3 in TS 38.211 [6].
<i>msg1-SubcarrierSpacing</i>	Same as UL carrier SCS	
<i>totalNumberOfRA-Preambles</i>	48	Total number of preambles used for contention based and contention free random access
<i>numberOfRA-PreamblesGroupA</i>	48	No group B.
<i>prach-RootSequenceIndex</i>	0	Logic sequence index = 0, resulting in root sequence = 1.
<i>ssb-perRACH-Occasion</i>	oneFourth	OneFourth: 1 SSB associated with 4 RACH occasions
<i>msg1-FDM</i>	One	One PRACH transmission occasions FDMed in one time instance.
<i>powerRampingStep</i>	dB2	
<i>preambleReceivedTargetPower</i>	dBm-120	
<i>preambleTransMax</i>	n6	Max number of RA preamble transmission performed before declaring a failure is 6
<i>ra-ResponseWindow</i>	sl10	10 slots
<i>zeroCorrelationZoneConfig</i>	11	N-CS configuration, $N_{cs} = 23$
Backoff Parameter Index	2	20ms, as defined in table 7.2-1 in TS 38.321 [7].
<i>csirs-ResourceList</i>	ra-PreambleIndex = 50	Associated with CSI-RS configured
<i>ra-OccasionList</i>	1	RA occasions allowed corresponding to CSI-RS
<i>rsrp-ThresholdCSI-RS</i>	RSRP_51	The actual value of the threshold is -105dBm, as defined in TS 38.331 [2].
Note:	For further information see Clause 6.3.2 in TS 38.331 [2].	

A.3.8.2.4 FR1 PRACH configuration 4

FR1 PRACH configuration 4 in this section provides the PRACH configuration for CSI-RS based non-contention based random access in FR1 to convey BFR.

Table A.3.8.2.4-1: Parameters for FR1 PRACH configuration 4

Field	Value	Comment
<i>prach-ConfigurationIndex</i>	0	160ms PRACH periodicity, and other detailed configuration defined in table 6.3.3.2-2 and table 6.3.3.2-3 in TS 38.211 [6].
<i>msg1-SubcarrierSpacing</i>	Same as UL carrier SCS	
<i>totalNumberOfRA-Preambles</i>	48	Total number of preambles used for contention based and contention free random access
<i>numberOfRA-PreamblesGroupA</i>	48	No group B.
<i>prach-RootSequenceIndex</i>	0	Logic sequence index = 0, resulting in root sequence = 1.
<i>ssb-perRACH-Occasion</i>	oneFourth	OneFourth: 1 SSB associated with 4 RACH occasions
<i>msg1-FDM</i>	One	One PRACH transmission occasions FDMed in one time instance.
<i>powerRampingStep</i>	dB2	
<i>preambleReceivedTargetPower</i>	dBm-120	
<i>preambleTransMax</i>	n200	Max number of RA preamble transmission performed before declaring a failure is 200
<i>ra-ResponseWindow</i>	sl1	1 slot
<i>zeroCorrelationZoneConfig</i>	11	N-CS configuration, $N_{cs} = 93$
Backoff Parameter Index	2	20ms, as defined in table 7.2-1 in TS 38.321 [7].
<i>BFR-CSIRS-Resource</i>	ra-PreambleIndex = 50	Associated with CSI-RS configured
<i>ra-OccasionList</i>	1	RA occasions allowed corresponding to CSI-RSh
<i>rsrp-ThresholdSSB</i>	RSRP_51	The actual value of the threshold is -105dBm, as defined in TS 38.331 [2].
Note:	For further information see Clause 6.3.2 in TS 38.331 [2].	

A.3.8.3 PRACH configurations in FR2

A.3.8.3.1 FR2 PRACH configuration 1

FR2 PRACH configuration 1 in this section provides the typical PRACH configuration for SSB-based contention based random access in FR2.

Table A.3.8.3.1-1: Parameters for FR2 PRACH configuration 1

Field	Value	Comment
<i>prach-ConfigurationIndex</i>	173	Preamble Format C2, with 160ms PRACH periodicity, and other detailed configuration defined in table 6.3.3.2-4 in TS 38.211 [6].
<i>msg1-SubcarrierSpacing</i>	Same as UL carrier SCS	
<i>totalNumberOfRA-Preambles</i>	48	Total number of preambles used for contention based and contention free random access
<i>numberOfRA-PreamblesGroupA</i>	48	No group B.
<i>prach-RootSequenceIndex</i>	0	Logic equence index = 0, resulting in root sequence = 1.
<i>ssb-perRACH-OccasionAndCB-PreamblesPerSSB</i>	oneFourth, n48	OneFourth: 1 SSB associated with 4 RACH occasions n48: 48 contention based preambles per SSB
<i>msg1-FDM</i>	One	One PRACH transmission occasions FDMed in one time instance.
<i>rsrp-ThresholdSSB</i>	RSRP_51	The actual value of the threshold is -105dBm, as defined in TS 38.331 [2].
<i>ra-ContentionResolutionTimer</i>	sf48	48 sub-frames
<i>powerRampingStep</i>	dB2	
<i>preambleReceivedTargetPower</i>	dBm-120	
<i>preambleTransMax</i>	n6	Max number of RA preamble transmission performed before declaring a failure is 6
<i>ra-ResponseWindow</i>	sl10	10 slots
<i>zeroCorrelationZoneConfig</i>	11	N-CS configuration, N _{CS} = 23
Backoff Parameter Index	2	20ms, as defined in table 7.2-1 in TS 38.321 [7].
Note: For further information see Clause 6.3.2 in TS 38.331 [2].		

A.3.8.3.2 FR2 PRACH configuration 2

FR2 PRACH configuration 2 in this section provides the typical PRACH configuration for SSB based non-contention based random access in FR2.

Table A.3.8.3.2-1: Parameters for FR2 PRACH configuration 2

Field	Value	Comment
<i>prach-ConfigurationIndex</i>	173	Preamble Format C2, with 160ms PRACH periodicity, and other detailed configuration defined in table 6.3.3.2-4 in TS 38.211 [6].
<i>msg1-SubcarrierSpacing</i>	Same as UL carrier SCS	
<i>totalNumberOfRA-Preambles</i>	48	Total number of preambles used for contention based and contention free random access
<i>numberOfRA-PreamblesGroupA</i>	48	No group B.
<i>prach-RootSequenceIndex</i>	0	Logic equence index = 0, resulting in root sequence = 1.
<i>ssb-perRACH-Occasion</i>	oneFourth	OneFourth: 1 SSB associated with 4 RACH occasions
<i>msg1-FDM</i>	One	One PRACH transmission occasions FDMed in one time instance.
<i>powerRampingStep</i>	dB2	
<i>preambleReceivedTargetPower</i>	dBm-120	
<i>preambleTransMax</i>	n6	Max number of RA preamble transmission performed before declaring a failure is 6
<i>ra-ResponseWindow</i>	sl10	10 slots
<i>zeroCorrelationZoneConfig</i>	11	N-CS configuration, N _{cs} = 23
Backoff Parameter Index	2	20ms, as defined in table 7.2-1 in TS 38.321 [7].
<i>ssb-ResourceList</i>	ra-PreambleIndex = 50	Associated with SSB index 0
<i>ra-ssb-OccasionMaskIndex</i>	1	PRACH occasion index 1 is allowed
<i>rsrp-ThresholdSSB</i>	RSRP_51	The actual value of the threshold is -105dBm, as defined in TS 38.331 [2].
Note:	For further information see Clause 6.3.2 in TS 38.331 [2].	

A.3.8.3.3 FR2 PRACH configuration 3

FR2 PRACH configuration 3 in this section provides the typical PRACH configuration for CSI-RS based non-contention based random access in FR2.

Field	Value	Comment
<i>prach-ConfigurationIndex</i>	173	Preamble Format C2, with 160ms PRACH periodicity, and other detailed configuration defined in table 6.3.3.2-4 in TS 38.211 [6].
<i>msg1-SubcarrierSpacing</i>	Same as UL carrier SCS	
<i>totalNumberOfRA-Preambles</i>	48	Total number of preambles used for contention based and contention free random access
<i>numberOfRA-PreamblesGroupA</i>	48	No group B.
<i>prach-RootSequenceIndex</i>	0	Logic equence index = 0, resulting in root sequence = 1.
<i>ssb-perRACH-Occasion</i>	oneFourth	OneFourth: 1 SSB associated with 4 RACH occasions
<i>msg1-FDM</i>	One	One PRACH transmission occasions FDMed in one time instance.
<i>powerRampingStep</i>	dB2	
<i>preambleReceivedTargetPower</i>	dBm-120	
<i>preambleTransMax</i>	n6	Max number of RA preamble transmission performed before declaring a failure is 6
<i>ra-ResponseWindow</i>	sl10	10 slots
<i>zeroCorrelationZoneConfig</i>	11	N-CS configuration, N _{CS} = 23
Backoff Parameter Index	2	20ms, as defined in table 7.2-1 in TS 38.321 [7].
<i>csirs-ResourceList</i>	ra-PreambleIndex = 50	Associated with CSI-RS configured
<i>ra-OccasionList</i>	1	RA occasions allowed corresponding to CSI-RS
<i>rsrp-ThresholdCSI-RS</i>	RSRP_51	The actual value of the threshold is -105dBm, as defined in TS 38.331 [2].
Note: For further information see Clause 6.3.2 in TS 38.331 [2].		

A.3.8.3.4 FR2 PRACH configuration 4

FR2 PRACH configuration 4 in this section provides the PRACH configuration for CSI-RS based non-contention based random access in FR2 to convey BFR.

Field	Value	Comment
<i>prach-ConfigurationIndex</i>	144	Preamble Format C0, with 160ms PRACH periodicity, and other detailed configuration defined in table 6.3.3.2-4 in TS 38.211 [6].
<i>msg1-SubcarrierSpacing</i>	Same as UL carrier SCS	
<i>totalNumberOfRA-Preambles</i>	48	Total number of preambles used for contention based and contention free random access
<i>numberOfRA-PreamblesGroupA</i>	48	No group B.
<i>prach-RootSequenceIndex</i>	0	Logic equence index = 0, resulting in root sequence = 1.
<i>ssb-perRACH-Occasion</i>	oneFourth	OneFourth: 1 SSB associated with 4 RACH occasions
<i>msg1-FDM</i>	One	One PRACH transmission occasions FDMed in one time instance.
<i>powerRampingStep</i>	dB2	
<i>preambleReceivedTargetPower</i>	dBm-120	
<i>preambleTransMax</i>	n200	Max number of RA preamble transmission performed before declaring a failure is 200.
<i>ra-ResponseWindow</i>	sl40	40 slots
<i>zeroCorrelationZoneConfig</i>	11	N-CS configuration, N _{cs} = 23
Backoff Parameter Index	2	20ms, as defined in table 7.2-1 in TS 38.321 [7].
<i>BFR-CSIRS-Resource</i>	ra-PreambleIndex = 50	Associated with CSI-RS configured
<i>ra-OccasionList</i>	1	RA occasions allowed corresponding to CSI-RS
<i>rsrp-ThresholdSSB</i>	RSRP_51	The actual value of the threshold is -105dBm, as defined in TS 38.331 [2].
Note: For further information see Clause 6.3.2 in TS 38.331 [2].		

A.3.9 BWP configurations

A.3.9.1 Introduction

This section provides the typical BWP configurations used for RRM test cases defined in Annex A. For downlink BWP, both initial BWP and dedicated BWP configurations are specified in section A.3.9.2 and for uplink BWP, both initial BWP and dedicated BWP configurations are specified in section A.3.9.3. To note that for other parameters not listed in this section, either it can be derived from the set up of each test or it is subjected to RAN5 specifications.

A.3.9.2 Downlink BWP configurations

A.3.9.2.1 Initial BWP

Table A.3.9.2.1-1: Downlink BWP patterns for initial BWP configuration

BWP Parameters	Unit	Values		
Reference BWP		DLBWP.0.1	DLBWP.0.2	
Starting PRB index		0	RB _a ^{Note 1}	
Bandwidth	RB	Same as RF channel defined in each test	same as RMSI CORSET(CORSET #0) defined in each test	
Note 1: RB _a is the lowest PRB index to guarantee the BWP including SSB PRB index (RB _J , RB _{J+1} ,..., RB _{J+19}) which is defined in Section A.3.10.				

A.3.9.2.2 Dedicated BWP

Table A.3.9.2.2-1: Downlink BWP patterns for dedicated BWP configuration

BWP Parameters	Unit	Values		
Reference BWP		DLBWP.1.1	DLBWP.1.2	DLBWP.1.3
Starting PRB index		0	RB _b ^{Note 1}	RB _a ^{Note 2}
Bandwidth	RB	Same as RF channel defined in each test	25 for SCS = 15KHz, 51 for SCS = 30KHz, 32 for SCS = 120KHz	25 for SCS = 15KHz, 51 for SCS = 30KHz, 32 for SCS = 120KHz
Note 1: RB _b is the lowest PRB index to guarantee the BWP not fully overlapped with SSB PRB index (RB _J , RB _{J+1} ,..., RB _{J+19}) which is defined in Section A.3.10.				
Note 2: RB _a is the lowest PRB index to guarantee the BWP including SSB PRB index (RB _J , RB _{J+1} ,..., RB _{J+19}) which is defined in Section A.3.10.				

A.3.9.3 Uplink BWP configurations

A.3.9.3.1 Initial BWP

Table A.3.9.3.1-1: Uplink BWP patterns for initial BWP configuration

BWP Parameters	Unit	Values		
Reference BWP		ULBWP.0.1	ULBWP.0.2	
Starting PRB index		0	RB _a ^{Note 1}	
Bandwidth	RB	Same as RF channel defined in each test	same as RMSI CORSET(CORSET #0) defined in each test	
Note 1: RB _a is the lowest PRB index to guarantee the BWP including SSB PRB index (RB _J , RB _{J+1} ,..., RB _{J+19}) which is defined in Section A.3.10.				

A.3.9.3.2 Dedicated BWP

Table A.3.9.3.2-1: Uplink BWP patterns for dedicated BWP configuration

BWP Parameters	Unit	Values		
		ULBWP.1.1	ULBWP.1.2	ULBWP.1.3
Reference BWP		ULBWP.1.1	ULBWP.1.2	ULBWP.1.3
Starting PRB index		0	RB_b ^{Note 1}	RB_a ^{Note 2}
Bandwidth	RB	Same as RF channel defined in each test	25 for SCS = 15KHz, 51 for SCS = 30KHz, 32 for SCS = 120KHz	25 for SCS = 15KHz, 51 for SCS = 30KHz, 32 for SCS = 120KHz
Note 1: RB_b is the lowest PRB index to guarantee the BWP not fully overlapped with SSB PRB index ($RB_J, RB_{J+1}, \dots, RB_{J+19}$) which is defined in Section A.3.10.				
Note 2: RB_a is the lowest PRB index to guarantee the BWP including SSB PRB index ($RB_J, RB_{J+1}, \dots, RB_{J+19}$) which is defined in Section A.3.10.				

A.3.10 SSB Configurations

A.3.10.1 SSB Configurations for FR1

A.3.10.1.1 SSB pattern 1 in FR1: SSB for SSB SCS=15 KHz in 10 MHz

Table A.3.10.1.1-1: SSB.1 FR1: SSB Pattern 1 for SSB SCS=15 KHz in 10 MHz channel

SSB Parameters	Values
Channel bandwidth	10 MHz
SSB SCS	15 KHz
SSB periodicity	20 ms
Number of SSBs per SS-burst	1
SS/PBCH block index	0
Indices of symbols containing SSB	2-5
Indices of slots containing SSB	0
RB numbers containing SSB within channel BW	$(RB_J, RB_{J+1}, \dots, RB_{J+19})$ ^{Note 1}
Note 1: RBs containing SSB can be configured in any frequency location within the cell bandwidth according to the allowed synchronization raster defined in TS 38.104 [13].	

A.3.10.1.2 SSB pattern 2 in FR1: SSB allocation for SSB SCS=30 KHz in 40 MHz

Table A.3.10.1.2-1: SSB.2 FR1: SSB Pattern 2 for SSB SCS=30 KHz in 40 MHz channel

SSB Parameters	Values
Channel bandwidth	40 MHz
SSB SCS	30 KHz
SSB periodicity	20 ms
Number of SSBs per SS-burst	1
SS/PBCH block index	0
Indices of symbols containing SSB	4-7 or 2-5 ^{Note 2}
Indices of slots containing SSB	0
RB numbers containing SSB within channel BW	(RB _J , RB _{J+1} ,..., RB _{J+19}) ^{Note 1}
Note 1:	RBs containing SSB can be configured in any frequency location within the cell bandwidth according to the allowed synchronization raster defined in TS 38.104 [13].
Note 2:	Symbols 4-7 is chosen, if the SSB pattern Case B should be used for the current band as indicated by Table 5.4.3.3-1 of TS 38.104 [13]; Otherwise, symbol 2-5 is chosen.

A.3.10.1.3 SSB pattern 1 in FR1: SSB for SSB SCS=15 KHz in 10 MHz

Table A.3.10.1.3-1: SSB.3 FR1: SSB Pattern 3 for SSB SCS=15 KHz in 10 MHz channel

SSB Parameters	Values	
Channel bandwidth	10 MHz	
SSB SCS	15 KHz	
SSB periodicity	20 ms	
Number of SSBs per SS-burst	2	
SS/PBCH block index	0	1
Symbol numbers of symbols containing SSB	2-5	8-11
RB numbers containing SSB within channel BW	0-19	

A.3.10.1.4 SSB pattern 4 in FR1: SSB allocation for SSB SCS=30 KHz in 40 MHz

Table A.3.10.1.4-1: SSB.4 FR1: SSB Pattern 4 for SSB SCS=30 KHz in 40 MHz channel

SSB Parameters	Values	
Channel bandwidth	40 MHz	
SSB SCS	30 KHz	
SSB periodicity	20 ms	
Number of SSBs per SS-burst	2	
SS/PBCH block index	0	1
Symbol numbers of symbols containing SSB	2-5	8-11
RB numbers containing SSB within channel BW	0-19	

A.3.10.2 SSB Configurations for FR2

A.3.10.2.1 SSB pattern 1 in FR2: SSB allocation for SSB SCS=120 KHz in 100 MHz

Table A.3.10.2.1-1: SSB.1 FR2: SSB Pattern 1 for SSB SCS = 120 KHz in 100 MHz channel with 2 SSBs per SS-burst

SSB Parameters	Values	
Channel bandwidth	100 MHz	
SSB SCS	120 KHz	
SSB periodicity	20 ms	
Number of SSBs per SS-burst	2	
SS/PBCH block index	0	1
Indices of symbols containing SSBs	4-7	8-11
Indices of slots containing SSB	0	0
RB numbers containing SSBs within channel BW	$(RB_J, RB_{J+1}, \dots, RB_{J+19})^{\text{Note 1}}$	
Note 1:	RBs containing SSB can be configured in any frequency location within the cell bandwidth according to the allowed synchronization raster defined in TS 38.104 [13].	

A.3.10.2.2 SSB pattern 2 in FR2: SSB allocation for SSB SCS=240 KHz in 100 MHz

Table A.3.10.2.2-1: SSB.2 FR2: SSB Pattern 2 for SSB SCS = 240 KHz in 100 MHz channel with 2 SSBs per SS-burst

SSB Parameters	Values	
Channel bandwidth	100 MHz	
SSB SCS	240 KHz	
SSB periodicity	20 ms	
Number of SSBs per SS-burst	2	
SS/PBCH block index	0	1
Indices of symbols containing SSBs	8-11	12-13, 0-1
Indices of slots containing SSB	0	0, 1
RB numbers containing SSBs within channel BW	$(RB_J, RB_{J+1}, \dots, RB_{J+19})^{\text{Note 1}}$	
Note 1:	RBs containing SSB can be configured in any frequency location within the cell bandwidth according to the allowed synchronization raster defined in TS 38.104 [13].	

A.3.10.2.3 SSB pattern 3 in FR2: SSB allocation for SSB SCS=120 KHz in 100 MHz

Table A.3.10.2.3-1: SSB.3 FR2: SSB Pattern 3 for SSB SCS = 120 KHz in 100 MHz channel with 1 SSB per SS-burst

SSB Parameters	Values
Channel bandwidth	100 MHz
SSB SCS	120 KHz
SSB periodicity	20 ms
Number of SSBs per SS-burst	1
SS/PBCH block index	0
Indices of symbols containing SSBs	4-7
Indices of slots containing SSB	0
RB numbers containing SSBs within channel BW	$(RB_J, RB_{J+1}, \dots, RB_{J+19})^{\text{Note 1}}$
Note 1:	RBs containing SSB can be configured in any frequency location within the cell bandwidth according to the allowed synchronization raster defined in TS 38.104 [13].

A.3.10.2.4 SSB pattern 4 in FR2: SSB allocation for SSB SCS=240 KHz in 100 MHz

Table A.3.10.2.4-1: SSB.4 FR2: SSB Pattern 4 for SSB SCS = 240 KHz in 100 MHz channel with 1 SSB per SS-burst

SSB Parameters	Values
Channel bandwidth	100 MHz
SSB SCS	240 KHz
SSB periodicity	20 ms
Number of SSBs per SS-burst	1
SS/PBCH block index	0
Indices of symbols containing SSBs	8-11
Indices of slots containing SSB	0
RB numbers containing SSBs within channel BW	(RB _J , RB _{J+1} , ..., RB _{J+19}) ^{Note 1}
Note 1:	RBs containing SSB can be configured in any frequency location within the cell bandwidth according to the allowed synchronization raster defined in TS 38.104 [13].

A.3.11 SMTC Configurations

A.3.11.1 SMTC pattern 1: SMTC period = 20 ms with SMTC duration = 1 ms

Table A.3.11.1-1: SMTC.1: SMTC Pattern 1 for SMTC period = 20 ms and duration = 1 ms

SMTC Parameters	Values
SMTC periodicity	20 ms
SMTC offset	0 ms
SMTC duration	1 ms

A.3.11.2 SMTC pattern 2: SMTC period = 20 ms with SMTC duration = 5 ms

Table A.3.11.2-1: SMTC.2: SMTC Pattern 2 for SMTC period = 20 ms and duration = 5 ms

SMTC Parameters	Values
SMTC periodicity	20 ms
SMTC offset	0 ms
SMTC duration	5 ms

A.3.11.3 SMTC pattern 3: SMTC period = 160 ms with SMTC duration = 1 ms

Table A.3.11.3-1: SMTC.3: SMTC Pattern 3 for SMTC period = 20 ms and duration = 5 ms

SMTC Parameters	Values
SMTC periodicity	160 ms
SMTC offset	0 ms
SMTC duration	1 ms

A.3.12 Test Cases with Different CC Configurations

A.3.12.1 EN-DC Test Cases with Different EN-DC Configurations

A.3.12.1.1 Introduction

In Annex A EN-DC test cases may be defined for two component carriers (CCs) as well as for more than two CCs to verify the same RRM requirement.

A.3.12.1.2 Principle of testing

If multiple EN-DC test cases are defined for two CCs as well as for more than two CCs to verify the same type of RRM requirement, which depends on the number of CCs, then from the UE performance point of view the test coverage can be considered fulfilled by executing only the EN-DC test cases with the maximum number of CCs in EN-DC supported by the UE. Otherwise if the same type of RRM requirement is independent of the number of CCs then from the UE performance point of view the test coverage can be considered fulfilled by executing only the EN-DC test cases with two CCs in EN-DC supported by the UE.

Editor's: The maximum number of CCs that can be used in FR2 tests in EN-DC would depend on the test equipment capability.

A.3.12.2 Carrier Aggregation Test Cases with Different CA Configurations

A.3.12.2.1 Introduction

In Annex A carrier aggregation test cases may be defined for two CCs as well as for more than two CCs to verify the same RRM requirement.

A.3.12.2.2 Principle of testing

If multiple carrier aggregation test cases are defined for two CCs as well as for more than two CCs to verify the same RRM requirement, which depends on the number of CCs, then from the UE performance point of view the test coverage can be considered fulfilled by executing only the CA test cases with the maximum number of CCs in CA supported by the UE. Otherwise if the same type of RRM requirement is independent of the number of CCs then from the UE performance point of view the test coverage can be considered fulfilled by executing only the CA test cases with at least two CCs in CA supported by the UE.

Editor's: The maximum number of CCs that can be used in FR2 tests in CA would depend on the test equipment capability.

A.3.13 Test Cases in Standalone and Non-Standalone Operations

A.3.13.1 Introduction

This clause defines a principle which is applicable to test cases verifying RRM requirements in standalone (SA) or EN-DC operations.

In Annex A test cases may be defined in SA and EN-DC operations to verify the same RRM requirement.

A.3.13.2 Principle of Testing

If test cases are defined in both SA and EN-DC operations to verify the same RRM requirement then the UE capable of both SA and EN-DC operations needs to verify that RRM requirement by performing test case(s) in either SA operation or in EN-DC operation.

If test cases are defined in both SA and EN-DC operations to verify at least one common RRM requirement then the UE capable of both SA and EN-DC operations needs to verify RRM requirements by performing test case(s) in either SA operation or in EN-DC operation provided that the performed test case(s):

- verifies the largest number of RRM requirements and
- verifies at least all RRM requirements covered in the test case(s), which is not performed.

A.3.14 CSI-RS configurations

A.3.14.1 FDD

Table A.3.14.1-1: CSI-RS Reference Measurement Channels for SCS=15kHz

	CSI-RS.1.1 FDD	CSI-RS.1.2 FDD	CSI-RS.1.3 FDD	CSI-RS.1.4 FDD
Resource Type	periodic	periodic	aperiodic	aperiodic
Resource Set Config				
nzp-CSI-ResourceSetId	0	0	0	0
repetition	n.a.	off	off	on
aperiodicTriggeringOffset	n.a.	n.a.	6	6
trs-Info	n.a.	n.a.	n.a.	n.a.
Resource Config				
nzp-CSI-RS-ResourceId	0 for resource #0	10 for resource #0	20 for resource #0	30 for resource #0
				31 for resource #1
				32 for resource #2
				33 for resource #3
		11 for resource #1	21 for resource #1	34 for resource #4
				35 for resource #5
				36 for resource #6
				37 for resource #7
powerControlOffset	0	0	0	0
powerControlOffsetSS	db0	db0	db0	db0
scramblingID	0	0	0	0
Period (slots)	TBD	slot10	n.a.	n.a.
Offset	TBD	TBD	n.a.	n.a.
qcl-InfoPeriodicCSI-RS	SSB#0	SSB#0 SSB#1	n.a.	n.a.
frequencyDomainAllocation	000001	000001	000001	000001
nrofPorts	2	1	1	1
firstOFDMSymbolInTimeDomain	5 for resource #0	TBD	TBD	0 for resource #0
				1 for resource #1
				2 for resource #2
		TBD	TBD	3 for resource #3
				4 for resource #4

				5 for resource #5
				6 for resource #6
				7 for resource #7
cdm-Type	FD-CDM2	noCDM	noCDM	noCDM
density	1	3	3	3
startingRB	0	0	0	0
nrofRBs	276	276	276	276

A.3.14.2 TDD

Table A.3.14.2-1: CSI-RS Reference Measurement Channels for SCS=15kHz

	CSI-RS.1.1 TDD	CSI-RS.1.2 TDD	CSI-RS.1.3 TDD	CSI-RS.1.4 TDD
Resource Type	periodic	periodic	aperiodic	aperiodic
Resource Set Config				
nzp-CSI-ResourceSetId	0	0	0	0
repetition	n.a.	off	off	on
aperiodicTriggeringOffset	n.a.	n.a.	6	6
trs-Info	n.a.	n.a.	n.a.	n.a.
Resource Config				
nzp-CSI-RS-ResourceId	0 for resource #0	10 for resource #0	20 for resource #0	30 for resource #0
				31 for resource #1
				32 for resource #2
				33 for resource #3
		11 for resource #1	21 for resource #1	34 for resource #4
				35 for resource #5
				36 for resource #6
				37 for resource #7
powerControlOffset	0	0	0	0
powerControlOffsetSS	db0	db0	db0	db0
scramblingID	0	0	0	0
Period (slots)	TBD	slot10	n.a.	n.a.
Offset	TBD	TBD	n.a.	n.a.
qcl-InfoPeriodicCSI-RS	SSB#0	SSB#0 SSB#1	n.a.	n.a.
frequencyDomainAllocation	000001	000001	000001	000001
nrofPorts	2	1	1	1
firstOFDMSymbolInTimeDomain	5 for resource #0	TBD	TBD	0 for resource #0
				1 for resource #1
				2 for resource #2
				3 for resource #3
		TBD	TBD	4 for resource #4
				5 for resource #5
				6 for resource #6
				7 for resource #7
cdm-Type	FD-CDM2	noCDM	noCDM	noCDM
density	1	3	3	3
startingRB	0	0	0	0
nrofRBs	276	276	276	276

Table A.3.14.2-2: CSI-RS Reference Measurement Channels for SCS=30kHz

	CSI-RS.2.1 TDD	CSI-RS.2.2 TDD	CSI-RS.2.3 TDD	CSI-RS.2.4 TDD
Resource Type	periodic	periodic	aperiodic	aperiodic
Resource Set Config				
nzp-CSI-ResourceSetId	0	0	0	0
repetition	n.a.	off	off	on
aperiodicTriggeringOffset	n.a.	n.a.	6	6
trs-Info	n.a.	n.a.	n.a.	n.a.
Resource Config				
nzp-CSI-RS-ResourceId	0 for resource #0	10 for resource #0	20 for resource #0	30 for resource #0
				31 for resource #1
				32 for resource #2
				33 for resource #3
		11 for resource #1	21 for resource #1	34 for resource #4
				35 for resource #5
				36 for resource #6
				37 for resource #7
powerControlOffset	0	0	0	0
powerControlOffsetSS	db0	db0	db0	db0
scramblingID	0	0	0	0
Period (slots)	TBD	slot20	n.a.	n.a.
Offset	TBD	TBD	n.a.	n.a.
qcl-InfoPeriodicCSI-RS	SSB#0	SSB#0 SSB#1	n.a.	n.a.
frequencyDomainAllocation	000001	000001	000001	000001
nrofPorts	2	1	1	1
firstOFDMSymbolInTimeDomain	5 for resource #0	TBD	TBD	0 for resource #0
				1 for resource #1
				2 for resource #2
				3 for resource #3
		TBD	TBD	4 for resource #4
				5 for resource #5
				6 for resource #6
				7 for resource #7
cdm-Type	FD-CDM2	noCDM	noCDM	noCDM
density	1	3	3	3
startingRB	0	0	0	0
nrofRBs	276	276	276	276

Table A.3.14.2-3: CSI-RS Reference Measurement Channels for SCS=120kHz

	CSI-RS.3.1 TDD	CSI-RS.3.2 TDD	CSI-RS.3.3 TDD	CSI-RS.3.4 TDD
Resource Type	periodic	periodic	aperiodic	aperiodic
Resource Set Config				
nzp-CSI-ResourceSetId	0	0	0	0
repetition	n.a.	off	off	on
aperiodicTriggeringOffset	n.a.	n.a.	6	6
trs-Info	n.a.	n.a.	n.a.	n.a.
Resource Config				
nzp-CSI-RS-ResourceId	0 for resource #0	10 for resource #0	20 for resource #0	30 for resource #0
				31 for resource #1
				32 for resource #2
				33 for resource #3
		11 for resource #1	21 for resource #1	34 for resource #4
				35 for resource #5
				36 for resource #6
				37 for resource #7
powerControlOffset	0	0	0	0
powerControlOffsetSS	db0	db0	db0	db0
scramblingID	0	0	0	0
Period (slots)	TBD	slot80	n.a.	n.a.
Offset	TBD	TBD	n.a.	n.a.
qcl-InfoPeriodicCSI-RS	SSB#0	SSB#0 SSB#1	n.a.	n.a.
frequencyDomainAllocation	000001	000001	000001	000001
nrofPorts	2	1	1	1
firstOFDMSymbolInTimeDomain	5 for resource #0	TBD	TBD	0 for resource #0
				1 for resource #1
				2 for resource #2
				3 for resource #3
		TBD	TBD	4 for resource #4
				5 for resource #5
				6 for resource #6
				7 for resource #7
cdm-Type	FD-CDM2	noCDM	noCDM	noCDM
density	1	3	3	3
startingRB	0	0	0	0
nrofRBs	276	276	276	276

A.3.15 Angle of Arrival (AoA) for FR2 RRM test cases

This clause specifies the AoA setups for FR2 RRM test cases in section A.5 and A.7. The applicable AoA setup is defined in each test case in section A.5 and A.7.

A.3.15.1 Setup 1: Single AoA in Rx beam peak direction

There is only one probe in the test. The DL signals, and noise if applicable, transmitted from the probe are aligned to the UE Rx beam peak direction (as defined in TS 38.101-2 [19]).

A.3.16 TCI State Configuration

A.3.16.1 Introduction

This section provides the configuration for TCI states with both SSB and CSI-RS. This section also provides the configuration for NZP-CSI-RS resources to which the physical channels shall be QCL'd.

A.3.16.2 TCI states

Table A.3.16.2-1: TCI States

Parameter	TCI.State.0	TCI.State.1	TCI.State.2	TCI.State.3
tc-StateId	Id0	Id1	Id2	Id3
qcl-Type1	typeC	typeC	typeA	typeA
qcl-Type2 ^{Note1}	typeD	typeD	typeD	typed
referenceSignal	SSB0	SSB1	CSI-RS0	CSI-RS1
Note 1: qcl-Type2 of typeD only where applicable. For RRM test cases, this will be only in FR2				

Table A.3.16.2-2: NZP-CSI-RS Resources

Parameter	CSI-RS.Config.0	CSI-RS.Config.1
nzp-CSI-RS-ResourceId	CSI-RSID0	CSI-RSID0
resourceMapping	TBD	TBD
powerControlOffset	0	0
scramblingID	0	0
periodicityAndOffset	Slots640	Slots640
qcl-InfoPeriodicCSI-RS	Id0	Id1

A.3.17 Configurations of CSI-RS for tracking

A.3.17.1 Configuration of CSI-RS for tracking for FR1

A.3.17.1.1 FDD

Table A.3.17.1.1-1: CSI-RS for tracking for SCS=15kHz

Parameter	Unit	Value
Reference channel		TRS.1.1 FDD
Bandwidth		BW of Active BWP ^{Note}
SCS	kHz	15
First subcarrier index in the PRB used for CSI-RS		$k_0=0$ for CSI-RS resource 1,2,3,4
First OFDM symbol in the PRB used for CSI-RS		$l_0 = 6$ for CSI-RS resource 1 and 3 $l_0 = 10$ for CSI-RS resource 2 and 4
Number of CSI-RS ports (X)		1 for CSI-RS resource 1,2,3,4
CDM Type		'No CDM' for CSI-RS resource 1,2,3,4
Density (ρ)		3 for CSI-RS resource 1,2,3,4
CSI-RS periodicity	ms	20 for CSI-RS resource 1,2,3,4
CSI-RS offset	slots	10 for CSI-RS resource 1 and 2 11 for CSI-RS resource 3 and 4
EPRE ratio to SSS	dB	-3
Note: BW of TRS is configured same as the BW size of UE active BWP in the RRM test cases		

Table A.3.17.1.1-2: CSI-RS for tracking for SCS=30kHz

Parameter	Unit	Value
Reference channel		TRS.1.2 FDD
Bandwidth		BW of Active BWP ^{Note}
SCS	kHz	30
First subcarrier index in the PRB used for CSI-RS		$k_0=0$ for CSI-RS resource 1,2,3,4
First OFDM symbol in the PRB used for CSI-RS		$l_0 = 6$ for CSI-RS resource 1 and 3 $l_0 = 10$ for CSI-RS resource 2 and 4
Number of CSI-RS ports (X)		1 for CSI-RS resource 1,2,3,4
CDM Type		'No CDM' for CSI-RS resource 1,2,3,4
Density (ρ)		3 for CSI-RS resource 1,2,3,4
CSI-RS periodicity	ms	40 for CSI-RS resource 1,2,3,4
CSI-RS offset	slots	20 for CSI-RS resource 1 and 2 21 for CSI-RS resource 3 and 4
EPRE ratio to SSS	dB	-3
Note: BW of TRS is configured same as the BW size of UE active BWP in the RRM test cases		

A.3.17.1.2 TDD

Table A.3.17.1.2-1: CSI-RS for tracking for SCS=15kHz

Parameter	Unit	Value
Reference channel		TRS.1.1 TDD
Bandwidth		BW of Active BWP ^{Note}
SCS	kHz	15
First subcarrier index in the PRB used for CSI-RS		$k_0=0$ for CSI-RS resource 1,2,3,4
First OFDM symbol in the PRB used for CSI-RS		$l_0 = 6$ for CSI-RS resource 1 and 3 $l_0 = 10$ for CSI-RS resource 2 and 4
Number of CSI-RS ports (X)		1 for CSI-RS resource 1,2,3,4
CDM Type		'No CDM' for CSI-RS resource 1,2,3,4
Density (ρ)		3 for CSI-RS resource 1,2,3,4
CSI-RS periodicity	ms	20 for CSI-RS resource 1,2,3,4
CSI-RS offset	slots	10 for CSI-RS resource 1 and 2 11 for CSI-RS resource 3 and 4
EPRE ratio to SSS	dB	-3
Note: BW of TRS is configured same as the BW size of UE active BWP in the RRM test cases		

Table A.3.17.1.2-2: CSI-RS for tracking for SCS=30kHz

Parameter	Unit	Value
Reference channel		TRS.1.2 TDD
Bandwidth		BW of Active BWP ^{Note}
SCS	kHz	30
First subcarrier index in the PRB used for CSI-RS		$k_0=0$ for CSI-RS resource 1,2,3,4
First OFDM symbol in the PRB used for CSI-RS		$l_0 = 6$ for CSI-RS resource 1 and 3 $l_0 = 10$ for CSI-RS resource 2 and 4
Number of CSI-RS ports (X)		1 for CSI-RS resource 1,2,3,4
CDM Type		'No CDM' for CSI-RS resource 1,2,3,4
Density (ρ)		3 for CSI-RS resource 1,2,3,4
CSI-RS periodicity	ms	40 for CSI-RS resource 1,2,3,4
CSI-RS offset	slots	20 for CSI-RS resource 1 and 2 21 for CSI-RS resource 3 and 4
EPRE ratio to SSS	dB	-3
Note: BW of TRS is configured same as the BW size of UE active BWP in the RRM test cases		

A.3.17.2 Configuration of CSI-RS for tracking for FR2

A.3.17.2.1 TDD

Table A.3.17.2.1-1: CSI-RS for tracking for SCS=120kHz

Parameter	Unit	Value
Reference channel		TRS.2.1 TDD
Bandwidth		BW of Active BWP ^{Note}
SCS	kHz	120
First subcarrier index in the PRB used for CSI-RS		$k_0=0$ for CSI-RS resource 1,2,3,4
First OFDM symbol in the PRB used for CSI-RS		$l_0 = 1$ for CSI-RS resource 1 and 3 $l_0 = 5$ for CSI-RS resource 2 and 4
Number of CSI-RS ports (X)		1 for CSI-RS resource 1,2,3,4
CDM Type		'No CDM' for CSI-RS resource 1,2,3,4
Density (ρ)		3 for CSI-RS resource 1,2,3,4
CSI-RS periodicity	ms	80 for CSI-RS resource 1,2,3,4
CSI-RS offset	slots	40 for CSI-RS resource 1 and 2 41 for CSI-RS resource 3 and 4
EPRE ratio to SSS	dB	-3
Note:	BW of TRS is configured same as the BW size of UE active BWP in the RRM test cases	

A.4 EN-DC tests with all NR cells in FR1

A.4.1 Void

A.4.2 Void

A.4.3 RRC_CONNECTED state mobility

A.4.3.1 Void

A.4.3.2 RRC Connection Mobility Control

A.4.3.2.1 Void

A.4.3.2.2 Random Access

A.4.3.2.2.1 Contention based random access test in FR1 for PSCell in EN-DC

A.4.3.2.2.1.1 Test Purpose and Environment

The purpose of this test is to verify that the behavior of the random access procedure is according to the requirements and that the PRACH power settings and timing are within specified limits. This test will verify the requirements in Clause 6.2.2.2 and Clause 7.1.2 in an AWGN model.

For this test two cells are used, with the configuration of Cell 1 (E-UTRA PCell) specified in section A.3.7.2.1 and Cell 2 configured as PSCell in FR1. Supported test parameters are shown in Table A.4.3.2.2.1.1-1. UE capable of EN-DC with PSCell in FR1 needs to be tested by using the parameters in Table A.4.3.2.2.1.1-2.

Table A.4.3.2.1.1-1: Supported test configurations for contention based random access test in FR1 for PSCell in EN-DC

Config	Description
1	LTE FDD, NR 15 kHz SSB SCS, 10MHz bandwidth, FDD duplex mode
2	LTE TDD, NR 15 kHz SSB SCS, 10MHz bandwidth, FDD duplex mode
3	LTE FDD, NR 30 kHz SSB SCS, 40MHz bandwidth, TDD duplex mode
4	LTE TDD, NR 30 kHz SSB SCS, 40MHz bandwidth, TDD duplex mode

Note: The UE is only required to be tested in one of the supported test configurations depending on UE capability

Table A.4.3.2.1.1-2: General test parameters for contention based random access test in FR1 for PSCell in EN-DC

Parameter		Unit	Test-1	Comments
SSB Configuration	Config 1,2		SSB pattern 1 in FR1	As defined in A.3.10, except for number of SSBs per SS-burst and SS/PBCH block index as below
	Config 3,4		SSB pattern 2 in FR1	
Number of SSBs per SS-burst			2	Different from the definition in A.3.10
SS/PBCH block index			0,1	Different from the definition in A.3.10
Duplex Mode for Cell 2	Config 1,2		FDD	
	Config 3,4		TDD	
TDD Configuration	Config 3,4		TDDConf.1.2	
OCNG Pattern ^{Note 1}			OCNG pattern 1	As defined in A.3.2.1.
PDSCH parameters ^{Note 4}	Config 1,2		SR.1.1 FDD	As defined in A.3.1.1.
	Config 3,4		SR.2.1 TDD	
NR RF Channel Number			1	
EPRE ratio of PSS to SSS		dB	0	
EPRE ratio of PBCH_DMRS to SSS		dB		
EPRE ratio of PBCH to PBCH_DMRS		dB		
EPRE ratio of PDCCH_DMRS to SSS		dB		
EPRE ratio of PDCCH to PDCCH_DMRS		dB		
EPRE ratio of PDSCH_DMRS to SSS		dB		
EPRE ratio of PDSCH to PDSCH_DMRS		dB		
SSB with index 0	\hat{E}_s / I_{ot}	dB	3	Power of SSB with index 0 is set to be above configured <i>rsrp-ThresholdSSB</i>
	N_{oc}	Config 1,2	-98	
		Config 3,4	-101	
	\hat{E}_s / N_{oc}	dB	3	
SS-RSRP ^{Note 3}		dBm/ SCS	-95	
SSB with index 1	\hat{E}_s / I_{ot}	dB	-17	Power of SSB with index 1 is set to be below configured <i>rsrp-ThresholdSSB</i>
	N_{oc}	Config 1,2	-98	
		Config 3,4	-101	
	\hat{E}_s / N_{oc}	dB	-17	
SS-RSRP ^{Note 3}		dBm/ SCS	-115	
I_0 ^{Note 2}	Config 1,2	dBm	-65.3/9.36MHz	For symbols without SSB index 1
	Config 3,4		-62.2/38.16MHz	
ss-PBCH-BlockPower		dBm/ SCS	-5	As defined in clause 6.3.2 in TS 38.331 [2].

Configured UE transmitted power ($P_{\text{CMAX}, f, c}$)	dBm	23	As defined in clause 6.2.4 in TS 38.101-1.
PRACH Configuration		FR1 PRACH configuration 1	As defined in A.3.8.2.
Propagation Condition	-	AWGN	
Note 1:	OCNG shall be used such that the cell is fully allocated and a constant total transmitted power spectral density is achieved for all OFDM symbols. The OCNG pattern is chosen during the test according to the presence of a DL reference measurement channel.		
Note 2:	SS-RSRP, Es/Iot and Io levels have been derived from other parameters for information purpose. They are not settable parameters.		
Note 3:	Void		
Note 4:	The DL PDSCH reference measurement channel is used in the test only when a downlink transmission dedicated to the UE under test is required.		

A.4.3.2.2.1.2 Test Requirements

Contention based random access is triggered by *not* explicitly assigning a random access preamble via dedicated signalling in the downlink.

A.4.3.2.2.1.2.1 Random Access Preamble Transmission

To test the UE behavior specified in Subclause 6.2.2.2.1.1 the System Simulator shall receive the Random Access Preamble which belongs to one of the Random Access Preambles associated with the SSB with index 0, which has SS-RSRP above the configured *rsrp-ThresholdSSB*.

In addition, the power applied to all preambles shall be in accordance with what is specified in Subclause 6.2.2.2. The power of the first preamble shall be -30 dBm with an accuracy specified in clause 6.3.4.2 of TS 38.101-1 [18]. The relative power applied to additional preambles shall have an accuracy specified in clause 6.3.4.3 of TS 38.101-1 [18].

The transmit timing of all PRACH transmissions shall be within the accuracy specified in Subclause 7.1.2.

A.4.3.2.2.1.2.2 Random Access Response Reception

To test the UE behavior specified in Subclause 6.2.2.2.1.2 the System Simulator shall transmit a Random Access Response containing a Random Access Preamble identifier corresponding to the transmitted Random Access Preamble after 5 preambles have been received by the System Simulator. In response to the first 4 preambles, the System Simulator shall transmit a Random Access Response *not* corresponding to the transmitted Random Access Preamble.

The UE may stop monitoring for Random Access Response(s) and shall transmit the msg3 if the Random Access Response contains a Random Access Preamble identifier corresponding to the transmitted Random Access Preamble.

The UE shall again perform the Random Access Resource selection procedure specified in clause 5.1.2 in TS38.321 [7], and transmit with the calculated PRACH transmission power when the backoff time expires if all received Random Access Responses contain Random Access Preamble identifiers that do not match the transmitted Random Access Preamble.

In addition, the power applied to all preambles shall be in accordance with what is specified in Subclause 6.2.2.2. The power of the first preamble shall be -30 dBm with an accuracy specified in clause 6.3.4.2 of TS 38.101-1 [18]. The relative power applied to additional preambles shall have an accuracy specified in clause 6.3.4.3 of TS 38.101-1 [18].

The transmit timing of all PRACH transmissions shall be within the accuracy specified in Subclause 7.1.2.

A.4.3.2.2.1.2.3 No Random Access Response Reception

To test the UE behavior specified in subclause 6.2.2.2.1.3 the System Simulator shall transmit a Random Access Response containing a Random Access Preamble identifier corresponding to the transmitted Random Access Preamble after 5 preambles have been received by the System Simulator. The System Simulator shall *not* respond to the first 4 preambles.

The UE shall again perform the Random Access Resource selection procedure specified in clause 5.1.2 in TS38.321 [7], and transmit with the calculated PRACH transmission power when the backoff time expires if no Random Access Response is received within the RA Response window.

In addition, the power applied to all preambles shall be in accordance with what is specified in Subclause 6.2.2.2. The power of the first preamble shall be -30 dBm with an accuracy specified in clause 6.3.4.2 of TS 38.101-1 [18]. The relative power applied to additional preambles shall have an accuracy specified in clause 6.3.4.3 of TS 38.101-1 [18].

The transmit timing of all PRACH transmissions shall be within the accuracy specified in Subclause 7.1.2.

A.4.3.2.2.1.2.4 Receiving a NACK on msg3

To test the UE behavior specified in subclause 6.2.2.2.1.4 the System Simulator shall NACK *all* UE msg3 following a successful Random Access Response.

The UE shall re-transmit the msg3 upon the reception of a NACK on msg3 until the maximum number of HARQ re-transmissions is reached.

A.4.3.2.2.1.2.5 Reception of an Incorrect Message over Temporary C-RNTI

To test the UE behavior specified in Subclause 6.2.2.2.1.5 the System Simulator shall send a message addressed to the temporary C-RNTI with a UE Contention Resolution Identity included in the MAC control element *not* matching the CCCH SDU transmitted in msg3 uplink message.

The UE shall again perform the Random Access Resource selection procedure specified in clause 5.1.2 in TS38.321 [7], and transmit with the calculated PRACH transmission power when the backoff time expires unless the received message includes a UE Contention Resolution Identity MAC control element and the UE Contention Resolution Identity included in the MAC control element matches the CCCH SDU transmitted in the uplink message.

A.4.3.2.2.1.2.6 Reception of a Correct Message over Temporary C-RNTI

To test the UE behavior specified in Subclause 6.2.2.2.1.5 the System Simulator shall send a message addressed to the temporary C-RNTI with a UE Contention Resolution Identity included in the MAC control element matching the CCCH SDU transmitted in the msg3 uplink message.

The UE shall send ACK if the Contention Resolution is successful.

A.4.3.2.2.1.2.7 Contention Resolution Timer expiry

To test the UE behavior specified in Subclause 6.2.2.2.1.6 the System Simulator shall *not* send a response to a msg3.

The UE shall again perform the Random Access Resource selection procedure specified in clause 5.1.2 in TS38.321 [7], and transmit with the calculated PRACH transmission power when the backoff time expires if the Contention Resolution Timer expires.

A.4.3.2.2.2 Non-contention based random access test in FR1 for PSCell in EN-DC

A.4.3.2.2.2.1 Test Purpose and Environment

The purpose of this test is to verify that the behavior of the random access procedure is according to the requirements and that the PRACH power settings and timing are within specified limits. This test will verify the requirements in Clause 6.2.2.2 and Clause 7.1.2 in an AWGN model.

For this test two cells are used, with the configuration of Cell 1 (E-UTRA PCell) specified in section A.3.7.2.1 and Cell 2 configured as PSCell in FR1. Supported test parameters are shown in Table A.4.3.2.2.1-1. UE capable of EN-DC with PSCell in FR1 needs to be tested by using the parameters in Table A.4.3.2.2.1-2 for SSB-based non-contention based random access test (Test 1) and CSI-RS-based non-contention based random access test (Test 2).

Table A.4.3.2.2.1-1: Supported test configurations for non-contention based random access test in FR1 for PSCell in EN-DC

Config	Description
1	LTE FDD, NR 15 kHz SSB SCS, 10MHz bandwidth, FDD duplex mode
2	LTE TDD, NR 15 kHz SSB SCS, 10MHz bandwidth, FDD duplex mode
3	LTE FDD, NR 30 kHz SSB SCS, 40MHz bandwidth, TDD duplex mode
4	LTE TDD, NR 30 kHz SSB SCS, 40MHz bandwidth, TDD duplex mode
Note:	The UE is only required to be tested in one of the supported test configurations depending on UE capability

Table A.4.3.2.2.1-2: General test parameters for non-contention based random access test in FR1 for PSCell in EN-DC

Parameter		Unit	Test-1	Test-2	Comments
SSB Configuration	Config 1,2		SSB pattern 1 in FR1	SSB pattern 1 in FR1	As defined in A.3.10, except for number of SSBs per SS-burst and SS/PBCH block index as below
	Config 3,4		SSB pattern 2 in FR1	SSB pattern 2 in FR1	
Number of SSBs per SS-burst			2	2	Different from the definition in A.3.10
SS/PBCH block index			0,1	0,1	Different from the definition in A.3.10
CSI-RS Configuration	Config 1,2		N/A	CSI-RS.1.1 FDD	As defined in A.3.1.4
	Config 3,4			CSI-RS.2.1 TDD	
Duplex Mode for Cell 2	Config 1,2		FDD	FDD	
	Config 3,4		TDD	TDD	
TDD Configuration	Config 3,4		TDDConf.1.2	TDDConf.1.2	
OCNG Pattern ^{Note 1}			OCNG pattern 1	OCNG pattern 1	As defined in A.3.2.1.
PDSCH parameters ^{Note 4}	Config 1,2		SR.1.1 FDD	SR.1.1 FDD	As defined in A.3.1.1.
	Config 3,4		SR.2.1 TDD	SR.2.1 TDD	
NR RF Channel Number			1	1	
EPRE ratio of PSS to SSS		dB	0	0	
EPRE ratio of PBCH_DMRS to SSS		dB			
EPRE ratio of PBCH to PBCH_DMRS		dB			
EPRE ratio of PDCCH_DMRS to SSS		dB			
EPRE ratio of PDCCH to PDCCH_DMRS		dB			
EPRE ratio of PDSCH_DMRS to SSS		dB			
EPRE ratio of PDSCH to PDSCH_DMRS		dB			
SSB with index 0	\hat{E}_s / I_{ot}	dB			3
	N_{oc}	Config 1,2	-98	-98	
		Config 3,4	-101	-101	
	\hat{E}_s / N_{oc}	dB	3	3	
SS-RSRP ^{Note 3}		dBm/ SCS	-95	-95	
SSB with index 1	\hat{E}_s / I_{ot}	dB	-17	-17	
	Config 1,2	dBm/15kHz	-98	-98	

	N_{oc}	Config 3,4		-101	-101	Power of SSB with index 1 is set to be below configured <i>rsrp-ThresholdSSB</i>
	\hat{E}_s/N_{oc}		dB	-17	-17	
	SS-RSRP ^{Note 3}		dBm/ SCS	-115	-115	
I_0 ^{Note 2}		Config 1,2	dBm	-65.3/9.36MHz	-65.3/9.36MHz	For symbols without SSB index 1
		Config 3,4		-62.2/38.16MHz	-62.2/38.16MHz	
ss-PBCH-BlockPower			dBm/ SCS	-5	-5	As defined in clause 6.3.2 in TS 38.331 [2].
Configured UE transmitted power ($P_{CMAX, f.c}$)			dBm	23	23	As defined in clause 6.2.4 in TS 38.101-1.
PRACH Configuration				FR1 PRACH configuration 2	FR1 PRACH configuration 3	As defined in A.3.8.2.
Propagation Condition			-	AWGN	AWGN	
<p>Note 1: OCNG shall be used such that the cell is fully allocated and a constant total transmitted power spectral density is achieved for all OFDM symbols. The OCNG pattern is chosen during the test according to the presence of a DL reference measurement channel.</p> <p>Note 2: SS-RSRP, E_s/I_0 and I_0 levels have been derived from other parameters for information purpose. They are not settable parameters.</p> <p>Note 3: Void</p> <p>Note 4: The DL PDSCH reference measurement channel is used in the test only when a downlink transmission dedicated to the UE under test is required.</p>						

A.4.3.2.2.2.2 Test Requirements

Non-Contention based random access is triggered by explicitly assigning a random access preamble via dedicated signalling in the downlink. In the test, the non-contention based random access procedure is not initialized for Other SI requested from UE or beam failure recovery.

A.4.3.2.2.2.2.1 SSB-based Random Access Preamble Transmission

In Test-1, to test the UE behavior specified in Subclause 6.2.2.2.2.1 for SSB-based Random Access Preamble transmission, with the contention-free Random Access Resources and the contention-free PRACH occasions associated with SSBs configured, the System Simulator shall receive the Random Access Preamble which has the Preamble Index associated with the SSB with index 0.

In addition, the System Simulator shall receive the Random Access Preamble on the PRACH occasion which belongs to the PRACH occasions corresponding to the SSB with index 0, and the selected PRACH occasion shall belong to the PRACH occasions permitted by the restrictions given by the *ra-ssb-OccasionMaskIndex*.

In addition, the power applied to all preambles shall be in accordance with what is specified in Subclause 6.2.2.2.. The power of the first preamble shall be -30 dBm with an accuracy specified in clause 6.3.4.2 of TS 38.101-1 [18]. The relative power applied to additional preambles shall have an accuracy specified in clause 6.3.4.3 of TS 38.101-1 [18].

The transmit timing of all PRACH transmissions shall be within the accuracy specified in Subclause 7.1.2.

A.4.3.2.2.2.2.2 CSI-RS-based Random Access Preamble Transmission

In Test-2, to test the UE behavior specified in Subclause 6.2.2.2.2.1 for CSI-RS-based Random Access Preamble transmission, with the contention-free Random Access Resources and the contention-free PRACH occasions associated with CSI-RSs configured, the System Simulator shall receive the Random Access Preamble which has the Preamble Index associated with the CSI-RS configured.

In addition, the System Simulator shall receive the Random Access Preamble on the PRACH occasion which belongs to the PRACH occasions corresponding to the CSI-RS configured, and the selected PRACH occasion shall belong to the PRACH occasions permitted by the restrictions given by the *ra-OccasionList*.

In addition, the power applied to all preambles shall be in accordance with what is specified in Subclause 6.2.2.2. The power of the first preamble shall be -30 dBm with an accuracy specified in clause 6.3.4.2 of TS 38.101-1 [18]. The relative power applied to additional preambles shall have an accuracy specified in clause 6.3.4.3 of TS 38.101-1 [18].

The transmit timing of all PRACH transmissions shall be within the accuracy specified in Subclause 7.1.2.

A.4.3.2.2.2.3 Random Access Response Reception

To test the UE behavior specified in Subclause 6.2.2.2.2 the System Simulator shall transmit a Random Access Response containing a Random Access Preamble identifier corresponding to the transmitted Random Access Preamble after 5 preambles have been received by the System Simulator. In response to the first 4 preambles, the System Simulator shall transmit a Random Access Response *not* corresponding to the transmitted Random Access Preamble.

The UE may stop monitoring for Random Access Response(s) if the Random Access Response contains a Random Access Preamble identifier corresponding to the transmitted Random Access Preamble.

The UE shall again perform the Random Access Resource selection procedure specified in clause 5.1.2 in TS38.321 [7], and transmit with the calculated PRACH transmission power if all received Random Access Responses contain Random Access Preamble identifiers that do not match the transmitted Random Access Preamble.

In addition, the power applied to all preambles shall be in accordance with what is specified in Subclause 6.2.2.2. The power of the first preamble shall be -30 dBm with an accuracy specified in clause 6.3.4.2 of TS 38.101-1 [18]. The relative power applied to additional preambles shall have an accuracy specified in clause 6.3.4.3 of TS 38.101-1 [18].

The transmit timing of all PRACH transmissions shall be within the accuracy specified in Subclause 7.1.2.

A.4.3.2.2.2.4 No Random Access Response Reception

To test the UE behavior specified in subclause 6.2.2.2.3 the System Simulator shall transmit a Random Access Response containing a Random Access Preamble identifier corresponding to the transmitted Random Access Preamble after 5 preambles have been received by the System Simulator. The System Simulator shall *not* respond to the first 4 preambles.

The UE shall again perform the Random Access Resource selection procedure specified in clause 5.1.2 in TS38.321 [7], and transmit with the calculated PRACH transmission power when the backoff time expires if no Random Access Response is received within the RA Response window configured in *RACH-ConfigCommon*.

In addition, the power applied to all preambles shall be in accordance with what is specified in Subclause 6.2.2.2. The power of the first preamble shall be -30 dBm with an accuracy specified in clause 6.3.4.2 of TS 38.101-1 [18]. The relative power applied to additional preambles shall have an accuracy specified in clause 6.3.4.3 of TS 38.101-1 [18].

The transmit timing of all PRACH transmissions shall be within the accuracy specified in Subclause 7.1.2.

A.4.3.2.3 Void

A.4.4 Timing

A.4.4.1 UE transmit timing

A.4.4.1.1 NR UE Transmit Timing Test for FR1

A.4.4.1.1.1 Test Purpose and environment

The purpose of this test is to verify that the UE can follow frame timing change of the connected gNodeB and that the UE initial transmit timing accuracy, maximum amount of timing change in one adjustment, minimum and maximum adjustment rate are within the specified limits. This test will verify the requirements in clause 7.1.2. Supported test configurations are shown in Table 4.4.1.1.1-1.

Table A.4.4.1.1.1-1: Supported test configurations for FR1 PSCell

Configuration	Description
1	FDD, SSB SCS 15 KHz, data SCS 15KHz, BW 10MHz
2	TDD, SSB SCS 15 KHz, data SCS 15KHz, BW 10MHz
3	TDD, SSB SCS 30 KHz, data SCS 30KHz, BW 40MHz
Note: The UE is only required to pass in one of the supported test configurations in FR1	

For this test a single NR cell is used. Table A.4.4.1.1.1-2 defines the parameters to be configured and strength of the transmitted signals. The transmit timing is verified by the UE transmitting SRS using the configuration defined in Table A.4.4.1.1.1-3.

Table A.4.4.1.1.1-2: Cell Specific Test Parameters for UL Transmit Timing test

Parameter	Unit	Config	Test1	Test2	Band Group
SSB ARFCN		1,2,3	Freq1	Freq1	
Duplex Mode		1	FDD		
		2,3	TDD		
TDD configuration		1	Not Applicable		
		2	TDDConf.1.1		
		3	TDDConf.1.2		
BW _{channel}	MHz	1	10: N _{RB,c} = 52		
		2	10: N _{RB,c} = 52		
		3	40: N _{RB,c} = 106		
Initial BWP Configuration		1,2,3	DLBWP.0.1 ULBWP.0.1		
Dedicated BWP Configuration		1,2,3	DLBWP.1.1 ULBWP.1.1		
DRx Cycle	ms	1,2,3	N/A	DRX.5 ^{Note5}	
PDSCH Reference measurement channel		1	SR.1.1 FDD		
		2	SR.1.1 TDD		
		3	SR.2.1 TDD		
CORESET Reference Channel		1	CR.1.1 FDD		
		2	CR.1.1 TDD		
		3	CR.2.1 TDD		

OCNG Patterns		1,2,3	OCNG pattern 1		
SMTc configuration		1,2	FR1 pattern 1		
		3	FR1 pattern 2		
PDSCH/PDCCH subcarrier spacing	kHz	1,2	15		
		3	30		
EPRE ratio of PSS to SSS	dB	1,2,3	0	0	
EPRE ratio of PBCH DMRS to SSS					
EPRE ratio of PBCH to PBCH DMRS					
EPRE ratio of PDCCH DMRS to SSS					
EPRE ratio of PDCCH to PDCCH DMRS					
EPRE ratio of PDSCH DMRS to SSS					
EPRE ratio of PDSCH to PDSCH					
EPRE ratio of OCNG DMRS to SSS(Note 1)					
EPRE ratio of OCNG to OCNG DMRS (Note 1)					
N_{oc} ^{Note2}	dBm/15 kHz	1,2,3	-98	-98	
N_{oc} ^{Note2}	dBm/SCS	1,2	-98	-98	
		3	-95	-95	
\hat{E}_s / I_{ot}		1,2,3	3	3	
\hat{E}_s / N_{oc}		1,2,3	3	3	
SS-RSRP ^{Note3}	dBm/SCS	1,2	-95	-95	
		3	-92	-92	
I_o ^{Note3}	dBm/9.36MHz	1,2	-65.2	-65.2	
	dBm/38.1MHz	3	-59.2	-59.2	
Propagation condition		1,2,3	AWGN		
SRS Config		1,2,3	Config1 ^{Note6}	Config2 ^{Note6}	
<p>Note 1: OCNG shall be used such that both cells are fully allocated and a constant total transmitted power spectral density is achieved for all OFDM symbols.</p> <p>Note 2: Interference from other cells and noise sources not specified in the test is assumed to be constant over subcarriers and time and shall be modelled as AWGN of appropriate power for N_{oc} to be fulfilled.</p> <p>Note 3: SS-RSRP and I_o levels have been derived from other parameters for information purposes. They are not settable parameters themselves.</p> <p>Note 4: SS-RSRP minimum requirements are specified assuming independent interference and noise at each receiver antenna port.</p> <p>Note 5: DRx related parameters are given in Table A.3.3.4-1</p> <p>Note 6: SRS configs are given in Table A.4.4.1.1.1-3</p>					

Table A.4.4.1.1.1-3: SRS Configuration for Timing Accuracy Test

	Field	Config1	Config 2	Comments
SRS-ResourceSet	srs-ResourceSetId	0	0	
	srs-ResourceIdList	0	0	
	resourceType	Periodic	Periodic	
	Usage	Codebook	Codebook	
SRS-Resource	SRS-ResourceSetId	0	0	
	nrofSRS-Ports	Port1	Port1	

transmissionComb	n2	n2	
combOffset-n2	0	0	
cyclicShift-n2	0	0	
resourceMapping startPosition	0	0	
resourceMapping nrofSymbols	n1	n1	
resourceMapping repetitionFactor	n1	n1	
freqDomainPosition	0	0	
freqDomainShift	0	0	
freqHopping c-SRS	sl1	sl1	
freqHopping b-SRS	0	0	
freqHopping b-hop	0	0	
groupOrSequenceHopping	Neither	Neither	
resourceType	Periodic	Periodic	
periodicityAndOffset-p	sl1	sl640	Offset to align with DRx periodicity
sequenceId	0	0	Any 10 bit number

A.4.4.1.1.2 Test requirements

The test sequence shall be carried out in RRC_CONNECTED for every test case.

Following will be the test sequence for this test

- 1) Set up E-UTRA PCell according to parameters given in Table A.3.7.2.1-1 and setup NR PSCell according to parameters given in Table A.4.4.1.1.1-1.
- 2) After connection set up with the cell, the test equipment will verify that the timing of the NR cell is within $(N_{TA} + N_{TA_offset}) \pm T_e$ of the first detected path of DL SSB.
 - a. The N_{TA} offset value (in T_c units) is 25600 for FR1 and 13792 for FR2
 - b. The T_e values depend on the DL and UL SCS for which the test is being run and are given in Table 7.1.2-1
- 3) The test system shall adjust the timing of the DL path by values given in Table A.4.4.1.1.2-1

Table A.4.4.1.1.2-1: Adjustment Value for DL Timing

SCS of SSB signals (KHz)	Adjustment Value	
	Test1	Test2
15	$+64*64T_c$	$+32*64T_c$
30	$+32*64T_c$	$+16*64T_c$
120	$+16*64T_c$	$+8*64T_c$
240	$+8*64T_c$	$+4*64T_c$

- 4) The test system shall verify that the adjustment step size and the adjustment rate shall be according to requirements specified in Section 7.1.2 Table 7.1.2-3. This will only be done for Test1.
- 5) The test system shall verify that the UE transmit timing offset stays within $(N_{TA} + N_{TA_offset}) \pm T_e$ of the first detected path of DL SSB. For Test 2 and Test 4 the UE transmit timing offset shall be verified for the first transmission in the DRX cycle immediately after DL timing adjustment.

A.4.4.2 UE timer accuracy

A.4.4.3 Timing advance

A.4.4.3.1 EN-DC FR1 timing advance adjustment accuracy

A.4.4.3.1.1 Test Purpose and Environment

The purpose of the test is to verify UE Timing Advance adjustment delay and accuracy requirement defined in clause 7.3.

A.4.4.3.1.2 Test Parameters

Supported test configurations are shown in table A.4.4.3.1.2-1. Both timing advance adjustment delay and accuracy are tested by using the parameters in table A.4.4.3.1.2-2, A.4.4.3.1.2-3 and A.4.4.3.1.2-4. The configuration of Cell 1 (LTE PCell) is specified in section A.3.7.2.1.

In all test cases, two cells are used. Cell 1 is the PCell in the primary Timing Advance Group (pTAG) and cell 2 is the PSCell in the secondary Timing Advance Group (sTAG). Each test consists of two successive time periods, with time duration of T1 and T2 respectively. In each time period, timing advance commands for sTAG are sent to the UE and Sounding Reference Signals (SRS), as specified in table A.4.4.3.1.2-3, are sent from the UE and received by the test equipment. By measuring the reception of the SRS, the transmit timing, and hence the timing advance adjustment accuracy, can be measured for PSCell in sTAG.

During time period T1, the test equipment shall send one message with a Timing Advance Command MAC Control Element for sTAG, as specified in Clause 6.1.3.4 in TS 38.321 [7]. The Timing Advance Command value shall be set to 31, which according to Clause 4.2 in TS 38.213 results in zero adjustment of the Timing Advance. In this way, a reference value for the timing advance for sTAG used by the UE is established.

During time period T2, the test equipment shall send a sequence of messages with Timing Advance Command MAC Control Elements for sTAG, with Timing Advance Command value specified in table A.4.4.3.1.2-2. This value shall result in changes of the timing advance for sTAG used by the UE, and the accuracy of the change shall then be measured, using the SRS sent from the UE.

As specified in Clause 7.3.2.1, the UE adjusts its uplink timing at slot $n+k$ for a timing advance command received in slot n . This delay must be taken into account when measuring the timing advance adjustment accuracy, via the SRS sent from the UE.

The UE Time Alignment Timer, described in Clause 5.2 in TS 38.321, shall be configured so that it does not expire in the duration of the test.

Table A.4.4.3.1.2-1: Timing advance supported test configurations

Config	Description
1	LTE FDD, NR 15 kHz SSB SCS, 10MHz bandwidth, FDD duplex mode
2	LTE FDD, NR 15 kHz SSB SCS, 10MHz bandwidth, TDD duplex mode
3	LTE FDD, NR 30 kHz SSB SCS, 40MHz bandwidth, TDD duplex mode
4	LTE TDD, NR 15 kHz SSB SCS, 10MHz bandwidth, FDD duplex mode
5	LTE TDD, NR 15 kHz SSB SCS, 10MHz bandwidth, TDD duplex mode
6	LTE TDD, NR 30 kHz SSB SCS, 40MHz bandwidth, TDD duplex mode
Note:	The UE is only required to be tested in one of the supported test configurations

Table A.4.4.3.1.2-2: General test parameters for timing advance

Parameter	Unit	Value	Comment
RF channel number		Cell 1: 1 Cell 2: 2	1 for E-UTRAN PCell 2 for NR PSCell
Initial DL BWP		DLBWP.0.1	As specified in Table A.3.9.2.1-1
Dedicated DL BWP		DLBWP.1.1	As specified in Table A.3.9.2.2-1
Initial UL BWP		ULBWP.0.1	As specified in Table A.3.9.3.1-1
Dedicated UL BWP		ULBWP.1.1	As specified in Table A.3.9.3.2-1
Timing Advance Command (T_A) value during T1		31	$N_{TA_new} = N_{TA_old}$ for the purpose of establishing a reference value from which the timing advance adjustment accuracy can be measured during T2
Timing Advance Command (T_A) value during T2		39	$N_{TA_new} = N_{TA_old} + 8192 * T_c$ (based on equation in TS 38.213 [3] section 4.2)
T1	s	5	
T2	s	5	

Table A.4.4.3.1.2-3: Cell specific test parameters for timing advance

Parameter		Unit	Test1	
			T1	T2
Duplex mode	Config 1,4		FDD	
	Config 2,3,5,6		TDD	
TDD configuration	Config 1,4		Not Applicable	
	Config 2,5		TDDConf.1.1	
	Config 3,6		TDDConf.2.1	
$BW_{channel}$	Config 1,4	MHz	10: $N_{RB,c} = 52$	
	Config 2,5		10: $N_{RB,c} = 52$	
	Config 3,6		40: $N_{RB,c} = 106$	
BWP BW	Config 1,4	MHz	10: $N_{RB,c} = 52$	
	Config 2,5		10: $N_{RB,c} = 52$	
	Config 3,6		40: $N_{RB,c} = 106$	
DRx Cycle		ms	Not Applicable	
PDSCH Reference measurement channel	Config 1,4		SR.1.1 FDD	
	Config 2,5		SR.1.1 TDD	
	Config 3,6		SR2.1 TDD	
CORESET Reference Channel	Config 1,4		CR.1.1 FDD	
	Config 2,5		CR.1.1 TDD	
	Config 3,6		CR2.1 TDD	
OCNG Patterns			OCNG pattern 1	
SMTC configuration	Config 1,2,4,5		SMTC.1 FR1	
	Config 3,6		SMTC.2 FR1	
PDSCH/PDCCH subcarrier spacing	Config 1,2,4,5	kHz	15 kHz	
	Config 3,6		30 kHz	
PUCCH/PUSCH subcarrier spacing	Config 1,2,4,5	kHz	15 kHz	
	Config 3,6		30 kHz	
EPRE ratio of PSS to SSS		dB	0	
EPRE ratio of PBCH DMRS to SSS				
EPRE ratio of PBCH to PBCH DMRS				
EPRE ratio of PDCCH DMRS to SSS				
EPRE ratio of PDCCH to PDCCH DMRS				
EPRE ratio of PDSCH DMRS to SSS				
EPRE ratio of PDSCH to PDSCH				
EPRE ratio of OCNG DMRS to SSS(Note 1)				
EPRE ratio of OCNG to OCNG DMRS (Note 1)				
N_{oc} Note2		dBm/15kHz z	-98	

N_{oc} <small>Note2</small>	Config 1,2,4,5	dBm/SCS	-98
	Config 3,6		-95
\hat{E}_s / I_{ot}		dB	3
\hat{E}_s / N_{oc}		dB	3
I_0 <small>Note3</small>	Config 1,2,4,5	dBm/ 9.36MHz	-67.57
	Config 3,6	dBm/ 38.16MHz	-62.58
Propagation condition		-	AWGN
Note 1: OCNG shall be used such that both cells are fully allocated and a constant total transmitted power spectral density is achieved for all OFDM symbols.			
Note 2: Interference from other cells and noise sources not specified in the test is assumed to be constant over subcarriers and time and shall be modelled as AWGN of appropriate power for N_{oc} to be fulfilled.			
Note 3: I_0 levels have been derived from other parameters for information purposes. They are not settable parameters themselves.			

Table A.4.4.3.1.2-4: Sounding Reference Symbol Configuration for timing advance

Field		Value	Comment
c-SRS	Config 1,2,4,5	12	Frequency hopping is disabled
	Config 3,6	24	
b-SRS		0	
b-hop		0	
freqDomainPosition		0	Frequency domain position of SRS
freqDomainShift		0	
groupOrSequenceHopping		neither	No group or sequence hopping
SRS-PeriodicityAndOffset		sl5=0	Once every 5 slots
pathlossReferenceRS		ssb-Index=0	SSB #0 is used for SRS path loss estimation
usage		nonCodebook	Non-codebook based UL transmission
startPosition		0	resourceMapping setting. SRS on last symbol of slot, and 1 symbols for SRS without repetition.
nrofSymbols		n1	
repetitionFactor		n1	
combOffset-n2		0	transmissionComb setting
cyclicShift-n2		0	
nrofSRS-Ports		port1	Number of antenna ports used for SRS transmission
Note: For further information see clause 6.3.2 in TS 38.331 [2].			

A.4.4.3.1.3 Test Requirements

The UE shall apply the signalled Timing Advance value for PSCell in sTAG to the transmission timing at the designated activation time i.e. k slots after the reception of the timing advance command, where:

$k = 4$ for Config 1, 2, 4, 5, and

$k = 7$ for Config 3, 6

The Timing Advance adjustment accuracy for PSCell in sTAG shall be within the limits specified in clause 7.3.2.2.

The rate of correct Timing Advance adjustments observed during repeated tests shall be at least 90%.

A.4.5 Signaling characteristics

A.4.5.1 Radio link Monitoring

In the following section, any uplink signal transmitted by the UE is used for detecting the In-/Out-of-Sync state of the UE. In terms of measurement, the uplink signal is verified on the basis of the UE output power:

For intra-band contiguous carrier aggregation, transmit OFF power is measured as the mean power per component carrier.

For UE with multiple transmit antennas, transmit OFF power is measured as the mean power at each transmit connector.

- UE output power higher than Transmit OFF power [-50] dBm (as defined in TS 38.101-3 [20]) means uplink signal
- UE output power equal to or less than Transmit OFF power [-50] dBm (as defined in TS 38.101-3 [20]) means no uplink signal.

A.4.5.1.1 Radio Link Monitoring Out-of-sync Test for FR1 PSCell configured with SSB-based RLM RS in non-DRX mode

A.4.5.1.1.1 Test Purpose and Environment

The purpose of this test is to verify that the UE properly detects the out of sync and in sync for the purpose of monitoring downlink radio link quality of the PSCell. This test will partly verify the FR1 PSCell radio link monitoring requirements in clause 8.1.

Supported test configurations are shown in table A.4.5.1.1.1-1. The test parameters are given in Tables A.4.5.1.1.1-2, A.4.5.1.1.1-3, and A.4.5.1.1.1-4 below. There are two cells, Cell 1 is the E-UTRAN PCell, and Cell 2 is the PSCell, in the test. The E-UTRAN PCell setting refers to Table A.3.7.2.1-1. The test consists of three successive time periods, with time duration of T1, T2 and T3 respectively. Figure A.4.5.1.1.1-1 shows the variation of the downlink SNR in the active Cell 2 to emulate out-of-sync and in-sync states. Prior to the start of the time duration T1, the UE shall be fully synchronized to Cell 1 and Cell 2. The UE shall be configured for periodic CSI reporting with a reporting periodicity of 5 ms. The UE is configured to perform inter-frequency measurements using Gap Pattern ID #0 (40ms) in test 1.

Table A.4.5.1.1.1-1: Supported test configurations for FR1 PSCell

Configuration	Description
1	LTE FDD, NR 15 KHz SSB SCS, 10MHz bandwidth, FDD duplex mode
2	LTE FDD, NR 15 KHz SSB SCS, 10MHz bandwidth, TDD duplex mode
3	LTE FDD, NR 30 KHz SSB SCS, 40MHz bandwidth, TDD duplex mode
4	LTE TDD, NR 15 KHz SSB SCS, 10MHz bandwidth, FDD duplex mode
5	LTE TDD, NR 15 KHz SSB SCS, 10MHz bandwidth, TDD duplex mode
6	LTE TDD, NR 30 KHz SSB SCS, 40MHz bandwidth, TDD duplex mode

Note: The UE is only required to pass in one of the supported test configurations in FR1

Table A.4.5.1.1.1-2: General test parameters for FR1 out-of-sync testing in non-DRX mode

Parameter	Unit	Value
		Test 1
Active E-UTRA PCell		Cell 1
E-UTRA RF Channel Number		1
Active PSCell		Cell 2

RF Channel Number			2
Duplex mode	Config 1, 4		FDD
	Config 2, 3, 5, 6		TDD
BW _{channel}	Config 1, 4	MHz	10: N _{RB,c} = 52
	Config 2, 5		10: N _{RB,c} = 52
	Config 3, 6		40: N _{RB,c} = 106
DL initial BWP configuration	Config 1, 2, 3, 4, 5, 6		DLBWP.0.1
DL dedicated BWP configuration	Config 1, 2, 3, 4, 5, 6		DLBWP.1.1
UL initial BWP configuration	Config 1, 2, 3, 4, 5, 6		ULBWP.0.1
UL dedicated BWP configuration	Config 1, 2, 3, 4, 5, 6		ULBWP.1.1
TDD Configuration	Config 1, 4		Not Applicable
	Config 2, 5		TDDConf.1.1
	Config 3, 6		TDDConf.2.1
CORESET Reference Channel	Config 1, 4		CR.1.1 FDD
	Config 2, 5		CR.1.1 TDD
	Config 3, 6		CR.2.1 TDD
SSB Configuration	Config 1, 4		SSB.1 FR1
	Config 2, 5		SSB.1 FR1
	Config 3, 6		SSB.2 FR1
SMTTC Configuration	Config 1, 2, 4, 5		SMTTC.1
	Config 3, 6		SMTTC.1
PDSCH/PDCCH subcarrier spacing	Config 1, 2, 4, 5		15 KHz
	Config 3, 6		30 KHz
PRACH Configuration	Config 1, 2, 4, 5		Table A.3.8.2.4-1
	Config 3, 6		Table A.3.8.2.4-1
SSB index assigned as RLM RS			0
OCNG parameters			OP.1
CP length			Normal
Correlation Matrix and Antenna Configuration			2x2 Low
Out of sync transmission parameters	DCI format		1-0
	Number of Control OFDM symbols		2
	Aggregation level	CCE	8
	Ratio of hypothetical PDCCH RE energy to average SSS RE energy	dB	4
	Ratio of hypothetical PDCCH DMRS energy to average SSS RE energy	dB	4
	DMRS precoder granularity		REG bundle size
REG bundle size			6
DRX			OFF
Gap pattern ID			gp0
Layer 3 filtering			Enabled
T310 timer		ms	0
T311 timer		ms	1000
N310			1
N311			1
CSI-RS configuration	Config 1, 4		[CSI-RS.1.3 FDD]
	Config 2, 5		[CSI-RS.1.3 TDD]
	Config 3, 6		[CSI-RS.2.3 TDD]
T1		s	1
T2		s	0.6
T3		s	0.6
D1		s	0.44
Note 1: All configurations are assigned to the UE prior to the start of time period T1.			
Note 2: UE-specific PDCCH is not transmitted after T1 starts.			
Note 3: E-UTRAN is in non-DRX mode under test.			

Table A.4.5.1.1.1-3: Cell specific test parameters for FR1 (Cell 2) for out-of-sync radio link monitoring tests in non-DRX mode

Parameter		Unit	Test 1				
			T1	T2	T3	T4	T5
EPRE ratio of PDCCH DMRS to SSS		dB	4				
EPRE ratio of PDCCH to PDCCH DMRS		dB	0				
EPRE ratio of PBCH DMRS to SSS		dB	0				
EPRE ratio of PBCH to PBCH DMRS		dB					
EPRE ratio of PSS to SSS		dB					
EPRE ratio of PDSCH DMRS to SSS		dB					
EPRE ratio of PDSCH to PDSCH DMRS		dB					
EPRE ratio of OCNG DMRS to SSS		dB					
EPRE ratio of OCNG to OCNG DMRS		dB					
SNR	Config 1, 4	dB	1	-7	-15	-4.5	1
	Config 2, 5		1	-7	-15	-4.5	1
	Config 3, 6		1	-7	-15	-4.5	1
N_{oc}	Config 1, 4	dBm/ 15	-98				
	Config 2, 5		-98				
	Config 3, 6	KHz	-98				
Propagation condition			TDL-C 300ns 100Hz				
<p>Note 1: OCNG shall be used such that the resources in Cell 2 are fully allocated and a constant total transmitted power spectral density is achieved for all OFDM symbols.</p> <p>Note 2: The signal contains PDCCH for UEs other than the device under test as part of OCNG.</p> <p>Note 3: SNR levels correspond to the signal to noise ratio over the SSS REs.</p>							

Table A.4.5.1.1.1-4: Measurement gap configuration for out-of-sync tests in non-DRX mode

Field	Test 1
	Value
gapOffset	0
<p>Note 1: E-UTRAN PCell and PSCell are SFN-synchronous and frame boundary aligned. (Ensure that RLM RS is partially overlapped with measurement gap).</p>	

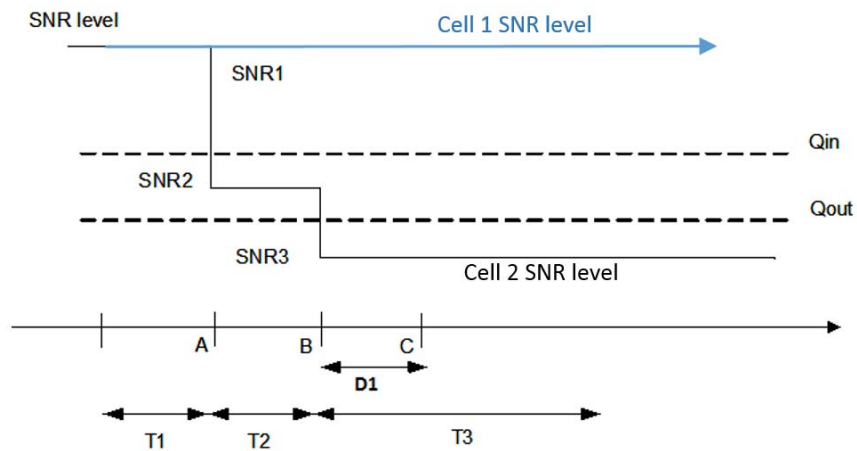

Figure A.4.5.1.1.1-1: SNR variation for out-of-sync testing

A.4.5.1.1.2 Test Requirements

The UE behavior in each test during time durations T1, T2 and T3 shall be as follows:

During the period from time point A to time point B the UE shall transmit uplink signal at least in all uplink slots configured for CSI transmission according to the configured periodic CSI reporting.

The UE shall stop transmitting uplink signal no later than time point C (D1 second after the start of the time duration T3).

The rate of correct events observed during repeated tests shall be at least 90%.

A.4.5.1.2 Radio Link Monitoring In-sync Test for FR1 PSCell configured with SSB-based RLM RS in non-DRX mode

A.4.5.1.2.1 Test Purpose and Environment

The purpose of this test is to verify that the UE properly detects the out of sync and in sync for the purpose of monitoring downlink radio link quality of the PSCell. This test will partly verify the FR1 PSCell radio link monitoring requirements in clause 8.1.

Supported test configurations are shown in table A.4.5.1.2.1-1. The test parameters are given in Tables A.4.5.1.2.1-2, and A.4.5.1.2.1-3 below. There are two cells, Cell 1 is the E-UTRAN PCell, and Cell 2 is the PSCell, in the test. The E-UTRAN PCell setting refers to Table A.3.7.2.1-1. The test consists of five successive time periods, with time duration of T1, T2, T3, T4 and T5 respectively. Figure A.4.5.1.2.1-1 shows the variation of the downlink SNR in the active Cell 2 to emulate out-of-sync and in-sync states. Prior to the start of the time duration T1, the UE shall be fully synchronized to Cell 1 and Cell 2. The UE shall be configured for periodic CSI reporting with a reporting periodicity of 5 ms.

Table A.4.5.1.2.1-1: Supported test configurations for FR1 PSCell

Configuration	Description
1	LTE FDD, NR 15 KHz SSB SCS, 10MHz bandwidth, FDD duplex mode
2	LTE FDD, NR 15 KHz SSB SCS, 10MHz bandwidth, TDD duplex mode
3	LTE FDD, NR 30 KHz SSB SCS, 40MHz bandwidth, TDD duplex mode
4	LTE TDD, NR 15 KHz SSB SCS, 10MHz bandwidth, FDD duplex mode
5	LTE TDD, NR 15 KHz SSB SCS, 10MHz bandwidth, TDD duplex mode
6	LTE TDD, NR 30 KHz SSB SCS, 40MHz bandwidth, TDD duplex mode

Note: The UE is only required to pass in one of the supported test configurations in FR1

Table A.4.5.1.2.1-2: General test parameters for FR1 in-sync testing in non-DRX mode

Parameter		Unit	Value
Active E-UTRA PCell			Cell 1
E-UTRA RF Channel Number			1
Active PSCell			Cell 2
RF Channel Number			2
Duplex mode	Config 1, 4		FDD
	Config 2, 3, 5, 6		TDD
BW _{channel}	Config 1, 4	MHz	10: N _{RB,c} = 52
	Config 2, 5		10: N _{RB,c} = 52
	Config 3, 6		40: N _{RB,c} = 106
DL initial BWP configuration	Config 1, 2, 3, 4, 5, 6		DLBWP.0.1
DL dedicated BWP configuration	Config 1, 2, 3, 4, 5, 6		DLBWP.1.1
UL initial BWP configuration	Config 1, 2, 3, 4, 5, 6		ULBWP.0.1
UL dedicated BWP configuration	Config 1, 2, 3, 4, 5, 6		ULBWP.1.1
TDD Configuration	Config 1, 4		Not Applicable
	Config 2, 5		TDDConf.1.1
	Config 3, 6		TDDConf.2.1
CORESET Reference Channel	Config 1, 4		CR.1.1 FDD
	Config 2, 5		CR.1.1 TDD
	Config 3, 6		CR.2.1 TDD
SSB Configuration	Config 1, 4		SSB.1 FR1
	Config 2, 5		SSB.1 FR1
	Config 3, 6		SSB.2 FR1
SMTTC Configuration	Config 1, 2, 4, 5		SMTTC.1
	Config 3, 6		SMTTC.1
PDSCH/PDCCH subcarrier spacing	Config 1, 2, 4, 5		15 KHz
	Config 3, 6		30 KHz
PRACH Configuration	Config 1, 2, 4, 5		Table A.3.8.2.4-1
	Config 3, 6		Table A.3.8.2.4-1
SSB index assigned as RLM RS			0
OCNG parameters			OP.1
CP length			Normal
Correlation Matrix and Antenna Configuration			2x2 Low
	DCI format		1-0
	Number of Control OFDM symbols		2
	Aggregation level	CCE	4

In sync transmission parameters	Ratio of hypothetical PDCCH RE energy to average SSS RE energy	dB	0
	Ratio of hypothetical PDCCH DMRS energy to average SSS RE energy	dB	0
	DMRS precoder granularity		REG bundle size
	REG bundle size		6
Out of sync transmission parameters	DCI format		1-0
	Number of Control OFDM symbols		2
	Aggregation level	CCE	8
	Ratio of hypothetical PDCCH RE energy to average SSS RE energy	dB	4
	Ratio of hypothetical PDCCH DMRS energy to average SSS RE energy	dB	4
	DMRS precoder granularity		REG bundle size
	REG bundle size		6
DRX			<i>OFF</i>
Gap pattern ID			N.A.
Layer 3 filtering			<i>Enabled</i>
T310 timer		ms	2000
T311 timer		ms	1000
N310			1
N311			1
CSI-RS configuration	Config 1, 4		[CSI-RS.1.3 FDD]
	Config 2, 5		[CSI-RS.1.3 TDD]
	Config 3, 6		[CSI-RS.2.3 TDD]
T1		s	0.5
T2		s	0.4
T3		s	1.46
T4		s	0.4
T5		s	1
D1		s	0.42
Note 1:	All configurations are assigned to the UE prior to the start of time period T1.		
Note 2:	UE-specific PDCCH is not transmitted after T1 starts.		
Note 3:	E-UTRAN is in non-DRX mode under test.		

Table A.4.5.1.2.1-3: Cell specific test parameters for FR1 (Cell 2) for in-sync radio link monitoring tests in non-DRX mode

Parameter		Unit	Test 1				
			T1	T2	T3	T4	T5
EPRE ratio of PDCCH DMRS to SSS		dB	4				
EPRE ratio of PDCCH to PDCCH DMRS		dB	0				
EPRE ratio of PBCH DMRS to SSS		dB	0				
EPRE ratio of PBCH to PBCH DMRS		dB					
EPRE ratio of PSS to SSS		dB					
EPRE ratio of PDSCH DMRS to SSS		dB					
EPRE ratio of PDSCH to PDSCH DMRS		dB					
EPRE ratio of OCNG DMRS to SSS		dB					
EPRE ratio of OCNG to OCNG DMRS		dB					
SNR	Config 1, 4	dB					
	Config 2, 5		1	-7	-15	-4.5	1
	Config 3, 6		1	-7	-15	-4.5	1
N_{oc}	Config 1, 4	dBm/ 15 KHz	-98				
	Config 2, 5		-98				
	Config 3, 6		-98				
Propagation condition			TDL-C 300ns 100Hz				
<p>Note 1: OCNG shall be used such that the resources in Cell 2 are fully allocated and a constant total transmitted power spectral density is achieved for all OFDM symbols.</p> <p>Note 2: The signal contains PDCCH for UEs other than the device under test as part of OCNG.</p> <p>Note 3: SNR levels correspond to the signal to noise ratio over the SSS REs.</p> <p>Note 4: The SNR in time periods T1, T2, T3, T4 and T5 is denoted as SNR1, SNR2, SNR3, SNR4 and SNR5 respectively in Figure A.4.5.1.2.1-1.</p> <p>Note 5: The SNR values are specified for testing a UE which supports 2RX on at least one band. For testing of a UE which supports 4RX on all bands, the SNR during T3 and T4 is modified as specified in section A.3.6.</p>							

Table A.4.5.1.2.1-4: Void

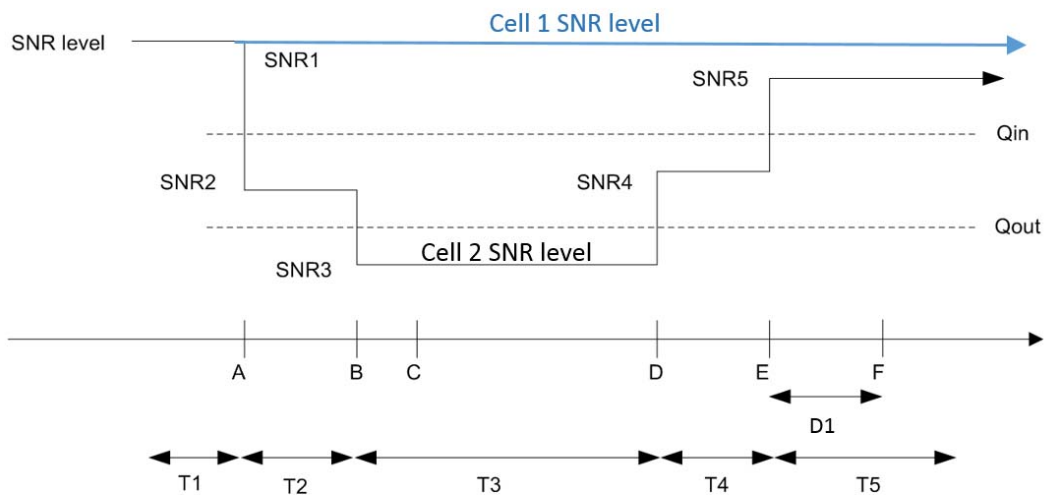

Figure A.4.5.1.2.1-1: SNR variation for in-sync testing

A.4.5.1.2.2 Test Requirements

The UE behaviour in each test during time durations T1, T2, T3, T4 and T5 shall be as follows:

During the period from time point A to time point F (D1 second after the start of time duration T5) the UE shall transmit uplink signal at least in all uplink slots configured for CSI transmission according to the configured periodic CSI reporting.

The rate of correct events observed during repeated tests shall be at least 90%.

A.4.5.1.3 Radio Link Monitoring Out-of-sync Test for FR1 PSCell configured with SSB-based RLM RS in DRX mode

A.4.5.1.3.1 Test Purpose and Environment

The purpose of this test is to verify that the UE properly detects the out of sync and in sync for the purpose of monitoring downlink radio link quality of the PSCell when DRX is used. This test will partly verify the FR1 radio link monitoring requirements in clause 8.1.

Supported test configurations are shown in table A.4.5.1.3.1-1. The test parameters are given in Tables A.4.5.1.3.1-2 and A.4.5.1.3.1-3. There are two cells, Cell 1 is the E-UTRAN PCell, and Cell 2 is the PSCell, in the test. The E-UTRAN PCell setting refers to Table A.3.7.2.1-1. The test consists of three successive time periods, with time duration of T1, T2 and T3 respectively. Figure A.4.5.1.3.1-1 shows the variation of the downlink SNR in the active Cell 2 to emulate out-of-sync and in-sync states. Prior to the start of the time duration T1, the UE shall be fully synchronized to Cell 1 and Cell 2. The UE shall be configured for periodic CSI reporting with a reporting periodicity of 5 ms. In the test, DRX configuration is enabled and DRX inactivity timer has already been expired, i.e. UE tries to decode PDCCH and to send periodic CSI during the period when On-duration timer is running. Time alignment timers shall be set to “infinity” so that UL timing alignment is maintained during the test.

Table A.4.5.1.3.1-1: Supported test configurations for FR1 PSCell

Configuration	Description
1	LTE FDD, NR 15 KHz SSB SCS, 10MHz bandwidth, FDD duplex mode
2	LTE FDD, NR 15 KHz SSB SCS, 10MHz bandwidth, TDD duplex mode
3	LTE FDD, NR 30 KHz SSB SCS, 40MHz bandwidth, TDD duplex mode
4	LTE TDD, NR 15 KHz SSB SCS, 10MHz bandwidth, FDD duplex mode
5	LTE TDD, NR 15 KHz SSB SCS, 10MHz bandwidth, TDD duplex mode
6	LTE TDD, NR 30 KHz SSB SCS, 40MHz bandwidth, TDD duplex mode
Note:	The UE is only required to pass in one of the supported test configurations in FR1

Table A.4.5.1.3.1-2: General test parameters for FR1 out-of-sync testing in DRX mode

Parameter	Unit	Value
		Test 1
Active E-UTRA PCell		Cell 1
E-UTRA RF Channel Number		1
Active PSCell		Cell 2
RF Channel Number		2
Duplex mode	Config 1, 4	FDD
	Config 2, 3, 5, 6	TDD
BW _{channel}	Config 1, 4	10: N _{RB,c} = 52
	Config 2, 5	10: N _{RB,c} = 52
	Config 3, 6	40: N _{RB,c} = 106

DL initial BWP configuration	Config 1, 2, 3, 4, 5, 6		DLBWP.0.1
DL dedicated BWP configuration	Config 1, 2, 3, 4, 5, 6		DLBWP.1.1
UL initial BWP configuration	Config 1, 2, 3, 4, 5, 6		ULBWP.0.1
UL dedicated BWP configuration	Config 1, 2, 3, 4, 5, 6		ULBWP.1.1
TDD Configuration	Config 1, 4		Not Applicable
	Config 2, 5		TDDConf.1.1
	Config 3, 6		TDDConf.2.1
CORESET Reference Channel	Config 1, 4		CR.1.1 FDD
	Config 2, 5		CR.1.1 TDD
	Config 3, 6		CR.2.1 TDD
SSB Configuration	Config 1, 4		SSB.1 FR1
	Config 2, 5		SSB.1 FR1
	Config 3, 6		SSB.2 FR1
SMTTC Configuration	Config 1, 2, 4, 5		SMTTC.1
	Config 3, 6		SMTTC.1
PDSCH/PDCCH subcarrier spacing	Config 1, 2, 4, 5		15 KHz
	Config 3, 6		30 KHz
PRACH Configuration	Config 1, 2, 4, 5		Table A.3.8.2.4-1
	Config 3, 6		Table A.3.8.2.4-1
SSB index assigned as RLM RS			0
OCNG parameters			OP.1
CP length			Normal
Correlation Matrix and Antenna Configuration			2x2 Low
Out of sync transmission parameters	DCI format		1-0
	Number of Control OFDM symbols		2
	Aggregation level	CCE	8
	Ratio of hypothetical PDCCH RE energy to average SSS RE energy	dB	4
	Ratio of hypothetical PDCCH DMRS energy to average SSS RE energy	dB	4
	DMRS precoder granularity		REG bundle size
	REG bundle size		6
DRX Configuration			[DRX.4]
Gap pattern ID			N.A.
Layer 3 filtering			<i>Enabled</i>
T310 timer	ms		0
T311 timer	ms		1000
N310			1
N311			1
CSI-RS configuration	Config 1, 4		[CSI-RS.1.3 FDD]
	Config 2, 5		[CSI-RS.1.3 TDD]
	Config 3, 6		[CSI-RS.2.3 TDD]
T1	s		1
T2	s		7
T3	s		7
D1	s		6.44
Note 1: All configurations are assigned to the UE prior to the start of time period T1.			
Note 2: UE-specific PDCCH is not transmitted after T1 starts.			
Note 3: E-UTRAN is in non-DRX mode under test.			

Table A.4.5.1.3.1-3: Cell specific test parameters for FR1 (Cell 2) for out-of-sync radio link monitoring tests in DRX mode

Parameter		Unit	Test 1		
			T1	T2	T3
EPRE ratio of PDCCH DMRS to SSS		dB	4		
EPRE ratio of PDCCH to PDCCH DMRS		dB	0		
EPRE ratio of PBCH DMRS to SSS		dB	0		
EPRE ratio of PBCH to PBCH DMRS		dB			
EPRE ratio of PSS to SSS		dB			
EPRE ratio of PDSCH DMRS to SSS		dB			
EPRE ratio of PDSCH to PDSCH DMRS		dB			
EPRE ratio of OCNG DMRS to SSS		dB			
EPRE ratio of OCNG to OCNG DMRS		dB			
SNR	Config 1, 4	dB			
	Config 2, 5		1	-7	-15
	Config 3, 6		1	-7	-15
N_{oc}	Config 1, 4	dBm/15 KHz	-98		
	Config 2, 5		-98		
	Config 3, 6		-98		
Propagation condition			TDL-C 300ns 100Hz		
<p>Note 1: OCNG shall be used such that the resources in Cell 2 are fully allocated and a constant total transmitted power spectral density is achieved for all OFDM symbols.</p> <p>Note 2: The signal contains PDCCH for UEs other than the device under test as part of OCNG.</p> <p>Note 3: SNR levels correspond to the signal to noise ratio over the SSS REs.</p> <p>Note 4: The SNR in time periods T1, T2 and T3 is denoted as SNR1, SNR2 and SNR3 respectively in Figure A.4.5.1.3.1-1.</p> <p>Note 5: The SNR values are specified for testing a UE which supports 2RX on at least one band. For testing of a UE which supports 4RX on all bands, the SNR during T3 is A.3.6.</p>					

Table A.4.5.1.3.1-4: Void

Table A.4.5.1.3.1-5: Void

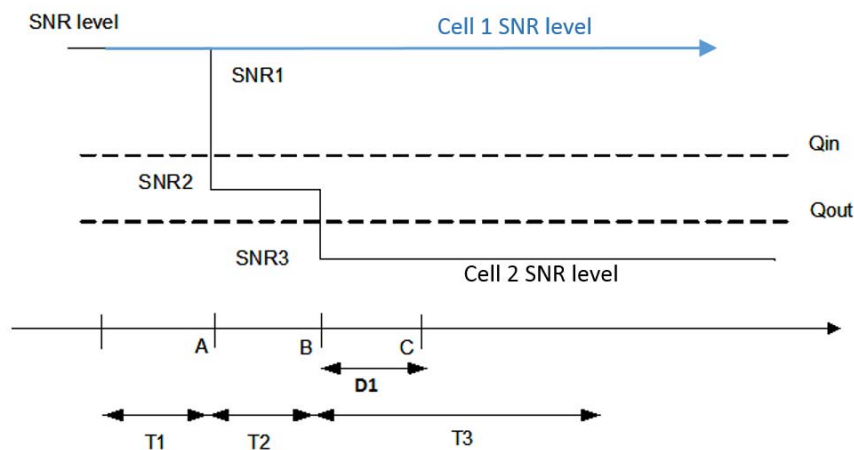

Figure A.4.5.1.3.1-1: SNR variation for out-of-sync testing

A.4.5.1.3.2 Test Requirements

The UE behavior in each test during time durations T1, T2 and T3 shall be as follows:

During the period from time point A to time point B the UE shall transmit uplink signal at least in all uplink slots configured for CSI transmission according to the configured periodic CSI reporting.

The UE shall stop transmitting uplink signal no later than time point C (D1 second after the start of the time duration T3).

The rate of correct events observed during repeated tests shall be at least 90%.

A.4.5.1.4 Radio Link Monitoring In-sync Test for FR1 PSCell configured with SSB-based RLM RS in DRX mode

A.4.5.1.4.1 Test Purpose and Environment

The purpose of this test is to verify that the UE properly detects the out of sync and in sync for the purpose of monitoring downlink radio link quality of the PSCell when DRX is used. This test will partly verify the FR1 radio link monitoring requirements in clause 8.1.

Supported test configurations are shown in table A.4.5.1.4.1-1. The test parameters are given in Tables A.4.5.1.4.1-2, and A.4.5.1.4.1-3. There are two cells, Cell 1 is the E-UTRAN PCell, and Cell 2 is the PSCell, in the test. The E-UTRAN PCell setting refers to Table A.3.7.2.1-1. The test consists of five successive time periods, with time duration of T1, T2, T3, T4 and T5 respectively. Figure A.4.5.1.4.1-1 shows the variation of the downlink SNR in the active Cell 2 to emulate out-of-sync and in-sync states. Prior to the start of the time duration T1, the UE shall be fully synchronized to Cell 1 and Cell 2. The UE shall be configured for periodic CSI reporting with a reporting periodicity of 5 ms. In the test, DRX configuration is enabled and DRX inactivity timer has already been expired, i.e. UE tries to decode PDCCH and to send periodic CSI during the period when On-duration timer is running. Time alignment timers shall be set to “infinity” so that UL timing alignment is maintained during the test.

Table A.4.5.1.4.1-1: Supported test configurations for FR1 PSCell

Configuration	Description
1	LTE FDD, NR 15 KHz SSB SCS, 10MHz bandwidth, FDD duplex mode
2	LTE FDD, NR 15 KHz SSB SCS, 10MHz bandwidth, TDD duplex mode
3	LTE FDD, NR 30 KHz SSB SCS, 40MHz bandwidth, TDD duplex mode
4	LTE TDD, NR 15 KHz SSB SCS, 10MHz bandwidth, FDD duplex mode
5	LTE TDD, NR 15 KHz SSB SCS, 10MHz bandwidth, TDD duplex mode
6	LTE TDD, NR 30 KHz SSB SCS, 40MHz bandwidth, TDD duplex mode
Note:	The UE is only required to pass in one of the supported test configurations in FR1

Table A.4.5.1.4.1-2: General test parameters for FR1 in-sync testing in DRX mode

Parameter	Unit	Value
		Test 1
Active E-UTRA PCell		Cell 1
E-UTRA RF Channel Number		1
Active PSCell		Cell 2
RF Channel Number		2
Duplex mode	Config 1, 4	FDD
	Config 2, 3, 5, 6	TDD
BW _{channel}	Config 1, 4	10: N _{RB,c} = 52
	Config 2, 5	10: N _{RB,c} = 52
	Config 3, 6	40: N _{RB,c} = 106

DL initial BWP configuration	Config 1, 2, 3, 4, 5, 6		DLBWP.0.1
DL dedicated BWP configuration	Config 1, 2, 3, 4, 5, 6		DLBWP.1.1
UL initial BWP configuration	Config 1, 2, 3, 4, 5, 6		ULBWP.0.1
UL dedicated BWP configuration	Config 1, 2, 3, 4, 5, 6		ULBWP.1.1
TDD Configuration	Config 1, 4		Not Applicable
	Config 2, 5		TDDConf.1.1
	Config 3, 6		TDDConf.2.1
CORESET Reference Channel	Config 1, 4		CR.1.1 FDD
	Config 2, 5		CR.1.1 TDD
	Config 3, 6		CR.2.1 TDD
SSB Configuration	Config 1, 4		SSB.1 FR1
	Config 2, 5		SSB.1 FR1
	Config 3, 6		SSB.2 FR1
SMTTC Configuration	Config 1, 2, 4, 5		SMTTC.1
	Config 3, 6		SMTTC.1
PDSCH/PDCCH subcarrier spacing	Config 1, 2, 4, 5		15 KHz
	Config 3, 6		30 KHz
PRACH Configuration	Config 1, 2, 4, 5		Table A.3.8.2.4-1
	Config 3, 6		Table A.3.8.2.4-1
SSB index assigned as RLM RS			0
OCNG parameters			OP.1
CP length			Normal
Correlation Matrix and Antenna Configuration			2x2 Low
In sync transmission parameters	DCI format		1-0
	Number of Control OFDM symbols		2
	Aggregation level	CCE	4
	Ratio of hypothetical PDCCH RE energy to average SSS RE energy	dB	0
	Ratio of hypothetical PDCCH DMRS energy to average SSS RE energy	dB	0
	DMRS precoder granularity		REG bundle size
	REG bundle size		6
Out of sync transmission parameters	DCI format		1-0
	Number of Control OFDM symbols		2
	Aggregation level	CCE	8
	Ratio of hypothetical PDCCH RE energy to average SSS RE energy	dB	4
	Ratio of hypothetical PDCCH DMRS energy to average SSS RE energy	dB	4
	DMRS precoder granularity		REG bundle size
	REG bundle size		6
DRX Configuration			Table A.3.3.3-1
Gap pattern ID			N.A.
Layer 3 filtering			Enabled

T310 timer		ms	2000
T311 timer		ms	1000
N310			1
N311			1
CSI-RS configuration	Config 1, 4		[CSI-RS.1.3 FDD]
	Config 2, 5		[CSI-RS.1.3 TDD]
	Config 3, 6		[CSI-RS.2.3 TDD]
T1		s	4
T2		s	1.6
T3		s	1.36
T4		s	0.4
T5		s	1.4
D1		s	1
Note 1: All configurations are assigned to the UE prior to the start of time period T1.			
Note 2: UE-specific PDCCH is not transmitted after T1 starts.			
Note 3: E-UTRAN is in non-DRX mode under test.			

Table A.4.5.1.4.1-3: Cell specific test parameters for FR1 (Cell 2) for in-sync radio link monitoring tests in DRX mode

Parameter		Unit	Test 1				
			T1	T2	T3	T4	T5
EPRE ratio of PDCCH DMRS to SSS		dB	4				
EPRE ratio of PDCCH to PDCCH DMRS			0				
EPRE ratio of PBCH DMRS to SSS			0				
EPRE ratio of PBCH to PBCH DMRS							
EPRE ratio of PSS to SSS							
EPRE ratio of PDSCH DMRS to SSS							
EPRE ratio of PDSCH to PDSCH DMRS							
EPRE ratio of OCNG DMRS to SSS							
EPRE ratio of OCNG to OCNG DMRS							
SNR	Config 1, 4		dB	1	-7	-15	-4.5
	Config 2, 5	1		-7	-15	-4.5	1
	Config 3, 6	1		-7	-15	-4.5	1
N_{oc}	Config 1, 4	dBm/15 KHz	-98				
	Config 2, 5		-98				
	Config 3, 6		-98				
Propagation condition			TDL-C 300ns 100Hz				
Note 1: OCNG shall be used such that the resources in Cell 2 are fully allocated and a constant total transmitted power spectral density is achieved for all OFDM symbols.							
Note 2: The signal contains PDCCH for UEs other than the device under test as part of OCNG.							
Note 3: SNR levels correspond to the signal to noise ratio over the SSS REs.							
Note 4: The SNR in time periods T1, T2, T3, T4 and T5 is denoted as SNR1, SNR2, SNR3, SNR4 and SNR5 respectively in Figure A.4.5.1.4.1-1.							
Note 5: The SNR values are specified for testing a UE which supports 2RX on at least one band. For testing of a UE which supports 4RX on all bands, the SNR during T3 and T4 is modified as specified in section A.3.6.							

Table A.4.5.1.4.1-4: Void

Table A.4.5.1.4.1-5: Void

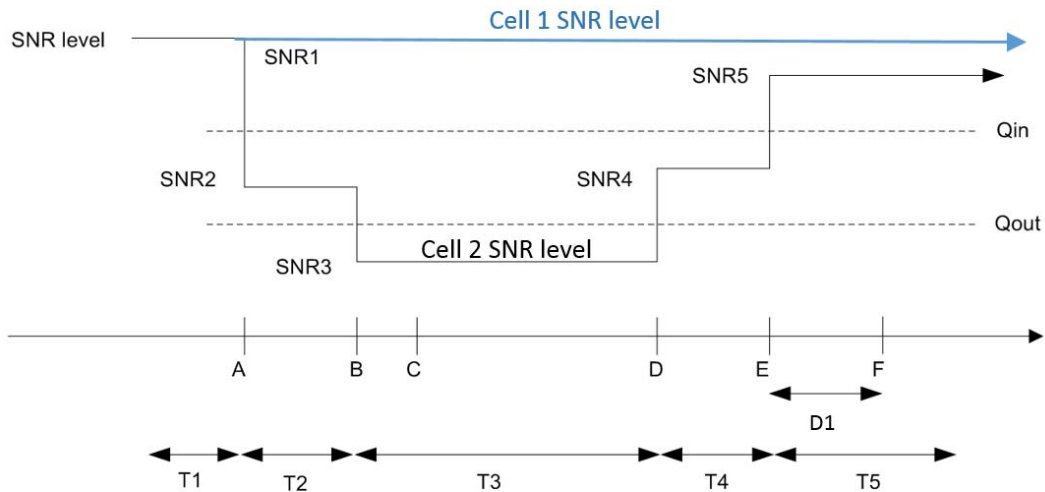

Figure A.4.5.1.4.1-1: SNR variation for in-sync testing

A.4.5.1.4.2 Test Requirements

The UE behaviour in each test during time durations T1, T2, T3, T4 and T5 shall be as follows:

During the period from time point A to time point F (D1 second after the start of time duration T5) the UE shall transmit uplink signal at least in all uplink slots configured for CSI transmission according to the configured periodic CSI reporting.

The rate of correct events observed during repeated tests shall be at least 90%.

A.4.5.1.5 EN-DC Radio Link Monitoring Out-of-sync Test for FR1 PSCell configured with CSI-RS-based RLM in non-DRX mode

A.4.5.1.5.1 Test Purpose and Environment

The purpose of this test is to verify that the UE properly detects the out of sync for the purpose of monitoring downlink CSI-RS based radio link quality of the PSCell when no DRX is used. This test will partly verify the FR1 PSCell CSI-RS Out-of-sync radio link monitoring requirements in clause 8.1.

The test parameters are given in Tables A.4.5.1.5.1-1, A.4.5.1.5.1-2, and A.4.5.1.5.1-3 below. There are two cells, cell 1 is the E-UTRAN PCell, and cell 2 is the PSCell, in the test. The test consists of three successive time periods, with time duration of T1, T2 and T3 respectively. Figure A.4.5.1.5.1-1 shows the variation of the downlink SNR in the E-UTRAN PCell and the PSCell to emulate out-of-sync and in-sync states. Prior to the start of the time duration T1, the UE shall be fully synchronized to cell 1 and cell 2. The UE shall be configured for periodic CSI reporting with a reporting periodicity of [5] or [10] ms. In the test, DRX configuration is not enabled. The UE is configured to perform inter-frequency measurements using GP ID #0 (40ms).

Table A.4.5.1.5.1-1: Supported test configurations for FR1 PSCell

Configuration	Description
1	LTE FDD, NR 15 kHz SSB SCS, 10MHz bandwidth, FDD duplex mode
2	LTE FDD, NR 15 kHz SSB SCS, 10MHz bandwidth, TDD duplex mode
3	LTE FDD, NR 30kHz SSB SCS, 40MHz bandwidth, TDD duplex mode
4	LTE TDD, NR 15 kHz SSB SCS, 10MHz bandwidth, FDD duplex mode
5	LTE TDD, NR 15 kHz SSB SCS, 10MHz bandwidth, TDD duplex mode
6	LTE TDD, NR 30kHz SSB SCS, 40MHz bandwidth, TDD duplex mode
Note: The UE is only required to pass in one of the supported test configurations in FR1	

Table A.4.5.1.5.1-2: General test parameters for FR1 PSCell for CSI-RS out-of-sync testing in non-DRX mode

Parameter		Unit	Value
			Test 1
Active E-UTRA PCell			Cell 1
E-UTRA RF Channel Number			1
Active PSCell			Cell 2
RF Channel Number			2
Duplex mode	Config 1, 4		FDD
	Config 2, 3, 5, 6		TDD
TDD Configuration	Config 1, 4		Not Applicable
	Config 2, 5		TDDConf.1.1
	Config 3, 6		TDDConf.1.2
CORESET Reference Channel	Config 1, 4		CR. 1.1 FDD
	Config 2, 5		CR. 1.1 TDD
	Config 3, 6		CR. 2.1 TDD
SSB Configuration	Config 1, 4		SSB.1 FR1
	Config 2, 5		SSB.1 FR1
	Config 3, 6		SSB.2 FR1
SMTTC Configuration	Config 1, 2, 4, 5		SMTTC.1
	Config 3, 6		SMTTC.1
PDSCH/PDCCH subcarrier spacing	Config 1, 2, 4, 5		15 KHz
	Config 3, 6		30 KHz
csi-RS-Index assigned as RLM RS			[0]
OCNG parameters			OCNG pattern 1
CP length			Normal
Correlation Matrix and Antenna Configuration			[2x2 Low]
Out of sync transmission parameters	DCI format		1-0
	Number of Control OFDM symbols		2
	Aggregation level	CCE	8
	Ratio of hypothetical PDCCH RE energy to average CSI-RS RE energy	dB	4
	Ratio of hypothetical PDCCH DMRS energy to average CSI-RS RE energy	dB	4
	DMRS precoder granularity		REG bundle size

	REG bundle size		6
DRX			OFF
Gap pattern ID			*[gp0]
Layer 3 filtering			Enabled
T310 timer		ms	0
T311 timer		ms	1000
N310			1
N311			1
NZP CSI-RS configuration			[ResourceId 1]
ZP CSI-RS configuration			TBD
CSI-IM configuration			TBD
Periodic CSI reporting			PUCCH
CSI reporting periodicity	Config 1, 2, 4, 5	slot	[5]
	Config 3, 6		[10]
T1		s	1
T2		s	0.4
T3		s	[0.6]
D1		s	[0.24]
Note 1: UE-specific PDCCH is not transmitted after T1 starts.			
Note 2: E-UTRAN is in non-DRX mode under test.			

Table A.4.5.1.5.1-3: Cell specific test parameters for FR1 for CSI-RS out-of-sync radio link monitoring in non-DRX mode

Parameter		Unit	Test 1		
			T1	T2	T3
PDCCH_beta		dB	4		
PDCCH_DMRS_beta		dB	4		
PBCH_beta		dB	0		
PSS_beta		dB			
SSS_beta		dB			
PDSCH_beta		dB			
OCNG_beta		dB			
SNR	Config 1, 4	dB	TBD	TBD	TBD
	Config 2, 5		TBD	TBD	TBD
	Config 3, 6		TBD	TBD	TBD
N_{oc}	Config 1, 4	dBm/15K	[-98]		
	Config 2, 5	Hz	[-98]		
	Config 3, 6		[-98]		
Propagation condition			[TDL-C 300ns 100Hz]		
Note 1: OCNG shall be used such that the resources in Cell 2 are fully allocated and a constant total transmitted power spectral density is achieved for all OFDM symbols.					
Note 2: The uplink resources for CSI reporting are assigned to the UE prior to the start of time period T1.					
Note 3: NZP CSI-RS resource set configuration for CSI reporting are assigned to the UE prior to the start of time period T1.					
Note 4: Measurement gap configuration is assigned to the UE prior to the start of time period T1.					
Note 5: The timers and layer 3 filtering related parameters are configured prior to the start of time period T1.					
Note 6: The signal contains PDCCH for UEs other than the device under test as part of OCNG.					
Note 7: SNR levels correspond to the signal to noise ratio over the SSS REs.					
Note 8: The SNR in time periods T1, T2 and T3 is denoted as SNR1, SNR2 and SNR3 respectively in figure A.4.5.1.5.1-1.					
Note 9: The SNR values are specified for testing a UE which supports 2RX on at least one band. For testing of a UE which supports 4RX on all bands, the SNR during T3 is [A.3.6].					

Table A.4.5.1.5.1-3A: Measurement gap configuration for FR1 CSI-RS out-of-sync radio link monitoring in non-DRX mode

Field	Test 1
	Value
gapOffset	[0]
Note 1: E-UTRAN PCell and PSCell are SFN-synchronous and frame boundary aligned. (Ensure that RLM RS is partially overlapped with measurement gap)	

Table A.4.5.1.5.1-4: NZP-CSI-RS resource configuration for FR1 CSI-RS out-of-sync radio link monitoring in non-DRX mode

Field	ResourceId 0	ResourceId 1
	Value	Value
frequencyDomainAllocation ^{Note 1}	row1	row2
startingRB	0	0
nrofRBs	Note 2	Note 2
Note 1: TS 38.211 [6] table 7.4.1.5.3-1		
Note 2: nrofRBs is derived based on the Configuration in Table A.4.5.1.5.1-1		

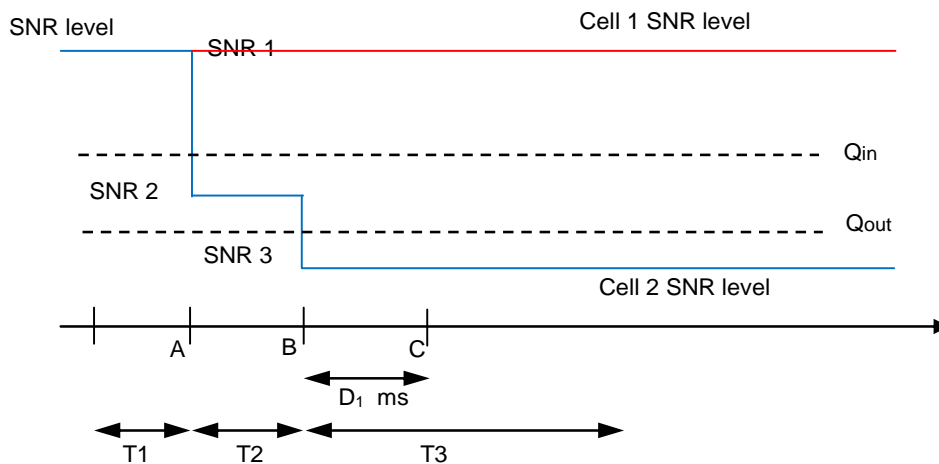

Figure A.4.5.1.5.1-1: SNR variation for CSI-RS out-of-sync testing

A.4.5.1.5.2 Test Requirements

The UE behaviour during time durations T1, T2, and T3 shall be as follows:

During time durations T1, T2 and T3, the UE shall transmit uplink signal at least in all subframes configured for CSI transmission on Cell 1 (E-UTRAN PCell).

During the period from time point A to time point B the UE shall transmit uplink signal in Cell 2 (PSCell) at least in all uplink slots configured for CSI transmission according to the configured periodic CSI reporting for Cell 2.

The UE shall stop transmitting uplink signal in Cell 2 (PSCell) no later than time point C ($D_1 = [\text{TBD}]$ ms) after the start of the time duration T3) on the PSCell.

The rate of correct events observed during repeated tests shall be at least 90%.

A.4.5.1.6 EN-DC Radio Link Monitoring In-sync Test for FR1 PSCell configured with CSI-RS-based RLM in non-DRX mode

A.4.5.1.6.1 Test Purpose and Environment

The purpose of this test is to verify that the UE properly detects the in sync for the purpose of monitoring downlink CSI-RS based radio link quality of the PSCell when no DRX is used. This test will partly verify the FR1 PSCell CSI-RS In-sync radio link monitoring requirements in clause 8.1.

The test parameters are given in Tables A.4.5.1.6.1-1, A.4.5.1.6.1-2, A.4.5.1.6.1-3, A.4.5.1.6.1-4, A.4.5.1.6.1-5, and A.4.5.1.6.1-6 below. There are two cells, cell 1 which is the E-UTRAN PCcell, and cell 2 is the PSCell, in the test. The test consists of five successive time periods, with time duration of T1, T2, T3, T4 and T5 respectively. Figure A.4.5.1.6.1-1 shows the variation of the downlink SNR in the PSCell to emulate out-of-sync and in-sync states. Prior to the start of the time duration T1, the UE shall be fully synchronized to cell 1 and cell 2. The UE shall be configured for periodic CSI reporting with a reporting periodicity of [5] or [10] ms. In the test, DRX configuration is not enabled. The UE is configured to perform inter-frequency measurements without gaps.

Table A.4.5.1.6.1-1: Supported test configurations for FR1 PSCell

Configuration	Description
1	LTE FDD, NR 15 kHz SSB SCS, 10MHz bandwidth, FDD duplex mode
2	LTE FDD, NR 15 kHz SSB SCS, 10MHz bandwidth, TDD duplex mode
3	LTE FDD, NR 30kHz SSB SCS, 40MHz bandwidth, TDD duplex mode
4	LTE TDD, NR 15 kHz SSB SCS, 10MHz bandwidth, FDD duplex mode
5	LTE TDD, NR 15 kHz SSB SCS, 10MHz bandwidth, TDD duplex mode
6	LTE TDD, NR 30kHz SSB SCS, 40MHz bandwidth, TDD duplex mode
Note:	The UE is only required to pass in one of the supported test configurations in FR1

Table A.4.5.1.6.1-2: General test parameters for FR1 PSCell for CSI-RS in-sync testing in non-DRX mode

Parameter		Unit	Value
			Test 1
Active E-UTRA PCcell			Cell 1
E-UTRA RF Channel Number			1
Active PSCell			Cell 2
RF Channel Number			2
Duplex mode	Config 1, 4		FDD
	Config 2, 3, 5, 6		TDD
TDD Configuration	Config 1, 4		Not Applicable
	Config 2, 5		TDDConf.1.1
	Config 3, 6		TDDConf.1.2
CORESET Reference Channel	Config 1, 4		CR. 1.1 FDD
	Config 2, 5		CR. 1.1 TDD
	Config 3, 6		CR. 2.1 TDD
SSB Configuration	Config 1, 4		SSB.1 FR1
	Config 2, 5		SSB.1 FR1
	Config 3, 6		SSB.2 FR1
SMTTC Configuration	Config 1, 2, 4, 5		SMTTC.1
	Config 3, 6		SMTTC.1

PDSCH/PDCCH subcarrier spacing	Config 1, 2, 4, 5		15 KHz
	Config 3, 6		30 KHz
csi-RS-Index assigned as RLM RS			[0]
OCNG parameters			OCNG pattern 1
CP length			Normal
Correlation Matrix and Antenna Configuration			[2x2 Low]
Out of sync transmission parameters	DCI format		1-0
	Number of Control OFDM symbols		2
	Aggregation level	CCE	8
	Ratio of hypothetical PDCCH RE energy to average CSI-RS RE energy	dB	4
	Ratio of hypothetical PDCCH DMRS energy to average CSI-RS RE energy	dB	4
	DMRS precoder granularity		REG bundle size
	REG bundle size		6
In sync transmission parameters	DCI format		1-0
	Number of Control OFDM symbols		2
	Aggregation level	CCE	4
	Ratio of hypothetical PDCCH RE energy to average CSI-RS RE energy	dB	0
	Ratio of hypothetical PDCCH DMRS energy to average CSI-RS RE energy	dB	0
	DMRS precoder granularity		REG bundle size
	REG bundle size		6
DRX			OFF
Gap pattern ID			[N.A.]
Layer 3 filtering			Enabled
T310 timer		ms	0
T311 timer		ms	1000
N310			1
N311			1
NZP CSI-RS configuration			[ResourceId 1]
ZP CSI-RS configuration			TBD
CSI-IM configuration			TBD
Periodic CSI reporting			PUCCH
CSI reporting periodicity	Config 1, 2, 4, 5	slot	[5]
	Config 3, 6		[10]
T1		s	1
T2		s	0.4
T3		s	[0.6]
D1		s	[0.24]
Note 1: UE-specific PDCCH is not transmitted after T1 starts.			
Note 2: E-UTRAN is in non-DRX mode under test.			

Table A.4.5.1.6.1-3: Cell specific test parameters for FR1 for CSI-RS in-sync radio link monitoring in non-DRX mode

Parameter		Unit	Test 1		
			T1	T2	T3
PDCCH_beta		dB	4		
PDCCH_DMRS_beta		dB	4		
PBCH_beta		dB	0		
PSS_beta		dB			
SSS_beta		dB			
PDSCH_beta		dB			
OCNG_beta		dB			
SNR	Config 1, 4	dB			
	Config 2, 5		TBD	TBD	TBD
	Config 3, 6		TBD	TBD	TBD
N_{oc}	Config 1, 4	dBm/15KHz	[-98]		
	Config 2, 5		[-98]		
	Config 3, 6		[-98]		
Propagation condition			[TDL-C 300ns 100Hz]		
Note 1: OCNG shall be used such that the resources in Cell 2 are fully allocated and a constant total transmitted power spectral density is achieved for all OFDM symbols.					
Note 2: The uplink resources for CSI reporting are assigned to the UE prior to the start of time period T1.					
Note 3: NZP CSI-RS resource set configuration for CSI reporting are assigned to the UE prior to the start of time period T1.					
Note 4: Measurement gap configuration is assigned to the UE prior to the start of time period T1.					
Note 5: The timers and layer 3 filtering related parameters are configured prior to the start of time period T1.					
Note 6: The signal contains PDCCH for UEs other than the device under test as part of OCNG.					
Note 7: SNR levels correspond to the signal to noise ratio over the SSS REs.					
Note 8: The SNR in time periods T1, T2 and T3 is denoted as SNR1, SNR2 and SNR3 respectively in figure A.4.5.1.6.1-1.					
Note 9: The SNR values are specified for testing a UE which supports 2RX on at least one band. For testing of a UE which supports 4RX on all bands, the SNR during T3 is [A.3.6].					

Table A.4.5.1.6.1-3A: Measurement gap configuration for FR1 CSI-RS in-sync radio link monitoring in non-DRX mode

Field	Test 4
	Value
gapOffset	[0]
Note 1: E-UTRAN PCell and PSCell are SFN-synchronous and frame boundary aligned. (Ensure that RLM RS is partially overlapped with measurement gap)	

Table A.4.5.1.6.1-4: NZP-CSI-RS resource configuration for FR1 CSI-RS in-sync radio link monitoring in non-DRX mode

Field	Resourceld 0	Resourceld 1
	Value	Value
frequencyDomainAllocation ^{Note 1}	row1	row2
startingRB	0	0
nrofRBs	Note 2	Note 2
Note 1: TS 38.211 [6] table 7.4.1.5.3-1		
Note 2: nrofRBs is derived based on the Configuration in Table A.4.5.1.6.1-1		

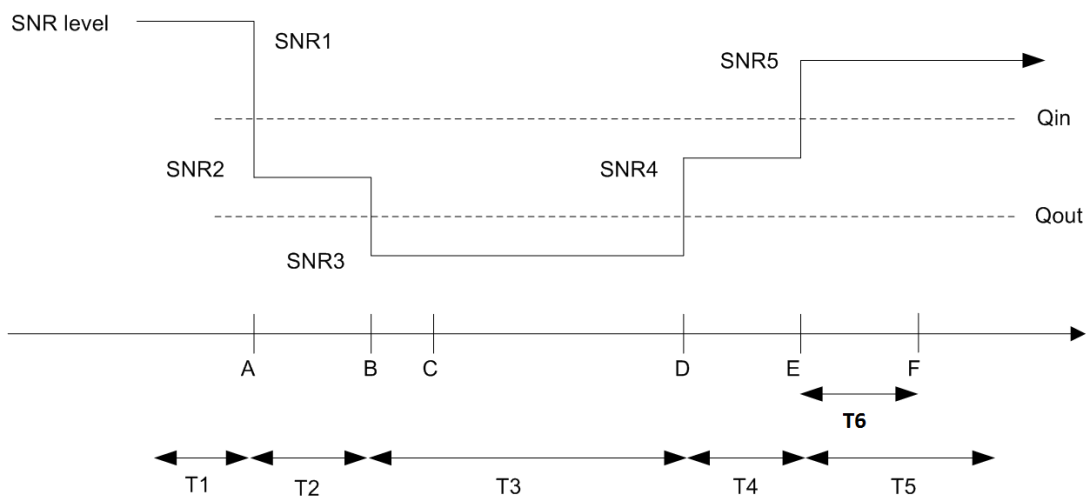

Figure A.4.5.1.6.1-1: SNR variation for CSI-RS in-sync testing

A.4.5.1.6.2 Test Requirements

The UE behaviour in each test during time durations T1, T2, T3, T4 and T5 shall be as follows:

During the period from time point A to time point F (T6 second after the start of time duration T5) the UE shall transmit uplink signal at least in all uplink slots configured for CSI transmission according to the configured periodic CSI reporting on the PSCell.

The rate of correct events observed during repeated tests shall be at least 90%.

A.4.5.1.7 EN-DC Radio Link Monitoring Out-of-sync Test for FR1 PSCell configured with CSI-RS-based RLM in DRX mode

A.4.5.1.7.1 Test Purpose and Environment

The purpose of this test is to verify that the UE properly detects the out of sync for the purpose of monitoring downlink CSI-RS based radio link quality of the PSCell when no DRX is used. This test will partly verify the FR1 PSCell CSI-RS Out-of-sync radio link monitoring requirements in clause 8.1.

The test parameters are given in Tables A.4.5.1.7.1-1, A.4.5.1.7.1-2, and A.4.5.1.7.1-3 below. There are two cells, cell 1 is the E-UTRAN PCell, and cell 2 is the PSCell, in the test. The test consists of three successive time periods, with time duration of T1, T2 and T3 respectively. Figure A.4.5.1.7.1-1 shows the variation of the downlink SNR in the E-UTRAN PCell and the PSCell to emulate out-of-sync and in-sync states. Prior to the start of the time duration T1, the UE shall be fully synchronized to cell 1 and cell 2. The UE shall be configured for periodic CSI reporting with a reporting periodicity of [5] or [10] ms. In the test, DRX configuration is enabled in PSCell and DRX inactivity timer has already been expired, i.e. UE tries to decode PDCCH and to send periodic CQI during the period when On-duration timer is running. Time alignment timers shall be set to “infinity” so that UL timing alignment is maintained during the test. The UE is configured to perform inter-frequency measurements without gap.

Table A.4.5.1.7.1-1: Supported test configurations for FR1 PSCell

Configuration	Description
1	LTE FDD, NR 15 kHz SSB SCS, 10MHz bandwidth, FDD duplex mode
2	LTE FDD, NR 15 kHz SSB SCS, 10MHz bandwidth, TDD duplex mode
3	LTE FDD, NR 30kHz SSB SCS, 40MHz bandwidth, TDD duplex mode
4	LTE TDD, NR 15 kHz SSB SCS, 10MHz bandwidth, FDD duplex mode
5	LTE TDD, NR 15 kHz SSB SCS, 10MHz bandwidth, TDD duplex mode
6	LTE TDD, NR 30kHz SSB SCS, 40MHz bandwidth, TDD duplex mode

Note: The UE is only required to pass in one of the supported test configurations in FR1

Table A.4.5.1.7.1-2: General test parameters for FR1 PSCell for CSI-RS out-of-sync testing in DRX mode

Parameter	Unit	Value
		Test 1
Active E-UTRA PCell		Cell 1
E-UTRA RF Channel Number		1
Active PSCell		Cell 2
RF Channel Number		2
Duplex mode	Config 1, 4	FDD
	Config 2, 3, 5, 6	TDD
TDD Configuration	Config 1, 4	Not Applicable
	Config 2, 5	TDDConf.1.1
	Config 3, 6	TDDConf.1.2
CORESET Reference Channel	Config 1, 4	CR. 1.1 FDD
	Config 2, 5	CR. 1.1 TDD
	Config 3, 6	CR. 2.1 TDD
SSB Configuration	Config 1, 4	SSB.1 FR1
	Config 2, 5	SSB.1 FR1
	Config 3, 6	SSB.2 FR1
SMTC Configuration	Config 1, 2, 4, 5	SMTC.1
	Config 3, 6	SMTC.1
PDSCH/PDCCH subcarrier spacing	Config 1, 2, 4, 5	15 KHz
	Config 3, 6	30 KHz
csi-RS-Index assigned as RLM RS		[0]
OCNG parameters		OCNG pattern 1
CP length		Normal
Correlation Matrix and Antenna Configuration		[2x2 Low]
	DCI format	1-0
	Number of Control OFDM symbols	2
	Aggregation level	CCE 8

Out of sync transmission parameters	Ratio of hypothetical PDCCH RE energy to average CSI-RS RE energy	dB	4
	Ratio of hypothetical PDCCH DMRS energy to average CSI-RS RE energy	dB	4
	DMRS precoder granularity		REG bundle size
	REG bundle size		6
DRX			640
Gap pattern ID			[N.A.]
Layer 3 filtering			Enabled
T310 timer		ms	0
T311 timer		ms	1000
N310			1
N311			1
NZP CSI-RS configuration			[ResourceId 1]
ZP CSI-RS configuration			TBD
CSI-IM configuration			TBD
Periodic CSI reporting			PUCCH
CSI reporting periodicity	Config 1, 2, 4, 5	slot	[5]
	Config 3, 6		[10]
T1		s	1
T2		s	0.4
T3		s	[0.6]
D1		s	[0.24]
Note 1: UE-specific PDCCH is not transmitted after T1 starts.			
Note 2: E-UTRAN is in non-DRX mode under test.			

Table A.4.5.1.7.1-3: Cell specific test parameters for FR1 for CSI-RS out-of-sync radio link monitoring in DRX mode

Parameter		Unit	Test 1		
			T1	T2	T3
PDCCH_beta		dB	4		
PDCCH_DMRS_beta		dB	4		
PBCH_beta		dB	0		
PSS_beta		dB			
SSS_beta		dB			
PDSCH_beta		dB			
OCNG_beta		dB			
SNR	Config 1, 4	dB	TBD	TBD	TBD
	Config 2, 5		TBD	TBD	TBD
	Config 3, 6		TBD	TBD	TBD
N_{oc}	Config 1, 4	dBm/15KHz	[-98]		
	Config 2, 5		[-98]		
	Config 3, 6		[-98]		
Propagation condition			[TDL-C 300ns 100Hz]		
Note 1: OCNG shall be used such that the resources in Cell 2 are fully allocated and a constant total transmitted power spectral density is achieved for all OFDM symbols.					
Note 2: The uplink resources for CSI reporting are assigned to the UE prior to the start of time period T1.					
Note 3: NZP CSI-RS resource set configuration for CSI reporting are assigned to the UE prior to the start of time period T1.					
Note 4: Measurement gap configuration is assigned to the UE prior to the start of time period T1.					
Note 5: The timers and layer 3 filtering related parameters are configured prior to the start of time period T1.					
Note 6: The signal contains PDCCH for UEs other than the device under test as part of OCNG.					
Note 7: SNR levels correspond to the signal to noise ratio over the SSS REs.					
Note 8: The SNR in time periods T1, T2 and T3 is denoted as SNR1, SNR2 and SNR3 respectively in figure A.4.5.1.7.1-1.					
Note 9: The SNR values are specified for testing a UE which supports 2RX on at least one band. For testing of a UE which supports 4RX on all bands, the SNR during T3 is [A.3.6].					

Table A.4.5.1.7.1-3A: Measurement gap configuration for FR1 CSI-RS out-of-sync radio link monitoring in DRX mode

Field	Test 6
	Value
gapOffset	[0]
Note 1: E-UTRAN PCell and PSCell are SFN-synchronous and frame boundary aligned. (Ensure that RLM RS is partially overlapped with measurement gap)	

Table A.4.5.1.7.1-4: NZP-CSI-RS resource configuration for FR1 CSI-RS out-of-sync radio link monitoring in DRX mode

Field	ResourceId 0	ResourceId 1
	Value	Value
frequencyDomainAllocation ^{Note 1}	row1	row2
startingRB	0	0
nrofRBs	Note 2	Note 2
Note 1: TS 38.211 [6] table 7.4.1.5.3-1		
Note 2: nrofRBs is derived based on the Configuration in Table A.4.5.1.7.1-1		

Table A.4.5.1.7.1-5: DRX-Configuration for FR1 CSI-RS out-of-sync radio link monitoring in DRX mode.

Field	Test 1 Value
	drx-onDurationTimer
drx-InactivityTimer	[ms1]
drx-RetransmissionTimerDL	[sl1]
drx-RetransmissionTimerUL	[sl1]
longDRX-CycleStartOffset	[ms640]
shortDRX	disable

Table A.4.5.1.7.1-6: TimeAlignmentTimer -Configuration for FR1 CSI-RS out-of-sync radio link monitoring in DRX mode.

Field		Test 1 Value
TimeAlignmentTimer		infinity
periodicityAndOffset in SchedulingRequestResourceConfig	Config 1, 2, 4, 5	[sl5]
	Config 3, 6	[sl10]

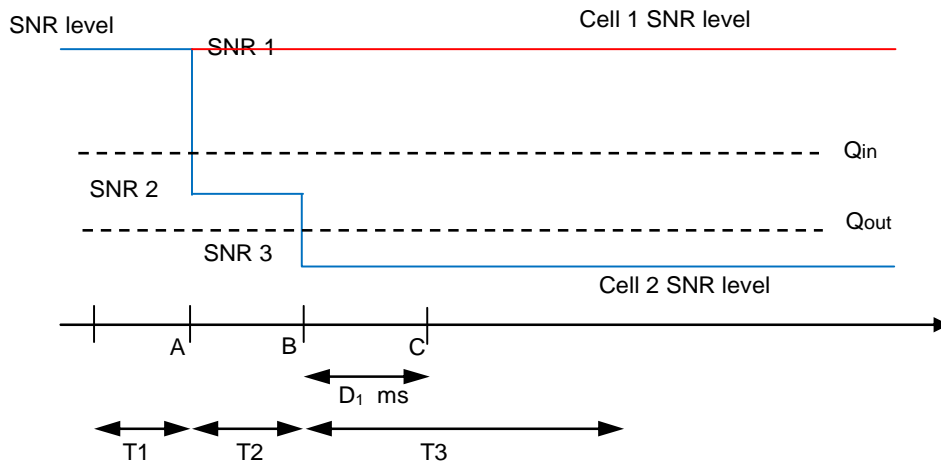

Figure A.4.5.1.7.1-1: SNR variation for CSI-RS out-of-sync testing

A.4.5.1.7.2 Test Requirements

The UE behaviour during time durations T1, T2, and T3 shall be as follows:

During time durations T1, T2 and T3, the UE shall transmit uplink signal at least in all subframes configured for CSI transmission on Cell 1 (E-UTRAN PCell).

During the period from time point A to time point B the UE shall transmit uplink signal in Cell 2 (PSCell) at least in all uplink slots configured for CSI transmission according to the configured periodic CSI reporting for Cell 2.

The UE shall stop transmitting uplink signal in Cell 2 (PSCell) no later than time point C ($D_1 = [\text{TBD}]$ ms after the start of the time duration T3) on the PSCell.

The rate of correct events observed during repeated tests shall be at least 90%.

A.4.5.1.8 EN-DC Radio Link Monitoring In-sync Test for FR1 PSCell configured with CSI-RS-based RLM in DRX mode

A.4.5.1.8.1 Test Purpose and Environment

The purpose of this test is to verify that the UE properly detects the in sync for the purpose of monitoring downlink CSI-RS based radio link quality of the PSCell when no DRX is used. This test will partly verify the FR1 PSCell CSI-RS In-sync radio link monitoring requirements in clause 8.1.

The test parameters are given in Tables A.4.5.1.8.1-1, A.4.5.1.8.1-2, A.4.5.1.8.1-3 and A.4.5.1.8.1-4 below. There are two cells, cell 1 which is the E-UTRAN PCell, and cell 2 is the NR PSCell, in the test. The test consists of five successive time periods, with time duration of T1, T2, T3, T4 and T5 respectively. Figure A.4.5.1.8.1-1 shows the variation of the downlink SNR in the PSCell to emulate out-of-sync and in-sync states. Prior to the start of the time duration T1, the UE shall be fully synchronized to cell 1 and cell 2. The UE shall be configured for periodic CSI reporting with a reporting periodicity of [5] or [10] ms. In the test, DRX configuration is not enabled. The UE is configured to perform inter-frequency measurements using GP ID #0 (40ms).

Table A.4.5.1.8.1-1: Supported test configurations for FR1 PSCell

Configuration	Description
1	LTE FDD, NR 15 kHz SSB SCS, 10MHz bandwidth, FDD duplex mode
2	LTE FDD, NR 15 kHz SSB SCS, 10MHz bandwidth, TDD duplex mode
3	LTE FDD, NR 30kHz SSB SCS, 40MHz bandwidth, TDD duplex mode
4	LTE TDD, NR 15 kHz SSB SCS, 10MHz bandwidth, FDD duplex mode
5	LTE TDD, NR 15 kHz SSB SCS, 10MHz bandwidth, TDD duplex mode
6	LTE TDD, NR 30kHz SSB SCS, 40MHz bandwidth, TDD duplex mode
Note: The UE is only required to pass in one of the supported test configurations in FR1	

Table A.4.5.1.8.1-2: General test parameters for FR1 PSCell for CSI-RS in-sync testing in non-DRX mode

Parameter		Unit	Value Test 8
Active E-UTRA PCell			Cell 1
E-UTRA RF Channel Number			1
Active PSCell			Cell 2
RF Channel Number			2
Duplex mode	Config 1, 4		FDD
	Config 2, 3, 5, 6		TDD
TDD Configuration	Config 1, 4		Not Applicable
	Config 2, 5		TDDConf. 1.1
	Config 3, 6		TDDConf. 1.2
CORESET Reference Channel	Config 1, 4		CR. 1.1 FDD
	Config 2, 5		CR. 1.1 TDD
	Config 3, 6		CR. 2.1 TDD
SSB Configuration	Config 1, 4		SSB.1 FR1
	Config 2, 5		SSB.1 FR1
	Config 3, 6		SSB.2 FR1
SMTC Configuration	Config 1, 2, 4, 5		SMTC.1
	Config 3, 6		SMTC.1
PDSCH/PDCCH subcarrier spacing	Config 1, 2, 4, 5		15 KHz
	Config 3, 6		30 KHz
csi-RS-Index assigned as RLM RS			[0]
OCNG parameters			OCNG pattern 1
CP length			Normal
Correlation Matrix and Antenna Configuration			[2x2 Low]
Out of sync transmission parameters	DCI format		1-0
	Number of Control OFDM symbols		2
	Aggregation level	CCE	8
	Ratio of hypothetical PDCCH RE energy to average CSI-RS RE energy	dB	4
	Ratio of hypothetical PDCCH DMRS energy to average CSI-RS RE energy	dB	4
	DMRS precoder granularity		REG bundle size

In sync transmission parameters	REG bundle size		6
	DCI format		1-0
	Number of Control OFDM symbols		2
	Aggregation level	CCE	4
	Ratio of hypothetical PDCCH RE energy to average CSI-RS RE energy	dB	0
	Ratio of hypothetical PDCCH DMRS energy to average CSI-RS RE energy	dB	0
	DMRS precoder granularity		REG bundle size
	REG bundle size		6
DRX			640
Gap pattern ID			*[gp0]
Layer 3 filtering			Enabled
T310 timer	ms		0
T311 timer	ms		1000
N310			1
N311			1
NZP CSI-RS configuration			[ResourceId 0]
ZP CSI-RS configuration			TBD
CSI-IM configuration			TBD
Periodic CSI reporting			PUCCH
CSI reporting periodicity	Config 1, 2, 4, 5	slot	[5]
	Config 3, 6		[10]
T1	s		1
T2	s		0.4
T3	s		[0.6]
D1	s		[0.44]
Note 1:	UE-specific PDCCH is not transmitted after T1 starts.		
Note 2:	E-UTRAN is in non-DRX mode under test.		

Table A.4.5.1.8.1-3: Cell specific test parameters for FR1 for CSI-RS in-sync radio link monitoring in non-DRX mode

Parameter		Unit	Test 1		
			T1	T2	T3
PDCCH_beta		dB	4		
PDCCH_DMRS_beta		dB	4		
PBCH_beta		dB	0		
PSS_beta		dB			
SSS_beta		dB			
PDSCH_beta		dB			
OCNG_beta		dB			
SNR	Config 1, 4	dB			
	Config 2, 5		TBD	TBD	TBD
	Config 3, 6		TBD	TBD	TBD
N_{oc}	Config 1, 4	dBm/15KHz	[-98]		
	Config 2, 5		[-98]		
	Config 3, 6		[-98]		
Propagation condition			[TDL-C 300ns 100Hz]		
<p>Note 1: OCNG shall be used such that the resources in Cell 2 are fully allocated and a constant total transmitted power spectral density is achieved for all OFDM symbols.</p> <p>Note 2: The uplink resources for CSI reporting are assigned to the UE prior to the start of time period T1.</p> <p>Note 3: NZP CSI-RS resource set configuration for CSI reporting are assigned to the UE prior to the start of time period T1.</p> <p>Note 4: Measurement gap configuration is assigned to the UE prior to the start of time period T1.</p> <p>Note 5: The timers and layer 3 filtering related parameters are configured prior to the start of time period T1.</p> <p>Note 6: The signal contains PDCCH for UEs other than the device under test as part of OCNG.</p> <p>Note 7: SNR levels correspond to the signal to noise ratio over the SSS REs.</p> <p>Note 8: The SNR in time periods T1, T2 and T3 is denoted as SNR1, SNR2 and SNR3 respectively in figure A.4.5.1.8.1-1.</p> <p>Note 9: The SNR values are specified for testing a UE which supports 2RX on at least one band. For testing of a UE which supports 4RX on all bands, the SNR during T3 is [A.3.6].</p>					

Table A.4.5.1.8.1-3A: Measurement gap configuration for FR1 CSI-RS in-sync radio link monitoring in non-DRX mode

Field	Test 8
	Value
gapOffset	[0]
<p>Note 1: E-UTRAN PCell and PSCell are SFN-synchronous and frame boundary aligned. (Ensure that RLM RS is partially overlapped with measurement gap)</p>	

Table A.4.5.1.8.1-4: NZP-CSI-RS resource configuration for FR1 CSI-RS in-sync radio link monitoring in non-DRX mode

Field	ResourceId 0	ResourceId 1
	Value	Value
frequencyDomainAllocation ^{Note 1}	row1	row2
startingRB	0	0
nrofRBs	Note 2	Note 2
Note 1: TS 38.211 [6] table 7.4.1.5.3-1		
Note 2: nrofRBs is derived based on the Configuration in Table A.4.5.1.8.1-1		

Table A.4.5.1.8.1-5: DRX-Configuration for FR1 CSI-RS in-sync radio link monitoring in DRX mode.

Field	Test 1 Value
	drx-onDurationTimer
drx-InactivityTimer	[ms1]
drx-RetransmissionTimerDL	[s1]
drx-RetransmissionTimerUL	[s1]
longDRX-CycleStartOffset	[ms40]
shortDRX	disable

Table A.4.5.1.8.1-6: TimeAlignmentTimer -Configuration for FR1 CSI-RS in-sync radio link monitoring in DRX mode.

Field		Test 1 Value
TimeAlignmentTimer		infinity
periodicityAndOffset in SchedulingRequestResourceConfig	Config 1, 2, 4, 5	[s15]
	Config 3, 6	[s10]

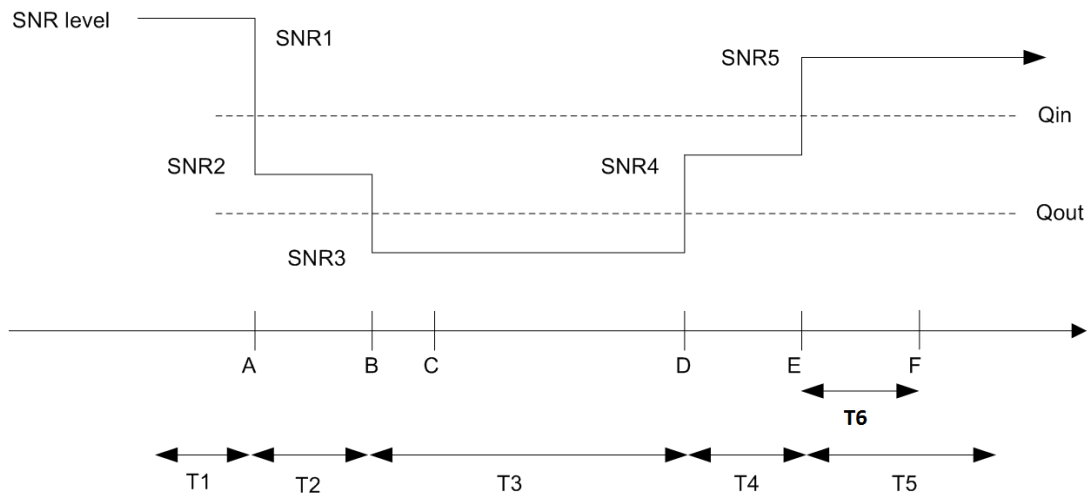

Figure A.4.5.1.8.1-1: SNR variation for CSI-RS in-sync testing

A.4.5.1.8.2 Test Requirements

The UE behaviour in each test during time durations T1, T2, T3, T4 and T5 shall be as follows:

During the period from time point A to time point F (T6 second after the start of time duration T5) the UE shall transmit uplink signal at least in all uplink slots configured for CSI transmission according to the configured periodic CSI reporting on the PSCell.

The rate of correct events observed during repeated tests shall be at least 90%.

A.4.5.2 Interruption

A.4.5.2.1 E-UTRAN – NR FR1 interruptions at transitions between active and non-active during DRX in synchronous EN-DC

A.4.5.2.1.1 Test Purpose and Environment

The purpose of this test is to verify that when LTE PCell is in DRX and NR PSCell is in non-DRX, NR PSCell interruptions due to transitions from active to non-active and from non-active to active during LTE PCell DRX the UE missed ACK/NACK does not exceed the limits. This test will verify the missed ACK/NACK rate for NR PSCell in EN-DC specified in TS38.133 section 8. 2.1.2. Supported test configurations are shown in table A.4.5.2.1.1-1.

The general test parameters and NR cell specific test parameters are given in Table A.4.5.2.1.1-2 and A.4.5.2.1.1-3. The E-UTRAN PCell DRX configuration parameters are given in Table A.4.5.2.1.1-4 below. And the E-UTRAN cell specific test parameters can refer to Table A.3.7.2.1-1. In the test there are two cells: Cell1 and Cell2. Cell1 is LTE PCell and Cell2 is NR FR1 PSCell. The test consists of one time period, with duration of T1. During T1, NR PSCell is continuously scheduled in DL while LTE PCell is not scheduled and has DRX configured. Prior to the start of the time duration T1, the UE shall be fully synchronized to Cell1 and Cell2. Cell1 shall be configured as LTE PCell and Cell2 shall be configured as NR PSCell. Prior to start of T1 the DRX inactivity timer for the LTE PCell has already expired. During T1 the UE shall be continuously scheduled on NR PSCell while not scheduled on LTE PCell. CORESET indicating a new transmission on PSCell shall be sent continuously during the whole time duration to ensure UE would not enter DRX state on PSCell.

Table A.4.5.2.1.1-1: Interruption at transitions between active and non-active during DRX supported test configurations

Config	Description
1	LTE FDD, NR 15 kHz SSB SCS, 10MHz bandwidth, FDD duplex mode
2	LTE FDD, NR 15 kHz SSB SCS, 10MHz bandwidth, TDD duplex mode
3	LTE FDD, NR 30kHz SSB SCS, 40MHz bandwidth, TDD duplex mode
4	LTE TDD, NR 15 kHz SSB SCS, 10MHz bandwidth, FDD duplex mode
5	LTE TDD, NR 15 kHz SSB SCS, 10MHz bandwidth, TDD duplex mode
6	LTE TDD, NR 30kHz SSB SCS, 40MHz bandwidth, TDD duplex mode

Note: The UE is only required to be tested in one of the supported test configurations

Table A.4.5.2.1.1-2: General test parameters for E-UTRAN – NR FR1 interruptions at transitions between active and non-active during DRX in synchronous EN-DC

Parameter	Unit	Value	Comment
RF Channel Number		1, 2	One is E-UTRAN RF channel and the other is NR RF channel
Active PCell		Cell1	PCell on E-UTRAN RF channel number 1.
Configured PSCell		Cell2	PSCell on NR RF channel number 2.
CP length		Normal	Applicable to cell1 and cell 2
DRX		ON	DRX related parameters are defined in Table A.4.5.2.1.1-3
Measurement gap pattern Id		OFF	
T1	s	10	

Table A.4.5.2.1.1-3: NR cell specific test parameters for E-UTRAN – NR FR1 interruptions at transitions between active and non-active during DRX in synchronous EN-DC

Parameter	Unit	Cell 2
Frequency Range		FR1
Duplex mode	Config 1,4	FDD
	Config 2,3,5,6	TDD
TDD configuration	Config 1,4	Not Applicable
	Config 2,5	TDDConf.1.1
	Config 3,6	TDDConf.2.1
BW _{channel}	Config 1,4	10: N _{RB,c} = 52
	Config 2,5	10: N _{RB,c} = 52
	Config 3,6	40: N _{RB,c} = 106
Initial BWP Configuration	Config 1,4	DLBWP.0
	Config 2,5	DLBWP.0
	Config 3,6	DLBWP.0
PDSCH Reference measurement channel	Config 1,4	SR.1.1 FDD
	Config 2,5	SR.1.1 TDD
	Config 3,6	SR2.1 TDD
RMSI CORESET parameters	Config 1,4	CR.1.1 FDD
	Config 2,5	CR.1.1 TDD
	Config 3,6	CR2.1 TDD
PDCCH CORESET parameters	Config 1,4	CCR.1.1 FDD
	Config 2,5	CCR.1.1 TDD
	Config 3,6	CCR2.1 TDD
OCNG Patterns		OP.1
SMTC Configuration		SMTC.1
TCI state		TCI.State.0
SSB Configuration	Config 1,2,4,5	SSB.1 FR1
	Config 3,6	SSB.2 FR1

Correlation Matrix and Antenna Configuration			1x2 Low
EPRE ratio of PSS to SSS		dB	0
EPRE ratio of PBCH DMRS to SSS			
EPRE ratio of PBCH to PBCH DMRS			
EPRE ratio of PDCCH DMRS to SSS			
EPRE ratio of PDCCH to PDCCH DMRS			
EPRE ratio of PDSCH DMRS to SSS			
EPRE ratio of PDSCH to PDSCH			
EPRE ratio of OCNG DMRS to SSS(Note 1)			
EPRE ratio of OCNG to OCNG DMRS (Note 1)			
N_{oc} ^{Note 2}		dBm/15 kHz	[-104]
SS-RSRP ^{Note 3}		dBm/15 kHz	[-87]
\bar{E}_s/I_{ot}		dB	17
\bar{E}_s/N_{oc}		dB	17
I_o ^{Note3}	Config 1,2,4,5	dBm/9.36MHz	-57.9
	Config 3,6	dBm/38.16MHz	-51.8
Time offset to cell1 ^{Note 4}		μ s	33
Propagation Condition			AWGN
<p>Note 1: OCNG shall be used such that both cells are fully allocated and a constant total transmitted power spectral density is achieved for all OFDM symbols.</p> <p>Note 2: Interference from other cells and noise sources not specified in the test is assumed to be constant over subcarriers and time and shall be modeled as AWGN of appropriate power for N_{oc} to be fulfilled.</p> <p>Note 3: SS-RSRP and I_o levels have been derived from other parameters for information purposes. They are not settable parameters themselves.</p> <p>Note 4: Receive time difference of signals received between subframe timing boundary of E-UTRA PCell and slot timing boundary of PSCell at the UE antenna connector including time alignment error between the two cells</p>			

Table A.4.5.2.1.1-4: E-UTRAN PCell DRX-Configuration for E-UTRAN - NR FR1 interruption at transitions between active and non-active during DRX in synchronous DC

Field	Cell1	Comment
	Value	
onDurationTimer	psf1	As specified in clause 6.3.2 in TS 36.331
drx-InactivityTimer ^{Note 1}	psf1	
drx-RetransmissionTimer	psf1	
longDRX-CycleStartOffset	Sf160	
shortDRX	disable	
Note 1: UE is continuously scheduled in NR PSCell		

A.4.5.2.1.2 Test Requirements

The UE shall be continuously scheduled in NR PSCell during the entire length of T1. UE shall not be scheduled in LTE PCell during T1. During the time duration T1 the UE shall transmit at least 99% of ACK/NACK on NR PSCell.

Interruption on NR PSCell shall not exceed X as defined in Table A.4.5.2.1.2-1.

Table A.4.5.2.1.2-1: Interruption length X at transition between active and non-active during DRX

μ	NR Slot length (ms)	Interruption length X
		Sync

0	1	1
1	0.5	1

The rate of correct events observed during repeated tests shall be at least 90%.

A.4.5.2.2 E-UTRAN – NR FR1 interruptions at transitions between active and non-active during DRX in asynchronous EN-DC

A.4.5.2.2.1 Test Purpose and Environment

The purpose of this test is to verify that when LTE PCell is in DRX and NR PSCell is in non-DRX, NR PSCell interruptions due to transitions from active to non-active and from non-active to active during LTE PCell DRX the UE missed ACK/NACK does not exceed the limits. This test will verify the missed ACK/NACK rate for NR PSCell in EN-DC specified in TS 38.133 section 8.2.1.2. Supported test configurations are shown in table A.4.5.2.2.1-1.

The general test parameters and NR cell specific test parameters are given in Table A.4.5.2.2.1-2 and A.4.5.2.2.1-3. The E-UTRAN PCell DRX configuration parameters are given in Table A.4.5.2.2.1-4 below. And the E-UTRAN cell specific test parameters can refer to Table A.3.7.2.1-1. In the test there are two cells: Cell1 and Cell2. Cell1 is LTE PCell and Cell2 is NR FR1 PSCell. The test consists of one time period, with duration of T1. During T1, NR PSCell is continuously scheduled in DL while LTE PCell is not scheduled and has DRX configured. Prior to the start of the time duration T1, Cell1 shall be configured as LTE PCell and Cell2 shall be configured as NR PSCell. Prior to start of T1 the DRX inactivity timer for the LTE PCell has already expired. During T1 the UE shall be continuously scheduled on NR PSCell while not scheduled on LTE PCell. PDCCH indicating a new transmission on PSCell shall be sent continuously during the whole time duration to ensure UE would not enter DRX state on PSCell.

Table A.4.5.2.2.1-1: Interruption at transitions between active and non-active during DRX supported test configurations

Config	Description
1	LTE FDD, NR 15 kHz SSB SCS, 10MHz bandwidth, FDD duplex mode
2	LTE FDD, NR 15 kHz SSB SCS, 10MHz bandwidth, TDD duplex mode
3	LTE FDD, NR 30kHz SSB SCS, 40MHz bandwidth, TDD duplex mode
4	LTE TDD, NR 15 kHz SSB SCS, 10MHz bandwidth, FDD duplex mode
5	LTE TDD, NR 15 kHz SSB SCS, 10MHz bandwidth, TDD duplex mode
6	LTE TDD, NR 30kHz SSB SCS, 40MHz bandwidth, TDD duplex mode

Note: The UE is only required to be tested in one of the supported test configurations

Table A.4.5.2.2.1-2: General test parameters for E-UTRAN – NR FR1 interruptions at transitions between active and non-active during DRX in asynchronous EN-DC

Parameter	Unit	Value	Comment
RF Channel Number		1, 2	One is E-UTRAN RF channel and the other is NR RF channel
Active PCell		Cell1	PCell on E-UTRAN RF channel number 1.
Configured PSCell		Cell2	PSCell on NR RF channel number 2.
CP length		Normal	Applicable to cell1 and cell 2
DRX		ON	DRX related parameters are defined in Table A.4.5.2.3.1-3
Measurement gap pattern Id		OFF	
T1	s	10	

Table A.4.5.2.2.1-3: NR cell specific test parameters for E-UTRAN – NR FR1 interruptions at transitions between active and non-active during DRX in asynchronous EN-DC

Parameter		Unit	Cell 2
Frequency Range			FR1
Duplex mode	Config 1,4		FDD
	Config 2,3,5,6		TDD
TDD configuration	Config 1,4		Not Applicable
	Config 2,5		TDDConf.1.1
	Config 3,6		TDDConf.2.1
BW _{channel}	Config 1,4		10: N _{RB,c} = 52
	Config 2,5		10: N _{RB,c} = 52
	Config 3,6		40: N _{RB,c} = 106
Initial BWP Configuration	Config 1,4		DLBWP.0
	Config 2,5		DLBWP.0
	Config 3,6		DLBWP.0
PDSCH Reference measurement channel	Config 1,4		SR.1.1 FDD
	Config 2,5		SR.1.1 TDD
	Config 3,6		SR2.1 TDD
RMSI CORESET parameters	Config 1,4		CR.1.1 FDD
	Config 2,5		CR.1.1 TDD
	Config 3,6		CR2.1 TDD
PDCCH CORESET parameters	Config 1,4		CCR.1.1 FDD
	Config 2,5		CCR.1.1 TDD
	Config 3,6		CCR2.1 TDD
OCNG Patterns			OP.1
SMTc Configuration			SMTc.1
TCI state			TCI.State.0
SSB Configuration	Config 1,2,4,5		SSB.1 FR1
	Config 3,6		SSB.2 FR1
Correlation Matrix and Antenna Configuration			1x2 Low
EPRE ratio of PSS to SSS		dB	0
EPRE ratio of PBCH DMRS to SSS			
EPRE ratio of PBCH to PBCH DMRS			
EPRE ratio of PDCCH DMRS to SSS			
EPRE ratio of PDCCH to PDCCH DMRS			
EPRE ratio of PDSCH DMRS to SSS			
EPRE ratio of PDSCH to PDSCH			
EPRE ratio of OCNG DMRS to SSS(Note 1)			
EPRE ratio of OCNG to OCNG DMRS (Note 1)			
N _{oc} ^{Note 2}		dBm/15 kHz	[-104]
SS-RSRP ^{Note 3}		dBm/15 kHz	[-87]
\hat{E}_s/I_{ot}		dB	17
\hat{E}_s/N_{oc}		dB	17
I _o ^{Note3}	Config 1,2,4,5	dBm/9.36MHz	-57.9
	Config 3,6	dBm/38.16MHz	-51.8
Time offset to cell1 ^{Note 4}		μs	500
Propagation Condition			AWGN

Note 1:	OCNG shall be used such that both cells are fully allocated and a constant total transmitted power spectral density is achieved for all OFDM symbols.
Note 2:	Interference from other cells and noise sources not specified in the test is assumed to be constant over subcarriers and time and shall be modeled as AWGN of appropriate power for N_{oc} to be fulfilled.
Note 3:	SS-RSRP and I_0 levels have been derived from other parameters for information purposes. They are not settable parameters themselves.
Note 4:	Receive time difference of signals received between subframe timing boundary of E-UTRA PCell and slot timing boundary of PSCell at the UE antenna connector including time alignment error between the two cells

Table A.4.5.2.2.1-4: E-UTRAN PCell DRX-Configuration for E-UTRAN – NR FR1 interruptions at transitions between active and non-active during DRX in asynchronous EN-DC

Field	Cell1	Comment
	Value	
onDurationTimer	psf1	As specified in clause 6.3.2 in TS 36.331
drx-InactivityTimer ^{Note 1}	psf1	
drx-RetransmissionTimer	psf1	
longDRX-CycleStartOffset	Sf320	
shortDRX	disable	
Note 1: UE is continuously scheduled in NR PSCell		

A.4.5.2.2.2 Test Requirements

The UE shall be continuously scheduled in NR PSCell during the entire length of T1. UE shall not be scheduled in LTE PCell during T1. During the time duration T1 the UE shall transmit at least 99% of ACK/NACK on NR PSCell.

Interruption on NR PSCell shall not exceed X as defined in Table A.4.5.2.2.2-1.

Table A.4.5.2.2.2-1: Interruption length X at transition between active and non-active during DRX

μ	NR Slot length (ms)	Interruption length X
		Async
0	1	2
1	0.5	2

The rate of correct events observed during repeated tests shall be at least 90%.

A.4.5.2.3 E-UTRAN – NR FR1 interruptions during measurements on deactivated NR SCC in synchronous EN-DC

A.4.5.2.3.1 Test Purpose and Environment

The purpose of this test is to verify E-UTRAN PCell and NR PSCell interruptions during the measurement on the deactivated NR SCC, the UE missed ACK/NACK does not exceed the limits. This test will verify the missed ACK/NACK rate for E-UTRAN PCell and NR PSCell in EN-DC specified in TS 38.133 section 8.2.1.2. Supported test configurations are shown in table A.4.5.2.3.1-1.

The general test parameters and NR cell specific test parameters are given in Table A.4.5.2.3.1-2 and A.4.5.2.3.1-3 below. And the E-UTRAN cell specific test parameters can refer to Table A.3.7.2.1-1. In the test there are three cells: Cell1 Cell2 and Cell3. Cell1 is LTE PCell, Cell2 and Cell 3 is NR PSCell and NR deactivated SCell. Cell1 shall be configured as LTE PCell and Cell2 shall be configured as NR PSCell. The test consists of one time period, with duration of T1. Prior to the start of the time duration T1, the UE is connected to Cell1 and Cell2. The point in time at which the RRC message including *measCycleSCell* or *allowInterruptions* for the deactivated NR SCells is received at the UE antenna connector, defines the start of time period T1. During T1, LTE PCell and NR PSCell are continuously scheduled in DL.

Table A.4.5.2.3.1-1: Interruptions during measurements on deactivated NR SCC supported test configurations

Config	Description
1	LTE FDD, NR 15 kHz SSB SCS, 10MHz bandwidth, FDD duplex mode
2	LTE FDD, NR 15 kHz SSB SCS, 10MHz bandwidth, TDD duplex mode
3	LTE FDD, NR 30kHz SSB SCS, 40MHz bandwidth, TDD duplex mode
4	LTE TDD, NR 15 kHz SSB SCS, 10MHz bandwidth, FDD duplex mode
5	LTE TDD, NR 15 kHz SSB SCS, 10MHz bandwidth, TDD duplex mode
6	LTE TDD, NR 30kHz SSB SCS, 40MHz bandwidth, TDD duplex mode

Note: The UE is only required to be tested in one of the supported test configurations

Table A.4.5.2.3.1-2: General test parameters for E-UTRAN – NR interruptions during measurements on deactivated NR SCC in synchronous EN-DC

Parameter	Unit	Value	Comment
RF Channel Number		1, 2	One is E-UTRAN RF channel and the other two are NR RF channel
Active PCell		Cell1	PCell on E-UTRAN RF channel number 1.
Active PSCell		Cell2	PSCell on NR RF channel number 2.
Configured deactivated SCell		Cell3	Deactivated SCell on NR RF channel number 2.
CP length		Normal	Applicable to cell1, cell 2 and cell3
DRX		OFF	
Measurement gap pattern Id		OFF	
SCell measurement cycle (measCycleSCell)	ms	640	
T1	s	10	

Table A.4.5.2.3.1-3: NR cell specific test parameters for E-UTRAN – NR interruptions during measurements on deactivated NR SCC in synchronous EN-DC

Parameter		Unit	Cell 2	Cell 3
Frequency Range			FR1	FR1
Duplex mode	Config 1,4		FDD	FDD
	Config 2,3,5,6		TDD	TDD
TDD configuration	Config 1,4		Not Applicable	Not Applicable
	Config 2,5		TDDConf.1.1	TDDConf.1.1
	Config 3,6		TDDConf.2.1	TDDConf.2.1
BW _{channel}	Config 1,4		10: N _{RB,c} = 52	10: N _{RB,c} = 52
	Config 2,5		10: N _{RB,c} = 52	10: N _{RB,c} = 52
	Config 3,6		40: N _{RB,c} = 106	40: N _{RB,c} = 106
Initial BWP Configuration	Config 1,4		DLBWP.0.1	DLBWP.0.1
	Config 2,5		DLBWP.0.1	DLBWP.0.1
	Config 3,6		DLBWP.0.1	DLBWP.0.1
PDSCH Reference measurement channel	Config 1,4		SR.1.1 FDD	-
	Config 2,5		SR.1.1 TDD	-
	Config 3,6		SR2.1 TDD	-
RMSI CORESET parameters	Config 1,4		CR.1.1 FDD	CR.1.1 FDD
	Config 2,5		CR.1.1 TDD	CR.1.1 TDD
	Config 3,6		CR2.1 TDD	CR2.1 TDD
PDCCH CORESET parameters	Config 1,4		CCR.1.1 FDD	CCR.1.1 FDD
	Config 2,5		CCR.1.1 TDD	CCR.1.1 TDD
	Config 3,6		CCR2.1 TDD	CCR2.1 TDD
OCNG Patterns			OP.1	OP.1
SMTTC Configuration			SMTTC.1	SMTTC.1
SSB Configuration	Config 1,2,4,5		SSB.1 FR1	SSB.1 FR1

		Config 3,6	SSB.2 FR1 1x2 Low	SSB.2 FR1 1x2 Low
Correlation Matrix and Antenna Configuration				
EPRE ratio of PSS to SSS		dB	0	0
EPRE ratio of PBCH DMRS to SSS				
EPRE ratio of PBCH to PBCH DMRS				
EPRE ratio of PDCCH DMRS to SSS				
EPRE ratio of PDCCH to PDCCH DMRS				
EPRE ratio of PDSCH DMRS to SSS				
EPRE ratio of PDSCH to PDSCH				
EPRE ratio of OCNG DMRS to SSS(Note 1)				
EPRE ratio of OCNG to OCNG DMRS (Note 1)				
N_{oc} ^{Note 2}		dBm/15 kHz	[-104]	[-104]
SS-RSRP ^{Note 3}		dBm/15 kHz	[-87]	[-87]
\bar{E}_s/I_{ot}		dB	17	17
\bar{E}_s/N_{oc}		dB	17	17
I_o ^{Note 3}	Config 1,2,4,5	dBm/9.36MHz	-57.9	-57.9
	Config 3,6	dBm/38.16MHz	-51.8	-51.8
Time offset to cell1 ^{Note 4}		μ s	33	33
Time offset to cell2 ^{Note 5}		μ s	-	3
Propagation Condition			AWGN	AWGN
<p>Note 1: OCNG shall be used such that both cells are fully allocated and a constant total transmitted power spectral density is achieved for all OFDM symbols.</p> <p>Note 2: Interference from other cells and noise sources not specified in the test is assumed to be constant over subcarriers and time and shall be modeled as AWGN of appropriate power for N_{oc} to be fulfilled.</p> <p>Note 3: SS-RSRP and I_o levels have been derived from other parameters for information purposes. They are not settable parameters themselves.</p> <p>Note 4: Receive time difference of signals received between subframe timing boundary of E-UTRA PCell and slot timing boundary of PSCell at the UE antenna connector including time alignment error between the two cells</p> <p>Note 5: Receive time difference between slot boundaries of signals received from the two cells at the UE antenna connector including time alignment error between the two cells.</p>				

A.4.5.2.3.2 Test Requirements

The UE shall be continuously scheduled in LTE PCell and NR PSCell during the entire length of T1. During the time duration T1 the UE shall transmit at least 99.5% of ACK/NACK on NR PSCell. The UE is only allowed to cause interruptions immediately before and immediately after an SMTC. Each interruption on NR PSCell shall not exceed the value defined in Table A.4.5.2.3.2-1 if the NR PSCell is not in the same band as the deactivated SCell or Table A.4.5.2.3.2-2 if the NR PSCell is in the same band as the deactivated SCell.

Table A.4.5.2.3.2-1: Interruption duration if the NR PSCell is not in the same band as the deactivated SCell

μ	NR Slot length (ms)	Interruption length
0	1	1
1	0.5	1

Table A.4.5.2.3.2-2: Interruption duration if the NR PSCell is in the same band as the deactivated SCell

μ	NR Slot length (ms)	Interruption length
0	1	1 + SMTC duration
1	0.5	2 + SMTC duration

Each interruption on E-UTRAN PCell shall not exceed 1ms + SMTC duration subframes for intraband EN-DC, 1 subframe for synchronous interband EN-DC.

The rate of correct events observed during repeated tests shall be at least 90%.

A.4.5.2.4 E-UTRAN – NR FR1 interruptions during measurements on deactivated NR SCC in asynchronous EN-DC

A.4.5.2.4.1 Test Purpose and Environment

The purpose of this test is to verify E-UTRAN PCell and NR PSCell interruptions during the measurement on the deactivated NR SCC, the UE missed ACK/NACK does not exceed the limits. This test will verify the missed ACK/NACK rate for E-UTRAN PCell and NR PSCell in EN-DC specified in TS 38.133 section 8.2.1. Supported test configurations are shown in table A.4.5.2.4.1-1.

The general test parameters and NR cell specific test parameters are given in Table A.4.5.2.4.1-2 and A.4.5.2.4.1-3 below. And the E-UTRAN cell specific test parameters can refer to Table A.3.7.2.1-1. In the test there are three cells: Cell1 Cell2 and Cell3. Cell1 is LTE PCell, Cell2 and Cell 3 is NR PSCell and NR deactivated SCell. Cell1 shall be configured as LTE PCell and Cell2 shall be configured as NR PSCell. The test consists of one time period, with duration of T1. Prior to the start of the time duration T1, the UE is connected to Cell1 and Cell2. The point in time at which the RRC message including *measCycleSCell* or *allowInterruptions* for the deactivated NR SCells is received at the UE antenna connector, defines the start of time period T1. During T1, LTE PCell and NR PSCell are continuously scheduled in DL.

Table A.4.5.2.4.1-1: Interruptions during measurements on deactivated NR SCC supported test configurations

Config	Description
1	LTE FDD, NR 15 kHz SSB SCS, 10MHz bandwidth, FDD duplex mode
2	LTE FDD, NR 15 kHz SSB SCS, 10MHz bandwidth, TDD duplex mode
3	LTE FDD, NR 30kHz SSB SCS, 40MHz bandwidth, TDD duplex mode
4	LTE TDD, NR 15 kHz SSB SCS, 10MHz bandwidth, FDD duplex mode
5	LTE TDD, NR 15 kHz SSB SCS, 10MHz bandwidth, TDD duplex mode
6	LTE TDD, NR 30kHz SSB SCS, 40MHz bandwidth, TDD duplex mode
Note:	The UE is only required to be tested in one of the supported test configurations

Table A.4.5.2.4.1-2: General test parameters for E-UTRAN – NR interruptions during measurements on deactivated NR SCC in asynchronous EN-DC

Parameter	Unit	Value	Comment
RF Channel Number		1, 2	One is E-UTRAN RF channel and the other two are NR RF channel
Active PCell		Cell1	PCell on E-UTRAN RF channel number 1.
Configured PSCell		Cell2	PSCell on NR RF channel number 2.
Configured deactivated SCell		Cell3	Deactivated SCell on NR RF channel number 2.
CP length		Normal	Applicable to cell1, cell 2 and cell3
DRX		OFF	
Measurement gap pattern Id		OFF	
SCell measurement cycle (measCycleSCell)	ms	640	
T1	s	10	

Table A.4.5.2.4.1-3: NR cell specific test parameters for E-UTRAN – NR interruptions during measurements on deactivated NR SCC in asynchronous EN-DC

Parameter		Unit	Cell 2	Cell 3
Frequency Range			FR1	FR1
Duplex mode	Config 1,4		FDD	FDD
	Config 2,3,5,6		TDD	TDD
TDD configuration	Config 1,4		Not Applicable	Not Applicable
	Config 2,5		TDDConf.1.1	TDDConf.1.1
	Config 3,6		TDDConf.2.1	TDDConf.2.1
BW _{channel}	Config 1,4		10: N _{RB,c} = 52	10: N _{RB,c} = 52
	Config 2,5		10: N _{RB,c} = 52	10: N _{RB,c} = 52
	Config 3,6		40: N _{RB,c} = 106	40: N _{RB,c} = 106
Initial BWP Configuration	Config 1,4		DLBWP.0.1	DLBWP.0.1
	Config 2,5		DLBWP.0.1	DLBWP.0.1
	Config 3,6		DLBWP.0.1	DLBWP.0.1
PDSCH Reference measurement channel	Config 1,4		SR.1.1 FDD	-
	Config 2,5		SR.1.1 TDD	-
	Config 3,6		SR2.1 TDD	-
RMSI CORESET parameters	Config 1,4		CR.1.1 FDD	CR.1.1 FDD
	Config 2,5		CR.1.1 TDD	CR.1.1 TDD
	Config 3,6		CR2.1 TDD	CR2.1 TDD
PDCCH CORESET parameters	Config 1,4		CCR.1.1 FDD	CCR.1.1 FDD
	Config 2,5		CCR.1.1 TDD	CCR.1.1 TDD
	Config 3,6		CCR2.1 TDD	CCR2.1 TDD
OCNG Patterns			OP.1	OP.1
SSB Configuration	Config 1,2,4,5		SSB.1 FR1	SSB.1 FR1
	Config 3,6		SSB.2 FR1	SSB.2 FR1
SMTC Configuration			SMTC.1	SMTC.1
Correlation Matrix and Antenna Configuration			1x2 Low	1x2 Low
EPRE ratio of PSS to SSS		dB	0	0
EPRE ratio of PBCH DMRS to SSS				
EPRE ratio of PBCH to PBCH DMRS				
EPRE ratio of PDCCH DMRS to SSS				
EPRE ratio of PDCCH to PDCCH DMRS				
EPRE ratio of PDSCH DMRS to SSS				
EPRE ratio of PDSCH to PDSCH				
EPRE ratio of OCNG DMRS to SSS(Note 1)				
EPRE ratio of OCNG to OCNG DMRS (Note 1)				
N _{oc} ^{Note 2}		dBm/15 kHz	[-104]	[-104]

SS-RSRP ^{Note 3}		dBm/15 kHz	[-87]	[-87]
\bar{E}_s/I_{ot}		dB	17	17
\bar{E}_s/N_{oc}		dB	17	17
I_o ^{Note 3}	Config 1,2,4,5	dBm/9.36MHz	-57.9	-57.9
	Config 3,6	dBm/38.16MHz	-51.8	-51.8
Time offset to cell1 ^{Note 4}		ms	3	3
Time offset to cell2 ^{Note 5}		μ s	-	3
Propagation Condition			AWGN	AWGN
<p>Note 1: OCNG shall be used such that both cells are fully allocated and a constant total transmitted power spectral density is achieved for all OFDM symbols.</p> <p>Note 2: Interference from other cells and noise sources not specified in the test is assumed to be constant over subcarriers and time and shall be modeled as AWGN of appropriate power for N_{oc} to be fulfilled.</p> <p>Note 3: SS-RSRP and I_o levels have been derived from other parameters for information purposes. They are not settable parameters themselves.</p> <p>Note 4: Receive time difference of signals received between subframe timing boundary of E-UTRA PCell and slot timing boundary of PSCell at the UE antenna connector including time alignment error between the two cells</p> <p>Note 5: Receive time difference between slot boundaries of signals received from the two cells at the UE antenna connector including time alignment error between the two cells.</p>				

A.4.5.2.4.2 Test Requirements

The UE shall be continuously scheduled in LTE PCell and NR PSCell during the entire length of T1. During the time duration T1 the UE shall transmit at least 99.5% of ACK/NACK on NR PSCell. The UE is only allowed to cause interruptions immediately before and immediately after an SMTC. Each interruption on NR PSCell shall not exceed the value defined in Table A.4.5.2.4.2-1 and Table A.4.5.2.4.2-2.

Table A.4.5.2.4.2-1: Interruption duration if the NR PSCell is not in the same band as the deactivated SCell

μ	NR Slot length (ms)	Interruption length
0	1	1
1	0.5	1

Table A.4.5.2.4.2-2: Interruption duration if the NR PSCell is in the same band as the deactivated SCell

μ	NR Slot length (ms)	Interruption length
0	1	1 + SMTC duration
1	0.5	2 + SMTC duration

Each interruption on E-UTRAN PCell shall not exceed 1ms + SMTC duration subframes for synchronous intraband EN-DC, or 2 subframes for asynchronous interband EN-DC.

The rate of correct events observed during repeated tests shall be at least 90%.

A.4.5.2.5 E-UTRAN – NR FR1 interruptions during measurements on deactivated E-UTRAN SCC in synchronous EN-DC

A.4.5.2.5.1 Test Purpose and Environment

The purpose of this test is to verify E-UTRAN PCell and NR PSCell interruptions during the measurement on the deactivated E-UTRAN SCC, the UE missed ACK/NACK does not exceed the limits. This test will verify the missed ACK/NACK rate for E-UTRAN PCell and NR PSCell in EN-DC specified in TS38.133 section 8. 2.1.2. Supported test configurations are shown in table A.4.5.2.5.1-1.

The general test parameters and NR cell specific test parameters are given in Table A.4.5.2.5.1-2 and A.4.5.2.5.1-3 below. And the E-UTRAN cell specific test parameters can refer to Table A.3.7.2.1-1. In the test there are three cells: Cell1, Cell2 and Cell3. Cell1 and Cell3 is E-UTRAN PCell and E-UTRAN deactivated SCell, Cell2 is NR FR1 PSCell. Cell1 shall be configured as LTE PCell and Cell2 shall be configured as NR PSCell. The test consists of one time period, with duration of T1. Prior to the start of the time duration T1, the UE is connected to Cell1 and Cell2. The point in time at which the RRC message including *measCycleSCell* or *allowInterruptions* for the deactivated E-UTRAN SCells is received at the UE antenna connector, defines the start of time period T1. During T1, LTE PCell and NR PSCell are continuously scheduled in DL.

Table A.4.5.2.5.1-1: Interruptions during measurements on deactivated E-UTRAN SCC supported test configurations

Config	Description
1	LTE FDD, NR 15 kHz SSB SCS, 10MHz bandwidth, FDD duplex mode
2	LTE FDD, NR 15 kHz SSB SCS, 10MHz bandwidth, TDD duplex mode
3	LTE FDD, NR 30kHz SSB SCS, 40MHz bandwidth, TDD duplex mode
4	LTE TDD, NR 15 kHz SSB SCS, 10MHz bandwidth, FDD duplex mode
5	LTE TDD, NR 15 kHz SSB SCS, 10MHz bandwidth, TDD duplex mode
6	LTE TDD, NR 30kHz SSB SCS, 40MHz bandwidth, TDD duplex mode

Note: The UE is only required to be tested in one of the supported test configurations

Table A.4.5.2.5.1-2: General test parameters for E-UTRAN – NR interruptions during measurements on deactivated E-UTRAN SCC in synchronous EN-DC

Parameter	Unit	Value	Comment
RF Channel Number		1, 2	One is E-UTRAN RF channel and the other two are NR RF channel
Active PCell		Cell1	PCell on E-UTRAN RF channel number 1.
Active PSCell		Cell2	PSCell on NR RF channel number 2.
Configured deactivated SCell		Cell3	Deactivated SCell on NR RF channel number 2.
CP length		Normal	Applicable to cell1, cell 2 and cell3
DRX		OFF	
Measurement gap pattern Id		OFF	
SCell measurement cycle (measCycleSCell)	ms	640	
T1	s	10	

Table A.4.5.2.5.1-3: NR cell specific test parameters for E-UTRAN – NR interruptions during measurements on deactivated E-UTRAN SCC in synchronous EN-DC

Parameter		Unit	Cell 2
Frequency Range			FR1
Duplex mode	Config 1,4		FDD
	Config 2,3,5,6		TDD
TDD configuration	Config 1,4		Not Applicable
	Config 2,5		TDDConf.1.1
	Config 3,6		TDDConf.2.1
BW _{channel}	Config 1,4	MHz	10: N _{RB,c} = 52
	Config 2,5		10: N _{RB,c} = 52
	Config 3,6		40: N _{RB,c} = 106
Initial BWP Configuration	Config 1,4		DLBWP.0.1
	Config 2,5		DLBWP.0.1
	Config 3,6		DLBWP.0.1
PDSCH Reference measurement channel	Config 1,4		SR.1.1 FDD
	Config 2,5		SR.1.1 TDD
	Config 3,6		SR2.1 TDD
RMSI CORESET parameters	Config 1,4		CR.1.1 FDD
	Config 2,5		CR.1.1 TDD
	Config 3,6		CR2.1 TDD
PDCCH CORESET parameters	Config 1,4		CCR.1.1 FDD
	Config 2,5		CCR.1.1 TDD
	Config 3,6		CCR2.1 TDD
OCNG Patterns			OP.1
SMTc Configuration			SMTc.1
SSB Configuration	Config 1,2,4,5		SSB.1 FR1
	Config 3,6		SSB.2 FR1
Correlation Matrix and Antenna Configuration			1x2 Low
EPRE ratio of PSS to SSS		dB	0
EPRE ratio of PBCH DMRS to SSS			
EPRE ratio of PBCH to PBCH DMRS			
EPRE ratio of PDCCH DMRS to SSS			
EPRE ratio of PDCCH to PDCCH DMRS			
EPRE ratio of PDSCH DMRS to SSS			
EPRE ratio of PDSCH to PDSCH			
EPRE ratio of OCNG DMRS to SSS(Note 1)			
EPRE ratio of OCNG to OCNG DMRS (Note 1)			
N _{oc} Note 2		dBm/15 kHz	[-104]
SS-RSRP Note 3		dBm/15 kHz	[-87]
\bar{E}_s/I_{ot}		dB	17
\bar{E}_s/N_{oc}		dB	17
I _o Note3	Config 1,2,4,5	dBm/9.36MHz	-57.9
	Config 3,6	dBm/38.16MHz	-51.8
Time offset to cell1 Note 4		μs	33
Propagation Condition			AWGN
<p>Note 1: OCNG shall be used such that both cells are fully allocated and a constant total transmitted power spectral density is achieved for all OFDM symbols.</p> <p>Note 2: Interference from other cells and noise sources not specified in the test is assumed to be constant over subcarriers and time and shall be modeled as AWGN of appropriate power for N_{oc} to be fulfilled.</p> <p>Note 3: SS-RSRP and I_o levels have been derived from other parameters for information purposes. They are not settable parameters themselves.</p> <p>Note 4: Receive time difference of signals received between subframe timing boundary of E-UTRA PCell and slot timing boundary of PSCell at the UE antenna connector including time alignment error between the two cells</p>			

A.4.5.2.5.2 Test Requirements

The UE shall be continuously scheduled in LTE PCell and NR PSCell during the entire length of T1. During the time duration T1 the UE shall transmit at least 99.5% of ACK/NACK on NR PSCell. The UE is only allowed to cause interruptions immediately before and immediately after an SMTC. Each interruption on NR PSCell shall not exceed X defined in Table A.4.5.2.5.2-1 if the NR PSCell is not in the same band as the E-UTRAN deactivated SCell or Y in Table A.4.5.2.3.2-1 if the NR PSCell is in the same band as the E-UTRAN deactivated SCell.

Table A.4.5.2.5.2-1: Interruption length X and Y at measurements on deactivated E-UTRA SCC

μ	NR Slot length (ms)	Interruption length X slot	Interruption length Y slot
		Sync	
0	1	1	1
1	0.5	1	1

Each interruption on E-UTRAN PCell shall not exceed 1 subframe if the PCell is not in the same band as the deactivated SCell, or 5 subframes if the PCell is in the same band as the deactivated SCell.

The rate of correct events observed during repeated tests shall be at least 90%.

A.4.5.2.6 E-UTRAN – NR FR1 interruptions during measurements on deactivated E-UTRAN SCC in asynchronous EN-DC

A.4.5.2.6.1 Test Purpose and Environment

The purpose of this test is to verify E-UTRAN PCell and NR PSCell interruptions during the measurement on the deactivated NR SCC, the UE missed ACK/NACK does not exceed the limits. This test will verify the missed ACK/NACK rate for E-UTRAN PCell and NR PSCell in EN-DC specified in TS 38.133 section 8.2.1. Supported test configurations are shown in table A.4.5.2.6.1-1.

The general test parameters and NR cell specific test parameters are given in Table A.4.5.2.6.1-1 and A.4.5.2.6.1-2 below. And the E-UTRAN cell specific test parameters can refer to Table A.3.7.2.1-1. In the test there are three cells: Cell1 Cell2 and Cell3. Cell1 and Cell3 is E-UTRAN PCell and E-UTRAN deactivated SCell, Cell2 is NR FR1 PSCell. Cell1 shall be configured as LTE PCell and Cell2 shall be configured as NR PSCell. The test consists of one time period, with duration of T1. Prior to the start of the time duration T1, the UE is connected to Cell1 and Cell2. The point in time at which the RRC message including *measCycleSCell* or *allowInterruptions* for the deactivated NR SCells is received at the UE antenna connector, defines the start of time period T1. During T1, LTE PCell and NR PSCell are continuously scheduled in DL.

Table A.4.5.2.6.1-1: Interruptions during measurements on deactivated E-UTRAN SCC supported test configurations

Config	Description
1	LTE FDD, NR 15 kHz SSB SCS, 10MHz bandwidth, FDD duplex mode
2	LTE FDD, NR 15 kHz SSB SCS, 10MHz bandwidth, TDD duplex mode
3	LTE FDD, NR 30kHz SSB SCS, 40MHz bandwidth, TDD duplex mode
4	LTE TDD, NR 15 kHz SSB SCS, 10MHz bandwidth, FDD duplex mode
5	LTE TDD, NR 15 kHz SSB SCS, 10MHz bandwidth, TDD duplex mode
6	LTE TDD, NR 30kHz SSB SCS, 40MHz bandwidth, TDD duplex mode

Note: The UE is only required to be tested in one of the supported test configurations

Table A.4.5.2.6.1-2: General test parameters for E-UTRAN – NR interruptions during measurements on deactivated E-UTRAN SCC in asynchronous EN-DC

Parameter	Unit	Value	Comment
RF Channel Number		1, 2	One is E-UTRAN RF channel and two is NR RF channel
Active PCell		Cell1	PCell on E-UTRAN RF channel number 1.
Configured PSCell		Cell2	PSCell on E-UTRAN RF channel number 1.
Configured deactivated SCell		Cell3	Deactivated SCell on NR RF channel number 2.
CP length		Normal	Applicable to cell1, cell 2 and cell3
DRX		OFF	
Measurement gap pattern Id		OFF	
SCell measurement cycle (measCycleSCell)	ms	640	
T1	s	10	

Table A.4.5.2.6.1-3: NR cell specific test parameters for E-UTRAN – NR interruptions during measurements on deactivated E-UTRAN SCC in asynchronous EN-DC

Parameter		Unit	Cell 2
Frequency Range			FR1
Duplex mode	Config 1,4		FDD
	Config 2,3,5,6		TDD
TDD configuration	Config 1,4		Not Applicable
	Config 2,5		TDDConf.1.1
	Config 3,6		TDDConf.2.1
BW _{channel}	Config 1,4		10: N _{RB,c} = 52
	Config 2,5		10: N _{RB,c} = 52
	Config 3,6		40: N _{RB,c} = 106
Initial BWP Configuration	Config 1,4		DLBWP.0.1
	Config 2,5		DLBWP.0.1
	Config 3,6		DLBWP.0.1
PDSCH Reference measurement channel	Config 1,4		SR.1.1 FDD
	Config 2,5		SR.1.1 TDD
	Config 3,6		SR2.1 TDD
RMSI CORESET parameters	Config 1,4		CR.1.1 FDD
	Config 2,5		CR.1.1 TDD
	Config 3,6		CR2.1 TDD
PDCCH CORESET parameters	Config 1,4		CCR.1.1 FDD
	Config 2,5		CCR.1.1 TDD
	Config 3,6		CCR2.1 TDD
OCNG Patterns			OP.1
SMTc Configuration			SMTc.1
SSB Configuration	Config 1,2,4,5		SSB.1 FR1
	Config 3,6		SSB.2 FR1
Correlation Matrix and Antenna Configuration			1x2 Low
EPRE ratio of PSS to SSS		dB	0
EPRE ratio of PBCH DMRS to SSS			
EPRE ratio of PBCH to PBCH DMRS			
EPRE ratio of PDCCH DMRS to SSS			
EPRE ratio of PDCCH to PDCCH DMRS			
EPRE ratio of PDSCH DMRS to SSS			
EPRE ratio of PDSCH to PDSCH			
EPRE ratio of OCNG DMRS to SSS(Note 1)			
EPRE ratio of OCNG to OCNG DMRS (Note 1)			
N _{oc} Note 2			
SS-RSRP Note 3		dBm/15 kHz	[-87]
\bar{E}_s/I_{ot}		dB	17
\bar{E}_s/N_{oc}		dB	17
I _o Note3	Config 1,2,4,5	dBm/9.36MHz	-57.9
	Config 3,6	dBm/38.16MHz	-51.8
Time offset to cell1 Note 4		μs	500
Propagation Condition			AWGN
<p>Note 1: OCNG shall be used such that both cells are fully allocated and a constant total transmitted power spectral density is achieved for all OFDM symbols.</p> <p>Note 2: Interference from other cells and noise sources not specified in the test is assumed to be constant over subcarriers and time and shall be modeled as AWGN of appropriate power for N_{oc} to be fulfilled.</p> <p>Note 3: SS-RSRP and I_o levels have been derived from other parameters for information purposes. They are not settable parameters themselves.</p> <p>Note 4: Receive time difference of signals received between subframe timing boundary of E-UTRA PCell and slot timing boundary of PSCell at the UE antenna connector including time alignment error between the two cells</p>			

A.4.5.2.6.2 Test Requirements

The UE shall be continuously scheduled in LTE PCell and NR PSCell during the entire length of T1. During the time duration T1 the UE shall transmit at least 99.5% of ACK/NACK on E-UTRAN PCell and NR PSCell. The UE is only allowed to cause interruptions immediately before and immediately after an SMTC. Each interruption on NR PSCell shall not exceed the value defined in Table A.4.5.2.4.2-1 and Table A.4.5.2.4.2-2.

Table A.4.5.2.6.2-1: Interruption duration if the NR PSCell is not in the same band as the E-UTRAN deactivated SCell

μ	NR Slot length (ms)	Interruption length
0	1	1
1	0.5	1

Table A.4.5.2.6.2-2: Interruption duration if the NR PSCell is in the same band as the E-UTRAN deactivated SCell

μ	NR Slot length (ms)	Interruption length
0	1	1 + SMTC duration
1	0.5	2 + SMTC duration

Each interruption on E-UTRAN PCell shall not exceed 1 subframe if the PCell is not in the same band as the deactivated SCell, or 5 subframes if the PCell is in the same band as the deactivated SCell.

The rate of correct events observed during repeated tests shall be at least 90%.

A.4.5.2.7 Void

A.4.5.3 SCell Activation and Deactivation Delay

A.4.5.3.1 SCell Activation and deactivation of known SCell in FR1 in non-DRX for 160ms SCell measurement cycle

A.4.5.3.1.1 Test Purpose and Environment

The purpose of this test is to verify that the SCell activation and deactivation times are within the requirements stated in section 8.3, when the SCell in FR1 is known by the UE at the time of activation.

The supported test configurations are shown in table A.4.5.3.1.1-1 below. The test parameters are given in Tables A.4.5.3.1.1-2 and cell-specific parameters in A.4.5.3.1.1-3 below. The test consists of three successive time periods, with duration of T1, T2 and T3, respectively. There are three carriers, E-UTRA has one cell, NR has two cells. All cells have constant signal levels throughout the test. Before the test starts the UE is connected to Cell 1 (PCell) on E-UTRA and Cell 2 (PSCell) on NR, but is not aware of Cell 3 (SCell) on NR. The UE is monitoring the PCell and PSCell. The UE shall be continuously scheduled in the PCell and PSCell throughout the whole test.

At the beginning of T1 the UE receives an RRC message by which the SCell (Cell 3) becomes configured on NR. The UE now starts monitoring the SCell. The test equipment sends a MAC message for activation of the SCell.

The point in time at which the MAC message is received at the UE antenna connector, in a slot # denoted m , defines the start of time period T2. The UE shall be able to report valid CSI in PSCell for the activated SCell at latest in slot $(m+T_{\text{HARQ}}+T_{\text{activation_time}}+T_{\text{CSI_Reporting}})$, as defined in section 8.3. The UE shall start reporting CSI in PSCell in slot

(m+k) and shall report CQI index 0 (out-of-range) until the SCell activation has been completed. Any PCell or PSCell interruption due to activation of SCell shall occur in the slot $(m+1+[T_{\text{HARQ}}])$ to $(m+1+[T_{\text{HARQ}}+3\text{ms}+T_{\text{SMTC_MAX}}+T_{\text{SMTC_duration}}])$, as defined in section 8.3.

Time period T3 starts when a MAC message for deactivation of SCell, sent from the test equipment to the UE in a slot # denoted n, is received at the UE antenna connector. The UE shall carry out deactivation of the SCell in a slot $(n+[T_{\text{HARQ}}+3\text{ms}])$, as defined in section 8.3, and any PCell and PSCell interruption due to the deactivation shall occur in the slot $(n+1+[T_{\text{HARQ}}])$ to $(n+1+[T_{\text{HARQ}}+3\text{ms}])$, as defined in section 8.3.

The test equipment verifies that potential interruption is carried out in the correct time span by monitoring ACK/NACK sent in PSCell during activation and deactivation of SCell, respectively.

The test equipment verifies the activation time by counting the slots from the time when the SCell activation command is sent until a CSI report with other than CQI index 0 is received.

The test equipment verifies the deactivation time by counting the slots from the time when the SCell deactivation command is sent until CQI reporting for SCell is discontinued.

Table A.4.5.3.1.1-1: known FR1 SCell activation in non-DRX for 160ms SCell measurement cycle supported test configurations

Configuration	Description
1	LTE FDD, NR 15 kHz SSB SCS, 10MHz bandwidth, FDD duplex mode
2	LTE FDD, NR 15 kHz SSB SCS, 10MHz bandwidth, TDD duplex mode
3	LTE FDD, NR 30kHz SSB SCS, 40MHz bandwidth, TDD duplex mode
4	LTE TDD, NR 15 kHz SSB SCS, 10MHz bandwidth, FDD duplex mode
5	LTE TDD, NR 15 kHz SSB SCS, 10MHz bandwidth, TDD duplex mode
6	LTE TDD, NR 30kHz SSB SCS, 40MHz bandwidth, TDD duplex mode
Note: The UE is only required to be tested in one of the supported test configurations	

Table A.4.5.3.1.1-2: General test parameters for known FR1 SCell activation case, 160ms SCell measurement cycle

Parameter	Unit	Value	Comment
RF Channel Number		1,2,3	One E-UTRAN radio channel (1) and two NR radio channel (2,3) are used for this test
Active PCell		Cell 1	Primary cell on E-UTRAN RF channel number 1. As specified in section A.3.7.2.1
Active PSCell		Cell 2	Primary secondary cell on NR RF channel number 2.
Configured deactivated SCell		Cell 3	Configured deactivated secondary cell on NR RF channel number 3
CP length		Normal	
DRX		OFF	Continuous monitoring of primary cell
CQI/PMI periodicity and offset configuration index		0	CQI reporting for SCell every second subframe
Cell-individual offset for cells on E-UTRA RF channel number	dB	0	Individual offset for cells on primary component carrier.
Cell-individual offset for cells on NR channel number	dB	0	Individual offset for cells on secondary component carrier.
SCell measurement cycle (measCycleSCell)	ms	160	
Cell3 timing offset to cell2	μs	0	
Time alignment error between cell3 and cell2	μs	≤ Time alignment error as specified in TS 38.104 [13] clause 6.5.3.1.	The value of time alignment error depends upon the type of carrier aggregation.

T1	s	[7]	During this time the PSCell shall be known and the SCell configured and detected.
T2	s	[1]	During this time the UE shall activate the SCell.
T3	s	[1]	During this time the UE shall deactivate the SCell.
T _{HARQ}	ms	TBD	the timing between DL data transmission and acknowledgement as specified in 38.321 [7]
T _{CSI_Reporting}	ms	[2]	the delay uncertainty in acquiring the first available CSI reporting resources as specified in 38.331 [2]
k	ms	$k_1 + 3 \cdot N_{\text{subframe, slot}}^{\text{subframe}} \cdot \mu + 1$	As specified in section 4.3 of 38.213

Table A. 4.5.3.1.1-3: Cell specific test parameters for known FR1 SCell activation case, 160ms SCell measurement cycle

Parameter		Unit	Cell 2			Cell 3		
			T1	T2	T3	T1	T2	T3
SSB ARFCN			freq1			freq1		
Duplex mode	Config 1,4		FDD					
	Config 2,3,5,6		TDD					
TDD configuration	Config 1,4		Not Applicable					
	Config 2,5		TDDConf.1.1					
	Config 3,6		TDDConf.2.1					
BW _{channel}	Config 1,4	MHz	10: N _{RB,c} = 52					
	Config 2,5		10: N _{RB,c} = 52					
	Config 3,6		40: N _{RB,c} = 106					
BWP BW	Config 1,4		10: N _{RB,c} = 52					
	Config 2,5		10: N _{RB,c} = 52					
	Config 3,6		40: N _{RB,c} = 106					
DRx Cycle		ms	Not Applicable					
PDSCH Reference measurement channel	Config 1,4		SR.1.1 FDD			SR.1.1 FDD		
	Config 2,5		SR.1.1 TDD			SR.1.1 TDD		
	Config 3,6		SR.2.1 TDD			SR.2.1 TDD		
RMSI CORESET Reference Channel	Config 1,4		CR.1.1 FDD			CR.1.1 FDD		
	Config 2,5		CR.1.1 TDD			CR.1.1 TDD		
	Config 3,6		CR.2.1 TDD			CR.2.1 TDD		
RMC CORESET Reference Channel	Config 1,4		CCR.1.1 FDD			CCR.1.1 FDD		
	Config 2,5		CCR.1.1 TDD			CCR.1.1 TDD		
	Config 3,6		CCR.2.1 TDD			CCR.2.1 TDD		
OCNG Patterns			OCNG pattern 1					
SMTC configuration			SMTC.1					
SSB configuration	Config 1,2,4,5		SSB.1 FR1					
	Config 3,6		SSB.2 FR1					
PDSCH/PDCCH subcarrier spacing	Config 1,2,4,5	kHz	15 kHz					
	Config 3,6		30kHz					
EPRE ratio of PSS to SSS		dB	0					
EPRE ratio of PBCH DMRS to SSS								
EPRE ratio of PBCH to PBCH DMRS								
EPRE ratio of PDCCH DMRS to SSS								
EPRE ratio of PDCCH to PDCCH DMRS								
EPRE ratio of PDSCH DMRS to SSS								
EPRE ratio of PDSCH to PDSCH								
EPRE ratio of OCNG DMRS to SSS(Note 1)								
EPRE ratio of OCNG to OCNG DMRS (Note 1)								

N_{oc} ^{Note2}		dBm/15kHz	[-104]
N_{oc} ^{Note2}	Config 1,2,4,5	dBm/SCS	[-104]
	Config 3,6		[-101]
\hat{E}_s / I_{ot}		dB	[17]
\hat{E}_s / N_{oc}		dB	[17]
SS-RSRP ^{Note3}	Config 1,2,4,5	dBm/SCS	[-87]
	Config 3,6		[-84]
SCH_RP ^{Note 3}		dBm/15 kHz	[-87]
Propagation condition		-	AWGN
<p>Note 1: OCNG shall be used such that both cells are fully allocated and a constant total transmitted power spectral density is achieved for all OFDM symbols.</p> <p>Note 2: Interference from other cells and noise sources not specified in the test is assumed to be constant over subcarriers and time and shall be modelled as AWGN of appropriate power for N_{oc} to be fulfilled.</p> <p>Note 3: SS-RSRP and SCH_RP levels have been derived from other parameters for information purposes. They are not settable parameters themselves.</p> <p>Note 4: The uplink resources for CSI reporting are assigned to the UE prior to the start of time period T2.]</p>			

A.4.5.3.1.2 Test Requirements

During T2 the UE shall send the first CSI report for SCell in a slot (m+k), or in a slot (m+1+[T_{HARQ}+3ms+T_{SSB_max}+T_{SMTC_duration}]+1) as defined in section 8.3 if the slot (m+k) was subject to interruption. Whether CSI report in slot (m+k) was interrupted or not is checked by monitoring ACK/NACK sent in PCell in slot (m+k).

During T2 the UE shall start sending CSI reports for SCell with non-zero CQI index at latest in a slot (m+T_{HARQ}+T_{activation_time}+T_{CSI_Reporting}), T_{activation_time} = [T_{SMTC_SCell}+5ms], as defined in section 8.3.

During T3 the UE shall stop sending CSI reports for SCell at latest in a slot (n+[T_{HARQ}+3ms]), as defined in section 8.3.

During T2 interruption of PCell / PSCell during SCell activation shall not happen outside the slot (m+1+[T_{HARQ}]) to (m+1+[T_{HARQ}+3ms+T_{SMTC_max}+T_{SMTC_duration}]), as defined in section 8.3.

During T3 interruption of PCell / PSCell during SCell deactivation shall not happen outside the slot (n+1+[T_{HARQ}]) to (n+1+[T_{HARQ}+3ms]), as defined in section 8.3.

The interruption of PSCell shall not be more than the values specified for EN-DC in Section 8.2.1.2.4.

All of the above test requirements shall be fulfilled in order for the observed SCell activation delay and SCell deactivation delay to be counted as correct. The rate of correct observed SCell activation delay and SCell deactivation delay during repeated tests shall be at least 90%.

NOTE: During T2 if there are no uplink resources for reporting the valid CSI in a slot (m+T_{HARQ}+T_{activation_time}+T_{CSI_Reporting}) as defined in section 8.3 then the UE shall use the next available uplink resource for reporting the corresponding valid CSI.

A.4.5.3.2 SCell Activation and deactivation of known SCell in FR1 in non-DRX for 320ms SCell measurement cycle

A.4.5.3.2.1 Test Purpose and Environment

The purpose of this test case is the same as for the test defined in section A.4.5.3.1.1. The supported test configurations are the same as defined in section A.4.5.3.1.1. The test parameters are the same except those

described in the following section. The listed parameter values in Tables A.4.5.3.2.1-1 will replace the values of corresponding parameters in Tables A.4.5.3.1.1-2.

Table A.4.5.3.2.1-1: General test parameters for known FR1 SCell activation case, 320ms SCell measurement cycle

Parameter	Unit	Value	Comment
SCell measurement cycle (measCycleSCell)	ms	320	

A.4.5.3.2.2 Test Requirements

The test requirements defined in section A.4.5.3.1.2 shall apply to this test case, except $T_{\text{activation_time}}$ will be replaced with the value $[T_{\text{SMTC_MAX}}+T_{\text{SMTC_SCell}}+5\text{ms}]$.

A.4.5.3.3 SCell Activation and deactivation of unknown SCell in FR1 in non-DRX

A.4.5.3.3.1 Test Purpose and Environment

The purpose of this test is to verify that the SCell activation and deactivation times are within the requirements stated in section 8.3, when the SCell in FR1 is unknown by the UE at the time of activation.

The supported test configurations are the same as defined in section A.4.5.3.1.1. The test parameters are the same except those described in the following section. The listed parameter values in Tables A.4.5.3.3.1-1 will replace the values of corresponding parameters in Tables A.4.5.3.1.1-2. The test consists of three successive time periods, with duration of T1, T2 and T3, respectively. There are three carriers, E-UTRA has one cell, NR has two cells. Cell 1 and Cell 2 have constant signal levels throughout the test. Before the test starts the UE is connected to Cell 1 (PCell) on E-UTRAN and Cell 2 (PSCell) on NR, but is not aware of Cell 3 (SCell) on NR. The UE is monitoring the PCell and PSCell. The UE shall be continuously scheduled in the PCell and PSCell throughout the whole test.

At the beginning of T1 the UE receives an RRC message by which the SCell (Cell 3) becomes configured on NR. During T1 the SCell is powered off and UE is not aware of SCell.

A MAC message for activation of SCell is sent by the test equipment [100ms] after the RRC message, in a slot # denoted m . The point in time at which the MAC message for activation of SCell is received at the UE antenna connector defines the start of time period T2. Immediately at beginning of T2 the transmission power of cell 3 is increased to same level as for cell 2. The UE shall be able to report valid CSI for the activated SCell at latest in slot $(m+T_{\text{HARQ}}+T_{\text{activation_time}}+T_{\text{CSI_Reporting}})$ as defined in section 8.3 provided the SCell can be successfully detected on the first attempt. The UE shall start reporting CSI in slot $(m+k)$ and shall report CQI index 0 (out-of-range) until the SCell activation has been completed. Any PCell interruption due to activation of SCell shall occur in the slot $(m+1+[T_{\text{HARQ}}])$ to $(m+1+[T_{\text{HARQ}}+3\text{ms}+T_{\text{SMTC_MAX}}+T_{\text{SMTC_duration}}])$ as defined in section 8.3.

Time period T3 starts when a MAC message for deactivation of the SCell, sent from the test equipment to the UE in a slot # denoted n , is received at the UE antenna connector. The UE shall carry out deactivation of the SCell at latest in slot $(n+[T_{\text{HARQ}}+3\text{ms}])$ as defined in section 8.3, and any PCell and PSCell interruption due to the deactivation shall occur in the $(n+1+[T_{\text{HARQ}}])$ to $(n+1+[T_{\text{HARQ}}+3\text{ms}])$ as defined in section 8.3.

The test equipment verifies that potential interruption is carried out in the correct time span by monitoring ACK/NACK sent in PSCell during activation of SCell, respectively.

The test equipment verifies the activation time by counting the slots from the time when the SCell activation command is sent until a CSI report with other than CQI index 0 is received.

The test equipment verifies the deactivation time by counting the slots from the time when the SCell1 deactivation command is sent until CQI reporting for SCell1 is discontinued.

Table A.4.5.3.3.1-1: General test parameters for unknown FR1 SCell activation case, 160ms SCell measurement cycle

Parameter	Unit	Value	Comment
T1	ms	[100]	During this time the PSCell shall be known and the SCell configured, but not detected.

A.4.5.3.3.2 Test Requirements

The test requirements defined in section A.4.5.3.1.2 shall apply to this test case, except $T_{\text{activation_time}}$ will be replaced with the value $[2 \cdot T_{\text{SMTC_MAX}} + 2 \cdot T_{\text{SMTC_SCell}} + 5\text{ms}]$ as defined in section 8.3.

A.4.5.3.4 SCell Activation and deactivation of SCell in FR2 in non-DRX

A.4.5.3.4.1 Test Purpose and Environment

The purpose of this test is to verify that the SCell activation and deactivation times are within the requirements stated in section 8.3, when the SCell is in FR2.

The supported test configurations are shown in table A.4.5.3.4.1-1 below. The test parameters are the same except those described in the following section. The listed parameter values in Tables A.4.5.3.4.1-2 will replace the values of corresponding parameters in Tables A.4.5.3.1.1-2. The test consists of three successive time periods, with duration of T1, T2 and T3, respectively. There are three carriers, E-UTRA has one cell (Cell 1), NR has two cells, PSCell (Cell 2) in FR1 and SCell (Cell 3) in FR2. Cell 1 and Cell 2 have constant signal levels throughout the test. Before the test starts the UE is connected to Cell 1 (PCell) on E-UTRAN and Cell 2 (PSCell) on NR, but is not aware of Cell 3 (SCell) on NR. The UE is monitoring the PCell and PSCell. The UE shall be continuously scheduled in the PCell and PSCell throughout the whole test.

At the beginning of T1 the UE receives an RRC message by which the SCell (Cell 3) becomes configured on NR. During T1 the SCell is powered off and UE is not aware of SCell.

A MAC message for activation of SCell is sent by the test equipment [100ms] after the RRC message, in a slot # denoted m . The point in time at which the MAC message for activation of SCell is received at the UE antenna connector defines the start of time period T2. Immediately at beginning of T2 the transmission power of cell 3 is increased to same level as for cell 2. The UE shall be able to report valid CSI for the activated SCell at latest in slot $(m + T_{\text{HARQ}} + T_{\text{activation_time}} + T_{\text{CSI_Reporting}})$ as defined in section 8.3 provided the SCell can be successfully detected on the first attempt. The UE shall start reporting CSI in slot $(m+k)$ and shall report CQI index 0 (out-of-range) until the SCell activation has been completed. Any PCell interruption due to activation of SCell shall occur in the slot $(m+1 + [T_{\text{HARQ}}])$ to $(m+1 + [T_{\text{HARQ}} + 3\text{ms} + T_{\text{SMTC_MAX}} + T_{\text{SMTC_duration}}])$ as defined in section 8.3.

Time period T3 starts when a MAC message for deactivation of the SCell, sent from the test equipment to the UE in a slot # denoted n , is received at the UE antenna connector. The UE shall carry out deactivation of the SCell at latest in slot $(n + [T_{\text{HARQ}} + 3\text{ms}])$ as defined in section 8.3, and any PCell and PSCell interruption due to the deactivation shall occur in the $(n+1 + [T_{\text{HARQ}}])$ to $(n+1 + [T_{\text{HARQ}} + 3\text{ms}])$ as defined in section 8.3.

The test equipment verifies that potential interruption is carried out in the correct time span by monitoring ACK/NACK sent in PSCell during activation of SCell, respectively.

The test equipment verifies the activation time by counting the slots from the time when the SCell activation command is sent until a CSI report with other than CQI index 0 is received.

The test equipment verifies the deactivation time by counting the slots from the time when the SCell1 deactivation command is sent until CQI reporting for SCell1 is discontinued.

Table A.4.5.3.4.1-1: FR2 SCell activation in non-DRX test configurations with FR1 PSCell

Configuration	Description
1	LTE FDD PCell, Cell 2 NR 15 kHz SSB SCS, 10MHz bandwidth, FDD duplex mode Cell 3 NR 120kHz SSB SCS, 100MHz bandwidth, TDD duplex mode
2	LTE FDD PCell, Cell 2 NR 15 kHz SSB SCS, 10MHz bandwidth, TDD duplex mode Cell 3 NR 120kHz SSB SCS, 100MHz bandwidth, TDD duplex mode
3	LTE FDD PCell, Cell 2 NR 30kHz SSB SCS, 40MHz bandwidth, TDD duplex mode Cell 3 NR 120kHz SSB SCS, 100MHz bandwidth, TDD duplex mode
4	LTE TDD PCell, Cell 2 NR 15 kHz SSB SCS, 10MHz bandwidth, FDD duplex mode Cell 3 NR 120kHz SSB SCS, 100MHz bandwidth, TDD duplex mode
5	LTE TDD PCell, Cell 2 NR 15 kHz SSB SCS, 10MHz bandwidth, TDD duplex mode Cell 3 NR 120kHz SSB SCS, 100MHz bandwidth, TDD duplex mode
6	LTE TDD PCell, Cell 2 NR 30kHz SSB SCS, 40MHz bandwidth, TDD duplex mode Cell 3 NR 120kHz SSB SCS, 100MHz bandwidth, TDD duplex mode

Note: The UE is only required to be tested in one of the supported test configurations

Table A.4.5.3.4.1-2: General test parameters for FR2 SCell activation case with FR1 PSCell

Parameter	Unit	Value	Comment
Active PCell		Cell 1	Primary cell on E-UTRAN RF channel number 1. As specified in section A.3.7.2.2

Table A.4.5.3.4.1-3: Cell specific test parameters for FR2 SCell activation case with FR1 PSCell

Parameter	Unit	Cell 2			Cell 3		
		T1	T2	T3	T1	T2	T3
SSB ARFCN		freq1			freq2		
Duplex mode	Config 1,4	FDD			TDD		
	Config 2,3,5,6	TDD			TDD		
TDD configuration	Config 1,4	Not Applicable			TDDConf.3.1		
	Config 2,5	TDDConf.1.1					
	Config 3,6	TDDConf.2.1					
BW _{channel}	Config 1,4	10: N _{RB,c} = 52			100: N _{RB,c} = 66		
	Config 2,5	10: N _{RB,c} = 52					
	Config 3,6	40: N _{RB,c} = 106					
BWP BW	Config 1,4	10: N _{RB,c} = 52			100: N _{RB,c} = 66		
	Config 2,5	10: N _{RB,c} = 52					
	Config 3,6	40: N _{RB,c} = 106					
DRx Cycle	ms	Not Applicable					
PDSCH Reference measurement channel	Config 1,4	SR.1.1 FDD			SR.3.1 TDD		
	Config 2,5	SR.1.1 TDD					
	Config 3,6	SR.2.1 TDD					
RMSI CORESET Reference Channel	Config 1,4	CR.1.1 FDD			CR.3.1 TDD		
	Config 2,5	CR.1.1 TDD					
	Config 3,6	CR.2.1 TDD					
RMC CORESET Reference Channel	Config 1,4	CCR.1.1 FDD			CCR.3.1 TDD		
	Config 2,5	CCR.1.1 TDD					
	Config 3,6	CCR.2.1 TDD					
OCNG Patterns		OCNG pattern 1					
SMTC configuration		SMTC.1					
TCI state		NA			CSI-RS.Config.0		
TRS configuration		NA			TRS.2.1 TDD		

SSB configuration	Config 1,2,4,5		SSB.1 FR1	SSB.1 FR2
	Config 3,6		SSB.2 FR1	
PDSCH/PDCCH subcarrier spacing	Config 1,2,4,5	kHz	15kHz	120kHz
	Config 3,6		30kHz	
EPRE ratio of PSS to SSS		dB	0	
EPRE ratio of PBCH DMRS to SSS				
EPRE ratio of PBCH to PBCH DMRS				
EPRE ratio of PDCCH DMRS to SSS				
EPRE ratio of PDCCH to PDCCH DMRS				
EPRE ratio of PDSCH DMRS to SSS				
EPRE ratio of PDSCH to PDSCH				
EPRE ratio of OCNG DMRS to SSS(Note 1)				
EPRE ratio of OCNG to OCNG DMRS (Note 1)				
N_{oc} ^{Note2}				
N_{oc} ^{Note2}	Config 1,2,4,5	dBm/SCS	[-104]	TBD
	Config 3,6		[-101]	TBD
\hat{E}_s / I_{ot}		dB	[17]	TBD
\hat{E}_s / N_{oc}		dB	[17]	TBD
SS-RSRP ^{Note3}	Config 1,2,4,5	dBm/SCS	[-87]	TBD
	Config 3,6		[-84]	TBD
SCH_RP ^{Note 3}		dBm/15 kHz	[-87]	TBD
Propagation condition		-	AWGN	
<p>Note 1: OCNG shall be used such that both cells are fully allocated and a constant total transmitted power spectral density is achieved for all OFDM symbols.</p> <p>Note 2: Interference from other cells and noise sources not specified in the test is assumed to be constant over subcarriers and time and shall be modelled as AWGN of appropriate power for N_{oc} to be fulfilled.</p> <p>Note 3: SS-RSRP and SCH_RP levels have been derived from other parameters for information purposes. They are not settable parameters themselves.</p> <p>Note 4: The uplink resources for CSI reporting are assigned to the UE prior to the start of time period T2.]</p>				

Table A.4.5.3.4.1-4: OTA related test parameters for FR2 SCell activation case with FR1 PSCell

Parameter	Unit	Cell 2			Cell 3		
		T1	T2	T3	T1	T2	T3
Angle of arrival configuration		NA			According to section A.3.15.1		
N_{oc} ^{Note1}	dBm/15kHz	[-104]			TBD		
N_{oc} ^{Note1}	Config 1,2,4,5	[-104]			TBD		
	Config 3,6	[-101]			TBD		
SS-RSRP ^{Note2}	Config 1,2,4,5	[-87]			TBD		
	Config 3,6	[-84]			TBD		
\hat{E}_s / I_{ot}	dB	[17]			TBD		
I_o ^{Note2}	dBm/95.04 MHz ^{Note4}	TBD			TBD		
<p>Note 1: Interference from other cells and noise sources not specified in the test is assumed to be constant over subcarriers and time and shall be modelled as AWGN of appropriate power for N_{oc} to be fulfilled.</p> <p>Note 2: SS-RSRP and I_o levels have been derived from other parameters for information purposes. They are not settable parameters themselves.</p> <p>Note 3: SS-RSRP minimum requirements are specified assuming independent interference and noise at each receiver antenna port.</p> <p>Note 4: Equivalent power received by an antenna with 0dBi gain at the centre of the quiet zone</p> <p>Note 5: As observed with 0dBi gain antenna at the centre of the quiet zone</p>							

A.4.5.3.4.2 Test Requirements

The test requirements defined in section A.4.5.3.1.2 shall apply to this test case, except $T_{\text{activation_time}}$ will be replaced with the value $[TBD * T_{\text{SMTC_SCell}} + 5\text{ms}]$ as defined in section 8.3.

A.4.5.4 UE UL carrier RRC reconfiguration Delay

A.4.5.4.1 UE UL carrier RRC reconfiguration Delay

Table A.4.5.4.1-1 - Table A.4.5.4.1-4 : Void

A.4.5.4.1.1 Test Purpose and Environment

The purpose of this test is to verify that when the UE receives a RRC message implying NR UL or Supplementary UL carrier configuration, the UE shall be ready to start transmission on the newly configured carrier within the time limits specified in section 8.4.2 and 8.4.3 for configuring and deconfiguring, respectively.

There are three cells: E-UTRAN PCell (Cell 1), FR1 PSCell (Cell 2) and FR1 SCell (Cell 3). For SCell, both NR uplink and supplementary uplink are broadcast by *ServingCellConfigCommonSIB*. The test parameters for PSCell and SCell are given in Table A. 4.5.4.1.1-1, Table A. 4.5.4.1.1-2, Table A. 4.5.4.1.1-3 and Table A. 4.5.4.1.1-4 below. The test parameters and applicability for E-UTRAN PCell are defined in A.3.7.2. The test consists two tests. In test 1, the test consists of three time periods, with duration of T1, T2 and T3 respectively. During time duration T1, NR uplink of cell 2 is configured to UE. At the start of T2, a supplementary uplink of cell2 is configured to UE through *RRCReconfiguration*, then UE shall start transmission both on the NR uplink and supplementary uplink. At the start of T3, the supplementary uplink is released through *RRCReconfiguration*.

In test 2, the test consists of three time periods, with duration of T1, T2 and T3 respectively. During time duration T1, supplementary uplink on cell 3 is configured to UE. At the start of T2, a NR uplink is configured to UE through *RRCReconfiguration*, then UE shall start transmission both on the NR uplink and supplementary uplink. At the start of T3, the NR uplink is released through *RRCReconfiguration*.

Table A.4.5.4.1.1-1: Supported test configurations

Configuration	PSCell (Cell2)	SCell (Cell3)
1	15 kHz SSB SCS, 10MHz bandwidth, FDD duplex mode	DL and UL: 15kHz SSB SCS, 10MHz bandwidth, FDD duplex mode; SUL: 15kHz SCS, 10MHz bandwidth, SUL duplex mode
2	15 kHz SSB SCS, 10MHz bandwidth, FDD duplex mode	DL and UL: 15kHz SSB SCS, 10MHz bandwidth, TDD duplex mode; SUL: 15kHz SCS, 10MHz bandwidth, SUL duplex mode
3	15 kHz SSB SCS, 10MHz bandwidth, FDD duplex mode	DL and UL: 30kHz SSB SCS, 40MHz bandwidth, TDD duplex mode; SUL: 30kHz SCS, 40MHz bandwidth, SUL duplex mode
4	15 kHz SSB SCS, 10MHz bandwidth, TDD duplex mode	DL and UL: 15kHz SSB SCS, 10MHz bandwidth, FDD duplex mode; SUL: 15kHz SCS, 10MHz bandwidth, SUL duplex mode
5	15 kHz SSB SCS, 10MHz bandwidth, TDD duplex mode	DL and UL: 15kHz SSB SCS, 10MHz bandwidth, TDD duplex mode; SUL: 15kHz SCS, 10MHz bandwidth, SUL duplex mode
6	15 kHz SSB SCS, 10MHz bandwidth, TDD duplex mode	DL and UL: 30kHz SSB SCS, 40MHz bandwidth, TDD duplex mode; SUL: 30kHz SCS, 40MHz bandwidth, SUL duplex mode
7	30 kHz SSB SCS, 40MHz bandwidth, TDD duplex mode	DL and UL: 15kHz SSB SCS, 10MHz bandwidth, FDD duplex mode;

		SUL: 15kHz SCS, 10MHz bandwidth, SUL duplex mode
8	30 kHz SSB SCS, 40MHz bandwidth, TDD duplex mode	DL and UL: 15kHz SSB SCS, 10MHz bandwidth, TDD duplex mode; SUL: 15kHz SCS, 10MHz bandwidth, SUL duplex mode
9	30 kHz SSB SCS, 40MHz bandwidth, TDD duplex mode	DL and UL: 30kHz SSB SCS, 40MHz bandwidth, TDD duplex mode; SUL: 30kHz SCS, 40MHz bandwidth, SUL duplex mode
Note: The UE is only required to be tested in one of the supported test configurations		

Table A.4.5.4.1.1-2: General test parameters for EN-DC UE UL carrier RRC reconfiguration Delay

Parameter	Unit	Test configuration	Value	Comment
RF Channel Number		Config 1,2,3, 4, 5, 6, 7, 8, 9	1, 2, 3	Three radio channels are used for these two tests.
Active cell		Config 1,2,3, 4, 5, 6, 7, 8, 9	Cell 1: E-UTRAN PCell Cell 2: FR1 PSCell Cell 3: FR1 SCell	E-UTRAN PCell on RF channel number 1 FR1 PSCell on RF channel number 2 FR1 SCell on RF channel number 3
CP length		Config 1,2,3, 4, 5, 6, 7, 8, 9	Normal	
DRX		Config 1,2,3, 4, 5, 6, 7, 8, 9	OFF	
Measurement gap pattern Id		Config 1,2,3, 4, 5, 6, 7, 8, 9	OFF	
Filter coefficient		Config 1,2,3, 4, 5, 6, 7, 8, 9	0	L3 filtering is not used
T1	s	Config 1,2,3, 4, 5, 6, 7, 8, 9	5	
T2	s	Config 1,2,3, 4, 5, 6, 7, 8, 9	5	
T3	s	Config 1,2,3, 4, 5, 6, 7, 8, 9	5	

Table A.4.5.4.1.1-3: NR Cell specific test parameters for EN-DC UE UL carrier RRC reconfiguration Delay on PSCell (Cell 2)

Parameter	Unit	Test Configuration	Test 1			Test 2		
			T1	T2	T3	T1	T2	T3
Channel number		Conf 1, 2, 3, 4, 5, 6, 7, 8, 9	2			2		
TDD configuration		Conf 1, 2, 3	N/A			N/A		
		Conf 4, 5, 6	TDD Conf.1.1			TDD Conf.1.1		
		Conf 7, 8, 9	TDD Conf.2.1			TDD Conf.2.1		
BW _{channel}	MHz	Conf 1, 2, 3	10: N _{RB,c} = 52			10: N _{RB,c} = 52		
		Conf 4, 5, 6	10: N _{RB,c} = 52			10: N _{RB,c} = 52		
		Conf 7, 8, 9	40: N _{RB,c} = 106			40: N _{RB,c} = 106		
PDSCH reference measurement channel as defined in A.3.1.1		Conf 1, 2, 3	SR.1.1 FDD			SR.1.1 FDD		
		Conf 4, 5, 6	SR.1.1 TDD			SR.1.1 TDD		
		Conf 7, 8, 9	SR 2.1 TDD			SR 2.1 TDD		
RMSI CORESET reference measurement channel as defined in A.3.1.2		Conf 1, 2, 3	CR.1.1 FDD			CR.1.1 FDD		
		Conf 4, 5, 6	CR.1.1 TDD			CR.1.1 TDD		
		Conf 7, 8, 9	CR.2.1 TDD			CR.2.1 TDD		

RMC CORESET reference measurement channel as defined in A.3.1.3		Conf 1, 2, 3	CCR.1.1 FDD			CCR.1.1 FDD		
		Conf 4, 5, 6	CCR.1.1 TDD			CCR.1.1 TDD		
		Conf 7, 8, 9	CCR.2.1 TDD			CCR.2.1 TDD		
OCNG Pattern ^{Note 1}		Conf 1, 2, 3, 4, 5, 6, 7, 8, 9	OP.1			OP.1		
SSB configuration		Conf 1, 2, 3, 4, 5, 6	SSB.1 FR1			SSB.1 FR1		
		Conf 7, 8, 9	SSB.2 FR1			SSB.2 FR1		
SMTC configuration		Conf 1, 2, 3, 4, 5, 6, 7, 8, 9	SMTC.1			SMTC.1		
DL initial BWP configuration		Conf 1, 2, 3, 4, 5, 6, 7, 8, 9	DLBWP.0.1			DLBWP.0.1		
DL dedicated BWP configuration		Conf 1, 2, 3, 4, 5, 6, 7, 8, 9	DLBWP.1.1			DLBWP.1.1		
UL dedicated BWP configuration		Conf 1, 2, 3, 4, 5, 6, 7, 8, 9	ULBWP.1.1			ULBWP.1.1		
EPRE ratio of PSS to SSS	dB	Conf 1, 2, 3, 4, 5, 6, 7, 8, 9	0			0		
EPRE ratio of PBCH_DMRS to SSS								
EPRE ratio of PBCH to PBCH_DMRS								
EPRE ratio of PDCCH_DMRS to SSS								
EPRE ratio of PDCCH to PDCCH_DMRS								
EPRE ratio of PDSCH_DMRS to SSS								
EPRE ratio of PDSCH to PDSCH_DMRS								
EPRE ratio of OCNG DMRS to SSS								
EPRE ratio of OCNG to OCNG DMRS								
N_{oc} ^{Note 2}	dBm / 15kHz	Conf 1, 2, 3, 4, 5, 6, 7, 8, 9	-102			-102		
	dBm/SCS	Conf 1,2,3,4,5,6	-102			-102		
		Conf 7,8,9	-99			-99		
\hat{E}_s / N_{oc}	dB	Conf 1, 2, 3, 4, 5, 6, 7, 8, 9	16	16	16	16	16	16
\hat{E}_s / I_{ot} ^{Note 3}	dB	Conf 1, 2, 3, 4, 5, 6, 7, 8, 9	16	16	16	16	16	16
SS-RSRP ^{Note 3}	dBm/SCS	Conf 1,2,3,4,5,6	-86	-86	-86	-86	-86	-86
		Conf 7,8,9	-83	-83	-83	-83	-83	-83
I_o ^{Note 3}	dBm/ 9.36 MHz	Conf 1,2,3,4,5,6	-57.9	-57.9	-57.9	-57.9	-57.9	-57.9
	dBm/ 38.16 MHz	Conf 7,8,9	-51.8	-51.8	-51.8	-51.8	-51.8	-51.8

Propagation Condition		Conf 1, 2, 3, 4, 5, 6, 7, 8, 9	AWGN	AWGN
Antenna configuration		Conf 1, 2, 3, 4, 5, 6, 7, 8, 9	1 x 2	1 x 2
NOTE 1: OCNB shall be used such that both cells are fully allocated, and a constant total transmitted power spectral density is achieved for all OFDM symbols.				
NOTE 2: Interference from other cells and noise sources not specified in the test is assumed to be constant over subcarriers and time and shall be modelled as AWGN of appropriate power for N_{oc} to be fulfilled.				
NOTE 3: \hat{E}_s/I_{ot} , I_o , and SS-RSRP levels have been derived from other parameters for information purposes. They are not settable parameters themselves.				

Table A.4.5.4.1.1-4: NR Cell specific test parameters for EN-DC UE UL carrier RRC reconfiguration Delay on SCell (Cell 3)

Parameter	Unit	Test Configuration	Test 1			Test 2		
			T1	T2	T3	T1	T2	T3
Channel number		Conf 1, 2, 3, 4, 5, 6, 7, 8, 9	3			3		
TDD configuration		Conf 1, 4, 7	N/A			N/A		
		Conf 2, 5, 8	TDDConf.1.1			TDDConf.1.1		
		Conf 3, 6, 9	TDDConf.2.1			TDDConf.2.1		
BW _{channel}	MHz	Conf 1, 4, 7	10: N _{RB,c} = 52			10: N _{RB,c} = 52		
		Conf 2, 5, 8	10: N _{RB,c} = 52			10: N _{RB,c} = 52		
		Conf 3, 6, 9	40: N _{RB,c} = 106			40: N _{RB,c} = 106		
PUSCH parameters for NR UL carrier		Conf 1, 4, 7	[TBD]	[TBD]	[TBD]	N/A	[TBD]	N/A
		Conf 2, 5, 8	[TBD]	[TBD]	[TBD]	N/A	[TBD]	N/A
		Conf 3, 6, 9	[TBD]	[TBD]	[TBD]	N/A	[TBD]	N/A
PUCCH parameters For NR UL carrier		Conf 1, 4, 7	[TBD]	[TBD]	[TBD]	N/A	[TBD]	N/A
		Conf 2, 5, 8	[TBD]	[TBD]	[TBD]	N/A	[TBD]	N/A
		Conf 3, 6, 9	[TBD]	[TBD]	[TBD]	N/A	[TBD]	N/A
PUSCH parameters for supplementary UL		Conf 1, 4, 7	N/A	[TBD]	N/A	[TBD]	[TBD]	[TBD]
		Conf 2, 5, 8	N/A	[TBD]	N/A	[TBD]	[TBD]	[TBD]
		Conf 3, 6, 9	N/A	[TBD]	N/A	[TBD]	[TBD]	[TBD]
PUCCH parameters for supplementary UL		Conf 1, 4, 7	N/A	[TBD]	N/A	[TBD]	[TBD]	[TBD]
		Conf 2, 5, 8	N/A	[TBD]	N/A	[TBD]	[TBD]	[TBD]
		Conf 3, 6, 9	N/A	[TBD]	N/A	[TBD]	[TBD]	[TBD]
PDSCH reference measurement channel as defined in A.3.1.1		Conf 1, 4, 7	SR.1.1 FDD			SR.1.1 FDD		
		Conf 2, 5, 8	SR.1.1 TDD			SR.1.1 TDD		
		Conf 3, 6, 9	SR.2.1 TDD			SR.2.1 TDD		
RMSI CORESET reference measurement channel as defined in A.3.1.2		Conf 1, 4, 7	CR.1.1 FDD			CR.1.1 FDD		
		Conf 2, 5, 8	CR.1.1 TDD			CR.1.1 TDD		
		Conf 3, 6, 9	CR.2.1 TDD			CR.2.1 TDD		
RMC CORESET reference measurement channel as defined in A.3.1.3		Conf 1, 4, 7	CCR.1.1 FDD			CCR.1.1 FDD		
		Conf 2, 5, 8	CCR.1.1 TDD			CCR.1.1 TDD		
		Conf 3, 6, 9	CCR.2.1 TDD			CCR.2.1 TDD		
OCNB Pattern ^{Note 1}		Conf 1, 2, 3	OP.1			OP.1		
SSB configuration		Conf 1, 2, 4, 5, 7, 8	SSB.1 FR1			SSB.1 FR1		
		Conf 3, 6, 9	SSB.2 FR1			SSB.2 FR1		
SMTB configuration		Conf 1, 2, 3, 4, 5, 6, 7, 8, 9	SMTB.1			SMTB.1		
DL initial BWP configuration		Conf 1, 2, 3, 4, 5, 6, 7, 8, 9	DLBWP.0.1			DLBWP.0.1		

DL dedicated BWP configuration		Conf 1, 2, 3, 4, 5, 6, 7, 8, 9	DLBWP.1.1			DLBWP.1.1		
UL dedicated BWP configuration		Conf 1, 2, 3, 4, 5, 6, 7, 8, 9	ULBWP.1.1			ULBWP.1.1		
EPRE ratio of PSS to SSS	dB	Conf 1, 2, 3, 4, 5, 6, 7, 8, 9	0			0		
EPRE ratio of PBCH_DMRS to SSS								
EPRE ratio of PBCH to PBCH_DMRS								
EPRE ratio of PDCCH_DMRS to SSS								
EPRE ratio of PDCCH to PDCCH_DMRS								
EPRE ratio of PDSCH_DMRS to SSS								
EPRE ratio of PDSCH to PDSCH_DMRS								
EPRE ratio of OCNG DMRS to SSS								
EPRE ratio of OCNG to OCNG DMRS								
N_{oc} ^{Note 2}	dBm / 15kHz	Conf 1, 2, 3, 4, 5, 6, 7, 8, 9	-102			-102		
	dBm/SCS	Conf 1, 2, 4, 5, 7, 8	-102			-102		
		Conf 3, 6, 9	-99			-99		
\hat{E}_s / N_{oc}	dB	Conf 1, 2, 3, 4, 5, 6, 7, 8, 9	16	16	16	16	16	16
\hat{E}_s / I_{ot} ^{Note 3}	dB	Conf 1, 2, 3, 4, 5, 6, 7, 8, 9	16	16	16	16	16	16
SS-RSRP ^{Note 3}	dBm/SCS	Conf 1, 2, 4, 5, 7, 8	-86	-86	-86	-86	-86	-86
		Conf 3, 6, 9	-83	-83	-83	-83	-83	-83
I_o ^{Note 3}	dBm/9.36 MHz	Conf 1, 2, 4, 5, 7, 8	-57.9	-57.9	-57.9	-57.9	-57.9	-57.9
	dBm/38.16 MHz	Conf 3, 6, 9	-51.8	-51.8	-51.8	-51.8	-51.8	-51.8
Propagation Condition		Conf 1, 2, 3, 4, 5, 6, 7, 8, 9	AWGN			AWGN		
Antenna configuration		Conf 1, 2, 3, 4, 5, 6, 7, 8, 9	1 x 2			1 x 2		
<p>NOTE 1: OCNG shall be used such that both cells are fully allocated, and a constant total transmitted power spectral density is achieved for all OFDM symbols.</p> <p>NOTE 2: Interference from other cells and noise sources not specified in the test is assumed to be constant over subcarriers and time and shall be modelled as AWGN of appropriate power for N_{oc} to be fulfilled.</p> <p>NOTE 3: \hat{E}_s / I_{ot}, I_o, and SS-RSRP levels have been derived from other parameters for information purposes. They are not settable parameters themselves.</p>								

A.4.5.4.1.2 Test Requirements

In test 1 the UE shall be ready to start transmission on the supplementary uplink carrier on SCell within [20]ms from the start of T2.

In test 1 the UE shall stop the transmission on the supplementary uplink carrier on SCell within [20]ms from the start of T3.

In test 2 the UE shall be ready to start transmission on the NR uplink carrier on SCell within [20]ms from the start of T2.

In test 2 the UE shall stop the transmission on the NR uplink carrier on SCell within [20]ms from the start of T3.

All of the above test requirements shall be fulfilled in order for the observed UE UL carrier configuration delay and UE UL carrier release delay to be counted as correct. The rate of correct observed UE UL carrier configuration delay and UE UL carrier release delay during repeated tests shall be at least 90%.

A.4.5.5 Beam Failure Detection and Link recovery procedures

A.4.5.5.1 EN-DC Beam Failure Detection and Link Recovery Test for FR1 PSCell configured with SSB-based BFD and LR in non-DRX mode

Editor's note: It is open whether BFD can be based on SSB. This test case will be updated accordingly.

A.4.5.5.1.1 Test Purpose and Environment

The purpose of this test is to verify that the UE properly detects SSB-based beam failure in the set q_0 configured for a serving PSCell and that the UE performs correct SSB-based link recovery based on beam candidate set q_1 . The purpose is to test the downlink monitoring for beam failure detection within the UEs active DL BWP of the PSCell, during the evaluation period, and link recovery, when no DRX is used. This test will partly verify the SSB based beam failure detection and link recovery for an FR1 serving cell requirements in clause 8.5.

The test parameters are given in Tables A.4.5.5.1.1-1, A.4.5.5.1.1-2, A.4.5.5.1.1-3 and A.4.5.5.1.1-4 below. There are two cells, cell 1 is the E-UTRAN PCell, and cell 2 is the PSCell, in the test. The test consists of five successive time periods, with time duration of T1, T2, T3, T4 and T5 respectively. Figure A.4.5.5.1.1-1 shows the variation of the downlink SNR of the PCell and the SNR of the SSB in set q_0 in the active PSCell to emulate SSB based beam failure. Figure A.4.5.5.1.1-1 additionally shows the variation of the downlink SNR of the SSB in set q_1 of the candidate beam used for link recovery. Prior to the start of the time duration T1, the UE shall be fully synchronized to cell 1 and cell 2. The UE shall be configured for periodic CSI reporting with a reporting periodicity of [2] ms. In the test, DRX configuration is not enabled. The UE is configured to perform inter-frequency measurements using GP ID #0 (40ms) in test 2.

Table A.4.5.5.1.1-1: Supported test configurations for FR1 PCell

Configuration	Description
1	LTE FDD, NR 15 kHz SSB SCS, 10MHz bandwidth, FDD duplex mode
2	LTE FDD, NR 15 kHz SSB SCS, 10MHz bandwidth, TDD duplex mode
3	LTE FDD, NR 30kHz SSB SCS, 40MHz bandwidth, TDD duplex mode
4	LTE TDD, NR 15 kHz SSB SCS, 10MHz bandwidth, FDD duplex mode
5	LTE TDD, NR 15 kHz SSB SCS, 10MHz bandwidth, TDD duplex mode
6	LTE TDD, NR 30kHz SSB SCS, 40MHz bandwidth, TDD duplex mode
Note:	The UE is only required to pass in one of the supported test configurations in FR1

Table A.4.5.5.1.1-2: General test parameters for FR1 PSCell for SSB-based beam failure detection and link recovery testing in non-DRX mode

Parameter		Unit	Value		Comment
			Test 1	Test 2	
Active PCell			Cell 1	Cell 1	
RF Channel Number			1	1	
Duplex mode	Config 1, 4		FDD	FDD	
	Config 2, 3, 5, 6		TDD	TDD	
TDD Configuration	Config 1, 4		Not Applicable	Not Applicable	
	Config 2, 5		[TDDConf.1.1]	[TDDConf.1.1]	
	Config 3, 6		[TDDConf.1.2]	[TDDConf.1.2]	
CORESET Reference Channel	Config 1, 4		[CR. 1.1 FDD]	[CR. 1.1 FDD]	
	Config 2, 5		[CR. 1.1 TDD]	[CR. 1.1 TDD]	
	Config 3, 6		[CR. 2.1 TDD]	[CR. 2.1 TDD]	
SSB Configuration	Config 1, 4		TBD (Note: periodicity is 20ms)	TBD (Note: periodicity is 20ms)	
	Config 2, 5		TBD (Note: periodicity is 20ms)	TBD (Note: periodicity is 20ms)	
	Config 3, 6		TBD (Note: periodicity is 20ms)	TBD (Note: periodicity is 20ms)	
SMTC Configuration	Config 1, 2, 4, 5		FR1 pattern 1	FR1 pattern 1	
	Config 3, 6		FR1 pattern 2	FR1 pattern 2	
PDSCH/PDCCH subcarrier spacing	Config 1, 2, 4, 5		15 KHz	15 KHz	
	Config 3, 6		30 KHz	30 KHz	
csi-RS-Index assigned as RLM RS			[0]	[0]	
OCNG parameters			TBD	TBD	
CP length			Normal	Normal	
Correlation Matrix and Antenna Configuration			[2x2 Low]	[2x2 Low]	
	DCI format		1-0	1-0	
	Number of Control OFDM symbols		2	2	
	Aggregation level	CC E	8	8	

Beam failure detection transmission parameters	Ratio of hypothetical PDCCH RE energy to average CSI-RS RE energy	dB	0	0	
	Ratio of hypothetical PDCCH DMRS energy to average CSI-RS RE energy	dB	0	0	
	DMRS precoder granularity		REG bundle size	REG bundle size	
	REG bundle size		6	6	
DRX			OFF	OFF	
Gap pattern ID			[N.A.]	*[gp0]	
ssb-Index			2	2	Number of SSB indexes used for beam failure detection
rlnInSyncOutOfSync Threshold			absent	absent	When the field is absent, the UE applies the value 0. (Table 8.1.1-1).
rsrp-ThresholdSSB			TBD	TBD	Threshold used for $Q_{out_LR_SSB}$
powerControlOffsetSS			NA	NA	Used for deriving rsrp-ThresholdCSI-RS
beamFailureInstanceMaxCount			[n2]	[n2]	see TS 38.321 [7], section 5.17
beamFailureDetectionTimer			[pbfd4]	[pbfd4]	see TS 38.321 [7], section 5.17
ZP CSI-RS configuration			TBD	TBD	
CSI-IM configuration			TBD	TBD	
Periodic CSI reporting			PUCCH	PUCCH	
CSI reporting periodicity	Config 1, 2, 4, 5	slot	[5]	[5]	
	Config 3, 6		[10]	[10]	
T1		s	1	1	During this time the the UE shall be fully synchronized to cell 1
T2		s	0.4	0.4	
T3		s	[0.6]	[0.6]	
D1		s	[0.24]	[0.44]	
Note 1: UE-specific PDCCH is not transmitted after T1 starts.					

Table A.4.5.5.1.1-3: Cell specific test parameters for FR1 PSCell for SSB-based beam failure detection and link recovery testing in non-DRX mode

Parameter		Unit	Test 1 and Test 2					Test 1 and Test 2				
			SSB of set q_0					SSB of set q_1				
			T1	T2	T3	T4	T5	T1	T2	T3	T4	T5
PDCCH_beta		dB	4					4				
PDCCH_DMRS_beta		dB	4					4				
PBCH_beta		dB	0					0				
PSS_beta		dB										
SSS_beta		dB										
PDSCH_beta		dB										
OCNG_beta		dB										
SNR		dB										
			TBD	TBD	TBD	TBD	TBD	TBD	TBD	TBD	TBD	
			TBD	TBD	TBD	TBD	TBD	TBD	TBD	TBD	TBD	
N_{oc}	Config 1	dBm/ 15K Hz	[-98]					[-98]				
	Config 2		[-98]					[-98]				
	Config 3		[-98]					[-98]				
Propagation condition			[TDL-C 300ns 100Hz]					[TDL-C 300ns 100Hz]				
<p>Note 1: OCNG shall be used such that the resources in Cell 1 are fully allocated and a constant total transmitted power spectral density is achieved for all OFDM symbols.</p> <p>Note 2: The uplink resources for CSI reporting are assigned to the UE prior to the start of time period T1.</p> <p>Note 3: NZP CSI-RS resource set configuration for CSI reporting are assigned to the UE prior to the start of time period T1.</p> <p>Note 4: Measurement gap configuration is assigned to the UE prior to the start of time period T1.</p> <p>Note 5: The timers and layer 3 filtering related parameters are configured prior to the start of time period T1.</p> <p>Note 6: The signal contains PDCCH for UEs other than the device under test as part of OCNG.</p> <p>Note 7: SNR levels correspond to the signal to noise ratio over the SSS REs.</p> <p>Note 8: The SNR in time periods T1, T2, T3, T4 and T5 is denoted as SNR1, SNR2 and SNR3 respectively in figure A.4.5.5.1.1-1.</p> <p>Note 9: The SNR values are specified for testing a UE which supports 2RX on at least one band. For testing of a UE which supports 4RX on all bands, the SNR during T3 is [A.3.6].</p>												

Table A.4.5.5.1.1-4: Measurement gap configuration for FR1 PSCell for SSB-based beam failure detection and link recovery testing in non-DRX mode

Field	Test 2
	Value
gapOffset	[0]

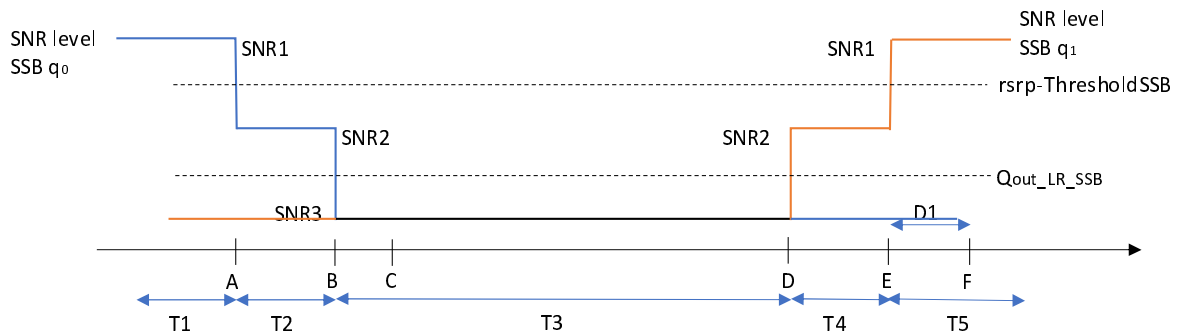

Figure A.4.5.5.1.1-1: SNR variation SSB for SSB-based beam failure detection and link recovery testing in non-DRX mode

A.4.5.5.1.2 Test Requirements

The UE behaviour during time durations T1, T2, T3, T4 and T5 shall be as follows:

During the time duration T1 and T2, the UE shall transmit uplink signal at least in all subframes configured for CSI transmission on Cell 1.

During the period from time point A to time point B the UE shall transmit uplink signal in Cell 1 in all uplink slots configured for CSI transmission according to the configured periodic CSI reporting for Cell 1.

During T3 the UE shall detect beam failure and initiate link recovery. During T4 and T5 the UE measures and evaluates beam candidate from beam candidate set q_1 .

No later than time point F occurring no later than $D1 = [\text{TBD}]$ ms after the start of T5, the UE shall transmit preamble on a beam associated with the candidate beam set q_1 .

Test is concluded once the test equipment has received the initial preamble transmission from the UE. The rate of correct events observed during repeated tests shall be at least 90%.

A.4.5.5.2 EN-DC Beam Failure Detection and Link Recovery Test for FR1 PSCell configured with SSB-based BFD and LR in DRX mode

Editor's note: It is open whether BFD can be based on SSB. This test case will be updated accordingly.

A.4.5.5.2.1 Test Purpose and Environment

The purpose of this test is to verify that the UE properly detects SSB-based beam failure in the set q_0 configured for a serving PSCell and that the UE performs correct SSB-based link recovery based on beam candidate set q_1 . The purpose is to test the downlink monitoring for beam failure detection within the UE's active DL BWP of the PSCell, during the evaluation period, and link recovery, when DRX is used. This test will partly verify the SSB based beam failure detection and link recovery for an FR1 serving cell requirements in clause 8.5.

The test parameters are given in Tables A.4.5.5.2.1-1, A.4.5.5.2.1-2, A.4.5.5.2.1-3, A.4.5.5.2.1-4 and A.4.5.5.2.1-5 below. There are two cells, cell 1 is the E-UTRAN PCell, and cell 2 is the PSCell, in the test. The test consists of five successive time periods, with time duration of T1, T2, T3, T4 and T5 respectively. Figure A.4.5.5.2.1-1 shows the variation of the downlink SNR of the PCell and the SNR of the SSB in set q_0 in the active PSCell to emulate SSB based beam failure. Figure A.4.5.5.2.1-1 additionally shows the variation of the downlink SNR of the SSB in set q_1 of the candidate beam used for link recovery. Prior to the start of the time duration T1, the UE shall be fully synchronized to cell 1 and cell 2. The UE shall be configured for periodic CSI reporting with a reporting periodicity

of [2] ms. In the test, DRX configuration is enabled in PSCell and DRX inactivity timer has already been expired, i.e. UE tries to decode PDCCH and to send periodic CQI during the period when On-duration timer is running. Time alignment timers shall be set to “infinity” so that UL timing alignment is maintained during the test. The UE is configured to perform inter-frequency measurements using GP ID #0 (40ms) in test 2.

Table A.4.5.5.2.1-1: Supported test configurations for FR1 PCell

Configuration	Description
1	LTE FDD, NR 15 kHz SSB SCS, 10MHz bandwidth, FDD duplex mode
2	LTE FDD, NR 15 kHz SSB SCS, 10MHz bandwidth, TDD duplex mode
3	LTE FDD, NR 30kHz SSB SCS, 40MHz bandwidth, TDD duplex mode
4	LTE TDD, NR 15 kHz SSB SCS, 10MHz bandwidth, FDD duplex mode
5	LTE TDD, NR 15 kHz SSB SCS, 10MHz bandwidth, TDD duplex mode
6	LTE TDD, NR 30kHz SSB SCS, 40MHz bandwidth, TDD duplex mode
Note: The UE is only required to pass in one of the supported test configurations in FR1	

Table A.4.5.5.2.1-2: General test parameters for FR1 PCell for SSB-based beam failure detection and link recovery testing in DRX mode

Parameter		Unit	Value		Comment
			Test 1	Test 2	
Active PCell			Cell 1	Cell 1	
RF Channel Number			1	1	
Duplex mode	Config 1, 4		FDD	FDD	
	Config 2, 3, 5, 6		TDD	TDD	
TDD Configuration	Config 1, 4		Not Applicable	Not Applicable	
	Config 2, 5		[TDDConf.1.1]	[TDDConf.1.1]	
	Config 3, 6		[TDDConf.1.2]	[TDDConf.1.2]	
CORESET Reference Channel	Config 1, 4		[CR. 1.1 FDD]	[CR. 1.1 FDD]	
	Config 2, 5		[CR. 1.1 TDD]	[CR. 1.1 TDD]	
	Config 3, 6		[CR. 2.1 TDD]	[CR. 2.1 TDD]	
SSB Configuration	Config 1, 4		TBD (Note: periodicity is 20ms)	TBD (Note: periodicity is 20ms)	
	Config 2, 5		TBD (Note: periodicity is 20ms)	TBD (Note: periodicity is 20ms)	
	Config 3, 6		TBD (Note: periodicity is 20ms)	TBD (Note: periodicity is 20ms)	
SMTC Configuration	Config 1, 2, 4, 5		FR1 pattern 1	FR1 pattern 1	
	Config 3, 6		FR1 pattern 2	FR1 pattern 2	
	Config 1, 2, 4, 5		15 KHz	15 KHz	

PDSCH/ PDCCH subcarrier spacing	Config 3, 6		30 KHz	30 KHz	
csi-RS-Index assigned as RLM RS			[0]	[0]	
OCNG parameters			TBD	TBD	
CP length			Normal	Normal	
Correlation Matrix and Antenna Configuration			[2x2 Low]	[2x2 Low]	
Beam failure detection transmission parameters	DCI format		1-0	1-0	
	Number of Control OFDM symbols		2	2	
	Aggregation level	CC E	8	8	
	Ratio of hypothetical PDCCH RE energy to average CSI-RS RE energy	dB	0	0	
	Ratio of hypothetical PDCCH DMRS energy to average CSI-RS RE energy	dB	0	0	
	DMRS precoder granularity		REG bundle size	REG bundle size	
	REG bundle size		6	6	
DRX			640	640	
Gap pattern ID			[N.A.]	*[gp0]	
ssb-Index			2	2	Number of SSB indexes used for beam failure detection
rlmInSyncOutOfSync Threshold			absent	absent	When the field is absent, the UE applies the value 0. (Table 8.1.1-1).
rsrp-ThresholdSSB			TBD	TBD	Threshold used for $Q_{out_LR_SSB}$
powerControlOffsetS S			NA	NA	Used for deriving rsrp-ThresholdCSI- RS
beamFailureInstance MaxCount			[n2]	[n2]	see TS 38.321 [7], section 5.17
beamFailureDetectio nTimer			[pbfd4]	[pbfd4]	see TS 38.321 [7], section 5.17
ZP CSI-RS configuration			TBD	TBD	
CSI-IM configuration			TBD	TBD	

Periodic CSI reporting			PUCCH	PUCCH	
CSI reporting periodicity	Config 1, 2, 4, 5	slot	[5]	[5]	
	Config 3, 6		[10]	[10]	
T1		s	1	1	During this time the the UE shall be fully synchronized to cell 1
T2		s	0.4	0.4	
T3		s	[0.6]	[0.6]	
D1		s	[0.24]	[0.44]	
Note 1: UE-specific PDCCH is not transmitted after T1 starts.					

Table A.4.5.2.1-3: Cell specific test parameters for FR1 PSCell for SSB-based beam failure detection and link recovery testing in DRX mode

Parameter	Unit	Test 1 and Test 2					Test 1 and Test 2									
		SSB of set q_0										SSB of set q_1				
		T1	T2	T3	T4	T5	T1	T2	T3	T4	T5					
PDCCH_beta	dB	4					4									
PDCCH_DMRS_beta	dB	4					4									
PBCH_beta	dB	0					0									
PSS_beta	dB															
SSS_beta	dB															
PDSCH_beta	dB															
OCNG_beta	dB															
SNR	Config 1	dB	TBD	TBD	TBD	TBD	TBD	TBD	TBD	TBD	TBD	TBD	TBD			
	Config 2		TBD	TBD	TBD	TBD	TBD	TBD	TBD	TBD	TBD	TBD	TBD			
	Config 3		TBD	TBD	TBD	TBD	TBD	TBD	TBD	TBD	TBD	TBD	TBD			
N_{oc}	Config 1	dBm/	[-98]					[-98]								
	Config 2	15K	[-98]					[-98]								
	Config 3	Hz	[-98]					[-98]								
Propagation condition		[TDL-C 300ns 100Hz]					[TDL-C 300ns 100Hz]									
Note 1:	OCNG shall be used such that the resources in Cell 1 are fully allocated and a constant total transmitted power spectral density is achieved for all OFDM symbols.															
Note 2:	The uplink resources for CSI reporting are assigned to the UE prior to the start of time period T1.															
Note 3:	NZP CSI-RS resource set configuration for CSI reporting are assigned to the UE prior to the start of time period T1.															
Note 4:	Measurement gap configuration is assigned to the UE prior to the start of time period T1.															
Note 5:	The timers and layer 3 filtering related parameters are configured prior to the start of time period T1.															
Note 6:	The signal contains PDCCH for UEs other than the device under test as part of OCNG.															
Note 7:	SNR levels correspond to the signal to noise ratio over the SSS REs.															
Note 8:	The SNR in time periods T1, T2, T3, T4 and T5 is denoted as SNR1, SNR2 and SNR3 respectively in figure A.4.5.2.1-1.															
Note 9:	The SNR values are specified for testing a UE which supports 2RX on at least one band. For testing of a UE which supports 4RX on all bands, the SNR during T3 is [A.3.6].															

Table A.4.5.2.1-4: Measurement gap configuration for FR1 PSCell for SSB-based beam failure detection and link recovery testing in DRX mode

Field	Test 2
	Value
gapOffset	[0]

Table A.4.5.5.2.1-5: DRX-Configuration for FR1 PSCell for SSB-based beam failure detection and link recovery testing in DRX mode.

Field	Test 5	Test 6
	Value	Value
drx-onDurationTimer	[ms6]	[ms6]
drx-InactivityTimer	[ms1]	[ms1]
drx-RetransmissionTimerDL	[sl1]	[sl1]
drx-RetransmissionTimerUL	[sl1]	[sl1]
longDRX-CycleStartOffset	[ms640]	[ms40]
shortDRX	disable	disable

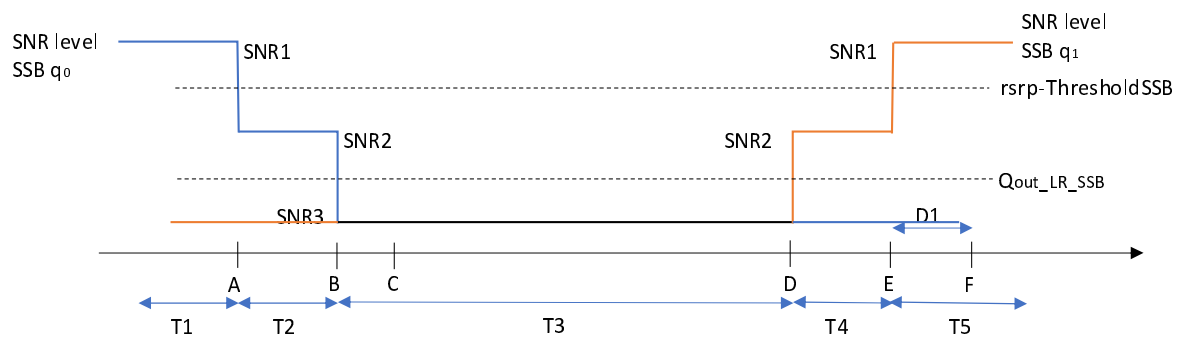

Figure A.4.5.5.2.1-1: SNR variation for SSB-based beam failure detection and link recovery testing in non-DRX mode

A.4.5.5.2.2 Test Requirements

The UE behaviour during time durations T1, T2, T3, T4 and T5 shall be as follows:

During the time duration T1 and T2, the UE shall transmit uplink signal at least in all subframes configured for CSI transmission on Cell 1.

During the period from time point A to time point B the UE shall transmit uplink signal in Cell 1 in all uplink slots configured for CSI transmission according to the configured periodic CSI reporting for Cell 1.

During T3 the shall detect beam failure and initiate link recovery. During T4 and T5 the UE measures and evaluate beam candidate from beam candidate set q_1 .

No later than time point F occurring no later than $D1 = [TBD]$ ms after the start of T5, the UE shall transmit preamble on a beam associated with the candidate beam set q_1 .

Test is concluded once the test equipment has received the initial preamble transmission from the UE. The rate of correct events observed during repeated tests shall be at least 90%.

A.4.5.5.3 EN-DC Beam Failure Detection and Link Recovery Test for FR1 PSCell configured with CSI-RS-based BFD and LR in non-DRX mode

A.4.5.5.3.1 Test Purpose and Environment

The purpose of this test is to verify that the UE properly detects CSI-RS-based beam failure in the set q_0 configured for a serving PSCell and that the UE performs correct CSI-RS-based link recovery based on beam candidate set q_1 . The purpose is to test the downlink monitoring for beam failure detection within the UEs active DL BWP of the PSCell, during the evaluation period, and link recovery, when no DRX is used. This test will partly verify the CSI-RS based beam failure detection and link recovery for an FR1 serving cell requirements in clause 8.5.

The test parameters are given in Tables A.4.5.5.3.1-1, A.4.5.5.3.1-2, A.4.5.5.3.1-3, A.4.5.5.3.1-4 and A.4.5.5.3.1-5 below. There are two cells, cell 1 is the E-UTRAN PCell, and cell 2 is the PSCell, in the test. The test consists of five successive time periods, with time duration of T1, T2, T3, T4 and T5 respectively. Figure A.4.5.5.3.1-1 shows the variation of the downlink SNR of the PSCell and the SNR of the CSI-RS in set q_0 in the active PSCell to emulate CSI-RS based beam failure. Figure A.4.5.5.3.1-1 additionally shows the variation of the downlink SNR of the CSI-RS in set q_1 of the candidate beam used for link recovery. Prior to the start of the time duration T1, the UE shall be fully synchronized to cell 1 and cel 2. The UE shall be configured for periodic CSI reporting with a reporting periodicity of [2] ms. In the test, DRX configuration is not enabled. The UE is configured to perform inter-frequency measurements using GP ID #0 (40ms) in test 2.

Table A.4.5.5.3.1-1: Supported test configurations for FR1 PSCell

Configuration	Description
1	LTE FDD, NR 15 kHz SSB SCS, 10MHz bandwidth, FDD duplex mode
2	LTE FDD, NR 15 kHz SSB SCS, 10MHz bandwidth, TDD duplex mode
3	LTE FDD, NR 30kHz SSB SCS, 40MHz bandwidth, TDD duplex mode
4	LTE TDD, NR 15 kHz SSB SCS, 10MHz bandwidth, FDD duplex mode
5	LTE TDD, NR 15 kHz SSB SCS, 10MHz bandwidth, TDD duplex mode
6	LTE TDD, NR 30kHz SSB SCS, 40MHz bandwidth, TDD duplex mode
Note:	The UE is only required to pass in one of the supported test configurations in FR1

Table A.4.5.5.3.1-2: General test parameters for FR1 PSCell for CSI-RS-based beam failure detection and link recovery testing in non-DRX mode

Parameter		Unit	Value		Comment
			Test 1	Test 2	
Active PCell			Cell 1	Cell 1	
RF Channel Number			1	1	
Duplex mode	Config 1, 4		FDD	FDD	
	Config 2, 3, 5, 6		TDD	TDD	
TDD Configuration	Config 1, 4		Not Applicable	Not Applicable	
	Config 2, 5		[TDDConf.1.1]	[TDDConf.1.1]	
	Config 3, 6		[TDDConf.1.2]	[TDDConf.1.2]	
CORESET Reference Channel	Config 1, 4		[CR. 1.1 FDD]	[CR. 1.1 FDD]	A.3.1.2
	Config 2, 5		[CR. 1.1 TDD]	[CR. 1.1 TDD]	
	Config 3, 6		[CR. 2.1 TDD]	[CR. 2.1 TDD]	

SSB Configuration	Config 1, 4		SSB.1 FR1	SSB.1 FR1	A.3.10
	Config 2, 5		SSB.1 FR1	SSB.1 FR1	
	Config 3, 6		SSB.2 FR1	SSB.2 FR1	
SMTC Configuration	Config 1, 2, 4, 5		FR1 pattern 1	FR1 pattern 1	A.3.11
	Config 3, 6		FR1 pattern 2	FR1 pattern 2	
PDSCH/PDCCH subcarrier spacing	Config 1, 2, 4, 5		15 KHz	15 KHz	
	Config 3, 6		30 KHz	30 KHz	
csi-RS-Index assigned as beam failure RS			[0]	[0]	
OCNG parameters			TBD	TBD	A.3.2.1
CP length			Normal	Normal	
Correlation Matrix and Antenna Configuration			[2x2 Low]	[2x2 Low]	
Beam failure detection transmission parameters	DCI format		1-0	1-0	
	Number of Control OFDM symbols		2	2	
	Aggregation level	CC E	8	8	
	Ratio of hypothetical PDCCH RE energy to average CSI-RS RE energy	dB	0	0	
	Ratio of hypothetical PDCCH DMRS energy to average CSI-RS RE energy	dB	0	0	
	DMRS precoder granularity		REG bundle size	REG bundle size	
	REG bundle size		6	6	
DRX			OFF	OFF	
Gap pattern ID			[N.A.]	*[gp0]	
csi-RS-Index			2	2	Number of SSB indexes used for beam failure detection
rminSyncOutOfSync Threshold			absent	absent	When the field is absent, the UE applies the value 0. (Table 8.1.1-1).

rsrp-ThresholdSSB			TBD	TBD	Threshold used for $Q_{out_LR_SSB}$
powerControlOffsetSS			db0	db0	Used for deriving rsrp-ThresholdCSI-RS
beamFailureInstanceMaxCount			n2	n2	see TS 38.321 [7], section 5.17
beamFailureDetectionTimer			pbfd4	pbfd4	see TS 38.321 [7], section 5.17
NZP CSI-RS configuration			[ResourceId 1]	[ResourceId 0]	
ZP CSI-RS configuration			TBD	TBD	
CSI-IM configuration			TBD	TBD	
Periodic CSI reporting			PUCCH	PUCCH	
CSI reporting periodicity	Config 1, 2, 4, 5	slot	[5]	[5]	
	Config 3, 6		[10]	[10]	
T1		s	1	1	During this time the the UE shall be fully synchronized to cell 1
T2		s	0.4	0.4	
T3		s	[TBD]	[TBD]	
D1		s	[0.24]	[0.44]	
Note 1: UE-specific PDCCH is not transmitted after T1 starts.					

Table A.4.5.5.3.1-3: Cell specific test parameters for FR1 PSCell for CSI-RS-based beam failure detection and link recovery testing in non-DRX mode

Parameter	Unit	Test 1 and Test 2					Test 1 and Test 2					
		CSI-RS of set q_0					CSI-RS of set q_1					
		T1	T2	T3	T4	T5	T1	T2	T3	T4	T5	
EPRE ratio of PSS to SSS	dB	0					0					
EPRE ratio of PBCH DMRS to SSS	dB											
EPRE ratio of PBCH to PBCH DMRS	dB											
EPRE ratio of PDCCH DMRS to SSS	dB											
EPRE ratio of PDCCH to PDCCH DMRS	dB											
EPRE ratio of PDSCH DMRS to SSS	dB											
EPRE ratio of PDSCH to PDSCH DMRS	dB											
EPRE ratio of OCNG DMRS to SSS ^(Note 1)	dB											
EPRE ratio of OCNG to OCNG DMRS ^(Note 1)	dB											
SNR _C SI-RS	Config 1	dB	TBD	TBD	TBD	TBD	TBD	TBD	TBD	TBD	TBD	
	Config 2		TBD	TBD	TBD	TBD	TBD	TBD	TBD	TBD	TBD	
	Config 3		TBD	TBD	TBD	TBD	TBD	TBD	TBD	TBD	TBD	
N_{oc}	Config 1	dBm/	[-98]					[-98]				
	Config 2	15K	[-98]					[-98]				
	Config 3	Hz	[-98]					[-98]				
SS-RSRP ^{Note 3}		dBm /SC S										
\hat{E}_s/I_{ot}												
\hat{E}_s/N_{oc}												
I _o	config 1, 2	dBm/										
	Config 3, 4	9.36 MHz dBm/ 38.1 MHz										
Propagation condition			[TDLC300]					[TDLC300]				
Note 1:	OCNG shall be used such that the resources in Cell 1 are fully allocated and a constant total transmitted power spectral density is achieved for all OFDM symbols.											
Note 2:	SS-RSRP and I _o levels have been derived from other parameters for information purposes. They are not settable parameters themselves.											

Table A.4.5.5.3.1-4: Measurement gap configuration for FR1 PSCell for CSI-RS-based beam failure detection and link recovery testing in non-DRX mode

Field	Test 2
	Value
gapOffset	[0]

Table A.4.5.5.3.1-5: NZP-CSI-RS resource configuration for FR1 PSCell for CSI-RS-based beam failure detection and link recovery testing in non-DRX mode

Field	ResourceId 0	ResourceId 1
	Value	Value
frequencyDomainAllocation ^{Note 1}	row1	row2
startingRB	0	0
nrofRBs	Note 2	Note 2
Note 1: TS 38.211 [6] table 7.4.1.5.3-1		
Note 2: nrofRBs is derived based on the Configuration in Table A.4.5.1.7.1-1		

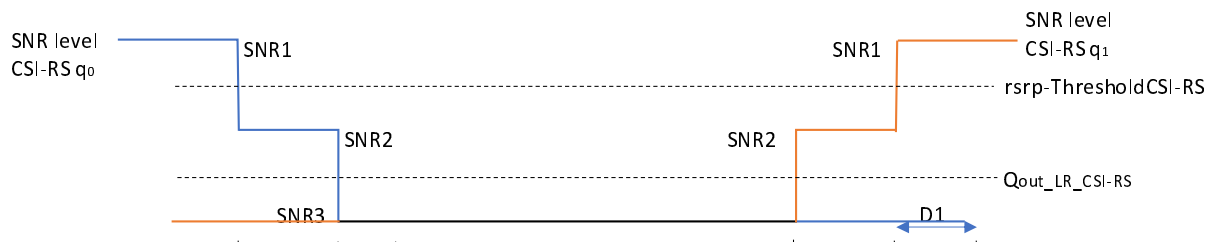

Figure A.4.5.5.3.1-1: SNR variation SSB for CSI-RS-based beam failure detection and link recovery testing in non-DRX mode

A.4.5.5.3.2 Test Requirements

The UE behaviour during time durations T1, T2, T3, T4 and T5 shall be as follows:

During the time duration T1 and T2, the UE shall transmit uplink signal at least in all subframes configured for CSI transmission on Cell 1.

During the period from time point A to time point B the UE shall transmit uplink signal in Cell 1 in all uplink slots configured for CSI transmission according to the configured periodic CSI reporting for Cell 1.

During T3 the shall detect beam failure and initiate link recovery. During T4 and T5 the UE measures and evaluate beam candidate from beam candidate set q_1 .

No later than time point F occurring no later than $D1 = [TBD]$ ms after the start of T5, the UE shall transmit preamble on a beam associated with the candidate beam set q_1 .

Test is concluded once the test equipment has received the initial preamble transmission from the UE. The rate of correct events observed during repeated tests shall be at least 90%.

A.4.5.5.4 EN-DC Beam Failure Detection and Link Recovery Test for FR1 PSCell configured with CSI-RS-based BFD and LR in DRX mode

A.4.5.5.4.1 Test Purpose and Environment

The purpose of this test is to verify that the UE properly detects CSI-RS-based beam failure in the set q_0 configured for a serving PSCell and that the UE performs correct CSI-RS-based link recovery based on beam candidate set q_1 . The purpose is to test the downlink monitoring for beam failure detection within the UEs active DL BWP of the PSCell, during the evaluation period, and link recovery, when DRX is used. This test will partly verify the CSI-RS based beam failure detection and link recovery for an FR1 serving cell requirements in clause 8.5.

The test parameters are given in Tables A.4.5.5.4.1-1, A.4.5.5.4.1-2, A.4.5.5.4.1-3, A.4.5.5.4.1-4, A.4.5.5.4.1-5 and A.4.5.5.4.1-6 below. There are two cells, cell 1 is the E-UTRAN PCell, and cell 2 is the PSCell, in the test. The test consists of five successive time periods, with time duration of T1, T2, T3, T4 and T5 respectively. Figure A.4.5.1.4.1-1 shows the variation of the downlink SNR of the PSCell and the SNR of the CSI-RS in set q_0 in the active PSCell to emulate CSI-RS based beam failure. Figure A.4.5.5.4.1-1 additionally shows the variation of the downlink SNR of the CSI-RS in set q_1 of the candidate beam used for link recovery. Prior to the start of the time duration T1, the UE shall be fully synchronized to cell 1 and cell 2. The UE shall be configured for periodic CSI reporting with a reporting periodicity of [2] ms. In the test, DRX configuration is enabled in PSCell and DRX inactivity timer has already been expired, i.e. UE tries to decode PDCCH and to send periodic CQI during the period when On-duration timer is running. Time alignment timers shall be set to “infinity” so that UL timing alignment is maintained during the test. The UE is configured to perform inter-frequency measurements using GP ID #0 (40ms) in test 2.

Table A.4.5.5.4.1-1: Supported test configurations for FR1 PSCell

Configuration	Description
1	LTE FDD, NR 15 kHz SSB SCS, 10MHz bandwidth, FDD duplex mode
2	LTE FDD, NR 15 kHz SSB SCS, 10MHz bandwidth, TDD duplex mode
3	LTE FDD, NR 30kHz SSB SCS, 40MHz bandwidth, TDD duplex mode
4	LTE TDD, NR 15 kHz SSB SCS, 10MHz bandwidth, FDD duplex mode
5	LTE TDD, NR 15 kHz SSB SCS, 10MHz bandwidth, TDD duplex mode
6	LTE TDD, NR 30kHz SSB SCS, 40MHz bandwidth, TDD duplex mode
Note:	The UE is only required to pass in one of the supported test configurations in FR1

Table A.4.5.5.4.1-2: General test parameters for FR1 PSCell for CSI-RS-based beam failure detection and link recovery testing in DRX mode

Parameter		Unit	Value		Comment
			Test 1	Test 2	
Active PCell			Cell 1	Cell 1	
RF Channel Number			1	1	
Duplex mode	Config 1, 4		FDD	FDD	
	Config 2, 3, 5, 6		TDD	TDD	
TDD Configuration	Config 1, 4		Not Applicable	Not Applicable	
	Config 2, 5		[TDDConf.1.1]	[TDDConf.1.1]	
	Config 3, 6		[TDDConf.1.2]	[TDDConf.1.2]	
CORESET Reference Channel	Config 1, 4		[CR. 1.1 FDD]	[CR. 1.1 FDD]	A.3.1.2
	Config 2, 5		[CR. 1.1 TDD]	[CR. 1.1 TDD]	
	Config 3, 6		[CR. 2.1 TDD]	[CR. 2.1 TDD]	
SSB Configuration	Config 1, 4		SSB.1 FR1	SSB.1 FR1	A.3.10
	Config 2, 5		SSB.1 FR1	SSB.1 FR1	
	Config 3, 6		SSB.2 FR1	SSB.2 FR1	
SMTC Configuration	Config 1, 2, 4, 5		FR1 pattern 1	FR1 pattern 1	A.3.11
	Config 3, 6		FR1 pattern 2	FR1 pattern 2	
PDSCH/PDCCH subcarrier spacing	Config 1, 2, 4, 5		15 KHz	15 KHz	
	Config 3, 6		30 KHz	30 KHz	
csi-RS-Index assigned as beam failure RS			[0]	[0]	
OCNG parameters			TBD	TBD	A.3.2.1
CP length			Normal	Normal	
Correlation Matrix and Antenna Configuration			[2x2 Low]	[2x2 Low]	
Beam failure detection transmission parameters	DCI format		1-0	1-0	
	Number of Control OFDM symbols		2	2	
	Aggregation level	CC E	8	8	
	Ratio of hypothetical PDCCH RE energy to average CSI-RS RE energy	dB	0	0	

	Ratio of hypothetical PDCCH DMRS energy to average CSI-RS RE energy	dB	0	0	
	DMRS precoder granularity		REG bundle size	REG bundle size	
	REG bundle size		6	6	
DRX			640	640	
Gap pattern ID			[N.A.]	*[gp0]	
csi-RS-Index			2	2	Number of SSB indexes used for beam failure detection
rlmInSyncOutOfSync Threshold			absent	absent	When the field is absent, the UE applies the value 0. (Table 8.1.1-1).
rsrp-ThresholdSSB			TBD	TBD	Threshold used for $Q_{out_LR_SSB}$
powerControlOffsetSS			db0	db0	Used for deriving rsrp-ThresholdCSI-RS
beamFailureInstanceMaxCount			[n2]	[n2]	see TS 38.321 [7], section 5.17
beamFailureDetectionTimer			[pbfd4]	[pbfd4]	see TS 38.321 [7], section 5.17
NZP CSI-RS configuration			[ResourceId 1]	[ResourceId 0]	
ZP CSI-RS configuration			TBD	TBD	
CSI-IM configuration			TBD	TBD	
Periodic CSI reporting			PUCCH	PUCCH	
CSI reporting periodicity	Config 1, 2, 4, 5	slot	[5]	[5]	
	Config 3, 6		[10]	[10]	
T1		s	1	1	During this time the the UE shall be fully synchronized to cell 1
T2		s	0.4	0.4	
T3		s	[TBD]	[TBD]	
D1		s	[0.24]	[0.44]	
Note 1: UE-specific PDCCH is not transmitted after T1 starts.					

Table A.4.5.4.1-3: Cell specific test parameters for FR1 PSCell for CSI-RS-based beam failure detection and link recovery testing in DRX mode

Parameter	Unit	Test 1 and Test 2					Test 1 and Test 2					
		CSI-RS of set q_0					CSI-RS of set q_1					
		T1	T2	T3	T4	T5	T1	T2	T3	T4	T5	
EPRE ratio of PSS to SSS	dB	0					0					
EPRE ratio of PBCH DMRS to SSS	dB											
EPRE ratio of PBCH to PBCH DMRS	dB											
EPRE ratio of PDCCH DMRS to SSS	dB											
EPRE ratio of PDCCH to PDCCH DMRS	dB											
EPRE ratio of PDSCH DMRS to SSS	dB											
EPRE ratio of PDSCH to PDSCH DMRS	dB											
EPRE ratio of OCNG DMRS to SSS ^(Note 1)	dB											
EPRE ratio of OCNG to OCNG DMRS ^(Note 1)	dB											
SNR _C SI-RS	Config 1	dB	TBD	TBD	TBD	TBD	TBD	TBD	TBD	TBD	TBD	
	Config 2		TBD	TBD	TBD	TBD	TBD	TBD	TBD	TBD	TBD	
	Config 3		TBD	TBD	TBD	TBD	TBD	TBD	TBD	TBD	TBD	
N_{oc}	Config 1	dBm/	[-98]					[-98]				
	Config 2	15K	[-98]					[-98]				
	Config 3	Hz	[-98]					[-98]				
SS-RSRP ^{Note 3}		dBm /SC S										
\hat{E}_s/I_{ot}												
\hat{E}_s/N_{oc}												
I _o	config 1, 2	dBm/										
	Config 3, 4	9.36 MHz dBm/ 38.1 MHz										
Propagation condition			[TDLC300]					[TDLC300]				
Note 1:	OCNG shall be used such that the resources in Cell 1 are fully allocated and a constant total transmitted power spectral density is achieved for all OFDM symbols.											
Note 2:	SS-RSRP and I _o levels have been derived from other parameters for information purposes. They are not settable parameters themselves.											

Table A.4.5.5.4.1-4: Measurement gap configuration for FR1 PSCell for CSI-RS-based beam failure detection and link recovery testing in DRX mode

Field	Test 2
	Value
gapOffset	[0]

Table A.4.5.5.4.1-5: NZP-CSI-RS resource configuration for FR1 PSCell for CSI-RS-based beam failure detection and link recovery testing in DRX mode

Field	ResourceId 0	ResourceId 1
	Value	Value
frequencyDomainAllocation ^{Note 1}	row1	row2
startingRB	0	0
nrofRBs	Note 2	Note 2
Note 1: TS 38.211 [6] table 7.4.1.5.3-1 Note 2: nrofRBs is derived based on the Configuration in Table A.4.5.1.7.1-1		

Table A.4.5.5.4.1-6: DRX-Configuration for FR1 PSCell for SSB-based beam failure detection and link recovery testing in DRX mode.

Field	Test 5	Test 6
	Value	Value
drx-onDurationTimer	[ms6]	[ms6]
drx-InactivityTimer	[ms1]	[ms1]
drx-RetransmissionTimerDL	[sl1]	[sl1]
drx-RetransmissionTimerUL	[sl1]	[sl1]
longDRX-CycleStartOffset	[ms640]	[ms40]
shortDRX	disable	disable

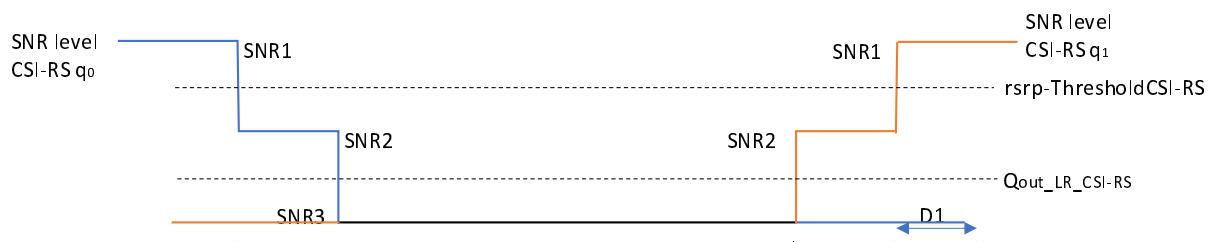

Figure A.4.5.1.4.1-1: SNR variation SSB for CSI-RS-based beam failure detection and link recovery testing in DRX mode

A.4.5.5.4.2 Test Requirements

The UE behaviour during time durations T1, T2, T3, T4 and T5 shall be as follows:

During the time duration T1 and T2, the UE shall transmit uplink signal at least in all subframes configured for CSI transmission on Cell 1.

During the period from time point A to time point B the UE shall transmit uplink signal in Cell 1 in all uplink slots configured for CSI transmission according to the configured periodic CSI reporting for Cell 1.

During T3 the shall detect beam failure and initiate link recovery. During T4 and T5 the UE measures and evaluate beam candidate from beam candidate set q_1 .

No later than time point F occurring no later than $D1 = [\text{TBD}]$ ms after the start of T5, the UE shall transmit preamble on a beam associated with the candidate beam set q_1 .

Test is concluded once the test equipment has received the initial preamble transmission from the UE. The rate of correct events observed during repeated tests shall be at least 90%.

A.4.5.6 Active BWP switch delay

A.4.5.6.1 DCI-based and Timer-based Active BWP Switch

A.4.5.6.1.1 E-UTRAN – NR PSCell FR1 DL active BWP switch in non-DRX in synchronous EN-DC

A.4.5.6.1.1.1 Test Purpose and Environment

The purpose of this test is to verify the DL BWP switch delay requirement defined in TS38.133 section 8.6, and interruption requirement for E-UTRA victim cell defined in TS36.133 section 7.32.2.7. Supported test configurations are shown in Table A.4.5.6.1.1.1-1.

The test scenario comprises of one E-UTRA PCell (Cell 1), and one NR PSCell (Cell 2) as given in Table A.4.5.6.1.1.1-2. Cell-specific parameters of E-UTRA PCell are specified in Table A.3.7.2.1-1 and Cell-specific parameters of NR PSCell is specified in Table A.4.5.6.1.1.1-3 below.

PDCCHs indicating new transmissions shall be sent continuously on PCell (Cell 1) to ensure that the UE will have ACK/NACK sending.

PDCCHs indicating new transmissions shall be sent continuously on PSCell (Cell 2) to ensure that the UE would have ACK/NACK sending except for the time duration when BWP is switching on Cell 2 and the time duration of T2.

Before the test starts,

- UE is connected to Cell 1 (PCell) on radio channel 1 (PCC), and Cell 2 (PSCell) on radio channel 2 (PSCC).
- UE is configured with 2 different UE-specific bandwidth parts for PSCell, BWP-1 and BWP-2, in Cell 2 before starting the test. BWP-1 and BWP-2 always include bandwidth of the initial DL BWP and SSB.
- UE is indicated in *firstActiveDownlinkBWP-Id* that the active DL BWP is BWP-1 in PSCell.
- UE is configured with a *bwp-InactivityTimer* timer value for PSCell.

All cells have constant signal levels throughout the test.

The test consists of 3 successive time periods, with durations of T1, T2, and T3, respectively.

During T1,

Time period T1 starts when a DCI format 1_1 command for PSCell DL BWP switch, sent from the test equipment to the UE, is received at the UE side in PSCell's slot # denoted i . The UE shall switch its bandwidth part from BWP-1 to BWP-2.

The UE shall be able to receive PDSCH at PSCell's slot ($i+T_{BWPswitchDelay}$) as defined in section 8.6 and starts to report valid ACK/NACK for the PSCell no later than at slot ($i+T_{BWPswitchDelay}+kI$). The UE shall be continuously scheduled on PSCell's BWP-2 starting from slot ($i+T_{BWPswitchDelay}$).

The starting time of PCell(Cell 1) interruption due to BWP switch on PSCell shall occur within the BWP switch delay.

During T2, the test equipment won't transmit DCI format for PDSCH reception on PSCell(Cell 2).

During T3,

The time period T3 starts from the slot # j immediately after the slot wherein *bwp-InactivityTimer* timer expires. The UE shall switch its bandwidth part from BWP-2 back to the default bandwidth part – BWP-1.

The UE shall be able to receive PDSCH at PSCell's slot ($j+T_{BWPswitchDelay}$) as defined in section 8.6 and starts to report valid ACK/NACK for the PSCell at latest at slot ($j+T_{BWPswitchDelay}+kI$). The UE shall be continuously scheduled on PSCell's BWP-1 starting from slot ($j+T_{BWPswitchDelay}$).

The starting time of PCell(Cell 1) interruption due to BWP switch of PSCell shall occur within the BWP switch delay.

The test equipment verifies the DL BWP switch time in PSCell by counting the slots from the time when the BWP switch command is received or *bwp-InactivityTimer* timer expires till an ACK is received.

The test equipment verifies that potential interruption to E-UTRA PCell is carried out in the correct time span by monitoring ACK/NACK sent in PCell during BWP switch of PSCell, respectively.

Table A.4.5.6.1.1-1: DL BWP switch supported test configurations

Config	Description
1	LTE FDD, NR 15 kHz SSB SCS, 10MHz bandwidth, FDD duplex mode
2	LTE FDD, NR 15 kHz SSB SCS, 10MHz bandwidth, TDD duplex mode
3	LTE FDD, NR 30kHz SSB SCS, 40MHz bandwidth, TDD duplex mode
4	LTE TDD, NR 15 kHz SSB SCS, 10MHz bandwidth, FDD duplex mode
5	LTE TDD, NR 15 kHz SSB SCS, 10MHz bandwidth, TDD duplex mode
6	LTE TDD, NR 30kHz SSB SCS, 40MHz bandwidth, TDD duplex mode
Note 1: The UE is only required to be tested in one of the supported test configurations.	
Note 2: A UE which fulfils the requirements in test case A.4.5.6.1.2 can skip the test cases in A.4.5.6.1.1.	

Table A.4.5.6.1.1-2: General test parameters for DL BWP switch in synchronous EN-DC

Parameter	Unit	Value	Comment
E-UTRA RF Channel Number		1	One E-UTRA radio channel is used for this test
NR RF Channel Number		2	One NR radio channel is used for this test
Active PCell		Cell 1	PCell on RF channel number 1.
Active PSCell		Cell 2	PSCell on RF channel number 2.
CP length		Normal	
DRX		OFF	For both PCell and PSCell
<i>bwp-InactivityTimer</i>	ms	[200]	
Cell-individual offset for cells on RF channel number 1	dB	0	Individual offset for cells on PCC.
Cell-individual offset for cells on RF channel number 2	dB	0	Individual offset for cells on PSCC.
Cell2 timing offset to cell1	µs	3	Synchronous EN-DC
T1	s	[0.2]	
T2	s	[0.2]	
T3	s	[0.2]	

Table A4.5.6.1.1-3: NR Cell specific test parameters for DL BWP switch in synchronous EN-DC

Parameter		Unit	Cell 2
Frequency Range			FR1
Duplex mode	Config 1,4		FDD
	Config 2,3,5,6		TDD
TDD configuration	Config 1,4		Not Applicable
	Config 2,5		TDDConf.1.1
	Config 3,6		TDDConf.1.2
BW _{channel}	Config 1,4		10 MHz: N _{RB,c} = 52
	Config 2,5		10 MHz: N _{RB,c} = 52
	Config 3,6		40 MHz: N _{RB,c} = 106
Active BWP ID			1, 2
Initial DL BWP Configuration	Config 1,4		DLBWP.0.2 ^{Note 4}
	Config 2,5		
	Config 3,6		
Active DL BWP-1 Configuration	Config 1,4		DLBWP.1.1 ^{Note 4}
	Config 2,5		
	Config 3,6		
Active DL BWP-2 Configuration	Config 1,4		DLBWP.1.3 ^{Note 4}
	Config 2,5		
	Config 3,6		
Initial UL BWP Configuration	Config 1,4		ULBWP.0.2 ^{Note 4}
	Config 2,5		
	Config 3,6		
Active UL BWP-1 Configuration	Config 1,4		ULBWP.1.1 ^{Note 4}
	Config 2,5		
	Config 3,6		
Active UL BWP-2 Configuration	Config 1,4		ULBWP.1.3 ^{Note 4}
	Config 2,5		
	Config 3,6		
PDSCH Reference measurement channel	Config 1,4		SR.1.1 FDD
	Config 2,5		SR.1.1 TDD
	Config 3,6		SR.2.1 TDD
RMSI CORESET parameters	Config 1,4		CR.1.1 FDD
	Config 2,5		CR.1.1 TDD
	Config 3,6		CR.2.1 TDD
Dedicated CORESET parameters	Config 1,4		CCR.1.1 FDD
	Config 2,5		CCR.1.1 TDD
	Config 3,6		CCR.2.1 TDD
OCNG Patterns			OP.1
SSB Configuration	Config 1,2,4,5		SSB.1 FR1
	Config 3,6		SSB.2 FR1
SMTC Configuration			SMTC.1
Correlation Matrix and Antenna Configuration			1x2 Low
EPRE ratio of PSS to SSS		dB	0
EPRE ratio of PBCH DMRS to SSS			
EPRE ratio of PBCH to PBCH DMRS			
EPRE ratio of PDCCH DMRS to SSS			
EPRE ratio of PDCCH to PDCCH DMRS			
EPRE ratio of PDSCH DMRS to SSS			
EPRE ratio of PDSCH to PDSCH			
EPRE ratio of OCNG DMRS to SSS(Note 1)			
EPRE ratio of OCNG to OCNG DMRS (Note 1)			
N _{oc} ^{Note 2}			

	Config 3,6		[-101]
N_{oc} ^{Note 2}		dBm/15kHz z	[-104]
SS-RSRP ^{Note 3}	Config 1,2,4,5	dBm/SCS	[-87]
	Config 3,6		[-90]
\hat{E}_s/I_{ot}		dB	[17]
\hat{E}_s/N_{oc}		dB	[17]
I_o ^{Note3}	Config 1,2,4,5	dBm/ 9.36MHz	[-59]
	Config 3,6	dBm/ 38.16MHz	[-61.9]
Propagation Condition			AWGN
<p>Note 1: OCNG shall be used such that both cells are fully allocated and a constant total transmitted power spectral density is achieved for all OFDM symbols.</p> <p>Note 2: Interference from other cells and noise sources not specified in the test is assumed to be constant over subcarriers and time and shall be modelled as AWGN of appropriate power for N_{oc} to be fulfilled.</p> <p>Note 3: SS-RSRP and I_o levels have been derived from other parameters for information purposes. They are not settable parameters themselves.</p> <p>Note 4: For unpaired spectrum, a DL BWP is linked with an UL BWP. DLBWP.0.2 is linked with ULBWP.0.2; DLBWP.1.1 is linked with ULBWP.1.1; DLBWP.1.3 is linked with ULBWP.1.3 defined in TS 38.213 section 12.</p>			

A.4.5.6.1.1.2 Test Requirements

During T1, the UE shall start to send the ACK for PSCell in a slot $(i+T_{BWPswitchDelay}+kI)$.

During T3, the UE shall start to send the ACK for PSCell in a slot $(j+T_{BWPswitchDelay}+kI)$.

Where, kI is the timing between DL data receiving and acknowledgement as specified in [7].

Depending on UE capability *bwp-SwitchingDelay* [2], UE shall finish BWP switch within the time duration $T_{BWPswitchDelay}$ defined in Table 8.6.2-1.

All of the above test requirements shall be fulfilled in order for the observed PSCell active BWP switch delay to be counted as correct.

The rate of correct events observed during repeated tests shall be at least 90%.

During T1, the start time of PCell interruption during PSCell active BWP switch shall not happen outside the BWP switch delay.

During T3, the start time of PCell interruption of during PSCell active BWP switch shall not happen outside the BWP switch delay.

The interruption of PCell shall not be longer than the interruption duration specified for active BWP switch in TS36.133 Section 7.32.2.7.

All of the above test requirements shall be fulfilled in order for the observed PCell active BWP switch interruption to be counted as correct.

The rate of correct events observed during repeated tests shall be at least 90%.

NOTE: During T1, T3 if there are no uplink resources for reporting the ACK in a slot $(i+T_{BWPswitchDelay}+kI)$, $(j+T_{BWPswitchDelay}+kI)$, then the UE shall use the next available uplink resource for reporting the corresponding ACK.

A.4.5.6.2 RRC-based Active BWP Switch

A.4.5.6.2.1 E-UTRAN – NR PSCell FR1 DL active BWP switch in non-DRX in synchronous EN-DC

A.4.5.6.2.1.1 Test Purpose and Environment

The purpose of this test is to verify the DL BWP switch delay requirement for RRC-based BWP switch defined in section 8.6. Supported test configurations are shown in Table A.4.5.6.2.1.1-1.

The test scenario comprises of one E-UTRA PCell (Cell 1) and one NR PSCell (Cell 2) as given in Table A.4.5.6.2.1.1-2. Cell-specific parameters of E-UTRA PCell are specified in Table A.3.7.2.1-1 and Cell-specific parameters of NR PSCell are specified in Table A.4.5.6.2.1.1-3 below.

PDCCHs indicating new transmissions shall be sent continuously on PCell (Cell 1) to ensure that the UE will have ACK/NACK sending.

Before the test starts,

- UE is connected to Cell 1 (PCell) on radio channel 1 (PCC) and to Cell 2 (PSCell) on radio channel 2 (PSCC).
- UE has bandwidth part BWP-1 in its RRC-configuration for Cell 1 (PSCell).
- UE is indicated in *firstActiveDownlinkBWP-Id* that the active DL BWP is BWP-1 in PSCell.

All cells have constant signal levels throughout the test.

The test consists of 1 time period, with duration of T1.

During T1,

Time period T1 starts when a *RRCReconfiguration* with bandwidth part configuration BWP-2, sent from the test equipment to the UE, is received at the UE side in PSCell's slot # denoted i . The UE shall switch its bandwidth part from BWP-1 to BWP-2.

The UE shall be able to receive PDSCH at PSCell's slot $(i+X)$ as defined in section 8.6 and starts to report valid ACK/NACK for the PSCell no later than at slot $(i+X+kI)$. The UE shall be continuously scheduled on PSCell's BWP-2 starting from slot $(i+X)$.

The test equipment verifies the DL BWP switch time in PSCell by counting the slots from the time when the RRC Reconfiguration message including BWP switch command is received till an ACK is received.

Table A.4.5.6.2.1.1-1: DL BWP switch supported test configurations

Config	Description
1	LTE FDD, NR 15 kHz SSB SCS, 10MHz bandwidth, FDD duplex mode
2	LTE FDD, NR 15 kHz SSB SCS, 10MHz bandwidth, TDD duplex mode
3	LTE FDD, NR 30kHz SSB SCS, 40MHz bandwidth, TDD duplex mode
4	LTE TDD, NR 15 kHz SSB SCS, 10MHz bandwidth, FDD duplex mode
5	LTE TDD, NR 15 kHz SSB SCS, 10MHz bandwidth, TDD duplex mode
6	LTE TDD, NR 30kHz SSB SCS, 40MHz bandwidth, TDD duplex mode
Note 1: The UE is only required to be tested in one of the supported test configurations	

Table A.4.5.6.2.1.1-2: General test parameters for DL BWP switch in synchronous EN-DC

Parameter	Unit	Value	Comment
E-UTRA RF Channel Number		1	One E-UTRA radio channel is used for this test
NR RF Channel Number		2	One NR radio channel is used for this test
Active PCell		Cell 1	PCell on RF channel number 1.
Active PSCell		Cell 2	PSCell on RF channel number 2.
CP length		Normal	
DRX		OFF	
Cell-individual offset for cells on RF channel number 1	dB	0	Individual offset for cells on PCC.
Cell-individual offset for cells on RF channel number 2	dB	0	Individual offset for cells on PSCC.
Cell2 timing offset to cell1	μs	3	Synchronous EN-DC
T1	s	[0.2]	

Table A.4.5.6.2.1.1-3: NR Cell specific test parameters for DL BWP switch in synchronous EN-DC

Parameter	Unit	Cell 2
Frequency Range		FR1
Duplex mode	Config 1,4	FDD
	Config 2,3,5,6	TDD
TDD configuration	Config 1,4	Not Applicable
	Config 2,5	TDDConf.1.1
	Config 3,6	TDDConf.1.2
BW _{channel}	Config 1,4	10 MHz: N _{RB,c} = 52
	Config 2,5	10 MHz: N _{RB,c} = 52
	Config 3,6	40 MHz: N _{RB,c} = 106
Active BWP ID		1, 2
Initial BWP Configuration	Config 1,4	DLBWP.0.2
	Config 2,5	
	Config 3,6	
Active BWP-0 Configuration	Config 1,4	NA
	Config 2,5	
	Config 3,6	
Active BWP-1 Configuration	Config 1,4	DLBWP.1.3
	Config 2,5	
	Config 3,6	
Active BWP-2 Configuration	Config 1,4	DLBWP.1.1
	Config 2,5	
	Config 3,6	
PDSCH Reference measurement channel	Config 1,4	SR.1.1 FDD
	Config 2,5	SR.1.1 TDD
	Config 3,6	SR2.1 TDD
RMSI CORESET parameters	Config 1,4	CR.1.1 FDD
	Config 2,5	CR.1.1 TDD
	Config 3,6	CR2.1 TDD
Dedicated CORESET parameters	Config 1,4	CCR.1.1 FDD
	Config 2,5	CCR.1.1 TDD
	Config 3,6	CCR.2.1 TDD
OCNG Patterns		OP.1
SSB Configuration	Config 1,2,4,5	SSB.1 FR1
	Config 3,6	SSB.2 FR1
SMTC Configuration		SMTC.1
Antenna Configuration		1x2
Propagation Condition		AWGN
EPRE ratio of PSS to SSS	dB	0
EPRE ratio of PBCH DMRS to SSS		

EPRE ratio of PBCH to PBCH DMRS			
EPRE ratio of PDCCH DMRS to SSS			
EPRE ratio of PDCCH to PDCCH DMRS			
EPRE ratio of PDSCH DMRS to SSS			
EPRE ratio of PDSCH to PDSCH			
EPRE ratio of OCNG DMRS to SSS(Note 1)			
EPRE ratio of OCNG to OCNG DMRS (Note 1)			
N_{oc} ^{Note 2}		dBm/15 kHz	[-104]
SS-RSRP ^{Note 3}		dBm/15 kHz	[-87]
\hat{E}_s/I_{ot}		dB	17
\hat{E}_s/N_{oc}		dB	17
I_o ^{Note3}	Config 1,2,4,5	dBm/9.36MHz	TBD
	Config 3,6	dBm/38.16MHz	TBD
<p>Note 1: OCNG shall be used such that both cells are fully allocated and a constant total transmitted power spectral density is achieved for all OFDM symbols.</p> <p>Note 2: Interference from other cells and noise sources not specified in the test is assumed to be constant over subcarriers and time and shall be modelled as AWGN of appropriate power for N_{oc} to be fulfilled.</p> <p>Note 3: SS-RSRP and I_o levels have been derived from other parameters for information purposes. They are not settable parameters themselves.</p> <p>Note 4: For unpaired spectrum, a DL BWP is linked with an UL BWP. DLBWP.0.2 is linked with ULBWP.0.2; DLBWP.1.1 is linked with ULBWP.1.1; DLBWP.1.3 is linked with ULBWP.1.3 defined in TS 38.213 [3] section 12.</p>			

A.4.5.6.2.2.2 Test Requirements

During T1, the UE shall start to send the ACK for PSCell in a slot ($i+X+kI$).

All of the above test requirements shall be fulfilled in order for the observed PSCell active BWP switch delay to be counted as correct.

The rate of correct events observed during repeated tests shall be at least 90%.

The rate of correct events observed during repeated tests shall be at least 90%.

NOTE: During T1, if there are no uplink resources for reporting the ACK in a slot ($i+X+kI$), then the UE shall use the next available uplink resource for reporting the corresponding ACK.

Editor's note: FFS value of X, kI for type 1 and type 2 UE.

A.4.5.7 PSCell addition and release delay

A.4.5.7.1 Addition and Release Delay of known NR PSCell

A.4.5.7.1.1 Test purpose and environment

The purpose of this test is to verify that the NR PSCell addition and release delays under EN-DC are within the requirements stated in section 7.31.2 [15] for the case when the PSCell is known by the UE at the time of addition.

Supported test configurations are shown in A.4.5.7.1.1-1. The test parameters for the E-UTRA cell are given in Table A.3.7.2.1-1. The E-UTRA cell once set up is not changed across time.

The test parameters for NR cell are given in Tables A.4.5.7.1.1-2 and cell-specific parameters in A.4.5.7.1.1-3 below. The test consists of five successive time periods with duration of T1, T2, T3, T4 and T5 respectively. There are two carriers each with one cell. Before the test starts the UE is connected to Cell 1 (E-UTRA PCell) on radio

channel 1 (PCC) but is not aware of Cell 2 (NR PSCell) on radio channel 2. The UE is only monitoring the PCC. During T1 only Cell1 is known to the UE.

Before the start of T2, the UE in the measurement control information that event-triggered reporting with Event A4 is configured for neighbour cell (Cell2). Before the start of T2 the UE is configured with the measurement gaps (gap pattern Id # 0). The Cell2 becomes known to the UE during T2. Therefore, during T2 the UE shall report Event A4. After receiving the Event A4, the test system shall send a RRC message to the UE to release the measurement gaps.

The test system shall send a RRC message to the UE to add PSCell (Cell 2) on radio channel 2. The RRC message (to add PSCell) also includes a request for the UE to start periodic CSI reporting for the PSCell after the PSCell has been successfully added. The RRC message to add PSCell shall be sent to the UE during period T2, after the measurement gaps are released by the test system. The point in time at which the RRC message to add PSCell (Cell2) is received at the UE antenna connector defines the start of period T3.

The test system shall observe the periodic reporting of CSI for PSCell during T4. The point in time at which the UE has sent PRACH to the PSCell (Cell 2) defines the start of period T4.

The test system shall send a RRC message to the UE to release PSCell (Cell 2) on radio channel 2. The RRC message to release PSCell (Cell2) shall be sent to the UE during period T4, after the UE has sent at least one CQI report with non-zero CQI index for PSCell (Cell 2). The point in time at which the RRC message to release PSCell (Cell2) is received at the UE antenna connector defines the start of period T5.

Table A.4.5.7.1.1-1: Supported test configurations for FR1 PSCell

Configuration	Description
1	LTE FDD, NR SCS 15 kHz, BW 10 MHz, FDD
2	LTE FDD, NR SCS 15 kHz, BW 10 MHz, TDD
3	LTE FDD, NR SCS 30 kHz, BW 40 MHz, TDD
4	LTE FDD, NR SCS 15 kHz, BW 10 MHz, FDD
5	LTE FDD, NR SCS 15 kHz, BW 10 MHz, TDD
6	LTE FDD, NR SCS 30 kHz, BW 40 MHz, TDD
Note:	The UE is only required to pass in one of the supported test configurations in FR1

Table A.4.5.7.1.1-2: General Test Parameters for PSCell Addition and Release

Parameter		Unit	Value	Comment
RF Channel Number			1, 2	Two radio channels are used for this test. One for E-UTRA cell and second for NR Cell
Initial Condition	Active PCell		Cell1	PCell on RF channel number 1.
	Neighbour cell		Cell2	Neighbour cell on RF channel number 2.
Final Condition	Active PCell		Cell1	PCell on RF channel number 1.
	Neighbour Cell		Cell2	PSCell on RF channel number 2.
A4	Hysteresis	dB	0	Hysteresis for evaluation of event A4.
	Threshold RSRP	dBm	-93	Actual RSRP threshold for event A4. Needs to take absolute accuracy tolerance in section 9.1.11.1 into account plus margin.
	Time to Trigger	S	0	
DRX			OFF	Continuous monitoring of primary cell
Measurement gap pattern Id			0	Gaps are configured before T2 and released before T3.
PRACH configuration on cell2			FR1 PRACH configuration 2	Captured in [A.3.8.2.1]
CQI/PMI periodicity and offset configuration index on cell2			TBD	CQI reporting for PSCell every uplink subframe
Cell-individual offset for cells on RF channel number 1		dB	0	Individual offset for cells on primary component carrier.
Cell-individual offset for cells on RF channel number 2		dB	0	Individual offset for cells on carrier frequency of cell2.
T1		S	5	During this time the PCell shall be known and cell2 shall be unknown.
T2		S	≤ 5	During this time the UE shall identify neighbour cell (cell2) and report event A4.
T3		S	1	During this time the UE adds the PSCell.
T4		S	1	During this time the UE sends CSI reports for PSCell.
T5		S	1	During this time the UE releases the PSCell.

Table A.4.5.7.1.1-3: Cell Specific Parameters for PSCell Addition and Release

Parameter	Unit	Config	Test				
			T1	T2	T3	T4	T5
E-UTRA RF Channel Number		1,2,3,4,5,6	1				
NR RF Channel Number		1,2,3,4,5,6	2				
TDD configuration		1,4	Not Applicable				
		2,5	TDDConf.1.1				
		3,6	TDDConf.1.2				
BW _{channel}	MHz	1,4	10: N _{RB,c} = 52				
		2,5	10: N _{RB,c} = 52				
		3,6	40: N _{RB,c} = 106				
Initial BWP Configuration		1,2,3	DLBWP.0.1 ULBWP.0.1				
Dedicated BWP Configuration		1,2,3	DLBWP.1.1 ULBWP.1.1				
PDSCH Reference measurement channel		1,4	SR.1.1 FDD				
		2,5	SR.1.1 TDD				
		3,6	SR.2.1 TDD				

RMSI CORESET Reference Channel		1,4	CR.1.1 FDD	
		2,5	CR.1.1 TDD	
		3,6	CR.2.1 TDD	
Dedicated CORESET Reference Channel		1,4	CCR.1.1 FDD	
		2,5	CCR.1.1 TDD	
		3,6	CCR.2.1 TDD	
OCNG Patterns		1,2,3,4,5,6	OP.1	
SSB configuration		1,2,4,5	SSB.1 FR1	
		3,6	SSB.2 FR1	
SMTC configuration		1,2,4,5	SMTC.1	
		3,6	SMTC.1	
EPRE ratio of PSS to SSS	dB	1,2,3,4,5,6	0	
EPRE ratio of PBCH DMRS to SSS				
EPRE ratio of PBCH to PBCH DMRS				
EPRE ratio of PDCCH DMRS to SSS				
EPRE ratio of PDCCH to PDCCH DMRS				
EPRE ratio of PDSCH DMRS to SSS				
EPRE ratio of PDSCH to PDSCH				
EPRE ratio of OCNG DMRS to SSS(Note 1)				
EPRE ratio of OCNG to OCNG DMRS (Note 1)				
N_{oc}^{Note2}				
N_{oc}^{Note2}	dBm/SCS	1,2,4,5	N/A	-85
		3,6	N/A	-82
\hat{E}_s/I_{ot}		1,2,3,4,5,6	-infinity	0
\hat{E}_s/N_{oc}		1,2,3,4,5,6	-infinity	0
SS-RSRP ^{Note3}	dBm/SCS	1,2,4,5	-infinity	-85
		3,6	-infinity	-82
I_o^{Note3}	dBm/9.36MHz	1,2,4,5	N/A	-57
	dBm/38.1MHz	3,6	N/A	-51
Propagation condition		1,2,3,4,5,6	AWGN	
<p>Note 1: OCNG shall be used such that both cells are fully allocated and a constant total transmitted power spectral density is achieved for all OFDM symbols.</p> <p>Note 2: Interference from other cells and noise sources not specified in the test is assumed to be constant over subcarriers and time and shall be modelled as AWGN of appropriate power for N_{oc} to be fulfilled.</p>				

Note 3: SS-RSRP and Io levels have been derived from other parameters for information purposes. They are not settable parameters themselves.

Note 4: SS-RSRP minimum requirements are specified assuming independent interference and noise at each receiver antenna port.

A.4.5.7.1.2 Test Requirements

The UE shall transmit the PRACH to PSCell at latest 232 ms^{Note1} into T3.

The UE shall send at least one CSI report for PSCell with non-zero CQI index during T4.

The UE shall periodically send CSI reports for PSCell after the UE has sent first CQI report with non-zero CQI index during T4

The UE shall stop sending CSI reports for PSCell in at latest [20]ms into T5.

All the above test requirements shall be fulfilled in order for the observed PSCell addition delay and PSCell release delay to be counted as correct. The rate of correct observed PSCell addition delay and PSCell release delay during repeated tests shall be at least 90%.

Note1: The PSCell addition delay can be expressed as follows as specified in Clause 7.31.2 [15]:

$$T_{\text{config_PSCell}} = T_{\text{RRC_delay}} + T_{\text{processing}} + T_{\text{search}} + T_{\Delta} + T_{\text{PSCell_DU}} + 2\text{ms}$$

Where:

$$T_{\text{RRC_delay}} = 20\text{ms}$$

$$T_{\text{processing}} = 20\text{ms}$$

$$T_{\text{search}} = 0$$

$$T_{\Delta} = 20\text{ms}$$

$$T_{\text{PSCell_DU}} = 16 \times 10 + 10 = 170\text{ms}$$

A.4.6 Measurement procedure

A.4.6.1 Intra-frequency Measurements

A.4.6.1.1 EN-DC event triggered reporting tests without gap under non-DRX

A.4.6.1.1.1 Test purpose and Environment

The purpose of this test is to verify that the UE makes correct reporting of an event. This test will partly verify the intra-frequency cell search requirements in clause 9.2.5.1 and 9.2.5.2.

A.4.6.1.1.2 Test parameters

Three cells are deployed in the test, which are E-UTRAN PCell (Cell 1), FR1 PSCell (Cell 2) and a FR1 neighbour cell (Cell 3) on the same frequency as the PSCell. The test parameters for PSCell are given in Table A.4.6.1.1.2-1, A.4.6.1.1.2-2, A.4.6.1.1.2-3 below and the test parameters and applicability for the E-UTRAN cell are defined in A.3.7.2. In the measurement control information a measurement object is configured for the frequency of the PSCell, and it is indicated to the UE that event-triggered reporting with Event A3 is used. The test consists of two successive time periods, with time duration of T1, and T2 respectively. During time duration T1, the UE shall not have any timing information of cell 3.

Table A.4.6.1.1.2-1: Supported test configurations

Configuration	Description
1	15 kHz SSB SCS, 10MHz bandwidth, FDD duplex mode
2	15 kHz SSB SCS, 10MHz bandwidth, TDD duplex mode
3	30 kHz SSB SCS, 40MHz bandwidth, TDD duplex mode
Note: The UE is only required to be tested in one of the supported test configurations.	

Table A.4.6.1.1.2-2: General test parameters for EN-DC intra-frequency event triggered reporting without gap for PSCell in FR1

Parameter	Unit	Test configuration	Value	Comment
Active cell		1, 2, 3	E-UTRAN Cell 1 and NR Cell 2	
Neighbour cell		1, 2, 3	NR Cell 3	Cell to be identified.
RF Channel Number		1, 2, 3	1: Cell 1 2: Cell 2 and Cell 3	
SSB configuration		1	SSB.1 FR1	
		2	SSB.1 FR1	
		3	SSB.2 FR1	
SMTC configuration		1	SMTC.2	
		2	SMTC.1	
		3	SMTC.1	
A3-Offset	dB	1, 2, 3	-4.5	
CP length		1, 2, 3	Normal	
Hysteresis	dB	1, 2, 3	0	
Time To Trigger	s	1, 2, 3	0	
Filter coefficient		1, 2, 3	0	L3 filtering is not used
DRX		1, 2, 3	N/A	OFF
Time offset between PCell and PSCell		1, 2, 3	3 μ s	Synchronous EN-DC
Time offset between serving and neighbour cells		1	3 ms	Asynchronous cells. The timing of Cell 3 is 3ms later than the timing of Cell 2.
		2	3 μ s	Synchronous cells
		3	3 μ s	Synchronous cells
T1	s	1, 2, 3	5	
T2	s	1, 2, 3	5	

Table A.4.6.1.1.2-3: NR Cell specific test parameters for EN-DC intra-frequency event triggered reporting without gap for PSCell in FR1

Parameter	Unit	Test configuration	Cell 2		Cell 3	
			T1	T2	T1	T2
TDD configuration		1	N/A		N/A	
		2	TDDConf.1.1		TDDConf.1.1	
		3	TDDConf.2.1		TDDConf.2.1	
PDSCH RMC configuration		1	SR.1.1 FDD		N/A	
		2	SR.1.1 TDD			
		3	SR.2.1 TDD			
RMSI CORESET RMC configuration		1	CR.1.1 FDD		CR.1.1 FDD	
		2	CR.1.1 TDD		CR.1.1 TDD	
		3	CR.2.1 TDD		CR.2.1 TDD	
		1	CCR.1.1 FDD		CCR.1.1 FDD	
		2	CCR.1.1 TDD		CCR.1.1 TDD	

Dedicated CORESET RMC configuration		3	CCR.2.1 TDD		CCR.2.1 TDD	
OCNG Patterns		1, 2, 3	OP.1		OP.1	
Initial BWP configuration		1, 2, 3	DLBWP.0.1 ULBWP.0.1		DLBWP.0.1 ULBWP.0.1	
Active DL BWP configuration		1, 2, 3	DLBWP.1.1		DLBWP.1.1	
Active UL BWP configuration		1, 2, 3	ULBWP.1.1		ULBWP.1.1	
RLM-RS		1, 2, 3	SSB		SSB	
N_{oc} ^{Note 2}	dBm/SCS	1	-98			
		2	-98			
		3	-95			
N_{oc} ^{Note 2}	dBm/15 KHz	1	-98			
		2				
		3				
\hat{E}_s / I_{ot}	dB	1	4	-1.46	-Infinity	-1.46
		2				
		3				
\hat{E}_s / N_{oc}	dB	1	4	4	-Infinity	4
		2				
		3				
SS-RSRP ^{Note 3}	dBm/SCS KHz	1	-94	-94	-Infinity	-94
		2	-94	-94	-Infinity	-94
		3	-91	-91	-Infinity	-91
I _o	dBm/9.36 MHz	1	-64.60	-62.25	-Infinity	-62.25
	dBm/9.36 MHz	2	-64.60	-62.25	-Infinity	-62.25
	dBm/38.16 MHz	3	-58.50	-56.16	-Infinity	-56.16
Propagation Condition		1, 2, 3	AWGN			
<p>Note 1: The resources for uplink transmission are assigned to the UE prior to the start of time period T2.</p> <p>Note 2: Interference from other cells and noise sources not specified in the test is assumed to be constant over subcarriers and time and shall be modelled as AWGN of appropriate power for N_{oc} to be fulfilled.</p> <p>Note 3: SS-RSRP levels have been derived from other parameters for information purposes. They are not settable parameters themselves.</p>						

A.4.6.1.1.3 Test Requirements

The UE shall send one Event A3 triggered measurement report, with a measurement reporting delay less than 800 ms from the beginning of time period T2. The UE is not required to read the neighbour cell SSB index in this test.

The UE shall not send event triggered measurement reports, as long as the reporting criteria are not fulfilled.

The rate of correct events observed during repeated tests shall be at least 90%.

NOTE: The actual overall delays measured in the test may be up to $2 \times TTI_{DCCH}$ higher than the measurement reporting delays above because of TTI insertion uncertainty of the measurement report in DCCH.

A.4.6.1.2 EN-DC event triggered reporting tests without gap under DRX

A.4.6.1.2.1 Test purpose and Environment

The purpose of this test is to verify that the UE makes correct reporting of an event. This test will partly verify the TDD intra-frequency cell search requirements in clause 9.2.5.1 and 9.2.5.2.

A.4.6.1.2.2 Test parameters

Three cells are deployed in the test, which are E-UTRAN PCell (Cell 1), FR1 PSCell (Cell 2) and a FR1 neighbour cell (Cell 3) on the same frequency as the PSCell. The test parameters for PSCell are given in Table A.4.6.1.2.1-1, A.4.6.1.2.1-2, A.4.6.1.2.1-3 and A.4.6.1.2.1-4 below and the test parameters and applicability for the E-UTRAN cell are defined in A.3.7.2. In the measurement control information a measurement object is configured for the frequency of the PSCell, and it is indicated to the UE that event-triggered reporting with Event A3 is used. The test consists of two successive time periods, with time duration of T1, and T2 respectively. During time duration T1, the UE shall not have any timing information of cell 3.

Table A.4.6.1.2.2-1: Supported test configurations

Configuration	Description
1	15 kHz SSB SCS, 10MHz bandwidth, FDD duplex mode
2	15 kHz SSB SCS, 10MHz bandwidth, TDD duplex mode
3	30 kHz SSB SCS, 40MHz bandwidth, TDD duplex mode
Note:	The UE is only required to be tested in one of the supported test configurations.

Table A.4.6.1.2.2-2: General test parameters for EN-DC intra-frequency event triggered reporting without gap for PSCell in FR1 with DRX

Parameter	Unit	Test configuration	Value		Comment
			Test 1	Test 2	
Active cell		1, 2, 3	E-UTRAN Cell 1 and NR Cell 2		
Neighbour cell		1, 2, 3	NR Cell 3		Cell to be identified.
RF Channel Number		1, 2, 3	1: Cell 1 2: Cell 2 and Cell 3		
SSB configuration		1	SSB.1 FR1		
		2	SSB.1 FR1		
		3	SSB.2 FR1		
SMTC configuration		1	SMTC.2		
		2	SMTC.1		
		3	SMTC.1		
A3-Offset	dB	1, 2, 3	-4.5		
CP length		1, 2, 3	Normal		
Hysteresis	dB	1, 2, 3	0		
Time To Trigger	s	1, 2, 3	0		
Filter coefficient		1, 2, 3	0		L3 filtering is not used
DRX		1, 2, 3	DRX.1	DRX.2	
Time offset between PCell and PSCell		1, 2, 3	3 μ s		Synchronous EN-DC
Time offset between serving and neighbour cells		1	3 ms		Asynchronous cells. The timing of Cell 3 is 3ms later than the timing of Cell 2.
		2	3 μ s		Synchronous cells
		3	3 μ s		Synchronous cells
T1	s	1, 2, 3	5		
T2	s	1, 2, 3	5	10	

Table A.4.6.1.2.2-3: NR Cell specific test parameters for EN-DC intra-frequency event triggered reporting without gap for PSCell in FR1 with DRX

Parameter	Unit	Test configuration	Cell 2		Cell 3	
			T1	T2	T1	T2
TDD configuration		1	N/A		N/A	
		2	TDDConf.1.1		TDDConf.1.1	
		3	TDDConf.2.1		TDDConf.2.1	
PDSCH RMC configuration		1	SR.1.1 FDD		N/A	
		2	SR.1.1 TDD			
		3	SR.2.1 TDD			
RMSI CORESET RMC configuration		1	CR.1.1 FDD		CR.1.1 FDD	
		2	CR.1.1 TDD		CR.1.1 TDD	
		3	CR.2.1 TDD		CR.2.1 TDD	
Dedicated CORESET RMC configuration		1	CCR.1.1 FDD		CCR.1.1 FDD	
		2	CCR.1.1 TDD		CCR.1.1 TDD	
		3	CCR.2.1 TDD		CCR.2.1 TDD	
OCNG Patterns		1, 2, 3	OP.1		OP.1	
Initial BWP configuration		1, 2, 3	DLBWP.0.1 ULBWP.0.1		DLBWP.0.1 ULBWP.0.1	
Active DL BWP configuration		1, 2, 3	DLBWP.1.1		DLBWP.1.1	
Active UL BWP configuration		1, 2, 3	ULBWP.1.1		ULBWP.1.1	
RLM-RS		1, 2, 3	SSB		SSB	
N_{oc} ^{Note 2}	dBm/SCS	1	-98			
		2	-98			
		3	-95			
N_{oc} ^{Note 2}	dBm/15 KHz	1	-98			
		2				
		3				
\hat{E}_s/I_{ot}	dB	1	4	-1.46	-Infinity	-1.46
		2				
		3				
\hat{E}_s/N_{oc}	dB	1	4	4	-Infinity	4
		2				
		3				
SS-RSRP ^{Note 3}	dBm/SCS KHz	1	-94	-94	-Infinity	-94
		2	-94	-94	-Infinity	-94
		3	-91	-91	-Infinity	-91
I _o	dBm/9.36 MHz	1	-64.60	-62.25	-Infinity	-62.25
	dBm/9.36 MHz	2	-64.60	-62.25	-Infinity	-62.25
	dBm/38.16 MHz	3	-58.50	-56.16	-Infinity	-56.16
Propagation Condition		1, 2, 3	AWGN			
<p>Note 1: The resources for uplink transmission are assigned to the UE prior to the start of time period T2.</p> <p>Note 2: Interference from other cells and noise sources not specified in the test is assumed to be constant over subcarriers and time and shall be modelled as AWGN of appropriate power for N_{oc} to be fulfilled.</p> <p>Note 3: SS-RSRP levels have been derived from other parameters for information purposes. They are not settable parameters themselves.</p>						

A.4.6.1.2.2 Test Requirements

In test 1, the UE shall send one Event A3 triggered measurement report, with a measurement reporting delay less than 920 ms from the beginning of time period T2. The UE is not required to read the neighbour cell SSB index in this test.

In test 2, the UE shall send one Event A3 triggered measurement report, with a measurement reporting delay less than 6400 ms from the beginning of time period T2. The UE is not required to read the neighbour cell SSB index in this test.

The UE shall not send event triggered measurement reports, as long as the reporting criteria are not fulfilled.

The rate of correct events observed during repeated tests shall be at least 90%.

NOTE: The actual overall delays measured in the test may be up to $2 \times TTI_{DCCCH}$ higher than the measurement reporting delays above because of TTI insertion uncertainty of the measurement report in DCCCH.

A.4.6.1.3 EN-DC event triggered reporting tests with per-UE gaps under non-DRX

A.4.6.1.3.1 Test purpose and Environment

The purpose of this test is to verify that the UE makes correct reporting of an event. This test will partly verify the TDD intra-frequency cell search requirements in clause 9.2.6.2 and 9.2.6.3.

A.4.6.1.3.2 Test parameters

Three cells are deployed in the test, which are E-UTRAN PCell (Cell 1), FR1 PSCell (Cell 2) and a FR1 neighbour cell (Cell 3) on the same frequency as the PSCell. The test parameters for PSCell are given in Table A.4.6.1.3.1-1 and A.4.6.1.3.1-2 below and the test parameters and applicability for the E-UTRAN cell are defined in A.3.7.2. In the measurement control information a measurement object is configured for the frequency of the PSCell, and it is indicated to the UE that event-triggered reporting with Event A3 is used. The test consists of two successive time periods, with time duration of T1, and T2 respectively. During time duration T1, the UE shall not have any timing information of cell 3.

There are two BWPs configured in Cell 2, BWP1 which contains the cell defining SSB, and BWP2 which does not contain any SSB of Cell 2. During the whole test, BWP2 is always scheduled as the active BWP for the UE.

Table A.4.6.1.3.2-1: Supported test configurations

Configuration	Description
1	15 kHz SSB SCS, 10MHz bandwidth, FDD duplex mode
2	15 kHz SSB SCS, 10MHz bandwidth, TDD duplex mode
3	30 kHz SSB SCS, 40MHz bandwidth, TDD duplex mode
Note: The UE is only required to be tested in one of the supported test configurations.	

Table A.4.6.1.3.2-2: General test parameters for EN-DC intra-frequency event triggered reporting with per-UE gaps for PSCell in FR1

Parameter	Unit	Test configuration	Value	Comment
Active cell		1, 2, 3	E-UTRAN Cell 1 and NR Cell 2	
Neighbour cell		1, 2, 3	NR Cell 3	Cell to be identified.
RF Channel Number		1, 2, 3	1: Cell 1 2: Cell 2 and Cell 3	
Measurement gap type		1, 2, 3	Per-UE gaps	
Measurement gap repetition periodicity	ms	1, 2, 3	40	
Measurement gap length	ms	1, 2, 3	6	
Measurement gap offset	ms	1, 2, 3	39	
SSB configuration		1	SSB.1 FR1	
		2	SSB.1 FR1	
		3	SSB.2 FR1	
SMTC configuration		1	SMTC.2	
		2	SMTC.1	
		3	SMTC.1	
CSI-RS parameters		1	CSI-RS.1.2 FDD	
		2	CSI-RS.1.2 TDD	
		3	CSI-RS.2.2 TDD	
A3-Offset	dB	1, 2, 3	-4.5	
CP length		1, 2, 3	Normal	
Hysteresis	dB	1, 2, 3	0	
Time To Trigger	s	1, 2, 3	0	
Filter coefficient		1, 2, 3	0	L3 filtering is not used
DRX		1, 2, 3	N/A	OFF
Time offset between PCell and PSCell		1, 2, 3	3 μ s	Synchronous EN-DC
Time offset between serving and neighbour cells		1	3 ms	Asynchronous cells. The timing of Cell 3 is 3ms later than the timing of Cell 2.
		2	3 μ s	Synchronous cells
		3	3 μ s	Synchronous cells
T1	s	1, 2, 3	5	
T2	s	1, 2, 3	5	

Table A.4.6.1.3.2-3: NR Cell specific test parameters for EN-DC intra-frequency event triggered reporting with per-UE gaps for PSCell in FR1

Parameter	Unit	Test configuration	Cell 2		Cell 3	
			T1	T2	T1	T2
TDD configuration		1	N/A		N/A	
		2	TDDConf.1.1	TDDConf.1.1		
		3	TDDConf.2.1	TDDConf.2.1		
PDSCH RMC configuration		1	SR.1.1 FDD	N/A		
		2	SR.1.1 TDD			
		3	SR.2.1 TDD			
RMSI CORESET RMC configuration		1	CR.1.1 FDD	CR.1.1 FDD		
		2	CR.1.1 TDD	CR.1.1 TDD		
		3	CR.2.1 TDD	CR.2.1 TDD		
		1	CCR.1.1 FDD	CCR.1.1 FDD		
		2	CCR.1.1 TDD	CCR.1.1 TDD		

Dedicated CORESET RMC configuration		3	CCR.2.1 TDD		CCR.2.1 TDD	
OCNG Patterns		1, 2, 3	OP.1		OP.1	
Initial BWP configuration		1, 2, 3	DLBWP.0.1 ULBWP.0.1		DLBWP.0.1 ULBWP.0.1	
Active DL BWP configuration		1, 2, 3	DLBWP.1.2		DLBWP.1.1	
Active UL BWP configuration		1, 2, 3	ULBWP.1.2		ULBWP.1.1	
RLM-RS		1, 2, 3	CSI-RS		SSB	
N_{oc} Note 2	dBm/SCS	1	-98			
		2	-98			
		3	-95			
N_{oc} Note 2	dBm/15 KHz	1	-98			
		2				
		3				
\hat{E}_s/I_{ot}	dB	1	4	-1.46	-Infinity	-1.46
		2				
		3				
\hat{E}_s/N_{oc}	dB	1	4	4	-Infinity	4
		2				
		3				
SS-RSRP Note 3	dBm/SCS KHz	1	-94	-94	-Infinity	-94
		2	-94	-94	-Infinity	-94
		3	-91	-91	-Infinity	-91
Io	dBm/9.36 MHz	1	-64.60	-62.25	-Infinity	-62.25
	dBm/9.36 MHz	2	-64.60	-62.25	-Infinity	-62.25
	dBm/38.16 MHz	3	-58.50	-56.16	-Infinity	-56.16
Propagation Condition		1, 2, 3	AWGN			
<p>Note 1: The resources for uplink transmission are assigned to the UE prior to the start of time period T2.</p> <p>Note 2: Interference from other cells and noise sources not specified in the test is assumed to be constant over subcarriers and time and shall be modelled as AWGN of appropriate power for N_{oc} to be fulfilled.</p> <p>Note 3: SS-RSRP levels have been derived from other parameters for information purposes. They are not settable parameters themselves.</p>						

A.4.6.1.3.3 Test Requirements

The UE shall send one Event A3 triggered measurement report, with a measurement reporting delay less than 800 ms from the beginning of time period T2. The UE is not required to read the neighbour cell SSB index in this test.

The UE shall not send event triggered measurement reports, as long as the reporting criteria are not fulfilled.

The rate of correct events observed during repeated tests shall be at least 90%.

NOTE: The actual overall delays measured in the test may be up to $2xTTI_{DCCH}$ higher than the measurement reporting delays above because of TTI insertion uncertainty of the measurement report in DCCH.

A.4.6.1.4 EN-DC event triggered reporting tests with per-UE gaps under DRX

A.4.6.1.4.1 Test purpose and Environment

The purpose of this test is to verify that the UE makes correct reporting of an event. This test will partly verify the intra-frequency cell search requirements in clause 9.2.6.2 and 9.2.6.3.

A.4.6.1.4.2 Test parameters

Three cells are deployed in the test, which are E-UTRAN PCell (Cell 1), FR1 PSCell (Cell 2) and a FR1 neighbour cell (Cell 3) on the same frequency as the PSCell. The test parameters for PSCell are given in Table A.4.6.1.4.2-1, A.4.6.1.4.2-2, A.4.6.1.4.2-3 A.4.6.1.4.2-4 and A.4.6.1.4.2-5 below and the test parameters and applicability for the E-UTRAN cell are defined in A.3.7.2. In the measurement control information a measurement object is configured for the frequency of the PSCell, and it is indicated to the UE that event-triggered reporting with Event A3 is used. The test consists of two successive time periods, with time duration of T1, and T2 respectively. During time duration T1, the UE shall not have any timing information of cell 3.

There are two BWPs configured in Cell 2, BWP1 which contains the cell defining SSB, and BWP2 which does not contain any SSB of Cell 2. During the whole test, BWP2 is always scheduled as the active BWP for the UE.

Table A.4.6.1.4.2-1: Supported test configurations

Configuration	Description
1	15 kHz SSB SCS, 10MHz bandwidth, FDD duplex mode
2	15 kHz SSB SCS, 10MHz bandwidth, TDD duplex mode
3	30 kHz SSB SCS, 40MHz bandwidth, TDD duplex mode
Note: The UE is only required to be tested in one of the supported test configurations.	

Table A.4.6.1.4.2-2: General test parameters for EN-DC intra-frequency event triggered reporting with per-UE gaps for PSCell in FR1 with DRX

Parameter	Unit	Test configuration	Value		Comment
			Test 1	Test 2	
Active cell		1, 2, 3	E-UTRAN Cell 1 and NR Cell 2		
Neighbour cell		1, 2, 3	NR Cell 3		Cell to be identified.
RF Channel Number		1, 2, 3	1: Cell 1 2: Cell 2 and Cell 3		
Measurement gap type		1, 2, 3	Per-UE gaps		
Measurement gap repetition periodicity	ms	1, 2, 3	40		
Measurement gap length	ms	1, 2, 3	6		
Measurement gap offset	ms	1, 2, 3	39		
SSB configuration		1	SSB.1 FR1		
		2	SSB.1 FR1		
		3	SSB.2 FR1		
SMTC configuration		1	SMTC.2		
		2	SMTC.1		
		3	SMTC.1		
CSI-RS parameters		1	CSI-RS.1.2 FDD		
		2	CSI-RS.1.2 TDD		
		3	CSI-RS.2.2 TDD		
A3-Offset	dB	1, 2, 3	-4.5		
CP length		1, 2, 3	Normal		
Hysteresis	dB	1, 2, 3	0		
Time To Trigger	s	1, 2, 3	0		
Filter coefficient		1, 2, 3	0		L3 filtering is not used
DRX		1, 2, 3	DRX.1	DRX.2	
Time offset between PCell and PSCell		1, 2, 3	3 μ s		Synchronous EN-DC
Time offset between serving and neighbour cells		1	3 ms		Asynchronous cells. The timing of Cell 3 is 3ms later than the timing of Cell 2.
		2	3 μ s		Synchronous cells

		3	3 μ s	Synchronous cells	
T1	s	1, 2, 3	5		
T2	s	1, 2, 3	5	10	

Table A.4.6.1.4.2-3: NR Cell specific test parameters for EN-DC intra-frequency event triggered reporting with per-UE gaps for PSCell in FR1 with DRX

Parameter	Unit	Test configuration	Cell 2		Cell 3	
			T1	T2	T1	T2
TDD configuration		1	N/A		N/A	
		2	TDDConf.1.1		TDDConf.1.1	
		3	TDDConf.2.1		TDDConf.2.1	
PDSCH RMC configuration		1	SR.1.1 FDD		N/A	
		2	SR.1.1 TDD			
		3	SR.2.1 TDD			
RMSI CORESET RMC configuration		1	CR.1.1 FDD		CR.1.1 FDD	
		2	CR.1.1 TDD		CR.1.1 TDD	
		3	CR.2.1 TDD		CR.2.1 TDD	
Dedicated CORESET RMC configuration		1	CCR.1.1 FDD		CCR.1.1 FDD	
		2	CCR.1.1 TDD		CCR.1.1 TDD	
		3	CCR.2.1 TDD		CCR.2.1 TDD	
OCNG Patterns		1, 2, 3	OP.1		OP.1	
Initial BWP configuration		1, 2, 3	DLBWP.0.1 ULBWP.0.1		DLBWP.0.1 ULBWP.0.1	
Active DL BWP configuration		1, 2, 3	DLBWP.1.2		DLBWP.1.1	
Active UL BWP configuration		1, 2, 3	ULBWP.1.2		ULBWP.1.1	
RLM-RS		1, 2, 3	CSI-RS		SSB	
N_{oc} ^{Note 2}	dBm/SCS	1	-98			
		2	-98			
		3	-95			
N_{oc} ^{Note 2}	dBm/15 KHz	1	-98			
		2				
		3				
\hat{E}_s/I_{ot}	dB	1	4	-1.46	-Infinity	-1.46
		2				
		3				
\hat{E}_s/N_{oc}	dB	1	4	4	-Infinity	4
		2				
		3				
SS-RSRP ^{Note 3}	dBm/SCS KHz	1	-94	-94	-Infinity	-94
		2	-94	-94	-Infinity	-94
		3	-91	-91	-Infinity	-91
I _o	dBm/9.36 MHz	1	-64.60	-62.25	-Infinity	-62.25
	dBm/9.36 MHz	2	-64.60	-62.25	-Infinity	-62.25
	dBm/38.16 MHz	3	-58.50	-56.16	-Infinity	-56.16
Propagation Condition		1, 2, 3	AWGN			
<p>Note 1: The resources for uplink transmission are assigned to the UE prior to the start of time period T2.</p> <p>Note 2: Interference from other cells and noise sources not specified in the test is assumed to be constant over subcarriers and time and shall be modelled as AWGN of appropriate power for N_{oc} to be fulfilled.</p> <p>Note 3: SS-RSRP levels have been derived from other parameters for information purposes. They are not settable parameters themselves.</p>						

Table A.4.6.1.4.2-4: Void**Table A.4.6.1.4.2-5: Void****A.4.6.1.4.3 Test Requirements**

In test 1, the UE shall send one Event A3 triggered measurement report, with a measurement reporting delay less than 920 ms from the beginning of time period T2. The UE is not required to read the neighbour cell SSB index in this test.

In test 2, the UE shall send one Event A3 triggered measurement report, with a measurement reporting delay less than 6400 ms from the beginning of time period T2. The UE is not required to read the neighbour cell SSB index in this test.

The UE shall not send event triggered measurement reports, as long as the reporting criteria are not fulfilled.

The rate of correct events observed during repeated tests shall be at least 90%.

NOTE: The actual overall delays measured in the test may be up to $2xTTI_{DCCH}$ higher than the measurement reporting delays above because of TTI insertion uncertainty of the measurement report in DCCH.

A.4.6.1.5 EN-DC event triggered reporting tests without gap under non-DRX with SSB index reading**A.4.6.1.5.1 Test purpose and Environment**

The purpose of this test is to verify that the UE makes correct reporting of an event. This test will partly verify the FDD intra-frequency cell search requirements in clause 9.2.5.1 and 9.2.5.2.

A.4.6.1.5.2 Test parameters

Three cells are deployed in the test, which are E-UTRAN PCell (Cell 1), FR1 PSCell (Cell 2) and a FR1 neighbour cell (Cell 3) on the same frequency as the PSCell. The test parameters for FDD PSCell are given in Table A.4.6.1.5.1-1 and A.4.6.1.5.1-2 below and the test parameters and applicability for the E-UTRAN cell are defined in A.3.7.2. In the measurement control information a measurement object is configured for the frequency of the PSCell, and it is indicated to the UE that event-triggered reporting with Event A3 is used. The test consists of two successive time periods, with time duration of T1, and T2 respectively. During time duration T1, the UE shall not have any timing information of cell 3.

Table A.4.6.1.5.2-1: Supported test configurations

Configuration	Description
1	15 kHz SSB SCS, 10MHz bandwidth, FDD duplex mode
Note: The UE is only required to be tested in one of the supported test configurations.	

Table A.4.6.1.5.2-2: General test parameters for EN-DC intra-frequency event triggered reporting without gap for FDD PSCell in FR1 with SSB index reading

Parameter	Unit	Test configuration	Value	Comment
Active cell		1	E-UTRAN Cell 1 and NR Cell 2	
Neighbour cell		1	NR Cell 3	Cell to be identified.
RF Channel Number		1	1: Cell 1 2: Cell 2 and Cell 3	
SSB configuration		1	SSB.1 FR1	
SMTC configuration		1	SMTC.2	
A3-Offset	dB	1	-4.5	
CP length		1	Normal	
Hysteresis	dB	1	0	
Time To Trigger	s	1	0	
Filter coefficient		1	0	L3 filtering is not used
DRX		1	N/A	OFF
Time offset between PCell and PSCell		1	3 μ s	Synchronous EN-DC
Time offset between serving and neighbour cells		1	3 ms	Asynchronous cells. The timing of Cell 3 is 3ms later than the timing of Cell 2.
T1	s	1	5	
T2	s	1	5	

Table A.4.6.1.5.2-3: NR Cell specific test parameters for EN-DC intra-frequency event triggered reporting without gap for FDD PSCell in FR1 with SSB index reading

Parameter	Unit	Test configuration	Cell 2		Cell 3	
			T1	T2	T1	T2
TDD configuration		1	N/A		N/A	
PDSCH RMC configuration		1	SR.1.1 FDD		N/A	
RMSI CORESET RMC configuration		1	CR.1.1 FDD		CR.1.1 FDD	
Dedicated CORESET RMC configuration		1	CCR.1.1 FDD		CCR.1.1 FDD	
OCNG Patterns		1	OP.1		OP.1	
Initial BWP configuration		1	DLBWP.0.1 ULBWP.0.1		DLBWP.0.1 ULBWP.0.1	
Active DL BWP configuration		1	DLBWP.1.1		DLBWP.1.1	
Active UL BWP configuration		1	ULBWP.1.1		ULBWP.1.1	
RLM-RS		1	SSB		SSB	
N_{oc} ^{Note 2}	dBm/SCS	1	-98			
N_{oc} ^{Note 2}	dBm/15 KHz	1	-98			
\hat{E}_s/I_{ot}	dB	1	4	-1.46	-Infinity	-1.46
\hat{E}_s/N_{oc}	dB	1	4	4	-Infinity	4
SS-RSRP ^{Note 3}	dBm/SCS KHz	1	-94	-94	-Infinity	-94
I_o	dBm/9.36 MHz	1	-64.60	-62.25	-Infinity	-62.25
Propagation Condition		1	AWGN			
<p>Note 1: The resources for uplink transmission are assigned to the UE prior to the start of time period T2.</p> <p>Note 2: Interference from other cells and noise sources not specified in the test is assumed to be constant over subcarriers and time and shall be modelled as AWGN of appropriate power for N_{oc} to be fulfilled.</p> <p>Note 3: SS-RSRP levels have been derived from other parameters for information purposes. They are not settable parameters themselves.</p>						

A.4.6.1.5.3 Test Requirements

The UE shall send one Event A3 triggered measurement report, with a measurement reporting delay less than 920 ms from the beginning of time period T2. The UE is required to read the neighbour cell SSB index and report the acquired SSB index in this test.

The UE shall not send event triggered measurement reports, as long as the reporting criteria are not fulfilled.

The rate of correct events observed during repeated tests shall be at least 90%.

NOTE: The actual overall delays measured in the test may be up to $2xTTI_{DCCH}$ higher than the measurement reporting delays above because of TTI insertion uncertainty of the measurement report in DCCH.

A.4.6.1.6 EN-DC event triggered reporting tests with SSB index reading with per-UE gaps

A.4.6.1.6.1 Test purpose and Environment

The purpose of this test is to verify that the UE makes correct reporting of an event. This test will partly verify the intra-frequency cell search requirements in clause 9.2.6.2 and 9.2.6.3.

A.4.6.1.6.2 Test parameters

Three cells are deployed in the test, which are E-UTRAN PCell (Cell 1), FR1 PSCell (Cell 2) and a FR1 neighbour cell (Cell 3) on the same frequency as the PSCell. The test parameters for PSCell are given in Table A.4.6.1.6.2-1 A.4.6.1.6.2-2 and A.4.6.1.6.2-3 below and the test parameters and applicability for the E-UTRAN cell are defined in A.3.7.2. In the measurement control information a measurement object is configured for the frequency of the PSCell, and it is indicated to the UE that event-triggered reporting with Event A3 is used. The test consists of two successive time periods, with time duration of T1, and T2 respectively. During time duration T1, the UE shall not have any timing information of cell 3.

There are two BWPs configured in Cell 2, BWP1 which contains the cell defining SSB, and BWP2 which does not contain any SSB of Cell 2. During the whole test, BWP2 is always scheduled as the active BWP for the UE.

Table A.4.6.1.6.2-1: Supported test configurations

Configuration	Description
1	15 kHz SSB SCS, 10MHz bandwidth, FDD duplex mode
Note:	The UE is only required to be tested in one of the supported test configurations.

Table A.4.6.1.6.2-2: General test parameters for EN-DC intra-frequency event triggered reporting with gap for PSCell in FR1 with SSB index reading

Parameter	Unit	Test configuration	Value	Comment
Active cell		1	E-UTRAN Cell 1 and NR Cell 2	
Neighbour cell		1	NR Cell 3	Cell to be identified.
RF Channel Number		1	1: Cell 1 2: Cell 2 and Cell 3	
Measurement gap type		1	Per-UE gaps	
Measurement gap repetition periodicity	ms	1	40	
Measurement gap length	ms	1	6	
Measurement gap offset	ms	1	39	
SSB configuration		1	SSB.1 FR1	
SMTC configuration		1	SMTC.2	
CSI-RS parameters		1	CSI-RS.1.2 FDD	
A3-Offset	dB	1	-4.5	
CP length		1	Normal	
Hysteresis	dB	1	0	
Time To Trigger	s	1	0	
Filter coefficient		1	0	L3 filtering is not used
DRX		1	N/A	OFF
Time offset between PCell and PSCell		1	3 μ s	Synchronous EN-DC
Time offset between serving and neighbour cells		1	3 ms	Asynchronous cells. The timing of Cell 3 is 3ms later than the timing of Cell 2.
T1	s	1	5	

T2	s	1	5	
----	---	---	---	--

Table A.4.6.1.6.2-3: NR Cell specific test parameters for EN-DC intra-frequency event triggered reporting with gap for PSCell in FR1 with SSB index reading

Parameter	Unit	Test configuration	Cell 2		Cell 3	
			T1	T2	T1	T2
TDD configuration		1	N/A		N/A	
PDSCH RMC configuration		1	SR.1.1 FDD		N/A	
RMSI CORESET RMC configuration		1	CR.1.1 FDD		CR.1.1 FDD	
Dedicated CORESET RMC configuration		1	CCR.1.1 FDD		CCR.1.1 FDD	
OCNG Patterns		1	OP.1		OP.1	
Initial BWP configuration		1	DLBWP.0.1 ULBWP.0.1		DLBWP.0.1 ULBWP.0.1	
Active DL BWP configuration		1	DLBWP.1.2		DLBWP.1.1	
Active UL BWP configuration		1	ULBWP.1.1		ULBWP.1.1	
RLM-RS		1	CSI-RS		SSB	
N_{oc} ^{Note 2}	dBm/SCS	1	-98			
N_{oc} ^{Note 2}	dBm/15 KHz	1	-98			
\hat{E}_s/I_{ot}	dB	1	4	-1.46	-Infinity	-1.46
\hat{E}_s/N_{oc}	dB	1	4	4	-Infinity	4
SS-RSRP ^{Note 3}	dBm/SCS KHz	1	-94	-94	-Infinity	-94
Io	dBm/9.36 MHz	1	-64.60	-62.25	-Infinity	-62.25
Propagation Condition		1	AWGN			
<p>Note 1: The resources for uplink transmission are assigned to the UE prior to the start of time period T2.</p> <p>Note 2: Interference from other cells and noise sources not specified in the test is assumed to be constant over subcarriers and time and shall be modelled as AWGN of appropriate power for N_{oc} to be fulfilled.</p> <p>Note 3: SS-RSRP levels have been derived from other parameters for information purposes. They are not settable parameters themselves.</p>						

A.4.6.1.6.3 Test Requirements

The UE shall send one Event A3 triggered measurement report, with a measurement reporting delay less than 920 ms from the beginning of time period T2. The UE is required to read the neighbour cell SSB index and report the acquired SSB index in this test.

The UE shall not send event triggered measurement reports, as long as the reporting criteria are not fulfilled.

The rate of correct events observed during repeated tests shall be at least 90%.

NOTE: The actual overall delays measured in the test may be up to $2xTTI_{DCC}$ higher than the measurement reporting delays above because of TTI insertion uncertainty of the measurement report in DCC.

A.4.6.2 Inter-frequency Measurements

A.4.6.2.1 EN-DC event triggered reporting tests for FR1 cell without SSB time index detection when DRX is not used

A.4.6.2.1.1 Test Purpose and Environment

The purpose of this test is to verify that the UE makes correct reporting of an event. This test will partly verify the EN-DC inter-frequency NR cell search requirements in clause 9.3.4.

In this test, there are three cells: LTE cell 1 as PCell on E-UTRA RF channel 1, NR cell 2 as PSCell in FR1 on NR RF channel 1 and NR cell 3 as neighbour cell in FR1 on NR RF channel 2. The test parameters and configurations are given in Tables A.4.6.2.1.1-1, A.4.6.2.1.1-2, and A.4.6.2.1.1-3.

In test 1 measurement gap pattern configuration # 0 as defined in Table A.4.6.2.1.1-2 is provided for a UE that does not support per-FR gap and in test 2 measurement gap pattern configuration #4 as defined in Table A.4.6.2.1.1-2 is provided for UE that support per-FR gap.

In the measurement control information, it is indicated to the UE that event-triggered reporting with Event A3 is used. The test consists of two successive time periods, with time duration of T1, and T2 respectively. During time duration T1, the UE shall not have any timing information of NR cell 3.

The configuration of LTE cell 1 is defined in table A.3.7.2.1-1. Supported test configurations are shown in table A.4.6.2.1.1-1.

Table A.4.6.2.1.1-1: EN-DC event triggered reporting tests without SSB index reading for FR1-FR1

Config	Description
1	LTE FDD, NR 15 kHz SSB SCS, 10MHz bandwidth, FDD duplex mode
2	LTE FDD, NR 15 kHz SSB SCS, 10MHz bandwidth, TDD duplex mode
3	LTE FDD, NR 30kHz SSB SCS, 40MHz bandwidth, TDD duplex mode
4	LTE TDD, NR 15 kHz SSB SCS, 10MHz bandwidth, FDD duplex mode
5	LTE TDD, NR 15 kHz SSB SCS, 10MHz bandwidth, TDD duplex mode
6	LTE TDD, NR 30kHz SSB SCS, 40MHz bandwidth, TDD duplex mode
Note 1:	The UE is only required to be tested in one of the supported test configurations
Note 2:	target NR cell3 has the same SCS, BW and duplex mode as NR serving cell2

Table A.4.6.2.1.1-2: General test parameters for EN-DC inter-frequency event triggered reporting without SSB time index detection

Parameter	Unit	Test configuration	Value		Comment
			Test 1	Test 2	
E-UTRA RF Channel Number		Config 1,2,3,4,5,6	1		One E-UTRAN TDD carrier frequencies is used.
NR RF Channel Number		Config 1,2,3,4,5,6	1, 2		Two FR1 NR carrier frequencies is used.
Active cell		Config 1,2,3,4,5,6	LTE Cell 1 (PCell) and NR cell 2 (PScell)		LTE Cell 1 is on E-UTRA RF channel number 1. NR Cell 2 is on NR RF channel number 1.
Neighbour cell		Config 1,2,3,4,5,6	NR cell 3		NR cell 3 is on NR RF channel number 2.
Gap Pattern Id		Config 1,2,3,4,5,6	0	4	As specified in clause 9.1.2-1.
Measurement gap offset		Config 1,2,3,4,5,6	39	19	
SMTC-SSB parameters		Config 1,4	SSB.1 FR1		As specified in clause A.3.10.1
		Config 2,5	SSB.1 FR1		As specified in clause A.3.10.1
		Config 3,6	SSB.2 FR1		As specified in clause A.3.10.1
A3-Offset	dB	Config 1,2,3,4,5,6	-6		
Hysteresis	dB	Config 1,2,3,4,5,6	0		
CP length		Config 1,2,3,4,5,6	Normal		
TimeToTrigger	s	Config 1,2,3,4,5,6	0		
Filter coefficient		Config 1,2,3,4,5,6	0		L3 filtering is not used
DRX		Config 1,2,3,4,5,6	OFF		DRX is not used
Time offset between PCell and PScell		Config 1,2,3,4,5,6	3 μ s		Synchronous EN-DC
Time offset between serving and neighbour cells		Config 1,4	3ms		Asynchronous cells. The timing of Cell 3 is 3ms later than the timing of Cell 2.
		Config 2,3,5,6	3 μ s		Synchronous cells.
T1	s	Config 1,2,3,4,5,6	5		
T2	s	Config 1,2,3,4,5,6	TBD	TBD	

Table A.4.6.2.1.1-3: Cell specific test parameters for EN-DC inter-frequency event triggered reporting without SSB time index detection

Parameter	Unit	Test configuration	Cell 2		Cell 3	
			T1	T2	T1	T2
NR RF Channel Number		Config 1,2,3,4,5,6	1		2	

Duplex mode		Config 1,4	FDD			
		Config 2,3,5,6	TDD			
BW _{channel}	MHz	Config 1,4	10: N _{RB,c} = 52			
		Config 2,5	10: N _{RB,c} = 52			
		Config 3,6	40: N _{RB,c} = 106			
BWP BW	MHz	Config 1,4	10: N _{RB,c} = 52			
		Config 2,5	10: N _{RB,c} = 52			
		Config 3,6	40: N _{RB,c} = 106			
TDD configuration		Config 2,5	TDDConf.1.1	TDDConf.1.1		
		Config 3,6	TDDConf.2.1	TDDConf.2.1		
Initial DL BWP		Config 1,2,3,4,5,6	DLBWP.0.1	NA		
Initial UL BWP		Config 1,2,3,4,5,6	ULBWP.0.1	NA		
Dedicated DL BWP		Config 1,2,3,4,5,6	DLBWP.1.1	NA		
Dedicated UL BWP		Config 1,2,3,4,5,6	ULBWP.1.1	NA		
OCNG Patterns defined in A.3.2.1.1 (OP.1)		Config 1,2,3,4,5,6	OP.1	OP.1		
PDSCH Reference measurement channel		Config 1,4	SR.1.1 FDD	-		
		Config 2,5	SR.1.1 TDD			
		Config 3,6	SR2.1 TDD			
CORESET Reference Channel		Config 1,4	CR.1.1 FDD	-		
		Config 2,5	CR.1.1 TDD			
		Config 3,6	CR2.1 TDD			
SMTC configuration defined in A.3.2.11.1 and A.3.2.11.2		Config 1,4	SMTC.2			
		Config 2,3,5,6	SMTC.1			
PDSCH/PDCCH subcarrier spacing	kHz	Config 1,2,4,5	15			
		Config 3,6	30			
EPRE ratio of PSS to SSS		Config 1,2,3,4,5,6	0	0		
EPRE ratio of PBCH DMRS to SSS						
EPRE ratio of PBCH to PBCH DMRS						
EPRE ratio of PDCCH DMRS to SSS						
EPRE ratio of PDCCH to PDCCH DMRS						
EPRE ratio of PDSCH DMRS to SSS						
EPRE ratio of PDSCH to PDSCH						
EPRE ratio of OCNG DMRS to SSS(Note 1)						
EPRE ratio of OCNG to OCNG DMRS (Note 1)						
N_{oc}^{Note2}	dBm/15 kHz		-98			
N_{oc}^{Note2}	dBm/S CS	Config 1,2,4,5	-98			
		Config 3,6	-95			
SS-RSRP ^{Note 3}	dBm/S CS	Config 1,2,4,5	-94	-94	-Infinity	-91
		Config 3,6	-91	-91	-Infinity	-88

\hat{E}_s / I_{ot}	dB	Config 1,2,3,4,5,6	4	4	-Infinity	7
\hat{E}_s / N_{oc}	dB	Config 1,2,3,4,5,6	4	4	-Infinity	7
I_o ^{Note3}	dBm/9. 36MHz	Config 1,2,4,5	-67.11	-67.11	-Infinity	-65.38
	dBm/38 .16MHz	Config 3,6	-62.27	-62.27	-Infinity	-61.06
Propagation Condition		Config 1,2,3,4,5,6	AWGN			
<p>Note 1: OCNG shall be used such that both cells are fully allocated and a constant total transmitted power spectral density is achieved for all OFDM symbols.</p> <p>Note 2: Interference from other cells and noise sources not specified in the test is assumed to be constant over subcarriers and time and shall be modelled as AWGN of appropriate power for N_{oc} to be fulfilled.</p> <p>Note 3: SS-RSRP and I_o levels have been derived from other parameters for information purposes. They are not settable parameters themselves.</p> <p>Note 4: SS-RSRP minimum requirements are specified assuming independent interference and noise at each receiver antenna port.</p>						

A.4.6.2.1.2 Test Requirements

In test 1 with per-UE gap, the UE shall send one Event A3 triggered measurement report, with a measurement reporting delay less than [TBD] ms from the beginning of time period T2. The UE shall not send event triggered measurement reports, as long as the reporting criteria are not fulfilled. The rate of correct events observed during repeated tests shall be at least 90%.

In test 2 with per-FR gap, the UE shall send one Event A3 triggered measurement report, with a measurement reporting delay less than [TBD] ms from the beginning of time period T2. The UE shall not send event triggered measurement reports, as long as the reporting criteria are not fulfilled. The rate of correct events observed during repeated tests shall be at least 90%.

In test 1 and 2 UE is not required to report SSB time index.

NOTE: The actual overall delays measured in the test may be up to $2xTTI_{DCCH}$ higher than the measurement reporting delays above because of TTI insertion uncertainty of the measurement report in DCCH.

A.4.6.2.2 EN-DC event triggered reporting tests for FR1 cell without SSB time index detection when DRX is used

A.4.6.2.2.1 Test Purpose and Environment

The purpose of this test is to verify that the UE makes correct reporting of an event. This test will partly verify the EN-DC inter-frequency NR cell search requirements in clause 9.3.4.

In this test, there are three cells: LTE cell 1 as PCell on E-UTRA RF channel 1, NR cell 2 as PSCell in FR1 on NR RF channel 1 and NR cell 3 as neighbour cell in FR1 on NR RF channel 2. The test parameters and configurations are given in Tables A.4.6.2.2.1-1, A.4.6.2.2.1-2, and A.4.6.2.2.1-3.

In test 1&2 measurement gap pattern configuration # 0 as defined in Table A.4.6.2.2.1-2 is provided for a UE that does not support per-FR gap and in test 3&4 measurement gap pattern configuration #4 as defined in Table A.4.6.2.2.1-2 is provided for UE that support per-FR gap.

In the measurement control information, it is indicated to the UE that event-triggered reporting with Event A3 is used. The test consists of two successive time periods, with time duration of T1, and T2 respectively. During time duration T1, the UE shall not have any timing information of NR cell 3.

The configuration of LTE cell 1 is defined in table A.3.7.2.1-1. Supported test configurations are shown in table A.4.6.2.2.1-1.

UE needs to be provided at least once every 500ms with new Timing Advance Command MAC control element to restart the Time alignment timer to keep UE uplink time alignment. Furthermore UE is allocated with PUSCH resource at every DRX cycle.

Table A.4.6.2.2.1-1: EN-DC event triggered reporting tests without SSB index reading for FR1-FR1

Config	Description
1	LTE FDD, NR 15 kHz SSB SCS, 10MHz bandwidth, FDD duplex mode
2	LTE FDD, NR 15 kHz SSB SCS, 10MHz bandwidth, TDD duplex mode
3	LTE FDD, NR 30kHz SSB SCS, 40MHz bandwidth, TDD duplex mode
4	LTE TDD, NR 15 kHz SSB SCS, 10MHz bandwidth, FDD duplex mode
5	LTE TDD, NR 15 kHz SSB SCS, 10MHz bandwidth, TDD duplex mode
6	LTE TDD, NR 30kHz SSB SCS, 40MHz bandwidth, TDD duplex mode
Note 1:	The UE is only required to be tested in one of the supported test configurations
Note 2:	target NR cell3 has the same SCS, BW and duplex mode as NR serving cell2

Table A.4.6.2.2.1-2: General test parameters for EN-DC inter-frequency event triggered reporting without SSB time index detection

Parameter	Unit	Test configuration	Value				Comment
			Test 1	Test 2	Test 3	Test 4	
E-UTRA RF Channel Number		Config 1,2,3,4,5,6	1				One E-UTRAN TDD carrier frequencies is used.
NR RF Channel Number		Config 1,2,3,4,5,6	1, 2				Two FR1 NR carrier frequencies is used.
Active cell		Config 1,2,3,4,5,6	LTE Cell 1 (PCell) and NR cell 2 (PScell)				LTE Cell 1 is on E-UTRA RF channel number 1. NR Cell 2 is on NR RF channel number 1.
Neighbour cell		Config 1,2,3,4,5,6	NR cell 3				NR cell 3 is on NR RF channel number 2.
Gap Pattern Id		Config 1,2,3,4,5,6	0		4		As specified in clause 9.1.2-1.
Measurement gap offset		Config 1,2,3,4,5,6	39		19		
SMTC-SSB parameters		Config 1,4	SSB.1 FR1				As specified in clause A.3.10.1
		Config 2,5	SSB.1 FR1				As specified in clause A.3.10.1
		Config 3,6	SSB.2 FR1				As specified in clause A.3.10.1
A3-Offset	dB	Config 1,2,3,4,5,6	-6				
Hysteresis	dB	Config 1,2,3,4,5,6	0				
CP length		Config 1,2,3,4,5,6	Normal				
TimeToTrigger	s	Config 1,2,3,4,5,6	0				
Filter coefficient		Config 1,2,3,4,5,6	0				L3 filtering is not used
DRX	ms	Config 1,2,3,4,5,6	DRX .1	DRX .2	DRX .1	DRX .2	DRX is used

Time offset between PCell and PSCell		Config 1,2,3,4,5,6	3 μ s				Synchronous EN-DC
Time offset between serving and neighbour cells		Config 1,4	3ms				Asynchronous cells. The timing of Cell 3 is 3ms later than the timing of Cell 2.
		Config 2,3,5,6	3 μ s				Synchronous cells.
T1	s	Config 1,2,3,4,5,6	5				
T2	s	Config 1,2,3,4,5,6	TBD	TBD	TBD	TBD	

Table A.4.6.2.2.1-3: Cell specific test parameters for EN-DC inter-frequency event triggered reporting without SSB time index detection

Parameter	Unit	Test configuration	Cell 2		Cell 3	
			T1	T2	T1	T2
NR RF Channel Number		Config 1,2,3,4,5,6	1		2	
Duplex mode		Config 1,4	FDD			
		Config 2,3,5,6	TDD			
BW _{channel}	MHz	Config 1,4	10: N _{RB,c} = 52			
		Config 2,5	10: N _{RB,c} = 52			
		Config 3,6	40: N _{RB,c} = 106			
BWP BW	MHz	Config 1,4	10: N _{RB,c} = 52			
		Config 2,5	10: N _{RB,c} = 52			
		Config 3,6	40: N _{RB,c} = 106			
TDD configuration		Config 2,5	TDDConf.1.1		TDDConf.1.1	
		Config 3,6	TDDConf.2.1		TDDConf.2.1	
Initial DL BWP		Config 1,2,3,4,5,6	DLBWP.0.1		NA	
Initial UL BWP		Config 1,2,3,4,5,6	ULBWP.0.1		NA	
Dedicated DL BWP		Config 1,2,3,4,5,6	DLBWP.1.1		NA	
Dedicated UL BWP		Config 1,2,3,4,5,6	ULBWP.1.1		NA	
OCNG Patterns defined in A.3.2.1.1 (OP.1)		Config 1,2,3,4,5,6	OP.1		OP.1	
PDSCH Reference measurement channel		Config 1,4	SR.1.1 FDD		-	
		Config 2,5	SR.1.1 TDD			
		Config 3,6	SR2.1 TDD			
CORESET Reference Channel		Config 1,4	CR.1.1 FDD		-	
		Config 2,5	CR.1.1 TDD			
		Config 3,6	CR2.1 TDD			
SMTC configuration defined in A.3.11.1 and A.3.11.2		Config 1,4	SMTC.2			
		Config 2,3,5,6	SMTC.1			
PDSCH/PDCCH subcarrier spacing	kHz	Config 1,2,4,5	15			
		Config 3,6	30			

EPRE ratio of PSS to SSS		Config 1,2,3,4,5,6	0	0		
EPRE ratio of PBCH DMRS to SSS						
EPRE ratio of PBCH to PBCH DMRS						
EPRE ratio of PDCCH DMRS to SSS						
EPRE ratio of PDCCH to PDCCH DMRS						
EPRE ratio of PDSCH DMRS to SSS						
EPRE ratio of PDSCH to PDSCH						
EPRE ratio of OCNG DMRS to SSS(Note 1)						
EPRE ratio of OCNG to OCNG DMRS (Note 1)						
N_{oc}^{Note2}	dBm/15 kHz		-98			
N_{oc}^{Note2}	dBm/S CS	Config 1,2,4,5	-98			
		Config 3,6	-95			
SS-RSRP ^{Note 3}	dBm/S CS	Config 1,2,4,5	-94	-94	-Infinity	-91
		Config 3,6	-91	-91	-Infinity	-88
\hat{E}_s / I_{ot}	dB	Config 1,2,3,4,5,6	4	4	-Infinity	7
\hat{E}_s / N_{oc}	dB	Config 1,2,3,4,5,6	4	4	-Infinity	7
I_o^{Note3}	dBm/9.36MHz	Config 1,2,4,5	-67.11	-67.11	-Infinity	-65.38
	dBm/38.16MHz	Config 3,6	-62.27	-62.27	-Infinity	-61.06
Propagation Condition		Config 1,2,3,4,5,6	AWGN			
<p>Note 1: OCNG shall be used such that both cells are fully allocated and a constant total transmitted power spectral density is achieved for all OFDM symbols.</p> <p>Note 2: Interference from other cells and noise sources not specified in the test is assumed to be constant over subcarriers and time and shall be modelled as AWGN of appropriate power for N_{oc} to be fulfilled.</p> <p>Note 3: SS-RSRP and I_o levels have been derived from other parameters for information purposes. They are not settable parameters themselves.</p> <p>Note 4: SS-RSRP minimum requirements are specified assuming independent interference and noise at each receiver antenna port.</p>						

A.4.6.2.2.2 Test Requirements

In test 1 with per-UE gap, the UE shall send one Event A3 triggered measurement report, with a measurement reporting delay less than [TBD] ms from the beginning of time period T2. The UE shall not send event triggered measurement reports, as long as the reporting criteria are not fulfilled. The rate of correct events observed during repeated tests shall be at least 90%.

In test 2 with per-FR gap, the UE shall send one Event A3 triggered measurement report, with a measurement reporting delay less than [TBD] ms from the beginning of time period T2. The UE shall not send event triggered measurement reports, as long as the reporting criteria are not fulfilled. The rate of correct events observed during repeated tests shall be at least 90%.

In test 3 with per-UE gap, the UE shall send one Event A3 triggered measurement report, with a measurement reporting delay less than [TBD] ms from the beginning of time period T2. The UE shall not send event triggered measurement reports, as long as the reporting criteria are not fulfilled. The rate of correct events observed during repeated tests shall be at least 90%.

In test 4 with per-FR gap, the UE shall send one Event A3 triggered measurement report, with a measurement reporting delay less than [TBD] ms from the beginning of time period T2. The UE shall not send event triggered measurement reports, as long as the reporting criteria are not fulfilled. The rate of correct events observed during repeated tests shall be at least 90%.

In test 1, 2, 3 and 4 UE is not required to report SSB time index.

NOTE: The actual overall delays measured in the test may be up to $2xTTI_{DCCCH}$ higher than the measurement reporting delays above because of TTI insertion uncertainty of the measurement report in DCCCH.

A.4.6.2.3 Void

A.4.6.2.4 Void

A.4.6.2.5 EN-DC event triggered reporting tests for FR1 cell with SSB time index detection when DRX is not used

A.4.6.2.5.1 Test Purpose and Environment

The purpose of this test is to verify that the UE makes correct reporting of an event. This test will partly verify the EN-DC inter-frequency NR cell search requirements in clause 9.3.4.

In this test, there are three cells: LTE cell 1 as PCell on E-UTRA RF channel 1, NR cell 2 as PSCell in FR1 on NR RF channel 1 and NR cell 3 as neighbour cell in FR1 on NR RF channel 2. The test parameters and configurations are given in Tables A.4.6.2.5.1-1, A.4.6.2.5.1-2, and A.4.6.2.5.1-3.

In test 1 measurement gap pattern configuration # 0 as defined in Table A.4.6.2.5.1-2 is provided for a UE that does not support per-FR gap and in test 2 measurement gap pattern configuration #4 as defined in Table A.4.6.2.5.1-2 is provided for UE that support per-FR gap.

In the measurement control information, it is indicated to the UE that event-triggered reporting with Event A3 is used. The test consists of two successive time periods, with time duration of T1, and T2 respectively. During time duration T1, the UE shall not have any timing information of NR cell 3.

The configuration of LTE cell 1 is defined in table A.3.7.2.1-1. Supported test configurations are shown in table A.4.6.2.5.1-1.

Table A.4.6.2.5.1-1: EN-DC event triggered reporting tests without SSB index reading for FR1-FR1

Config	Description
1	LTE FDD, NR 15 kHz SSB SCS, 10MHz bandwidth, FDD duplex mode
2	LTE FDD, NR 15 kHz SSB SCS, 10MHz bandwidth, TDD duplex mode
3	LTE FDD, NR 30kHz SSB SCS, 40MHz bandwidth, TDD duplex mode
4	LTE TDD, NR 15 kHz SSB SCS, 10MHz bandwidth, FDD duplex mode
5	LTE TDD, NR 15 kHz SSB SCS, 10MHz bandwidth, TDD duplex mode
6	LTE TDD, NR 30kHz SSB SCS, 40MHz bandwidth, TDD duplex mode
Note 1:	The UE is only required to be tested in one of the supported test configurations
Note 2:	target NR cell3 has the same SCS, BW and duplex mode as NR serving cell2

Table A.4.6.2.5.1-2: General test parameters for EN-DC inter-frequency event triggered reporting with SSB time index detection

Parameter	Unit	Test configuration	Value		Comment
			Test 1	Test 2	
E-UTRA RF Channel Number		Config 1,2,3,4,5,6	1		One E-UTRAN TDD carrier frequencies is used.
NR RF Channel Number		Config 1,2,3,4,5,6	1, 2		Two FR1 NR carrier frequencies is used.
Active cell		Config 1,2,3,4,5,6	LTE Cell 1 (PCell) and NR cell 2 (PScell)		LTE Cell 1 is on E-UTRA RF channel number 1. NR Cell 2 is on NR RF channel number 1.
Neighbour cell		Config 1,2,3,4,5,6	NR cell 3		NR cell 3 is on NR RF channel number 2.
Gap Pattern Id		Config 1,2,3,4,5,6	0	4	As specified in clause 9.1.2-1.
Measurement gap offset		Config 1,2,3,4,5,6	39	19	
SMTC-SSB parameters		Config 1,4	SSB.1 FR1		As specified in clause A.3.10.1
		Config 2,5	SSB.1 FR1		As specified in clause A.3.10.1
		Config 3,6	SSB.2 FR1		As specified in clause A.3.10.1
A3-Offset	dB	Config 1,2,3,4,5,6	-6		
Hysteresis	dB	Config 1,2,3,4,5,6	0		
CP length		Config 1,2,3,4,5,6	Normal		
TimeToTrigger	s	Config 1,2,3,4,5,6	0		
Filter coefficient		Config 1,2,3,4,5,6	0		L3 filtering is not used
DRX		Config 1,2,3,4,5,6	OFF		DRX is not used
Time offset between PCell and PScell		Config 1,2,3,4,5,6	3 μ s		Synchronous EN-DC
Time offset between serving and neighbour cells		Config 1,4	3ms		Asynchronous cells. The timing of Cell 3 is 3ms later than the timing of Cell 2.
		Config 2,3,5,6	3 μ s		Synchronous cells.
T1	s	Config 1,2,3,4,5,6	5		
T2	s	Config 1,2,3,4,5,6	TBD	TBD	

Table A.4.6.2.5.1-3: Cell specific test parameters for EN-DC inter-frequency event triggered reporting with SSB time index detection

Parameter	Unit	Test configuration	Cell 2		Cell 3	
			T1	T2	T1	T2
NR RF Channel Number		Config 1,2,3,4,5,6	1		2	

Duplex mode		Config 1,4	FDD	
		Config 2,3,5,6	TDD	
BW _{channel}	MHz	Config 1,4	10: N _{RB,c} = 52	
		Config 2,5	10: N _{RB,c} = 52	
		Config 3,6	40: N _{RB,c} = 106	
BWP BW	MHz	Config 1,4	10: N _{RB,c} = 52	
		Config 2,5	10: N _{RB,c} = 52	
		Config 3,6	40: N _{RB,c} = 106	
TDD configuration		Config 2,5	TDDConf.1.1	TDDConf.1.1
		Config 3,6	TDDConf.2.1	TDDConf.2.1
Initial DL BWP		Config 1,2,3,4,5,6	DLBWP.0.1	NA
Initial UL BWP		Config 1,2,3,4,5,6	ULBWP.0.1	NA
Dedicated DL BWP		Config 1,2,3,4,5,6	DLBWP.1.1	NA
Dedicated UL BWP		Config 1,2,3,4,5,6	ULBWP.1.1	NA
OCNG Patterns defined in A.3.2.1.1 (OP.1)		Config 1,2,3,4,5,6	OP.1	OP.1
PDSCH Reference measurement channel		Config 1,4	SR.1.1 FDD	-
		Config 2,5	SR.1.1 TDD	
		Config 3,6	SR2.1 TDD	
CORESET Reference Channel		Config 1,4	CR.1.1 FDD	-
		Config 2,5	CR.1.1 TDD	
		Config 3,6	CR2.1 TDD	
SMTC configuration defined in A.3.2.11.1 and A.3.2.11.2		Config 1,4	SMTC.2	
		Config 2,3,5,6	SMTC.1	
PDSCH/PDCCH subcarrier spacing	kHz	Config 1,2,4,5	15	
		Config 3,6	30	
EPRE ratio of PSS to SSS		Config 1,2,3,4,5,6	0	0
EPRE ratio of PBCH DMRS to SSS				
EPRE ratio of PBCH to PBCH DMRS				
EPRE ratio of PDCCH DMRS to SSS				
EPRE ratio of PDCCH to PDCCH DMRS				
EPRE ratio of PDSCH DMRS to SSS				
EPRE ratio of PDSCH to PDSCH				
EPRE ratio of OCNG DMRS to SSS(Note 1)				
EPRE ratio of OCNG to OCNG DMRS (Note 1)				
N_{oc}^{Note2}	dBm/15 kHz			
N_{oc}^{Note2}	dBm/S CS	Config 1,2,4,5	-98	
		Config 3,6	-95	

SS-RSRP ^{Note 3}	dBm/S CS	Config 1,2,4,5	-94	-94	-Infinity	-91
		Config 3,6	-91	-91	-Infinity	-88
\hat{E}_s / I_{ot}	dB	Config 1,2,3,4,5,6	4	4	-Infinity	7
\hat{E}_s / N_{oc}	dB	Config 1,2,3,4,5,6	4	4	-Infinity	7
I _o ^{Note3}	dBm/9. 36MHz	Config 1,2,4,5	-67.11	-67.11	-Infinity	-65.38
	dBm/38 .16MHz	Config 3,6	-62.27	-62.27	-Infinity	-61.06
Propagation Condition		Config 1,2,3,4,5,6	AWGN			
<p>Note 1: OCNG shall be used such that both cells are fully allocated and a constant total transmitted power spectral density is achieved for all OFDM symbols.</p> <p>Note 2: Interference from other cells and noise sources not specified in the test is assumed to be constant over subcarriers and time and shall be modelled as AWGN of appropriate power for N_{oc} to be fulfilled.</p> <p>Note 3: SS-RSRP and I_o levels have been derived from other parameters for information purposes. They are not settable parameters themselves.</p> <p>Note 4: SS-RSRP minimum requirements are specified assuming independent interference and noise at each receiver antenna port.</p>						

A.4.6.2.5.2 Test Requirements

In test 1 with per-UE gap, the UE shall send one Event A3 triggered measurement report, with a measurement reporting delay less than [TBD] ms from the beginning of time period T2. The UE shall not send event triggered measurement reports, as long as the reporting criteria are not fulfilled. The rate of correct events observed during repeated tests shall be at least 90%.

In test 2 with per-FR gap, the UE shall send one Event A3 triggered measurement report, with a measurement reporting delay less than [TBD] ms from the beginning of time period T2. The UE shall not send event triggered measurement reports, as long as the reporting criteria are not fulfilled. The rate of correct events observed during repeated tests shall be at least 90%.

In test 1 and 2 UE is required to report SSB time index.

NOTE: The actual overall delays measured in the test may be up to $2 \times TTI_{DCC}$ higher than the measurement reporting delays above because of TTI insertion uncertainty of the measurement report in DCC.

A.4.6.2.6 EN-DC event triggered reporting tests for FR1 cell with SSB time index detection when DRX is used

A.4.6.2.6.1 Test Purpose and Environment

The purpose of this test is to verify that the UE makes correct reporting of an event. This test will partly verify the EN-DC inter-frequency NR cell search requirements in clause 9.3.4.

In this test, there are three cells: LTE cell 1 as PCell on E-UTRA RF channel 1, NR cell 2 as PSCell in FR1 on NR RF channel 1 and NR cell 3 as neighbour cell in FR1 on NR RF channel 2. The test parameters and configurations are given in Tables A.4.6.2.6.1-1, A.4.6.2.6.1-2, and A.4.6.2.6.1-3.

In test 1&2 measurement gap pattern configuration # 0 as defined in Table A.4.6.2.6.1-2 is provided for a UE that does not support per-FR gap and in test 3&4 measurement gap pattern configuration #4 as defined in Table A.4.6.2.6.1-2 is provided for UE that support per-FR gap.

In the measurement control information, it is indicated to the UE that event-triggered reporting with Event A3 is used. The test consists of two successive time periods, with time duration of T1, and T2 respectively. During time duration T1, the UE shall not have any timing information of NR cell 3.

The configuration of LTE cell 1 is defined in table A.3.7.2.1-1. Supported test configurations are shown in table A.4.6.2.6.1-1.

UE needs to be provided at least once every 500ms with new Timing Advance Command MAC control element to restart the Time alignment timer to keep UE uplink time alignment. Furthermore UE is allocated with PUSCH resource at every DRX cycle.

Table A.4.6.2.6.1-1: EN-DC event triggered reporting tests without SSB index reading for FR1-FR1

Config	Description
1	LTE FDD, NR 15 kHz SSB SCS, 10MHz bandwidth, FDD duplex mode
2	LTE FDD, NR 15 kHz SSB SCS, 10MHz bandwidth, TDD duplex mode
3	LTE FDD, NR 30kHz SSB SCS, 40MHz bandwidth, TDD duplex mode
4	LTE TDD, NR 15 kHz SSB SCS, 10MHz bandwidth, FDD duplex mode
5	LTE TDD, NR 15 kHz SSB SCS, 10MHz bandwidth, TDD duplex mode
6	LTE TDD, NR 30kHz SSB SCS, 40MHz bandwidth, TDD duplex mode

Note 1: The UE is only required to be tested in one of the supported test configurations
Note 2: target NR cell3 has the same SCS, BW and duplex mode as NR serving cell2

Table A.4.6.2.6.1-2: General test parameters for EN-DC inter-frequency event triggered reporting with SSB time index detection

Parameter	Unit	Test configuration	Value				Comment
			Test 1	Test 2	Test 3	Test 4	
E-UTRA RF Channel Number		Config 1,2,3,4,5,6	1				One E-UTRAN TDD carrier frequencies is used.
NR RF Channel Number		Config 1,2,3,4,5,6	1, 2				Two FR1 NR carrier frequencies is used.
Active cell		Config 1,2,3,4,5,6	LTE Cell 1 (PCell) and NR cell 2 (PScell)				LTE Cell 1 is on E-UTRA RF channel number 1. NR Cell 2 is on NR RF channel number 1.
Neighbour cell		Config 1,2,3,4,5,6	NR cell 3				NR cell 3 is on NR RF channel number 2.
Gap Pattern Id		Config 1,2,3,4,5,6	0		4		As specified in clause 9.1.2-1.
Measurement gap offset		Config 1,2,3,4,5,6	39		19		
SMTC-SSB parameters		Config 1,4	SSB.1 FR1				As specified in clause A.3.10.1
		Config 2,5	SSB.1 FR1				As specified in clause A.3.10.1
		Config 3,6	SSB.2 FR1				As specified in clause A.3.10.1
A3-Offset	dB	Config 1,2,3,4,5,6	-6				
Hysteresis	dB	Config 1,2,3,4,5,6	0				
CP length		Config 1,2,3,4,5,6	Normal				
TimeToTrigger	s	Config 1,2,3,4,5,6	0				

Filter coefficient		Config 1,2,3,4,5,6	0				L3 filtering is not used
DRX	ms	Config 1,2,3,4,5,6	DRX .1	DRX .2	DRX .1	DRX .2	DRX is used
Time offset between PCell and PSCell		Config 1,2,3,4,5,6	3 μ s				Synchronous EN-DC
Time offset between serving and neighbour cells		Config 1,4	3ms				Asynchronous cells. The timing of Cell 3 is 3ms later than the timing of Cell 2.
		Config 2,3,5,6	3 μ s				Synchronous cells.
T1	s	Config 1,2,3,4,5,6	5				
T2	s	Config 1,2,3,4,5,6	TBD	TBD	TBD	TBD	

Table A.4.6.2.6.1-3: Cell specific test parameters for EN-DC inter-frequency event triggered reporting with SSB time index detection

Parameter	Unit	Test configuration	Cell 2		Cell 3	
			T1	T2	T1	T2
NR RF Channel Number		Config 1,2,3,4,5,6	1		2	
Duplex mode		Config 1,4	FDD			
		Config 2,3,5,6	TDD			
BW _{channel}	MHz	Config 1,4	10: N _{RB,c} = 52			
		Config 2,5	10: N _{RB,c} = 52			
		Config 3,6	40: N _{RB,c} = 106			
BWP BW	MHz	Config 1,4	10: N _{RB,c} = 52			
		Config 2,5	10: N _{RB,c} = 52			
		Config 3,6	40: N _{RB,c} = 106			
OCNG Patterns defined in A.3.2.1.1 (OP.1)		Config 1,2,3,4,5,6	OP.1		OP.1	
PDSCH Reference measurement channel		Config 1,4	SR.1.1 FDD		-	
		Config 2,5	SR.1.1 TDD			
		Config 3,6	SR2.1 TDD			
CORESET Reference Channel		Config 1,4	CR.1.1 FDD		-	
		Config 2,5	CR.1.1 TDD			
		Config 3,6	CR2.1 TDD			
TDD configuration		Config 2,5	TDDConf.1.1			
		Config 3,6	TDDConf.2.1			
Initial DL BWP		Config 1,2,3,4,5,6	DLBWP.0.1			
Initial UL BWP		Config 1,2,3,4,5,6	ULBWP.0.1			
Dedicated DL BWP		Config 1,2,3,4,5,6	DLBWP.1.1			
Dedicated UL BWP		Config 1,2,3,4,5,6	ULBWP.1.1			
SMTC configuration defined in A.3.11.1 and A.3.11.2		Config 1,4	SMTC.2			

		Config 2,3,5,6	SMTC.1			
PDSCH/PDCCH subcarrier spacing	kHz	Config 1,2,4,5	15			
		Config 3,6	30			
EPRE ratio of PSS to SSS		Config 1,2,3,4,5,6	0	0	0	0
EPRE ratio of PBCH DMRS to SSS						
EPRE ratio of PBCH to PBCH DMRS						
EPRE ratio of PDCCH DMRS to SSS						
EPRE ratio of PDCCH to PDCCH DMRS						
EPRE ratio of PDSCH DMRS to SSS						
EPRE ratio of PDSCH to PDSCH						
EPRE ratio of OCNG DMRS to SSS(Note 1)						
EPRE ratio of OCNG to OCNG DMRS (Note 1)						
N_{oc} Note2	dBm/15 kHz		-98			
N_{oc} Note2	dBm/S CS	Config 1,2,4,5	-98			
		Config 3,6	-95			
SS-RSRP Note 3	dBm/S CS	Config 1,2,4,5	-94	-94	-Infinity	-91
		Config 3,6	-91	-91	-Infinity	-88
\hat{E}_s / I_{ot}	dB	Config 1,2,3,4,5,6	4	4	-Infinity	7
\hat{E}_s / N_{oc}	dB	Config 1,2,3,4,5,6	4	4	-Infinity	7
I_o Note3	dBm/9.36MHz	Config 1,2,4,5	-67.11	-67.11	-Infinity	-65.38
	dBm/38.16MHz	Config 3,6	-62.27	-62.27	-Infinity	-61.06
Propagation Condition		Config 1,2,3,4,5,6	AWGN			
<p>Note 1: OCNG shall be used such that both cells are fully allocated and a constant total transmitted power spectral density is achieved for all OFDM symbols.</p> <p>Note 2: Interference from other cells and noise sources not specified in the test is assumed to be constant over subcarriers and time and shall be modelled as AWGN of appropriate power for N_{oc} to be fulfilled.</p> <p>Note 3: SS-RSRP and I_o levels have been derived from other parameters for information purposes. They are not settable parameters themselves.</p> <p>Note 4: SS-RSRP minimum requirements are specified assuming independent interference and noise at each receiver antenna port.</p>						

A.4.6.2.6.2 Test Requirements

In test 1 with per-UE gap, the UE shall send one Event A3 triggered measurement report, with a measurement reporting delay less than [TBD] ms from the beginning of time period T2. The UE shall not send event triggered measurement reports, as long as the reporting criteria are not fulfilled. The rate of correct events observed during repeated tests shall be at least 90%.

In test 2 with per-FR gap, the UE shall send one Event A3 triggered measurement report, with a measurement reporting delay less than [TBD] ms from the beginning of time period T2. The UE shall not send event triggered measurement reports, as long as the reporting criteria are not fulfilled. The rate of correct events observed during repeated tests shall be at least 90%.

In test 3 with per-UE gap, the UE shall send one Event A3 triggered measurement report, with a measurement reporting delay less than [TBD] ms from the beginning of time period T2. The UE shall not send event triggered measurement reports, as long as the reporting criteria are not fulfilled. The rate of correct events observed during repeated tests shall be at least 90%.

In test 4 with per-FR gap, the UE shall send one Event A3 triggered measurement report, with a measurement reporting delay less than [TBD] ms from the beginning of time period T2. The UE shall not send event triggered measurement reports, as long as the reporting criteria are not fulfilled. The rate of correct events observed during repeated tests shall be at least 90%.

In test 1, 2, 3 and 4 UE is required to report SSB time index.

NOTE: The actual overall delays measured in the test may be up to $2xTTI_{DCCCH}$ higher than the measurement reporting delays above because of TTI insertion uncertainty of the measurement report in DCCCH.

A.4.6.2.7 Void

A.4.6.2.8 Void

A.4.7 Measurement Performance requirements

A.4.7.1 SS-RSRP

A.4.7.1.1 EN-DC Intra-frequency measurement accuracy with FR1 serving cell and FR1 target cell

A.4.7.1.1.1 Test Purpose and Environment

The purpose of this test is to verify that the SS-RSRP measurement accuracy is within the specified limits. This test will verify the requirements in Sections 10.1.2.1.1 and 10.1.2.1.2 for intra frequency measurements.

A.4.7.1.1.2 Test parameters

In this set of test cases all NR cells are on the same carrier frequency. Supported test configurations are shown in table A.4.7.1.1.2-1. Both absolute and relative accuracy of SS-RSRP intra frequency measurements are tested by using the parameters in A.4.7.1.1.2-2. The configuration of cell 1 (E-UTRA PCell) is specified in section A.3.7.2.1. In all test cases, Cell 2 is the PSCell, and Cell 3 the target cell.

Table A.4.7.1.1.2-1: SS-RSRP Intra frequency SS-RSRP supported test configurations

Config	Description
1	NR 15 kHz SSB SCS, 10MHz bandwidth, FDD duplex mode
2	NR 15 kHz SSB SCS, 10MHz bandwidth, TDD duplex mode
3	NR 30kHz SSB SCS, 40MHz bandwidth, TDD duplex mode
4	LTE TDD, NR 15 kHz SSB SCS, 10MHz bandwidth, FDD duplex mode
5	LTE TDD, NR 15 kHz SSB SCS, 10MHz bandwidth, TDD duplex mode
6	LTE TDD, NR 30kHz SSB SCS, 40MHz bandwidth, TDD duplex mode

Note: The UE is only required to be tested in one of the supported test configurations

Table A.4.7.1.1.2-2: SS-RSRP Intra frequency test parameters

Parameter		Unit	Test 1		Test 2		Test 3	
			Cell 2	Cell 3	Cell 2	Cell 3	Cell 2	Cell 3
SSB ARFCN			freq1		freq1		freq1	
Duplex mode	Config 1,4		FDD					
	Config 2,3,5,6		TDD					
TDD configuration	Config 1,4		Not Applicable					
	Config 2,5		TDDConf.1.1					
	Config 3,6		TDDConf.2.1					
BW _{channel}	Config 1,4	MHz	10: N _{RB,c} = 52					
	Config 2,5		10: N _{RB,c} = 52					
	Config 3,6		40: N _{RB,c} = 106					
Downlink initial BWP configuration			DLBWP.0.1					
Downlink dedicated BWP configuration			DLBWP.1.1					
Uplink initial BWP configuration			ULBWP.0.1					
Uplink dedicated BWP configuration			ULBWP.1.1					
DRX Cycle		ms	Not Applicable					
PDSCH Reference measurement channel	Config 1,4		SR.1.1 FDD		SR.1.1 FDD		SR.1.1 FDD	
	Config 2,5		SR.1.1 TDD	-	SR.1.1 TDD	-	SR.1.1 TDD	-
	Config 3,6		SR2.1 TDD		SR2.1 TDD		SR2.1 TDD	
RMSI CORESET Reference Channel	Config 1,4		CR.1.1 FDD		CR.1.1 FDD		CR.1.1 FDD	
	Config 2,5		CR.1.1 TDD	-	CR.1.1 TDD	-	CR.1.1 TDD	-
	Config 3,6		CR2.1 TDD		CR2.1 TDD		CR2.1 TDD	
Control Channel RMC	Config 1,4		CCR.1.1 FDD		CCR.1.1 FDD		CCR.1.1 FDD	
	Config 2,5		CCR.1.1 TDD	-	CCR.1.1 TDD	-	CCR.1.1 TDD	-
	Config 3,6		CCR2.1 TDD		CCR2.1 TDD		CCR2.1 TDD	
SSB configuration	Config 1,4		SSB 1 FR1		SSB 1 FR1		SSB 1 FR1	
	Config 2,5		SSB 1 FR1	-	SSB 1 FR1	-	SSB 1 FR1	-
	Config 3,6		SSB 2 FR1		SSB 2 FR1		SSB 2 FR1	
SMTC configuration			SMTC.1					
OCNG Patterns			OP.1					
PDSCH/PDCCH subcarrier spacing	Config 1,2,4,5	kHz	15 kHz					
	Config 3,6		30kHz					
EPRE ratio of PSS to SSS		dB	0	0	0	0	0	0
EPRE ratio of PBCH DMRS to SSS								
EPRE ratio of PBCH to PBCH DMRS								
EPRE ratio of PDCCH DMRS to SSS								
EPRE ratio of PDCCH to PDCCH DMRS								
EPRE ratio of PDSCH DMRS to SSS								
EPRE ratio of PDSCH to PDSCH								
EPRE ratio of OCNG DMRS to SSS(Note 1)								
EPRE ratio of OCNG to OCNG DMRS (Note 1)								
N _{oc} ^{Note2}	Config 1,2,4,5							
		NR_FDD_FR1_B	-115.5					
		NR_TDD_FR1_C	-115					
		NR_FDD_FR1_D, NR_TDD_FR1_D	-114.5					
		NR_FDD_FR1_E, NR_TDD_FR1_E	-114					
		NR_FDD_FR1_G	-113					
		NR_FDD_FR1_H	-112.5					
		NR_TDD_FR1_A	-112.5					
	Config 3,6	-113	-94	-116				

		NR_FDD_FR1_B							-115.5		
		NR_TDD_FR1_C							-115		
		NR_FDD_FR1_D, NR_TDD_FR1_D							-114.5		
		NR_FDD_FR1_E, NR_TDD_FR1_E							-114		
		NR_FDD_FR1_G							-113		
		NR_FDD_FR1_H							-112.5		
N_{oc} ^{Note2}	Config 1,2,4,5		dBm/SCS	-106		-88		Same as Noc/15kHz			
	Config 3,6	NR_FDD_FR1_A, NR_TDD_FR1_A		-110		-91		-113			
		NR_FDD_FR1_B						-112.5			
		NR_TDD_FR1_C						-112			
		NR_FDD_FR1_D, NR_TDD_FR1_D						-111.5			
		NR_FDD_FR1_E, NR_TDD_FR1_E						-111			
		NR_FDD_FR1_G						-110			
	NR_FDD_FR1_H	-109.5									
\hat{E}_s/I_{ot}			dB	2.5	-6	2.5	-6	0.46	-5.76		
\hat{E}_s/N_{oc}			dB	6	1	6	1	3	-1		
SS- RSRP ^{Note3}	Config 1,2,4,5	NR_FDD_FR1_A, NR_TDD_FR1_A	dBm/SCS	-100	-105	-82	-87	-113	-117		
		NR_FDD_FR1_B						-112.5	-116.5		
		NR_TDD_FR1_C						-112	-116		
		NR_FDD_FR1_D, NR_TDD_FR1_D						-111.5	-115.5		
		NR_FDD_FR1_E, NR_TDD_FR1_E						-111	-115		
		NR_FDD_FR1_G						-110	-114		
	NR_FDD_FR1_H	-109.5		-113.5							
	Config 3,6	NR_FDD_FR1_A, NR_TDD_FR1_A		-106	-109	-85	-90	-110	-114		
		NR_FDD_FR1_B						-109.5	-113.5		
		NR_TDD_FR1_C						109	-113		
		NR_FDD_FR1_D, NR_TDD_FR1_D						-108.55	-112.5		
		NR_FDD_FR1_E, NR_TDD_FR1_E						-108	-112		
		NR_FDD_FR1_G						-107	-111		
	NR_FDD_FR1_H	-106.5		-110.5							
	I_0 ^{Note3}	Config 1,2,4,5		NR_FDD_FR1_A, NR_TDD_FR1_A	dBm/ 9.36MHz	-70.09		-52.09		-82.26	
				NR_FDD_FR1_B						-81.76	
NR_TDD_FR1_C			-81.26								
NR_FDD_FR1_D, NR_TDD_FR1_D			-80.76								
NR_FDD_FR1_E, NR_TDD_FR1_E			-80.26								
NR_FDD_FR1_G			-79.26								
NR_FDD_FR1_H			-78.76								
Config 3,6		NR_FDD_FR1_A, NR_TDD_FR1_A	dBm/ 38.16MHz	-70.99		-51.99		-76.16			
		NR_FDD_FR1_B						-75.66			
		NR_TDD_FR1_C						-75.16			
		NR_FDD_FR1_D, NR_TDD_FR1_D						-74.66			
		NR_FDD_FR1_E, NR_TDD_FR1_E						-74.16			
		NR_FDD_FR1_G						-73.16			
		NR_FDD_FR1_H						-72.66			

Propagation condition	-	AWGN
Antenna configuration		1x2
Note 1:	OCNG shall be used such that both cells are fully allocated and a constant total transmitted power spectral density is achieved for all OFDM symbols.	
Note 2:	Interference from other cells and noise sources not specified in the test is assumed to be constant over subcarriers and time and shall be modelled as AWGN of appropriate power for N_{oc} to be fulfilled.	
Note 3:	SS-RSRP and I_0 levels have been derived from other parameters for information purposes. They are not settable parameters themselves.	
Note 4:	SS-RSRP minimum requirements are specified assuming independent interference and noise at each receiver antenna port.	

A.4.7.1.1.3 Test Requirements

The SS-RSRP measurement accuracy for cell 1 and cell 2 shall fulfil absolute requirement in section 10.1.2.1.1 and relative requirement in section 10.1.2.1.2.

A.4.7.1.2 EN-DC inter-frequency measurement accuracy with FR1 serving cell and FR1 target cell

A.4.7.1.2.1 Test Purpose and Environment

The purpose of this test is to verify that the SS-RSRP measurement accuracy is within the specified limits. This test will verify the requirements in Sections 10.1.4.1.1 and 10.1.4.1.2 for inter-frequency measurements with the testing configurations in Table A.4.7.1.2.1-1.

Table A.4.7.1.2.1-1: Applicable NR configurations for FR1 inter-frequency SS-RSRP accuracy test

Config	Description
1	LTE FDD, NR 15 kHz SSB SCS, 10MHz bandwidth, FDD duplex mode
2	LTE FDD, NR 15 kHz SSB SCS, 10MHz bandwidth, TDD duplex mode
3	LTE FDD, NR 30kHz SSB SCS, 40MHz bandwidth, TDD duplex mode
4	LTE TDD, NR 15 kHz SSB SCS, 10MHz bandwidth, FDD duplex mode
5	LTE TDD, NR 15 kHz SSB SCS, 10MHz bandwidth, TDD duplex mode
6	LTE TDD, NR 30kHz SSB SCS, 40MHz bandwidth, TDD duplex mode
Note:	The UE is only required to be tested in one of the supported test configurations

A.4.7.1.2.2 Test parameters

In this set of test cases there are three cells in the test, E-UTRAN PCell (Cell 1), FR1 PSCell (Cell 2) and a FR1 neighbour cell (Cell 3) on a different frequency than the PSCell. The test parameters and applicability for Cell 1 are defined in A.3.7.2. The test parameters for the Cell 2 and Cell 3 are given in Table A.4.7.1.2.2-1 below. Both absolute and relative accuracy of RSRP intra frequency measurements are tested by using the parameters in Table A.4.7.1.2.2-1. The inter frequency measurements are supported by a measurement gap.

Table A.4.7.1.2.2-1: SS-RSRP inter-frequency test parameters

Parameter	Config	Unit	Test 1		Test 2		
			Cell 2	Cell 3	Cell 2	Cell 3	
SSB ARFCN	1~6		freq1	freq2	freq1	freq2	
BW _{channel}	1,4	MHz	10: N _{RB,c} = 52		10: N _{RB,c} = 52		
	2,5		10: N _{RB,c} = 52		10: N _{RB,c} = 52		
	3,6		40: N _{RB,c} = 106		40: N _{RB,c} = 106		
Duplex mode	1,4		FDD		FDD		
	2,5		TDD		TDD		
	3,6		TDD		TDD		
TDD configuration	1,4		N/A		N/A		
	2,5		TDDConf.1.1		TDDConf.1.1		
	3,6		TDDConf.2.1		TDDConf.2.1		
PDSCH Reference measurement channel	1,4		SR.1.1 FDD	-	SR.1.1 FDD	-	
	2,5		SR.1.1 TDD		SR.1.1 TDD		
	3,6		SR.2.1 FDD		SR.2.1 FDD		
RMSI CORESET Reference Channel	1,4		CR.1.1 FDD	-	CR.1.1 FDD	-	
	2,5		CR.1.1 TDD		CR.1.1 TDD		
	3,6		CR.2.1 FDD		CR.2.1 FDD		
Dedicated CORESET Reference Channel	1,4		CCR.1.1 FDD	-	CCR.1.1 FDD	-	
	2,5		CCR.1.1 TDD		CCR.1.1 TDD		
	3,6		CCR.2.1 TDD		CCR.2.1 TDD		
SSB configuration	1,4		SSB.1 FR1		SSB.1 FR1		
	2,5		SSB.1 FR1		SSB.1 FR1		
	3,6		SSB.2 FR1		SSB.2 FR1		
OCNG Patterns	1~6		OP.1		OP.1		
DL BWP	1~6		DLBWP.1.1		DLBWP.1.1		
UL BWP	1~6		ULBWP.1.1		ULBWP.1.1		
SMTC configuration	1~6		SMTC.1		SMTC.1		
EPRE ratio of PSS to SSS	1~6	dB	0	0	0	0	
EPRE ratio of PBCH DMRS to SSS							
EPRE ratio of PBCH to PBCH DMRS							
EPRE ratio of PDCCH DMRS to SSS							
EPRE ratio of PDCCH to PDCCH DMRS							
EPRE ratio of PDSCH DMRS to SSS							
EPRE ratio of PDSCH to PDSCH DMRS							
EPRE ratio of OCNG DMRS to SSS ^{Note 1}							
EPRE ratio of OCNG to OCNG DMRS ^{Note 1}							
N _{oc} ^{Note2}	1~6	dBm/15 kHz	-94.65		TBD	NR_FDD_FR1_A, NR_TDD_FR1_A	TBD
						NR_FDD_FR1_B	TBD
						NR_TDD_FR1_C	TBD
						NR_FDD_FR1_D, NR_TDD_FR1_D	TBD
						NR_FDD_FR1_E, NR_TDD_FR1_E	TBD
						NR_FDD_FR1_G	TBD
						NR_FDD_FR1_H	TBD

N_{oc} Note2	NR_FDD_FR1_A, NR_TDD_FR1_A	1,2,4,5	dBm/SS B SCS	-94.65		TBD	TBD	
	NR_FDD_FR1_B						TBD	
	NR_TDD_FR1_C						TBD	
	NR_FDD_FR1_D, NR_TDD_FR1_D						TBD	
	NR_FDD_FR1_E, NR_TDD_FR1_E						TBD	
	NR_FDD_FR1_G						TBD	
	NR_FDD_FR1_H						TBD	
	NR_FDD_FR1_A, NR_TDD_FR1_A	3,6		-91.65		TBD	TBD	
	NR_FDD_FR1_B						TBD	
	NR_TDD_FR1_C						TBD	
	NR_FDD_FR1_D, NR_TDD_FR1_D						TBD	
	NR_FDD_FR1_E, NR_TDD_FR1_E						TBD	
	NR_FDD_FR1_G						TBD	
	NR_FDD_FR1_H						TBD	
\hat{E}_s/I_{ot}		1~6	dB	10	10	TBD	TBD	
SS- RSRP Note3	NR_FDD_FR1_A, NR_TDD_FR1_A	1,2,4,5	dBm/SC S	-84.65		TBD	TBD	
	NR_FDD_FR1_B						TBD	
	NR_TDD_FR1_C						TBD	
	NR_FDD_FR1_D, NR_TDD_FR1_D						TBD	
	NR_FDD_FR1_E, NR_TDD_FR1_E						TBD	
	NR_FDD_FR1_G						TBD	
	NR_FDD_FR1_H						TBD	
	NR_FDD_FR1_A, NR_TDD_FR1_A	3,6		-81.65		TBD	TBD	
	NR_FDD_FR1_B						TBD	
	NR_TDD_FR1_C						TBD	
	NR_FDD_FR1_D, NR_TDD_FR1_D						TBD	
	NR_FDD_FR1_E, NR_TDD_FR1_E						TBD	
	NR_FDD_FR1_G						TBD	
	NR_FDD_FR1_H						TBD	
I_o Note3	NR_FDD_FR1_A, NR_TDD_FR1_A	1,2,4,5	dBm/ 9.36MH z	-56.28		TBD	TBD	
	NR_FDD_FR1_B						TBD	
	NR_TDD_FR1_C						TBD	
	NR_FDD_FR1_D, NR_TDD_FR1_D						TBD	
	NR_FDD_FR1_E, NR_TDD_FR1_E						TBD	
	NR_FDD_FR1_G						TBD	
	NR_FDD_FR1_H						TBD	
	NR_FDD_FR1_A, NR_TDD_FR1_A	3,6		dBm/ 38.16M Hz		-50.19	TBD	TBD
	NR_FDD_FR1_B							TBD
	NR_TDD_FR1_C							TBD
	NR_FDD_FR1_D, NR_TDD_FR1_D							TBD
	NR_FDD_FR1_E, NR_TDD_FR1_E							TBD
	NR_FDD_FR1_G							TBD
	NR_FDD_FR1_H							TBD

\hat{E}_s/N_{oc}	1~6	dB	10	10	TBD	TBD
Propagation condition	1~6	-	AWGN		AWGN	
Note 1:	OCNG shall be used such that both cells are fully allocated and a constant total transmitted power spectral density is achieved for all OFDM symbols.					
Note 2:	Interference from other cells and noise sources not specified in the test is assumed to be constant over subcarriers and time and shall be modelled as AWGN of appropriate power for N_{oc} to be fulfilled.					
Note 3:	RSRP and I_0 levels have been derived from other parameters for information purposes. They are not settable parameters themselves.					
Note 4:	RSRP minimum requirements are specified assuming independent interference and noise at each receiver antenna port.					

A.4.7.1.2.3 Test Requirements

The SS-RSRP measurement accuracy for Cell 2 and Cell 3 shall fulfil the Absolute requirement in section 10.1.4.1.1 and Relative requirement in section 10.1.4.1.2.

A.4.7.1.3 Void

A.4.7.2 SS-RSRQ

A.4.7.2.1 EN-DC Intra-frequency measurement accuracy with FR1 serving cell and FR1 target cell

A.4.7.2.1.1 Test Purpose and Environment

The purpose of this test is to verify that the SS-RSRQ measurement accuracy is within the specified limits. This test will verify the requirements in Clause 10.1.7.1.1.

A.4.7.2.1.2 Test Parameters

In this test case all cells are on the same carrier frequency. Supported test configuration are shown in Table A.4.7.2.1.2-1. The absolute accuracy of SS-RSRQ intra-frequency measurement is test by using the parameters in Table A.4.7.2.1.2-2. The configuration of cell 1 (E-UTRA PCell) is specified in section A.3.7.2.1. In all test cases, Cell 2 is the PCell and Cell 3 is the target cell.

Table A.4.7.2.1.2-1: SS-RSRQ Intra frequency SS-RSRQ supported test configurations

Config	Description
1	LTE FDD, NR 15 kHz SSB SCS, 10MHz bandwidth, FDD duplex mode
2	LTE FDD, NR 15 kHz SSB SCS, 10MHz bandwidth, TDD duplex mode
3	LTE FDD, NR 30kHz SSB SCS, 40MHz bandwidth, TDD duplex mode
4	LTE TDD, NR 15 kHz SSB SCS, 10MHz bandwidth, FDD duplex mode
5	LTE TDD, NR 15 kHz SSB SCS, 10MHz bandwidth, TDD duplex mode
6	LTE TDD, NR 30kHz SSB SCS, 40MHz bandwidth, TDD duplex mode

Note: The UE is only required to be tested in one of the supported test configurations

Table A.4.7.2.1.2-2: SS-RSRQ Intra frequency test parameters

Parameter	Unit	Test 1		Test 2		Test 3	
		Cell 2	Cell 3	Cell 2	Cell 3	Cell 2	Cell 3
SSB ARFCN		freq1		freq1		freq1	
Duplex mode	Config 1,4	FDD					
	Config 2,3,5,6	TDD					
TDD configuration	Config 1,4	Not Applicable					
	Config 2,5	TDDConf.1.1					

BW _{channel}	Config 3,6	MHz	TDDConf.2.1													
	Config 1,4		10: N _{RB,c} = 52													
	Config 2,5		10: N _{RB,c} = 52													
	Config 3,6		40: N _{RB,c} = 106													
BWP configuration	Initial DL BWP		DLBWP.0.1													
	Dedicated DL BWP		DLBWP.1.1													
	Initial UL BWP		ULBWP.0.1													
	Dedicated UL BWP		ULBWP.1.1													
DRX Cycle		ms	Not Applicable													
PDSCH Reference measurement channel	Config 1,4		SR.1.1 FDD	-	SR.1.1 FDD	-	SR.1.1 FDD	-								
	Config 2,5		SR.1.1 TDD		SR.1.1 TDD		SR.1.1 TDD									
	Config 3,6		SR2.1 TDD		SR2.1 TDD		SR2.1 TDD									
RMSI CORESET Reference Channel	Config 1,4		CR.1.1 FDD	-	CR.1.1 FDD	-	CR.1.1 FDD	-								
	Config 2,5		CR.1.1 TDD		CR.1.1 TDD		CR.1.1 TDD									
	Config 3,6		CR.2.1 TDD		CR.2.1 TDD		CR.2.1 TDD									
Control Channel RMC	Config 1,4		CCR.1.1 FDD	-	CCR.1.1 FDD	-	CCR.1.1 FDD	-								
	Config 2,5		CCR.1.1 TDD		CCR.1.1 TDD		CCR.1.1 TDD									
	Config 3,6		CCR.2.1 TDD		CCR.2.1 TDD		CCR.2.1 TDD									
OCNG Patterns			OP. 1													
SS-RSSI-Measurement			Not Applicable													
STMC configuration			SMTc.1													
SSB configuration	Config 1,2,4,5		SSB.1 FR1													
	Config 3,6		SSB.2 FR1													
PDSCH/PDCCH subcarrier spacing	Config 1,2,4,5	kHz	15 kHz													
	Config 3,6		30kHz													
EPRE ratio of PSS to SSS		dB	0	0	0	0	0	0								
EPRE ratio of PBCH DMRS to SSS																
EPRE ratio of PBCH to PBCH DMRS																
EPRE ratio of PDCCH DMRS to SSS																
EPRE ratio of PDCCH to PDCCH DMRS																
EPRE ratio of PDSCH DMRS to SSS																
EPRE ratio of PDSCH to PDSCH																
EPRE ratio of OCNG DMRS to SSS(Note 1)																
EPRE ratio of OCNG to OCNG DMRS (Note 1)																
N _{oc} Note2	NR_FDD_FR1_A, NR_TDD_FR1_A								dBm/15k Hz	-91		[-110.05]			[-120]	
	NR_FDD_FR1_B, NR_TDD_FR1_B	[-119.5]														
	NR_FDD_FR1_C, NR_TDD_FR1_C		[-119]													
	NR_FDD_FR1_D, NR_TDD_FR1_D			[-118.5]												
	NR_FDD_FR1_E, NR_TDD_FR1_E				[-118]											
	NR_FDD_FR1_F, NR_TDD_FR1_F					[-117]										
	NR_FDD_FR1_G, NR_TDD_FR1_G						[-117]									
	NR_FDD_FR1_H, NR_TDD_FR1_H							[-116.5]								
N _{oc} Note2	Config 1,2,4,5								dBm/SC S		-91	[-110.05]		Same as Noc for 15kHz		
	Config 3,6	NR_FDD_FR1_A, NR_TDD_FR1_A													-88	[-107.05]
		NR_FDD_FR1_B, NR_TDD_FR1_B	[-116.5]													
		NR_FDD_FR1_C, NR_TDD_FR1_C		[-116]												

		NR_FDD_FR1_D, NR_TDD_FR1_D						[-115.5]	
		NR_FDD_FR1_E, NR_TDD_FR1_E						[-115]	
		NR_FDD_FR1_G						[-114]	
		NR_FDD_FR1_H						[-113.5]	
\hat{E}_s / I_{ot}			dB	-1.76		-4.7		-5.46	-5.46
\hat{E}_s / N_{oc}			dB	3	3	-2.9	-2.9	-4	-4
SS- RSRP Note3	Config 1,2,4,5	NR_FDD_FR1_A, NR_TDD_FR1_A	dBm/SC S	-88	-88	[- 112.95]	[- 112.95]	[-124]	[-124]
		NR_FDD_FR1_B						[- 123.5]	[- 123.5]
		NR_TDD_FR1_C						[-123]	[-123]
		NR_FDD_FR1_D, NR_TDD_FR1_D						[- 122.5]	[- 122.5]
		NR_FDD_FR1_E, NR_TDD_FR1_E						[-122]	[-122]
		NR_FDD_FR1_G						[-121]	[-121]
	NR_FDD_FR1_H	[- 120.5]		[- 120.5]					
	Config 3,6	NR_FDD_FR1_A, NR_TDD_FR1_A		[-121]	[-121]				
		NR_FDD_FR1_B		[- 120.5]	[- 120.5]				
		NR_TDD_FR1_C		[-120]	[-120]				
		NR_FDD_FR1_D, NR_TDD_FR1_D		[- 119.5]	[- 119.5]				
		NR_FDD_FR1_E, NR_TDD_FR1_E		[-119]	[-119]				
		NR_FDD_FR1_G		[-118]	[-118]				
		NR_FDD_FR1_H		[- 117.5]	[- 117.5]				
SS-RSRQ Note3	NR_FDD_FR1_A, NR_TDD_FR1_A	dB	-14.77	-14.77	-16.76	-16.76	[- 17.34]	[- 17.34]	
	NR_FDD_FR1_B								
	NR_TDD_FR1_C								
	NR_FDD_FR1_D, NR_TDD_FR1_D								
	NR_FDD_FR1_E, NR_TDD_FR1_E								
	NR_FDD_FR1_G								
	NR_FDD_FR1_H								
I _o Note3	Config 1,2,4,5	NR_FDD_FR1_A, NR_TDD_FR1_A	dBm/ 9.36MHz	-56		[-79]		[-89.5]	
		NR_FDD_FR1_B						[-89]	
		NR_TDD_FR1_C						[-88.5]	
		NR_FDD_FR1_D, NR_TDD_FR1_D						[-88]	
		NR_FDD_FR1_E, NR_TDD_FR1_E						[-87.5]	
		NR_FDD_FR1_G						[-86.5]	
		NR_FDD_FR1_H						[-86]	
	Config 3,6	NR_FDD_FR1_A, NR_TDD_FR1_A		dBm/ 38.16M Hz	-50.00		[-73]		[-83.41]
		NR_FDD_FR1_B							[-82.91]
		NR_TDD_FR1_C							[-82.41]
		NR_FDD_FR1_D, NR_TDD_FR1_D							[-81.91]

		NR_FDD_FR1_E, NR_TDD_FR1_E						[81.41]
		NR_FDD_FR1_G						[80.41]
		NR_FDD_FR1_H						[-79.91]
Propagation condition			-	AWGN	AWGN	AWGN	AWGN	AWGN
Antenna configuration				1x2	1x2	1x2	1x2	1x2
Note 1:	OCNG shall be used such that both cells are fully allocated and a constant total transmitted power spectral density is achieved for all OFDM symbols.							
Note 2:	Interference from other cells and noise sources not specified in the test is assumed to be constant over subcarriers and time and shall be modelled as AWGN of appropriate power for N_{oc} to be fulfilled.							
Note 3:	SS-RSRQ, SS-RSRP, and I_o levels have been derived from other parameters for information purposes. They are not settable parameters themselves.							
Note 4:	SS-RSRQ, SS-RSRP minimum requirements are specified assuming independent interference and noise at each receiver antenna port.							
Note 5:	NR operating band groups are as defined in Section 3.5.2.							

A.4.7.2.1.3 Test Requirements

The SS-RSRQ measurement accuracy shall fulfil the requirements in section 10.1.7.1.1.

A.4.7.2.2 EN-DC Inter-frequency measurement accuracy with FR1 serving cell and FR1 target cell

A.4.7.2.2.1 Test Purpose and Environment

The purpose of this test is to verify that the SS-RSRQ measurement accuracy is within the specified limits. This test will verify the requirements in Clause 10.1.9.1.1 and 10.1.9.1.2 for inter frequency measurement.

A.4.7.2.2.2 Test Parameters

In this test case the two NR cells (i.e., Cell 2 and Cell 3) are on different carrier frequencies and measurement gaps are provided. Supported test configurations are shown in Table A.4.7.2.2.2-1. Both absolute accuracy and relative accuracy requirements of SS-RSRQ inter-frequency measurement are tested by using test parameters in Table A.4.7.2.2.2-2. In all test cases, Cell 2 is the PSCell and Cell 3 is target cell. Cell 1 is the E-UTRA cell which specific test parameters for this test case are specified in Table A.3.7.2.1-1.

Table A.4.7.2.2.2-1: SS-RSRQ Inter frequency SS-RSRQ supported test configurations

Config	Description
1	LTE FDD, NR 15 kHz SSB SCS, 10MHz bandwidth, FDD duplex mode
2	LTE FDD, NR 15 kHz SSB SCS, 10MHz bandwidth, TDD duplex mode
3	LTE FDD, NR 30kHz SSB SCS, 40MHz bandwidth, TDD duplex mode
4	LTE TDD, NR 15 kHz SSB SCS, 10MHz bandwidth, FDD duplex mode
5	LTE TDD, NR 15 kHz SSB SCS, 10MHz bandwidth, TDD duplex mode
6	LTE TDD, NR 30kHz SSB SCS, 40MHz bandwidth, TDD duplex mode

Note: The UE is only required to be tested in one of the supported test configurations

Table A.4.7.2.2.2-1: SS-RSRQ Inter frequency test parameters

Parameter	Unit	Test 1		Test 2		Test 3	
		Cell 2	Cell 3	Cell 2	Cell 3	Cell 2	Cell 3
SSB ARFCN		freq1	freq2	freq1	freq2	freq1	freq2
Duplex mode	Config 1,4	FDD					
	Config 2,3,5,6	TDD					
TDD configuration	Config 1,4	Not Applicable					

	Config 2,5		TDDConf.1.1					
	Config 3,6		TDDConf.2.1					
BW _{channel}	Config 1,4	MHz	10: N _{RB,c} = 52					
	Config 2,5		10: N _{RB,c} = 52					
	Config 3,6		40: N _{RB,c} = 106					
BWP BW	Config 1,4	MHz	10: N _{RB,c} = 52					
	Config 2,5		10: N _{RB,c} = 52					
	Config 3,6		40: N _{RB,c} = 106					
DRX Cycle		ms	Not Applicable					
PDSCH Reference measurement channel	Config 1,4		SR.1.1 FDD		SR.1.1 FDD		SR.1.1 FDD	
	Config 2,5		SR.1.1 TDD	-	SR.1.1 TDD	-	SR.1.1 TDD	-
	Config 3,6		SR.2.1 TDD		SR.2.1 TDD		SR.2.1 TDD	
RMSI CORESET Reference Channel	Config 1,4		CR.1.1 FDD		CR.1.1 FDD		CR.1.1 FDD	
	Config 2,5		CR.1.1 TDD	-	CR.1.1 TDD	-	CR.1.1 TDD	-
	Config 3,6		CR.2.1 TDD		CR.2.1 TDD		CR.2.1 TDD	
Dedicated CORESET Reference Channel	Config 1,4		CCR.1.1 FDD		CCR.1.1 FDD		CCR.1.1 FDD	
	Config 2,5		CCR.1.1 TDD	-	CCR.1.1 TDD	-	CCR.1.1 TDD	-
	Config 3,6		CCR.2.1 TDD		CCR.2.1 TDD		CCR.2.1 TDD	
OCNG Patterns			OCNG pattern 1					
SMTC configuration	Config 1,2,4,5		SMTC pattern 1					
	Config 3,6		SMTC pattern 2					
SSB configuration	Config 1,2,4,5		SSB pattern 1 in FR1					
	Config 3,6		SSB pattern 2 in FR1					
PDSCH/PDCCH subcarrier spacing	Config 1,2,4,5	kHz	15 kHz					
	Config 3,6		30 kHz					
EPRE ratio of PSS to SSS		dB	0	0	0	0	0	0
EPRE ratio of PBCH DMRS to SSS								
EPRE ratio of PBCH to PBCH DMRS								
EPRE ratio of PDCCH DMRS to SSS								
EPRE ratio of PDCCH to PDCCH DMRS								
EPRE ratio of PDSCH DMRS to SSS								
EPRE ratio of PDSCH to PDSCH								
EPRE ratio of OCNG DMRS to SSS(Note 1)								
EPRE ratio of OCNG to OCNG DMRS (Note 1)								
N _{oc} Note2	Config 1,2,4,5							
		NR_TDD_FR1_A	TBD					
		NR_FDD_FR1_B	TBD					
		NR_TDD_FR1_C	TBD					
		NR_FDD_FR1_D	TBD					
		NR_TDD_FR1_D	TBD					
		NR_FDD_FR1_E	TBD					
NR_TDD_FR1_E	TBD							
NR_FDD_FR1_G	TBD							

N_{oc} ^{Note2}	Config 3,6	NR_FDD_FR1_H	dBm/15kHz z	-86.27			TBD		
		NR_FDD_FR1_A							
		NR_TDD_FR1_A							
		NR_FDD_FR1_B							
		NR_TDD_FR1_C							
		NR_FDD_FR1_D							
		NR_TDD_FR1_D							
		NR_FDD_FR1_E							
NR_TDD_FR1_E									
NR_FDD_FR1_G									
NR_FDD_FR1_H									
N_{oc} ^{Note2}	Config 1,2,4,5	NR_FDD_FR1_A	dBm/SCS	-80.18		TBD	TBD		
		NR_TDD_FR1_A							
		NR_FDD_FR1_B							
		NR_TDD_FR1_C							
		NR_FDD_FR1_D							
		NR_TDD_FR1_D							
		NR_FDD_FR1_E							
	NR_TDD_FR1_E								
	NR_FDD_FR1_G								
	NR_FDD_FR1_H								
	Config 3,6	NR_FDD_FR1_A		-83.27		TBD	TBD		
		NR_TDD_FR1_A							
		NR_FDD_FR1_B							
		NR_TDD_FR1_C							
NR_FDD_FR1_D									
NR_TDD_FR1_D									
NR_FDD_FR1_E									
NR_TDD_FR1_E									
NR_FDD_FR1_G									
NR_FDD_FR1_H									
\hat{E}_s / I_{ot}			dB	-1.75		TBD	TBD	TBD	
\hat{E}_s / N_{oc}			dB	-1.75		TBD	TBD	TBD	
SS-RSRP ^{Not e3}	Config 1,2,4,5	NR_FDD_FR1_A	dBm/SCS	-81.93	-81.93	TBD	TBD	TBD	TBD
		NR_TDD_FR1_A							
		NR_FDD_FR1_B							
		NR_TDD_FR1_C							
		NR_FDD_FR1_D							
		NR_TDD_FR1_D							
		NR_FDD_FR1_E							
	NR_TDD_FR1_E								
	NR_FDD_FR1_G								
	NR_FDD_FR1_H								
	Config 3,6	NR_FDD_FR1_A		-85.02	-85.02	TBD	TBD	TBD	TBD
		NR_TDD_FR1_A							
		NR_FDD_FR1_B							
		NR_TDD_FR1_C							
NR_FDD_FR1_D									
NR_TDD_FR1_D									
NR_FDD_FR1_E									
NR_TDD_FR1_E									
NR_FDD_FR1_G									
NR_FDD_FR1_H									
SS-RSRQ ^{Note3}			dB	-14.77	-14.77	TBD	TBD	TBD	TBD
	NR_FDD_FR1_A								
	NR_TDD_FR1_A								
	NR_TDD_FR1_D								

		NR_FDD_FR1_E NR_TDD_FR1_E						TBD	TBD								
		NR_FDD_FR1_G NR_FDD_FR1_H						TBD	TBD								
I _o Note3	Config 1,2,4,5	NR_FDD_FR1_A NR_TDD_FR1_A	dBm/ 9.36MHz	-50	TBD	TBD	TBD	TBD	TBD								
		NR_FDD_FR1_B NR_TDD_FR1_C															
		NR_FDD_FR1_D NR_TDD_FR1_D															
		NR_FDD_FR1_E NR_TDD_FR1_E															
		NR_FDD_FR1_G NR_FDD_FR1_H															
		Config 3,6								NR_FDD_FR1_A NR_TDD_FR1_A	dBm/ 38.16MHz	-50	TBD	TBD	TBD	TBD	TBD
										NR_FDD_FR1_B NR_TDD_FR1_C							
	NR_FDD_FR1_D NR_TDD_FR1_D																
	NR_FDD_FR1_E NR_TDD_FR1_E																
	NR_FDD_FR1_G NR_FDD_FR1_H																
	Propagation condition		-	AWGN	AWGN	AWGN	AWGN	AWG N	AWG N								
	<p>Note 1: OCNG shall be used such that both cells are fully allocated and a constant total transmitted power spectral density is achieved for all OFDM symbols.</p> <p>Note 2: Interference from other cells and noise sources not specified in the test is assumed to be constant over subcarriers and time and shall be modelled as AWGN of appropriate power for N_{oc} to be fulfilled.</p> <p>Note 3: SS-RSRQ, SS-RSRP, and I_o levels have been derived from other parameters for information purposes. They are not settable parameters themselves.</p> <p>Note 4: SS-RSRQ, SS-RSRP minimum requirements are specified assuming independent interference and noise at each receiver antenna port.</p> <p>Note 5: NR operating band groups are as defined in Section 3.5.2.</p>																

A.4.7.2.2.3 Test Requirements

The SS-RSRQ measurement accuracy shall fulfil the requirements in section 10.1.9.1.1 and 10.1.9.1.2.

A.4.7.3 SS-SINR

A.4.7.3.1 EN-DC Intra-frequency measurement accuracy with FR1 serving cell and FR1 target cell

A.4.7.3.1.1 Test Purpose and Environment

The purpose of this test is to verify that the SS-SINR measurement accuracy is within the specified limits. This test will verify the requirements in Clause 10.1.12.1.1.

A.4.7.3.1.2 Test Parameters

In this test case all cells are on the same carrier frequency. Supported test configuration are shown in Table A.4.7.3.1.2-1. The absolute accuracy of SS-SINR intra-frequency measurement is test by using the parameters in Table A.4.7.3.1.2-2. The configuration of cell 1 (E-UTRA PCell) is specified in section A.3.7.2.1. In all test cases, Cell 2 is the PCell and Cell 3 is the target cell.

Table A.4.7.3.1.2-1: SS-SINR Intra frequency SS-SINR supported test configurations

Config	Description
1	LTE FDD, NR 15 kHz SSB SCS, 10MHz bandwidth, FDD duplex mode
2	LTE FDD, NR 15 kHz SSB SCS, 10MHz bandwidth, TDD duplex mode
3	LTE FDD, NR 30 kHz SSB SCS, 40MHz bandwidth, TDD duplex mode
4	LTE TDD, NR 15 kHz SSB SCS, 10MHz bandwidth, FDD duplex mode
5	LTE TDD, NR 15 kHz SSB SCS, 10MHz bandwidth, TDD duplex mode
6	LTE TDD, NR 30 kHz SSB SCS, 40MHz bandwidth, TDD duplex mode

Note: The UE is only required to be tested in one of the supported test configurations

Table A.4.7.3.1.2-2: SS-SINR Intra frequency test parameters

Parameter		Unit	Test 1		Test 2	
			Cell 2	Cell 3	Cell 2	Cell 3
SSB ARFCN			freq1		freq1	
Duplex mode	Config 1,4		FDD			
	Config 2,3,5,6		TDD			
TDD configuration	Config 1,4		Not Applicable			
	Config 2,5		TDDConf.1.1			
	Config 3,6		TDDConf.2.1			
Downlink initial BWP configuration			DLBWP.0.1			
Downlink dedicated BWP configuration			DLBWP.1.1			
Uplink initial BWP configuration			ULBWP.0.1			
Uplink dedicated BWP configuration			ULBWP.1.1			
DRX Cycle configuration		ms	Not Applicable			
TRS configuration			TRS.2.1 TDD			
TCI state			TCI.State.0			
PDSCH Reference measurement channel	Config 1,4		SR.1.1 FDD	-	SR.1.1 FDD	-
	Config 2,5		SR.1.1 TDD		SR.1.1 TDD	
	Config 3,6		SR.2.1 TDD		SR.2.1 TDD	
RMSI CORESET Reference Channel	Config 1,4		CR.1.1 FDD	-	CR.1.1 FDD	-
	Config 2,5		CR.1.1 TDD		CR.1.1 TDD	
	Config 3,6		CR.2.1 TDD		CR.2.1 TDD	
Dedicated CORESET Reference Channel	Config 1,4		CCR.1.1 FDD	-	CCR.1.1 FDD	-
	Config 2,5		CCR.1.1 TDD		CCR.1.1 TDD	
	Config 3,6		CCR.2.1 TDD		CCR.2.1 TDD	
OCNG Patterns			OP.1			
SS-RSSI-Measurement			Not Applicable			
SMTC configuration			SMTC.1			
SSB configuration	Config 1,2,4,5		SSB.1 FR1			
	Config 3,6		SSB.2 FR1			
PDSCH/PDCCH subcarrier spacing	Config 1,2,4,5	kHz	15			
	Config 3,6		30			
EPRE ratio of PSS to SSS		dB	0	0	0	0
EPRE ratio of PBCH DMRS to SSS						
EPRE ratio of PBCH to PBCH DMRS						
EPRE ratio of PDCCH DMRS to SSS						
EPRE ratio of PDCCH to PDCCH DMRS						
EPRE ratio of PDSCH DMRS to SSS						
EPRE ratio of PDSCH to PDSCH						
EPRE ratio of OCNG DMRS to SSS(Note 1)						
EPRE ratio of OCNG to OCNG DMRS (Note 1)						

N_{oc} <small>Note2</small>		NR_FDD_FR1_A, NR_TDD_FR1_A	dBm/15kHz z	TBD	TBD		
		NR_FDD_FR1_B			TBD		
		NR_TDD_FR1_C			TBD		
		NR_FDD_FR1_D, NR_TDD_FR1_D			TBD		
		NR_FDD_FR1_E, NR_TDD_FR1_E			TBD		
		NR_FDD_FR1_G			TBD		
		NR_FDD_FR1_H			TBD		
N_{oc} <small>Note2</small>	Config 1,2,4,5		dBm/SCS	TBD	Same as Noc for 15kHz		
					Config 3,6	NR_FDD_FR1_A, NR_TDD_FR1_A	TBD
	NR_FDD_FR1_B					TBD	
	NR_TDD_FR1_C					TBD	
	NR_FDD_FR1_D, NR_TDD_FR1_D					TBD	
	NR_FDD_FR1_E, NR_TDD_FR1_E					TBD	
	NR_FDD_FR1_G					TBD	
	NR_FDD_FR1_H				TBD		
\hat{E}_s/I_{ot}			dB	[5]	[-3.19]	[-5.46]	[-5.46]
\hat{E}_s/N_{oc}			dB	TBD	TBD	TBD	TBD
SS-RSRP <small>Note3</small>	Config 1,2,4,5	NR_FDD_FR1_A, NR_TDD_FR1_A	dBm/SCS	TBD	TBD	TBD	TBD
		NR_FDD_FR1_B				TBD	TBD
		NR_TDD_FR1_C				TBD	TBD
		NR_FDD_FR1_D, NR_TDD_FR1_D				TBD	TBD
		NR_FDD_FR1_E, NR_TDD_FR1_E				TBD	TBD
		NR_FDD_FR1_G				TBD	TBD
		NR_FDD_FR1_H				TBD	TBD
	Config 3,6	NR_FDD_FR1_A, NR_TDD_FR1_A		TBD	TBD	TBD	TBD
		NR_FDD_FR1_B				TBD	TBD
		NR_TDD_FR1_C				TBD	TBD
		NR_FDD_FR1_D, NR_TDD_FR1_D				TBD	TBD
		NR_FDD_FR1_E, NR_TDD_FR1_E				TBD	TBD
		NR_FDD_FR1_G				TBD	TBD
		NR_FDD_FR1_H				TBD	TBD
SS-SINR <small>Note3</small>			dB	[5]	[-3.19]	[-5.46]	[-5.46]
I_o <small>Note3</small>	Config 1,2,4,5	NR_FDD_FR1_A, NR_TDD_FR1_A	dBm/ 9.36MHz	TBD	TBD		
		NR_FDD_FR1_B			TBD		
		NR_TDD_FR1_C			TBD		

		NR_FDD_FR1_D, NR_TDD_FR1_D	dBm/ 38.16MHz	TBD	TBD
		NR_FDD_FR1_E, NR_TDD_FR1_E			TBD
		NR_FDD_FR1_G			TBD
		NR_FDD_FR1_H			TBD
	Config 3,6	NR_FDD_FR1_A, NR_TDD_FR1_A			TBD
		NR_FDD_FR1_B			TBD
		NR_TDD_FR1_C			TBD
		NR_FDD_FR1_D, NR_TDD_FR1_D			TBD
		NR_FDD_FR1_E, NR_TDD_FR1_E			TBD
		NR_FDD_FR1_G			TBD
		NR_FDD_FR1_H			TBD
	Propagation condition				-
Antenna configuration		-	1x2		
Note 1: OCNG shall be used such that both cells are fully allocated and a constant total transmitted power spectral density is achieved for all OFDM symbols.					
Note 2: Interference from other cells and noise sources not specified in the test is assumed to be constant over subcarriers and time and shall be modelled as AWGN of appropriate power for N_{oc} to be fulfilled.					
Note 3: SS-SINR, SS-RSRP, and Io levels have been derived from other parameters for information purposes. They are not settable parameters themselves.					
Note 4: SS-SINR, SS-RSRP minimum requirements are specified assuming independent interference and noise at each receiver antenna port.					
Note 5: NR operating band groups are as defined in Section 3.5.2.					

A.4.7.3.1.3 Test Requirements

The SS-SINR measurement accuracy shall fulfil the requirements in section 10.1.12.1.1.

A.4.7.3.2 EN-DC Inter-frequency measurement accuracy with FR1 serving cell and FR1 target cell

A.4.7.3.2.1 Test Purpose and Environment

The purpose of this test is to verify that the SS-SINR measurement accuracy is within the specified limits. This test will verify the requirements in Clause 10.1.14.1.1 and 10.1.14.1.2 for inter frequency measurement.

A.4.7.3.2.2 Test Parameters

In this test case the two NR cells (i.e., Cell 2 and Cell 3) are on different carrier frequencies and measurement gaps are provided. Supported test configurations are shown in Table A.4.7.3.2.2-1. Both absolute accuracy and relative accuracy requirements of SS-SINR inter-frequency measurement are tested by using test parameters in Table A.4.7.3.2.2-2. In all test cases, Cell 2 is the PSCell and Cell 3 is target cell. Cell 1 is the E-UTRA cell of which specific test parameters for this test case are specified in Table A.3.7.2.1-1.

Table A.4.7.3.2.2-1: SS-SINR Inter frequency SS-SINR supported test configurations

Config	Description
1	LTE FDD, NR 15 kHz SSB SCS, 10MHz bandwidth, FDD duplex mode
2	LTE FDD, NR 15 kHz SSB SCS, 10MHz bandwidth, TDD duplex mode
3	LTE FDD, NR 30 kHz SSB SCS, 40MHz bandwidth, TDD duplex mode
4	LTE TDD, NR 15 kHz SSB SCS, 10MHz bandwidth, FDD duplex mode
5	LTE TDD, NR 15 kHz SSB SCS, 10MHz bandwidth, TDD duplex mode
6	LTE TDD, NR 30 kHz SSB SCS, 40MHz bandwidth, TDD duplex mode

Note: The UE is only required to be tested in one of the supported test configurations

Table A.4.7.3.2.2-1: SS-SINR Inter frequency test parameters

Parameter		Unit	Test 1		Test 2		Test 3	
			Cell 2	Cell 3	Cell 2	Cell 3	Cell 2	Cell 3
SSB ARFCN			freq1	freq2	freq1	freq2	freq1	freq2
Duplex mode	Config 1,4		FDD					
	Config 2,3,5,6		TDD					
TDD configuration	Config 1,4		Not Applicable					
	Config 2,5		TDDConf.1.1					
	Config 3,6		TDDConf.2.1					
Downlink initial BWP configuration			DLBWP.0.1					
Downlink dedicated BWP configuration			DLBWP.1.1					
Uplink initial BWP configuration			ULBWP.0.1					
Uplink dedicated BWP configuration			ULBWP.1.1					
DRX Cycle configuration		ms	Not Applicable					
TRS configuration			TRS.2.1 TDD					
TCI state			TCI.State.0					
PDSCH Reference measurement channel	Config 1,4		SR.1.1 FDD	-	SR.1.1 FDD	-	SR.1.1 FDD	-
	Config 2,5		SR.1.1 TDD	-	SR.1.1 TDD	-	SR.1.1 TDD	-
	Config 3,6		SR.2.1 TDD	-	SR.2.1 TDD	-	SR.2.1 TDD	-
RMSI CORESET Reference Channel	Config 1,4		CR.1.1 FDD	-	CR.1.1 FDD	-	CR.1.1 FDD	-
	Config 2,5		CR.1.1 TDD	-	CR.1.1 TDD	-	CR.1.1 TDD	-
	Config 3,6		CR.2.1 TDD	-	CR.2.1 TDD	-	CR.2.1 TDD	-
Dedicated CORESET Reference Channel	Config 1,4		CCR.1.1 FDD	-	CCR.1.1 FDD	-	CCR.1.1 FDD	-
	Config 2,5		CCR.1.1 TDD	-	CCR.1.1 TDD	-	CCR.1.1 TDD	-
	Config 3,6		CCR.2.1 TDD	-	CCR.2.1 TDD	-	CCR.2.1 TDD	-
OCNG Patterns			OP.1					
SS-RSSI-Measurement			Not Applicable					
SMTC configuration			SMTC.1					
SSB configuration	Config 1,2,4,5		SSB.1 FR1					
	Config 3,6		SSB.2 FR1					
PDSCH/PDCCH subcarrier spacing	Config 1,2,4,5	kHz	15					
	Config 3,6		30					
EPRE ratio of PSS to SSS		dB	0	0	0	0	0	0
EPRE ratio of PBCH DMRS to SSS			0	0	0	0	0	0
EPRE ratio of PBCH to PBCH DMRS			0	0	0	0	0	0
EPRE ratio of PDCCH DMRS to SSS			0	0	0	0	0	0
EPRE ratio of PDCCH to PDCCH DMRS			0	0	0	0	0	0
EPRE ratio of PDSCH DMRS to SSS			0	0	0	0	0	0
EPRE ratio of PDSCH to PDSCH			0	0	0	0	0	0
EPRE ratio of OCNG DMRS to SSS(Note 1)			0	0	0	0	0	0

EPRE ratio of OCNG to OCNG DMRS (Note 1)										
N_{oc} Note2	Config 1,2,4,5	NR_FDD_FR1_A	dBm/15k Hz	TBD	TBD				TBD	
		NR_TDD_FR1_A							TBD	
		NR_FDD_FR1_B							TBD	
		NR_TDD_FR1_C							TBD	
		NR_FDD_FR1_D							TBD	
		NR_TDD_FR1_D							TBD	
		NR_FDD_FR1_E							TBD	
NR_TDD_FR1_E	TBD									
N_{oc} Note2	Config 3,6	NR_FDD_FR1_G	dBm/15k Hz	TBD	TBD				TBD	
		NR_TDD_FR1_G							TBD	
		NR_FDD_FR1_H							TBD	
		NR_TDD_FR1_H							TBD	
		NR_FDD_FR1_A							TBD	
		NR_TDD_FR1_A							TBD	
		NR_FDD_FR1_B							TBD	
NR_TDD_FR1_C	TBD									
N_{oc} Note2	Config 1,2,4,5	NR_FDD_FR1_D	dBm/SC S	TBD	TBD				TBD	
		NR_TDD_FR1_D							TBD	
		NR_FDD_FR1_E							TBD	
		NR_TDD_FR1_E							TBD	
		NR_FDD_FR1_G							TBD	
		NR_TDD_FR1_G							TBD	
		NR_FDD_FR1_H							TBD	
	Config 3,6	NR_FDD_FR1_A		TBD	TBD					TBD
		NR_TDD_FR1_A								TBD
		NR_FDD_FR1_B								TBD
		NR_TDD_FR1_C								TBD
		NR_FDD_FR1_D								TBD
		NR_TDD_FR1_D								TBD
		NR_FDD_FR1_E								TBD
NR_TDD_FR1_E	TBD									
\hat{E}_s / I_{ot}			dB	[-1.75]	[-1.75]	[20]	[20]	[-4.0]	[-4.0]	
			dB	TBD	TBD	TBD	TBD	TBD	TBD	
SS-RSRP ^{Not e3}	Config 1,2,4,5	NR_FDD_FR1_G	dBm/SC S	TBD	TBD	TBD	TBD	TBD	TBD	
		NR_TDD_FR1_G						TBD		
		NR_FDD_FR1_H						TBD		
		NR_TDD_FR1_H						TBD		
		NR_FDD_FR1_A						TBD		
		NR_TDD_FR1_A						TBD		
		NR_FDD_FR1_B						TBD		
	NR_TDD_FR1_C	TBD								
	Config 3,6	NR_FDD_FR1_D		TBD	TBD	TBD	TBD			TBD
		NR_TDD_FR1_D								TBD
		NR_FDD_FR1_E								TBD
		NR_TDD_FR1_E								TBD
		NR_FDD_FR1_G								TBD
		NR_TDD_FR1_G								TBD
NR_FDD_FR1_H		TBD								
NR_TDD_FR1_H	TBD									

		NR_FDD_FR1_E NR_TDD_FR1_E						TBD	TBD
		NR_FDD_FR1_G NR_FDD_FR1_H						TBD	TBD
SS-SINR ^{Note3}		NR_FDD_FR1_A NR_TDD_FR1_A	dB	[-1.75]	[-1.75]	[20]	[20]	[-4.0]	[-4.0]
		NR_FDD_FR1_B NR_TDD_FR1_C							
		NR_FDD_FR1_D NR_TDD_FR1_D							
		NR_FDD_FR1_E NR_TDD_FR1_E							
		NR_FDD_FR1_G NR_FDD_FR1_H							
Io ^{Note3}	Config 1,2,4,5	NR_FDD_FR1_A NR_TDD_FR1_A	dBm/ 9.36MHz	TBD	TBD	TBD	TBD	TBD	TBD
		NR_FDD_FR1_B NR_TDD_FR1_C							
		NR_FDD_FR1_D NR_TDD_FR1_D							
		NR_FDD_FR1_E NR_TDD_FR1_E							
		NR_FDD_FR1_G NR_FDD_FR1_H							
	Config 3,6	NR_FDD_FR1_A NR_TDD_FR1_A	dBm/ 38.16MHz	TBD	TBD	TBD	TBD	TBD	TBD
		NR_FDD_FR1_B NR_TDD_FR1_C							
		NR_FDD_FR1_D NR_TDD_FR1_D							
		NR_FDD_FR1_E NR_TDD_FR1_E							
		NR_FDD_FR1_G NR_FDD_FR1_H							
Propagation condition			-	AWGN					
Antenna configuration			-	1x2					
<p>Note 1: OCNG shall be used such that both cells are fully allocated and a constant total transmitted power spectral density is achieved for all OFDM symbols.</p> <p>Note 2: Interference from other cells and noise sources not specified in the test is assumed to be constant over subcarriers and time and shall be modelled as AWGN of appropriate power for N_{ac} to be fulfilled.</p> <p>Note 3: SS-SINR, SS-RSRP, and Io levels have been derived from other parameters for information purposes. They are not settable parameters themselves.</p> <p>Note 4: SS-SINR, SS-RSRP minimum requirements are specified assuming independent interference and noise at each receiver antenna port.</p> <p>Note 5: NR operating band groups are as defined in Section 3.5.2.</p>									

A.4.7.3.2.3 Test Requirements

The SS-SINR measurement accuracy shall fulfil the requirements in section 10.1.14.1.1 and 10.1.14.1.2.

A.4.7.4 L1-RSRP measurement for beam reporting

A.4.7.4.1 SSB based L1-RSRP measurement

A.4.7.4.1.1 Test Purpose and Environment

The purpose of this test is to verify that the L1-RSRP measurement accuracy is within the specified limits. This test will verify the requirements in Sections 9.5.2 and section 10.1.19.1 for L1-RSRP measurements based on SSB with the testing configurations for NR cells in Table A.4.7.4.1.1-1.

Table A.4.7.4.1.1-1: Applicable NR configurations for FR1 SSB based L1-RSRP test

Config	Description
1	LTE FDD, NR 15 kHz SSB SCS, 10MHz bandwidth, FDD duplex mode
2	LTE FDD, NR 15 kHz SSB SCS, 10MHz bandwidth, TDD duplex mode
3	LTE FDD, NR 30kHz SSB SCS, 40MHz bandwidth, TDD duplex mode
4	LTE TDD, NR 15 kHz SSB SCS, 10MHz bandwidth, FDD duplex mode
5	LTE TDD, NR 15 kHz SSB SCS, 10MHz bandwidth, TDD duplex mode
6	LTE TDD, NR 30kHz SSB SCS, 40MHz bandwidth, TDD duplex mode

Note: The UE is only required to be tested in one of the supported test configurations

A.4.7.4.1.2 Test parameters

In this set of test cases there are two cells in the test, E-UTRAN PCell (Cell 1), FR1 PSCell (Cell 2). The test parameters and applicability for Cell 1 are defined in A.3.7.2. The test parameters for the Cell 2 are given in Table A.4.7.4.1.2-1 below. The absolute and relative accuracy of L1-RSRP measurements are tested by using the parameters in Table A.4.7.4.1.2-1.

There is no measurement gap configured in the test. Before the test, UE is configured one SSB resource set with two SSB resources. UE is configured to perform RLM, BFD and L1-RSRP measurement based on the SSB resources 0 and 1.

Table A.4.7.4.1.2-1: FR1 SSB based L1-RSRP test parameters

Parameter	Config	Unit	Test 1	Test 2
SSB GSCN	1~6		freq1	freq1
Duplex mode	1,4		FDD	FDD
	2,5		TDD	TDD
	3,6		TDD	TDD
TDD Configuration	1,4		N/A	N/A
	2,5		TDDConf.1.1	TDDConf.1.1
	3,6		TDDConf.2.1	TDDConf.2.1
BW _{channel}	1,4	MHz	10: N _{RB,c} = 52	10: N _{RB,c} = 52
	2,5		10: N _{RB,c} = 52	10: N _{RB,c} = 52
	3,6		40: N _{RB,c} = 106	40: N _{RB,c} = 106
PDSCH Reference measurement channel	1,4		SR.1.1 FDD	SR.1.1 FDD
	2,5		SR.1.1 TDD	SR.1.1 TDD
	3,6		SR.2.1 TDD	SR.2.1 TDD
RMSI CORESET Reference Channel	1,4		CR.1.1 FDD	CR.1.1 FDD
	2,5		CR.1.1 TDD	CR.1.1 TDD
	3,6		CR.2.1 TDD	CR.2.1 TDD
Dedicated CORESET Reference Channel	1,4		CCR.1.1 FDD	CCR.1.1 FDD
	2,5		CCR.1.1 TDD	CCR.1.1 TDD
	3,6		CCR.2.1 TDD	CCR.2.1 TDD
SSB configuration	1,4		SSB.3 FR1	SSB.3 FR1
	2,5		SSB.3 FR1	SSB.3 FR1

		3,6		SSB.4 FR1	SSB.4 FR1
OCNG Patterns		1~6		OP.1	OP.1
Initial BWP Configuration		1~6		DLBWP.0.1 ULBWP.0.1	DLBWP.0.1 ULBWP.0.1
Dedicated BWP configuration		1~6		DLBWP.1.1 ULBWP.1.1	DLBWP.1.1 ULBWP.1.1
SMTC configuration		1~6		SMTC.1	SMTC.1
reportConfigType		1~6		periodic	periodic
reportQuantity		1~6		ssb-Index-RSRP	ssb-Index-RSRP
Number of reported RS		1~6		2	2
L1-RSRP reporting period		1~6		slot80	slot80
EPRE ratio of PSS to SSS		1~6	dB	0	0
EPRE ratio of PBCH DMRS to SSS					
EPRE ratio of PBCH to PBCH DMRS					
EPRE ratio of PDCCH DMRS to SSS					
EPRE ratio of PDCCH to PDCCH DMRS					
EPRE ratio of PDSCH DMRS to SSS					
EPRE ratio of PDSCH to PDSCH DMRS					
EPRE ratio of OCNG DMRS to SSS ^{Note 1}					
EPRE ratio of OCNG to OCNG DMRS ^{Note 1}					
N_{oc} ^{Note2}	NR_FDD_FR1_A, NR_TDD_FR1_A	1~6	dBm/15kHz	-94.65	-117
	NR_FDD_FR1_B				-116.5
	NR_TDD_FR1_C				-116
	NR_FDD_FR1_D, NR_TDD_FR1_D				-115.5
	NR_FDD_FR1_E, NR_TDD_FR1_E				-115
	NR_FDD_FR1_G				-114
	NR_FDD_FR1_H				-113.5
N_{oc} ^{Note2}	NR_FDD_FR1_A, NR_TDD_FR1_A	1,2,4,5	dBm/SSB SCS	-94.65	-117
	NR_FDD_FR1_B				-116.5
	NR_TDD_FR1_C				-116
	NR_FDD_FR1_D, NR_TDD_FR1_D				-115.5
	NR_FDD_FR1_E, NR_TDD_FR1_E				-115
	NR_FDD_FR1_G				-114
	NR_FDD_FR1_H	-113.5			
	NR_FDD_FR1_A, NR_TDD_FR1_A	3,6		-91.65	-114
	NR_FDD_FR1_B				-113.5
	NR_TDD_FR1_C				-114
	NR_FDD_FR1_D, NR_TDD_FR1_D				-112.5
	NR_FDD_FR1_E, NR_TDD_FR1_E				-112
	NR_FDD_FR1_G				-111
	NR_FDD_FR1_H				-110.5
\hat{E}_s/I_{ot}		1~6	dB	10	-3
SSB RSRP ^{Note3}	NR_FDD_FR1_A, NR_TDD_FR1_A	1,2,4,5	dBm/SSB SCS	-84.65	-120
	NR_FDD_FR1_B				-119.5
	NR_TDD_FR1_C				-119
	NR_FDD_FR1_D, NR_TDD_FR1_D				-118.5

	NR_FDD_FR1_E, NR_TDD_FR1_E				-118			
	NR_FDD_FR1_G				-117			
	NR_FDD_FR1_H				-116.5			
	NR_FDD_FR1_A, NR_TDD_FR1_A	3,6		-81.65	-117			
	NR_FDD_FR1_B				-116.5			
	NR_TDD_FR1_C				-116			
	NR_FDD_FR1_D, NR_TDD_FR1_D				-115.5			
	NR_FDD_FR1_E, NR_TDD_FR1_E				-115			
	NR_FDD_FR1_G				-114			
	NR_FDD_FR1_H				-113.5			
I _o Note3	NR_FDD_FR1_A, NR_TDD_FR1_A				1,2,4,5	dBm/9.36 MHz	-56.28	-87.28
	NR_FDD_FR1_B							-86.78
	NR_TDD_FR1_C	-86.28						
	NR_FDD_FR1_D, NR_TDD_FR1_D	-85.78						
	NR_FDD_FR1_E, NR_TDD_FR1_E	-85.28						
	NR_FDD_FR1_G	-84.28						
	NR_FDD_FR1_H	-83.78						
	NR_FDD_FR1_A, NR_TDD_FR1_A	3,6	dBm/38.16 MHz	-50.19	-81.19			
	NR_FDD_FR1_B				-80.69			
	NR_TDD_FR1_C				-80.19			
	NR_FDD_FR1_D, NR_TDD_FR1_D				-79.69			
	NR_FDD_FR1_E, NR_TDD_FR1_E				-79.19			
	NR_FDD_FR1_G				-78.19			
	NR_FDD_FR1_H	-77.69						
	\hat{E}_s / N_{oc}	1~6	dB	10	-3			
	Propagation condition	1~6		AWGN	AWGN			
	Note 1:	OCNG shall be used such that both cells are fully allocated and a constant total transmitted power spectral density is achieved for all OFDM symbols.						
	Note 2:	Interference from other cells and noise sources not specified in the test is assumed to be constant over subcarriers and time and shall be modelled as AWGN of appropriate power for N_{oc} to be fulfilled.						
Note 3:	RSRP and I _o levels have been derived from other parameters for information purposes. They are not settable parameters themselves.							
Note 4:	RSRP minimum requirements are specified assuming independent interference and noise at each receiver antenna port.							

A.4.7.4.1.3 Test Requirements

For at least one reported L1-RSRP during 480ms, the accuracy for SSB#0 and SSB#1 of Cell 2 shall fulfil the requirements in sections 10.1.19.1.

A.4.7.4.2 CSI-RS based L1-RSRP measurement on resource set with repetition off

A.4.7.4.2.1 Test Purpose and Environment

The purpose of this test is to verify that the L1-RSRP measurement accuracy is within the specified limits. This test will verify the requirements in Sections 9.5.3 and section 10.1.19.2 for L1-RSRP measurements based on CSI-RS with the testing configurations for NR cells in Table A.4.7.4.2.1-1.

Table A.4.7.4.2.1-1: Applicable NR configurations for FR1 CSI-RS based L1-RSRP test

Config	Description
1	LTE FDD, NR 15 kHz CSI-RS SCS, 10MHz bandwidth, FDD duplex mode
2	LTE FDD, NR 15 kHz CSI-RS SCS, 10MHz bandwidth, TDD duplex mode
3	LTE FDD, NR 30kHz CSI-RS SCS, 40MHz bandwidth, TDD duplex mode
4	LTE TDD, NR 15 kHz CSI-RS SCS, 10MHz bandwidth, FDD duplex mode
5	LTE TDD, NR 15 kHz CSI-RS SCS, 10MHz bandwidth, TDD duplex mode
6	LTE TDD, NR 30kHz CSI-RS SCS, 40MHz bandwidth, TDD duplex mode

Note: The UE is only required to be tested in one of the supported test configurations

A.4.7.4.2.2 Test parameters

In this set of test cases there are two cells in the test, E-UTRAN PCell (Cell 1), FR1 PSCell (Cell 2). The test parameters and applicability for Cell 1 are defined in A.3.7.2. The test parameters for the Cell 2 are given in Table A.4.7.4.2.2-1 below. The absolute and relative accuracy of L1-RSRP measurements are tested by using the parameters in Table A.4.7.4.2.2-1.

There is no measurement gap configured in the test. Before the test, UE is configured one CSI-RS resource set with two CSI-RS resources. UE is configured to perform RLM and BFD based on SSB 0 and 1. CSI-RS is not transmitted in the same OFDM symbols as SSB.

Table A.4.7.4.2.2-1: FR1 CSI-RS based L1-RSRP test parameters

Parameter	Config	Unit	Test 1	Test 2
SSB GSCN	1~6		freq1	freq1
Duplex mode	1,4		FDD	FDD
	2,5		TDD	TDD
	3,6		TDD	TDD
TDD Configuration	1,4		N/A	N/A
	2,5		TDDConf.1.1	TDDConf.1.1
	3,6		TDDConf.2.1	TDDConf.2.1
BW _{channel}	1,4	MHz	10: N _{RB,c} = 52	10: N _{RB,c} = 52
	2,5		10: N _{RB,c} = 52	10: N _{RB,c} = 52
	3,6		40: N _{RB,c} = 106	40: N _{RB,c} = 106
PDSCH Reference measurement channel	1,4		SR.1.1 FDD	SR.1.1 FDD
	2,5		SR.1.1 TDD	SR.1.1 TDD
	3,6		SR.2.1 TDD	SR.2.1 TDD
RMSI CORESET Reference Channel	1,4		CR.1.1 FDD	CR.1.1 FDD
	2,5		CR.1.1 TDD	CR.1.1 TDD
	3,6		CR.2.1 TDD	CR.2.1 TDD
Dedicated CORESET Reference Channel	1,4		CCR.1.1 FDD	CCR.1.1 FDD
	2,5		CCR.1.1 TDD	CCR.1.1 TDD
	3,6		CCR.2.1 TDD	CCR.2.1 TDD
SSB configuration	1,4		SSB.1 FR1	SSB.1 FR1
	2,5		SSB.1 FR1	SSB.1 FR1
	3,6		SSB.2 FR1	SSB.2 FR1
OCNG Patterns	1~6		OP.1	OP.1
Initial BWP Configuration	1~6		DLBWP.0.1	DLBWP.0.1

				ULBWP.0.1	ULBWP.0.1
Dedicated BWP configuration	1~6			DLBWP.1.1 ULBWP.1.1	DLBWP.1.1 ULBWP.1.1
SMTTC configuration	1~6			SMTTC.1	SMTTC.1
CSI-RS	1,4			CSI-RS 1.2 FDD	CSI-RS 1.2 FDD
	2,5			CSI-RS 1.2 TDD	CSI-RS 1.2 TDD
	3,6			CSI-RS 2.2 TDD	CSI-RS 2.2 FDD
reportConfigType	1~6			periodic	periodic
reportQuantity	1~6			cri-RSRP	cri-RSRP
Number of reported RS	1~6			2	2
L1-RSRP reporting period	1~6			slot80	slot80
EPRE ratio of PSS to SSS	1~6	dB	0	0	0
EPRE ratio of PBCH DMRS to SSS					
EPRE ratio of PBCH to PBCH DMRS					
EPRE ratio of PDCCH DMRS to SSS					
EPRE ratio of PDCCH to PDCCH DMRS					
EPRE ratio of PDSCH DMRS to SSS					
EPRE ratio of PDSCH to PDSCH DMRS					
EPRE ratio of OCNG DMRS to SSS ^{Note 1}					
EPRE ratio of OCNG to OCNG DMRS ^{Note 1}					
N_{oc} <small>Note2</small>	NR_FDD_FR1_A, NR_TDD_FR1_A	1~6	dBm/15kHz	-94.65	-117
	NR_FDD_FR1_B				-116.5
	NR_TDD_FR1_C				-116
	NR_FDD_FR1_D, NR_TDD_FR1_D				-115.5
	NR_FDD_FR1_E, NR_TDD_FR1_E				-115
	NR_FDD_FR1_G				-114
	NR_FDD_FR1_H				-113.5
	N_{oc} <small>Note2</small>				NR_FDD_FR1_A, NR_TDD_FR1_A
NR_FDD_FR1_B		-116.5			
NR_TDD_FR1_C		-116			
NR_FDD_FR1_D, NR_TDD_FR1_D		-115.5			
NR_FDD_FR1_E, NR_TDD_FR1_E		-115			
NR_FDD_FR1_G		-114			
NR_FDD_FR1_H		-113.5			
NR_FDD_FR1_A, NR_TDD_FR1_A		3,6	-91.65	-114	
NR_FDD_FR1_B				-113.5	
NR_TDD_FR1_C				-114	
NR_FDD_FR1_D, NR_TDD_FR1_D				-112.5	
NR_FDD_FR1_E, NR_TDD_FR1_E				-112	
NR_FDD_FR1_G				-111	
NR_FDD_FR1_H				-110.5	
\hat{E}_s/I_{ot}				1~6	dB
CSI-RS RSRP <small>Note3</small>		NR_FDD_FR1_A, NR_TDD_FR1_A	1,2,4,5	dBm/CSI-RS SCS	-84.65
	NR_FDD_FR1_B	-119.5			
	NR_TDD_FR1_C	-119			
	NR_FDD_FR1_D, NR_TDD_FR1_D	-118.5			

	NR_FDD_FR1_E, NR_TDD_FR1_E				-118			
	NR_FDD_FR1_G				-117			
	NR_FDD_FR1_H				-116.5			
	NR_FDD_FR1_A, NR_TDD_FR1_A	3,6		-81.65	-117			
	NR_FDD_FR1_B				-116.5			
	NR_TDD_FR1_C				-116			
	NR_FDD_FR1_D, NR_TDD_FR1_D				-115.5			
	NR_FDD_FR1_E, NR_TDD_FR1_E				-115			
	NR_FDD_FR1_G				-114			
	NR_FDD_FR1_H				-113.5			
I _o Note3	NR_FDD_FR1_A, NR_TDD_FR1_A				1,2,4,5	dBm/9.36 MHz	-56.28	-87.28
	NR_FDD_FR1_B							-86.78
	NR_TDD_FR1_C	-86.28						
	NR_FDD_FR1_D, NR_TDD_FR1_D	-85.78						
	NR_FDD_FR1_E, NR_TDD_FR1_E	-85.28						
	NR_FDD_FR1_G	-84.28						
	NR_FDD_FR1_H	-83.78						
	NR_FDD_FR1_A, NR_TDD_FR1_A	3,6	dBm/38.16 MHz	-50.19	-81.19			
	NR_FDD_FR1_B				-80.69			
	NR_TDD_FR1_C				-80.19			
	NR_FDD_FR1_D, NR_TDD_FR1_D				-79.69			
	NR_FDD_FR1_E, NR_TDD_FR1_E				-79.19			
	NR_FDD_FR1_G				-78.19			
	NR_FDD_FR1_H	-77.69						
	\hat{E}_s / N_{oc}	1~6	dB	10	-3			
	Propagation condition	1~6		AWGN	AWGN			
	Note 1:	OCNG shall be used such that both cells are fully allocated and a constant total transmitted power spectral density is achieved for all OFDM symbols.						
	Note 2:	Interference from other cells and noise sources not specified in the test is assumed to be constant over subcarriers and time and shall be modelled as AWGN of appropriate power for N_{oc} to be fulfilled.						
Note 3:	RSRP and I _o levels have been derived from other parameters for information purposes. They are not settable parameters themselves.							
Note 4:	RSRP minimum requirements are specified assuming independent interference and noise at each receiver antenna port.							

A.4.7.4.2.3 Test Requirements

The L1-RSRP measurement accuracy for CSI-RS#0 and CSI-RS#1 of Cell 2 shall fulfil the requirements in sections 10.1.19.2.

A.4.7.5 SFTD accuracy

A.4.7.5.1 Test Purpose and Environment

The purpose of this set of tests is to verify that the SFTD measurement accuracy is within the specified limits. This test will verify the requirements as specified in section 9.1.27 in TS 36.133 [15] for EN-DC SFTD measurements.

A.4.7.5.2 Test Requirements

Supported test configurations are shown in Table A.4.7.5.2-1. In this set of test cases there are two cells on different carriers. Cell 1 is E-UTRAN PCell and Cell 2 is NR FR1 PCell. The test parameters of cell 1 are given in section A.3.7.2.1. The test parameters of cell 2 are given in Table A.4.7.5.2-2. The SFTD between PCell and PCell shall be set by the test equipment to one of the time differences in Table A.4.7.5.2-3.

Table A.4.7.5.2-1: Supported test configurations for SFTD accuracy

Configuration	Description
1	NR 15 kHz SSB SCS, 10MHz bandwidth, FDD duplex mode, LTE FDD
2	NR 15 kHz SSB SCS, 10MHz bandwidth, TDD duplex mode, LTE FDD
3	NR 30 kHz SSB SCS, 40MHz bandwidth, TDD duplex mode, LTE FDD
4	NR 15 kHz SSB SCS, 10MHz bandwidth, FDD duplex mode, LTE TDD
5	NR 15 kHz SSB SCS, 10MHz bandwidth, TDD duplex mode, LTE TDD
6	NR 30kHz SSB SCS, 40MHz bandwidth, TDD duplex mode, LTE TDD

Note: The UE is only required to be tested in one of the supported test configurations

Table A.4.7.5.2-2: Test parameters for SFTD accuracy

Parameter	Config	Unit	Test 1
SSB GSCN	1~6		freq1
Duplex mode	1,4		FDD
	2,5		TDD
	3,6		TDD
TDD Configuration	1,4		N/A
	2,5		TDDConf.1.1
	3,6		TDDConf.2.1
BW _{channel}	1,4	MHz	10: N _{RB,c} = 52
	2,5		10: N _{RB,c} = 52
	3,6		40: N _{RB,c} = 106
PDSCH Reference measurement channel	1,4		SR.1.1 FDD
	2,5		SR.1.1 TDD
	3,6		SR.2.1 TDD
RMSI CORESET Reference Channel	1,4		CR.1.1 FDD
	2,5		CR.1.1 TDD
	3,6		CR.2.1 TDD
RMC CORESET Reference Channel	1,4		CCR.1.1 FDD
	2,5		CCR.1.1 TDD
	3,6		CCR.2.1 TDD
SSB configuration	1,4		SSB.1 FR1
	2,5		SSB.1 FR1
	3,6		SSB.2 FR1
SMTc configuration	1~6		SMTc.1
DL BWP configuration	1~6		DLBWP.1.1
UL BWP configuration	1~6		ULBWP.1.1
OCNG Patterns	1~6		OP.1
EPRE ratio of PSS to SSS	1~6	dB	0
EPRE ratio of PBCH DMRS to SSS			
EPRE ratio of PBCH to PBCH DMRS			
EPRE ratio of PDCCH DMRS to SSS			
EPRE ratio of PDCCH to PDCCH DMRS			
EPRE ratio of PDSCH DMRS to SSS			
EPRE ratio of PDSCH to PDSCH DMRS			
EPRE ratio of OCNG DMRS to SSS ^{Note 1}			
EPRE ratio of OCNG to OCNG DMRS ^{Note 1}			
N _{oc} ^{Note 2}	1~6	dBm/15kHz	-104

	NR_TDD_FR1_C			
	NR_FDD_FR1_D, NR_TDD_FR1_D			
	NR_FDD_FR1_E, NR_TDD_FR1_E			
	NR_FDD_FR1_G			
	NR_FDD_FR1_H			
N_{oc} <small>Note2</small>	NR_FDD_FR1_A, NR_TDD_FR1_A	1,2,4,5	dBm/SSB SCS	-104
	NR_FDD_FR1_B			
	NR_TDD_FR1_C			
	NR_FDD_FR1_D, NR_TDD_FR1_D			
	NR_FDD_FR1_E, NR_TDD_FR1_E			
	NR_FDD_FR1_G			
	NR_FDD_FR1_H			
	NR_FDD_FR1_A, NR_TDD_FR1_A	3,6		-101
	NR_FDD_FR1_B			
	NR_TDD_FR1_C			
	NR_FDD_FR1_D, NR_TDD_FR1_D			
	NR_FDD_FR1_E, NR_TDD_FR1_E			
	NR_FDD_FR1_G			
	NR_FDD_FR1_H			
\hat{E}_s / I_{ot}	1-6	dB	-3	
\hat{E}_s / N_{oc}	1-6	dB	-3	
SS-RSRP <small>Note3</small>	NR_FDD_FR1_A, NR_TDD_FR1_A	1,2,4,5	dBm/SCS	-107
	NR_FDD_FR1_B			
	NR_TDD_FR1_C			
	NR_FDD_FR1_D, NR_TDD_FR1_D			
	NR_FDD_FR1_E, NR_TDD_FR1_E			
	NR_FDD_FR1_G			
	NR_FDD_FR1_H			
	NR_FDD_FR1_A, NR_TDD_FR1_A	3,6		-104
	NR_FDD_FR1_B			
	NR_TDD_FR1_C			
	NR_FDD_FR1_D, NR_TDD_FR1_D			
	NR_FDD_FR1_E, NR_TDD_FR1_E			
	NR_FDD_FR1_G			
	NR_FDD_FR1_H			
I_o <small>Note3</small>	NR_FDD_FR1_A, NR_TDD_FR1_A	1,2,4,5	dBm/9.36 MHz	-74.28
	NR_FDD_FR1_B			
	NR_TDD_FR1_C			
	NR_FDD_FR1_D, NR_TDD_FR1_D			
	NR_FDD_FR1_E, NR_TDD_FR1_E			
	NR_FDD_FR1_G			
	NR_FDD_FR1_H			
	NR_FDD_FR1_A, NR_TDD_FR1_A	3,6	dBm/38.16 MHz	-68.18
	NR_FDD_FR1_B			
	NR_TDD_FR1_C			

	NR_FDD_FR1_D, NR_TDD_FR1_D			
	NR_FDD_FR1_E, NR_TDD_FR1_E			
	NR_FDD_FR1_G			
	NR_FDD_FR1_H			
Propagation condition		1~6		AWGN
Antenna configuration		1~6		1x2
Note 1:	OCNG shall be used such that both cells are fully allocated and a constant total transmitted power spectral density is achieved for all OFDM symbols.			
Note 2:	Interference from other cells and noise sources not specified in the test is assumed to be constant over subcarriers and time and shall be modelled as AWGN of appropriate power for N_{oc} to be fulfilled.			
Note 3:	SS-RSRP and l_0 levels have been derived from other parameters for information purposes. They are not settable parameters themselves.			
Note 4:	SS-RSRP minimum requirements are specified assuming independent interference and noise at each receiver antenna port.			

Table A.4.7.5.2-3: Timing offsets for SFTD accuracy test

Configuration	SFN offset between PCell and PSCell	Frame boundary offset between PCell and PSCell (Ts)
1	100	-122000
2	300	-60540
3	500	1000
4	700	62540
5	900	124000

A.4.7.5.3 Test Requirements

The SFTD reported by the UE consists of 2 elements, SFN offset and frame boundary offset between PCell and PSCell. The reported SFTD accuracy shall fulfil the requirement in section 9.1.27 in TS 36.133 [15].

A.4.8 Void

A.5 EN-DC tests with one or more NR cells in FR2

A.5.1 Void

A.5.2 Void

A.5.3 RRC_CONNECTED state mobility

A.5.3.1 Void

A.5.3.2 RRC Connection Mobility Control

A.5.3.2.1 Void

A.5.3.2.2 Random Access

A.5.3.2.2.1 Contention based random access test in FR2 for PSCell/SCell in EN-DC

A.5.3.2.2.1.1 Test Purpose and Environment

The purpose of this test is to verify that the behavior of the random access procedure is according to the requirements and that the PRACH power settings and timing are within specified limits. This test will verify the requirements in Clause 6.2.2.2 and Clause 7.1.2 in an AWGN model.

For this test two cells are used, with the configuration of Cell 1 (E-UTRA PCell) specified in section A.3.7.2.1 and Cell 2 configured as PSCell or SCell in FR2. Supported test parameters are shown in Table A.5.3.2.2.1.1-1. UE capable of EN-DC with PSCell or SCell in FR2 needs to be tested by using the parameters in Table A.5.3.2.2.1.1-2 and Table A.5.3.2.2.1.1-3.

Table A.5.3.2.2.1.1-1: Supported test configurations for non-contention based random access test in FR2 for PSCell/SCell in EN-DC

Config	Description
1	LTE FDD, NR PSCell/SCell 120 kHz SSB SCS, 100MHz bandwidth, TDD duplex mode
2	LTE TDD, NR PSCell/SCell 120 kHz SSB SCS, 100MHz bandwidth, TDD duplex mode
Note:	The UE is only required to be tested in one of the supported test configurations depending on UE capability

Table A.5.3.2.2.1-2: General test parameters for contention based random access test in FR2 for PSCell/SCell in EN-DC

Parameter		Unit	Test-1	Comments
SSB Configuration	Config 1,2		SSB pattern 1 in FR2	As defined in A.3.10, except for number of SSBs per SS-burst and SS/PBCH block index as below
Number of SSBs per SS-burst			2	Different from the definition in A.3.10
SS/PBCH block index			0,1	Different from the definition in A.3.10
Duplex Mode for Cell 2	Config 1,2		TDD	
TDD Configuration	Config 1,2		TDDConf.3.1	
OCNG Pattern ^{Note 1}			OCNG pattern 1	As defined in A.3.2.1.
PDSCH parameters _{Note 2}	Config 1,2		SR3.1 TDD	As defined in A.3.1.1.
NR RF Channel Number			1	
EPRE ratio of PSS to SSS		dB	0	
EPRE ratio of PBCH_DMRS to SSS		dB		
EPRE ratio of PBCH to PBCH_DMRS		dB		
EPRE ratio of PDCCH_DMRS to SSS		dB		
EPRE ratio of PDCCH to PDCCH_DMRS		dB		
EPRE ratio of PDSCH_DMRS to SSS		dB		
EPRE ratio of PDSCH to PDSCH_DMRS		dB		
<p>Note 1: OCNG shall be used such that the cell is fully allocated and a constant total transmitted power spectral density is achieved for all OFDM symbols. The OCNG pattern is chosen during the test according to the presence of a DL reference measurement channel.</p> <p>Note 2: The DL PDSCH reference measurement channel is used in the test only when a downlink transmission dedicated to the UE under test is required.</p>				

Table A.5.3.2.2.1.1-3: OTA-related test parameters for contention based random access test in FR2 for PSCell/SCell in EN-DC

Parameter		Unit	Test-1	Comments
AoA setup			TBD	As defined in A.x.
SSB with index 0	\hat{E}_s / I_{ot}	dB	3	SSB with index 0 is signalled to be above configured <i>rsrp-ThresholdSSB</i>
	N_{oc} Config 1,2	dBm/15kHz	TBD	
	\hat{E}_s / N_{oc}	dB	3	
	SS-RSRP ^{Note 2}	dBm/ SCS	TBD	
SSB with index 1	\hat{E}_s / I_{ot}	dB	-17	SSB with index 1 is signalled to be below configured <i>rsrp-ThresholdSSB</i>
	N_{oc} Config 1,2	dBm/15kHz	TBD	
	\hat{E}_s / N_{oc}	dB	-17	
	SS-RSRP ^{Note 2}	dBm/ SCS	TBD	
I_o ^{Note 1} Config 1,2	dBm	TBD	For symbols without SSB index 1	
ss-PBCH-BlockPower		dBm/ SCS	TBD	As defined in clause 6.3.2 in TS 38.331 [2].
Configured UE transmitted power ($P_{CMAX, f, c}$)		dBm	TBD	As defined in clause 6.2.4 in TS 38.101-2.
PRACH Configuration			FR2 PRACH configuration 1	As defined in A.3.8.3.
Propagation Condition		-	AWGN	
Note 1: I_o level has been derived from other parameters for information purpose. It is not a settable parameter.				
Note 2: RSRP level has been derived from other parameters for information purposes. It is not a settable parameter.				

A.5.3.2.2.1.2 Test Requirements

Contention based random access is triggered by *not* explicitly assigning a random access preamble via dedicated signalling in the downlink.

A.5.3.2.2.1.2.1 Random Access Preamble Transmission

To test the UE behavior specified in Subclause 6.2.2.2.1.1 the System Simulator shall receive the Random Access Preamble which belongs to one of the Random Access Preambles associated with the SSB with index 0, which has SS-RSRP above the configured *rsrp-ThresholdSSB*.

In addition, the power applied to all preambles shall be in accordance with what is specified in Subclause 6.2.2.2. The power of the first preamble shall be [TBD] dBm with an accuracy specified in clause 6.3.4.2 of TS 38.101-2 [19]. The relative power applied to additional preambles shall have an accuracy specified in clause 6.3.4.3 of TS 38.101-2 [19].

The transmit timing of all PRACH transmissions shall be within the accuracy specified in Subclause 7.1.2.

A.5.3.2.2.1.2.2 Random Access Response Reception

To test the UE behavior specified in Subclause 6.2.2.2.1.2 the System Simulator shall transmit a Random Access Response containing a Random Access Preamble identifier corresponding to the transmitted Random Access Preamble after 5 preambles have been received by the System Simulator. In response to the first 4 preambles, the System Simulator shall transmit a Random Access Response *not* corresponding to the transmitted Random Access Preamble.

The UE may stop monitoring for Random Access Response(s) and shall transmit the msg3 if the Random Access Response contains a Random Access Preamble identifier corresponding to the transmitted Random Access Preamble.

The UE shall again perform the Random Access Resource selection procedure specified in clause 5.1.2 in TS38.321 [7], and transmit with the calculated PRACH transmission power when the backoff time expires if all received Random Access Responses contain Random Access Preamble identifiers that do not match the transmitted Random Access Preamble.

In addition, the power applied to all preambles shall be in accordance with what is specified in Subclause 6.2.2.2. The power of the first preamble shall be [TBD] dBm with an accuracy specified in clause 6.3.4.2 of TS 38.101-2 [19]. The relative power applied to additional preambles shall have an accuracy specified in clause 6.3.4.3 of TS 38.101-2 [19].

The transmit timing of all PRACH transmissions shall be within the accuracy specified in Subclause 7.1.2.

A.5.3.2.2.1.2.3 No Random Access Response Reception

To test the UE behavior specified in subclause 6.2.2.2.1.3 the System Simulator shall transmit a Random Access Response containing a Random Access Preamble identifier corresponding to the transmitted Random Access Preamble after 5 preambles have been received by the System Simulator. The System Simulator shall *not* respond to the first 4 preambles.

The UE shall again perform the Random Access Resource selection procedure specified in clause 5.1.2 in TS38.321 [7], and transmit with the calculated PRACH transmission power when the backoff time expires if no Random Access Response is received within the RA Response window.

In addition, the power applied to all preambles shall be in accordance with what is specified in Subclause 6.2.2.2. The power of the first preamble shall be [TBD] dBm with an accuracy specified in clause 6.3.4.2 of TS 38.101-2 [19]. The relative power applied to additional preambles shall have an accuracy specified in clause 6.3.4.3 of TS 38.101-2 [19].

The transmit timing of all PRACH transmissions shall be within the accuracy specified in Subclause 7.1.2.

A.5.3.2.2.1.2.4 Receiving a NACK on msg3

To test the UE behavior specified in subclause 6.2.2.2.1.4 the System Simulator shall NACK *all* UE msg3 following a successful Random Access Response.

The UE shall re-transmit the msg3 upon the reception of a NACK on msg3 until the maximum number of HARQ re-transmissions is reached.

A.5.3.2.2.1.2.5 Reception of an Incorrect Message over Temporary C-RNTI

To test the UE behavior specified in Subclause 6.2.2.2.1.5 the System Simulator shall send a message addressed to the temporary C-RNTI with a UE Contention Resolution Identity included in the MAC control element *not* matching the CCCH SDU transmitted in msg3 uplink message.

The UE shall again perform the Random Access Resource selection procedure specified in clause 5.1.2 in TS38.321 [7], and transmit with the calculated PRACH transmission power when the backoff time expires unless the received message includes a UE Contention Resolution Identity MAC control element and the UE Contention Resolution Identity included in the MAC control element matches the CCCH SDU transmitted in the uplink message.

A.5.3.2.2.1.2.6 Reception of a Correct Message over Temporary C-RNTI

To test the UE behavior specified in Subclause 6.2.2.2.1.5 the System Simulator shall send a message addressed to the temporary C-RNTI with a UE Contention Resolution Identity included in the MAC control element matching the CCCH SDU transmitted in the msg3 uplink message.

The UE shall send ACK if the Contention Resolution is successful.

A.5.3.2.2.1.2.7 Contention Resolution Timer expiry

To test the UE behavior specified in Subclause 6.2.2.2.1.6 the System Simulator shall *not* send a response to a msg3.

The UE shall again perform the Random Access Resource selection procedure specified in clause 5.1.2 in TS38.321 [7], and transmit with the calculated PRACH transmission power when the backoff time expires if the Contention Resolution Timer expires.

A.5.3.2.2.2 Non-contention based random access test in FR2 for PSCell/SCell in EN-DC

A.5.3.2.2.2.1 Test Purpose and Environment

The purpose of this test is to verify that the behavior of the random access procedure is according to the requirements and that the PRACH power settings and timing are within specified limits. This test will verify the requirements in Clause 6.2.2.2 and Clause 7.1.2 in an AWGN model.

For this test two cells are used, with the configuration of Cell 1 (E-UTRA PCell) specified in section A.3.7.2.1 and Cell 2 configured as PSCell or SCell in FR2. Supported test parameters are shown in Table A.5.3.2.2.1-1. UE capable of EN-DC with PSCell in FR1 needs to be tested by using the parameters in Table A.5.3.2.2.1-2 for SSB-based non-contention based random access test (Test 1) and CSI-RS-based non-contention based random access test (Test 2).

Table A.5.3.2.2.1-1: Supported test configurations for non-contention based random access test in FR2 for PSCell/SCell in EN-DC

Config	Description
1	LTE FDD, NR PSCell/SCell 120 kHz SSB SCS, 100MHz bandwidth, TDD duplex mode
2	LTE TDD, NR PSCell/SCell 120 kHz SSB SCS, 100MHz bandwidth, TDD duplex mode
Note:	The UE is only required to be tested in one of the supported test configurations depending on UE capability

Table A.5.3.2.2.1-2: General test parameters for non-contention based random access test in FR2 for PSCell/SCell in EN-DC

Parameter		Unit	Test-1	Test-2	Comments
SSB Configuration	Config 1,2		SSB pattern 1 in FR2	SSB pattern 1 in FR2	As defined in A.3.10, except of Number of SSBs per SS-burst and SS/PBCH block index as below
Number of SSBs per SS-burst			2	2	Different from the definition in A.3.10
SS/PBCH block index			0,1	0,1	Different from the definition in A.3.10
CSI-RS Configuration	Config 1,2		N/A	CSI-RS.3.1 TDD	As defined in A.3.1.4
Duplex Mode for Cell 2	Config 1,2		TDD	TDD	
TDD Configuration	Config 1,2		TDDConf.3.1	TDDConf.3.1	
OCNG Pattern ^{Note 1}			OCNG pattern 1	OCNG pattern 1	As defined in A.3.2.1.
PDSCH parameters ^{Note 2}	Config 1,2		SR3.1 TDD	SR3.1 TDD	As defined in A.3.1.1.
NR RF Channel Number			1	1	
EPRE ratio of PSS to SSS		dB	0	0	
EPRE ratio of PBCH_DMRS to SSS		dB			
EPRE ratio of PBCH to PBCH_DMRS		dB			
EPRE ratio of PDCCH_DMRS to SSS		dB			
EPRE ratio of PDCCH to PDCCH_DMRS		dB			
EPRE ratio of PDSCH_DMRS to SSS		dB			
EPRE ratio of PDSCH to PDSCH_DMRS		dB			
<p>Note 1: OCNG shall be used such that the cell is fully allocated and a constant total transmitted power spectral density is achieved for all OFDM symbols. The OCNG pattern is chosen during the test according to the presence of a DL reference measurement channel.</p> <p>Note 2: The DL PDSCH reference measurement channel is used in the test only when a downlink transmission dedicated to the UE under test is required.</p>					

Table A.5.3.2.2.1-3: OTA-related test parameters for non-contention based random access test in FR2 for PSCell/SCell in EN-DC

Parameter		Unit	Test-1	Test-2	Comments
AoA setup			TBD	TBD	As defined in A.x.
SSB with index 0	\hat{E}_s / I_{ot}	dB	3	3	SSB with index 0 is signalled to be above configured <i>rsrp-ThresholdSSB</i>
	N_{oc} Config 1,2	dBm/15kHz	TBD	TBD	
	\hat{E}_s / N_{oc}	dB	3	3	
	SS-RSRP ^{Note 2}	dBm/ SCS	TBD	TBD	
SSB with index 1	\hat{E}_s / I_{ot}	dB	-17	-17	SSB with index 1 is signalled to be below configured <i>rsrp-ThresholdSSB</i>
	N_{oc} Config 1,2	dBm/15kHz	TBD	TBD	
	\hat{E}_s / N_{oc}	dB	-17	-17	
	SS-RSRP ^{Note 2}	dBm/ SCS	TBD	TBD	
I_0 ^{Note 1}	Config 1,2	dBm	TBD	TBD	For symbols without SSB index 1
ss-PBCH-BlockPower		dBm/ SCS	TBD	TBD	As defined in clause 6.3.2 in TS 38.331 [2].
Configured UE transmitted power ($P_{CMAX, f, c}$)		dBm	TBD	TBD	As defined in clause 6.2.4 in TS 38.101-2.
PRACH Configuration			FR2 PRACH configuration 2	FR2 PRACH configuration 3	As defined in A.3.8.3.
Propagation Condition		-	AWGN	AWGN	
Note 1: I_0 level has been derived from other parameters for information purpose. It is not a settable parameter. Note 2: RSRP level has been derived from other parameters for information purposes. It is not a settable parameter.					

A.5.3.2.2.2.2 Test Requirements

Non-Contention based random access is triggered by explicitly assigning a random access preamble via dedicated signalling in the downlink. In the test, the non-contention based random access procedure is not initialized for Other SI requested from UE or beam failure recovery.

A.5.3.2.2.2.2.1 SSB-based Random Access Preamble Transmission

In Test-1, to test the UE behavior specified in Subclause 6.2.2.2.1 for SSB-based Random Access Preamble transmission, with the contention-free Random Access Resources and the contention-free PRACH occasions associated with SSBs configured, the System Simulator shall receive the Random Access Preamble which has the Preamble Index associated with the SSB with index 0.

In addition, the System Simulator shall receive the Random Access Preamble on the PRACH occasion which belongs to the PRACH occasions corresponding to the SSB with index 0, and the selected PRACH occasion shall belong to the PRACH occasions permitted by the restrictions given by the *ra-ssb-OccasionMaskIndex*.

In addition, the power applied to all preambles shall be in accordance with what is specified in Subclause 6.2.2.2. The power of the first preamble shall be [TBD] dBm with an accuracy specified in clause 6.3.4.2 of TS 38.101-2 [19]. The relative power applied to additional preambles shall have an accuracy specified in clause 6.3.4.3 of TS 38.101-2 [19].

The transmit timing of all PRACH transmissions shall be within the accuracy specified in Subclause 7.1.2.

A.5.3.2.2.2.2.2 CSI-RS-based Random Access Preamble Transmission

In Test-2, to test the UE behavior specified in Subclause 6.2.2.2.1 for CSI-RS-based Random Access Preamble transmission, with the contention-free Random Access Resources and the contention-free PRACH occasions

associated with CSI-RSs configured, the System Simulator shall receive the Random Access Preamble which has the Preamble Index associated with the CSI-RS configured.

In addition, the System Simulator shall receive the Random Access Preamble on the PRACH occasion which belongs to the PRACH occasions corresponding to the CSI-RS configured, and the selected PRACH occasion shall belong to the PRACH occasions permitted by the restrictions given by the *ra-OccasionList*.

In addition, the power applied to all preambles shall be in accordance with what is specified in Subclause 6.2.2.2. The power of the first preamble shall be [TBD] dBm with an accuracy specified in clause 6.3.4.2 of TS 38.101-2 [19]. The relative power applied to additional preambles shall have an accuracy specified in clause 6.3.4.3 of TS 38.101-2 [19].

The transmit timing of all PRACH transmissions shall be within the accuracy specified in Subclause 7.1.2.

A.5.3.2.2.2.3 Random Access Response Reception

To test the UE behavior specified in Subclause 6.2.2.2.2 the System Simulator shall transmit a Random Access Response containing a Random Access Preamble identifier corresponding to the transmitted Random Access Preamble after 5 preambles have been received by the System Simulator. In response to the first 4 preambles, the System Simulator shall transmit a Random Access Response *not* corresponding to the transmitted Random Access Preamble.

The UE may stop monitoring for Random Access Response(s) if the Random Access Response contains a Random Access Preamble identifier corresponding to the transmitted Random Access Preamble.

The UE shall again perform the Random Access Resource selection procedure specified in clause 5.1.2 in TS38.321 [7], and transmit with the calculated PRACH transmission power if all received Random Access Responses contain Random Access Preamble identifiers that do not match the transmitted Random Access Preamble.

In addition, the power applied to all preambles shall be in accordance with what is specified in Subclause 6.2.2.2. The power of the first preamble shall be [TBD] dBm with an accuracy specified in clause 6.3.4.2 of TS 38.101-2 [19]. The relative power applied to additional preambles shall have an accuracy specified in clause 6.3.4.3 of TS 38.101-2 [19].

The transmit timing of all PRACH transmissions shall be within the accuracy specified in Subclause 7.1.2.

A.5.3.2.2.2.4 No Random Access Response Reception

To test the UE behavior specified in subclause 6.2.2.2.3 the System Simulator shall transmit a Random Access Response containing a Random Access Preamble identifier corresponding to the transmitted Random Access Preamble after 5 preambles have been received by the System Simulator. The System Simulator shall *not* respond to the first 4 preambles.

The UE shall again perform the Random Access Resource selection procedure specified in clause 5.1.2 in TS38.321 [7], and transmit with the calculated PRACH transmission power when the backoff time expires if no Random Access Response is received within the RA Response window configured in *RACH-ConfigCommon*.

In addition, the power applied to all preambles shall be in accordance with what is specified in Subclause 6.2.2.2. The power of the first preamble shall be [TBD] dBm with an accuracy specified in clause 6.3.4.2 of TS 38.101-2 [19]. The relative power applied to additional preambles shall have an accuracy specified in clause 6.3.4.3 of TS 38.101-2 [19].

The transmit timing of all PRACH transmissions shall be within the accuracy specified in Subclause 7.1.2.

A.5.3.2.3 Void

A.5.4 Timing

A.5.4.1 UE transmit timing

A.5.4.1.1 NR UE Transmit Timing Test for FR2

A.5.4.1.1.1 Test Purpose and environment

The purpose of this test is to verify that the UE can follow frame timing change of the connected gNodeB and that the UE initial transmit timing accuracy, maximum amount of timing change in one adjustment, minimum and maximum adjustment rate are within the specified limits. This test will verify the requirements in clause 7.1.2.

Supported test configurations are shown in Table 5.4.1.1.1-1.

Table A.5.4.1.1.1-1: Supported test configurations for FR2 PSCell

Configuration	Description
1	TDD, SSB SCS 240 KHz, data SCS 120kHz, BW 100MHz

For this test a single NR cell is used. Table A.5.4.1.1.1-2 defines the parameters to be configured and strength of the transmitted signals. The transmit timing is verified by the UE transmitting SRS using the configuration defined in Table A.5.4.1.1.1-3.

Table A.5.4.1.1.1-2: Cell Specific Test Parameters for UL Transmit Timing test

Parameter	Unit	Config	Test1	Test2	Band Group
SSB ARFCN		1	Freq1	Freq1	
Duplex Mode		1	TDD		
TDD configuration		1	TDDConf.1.2		
BW _{channel}	MHz	1	100: NRB,c = 66		
Initial BWP Configuration		1	DLBWP.0.1 ULBWP.0.1		
Dedicated BWP Configuration		1	DLBWP.1.1 ULBWP.1.1		
TRS Configuration		1	TRS.2.1 TDD		
TCI State		1	CSI-RS.Config.0		
DRx Cycle	ms	1	N/A	DRX.5 ^{Note5}	
PDSCH Reference measurement channel		1	SR.3.1 TDD		

CORESET Reference Channel		1	CR.3.1 TDD		
OCNG Patterns		1	OCNG pattern 1		
SMTC configuration		1	FR2 pattern 2		
PDSCH/PDCCH subcarrier spacing	kHz	1	120		
EPRE ratio of PSS to SSS	dB	1	0	0	
EPRE ratio of PBCH DMRS to SSS					
EPRE ratio of PBCH to PBCH DMRS					
EPRE ratio of PDCCH DMRS to SSS					
EPRE ratio of PDCCH to PDCCH DMRS					
EPRE ratio of PDSCH DMRS to SSS					
EPRE ratio of PDSCH to PDSCH					
EPRE ratio of OCNG DMRS to SSS(Note 1)					
EPRE ratio of OCNG to OCNG DMRS (Note 1)					
N_{oc} ^{Note2}	dBm/15 kHz	1	TBD	TBD	
N_{oc} ^{Note2}	dBm/SCS	1	TBD	TBD	
\hat{E}_s/I_{ot}		1	3	3	
\hat{E}_s/N_{oc}		1	3	3	
SS-RSRP ^{Note3}	dBm/SCS	1	TBD	TBD	
I_o ^{Note3}	dBm/95MHz	1	TBD	TBD	
Propagation condition		1	AWGN		
SRS Config		1	Config1 ^{Note6}	Config2 ^{Note6}	
<p>Note 1: OCNG shall be used such that both cells are fully allocated and a constant total transmitted power spectral density is achieved for all OFDM symbols.</p> <p>Note 2: Interference from other cells and noise sources not specified in the test is assumed to be constant over subcarriers and time and shall be modelled as AWGN of appropriate power for N_{oc} to be fulfilled.</p> <p>Note 3: SS-RSRP and I_o levels have been derived from other parameters for information purposes. They are not settable parameters themselves.</p> <p>Note 4: SS-RSRP minimum requirements are specified assuming independent interference and noise at each receiver antenna port.</p> <p>Note 5: DRX related parameters are given in Table A.3.3.4-1</p> <p>Note 6: SRS configs are given in Table A.5.4.1.1.1-3</p>					

Table A.5.4.1.1-3: SRS Configuration for Timing Accuracy Test

	Field	Config1	Config 2	Comments
SRS-ResourceSet	srs-ResourceSetId	0	0	
	srs-ResourceSetList	0	0	
	resourceType	Periodic	Periodic	
	Usage	Codebook	Codebook	
SRS-Resource	SRS-ResourceSetId	0	0	
	nrofSRS-Ports	Port1	Port1	
	transmissionComb	n2	n2	
	combOffset-n2	0	0	
	cyclicShift-n2	0	0	
	resourceMapping startPosition	0	0	
	resourceMapping nrofSymbols	n1	n1	
	resourceMapping repetitionFactor	n1	n1	
	freqDomainPosition	0	0	
	freqDomainShift	0	0	
	freqHopping c-SRS	sl1	sl1	
	freqHopping b-SRS	0	0	
	freqHopping b-hop	0	0	
	groupOrSequenceHopping	Neither	Neither	
	resourceType	Periodic	Periodic	
	periodicityAndOffset-p	sl1	sl640	Offset to align with DRx periodicity
	sequenceId	0	0	Any 10 bit number

Table A.5.4.1.1-4: Void**A.5.4.1.1.2 Test requirements**

The test sequence shall be carried out in RRC_CONNECTED for every test case.

Following will be the test sequence for this test

- 1) Set up E-UTRA PCell according to parameters given in Table A.3.7.2.1-1 and setup NR PCell according to parameters given in Table A.5.4.1.1-1.
- 2) After connection set up with the cell, the test equipment will verify that the timing of the NR cell is within $(N_{TA} + N_{TA_offset}) \pm T_e$ of the first detected path of DL SSB.
 - a. The N_{TA} offset value (in T_c units) is 25600 for FR1 and 13792 for FR2
 - b. The T_e values depend on the DL and UL SCS for which the test is being run and are given in Table 7.1.2-1
- 3) The test system shall adjust the timing of the DL path by values given in Table A.5.4.1.1.2-1

Table A.5.4.1.1.2-1 Adjustment Value for DL Timing

SCS of SSB signals (KHz)	Adjustment Value	
	Test1	Test2
15	+64*64T _c	+32*64T _c
30	+32*64T _c	+16*64T _c

120	$+16 \cdot 64T_c$	$+8 \cdot 64T_c$
240	$+8 \cdot 64T_c$	$+4 \cdot 64T_c$

- 4) The test system shall verify that the adjustment step size and the adjustment rate shall be according to requirements specified in Section 7.1.2 Table 7.1.2-3. This will only be done for Test1.
- 5) The test system shall verify that the UE transmit timing offset stays within $(N_{TA} + N_{TA_offset}) \pm T_e$ of the first detected path of DL SSB. For Test 2 and Test 4 the UE transmit timing offset shall be verified for the first transmission in the DRX cycle immediately after DL timing adjustment

A.5.4.2 UE timer accuracy

A.5.4.3 Timing advance

A.5.4.3.1 EN-DC FR2 timing advance adjustment accuracy

A.5.4.3.1.1 Test Purpose and Environment

The purpose of the test is to verify UE Timing Advance adjustment delay and accuracy requirement defined in clause 7.3.

A.5.4.3.1.2 Test Parameters

Supported test configurations are shown in table A.5.4.3.1.2-1. Both timing advance adjustment delay and accuracy are tested by using the parameters in table A.5.4.3.1.2-2, A.5.4.3.1.2-3 and A.5.4.3.1.2-4. The configuration of Cell 1 (LTE PCell) is specified in section A.3.7.2.1.

In all test cases, two cells are used. Cell 1 is the PCell in the primary Timing Advance Group (pTAG) and cell 2 is the PSCell in the secondary Timing Advance Group (sTAG). Each test consists of two successive time periods, with time duration of T1 and T2 respectively. In each time period, timing advance commands for sTAG are sent to the UE and Sounding Reference Signals (SRS), as specified in table A.5.4.3.1.2-3, are sent from the UE and received by the test equipment. By measuring the reception of the SRS, the transmit timing, and hence the timing advance adjustment accuracy, can be measured for PSCell in sTAG.

During time period T1, the test equipment shall send one message with a Timing Advance Command MAC Control Element for sTAG, as specified in Clause 6.1.3.4 in TS 38.321 [7]. The Timing Advance Command value shall be set to 31, which according to Clause 4.2 in TS 38.213 results in zero adjustment of the Timing Advance. In this way, a reference value for the timing advance for sTAG used by the UE is established.

During time period T2, the test equipment shall send a sequence of messages with Timing Advance Command MAC Control Elements for sTAG, with Timing Advance Command value specified in table A.5.4.3.1.2-2. This value shall result in changes of the timing advance for sTAG used by the UE, and the accuracy of the change shall then be measured, using the SRS sent from the UE.

As specified in Clause 7.3.2.1, the UE adjusts its uplink timing at slot $n+k$ for a timing advance command received in slot n . This delay must be taken into account when measuring the timing advance adjustment accuracy, via the SRS sent from the UE.

The UE Time Alignment Timer, described in Clause 5.2 in TS 38.321, shall be configured so that it does not expire in the duration of the test.

Table A.5.4.3.1.2-1: Timing advance supported test configurations

Config	Description
1	LTE FDD, NR 120 kHz SSB SCS, 100MHz bandwidth, TDD duplex mode
2	LTE TDD, NR 120 kHz SSB SCS, 100MHz bandwidth, TDD duplex mode
Note: The UE is only required to be tested in one of the supported test configurations	

Table A.5.4.3.1.2-2: General test parameters for timing advance

Parameter	Unit	Value	Comment
RF channel number		Cell 1: 1 Cell 2: 2	1 for E-UTRAN PCell 2 for NR PCell
Initial DL BWP		DLBWP.0.1	As specified in Table A.3.9.2.1-1
Dedicated DL BWP		DLBWP.1.1	As specified in Table A.3.9.2.2-1
Initial UL BWP		ULBWP.0.1	As specified in Table A.3.9.3.1-1
Dedicated UL BWP		ULBWP.1.1	As specified in Table A.3.9.3.2-1
Timing Advance Command (T_A) value during T1		31	$N_{TA_new} = N_{TA_old}$ for the purpose of establishing a reference value from which the timing advance adjustment accuracy can be measured during T2
Timing Advance Command (T_A) value during T2		39	$N_{TA_new} = N_{TA_old} + 8192 * T_c$ (based on equation in TS 38.213 [3] section 4.2)
T1	s	5	
T2	s	5	

Table A.5.4.3.1.2-3: Cell specific test parameters for timing advance

Parameter	Unit	Test1	
		T1	T2
Duplex mode		TDD	
TDD configuration		TDDConf.3.1	
BW_{channel}	MHz	100: $N_{\text{RB,c}} = 66$	
BWP BW	MHz	100: $N_{\text{RB,c}} = 66$	
DRx Cycle	ms	Not Applicable	
PDSCH Reference measurement channel		SR.3.1 TDD	
CORESET Reference Channel		CR.3.1 TDD	
TRS configuration		TRS.2.1 TDD	
TCI configuration		CSI-RS.Config.0	
OCNG Patterns		OCNG pattern 1	
SMTC configuration		SMTC.1 FR2	
PDSCH/PDCCH subcarrier spacing	kHz	120 kHz	
PUCCH/PUSCH subcarrier spacing	kHz	120 kHz	
EPRE ratio of PSS to SSS	dB	0	
EPRE ratio of PBCH DMRS to SSS			
EPRE ratio of PBCH to PBCH DMRS			
EPRE ratio of PDCCH DMRS to SSS			
EPRE ratio of PDCCH to PDCCH DMRS			
EPRE ratio of PDSCH DMRS to SSS			
EPRE ratio of PDSCH to PDSCH			
EPRE ratio of OCNG DMRS to SSS(Note 1)			
EPRE ratio of OCNG to OCNG DMRS (Note 1)			
UE orientation around TBD axis and TBD axis	degrees	TBD	
N_{oc} ^{Note2}	dBm/15kHz	-98	
N_{oc} ^{Note2}	dBm/SCS	-89	
\hat{E}_s / I_{ot}	dB	3	
\hat{E}_s / N_{oc}	dB	3	
I_{o} ^{Note3}	dBm/95.04MHz	-57.96	
Propagation condition	-	AWGN	
Note 1: OCNG shall be used such that both cells are fully allocated and a constant total transmitted power spectral density is achieved for all OFDM symbols.			

Table A.5.4.3.1.2-4: Sounding Reference Symbol Configuration for timing advance

Field	Value	Comment
c-SRS	16	Frequency hopping is disabled
b-SRS	0	
b-hop	0	
freqDomainPosition	0	Frequency domain position of SRS
freqDomainShift	0	
groupOrSequenceHopping	neither	No group or sequence hopping
SRS-PeriodicityAndOffset	sl5=0	Once every 5 slots
pathlossReferenceRS	ssb-Index=0	SSB #0 is used for SRS path loss estimation
usage	nonCodebook	Non-codebook based UL transmission
startPosition	0	resourceMapping setting. SRS on last symbol of slot, and 1 symbols for SRS without repetition.
nrofSymbols	n1	
repetitionFactor	n1	
combOffset-n2	0	transmissionComb setting
cyclicShift-n2	0	
nrofSRS-Ports	port1	Number of antenna ports used for SRS transmission
Note:	For further information see clause 6.3.2 in TS 38.331 [2].	

A.5.4.3.1.3 Test Requirements

The UE shall apply the signalled Timing Advance value for PSCell in sTAG to the transmission timing at the designated activation time i.e. k slots after the reception of the timing advance command, where $k = 24$.

The Timing Advance adjustment accuracy for PSCell in sTAG shall be within the limits specified in clause 7.3.2.2.

The rate of correct Timing Advance adjustments observed during repeated tests shall be at least 90%.

A.5.5 Signaling characteristics

A.5.5.1 Radio link Monitoring

In the following section, any uplink signal transmitted by the UE is used for detecting the In-/Out-of-Sync state of the UE. In terms of measurement, the uplink signal is verified on the basis of the UE output power:

Editor note: The metric for the detection of the UE UL transmitted signal by the TE is FFS.

A.5.5.1.1 Radio Link Monitoring Out-of-sync Test for FR2 PSCell configured with SSB-based RLM RS in non-DRX mode

A.5.5.1.1.1 Test Purpose and Environment

The purpose of this test is to verify that the UE properly detects the out of sync and in sync for the purpose of monitoring downlink radio link quality of the PSCell. This test will partly verify the FR2 radio link monitoring requirements in clause 8.1.

Supported test configurations are shown in table A.5.5.1.1.1-1. The test parameters are given in Tables A.5.5.1.1.1-2, A.5.5.1.1.1-3, and A.5.5.1.1.1-4 below. There are two cells, Cell 1 is the E-UTRAN PCell, and Cell 2 is the PSCell, in the test. The E-UTRAN PCell setting refers to Table A.3.7.2.1-2. The test consists of three successive time periods, with time duration of T1, T2 and T3 respectively. Figure A.5.5.1.1.1-1 shows the variation of the downlink SNR in the active cell to emulate out-of-sync and in-sync states. Prior to the start of the time duration T1, the UE shall be fully synchronized to Cell 1 and Cell 2. The UE shall be configured for periodic CSI reporting with

a reporting periodicity of 5 ms. UE is configured to perform inter-frequency measurements using Gap Pattern ID #0 (40ms) in test 1.

Table A.5.5.1.1.1-1: Supported test configurations for FR2 PSCell

Configuration	Description
1	FDD LTE PCell, NR 120 KHz SSB SCS, 100MHz bandwidth, TDD duplex mode
2	TDD LTE PCell, NR 120 KHz SSB SCS, 100MHz bandwidth, TDD duplex mode
Note: The UE is only required to pass in one of the supported test configurations in FR2	

Table A.5.5.1.1.1-2: General test parameters for FR2 out-of-sync testing in non-DRX mode

Parameter		Unit	Value Test 1
Active E-UTRA PCell			Cell 1
E-UTRA RF Channel Number			1
Active PSCell			Cell 2
RF Channel Number			2
Duplex mode	Config 1, 2		TDD
BW _{channel}	Config 1, 2		100: N _{RB,C} = 66
DL initial BWP configuration	Config 1, 2		DLBWP.0.1
DL dedicated BWP configuration	Config 1, 2		DLBWP.1.1
UL initial BWP configuration	Config 1, 2		ULBWP.0.1
UL dedicated BWP configuration	Config 1, 2		ULBWP.1.1
TDD Configuration	Config 1, 2		TBD
CORESET Reference Channel	Config 1, 2		CR.3.1 TDD
SSB Configuration	Config 1, 2		SSB.1 FR2
SMTc Configuration	Config 1, 2		SMTc.1
PDSCH/PDCCH subcarrier spacing	Config 1, 2		120 KHz
PRACH Configuration	Config 1, 2		Table A.3.8.3.4
SSB index assigned as RLM RS	Config 1, 2		0,1
TCI Configuration	Config 1, 2		TBD
OCNG parameters			OP.1
CP length			Normal
Correlation Matrix and Antenna Configuration			2x2 Low
Out of sync transmission parameters	DCI format		1-0
	Number of Control OFDM symbols		2
	Aggregation level	CCE	8
	Ratio of hypothetical PDCCH RE energy to average SSS RE energy	dB	4
	Ratio of hypothetical PDCCH DMRS energy to average SSS RE energy	dB	4
	DMRS precoder granularity		REG bundle size
	REG bundle size		6
DRX			OFF
Gap pattern ID			gp0
Layer 3 filtering			Enabled

T310 timer	ms	0
T311 timer	ms	1000
N310		1
N311		1
CSI-RS configuration	Config 1, 2	[CSI-RS.3.3 TDD]
T1	s	[1]
T2	s	[10]
T3	s	[12]
D1	s	[9.64]
<p>Note 1: All configurations are assigned to the UE prior to the start of time period T1. Note 2: UE-specific PDCCH is not transmitted after T1 starts. Note 3: E-UTRAN is in non-DRX mode under test.</p>		

Table A.5.5.1.1-3: OTA related cell specific test parameters for FR2 (Cell 2) for out-of-sync radio link monitoring tests in non-DRX mode

Parameter		Unit	Test 1		
			T1	T2	T3
ssb-Index 0 AoA Configuration	Config 1, 2		TBD		
ssb-Index 1 AoA Configuration	Config 1, 2		TBD		
EPRE ratio of PDCCH DMRS to SSS		dB	4		
EPRE ratio of PDCCH to PDCCH DMRS		dB	0		
EPRE ratio of PBCH DMRS to SSS		dB	0		
EPRE ratio of PBCH to PBCH DMRS		dB			
EPRE ratio of PSS to SSS		dB			
EPRE ratio of PDSCH DMRS to SSS		dB			
EPRE ratio of PDSCH to PDSCH DMRS		dB			
EPRE ratio of OCNG DMRS to SSS		dB			
EPRE ratio of OCNG to OCNG DMRS		dB			
ssb-Index 0 SNR	Config 1, 2	dB	1	-7	-15
ssb-Index 1 SNR	Config 1, 2	dB	1	-15	-15
N_{oc}	Config 1, 2	dBm/1 5KHz	-98		
Propagation condition			TDL-A 30ns 75Hz		
<p>Note 1: OCNG shall be used such that the resources in Cell 2 are fully allocated and a constant total transmitted power spectral density is achieved for all OFDM symbols. Note 2: The signal contains PDCCH for UEs other than the device under test as part of OCNG. Note 3: SNR levels correspond to the signal to noise ratio over the SSS REs. Note 4: The SNR values are specified for testing a UE which supports 2RX on at least one band. For testing of a UE which supports 4RX on all bands, the SNR during T3 is A.3.6.</p>					

Table A.5.5.1.1-4: Measurement gap configuration for out-of-sync tests in non-DRX mode

Field	Test 1
	Value
gapOffset	0
<p>Note 1: E-UTRAN PCell and PSCell are SFN-synchronous and frame boundary aligned. (Ensure that RLM RS is partially overlapped with measurement gap).</p>	

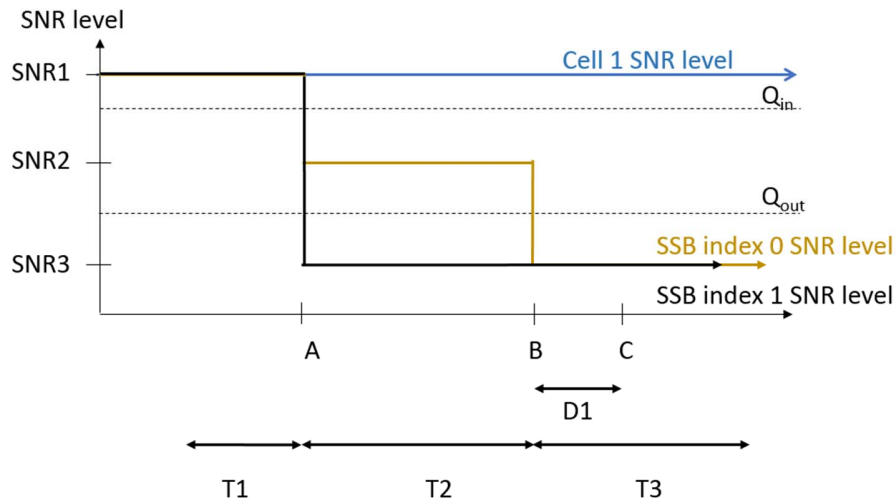

Figure A.5.5.1.1.1-1: SNR variation for out-of-sync testing

A.5.5.1.1.2 Test Requirements

The UE behavior in each test during time durations T1, T2 and T3 shall be as follows:

During the period from time point A to time point B the UE shall transmit uplink signal at least in all uplink slots configured for CSI transmission according to the configured periodic CSI reporting.

The UE shall stop transmitting uplink signal no later than time point C (D1 second after the start of the time duration T3).

The rate of correct events observed during repeated tests shall be at least 90%.

A.5.5.1.2 Radio Link Monitoring In-sync Test for FR2 PSCell configured with SSB-based RLM RS in non-DRX mode

A.5.5.1.2.1 Test Purpose and Environment

The purpose of this test is to verify that the UE properly detects the out of sync and in sync for the purpose of monitoring downlink radio link quality of the PSCell. This test will partly verify the FR2 radio link monitoring requirements in clause 8.1.

Supported test configurations are shown in table A.5.5.1.2.1-1. The test parameters are given in Tables A.5.5.1.2.1-2, and A.5.5.1.2.1-3 below. There are two cells, Cell 1 is the E-UTRAN PCell, and Cell 2 is the PSCell, in the test. The E-UTRAN PCell setting refers to Table A.3.7.2.1-2. The test consists of five successive time periods, with time duration of T1, T2, T3, T4 and T5 respectively. Figure A.5.5.1.2.1-1 shows the variation of the downlink SNR in the active cell to emulate out-of-sync and in-sync states. Prior to the start of the time duration T1, the UE shall be fully synchronized to Cell 1 and Cell 2. The UE shall be configured for periodic CSI reporting with a reporting periodicity of 5ms.

Table A.5.5.1.2.1-1: Supported test configurations for FR2 PSCell

Configuration	Description
1	FDD LTE PCell, NR 120 KHz SSB SCS, 100MHz bandwidth, TDD duplex mode
2	TDD LTE PCell, NR 120 KHz SSB SCS, 100MHz bandwidth, TDD duplex mode
Note:	The UE is only required to pass in one of the supported test configurations in FR2

Table A.5.5.1.2.1-2: General test parameters for FR2 in-sync testing in non-DRX mode

Parameter		Unit	Value	
			Test 1	
Active E-UTRA PCell			Cell 1	
E-UTRA RF Channel Number			1	
Active PSCell			Cell 2	
RF Channel Number			2	
Duplex mode		Config 1	TDD	
BW _{channel}		Config 1	100: N _{RB,c} = 66	
DL initial BWP configuration		Config 1	DLBWP.0.1	
DL dedicated BWP configuration		Config 1	DLBWP.1.1	
UL initial BWP configuration		Config 1	ULBWP.0.1	
UL dedicated BWP configuration		Config 1	ULBWP.1.1	
TDD Configuration		Config 1	TBD	
CORESET Reference Channel		Config 1	CR.3.1 TDD	
SSB Configuration		Config 1	SSB.1 FR2	
SMTTC Configuration		Config 1	TBD (Note SMTTC periodicity =160ms)	
PDSCH/PDCCH subcarrier spacing		Config 1	120 KHz	
PRACH Configuration		Config 1	Table A.3.8.3.4	
SSB index assigned as RLM RS		Config 1	0,1	
TCI Configuration		Config 1	TBD	
OCNG parameters			OP.1	
CP length			Normal	
Correlation Matrix and Antenna Configuration			2x2 Low	
In sync transmission parameters	DCI format		1-0	
	Number of Control OFDM symbols		2	
	Aggregation level		CCE	4
	Ratio of hypothetical PDCCH RE energy to average SSS RE energy		dB	0
	Ratio of hypothetical PDCCH DMRS energy to average SSS RE energy		dB	0
	DMRS precoder granularity			REG bundle size
	REG bundle size			6
Out of sync transmission parameters	DCI format		1-0	
	Number of Control OFDM symbols		2	
	Aggregation level		CCE	8
	Ratio of hypothetical PDCCH RE energy to average SSS RE energy		dB	4
	Ratio of hypothetical PDCCH DMRS energy to average SSS RE energy		dB	4
	DMRS precoder granularity			REG bundle size
	REG bundle size			6

DRX			OFF
Gap pattern ID			N.A.
Layer 3 filtering			Enabled
T310 timer		ms	[6000]
T311 timer		ms	1000
N310			1
N311			1
CSI-RS configuration	Config 1		[CSI-RS.3.3 TDD]
T1		s	[0.5]
T2		s	[2]
T3		s	[1.86]
T4		s	[0.02]
T5		s	[7]
D1		s	[6.5]
Note 1: All configurations are assigned to the UE prior to the start of time period T1.			
Note 2: UE-specific PDCCH is not transmitted after T1 starts.			
Note 3: E-UTRAN is in non-DRX mode under test.			

Table A.5.5.1.2.1-3: OTA related cell specific test parameters for FR2 (Cell 2) for in-sync radio link monitoring tests in non-DRX mode

Parameter		Unit	Test 1				
			T1	T2	T3	T4	T5
ssb-Index 0 AoA Configuration	Config 1, 2		TBD				
ssb-Index 1 AoA Configuration	Config 1, 2		TBD				
EPRE ratio of PDCCH DMRS to SSS		dB	4				
EPRE ratio of PDCCH to PDCCH DMRS		dB	0				
EPRE ratio of PBCH DMRS to SSS		dB	0				
EPRE ratio of PBCH to PBCH DMRS		dB					
EPRE ratio of PSS to SSS		dB					
EPRE ratio of PDSCH DMRS to SSS		dB					
EPRE ratio of PDSCH to PDSCH DMRS		dB					
EPRE ratio of OCNG DMRS to SSS		dB					
EPRE ratio of OCNG to OCNG DMRS		dB					
ssb-Index 0 SNR	Config 1, 2	dB	1	-7	-15	-4.5	1
ssb-Index 1 SNR	Config 1, 2	dB	1	-15	-15	-15	-15
N_{oc}	Config 1, 2	dBm/15KHz	-98				
Propagation condition			TDL-A 30ns 75Hz				
Note 1: OCNG shall be used such that the resources in Cell 2 are fully allocated and a constant total transmitted power spectral density is achieved for all OFDM symbols.							
Note 2: The signal contains PDCCH for UEs other than the device under test as part of OCNG.							
Note 3: SNR levels correspond to the signal to noise ratio over the SSS REs.							
Note 4: The SNR values are specified for testing a UE which supports 2RX on at least one band. For testing of a UE which supports 4RX on all bands, the SNR during T3 is A.3.6.							

Table A.5.5.1.2.1-4: Void

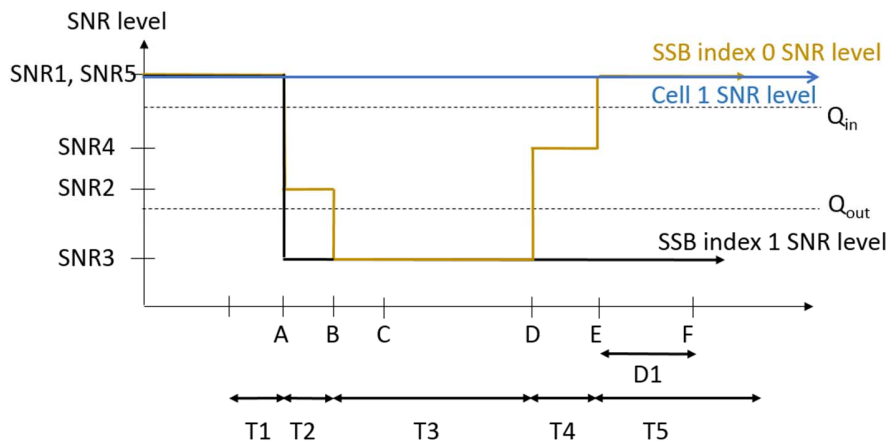

Figure A.5.5.1.2.1-1: SNR variation for in-sync testing

A.5.5.1.2.2 Test Requirements

The UE behaviour in each test during time durations T1, T2, T3, T4 and T5 shall be as follows:

During the period from time point A to time point F (D1 second after the start of time duration T5) the UE shall transmit uplink signal at least in all uplink slots configured for CSI transmission according to the configured periodic CSI reporting.

The rate of correct events observed during repeated tests shall be at least 90%.

A.5.5.1.3 Radio Link Monitoring Out-of-sync Test for FR2 PSCell configured with SSB-based RLM RS in DRX mode

A.5.5.1.3.1 Test Purpose and Environment

The purpose of this test is to verify that the UE properly detects the out of sync and in sync for the purpose of monitoring downlink radio link quality of the PSCell when DRX is used. This test will partly verify the FR2 radio link monitoring requirements in clause 8.1.

Supported test configurations are shown in table A.5.5.1.3.1-1. The test parameters are given in Tables A.5.5.1.3.1-2, and A.5.5.1.3.1-3. There are two cells, Cell 1 is the E-UTRAN PCell, and Cell 2 is the PSCell, in the test. The E-UTRAN PCell setting refers to Table A.3.7.2.1-2. The test consists of three successive time periods, with time duration of T1, T2 and T3 respectively. Figure A.5.5.1.3.1-1 shows the variation of the downlink SNR in the active cell to emulate out-of-sync and in-sync states. Prior to the start of the time duration T1, the UE shall be fully synchronized to Cell 1 and Cell 2. The UE shall be configured for periodic CSI reporting with a reporting periodicity of 5 ms. In the test, DRX configuration is enabled and DRX inactivity timer has already been expired, i.e. UE tries to decode PDCCH and to send periodic CSI during the period when On-duration timer is running. Time alignment timers shall be set to “infinity” so that UL timing alignment is maintained during the test.

Table A.5.5.1.3.1-1: Supported test configurations for FR2 PSCell

Configuration	Description
1	FDD LTE PCell, NR 120 KHz SSB SCS, 100MHz bandwidth, TDD duplex mode
2	TDD LTE PCell, NR 120 KHz SSB SCS, 100MHz bandwidth, TDD duplex mode
Note: The UE is only required to pass in one of the supported test configurations in FR2	

Table A.5.5.1.3.1-2: General test parameters for FR2 out-of-sync testing in DRX mode

Parameter		Unit	Value Test 1
Active E-UTRA PCell			Cell 1
E-UTRA RF Channel Number			1
Active PSCell			Cell 2
RF Channel Number			2
Duplex mode	Config 1, 2		TDD
BW _{channel}	Config 1, 2		100: N _{RB,c} = 66
DL initial BWP configuration	Config 1, 2		DLBWP.0.1
DL dedicated BWP configuration	Config 1, 2		DLBWP.1.1
UL initial BWP configuration	Config 1, 2		ULBWP.0.1
UL dedicated BWP configuration	Config 1, 2		ULBWP.1.1
TDD Configuration	Config 1, 2		TBD
CORESET Reference Channel	Config 1, 2		CR.3.1 TDD
SSB Configuration	Config 1, 2		SSB.1 FR2
SMTC Configuration	Config 1, 2		SMTC.1
PDSCH/PDCCH subcarrier spacing	Config 1, 2		120 KHz
PRACH Configuration	Config 1, 2		Table A.3.8.3.4
SSB index assigned as RLM RS	Config 1, 2		0,1
TCI Configuration	Config 1, 2		TBD
OCNG parameters			OP.1
CP length			Normal
Correlation Matrix and Antenna Configuration			2x2 Low
Out of sync transmission parameters	DCI format		1-0
	Number of Control OFDM symbols		2
	Aggregation level	CCE	8
	Ratio of hypothetical PDCCH RE energy to average SSS RE energy	dB	4
	Ratio of hypothetical PDCCH DMRS energy to average SSS RE energy	dB	4
	DMRS precoder granularity		REG bundle size
	REG bundle size		6
DRX Configuration			[DRX.3]
Gap pattern ID			N.A.
Layer 3 filtering			Enabled
T310 timer		ms	0
T311 timer		ms	1000
N310			1

N311			1
CSI-RS configuration	Config 1, 2		[CSI-RS.3.3 TDD]
T1		s	[1]
T2		s	[15]
T3		s	[15]
D1		s	[14.44]
Note 1: All configurations are assigned to the UE prior to the start of time period T1.			
Note 2: UE-specific PDCCH is not transmitted after T1 starts.			
Note 3: E-UTRAN is in non-DRX mode under test.			

Table A.5.5.1.3.1-3: OTA related cell specific test parameters for FR2 (Cell 2) for out-of-sync radio link monitoring tests in non-DRX mode

Parameter		Unit	Test 1		
			T1	T2	T3
ssb-Index 0 AoA Configuration	Config 1, 2		TBD		
ssb-Index 1 AoA Configuration	Config 1, 2		TBD		
EPRE ratio of PDCCH DMRS to SSS		dB	4		
EPRE ratio of PDCCH to PDCCH DMRS		dB	0		
EPRE ratio of PBCH DMRS to SSS		dB	0		
EPRE ratio of PBCH to PBCH DMRS		dB			
EPRE ratio of PSS to SSS		dB			
EPRE ratio of PDSCH DMRS to SSS		dB			
EPRE ratio of PDSCH to PDSCH DMRS		dB			
EPRE ratio of OCNG DMRS to SSS		dB			
EPRE ratio of OCNG to OCNG DMRS		dB			
ssb-Index 0 SNR	Config 1, 2	dB	1	-7	-15
ssb-Index 1 SNR	Config 1, 2		1	-15	-15
N_{oc}	Config 1, 2	dBm/15K Hz	-98		
Propagation condition			TDL-A 30ns 75Hz		
Note 1: OCNG shall be used such that the resources in Cell 2 are fully allocated and a constant total transmitted power spectral density is achieved for all OFDM symbols.					
Note 2: The signal contains PDCCH for UEs other than the device under test as part of OCNG.					
Note 3: SNR levels correspond to the signal to noise ratio over the SSS REs.					
Note 4: The SNR values are specified for testing a UE which supports 2RX on at least one band. For testing of a UE which supports 4RX on all bands, the SNR during T3 is A.3.6.					

Table A.5.5.1.3.1-4: Void

Table A.5.5.1.3.1-5: Void

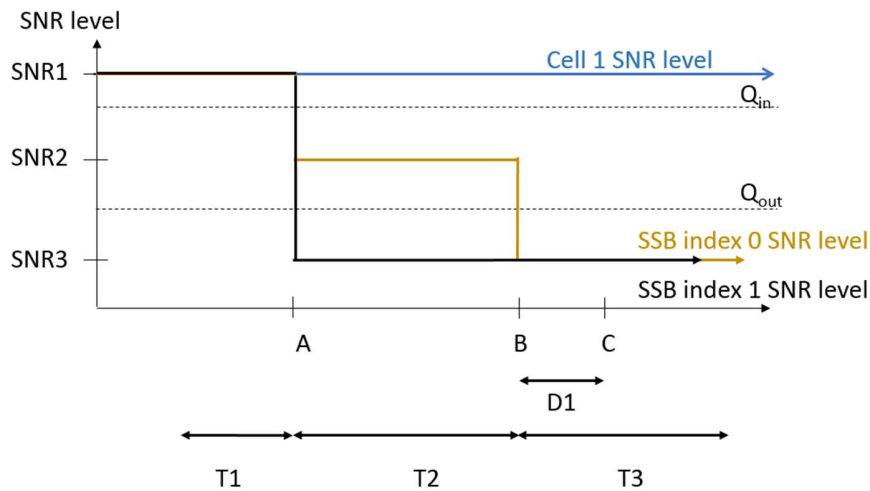

Figure A.5.5.1.3.1-1: SNR variation for out-of-sync testing

A.5.5.1.3.2 Test Requirements

The UE behavior in each test during time durations T1, T2 and T3 shall be as follows:

During the period from time point A to time point B the UE shall transmit uplink signal at least in all uplink slots configured for CSI transmission according to the configured periodic CSI reporting.

The UE shall stop transmitting uplink signal no later than time point C (D1 second after the start of the time duration T3).

The rate of correct events observed during repeated tests shall be at least 90%.

A.5.5.1.4 Radio Link Monitoring In-sync Test for FR2 PSCell configured with SSB-based RLM RS in DRX mode

A.5.5.1.4.1 Test Purpose and Environment

The purpose of this test is to verify that the UE properly detects the out of sync and in sync for the purpose of monitoring downlink radio link quality of the PSCell when DRX is used. This test will partly verify the FR2 radio link monitoring requirements in clause 8.1.

Supported test configurations are shown in table A.5.5.1.4.1-1. The test parameters are given in Tables A.5.5.1.4.1-2, and A.5.5.1.4.1-3. There are two cells, Cell 1 is the E-UTRAN PCell, and Cell 2 is the PSCell, in the test. The E-UTRAN PCell setting refers to Table A.3.7.2.1-2. The test consists of five successive time periods, with time duration of T1, T2, T3, T4 and T5 respectively. Figure A.5.5.1.4.1-1 shows the variation of the downlink SNR in the active cell to emulate out-of-sync and in-sync states. Prior to the start of the time duration T1, the UE shall be fully synchronized to Cell 1 and Cell 2. The UE shall be configured for periodic CSI reporting with a reporting periodicity of 5 ms. In the test, DRX configuration is enabled and DRX inactivity timer has already been expired, i.e. UE tries to decode PDCCH and to send periodic CSI during the period when On-duration timer is running. Time alignment timers shall be set to “infinity” so that UL timing alignment is maintained during the test.

Table A.5.5.1.4.1-1: Supported test configurations for FR2 PSCell

Configuration	Description
1	FDD LTE PCell, NR 120 KHz SSB SCS, 100MHz bandwidth, TDD duplex mode
2	TDD LTE PCell, NR 120 KHz SSB SCS, 100MHz bandwidth, TDD duplex mode
Note: The UE is only required to pass in one of the supported test configurations in FR2	

Table A.5.5.1.4.1-2: General test parameters for FR2 in-sync testing in DRX mode

Parameter		Unit	Value Test 1
Active E-UTRA PCell			Cell 1
E-UTRA RF Channel Number			1
Active PSCell			Cell 2
RF Channel Number			2
Duplex mode	Config 1, 2		TDD
BW _{channel}	Config 1, 2		100: N _{RB,c} = 66
DL initial BWP configuration	Config 1, 2		DLBWP.0.1
DL dedicated BWP configuration	Config 1, 2		DLBWP.1.1
UL initial BWP configuration	Config 1, 2		ULBWP.0.1
UL dedicated BWP configuration	Config 1, 2		ULBWP.1.1
TDD Configuration	Config 1, 2		TBD
CORESET Reference Channel	Config 1, 2		CR.3.1 TDD
SSB Configuration	Config 1, 2		SSB.1 FR2
SMTC Configuration	Config 1, 2		TBD (SMTC periodicity = 160ms)
PDSCH/PDCCH subcarrier spacing	Config 1, 2		120 KHz
PRACH Configuration	Config 1, 2		Table A.3.8.3.4
SSB index assigned as RLM RS	Config 1, 2		0,1
TCI Configuration	Config 1, 2		TBD
OCNG parameters			OP.1
CP length			Normal
Correlation Matrix and Antenna Configuration			2x2 Low
In sync transmission parameters	DCI format		1-0
	Number of Control OFDM symbols		2
	Aggregation level	CCE	4
	Ratio of hypothetical PDCCH RE energy to average SSS RE energy	dB	0
	Ratio of hypothetical PDCCH DMRS energy to average SSS RE energy	dB	0
	DMRS precoder granularity		REG bundle size
	REG bundle size		6
	DCI format		1-0
	Number of Control OFDM symbols		2
	Aggregation level	CCE	8

Out of sync transmission parameters	Ratio of hypothetical PDCCH RE energy to average SSS RE energy	dB	4
	Ratio of hypothetical PDCCH DMRS energy to average SSS RE energy	dB	4
	DMRS precoder granularity		REG bundle size
	REG bundle size		6
DRX Configuration			[DRX.3]
Gap pattern ID			N.A.
Layer 3 filtering			<i>Enabled</i>
T310 timer		ms	[6000]
T311 timer		ms	1000
N310			1
N311			1
CSI-RS configuration	Config 1, 2		[CSI-RS.3.3 TDD]
T1		s	[4]
T2		s	[6]
T3		s	[5.54]
T4		s	[0.02]
T5		s	[7]
D1		s	[6.5]
Note 1: All configurations are assigned to the UE prior to the start of time period T1.			
Note 2: UE-specific PDCCH is not transmitted after T1 starts.			
Note 3: E-UTRAN is in non-DRX mode under test.			

Table A.5.5.1.4.1-3: OTA related cell specific test parameters for FR2 (Cell 2) for in-sync radio link monitoring test in DRX mode

Parameter		Unit	Test 1				
			T1	T2	T3	T4	T5
ssb-Index 0 AoA Configuration	Config 1, 2		TBD				
ssb-Index 1 AoA Configuration	Config 1, 2		TBD				
EPRE ratio of PDCCH DMRS to SSS		dB	4				
EPRE ratio of PDCCH to PDCCH DMRS		dB	0				
EPRE ratio of PBCH DMRS to SSS		dB	0				
EPRE ratio of PBCH to PBCH DMRS		dB					
EPRE ratio of PSS to SSS		dB					
EPRE ratio of PDSCH DMRS to SSS		dB					
EPRE ratio of PDSCH to PDSCH DMRS		dB					
EPRE ratio of OCNG DMRS to SSS		dB					
EPRE ratio of OCNG to OCNG DMRS		dB					
ssb-Index 0 SNR	Config 1, 2	dB	1	-7	-15	-4.5	1
ssb-Index 1 SNR	Config 1, 2		1	-15	-15	-15	-15
N_{oc}	Config 1, 2	dBm/1 5KHz	-98				
Propagation condition			TDL-A 30ns 75Hz				
Note 1: OCNG shall be used such that the resources in Cell 2 are fully allocated and a constant total transmitted power spectral density is achieved for all OFDM symbols. Note 2: The signal contains PDCCH for UEs other than the device under test as part of OCNG.3 Note 3: SNR levels correspond to the signal to noise ratio over the SSS REs. Note 4: The SNR values are specified for testing a UE which supports 2RX on at least one band. For testing of a UE which supports 4RX on all bands, the SNR during T3 is A.3.6.							

Table A.5.5.1.4.1-4: Void

Table A.5.5.1.4.1-5: Void

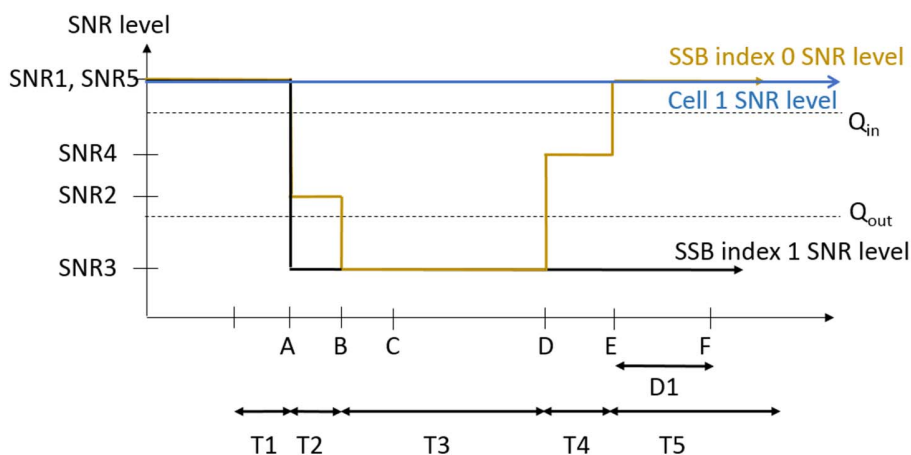

Figure A.5.5.1.4.1-1: SNR variation for in-sync testing.

A.5.5.1.4.2 Test Requirements

The UE behaviour in each test during time durations T1, T2, T3, T4 and T5 shall be as follows:

During the period from time point A to time point F (D1 second after the start of time duration T5) the UE shall transmit uplink signal at least in all uplink slots configured for CSI transmission according to the configured periodic CSI reporting.

The rate of correct events observed during repeated tests shall be at least 90%.

A.5.5.1.5 EN-DC Radio Link Monitoring Out-of-sync Test for FR2 PSCell configured with CSI-RS-based RLM in non-DRX mode

A.5.5.1.5.1 Test Purpose and Environment

The purpose of this test is to verify that the UE properly detects the out of sync for the purpose of monitoring downlink CSI-RS based radio link quality of the PSCell when no DRX is used. This test will partly verify the FR2 TDD PSCell CSI-RS Out-of-sync radio link monitoring requirements in clause 8.1.

The test parameters are given in Tables A.5.5.1.5.1-1, A.5.5.1.5.1-2, and A.5.5.1.5.1-3 below. There are two cells, cell 1 is the E-UTRAN PCell, and cell 2 is the PSCell, in the test. The test consists of three successive time periods, with time duration of T1, T2 and T3 respectively. Figure A.5.5.1.5.1-1 shows the variation of the downlink SNR in the E-UTRAN PCell and the PSCell to emulate out-of-sync and in-sync states. Prior to the start of the time duration T1, the UE shall be fully synchronized to cell 1 and cell 2. The UE shall be configured for periodic CSI reporting with a reporting periodicity of [5] or [10] ms. In the test, DRX configuration is not enabled. The UE is configured to perform inter-frequency measurements using GP ID #0 (40ms).

Table A.5.5.1.5.1-1: Supported test configurations for FR2 PSCell

Configuration	Description
1	LTE FDD, NR 120 kHz SSB SCS, 100MHz bandwidth, TDD duplex mode
2	LTE TDD, NR 240 kHz SSB SCS, 100MHz bandwidth, TDD duplex mode
Note: The UE is only required to pass in one of the supported test configurations in FR2	

Table A.5.5.1.5.1-2: General test parameters for FR2 PSCell for CSI-RS out-of-sync testing in non-DRX mode

Parameter		Unit	Value
			Test 1
Active E-UTRA PCell			Cell 1
E-UTRA RF Channel Number			1
Active PSCell			Cell 2
RF Channel Number			2
Duplex Mode			TDD
TDD Configuration	Config 1		TDDConf.3.1
	Config 2		TDDConf.3.1
CORESET Reference Channel	Config 1		CR. 3.1 TDD
	Config 2		CR. 3.1 TDD
SSB Configuration	Config 1		SSB.1 FR2
	Config 2		SSB.1 FR2
SMTc Configuration	Config 1		SMTc.1
	Config 2		SMTc.1
	Config 1		120 KHz

PDSCH/PDCCH subcarrier spacing	Config 2		120 KHz
csi-RS-Index assigned as RLM RS			[0]
TRS configuration			TRS.2.1 TDD
TCI configuration			CSI-RS.Config.0
OCNG parameters			OP.1
CP length			Normal
Correlation Matrix and Antenna Configuration			[2x2 Low]
Out of sync transmission parameters	DCI format		1-0
	Number of Control OFDM symbols		2
	Aggregation level	CCE	8
	Ratio of hypothetical PDCCH RE energy to average CSI-RS RE energy	dB	4
	Ratio of hypothetical PDCCH DMRS energy to average CSI-RS RE energy	dB	4
	DMRS precoder granularity		REG bundle size
	REG bundle size		6
DRX			OFF
Gap pattern ID			*[gp0]
Layer 3 filtering			Enabled
T310 timer		ms	0
T311 timer		ms	1000
N310			1
N311			1
NZP CSI-RS configuration			[ResourceId 0]
ZP CSI-RS configuration			TBD
CSI-IM configuration			TBD
Periodic CSI reporting			PUCCH
CSI reporting periodicity	Config 1	slot	[5]
	Config 2		[10]
T1		s	1
T2		s	0.4
T3		s	[0.6]
D1		s	[0.44]
Note 1: UE-specific PDCCH is not transmitted after T1 starts.			
Note 2: E-UTRAN is in non-DRX mode under test.			

Table A.5.5.1.5.1-3: Cell specific test parameters for FR2 for CSI-RS out-of-sync radio link monitoring in non-DRX mode

Parameter		Unit	Test 1		
			T1	T2	T3
PDCCH_beta		dB	4		
PDCCH_DMRS_beta		dB	4		
PBCH_beta		dB	0		
PSS_beta		dB			
SSS_beta		dB			
PDSCH_beta		dB			
OCNG_beta		dB			
SNR	Config 1	dB			
	Config 2		TBD	TBD	TBD
N_{oc}	Config 1	dBm/15KHz	TBD		
	Config 2		TBD		
Propagation condition			[TDL-A 30ns 75Hz]		
Note 1: OCNG shall be used such that the resources in Cell 2 are fully allocated and a constant total transmitted power spectral density is achieved for all OFDM symbols.					
Note 2: The uplink resources for CSI reporting are assigned to the UE prior to the start of time period T1.					
Note 3: NZP CSI-RS resource set configuration for CSI reporting are assigned to the UE prior to the start of time period T1.					
Note 4: Measurement gap configuration is assigned to the UE prior to the start of time period T1.					
Note 5: The timers and layer 3 filtering related parameters are configured prior to the start of time period T1.					
Note 6: The signal contains PDCCH for UEs other than the device under test as part of OCNG.					
Note 7: SNR levels correspond to the signal to noise ratio over the SSS REs.					
Note 8: The SNR in time periods T1, T2 and T3 is denoted as SNR1, SNR2 and SNR3 respectively in figure A.5.5.1.5.1-1.					
Note 9: The SNR values are specified for testing a UE which supports 2RX on at least one band. For testing of a UE which supports 4RX on all bands, the SNR during T3 is [A.3.6].					

Table A.5.5.1.5.1-3A: Measurement gap configuration for FR2 CSI-RS out-of-sync radio link monitoring in non-DRX mode

Field	Test 2
	Value
gapOffset	[0]
Note 1: E-UTRAN PCell and PSCell are SFN-synchronous and frame boundary aligned. (Ensure that RLM RS is partially overlapped with measurement gap)	

Table A.5.5.1.5.1-4: NZP-CSI-RS resource configuration for FR2 CSI-RS out-of-sync radio link monitoring in non-DRX mode

Field	ResourceId 0	ResourceId 1
	Value	Value
frequencyDomainAllocation ^{Note 1}	row1	row2
startingRB	0	0
nrofRBs	Note 2	Note 2
Note 1: TS 38.211 [6] table 7.4.1.5.3-1 Note 2: nrofRBs is derived based on the Configuration in Table A.5.5.1.5.1-1		

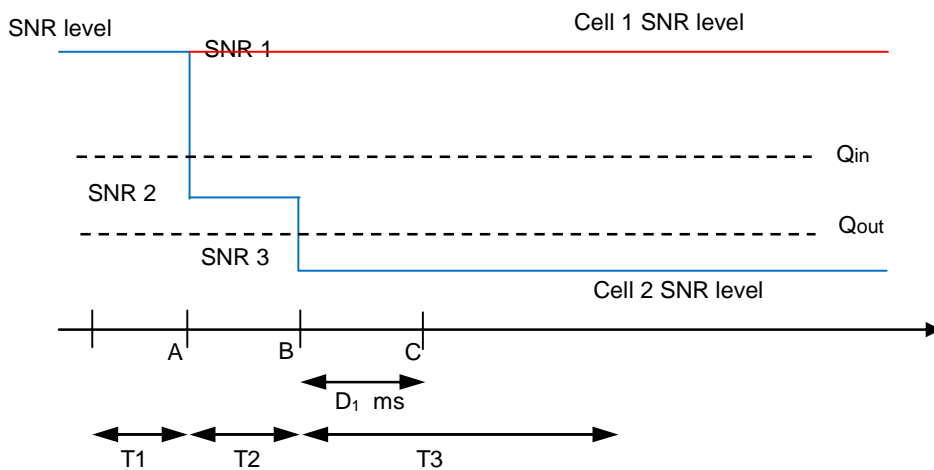

Figure A.5.5.1.5.1-1: SNR variation for CSI-RS out-of-sync testing

A.5.5.1.5.2 Test Requirements

The UE behaviour during time durations T1, T2, and T3 shall be as follows:

During time durations T1, T2 and T3, the UE shall transmit uplink signal at least in all subframes configured for CSI transmission on Cell 1 (E-UTRAN PCell).

During the period from time point A to time point B the UE shall transmit uplink signal in Cell 2 (PSCell) at least in all uplink slots configured for CSI transmission according to the configured periodic CSI reporting for Cell 2.

The UE shall stop transmitting uplink signal in Cell 2 (PSCell) no later than time point C ($D_1 = [TBD]$ ms after the start of the time duration T3) on the PSCell.

The rate of correct events observed during repeated tests shall be at least 90%.

A.5.5.1.6 EN-DC Radio Link Monitoring In-sync Test for FR2 PSCell configured with CSI-RS-based RLM in non-DRX mode

A.5.5.1.6.1 Test Purpose and Environment

The purpose of this test is to verify that the UE properly detects the in sync for the purpose of monitoring downlink CSI-RS based radio link quality of the PSCell when no DRX is used. This test will partly verify the FR2 TDD PSCell CSI-RS In-sync radio link monitoring requirements in clause 8.1.

The test parameters are given in Tables A.5.5.1.6.1-1, A.5.5.1.6.1-2, A.5.5.1.6.1-3, A.5.5.1.6.1-4, A.5.5.1.6.1-5, and A.5.5.1.6.1-6 below. There are two cells, cell 1 which is the E-UTRAN PCell, and cell 2 is the PSCell, in the test. The test consists of five successive time periods, with time duration of T1, T2, T3, T4 and T5 respectively. Figure A.5.5.1.6.1-1 shows the variation of the downlink SNR in the PSCell to emulate out-of-sync and in-sync states. Prior to the start of the time duration T1, the UE shall be fully synchronized to cell 1 and cell 2. The UE shall be configured for periodic CSI reporting with a reporting periodicity of [5] or [10] ms. In the test, DRX configuration is not enabled. The UE is configured to perform inter-frequency measurements without gap.

Table A.5.5.1.6.1-1: Supported test configurations for FR2 PSCell

Configuration	Description
1	LTE FDD, NR 120 kHz SSB SCS, 100MHz bandwidth, TDD duplex mode
2	LTE TDD, NR 240 kHz SSB SCS, 100MHz bandwidth, TDD duplex mode
Note:	The UE is only required to pass in one of the supported test configurations in FR2

Table A.5.5.1.6.1-2: General test parameters for FR2 PSCell for CSI-RS in-sync testing in non-DRX mode

Parameter		Unit	Value
			Test 1
Active E-UTRA PCell			Cell 1
E-UTRA RF Channel Number			1
Active PSCell			Cell 2
RF Channel Number			2
Duplex Mode			TDD
TDD Configuration	Config 1		TDDConf.3.1
	Config 2		TDDConf.3.1
CORESET Reference Channel	Config 1		CR. 3.1 TDD
	Config 2		CR. 3.1 TDD
SSB Configuration	Config 1		SSB.1 FR2
	Config 2		SSB.1 FR2
SMT C Configuration	Config 1		SMT C.1
	Config 2		SMT C.1
PDSCH/PDCCH subcarrier spacing	Config 1		120 KHz
	Config 2		120 KHz
csi-RS-Index assigned as RLM RS			[0]
OCNG parameters			OCNG pattern 1
TRS configuration			TRS.2.1 TDD
TCI configuration			CSI-RS.Config.0
CP length			Normal
Correlation Matrix and Antenna Configuration			[2x2 Low]
	DCI format		1-0

Out of sync transmission parameters	Number of Control OFDM symbols		2
	Aggregation level	CCE	8
	Ratio of hypothetical PDCCH RE energy to average CSI-RS RE energy	dB	4
	Ratio of hypothetical PDCCH DMRS energy to average CSI-RS RE energy	dB	4
	DMRS precoder granularity		REG bundle size
	REG bundle size		6
In sync transmission parameters	DCI format		1-0
	Number of Control OFDM symbols		2
	Aggregation level	CCE	4
	Ratio of hypothetical PDCCH RE energy to average CSI-RS RE energy	dB	0
	Ratio of hypothetical PDCCH DMRS energy to average CSI-RS RE energy	dB	0
	DMRS precoder granularity		REG bundle size
	REG bundle size		6
DRX			<i>OFF</i>
Gap pattern ID			[N.A.]
Layer 3 filtering			<i>Enabled</i>
T310 timer	ms		0
T311 timer	ms		1000
N310			1
N311			1
NZP CSI-RS configuration			[ResourceId 1]
ZP CSI-RS configuration			TBD
CSI-IM configuration			TBD
Periodic CSI reporting			PUCCH
CSI reporting periodicity	Config 1	slot	[5]
	Config 2		[10]
T1	s		1
T2	s		0.4
T3	s		[0.6]
D1	s		[0.24]
Note 1: UE-specific PDCCH is not transmitted after T1 starts.			
Note 2: E-UTRAN is in non-DRX mode under test.			

Table A.5.5.1.6.1-3: Cell specific test parameters for FR2 for CSI-RS in-sync radio link monitoring in non-DRX mode

Parameter		Unit	Test 1		
			T1	T2	T3
PDCCH_beta		dB	4		
PDCCH_DMRS_beta		dB	4		
PBCH_beta		dB	0		
PSS_beta		dB			
SSS_beta		dB			
PDSCH_beta		dB			
OCNG_beta		dB			
SNR	Config 1	dB			
	Config 2		TBD	TBD	TBD
N_{oc}	Config 1	dBm/15KHz	TBD		
	Config 2		TBD		
Propagation condition			[TDL-A 30ns 75Hz]		
<p>Note 1: OCNG shall be used such that the resources in Cell 2 are fully allocated and a constant total transmitted power spectral density is achieved for all OFDM symbols.</p> <p>Note 2: The uplink resources for CSI reporting are assigned to the UE prior to the start of time period T1.</p> <p>Note 3: NZP CSI-RS resource set configuration for CSI reporting are assigned to the UE prior to the start of time period T1.</p> <p>Note 4: Measurement gap configuration is assigned to the UE prior to the start of time period T1.</p> <p>Note 5: The timers and layer 3 filtering related parameters are configured prior to the start of time period T1.</p> <p>Note 6: The signal contains PDCCH for UEs other than the device under test as part of OCNG.</p> <p>Note 7: SNR levels correspond to the signal to noise ratio over the SSS REs.</p> <p>Note 8: The SNR in time periods T1, T2 and T3 is denoted as SNR1, SNR2 and SNR3 respectively in figure A.5.5.1.6.1-1.</p> <p>Note 9: The SNR values are specified for testing a UE which supports 2RX on at least one band. For testing of a UE which supports 4RX on all bands, the SNR during T3 is [A.3.6].</p>					

Table A.5.5.1.6.1-3A: Measurement gap configuration for FR2 CSI-RS in-sync radio link monitoring in non-DRX mode

Field	Test 4
	Value
gapOffset	[0]
<p>Note 1: E-UTRAN PCell and PSCell are SFN-synchronous and frame boundary aligned. (Ensure that RLM RS is partially overlapped with measurement gap)</p>	

Table A.5.5.1.6.1-4: NZP-CSI-RS resource configuration for FR2 CSI-RS in-sync radio link monitoring in non-DRX mode

Field	ResourceId 0	ResourceId 1
	Value	Value
frequencyDomainAllocation ^{Note 1}	row1	row2
startingRB	0	0
nrofRBs	Note 2	Note 2
Note 1: TS 38.211 [6] table 7.4.1.5.3-1		
Note 2: nrofRBs is derived based on the Configuration in Table A.5.5.1.6.1-1		

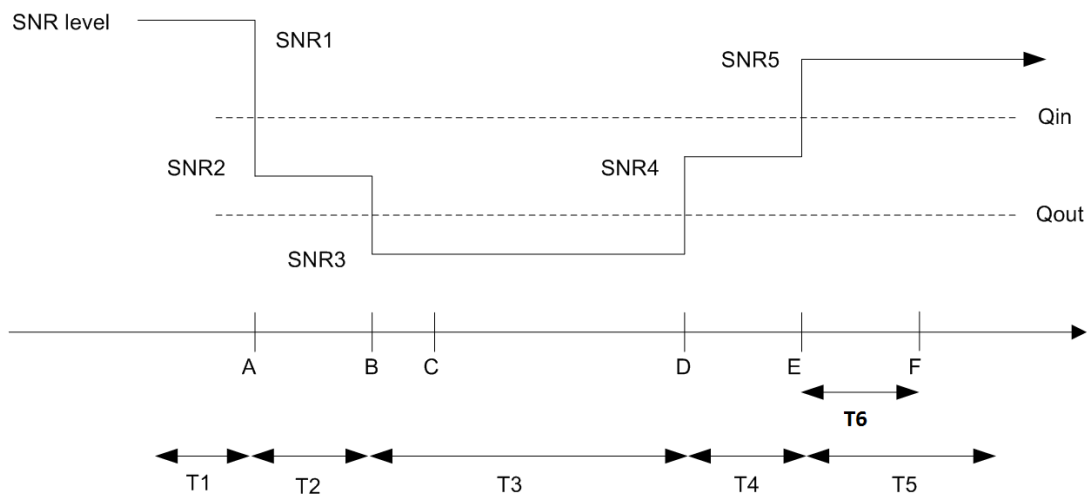
**Figure A.5.5.1.6.1-1: SNR variation for CSI-RS in-sync testing****A.5.5.1.6.2 Test Requirements**

The UE behaviour in each test during time durations T1, T2, T3, T4 and T5 shall be as follows:

During the period from time point A to time point F (T6 second after the start of time duration T5) the UE shall transmit uplink signal at least in all uplink slots configured for CSI transmission according to the configured periodic CSI reporting on the PSCell.

The rate of correct events observed during repeated tests shall be at least 90%.

A.5.5.1.7 EN-DC Radio Link Monitoring Out-of-sync Test for FR2 PSCell configured with CSI-RS-based RLM in DRX mode**A.5.5.1.7.1 Test Purpose and Environment**

The purpose of this test is to verify that the UE properly detects the out of sync for the purpose of monitoring downlink CSI-RS based radio link quality of the PSCell when no DRX is used. This test will partly verify the FR2 TDD PSCell CSI-RS Out-of-sync radio link monitoring requirements in clause 8.1.

The test parameters are given in Tables A.5.5.1.7.1-1, A.5.5.1.7.1-2, and A.5.5.1.7.1-3 below. There are two cells, cell 1 is the E-UTRAN PCell, and cell 2 is the PSCell, in the test. The test consists of three successive time periods, with time duration of T1, T2 and T3 respectively. Figure A.5.5.1.7.1-1 shows the variation of the downlink SNR in the E-UTRAN PCell and the PSCell to emulate out-of-sync and in-sync states. Prior to the start of the time duration T1, the UE shall be fully synchronized to cell 1 and cell 2. The UE shall be configured for periodic CSI reporting with a reporting periodicity of [5] or [10] ms. In the test, DRX configuration is enabled in PSCell and DRX inactivity timer has already been expired, i.e. UE tries to decode PDCCH and to send periodic CQI during the period when On-duration timer is running. Time alignment timers shall be set to “infinity” so that UL timing alignment is maintained during the test. The UE is configured to perform inter-frequency measurements without gap.

Table A.5.5.1.7.1-1: Supported test configurations for FR2 PSCell

Configuration	Description
1	LTE FDD, NR 120 kHz SSB SCS, 100MHz bandwidth, TDD duplex mode
2	LTE TDD, NR 240 kHz SSB SCS, 100MHz bandwidth, TDD duplex mode
Note:	The UE is only required to pass in one of the supported test configurations in FR2

Table A.5.5.1.7.1-2: General test parameters for FR2 PSCell for CSI-RS out-of-sync testing in DRX mode

Parameter		Unit	Value Test 1
Active E-UTRA PCell			Cell 1
E-UTRA RF Channel Number			1
Active PSCell			Cell 2
RF Channel Number			2
Duplex Mode			TDD
TDD Configuration	Config 1		TDDConf.3.1
	Config 2		TDDConf.3.1
CORESET Reference Channel	Config 1		CR. 3.1 TDD
	Config 2		CR. 3.1 TDD
SSB Configuration	Config 1		SSB.1 FR2
	Config 2		SSB.1 FR2
SMTC Configuration	Config 1		SMTC.1
	Config 2		SMTC.1
PDSCH/PDCC H subcarrier spacing	Config 1		120 KHz
	Config 2		120 KHz
csi-RS-Index assigned as RLM RS			[0]
TRS configuration			TRS.2.1 TDD
TCI configuration			CSI-RS.Config.0
OCNG parameters			OCNG pattern 1
CP length			Normal
Correlation Matrix and Antenna Configuration			[2x2 Low]
Out of sync transmission parameters	DCI format		1-0
	Number of Control OFDM symbols		2
	Aggregation level	CCE	8
	Ratio of hypothetical PDCCH RE energy to average CSI-RS RE energy	dB	4
	Ratio of hypothetical PDCCH DMRS energy to average CSI-RS RE energy	dB	4
	DMRS precoder granularity		REG bundle size
	REG bundle size		6
DRX			640
Gap pattern ID			[N.A.]
Layer 3 filtering			Enabled
T310 timer		ms	0
T311 timer		ms	1000
N310			1
N311			1
NZP CSI-RS configuration			[ResourceId 1]
ZP CSI-RS configuration			TBD
CSI-IM configuration			TBD
Periodic CSI reporting			PUCCH
CSI reporting periodicity	Config 1	slot	[5]
	Config 2		[10]
T1		s	1
T2		s	0.4

T3	s	[0.6]
D1	s	[0.24]
Note 1: UE-specific PDCCH is not transmitted after T1 starts.		
Note 2: E-UTRAN is in non-DRX mode under test.		

Table A.5.5.1.7.1-3: Cell specific test parameters for FR2 for CSI-RS out-of-sync radio link monitoring in DRX mode

Parameter		Unit	Test 1		
			T1	T2	T3
PDCCH_beta		dB	4		
PDCCH_DMRS_beta		dB	4		
PBCH_beta		dB	0		
PSS_beta		dB			
SSS_beta		dB			
PDSCH_beta		dB			
OCNG_beta		dB			
SNR		dB			
			TBD	TBD	TBD
N_{oc}		Config 1	TBD		
		Config 2	TBD		
Propagation condition			[TDL-A 30ns 75Hz]		
Note 1: OCNG shall be used such that the resources in Cell 2 are fully allocated and a constant total transmitted power spectral density is achieved for all OFDM symbols.					
Note 2: The uplink resources for CSI reporting are assigned to the UE prior to the start of time period T1.					
Note 3: NZP CSI-RS resource set configuration for CSI reporting are assigned to the UE prior to the start of time period T1.					
Note 4: Measurement gap configuration is assigned to the UE prior to the start of time period T1.					
Note 5: The timers and layer 3 filtering related parameters are configured prior to the start of time period T1.					
Note 6: The signal contains PDCCH for UEs other than the device under test as part of OCNG.					
Note 7: SNR levels correspond to the signal to noise ratio over the SSS REs.					
Note 8: The SNR in time periods T1, T2 and T3 is denoted as SNR1, SNR2 and SNR3 respectively in figure A.5.5.1.7.1-1.					
Note 9: The SNR values are specified for testing a UE which supports 2RX on at least one band. For testing of a UE which supports 4RX on all bands, the SNR during T3 is [A.3.6].					

Table A.5.5.1.7.1-3A: Measurement gap configuration for FR2 CSI-RS out-of-sync radio link monitoring in DRX mode

Field	Test 6
	Value
gapOffset	[0]
Note 1: E-UTRAN PCell and PSCell are SFN-synchronous and frame boundary aligned. (Ensure that RLM RS is partially overlapped with measurement gap)	

Table A.5.5.1.7.1-4: NZP-CSI-RS resource configuration for FR2 CSI-RS out-of-sync radio link monitoring in DRX mode

Field	ResourceId 0	ResourceId 1
	Value	Value
frequencyDomainAllocation ^{Note 1}	row1	row2
startingRB	0	0
nrofRBs	Note 2	Note 2
Note 1: TS 38.211 [6] table 7.4.1.5.3-1		
Note 2: nrofRBs is derived based on the Configuration in Table A.5.5.1.7.1-1		

Table A.5.5.1.7.1-5: DRX-Configuration for FR2 CSI-RS out-of-sync radio link monitoring in DRX mode.

Field	Test 1 Value
	drx-onDurationTimer
drx-InactivityTimer	[ms1]
drx-RetransmissionTimerDL	[sl1]
drx-RetransmissionTimerUL	[sl1]
longDRX-CycleStartOffset	[ms640]
shortDRX	disable

Table A.5.5.1.7.1-6: TimeAlignmentTimer -Configuration for FR2 CSI-RS out-of-sync radio link monitoring in DRX mode.

Field	Test 1 Value	
	TimeAlignmentTimer	infinity
periodicityAndOffset in SchedulingRequestResourceConfig	Config 1, 2, 4, 5	[sl5]
	Config 3, 6	[sl10]

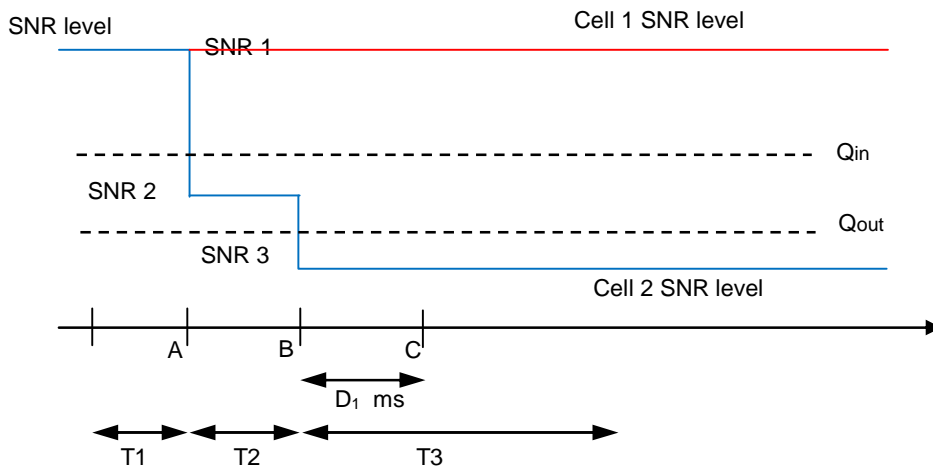

Figure A.5.5.1.7.1-1: SNR variation for CSI-RS out-of-sync testing

A.5.5.1.7.2 Test Requirements

The UE behaviour during time durations T1, T2, and T3 shall be as follows:

During time durations T1, T2 and T3, the UE shall transmit uplink signal at least in all subframes configured for CSI transmission on Cell 1 (E-UTRAN PCell).

During the period from time point A to time point B the UE shall transmit uplink signal in Cell 2 (PSCell) at least in all uplink slots configured for CSI transmission according to the configured periodic CSI reporting for Cell 2.

The UE shall stop transmitting uplink signal in Cell 2 (PSCell) no later than time point C ($D_1 = [\text{TBD}]$ ms after the start of the time duration T3) on the PSCell.

The rate of correct events observed during repeated tests shall be at least 90%.

A.5.5.1.8 EN-DC Radio Link Monitoring In-sync Test for FR2 PSCell configured with CSI-RS-based RLM in DRX mode

A.5.5.1.8.1 Test Purpose and Environment

The purpose of this test is to verify that the UE properly detects the in sync for the purpose of monitoring downlink CSI-RS based radio link quality of the PSCell when no DRX is used. This test will partly verify the FR2 TDD PSCell CSI-RS In-sync radio link monitoring requirements in clause 8.1.

The test parameters are given in Tables A.5.5.1.8.1-1, A.5.5.1.8.1-2, A.5.5.1.8.1-3 and A.5.5.1.8.1-4 below. There are two cells, cell 1 which is the E-UTRAN PCell, and cell 2 is the NR PSCell, in the test. The test consists of five successive time periods, with time duration of T1, T2, T3, T4 and T5 respectively. Figure A.5.5.1.8.1-1 shows the variation of the downlink SNR in the PSCell to emulate out-of-sync and in-sync states. Prior to the start of the time duration T1, the UE shall be fully synchronized to cell 1 and cell 2. The UE shall be configured for periodic CSI reporting with a reporting periodicity of [5] or [10] ms. In the test, DRX configuration is not enabled. The UE is configured to perform inter-frequency measurements using GP ID #0 (40ms).

Table A.5.5.1.8.1-1: Supported test configurations for FR2 PSCell

Configuration	Description
1	LTE FDD, NR 120 kHz SSB SCS, 100MHz bandwidth, TDD duplex mode
2	LTE TDD, NR 240 kHz SSB SCS, 100MHz bandwidth, TDD duplex mode
Note: The UE is only required to pass in one of the supported test configurations in FR2	

Table A.5.5.1.8.1-2: General test parameters for FR2 PSCell for CSI-RS in-sync testing in non-DRX mode

Parameter		Unit	Value Test 1
Active E-UTRA PCell			Cell 1
E-UTRA RF Channel Number			1
Active PSCell			Cell 2
RF Channel Number			2
Duplex Mode			TDD
TDD Configuration	Config 1		TDDConf.3.1
	Config 2		TDDConf.3.1
CORESET Reference Channel	Config 1		CR. 3.1 TDD
	Config 2		CR. 3.1 TDD
SSB Configuration	Config 1		SSB.1 FR2
	Config 2		SSB.1 FR2
SMTC Configuration	Config 1		SMTC.1
	Config 2		SMTC.1
PDSCH/PDCCH subcarrier spacing	Config 1		120 KHz
	Config 2		120 KHz
csi-RS-Index assigned as RLM RS			[0]
TRS configuration			TRS.2.1 TDD
TCI configuration			CSI-RS.Config.0
OCNG parameters			OCNG pattern 1
CP length			Normal
Correlation Matrix and Antenna Configuration			[2x2 Low]
Out of sync transmission parameters	DCI format		1-0
	Number of Control OFDM symbols		2
	Aggregation level	CCE	8
	Ratio of hypothetical PDCCH RE energy to average CSI-RS RE energy	dB	4
	Ratio of hypothetical PDCCH DMRS energy to average CSI-RS RE energy	dB	4
	DMRS precoder granularity		REG bundle size
	REG bundle size		6
DCI format			1-0

In sync transmission parameters	Number of Control OFDM symbols		2
	Aggregation level	CCE	4
	Ratio of hypothetical PDCCH RE energy to average CSI-RS RE energy	dB	0
	Ratio of hypothetical PDCCH DMRS energy to average CSI-RS RE energy	dB	0
	DMRS precoder granularity		REG bundle size
	REG bundle size		6
DRX			640
Gap pattern ID			*[gp0]
Layer 3 filtering			<i>Enabled</i>
T310 timer		ms	0
T311 timer		ms	1000
N310			1
N311			1
NZP CSI-RS configuration			[ResourceId 0]
ZP CSI-RS configuration			TBD
CSI-IM configuration			TBD
Periodic CSI reporting			PUCCH
CSI reporting periodicity	Config 1	slot	[5]
	Config 2		[10]
T1		s	1
T2		s	0.4
T3		s	[0.6]
D1		s	[0.44]
Note 1: UE-specific PDCCH is not transmitted after T1 starts.			
Note 2: E-UTRAN is in non-DRX mode under test.			

Table A.5.5.1.8.1-3: Cell specific test parameters for FR2 for CSI-RS in-sync radio link monitoring in non-DRX mode

Parameter		Unit	Test 1		
			T1	T2	T3
PDCCH_beta		dB	4		
PDCCH_DMRS_beta		dB	4		
PBCH_beta		dB	0		
PSS_beta		dB			
SSS_beta		dB			
PDSCH_beta		dB			
OCNG_beta		dB			
SNR	Config 1	dB			
	Config 2		TBD	TBD	TBD
N_{oc}	Config 1	dBm/15KHz	TBD		
	Config 2		TBD		
Propagation condition			[TDL-A 30ns 75Hz]		
Note 1: OCNG shall be used such that the resources in Cell 2 are fully allocated and a constant total transmitted power spectral density is achieved for all OFDM symbols.					
Note 2: The uplink resources for CSI reporting are assigned to the UE prior to the start of time period T1.					
Note 3: NZP CSI-RS resource set configuration for CSI reporting are assigned to the UE prior to the start of time period T1.					
Note 4: Measurement gap configuration is assigned to the UE prior to the start of time period T1.					
Note 5: The timers and layer 3 filtering related parameters are configured prior to the start of time period T1.					
Note 6: The signal contains PDCCH for UEs other than the device under test as part of OCNG.					
Note 7: SNR levels correspond to the signal to noise ratio over the SSS REs.					
Note 8: The SNR in time periods T1, T2 and T3 is denoted as SNR1, SNR2 and SNR3 respectively in figure A.5.5.1.8.1-1.					
Note 9: The SNR values are specified for testing a UE which supports 2RX on at least one band. For testing of a UE which supports 4RX on all bands, the SNR during T3 is [A.3.6].					

Table A.5.5.1.8.1-3A: Measurement gap configuration for FR2 CSI-RS in-sync radio link monitoring in non-DRX mode

Field	Test 8
	Value
gapOffset	[0]
Note 1: E-UTRAN PCell and PSCell are SFN-synchronous and frame boundary aligned. (Ensure that RLM RS is partially overlapped with measurement gap)	

Table A.5.5.1.8.1-4: NZP-CSI-RS resource configuration for FR2 CSI-RS in-sync radio link monitoring in non-DRX mode

Field	ResourceId 0	ResourceId 1
	Value	Value
frequencyDomainAllocation ^{Note 1}	row1	row2
startingRB	0	0
nrofRBs	Note 2	Note 2
Note 1: TS 38.211 [6] table 7.4.1.5.3-1		
Note 2: nrofRBs is derived based on the Configuration in Table A.5.5.1.8.1-1		

Table A.5.5.1.8.1-5: DRX-Configuration for FR2 CSI-RS in-sync radio link monitoring in DRX mode.

Field	Test 1 Value
	drx-onDurationTimer
drx-InactivityTimer	[ms1]
drx-RetransmissionTimerDL	[sl1]
drx-RetransmissionTimerUL	[sl1]
longDRX-CycleStartOffset	[ms40]
shortDRX	disable

Table A.5.5.1.8.1-6: TimeAlignmentTimer -Configuration for FR2 CSI-RS in-sync radio link monitoring in DRX mode.

Field	Test 1 Value	
	TimeAlignmentTimer	infinity
periodicityAndOffset in SchedulingRequestResourceConfig	Config 1, 2, 4, 5	[sl5]
	Config 3, 6	[sl10]

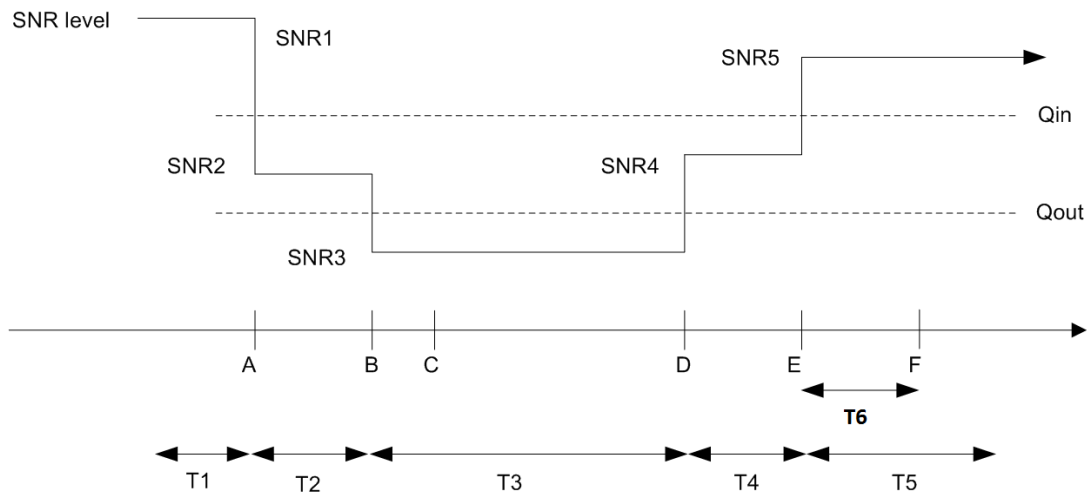

Figure A.5.5.1.8.1-1: SNR variation for CSI-RS in-sync testing

A.5.5.1.8.2 Test Requirements

The UE behaviour in each test during time durations T1, T2, T3, T4 and T5 shall be as follows:

During the period from time point A to time point F (T6 second after the start of time duration T5) the UE shall transmit uplink signal at least in all uplink slots configured for CSI transmission according to the configured periodic CSI reporting on the PSCell.

The rate of correct events observed during repeated tests shall be at least 90%.

A.5.5.2 Interruption

A.5.5.2.1 E-UTRAN – NR FR2 interruptions at transitions between active and non-active during DRX in synchronous EN-DC

A.5.5.2.1.1 Test Purpose and Environment

The purpose of this test is to verify that when LTE PCell is in DRX and NR PSCell is in non-DRX, NR PSCell interruptions due to transitions from active to non-active and from non-active to active during LTE PCell DRX the UE missed ACK/NACK does not exceed the limits. This test will verify the missed ACK/NACK rate for NR PSCell in EN-DC specified in section 8. 2.1.2. Supported test configurations are shown in table A.5.5.2.1.1-1.

The general test parameters are given in Table A.5.5.2.1.1-2, and NR cell specific test parameters are given in Table A.5.5.2.1.1-3 and A.5.5.2.1.1-4. The E-UTRAN PCell DRX configuration parameters are given in Table A.5.5.2.1.1-5 below. And the E-UTRAN cell specific test parameters can refer to Table A.3.7.2.2-1. In the test there are two cells: Cell1 and Cell2. Cell1 is LTE PCell and Cell2 is NR FR2 PSCell. The test consists of one time period, with duration of T1. During T1, NR PSCell is continuously scheduled in DL while LTE PCell is not scheduled and has DRX configured. Prior to the start of the time duration T1, Cell1 shall be configured as LTE PCell and Cell2 shall be configured as NR PSCell. Prior to start of T1 the DRX inactivity timer for the LTE PCell have already expired. During T1 the UE shall be continuously scheduled on NR PSCell while not scheduled on LTE PCell. PDCCH indicating a new transmission on PSCell shall be sent continuously during the whole time duration to ensure UE would not enter DRX state on PSCell.

Table A.5.5.2.1.1-1: Interruption at transitions between active and non-active during DRX supported test configurations

Config	Description
1	LTE FDD, NR 120 kHz SSB SCS, 100MHz bandwidth, TDD duplex mode
2	LTE TDD, NR 120 kHz SSB SCS, 100MHz bandwidth, TDD duplex mode

Table A.5.5.2.1.1-2: General test parameters for E-UTRAN – NR FR2 interruptions at transitions between active and non-active during DRX in synchronous EN-DC

Parameter	Unit	Value	Comment
RF Channel Number		1, 2	One is E-UTRAN RF channel and the other is NR RF channel
Active PCell		Cell1	PCell on E-UTRAN RF channel number 1.
Configured PSCell		Cell2	PSCell on NR RF channel number 2.
CP length		Normal	Applicable to cell1 and cell 2
DRX		ON	DRX related parameters are defined in Table A.5.5.2.1.1-3
Measurement gap pattern Id		OFF	
T1	s	10	

Table A.5.5.2.1.1-3: NR cell specific test parameters for E-UTRAN – NR FR2 interruptions at transitions between active and non-active during DRX in synchronous EN-DC

Parameter		Unit	Cell 2
Connection Type			Conducted
Frequency Range			FR2
Duplex mode	Config 1,2		TDD
TDD configuration	Config 1,2		TBD
BW _{channel}	Config 1,2	MHz	100: N _{RB,c} = 66
Initial BWP Configuration	Config 1,2		TBD
PDSCH Reference measurement channel	Config 1,2		SR.3.1 TDD
RMSI CORESET parameters	Config 1,2		CR.3.1 TDD
PDCCH CORESET parameters	Config 1,2		TBD
OCNG Patterns			OP.1
SMTTC Configuration	Config 1,2		SMTTC.1 FR2
EPRE ratio of PSS to SSS		dB	0
EPRE ratio of PBCH DMRS to SSS			
EPRE ratio of PBCH to PBCH DMRS			
EPRE ratio of PDCCH DMRS to SSS			
EPRE ratio of PDCCH to PDCCH DMRS			
EPRE ratio of PDSCH DMRS to SSS			
EPRE ratio of PDSCH to PDSCH			
EPRE ratio of OCNG DMRS to SSS(Note 1)			
EPRE ratio of OCNG to OCNG DMRS (Note 1)			
E _s /N _{oc}		dB	TBD
Propagation Condition			AWGN
Time offset to cell1 ^{Note 2}		μs	3
Note 1: OCNG shall be used such that both cells are fully allocated and a constant total transmitted power spectral density is achieved for all OFDM symbols.			
Note 2: Receive time difference of signals received between subframe timing boundary of E-UTRA PCell and slot timing boundary of PSCell including time alignment error between the two cells			

Table A.5.5.2.1.1-4: NR cell specific OTA related test parameters for E-UTRAN – NR FR2 interruptions at transitions between active and non-active during DRX in synchronous EN-DC

Parameter		Unit	Cell 2
UE orientation around TBD axis and TBD axis			TBD
Relative difference in angle of arrival of cell 2 relative to cell 1		degrees	TBD
N_{oc} ^{Note1}	NR_TDD_FR2_A	dBm/15kHz ^{Note4}	TBD
	NR_TDD_FR2_B		
	NR_TDD_FR2_C		
	NR_TDD_FR2_D		
	NR_TDD_FR2_E		
	NR_TDD_FR2_F		
N_{oc} ^{Note1}	NR_TDD_FR2_G	dBm/SCS ^{Note3}	TBD
	NR_TDD_FR2_A		
	NR_TDD_FR2_B		
	NR_TDD_FR2_C		
	NR_TDD_FR2_D		
	NR_TDD_FR2_E		
SS-RSRP ^{Note2}	NR_TDD_FR2_F	dBm/SCS ^{Note4}	TBD
	NR_TDD_FR2_G		
	NR_TDD_FR2_A		
	NR_TDD_FR2_B		
	NR_TDD_FR2_C		
	NR_TDD_FR2_D		
\hat{E}_s/I_{ot}		dB	TBD
I_o ^{Note2}	NR_TDD_FR2_A	dBm/95.04 MHz ^{Note4}	TBD
<p>Note 1: Interference from other cells and noise sources not specified in the test is assumed to be constant over subcarriers and time and shall be modeled as AWGN of appropriate power for N_{oc} to be fulfilled.</p> <p>Note 2: SS-RSRP and I_o levels have been derived from other parameters for information purposes. They are not settable parameters themselves.</p> <p>Note 3: SS-RSRP minimum requirements are specified assuming independent interference and noise at each receiver antenna port.</p> <p>Note 4: Equivalent power received by an antenna with 0dBi gain at the center of the quiet zone</p> <p>Note 5: As observed with 0dBi gain antenna at the center of the quiet zone</p>			

Table A.5.5.2.1.1-5: E-UTRAN PCell DRX-Configuration for E-UTRAN TDD – NR FR2 TDD interruptions at transitions between active and non-active during DRX in synchronous EN-DC

Field	Cell1	Comment
	Value	
onDurationTimer	psf1	As specified in clause 6.3.2 in TS 36.331
drx-InactivityTimer ^{Note 1}	psf1	
drx-RetransmissionTimer	psf1	
longDRX-CycleStartOffset	Sf160	
shortDRX	disable	
Note 1: UE is continuously scheduled in NR PSCell		

A.5.5.2.1.2 Test Requirements

The UE shall be continuously scheduled in NR PSCell during the entire length of T1. UE shall not be scheduled in LTE PCell during T1. During the time duration T1 the UE shall transmit at least 99% of ACK/NACK on NR PSCell.

Interruption on NR PSCell shall not exceed 0.625ms (5 slots) as defined in section 8. 2.1.

The rate of correct events observed during repeated tests shall be at least 90%.

A.5.5.2.2 E-UTRAN – NR FR2 interruptions at transitions between active and non-active during DRX in asynchronous EN-DC

A.5.5.2.2.1 Test Purpose and Environment

The purpose of this test is to verify that when LTE PCell is in DRX and NR PSCell is in non-DRX, NR PSCell interruptions due to transitions from active to non-active and from non-active to active during LTE PCell DRX the UE missed ACK/NACK does not exceed the limits. This test will verify the missed ACK/NACK rate for NR PSCell in EN-DC specified in section 8. 2.1.2. Supported test configurations are shown in table A.5.5.2.2.1-1.

The general test parameters are given in Table A.5.5.2.2.1-2, and NR cell specific test parameters are given in Table A.5.5.2.2.1-3 and A.5.5.2.2.1-4. The E-UTRAN PCell DRX configuration parameters are given in Table A.5.5.2.2.1-5 below. And the E-UTRAN cell specific test parameters can refer to Table A.3.7.2.2-1. In the test there are two cells: Cell1 and Cell2. Cell1 is LTE PCell and Cell2 is NR PSCell. The test consists of one time period, with duration of T1. During T1, NR PSCell is continuously scheduled in DL while LTE PCell is not scheduled and has DRX configured. Prior to the start of the time duration T1, Cell1 shall be configured as LTE PCell and Cell2 shall be configured as NR PSCell. Prior to start of T1 the DRX inactivity timer for the LTE PCell have already expired. During T1 the UE shall be continuously scheduled on NR PSCell while not scheduled on LTE PCell. PDCCH indicating a new transmission on PSCell shall be sent continuously during the whole time duration to ensure UE would not enter DRX state on PSCell.

Table A.5.5.2.2.1-1: Interruption at transitions between active and non-active during DRX supported test configurations

Config	Description
1	LTE FDD, NR 120 kHz SSB SCS, 100MHz bandwidth, TDD duplex mode
2	LTE TDD, NR 120 kHz SSB SCS, 100MHz bandwidth, TDD duplex mode

Table A.5.5.2.2.1-2: General test parameters for E-UTRAN – NR FR2 interruptions at transitions between active and non-active during DRX in asynchronous EN-DC

Parameter	Unit	Value	Comment
RF Channel Number		1, 2	One is E-UTRAN RF channel and the other is NR RF channel
Active PCell		Cell1	PCell on E-UTRAN RF channel number 1.
Configured PSCell		Cell2	PSCell on NR RF channel number 2.
CP length		Normal	Applicable to cell1 and cell 2
DRX		ON	DRX related parameters are defined in Table A.5.5.2.2.1-3
Measurement gap pattern Id		OFF	
T1	s	10	

Table A.5.5.2.2.1-3: NR cell specific test parameters for E-UTRAN – NR FR2 interruptions at transitions between active and non-active during DRX in asynchronous EN-DC

Parameter		Unit	Cell 2
Connection Type			Conducted
Frequency Range			FR2
Duplex mode	Config 1,2		TDD
TDD configuration	Config 1,2		TBD
BW _{channel}	Config 1,2	MHz	100: N _{RB,c} = 66
Initial BWP Configuration	Config 1,2		TBD
PDSCH Reference measurement channel	Config 1,2		SR.3.1 TDD
RMSI CORESET parameters	Config 1,2		CR.3.1 TDD
PDCCH CORESET parameters	Config 1,2		TBD
OCNG Patterns			OP.1
SMTc Configuration	Config 1,2		SMTc.1 FR2
EPRE ratio of PSS to SSS		dB	0
EPRE ratio of PBCH DMRS to SSS			
EPRE ratio of PBCH to PBCH DMRS			
EPRE ratio of PDCCH DMRS to SSS			
EPRE ratio of PDCCH to PDCCH DMRS			
EPRE ratio of PDSCH DMRS to SSS			
EPRE ratio of PDSCH to PDSCH			
EPRE ratio of OCNG DMRS to SSS(Note 1)			
EPRE ratio of OCNG to OCNG DMRS (Note 1)			
E _s /N _{oc}		dB	TBD
Propagation Condition			AWGN
Time offset to cell1 ^{Note 2}		ms	3
Note 1: OCNG shall be used such that both cells are fully allocated and a constant total transmitted power spectral density is achieved for all OFDM symbols.			
Note 2: Receive time difference of signals received between subframe timing boundary of E-UTRA PCell and slot timing boundary of PSCell including time alignment error between the two cells			

Table A.5.5.2.2.1-4: NR cell specific OTA related test parameters for E-UTRAN – NR FR2 interruptions at transitions between active and non-active during DRX in asynchronous EN-DC

Parameter		Unit	Cell 2
UE orientation around TBD axis and TBD axis			TBD
Relative difference in angle of arrival of cell 2 relative to cell 1		degrees	TBD
N _{oc} ^{Note1}	NR_TDD_FR2_A	dBm/15kHz ^{Note4}	TBD
	NR_TDD_FR2_B		
	NR_TDD_FR2_C		
	NR_TDD_FR2_D		
	NR_TDD_FR2_E		
	NR_TDD_FR2_F		
	NR_TDD_FR2_G		
N _{oc} ^{Note1}	NR_TDD_FR2_A	dBm/SCS ^{Note3}	TBD
	NR_TDD_FR2_B		
	NR_TDD_FR2_C		
	NR_TDD_FR2_D		
	NR_TDD_FR2_E		
	NR_TDD_FR2_F		
	NR_TDD_FR2_G		
SS-RSRP ^{Note2}	NR_TDD_FR2_A	dBm/SCS ^{Note4}	TBD
	NR_TDD_FR2_B		
	NR_TDD_FR2_C		

	NR_TDD_FR2_D		
	NR_TDD_FR2_E		
	NR_TDD_FR2_F		
	NR_TDD_FR2_G		
\hat{E}_s / I_{ot}		dB	TBD
I_o ^{Note2}	NR_TDD_FR2_A	dBm/95.04 MHz ^{Note4}	TBD
<p>Note 1: Interference from other cells and noise sources not specified in the test is assumed to be constant over subcarriers and time and shall be modeled as AWGN of appropriate power for N_{oc} to be fulfilled.</p> <p>Note 2: SS-RSRP and I_o levels have been derived from other parameters for information purposes. They are not settable parameters themselves.</p> <p>Note 3: SS-RSRP minimum requirements are specified assuming independent interference and noise at each receiver antenna port.</p> <p>Note 4: Equivalent power received by an antenna with 0dBi gain at the center of the quiet zone</p> <p>Note 5: As observed with 0dBi gain antenna at the center of the quiet zone</p>			

Table A.5.5.2.1-5: E-UTRAN PCell DRX-Configuration for E-UTRAN – NR FR2 interruptions at transitions between active and non-active during DRX in asynchronous EN-DC

Field	Cell1 Value	Comment
	onDurationTimer	
drx-InactivityTimer ^{Note 1}	psf1	As specified in clause 6.3.2 in TS 36.331
drx-RetransmissionTimer	psf1	
longDRX-CycleStartOffset	Sf320	
shortDRX	disable	
Note 1: UE is continuously scheduled in NR PSCell		

A.5.5.2.2.2 Test Requirements

The UE shall be continuously scheduled in NR PSCell during the entire length of T1. UE shall not be scheduled in LTE PCell during T1. During the time duration T1 the UE shall transmit at least 99% of ACK/NACK on NR PSCell.

Interruption on NR PSCell shall not exceed 0.625ms (5 slots) as defined in section 8. 2.1.

The rate of correct events observed during repeated tests shall be at least 90%.

A.5.5.2.3 E-UTRAN – NR FR2 interruptions during measurements on deactivated NR SCC in synchronous EN-DC

A.5.5.2.3.1 Test Purpose and Environment

The purpose of this test is to verify NR PSCell interruptions during the measurement on the deactivated NR SCC, the UE missed ACK/NACK does not exceed the limits. This test will verify the missed ACK/NACK rate for NR PSCell in EN-DC specified in section 8. 2.1.2. Supported test configurations are shown in table A.5.5.2.3.1-1.

The general test parameters are given in Table A.5.5.2.3.1-2, and NR cell specific test parameters are given in Table A.5.5.2.3.1-3 and A.5.5.2.3.1-4 below. And the E-UTRAN cell specific test parameters can refer to Table A.3.7.2.1-2. In the test there are three cells: Cell1 Cell2 and Cell3. Cell1 is LTE PCell, Cell2 and Cell 3 is NR FR2 PSCell and NR FR2 deactivated SCell. Cell1 shall be configured as LTE PCell and Cell2 shall be configured as NR PSCell. The test consists of one time period, with duration of T1. Prior to the start of the time duration T1, the UE is connected to Cell1 and Cell2. The point in time at which the RRC message including *measCycleSCell* or *allowInterruptions* for the deactivated NR SCells is received by the UE, defines the start of time period T1. During T1, LTE PCell and NR PSCell are continuously scheduled in DL.

Table A.5.5.2.3.1-1: Interruption during measurements on deactivated NR SCC supported test configurations

Config	Description
1	LTE FDD, NR 120 kHz SSB SCS, 100MHz bandwidth, TDD duplex mode
2	LTE TDD, NR 120 kHz SSB SCS, 100MHz bandwidth, TDD duplex mode

Table A.5.5.2.3.1-2: General test parameters for E-UTRAN – NR FR2 interruptions during measurements on deactivated NR SCC in synchronous EN-DC

Parameter	Unit	Value	Comment
RF Channel Number		1, 2	One is E-UTRAN RF channel and the other two are NR RF channel
Active PCell		Cell1	PCell on E-UTRAN RF channel number 1.
Configured PSCell		Cell2	PSCell on NR RF channel number 2.
Configured deactivated SCell		Cell3	Deactivated SCell on NR RF channel number 2.
CP length		Normal	Applicable to cell1, cell 2 and cell3
DRX		OFF	
Measurement gap pattern Id		OFF	
SCell measurement cycle (measCycleSCell)	ms	640	
T1	s	10	

Table A.5.5.2.3.1-3: NR cell specific test parameters for E-UTRAN – NR FR2 interruptions during measurements on deactivated NR SCC in synchronous EN-DC

Parameter		Unit	Cell 2	Cell 3
Connection Type			Conducted	Conducted
Frequency Range			FR2	FR2
Duplex mode	Config 1		FDD	FDD
	Config 2		TDD	TDD
TDD configuration	Config 1		N.A	N.A
	Config 2		TBD	TBD
BW _{channel}	Config 1,2	MHz	100: N _{RB,c} = 66	100: N _{RB,c} = 66
Initial BWP Configuration	Config 1,2		TBD	TBD
PDSCH Reference measurement channel	Config 1,2		SR.3.1 TDD	-
RMSI CORESET parameters	Config 1,2		CR.3.1 TDD	CR.3.1 TDD
PDCCH CORESET parameters	Config 1,2		TBD	TBD
OCNG Patterns			OP.1	OP.1
SMTTC Configuration	Config 1,2		SMTTC.1 FR2	SMTTC.1 FR2
EPRE ratio of PSS to SSS		dB	0	0
EPRE ratio of PBCH DMRS to SSS				
EPRE ratio of PBCH to PBCH DMRS				
EPRE ratio of PDCCH DMRS to SSS				
EPRE ratio of PDCCH to PDCCH DMRS				
EPRE ratio of PDSCH DMRS to SSS				
EPRE ratio of PDSCH to PDSCH				
EPRE ratio of OCNG DMRS to SSS(Note 1)				
EPRE ratio of OCNG to OCNG DMRS (Note 1)				
\bar{E}_s/N_{oc}		dB	TBD	TBD
Propagation Condition			AWGN	AWGN
Time offset to cell1 ^{Note 2}		μ s	3	3
Time offset to cell1 ^{Note 3}		μ s	-	3
<p>Note 1: OCNG shall be used such that both cells are fully allocated and a constant total transmitted power spectral density is achieved for all OFDM symbols.</p> <p>Note 2: Receive time difference of signals received between subframe timing boundary of E-UTRA PCell and slot timing boundary of PSCell including time alignment error between the two cells</p> <p>Note 3: Receive time difference of signals received between slot timing boundary from two NR Cells including time alignment error between the two cells</p>				

Table A.5.5.2.3.1-4: NR cell specific OTA related test parameters for E-UTRAN – NR FR2 interruptions during measurements on deactivated NR SCC in synchronous EN-DC

Parameter		Unit	Cell 2	Cell 3
UE orientation around TBD axis and TBD axis			TBD	
Relative difference in angle of arrival of cell 2 and cell 3 relative to cell 1		degrees	TBD	
N_{oc} ^{Note1}	NR_TDD_FR2_A	dBm/15kHz ^{Note4}	TBD	TBD
	NR_TDD_FR2_B			
	NR_TDD_FR2_C			
	NR_TDD_FR2_D			
	NR_TDD_FR2_E			
	NR_TDD_FR2_F			
	NR_TDD_FR2_G			
N_{oc} ^{Note1}	NR_TDD_FR2_A	dBm/SCS ^{Note3}	TBD	TBD
	NR_TDD_FR2_B			
	NR_TDD_FR2_C			
	NR_TDD_FR2_D			

	NR_TDD_FR2_E			
	NR_TDD_FR2_F			
	NR_TDD_FR2_G			
SS-RSRP ^{Note2}	NR_TDD_FR2_A	dBm/SCS ^{Note4}	TBD	TBD
	NR_TDD_FR2_B			
	NR_TDD_FR2_C			
	NR_TDD_FR2_D			
	NR_TDD_FR2_E			
	NR_TDD_FR2_F			
	NR_TDD_FR2_G			
\hat{E}_s / I_{ot}		dB	TBD	TBD
I_o ^{Note2}	NR_TDD_FR2_A	dBm/95.04 MHz ^{Note4}	TBD	TBD
<p>Note 1: Interference from other cells and noise sources not specified in the test is assumed to be constant over subcarriers and time and shall be modeled as AWGN of appropriate power for N_{oc} to be fulfilled.</p> <p>Note 2: SS-RSRP and I_o levels have been derived from other parameters for information purposes. They are not settable parameters themselves.</p> <p>Note 3: SS-RSRP minimum requirements are specified assuming independent interference and noise at each receiver antenna port.</p> <p>Note 4: Equivalent power received by an antenna with 0dBi gain at the center of the quiet zone</p> <p>Note 5: As observed with 0dBi gain antenna at the center of the quiet zone</p>				

A.5.5.2.3.2 Test Requirements

The UE shall be continuously scheduled in LTE PCell and NR PSCell during the entire length of T1. During the time duration T1 the UE shall transmit at least 99.5% of ACK/NACK on NR PSCell. The UE is only allowed to cause interruptions immediately before and immediately after an SMTC. Each interruption on NR PSCell shall not exceed the value defined in Table A.5.5.2.3.2-1 and Table A.5.5.2.3.2-2.

Table A.5.5.2.3.2-1: Interruption duration if the NR PSCell is not in the same band as the deactivated SCell

μ	NR Slot length (ms)	Interruption length
3	0.125	4

Table A.5.5.2.3.2-2: Interruption duration if the NR PSCell is not in the same band as the deactivated SCell

μ	NR Slot length (ms)	Interruption length
3	0.125	8 + SMTC duration

The rate of correct events observed during repeated tests shall be at least 90%.

A.5.5.2.4 E-UTRAN – NR FR2 interruptions during measurements on deactivated NR SCC in asynchronous EN-DC

A.5.5.2.4.1 Test Purpose and Environment

The purpose of this test is to verify NR PSCell interruptions during the measurement on the deactivated NR SCC, the UE missed ACK/NACK does not exceed the limits. This test will verify the missed ACK/NACK rate for NR PSCell in EN-DC specified in section 8. 2.1.2. Supported test configurations are shown in table A.5.5.2.4.1-1.

The general test parameters are given in Table A.5.5.2.4.1-2, and NR cell specific test parameters are given in Table A.5.5.2.4.1-3 and A.5.5.2.4.1-4 below. And the E-UTRAN cell specific test parameters can refer to Table A.3.7.2.1-2. In the test there are three cells: Cell1 Cell2 and Cell3. Cell1 is LTE PCell, Cell2 and Cell 3 is NR FR2 PSCell and NR FR2 deactivated SCell. Cell1 shall be configured as LTE PCell and Cell2 shall be configured as NR PSCell. The test consists of one time period, with duration of T1. Prior to the start of the time duration T1, the UE is connected to Cell1 and Cell2. The point in time at which the RRC message including *measCycleSCell* or *allowInterruptions* for the deactivated NR SCells is received by the UE, defines the start of time period T1. During T1, LTE PCell and NR PSCell are continuously scheduled in DL.

Table A.5.5.2.4.1-1: Interruption during measurements on deactivated NR SCC supported test configurations

Config	Description
1	LTE FDD, NR 120 kHz SSB SCS, 100MHz bandwidth, TDD duplex mode
2	LTE TDD, NR 120 kHz SSB SCS, 100MHz bandwidth, TDD duplex mode

Table A.5.5.2.4.1-2: General test parameters for E-UTRAN – NR interruptions during measurements on deactivated NR SCC in asynchronous EN-DC

Parameter	Unit	Value	Comment
RF Channel Number		1, 2	One is E-UTRAN RF channel and the other two are NR RF channel
Active PCell		Cell1	PCell on E-UTRAN RF channel number 1.
Configured PSCell		Cell2	PSCell on NR RF channel number 2.
Configured deactivated SCell		Cell3	Deactivated SCell on NR RF channel number 2.
CP length		Normal	Applicable to cell1, cell 2 and cell3
AoA number		1	Applicable to cell2 and cell3
DRX		OFF	
Measurement gap pattern Id		OFF	
SCell measurement cycle (<i>measCycleSCell</i>)	ms	640	
T1	s	10	

Table A.5.5.2.3.1-3: NR cell specific test parameters for E-UTRAN – NR interruptions during measurements on deactivated NR SCC in asynchronous EN-DC

Parameter		Unit	Cell 2	Cell 3
Connection Type			Conducted	Conducted
Frequency Range			FR2	FR2
Duplex mode	Config 1		FDD	FDD
	Config 2		TDD	TDD
TDD configuration	Config 1		N.A	N.A
	Config 2		TBD	TBD
BW _{channel}	Config 1,2	MHz	100: N _{RB,c} = 66	100: N _{RB,c} = 66
Initial BWP Configuration	Config 1,2		TBD	TBD
PDSCH Reference measurement channel	Config 1,2		SR.3.1 TDD	-
RMSI CORESET parameters	Config 1,2		CR.3.1 TDD	CR.3.1 TDD
PDCCH CORESET parameters	Config 1,2		TBD	TBD
OCNG Patterns			OP.1	OP.1
SMTTC Configuration	Config 1,2		SMTTC.1 FR2	SMTTC.1 FR2
EPRE ratio of PSS to SSS		dB	0	0
EPRE ratio of PBCH DMRS to SSS				
EPRE ratio of PBCH to PBCH DMRS				
EPRE ratio of PDCCH DMRS to SSS				
EPRE ratio of PDCCH to PDCCH DMRS				
EPRE ratio of PDSCH DMRS to SSS				
EPRE ratio of PDSCH to PDSCH				
EPRE ratio of OCNG DMRS to SSS(Note 1)				
EPRE ratio of OCNG to OCNG DMRS (Note 1)				
\bar{E}_s/N_{oc}		dB	TBD	TBD
Propagation Condition			AWGN	AWGN
Time offset to cell1 ^{Note 2}		ms	3	3
Time offset to cell1 ^{Note 3}		μs	-	3
<p>Note 1: OCNG shall be used such that both cells are fully allocated and a constant total transmitted power spectral density is achieved for all OFDM symbols.</p> <p>Note 2: Receive time difference of signals received between subframe timing boundary of E-UTRA PCell and slot timing boundary of PSCell including time alignment error between the two cells</p> <p>Note 3: Receive time difference of signals received between slot timing boundary from two NR Cells including time alignment error between the two cells</p>				

Table A.5.5.2.4.1-4: NR cell specific OTA related test parameters for E-UTRAN – NR FR2 interruptions during measurements on deactivated NR SCC in asynchronous EN-DC

Parameter		Unit	Cell 2	Cell 3
UE orientation around TBD axis and TBD axis			TBD	
Relative difference in angle of arrival of cell 2 and cell 3 relative to cell 1		degrees	TBD	
N_{oc} ^{Note1}	NR_TDD_FR2_A	dBm/15kHz ^{Note4}	TBD	TBD
	NR_TDD_FR2_B			
	NR_TDD_FR2_C			
	NR_TDD_FR2_D			
	NR_TDD_FR2_E			
	NR_TDD_FR2_F			
N_{oc} ^{Note1}	NR_TDD_FR2_A	dBm/SCS ^{Note3}	TBD	TBD
	NR_TDD_FR2_B			
	NR_TDD_FR2_C			
	NR_TDD_FR2_D			

	NR_TDD_FR2_E			
	NR_TDD_FR2_F			
	NR_TDD_FR2_G			
SS-RSRP ^{Note2}	NR_TDD_FR2_A	dBm/SCS ^{Note4}	TBD	TBD
	NR_TDD_FR2_B			
	NR_TDD_FR2_C			
	NR_TDD_FR2_D			
	NR_TDD_FR2_E			
	NR_TDD_FR2_F			
	NR_TDD_FR2_G			
\hat{E}_s / I_{ot}		dB	TBD	TBD
I_o ^{Note2}	NR_TDD_FR2_A	dBm/95.04 MHz ^{Note4}	TBD	TBD
<p>Note 1: Interference from other cells and noise sources not specified in the test is assumed to be constant over subcarriers and time and shall be modeled as AWGN of appropriate power for N_{oc} to be fulfilled.</p> <p>Note 2: SS-RSRP and I_o levels have been derived from other parameters for information purposes. They are not settable parameters themselves.</p> <p>Note 3: SS-RSRP minimum requirements are specified assuming independent interference and noise at each receiver antenna port.</p> <p>Note 4: Equivalent power received by an antenna with 0dBi gain at the center of the quiet zone</p> <p>Note 5: As observed with 0dBi gain antenna at the center of the quiet zone</p>				

A.5.5.2.4.2 Test Requirements

The UE shall be continuously scheduled in LTE PCell and NR PSCell during the entire length of T1. During the time duration T1 the UE shall transmit at least 99.5% of ACK/NACK on NR PSCell. The UE is only allowed to cause interruptions immediately before and immediately after an SMTC. Each interruption on NR PSCell shall not exceed the value defined in Table A.5.5.2.4.2-1 and Table A.5.5.2.4.2-2.

Table A.5.5.2.4.2-1: Interruption duration if the NR PSCell is not in the same band as the deactivated SCell

μ	NR Slot length (ms)	Interruption length
3	0.125	4

Table A.5.5.2.4.2-2: Interruption duration if the NR PSCell is not in the same band as the deactivated SCell

μ	NR Slot length (ms)	Interruption length
3	0.125	8 + SMTC duration

The rate of correct events observed during repeated tests shall be at least 90%.

A.5.5.2.5 E-UTRAN – NR FR2 interruptions during measurements on deactivated E-UTRAN SCC in synchronous EN-DC

A.5.5.2.5.1 Test Purpose and Environment

The purpose of this test is to verify NR PSCell interruptions during the measurement on the deactivated E-UTRAN SCC, the UE missed ACK/NACK does not exceed the limits. This test will verify the missed ACK/NACK rate for NR PSCell in EN-DC specified in section 8. 2.1.2. Supported test configurations are shown in table A.5.5.2.5.1-1.

The general test parameters are given in Table A.5.5.2.5.1-2, and NR cell specific test parameters are given in Table A.5.5.2.5.1-3 and A.5.5.2.5.1-4 below. And the E-UTRAN cell specific test parameters can refer to Table A.3.7.2.1-2. In the test there are three cells: Cell1 Cell2 and Cell3. Cell1 and Cell3 is LTE PCell and LTE deactivated SCell, Cell2 is NR FR2 PSCell. Cell1 shall be configured as LTE PCell and Cell2 shall be configured as NR PSCell. The test consists of one time period, with duration of T1. Prior to the start of the time duration T1, the UE is connected to Cell1 and Cell2. The point in time at which the RRC message including *measCycleSCell* or *allowInterruptions* for the deactivated NR SCells is received by the UE, defines the start of time period T1. During T1, LTE PCell and NR PSCell are continuously scheduled in DL.

Table A.5.5.2.5.1-1: Interruption during measurements on deactivated E-UTRAN SCC supported test configurations

Config	Description
1	LTE FDD, NR 120 kHz SSB SCS, 100MHz bandwidth, TDD duplex mode
2	LTE TDD, NR 120 kHz SSB SCS, 100MHz bandwidth, TDD duplex mode

Table A.5.5.2.5.1-2: General test parameters for E-UTRAN – NR FR2 interruptions during measurements on deactivated E-UTRAN SCC in synchronous EN-DC

Parameter	Unit	Value	Comment
RF Channel Number		1, 2	One is E-UTRAN RF channel and two is NR RF channel
Active PCell		Cell1	PCell on E-UTRAN RF channel number 1.
Configured PSCell		Cell2	PSCell on NR RF channel number 2.
Configured deactivated SCell		Cell3	Deactivated SCell on E-UTRAN RF channel number 1.
CP length		Normal	Applicable to cell1, cell 2 and cell3
DRX		OFF	
Measurement gap pattern Id		OFF	
SCell measurement cycle (<i>measCycleSCell</i>)	ms	640	
T1	s	10	

Table A.5.5.2.5.1-3: NR cell specific test parameters for E-UTRAN – NR FR2 interruptions during measurements on deactivated E_UTRAN SCC in synchronous EN-DC

Parameter		Unit	Cell 2
Connection Type			Conducted
Frequency Range			FR2
Duplex mode	Config 1,2		TDD
TDD configuration	Config 1,2		TBD
BW _{channel}	Config 1,2	MHz	100: N _{RB,c} = 66
Initial BWP Configuration	Config 1,2		TBD
PDSCH Reference measurement channel	Config 1,2		SR.3.1 TDD
RMSI CORESET parameters	Config 1,2		CR.3.1 TDD
PDCCH CORESET parameters	Config 1,2		TBD
OCNG Patterns			OP.1
SMTTC Configuration	Config 1,2		SMTTC.1 FR2
EPRE ratio of PSS to SSS		dB	0
EPRE ratio of PBCH DMRS to SSS			
EPRE ratio of PBCH to PBCH DMRS			
EPRE ratio of PDCCH DMRS to SSS			
EPRE ratio of PDCCH to PDCCH DMRS			
EPRE ratio of PDSCH DMRS to SSS			
EPRE ratio of PDSCH to PDSCH			
EPRE ratio of OCNG DMRS to SSS(Note 1)			
EPRE ratio of OCNG to OCNG DMRS (Note 1)			
\bar{E}_s/N_{oc}		dB	TBD
Propagation Condition			AWGN
Time offset to cell1 ^{Note 2}		μs	3
Note 1: OCNG shall be used such that both cells are fully allocated and a constant total transmitted power spectral density is achieved for all OFDM symbols.			
Note 2: Receive time difference of signals received between subframe timing boundary of E-UTRA PCell and slot timing boundary of PSCell including time alignment error between the two cells			

Table A.5.5.2.5.1-4: NR cell specific OTA related test parameters for E-UTRAN – NR FR2 interruptions during measurements on deactivated E_UTRAN SCC in synchronous EN-DC

Parameter		Unit	Cell 2
UE orientation around TBD axis and TBD axis			TBD
Relative difference in angle of arrival of cell 2 relative to cell 1		degrees	TBD
N_{oc} ^{Note1}	NR_TDD_FR2_A	dBm/15kHz ^{Note4}	TBD
	NR_TDD_FR2_B		
	NR_TDD_FR2_C		
	NR_TDD_FR2_D		
	NR_TDD_FR2_E		
	NR_TDD_FR2_F		
N_{oc} ^{Note1}	NR_TDD_FR2_G	dBm/SCS ^{Note3}	TBD
	NR_TDD_FR2_A		
	NR_TDD_FR2_B		
	NR_TDD_FR2_C		
	NR_TDD_FR2_D		
	NR_TDD_FR2_E		
SS-RSRP ^{Note2}	NR_TDD_FR2_F	dBm/SCS ^{Note4}	TBD
	NR_TDD_FR2_G		
	NR_TDD_FR2_A		
	NR_TDD_FR2_B		
	NR_TDD_FR2_C		
	NR_TDD_FR2_D		

	NR_TDD_FR2_E		
	NR_TDD_FR2_F		
	NR_TDD_FR2_G		
\hat{E}_s/I_{ot}		dB	TBD
I_o^{Note2}	NR_TDD_FR2_A	dBm/95.04 MHz ^{Note4}	TBD
<p>Note 1: Interference from other cells and noise sources not specified in the test is assumed to be constant over subcarriers and time and shall be modeled as AWGN of appropriate power for N_{oc} to be fulfilled.</p> <p>Note 2: SS-RSRP and I_o levels have been derived from other parameters for information purposes. They are not settable parameters themselves.</p> <p>Note 3: SS-RSRP minimum requirements are specified assuming independent interference and noise at each receiver antenna port.</p> <p>Note 4: Equivalent power received by an antenna with 0dBi gain at the center of the quiet zone</p> <p>Note 5: As observed with 0dBi gain antenna at the center of the quiet zone</p>			

A.5.5.2.5.2 Test Requirements

The UE shall be continuously scheduled in LTE PCell and NR PSCell during the entire length of T1. During the time duration T1 the UE shall transmit at least 99.5% of ACK/NACK on NR PSCell. The UE is only allowed to cause interruptions immediately before and immediately after an SMTC. Each interruption on NR PSCell shall not exceed the value defined in Table A.5.5.2.5.2-1 and Table A.5.5.2.5.2-2.

Table A.5.5.2.5.2-1: Interruption duration if the NR PSCell is not in the same band as the deactivated SCell

μ	NR Slot length (ms)	Interruption length
3	0.125	5

Table A.5.5.2.5.2-2: Interruption duration if the NR PSCell is not in the same band as the deactivated SCell

μ	NR Slot length (ms)	Interruption length
3	0.125	4 + SMTC duration

The rate of correct events observed during repeated tests shall be at least 90%.

A.5.5.2.6 E-UTRAN – NR FR2 interruptions during measurements on deactivated E-UTRAN SCC in asynchronous EN-DC

A.5.5.2.6.1 Test Purpose and Environment

The purpose of this test is to verify NR PSCell interruptions during the measurement on the deactivated E-UTRAN SCC, the UE missed ACK/NACK does not exceed the limits. This test will verify the missed ACK/NACK rate for NR PSCell in EN-DC specified in section 8. 2.1.2. Supported test configurations are shown in table A.5.5.2.6.1-1.

The general test parameters are given in Table A.5.5.2.6.1-2, and NR cell specific test parameters are given in Table A.5.5.2.6.1-3 and A.5.5.2.6.1-4 below. And the E-UTRAN cell specific test parameters can refer to Table A.3.7.2.1-2. In the test there are three cells: Cell1 Cell2 and Cell3. Cell1 and Cell3 is LTE PCell and LTE deactivated SCell, Cell2 is NR FR2 PSCell. Cell1 shall be configured as LTE PCell and Cell2 shall be configured as NR PSCell. The test consists of one time period, with duration of T1. Prior to the start of the time duration T1, the UE is connected to Cell1 and Cell2. The point in time at which the RRC message including *measCycleSCell* or *allowInterruptions* for

the deactivated NR SCells is received by the UE, defines the start of time period T1. During T1, LTE PCell and NR PSCell are continuously scheduled in DL.

Table A.5.5.2.6.1-1: Interruption during measurements on deactivated E-UTRAN SCC supported test configurations

Config	Description
1	LTE FDD, NR 120 kHz SSB SCS, 100MHz bandwidth, TDD duplex mode
2	LTE TDD, NR 120 kHz SSB SCS, 100MHz bandwidth, TDD duplex mode

Table A.5.5.2.6.1-2: General test parameters for E-UTRAN – NR FR2 interruptions during measurements on deactivated E-UTRAN SCC in asynchronous EN-DC

Parameter	Unit	Value	Comment
RF Channel Number		1, 2	One is E-UTRAN RF channel and two is E-UTRAN RF channel
Active PCell		Cell1	PCell on E-UTRAN RF channel number 1.
Configured PSCell		Cell2	PSCell on NR RF channel number 2.
Configured deactivated SCell		Cell3	Deactivated SCell on E-UTRAN RF channel number 1.
CP length		Normal	Applicable to cell1, cell 2 and cell3
DRX		OFF	
Measurement gap pattern Id		OFF	
SCell measurement cycle (measCycleSCell)	ms	640	
T1	s	10	

Table A.5.5.2.6.1-3: NR cell specific test parameters for E-UTRAN – NR FR2 interruptions during measurements on deactivated E_UTRAN SCC in asynchronous EN-DC

Parameter		Unit	Cell 2
Connection Type			Conducted
Frequency Range			FR2
Duplex mode	Config 1,2		TDD
TDD configuration	Config 1,2		TBD
BW _{channel}	Config 1,2	MHz	100: N _{RB,c} = 66
Initial BWP Configuration	Config 1,2		TBD
PDSCH Reference measurement channel	Config 1,2		SR.3.1 TDD
RMSI CORESET parameters	Config 1,2		CR.3.1 TDD
PDCCH CORESET parameters	Config 1,2		TBD
OCNG Patterns			OP.1
SMTTC Configuration	Config 1,2		SMTTC.1 FR2
EPRE ratio of PSS to SSS		dB	0
EPRE ratio of PBCH DMRS to SSS			
EPRE ratio of PBCH to PBCH DMRS			
EPRE ratio of PDCCH DMRS to SSS			
EPRE ratio of PDCCH to PDCCH DMRS			
EPRE ratio of PDSCH DMRS to SSS			
EPRE ratio of PDSCH to PDSCH			
EPRE ratio of OCNG DMRS to SSS(Note 1)			
EPRE ratio of OCNG to OCNG DMRS (Note 1)			
\bar{E}_s/N_{oc}		dB	TBD
Propagation Condition			AWGN
Time offset to cell1 ^{Note 2}		ms	3
Note 1: OCNG shall be used such that both cells are fully allocated and a constant total transmitted power spectral density is achieved for all OFDM symbols.			
Note 2: Receive time difference of signals received between subframe timing boundary of E-UTRA PCell and slot timing boundary of PSCell including time alignment error between the two cells			

Table A.5.5.2.6.1-4: NR cell specific OTA related test parameters for E-UTRAN – NR FR2 interruptions during measurements on deactivated E_UTRAN SCC in asynchronous EN-DC

Parameter		Unit	Cell 2
UE orientation around TBD axis and TBD axis			TBD
Relative difference in angle of arrival of cell 2 relative to cell 1		degrees	TBD
N_{oc} ^{Note1}	NR_TDD_FR2_A	dBm/15kHz ^{Note4}	TBD
	NR_TDD_FR2_B		
	NR_TDD_FR2_C		
	NR_TDD_FR2_D		
	NR_TDD_FR2_E		
	NR_TDD_FR2_F		
	NR_TDD_FR2_G		
N_{oc} ^{Note1}	NR_TDD_FR2_A	dBm/SCS ^{Note3}	TBD
	NR_TDD_FR2_B		
	NR_TDD_FR2_C		
	NR_TDD_FR2_D		
	NR_TDD_FR2_E		
	NR_TDD_FR2_F		
	NR_TDD_FR2_G		
SS-RSRP ^{Note2}	NR_TDD_FR2_A	dBm/SCS ^{Note4}	TBD
	NR_TDD_FR2_B		
	NR_TDD_FR2_C		
	NR_TDD_FR2_D		

	NR_TDD_FR2_E		
	NR_TDD_FR2_F		
	NR_TDD_FR2_G		
\hat{E}_s/I_{ot}		dB	TBD
I_o^{Note2}	NR_TDD_FR2_A	dBm/95.04 MHz ^{Note4}	TBD
<p>Note 1: Interference from other cells and noise sources not specified in the test is assumed to be constant over subcarriers and time and shall be modeled as AWGN of appropriate power for N_{oc} to be fulfilled.</p> <p>Note 2: SS-RSRP and I_o levels have been derived from other parameters for information purposes. They are not settable parameters themselves.</p> <p>Note 3: SS-RSRP minimum requirements are specified assuming independent interference and noise at each receiver antenna port.</p> <p>Note 4: Equivalent power received by an antenna with 0dBi gain at the center of the quiet zone</p> <p>Note 5: As observed with 0dBi gain antenna at the center of the quiet zone</p>			

A.5.5.2.6.2 Test Requirements

The UE shall be continuously scheduled in LTE PCell and NR PSCell during the entire length of T1. During the time duration T1 the UE shall transmit at least 99.5% of ACK/NACK on NR PSCell. The UE is only allowed to cause interruptions immediately before and immediately after an SMTC. Each interruption on NR PSCell shall not exceed the value defined in Table A.5.5.2.6.2-1 and Table A.5.5.2.6.2-2.

Table A.5.5.2.6.2-1: Interruption duration if the NR PSCell is not in the same band as the deactivated SCell

μ	NR Slot length (ms)	Interruption length
3	0.125	5

Table A.5.5.2.6.2-2: Interruption duration if the NR PSCell is not in the same band as the deactivated SCell

μ	NR Slot length (ms)	Interruption length
3	0.125	4 + SMTC duration

The rate of correct events observed during repeated tests shall be at least 90%.

A.5.5.3 SCell Activation and Deactivation Delay

A.5.5.3.1 SCell Activation and deactivation of SCell in FR2 intra-band in non-DRX

A.5.5.3.1.1 Test Purpose and Environment

The purpose of this test case is the same as for the test defined in section A.4.5.3.1.1 except the SCell is in FR2 intra-band.

The supported test configurations are shown in table A.5.5.3.1.1-1 below. The general and cell specific test parameters are the same except those described in the following section. The listed parameter values in Tables A.5.5.3.1.1-2 and A.5.5.3.1.1-3 will replace the values of corresponding parameters in Tables A.4.5.3.1.1-2 and A.4.5.3.1.1-3. In this case, OTA related test parameters are shown in table A.5.5.3.1.1-4 below.

Table A.5.5.3.1.1-1: Supported test configurations for FR2 SCell activation case with FR2 PSCell

Configuration	Description
1	FDD LTE PCell, Cell 2&3 120 kHz SSB SCS, 100MHz bandwidth, TDD duplex mode
2	TDD LTE PCell, Cell 2&3 120 kHz SSB SCS, 100MHz bandwidth, TDD duplex mode
Note: The UE is only required to pass in one of the supported test configurations	

Table A.5.5.3.1.1-2: General test parameters for FR2 SCell activation case with FR2 PSCell

Parameter	Unit	Value	Comment
Active PCell		Cell 1	Primary cell on E-UTRAN RF channel number 1. As specified in section A.3.7.2.2

Table A.5.5.3.1.1-3: Cell specific test parameters for FR2 SCell activation case with FR2 PSCell

Parameter ^{Note 5}	Unit	Cell 2			Cell 3		
		T1	T2	T3	T1	T2	T3
SSB ARFCN		freq2			freq2		
Duplex mode		TDD			TDD		
TDD configuration		TDDConf.3.1			TDDConf.3.1		
BW _{channel}	MHz	100: N _{RB,c} = 66			100: N _{RB,c} = 66		
PDSCH Reference measurement channel		SR.3.1 TDD			SR.3.1 TDD		
RMSI CORESET Reference Channel		CR.3.1 TDD			CR.3.1 TDD		
RMC CORESET Reference Channel		CCR.3.1 TDD			CCR.3.1 TDD		
OCNG Patterns		OP.1					
SMTc configuration		SMTc.1					
SSB configuration		SSB.1 FR2					
TCI state		CSI-RS.Config.0					
TRS configuration		TRS.2.1 TDD					
EPRE ratio of PSS to SSS	dB	0					
EPRE ratio of PBCH_DMRS to SSS							
EPRE ratio of PBCH to PBCH_DMRS							
EPRE ratio of PDCCH_DMRS to SSS							
EPRE ratio of PDCCH to PDCCH_DMRS							
EPRE ratio of PDSCH_DMRS to SSS							
EPRE ratio of PDSCH to PDSCH_DMRS							
EPRE ratio of OCNG DMRS to SSS ^{Note 1}							
EPRE ratio of OCNG to OCNG DMRS ^{Note 1}							
\hat{E}_s / N_{oc}	dB	TBD					
Propagation conditions		AWGN					
<p>Note 1: OCNG shall be used such that both cells are fully allocated and a constant total transmitted power spectral density is achieved for all OFDM symbols.</p> <p>Note 2: Interference from other cells and noise sources not specified in the test is assumed to be constant over subcarriers and time and shall be modelled as AWGN of appropriate power for N_{oc} to be fulfilled.</p> <p>Note 3: SS-RSRP and I_o levels have been derived from other parameters for information purposes. They are not settable parameters themselves.</p> <p>Note 4: SS-RSRP minimum requirements are specified assuming independent interference and noise at each receiver antenna port.</p> <p>Note 5: All parameters apply for configuration 1 and 2</p>							

Table A.5.5.3.1-4: OTA related test parameters for FR2 SCell activation case with FR2 PSCell

Parameter ^{Note 6}	Unit	Cell 2			Cell 3		
		T1	T2	T3	T1	T2	T3
Angle of arrival configuration		According to table A.3.15.1			According to table A.3.15.1		
N_{oc} ^{Note1}	dBm/15kHz ^{Note4}	TBD			TBD		
N_{oc} ^{Note1}	dBm/SCS ^{Note3}	TBD			TBD		
SS-RSRP ^{Note2}	dBm/SCS ^{Note4}	TBD			TBD		
\hat{E}_s/I_{ot}	dB	TBD			TBD		
I_o ^{Note2}	dBm/95.04 MHz ^{Note4}	TBD			TBD		
<p>Note 1: Interference from other cells and noise sources not specified in the test is assumed to be constant over subcarriers and time and shall be modelled as AWGN of appropriate power for N_{oc} to be fulfilled.</p> <p>Note 2: SS-RSRP and I_o levels have been derived from other parameters for information purposes. They are not settable parameters themselves.</p> <p>Note 3: SS-RSRP minimum requirements are specified assuming independent interference and noise at each receiver antenna port.</p> <p>Note 4: Equivalent power received by an antenna with 0dBi gain at the centre of the quiet zone</p> <p>Note 5: As observed with 0dBi gain antenna at the centre of the quiet zone</p> <p>Note 6: All parameters apply for configuration 1 and 2</p>							

A.5.5.3.1.2 Test Requirements

The test requirements defined in section A.4.5.3.1.2 shall apply to this test case, except $T_{activation_time}$ will be replaced with the value [$T_{SMTC_SCell} + 5ms$] as defined in section 8.3.

A.5.5.3.2 SCell Activation and deactivation of known SCell in FR1 in non-DRX for 160ms SCell measurement cycle

A.5.5.3.2.1 Test Purpose and Environment

The purpose of this test case is the same as for the test defined in section A.4.5.3.1.1, except PSCell is in FR2.

The supported test configurations are shown in table A.5.5.3.2.1-1 below. The general test parameters are the same in Tables A.4.5.3.1.1-2. The cell specific test parameters are given in Tables A.5.5.3.2.1-2. In this case, OTA related test parameters are the same as in table A.5.5.3.2.1-3.

Table A.5.5.3.2.1-1: Supported test configurations for FR1 SCell activation case with PSCell is FR2

Configuration	Description
1	FDD LTE PCell, Cell 2 NR 120 kHz SSB SCS, 100MHz bandwidth, TDD duplex mode Cell 3 NR 15 kHz SSB SCS, 10MHz bandwidth, FDD duplex mode
2	FDD LTE PCell, Cell 2 NR 120 kHz SSB SCS, 100MHz bandwidth, TDD duplex mode Cell 3 NR 15 kHz SSB SCS, 10MHz bandwidth, TDD duplex mode
3	FDD LTE PCell, Cell 2 NR 120 kHz SSB SCS, 100MHz bandwidth, TDD duplex mode Cell 3 NR 30kHz SSB SCS, 40MHz bandwidth, TDD duplex mode
4	TDD LTE PCell, Cell 2 NR 120 kHz SSB SCS, 100MHz bandwidth, TDD duplex mode Cell 3 NR 15 kHz SSB SCS, 10MHz bandwidth, FDD duplex mode
5	TDD LTE PCell, Cell 2 NR 120 kHz SSB SCS, 100MHz bandwidth, TDD duplex mode Cell 3 NR 15 kHz SSB SCS, 10MHz bandwidth, TDD duplex mode
6	TDD LTE PCell, Cell 2 NR 120 kHz SSB SCS, 100MHz bandwidth, TDD duplex mode Cell 3 NR 30kHz SSB SCS, 40MHz bandwidth, TDD duplex mode
Note:	The UE is only required to pass in one of the supported test configurations

Table A.5.5.3.2.1-2: Cell specific test parameters for FR1 SCell activation case with FR2 PSCell

Parameter		Unit	Cell 2			Cell 3		
			T1	T2	T3	T1	T2	T3
SSB ARFCN			freq2			freq1		
Duplex mode	Config 1,4		TDD			FDD		
	Config 2,3,5,6		TDD			TDD		
TDD configuration	Config 1,4		TDDConf.3.1			Not Applicable		
	Config 2,5					TDDConf.1.1		
	Config 3,6					TDDConf.2.1		
BW _{channel}	Config 1,4	MHz	100: N _{RB,c} = 66			10: N _{RB,c} = 52		
	Config 2,5					10: N _{RB,c} = 52		
	Config 3,6					40: N _{RB,c} = 106		
BWP BW	Config 1,4		100: N _{RB,c} = 66			10: N _{RB,c} = 52		
	Config 2,5					10: N _{RB,c} = 52		
	Config 3,6					40: N _{RB,c} = 106		
DRx Cycle		ms	Not Applicable					
PDSCH Reference measurement channel	Config 1,4		SR.3.1 TDD			SR.1.1 FDD		
	Config 2,5					SR.1.1 TDD		
	Config 3,6					SR.2.1 TDD		
RMSI CORESET Reference Channel	Config 1,4		CR.3.1 TDD			CR.1.1 FDD		
	Config 2,5					CR.1.1 TDD		
	Config 3,6					CR.2.1 TDD		
RMC CORESET Reference Channel	Config 1,4		CCR.3.1 TDD			CCR.1.1 FDD		
	Config 2,5					CCR.1.1 TDD		
	Config 3,6					CCR.2.1 TDD		
OCNG Patterns			OCNG pattern 1					
SMTc configuration			SMTc.1					
TCI state			CSI-RS.Config.0			NA		
TRS configuration			TRS.2.1 TDD			NA		
SSB configuration	Config 1,2,4,5		SSB.1 FR2			SSB.1 FR1		
	Config 3,6					SSB.2 FR1		
PDSCH/PDCCH subcarrier spacing	Config 1,2,4,5	kHz	120kHz			15kHz		
	Config 3,6					30kHz		
EPRE ratio of PSS to SSS		dB	0					
EPRE ratio of PBCH DMRS to SSS								
EPRE ratio of PBCH to PBCH DMRS								
EPRE ratio of PDCCH DMRS to SSS								
EPRE ratio of PDCCH to PDCCH DMRS								
EPRE ratio of PDSCH DMRS to SSS								
EPRE ratio of PDSCH to PDSCH								
EPRE ratio of OCNG DMRS to SSS(Note 1)								
EPRE ratio of OCNG to OCNG DMRS (Note 1)								
N_{oc}^{Note2}								
N_{oc}^{Note2}	Config 1,2,4,5	dBm/SCS	TBD			[-104]		
	Config 3,6		TBD			[-101]		
\hat{E}_s / I_{ot}		dB	TBD			[17]		
\hat{E}_s / N_{oc}		dB	TBD			[17]		
SS-RSRP ^{Note3}	Config 1,2,4,5	dBm/SCS	TBD			[-87]		
	Config 3,6		TBD			[-84]		
SCH_RP ^{Note3}		dBm/15 kHz	TBD			[-87]		
Propagation condition		-	AWGN					

Note 1:	OCNG shall be used such that both cells are fully allocated and a constant total transmitted power spectral density is achieved for all OFDM symbols.
Note 2:	Interference from other cells and noise sources not specified in the test is assumed to be constant over subcarriers and time and shall be modelled as AWGN of appropriate power for N_{oc} to be fulfilled.
Note 3:	SS-RSRP and SCH_RP levels have been derived from other parameters for information purposes. They are not settable parameters themselves.
Note 4:	The uplink resources for CSI reporting are assigned to the UE prior to the start of time period T2.]

Table A.5.5.3.2.1-3: OTA related test parameters for FR1 SCell activation case with FR2 PSCell

Parameter	Unit	Cell 2			Cell 3		
		T1	T2	T3	T1	T2	T3
Angle of arrival configuration		According to section A.3.15.1			NA		
N_{oc} ^{Note1}	dBm/15kHz	TBD			[-104]		
N_{oc} ^{Note1}	Config 1,2,4,5	TBD			[-104]		
	Config 3,6	TBD			[-101]		
SS-RSRP ^{Note2}	Config 1,2,4,5	TBD			[-87]		
	Config 3,6	TBD			[-84]		
\hat{E}_s / I_{ot}	dB	TBD			[17]		
I_o ^{Note2}	dBm/95.04 MHz ^{Note4}	TBD			TBD		
Note 1:	Interference from other cells and noise sources not specified in the test is assumed to be constant over subcarriers and time and shall be modelled as AWGN of appropriate power for N_{oc} to be fulfilled.						
Note 2:	SS-RSRP and I_o levels have been derived from other parameters for information purposes. They are not settable parameters themselves.						
Note 3:	SS-RSRP minimum requirements are specified assuming independent interference and noise at each receiver antenna port.						
Note 4:	Equivalent power received by an antenna with 0dBi gain at the centre of the quiet zone						
Note 5:	As observed with 0dBi gain antenna at the centre of the quiet zone						

A.5.5.3.2.2 Test Requirements

The test requirements defined in section A.4.5.3.1.2 shall apply to this test case.

A.5.5.3.3 SCell Activation and deactivation of known SCell in FR1 in non-DRX for 320ms SCell measurement cycle

A.5.5.3.3.1 Test Purpose and Environment

The purpose of this test case is the same as for the test defined in section A.4.5.3.2.1, except PSCell is in FR2.

The supported test configurations are same as defined in section A.5.5.3.2.1. The general test parameters are the same as defined in section A.4.5.3.2.1. The cell specific test parameters are the same as in Tables A.5.5.3.2.1-2. In this case, OTA related test parameters are the same as in Table A.5.5.3.2.1-3.

A.5.5.3.3.2 Test Requirements

The test requirements defined in section A.4.5.3.2.2 shall apply to this test case.

A.5.5.3.4 SCell Activation and deactivation of unknown SCell in FR1 in non-DRX

A.5.5.3.4.1 Test Purpose and Environment

The purpose of this test case is the same as for the test defined in section A.4.5.3.3.1, except PSCell is in FR2.

The supported test configurations are same as defined in section A.5.5.3.2.1. The general test parameters are the same as defined in section A.4.5.3.3.1. The cell specific test parameters are the same as in Tables A.5.5.3.2.1-2. In this case, OTA related test parameters are the same as in Table A.5.5.3.2.1-3.

A.5.5.3.4.2 Test Requirements

The test requirements defined in section A.4.5.3.3.2 shall apply to this test case.

A.5.5.4 UE UL carrier RRC reconfiguration Delay

A.5.5.5 Beam Failure Detection and Link recovery procedures

A.5.5.5.1 EN-DC Beam Failure Detection and Link Recovery Test for FR2 PSCell configured with SSB-based BFD and LR in non-DRX mode

Editor's note: It is open whether BFD can be based on SSB. This test case will be updated accordingly.

A.5.5.5.1.1 Test Purpose and Environment

The purpose of this test is to verify that the UE properly detects SSB-based beam failure in the set q_0 configured for a serving PSCell and that the UE performs correct SSB-based link recovery based on beam candidate set q_1 . The purpose is to test the downlink monitoring for beam failure detection within the UEs active DL BWP of the PSCell, during the evaluation period, and link recovery, when no DRX is used. This test will partly verify the SSB based beam failure detection and link recovery for an FR2 serving cell requirements in clause 8.5.

The test parameters are given in Tables A.5.5.5.1.1-1, A.5.5.5.1.1-2, A.5.5.5.1.1-3 and A.5.5.5.1.1-4 below. There are two cells, cell 1 is the E-UTRAN PCell, and cell 2 is the PSCell, in the test. The test consists of five successive time periods, with time duration of T1, T2, T3, T4 and T5 respectively. Figure A.5.5.5.1.1-1 shows the variation of the downlink SNR of the PCell and the SNR of the SSB in set q_0 in the active PSCell to emulate SSB based beam failure. Figure A.5.5.5.1.1-1 additionally shows the variation of the downlink SNR of the SSB in set q_1 of the candidate beam used for link recovery. Prior to the start of the time duration T1, the UE shall be fully synchronized to cell 1 and cell 2. The UE shall be configured for periodic CSI reporting with a reporting periodicity of [2] ms. In the test, DRX configuration is not enabled. The UE is configured to perform inter-frequency measurements using GP ID #0 (40ms) in test 2.

Table A.5.5.5.1.1-1: Supported test configurations for FR2 PSCell

Configuration	Description
1	LTE FDD, TDD duplex mode, 120 kHz SSB SCS, 100MHz bandwidth
2	LTE TDD, TDD duplex mode, 240 kHz SSB SCS, 100MHz bandwidth
Note:	The UE is only required to pass in one of the supported test configurations in FR2

Table A.5.5.5.1.1-2: General test parameters for FR2 PCell for SSB-based beam failure detection and link recovery testing in non-DRX mode

Parameter	Unit	Value		Comment
		Test 1	Test 2	
Active E-UTRA PCell		Cell 1	Cell 1	

E-UTRA RF Channel Number			1	1	
Active PCell			Cell 2	Cell 2	
RF Channel Number			2	2	
Duplex mode	Config 1		TDD	TDD	
	Config 2		TDD	TDD	
TDD Configuration	Config 1		[TDDConf.3.1]	[TDDConf.3.1]	
	Config 2		[TDDConf.3.1]	[TDDConf.3.1]	
CORESET Reference Channel	Config 1		[CR. 3.1 TDD]	[CR. 3.1 TDD]	
	Config 2		[CR. 3.1 TDD]	[CR. 3.1 TDD]	
SSB Configuration	Config 1		TBD (Note: periodicity is 20ms)	TBD (Note: periodicity is 20ms)	
	Config 2		TBD (Note: periodicity is 20ms)	TBD (Note: periodicity is 20ms)	
SMTC Configuration	Config 1		TDD	TDD	
	Config 2		TDD	TDD	
PDSCH/PDCCH subcarrier spacing	Config 1		120 KHz	120 KHz	
	Config 2		120 KHz	120 KHz	
csi-RS-Index assigned as RLM RS			[0]	[0]	
OCNG parameters			TBD	TBD	
CP length			Normal	Normal	
Correlation Matrix and Antenna Configuration			[2x2 Low]	[2x2 Low]	
Beam failure detection transmission parameters	DCI format		1-0	1-0	
	Number of Control OFDM symbols		2	2	
	Aggregation level	CC E	8	8	
	Ratio of hypothetical PDCCH RE energy to average CSI-RS RE energy	dB	0	0	
	Ratio of hypothetical PDCCH DMRS energy to average CSI-RS RE energy	dB	0	0	
	DMRS precoder granularity		REG bundle size	REG bundle size	
	REG bundle size		6	6	
DRX			OFF	OFF	

Gap pattern ID			[N.A.]	*[gp0]	
ssb-Index			2	2	Number of SSB indexes used for beam failure detection
rlmInSyncOutOfSync Threshold			absent	absent	When the field is absent, the UE applies the value 0. (Table 8.1.1-1).
rsrp-ThresholdSSB			TBD	TBD	Threshold used for $Q_{out_LR_SSB}$
powerControlOffsetSS			NA	NA	Used for deriving rsrp-ThresholdCSI-RS
beamFailureInstanceMaxCount			[n2]	[n2]	see TS 38.321 [7], section 5.17
beamFailureDetectionTimer			[pbfd4]	[pbfd4]	see TS 38.321 [7], section 5.17
ZP CSI-RS configuration			TBD	TBD	
CSI-IM configuration			TBD	TBD	
Periodic CSI reporting			PUCCH	PUCCH	
CSI reporting periodicity	Config 1	slot	[5]	[5]	
	Config 2		[10]	[10]	
T1		s	1	1	During this time the the UE shall be fully synchronized to cell 1
T2		s	0.4	0.4	
T3		s	[0.6]	[0.6]	
D1		s	[0.24]	[0.44]	
Note 1: UE-specific PDCCH is not transmitted after T1 starts.					

Table A.5.5.1.1-3: Cell specific test parameters for FR2 PSCell for SSB-based beam failure detection and link recovery testing in non-DRX mode

Parameter	Unit	Test 1 and Test 2					Test 1 and Test 2					
		SSB of set q_0					SSB of set q_1					
		T1	T2	T3	T4	T5	T1	T2	T3	T4	T5	
PDCCH_beta	dB	4					4					
PDCCH_DMRS_beta	dB	4					4					
PBCH_beta	dB	0					0					
PSS_beta	dB											
SSS_beta	dB											
PDSCH_beta	dB											
OCNG_beta	dB											
SNR	Config 1	dB	TBD	TBD	TBD	TBD	TBD	TBD	TBD	TBD	TBD	
	Config 2		TBD	TBD	TBD	TBD	TBD	TBD	TBD	TBD	TBD	
	Config 3		TBD	TBD	TBD	TBD	TBD	TBD	TBD	TBD	TBD	
N_{oc}	Config 1	dBm/	[-98]					[-98]				
	Config 2	15K	[-98]					[-98]				
	Config 3	Hz	[-98]					[-98]				
Propagation condition		[TDL-C 300ns 100Hz]					[TDL-C 300ns 100Hz]					
Note 1:	OCNG shall be used such that the resources in Cell 1 are fully allocated and a constant total transmitted power spectral density is achieved for all OFDM symbols.											
Note 2:	The uplink resources for CSI reporting are assigned to the UE prior to the start of time period T1.											
Note 3:	NZP CSI-RS resource set configuration for CSI reporting are assigned to the UE prior to the start of time period T1.											
Note 4:	Measurement gap configuration is assigned to the UE prior to the start of time period T1.											
Note 5:	The timers and layer 3 filtering related parameters are configured prior to the start of time period T1.											
Note 6:	The signal contains PDCCH for UEs other than the device under test as part of OCNG.											
Note 7:	SNR levels correspond to the signal to noise ratio over the SSS REs.											
Note 8:	The SNR in time periods T1, T2, T3, T4 and T5 is denoted as SNR1, SNR2 and SNR3 respectively in figure A.5.5.1.1-1.											
Note 9:	The SNR values are specified for testing a UE which supports 2RX on at least one band. For testing of a UE which supports 4RX on all bands, the SNR during T3 is [A.3.6].											

Table A.5.5.1.1-4: Measurement gap configuration for FR2 PSCell for SSB-based beam failure detection and link recovery testing in non-DRX mode

Field	Test 2
	Value
gapOffset	[0]

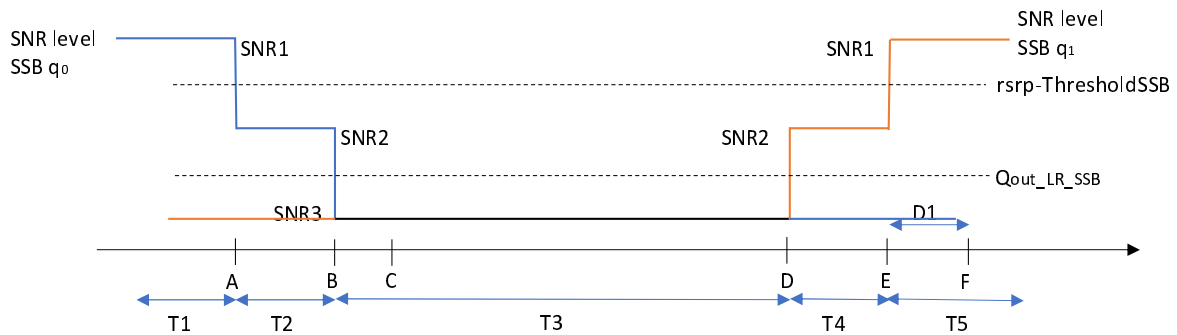

Figure A.5.5.5.1.1-1: SNR variation SSB for SSB-based beam failure detection and link recovery testing in non-DRX mode

A.5.5.5.1.2 Test Requirements

The UE behaviour during time durations T1, T2, T3, T4 and T5 shall be as follows:

During the time duration T1 and T2, the UE shall transmit uplink signal at least in all subframes configured for CSI transmission on Cell 1.

During the period from time point A to time point B the UE shall transmit uplink signal in Cell 1 in all uplink slots configured for CSI transmission according to the configured periodic CSI reporting for Cell 1.

During T3 the UE shall detect beam failure and initiate link recovery. During T4 and T5 the UE measures and evaluates beam candidate from beam candidate set q_1 .

No later than time point F occurring no later than $D1 = [\text{TBD}]$ ms after the start of T5, the UE shall transmit preamble on a beam associated with the candidate beam set q_1 .

Test is concluded once the test equipment has received the initial preamble transmission from the UE. The rate of correct events observed during repeated tests shall be at least 90%.

A.5.5.5.2 EN-DC Beam Failure Detection and Link Recovery Test for FR2 PSCell configured with SSB-based BFD and LR in DRX mode

Editor's note: It is open whether BFD can be based on SSB. This test case will be updated accordingly.

A.5.5.5.2.1 Test Purpose and Environment

The purpose of this test is to verify that the UE properly detects SSB-based beam failure in the set q_0 configured for a serving PSCell and that the UE performs correct SSB-based link recovery based on beam candidate set q_1 . The purpose is to test the downlink monitoring for beam failure detection within the UE's active DL BWP of the PSCell, during the evaluation period, and link recovery, when DRX is used. This test will partly verify the SSB based beam failure detection and link recovery for an FR2 serving cell requirements in clause 8.5.

The test parameters are given in Tables A.5.5.5.2.1-1, A.5.5.5.2.1-2, A.5.5.5.2.1-3, A.5.5.5.2.1-4 and A.5.5.5.2.1-5 below. There are two cells, cell 1 is the E-UTRAN PCell, and cell 2 is the PSCell, in the test. The test consists of five successive time periods, with time duration of T1, T2, T3, T4 and T5 respectively. Figure A.5.5.5.2.1-1 shows the variation of the downlink SNR of the PCell and the SNR of the SSB in set q_0 in the active PSCell to emulate SSB based beam failure. Figure A.5.5.5.2.1-1 additionally shows the variation of the downlink SNR of the SSB in set q_1 of the candidate beam used for link recovery. Prior to the start of the time duration T1, the UE shall be fully synchronized to cell 1 and cell 2. The UE shall be configured for periodic CSI reporting with a reporting periodicity

of [2] ms. In the test, DRX configuration is enabled in PCSEll and DRX inactivity timer has already been expired, i.e. UE tries to decode PDCCH and to send periodic CQI during the period when On-duration timer is running. Time alignment timers shall be set to “infinity” so that UL timing alignment is maintained during the test. The UE is configured to perform inter-frequency measurements using GP ID #0 (40ms) in test 2.

Table A.5.5.2.1-1: Supported test configurations for FR2 PSCell

Configuration	Description
1	LTE FDD, TDD duplex mode, 120 kHz SSB SCS, 100MHz bandwidth
2	LTE TDD, TDD duplex mode, 240 kHz SSB SCS, 100MHz bandwidth
Note: The UE is only required to pass in one of the supported test configurations in FR2	

Table A.5.5.2.1-2: General test parameters for FR2 PSCell for SSB-based beam failure detection and link recovery testing in DRX mode

Parameter	Unit	Value		Comment
		Test 1	Test 2	
Active E-UTRA PCell		Cell 1	Cell 1	
E-UTRA RF Channel Number		1	1	
Active PCell		Cell 2	Cell 2	
RF Channel Number		2	2	
Duplex mode	Config 1	TDD	TDD	
	Config 2	TDD	TDD	
TDD Configuration	Config 1	[TDDConf.3.1]	[TDDConf.3.1]	
	Config 2	[TDDConf.3.1]	[TDDConf.3.1]	
CORESET Reference Channel	Config 1	[CR. 3.1 TDD]	[CR. 3.1 TDD]	
	Config 2	[CR. 3.1 TDD]	[CR. 3.1 TDD]	
SSB Configuration	Config 1	TBD (Note: periodicity is 20ms)	TBD (Note: periodicity is 20ms)	
	Config 2	TBD (Note: periodicity is 20ms)	TBD (Note: periodicity is 20ms)	
SMTC Configuration	Config 1	TDD	TDD	
	Config 2	TDD	TDD	
PDSCH/PDCCH subcarrier spacing	Config 1	120 KHz	120 KHz	
	Config 2	120 KHz	120 KHz	
csi-RS-Index assigned as RLM RS		[0]	[0]	
OCNG parameters		TBD	TBD	
CP length		Normal	Normal	
Correlation Matrix and Antenna Configuration		[2x2 Low]	[2x2 Low]	
	DCI format	1-0	1-0	
	Number of Control OFDM symbols	2	2	

Beam failure detection transmission parameters	Aggregation level	CC E	8	8	
	Ratio of hypothetical PDCCH RE energy to average CSI-RS RE energy	dB	0	0	
	Ratio of hypothetical PDCCH DMRS energy to average CSI-RS RE energy	dB	0	0	
	DMRS precoder granularity		REG bundle size	REG bundle size	
	REG bundle size		6	6	
DRX			640	640	
Gap pattern ID			[N.A.]	*[gp0]	
ssb-Index			2	2	Number of SSB indexes used for beam failure detection
rlmInSyncOutOfSync Threshold			absent	absent	When the field is absent, the UE applies the value 0. (Table 8.1.1-1).
rsrp-ThresholdSSB			TBD	TBD	Threshold used for $Q_{out_LR_SSB}$
powerControlOffsetSS			NA	NA	Used for deriving rsrp-ThresholdCSI-RS
beamFailureInstanceMaxCount			[n2]	[n2]	see TS 38.321 [7], section 5.17
beamFailureDetectionTimer			[pbfd4]	[pbfd4]	see TS 38.321 [7], section 5.17
ZP CSI-RS configuration			TBD	TBD	
CSI-IM configuration			TBD	TBD	
Periodic CSI reporting			PUCCH	PUCCH	
CSI reporting periodicity	Config 1, 2	slot	[5]	[5]	
	Config 3		[10]	[10]	
T1		s	1	1	During this time the the UE shall be fully synchronized to cell 1
T2		s	0.4	0.4	
T3		s	[0.6]	[0.6]	
D1		s	[0.24]	[0.44]	
Note 1: UE-specific PDCCH is not transmitted after T1 starts.					

Table A.5.5.2.1-3: Cell specific test parameters for FR2 PSCell for SSB-based beam failure detection and link recovery testing in DRX mode

Parameter	Unit	Test 1 and Test 2					Test 1 and Test 2					
		SSB of set q_0					SSB of set q_1					
		T1	T2	T3	T4	T5	T1	T2	T3	T4	T5	
PDCCH_beta	dB	4					4					
PDCCH_DMRS_beta	dB	4					4					
PBCH_beta	dB	0					0					
PSS_beta	dB											
SSS_beta	dB											
PDSCH_beta	dB											
OCNG_beta	dB											
SNR	Config 1	dB	TBD	TBD	TBD	TBD	TBD	TBD	TBD	TBD	TBD	
	Config 2		TBD	TBD	TBD	TBD	TBD	TBD	TBD	TBD	TBD	
	Config 3		TBD	TBD	TBD	TBD	TBD	TBD	TBD	TBD	TBD	
N_{oc}	Config 1	dBm/	[-98]					[-98]				
	Config 2	15K	[-98]					[-98]				
	Config 3	Hz	[-98]					[-98]				
Propagation condition		[TDL-C 300ns 100Hz]					[TDL-C 300ns 100Hz]					
Note 1:	OCNG shall be used such that the resources in Cell 1 are fully allocated and a constant total transmitted power spectral density is achieved for all OFDM symbols.											
Note 2:	The uplink resources for CSI reporting are assigned to the UE prior to the start of time period T1.											
Note 3:	NZP CSI-RS resource set configuration for CSI reporting are assigned to the UE prior to the start of time period T1.											
Note 4:	Measurement gap configuration is assigned to the UE prior to the start of time period T1.											
Note 5:	The timers and layer 3 filtering related parameters are configured prior to the start of time period T1.											
Note 6:	The signal contains PDCCH for UEs other than the device under test as part of OCNG.											
Note 7:	SNR levels correspond to the signal to noise ratio over the SSS REs.											
Note 8:	The SNR in time periods T1, T2, T3, T4 and T5 is denoted as SNR1, SNR2 and SNR3 respectively in figure A.5.5.2.1-1.											
Note 9:	The SNR values are specified for testing a UE which supports 2RX on at least one band. For testing of a UE which supports 4RX on all bands, the SNR during T3 is [A.3.6].											

Table A.5.5.2.1-4: Measurement gap configuration for FR2 PSCell for SSB-based beam failure detection and link recovery testing in DRX mode

Field	Test 2
	Value
gapOffset	[0]

Table A.5.5.2.1-5: DRX-Configuration for FR2 PSCell for SSB-based beam failure detection and link recovery testing in DRX mode.

Field	Test 5	Test 6
	Value	Value
drx-onDurationTimer	[ms6]	[ms6]
drx-InactivityTimer	[ms1]	[ms1]
drx-RetransmissionTimerDL	[sl1]	[sl1]
drx-RetransmissionTimerUL	[sl1]	[sl1]
longDRX-CycleStartOffset	[ms640]	[ms40]
shortDRX	disable	disable

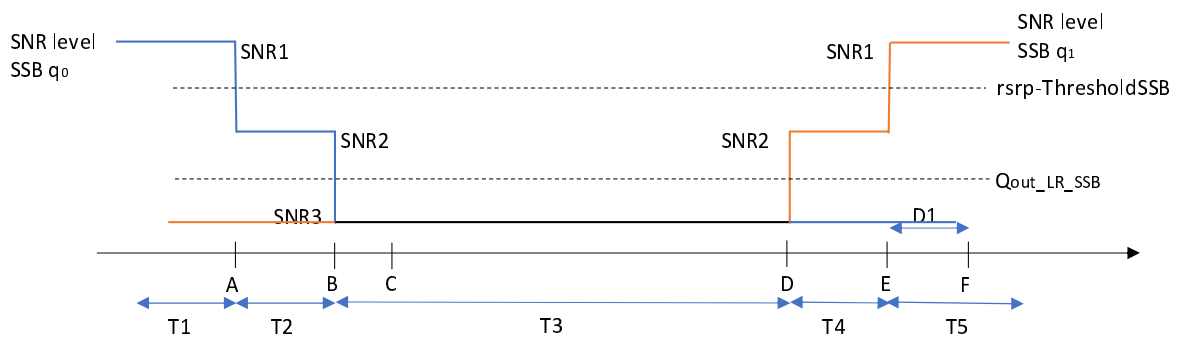

Figure A.5.5.2.1-1: SNR variation for SSB-based beam failure detection and link recovery testing in non-DRX mode

A.5.5.2.2 Test Requirements

The UE behaviour during time durations T1, T2, T3, T4 and T5 shall be as follows:

During the time duration T1 and T2, the UE shall transmit uplink signal at least in all subframes configured for CSI transmission on Cell 1.

During the period from time point A to time point B the UE shall transmit uplink signal in Cell 1 in all uplink slots configured for CSI transmission according to the configured periodic CSI reporting for Cell 1.

During T3 the UE shall detect beam failure and initiate link recovery. During T4 and T5 the UE measures and evaluates beam candidate from beam candidate set q_1 .

No later than time point F occurring no later than $D1 = [TBD]$ ms after the start of T5, the UE shall transmit preamble on a beam associated with the candidate beam set q_1 .

Test is concluded once the test equipment has received the initial preamble transmission from the UE. The rate of correct events observed during repeated tests shall be at least 90%.

A.5.5.5.3 EN-DC Beam Failure Detection and Link Recovery Test for FR2 PSCell configured with CSI-RS-based BFD and LR in non-DRX mode

A.5.5.5.3.1 Test Purpose and Environment

The purpose of this test is to verify that the UE properly detects CSI-RS-based beam failure in the set q_0 configured for a serving PSCell and that the UE performs correct CSI-RS-based link recovery based on beam candidate set q_1 . The purpose is to test the downlink monitoring for beam failure detection within the UEs active DL BWP of the PSCell, during the evaluation period, and link recovery, when no DRX is used. This test will partly verify the CSI-RS based beam failure detection and link recovery for an FR2 serving cell requirements in clause 8.5.

The test parameters are given in Tables A.5.5.5.3.1-1, A.5.5.5.3.1-2, A.5.5.5.3.1-3, A.5.5.5.3.1-4 and A.5.5.5.3.1-5 below. There are two cells, cell 1 is the E-UTRAN PCell, and cell 2 is the PSCell, in the test. The test consists of five successive time periods, with time duration of T1, T2, T3, T4 and T5 respectively. Figure A.5.5.5.3.1-1 shows the variation of the downlink SNR of the PCell and the SNR of the CSI-RS in set q_0 in the active PSCell to emulate CSI-RS based beam failure. Figure A.5.5.5.3.1-1 additionally shows the variation of the downlink SNR of the CSI-RS in set q_1 of the candidate beam used for link recovery. Prior to the start of the time duration T1, the UE shall be fully synchronized to cell 1 and cell 2. The UE shall be configured for periodic CSI reporting with a reporting periodicity of [2] ms. In the test, DRX configuration is not enabled. The UE is configured to perform inter-frequency measurements using GP ID #0 (40ms) in test 2.

Table A.5.5.5.3.1-1: Supported test configurations for FR2 PSCell

Configuration	Description
1	LTE FDD, TDD duplex mode, 120 kHz SSB SCS, 100MHz bandwidth

Table A.5.5.5.3.1-2: General test parameters for FR2 PSCell for CSI-RS-based beam failure detection and link recovery testing in non-DRX mode

Parameter		Unit	Value		Comment
			Test 1	Test 2	
Active E-UTRA PCell			Cell 1	Cell 1	
E-UTRA RF Channel Number			1	1	
Active PCell			Cell 2	Cell 2	
RF Channel Number			2	2	
Duplex mode	Config 1		TDD	TDD	
TDD Configuration	Config 1		[TDDConf.3.1]	[TDDConf.3.1]	
CORESET Reference Channel	Config 1		[CR. 3.1 TDD]	[CR. 3.1 TDD]	A.3.1.2
SSB Configuration	Config 1		SSB.1 FR2	SSB.1 FR2	A.3.10
SMTTC Configuration	Config 1		SMTTC.1	SMTTC.1	A.3.11

PDSCH /PDCCH subcarrier spacing	Config 1		120 KHz	120 KHz	
csi-RS-Index assigned as RLM RS			[0]	[0]	
OCNG parameters			TBD	TBD	A.3.2.1
CP length			Normal	Normal	
Correlation Matrix and Antenna Configuration			[2x2 Low]	[2x2 Low]	
Beam failure detection transmission parameters	DCI format		1-0	1-0	
	Number of Control OFDM symbols		2	2	
	Aggregation level	CC	8	8	
	Ratio of hypothetical PDCCH RE energy to average CSI-RS RE energy	dB	0	0	
	Ratio of hypothetical PDCCH DMRS energy to average CSI-RS RE energy	dB	0	0	
	DMRS precoder granularity		REG bundle size	REG bundle size	
	REG bundle size		6	6	
DRX			OFF	OFF	
Gap pattern ID			[N.A.]	*[gp0]	
csi-RS-Index			2	2	Number of SSB indexes used for beam failure detection
rlmInSyncOutOfSync Threshold			absent	absent	When the field is absent, the UE applies the value 0. (Table 8.1.1-1).
rsrp-ThresholdSSB			TBD	TBD	Threshold used for $Q_{out_LR_SSB}$
powerControlOffsetSS			NA	NA	Used for deriving $rsrp_ThresholdCSI-RS$
beamFailureInstanceMaxCount			[n2]	[n2]	see TS 38.321 [7], section 5.17
beamFailureDetectionTimer			[pbfd4]	[pbfd4]	see TS 38.321 [7], section 5.17
ZP CSI-RS configuration			TBD	TBD	

CSI-IM configuration			TBD	TBD	
Periodic CSI reporting			PUCCH	PUCCH	
CSI reporting periodicity	Config 1, 2	slot	[5]	[5]	
	Config 3		[10]	[10]	
T1		s	1	1	During this time the the UE shall be fully synchronized to cell 1
T2		s	0.4	0.4	
T3		s	[TBD]	[TBD]	
D1		s	[0.24]	[0.44]	
Note 1: UE-specific PDCCH is not transmitted after T1 starts.					

Table A.5.5.3.1-3: Cell specific test parameters for FR2 PSCell for CSI-RS-based beam failure detection and link recovery testing in non-DRX mode

Parameter	Unit	Test 1 and Test 2					Test 1 and Test 2					
		CSI-RS of set q_0					CSI-RS of set q_1					
		T1	T2	T3	T4	T5	T1	T2	T3	T4	T5	
EPRE ratio of PSS to SSS	dB	0					0					
EPRE ratio of PBCH DMRS to SSS	dB											
EPRE ratio of PBCH to PBCH DMRS	dB											
EPRE ratio of PDCCH DMRS to SSS	dB											
EPRE ratio of PDCCH to PDCCH DMRS	dB											
EPRE ratio of PDSCH DMRS to SSS	dB											
EPRE ratio of PDSCH to PDSCH DMRS	dB											
EPRE ratio of OCNG DMRS to SSS ^(Note 1)	dB											
EPRE ratio of OCNG to OCNG DMRS ^(Note 1)	dB											
SNR _C SI-RS	Config 1	dB	TBD	TBD	TBD	TBD	TBD	TBD	TBD	TBD	TBD	
	Config 2		TBD	TBD	TBD	TBD	TBD	TBD	TBD	TBD	TBD	
	Config 3		TBD	TBD	TBD	TBD	TBD	TBD	TBD	TBD	TBD	
N_{oc}	Config 1	dBm/	[-98]					[-98]				
	Config 2	15K	[-98]					[-98]				
	Config 3	Hz	[-98]					[-98]				
SS-RSRP ^{Note 3}		dBm /SC S										
\hat{E}_s/I_{ot}												
\hat{E}_s/N_{oc}												
I _o	config 1, 2	dBm/										
	Config 3, 4	9.36 MHz 38.1 MHz										
Propagation condition			[TDLA30-75]					[TDLA30-75]				
Note 1: OCNG shall be used such that the resources in Cell 1 are fully allocated and a constant total transmitted power spectral density is achieved for all OFDM symbols. Note 2: SS-RSRP and I _o levels have been derived from other parameters for information purposes. They are not settable parameters themselves.												

Table A.5.5.3.1-4: Measurement gap configuration for FR2 PSCell for CSI-RS-based beam failure detection and link recovery testing in non-DRX mode

Field	Test 2
	Value
gapOffset	[0]

Table A.5.5.3.1-5: NZP-CSI-RS resource configuration for FR2 PSCell for CSI-RS-based beam failure detection and link recovery testing in non-DRX mode

Field	ResourceId 0	ResourceId 1
	Value	Value
frequencyDomainAllocation ^{Note 1}	row1	row2
startingRB	0	0
nrofRBs	Note 2	Note 2
Note 1: TS 38.211 [6] table 7.4.1.5.3-1 Note 2: nrofRBs is derived based on the Configuration in Table A.4.5.1.7.1-1		

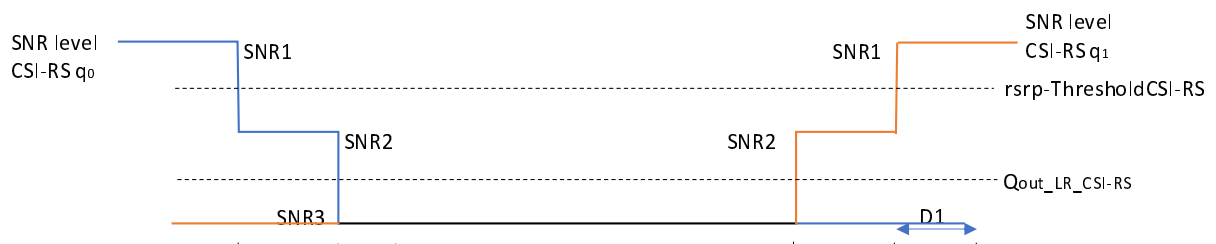

Figure A.5.5.3.1-1: SNR variation SSB for CSI-RS based beam failure detection and link recovery testing in non-DRX mode

A.5.5.3.2 Test Requirements

The UE behaviour during time durations T1, T2, T3, T4 and T5 shall be as follows:

During the time duration T1 and T2, the UE shall transmit uplink signal at least in all subframes configured for CSI transmission on Cell 1.

During the period from time point A to time point B the UE shall transmit uplink signal in Cell 1 in all uplink slots configured for CSI transmission according to the configured periodic CSI reporting for Cell 1.

During T3 the shall detect beam failure and initiat link recovery. During T4 and T5 the UE measures and evaluate beam candidate from beam candidate set q_1 .

No later than time point F occurring no later than $D1 = [TBD]$ ms after the start of T5, the UE shall transmit preamble on a beam associated with the candidate beam set q_1 .

Test is concluded once the test equipment has received the initial preamble transmission from the UE. The rate of correct events observed during repeated tests shall be at least 90%.

A.5.5.5.4 EN-DC Beam Failure Detection and Link Recovery Test for FR2 PSCell configured with CSI-RS-based BFD and LR in DRX mode

A.5.5.5.4.1 Test Purpose and Environment

The purpose of this test is to verify that the UE properly detects CSI-RS-based beam failure in the set q_0 configured for a serving PSCell and that the UE performs correct CSI-RS-based link recovery based on beam candidate set q_1 . The purpose is to test the downlink monitoring for beam failure detection within the UEs active DL BWP of the PSCell, during the evaluation period, and link recovery, when DRX is used. This test will partly verify the CSI-RS based beam failure detection and link recovery for an FR2 serving cell requirements in clause 8.5.

The test parameters are given in Tables A.5.5.5.4.1-1, A.5.5.5.4.1-2, A.5.5.5.4.1-3, A.5.5.5.4.1-4, A.5.5.5.4.1-5 and A.5.5.5.4.1-6 below. There are two cells, cell 1 is the E-UTRAN PCell, and cell 2 is the PSCell, in the test. The test consists of five successive time periods, with time duration of T1, T2, T3, T4 and T5 respectively. Figure A.5.5.5.4.1-1 shows the variation of the downlink SNR of the PCell and the SNR of the CSI-RS in set q_0 in the active PSCell to emulate CSI-RS based beam failure. Figure A.5.5.5.4.1-1 additionally shows the variation of the downlink SNR of the CSI-RS in set q_1 of the candidate beam used for link recovery. Prior to the start of the time duration T1, the UE shall be fully synchronized to cell 1 and cell 2. The UE shall be configured for periodic CSI reporting with a reporting periodicity of [2] ms. In the test, DRX configuration is enabled in PCell and DRX inactivity timer has already been expired, i.e. UE tries to decode PDCCH and to send periodic CQI during the period when On-duration timer is running. Time alignment timers shall be set to “infinity” so that UL timing alignment is maintained during the test. The UE is configured to perform inter-frequency measurements using GP ID #0 (40ms) in test 2.

Table A.5.5.5.4.1-1: Supported test configurations for FR2 PSCell

Configuration	Description
1	LTE FDD, TDD duplex mode, 120 kHz SSB SCS, 100MHz bandwidth

Table A.5.5.5.4.1-2: General test parameters for FR2 PSCell for CSI-RS-based beam failure detection and link recovery testing in DRX mode

Parameter		Unit	Value		Comment
			Test 1	Test 2	
Active E-UTRA PCell			Cell 1	Cell 1	
E-UTRA RF Channel Number			1	1	
Active PCell			Cell 2	Cell 2	
RF Channel Number			2	2	
Duplex mode	Config 1		TDD	TDD	
TDD Configuration	Config 1		[TDDConf.3.1]	[TDDConf.3.1]	
CORESET Reference Channel	Config 1		[CR. 3.1 TDD]	[CR. 3.1 TDD]	A.3.1.2
SSB Configuration	Config 1		SSB.1 FR2	SSB.1 FR2	A.3.10
SMTC Configuration	Config 1		SMTC.1	SMTC.1	A.3.11

PDSCH /PDCCH subcarrier spacing	Config 1		120 KHz	120 KHz	
csi-RS-Index assigned as RLM RS			[0]	[0]	
OCNG parameters			TBD	TBD	A.3.2.1
CP length			Normal	Normal	
Correlation Matrix and Antenna Configuration			[2x2 Low]	[2x2 Low]	
Beam failure detection transmission parameters	DCI format		1-0	1-0	
	Number of Control OFDM symbols		2	2	
	Aggregation level	CC E	8	8	
	Ratio of hypothetical PDCCH RE energy to average CSI-RS RE energy	dB	0	0	
	Ratio of hypothetical PDCCH DMRS energy to average CSI-RS RE energy	dB	0	0	
	DMRS precoder granularity		REG bundle size	REG bundle size	
	REG bundle size		6	6	
DRX			640	640	
Gap pattern ID			[N.A.]	*[gp0]	
csi-RS-Index			2	2	Number of SSB indexes used for beam failure detection
rlmInSyncOutOfSync Threshold			absent	absent	When the field is absent, the UE applies the value 0. (Table 8.1.1-1).
rsrp-ThresholdSSB			TBD	TBD	Threshold used for $Q_{out_LR_SSB}$
powerControlOffsetSS			NA	NA	Used for deriving $rsrp_ThresholdCSI-RS$
beamFailureInstanceMaxCount			[n2]	[n2]	see TS 38.321 [7], section 5.17
beamFailureDetectionTimer			[pbfd4]	[pbfd4]	see TS 38.321 [7], section 5.17
ZP CSI-RS configuration			TBD	TBD	

CSI-IM configuration			TBD	TBD	
Periodic CSI reporting			PUCCH	PUCCH	
CSI reporting periodicity	Config 1, 2	slot	[5]	[5]	
	Config 3		[10]	[10]	
T1		s	1	1	During this time the the UE shall be fully synchronized to cell 1
T2		s	0.4	0.4	
T3		s	[TBD]	[TBD]	
D1		s	[0.24]	[0.44]	
Note 1: UE-specific PDCCH is not transmitted after T1 starts.					

Table A.5.5.4.1-3: Cell specific test parameters for FR2 PSCell for CSI-RS-based beam failure detection and link recovery testing in DRX mode

Parameter	Unit	Test 1 and Test 2					Test 1 and Test 2					
		CSI-RS of set q_0					CSI-RS of set q_1					
		T1	T2	T3	T4	T5	T1	T2	T3	T4	T5	
EPRE ratio of PSS to SSS	dB	0					0					
EPRE ratio of PBCH DMRS to SSS	dB											
EPRE ratio of PBCH to PBCH DMRS	dB											
EPRE ratio of PDCCH DMRS to SSS	dB											
EPRE ratio of PDCCH to PDCCH DMRS	dB											
EPRE ratio of PDSCH DMRS to SSS	dB											
EPRE ratio of PDSCH to PDSCH DMRS	dB											
EPRE ratio of OCNG DMRS to SSS ^(Note 1)	dB											
EPRE ratio of OCNG to OCNG DMRS ^(Note 1)	dB											
SNR _C SI-RS	Config 1	dB	TBD	TBD	TBD	TBD	TBD	TBD	TBD	TBD	TBD	
	Config 2		TBD	TBD	TBD	TBD	TBD	TBD	TBD	TBD	TBD	
	Config 3		TBD	TBD	TBD	TBD	TBD	TBD	TBD	TBD	TBD	
N_{oc}	Config 1	dBm/	[-98]					[-98]				
	Config 2	15K	[-98]					[-98]				
	Config 3	Hz	[-98]					[-98]				
SS-RSRP ^{Note 3}		dBm/SCS										
\hat{E}_s/I_{ot}												
\hat{E}_s/N_{oc}												
I _o	config 1, 2	dBm/9.36 MHz										
	Config 3, 4	dBm/38.1 MHz										
Propagation condition			[TDLA30-75]					[TDLA30-75]				
Note 1:	OCNG shall be used such that the resources in Cell 1 are fully allocated and a constant total transmitted power spectral density is achieved for all OFDM symbols.											
Note 2:	SS-RSRP and I _o levels have been derived from other parameters for information purposes. They are not settable parameters themselves.											

Table A.5.5.4.1-4: Measurement gap configuration for FR2 PSCell for CSI-RS-based beam failure detection and link recovery testing in DRX mode

Field	Test 2
	Value
gapOffset	[0]

Table A.5.5.4.1-5: NZP-CSI-RS resource configuration for FR2 PSCell for CSI-RS-based beam failure detection and link recovery testing in DRX mode

Field	ResourceId 0	ResourceId 1
	Value	Value
frequencyDomainAllocation ^{Note 1}	row1	row2
startingRB	0	0
nrofRBs	Note 2	Note 2
Note 1: TS 38.211 [6] table 7.4.1.5.3-1 Note 2: nrofRBs is derived based on the Configuration in Table A.4.5.1.7.1-1		

Table A.5.5.4.1-6: DRX-Configuration for FR2 PSCell for SSB-based beam failure detection and link recovery testing in DRX mode.

Field	Test 5	Test 6
	Value	Value
drx-onDurationTimer	[ms6]	[ms6]
drx-InactivityTimer	[ms1]	[ms1]
drx-RetransmissionTimerDL	[sl1]	[sl1]
drx-RetransmissionTimerUL	[sl1]	[sl1]
longDRX-CycleStartOffset	[ms640]	[ms40]
shortDRX	disable	disable

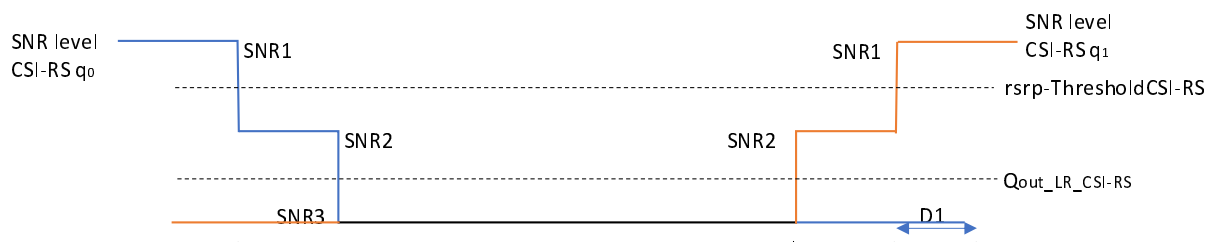

Figure A.5.5.4.1-1: SNR variation SSB for CSI-RS-based beam failure detection and link recovery testing in DRX mode

A.5.5.4.2 Test Requirements

The UE behaviour during time durations T1, T2, T3, T4 and T5 shall be as follows:

During the time duration T1 and T2, the UE shall transmit uplink signal at least in all subframes configured for CSI transmission on Cell 1.

During the period from time point A to time point B the UE shall transmit uplink signal in Cell 1 in all uplink slots configured for CSI transmission according to the configured periodic CSI reporting for Cell 1.

During T3 the shall detect beam failure and initiate link recovery. During T4 and T5 the UE measures and evaluate beam candidate from beam candidate set q_1 .

No later than time point F occurring no later than $D1 = [\text{TBD}]$ ms after the start of T5, the UE shall transmit preamble on a beam associated with the candidate beam set q_1 .

Test is concluded once the test equipment has received the initial preamble transmission from the UE. The rate of correct events observed during repeated tests shall be at least 90%.

A.5.5.6 Active BWP switch delay

A.5.5.6.1 DCI-based and Timer-based Active BWP Switch

A.5.5.6.1.1 E-UTRAN – NR PSCell FR2 DL active BWP switch with non-DRX in synchronous EN-DC

A.5.5.6.1.1.1 Test Purpose and Environment

The purpose of this test is to verify the DL BWP switch delay requirement defined in TS38.133 section 8.6, and interruption requirement for E-UTRA victim cell defined in TS36.133 section 7.32.2.7. Supported test configurations are shown in Table A.5.5.6.1.1.1-1.

The test scenario comprises of one E-UTRA PCell (Cell 1), and one NR PSCell (Cell 2) as given in Table A.5.5.6.1.1.1-2. Cell-specific parameters of E-UTRA PCell are specified in Table A.3.7.2.1-1 and Cell-specific parameters of NR PSCell is specified in Table A.5.5.6.1.1.1-3 below. The OTA related test parameters for FR2 is shown in Table A.5.5.6.1.1.1-4.

PDCCHs indicating new transmissions shall be sent continuously on PCell (Cell 1) to ensure that the UE will have ACK/NACK sending.

PDCCHs indicating new transmissions shall be sent continuously on PSCell (Cell 2) to ensure that the UE would have ACK/NACK sending except for the time duration when BWP is switching on Cell 2 and the time duration of T2.

Before the test starts,

- UE is connected to Cell 1 (PCell) on radio channel 1 (PCC), and Cell 2 (PSCell) on radio channel 2 (PSCC).
- UE is configured with 2 different UE-specific bandwidth parts for PSCell, BWP-1 and BWP-2, in Cell 2 before starting the test. BWP-1 and BWP-2 always include bandwidth of the initial DL BWP and SSB.
- UE is indicated in *firstActiveDownlinkBWP-Id* that the active DL BWP is BWP-1 in PSCell.
- UE is configured with a *bwp-InactivityTimer* timer value for PSCell.

All cells have constant signal levels throughout the test.

The test consists of 3 successive time periods, with durations of T1, T2, and T3, respectively.

During T1,

Time period T1 starts when a DCI format 1_1 command for PSCell DL BWP switch, sent from the test equipment to the UE, is received at the UE side in PSCell's slot # denoted i . The UE should switch its bandwidth part from BWP-1 to BWP-2.

The UE shall be able to receive PDSCH at PSCell's slot ($i+T_{BWPswitchDelay}$) as defined in section 8.6 and starts to report valid ACK/NACK for the PSCell no later than at slot ($i+T_{BWPswitchDelay}+kI$). The UE shall be continuously scheduled on PSCell's BWP-2 starting from slot ($i+T_{BWPswitchDelay}$).

The starting time of PCell(Cell 1) interruption due to BWP switch on PSCell shall occur within the BWP switch delay.

During T2, the test equipment won't transmit DCI format for PDSCH reception on PSCell(Cell 2).

During T3,

The time period T3 starts from the slot # j immediately after the slot wherein *bwp-InactivityTimer* timer expires. The UE should switch its bandwidth part from BWP-2 back to the default bandwidth part – BWP-1.

The UE shall be able to receive PDSCH at PSCell's slot ($j+T_{BWPswitchDelay}$) as defined in section 8.6 and starts to report valid ACK/NACK for the PSCell at latest at slot ($j+T_{BWPswitchDelay}+kI$). The UE shall be continuously scheduled on PSCell's BWP-1 starting from slot ($j+T_{BWPswitchDelay}$).

The starting time of PCell(Cell 1) interruption due to BWP switch of PSCell shall occur within the BWP switch delay.

The test equipment verifies the DL BWP switch time in PSCell by counting the slots from the time when the BWP switch command is received or *bwp-InactivityTimer* timer expires till an ACK is received.

The test equipment verifies that potential interruption to E-UTRA PCell is carried out in the correct time span by monitoring ACK/NACK sent in PCell during BWP switch of PSCell, respectively.

Table A.5.5.6.1.1-1: DL BWP switch supported test configurations

Config	Description
1	LTE FDD, NR 120 kHz SSB SCS, 100MHz bandwidth, TDD duplex mode
2	LTE TDD, NR 120 kHz SSB SCS, 100MHz bandwidth, TDD duplex mode

Note 1: The UE is only required to be tested in one of the supported test configurations
Note 2: A UE which fulfils the requirements in test case A.5.5.2.2 can skip the test cases in A.5.5.2.1.

Table A.5.5.6.1.1-2: General test parameters for DL BWP switch in synchronous EN-DC

Parameter	Unit	Value	Comment
E-UTRA RF Channel Number		1	One E-UTRA radio channel is used for this test
NR RF Channel Number		2	One NR radio channel is used for this test
Active PCell		Cell 1	PCell on RF channel number 1.
Active PSCell		Cell 2	PSCell on RF channel number 2.
CP length		Normal	
DRX		OFF	For both PCell and PSCell
<i>bwp-InactivityTimer</i>	ms	[200]	
Cell-individual offset for cells on RF channel number 1	dB	0	Individual offset for cells on PCC.
Cell-individual offset for cells on RF channel number 2	dB	0	Individual offset for cells on PSCC.
Cell2 timing offset to cell1	μs	3	Synchronous EN-DC
T1	s	[0.2]	
T2	s	[0.2]	
T3	s	[0.2]	

Table A.5.5.6.1.1.1-3: NR Cell specific test parameters for DL BWP switch in synchronous EN-DC

Parameter	Unit	Cell 2
Frequency Range		FR2
Duplex mode		TDD
TDD configuration		TDDConf.3.1
$BW_{channel}$		100 MHz: $N_{RB,c} = 66$
Active BWP ID		1, 2
Initial DL BWP Configuration		DLBWP.0.2 ^{Note 2}
Active DL BWP-1 Configuration		DLBWP.1.1 ^{Note 2}
Active DL BWP-2 Configuration		DLBWP.1.3 ^{Note 2}
Initial UL BWP Configuration		ULBWP.0.2 ^{Note 2}
Active UL BWP-1 Configuration		ULBWP.1.1 ^{Note 2}
Active UL BWP-2 Configuration		ULBWP.1.3 ^{Note 2}
PDSCH Reference measurement channel		SR.3.1 TDD
RMSI CORESET parameters		CR.3.1 TDD
Dedicated CORESET parameters		CCR.3.1 TDD
OCNG Patterns		OP.1
SSB Configuration		SSB.1 FR2
SMTC Configuration		SMTC.1
TCI State		TRS.2.1 TDD
TRS Configuration		TCI.State.0
Correlation Matrix and Antenna Configuration		1x2 Low
EPRE ratio of PSS to SSS	dB	0
EPRE ratio of PBCH DMRS to SSS		
EPRE ratio of PBCH to PBCH DMRS		
EPRE ratio of PDCCH DMRS to SSS		
EPRE ratio of PDCCH to PDCCH DMRS		
EPRE ratio of PDSCH DMRS to SSS		
EPRE ratio of PDSCH to PDSCH		
EPRE ratio of OCNG DMRS to SSS(Note 1)		
EPRE ratio of OCNG to OCNG DMRS (Note 1)		
Propagation Condition		
Note 1: OCNG shall be used such that both cells are fully allocated and a constant total transmitted power spectral density is achieved for all OFDM symbols.		
Note 2: For unpaired spectrum, a DL BWP is linked with an UL BWP. DLBWP.0.2 is linked with ULBWP.0.2; DLBWP.1.1 is linked with ULBWP.1.1; DLBWP.1.3 is linked with ULBWP.1.3 defined in TS38.213 section 12.		

Table A.5.5.6.1.1-4: OTA related test parameters for DL BWP switch in synchronous EN-DC

Parameter	Unit	Cell 2
Angle of arrival configuration		According to section A.3.8.1
N_{oc} ^{Note 1}	dBm/15 kHz	TBD
N_{oc} ^{Note 1}	dBm/SCS	TBD
SS-RSRP ^{Note 2}	dBm/120 kHz ^{Note 3}	TBD
\bar{E}_s/I_{ot}	dB	TBD
I_o ^{Note 2}	dBm/95.04 MHz ^{Note 4}	TBD
Note 1:	Interference from other cells and noise sources not specified in the test is assumed to be constant over subcarriers and time and shall be modelled as AWGN of appropriate power for N_{oc} to be fulfilled.	
Note 2:	SS-RSRP and I_o levels have been derived from other parameters for information purposes. They are not settable parameters themselves.	
Note 3:	SS-RSRP minimum requirements are specified assuming independent interference and noise at each receiver antenna port.	
Note 4:	Equivalent power received by an antenna with 0dBi gain at the centre of the quiet zone	
Note 5:	As observed with 0dBi gain antenna at the centre of the quiet zone.	

A.5.5.6.1.1.2 Test Requirements

During T1, the UE shall start to send the ACK for PSCell in a slot $(i+T_{BWPswitchDelay}+kI)$.

During T3, the UE shall start to send the ACK for PSCell in a slot $(j+T_{BWPswitchDelay}+kI)$.

Where, kI is the timing between DL data receiving and acknowledgement as specified in [7].

Depending on UE capability *bwp-SwitchingDelay* [2], UE shall finish BWP switch within the time duration $T_{BWPswitchDelay}$ defined in Table 8.6.2-1.

All of the above test requirements shall be fulfilled in order for the observed PSCell active BWP switch delay to be counted as correct.

The rate of correct events observed during repeated tests shall be at least 90%.

During T1, the start time of PCell interruption during PSCell active BWP switch shall not happen outside the BWP switch delay.

During T3, the start time of PCell interruption during PSCell active BWP switch shall not happen outside the BWP switch delay.

The interruption of PCell shall not be longer than the interruption duration specified for active BWP switch in TS36.133 Section 7.32.2.7.

All of the above test requirements shall be fulfilled in order for the observed PCell active BWP switch interruption to be counted as correct.

The rate of correct events observed during repeated tests shall be at least 90%.

NOTE: During T1, T3 if there are no uplink resources for reporting the ACK in a slot $(i+Y1)$, $(j+Y2)$, then the UE shall use the next available uplink resource for reporting the corresponding ACK.

Editor's note: whether E-UTRA PCell's interruption test requirement is needed or not depends on whether E-UTRA Pcell's interruption could be tested when PSCell is FR2 cell.

A.5.5.6.1.2 E-UTRAN – NR PSCell FR2 DL active BWP switch with FR2 SCell in non-DRX in synchronous EN-DC

A.5.5.6.1.2.1 Test Purpose and Environment

The purpose of this test is to verify the DL BWP switch delay requirement defined in section 8.6, and interruption requirements for NR victim cell defined in section 8.2.1.2.7 and interruption requirement for E-UTRA victim cell defined in TS36.133 section 7.32.2.7. Supported test configurations are shown in Table A.5.5.6.1.2.1-1.

The test scenario comprises of one E-UTRA PCell (Cell 1), one NR PSCell (Cell 2) and one NR SCell (Cell 3) as given in Table A.5.5.6.1.2.1-2. Cell-specific parameters of E-UTRA PCell are specified in Table A.3.7.2.1-1 and Cell-specific parameters of NR PSCell and SCell are specified in Table A.5.5.6.1.2.1-3 below.

PDCCHs indicating new transmissions shall be sent continuously on PCell (Cell 1) and SCell (Cell 3) to ensure that the UE will have ACK/NACK sending.

PDCCHs indicating new transmissions shall be sent continuously on PSCell (Cell 2) to ensure that the UE would have ACK/NACK sending except for the time duration when BWP is switching on Cell 2 and the time duration of T2.

Before the test starts,

- UE is connected to Cell 1 (PCell) on radio channel 1 (PCC), Cell 2 (PSCell) on radio channel 2 (PSCC) and Cell 3 (SCell) on radio channel 3 (SCC).
- UE is configured with 2 different UE-specific bandwidth parts for PSCell, BWP-1 and BWP-2, in Cell 2 before starting the test. BWP-1 and BWP-2 always include bandwidth of the initial DL BWP and SSB.
- UE is configured with 1 UE-specific bandwidth parts the same as initial BWP for SCell, BWP-0 in Cell 3 before starting the test.
- UE is indicated in *firstActiveDownlinkBWP-Id* that the active DL BWP is BWP-1 in PSCell.
- UE is indicated in *firstActiveDownlinkBWP-Id* that the active DL BWP is BWP-0 in SCell.
- UE is configured with a *bwp-InactivityTimer* timer value for PSCell.

All cells have constant signal levels throughout the test.

The test consists of 3 successive time periods, with durations of T1, T2, and T3, respectively.

During T1,

Time period T1 starts when a DCI format 1_1 command for PSCell DL BWP switch, sent from the test equipment to the UE, is received at the UE side in PSCell's slot # denoted i . The UE shall switch its bandwidth part from BWP-1 to BWP-2.

The UE shall be able to receive PDSCH at PSCell's slot $(i + T_{BWPswitchDelay})$ as defined in section 8.6 and starts to report valid ACK/NACK for the PSCell no later than at slot $(i + T_{BWPswitchDelay} + kI)$. The UE shall be continuously scheduled on PSCell's BWP-2 starting from slot $(i + T_{BWPswitchDelay})$.

PCell(Cell 1) interruption due to BWP switch on PSCell shall occur within the BWP switch delay.

SCell(Cell 3) interruption due to BWP switch on PSCell shall occur within the BWP switch delay.

During T2, the test equipment won't transmit DCI format for PDSCH reception on PSCell(Cell 2).

During T3,

The time period T3 starts from the slot # j immediately after the slot wherein *bwp-InactivityTimer* timer expires. The UE shall switch its bandwidth part from BWP-2 back to the default bandwidth part – BWP-1.

The UE shall be able to receive PDSCH at PSCell's slot ($j+T_{BWPswitchDelay}$) as defined in section 8.6 and starts to report valid ACK/NACK for the PSCell at latest at slot ($j+T_{BWPswitchDelay}+kI$). The UE shall be continuously scheduled on PSCell's BWP-1 starting from slot ($j+T_{BWPswitchDelay}$).

PCell(Cell 1) interruption due to BWP switch of PSCell shall occur within the BWP switch delay.

SCell(Cell 3) interruption due to BWP switch of PSCell shall occur within the BWP switch delay.

The test equipment verifies the DL BWP switch time in PSCell by counting the slots from the time when the BWP switch command is received or *bwp-InactivityTimer* timer expires till an ACK is received.

The test equipment verifies that potential interruption to E-UTRA PCell and NR SCell is carried out in the correct time span by monitoring ACK/NACK sent in PCell and SCell during BWP switch of PSCell, respectively.

Table A.5.5.6.1.2.1-1: DL BWP switch supported test configurations

Config	Description
1	LTE FDD, NR 120 kHz SSB SCS, 100MHz bandwidth, TDD duplex mode
2	LTE TDD, NR 120 kHz SSB SCS, 100MHz bandwidth, TDD duplex mode
Note 1: The UE is only required to be tested in one of the supported test configurations	
Note 2: A UE which fulfils the requirements in test case A.5.5.6.1.2 can skip the test cases in A.5.5.6.1.1.	
Note 3: NR configuration is the same for PSCell and SCells.	

Table A.5.5.6.1.2.1-2: General test parameters for DL BWP switch in synchronous EN-DC

Parameter	Unit	Value	Comment
E-UTRA RF Channel Number		1	One E-UTRA radio channel is used for this test
NR RF Channel Number		2, 3	Two NR radio channel is used for this test
Active PCell		Cell 1	PCell on RF channel number 1.
Active PSCell		Cell 2	PSCell on RF channel number 2.
Active SCell		Cell 3	SCell on RF channel number 3.
CP length		Normal	
DRX		OFF	
<i>bwp-InactivityTimer</i>	ms	[200]	
Cell-individual offset for cells on RF channel number 1	dB	0	Individual offset for cells on PCC.
Cell-individual offset for cells on RF channel number 2	dB	0	Individual offset for cells on PSCC.
Cell-individual offset for cells on RF channel number 3	dB	0	Individual offset for cells on SCC.
Cell2 timing offset to cell1	μs	3	Synchronous EN-DC
Cell3 timing offset to cell2	μs	3	Synchronous cells
T1	s	[0.2]	
T2	s	[0.2]	
T3	s	[0.2]	

Table A.5.5.6.1.2.1-3: NR Cell specific test parameters for DL BWP switch in synchronous EN-DC

Parameter	Unit	Cell 2	Cell 3
Frequency Range		FR2	
Duplex mode		TDD	
TDD configuration		TDDConf.3.1	
BW_{channel}		100 MHz: $N_{RB,c} = 66$	
Active BWP ID		1, 2	0
Initial BWP Configuration		DLBWP.0.2	DLBWP.0.2
Active BWP-0 Configuration		NA	DLBWP.0.2
Active BWP-1 Configuration		DLBWP.1.3	NA
Active BWP-2 Configuration		DLBWP.1.1	NA
PDSCH Reference measurement channel		SR.3.1 TDD	
RMSI CORESET parameters		CR.3.1 TDD	
Dedicated CORESET parameters		CCR.3.1 TDD	
OCNG Patterns		OP.1	
SSB Configuration		SSB.1 FR2	
SMTC Configuration		SMTC.1	
TCI State		TBD	
TRS Configuration		TBD	
Antenna Configuration		1x2	
Propagation Condition		AWGN	
EPRE ratio of PSS to SSS	dB	0	0
EPRE ratio of PBCH DMRS to SSS			
EPRE ratio of PBCH to PBCH DMRS			
EPRE ratio of PDCCH DMRS to SSS			
EPRE ratio of PDCCH to PDCCH DMRS			
EPRE ratio of PDSCH DMRS to SSS			
EPRE ratio of PDSCH to PDSCH			
EPRE ratio of OCNG DMRS to SSS(Note 1)			
EPRE ratio of OCNG to OCNG DMRS (Note 1)			
Note 1:			
Note 2:	Interference from other cells and noise sources not specified in the test is assumed to be constant over subcarriers and time and shall be modelled as AWGN of appropriate power for N_{oc} to be fulfilled.		
Note 3:	SS-RSRP and I_o levels have been derived from other parameters for information purposes. They are not settable parameters themselves.		
Note 4:	For unpaired spectrum, a DL BWP is linked with an UL BWP. DLBWP.0.2 is linked with ULBWP.0.2; DLBWP.1.1 is linked with ULBWP.1.1; DLBWP.1.3 is linked with ULBWP.1.3.		

Table A.5.5.6.1.2.1-4: OTA related test parameters for DL BWP switch in synchronous EN-DC

Parameter	Unit	Cell 2	Cell 3
Angle of arrival configuration		According to section A.3.8.1	According to section A.3.8.1
N_{oc} ^{Note 1}	dBm/15 kHz	TBD	TBD
SS-RSRP ^{Note 2}	dBm/120 kHz ^{Note 3}	TBD	TBD
\bar{E}_s/I_{ot}	dB	TBD	TBD
I_o ^{Note 2}	dBm/95.04 MHz ^{Note 4}	TBD	TBD
Note 1:	Interference from other cells and noise sources not specified in the test is assumed to be constant over subcarriers and time and shall be modelled as AWGN of appropriate power for N_{oc} to be fulfilled.		
Note 2:	SS-RSRP and I_o levels have been derived from other parameters for information purposes. They are not settable parameters themselves.		
Note 3:	SS-RSRP minimum requirements are specified assuming independent interference and noise at each receiver antenna port.		
Note 4:	Equivalent power received by an antenna with 0dBi gain at the centre of the quiet zone		
Note 5:	As observed with 0dBi gain antenna at the centre of the quiet zone.		

A.5.5.6.1.2.2 Test Requirements

During T1, the UE shall start to send the ACK for PSCell in a slot $(i+T_{BWPswitchDelay}+kI)$.

During T3, the UE shall start to send the ACK for PSCell in a slot $(j+T_{BWPswitchDelay}+kI)$.

All of the above test requirements shall be fulfilled in order for the observed PSCell active BWP switch delay to be counted as correct.

The rate of correct events observed during repeated tests shall be at least 90%.

During T1, the start of the interruption of PCell during PSCell active BWP switch shall not happen outside the BWP switch delay.

During T3, the start of the interruption of PCell during PSCell active BWP switch shall not happen outside the BWP switch delay.

The interruption of PCell shall not be longer than the interruption duration specified for active BWP switch in TS36.133 Section 7.32.2.7.

During T1, the start of the interruption of SCell during PSCell active BWP switch shall not happen outside the BWP switch delay.

During T3, the start of the interruption of SCell during PSCell active BWP switch shall not happen outside the BWP switch delay.

The interruption of SCell shall not be longer than the interruption duration specified for active BWP switch in Section 8.6.2.

All of the above test requirements shall be fulfilled in order for the observed PCell active BWP switch interruption to be counted as correct.

The rate of correct events observed during repeated tests shall be at least 90%.

NOTE: During T1, T3 if there are no uplink resources for reporting the ACK in a slot $(i+T_{BWPswitchDelay}+kI)$, $(j+T_{BWPswitchDelay}+kI)$, then the UE shall use the next available uplink resource for reporting the corresponding ACK.

Editor's note: FFS value of kI for type 1 and type 2 UE.

A.5.5.6.2 RRC-based Active BWP Switch

A.5.5.6.2.1 E-UTRAN – NR PSCell FR2 DL active BWP switch with non-DRX in synchronous EN-DC

A.5.5.6.2.1.1 Test Purpose and Environment

The purpose of this test is to verify the DL BWP switch delay requirement for RRC-based BWP switch defined in section 8.6. Supported test configurations are shown in Table A.5.5.6.2.1.1-1.

The test scenario comprises of one E-UTRA PCell (Cell 1) and one NR PSCell (Cell 2) as given in Table A.5.5.6.2.1.1-2. Cell-specific parameters of E-UTRA PCell are specified in Table A.3.7.2.1-1 and Cell-specific parameters of NR PSCell are specified in Table A.5.5.6.2.1.1-3 below.

PDCCHs indicating new transmissions shall be sent continuously on PCell (Cell 1) to ensure that the UE will have ACK/NACK sending.

Before the test starts,

- UE is connected to Cell 1 (PCell) on radio channel 1 (PCC) and to Cell 2 (PSCell) on radio channel 2 (PSCC).

- UE has bandwidth part BWP-1 in its RRC-configuration for Cell 2 (PSCell).
- UE is indicated in *firstActiveDownlinkBWP-Id* that the active DL BWP is BWP-1 in PSCell.

All cells have constant signal levels throughout the test.

The test consists of 1 time period, with duration of T1.

During T1,

Time period T1 starts when a *RRCReconfiguration* with bandwidth part configuration BWP-2, sent from the test equipment to the UE, is received at the UE side in PSCell's slot # denoted *i*. The UE shall switch its bandwidth part from BWP-1 to BWP-2.

The UE shall be able to receive PDSCH at PSCell's slot (*i+X*) as defined in section 8.6 and starts to report valid ACK/NACK for the PSCell no later than at slot (*i+X+k1*). The UE shall be continuously scheduled on PSCell's BWP-2 starting from slot (*i+X*).

The test equipment verifies the DL BWP switch time in PSCell by counting the slots from the time when the RRC Reconfiguration message including BWP switch command is received till an ACK is received.

Table A.5.5.6.2.1.1-1: DL BWP switch supported test configurations

Config	Description
1	LTE FDD, NR 120 kHz SSB SCS, 100MHz bandwidth, TDD duplex mode
2	LTE TDD, NR 120 kHz SSB SCS, 100MHz bandwidth, TDD duplex mode
Note 1: The UE is only required to be tested in one of the supported test configurations	

Table A.5.5.6.2.1.1-2: General test parameters for DL BWP switch in synchronous EN-DC

Parameter	Unit	Value	Comment
E-UTRA RF Channel Number		1	One E-UTRA radio channel is used for this test
NR RF Channel Number		2	One NR radio channel is used for this test
Active PCell		Cell 1	PCell on RF channel number 1.
Active PSCell		Cell 2	PSCell on RF channel number 2.
CP length		Normal	
DRX		OFF	
Cell-individual offset for cells on RF channel number 1	dB	0	Individual offset for cells on PCC.
Cell-individual offset for cells on RF channel number 2	dB	0	Individual offset for cells on PSCC.
Cell2 timing offset to cell1	μs	3	Synchronous EN-DC
T1	s	[0.2]	

Table A.5.5.6.2.1.1-3: NR Cell specific test parameters for DL BWP switch in synchronous EN-DC

Parameter	Unit	Cell 2
Frequency Range		FR2
Duplex mode		TDD
TDD configuration		TDDConf.3.1
BW_{channel}		100 MHz: $N_{RB,c} = 66$
Active BWP ID		1, 2
Initial BWP Configuration		DLBWP.0.2
Active BWP-0 Configuration		NA
Active BWP-1 Configuration		DLBWP.1.3
Active BWP-2 Configuration		DLBWP.1.1
PDSCH Reference measurement channel		SR.3.1 TDD
RMSI CORESET parameters		CR.3.1 TDD
Dedicated CORESET parameters		CCR.3.1 TDD
OCNG Patterns		OP.1
SSB Configuration		SSB.1 FR2
SMTC Configuration		SMTC.1
TCI State		TBD
TRS Configuration		TBD
Antenna Configuration		1x2
Propagation Condition		AWGN
EPRE ratio of PSS to SSS	dB	0
EPRE ratio of PBCH DMRS to SSS		
EPRE ratio of PBCH to PBCH DMRS		
EPRE ratio of PDCCH DMRS to SSS		
EPRE ratio of PDCCH to PDCCH DMRS		
EPRE ratio of PDSCH DMRS to SSS		
EPRE ratio of PDSCH to PDSCH		
EPRE ratio of OCNG DMRS to SSS(Note 1)		
EPRE ratio of OCNG to OCNG DMRS (Note 1)		
Note 1: OCNG shall be used such that both cells are fully allocated and a constant total transmitted power spectral density is achieved for all OFDM symbols.		
Note 2: Interference from other cells and noise sources not specified in the test is assumed to be constant over subcarriers and time and shall be modelled as AWGN of appropriate power for N_{oc} to be fulfilled.		
Note 3: SS-RSRP and I_0 levels have been derived from other parameters for information purposes. They are not settable parameters themselves.		
Note 4: For unpaired spectrum, a DL BWP is linked with an UL BWP. DLBWP.0.2 is linked with ULBWP.0.2; DLBWP.1.1 is linked with ULBWP.1.1; DLBWP.1.3 is linked with ULBWP.1.3 defined in TS 38.213 [3] section 12.		

A.5.5.6.1.2.2 Test Requirements

During T1, the UE shall start to send the ACK for PSCell in a slot $(i+X+kI)$.

All of the above test requirements shall be fulfilled in order for the observed PSCell active BWP switch delay to be counted as correct.

The rate of correct events observed during repeated tests shall be at least 90%.

The rate of correct events observed during repeated tests shall be at least 90%.

NOTE: During T1, if there are no uplink resources for reporting the ACK in a slot $(i+X+kI)$, then the UE shall use the next available uplink resource for reporting the corresponding ACK.

Editor's note: FFS value of X, k1 for type 1 and type 2 UE.

A.5.6 Measurement procedure

A.5.6.1 Intra-frequency Measurements

A.5.6.1.1 EN-DC event triggered reporting test without gap under non-DRX

A.5.6.1.1.1 Test purpose and Environment

The purpose of this test is to verify that the UE makes correct reporting of an event. This test will partly verify the TDD intra-frequency cell search requirements in clause 9.2.5.1 and 9.2.5.2. Supported test configurations are shown in table A.5.6.1.1.1-1.

Table A.5.6.1.1.1-1: supported test configurations

Configuration	Description
1	LTE FDD, 120 kHz SSB SCS, 100MHz bandwidth, TDD duplex mode
2	LTE TDD, 120 kHz SSB SCS, 100MHz bandwidth, TDD duplex mode
3	LTE FDD, 240 kHz SSB SCS, 100MHz bandwidth, TDD duplex mode
4	LTE TDD, 240 kHz SSB SCS, 100MHz bandwidth, TDD duplex mode
Note:	The UE is only required to be tested in one of the supported test configurations.

There are three cells in the test, E-UTRAN PCell (Cell 1), FR2 PCell (Cell 2) and a FR2 neighbour cell (Cell 3) on the same frequency as the PCell. The test parameters and applicability for Cell 1 are defined in A.3.7.2. The test parameters for the Cell 2 and Cell 3 are given in Table A.5.6.1.1.1-2, A.5.6.1.1.1-3 and A.5.6.1.1.1-4 below.

In the measurement control information a measurement object is configured for the frequency of the PCell, and it is indicated to the UE that event-triggered reporting with Event A3 is used.

The test consists of two successive time periods, with time duration of T1, and T2 respectively. During time duration T1, the UE shall not have any timing information of cell 3.

Table A.5.6.1.1.1-2: General test parameters for intra-frequency event triggered reporting for EN-DC with TDD PSCell in FR2 without gap without DRX

Parameter	Unit	Config	Value	Comment
Active cell		1~4	E-UTRAN PCell (Cell 1) PSCell (Cell 2)	
Neighbour cell		1~4	Cell 3	Cell to be identified.
RF Channel Number		1~4	1: Cell 1 2: Cell 2 and Cell 3	One TDD carrier frequency is used for the NR cells and one TDD or FDD carrier frequency is used for E-UTRAN cell.
SMTC configuration		1~4	SMTC.1	
A3-Offset	dB	1~4	-6	
CP length		1~4	Normal	
Hysteresis	dB	1~4	0	
Time To Trigger	s	1~4	0	
Filter coefficient		1~4	0	L3 filtering is not used
DRX		1~4	OFF	
Time offset between Cell 1 and Cell 2		1~4	3 μ s	Synchronous EN-DC
Time offset between Cell 2 and Cell 3		1~4	3 μ s	Synchronous cells
T1	s	1~4	5	
T2	s	1~4	5	

Table A.5.6.1.1.1-3: NR Cell specific test parameters for intra-frequency event triggered reporting for EN-DC with TDD PSCell in FR2 without gap without DRX

Parameter	Unit	Config	Cell 2		Cell 3	
			T1	T2	T1	T2
TDD configuration		1~4	TDDConf.3.1		TDDConf.3.1	
Initial BWP configuration		1~4	DLBWP.0.1 ULBWP.0.1		DLBWP.0.1 ULBWP.0.1	
Active DL BWP configuration		1~4	DLBWP.1.1		DLBWP.1.1	
Active UL BWP configuration		1~4	ULBWP.1.1		ULBWP.1.1	
RLM-RS		1~4	SSB		SSB	
PDSCH RMC configuration		1~4	SR.3.1 TDD		N/A	
RMSI CORESET RMC configuration		1~4	CR.3.1 TDD		CR.3.1 TDD	
Dedicated CORESET RMC configuration		1~4	CCR.3.1 TDD		CCR.3.1 TDD	
OCNG Patterns		1~4	OP.1		OP.1	
TRS configuration		1~4	TRS.2.1 TDD		N/A	
TCI state		1~4	CSI-RS.Config.0		N/A	
SSB configuration		1, 2	SSB.1 FR2		SSB.1 FR2	
		3, 4	SSB.2 FR2		SSB.2 FR2	
Propagation Condition		1~4	AWGN			

Table A.5.6.1.1.1-4: NR OTA Cell specific test parameters for intra-frequency event triggered reporting for EN-DC with TDD PSCell in FR2 without gap without DRX

Parameter	Unit	Config	Cell 2		Cell 3	
			T1	T2	T1	T2
AoA setup		1~4	A.3.8.x			
\hat{E}_s/I_{ot}	dB	1~4	TBD	TBD	TBD	TBD
N_{oc} Note 2	dBm/15 KHz	1~4	TBD			
N_{oc} Note 2	dBm/SCS	1, 2	TBD			
		3, 4	TBD			
SS-RSRP	dBm/SCS	1, 2	TBD	TBD	TBD	TBD
		3, 4	TBD	TBD	TBD	TBD
\hat{E}_s/N_{oc}	dB	1~4	TBD	TBD	TBD	TBD
I_o	dBm/95.04MHz	1~4	TBD		TBD	
Note 1:	The resources for uplink transmission are assigned to the UE prior to the start of time period T2.					
Note 2:	Interference from other cells and noise sources not specified in the test is assumed to be constant over subcarriers and time and shall be modelled as AWGN of appropriate power for N_{oc} to be fulfilled.					
Note 3:	SS-RSRP levels have been derived from other parameters for information purposes. They are not settable parameters themselves.					

A.5.6.1.1.2 Test Requirements

In the test, the UE shall send one Event A3 triggered measurement report, with a measurement reporting delay less than X ms from the beginning of time period T2, where X is

- 2.4s for a UE supporting power class 1,
- 1.44s for a UE supporting power class 2 or 3,
- [1.44s] for a UE supporting power class 4

The UE is not required to read the neighbour cell SSB index in this test.

The UE shall not send event triggered measurement reports, as long as the reporting criteria are not fulfilled.

The rate of correct events observed during repeated tests shall be at least 90%.

NOTE: The actual overall delays measured in the test may be up to 2xTTIDCCH higher than the measurement reporting delays above because of TTI insertion uncertainty of the measurement report in DCCH.

A.5.6.1.2 EN-DC event triggered reporting test without gap under DRX

A.5.6.1.2.1 Test purpose and Environment

The purpose of this test is to verify that the UE makes correct reporting of an event. This test will partly verify the TDD intra-frequency cell search requirements in clause 9.2.5.1 and 9.2.5.2. Supported test configurations are shown in table A.5.6.1.2.1-1.

Table A.5.6.1.2.1-1: supported test configurations

Configuration	Description
1	LTE FDD, 120 kHz SSB SCS, 100MHz bandwidth, TDD duplex mode
2	LTE TDD, 120 kHz SSB SCS, 100MHz bandwidth, TDD duplex mode
3	LTE FDD, 240 kHz SSB SCS, 100MHz bandwidth, TDD duplex mode
4	LTE TDD, 240 kHz SSB SCS, 100MHz bandwidth, TDD duplex mode
Note:	The UE is only required to be tested in one of the supported test configurations.

There are three cells in the test, E-UTRAN PCell (Cell 1), FR2 PCell (Cell 2) and a FR2 neighbour cell (Cell 3) on the same frequency as the PCell. The test parameters and applicability for Cell 1 are defined in A.3.7.2. The test parameters for the Cell 2 and Cell 3 are given in Table A.5.6.1.2.1-2 ~ Table A.5.6.1.2.1-6 below.

In the measurement control information a measurement object is configured for the frequency of the PCell, and it is indicated to the UE that event-triggered reporting with Event A3 is used.

The test consists of two successive time periods, with time duration of T1, and T2 respectively. During time duration T1, the UE shall not have any timing information of cell 3.

Table A.5.6.1.2.1-2: General test parameters for intra-frequency event triggered reporting for EN-DC with TDD PCell in FR2 without gap with DRX

Parameter	Unit	Config	Value		Comment
			Test 1	Test 2	
Active cell		1~4	E-UTRAN PCell (Cell 1) PCell (Cell 2)		
Neighbour cell		1~4	Cell 3		Cell to be identified.
RF Channel Number		1~4	1: Cell 1 2: Cell 2 and Cell 3		One TDD carrier frequency is used for the NR cells and one TDD or FDD carrier frequency is used for E-UTRAN cell.
SMTC configuration		1~4	SMTC.1		
A3-Offset	dB	1~4	-6		
CP length		1~4	Normal		
Hysteresis	dB	1~4	0		
Time To Trigger	s	1~4	0		
Filter coefficient		1~4	0		L3 filtering is not used
DRX		1~4	DRX.1	DRX.2	DRX related parameters are defined in Table A.5.6.1.2.1-4
Time offset between Cell 1 and Cell 2		1~4	3 μ s		Synchronous EN-DC
Time offset between Cell 2 and Cell 3		1~4	3 μ s		Synchronous cells
T1	s	1~4	5		
T2	s	1~4	10	52	

Table A.5.6.1.2.1-3: NR Cell specific test parameters for intra-frequency event triggered reporting for EN-DC with TDD PSCell in FR2 without gap with DRX

Parameter	Unit	Config	Cell 2		Cell 3	
			T1	T2	T1	T2
TDD configuration		1~4	TDDConf.3.1		TDDConf.3.1	
Initial BWP configuration		1~4	DLBWP.0.1 ULBWP.0.1		DLBWP.0.1 ULBWP.0.1	
Active DL BWP configuration		1~4	DLBWP.1.1		DLBWP.1.1	
Active UL BWP configuration		1~4	ULBWP.1.1		ULBWP.1.1	
RLM-RS		1~4	SSB		SSB	
PDSCH RMC configuration		1~4	SR.3.1 TDD		N/A	
RMSI CORESET RMC configuration		1~4	CR.3.1 TDD		CR.3.1 TDD	
Dedicated CORESET RMC configuration		1~4	CCR.3.1 TDD		CCR.3.1 TDD	
OCNG Patterns		1~4	OP.1		OP.1	
TRS configuration		1~4	TRS.2.1 TDD		N/A	
TCI state		1~4	CSI-RS.Config.0		N/A	
SSB configuration		1, 2	SSB.1 FR2		SSB.1 FR2	
		3, 4	SSB.2 FR2		SSB.2 FR2	
Propagation Condition		1~4	AWGN			

Table A.5.6.1.2.1-4: NR OTA Cell specific test parameters for intra-frequency event triggered reporting for EN-DC with TDD PSCell in FR2 without gap with DRX

Parameter	Unit	Config	Cell 2		Cell 3	
			T1	T2	T1	T2
AoA setup		1~4	A.3.8.x			
\hat{E}_s/I_{ot}	dB	1~4	TBD	TBD	TBD	TBD
N_{oc} ^{Note 2}	dBm/15 KHz	1~4	TBD			
N_{oc} ^{Note 2}	dBm/SCS	1, 2	TBD			
		3, 4	TBD			
SS-RSRP	dBm/SCS	1, 2	TBD	TBD	TBD	TBD
		3, 4	TBD	TBD	TBD	TBD
\hat{E}_s/N_{oc}	dB	3, 4	TBD	TBD	TBD	TBD
I_o	dBm/95.04MHz	1~4	TBD		TBD	
Note 1:	The resources for uplink transmission are assigned to the UE prior to the start of time period T2.					
Note 2:	Interference from other cells and noise sources not specified in the test is assumed to be constant over subcarriers and time and shall be modelled as AWGN of appropriate power for N_{oc} to be fulfilled.					
Note 3:	SS-RSRP levels have been derived from other parameters for information purposes. They are not settable parameters themselves.					

Table A.5.6.1.2.1-5: Void**Table A.5.6.1.2.1-6: Void****A.5.6.1.2.2 Test Requirements**

In test 1, the UE shall send one Event A3 triggered measurement report, with a measurement reporting delay less than X ms from the beginning of time period T2, where X is

- 7.2s for a UE supporting power class 1,
- 4.32s for a UE supporting power class 2 or 3,
- [4.32s] for a UE supporting power class 4

In test 2, the UE shall send one Event A3 triggered measurement report, with a measurement reporting delay less than X ms from the beginning of time period T2, where X is

- 51.2s for a UE supporting power class 1,
- 30.72s for a UE supporting power class 2 or 3,
- [30.72s] for a UE supporting power class 4

The UE is not required to read the neighbour cell SSB index in this test.

The UE shall not send event triggered measurement reports, as long as the reporting criteria are not fulfilled.

The rate of correct events observed during repeated tests shall be at least 90%.

NOTE: The actual overall delays measured in the test may be up to $2xTTI_{DCCCH}$ higher than the measurement reporting delays above because of TTI insertion uncertainty of the measurement report in DCCCH.

A.5.6.1.3 EN-DC event triggered reporting test with per-UE gaps under non-DRX**A.5.6.1.3.1 Test purpose and Environment**

The purpose of this test is to verify that the UE makes correct reporting of an event. This test will partly verify the TDD intra-frequency cell search requirements in clause 9.2.5.1 and 9.2.5.2. Supported test configurations are shown in table A.5.6.1.3.1-1.

Table A.5.6.1.3.1-1: supported test configurations

Configuration	Description
1	LTE FDD, 120 kHz SSB SCS, 100MHz bandwidth, TDD duplex mode
2	LTE TDD, 120 kHz SSB SCS, 100MHz bandwidth, TDD duplex mode
3	LTE FDD, 240 kHz SSB SCS, 100MHz bandwidth, TDD duplex mode
4	LTE TDD, 240 kHz SSB SCS, 100MHz bandwidth, TDD duplex mode
Note:	The UE is only required to be tested in one of the supported test configurations.

There are three cells in the test, E-UTRAN PCell (Cell 1), FR2 PSCell (Cell 2) and a FR2 neighbour cell (Cell 3) on the same frequency as the PSCell. The test parameters and applicability for Cell 1 are defined in A.3.7.2. The test parameters for the Cell 2 and Cell 3 are given in Table A.5.6.1.3.1-2 ~ 4 below.

There are two BWPs configured in Cell 2, BWP1 which contains the cell defining SSB, and BWP2 which does not contain any SSB of Cell 2. During the whole test, BWP2 is always scheduled as the active BWP for the UE.

In the measurement control information a measurement object is configured for the frequency of the PSCell, and it is indicated to the UE that event-triggered reporting with Event A3 is used.

The test consists of two successive time periods, with time duration of T1, and T2 respectively. During time duration T1, the UE shall not have any timing information of cell 3.

Table A.5.6.1.3.1-2: General test parameters for intra-frequency event triggered reporting for EN-DC with TDD PSCell in FR2 with per-UE gaps without DRX

Parameter	Unit	Config	Value	Comment
Active cell		1~4	E-UTRAN PCell (Cell 1) PSCell (Cell 2)	
Neighbour cell		1~4	Cell 3	Cell to be identified.
RF Channel Number		1~4	1: Cell 1 2: Cell 2 and Cell 3	One TDD carrier frequency is used for the NR cells and one TDD or FDD carrier frequency is used for E-UTRAN cell.
Gap type		1~4	Per-UE gaps	
Measurement gap repetition periodicity	ms	1~4	40	
Measurement gap length	ms	1~4	6	
Measurement gap offset	ms	1~4	39	
SMTC configuration		1~4	SMTC.1	
CSI-RS parameters		1~4	CSI-RS.3.2 TDD	
A3-Offset	dB	1~4	-6	
CP length		1~4	Normal	
Hysteresis	dB	1~4	0	
Time To Trigger	s	1~4	0	
Filter coefficient		1~4	0	L3 filtering is not used
DRX		1~4	OFF	
Time offset between Cell 1 and Cell 2		1~4	3 μ s	Synchronous EN-DC
Time offset between Cell 2 and Cell 3		1~4	3 μ s	Synchronous cells
T1	s	1~4	5	
T2	s	1~4	5	

Table A.5.6.1.3.1-3: NR Cell specific test parameters for intra-frequency event triggered reporting for EN-DC with TDD PSCell in FR2 with per-UE gaps without DRX

Parameter	Unit	Config	Cell 2		Cell 3	
			T1	T2	T1	T2
TDD configuration		1~4	TDDConf.3.1		TDDConf.3.1	
Initial BWP configuration		1~4	DLBWP.0.1 ULBWP.0.1		DLBWP.0.1 ULBWP.0.1	
Active DL BWP configuration		1~4	DLBWP.1.2		DLBWP.1.1	
Active UL BWP configuration		1~4	ULBWP.1.2		ULBWP.1.1	
RLM-RS		1~4	CSI-RS		SSB	
PDSCH RMC configuration		1~4	SR.3.1 TDD		N/A	
RMSI CORESET RMC configuration		1~4	CR.3.1 TDD		CR.3.1 TDD	
Dedicated CORESET RMC configuration		1~4	CCR.3.1 TDD		CCR.3.1 TDD	
TRS configuration		1~4	TRS.2.1 TDD		N/A	
TCI state		1~4	CSI-RS.Config.0		N/A	
OCNG Patterns		1~4	OP.1		OP.1	
SSB		1, 2	SSB.1 FR2		SSB.1 FR2	
		3, 4	SSB.2 FR2		SSB.2 FR2	
Propagation Condition		1~4	AWGN			

Table A.5.6.1.3.1-4: NR OTA Cell specific test parameters for intra-frequency event triggered reporting for EN-DC with TDD PSCell in FR2 with per-UE gaps without DRX

Parameter	Unit	Config	Cell 2		Cell 3	
			T1	T2	T1	T2
AoA setup		1~4	A.3.8.x			
\hat{E}_s/I_{ot}	dB	1~4	TBD	TBD	TBD	TBD
N_{oc} Note 2	dBm/15 KHz	1~4	TBD			
N_{oc} Note 2	dBm/SCS	1, 2	TBD			
		3, 4	TBD			
SS-RSRP	dBm/SCS	1, 2	TBD	TBD	TBD	TBD
		3, 4	TBD	TBD	TBD	TBD
\hat{E}_s/N_{oc}	dB	3, 4	TBD	TBD	TBD	TBD
I_o	dBm/95.04MHz	1~4	TBD		TBD	
Note 1:	The resources for uplink transmission are assigned to the UE prior to the start of time period T2.					
Note 2:	Interference from other cells and noise sources not specified in the test is assumed to be constant over subcarriers and time and shall be modelled as AWGN of appropriate power for N_{oc} to be fulfilled.					
Note 3:	SS-RSRP levels have been derived from other parameters for information purposes. They are not settable parameters themselves.					

A.5.6.1.3.2 Test Requirements

In the test, the UE shall send one Event A3 triggered measurement report, with a measurement reporting delay less than X ms from the beginning of time period T2, where X is

- 3.2s for a UE supporting power class 1,
- 1.92s for a UE supporting power class 2 or 3,
- [1.92s] for a UE supporting power class 4

The UE is not required to read the neighbour cell SSB index in this test.

The UE shall not send event triggered measurement reports, as long as the reporting criteria are not fulfilled.

The rate of correct events observed during repeated tests shall be at least 90%.

NOTE: The actual overall delays measured in the test may be up to $2 \times TTI_{DCCH}$ higher than the measurement reporting delays above because of TTI insertion uncertainty of the measurement report in DCCH.

A.5.6.1.4 EN-DC event triggered reporting test with per-UE gaps under DRX

A.5.6.1.4.1 Test purpose and Environment

The purpose of this test is to verify that the UE makes correct reporting of an event. This test will partly verify the TDD intra-frequency cell search requirements in clause 9.2.5.1 and 9.2.5.2. Supported test configurations are shown in table A.5.6.1.4.1-1.

Table A.5.6.1.4.1-1: supported test configurations

Configuration	Description
1	LTE FDD, 120 kHz SSB SCS, 100MHz bandwidth, TDD duplex mode
2	LTE TDD, 120 kHz SSB SCS, 100MHz bandwidth, TDD duplex mode
3	LTE FDD, 240 kHz SSB SCS, 100MHz bandwidth, TDD duplex mode
4	LTE TDD, 240 kHz SSB SCS, 100MHz bandwidth, TDD duplex mode
Note:	The UE is only required to be tested in one of the supported test configurations.

There are three cells in the test, E-UTRAN PCell (Cell 1), FR2 PCell (Cell 2) and a FR2 neighbour cell (Cell 3) on the same frequency as the PCell. The test parameters and applicability for Cell 1 are defined in A.3.7.2. The test parameters for the Cell 2 and Cell 3 are given in Table A.5.6.1.4.1-2 ~ 6.

During the test, Cell 2 and Cell 3 are transmitted from the direction determined according to A3.8.

There are two BWPs configured in Cell 2, BWP1 which contains the cell defining SSB, and BWP2 which does not contain any SSB of Cell 2. During the whole test, BWP2 is always scheduled as the active BWP for the UE.

In the measurement control information a measurement object is configured for the frequency of the PCell, and it is indicated to the UE that event-triggered reporting with Event A3 is used.

The test consists of two successive time periods, with time duration of T1, and T2 respectively. During time duration T1, the UE shall not have any timing information of cell 3.

Table A.5.6.1.4.1-2: General test parameters for intra-frequency event triggered reporting for EN-DC with TDD PSCell in FR2 with per-UE gaps with DRX

Parameter	Unit	Config	Value		Comment
			Test 1	Test 2	
Active cell		1~4	E-UTRAN PCell (Cell 1) PSCell (Cell 2)		
Neighbour cell		1~4	Cell 3		Cell to be identified.
RF Channel Number		1~4	1: Cell 1 2: Cell 2 and Cell 3		One TDD carrier frequency is used for the NR cells and one TDD or FDD carrier frequency is used for E-UTRAN cell.
Gap type		1~4	Per-UE gaps		
Measurement gap repetition periodicity	ms	1~4	40		
Measurement gap length	ms	1~4	6		
Measurement gap offset	ms	1~4	39		
SMTC configuration		1~4	SMTC.1		
CSI-RS parameters		1~4	CSI-RS.3.2 TDD		
A3-Offset	dB	1~4	-6		
CP length		1~4	Normal		
Hysteresis	dB	1~4	0		
Time To Trigger	s	1~4	0		
Filter coefficient		1~4	0		L3 filtering is not used
DRX		1~4	DRX.1	DRX.2	DRX related parameters are defined in Table A.5.6.1.4.1-5
Time offset between Cell 1 and Cell 2		1~4	3 μ s		Synchronous EN-DC
Time offset between Cell 2 and Cell 3		1~4	3 μ s		Synchronous cells
T1	s	1~4	5		
T2	s	1~4	10	52	

Table A.5.6.1.4.1-3: NR Cell specific test parameters for intra-frequency event triggered reporting for EN-DC with TDD PSCell in FR2 with per-UE gaps with DRX

Parameter	Unit	Config	Cell 2		Cell 3	
			T1	T2	T1	T2
TDD configuration		1~4	TDDConf.3.1		TDDConf.3.1	
Initial BWP configuration		1~4	DLBWP.0.1 ULBWP.0.1		DLBWP.0.1 ULBWP.0.1	
Active DL BWP configuration		1~4	DLBWP.1.2		DLBWP.1.1	
Active UL BWP configuration		1~4	ULBWP.1.2		ULBWP.1.1	
RLM-RS		1~4	CSI-RS		SSB	
PDSCH RMC configuration		1~4	SR.3.1 TDD		N/A	
RMSI CORESET RMC configuration		1~4	CR.3.1 TDD		CR.3.1 TDD	
Dedicated CORESET RMC configuration		1~4	CCR.3.1 TDD		CCR.3.1 TDD	
TRS configuration		1~4	TRS.2.1 TDD		N/A	
TCI state		1~4	CSI-RS.Config.0		N/A	
OCNG Patterns		1~4	OP.1		OP.1	
SSB		1, 2	SSB.1 FR2		SSB.1 FR2	
		3, 4	SSB.2 FR2		SSB.2 FR2	
Propagation Condition		1~4	AWGN			

Table A.5.6.1.4.1-4: NR Cell specific test parameters for intra-frequency event triggered reporting for EN-DC with TDD PSCell in FR2 with per-UE gaps with DRX

Parameter	Unit	Config	Cell 2		Cell 3	
			T1	T2	T1	T2
AoA setup		1~4	A.3.8.x			
\hat{E}_s/I_{ot}	dB	1~4	TBD	TBD	TBD	TBD
N_{oc} ^{Note 2}	dBm/15 KHz	1~4	TBD			
N_{oc} ^{Note 2}	dBm/SCS	1, 2	TBD			
		3, 4	TBD			
SS-RSRP	dBm/SCS	1, 2	TBD	TBD	TBD	TBD
		3, 4	TBD	TBD	TBD	TBD
\hat{E}_s/N_{oc}	dB	3, 4	TBD	TBD	TBD	TBD
I_o	dBm/95.04MHz	1~4	TBD		TBD	
	<p>Note 1: The resources for uplink transmission are assigned to the UE prior to the start of time period T2.</p> <p>Note 2: Interference from other cells and noise sources not specified in the test is assumed to be constant over subcarriers and time and shall be modelled as AWGN of appropriate power for N_{oc} to be fulfilled.</p> <p>Note 3: SS-RSRP levels have been derived from other parameters for information purposes. They are not settable parameters themselves.</p>					

Table A.5.6.1.4.1-5: Void**Table A.5.6.1.4.1-6: Void****A.5.6.1.4.2 Test Requirements**

In test 1, the UE shall send one Event A3 triggered measurement report, with a measurement reporting delay less than X ms from the beginning of time period T2, where X is

- 7.2s for a UE supporting power class 1,
- 4.32s for a UE supporting power class 2 or 3,
- [4.32s] for a UE supporting power class 4

In test 2, the UE shall send one Event A3 triggered measurement report, with a measurement reporting delay less than X ms from the beginning of time period T2, where X is

- 51.20s for a UE supporting power class 1,
- 30.72s for a UE supporting power class 2 or 3,
- [30.72s] for a UE supporting power class 4

The UE is not required to read the neighbour cell SSB index in this test.

The UE shall not send event triggered measurement reports, as long as the reporting criteria are not fulfilled.

The rate of correct events observed during repeated tests shall be at least 90%.

NOTE: The actual overall delays measured in the test may be up to $2xTTI_{DCCCH}$ higher than the measurement reporting delays above because of TTI insertion uncertainty of the measurement report in DCCCH.

A.5.6.2 Inter-frequency Measurements**A.5.6.2.1 EN-DC event triggered reporting tests for FR2 cell without SSB time index detection when DRX is not used****A.5.6.2.1.1 Test Purpose and Environment**

The purpose of this test is to verify that the UE makes correct reporting of an event. This test will partly verify the EN-DC inter-frequency NR cell search requirements in clause 9.3.4.

In this test, there are three cells: LTE cell 1 as PCell on E-UTRA RF channel 1, NR cell 2 as PSCell in FR2 on NR RF channel 1 and NR cell 3 as neighbour cell in FR2 on NR RF channel 2. The test parameters and configurations are given in Tables A.5.6.2.1.1-1, A.5.6.2.1.1-2, and A.5.6.2.1.1-3.

In test 1 measurement gap pattern configuration # 0 as defined in Table A.5.6.2.1.1-2 is provided for UE that does not support per-FR gap and in test 2 measurement gap pattern configuration #13 as defined in Table A.5.6.2.1.1-2 is provided for UE that supports per-FR gap.

In the measurement control information, it is indicated to the UE that event-triggered reporting with Event A3 is used. The test consists of two successive time periods, with time duration of T1, and T2 respectively. During time duration T1, the UE shall not have any timing information of NR cell 3.

The configuration of LTE cell 1 is defined in table A.3.7.2.2-1. Supported test configurations are shown in table A.5.6.2.1.1-1.

Table A.5.6.2.1.1-1 EN-DC event triggered reporting tests without SSB index reading for FR2-FR2

Config	Description
1	LTE FDD, 120 kHz SSB SCS, 100MHz bandwidth, TDD duplex mode
2	LTE TDD, 120 kHz SSB SCS, 100MHz bandwidth, TDD duplex mode
Note 1: The UE is only required to be tested in one of the supported test configurations	
Note 2: target NR cell has the same SCS, BW and duplex mode as NR serving cell	

Table A.5.6.2.1.1-2: General test parameters for EN-DC inter-frequency event triggered reporting without SSB time index detection

Parameter	Unit	Test configuration	Value		Comment
			Test 1	Test 2	
E-UTRA RF Channel Number		Config 1,2	1		One E-UTRAN TDD carrier frequencies is used.
NR RF Channel Number		Config 1,2	1, 2		Two FR1 NR carrier frequencies is used.
Active cell		Config 1,2	LTE Cell 1 (PCell) and NR cell 2 (PScell)		LTE Cell 1 is on E-UTRA RF channel number 1. NR Cell 2 is on NR RF channel number 1.
Neighbour cell		Config 1,2	NR cell 3		NR cell 3 is on NR RF channel number 2.
Gap Pattern Id		Config 1,2	0	13	As specified in clause 9.1.2-1.
Measurement gap offset		Config 1,2	39	39	
SMTC-SSB parameters		Config 1,2	SSB.1 FR2		As specified in clause A.3.10.2
A3-Offset	dB	Config 1,2	-6		
Hysteresis	dB	Config 1,2	0		
CP length		Config 1,2	Normal		
TimeToTrigger	s	Config 1,2	0		
Filter coefficient		Config 1,2	0		L3 filtering is not used
DRX		Config 1,2	OFF		DRX is not used
Time offset between PCell and PScell		Config 1,2	3 μs		Synchronous EN-DC
Time offset between serving and neighbour cells		Config 1,2	3μs		Synchronous cells.
T1	s	Config 1,2	5		
T2	s	Config 1,2	TBD	TBD	

Table A.5.6.2.1.1-3: Cell specific test parameters for EN-DC inter-frequency event triggered reporting without SSB time index detection

Parameter	Unit	Test configuration	Cell 2		Cell 3	
			T1	T2	T1	T2
NR RF Channel Number		Config 1,2	1		2	
Duplex mode		Config 1,2	TDD		TDD	
BW _{channel}	MHz	Config 1,2	100: N _{RB,c} = 66		100: N _{RB,c} = 66	
BWP BW	MHz	Config 1,2	100: N _{RB,c} = 66		100: N _{RB,c} = 66	
TDD configuration		Config 1,2	TDDConf.3.1		TDDConf.3.1	

Initial DL BWP		Config 1,2	DLBWP.0.1	NA		
Initial UL BWP		Config 1,2	ULBWP.0.1	NA		
Dedicated DL BWP		Config 1,2	DLBWP.1.1	NA		
Dedicated UL BWP		Config 1,2	ULBWP.1.1	NA		
OCNG Patterns defined in A.3.2.1.1 (OP.1)		Config 1,2	OP.1	OP.1		
TRS configuration		Config 1,2	TRS.2.1 TDD	NA		
TCI configuration		Config 1,2	CSI-RS.Config.0	NA		
PDSCH Reference measurement channel		Config 1,2	SR.3.1 TDD	-		
CORESET Reference Channel		Config 1,2	CR.3.1 TDD	-		
SMTTC configuration defined in A.3.11.1 and A.3.11.2		Config 1,2	SMTTC.1	SMTTC.1		
PDSCH/PDCCH subcarrier spacing	kHz	Config 1,2	120	120		
EPRE ratio of PSS to SSS		Config 1,2	0	0		
EPRE ratio of PBCH DMRS to SSS						
EPRE ratio of PBCH to PBCH DMRS						
EPRE ratio of PDCCH DMRS to SSS						
EPRE ratio of PDCCH to PDCCH DMRS						
EPRE ratio of PDSCH DMRS to SSS						
EPRE ratio of PDSCH to PDSCH						
EPRE ratio of OCNG DMRS to SSS(Note 1)						
EPRE ratio of OCNG to OCNG DMRS (Note 1)						
UE orientation around TBD axis and TBD axis	degrees					
Relative difference in angle of arrival of cell 3 relative to cell 2	degrees	Config 1,2	NA	NA	TBD	
N_{oc} ^{Note2}	dBm/15 kHz Note5		TBD		TBD	
N_{oc} ^{Note2}	dBm/S CS Note4	Config 1,2	TBD		TBD	
SS-RSRP ^{Note 3}	dBm/S CS Note5	Config 1,2	TBD	TBD	TBD	TBD
\hat{E}_s / I_{ot}	dB	Config 1,2	TBD	TBD	TBD	TBD
\hat{E}_s / N_{oc}	dB	Config 1,2	TBD	TBD	TBD	TBD

I_o ^{Note3}	dBm/95 .04 MHz Note5	Config 1,2	TBD	TBD	TBD	TBD
Propagation Condition		Config 1,2	AWGN			
Note 1:	OCNG shall be used such that both cells are fully allocated and a constant total transmitted power spectral density is achieved for all OFDM symbols.					
Note 2:	Interference from other cells and noise sources not specified in the test is assumed to be constant over subcarriers and time and shall be modelled as AWGN of appropriate power for N_{oc} to be fulfilled.					
Note 3:	SS-RSRP and I_o levels have been derived from other parameters for information purposes. They are not settable parameters themselves.					
Note 4:	SS-RSRP minimum requirements are specified assuming independent interference and noise at each receiver antenna port.					
Note 5:	Equivalent power received by an antenna with 0dBi gain at the centre of the quiet zone					
Note 6:	As observed with 0dBi gain antenna at the centre of the quiet zone					

A.5.6.2.1.2 Test Requirements

In test 1 with per-UE gap, the UE shall send one Event A3 triggered measurement report, with a measurement reporting delay less than [TBD] ms from the beginning of time period T2. The UE shall not send event triggered measurement reports, as long as the reporting criteria are not fulfilled. The rate of correct events observed during repeated tests shall be at least 90%.

In test 2 with per-FR gap, the UE shall send one Event A3 triggered measurement report, with a measurement reporting delay less than [TBD] ms from the beginning of time period T2. The UE shall not send event triggered measurement reports, as long as the reporting criteria are not fulfilled. The rate of correct events observed during repeated tests shall be at least 90%.

In test 1 and 2 UE is not required to report SSB time index.

NOTE: The actual overall delays measured in the test may be up to $2 \times TTI_{DCCCH}$ higher than the measurement reporting delays above because of TTI insertion uncertainty of the measurement report in DCCCH.

A.5.6.2.2 EN-DC event triggered reporting tests for FR2 cell without SSB time index detection when DRX is used

A.5.6.2.2.1 Test Purpose and Environment

The purpose of this test is to verify that the UE makes correct reporting of an event. This test will partly verify the EN-DC inter-frequency NR cell search requirements in clause 9.3.4.

In this test, there are three cells: LTE cell 1 as PCell on E-UTRA RF channel 1, NR cell 2 as PSCell in FR2 on NR RF channel 1 and NR cell 3 as neighbour cell in FR2 on NR RF channel 2. The test parameters and configurations are given in Tables A.5.6.2.2.1-1, A.5.6.2.2.1-2, and A.5.6.2.2.1-3.

In test 1&2 measurement gap pattern configuration # 0 as defined in Table A.5.6.2.2.1-2 is provided for UE that does not support per-FR gap and in test 3&4 measurement gap pattern configuration #13 as defined in Table A.5.6.2.2.1-2 is provided for UE that supports per-FR gap.

In the measurement control information, it is indicated to the UE that event-triggered reporting with Event A3 is used. The test consists of two successive time periods, with time duration of T1, and T2 respectively. During time duration T1, the UE shall not have any timing information of NR cell 3.

The configuration of LTE cell 1 is defined in table A.3.7.2.2-1. Supported test configurations are shown in table A.5.6.2.2.1-1.

UE needs to be provided at least once every 500ms with new Timing Advance Command MAC control element to restart the Time alignment timer to keep UE uplink time alignment. Furthermore UE is allocated with PUSCH resource at every DRX cycle.

Table A.5.6.2.2.1-1 EN-DC event triggered reporting tests without SSB index reading for FR2-FR2

Config	Description
1	LTE FDD, 120 kHz SSB SCS, 100MHz bandwidth, TDD duplex mode
2	LTE TDD, 120 kHz SSB SCS, 100MHz bandwidth, TDD duplex mode
Note 1: The UE is only required to be tested in one of the supported test configurations	
Note 2: target NR cell has the same SCS, BW and duplex mode as NR serving cell	

Table A.5.6.2.2.1-2: General test parameters for EN-DC inter-frequency event triggered reporting without SSB time index detection

Parameter	Unit	Test configuration	Value				Comment
			Test 1	Test 2	Test 3	Test 4	
E-UTRA RF Channel Number		Config 1,2	1				One E-UTRAN TDD carrier frequencies is used.
NR RF Channel Number		Config 1,2	1, 2				Two FR1 NR carrier frequencies is used.
Active cell		Config 1,2	LTE Cell 1 (PCell) and NR cell 2 (PSCell)				LTE Cell 1 is on E-UTRA RF channel number 1. NR Cell 2 is on NR RF channel number 1.
Neighbour cell		Config 1,2	NR cell 3				NR cell 3 is on NR RF channel number 2.
Gap Pattern Id		Config 1,2	0		13		As specified in clause 9.1.2-1.
Measurement gap offset		Config 1,2	39		39		
SMTC-SSB parameters		Config 1,2	SSB.1 FR2				As specified in clause A.3.10.2
A3-Offset	dB	Config 1,2	-6				
Hysteresis	dB	Config 1,2	0				
CP length		Config 1,2	Normal				
TimeToTrigger	s	Config 1,2	0				
Filter coefficient		Config 1,2	0				L3 filtering is not used
DRX		Config 1,2	DRX .1	DRX .2	DRX .1	DRX .2	DRX is not used
Time offset between PCell and PSCell		Config 1,2	3 μs				Synchronous EN-DC
Time offset between serving and neighbour cells		Config 1,2	3μs				Synchronous cells.
T1	s	Config 1,2	5				
T2	s	Config 1,2	TBD	TBD	TBD	TBD	

Table A.5.6.2.2.1-3: Cell specific test parameters for EN-DC inter-frequency event triggered reporting without SSB time index detection

Parameter	Unit	Test configuration	Cell 2		Cell 3	
			T1	T2	T1	T2
NR RF Channel Number		Config 1,2	1		2	
Duplex mode		Config 1,2	TDD		TDD	

$BW_{channel}$	MHz	Config 1,2	100: $N_{RB,c} = 66$	100: $N_{RB,c} = 66$		
BWP BW	MHz	Config 1,2	100: $N_{RB,c} = 66$	100: $N_{RB,c} = 66$		
TDD configuration		Config 1,2	TDDConf.3.1	TDDConf.3.1		
Initial DL BWP		Config 1,2	DLBWP.0.1	NA		
Initial UL BWP		Config 1,2	ULBWP.0.1			
Dedicated DL BWP		Config 1,2	DLBWP.1.1	NA		
Dedicated UL BWP		Config 1,2	ULBWP.1.1	NA		
OCNG Patterns defined in A.3.2.1.1 (OP.1)		Config 1,2	OP.1	OP.1		
TRS configuration		Config 1,2	TRS.2.1 TDD	NA		
TCI configuration		Config 1,2	CSI-RS.Config.0	NA		
PDSCH Reference measurement channel		Config 1,2	SR.3.1 TDD	-		
CORESET Reference Channel		Config 1,2	CR.3.1 TDD	-		
SMTC configuration defined in A.3.11.1 and A.3.11.2		Config 1,2	SMTC.1	SMTC.1		
PDSCH/PDCCH subcarrier spacing	kHz	Config 1,2	120	120		
EPRE ratio of PSS to SSS		Config 1,2	0	0		
EPRE ratio of PBCH DMRS to SSS						
EPRE ratio of PBCH to PBCH DMRS						
EPRE ratio of PDCCH DMRS to SSS						
EPRE ratio of PDCCH to PDCCH DMRS						
EPRE ratio of PDSCH DMRS to SSS						
EPRE ratio of PDSCH to PDSCH						
EPRE ratio of OCNG DMRS to SSS(Note 1)						
EPRE ratio of OCNG to OCNG DMRS (Note 1)						
UE orientation around TBD axis and TBD axis	degrees	Config 1,2	NA	TBD		
Relative difference in angle of arrival of cell 3 relative to cell 2	degrees	Config 1,2	NA	NA	TBD	
N_{oc} Note2	dBm/15 kHz Note5		TBD	TBD		
N_{oc} Note2	dBm/S CS Note4	Config 1,2	TBD	TBD		
SS-RSRP Note 3	dBm/S CS Note5	Config 1,2	TBD	TBD	TBD	TBD

\hat{E}_s / I_{ot}	dB	Config 1,2	TBD	TBD	TBD	TBD
\hat{E}_s / N_{oc}	dB	Config 1,2	TBD	TBD	TBD	TBD
I_o ^{Note3}	dBm/95 .04 MHz Note5	Config 1,2	TBD	TBD	TBD	TBD
Propagation Condition		Config 1,2	AWGN			
Note 1:	OCNG shall be used such that both cells are fully allocated and a constant total transmitted power spectral density is achieved for all OFDM symbols.					
Note 2:	Interference from other cells and noise sources not specified in the test is assumed to be constant over subcarriers and time and shall be modelled as AWGN of appropriate power for N_{oc} to be fulfilled.					
Note 3:	SS-RSRP and I_o levels have been derived from other parameters for information purposes. They are not settable parameters themselves.					
Note 4:	SS-RSRP minimum requirements are specified assuming independent interference and noise at each receiver antenna port.					
Note 5:	Equivalent power received by an antenna with 0dBi gain at the centre of the quiet zone					
Note 6:	As observed with 0dBi gain antenna at the centre of the quiet zone					

A.5.6.2.2.2 Test Requirements

In test 1 with per-UE gap, the UE shall send one Event A3 triggered measurement report, with a measurement reporting delay less than [TBD] ms from the beginning of time period T2. The UE shall not send event triggered measurement reports, as long as the reporting criteria are not fulfilled. The rate of correct events observed during repeated tests shall be at least 90%.

In test 2 with per-FR gap, the UE shall send one Event A3 triggered measurement report, with a measurement reporting delay less than [TBD] ms from the beginning of time period T2. The UE shall not send event triggered measurement reports, as long as the reporting criteria are not fulfilled. The rate of correct events observed during repeated tests shall be at least 90%.

In test 3 with per-UE gap, the UE shall send one Event A3 triggered measurement report, with a measurement reporting delay less than [TBD] ms from the beginning of time period T2. The UE shall not send event triggered measurement reports, as long as the reporting criteria are not fulfilled. The rate of correct events observed during repeated tests shall be at least 90%.

In test 4 with per-FR gap, the UE shall send one Event A3 triggered measurement report, with a measurement reporting delay less than [TBD] ms from the beginning of time period T2. The UE shall not send event triggered measurement reports, as long as the reporting criteria are not fulfilled. The rate of correct events observed during repeated tests shall be at least 90%.

In test 1, 2, 3 and 4 UE is not required to report SSB time index.

NOTE: The actual overall delays measured in the test may be up to $2xTTI_{DCCH}$ higher than the measurement reporting delays above because of TTI insertion uncertainty of the measurement report in DCCH.

A.5.6.2.3 EN-DC event triggered reporting tests for FR2 cell with SSB time index detection when DRX is not used

A.5.6.2.3.1 Test Purpose and Environment

The purpose of this test is to verify that the UE makes correct reporting of an event. This test will partly verify the EN-DC inter-frequency NR cell search requirements in clause 9.3.4.

In this test, there are three cells: LTE cell 1 as PCell on E-UTRA RF channel 1, NR cell 2 as PSCell in FR2 on NR RF channel 1 and NR cell 3 as neighbour cell in FR2 on NR RF channel 2. The test parameters and configurations are given in Tables A.5.6.2.3.1-1, A.5.6.2.3.1-2, and A.5.6.2.3.1-3.

In test 1 measurement gap pattern configuration # 0 as defined in Table A.5.6.2.3.1-1 is provided for UE that does not support per-FR gap and in test 2 measurement gap pattern configuration #13 as defined in Table A.5.6.2.3.1-1 is provided for UE that supports per-FR gap.

In the measurement control information, it is indicated to the UE that event-triggered reporting with Event A3 is used. The test consists of two successive time periods, with time duration of T1, and T2 respectively. During time duration T1, the UE shall not have any timing information of NR cell 3.

The configuration of LTE cell 1 is defined in table A.3.7.2.2-1. Supported test configurations are shown in table A.5.6.2.3.1-1.

Table A.5.6.2.3.1-1 EN-DC event triggered reporting tests with SSB index reading for FR2-FR2

Config	Description
1	LTE FDD, 120 kHz SSB SCS, 100MHz bandwidth, TDD duplex mode
2	LTE TDD, 120 kHz SSB SCS, 100MHz bandwidth, TDD duplex mode
Note 1:	The UE is only required to be tested in one of the supported test configurations
Note 2:	target NR cell has the same SCS, BW and duplex mode as NR serving cell

Table A.5.6.2.3.1-2: General test parameters for EN-DC inter-frequency event triggered reporting with SSB time index detection

Parameter	Unit	Test configuration	Value		Comment
			Test 1	Test 2	
E-UTRA RF Channel Number		Config 1,2	1		One E-UTRAN TDD carrier frequencies is used.
NR RF Channel Number		Config 1,2	1, 2		Two FR1 NR carrier frequencies is used.
Active cell		Config 1,2	LTE Cell 1 (PCell) and NR cell 2 (PScell)		LTE Cell 1 is on E-UTRA RF channel number 1. NR Cell 2 is on NR RF channel number 1.
Neighbour cell		Config 1,2	NR cell 3		NR cell 3 is on NR RF channel number 2.
Gap Pattern Id		Config 1,2	0	13	As specified in clause 9.1.2-1.
Measurement gap offset		Config 1,2	39	39	
SMTC-SSB parameters		Config 1,2	SSB.1 FR2		As specified in clause A.3.10.2
A3-Offset	dB	Config 1,2	-6		
Hysteresis	dB	Config 1,2	0		
CP length		Config 1,2	Normal		
TimeToTrigger	s	Config 1,2	0		
Filter coefficient		Config 1,2	0		L3 filtering is not used
DRX		Config 1,2	OFF		DRX is not used
Time offset between PCell and PScell		Config 1,2	3 μ s		Synchronous EN-DC
Time offset between serving and neighbour cells		Config 1,2	3 μ s		Synchronous cells.
T1	s	Config 1,2	5		
T2	s	Config 1,2	TBD	TBD	

Table A.5.6.2.3.1-3: Cell specific test parameters for EN-DC inter-frequency event triggered reporting with SSB time index detection

Parameter	Unit	Test configuration	Cell 2		Cell 3	
			T1	T2	T1	T2
NR RF Channel Number		Config 1,2	1		2	
Duplex mode		Config 1,2	TDD		TDD	
BW _{channel}	MHz	Config 1,2	100: N _{RB,c} = 66		100: N _{RB,c} = 66	
BWP BW	MHz	Config 1,2	100: N _{RB,c} = 66		100: N _{RB,c} = 66	
TDD configuration		Config 1,2	TDDConf.3.1		TDDConf.3.1	
Initial DL BWP		Config 1,2	DLBWP.0.1		NA	
Initial UL BWP		Config 1,2	DLBWP.0.1			
Dedicated DL BWP		Config 1,2	DLBWP.1.1		NA	
Dedicated UL BWP		Config 1,2	ULBWP.1.1		NA	

OCNG Patterns defined in A.3.2.1.1 (OP.1)		Config 1,2	OP.1		OP.1	
PDSCH Reference measurement channel		Config 1,2	SR.3.1 TDD		-	
CORESET Reference Channel		Config 1,2	CR.3.1 TDD		-	
TRS configuration		Config 1,2	TRS.2.1 TDD		NA	
TCI configuration		Config 1,2	CSI-RS.Config.0		NA	
SMTC configuration defined in A.3.11.1 and A.3.11.2		Config 1,2	SMTC.1		SMTC.1	
PDSCH/PDCCH subcarrier spacing	kHz	Config 1,2	120		120	
EPRE ratio of PSS to SSS		Config 1,2	0		0	
EPRE ratio of PBCH DMRS to SSS						
EPRE ratio of PBCH to PBCH DMRS						
EPRE ratio of PDCCH DMRS to SSS						
EPRE ratio of PDCCH to PDCCH DMRS						
EPRE ratio of PDSCH DMRS to SSS						
EPRE ratio of PDSCH to PDSCH						
EPRE ratio of OCNG DMRS to SSS(Note 1)						
EPRE ratio of OCNG to OCNG DMRS (Note 1)						
UE orientation around TBD axis and TBD axis	degrees					
Relative difference in angle of arrival of cell 3 relative to cell 2	degrees	Config 1,2	NA		NA	TBD
N_{oc} Note2	dBm/15 kHz Note5		TBD		TBD	
N_{oc} Note2	dBm/S CS Note4	Config 1,2	TBD		TBD	
SS-RSRP Note 3	dBm/S CS Note5	Config 1,2	TBD	TBD	TBD	TBD
\hat{E}_s / I_{ot}	dB	Config 1,2	TBD	TBD	TBD	TBD
\hat{E}_s / N_{oc}	dB	Config 1,2	TBD	TBD	TBD	TBD
I_o Note3	dBm/95 .04 MHz Note5	Config 1,2	TBD	TBD	TBD	TBD
Propagation Condition		Config 1,2	AWGN			

Note 1:	OCNG shall be used such that both cells are fully allocated and a constant total transmitted power spectral density is achieved for all OFDM symbols.
Note 2:	Interference from other cells and noise sources not specified in the test is assumed to be constant over subcarriers and time and shall be modelled as AWGN of appropriate power for N_{oc} to be fulfilled.
Note 3:	SS-RSRP and I_0 levels have been derived from other parameters for information purposes. They are not settable parameters themselves.
Note 4:	SS-RSRP minimum requirements are specified assuming independent interference and noise at each receiver antenna port.
Note 5:	Equivalent power received by an antenna with 0dBi gain at the centre of the quiet zone
Note 6:	As observed with 0dBi gain antenna at the centre of the quiet zone

A.5.6.2.3.2 Test Requirements

In test 1 with per-UE gap, the UE shall send one Event A3 triggered measurement report, with a measurement reporting delay less than [TBD] ms from the beginning of time period T2. The UE shall not send event triggered measurement reports, as long as the reporting criteria are not fulfilled. The rate of correct events observed during repeated tests shall be at least 90%.

In test 2 with per-FR gap, the UE shall send one Event A3 triggered measurement report, with a measurement reporting delay less than [TBD] ms from the beginning of time period T2. The UE shall not send event triggered measurement reports, as long as the reporting criteria are not fulfilled. The rate of correct events observed during repeated tests shall be at least 90%.

In test 1 and 2 UE is required to report SSB time index.

NOTE: The actual overall delays measured in the test may be up to $2xTTI_{DCC}$ higher than the measurement reporting delays above because of TTI insertion uncertainty of the measurement report in DCC.

A.5.6.2.4 EN-DC event triggered reporting tests for FR2 cell with SSB time index detection when DRX is used

A.5.6.2.4.1 Test Purpose and Environment

The purpose of this test is to verify that the UE makes correct reporting of an event. This test will partly verify the EN-DC inter-frequency NR cell search requirements in clause 9.3.4.

In this test, there are three cells: LTE cell 1 as PCell on E-UTRA RF channel 1, NR cell 2 as PSCell in FR2 on NR RF channel 1 and NR cell 3 as neighbour cell in FR2 on NR RF channel 2. The test parameters and configurations are given in Tables A.5.6.2.4.1-1, A.5.6.2.4.1-2, and A.5.6.2.4.1-3.

In test 1&2 measurement gap pattern configuration # 0 as defined in Table A.5.6.2.4.1-2 is provided for UE that does not support per-FR gap and in test 3&4 measurement gap pattern configuration #13 as defined in Table A.5.6.2.4.1-2 is provided for UE that supports per-FR gap.

In the measurement control information, it is indicated to the UE that event-triggered reporting with Event A3 is used. The test consists of two successive time periods, with time duration of T1, and T2 respectively. During time duration T1, the UE shall not have any timing information of NR cell 3.

The configuration of LTE cell 1 is defined in table A.3.7.2.2-1. Supported test configurations are shown in table A.5.6.2.4.1-1.

UE needs to be provided at least once every 500ms with new Timing Advance Command MAC control element to restart the Time alignment timer to keep UE uplink time alignment. Furthermore UE is allocated with PUSCH resource at every DRX cycle.

Table A.5.6.2.4.1-1: EN-DC event triggered reporting tests with SSB index reading for FR2-FR2

Config	Description
1	LTE FDD, 120 kHz SSB SCS, 100MHz bandwidth, TDD duplex mode
2	LTE TDD, 120 kHz SSB SCS, 100MHz bandwidth, TDD duplex mode
Note 1: The UE is only required to be tested in one of the supported test configurations	
Note 2: target NR cell has the same SCS, BW and duplex mode as NR serving cell	

Table A.5.6.2.4.1-2: General test parameters for EN-DC inter-frequency event triggered reporting with SSB time index detection

Parameter	Unit	Test configuration	Value				Comment
			Test 1	Test 2	Test 3	Test 4	
E-UTRA RF Channel Number		Config 1,2	1				One E-UTRAN TDD carrier frequencies is used.
NR RF Channel Number		Config 1,2	1, 2				Two FR1 NR carrier frequencies is used.
Active cell		Config 1,2	LTE Cell 1 (PCell) and NR cell 2 (PScell)				LTE Cell 1 is on E-UTRA RF channel number 1. NR Cell 2 is on NR RF channel number 1.
Neighbour cell		Config 1,2	NR cell 3				NR cell 3 is on NR RF channel number 2.
Gap Pattern Id		Config 1,2	0		13		As specified in clause 9.1.2-1.
Measurement gap offset		Config 1,2	39		39		
SMTC-SSB parameters		Config 1,2	SSB.1 FR2				As specified in clause A.3.10.2
A3-Offset	dB	Config 1,2	-6				
Hysteresis	dB	Config 1,2	0				
CP length		Config 1,2	Normal				
TimeToTrigger	s	Config 1,2	0				
Filter coefficient		Config 1,2	0				L3 filtering is not used
DRX		Config 1,2	DRX .1	DRX .2	DRX .1	DRX .2	DRX is not used
Time offset between PCell and PScell		Config 1,2	3 μs				Synchronous EN-DC
Time offset between serving and neighbour cells		Config 1,2	3μs				Synchronous cells.
T1	s	Config 1,2	5				
T2	s	Config 1,2	TBD	TBD	TBD	TBD	

Table A.5.6.2.4.1-3: Cell specific test parameters for EN-DC inter-frequency event triggered reporting with SSB time index detection

Parameter	Unit	Test configuration	Cell 2		Cell 3	
			T1	T2	T1	T2
NR RF Channel Number		Config 1,2	1		2	
Duplex mode		Config 1,2	TDD		TDD	
BW _{channel}	MHz	Config 1,2	100: N _{RB,c} = 66		100: N _{RB,c} = 66	
BWP BW	MHz	Config 1,2	100: N _{RB,c} = 66		100: N _{RB,c} = 66	
TDD configuration		Config 1,2	TDDConf.3.1		TDDConf.3.1	

Initial DL BWP		Config 1,2	DLBWP.0.1	NA		
Initial UL BWP		Config 1,2	ULBWP.0.1			
Dedicated DL BWP		Config 1,2	DLBWP.1.1	NA		
Dedicated UL BWP		Config 1,2	ULBWP.1.1	NA		
OCNG Patterns defined in A.3.2.1.1 (OP.1)		Config 1,2	OP.1	OP.1		
PDSCH Reference measurement channel		Config 1,2	SR.3.1 TDD	-		
CORESET Reference Channel		Config 1,2	CR.3.1 TDD	-		
TRS configuration		Config 1,2	TRS.2.1 TDD	NA		
TCI configuration		Config 1,2	CSI-RS.Config.0	NA		
SMTC configuration defined in A.3.11.1 and A.3.11.2		Config 1,2	SMTC.1	SMTC.1		
PDSCH/PDCCH subcarrier spacing	kHz	Config 1,2	120	120		
EPRE ratio of PSS to SSS		Config 1,2	0	0		
EPRE ratio of PBCH DMRS to SSS						
EPRE ratio of PBCH to PBCH DMRS						
EPRE ratio of PDCCH DMRS to SSS						
EPRE ratio of PDCCH to PDCCH DMRS						
EPRE ratio of PDSCH DMRS to SSS						
EPRE ratio of PDSCH to PDSCH						
EPRE ratio of OCNG DMRS to SSS(Note 1)						
EPRE ratio of OCNG to OCNG DMRS (Note 1)						
UE orientation around TBD axis and TBD axis	degrees					
Relative difference in angle of arrival of cell 3 relative to cell 2	degrees	Config 1,2	NA	NA	TBD	
N_{oc} ^{Note2}	dBm/15 kHz Note5		TBD		TBD	
N_{oc} ^{Note2}	dBm/S CS Note4	Config 1,2	TBD		TBD	
SS-RSRP ^{Note 3}	dBm/S CS Note5	Config 1,2	TBD	TBD	TBD	TBD
\hat{E}_s / I_{ot}	dB	Config 1,2	TBD	TBD	TBD	TBD
\hat{E}_s / N_{oc}	dB	Config 1,2	TBD	TBD	TBD	TBD

I_{o} ^{Note3}	dBm/95 .04 MHz Note5	Config 1,2	TBD	TBD	TBD	TBD
Propagation Condition		Config 1,2	AWGN			
Note 1:	OCNG shall be used such that both cells are fully allocated and a constant total transmitted power spectral density is achieved for all OFDM symbols.					
Note 2:	Interference from other cells and noise sources not specified in the test is assumed to be constant over subcarriers and time and shall be modelled as AWGN of appropriate power for N_{oc} to be fulfilled.					
Note 3:	SS-RSRP and I_o levels have been derived from other parameters for information purposes. They are not settable parameters themselves.					
Note 4:	SS-RSRP minimum requirements are specified assuming independent interference and noise at each receiver antenna port.					
Note 5:	Equivalent power received by an antenna with 0dBi gain at the centre of the quiet zone					
Note 6:	As observed with 0dBi gain antenna at the centre of the quiet zone					

A.5.6.2.2.4 Test Requirements

In test 1 with per-UE gap, the UE shall send one Event A3 triggered measurement report, with a measurement reporting delay less than [TBD] ms from the beginning of time period T2. The UE shall not send event triggered measurement reports, as long as the reporting criteria are not fulfilled. The rate of correct events observed during repeated tests shall be at least 90%.

In test 2 with per-FR gap, the UE shall send one Event A3 triggered measurement report, with a measurement reporting delay less than [TBD] ms from the beginning of time period T2. The UE shall not send event triggered measurement reports, as long as the reporting criteria are not fulfilled. The rate of correct events observed during repeated tests shall be at least 90%.

In test 3 with per-UE gap, the UE shall send one Event A3 triggered measurement report, with a measurement reporting delay less than [TBD] ms from the beginning of time period T2. The UE shall not send event triggered measurement reports, as long as the reporting criteria are not fulfilled. The rate of correct events observed during repeated tests shall be at least 90%.

In test 4 with per-FR gap, the UE shall send one Event A3 triggered measurement report, with a measurement reporting delay less than [TBD] ms from the beginning of time period T2. The UE shall not send event triggered measurement reports, as long as the reporting criteria are not fulfilled. The rate of correct events observed during repeated tests shall be at least 90%.

In test 1, 2, 3 and 4 UE is required to report SSB time index.

NOTE: The actual overall delays measured in the test may be up to $2xTTI_{DCC}$ higher than the measurement reporting delays above because of TTI insertion uncertainty of the measurement report in DCC.

A.5.6.2.5 EN-DC event triggered reporting tests for FR2 cell without SSB time index detection when DRX is not used

A.5.6.2.5.1 Test Purpose and Environment

The purpose of this test is to verify that the UE makes correct reporting of an event. This test will partly verify the EN-DC inter-frequency NR cell search requirements in clause 9.3.4.

In this test, there are three cells: LTE cell 1 as PCell on E-UTRA RF channel 1, NR cell 2 as PSCell in FR1 on NR RF channel 1 and NR cell 3 as neighbour cell in FR2 on NR RF channel 2. The test parameters and configurations are given in Tables A.5.6.2.5.1-1, A.5.6.2.5.1-2, and A.5.6.2.5.1-3.

In test 1 measurement gap pattern configuration # 0 as defined in Table A.5.6.2.5.1-2 is provided for a UE that does not support per-FR gap and in test 2 measurement gap pattern configuration #13 as defined in Table A.5.6.2.5.1-2 is provided for UE that support per-FR gap.

In the measurement control information, it is indicated to the UE that event-triggered reporting with Event A3 is used. The test consists of two successive time periods, with time duration of T1, and T2 respectively. During time duration T1, the UE shall not have any timing information of NR cell 3.

The configuration of LTE cell 1 is defined in table A.3.7.2.1-1. Supported test configurations are shown in table A.5.6.2.5.1-1.

Table A.5.6.2.5.1-1: EN-DC event triggered reporting tests without SSB index reading for FR1-FR2

Config	Description of serving cell	Description of target cell
1	LTE FDD, NR 15 kHz SSB SCS, 10MHz bandwidth, FDD duplex mode	120 kHz SSB SCS, 100MHz bandwidth, TDD duplex mode
2	LTE FDD, NR 15 kHz SSB SCS, 10MHz bandwidth, TDD duplex mode	
3	LTE FDD, NR 30kHz SSB SCS, 40MHz bandwidth, TDD duplex mode	
4	LTE TDD, NR 15 kHz SSB SCS, 10MHz bandwidth, FDD duplex mode	
5	LTE TDD, NR 15 kHz SSB SCS, 10MHz bandwidth, TDD duplex mode	
6	LTE TDD, NR 30kHz SSB SCS, 40MHz bandwidth, TDD duplex mode	
Note: The UE is only required to be tested in one of the supported test configurations		

Table A.5.6.2.5.1-2: General test parameters for EN-DC inter-frequency event triggered reporting without SSB time index detection

Parameter	Unit	Test configuration	Value		Comment
			Test 1	Test 2	
E-UTRA RF Channel Number		Config 1,2,3,4,5,6	1		One E-UTRAN TDD carrier frequencies is used.
NR RF Channel Number		Config 1,2,3,4,5,6	1, 2		Two FR1 NR carrier frequencies is used.
Active cell		Config 1,2,3,4,5,6	LTE Cell 1 (PCell) and NR cell 2 (PScell)		LTE Cell 1 is on E-UTRA RF channel number 1. NR Cell 2 is on NR RF channel number 1.
Neighbour cell		Config 1,2,3,4,5,6	NR cell 3		NR cell 3 is on NR RF channel number 2.
Gap Pattern Id		Config 1,2,3,4,5,6	0	13	As specified in clause 9.1.2-1.
Measurement gap offset		Config 1,2,3,4,5,6	39	39	
SMTC-SSB parameters on NR RF Channel 1		Config 1,4	SSB.1 FR1		As specified in clause A.3.10.1
		Config 2,5	SSB.1 FR1		As specified in clause A.3.10.1
		Config 3,6	SSB.2 FR1		As specified in clause A.3.10.1
SMTC-SSB parameters on NR RF Channel 2		Config 1,2,3,4,5,6	SSB.1 FR2		As specified in clause A.3.10.2
<i>offsetMO</i>	dB	Config 1,2,3,4,5,6	6		
Hysteresis	dB	Config 1,2,3,4,5,6	0		
<i>a4-Threshold</i>	dBm	Config 1,2,3,4,5,6	TBD		
CP length		Config 1,2,3,4,5,6	Normal		
TimeToTrigger	s	Config 1,2,3,4,5,6	0		
Filter coefficient		Config 1,2,3,4,5,6	0		L3 filtering is not used
DRX		Config 1,2,3,4,5,6	OFF		DRX is not used
Time offset between PCell and PSCell		Config 1,2,3,4,5,6	3 μ s		Synchronous EN-DC
Time offset between serving and neighbour cells		Config 1,4	3ms		Asynchronous cells. The timing of Cell 3 is 3ms later than the timing of Cell 2.
		Config 2,3,5,6	3 μ s		Synchronous cells.
T1	s	Config 1,2,3,4,5,6	5		
T2	s	Config 1,2,3,4,5,6	TBD	TBD	

Table A.5.6.2.5.1-3: Cell specific test parameters for EN-DC inter-frequency event triggered reporting without SSB time index detection

Parameter	Unit	Cell 1	Cell 2	Cell 3
-----------	------	--------	--------	--------

		Test configuration	T1	T2	T1	T2
NR RF Channel Number		Config 1,2,3,4,5,6	1		2	
Duplex mode		Config 1,4	FDD		TDD	
		Config 2,3,5,6	TDD		TDD	
BW _{channel}	MHz	Config 1,4	10: N _{RB,c} = 52		100: N _{RB,c} = 66	
		Config 2,5	10: N _{RB,c} = 52		100: N _{RB,c} = 66	
		Config 3,6	40: N _{RB,c} = 106		100: N _{RB,c} = 66	
BWP BW	MHz	Config 1,4	10: N _{RB,c} = 52		100: N _{RB,c} = 66	
		Config 2,5	10: N _{RB,c} = 52		100: N _{RB,c} = 66	
		Config 3,6	40: N _{RB,c} = 106		100: N _{RB,c} = 66	
TDD configuration		Config 2,5	TDDConf.1.1		TDDConf.3.1	
		Config 3,6	TDDConf.2.1		TDDConf.3.1	
Initial DL BWP		Config 1,2,3,4,5,6	DLBWP.0.1		NA	
Initial UL BWP		Config 1,2,3,4,5,6	ULBWP.0.1		NA	
Dedicated DL BWP		Config 1,2,3,4,5,6	DLBWP.1.1		NA	
Dedicated UL BWP		Config 1,2,3,4,5,6	ULBWP.1.1		NA	
OCNG Patterns defined in A.3.2.1.1 (OP.1)		Config 1,2,3,4,5,6	OP.1		OP.1	
PDSCH Reference measurement channel		Config 1,4	SR.1.1 FDD		-	
		Config 2,5	SR.1.1 TDD			
		Config 3,6	SR2.1 TDD			
CORESET Reference Channel		Config 1,4	CR.1.1 FDD		-	
		Config 2,5	CR.1.1 TDD			
		Config 3,6	CR2.1 TDD			
SMTC configuration defined in A.3.11.1 and A.3.11.2		Config 1,4	SMTC.2		SMTC.2	
		Config 2,3,5,6	SMTC.1		SMTC.1	
PDSCH/PDCCH subcarrier spacing	kHz	Config 1,2,4,5	15		120	
		Config 3,6	30		120	
EPRE ratio of PSS to SSS		Config 1,2,3,4,5,6	0		0	
EPRE ratio of PBCH DMRS to SSS						
EPRE ratio of PBCH to PBCH DMRS						
EPRE ratio of PDCCH DMRS to SSS						
EPRE ratio of PDCCH to PDCCH DMRS						
EPRE ratio of PDSCH DMRS to SSS						
EPRE ratio of PDSCH to PDSCH						
EPRE ratio of OCNG DMRS to SSS(Note 1)						
EPRE ratio of OCNG to OCNG DMRS (Note 1)						

UE orientation around TBD axis and TBD axis	degrees	Config 1,2,3,4,5,6	NA		TBD	
Relative difference in angle of arrival of cell 3 relative to cell 2	degrees	Config 1,2,3,4,5,6	NA		NA	TBD
N_{oc} Note2	dBm/15 kHz Note5		NA		TBD	
N_{oc} Note2	dBm/S CS Note4	Config 1,2,4,5	NA		TBD	
		Config 3,6	NA		TBD	
SS-RSRP Note 3	dBm/S CS Note5	Config 1,2,4,5	NA	NA	-Infinity	TBD
		Config 3,6	NA	NA	-Infinity	TBD
\hat{E}_s / I_{ot}	dB	Config 1,2,3,4,5,6	NA	NA	-Infinity	TBD
\hat{E}_s / N_{oc}	dB	Config 1,2,3,4,5,6	NA	NA	-Infinity	TBD
I_o Note3	dBm/9.36MHz	Config 1,2,4,5	NA	NA	-	-
	dBm/38.16MHz	Config 3,6	NA	NA	-	-
	dBm/95.04 MHz Note5	Config 1,2,3,4,5,6	-	-	-Infinity	TBD
Propagation Condition		Config 1,2,3,4,5,6	AWGN			
<p>Note 1: OCNG shall be used such that both cells are fully allocated and a constant total transmitted power spectral density is achieved for all OFDM symbols.</p> <p>Note 2: Interference from other cells and noise sources not specified in the test is assumed to be constant over subcarriers and time and shall be modelled as AWGN of appropriate power for N_{oc} to be fulfilled.</p> <p>Note 3: SS-RSRP and I_o levels have been derived from other parameters for information purposes. They are not settable parameters themselves.</p> <p>Note 4: SS-RSRP minimum requirements are specified assuming independent interference and noise at each receiver antenna port.</p> <p>Note 5: Equivalent power received by an antenna with 0dBi gain at the centre of the quiet zone</p> <p>Note 6: As observed with 0dBi gain antenna at the centre of the quiet zone</p>						

A.5.6.2.5.2 Test Requirements

In test 1 with per-UE gap, the UE shall send one Event A4 triggered measurement report, with a measurement reporting delay less than [TBD] ms from the beginning of time period T2. The UE shall not send event triggered measurement reports, as long as the reporting criteria are not fulfilled. The rate of correct events observed during repeated tests shall be at least 90%.

In test 2 with per-FR gap, the UE shall send one Event A4 triggered measurement report, with a measurement reporting delay less than [TBD] ms from the beginning of time period T2. The UE shall not send event triggered measurement reports, as long as the reporting criteria are not fulfilled. The rate of correct events observed during repeated tests shall be at least 90%.

In test 1 and 2 UE is not required to report SSB time index.

NOTE: The actual overall delays measured in the test may be up to $2xTTI_{DCC}$ higher than the measurement reporting delays above because of TTI insertion uncertainty of the measurement report in DCC.

A.5.6.2.6 EN-DC event triggered reporting tests for FR2 cell without SSB time index detection when DRX is used

A.5.6.2.6.1 Test Purpose and Environment

The purpose of this test is to verify that the UE makes correct reporting of an event. This test will partly verify the EN-DC inter-frequency NR cell search requirements in clause 9.3.4.

In this test, there are three cells: LTE cell 1 as PCell on E-UTRA RF channel 1, NR cell 2 as PSCell in FR1 on NR RF channel 1 and NR cell 3 as neighbour cell in FR2 on NR RF channel 2. The test parameters and configurations are given in Tables A.5.6.2.6.1-1, A.5.6.2.6.1-2, and A.5.6.2.6.1-3.

In test 1&2 measurement gap pattern configuration # 0 as defined in Table A.5.6.2.6.1-2 is provided for a UE that does not support per-FR gap and in test 3&4 measurement gap pattern configuration #13 as defined in Table A.5.6.2.6.1-2 is provided for UE that support per-FR gap.

In the measurement control information, it is indicated to the UE that event-triggered reporting with Event A3 is used. The test consists of two successive time periods, with time duration of T1, and T2 respectively. During time duration T1, the UE shall not have any timing information of NR cell 3.

The configuration of LTE cell 1 is defined in table A.3.7.2.1-1. Supported test configurations are shown in table A.5.6.2.6.1-1.

UE needs to be provided at least once every 500ms with new Timing Advance Command MAC control element to restart the Time alignment timer to keep UE uplink time alignment. Furthermore UE is allocated with PUSCH resource at every DRX cycle.

Table A.5.6.2.6.1-1: EN-DC event triggered reporting tests without SSB index reading for FR1-FR2

Config	Description of serving cell	Description of target cell
1	LTE FDD, NR 15 kHz SSB SCS, 10MHz bandwidth, FDD duplex mode	120 kHz SSB SCS, 100MHz bandwidth, TDD duplex mode
2	LTE FDD, NR 15 kHz SSB SCS, 10MHz bandwidth, TDD duplex mode	
3	LTE FDD, NR 30kHz SSB SCS, 40MHz bandwidth, TDD duplex mode	
4	LTE TDD, NR 15 kHz SSB SCS, 10MHz bandwidth, FDD duplex mode	
5	LTE TDD, NR 15 kHz SSB SCS, 10MHz bandwidth, TDD duplex mode	
6	LTE TDD, NR 30kHz SSB SCS, 40MHz bandwidth, TDD duplex mode	
Note: The UE is only required to be tested in one of the supported test configurations		

Table A.5.6.2.6.1-2: General test parameters for EN-DC inter-frequency event triggered reporting without SSB time index detection

Parameter	Unit	Test configuration	Value				Comment
			Test 1	Test 2	Test 3	Test 4	
E-UTRA RF Channel Number		Config 1,2,3,4,5,6	1				One E-UTRAN TDD carrier frequencies is used.
NR RF Channel Number		Config 1,2,3,4,5,6	1, 2				Two FR1 NR carrier frequencies is used.
Active cell		Config 1,2,3,4,5,6	LTE Cell 1 (PCell) and NR cell 2 (PScell)				LTE Cell 1 is on E-UTRA RF channel number 1. NR Cell 2 is on NR RF channel number 1.
Neighbour cell		Config 1,2,3,4,5,6	NR cell 3				NR cell 3 is on NR RF channel number 2.
Gap Pattern Id		Config 1,2,3,4,5,6	0		13		As specified in clause 9.1.2-1.
Measurement gap offset		Config 1,2,3,4,5,6	39		39		
SMTC-SSB parameters on NR RF Channel 1		Config 1,4	SSB.1 FR1				As specified in clause A.3.10.1
		Config 2,5	SSB.1 FR1				As specified in clause A.3.10.1
		Config 3,6	SSB.2 FR1				As specified in clause A.3.10.1
SMTC-SSB parameters on NR RF Channel 2		Config 1,2,3,4,5,6	SSB.1 FR2				As specified in clause A.3.10.2
	offsetMO	Config 1,2,3,4,5,6	6				
Hysteresis	dB	Config 1,2,3,4,5,6	0				
a4-Threshold	dBm	Config 1,2,3,4,5,6	TBD				
CP length		Config 1,2,3,4,5,6	Normal				
TimeToTrigger	s	Config 1,2,3,4,5,6	0				
Filter coefficient		Config 1,2,3,4,5,6	0				L3 filtering is not used
DRX		Config 1,2,3,4,5,6	DRX .1	DRX .2	DRX .1	DRX .2	DRX is used
Time offset between PCell and PSCell		Config 1,2,3,4,5,6	3 μs				Synchronous EN-DC
Time offset between serving and neighbour cells		Config 1,4	3ms				Asynchronous cells. The timing of Cell 3 is 3ms later than the timing of Cell 2.
		Config 2,3,5,6	3μs				Synchronous cells.
T1	s	Config 1,2,3,4,5,6	5				
T2	s	Config 1,2,3,4,5,6	TBD	TBD	TBD	TBD	

Table A.5.6.2.6.1-3: Cell specific test parameters for EN-DC inter-frequency event triggered reporting without SSB time index detection

Parameter	Unit	Cell 1	Cell 2	Cell 3
-----------	------	--------	--------	--------

		Test configuration	T1	T2	T1	T2
NR RF Channel Number		Config 1,2,3,4,5,6	1		2	
Duplex mode		Config 1,4	FDD		TDD	
		Config 2,3,5,6	TDD		TDD	
BW _{channel}	MHz	Config 1,4	10: N _{RB,c} = 52		100: N _{RB,c} = 66	
		Config 2,5	10: N _{RB,c} = 52		100: N _{RB,c} = 66	
		Config 3,6	40: N _{RB,c} = 106		100: N _{RB,c} = 66	
BWP BW	MHz	Config 1,4	10: N _{RB,c} = 52		100: N _{RB,c} = 66	
		Config 2,5	10: N _{RB,c} = 52		100: N _{RB,c} = 66	
		Config 3,6	40: N _{RB,c} = 106		100: N _{RB,c} = 66	
TDD configuration		Config 2,5	TDDConf.1.1		TDDConf.3.1	
		Config 3,6	TDDConf.2.1		TDDConf.3.1	
Initial DL BWP		Config 1,2,3,4,5,6	DLBWP.0.1		NA	
Initial UL BWP		Config 1,2,3,4,5,6	ULBWP.0.1		NA	
Dedicated DL BWP		Config 1,2,3,4,5,6	DLBWP.1.1		NA	
Dedicated UL BWP		Config 1,2,3,4,5,6	ULBWP.1.1		NA	
OCNG Patterns defined in A.3.2.1.1 (OP.1)		Config 1,2,3,4,5,6	OP.1		OP.1	
PDSCH Reference measurement channel		Config 1,4	SR.1.1 FDD		-	
		Config 2,5	SR.1.1 TDD			
		Config 3,6	SR2.1 TDD			
CORESET Reference Channel		Config 1,4	CR.1.1 FDD		-	
		Config 2,5	CR.1.1 TDD			
		Config 3,6	CR2.1 TDD			
SMTC configuration defined in A.3.11.1 and A.3.11.2		Config 1,4	SMTC.2		SMTC.2	
		Config 2,3,5,6	SMTC.1		SMTC.1	
PDSCH/PDCCH subcarrier spacing	kHz	Config 1,2,4,5	15		120	
		Config 3,6	30		120	
EPRE ratio of PSS to SSS		Config 1,2,3,4,5,6	0		0	
EPRE ratio of PBCH DMRS to SSS						
EPRE ratio of PBCH to PBCH DMRS						
EPRE ratio of PDCCH DMRS to SSS						
EPRE ratio of PDCCH to PDCCH DMRS						
EPRE ratio of PDSCH DMRS to SSS						
EPRE ratio of PDSCH to PDSCH						
EPRE ratio of OCNG DMRS to SSS(Note 1)						
EPRE ratio of OCNG to OCNG DMRS (Note 1)						

UE orientation around TBD axis and TBD axis	degrees	Config 1,2,3,4,5,6	NA		TBD	
Relative difference in angle of arrival of cell 3 relative to cell 2	degrees	Config 1,2,3,4,5,6	NA		NA	TBD
N_{oc} Note2	dBm/15 kHz Note5		NA		TBD	
N_{oc} Note2	dBm/S CS Note4	Config 1,2,4,5	NA		TBD	
		Config 3,6	NA		TBD	
SS-RSRP Note 3	dBm/S CS Note5	Config 1,2,4,5	NA	NA	TBD	TBD
		Config 3,6	NA	NA	TBD	TBD
\hat{E}_s / I_{ot}	dB	Config 1,2,3,4,5,6	NA	NA	TBD	TBD
\hat{E}_s / N_{oc}	dB	Config 1,2,3,4,5,6	NA	NA	TBD	TBD
I_o Note3	dBm/9.36MHz	Config 1,2,4,5	NA	NA	-	-
	dBm/38.16MHz	Config 3,6	NA	NA	-	-
	dBm/95.04 MHz Note5	Config 1,2,3,4,5,6	-	-	TBD	TBD
Propagation Condition		Config 1,2,3,4,5,6	AWGN			
<p>Note 1: OCNG shall be used such that both cells are fully allocated and a constant total transmitted power spectral density is achieved for all OFDM symbols.</p> <p>Note 2: Interference from other cells and noise sources not specified in the test is assumed to be constant over subcarriers and time and shall be modelled as AWGN of appropriate power for N_{oc} to be fulfilled.</p> <p>Note 3: SS-RSRP and I_o levels have been derived from other parameters for information purposes. They are not settable parameters themselves.</p> <p>Note 4: SS-RSRP minimum requirements are specified assuming independent interference and noise at each receiver antenna port.</p> <p>Note 5: Equivalent power received by an antenna with 0dBi gain at the centre of the quiet zone</p> <p>Note 6: As observed with 0dBi gain antenna at the centre of the quiet zone</p>						

A.5.6.2.6.2 Test Requirements

In test 1 with per-UE gap, the UE shall send one Event A4 triggered measurement report, with a measurement reporting delay less than [TBD] ms from the beginning of time period T2. The UE shall not send event triggered measurement reports, as long as the reporting criteria are not fulfilled. The rate of correct events observed during repeated tests shall be at least 90%.

In test 2 with per-FR gap, the UE shall send one Event A4 triggered measurement report, with a measurement reporting delay less than [TBD] ms from the beginning of time period T2. The UE shall not send event triggered measurement reports, as long as the reporting criteria are not fulfilled. The rate of correct events observed during repeated tests shall be at least 90%.

In test 3 with per-UE gap, the UE shall send one Event A4 triggered measurement report, with a measurement reporting delay less than [TBD] ms from the beginning of time period T2. The UE shall not send event triggered measurement reports, as long as the reporting criteria are not fulfilled. The rate of correct events observed during repeated tests shall be at least 90%.

In test 4 with per-FR gap, the UE shall send one Event A4 triggered measurement report, with a measurement reporting delay less than [TBD] ms from the beginning of time period T2. The UE shall not send event triggered measurement reports, as long as the reporting criteria are not fulfilled. The rate of correct events observed during repeated tests shall be at least 90%.

In test 1, 2, 3 and 4 UE is not required to report SSB time index.

NOTE: The actual overall delays measured in the test may be up to $2 \times TTI_{DCCH}$ higher than the measurement reporting delays above because of TTI insertion uncertainty of the measurement report in DCCH.

A.5.6.2.7 EN-DC event triggered reporting tests for FR2 cell with SSB time index detection when DRX is not used

A.5.6.2.7.1 Test Purpose and Environment

The purpose of this test is to verify that the UE makes correct reporting of an event. This test will partly verify the EN-DC inter-frequency NR cell search requirements in clause 9.3.4.

In this test, there are three cells: LTE cell 1 as PCell on E-UTRA RF channel 1, NR cell 2 as PSCell in FR1 on NR RF channel 1 and NR cell 3 as neighbour cell in FR2 on NR RF channel 2. The test parameters and configurations are given in Tables A.5.6.2.7.1-1, A.5.6.2.7.1-2, and A.5.6.2.7.1-3.

In test 1 measurement gap pattern configuration # 0 as defined in Table A.5.6.2.7.1-2 is provided for a UE that does not support per-FR gap and in test 2 measurement gap pattern configuration #13 as defined in Table A.5.6.2.7.1-2 is provided for UE that support per-FR gap.

In the measurement control information, it is indicated to the UE that event-triggered reporting with Event A3 is used. The test consists of two successive time periods, with time duration of T1, and T2 respectively. During time duration T1, the UE shall not have any timing information of NR cell 3.

The configuration of LTE cell 1 is defined in table A.3.7.2.1-1. Supported test configurations are shown in table A.5.6.2.7.1-1.

Table A.5.6.2.7.1-1: EN-DC event triggered reporting tests with SSB index reading for FR1-FR2

Config	Description of serving cell	Description of target cell
1	LTE FDD, NR 15 kHz SSB SCS, 10MHz bandwidth, FDD duplex mode	120 kHz SSB SCS, 100MHz bandwidth, TDD duplex mode
2	LTE FDD, NR 15 kHz SSB SCS, 10MHz bandwidth, TDD duplex mode	
3	LTE FDD, NR 30kHz SSB SCS, 40MHz bandwidth, TDD duplex mode	
4	LTE TDD, NR 15 kHz SSB SCS, 10MHz bandwidth, FDD duplex mode	
5	LTE TDD, NR 15 kHz SSB SCS, 10MHz bandwidth, TDD duplex mode	
6	LTE TDD, NR 30kHz SSB SCS, 40MHz bandwidth, TDD duplex mode	
Note: The UE is only required to be tested in one of the supported test configurations		

Table A.5.6.2.7.1-2: General test parameters for EN-DC inter-frequency event triggered reporting with SSB time index detection

Parameter	Unit	Test configuration	Value		Comment
			Test 1	Test 2	
E-UTRA RF Channel Number		Config 1,2,3,4,5,6	1		One E-UTRAN TDD carrier frequencies is used.
NR RF Channel Number		Config 1,2,3,4,5,6	1, 2		Two FR1 NR carrier frequencies is used.
Active cell		Config 1,2,3,4,5,6	LTE Cell 1 (PCell) and NR cell 2 (PScell)		LTE Cell 1 is on E-UTRA RF channel number 1. NR Cell 2 is on NR RF channel number 1.
Neighbour cell		Config 1,2,3,4,5,6	NR cell 3		NR cell 3 is on NR RF channel number 2.
Gap Pattern Id		Config 1,2,3,4,5,6	0	13	As specified in clause 9.1.2-1.
Measurement gap offset		Config 1,2,3,4,5,6	39	39	
SMTC-SSB parameters on NR RF Channel 1		Config 1,4	SSB.1 FR1		As specified in clause A.3.10.1
		Config 2,5	SSB.1 FR1		As specified in clause A.3.10.1
		Config 3,6	SSB.2 FR1		As specified in clause A.3.10.1
SMTC-SSB parameters on NR RF Channel 2		Config 1,2,3,4,5,6	SSB.1 FR2		As specified in clause A.3.10.2
<i>offsetMO</i>	dB	Config 1,2,3,4,5,6	6		
Hysteresis	dB	Config 1,2,3,4,5,6	0		
<i>a4-Threshold</i>	dBm	Config 1,2,3,4,5,6	TBD		
CP length		Config 1,2,3,4,5,6	Normal		
TimeToTrigger	s	Config 1,2,3,4,5,6	0		
Filter coefficient		Config 1,2,3,4,5,6	0		L3 filtering is not used
DRX		Config 1,2,3,4,5,6	OFF		DRX is not used
Time offset between PCell and PSCell		Config 1,2,3,4,5,6	3 μs		Synchronous EN-DC
Time offset between serving and neighbour cells		Config 1,4	3ms		Asynchronous cells. The timing of Cell 3 is 3ms later than the timing of Cell 2.
		Config 2,3,5,6	3μs		Synchronous cells.
T1	s	Config 1,2,3,4,5,6	5		
T2	s	Config 1,2,3,4,5,6	TBD	TBD	

Table A.5.6.2.7.1-3: Cell specific test parameters for EN-DC inter-frequency event triggered reporting with SSB time index detection

Parameter	Unit		Cell 2	Cell 3
-----------	------	--	--------	--------

		Test configuration	T1	T2	T1	T2
NR RF Channel Number		Config 1,2,3,4,5,6	1		2	
Duplex mode		Config 1,4	FDD		TDD	
		Config 2,3,5,6	TDD		TDD	
BW _{channel}	MHz	Config 1,4	10: N _{RB,c} = 52		100: N _{RB,c} = 66	
		Config 2,5	10: N _{RB,c} = 52		100: N _{RB,c} = 66	
		Config 3,6	40: N _{RB,c} = 106		100: N _{RB,c} = 66	
BWP BW	MHz	Config 1,4	10: N _{RB,c} = 52		100: N _{RB,c} = 66	
		Config 2,5	10: N _{RB,c} = 52		100: N _{RB,c} = 66	
		Config 3,6	40: N _{RB,c} = 106		100: N _{RB,c} = 66	
OCNG Patterns defined in A.3.2.1.1 (OP.1)		Config 1,2,3,4,5,6	OP.1		OP.1	
PDSCH Reference measurement channel		Config 1,4	SR.1.1 FDD		-	
		Config 2,5	SR.1.1 TDD			
		Config 3,6	SR2.1 TDD			
CORESET Reference Channel		Config 1,4	CR.1.1 FDD		-	
		Config 2,5	CR.1.1 TDD			
		Config 3,6	CR2.1 TDD			
TDD configuration		Config 2,5	TDDConf.1.1		TDDConf.3.1	
		Config 3,6	TDDConf.2.1		TDDConf.3.1	
Initial DL BWP		Config 1,2,3,4,5,6	DLBWP.0.1		NA	
Initial UL BWP		Config 1,2,3,4,5,6	ULBWP.0.1		NA	
Dedicated DL BWP		Config 1,2,3,4,5,6	DLBWP.1.1		NA	
Dedicated UL BWP		Config 1,2,3,4,5,6	ULBWP.1.1		NA	
SMTC configuration defined in A.3.11.1 and A.3.11.2		Config 1,4	SMTC.2		SMTC.2	
		Config 2,3,5,6	SMTC.1		SMTC.1	
PDSCH/PDCCH subcarrier spacing	kHz	Config 1,2,4,5	15		120	
		Config 3,6	30		120	
EPRE ratio of PSS to SSS		Config 1,2,3,4,5,6	0		0	
EPRE ratio of PBCH DMRS to SSS						
EPRE ratio of PBCH to PBCH DMRS						
EPRE ratio of PDCCH DMRS to SSS						
EPRE ratio of PDCCH to PDCCH DMRS						
EPRE ratio of PDSCH DMRS to SSS						
EPRE ratio of PDSCH to PDSCH						
EPRE ratio of OCNG DMRS to SSS(Note 1)						
EPRE ratio of OCNG to OCNG DMRS (Note 1)						

UE orientation around TBD axis and TBD axis	degrees	Config 1,2,3,4,5,6	NA		TBD	
Relative difference in angle of arrival of cell 3 relative to cell 2	degrees	Config 1,2,3,4,5,6	NA		NA	TBD
N_{oc} Note2	dBm/15 kHz Note5		NA		TBD	
N_{oc} Note2	dBm/S CS Note4	Config 1,2,4,5	NA		TBD	
		Config 3,6	NA		TBD	
SS-RSRP Note 3	dBm/S CS Note5	Config 1,2,4,5	NA	NA	-Infinity	TBD
		Config 3,6	NA	NA	-Infinity	TBD
\hat{E}_s / I_{ot}	dB	Config 1,2,3,4,5,6	NA	NA	-Infinity	TBD
\hat{E}_s / N_{oc}	dB	Config 1,2,3,4,5,6	NA	NA	-Infinity	TBD
I_o Note3	dBm/9.36MHz	Config 1,2,4,5	NA	NA	-	-
	dBm/38.16MHz	Config 3,6	NA	NA	-	-
	dBm/95.04 MHz Note5	Config 1,2,3,4,5,6	-	-	-Infinity	TBD
Propagation Condition		Config 1,2,3,4,5,6	AWGN			
<p>Note 1: OCNG shall be used such that both cells are fully allocated and a constant total transmitted power spectral density is achieved for all OFDM symbols.</p> <p>Note 2: Interference from other cells and noise sources not specified in the test is assumed to be constant over subcarriers and time and shall be modelled as AWGN of appropriate power for N_{oc} to be fulfilled.</p> <p>Note 3: SS-RSRP and I_o levels have been derived from other parameters for information purposes. They are not settable parameters themselves.</p> <p>Note 4: SS-RSRP minimum requirements are specified assuming independent interference and noise at each receiver antenna port.</p> <p>Note 5: Equivalent power received by an antenna with 0dBi gain at the centre of the quiet zone</p> <p>Note 6: As observed with 0dBi gain antenna at the centre of the quiet zone</p>						

A.5.6.2.7.2 Test Requirements

In test 1 with per-UE gap, the UE shall send one Event A4 triggered measurement report, with a measurement reporting delay less than [TBD] ms from the beginning of time period T2. The UE shall not send event triggered measurement reports, as long as the reporting criteria are not fulfilled. The rate of correct events observed during repeated tests shall be at least 90%.

In test 2 with per-FR gap, the UE shall send one Event A4 triggered measurement report, with a measurement reporting delay less than [TBD] ms from the beginning of time period T2. The UE shall not send event triggered measurement reports, as long as the reporting criteria are not fulfilled. The rate of correct events observed during repeated tests shall be at least 90%.

In test 1 and 2 UE is required to report SSB time index.

NOTE: The actual overall delays measured in the test may be up to $2xTTI_{DCCH}$ higher than the measurement reporting delays above because of TTI insertion uncertainty of the measurement report in DCCH.

A.5.6.2.8 EN-DC event triggered reporting tests for FR2 cell with SSB time index detection when DRX is used

A.5.6.2.8.1 Test Purpose and Environment

The purpose of this test is to verify that the UE makes correct reporting of an event. This test will partly verify the EN-DC inter-frequency NR cell search requirements in clause 9.3.4.

In this test, there are three cells: LTE cell 1 as PCell on E-UTRA RF channel 1, NR cell 2 as PSCell in FR1 on NR RF channel 1 and NR cell 3 as neighbour cell in FR2 on NR RF channel 2. The test parameters and configurations are given in Tables A.5.6.2.8.1-1, A.5.6.2.8.1-2, and A.5.6.2.8.1-3.

In test 1&2 measurement gap pattern configuration # 0 as defined in Table A.5.6.2.8.1-2 is provided for a UE that does not support per-FR gap and in test 3&4 measurement gap pattern configuration #13 as defined in Table A.5.6.2.8.1-2 is provided for UE that support per-FR gap.

In the measurement control information, it is indicated to the UE that event-triggered reporting with Event A3 is used. The test consists of two successive time periods, with time duration of T1, and T2 respectively. During time duration T1, the UE shall not have any timing information of NR cell 3.

The configuration of LTE cell 1 is defined in table A.3.7.2.1-1. Supported test configurations are shown in table A.5.6.2.8.1-1.

UE needs to be provided at least once every 500ms with new Timing Advance Command MAC control element to restart the Time alignment timer to keep UE uplink time alignment. Furthermore UE is allocated with PUSCH resource at every DRX cycle.

Table A.5.6.2.8.1-1: EN-DC event triggered reporting tests without SSB index reading for FR1-FR2

Config	Description of serving cell	Description of target cell
1	LTE FDD, NR 15 kHz SSB SCS, 10MHz bandwidth, FDD duplex mode	120 kHz SSB SCS, 100MHz bandwidth, TDD duplex mode
2	LTE FDD, NR 15 kHz SSB SCS, 10MHz bandwidth, TDD duplex mode	
3	LTE FDD, NR 30kHz SSB SCS, 40MHz bandwidth, TDD duplex mode	
4	LTE TDD, NR 15 kHz SSB SCS, 10MHz bandwidth, FDD duplex mode	
5	LTE TDD, NR 15 kHz SSB SCS, 10MHz bandwidth, TDD duplex mode	
6	LTE TDD, NR 30kHz SSB SCS, 40MHz bandwidth, TDD duplex mode	
Note: The UE is only required to be tested in one of the supported test configurations		

Table A.5.6.2.8.1-2: General test parameters for EN-DC inter-frequency event triggered reporting with SSB time index detection

Parameter	Unit	Test configuration	Value				Comment
			Test 1	Test 2	Test 3	Test 4	
E-UTRA RF Channel Number		Config 1,2,3,4,5,6	1				One E-UTRAN TDD carrier frequencies is used.
NR RF Channel Number		Config 1,2,3,4,5,6	1, 2				Two FR1 NR carrier frequencies is used.
Active cell		Config 1,2,3,4,5,6	LTE Cell 1 (PCell) and NR cell 2 (PScell)				LTE Cell 1 is on E-UTRA RF channel number 1. NR Cell 2 is on NR RF channel number 1.
Neighbour cell		Config 1,2,3,4,5,6	NR cell 3				NR cell 3 is on NR RF channel number 2.
Gap Pattern Id		Config 1,2,3,4,5,6	0		13		As specified in clause 9.1.2-1.
Measurement gap offset		Config 1,2,3,4,5,6	39		39		
SMTC-SSB parameters on NR RF Channel 1		Config 1,4	SSB.1 FR1				As specified in clause A.3.10.1
		Config 2,5	SSB.1 FR1				As specified in clause A.3.10.1
		Config 3,6	SSB.2 FR1				As specified in clause A.3.10.1
SMTC-SSB parameters on NR RF Channel 2		Config 1,2,3,4,5,6	SSB.1 FR2				As specified in clause A.3.10.2
	<i>offsetMO</i>	Config 1,2,3,4,5,6	6				
Hysteresis	dB	Config 1,2,3,4,5,6	0				
<i>a4-Threshold</i>	dBm	Config 1,2,3,4,5,6	TBD				
CP length		Config 1,2,3,4,5,6	Normal				
TimeToTrigger	s	Config 1,2,3,4,5,6	0				
Filter coefficient		Config 1,2,3,4,5,6	0				L3 filtering is not used
DRX		Config 1,2,3,4,5,6	DRX .1	DRX .2	DRX .1	DRX .2	DRX is used
Time offset between PCell and PSCell		Config 1,2,3,4,5,6	3 μs				Synchronous EN-DC
Time offset between serving and neighbour cells		Config 1,4	3ms				Asynchronous cells. The timing of Cell 3 is 3ms later than the timing of Cell 2.
		Config 2,3,5,6	3μs				Synchronous cells.
T1	s	Config 1,2,3,4,5,6	5				
T2	s	Config 1,2,3,4,5,6	TBD	TBD	TBD	TBD	

Table A.5.6.2.8.1-3: Cell specific test parameters for EN-DC inter-frequency event triggered reporting with SSB time index detection

Parameter	Unit	Cell 1	Cell 2	Cell 3
-----------	------	--------	--------	--------

		Test configuration	T1	T2	T1	T2
NR RF Channel Number		Config 1,2,3,4,5,6	1		2	
Duplex mode		Config 1,4	FDD		TDD	
		Config 2,3,5,6	TDD		TDD	
BW _{channel}	MHz	Config 1,4	10: N _{RB,c} = 52		100: N _{RB,c} = 66	
		Config 2,5	10: N _{RB,c} = 52		100: N _{RB,c} = 66	
		Config 3,6	40: N _{RB,c} = 106		100: N _{RB,c} = 66	
BWP BW	MHz	Config 1,4	10: N _{RB,c} = 52		100: N _{RB,c} = 66	
		Config 2,5	10: N _{RB,c} = 52		100: N _{RB,c} = 66	
		Config 3,6	40: N _{RB,c} = 106		100: N _{RB,c} = 66	
OCNG Patterns defined in A.3.2.1.1 (OP.1)		Config 1,2,3,4,5,6	OP.1		OP.1	
PDSCH Reference measurement channel		Config 1,4	SR.1.1 FDD		-	
		Config 2,5	SR.1.1 TDD			
		Config 3,6	SR2.1 TDD			
CORESET Reference Channel		Config 1,4	CR.1.1 FDD		-	
		Config 2,5	CR.1.1 TDD			
		Config 3,6	CR2.1 TDD			
TDD configuration		Config 2,5	TDDConf.1.1		TDDConf.3.1	
		Config 3,6	TDDConf.2.1		TDDConf.3.1	
Initial DL BWP		Config 1,2,3,4,5,6	DLBWP.0.1		NA	
Initial UL BWP		Config 1,2,3,4,5,6	ULBWP.0.1		NA	
Dedicated DL BWP		Config 1,2,3,4,5,6	DLBWP.1.1		NA	
Dedicated UL BWP		Config 1,2,3,4,5,6	ULBWP.1.1		NA	
SMTC configuration defined in A.3.11.1 and A.3.11.2		Config 1,4	SMTC.2		SMTC.2	
		Config 2,3,5,6	SMTC.1		SMTC.1	
PDSCH/PDCCH subcarrier spacing	kHz	Config 1,2,4,5	15		120	
		Config 3,6	30		120	
EPRE ratio of PSS to SSS		Config 1,2,3,4,5,6	0		0	
EPRE ratio of PBCH DMRS to SSS						
EPRE ratio of PBCH to PBCH DMRS						
EPRE ratio of PDCCH DMRS to SSS						
EPRE ratio of PDCCH to PDCCH DMRS						
EPRE ratio of PDSCH DMRS to SSS						
EPRE ratio of PDSCH to PDSCH						
EPRE ratio of OCNG DMRS to SSS(Note 1)						
EPRE ratio of OCNG to OCNG DMRS (Note 1)						

UE orientation around TBD axis and TBD axis	degrees	Config 1,2,3,4,5,6	NA		TBD	
Relative difference in angle of arrival of cell 3 relative to cell 2	degrees	Config 1,2,3,4,5,6	NA		NA	TBD
N_{oc} Note2	dBm/15 kHz Note5		NA		TBD	
N_{oc} Note2	dBm/S CS Note4	Config 1,2,4,5	NA		TBD	
		Config 3,6	NA		TBD	
SS-RSRP Note 3	dBm/S CS Note5	Config 1,2,4,5	NA	NA	TBD	TBD
		Config 3,6	NA	NA	TBD	TBD
\hat{E}_s / I_{ot}	dB	Config 1,2,3,4,5,6	NA	NA	TBD	TBD
\hat{E}_s / N_{oc}	dB	Config 1,2,3,4,5,6	NA	NA	TBD	TBD
I_o Note3	dBm/9.36MHz	Config 1,2,4,5	NA	NA	-	-
	dBm/38.16MHz	Config 3,6	NA	NA	-	-
	dBm/95.04 MHz Note5	Config 1,2,3,4,5,6	-	-	TBD	TBD
Propagation Condition		Config 1,2,3,4,5,6	AWGN			
<p>Note 1: OCNG shall be used such that both cells are fully allocated and a constant total transmitted power spectral density is achieved for all OFDM symbols.</p> <p>Note 2: Interference from other cells and noise sources not specified in the test is assumed to be constant over subcarriers and time and shall be modelled as AWGN of appropriate power for N_{oc} to be fulfilled.</p> <p>Note 3: SS-RSRP and I_o levels have been derived from other parameters for information purposes. They are not settable parameters themselves.</p> <p>Note 4: SS-RSRP minimum requirements are specified assuming independent interference and noise at each receiver antenna port.</p> <p>Note 5: Equivalent power received by an antenna with 0dBi gain at the centre of the quiet zone</p> <p>Note 6: As observed with 0dBi gain antenna at the centre of the quiet zone</p>						

A.5.6.2.8.2 Test Requirements

In test 1 with per-UE gap, the UE shall send one Event A4 triggered measurement report, with a measurement reporting delay less than [TBD] ms from the beginning of time period T2. The UE shall not send event triggered measurement reports, as long as the reporting criteria are not fulfilled. The rate of correct events observed during repeated tests shall be at least 90%.

In test 2 with per-FR gap, the UE shall send one Event A4 triggered measurement report, with a measurement reporting delay less than [TBD] ms from the beginning of time period T2. The UE shall not send event triggered measurement reports, as long as the reporting criteria are not fulfilled. The rate of correct events observed during repeated tests shall be at least 90%.

In test 3 with per-UE gap, the UE shall send one Event A4 triggered measurement report, with a measurement reporting delay less than [TBD] ms from the beginning of time period T2. The UE shall not send event triggered measurement reports, as long as the reporting criteria are not fulfilled. The rate of correct events observed during repeated tests shall be at least 90%.

In test 4 with per-FR gap, the UE shall send one Event A4 triggered measurement report, with a measurement reporting delay less than [TBD] ms from the beginning of time period T2. The UE shall not send event triggered

measurement reports, as long as the reporting criteria are not fulfilled. The rate of correct events observed during repeated tests shall be at least 90%.

In test 1, 2, 3 and 4 UE is required to report SSB time index.

NOTE: The actual overall delays measured in the test may be up to $2 \times TTI_{DCCH}$ higher than the measurement reporting delays above because of TTI insertion uncertainty of the measurement report in DCCH.

A.5.7 Measurement Performance requirements

A.5.7.1 SS-RSRP

A.5.7.1.1 EN-DC intra-frequency case measurement accuracy with FR2 serving cell and FR2 target cell

A.5.7.1.1.1 Test Purpose and Environment

The purpose of this test is to verify that the SS-RSRP measurement accuracy is within the specified limits. This test will verify the requirements in Sections 10.1.2.1.1 and 10.1.2.1.1 for intra-frequency measurements.

A.5.7.1.1.2 Test parameters

In this set of test cases all NR cells are on the same carrier frequency. Supported test configurations are shown in table A.5.7.1.1.2-1. Both absolute and relative accuracy of SS-RSRP intra frequency measurements are tested by using the parameters in Table A.5.7.1.1.2-2 and A.5.7.1.1.2-3. The E-UTRA PCell is configured as specified in section A.3.7.2.2. In all test cases, Cell 1 is the PCell, cell 2 is the PSCell and Cell 3 the target cell.

Table A.5.7.1.1.2-1: SS-RSRP Intra frequency SS-RSRP supported test configurations

Configuration	Description
1	FDD LTE PCell, Cell 2&3 120 kHz SSB SCS, 100MHz bandwidth, TDD duplex mode
2	TDD LTE PCell, Cell 2&3 120 kHz SSB SCS, 100MHz bandwidth, TDD duplex mode
Note: The UE is only required to pass in one of the supported test configurations	

Table A.5.7.1.1.2-2: SS-RSRP Intra frequency general test parameters

Parameter ^{Note 5}	Unit	Test 1		Test 2		Test 3	
		Cell 2	Cell 3	Cell 2	Cell 3	Cell 2	Cell 3
SSB ARFCN		freq1		freq1		freq1	
Duplex mode		TDD		TDD		TDD	
TDD configuration		TDDConf.3.1		TDDConf.3.1		TDDConf.3.1	
BW _{channel}	MHz	100: N _{RB,c} = 66		100: N _{RB,c} = 66		100: N _{RB,c} = 66	
PDSCH Reference measurement channel		SR.3.1 TDD	-	SR.3.1 TDD	-	SR.3.1 TDD	-
RMSI CORESET Reference Channel		CR.3.1 TDD	-	CR.3.1 TDD	-	CR.3.1 TDD	-
Dedicated CORESET Reference Channel		CCR.3. 1 TDD	-	CCR.3. 1 TDD	-	CCR.3. 1 TDD	-
OCNG Patterns		OP.1	OP.1	OP.1	OP.1	OP.1	OP.1
SSB configuration		SSB.1 FR2	SSB.1 FR2	SSB.1 FR2	SSB.1 FR2	SSB.1 FR2	SSB.1 FR2
SMTC configuration		SMTC. 1	SMTC. 1	SMTC. 1	SMTC. 1	SMTC. 1	SMTC. 1
PDSCH/PDCCH subcarrier spacing	kHz	120	120	120	120	120	120
EPRE ratio of PSS to SSS	dB	0	0	0	0	0	0
EPRE ratio of PBCH_DMRS to SSS							
EPRE ratio of PBCH to PBCH_DMRS							
EPRE ratio of PDCCH_DMRS to SSS							
EPRE ratio of PDCCH to PDCCH_DMRS							
EPRE ratio of PDSCH_DMRS to SSS							
EPRE ratio of PDSCH to PDSCH_DMRS							
EPRE ratio of OCNG DMRS to SSS ^{Note 1}							
EPRE ratio of OCNG to OCNG DMRS ^{Note 1}							
\hat{E}_s / N_{oc}	dB	6	1	6	1	3	-1
Propagation conditions		AWGN					
Note 1:	OCNG shall be used such that both cells are fully allocated and a constant total transmitted power spectral density is achieved for all OFDM symbols.						
Note 2:	Interference from other cells and noise sources not specified in the test is assumed to be constant over subcarriers and time and shall be modelled as AWGN of appropriate power for N_{oc} to be fulfilled.						
Note 3:	SS-RSRP and I _o levels have been derived from other parameters for information purposes. They are not settable parameters themselves.						
Note 4:	SS-RSRP minimum requirements are specified assuming independent interference and noise at each receiver antenna port.						
Note 5:	All parameters apply for configuration 1 and 2						

Table A.5.7.1.1.2-3: SS-RSRP Intra frequency OTA related test parameters

Parameter ^{Note 6}	Unit	Test 1		Test 2		Test 3	
		Cell 2	Cell 3	Cell 2	Cell 3	Cell 2	Cell 3
Angle of arrival configuration		According to section A.3.8.X		According to section A.3.8.X		According to section A.3.8.X	
N_{oc} ^{Note1}	NR_TDD_FR2_A	dBm/15kHz ^{Note4}	TBD	TBD	TBD	TBD	TBD
	NR_TDD_FR2_B						
	NR_TDD_FR2_F						
	NR_TDD_FR2_G						
	NR_TDD_FR2_T						

N_{oc} ^{Note1}	NR_TDD_FR2_Y	dBm/SCS ^{Note3}	TBD		TBD		TBD	
	NR_TDD_FR2_A						TBD	
	NR_TDD_FR2_B						TBD	
	NR_TDD_FR2_F						TBD	
	NR_TDD_FR2_G						TBD	
	NR_TDD_FR2_T						TBD	
SS-RSRP ^{Note2}	NR_TDD_FR2_A	dBm/SCS ^{Note4}	TBD	TBD	TBD	TBD	TBD	TBD
	NR_TDD_FR2_B						TBD	TBD
	NR_TDD_FR2_F						TBD	TBD
	NR_TDD_FR2_G						TBD	TBD
	NR_TDD_FR2_T						TBD	TBD
	NR_TDD_FR2_Y						TBD	TBD
\hat{E}_s / I_{ot}		dB	TBD	TBD	TBD	TBD	TBD	TBD
I_o ^{Note2}	NR_TDD_FR2_A	dBm/95.04 MHz ^{Note4}	TBD		TBD		TBD	
	NR_TDD_FR2_B						TBD	
	NR_TDD_FR2_F						TBD	
	NR_TDD_FR2_G						TBD	
	NR_TDD_FR2_T						TBD	
	NR_TDD_FR2_Y						TBD	
<p>Note 1: Interference from other cells and noise sources not specified in the test is assumed to be constant over subcarriers and time and shall be modelled as AWGN of appropriate power for N_{oc} to be fulfilled.</p> <p>Note 2: SS-RSRP and I_o levels have been derived from other parameters for information purposes. They are not settable parameters themselves.</p> <p>Note 3: SS-RSRP minimum requirements are specified assuming independent interference and noise at each receiver antenna port.</p> <p>Note 4: Equivalent power received by an antenna with 0dBi gain at the centre of the quiet zone</p> <p>Note 5: As observed with 0dBi gain antenna at the centre of the quiet zone</p> <p>Note 6: All parameters apply for configuration 1 and 2</p>								

A.5.7.1.1.3 Test Requirements

The SS-RSRP measurement accuracy shall fulfil the absolute accuracy requirements in sections 10.1.3.1.1 and relative accuracy requirements in section 10.1.3.1.2.

A.5.7.1.2 EN-DC inter-frequency case measurement accuracy with FR2 serving cell and FR2 target cell

A.5.7.1.2.1 Test Purpose and Environment

The purpose of this test is to verify that the SS-RSRP measurement accuracy is within the specified limits. This test will verify the requirements in Sections 10.1.5.1.1 and 10.1.5.1.2 for intra frequency measurements with the testing configurations for NR cells in Table A.5.7.1.2.1-1.

Table A.5.7.1.2.1-1: Applicable NR configurations for FR2 inter-frequency SS-RSRP accuracy test

Configuration	Description
1	FDD LTE PCell, 120 kHz SSB SCS, 100MHz bandwidth, TDD duplex mode
2	TDD LTE PCell, 120 kHz SSB SCS, 100MHz bandwidth, TDD duplex mode
3	FDD LTE PCell, 240 kHz SSB SCS, 100MHz bandwidth, TDD duplex mode
4	TDD LTE PCell, 240 kHz SSB SCS, 100MHz bandwidth, TDD duplex mode

A.5.7.1.2.2 Test parameters

In this set of test cases there are three cells in the test, E-UTRAN PCell (Cell 1), FR2 PSCell (Cell 2) and a FR2 neighbour cell (Cell 3) on a different frequency than the PSCell. The test parameters and applicability for Cell 1 are defined in A.3.7.2. The test parameters for the Cell 2 and Cell 3 are given in Table A.5.7.1.2.2-1 and Table A.5.7.1.2.2-2 below. Both absolute and relative accuracy of RSRP intra frequency measurements are tested by using the parameters in Table A.5.7.1.2.2-1 and Table A.5.7.1.2.2-2. The inter frequency measurements are supported by a measurement gap. The TCI status for Cell 2 is defined in Table [TBD] and TRS configuration for Cell 2 is defined in Table [TBD].

Table A.5.7.1.2.2-1: SS-RSRP inter-frequency test parameters

Parameter	Config	Unit	Test 1		Test 2	
			Cell 2	Cell 3	Cell 2	Cell 3
SSB ARFCN	1~4		freq1	freq2	freq1	freq2
BW _{channel}	1~4		100: N _{RB,c} = 66		100: N _{RB,c} = 66	
Duplex mode	1~4		TDD	TDD	TDD	TDD
TDD configuration	1~4		TDDConf.3.1		TDDConf.3.1	
PDSCH Reference measurement channel	1~4		SR.3.1 TDD	-	SR.3.1 TDD	-
RMSI CORESET Reference Channel	1~4		CR.3.1 TDD	-	CR.3.1 TDD	-
Dedicated CORESET Reference Channel	1~4		CCR.3.1 TDD	-	CCR.3.1 TDD	-
SSB configuration	1,2		SSB.1 FR2		SSB.1 FR2	
	3,4		SSB.2 FR2		SSB.2 FR2	
OCNG Patterns	1~4		OP.1		OP.1	
DL BWP	1~4		DLBWP.1.1		DLBWP.1.1	
UL BWP	1~4		ULBWP.1.1		ULBWP.1.1	
SMTc configuration	1~4		SMTc.1		SMTc.1	
EPRE ratio of PSS to SSS	1~4	dB	0	0	0	0
EPRE ratio of PBCH DMRS to SSS						
EPRE ratio of PBCH to PBCH DMRS						
EPRE ratio of PDCCH DMRS to SSS						
EPRE ratio of PDCCH to PDCCH DMRS						
EPRE ratio of PDSCH DMRS to SSS						
EPRE ratio of PDSCH to PDSCH DMRS						
EPRE ratio of OCNG DMRS to SSS ^{Note 1}						
EPRE ratio of OCNG to OCNG DMRS ^{Note 1}						
Propagation condition						
Note 1:	OCNG shall be used such that both cells are fully allocated and a constant total transmitted power spectral density is achieved for all OFDM symbols.					
Note 2:	Interference from other cells and noise sources not specified in the test is assumed to be constant over subcarriers and time and shall be modelled as AWGN of appropriate power for N_{oc} to be fulfilled.					

Table A.5.7.1.2.2-2: SS-RSRP inter-frequency OTA related test parameters

Parameter		Config	Unit	Test 1		Test 2	
				Cell 2	Cell 3	Cell 2	Cell 3
N_{oc}	NR_TDD_FR2_A	1~4	dBm/15 kHz	TBD	TBD	TBD	TBD
	NR_TDD_FR2_B						TBD
	NR_TDD_FR2_F						TBD
	NR_TDD_FR2_G						TBD
	NR_TDD_FR2_T						TBD
	NR_TDD_FR2_Y						TBD
N_{oc}	NR_TDD_FR2_A	1,2	dBm/SS B SCS	TBD	TBD	TBD	TBD
	NR_TDD_FR2_B						TBD
	NR_TDD_FR2_F						TBD
	NR_TDD_FR2_G						TBD
	NR_TDD_FR2_T						TBD
	NR_TDD_FR2_Y						TBD
	NR_TDD_FR2_A	3,4	dBm/SS B SCS	TBD	TBD	TBD	TBD
	NR_TDD_FR2_B						TBD
	NR_TDD_FR2_F						TBD
	NR_TDD_FR2_G						TBD
	NR_TDD_FR2_T						TBD
	NR_TDD_FR2_Y						TBD
\hat{E}_s/I_{ot}		1~4	dB	TBD	TBD	TBD	TBD
SS-RSRP ^{Note1}	NR_TDD_FR2_A	1,2	dBm/SC S	TBD	TBD	TBD	TBD
	NR_TDD_FR2_B						TBD
	NR_TDD_FR2_F						TBD
	NR_TDD_FR2_G						TBD
	NR_TDD_FR2_T						TBD
	NR_TDD_FR2_Y						TBD
	NR_TDD_FR2_A	3,4	dBm/SC S	TBD	TBD	TBD	TBD
	NR_TDD_FR2_B						TBD
	NR_TDD_FR2_F						TBD
	NR_TDD_FR2_G						TBD
	NR_TDD_FR2_T						TBD
	NR_TDD_FR2_Y						TBD
I_o ^{Note1}	NR_TDD_FR2_A	1~4	dBm/95.04M Hz	TBD	TBD	TBD	TBD
	NR_TDD_FR2_B						TBD
	NR_TDD_FR2_F						TBD
	NR_TDD_FR2_G						TBD
	NR_TDD_FR2_T						TBD
	NR_TDD_FR2_Y						TBD
\hat{E}_s/N_{oc}		1~4	dB	TBD	TBD	TBD	TBD
<p>Note 1: RSRP and I_o levels have been derived from other parameters for information purposes. They are not settable parameters themselves.</p> <p>Note 2: RSRP minimum requirements are specified assuming independent interference and noise at each receiver antenna port.</p>							

A.5.7.1.2.3 Test Requirements

The SS-RSRP measurement accuracy for Cell 2 and Cell 3 shall fulfil the requirements in sections 10.1.5.1.1 and 10.1.5.1.2.

A.5.7.1.3 EN-DC inter-frequency measurement accuracy with FR1 serving cell and FR2 target cell

A.5.7.1.3.1 Test Purpose and Environment

The purpose of this test is to verify that the SS-RSRP measurement accuracy is within the specified limits. This test will verify the requirements in Sections 10.1.5.1.1 for inter-frequency measurements with the testing configurations in Table A.5.7.1.3.1-1.

Table A.5.7.1.3.1-1: Applicable NR configurations for FR1 inter-frequency SS-RSRP accuracy test

Config	Description of serving cell	Description of target cell
1	LTE FDD, NR 15 kHz SSB SCS, 10MHz bandwidth, FDD duplex mode	120 kHz SSB SCS, 100MHz bandwidth, TDD duplex mode
2	LTE FDD, NR 15 kHz SSB SCS, 10MHz bandwidth, TDD duplex mode	
3	LTE FDD, NR 30kHz SSB SCS, 40MHz bandwidth, TDD duplex mode	
4	LTE TDD, NR 15 kHz SSB SCS, 10MHz bandwidth, FDD duplex mode	
5	LTE TDD, NR 15 kHz SSB SCS, 10MHz bandwidth, TDD duplex mode	
6	LTE TDD, NR 30kHz SSB SCS, 40MHz bandwidth, TDD duplex mode	
Note: The UE is only required to be tested in one of the supported test configurations		

A.5.7.1.3.2 Test parameters

In this set of test cases there are three cells in the test, E-UTRAN PCell (Cell 1), FR1 PSCell (Cell 2) and a FR1 neighbour cell (Cell 3) on a different frequency than the PSCell. The test parameters and applicability for Cell 1 are defined in A.3.7.2. The test parameters for the Cell 2 and Cell 3 are given in Table A.5.7.1.3.2-1 and Table A.5.7.1.3.2-2 below. Both absolute and relative accuracy of RSRP intra frequency measurements are tested by using the parameters in Table A.5.7.1.3.2-1 and Table A.5.7.1.3.2-2. The inter frequency measurements are supported by a measurement gap.

Table A.5.7.1.3.2-1: SS-RSRP inter-frequency test parameters

Parameter	Config	Unit	Test 1		Test 2	
			Cell 2	Cell 3	Cell 2	Cell 3
SSB ARFCN	1~6		freq1	freq2	freq1	freq2
BW _{channel}	1,4	MHz	10: N _{RB,c} = 52	100: N _{RB,c} = 66	10: N _{RB,c} = 52	100: N _{RB,c} = 66
	2,5		10: N _{RB,c} = 52		10: N _{RB,c} = 52	
	3,6		40: N _{RB,c} = 106		40: N _{RB,c} = 106	
Duplex mode	1,4		FDD	TDD	FDD	TDD
	2,5		TDD		TDD	
	3,6		TDD		TDD	
TDD configuration	1,4		N/A	TDDConf. 3.1	N/A	TDDConf. 3.1
	2,5		TDDConf. 1.1		TDDConf. 1.1	
	3,6		TDDConf. 2.1		TDDConf. 2.1	
PDSCH Reference measurement channel	1,4		SR.1.1 FDD	-	SR.1.1 FDD	-
	2,5		SR.1.1 TDD		SR.1.1 TDD	
	3,6		SR.2.1 FDD		SR.2.1 FDD	
RMSI CORESET Reference Channel	1,4		CR.1.1 FDD	-	CR.1.1 FDD	-
	2,5		CR.1.1 TDD		CR.1.1 TDD	
	3,6		CR.2.1 FDD		CR.2.1 FDD	
Dedicated CORESET Reference Channel	1,4		CCR.1.1 FDD	-	CCR.1.1 FDD	-
	2,5		CCR.1.1 TDD		CCR.1.1 TDD	
	3,6		CCR.2.1 TDD		CCR.2.1 TDD	
SSB configuration	1,4		SSB.1 FR1	SSB.1 FR2	SSB.1 FR1	SSB.1 FR2
	2,5		SSB.1 FR1		SSB.1 FR1	
	3,6		SSB.2 FR1		SSB.2 FR1	
OCNG Patterns	1~6		OP.1		OP.1	
DL BWP	1~6		DLBWP.1.1		DLBWP.1.1	
UL BWP	1~6		ULBWP.1.1		ULBWP.1.1	
SMTc configuration	1~6		SMTc.1		SMTc.1	
EPRE ratio of PSS to SSS	1~6	dB	0	0	0	0
EPRE ratio of PBCH DMRS to SSS						
EPRE ratio of PBCH to PBCH DMRS						
EPRE ratio of PDCCH DMRS to SSS						
EPRE ratio of PDCCH to PDCCH DMRS						
EPRE ratio of PDSCH DMRS to SSS						
EPRE ratio of PDSCH to PDSCH DMRS						
EPRE ratio of OCNG DMRS to SSS ^{Note 1}						
EPRE ratio of OCNG to OCNG DMRS ^{Note 1}						
Propagation condition						
<p>Note 1: OCNG shall be used such that both cells are fully allocated and a constant total transmitted power spectral density is achieved for all OFDM symbols.</p> <p>Note 2: Interference from other cells and noise sources not specified in the test is assumed to be constant over subcarriers and time and shall be modelled as AWGN of appropriate power for N_{oc} to be fulfilled.</p>						

Table A.5.7.1.3.2-2: SS-RSRP inter-frequency OTA related test parameters

Parameter		Config	Unit	Test 1		Test 2		
				Cell 2	Cell 3	Cell 2	Cell 3	
N_{oc} Note2	NR_FDD_FR1_A, NR_TDD_FR1_A	1~6	dBm/15 kHz	TBD		TBD	TBD	
	NR_FDD_FR1_B						TBD	
	NR_TDD_FR1_C						TBD	
	NR_FDD_FR1_D, NR_TDD_FR1_D						TBD	
	NR_FDD_FR1_E, NR_TDD_FR1_E						TBD	
	NR_FDD_FR1_G						TBD	
	NR_FDD_FR1_H						TBD	
N_{oc} Note2	NR_FDD_FR1_A, NR_TDD_FR1_A	1,2,4,5	dBm/SS B SCS	TBD	N/A	TBD	TBD	
	NR_FDD_FR1_B						TBD	
	NR_TDD_FR1_C						TBD	
	NR_FDD_FR1_D, NR_TDD_FR1_D						TBD	
	NR_FDD_FR1_E, NR_TDD_FR1_E						TBD	
	NR_FDD_FR1_G						TBD	
	NR_FDD_FR1_H						TBD	
	NR_FDD_FR1_A, NR_TDD_FR1_A	3,6		TBD		TBD	TBD	TBD
	NR_FDD_FR1_B							TBD
	NR_TDD_FR1_C							TBD
	NR_FDD_FR1_D, NR_TDD_FR1_D							TBD
	NR_FDD_FR1_E, NR_TDD_FR1_E							TBD
	NR_FDD_FR1_G							TBD
	NR_FDD_FR1_H							TBD
\hat{E}_s/I_{ot}	1~6	dB	TBD	TBD	TBD	TBD		
SS- RSR pNote3	NR_FDD_FR1_A, NR_TDD_FR1_A	1,2,4,5	dBm/SC S	TBD	TBD	TBD	TBD	
	NR_FDD_FR1_B						TBD	
	NR_TDD_FR1_C						TBD	
	NR_FDD_FR1_D, NR_TDD_FR1_D						TBD	
	NR_FDD_FR1_E, NR_TDD_FR1_E						TBD	
	NR_FDD_FR1_G						TBD	
	NR_FDD_FR1_H						TBD	
	NR_FDD_FR1_A, NR_TDD_FR1_A	3,6		TBD		TBD	TBD	TBD
	NR_FDD_FR1_B							TBD
	NR_TDD_FR1_C							TBD
	NR_FDD_FR1_D, NR_TDD_FR1_D							TBD
	NR_FDD_FR1_E, NR_TDD_FR1_E							TBD
	NR_FDD_FR1_G							TBD
	NR_FDD_FR1_H							TBD

I _o ^{Note3}	NR_FDD_FR1_A, NR_TDD_FR1_A	1,2,4,5	dBm/ 9.36MHz	N/A	TBD	TBD	
	NR_FDD_FR1_B					TBD	
	NR_TDD_FR1_C					TBD	
	NR_FDD_FR1_D, NR_TDD_FR1_D					TBD	
	NR_FDD_FR1_E, NR_TDD_FR1_E					TBD	
	NR_FDD_FR1_G					TBD	
	NR_FDD_FR1_H	TBD					
	NR_FDD_FR1_A, NR_TDD_FR1_A	3,6	dBm/ 38.16M Hz	N/A		TBD	
	NR_FDD_FR1_B					TBD	
	NR_TDD_FR1_C					TBD	
	NR_FDD_FR1_D, NR_TDD_FR1_D					TBD	
	NR_FDD_FR1_E, NR_TDD_FR1_E					TBD	
	NR_FDD_FR1_G					TBD	
	NR_FDD_FR1_H	TBD					
	NR_TDD_FR2_A	1~6	dBm/ 95.04M Hz	N/A		TBD	N/A
NR_TDD_FR2_B	TBD						
NR_TDD_FR2_F	TBD						
NR_TDD_FR2_G	TBD						
NR_TDD_FR2_T	TBD						
NR_TDD_FR2_Y	TBD						
\hat{E}_s / N_{oc}	1~6	dB	TBD	TBD	TBD	TBD	
Note 1: RSRP and I _o levels have been derived from other parameters for information purposes. They are not settable parameters themselves. Note 2: RSRP minimum requirements are specified assuming independent interference and noise at each receiver antenna port.							

A.5.7.1.3.3 Test Requirements

The SS-RSRP measurement accuracy for Cell 3 shall fulfil the Absolute requirement in section 10.1.5.1.1.

A.5.7.2 SS-RSRQ

A.5.7.2.1 EN-DC Intra-frequency measurement accuracy with FR2 serving cell and FR2 TDD target cell

A.5.7.2.1.1 Test Purpose and Environment

The purpose of this test is to verify that the SS-RSRQ measurement accuracy is within the specified limits. This test will verify the requirements in Clause 10.1.8.1.1.

A.5.7.2.1.2 Test Parameters

In this test case all cells are on the same carrier frequency. Supported test configurations are shown in Table A.5.7.2.1.2-1. The absolute accuracy of SS-RSRQ intra-frequency measurement is test by using the parameters in Table A.5.7.2.1.2-2 and Table A.5.7.2.1.2-3. The configuration of cell 1 (E-UTRA PCell) is specified in section A.3.7.2.1. In all test cases, Cell 2 is the PSCell and Cell 3 is the target cell.

Table A.5.7.2.1.2-1: SS-RSRQ Intra frequency SS-RSRQ supported test configurations

Configuration	Description
1	FDD LTE PCell, Cell 2&3 120 kHz SSB SCS, 100MHz bandwidth, TDD duplex mode
2	TDD LTE PCell, Cell 2&3 120 kHz SSB SCS, 100MHz bandwidth, TDD duplex mode
Note: The UE is only required to pass in one of the supported test configurations	

Table A.5.7.2.1.2-2: SS-RSRQ Intra frequency test parameters

Parameter	Unit	Test 1		Test 2		Test 3	
		Cell 2	Cell 3	Cell 2	Cell 3	Cell 2	Cell 3
SSB ARFCN		Freq1		Freq1		Freq1	
Duplex mode		TDD		TDD		TDD	
TDD configuration		TDDConf.3.1		TDDConf.3.1		TDDConf.3.1	
BW _{channel}	MHz	100: N _{RB,c} = 66		100: N _{RB,c} = 66		100: N _{RB,c} = 66	
BWP configuration	Initial DL BWP	DLBWP.0.1					
	Dedicated DL BWP	DLBWP.1.1					
	Initial UL BWP	ULBWP.0.1					
	Dedicated UL BWP	ULBWP.1.1					
TRS configuration		TRS.2.1 TDD		TRS.2.1 TDD		TRS.2.1 TDD	
TCI state		TCI.State.0		TCI.State.0		TCI.State.0	
PDSCH Reference measurement channel		SR.3.1 TDD		SR.3.1 TDD		SR.3.1 TDD	
RMSI CORESET Reference Channel		CR.3.1 TDD	-	CR.3.1 TDD	-	CR.3.1 TDD	-
Control channel RMC		CCR.3.1 TDD	-	CCR.3.1 TDD	-	CCR.3.1 TDD	-
OCNG Patterns		OP.1	OP.1	OP.1	OP.1	OP.1	OP.1
SMTC configuration		SMTC.1					
SSB configuration		SSB.1 FR2	SSB.1 FR2	SSB.1 FR2	SSB.1 FR2	SSB.1 FR2	SSB.1 FR2
PDSCH/PDCCH subcarrier spacing	kHz	120	120	120	120	120	120
SS-RSSI-Measurement		Not Applicable					
EPRE ratio of PSS to SSS	dB	0	0	0	0	0	0
EPRE ratio of PBCH_DMRS to SSS							
EPRE ratio of PBCH to PBCH_DMRS							
EPRE ratio of PDCCH_DMRS to SSS							
EPRE ratio of PDCCH to PDCCH_DMRS							
EPRE ratio of PDSCH_DMRS to SSS							
EPRE ratio of PDSCH to PDSCH_DMRS							
EPRE ratio of OCNG DMRS to SSS ^{Note 1}							
EPRE ratio of OCNG to OCNG DMRS ^{Note 1}							
\hat{E}_s / N_{oc}	dB	3	3	-2.9	-2.9	-4	-4
Note 1:	OCNG shall be used such that both cells are fully allocated and a constant total transmitted power spectral density is achieved for all OFDM symbols.						
Note 2:	Interference from other cells and noise sources not specified in the test is assumed to be constant over subcarriers and time and shall be modelled as AWGN of appropriate power for N_{oc} to be fulfilled.						
Note 3:	SS-RSRQ, SS-RSRP, and I _o levels have been derived from other parameters for information purposes. They are not settable parameters themselves.						
Note 4:	SS-RSRQ and SS-RSRP minimum requirements are specified assuming independent interference and noise at each receiver antenna port.						

Table A.5.7.2.1.2-3: SS-RSRQ Intra frequency OTA related test parameters

Parameter		Unit	Test 1		Test 2		Test 3	
			Cell 1	Cell 2	Cell 1	Cell 2	Cell 1	Cell 2
Angle of arrival configuration			According to section A.3.15.x		According to section A.3.15.x		According to section A.3.15.x	
N_{oc} ^{Note1}	NR_TDD_FR2_A	dBm/15kHz ^{Note4}	TBD		TBD		TBD	
	NR_TDD_FR2_B						TBD	
	NR_TDD_FR2_F						TBD	
	NR_TDD_FR2_G						TBD	
	NR_TDD_FR2_T						TBD	
N_{oc} ^{Note1}	NR_TDD_FR2_A	dBm/SCS ^{Note3}	TBD		TBD		TBD	
	NR_TDD_FR2_B						TBD	
	NR_TDD_FR2_F						TBD	
	NR_TDD_FR2_G						TBD	
	NR_TDD_FR2_T						TBD	
SS-RSRP ^{Note2}	NR_TDD_FR2_A	dBm/SCS ^{Note4}	TBD	TBD	TBD	TBD	TBD	TBD
	NR_TDD_FR2_B						TBD	TBD
	NR_TDD_FR2_F						TBD	TBD
	NR_TDD_FR2_G						TBD	TBD
	NR_TDD_FR2_T						TBD	TBD
SS-RSRQ ^{Note2}	NR_TDD_FR2_A	dB	TBD	TBD	TBD	TBD	TBD	TBD
	NR_TDD_FR2_B						TBD	TBD
	NR_TDD_FR2_C						TBD	TBD
	NR_TDD_FR2_D						TBD	TBD
	NR_TDD_FR2_E						TBD	TBD
\hat{E}_s / I_{ot}		dB	TBD	TBD	TBD	TBD	TBD	TBD
							TBD	TBD
I_o ^{Note2}	NR_TDD_FR2_A	dBm/95.04 MHz ^{Note4}	TBD		TBD		TBD	
	NR_TDD_FR2_B						TBD	
	NR_TDD_FR2_F						TBD	
	NR_TDD_FR2_G						TBD	
	NR_TDD_FR2_T						TBD	
							TBD	

Note 1: Interference from other cells and noise sources not specified in the test is assumed to be constant over subcarriers and time and shall be modelled as AWGN of appropriate power for N_{oc} to be fulfilled.

Note 2: SS-RSRQ, SS-RSRP, and I_o levels have been derived from other parameters for information purposes. They are not settable parameters themselves.

Note 3: SS-RSRQ and SS-RSRP minimum requirements are specified assuming independent interference and noise at each receiver antenna port.

Note 4: Equivalent power received by an antenna with 0dBi gain at the centre of the quiet zone

Note 5: As observed with 0dBi gain antenna at the centre of the quiet zone

Note 6: NR operating band groups are as defined in Section 3.5.2.

A.5.7.2.1.3 Test Requirements

The SS-RSRQ measurement accuracy shall fulfil the requirements in section 10.1.8.1.1.

A.5.7.2.2 EN-DC Inter-frequency measurement accuracy with FR2 serving cell and FR2 TDD target cell

A.5.7.2.2.1 Test Purpose and Environment

The purpose of this test is to verify that the SS-RSRQ measurement accuracy is within the specified limits. This test will verify the requirements in Clause 10.1.9.1.1 and 10.1.9.1.2 for inter-frequency measurement.

A.5.7.2.2.2 Test Parameters

In this test case the two NR cells (i.e., Cell 2 and Cell 3) are on different carrier frequencies and measurement gaps are provided. Supported test configurations are shown in Table A.5.7.2.2.2-1. Both absolute accuracy and relative accuracy requirements of SS-RSRQ inter-frequency measurement are tested by using test setup in Table A.5.7.2.2.2-2 and Table A.5.7.2.2.2-3. In all test cases, Cell 2 is the PSCell and Cell 3 is target cell. Cell 1 is the E-UTRA cell which specific test parameters for this test case are specified in Table A.3.7.2.1-1.

Table A.5.7.2.2.2-1: SS-RSRQ Inter frequency SS-RSRQ supported test configurations

Configuration	Description
1	LTE FDD, NR 120 kHz SSB SCS, 100MHz bandwidth, TDD duplex mode
2	LTE TDD, NR 120 kHz SSB SCS, 100MHz bandwidth, TDD duplex mode

Table A. 5.7.2.2.2-2: SS-RSRQ Inter frequency general test parameters

Parameter	Unit	Test 1		Test 2		Test 3	
		Cell 2	Cell 3	Cell 2	Cell 3	Cell 2	Cell 3

SSB ARFCN		Freq1	freq2	freq1	Freq2	freq1	Freq2
Duplex mode		TDD		TDD		TDD	
TDD configuration		TDDConf.3.1		TDDConf.3.1		TDDConf.3.1	
BW _{channel}	MHz	100: N _{RB,c} = 66		100: N _{RB,c} = 66		100: N _{RB,c} = 66	
PDSCH Reference measurement channel		SR.3.1 TDD	-	SR.3.1 TDD	-	SR.3.1 TDD	-
RMSI CORESET Reference Channel		CR.3.1 TDD	-	CR.3.1 TDD	-	CR.3.1 TDD	-
OCNG Patterns		OP.1	OP.1	OP.1	OP.1	OP.1	OP.1
SMTTC configuration		SMTTC. 1 FR2	SMTTC. 1 FR2	SMTTC. 1 FR2	SMTTC. 1 FR2	SMTTC. 1 FR2	SMTTC. 1 FR2
PDSCH/PDCCH subcarrier spacing	kHz	120	120	120	120	120	120
EPRE ratio of PSS to SSS	dB	0	0	0	0	0	0
EPRE ratio of PBCH_DMRS to SSS							
EPRE ratio of PBCH to PBCH_DMRS							
EPRE ratio of PDCCH_DMRS to SSS							
EPRE ratio of PDCCH to PDCCH_DMRS							
EPRE ratio of PDSCH_DMRS to SSS							
EPRE ratio of PDSCH to PDSCH_DMRS							
EPRE ratio of OCNG DMRS to SSS ^{Note 1}							
\hat{E}_s / N_{oc}	dB	TBD	TBD	TBD	TBD	TBD	TBD
<p>Note 1: OCNG shall be used such that both cells are fully allocated and a constant total transmitted power spectral density is achieved for all OFDM symbols.</p> <p>Note 2: Interference from other cells and noise sources not specified in the test is assumed to be constant over subcarriers and time and shall be modelled as AWGN of appropriate power for N_{oc} to be fulfilled.</p> <p>Note 3: SS-RSRQ, SS-RSRP and Io levels have been derived from other parameters for information purposes. They are not settable parameters themselves.</p> <p>Note 4: SS-RSRQ and SS-RSRP minimum requirements are specified assuming independent interference and noise at each receiver antenna port.</p>							

Table A. 5.7.2.2-3: SS-RSRQ Inter frequency OTA related test parameters

Parameter	Unit	Test 1		Test 2		Test 3	
		Cell 2	Cell 3	Cell 2	Cell 3	Cell 2	Cell 3
UE orientation around TBD axis and TBD axis	degrees	TBD		TBD		TBD	
Relative difference in angle of arrival of cell 2 relative to cell 1	degrees	NA	TBD	NA	0	NA	0
N_{oc} ^{Note1}	NR_TDD_FR2_A	dBm/15kHz ^{Note4}	TBD	TBD	TBD	TBD	
	NR_TDD_FR2_B					TBD	
	NR_TDD_FR2_F					TBD	
	NR_TDD_FR2_G					TBD	
	NR_TDD_FR2_T					TBD	
N_{oc} ^{Note1}	NR_TDD_FR2_A	dBm/SCS ^{Note3}	TBD	TBD	TBD	TBD	
	NR_TDD_FR2_B					TBD	
	NR_TDD_FR2_F					TBD	
	NR_TDD_FR2_G					TBD	
	NR_TDD_FR2_Y					TBD	
SS-RSRP ^{Note2}	NR_TDD_FR2_A	dBm/SCS ^{Note4}	TBD	TBD	TBD	TBD	TBD
	NR_TDD_FR2_B					TBD	TBD
	NR_TDD_FR2_F					TBD	TBD

	NR_TDD_FR2_G						TBD	TBD
	NR_TDD_FR2_T						TBD	TBD
	NR_TDD_FR2_Y						TBD	TBD
SS-RSRQ ^{Note2}	NR_TDD_FR2_A	dB	TBD	TBD	TBD	TBD	TBD	TBD
	NR_TDD_FR2_B						TBD	TBD
	NR_TDD_FR2_F						TBD	TBD
	NR_TDD_FR2_G						TBD	TBD
	NR_TDD_FR2_T						TBD	TBD
	NR_TDD_FR2_Y						TBD	TBD
\hat{E}_s / I_{ot}		dB	TBD	TBD	TBD	TBD	TBD	TBD
I _o ^{Note2}	NR_TDD_FR2_A	dBm/95.04 MHz ^{Note4}	TBD	TBD	TBD	TBD	TBD	TBD
	NR_TDD_FR2_B						TBD	TBD
	NR_TDD_FR2_F						TBD	TBD
	NR_TDD_FR2_G						TBD	TBD
	NR_TDD_FR2_T						TBD	TBD
	NR_TDD_FR2_Y						TBD	TBD
<p>Note 1: Interference from other cells and noise sources not specified in the test is assumed to be constant over subcarriers and time and shall be modelled as AWGN of appropriate power for N_{oc} to be fulfilled.</p> <p>Note 2: SS-RSRQ, SS-RSRP, and I_o levels have been derived from other parameters for information purposes. They are not settable parameters themselves.</p> <p>Note 3: SS-RSRQ and SS-RSRP minimum requirements are specified assuming independent interference and noise at each receiver antenna port.</p> <p>Note 4: Equivalent power received by an antenna with 0dBi gain at the centre of the quiet zone</p> <p>Note 5: As observed with 0dBi gain antenna at the centre of the quiet zone</p> <p>Note 6: NR operating band groups are as defined in Section 3.5.2.</p>								

A.5.7.2.2.3 Test Requirements

The SS-RSRQ measurement accuracy shall fulfil the requirements in section 10.1.9.1.1 and 10.1.9.1.2.

A.5.7.3 SS-SINR

A.5.7.3.1 Intra-frequency case

A.5.7.3.1.1 Test Purpose and Environment

The purpose of this test is to verify that the SS-SINR measurement accuracy is within the specified limits. This test will verify the requirements in Clause 10.1.13.1.1.

A.5.7.3.1.2 Test Parameters

In this test case all cells are on the same carrier frequency. Supported test configurations are shown in Table A.5.7.3.1.2-1. The absolute accuracy of SS-SINR intra-frequency measurement is test by using the parameters in Table A.5.7.3.1.2-2 and Table A.5.7.3.1.2-3. The configuration of cell 1 (E-UTRA PCell) is specified in section A.3.7.2.1. In all test cases, Cell 2 is the PSCell and Cell 3 is the target cell. The TCI status for Cell 1 is defined in Table [TBD] and TRS configuration for Cell 1 is defined in Table [TBD].

Table A.5.7.3.1.2-1: SS-SINR Intra frequency SS-SINR supported test configurations

Configuration	Description
1	FDD LTE PCell, Cell 2&3 120 kHz SSB SCS, 100MHz bandwidth, TDD duplex mode
2	TDD LTE PCell, Cell 2&3 120 kHz SSB SCS, 100MHz bandwidth, TDD duplex mode
Note: The UE is only required to pass in one of the supported test configurations	

Table A.5.7.3.1.2-2: SS-SINR Intra frequency test parameters

Parameter	Unit	Test 1		Test 2		Test 3	
		Cell 2	Cell 3	Cell 2	Cell 3	Cell 2	Cell 3
SSB ARFCN		Freq2		Freq2		Freq2	
Duplex mode		TDD		TDD		TDD	
TDD configuration		TDDConf.3.1		TDDConf.3.1		TDDConf.3.1	
BW _{channel}	MHz	100: N _{RB,c} = 66		100: N _{RB,c} = 66		100: N _{RB,c} = 66	
Downlink initial BWP configuration		DLBWP.0.1					
Downlink dedicated BWP configuration		DLBWP.1.1					
Uplink initial BWP configuration		ULBWP.0.1					
Uplink dedicated BWP configuration		ULBWP.1.1					
DRX cycle configuration	ms	Not applicable					
TRS configuration		TRS.2.1 TDD					
TCI state		TCI.State.0					
PDSCH Reference measurement channel		SR.3.1 TDD		SR.3.1 TDD		SR.3.1 TDD	
RMSI CORESET Reference Channel		CR.3.1 TDD	-	CR.3.1 TDD	-	CR.3.1 TDD	-
Dedicated RMSI CORESET Reference Channel		CCR.3 .1 TDD	-	CCR.3 .1 TDD	-	CCR.3 .1 TDD	-
OCNG Patterns		OP.1	OP.1	OP.1	OP.1	OP.1	OP.1
SMTC configuration		SMTC.1					
SSB configuration		SSB.1 FR2	SSB.1 FR2	SSB.1 FR2	SSB.1 FR2	SSB.1 FR2	SSB.1 FR2
PDSCH/PDCCH subcarrier spacing	kHz	120	120	120	120	120	120
SS-RSSI-Measurement		Not Applicable					
EPRE ratio of PSS to SSS	dB	0	0	0	0	0	0
EPRE ratio of PBCH_DMRS to SSS							
EPRE ratio of PBCH to PBCH_DMRS							
EPRE ratio of PDCCH_DMRS to SSS							
EPRE ratio of PDCCH to PDCCH_DMRS							
EPRE ratio of PDSCH_DMRS to SSS							
EPRE ratio of PDSCH to PDSCH_DMRS							
EPRE ratio of OCNG DMRS to SSS ^{Note 1}							
EPRE ratio of OCNG to OCNG DMRS ^{Note 1}							
\hat{E}_s / N_{oc}	dB	TBD	TBD	TBD	TBD	TBD	TBD
<p>Note 1: OCNG shall be used such that both cells are fully allocated and a constant total transmitted power spectral density is achieved for all OFDM symbols.</p> <p>Note 2: Interference from other cells and noise sources not specified in the test is assumed to be constant over subcarriers and time and shall be modelled as AWGN of appropriate power for N_{oc} to be fulfilled.</p> <p>Note 3: SS-SINR, SS-RSRP, and Io levels have been derived from other parameters for information purposes. They are not settable parameters themselves.</p> <p>Note 4: SS-SINR and SS-RSRP minimum requirements are specified assuming independent interference and noise at each receiver antenna port.</p>							

Table A.5.7.3.1.2-3: SS-SINR Intra frequency OTA related test parameters

Parameter	Unit	Test 1		Test 2		Test 3	
		Cell 2	Cell 3	Cell 2	Cell 3	Cell 2	Cell 3
Angle of arrival configuration		According to section A.3.8.X		According to section A.3.8.X		According to section A.3.8.X	
N_{oc} ^{Note1}	NR_TDD_FR2_A	dBm/15kHz ^{Note4}	TBD	TBD	TBD	TBD	
	NR_TDD_FR2_B					TBD	
	NR_TDD_FR2_F					TBD	

	NR_TDD_FR2_G							TBD
	NR_TDD_FR2_T							TBD
	NR_TDD_FR2_Y							TBD
N_{oc} ^{Note1}	NR_TDD_FR2_A	dBm/SCS ^{Note3}	TBD	TBD	TBD	TBD	TBD	TBD
	NR_TDD_FR2_B							TBD
	NR_TDD_FR2_F							TBD
	NR_TDD_FR2_G							TBD
	NR_TDD_FR2_T							TBD
	NR_TDD_FR2_Y							TBD
SS-RSRP ^{Note2}	NR_TDD_FR2_A	dBm/SCS ^{Note4}	TBD	TBD	TBD	TBD	TBD	TBD
	NR_TDD_FR2_B							TBD
	NR_TDD_FR2_F							TBD
	NR_TDD_FR2_G							TBD
	NR_TDD_FR2_T							TBD
	NR_TDD_FR2_Y							TBD
SS-SINR ^{Note2}	NR_TDD_FR2_A	dB	TBD	TBD	TBD	TBD	TBD	TBD
	NR_TDD_FR2_B							TBD
	NR_TDD_FR2_C							TBD
	NR_TDD_FR2_D							TBD
	NR_TDD_FR2_E							TBD
	NR_TDD_FR2_F							TBD
\hat{E}_s / I_{ot}		dB	TBD	TBD	TBD	TBD	TBD	TBD
I_o ^{Note2}	NR_TDD_FR2_A	dBm/95.04 MHz ^{Note4}	TBD	TBD	TBD	TBD	TBD	TBD
	NR_TDD_FR2_B							TBD
	NR_TDD_FR2_F							TBD
	NR_TDD_FR2_G							TBD
	NR_TDD_FR2_T							TBD
	NR_TDD_FR2_Y							TBD
<p>Note 1: Interference from other cells and noise sources not specified in the test is assumed to be constant over subcarriers and time and shall be modelled as AWGN of appropriate power for N_{oc} to be fulfilled.</p> <p>Note 2: SS-SINR, SS-RSRP, and I_o levels have been derived from other parameters for information purposes. They are not settable parameters themselves.</p> <p>Note 3: SS-SINR and SS-RSRP minimum requirements are specified assuming independent interference and noise at each receiver antenna port.</p> <p>Note 4: Equivalent power received by an antenna with 0dBi gain at the centre of the quiet zone</p> <p>Note 5: As observed with 0dBi gain antenna at the centre of the quiet zone</p> <p>Note 6: NR operating band groups are as defined in Section 3.5.2.</p>								

A.5.7.3.1.3 Test Requirements

The SS-SINR measurement accuracy shall fulfil the requirements in section 10.1.13.1.1.

A.5.7.3.2 EN-DC Inter-frequency measurement accuracy with FR2 serving cell and FR2 TDD target cell

A.5.7.3.2.1 Test Purpose and Environment

The purpose of this test is to verify that the SS-SINR measurement accuracy is within the specified limits. This test will verify the requirements in Clause 10.1.15.1.1 and 10.1.15.1.2 for inter-frequency measurement.

A.5.7.3.2.2 Test Parameters

In this test case the two NR cells (i.e., Cell 2 and Cell 3) are on different carrier frequencies and measurement gaps are provided. Supported test configurations are shown in Table A.5.7.3.2.2-1. Both absolute accuracy and relative accuracy requirements of SS-SINR inter-frequency measurement are tested by using test setup in Table A.5.7.3.2.2-2 and Table A.5.7.3.2.2-3. In all test cases, Cell 2 is the PSCell and Cell 3 is target cell. Cell 1 is the E-UTRA cell

which specific test parameters for this test case are specified in Table A.3.7.2.1-1. The TCI status for Cell 1 is defined in Table [TBD] and TRS configuration for Cell 1 is defined in Table [TBD].

Table A.5.7.3.2.2-1: SS-SINR Inter frequency SS-SINR supported test configurations

Configuration	Description
1	LTE FDD, NR 120 kHz SSB SCS, 100MHz bandwidth, TDD duplex mode
2	LTE TDD, NR 120 kHz SSB SCS, 100MHz bandwidth, TDD duplex mode

Table A. 5.7.2.2.2-2: SS-SINR Inter frequency general test parameters

Parameter	Unit	Test 1		Test 2		Test 3	
		Cell 2	Cell 3	Cell 2	Cell 3	Cell 2	Cell 3
SSB ARFCN		Freq1	freq2	freq1	Freq2	freq1	Freq2
Duplex mode		TDD		TDD		TDD	
TDD configuration		TDDConf.3.1		TDDConf.3.1		TDDConf.3.1	
$BW_{channel}$	MHz	100: $N_{RB,c} = 66$		100: $N_{RB,c} = 66$		100: $N_{RB,c} = 66$	
Downlink initial BWP configuration		DLBWP.0.1					
Downlink dedicated BWP configuration		DLBWP.1.1					
Uplink initial BWP configuration		ULBWP.0.1					
Uplink dedicated BWP configuration		ULBWP.1.1					
DRX cycle configuration	ms	Not applicable					
TRS configuration		TRS.2.1 TDD					
TCI state		TCI.State.0					
PDSCH Reference measurement channel		SR.3.1 TDD	-	SR.3.1 TDD	-	SR.3.1 TDD	-
RMSI CORESET Reference Channel		CR.3.1 TDD	-	CR.3.1 TDD	-	CR.3.1 TDD	-
OCNG Patterns		OP.1	OP.1	OP.1	OP.1	OP.1	OP.1
SMTC configuration		SMTC. 1 FR2	SMTC. 1 FR2	SMTC. 1 FR2	SMTC. 1 FR2	SMTC. 1 FR2	SMTC. 1 FR2
PDSCH/PDCCH subcarrier spacing	kHz	120	120	120	120	120	120
EPRE ratio of PSS to SSS	dB	0	0	0	0	0	0
EPRE ratio of PBCH_DMRS to SSS							
EPRE ratio of PBCH to PBCH_DMRS							
EPRE ratio of PDCCH_DMRS to SSS							
EPRE ratio of PDCCH to PDCCH_DMRS							
EPRE ratio of PDSCH_DMRS to SSS							
EPRE ratio of PDSCH to PDSCH_DMRS							
EPRE ratio of OCNG DMRS to SSS ^{Note 1}							
\hat{E}_s / N_{oc}	dB	TBD	TBD	TBD	TBD	TBD	TBD
Note 1:	OCNG shall be used such that both cells are fully allocated and a constant total transmitted power spectral density is achieved for all OFDM symbols.						
Note 2:	Interference from other cells and noise sources not specified in the test is assumed to be constant over subcarriers and time and shall be modelled as AWGN of appropriate power for N_{oc} to be fulfilled.						
Note 3:	SS-SINR, SS-RSRP and I_o levels have been derived from other parameters for information purposes. They are not settable parameters themselves.						
Note 4:	SS-SINR and SS-RSRP minimum requirements are specified assuming independent interference and noise at each receiver antenna port.						

Table A. 5.7.2.2-3: SS-SINR Inter frequency OTA related test parameters

Parameter		Unit	Test 1		Test 2		Test 3	
			Cell 2	Cell 3	Cell 2	Cell 3	Cell 2	Cell 3
UE orientation around TBD axis and TBD axis		degrees	TBD		TBD		TBD	
Relative difference in angle of arrival of cell 2 relative to cell 1		degrees	NA	TBD	NA	0	NA	0
N_{oc} ^{Note1}	NR_TDD_FR2_A	dBm/15kHz ^{Note4}	TBD		TBD		TBD	
	NR_TDD_FR2_B						TBD	
	NR_TDD_FR2_F						TBD	
	NR_TDD_FR2_G						TBD	
	NR_TDD_FR2_T						TBD	
N_{oc} ^{Note1}	NR_TDD_FR2_A	dBm/SCS ^{Note3}	TBD		TBD		TBD	
	NR_TDD_FR2_B						TBD	
	NR_TDD_FR2_F						TBD	
	NR_TDD_FR2_G						TBD	
	NR_TDD_FR2_T						TBD	
SS-RSRP ^{Note2}	NR_TDD_FR2_A	dBm/SCS ^{Note4}	TBD	TBD	TBD	TBD	TBD	TBD
	NR_TDD_FR2_B						TBD	TBD
	NR_TDD_FR2_F						TBD	TBD
	NR_TDD_FR2_G						TBD	TBD
	NR_TDD_FR2_T						TBD	TBD
SS-SINR ^{Note2}	NR_TDD_FR2_A	dB	TBD	TBD	TBD	TBD	TBD	TBD
	NR_TDD_FR2_B						TBD	TBD
	NR_TDD_FR2_F						TBD	TBD
	NR_TDD_FR2_G						TBD	TBD
	NR_TDD_FR2_T						TBD	TBD
\hat{E}_s / I_{ot}	NR_TDD_FR2_A	dB	TBD	TBD	TBD	TBD	TBD	TBD
	NR_TDD_FR2_B						TBD	TBD
	NR_TDD_FR2_F						TBD	TBD
	NR_TDD_FR2_G						TBD	TBD
	NR_TDD_FR2_T						TBD	TBD
I_o ^{Note2}	NR_TDD_FR2_A	dBm/95.04 MHz ^{Note4}	TBD		TBD		TBD	
	NR_TDD_FR2_B						TBD	
	NR_TDD_FR2_F						TBD	
	NR_TDD_FR2_G						TBD	
	NR_TDD_FR2_T						TBD	
<p>Note 1: Interference from other cells and noise sources not specified in the test is assumed to be constant over subcarriers and time and shall be modelled as AWGN of appropriate power for N_{oc} to be fulfilled.</p> <p>Note 2: SS-SINR, SS-RSRP, and I_o levels have been derived from other parameters for information purposes. They are not settable parameters themselves.</p> <p>Note 3: SS-SINR and SS-RSRP minimum requirements are specified assuming independent interference and noise at each receiver antenna port.</p> <p>Note 4: Equivalent power received by an antenna with 0dBi gain at the centre of the quiet zone</p> <p>Note 5: As observed with 0dBi gain antenna at the centre of the quiet zone</p> <p>Note 6: NR operating band groups are as defined in Section 3.5.2.</p>								

A.5.7.3.2.3 Test Requirements

The SS-SINR measurement accuracy shall fulfil the requirements in section 10.1.15.1.1 and 10.1.15.1.2.

A.5.7.4 L1-RSRP measurement for beam reporting

A.5.7.4.1 SSB based L1-RSRP measurement

A.5.7.4.1.1 Test Purpose and Environment

The purpose of this test is to verify that the L1-RSRP measurement accuracy is within the specified limits. This test will verify the requirements in Sections 9.5.2 and section 10.1.20.1 for L1-RSRP measurements based on SSB with the testing configurations for NR cells in Table A.5.7.4.1.1-1.

The AoA setup for this test is Setup 1 as defined in section A.3.15.

Table A.5.7.4.1.1-1: Applicable NR configurations for FR2 SSB based L1-RSRP test

Config	Description
1	LTE FDD, NR 120 kHz SSB SCS, 100MHz bandwidth, TDD duplex mode
2	LTE TDD, NR 120 kHz SSB SCS, 100MHz bandwidth, TDD duplex mode
3	LTE FDD, NR 240 kHz SSB SCS, 100MHz bandwidth, TDD duplex mode
4	LTE TDD, NR 240 kHz SSB SCS, 100MHz bandwidth, TDD duplex mode
Note:	The UE is only required to be tested in one of the supported test configurations

A.5.7.4.1.2 Test parameters

In this set of test cases there are two cells in the test, E-UTRAN PCell (Cell 1), FR1 PSCell (Cell 2). The test parameters and applicability for Cell 1 are defined in A.3.7.2. The test parameters for the Cell 2 are given in Table A.5.7.4.1.2-1 and Table A.5.7.4.1.2-2 below. The absolute and relative accuracy of L1-RSRP measurements are tested by using the parameters in Table A.5.7.4.1.2-1 and Table A.5.7.4.1.2-2.

There is no measurement gap configured in the test. Before the test, UE is configured one SSB resource set with two SSB resources. UE is configured to perform RLM, BFD and L1-RSRP measurement based on the SSB resources 0 and 1. The TCI status for Cell 2 is defined in Table [TBD] and TRS configuration for Cell 2 is defined in Table [TBD].

Table A.5.7.4.1.2-1: FR2 SSB based L1-RSRP general test parameters

Parameter	Config	Unit	Test 1	Test 2
SSB GSCN	1~4		freq1	freq1
Duplex mode	1~4		TDD	TDD
TDD Configuration	1~4		TDDConf.3.1	TDDConf.3.1
$BW_{channel}$	1~4	MHz	100: $N_{RB,c} = 66$	100: $N_{RB,c} = 66$
PDSCH Reference measurement channel	1~4		SR.3.1 TDD	SR.3.1 TDD
RMSI CORESET Reference Channel	1~4		CR.3.1 TDD	CR.3.1 TDD
Dedicated CORESET Reference Channel	1~4		CCR.3.1 TDD	CCR.3.1 TDD
SSB configuration	1,2		SSB.1 FR2	SSB.1 FR2
	3,4		SSB.2 FR2	SSB.2 FR2
OCNG Patterns	1~4		OP.1	OP.1
Initial BWP Configuration	1~4		DLBWP.0.1	DLBWP.0.1
			ULBWP.0.1	ULBWP.0.1
Dedicated BWP configuration	1~4		DLBWP.1.3	DLBWP.1.3
			ULBWP.1.3	ULBWP.1.3
TRS Configuration	1~4		TRS.2.1 TDD	TRS.2.1 TDD
TCI Configuration	1~4		TCI.State.2	TCI.State.2
SMTC configuration	1~4		SMTC.1	SMTC.1
reportConfigType	1~4		periodic	periodic
reportQuantity	1~4		ssb-Index-RSRP	ssb-Index-RSRP
Number of reported RS	1~4		2	2
L1-RSRP reporting period	1~4		slot640	slot640
Propagation condition	1~4		AWGN	AWGN
EPRE ratio of PSS to SSS	1~4	dB	0	0
EPRE ratio of PBCH DMRS to SSS				
EPRE ratio of PBCH to PBCH DMRS				
EPRE ratio of PDCCH DMRS to SSS				
EPRE ratio of PDCCH to PDCCH DMRS				
EPRE ratio of PDSCH DMRS to SSS				
EPRE ratio of PDSCH to PDSCH DMRS				
EPRE ratio of OCNG DMRS to SSS ^{Note 1}				
EPRE ratio of OCNG to OCNG DMRS ^{Note 1}				
<p>Note 1: OCNG shall be used such that both cells are fully allocated and a constant total transmitted power spectral density is achieved for all OFDM symbols.</p> <p>Note 2: Interference from other cells and noise sources not specified in the test is assumed to be constant over subcarriers and time and shall be modelled as AWGN of appropriate power for N_{oc} to be fulfilled.</p>				

Table A.5.7.4.1.2-2: FR2 SSB based L1-RSRP OTA related test parameters

	Parameter	Config	Unit	Test 1	Test 2
N_{oc} Note1	NR_TDD_FR2_A	1~4	dBm/15kHz	TBD	TBD
	NR_TDD_FR2_B				TBD
	NR_TDD_FR2_F				TBD
	NR_TDD_FR2_G				TBD
	NR_TDD_FR2_T				TBD
	NR_TDD_FR2_Y				TBD
N_{oc} Note1	NR_TDD_FR2_A	1,2	dBm/SSB SCS	TBD	TBD
	NR_TDD_FR2_B				TBD
	NR_TDD_FR2_F				TBD

	NR_TDD_FR2_G				TBD			
	NR_TDD_FR2_T				TBD			
	NR_TDD_FR2_Y				TBD			
	NR_TDD_FR2_A	3,4		TBD	TBD			
	NR_TDD_FR2_B				TBD			
	NR_TDD_FR2_F				TBD			
	NR_TDD_FR2_G				TBD			
	NR_TDD_FR2_T				TBD			
	NR_TDD_FR2_Y				TBD			
								TBD
								TBD
	\hat{E}_s/I_{ot}	1~4	dB	TBD	TBD			
SSB RSRP Note1	NR_TDD_FR2_A	1,2	dBm/SSB SCS	TBD	TBD			
	NR_TDD_FR2_B				TBD			
	NR_TDD_FR2_F				TBD			
	NR_TDD_FR2_G				TBD			
	NR_TDD_FR2_T				TBD			
	NR_TDD_FR2_Y				TBD			
	NR_TDD_FR2_A	3,4		TBD	TBD			
	NR_TDD_FR2_B				TBD			
	NR_TDD_FR2_F				TBD			
	NR_TDD_FR2_G				TBD			
	NR_TDD_FR2_T				TBD			
	NR_TDD_FR2_Y				TBD			
I _o Note1	NR_TDD_FR2_A	1,2	dBm/95.04M Hz	TBD	TBD			
	NR_TDD_FR2_B				TBD			
	NR_TDD_FR2_F				TBD			
	NR_TDD_FR2_G				TBD			
	NR_TDD_FR2_T				TBD			
	NR_TDD_FR2_Y				TBD			
	NR_TDD_FR2_A	3,4		TBD	TBD			
	NR_TDD_FR2_B				TBD			
	NR_TDD_FR2_F				TBD			
	NR_TDD_FR2_G				TBD			
	NR_TDD_FR2_T				TBD			
	NR_TDD_FR2_Y				TBD			
	\hat{E}_s/N_{oc}	1~4	dB	TBD	TBD			
Note 1:	RSRP and I _o levels have been derived from other parameters for information purposes. They are not settable parameters themselves.							
Note 2:	RSRP minimum requirements are specified assuming independent interference and noise at each receiver antenna port.							

A.5.7.4.1.3 Test Requirements

For at least one reported L1-RSRP during 480ms, the accuracy for SSB#0 and SSB#1 of Cell 2 shall fulfil the requirements in sections 10.1.20.1. The reported L1-RSRP value shall include the Rx antenna gain in the range of TBD.

A.5.7.4.2 CSI-RS based L1-RSRP measurement on resource set with repetition off

A.5.7.4.2.1 Test Purpose and Environment

The purpose of this test is to verify that the L1-RSRP measurement accuracy is within the specified limits. This test will verify the requirements in Sections 9.5.3 and section 10.1.20.2 for L1-RSRP measurements based on CSI-RS with the testing configurations for NR cells in Table A.5.7.4.2.1-1.

The AoA setup for this test is Setup 1 as defined in section A.3.15.

Table A.5.7.4.2.1-1: Applicable NR configurations for FR2 CSI-RS based L1-RSRP test

Config	Description
1	LTE FDD, NR 120 kHz CSI-RS SCS, 100MHz bandwidth, TDD duplex mode
2	LTE TDD, NR 120 kHz CSI-RS SCS, 100MHz bandwidth, TDD duplex mode
Note: The UE is only required to be tested in one of the supported test configurations	

A.5.7.4.2.2 Test parameters

In this set of test cases there are two cells in the test, E-UTRAN PCell (Cell 1), FR1 PCell (Cell 2). The test parameters and applicability for Cell 1 are defined in A.3.7.2. The test parameters for the Cell 2 are given in Table A.5.7.4.2.2-1 and Table A.5.7.4.2.2-2 below. The absolute and relative accuracy of L1-RSRP measurements are tested by using the parameters in Table A.5.7.4.2.2-1 and Table A.5.7.4.2.2-2.

There is no measurement gap configured in the test. Before the test, UE is configured one CSI-RS resource set with two CSI-RS resources. UE is configured to perform RLM and BFD based on SSB 0 and 1. CSI-RS is not transmitted in the same OFDM symbols as SSB. The TCI status for Cell 2 is defined in Table [TBD] and TRS configuration for Cell 2 is defined in Table [TBD].

Table A.5.7.4.2.2-1: FR2 CSI-RS based L1-RSRP general test parameters

Parameter	Config	Unit	Test 1	Test 2
SSB GSCN	1~2		freq1	freq1
Duplex mode	1~2		TDD	TDD
TDD Configuration	1~2		TDDConf.3.1	TDDConf.3.1
BW _{channel}	1~2	MHz	100: N _{RB,c} = 66	100: N _{RB,c} = 66
PDSCH Reference measurement channel	1~2		SR.3.1 TDD	SR.3.1 TDD
RMSI CORESET Reference Channel	1~2		CR.3.1 TDD	CR.3.1 TDD
Dedicated CORESET Reference Channel	1~2		CCR.3.1 TDD	CCR.3.1 TDD
SSB configuration	1~2		SSB.1 FR2	SSB.1 FR2
OCNG Patterns	1~2		OP.1	OP.1
Initial BWP Configuration	1~2		DLBWP.0.1 ULBWP.0.1	DLBWP.0.1 ULBWP.0.1
Dedicated BWP configuration	1~2		DLBWP.1.3 ULBWP.1.3	DLBWP.1.3 ULBWP.1.3
TRS Configuration	1~2		TRS.2.1 TDD	TRS.2.1 TDD
TCI Configuration	1~2		TCI.State.2	TCI.State.2
SMTC configuration	1~2		SMTC.1	SMTC.1
CSI-RS	1~2		CSI-RS.3.2 TDD	CSI-RS.3.2 TDD
reportConfigType	1~2		periodic	periodic
reportQuantity	1~2		cri-RSRP	cri-RSRP
Number of reported RS	1~2		2	2
L1-RSRP reporting period	1~2		slot640	slot640
Propagation condition	1~2		AWGN	AWGN
EPRE ratio of PSS to SSS	1~2	dB	0	0
EPRE ratio of PBCH DMRS to SSS				
EPRE ratio of PBCH to PBCH DMRS				
EPRE ratio of PDCCH DMRS to SSS				
EPRE ratio of PDCCH to PDCCH DMRS				
EPRE ratio of PDSCH DMRS to SSS				
EPRE ratio of PDSCH to PDSCH DMRS				
EPRE ratio of OCNG DMRS to SSS ^{Note 1}				
EPRE ratio of OCNG to OCNG DMRS ^{Note 1}				
Note 1: OCNG shall be used such that both cells are fully allocated and a constant total transmitted power spectral density is achieved for all OFDM symbols.				
Note 2: Interference from other cells and noise sources not specified in the test is assumed to be constant over subcarriers and time and shall be modelled as AWGN of appropriate power for N_{oc} to be fulfilled.				

Table A.5.7.4.2.2-2: FR2 CSI-RS based L1-RSRP OTA related test parameters

Parameter	Config	Unit	Test 1	Test 2
N_{oc} Note2	NR_TDD_FR2_A	1~2	dBm/15kHz	TBD
	NR_TDD_FR2_B			TBD
	NR_TDD_FR2_F			TBD
	NR_TDD_FR2_G			TBD
	NR_TDD_FR2_T			TBD
	NR_TDD_FR2_Y			TBD
	NR_TDD_FR2_A	1~2	dBm/CSI-RS SCS	TBD
	NR_TDD_FR2_B			TBD

N_{oc} Note2	NR_TDD_FR2_F				TBD
	NR_TDD_FR2_G				TBD
	NR_TDD_FR2_T				TBD
	NR_TDD_FR2_Y				TBD
\hat{E}_s/I_{ot}		1~2	dB	TBD	TBD
CSI-RS RSRP Note3	NR_TDD_FR2_A	1~2	dBm/CSI-RS SCS	TBD	TBD
	NR_TDD_FR2_B				TBD
	NR_TDD_FR2_F				TBD
	NR_TDD_FR2_G				TBD
	NR_TDD_FR2_T				TBD
I_o Note3	NR_TDD_FR2_A	1~2	dBm/95.04M Hz	TBD	TBD
	NR_TDD_FR2_B				TBD
	NR_TDD_FR2_F				TBD
	NR_TDD_FR2_G				TBD
	NR_TDD_FR2_T				TBD
\hat{E}_s/N_{oc}		1~2	dB	TBD	TBD
Note 1: RSRP and I_o levels have been derived from other parameters for information purposes. They are not settable parameters themselves.					
Note 2: RSRP minimum requirements are specified assuming independent interference and noise at each receiver antenna port.					

A.5.7.4.2.3 Test Requirements

The L1-RSRP measurement accuracy for CSI-RS#0 and CSI-RS#1 of Cell 2 shall fulfil the requirements in sections 10.1.20.2. The reported L1-RSRP value shall include the Rx antenna gain in the range of TBD.

A.5.8 PSCell addition and release delay

A.5.8.1 Addition and Release Delay of NR PSCell

A.5.8.1.1 Test purpose and environment

The purpose of this test is to verify that the NR PSCell addition and release delays under EN-DC are within the requirements stated in section 7.31.2 of TS 36.133 [15] for the case when the PSCell is unknown by the UE at the time of addition.

Supported test configurations are shown in A.5.8.1.1-1. The test parameters for the E-UTRA cell are given in Table A.3.7.2.1-1. The E-UTRA cell once set up is not changed across time.

The test parameters for NR cell are given in Tables A.5.8.1.1-2 and cell-specific parameters in A.5.8.1.1-3 below. The test consists of four successive time periods with duration of T1, T2, T3 and T4. There are two carriers each with one cell. Before the test starts the UE is connected to Cell 1 (E-UTRA PCell) on radio channel 1 (PCC) but is not aware of Cell 2 (NR PSCell) on radio channel 2. The UE is only monitoring the PCC. During T1 only Cell1 is known to the UE.

The test system shall send a RRC message to the UE to add PSCell (Cell 2) on radio channel 2. The RRC message (to add PSCell) also includes a request for the UE to start periodic CSI reporting for the PSCell after the PSCell has been successfully added. The RRC message to add PSCell shall be sent to the UE during period T1. The point in time at which the RRC message to add PSCell (Cell2) is received at the UE antenna connector defines the start of period T2.

The test system shall observe the periodic reporting of CSI for PSCell during T3. The point in time at which the UE has sent PRACH to the PSCell (Cell 2) defines the start of period T3.

The test system shall send a RRC message to the UE to release PSCell (Cell 2) on radio channel 2. The RRC message to release PSCell (Cell2) shall be sent to the UE during period T3, after the UE has sent at least one CQI report with non-zero CQI index for PSCell (Cell 2). The point in time at which the RRC message to release PSCell (Cell2) is received at the UE antenna connector defines the start of period T4.

Table A.5.8.1.1-1: Supported test configurations for FR2 PSCell

Configuration	Description
1	LTE FDD, NR TDD, SSB SCS 240 kHz, data SCS 120kHz, BW 100MHz
2	LTE TDD, NR TDD, SSB SCS 240 kHz, data SCS 120kHz, BW 100MHz
Note:	The UE is only required to be tested in one of the supported test configurations

Table A.5.8.1.1-2: General Test Parameters for PSCell Addition and Release

Parameter	Unit	Value	Comment	
RF Channel Number		1, 2	Two radio channels are used for this test. One for E-UTRA cell and second for NR Cell	
Initial Condition	Active PCell	Cell1	PCell on RF channel number 1.	
	Neighbour cell	Cell2	Neighbour cell on RF channel number 2.	
Final Condition	Active PCell	Cell1	PCell on RF channel number 1.	
	Neighbour Cell	Cell2	PSCell on RF channel number 2.	
A4	Hysteresis	dB	0	Hysteresis for evaluation of event A4.
	Threshold RSRP	dBm	-93	Actual RSRP threshold for event A4. Needs to take absolute accuracy tolerance in section 9.1.11.1 into account plus margin.
	Time to Trigger	s	0	
DRX		OFF	Continuous monitoring of primary cell	
PRACH configuration on cell2		FR2 configuration 2	Captured in [A.3.8.3.2]	
CQI/PMI periodicity and offset configuration index on cell2		TBD	CQI reporting for PSCell every uplink subframe	
Cell-individual offset for cells on RF channel number 1	dB	0	Individual offset for cells on primary component carrier.	
Cell-individual offset for cells on RF channel number 2	dB	0	Individual offset for cells on carrier frequency of cell2.	
T1	s	5	During this time the PCell shall be known and cell2 shall be unknown.	
T2	s	1	During this time the UE adds the PSCell.	
T3	s	1	During this time the UE sends CSI reports for PSCell.	
T4	s	1	During this time the UE releases the PSCell.	

Table A.5.8.1.1-3: Cell Specific Parameters for PSCell Addition and Release

Parameter	Unit	Config	Test			
			T1	T2	T3	T4
E-UTRA Channel Number		1,2	1			
NR Channel Number		1,2	2			
Duplex Mode		1,2	TDD			
TDD configuration		1,2	TDDConf.1.2			
BW _{channel}	MHz	1,2	100: NRB,c = 66			
Initial BWP Configuration		1,2	DLBWP.0.1 ULBWP.0.1			
Dedicated BWP Configuration		1,2	DLBWP.1.1 ULBWP.1.1			
TRS Configuration		1	TRS.2.1 TDD			
TCI State		1	CSI-RS.Config.0			
PDSCH Reference measurement channel		1,2	SR.3.1 TDD			
RMSI CORESET Reference Channel		1,2	CR.3.1 TDD			
Dedicated CORESET Reference Channel		1,2	CCR.3.1 TDD			
OCNG Patterns		1,2	OP.1			
SSB configuration		1,2	SSB.1 FR2			
SMTc configuration		1,2	SMTc.2			
EPRE ratio of PSS to SSS	dB	1,2	0			
EPRE ratio of PBCH DMRS to SSS						
EPRE ratio of PBCH to PBCH DMRS						
EPRE ratio of PDCCH DMRS to SSS						
EPRE ratio of PDCCH to PDCCH DMRS						
EPRE ratio of PDSCH DMRS to SSS						
EPRE ratio of PDSCH to PDSCH						
EPRE ratio of OCNG DMRS to SSS(Note 1)						
EPRE ratio of OCNG to OCNG DMRS (Note 1)						
N_{oc} ^{Note2}						
N_{oc} ^{Note2}	dBm/SCS	1,2	N/A	TBD		
\hat{E}_s/I_{ot}		1,2	-infinity	TBD		
\hat{E}_s/N_{oc}		1,2	-infinity	TBD		
SS-RSRP ^{Note3}	dBm/SCS	1,2	-infinity	TBD		
I_o ^{Note3}	dBm/95MHz	1,2	N/A	TBD		
Propagation condition		1,2	AWGN			

A.5.8.1.2 Test Requirements

The UE shall transmit the PRACH to PSCell at latest [732] ms^{Note1} into T2.

The UE shall send at least one CSI report for PSCell with non-zero CQI index during T4.

The UE shall periodically send CSI reports for PSCell after the UE has sent first CQI report with non-zero CQI index during T4

The UE shall stop sending CSI reports for PSCell in at latest [20] ms into T5.

All the above test requirements shall be fulfilled for the observed PSCell addition delay and PSCell release delay to be counted as correct. The rate of correct observed PSCell addition delay and PSCell release delay during repeated tests shall be at least 90%.

Note1: The PSCell addition delay can be expressed as follows as specified in Clause 7.31.2 of TS 36.133 [15]:

$$T_{\text{config_PSCell}} = T_{\text{RRC_delay}} + T_{\text{processing}} + T_{\text{search}} + T_{\Delta} + T_{\text{PSCell_DU}} + 2\text{ms}$$

Where:

$$T_{\text{RRC_delay}} = 20\text{ms}$$

$$T_{\text{processing}} = 40\text{ms}$$

$$T_{\text{search}} = 8 \times 3 \times 20 = 480 \text{ ms}$$

$$T_{\Delta} = 20\text{ms}$$

$$T_{\text{PSCell_DU}} = 16 \times 10 + 10 = 170 \text{ ms}$$

A.6 NR standalone tests with all NR cells in FR1

A.6.1 SA: RRC_IDLE state mobility

A.6.1.1 Cell re-selection to NR

A.6.1.1.1 Cell reselection to FR1 intra-frequency NR case

A.6.1.1.1.1 Test Purpose and Environment

This test is to verify the requirement for the intra frequency NR cell reselection requirements specified in clause 4.2.2.3.

A.6.1.1.1.2 Test Parameters

The test scenario comprises of 1 NR carrier and 2 cells as given in tables A.6.1.1.1.2-1, A.6.1.1.1.2-2 and A.6.1.1.1.2-3. The test consists of three successive time periods, with time duration of T1, T2, and T3 respectively. Only cell 1 is already identified by the UE prior to the start of the test. Cell 1 and cell 2 belong to different tracking areas. Furthermore, UE has not registered with network for the tracking area containing cell 2.

Table A.6.1.1.1.2-1: Supported test configurations

Configuration	Description
1	15 kHz SSB SCS, 10MHz bandwidth, FDD duplex mode
2	15 kHz SSB SCS, 10MHz bandwidth, TDD duplex mode
3	30 kHz SSB SCS, 40MHz bandwidth, TDD duplex mode
Note: The UE is only required to be tested in one of the supported test configurations.	

Table A.6.1.1.1.2-2: General test parameters for intra frequency NR cell re-selection test case

Parameter		Unit	Test configuration	Value	Comment
Initial condition	Active cell		1, 2, 3	Cell1	
	Neighbour cells		1, 2, 3	Cell2	
T2 end condition	Active cell		1, 2, 3	Cell2	
	Neighbour cells		1, 2, 3	Cell1	
Final condition	Active cell		1, 2, 3	Cell1	
RF Channel Number			1, 2, 3	1	
Time offset between cells			1	3 ms	Asynchronous cells
			2	3 μ s	Synchronous cells
			3	3 μ s	Synchronous cells
Access Barring Information		-	1, 2, 3	Not Sent	No additional delays in random access procedure.
SSB configuration			1	SSB.1 FR1	
			2	SSB.1 FR1	
			3	SSB.2 FR1	
SMTC configuration			1	SMTC pattern 2	
			2	SMTC pattern 1	
			3	SMTC pattern 1	

DRX cycle length	s	1, 2, 3	1.28	The value shall be used for all cells in the test.
PRACH configuration index		1, 2, 3	87	The detailed configuration is specified in TS 38.211 clause 6.3.3.2
rangeToBestCell		1, 2, 3	Not configured	
T1	s	1, 2, 3	>7	During T1, Cell 2 shall be powered off, and during the off time the physical cell identity shall be changed, The intention is to ensure that Cell 2 has not been detected by the UE prior to the start of period T2
T2	s	1, 2, 3	40	T2 needs to be defined so that cell re-selection reaction time is taken into account.
T3	s	1, 2, 3	15	T3 needs to be defined so that cell re-selection reaction time is taken into account.

Table A.6.1.1.1.2-3: Cell specific test parameters for intra frequency NR cell re-selection test case in AWGN

Parameter	Unit	Test configuration	Cell 1			Cell 2		
			T1	T2	T3	T1	T2	T3
TDD configuration		1	N/A			N/A		
		2	TDDConf.1.1			TDDConf.1.1		
		3	TDDConf.2.1			TDDConf.2.1		
PDSCH RMC configuration		1	SR.1.1 FDD			N/A		
		2	SR.1.1 TDD					
		3	SR.2.1 TDD					
RMSI CORESET RMC configuration		1	CR.1.1 FDD			CR.1.1 FDD		
		2	CR.1.1 TDD			CR.1.1 TDD		
		3	CR.2.1 TDD			CR.2.1 TDD		
Dedicated CORESET RMC configuration		1	CCR.1.1 FDD			CCR.1.1 FDD		
		2	CCR.1.1 TDD			CCR.1.1 TDD		
		3	CCR.2.1 TDD			CCR.2.1 TDD		
OCNG Pattern		1, 2, 3	OP.1 defined in A.3.2.1			OP.1 defined in A.3.2.1		
Initial DL BWP configuration		1, 2, 3	DLBWP.0.1			DLBWP.0.1		
Initial UL BWP configuration		1, 2, 3	ULBWP.0.1			ULBWP.0.1		
RLM-RS		1, 2, 3	SSB			SSB		
Qrxlevmin	dBm/SCS	1, 2	-140			-140		
		3	-137			-137		
Pcompensation	dB	1, 2, 3	0			0		
Qhysts	dB	1, 2, 3	0			0		
Qoffsets _{s, n}	dB	1, 2, 3	0			0		
Cell_selection_and_reselection_quality_measurement		1, 2, 3	SS-RSRP			SS-RSRP		
\hat{E}_s / I_{ot}	dB	1	16	-3.11	2.79	-infinity	2.79	-3.11
		2						
		3						
N_{oc} ^{Note2}	dBm/SCS	1	-98					
		2	-98					
		3	-95					
N_{oc} ^{Note2}	dBm/15 kHz	1	-98					
		2						
		3						
\hat{E}_s / N_{oc}	dB	1	16	13	16	-infinity	16	13
		2						
		3						
SS-RSRP ^{Note3}	dBm/SCS	1	-82	-85	-82	-infinity	-82	-85
		2	-82	-85	-82	-infinity	-82	-85
		3	-79	-82	-79	-infinity	-79	-82
I _o	dBm/9.36 MHz	1	-53.94	-52.21	-52.21	-infinity	-52.21	-52.21
	dBm/9.36 MHz	2	-53.94	-52.21	-52.21	-infinity	-52.21	-52.21
	dBm/38.16 MHz	3	-47.85	-46.12	-46.12	-infinity	-46.12	-46.12
Treselection	s	1, 2, 3	0	0	0	0	0	0
Sintrasearch	dB	1, 2, 3	Not sent			Not sent		
Propagation Condition		1, 2, 3	AWGN					

Note 1: OCNG shall be used such that both cells are fully allocated and a constant total transmitted power spectral density is achieved for all OFDM symbols.

Note 2: Interference from other cells and noise sources not specified in the test is assumed to be constant over subcarriers and time and shall be modelled as AWGN of appropriate power for N_{oc} to be fulfilled.

Note 3: SS-RSRP levels have been derived from other parameters for information purposes. They are not settable parameters themselves.

A.6.1.1.1.3 Test Requirements

The cell reselection delay to a newly detectable cell is defined as the time from the beginning of time period T2, to the moment when the UE camps on Cell 2, and starts to send preambles on the PRACH for sending the RRC CONNECTION REQUEST message to perform a Tracking Area Update procedure on Cell 2.

The cell re-selection delay to a newly detectable cell shall be less than 34 s.

The cell reselection delay to an already detected cell is defined as the time from the beginning of time period T3, to the moment when the UE camps on cell 1, and starts to send preambles on the PRACH for sending the RRC CONNECTION REQUEST message to perform a Tracking Area Update procedure on cell 1.

The cell re-selection delay to an already detected cell shall be less than 8 s.

The rate of correct cell reselections observed during repeated tests shall be at least 90%.

NOTE: The cell re-selection delay to a newly detectable cell can be expressed as: $T_{\text{detect, NR_Intra}} + T_{\text{SI-NR}}$, and to an already detected cell can be expressed as: $T_{\text{evaluate, NR_intra}} + T_{\text{SI-NR}}$,

Where:

$T_{\text{detect, NR_Intra}}$ See Table 4.2.2.3-1 in clause 4.2.2.3

$T_{\text{evaluate, NR_intra}}$ See Table 4.2.2.3-1 in clause 4.2.2.3

$T_{\text{SI-NR}}$ Maximum repetition period of relevant system info blocks that needs to be received by the UE to camp on a cell; 1280ms is assumed in this test case.

This gives a total of 33.28 s, allow 34 s for the cell re-selection delay to a newly detectable cell and 7.68 s for the cell re-selection delay to an already detected cell in the test case, which we allow 8 s.

A.6.1.1.2 Cell reselection to FR1 inter-frequency NR case

A.6.1.1.2.1 Test Purpose and Environment

This test is to verify the requirement for the inter frequency NR cell reselection requirements specified in clause 4.2.2.4.

A.6.1.1.2.2 Test Parameters

The test scenario comprises of 2 cells on 2 different NR carriers respectively as given in tables A.6.1.1.2.2-1, A.6.1.1.2.2-2 and A.6.1.1.2.2-3. The test consists of three successive time periods, with time duration of T1, T2, and T3 respectively. Both cell 1 and cell 2 are already identified by the UE prior to the start of the test. Cell 1 and cell 2 belong to different tracking areas and cell 2 is of higher priority than cell 1.

Table A.6.1.1.2.2-1: Supported test configurations

Configuration	Description of serving cell	Description of target cell
1	15 kHz SSB SCS, 10MHz bandwidth, FDD duplex mode	15 kHz SSB SCS, 10MHz bandwidth, FDD duplex mode
2	15 kHz SSB SCS, 10MHz bandwidth, TDD duplex mode	15 kHz SSB SCS, 10MHz bandwidth, TDD duplex mode
3	30 kHz SSB SCS, 40MHz bandwidth, TDD duplex mode	30 kHz SSB SCS, 40MHz bandwidth, TDD duplex mode
Note:	The UE is only required to be tested in one of the supported test configurations.	

Table A.6.1.1.2.2-2: General test parameters for FR1 inter frequency NR cell re-selection test case

Parameter		Unit	Test configuration	Value	Comment
Initial condition	Active cell		1, 2, 3	Cell2	The UE camps on cell 2 in the initial phase and during T1 period the UE reselects to cell 1
T1 end condition	Active cell		1, 2, 3	Cell1	The UE shall perform reselection to cell 1 during T1
	Neighbour cells		1, 2, 3	Cell2	
T3 end condition	Active cell		1, 2, 3	Cell2	The UE shall perform reselection to cell 2 with higher priority during T3
RF Channel Number			1, 2, 3	1, 2	
Time offset between cells			1	3 ms	Asynchronous cells
			2	3 μ s	Synchronous cells
			3	3 μ s	Synchronous cells
Access Barring Information		-	1, 2, 3	Not Sent	No additional delays in random access procedure.
SSB configuration			1	SSB.1 FR1	
			2	SSB.1 FR1	
			3	SSB.2 FR1	
SMTC configuration			1	SMTC pattern 2	
			2	SMTC pattern 1	
			3	SMTC pattern 1	
DRX cycle length		s	1, 2, 3	1.28	The value shall be used for all cells in the test.
PRACH configuration index			1, 2, 3	87	The detailed configuration is specified in TS 38.211 clause 6.3.3.2
rangeToBestCell			1, 2, 3	Not configured	
T1		s	1, 2, 3	15	T1 needs to be defined so that cell re-selection reaction time is taken into account.
T2		s	1, 2, 3	>7	During T2, cell 2 shall be powered off, and during the off time the physical cell identity shall be changed. The intention is to ensure that cell 2 has not been detected by the UE prior to the start of period T3.
T3		s	1, 2, 3	75	T3 needs to be defined so that cell re-selection reaction time is taken into account.

Table A.6.1.1.2.2-3: Cell specific test parameters for FR1 inter frequency NR cell re-selection test case in AWGN

Parameter	Unit	Test configuration	Cell 1			Cell 2		
			T1	T2	T3	T1	T2	T3
TDD configuration		1	N/A			N/A		
		2	TDDConf.1.1			TDDConf.1.1		
		3	TDDConf.2.1			TDDConf.2.1		
PDSCH RMC configuration		1	SR.1.1 FDD			N/A		
		2	SR.1.1 TDD					
		3	SR.2.1 TDD					
RMSI CORESET RMC configuration		1	CR.1.1 FDD			CR.1.1 FDD		
		2	CR.1.1 TDD			CR.1.1 TDD		
		3	CR.2.1 TDD			CR.2.1 TDD		

Dedicated CORESET RMC configuration		1	CCR.1.1 FDD			CCR.1.1 FDD		
		2	CCR.1.1 TDD			CCR.1.1 TDD		
		3	CCR.2.1 TDD			CCR.2.1 TDD		
OCNG Pattern		1, 2, 3	OP.1 defined in A.3.2.1			OP.1 defined in A.3.2.1		
Initial DL BWP configuration		1, 2, 3	DLBWP.0.1			DLBWP.0.1		
Initial UL BWP configuration		1, 2, 3	ULBWP.0.1			ULBWP.0.1		
RLM-RS		1, 2, 3	SSB			SSB		
Qrxlevmin	dBm/SCS	1, 2	-140			-140		
		3	-137			-137		
Pcompensation	dB	1, 2, 3	0			0		
Qhysts	dB	1, 2, 3	0			0		
Qoffset _{s, n}	dB	1, 2, 3	0			0		
Cell_selection_and_reselection_quality_measurement		1, 2, 3	SS-RSRP			SS-RSRP		
\hat{E}_s / I_{ot}	dB	1	14	14	14	-4	-infinity	12
		2						
		3						
N_{oc} Note2	dBm/SCS	1	-98					
		2	-98					
		3	-95					
N_{oc} Note2	dBm/15 kHz	1	-98					
		2						
		3						
\hat{E}_s / N_{oc}	dB	1	14	14	14	-4	-infinity	12
		2						
		3						
SS-RSRP Note3	dBm/SCS	1	-84	-84	-84	-102	-infinity	-86
		2	-84	-84	-84	-102	-infinity	-86
		3	-81	-81	-81	-99	-infinity	-83
I _o	dBm/9.36 MHz	1	-55.88	-55.88	-55.88	-68.60	-infinity	-57.78
	dBm/9.36 MHz	2	-55.88	-55.88	-55.88	-68.60	-infinity	-57.78
	dBm/38.16 MHz	3	-49.79	-49.79	-49.79	-62.50	-infinity	-51.69
Treselection	s	1, 2, 3	0	0	0	0	0	0
Snonintrasearch	dB	1, 2, 3	50			Not sent		
Thresh _{x, high}	dB	1, 2, 3	48			48		
Thresh _{servng, low}	dB	1, 2, 3	44			44		
Thresh _{x, low}	dB	1, 2, 3	50			50		
Propagation Condition		1, 2, 3	AWGN					
Note 1:	OCNG shall be used such that both cells are fully allocated and a constant total transmitted power spectral density is achieved for all OFDM symbols.							
Note 2:	Interference from other cells and noise sources not specified in the test is assumed to be constant over subcarriers and time and shall be modelled as AWGN of appropriate power for N_{oc} to be fulfilled.							
Note 3:	SS-RSRP levels have been derived from other parameters for information purposes. They are not settable parameters themselves.							

A.6.1.1.2.3 Test Requirements

The cell reselection delay to a higher priority cell is defined as the time from the beginning of time period T3, to the moment when the UE camps again on cell 2, and starts to send preambles on the PRACH for sending the RRC CONNECTION REQUEST message to perform a Tracking Area Update procedure on cell 2.

The cell re-selection delay to a higher priority cell shall be less than 68 s.

The cell reselection delay to a lower priority cell is defined as the time from the beginning of time period T1, to the moment when the UE camps on cell 1, and starts to send preambles on the PRACH for sending the RRC CONNECTION REQUEST message to perform a Tracking Area Update procedure on cell 1.

The cell re-selection delay to a lower priority cell shall be less than 8 s.

The rate of correct cell reselections observed during repeated tests shall be at least 90%.

NOTE: The cell re-selection delay to a higher priority cell can be expressed as: $T_{\text{higher_priority_search}} + T_{\text{evaluate, NR_inter}} + T_{\text{SI-NR}}$, and to a lower priority cell can be expressed as: $T_{\text{evaluate, NR_inter}} + T_{\text{SI-NR}}$.

Where:

$T_{\text{higher_priority_search}}$	See clause 4.2.2.7
$T_{\text{evaluate, NR_inter}}$	See Table 4.2.2.4-1 in clause 4.2.2.4
$T_{\text{SI-NR}}$	Maximum repetition period of relevant system info blocks that needs to be received by the UE to camp on a cell; 1280 ms is assumed in this test case.

This gives a total of 67.68 s, allow 68 s for the cell re-selection delay to a higher priority cell and 7.68 s for the cell re-selection delay to a lower priority cell in the test case, which we allow 8 s.

A.6.1.2 Inter-RAT E-UTRAN cell re-selection

A.6.1.2.1 Cell reselection to higher priority E-UTRAN

A.6.1.2.1.1 Test Purpose and Environment

This test is to verify the requirement for the NR to E-UTRAN inter-RAT cell reselection requirements specified in clause 4.2.2.5 when the E-UTRAN cell is of higher priority.

A.6.1.2.1.2 Test Parameters

The test scenario comprises of one NR cell and one E-UTRAN cell as given in tables A.6.1.2.1.2-1, A.6.1.2.1.2-2, A.6.1.2.1.2-3 and A.6.1.2.1.2-4. The test consists of three successive time periods, with time duration of T1, T2, and T3 respectively. NR cell 1 is already identified by the UE prior to the start of the test. E-UTRAN cell 2 is of higher priority than cell 1.

Table A.6.1.2.1.2-1: Supported test configurations

Configuration	Description of serving cell	Description of target cell
1	NR 15 kHz SSB SCS, 10MHz bandwidth, FDD duplex mode	LTE 10MHz bandwidth, TDD duplex mode
2	NR 15 kHz SSB SCS, 10MHz bandwidth, TDD duplex mode	LTE 10MHz bandwidth, TDD duplex mode
3	NR 30 kHz SSB SCS, 40MHz bandwidth, TDD duplex mode	LTE 10MHz bandwidth, TDD duplex mode
4	NR 15 kHz SSB SCS, 10MHz bandwidth, FDD duplex mode	LTE 10MHz bandwidth, FDD duplex mode
5	NR 15 kHz SSB SCS, 10MHz bandwidth, TDD duplex mode	LTE 10MHz bandwidth, FDD duplex mode
6	NR 30 kHz SSB SCS, 40MHz bandwidth, TDD duplex mode	LTE 10MHz bandwidth, FDD duplex mode
Note: The UE is only required to be tested in one of the supported test configurations.		

Table A.6.1.2.1.2-2: General test parameters for NR to E-UTRAN cell re-selection test case

Parameter		Unit	Test configuration	Value	Comment
Initial condition	Active cell		1, 2, 3, 4, 5, 6	Cell1	The UE camps on cell 1 in the initial phase and during T2 period the UE reselects to cell 2.
T2 end condition	Active cell		1, 2, 3, 4, 5, 6	Cell2	The UE shall perform reselection to cell 2 during T2.
	Neighbour cells		1, 2, 3, 4, 5, 6	Cell1	
T3 end condition	Active cell		1, 2, 3, 4, 5, 6	Cell1	The UE shall perform reselection to cell 1 during T3 for iteration of the tests.
	Neighbour cells		1, 2, 3, 4, 5, 6	Cell2	
Access Barring Information		-	1, 2, 3, 4, 5, 6	Not Sent	No additional delays in random access procedure.
DRX cycle length		s	1, 2, 3, 4, 5, 6	1.28	The value shall be used for all cells in the test.
NR PRACH configuration index			1, 2, 3, 4, 5, 6	87	The detailed configuration is specified in TS 38.211 clause 6.3.3.2
E-UTRAN PRACH configuration index			1, 2, 3, 4, 5, 6	4	As specified in table 5.7.1-2 in TS 36.211
T1		s	1, 2, 3, 4, 5, 6	>7	During T1, cell 2 shall be powered off, and during the off time the physical cell identity shall be changed. The intention is to ensure that cell 2 has not been detected by the UE prior to the start of period T2.
T2		s	1, 2, 3, 4, 5, 6	75	T2 needs to be defined so that cell re-selection reaction time is taken into account.
T3		s	1, 2, 3, 4, 5, 6	15	T3 needs to be defined so that cell re-selection reaction time is taken into account.

Table A.6.1.2.1.2-3: Cell specific test parameters for NR cell 1

Parameter	Unit	Test configuration	Cell 1		
			T1	T2	T3
TDD configuration		1, 4	N/A		
		2, 5	TDDConf.1.1		
		3, 6	TDDConf.2.1		
PDSCH parameters		1, 4	SR.1.1 FDD		
		2, 5	SR.1.1 TDD		
		3, 6	SR.2.1 TDD		
RMSI CORESET parameters		1, 4	CR.1.1 FDD		
		2, 5	CR.1.1 TDD		
		3, 6	CR.2.1 TDD		
Dedicated CORESET parameters		1, 4	CCR.1.1 FDD		
		2, 5	CCR.1.1 TDD		
		3, 6	CCR.2.1 TDD		
SSB parameters		1, 4	SSB.1 FR1		
		2, 5	SSB.1 FR1		
		3, 6	SSB.2 FR1		
NR SMTC parameters		1, 4	SMTC pattern 2		
		2, 5	SMTC pattern 1		
		3, 6	SMTC pattern 1		

OCNG Pattern		1, 2, 3, 4, 5, 6	OP.1 defined in A.3.2.1		
Initial DL BWP configuration		1, 2, 3, 4, 5, 6	DLBWP.0		
Initial UL BWP configuration		1, 2, 3, 4, 5, 6	ULBWP.0		
RLM-RS		1, 2, 3, 4, 5, 6	SSB		
Qrxlevmin	dBm/SCS	1, 2, 4, 5	-140		
		3, 6	-137		
N_{oc}	dBm/SCS	1, 4	-98		
		2, 5	-98		
		3, 6	-95		
N_{oc}	dBm/15 kHz	1, 2, 3, 4, 5, 6	-98		
SS-RSRP	dBm/SCS	1, 4	-84	-84	-84
		2, 5	-84	-84	-84
		3, 6	-81	-81	-81
\hat{E}_s / I_{ot}	dB	1, 4	14	14	14
		2, 5			
		3, 6			
\hat{E}_s / N_{oc}	dB	1, 4	14	14	14
		2, 5			
		3, 6			
Io	dBm/9.36 MHz	1, 4	-55.88	-55.88	-55.88
	dBm/9.36 MHz	2, 5	-55.88	-55.88	-55.88
	dBm/38.16 MHz	3, 6	-49.79	-49.79	-49.79
Treselection	S	1, 2, 3, 4, 5, 6	0		
Snointrasearch	dB	1, 2, 3, 4, 5, 6	50		
Thresh _{x, high} (Note 2)	dB	1, 2, 3, 4, 5, 6	48		
Thresh _{servicing, low}	dB	1, 2, 3, 4, 5, 6	44		
Thresh _{x, low}	dB	1, 2, 3, 4, 5, 6	50		
Propagation Condition		1, 2, 3, 4, 5, 6	AWGN		
Note 1:	OCNG shall be used such that both cells are fully allocated and a constant total transmitted power spectral density is achieved for all OFDM symbols.				
Note 2:	This refers to the value of Thresh _{x, high} which is included in NR system information, and is a threshold for the E-UTRA target cell				

Table A.6.1.2.1.2-4: Cell specific test parameters for E-UTRA cell 2

Parameter	Unit	Cell 2		
		T1	T2	T3
E-UTRA RF Channel number		1		
BW _{channel}	MHz	10		
OCNG Patterns defined in TS 36.133 clause A.3.2		OP.2 TDD for test configuration 1, 2, 3; OP.2 FDD for test configuration 4, 5, 6		
PBCH_RA	dB	0		
PBCH_RB	dB			
PSS_RA	dB			
SSS_RA	dB			
PCFICH_RB	dB			
PHICH_RA	dB			
PHICH_RB	dB			
PDCCH_RA	dB			
PDCCH_RB	dB			
PDSCH_RA	dB			
PDSCH_RB	dB			
OCNG_RA ^{Note 1}	dB			
OCNG_RB ^{Note 1}	dB			

Qrxlevmin	dBm	-140		
N_{oc}	dBm/15 kHz	-98		
RSRP	dBm/15 KHz	-infinity	-86	-102
\hat{E}_s / I_{ot}	dB	-infinity	12	-4
\hat{E}_s / N_{oc}	dB	-infinity	12	-4
Treselection _{EUTRAN}	S	0		
Snonintrasearch	dB	Not sent		
Thresh _{x, high} (Note 2)	dB	48		
Thresh _{-serving, low}	dB	44		
Thresh _{x, low}	dB	50		
Propagation Condition		AWGN		
<p>Note 1: OCNG shall be used such that both cells are fully allocated and a constant total transmitted power spectral density is achieved for all OFDM symbols.</p> <p>Note 2: This refers to the value of Thresh_{x, high} which is included in E-UTRA system information, and is a threshold for the NR target cell</p>				

A.6.1.2.1.3 Test Requirements

The cell reselection delay to a higher priority E-UTRAN cell is defined as the time from the beginning of time period T2, to the moment when the UE camps on cell 2, and starts to send preambles on the PRACH for sending the RRC CONNECTION REQUEST message to perform a Tracking Area Update procedure on cell 2.

The cell re-selection delay to a higher priority cell shall be less than 68 s.

The rate of correct cell reselections observed during repeated tests shall be at least 90%.

NOTE: The cell re-selection delay to a higher priority cell can be expressed as: $T_{\text{higher_priority_search}} + T_{\text{evaluate, E-UTRAN}} + T_{\text{SI-E-UTRA}}$,

Where:

$T_{\text{higher_priority_search}}$ See clause 4.2.2.7

$T_{\text{evaluate, E-UTRAN}}$ See Table 4.2.2.5-1 in clause 4.2.2.5

$T_{\text{SI-E-UTRA}}$ Maximum repetition period of relevant system info blocks that needs to be received by the UE to camp on a cell; 1280 ms is assumed in this test case.

This gives a total of 67.68 s, allow 68 s for the cell re-selection delay to a higher priority E-UTRAN cell.

A.6.1.2.2 Cell reselection to lower priority E-UTRAN

A.6.1.2.2.1 Test Purpose and Environment

This test is to verify the requirement for the NR to E-UTRAN inter-RAT cell reselection requirements specified in clause 4.2.2.5 when the E-UTRAN cell is of lower priority.

A.6.1.2.2.2 Test Parameters

The test scenario comprises of one NR cell and one E-UTRAN cell as given in tables A.6.1.2.2.2-1, A.6.1.2.2.2-2, A.6.1.2.2.2-3 and A.6.1.2.2.2-4. The test consists of three successive time periods, with time duration of T1 and T2 respectively. Both NR cell 1 and E-UTRAN cell 2 are already identified by the UE prior to the start of the test. E-UTRAN cell 2 is of lower priority than cell 1.

Table A.6.1.2.2-1: Supported test configurations

Configuration	Description of serving cell	Description of target cell
1	NR 15 kHz SSB SCS, 10MHz bandwidth, FDD duplex mode	LTE 10MHz bandwidth, TDD duplex mode
2	NR 15 kHz SSB SCS, 10MHz bandwidth, TDD duplex mode	LTE 10MHz bandwidth, TDD duplex mode
3	NR 30 kHz SSB SCS, 40MHz bandwidth, TDD duplex mode	LTE 10MHz bandwidth, TDD duplex mode
4	NR 15 kHz SSB SCS, 10MHz bandwidth, FDD duplex mode	LTE 10MHz bandwidth, FDD duplex mode
5	NR 15 kHz SSB SCS, 10MHz bandwidth, TDD duplex mode	LTE 10MHz bandwidth, FDD duplex mode
6	NR 30 kHz SSB SCS, 40MHz bandwidth, TDD duplex mode	LTE 10MHz bandwidth, FDD duplex mode

Note: The UE is only required to be tested in one of the supported test configurations.

Table A.6.1.2.2-2: General test parameters for NR to E-UTRAN cell re-selection test case

Parameter		Unit	Test configuration	Value	Comment
Initial condition	Active cell		1, 2, 3, 4, 5, 6	Cell2	The UE camps on cell 1 in the initial phase.
T1 end condition	Active cell		1, 2, 3, 4, 5, 6	Cell2	The UE shall perform reselection to cell 2 during T1.
	Neighbour cells		1, 2, 3, 4, 5, 6	Cell1	
T2 end condition	Active cell		1, 2, 3, 4, 5, 6	Cell1	The UE shall perform reselection to cell 1 during T2 for iteration of the tests.
	Neighbour cells		1, 2, 3, 4, 5, 6	Cell2	
Access Barring Information		-	1, 2, 3, 4, 5, 6	Not Sent	No additional delays in random access procedure.
DRX cycle length		s	1, 2, 3, 4, 5, 6	1.28	The value shall be used for all cells in the test.
NR PRACH configuration index			1, 2, 3, 4, 5, 6	87	The detailed configuration is specified in TS 38.211 clause 6.3.3.2
E-UTRAN PRACH configuration index			1, 2, 3, 4, 5, 6	4	As specified in table 5.7.1-2 in TS 36.211
T1		s	1, 2, 3, 4, 5, 6	15	T1 needs to be defined so that cell re-selection reaction time is taken into account.
T2		s	1, 2, 3, 4, 5, 6	75	T2 needs to be defined so that cell re-selection reaction time is taken into account.

Table A.6.1.2.2.2-3: Cell specific test parameters for NR cell 1

Parameter	Unit	Test configuration	Cell 1	
			T1	T2
TDD configuration		1, 4	N/A	
		2, 5	TDDConf.1.1	
		3, 6	TDDConf.2.1	
PDSCH RMC configuration		1, 4	SR.1.1 FDD	
		2, 5	SR.1.1 TDD	
		3, 6	SR.2.1 TDD	
RMSI CORESET RMC configuration		1, 4	CR.1.1 FDD	
		2, 5	CR.1.1 TDD	
		3, 6	CR.2.1 TDD	
Dedicated CORESET RMC configuration		1, 4	CCR.1.1 FDD	
		2, 5	CCR.1.1 TDD	
		3, 6	CCR.2.1 TDD	
SSB configuration		1, 4	SSB.1 FR1	
		2, 5	SSB.1 FR1	
		3, 6	SSB.2 FR1	
SMTC configuration		1, 4	SMTC pattern 2	
		2, 5	SMTC pattern 1	
		3, 6	SMTC pattern 1	
OCNG Pattern		1, 2, 3, 4, 5, 6	OP.1 defined in A.3.2.1	
Initial DL BWP configuration		1, 2, 3, 4, 5, 6	DLBWP.0	
Initial UL BWP configuration		1, 2, 3, 4, 5, 6	ULBWP.0	
RLM-RS		1, 2, 3, 4, 5, 6	SSB	
Qrxlevmin	dBm/SCS	1, 2, 4, 5	-140	
		3, 6	-137	
N_{oc}	dBm/SCS	1, 4	-98	
		2, 5	-98	
		3, 6	-95	
N_{oc}	dBm/15 kHz	1, 2, 3, 4, 5, 6	-98	
SS-RSRP	dBm/SCS	1, 4	-102	-86
		2, 5	-102	-86
		3, 6	-99	-83
\hat{E}_s/I_{ot}	dB	1, 4	-4	12
		2, 5		
		3, 6		
\hat{E}_s/N_{oc}	dB	1, 4	-4	12
		2, 5		
		3, 6		
Io	dBm/9.36 MHz	1, 4	-68.60	-57.78
	dBm/9.36 MHz	2, 5	-68.60	-57.78
	dBm/38.16 MHz	3, 6	-62.50	-51.69
Treselection	S	1, 2, 3, 4, 5, 6	0	
Snonintrasearch	dB	1, 2, 3, 4, 5, 6	50	
Thresh _{x, high} (Note 2)	dB	1, 2, 3, 4, 5, 6	48	
Thresh _{-serving, low}	dB	1, 2, 3, 4, 5, 6	44	
Thresh _{x, low}	dB	1, 2, 3, 4, 5, 6	50	
Propagation Condition		1, 2, 3, 4, 5, 6	AWGN	
Note 1: OCNG shall be used such that both cells are fully allocated and a constant total transmitted power spectral density is achieved for all OFDM symbols.				
Note 2: This refers to the value of Thresh _{x, high} which is included in NR system information, and is a threshold for the E-UTRA target cell				

Table A.6.1.2.2.2-4: Cell specific test parameters for E-UTRA cell 2

Parameter	Unit	Cell 2	
		T1	T2 T3
E-UTRA RF Channel number		1	
BW_{channel}	MHz	10	
OCNG Patterns defined in TS 36.133 clause A.3.2		OP.2 TDD for test configuration 1, 2, 3; OP.2 FDD for test configuration 4, 5, 6	
PBCH_RA	dB	0	
PBCH_RB	dB		
PSS_RA	dB		
SSS_RA	dB		
PCFICH_RB	dB		
PHICH_RA	dB		
PHICH_RB	dB		
PDCCH_RA	dB		
PDCCH_RB	dB		
PDSCH_RA	dB		
PDSCH_RB	dB		
OCNG_RA ^{Note 1}	dB		
OCNG_RB ^{Note 1}	dB		
Q_{rxlevmin}	dBm	-140	
N_{oc}	dBm/15 kHz	-98	
RSRP	dBm/15 KHz	-84	-84
\hat{E}_s / I_{ot}	dB	14	14
\hat{E}_s / N_{oc}	dB	14	14
$T_{\text{reselectionEUTRAN}}$	S	0	
$S_{\text{nonintrasearch}}$	dB	Not sent	
$\text{Thresh}_{x, \text{high}}$ (Note 2)	dB	48	
$\text{Thresh}_{\text{servicing, low}}$	dB	44	
$\text{Thresh}_{x, \text{low}}$	dB	50	
Propagation Condition		AWGN	
Note 1: OCNG shall be used such that both cells are fully allocated and a constant total transmitted power spectral density is achieved for all OFDM symbols. Note 2: This refers to the value of $\text{Thresh}_{x, \text{high}}$ which is included in E-UTRA system information, and is a threshold for the NR target cell			

A.6.1.2.2.3 Test Requirements

The cell reselection delay to a lower priority E-UTRAN cell is defined as the time from the beginning of time period T1, to the moment when the UE camps on cell 2, and starts to send preambles on the PRACH for sending the RRC CONNECTION REQUEST message to perform a Tracking Area Update procedure on cell 2.

The cell re-selection delay to a lower priority cell shall be less than 8 s.

The rate of correct cell reselections observed during repeated tests shall be at least 90%.

NOTE: The cell re-selection delay to a lower priority cell can be expressed as: $T_{\text{evaluate, E-UTRAN}} + T_{\text{SI-E-UTRA}}$,

Where:

$T_{\text{evaluate, E-UTRAN}}$ See Table 4.2.2.5-1 in clause 4.2.2.5

$T_{\text{SI-E-UTRA}}$ Maximum repetition period of relevant system info blocks that needs to be received by the UE to camp on a cell; 1280 ms is assumed in this test case.

This gives a total of 7.68 s, allow 8 s for the cell re-selection delay to a lower priority E-UTRAN cell.

A.6.2 SA: RRC_INACTIVE state mobility

A.6.3 RRC_CONNECTED state mobility

A.6.3.1 Handover

A.6.3.1.1 Intra-frequency handover from FR1 to FR1; known target cell

A.6.3.1.1.1 Test Purpose and Environment

This test is to verify the requirement for the NR FR1-NR FR1 intra frequency handover requirements specified in clause 6.1.1.2 [v15.2.1].

A.6.3.1.1.2 Test Parameters

Supported test configurations are shown in table A.6.3.1.1.2-1. Both handover delay and interruption length are tested by using the parameters in table A.6.3.1.1.2-2, and A.6.3.1.1.2-3.

The test consists of three successive time periods, with time durations of T1, T2 and T3 respectively. At the start of time duration T1, the UE may not have any timing information of cell 2.

NR shall send a RRC message implying handover to cell 2. The RRC message implying handover shall be sent to the UE during period T2, after the UE has reported Event A3. T3 is defined as the end of the last TTI containing the RRC message implying handover.

Table A.6.3.1.1.2-1: Intra-frequency handover from FR1 to FR1 test configurations

Config	Description
1	Source cell: NR 15 kHz SSB SCS, 10MHz bandwidth, FDD duplex mode Target cell: NR 15 kHz SSB SCS, 10MHz bandwidth, FDD duplex mode
2	Source cell: NR 15 kHz SSB SCS, 10MHz bandwidth, TDD duplex mode Target cell: NR 15 kHz SSB SCS, 10MHz bandwidth, TDD duplex mode
3	Source cell: NR 30 kHz SSB SCS, 40MHz bandwidth, TDD duplex mode Target cell: NR 30 kHz SSB SCS, 40MHz bandwidth, TDD duplex mode
Note:	The UE is only required to be tested in one of the supported test configurations

Table A.6.3.1.1.2-2: General test parameters Intra-frequency handover from FR1 to FR1

Parameter	Unit	Value	Comment
Initial conditions	Active cell	Cell 1	
	Neighbouring cell	Cell 2	
Final condition	Active cell	Cell 2	
A3-Offset	dB	0	
Hysteresis	dB	0	
Time To Trigger	s	0	
Filter coefficient		0	L3 filtering is not used
Access Barring Information	-	Not Sent	No additional delays in random access procedure.
PRACH configuration index		TBD	As specified in table Table 6.3.3.2-3 in TS 38.211
Time offset between cells		3 μ s	Synchronous cells

T1	s	5	
T2	s	≤5	

Table A.6.3.1.1.2-3: Cell specific test parameters for NR FR1-FR1 Intra frequency handover test case

Parameter		Unit	Cell 1			Cell 2		
			T1	T2	T3	T1	T2	T3
NR RF Channel Number			1			1		
Duplex mode	Config 1		FDD					
	Config 2,3		TDD					
TDD configuration	Config 1		Not Applicable					
	Config 2		TDDConf.1.1					
	Config 3		TDDConf.2.1					
BW _{channel}	Config 1	MHz	10: N _{RB,c} = 52					
	Config 2		10: N _{RB,c} = 52					
	Config 3		40: N _{RB,c} = 106					
BWP BW	Config 1	MHz	10: N _{RB,c} = 52					
	Config 2		10: N _{RB,c} = 52					
	Config 3		40: N _{RB,c} = 106					
DRx Cycle		ms	Not Applicable					
PDSCH Reference measurement channel	Config 1		SR.1.1 FDD					
	Config 2		SR.1.1 TDD					
	Config 3		SR2.1 TDD					
CORESET Reference Channel	Config 1		CR.1.1 FDD					
	Config 2		CR.1.1 TDD					
	Config 3		CR2.1 TDD					
OCNG Patterns			OCNG pattern 1					
SMTC configuration	Config 1,2		SMTC.1 FR1					
	Config 3		SMTC.2 FR1					
PDSCH/PDCCH subcarrier spacing	Config 1,2	kHz	15 kHz					
	Config 3		30 kHz					
PUCCH/PUSCH subcarrier spacing	Config 1,2	kHz	15 kHz					
	Config 3		30 kHz					
PRACH configuration			FR1 PRACH configuration 1					
BWP configuraiton	Initial DL BWP		DLBWP.0.1					
	Dedicated DL BWP		DLBWP.1.1					
	Initial UL BWP		ULBWP.0.1					
	Dedicated UL BWP		ULBWP.1.1					
EPRE ratio of PSS to SSS		dB	0					
EPRE ratio of PBCH DMRS to SSS								
EPRE ratio of PBCH to PBCH DMRS								
EPRE ratio of PDCCH DMRS to SSS								
EPRE ratio of PDCCH to PDCCH DMRS								
EPRE ratio of PDSCH DMRS to SSS								
EPRE ratio of PDSCH to PDSCH								
EPRE ratio of OCNG DMRS to SSS(Note 1)								
EPRE ratio of OCNG to OCNG DMRS (Note 1)								
N_{oc}^{Note2}		dBm/15kHz	-98					
N_{oc}^{Note2}	Config 1,2	dBm/SCS	-98					
	Config 3		-95					
\hat{E}_s/I_{ot}		dB	8	-3.3	-3.3	-	2.36	2.36

\hat{E}_s / N_{oc}		dB	8	8	8	- Infinity	11	11
I _o Note3	Config 1,2	dBm/ 9.36MHz	-64.7	-60.87	-60.87	-64.7	-60.87	-60.87
	Config 3	dBm/ 38.16MHz	-60.55	-57.36	-57.36	-60.55	-57.36	-57.36
Propagation condition		-	AWGN					
Note 1: OCNG shall be used such that both cells are fully allocated and a constant total transmitted power spectral density is achieved for all OFDM symbols.								
Note 2: Interference from other cells and noise sources not specified in the test is assumed to be constant over subcarriers and time and shall be modelled as AWGN of appropriate power for N_{oc} to be fulfilled.								
Note 3: I _o levels have been derived from other parameters for information purposes. They are not settable parameters themselves.								

A.6.3.1.1.3 Test Requirements

The UE shall start to transmit the PRACH to Cell 2 less than [220] ms from the beginning of time period T3. The rate of correct handovers observed during repeated tests shall be at least 90%.

NOTE: The handover delay can be expressed as: RRC procedure delay + T_{interrupt}, where:

RRC procedure delay = [10] ms and is specified in clause 12 in TS 38.331 [2].

T_{interrupt} = [210] ms in the test. T_{interrupt} is defined in clause 6.1.1.2.2 [TS38.133].

This gives a total of [220] ms.

A.6.3.1.2 Intra-frequency handover from FR1 to FR1; unknown target cell

A.6.3.1.2.1 Test Purpose and Environment

This test is to verify the requirement for the NR FR1-NR FR1 intra frequency handover requirements specified in clause 6.1.1.2 [v15.2.1].

A.6.3.1.2.2 Test Parameters

Supported test configurations are shown in table A.6.3.1.2.2-1. Both handover delay and interruption length are tested by using the parameters in table A.6.3.1.2.2-2, and A.6.3.1.2.2-3.

The test scenario comprises of two carriers and one cell on each carrier. No gap patterns are configured in the test case. The test consists of two successive time periods, with time durations of T1, T2 respectively. At the start of time duration T1, the UE does not have any timing information of cell 2. Starting T2, cell 2 becomes detectable and the UE receives a RRC handover command from the network. The start of T2 is the instant when the last TTI containing the RRC message implying handover is sent to the UE.

Table A.6.3.1.2.2-1: Intra-frequency handover from FR1 to FR1 test configurations

Config	Description
1	Source cell: NR 15 kHz SSB SCS, 10MHz bandwidth, FDD duplex mode Target cell: NR 15 kHz SSB SCS, 10MHz bandwidth, FDD duplex mode
2	Source cell: NR 15 kHz SSB SCS, 10MHz bandwidth, TDD duplex mode Target cell: NR 15 kHz SSB SCS, 10MHz bandwidth, TDD duplex mode
3	Source cell: NR 30 kHz SSB SCS, 40MHz bandwidth, TDD duplex mode Target cell: NR 30 kHz SSB SCS, 40MHz bandwidth, TDD duplex mode
Note:	The UE is only required to be tested in one of the supported test configurations

Table A.6.3.1.2.2-2: General test parameters Intra-frequency handover from FR1 to FR1

Parameter		Unit	Value	Comment
Initial conditions	Active cell		Cell 1	
	Neighbouring cell		Cell 2	
Final condition	Active cell		Cell 2	
A3-Offset		dB	0	
Hysteresis		dB	0	
Time To Trigger		s	0	
Filter coefficient			0	L3 filtering is not used
Access Barring Information		-	Not Sent	No additional delays in random access procedure.
PRACH configuration index			TBD	As specified in table Table 6.3.3.2-3 in TS 38.211
Time offset between cells			3 μ s	Synchronous cells
T1		s	5	
T2		s	≤ 5	

Table A.6.3.1.2.2-3: Cell specific test parameters for NR FR1-FR1 Intra frequency handover test case

Parameter		Unit	Cell 1		Cell 2	
			T1	T2	T1	T2
NR RF Channel Number			1		1	
Duplex mode	Config 1		FDD			
	Config 2,3		TDD			
TDD configuration	Config 1		Not Applicable			
	Config 2		TDDConf. 1.1			
	Config 3		TDDConf. 2.1			
BW _{channel}	Config 1	MHz	10: N _{RB,c} = 52			
	Config 2		10: N _{RB,c} = 52			
	Config 3		40: N _{RB,c} = 106			
BWP BW	Config 1	MHz	10: N _{RB,c} = 52			
	Config 2		10: N _{RB,c} = 52			
	Config 3		40: N _{RB,c} = 106			
DRx Cycle		ms	Not Applicable			
PDSCH Reference measurement channel	Config 1		SR.1.1 FDD			
	Config 2		SR.1.1 TDD			
	Config 3		SR2.1 TDD			
CORESET Reference Channel	Config 1		CR.1.1 FDD			
	Config 2		CR.1.1 TDD			
	Config 3		CR2.1 TDD			
OCNG Patterns			OCNG pattern 1			
SMTC configuration	Config 1,2		SMTC.1 FR1			
	Config 3		SMTC.2 FR1			
PDSCH/PDCCH subcarrier spacing	Config 1,2	kHz	15 kHz			
	Config 3		30 kHz			
PUCCH/PUSCH subcarrier spacing	Config 1,2	kHz	15 kHz			
	Config 3		30 kHz			
PRACH configuration			FR1 PRACH configuration 1			
BWP configuration	Initial DL BWP		DLBWP.0.1			
	Dedicated DL BWP		DLBWP.1.1			
	Initial UL BWP		ULBWP.0.1			
	Dedicated UL BWP		ULBWP.1.1			
EPRE ratio of PSS to SSS		dB	0			
EPRE ratio of PBCH DMRS to SSS						
EPRE ratio of PBCH to PBCH DMRS						

EPRE ratio of PDCCH DMRS to SSS						
EPRE ratio of PDCCH to PDCCH DMRS						
EPRE ratio of PDSCH DMRS to SSS						
EPRE ratio of PDSCH to PDSCH						
EPRE ratio of OCNG DMRS to SSS(Note 1)						
EPRE ratio of OCNG to OCNG DMRS (Note 1)						
N_{oc} Note2		dBm/15kHz	-98			
N_{oc} Note2	Config 1,2	dBm/SCS	-98			
	Config 3		-95			
\hat{E}_s / I_{ot}		dB	8	-0.64	-Infinity	-0.64
\hat{E}_s / N_{oc}		dB	8	8	-Infinity	8
I_o Note3	Config 1,2	dBm/ 9.36MHz	-64.7	-62.37	-64.7	-62.37
	Config 3	dBm/ 38.16MHz	-60.55	-58.66	-60.55	-58.66
Propagation condition		-	AWGN			
Note 1: OCNG shall be used such that both cells are fully allocated and a constant total transmitted power spectral density is achieved for all OFDM symbols.						
Note 2: Interference from other cells and noise sources not specified in the test is assumed to be constant over subcarriers and time and shall be modelled as AWGN of appropriate power for N_{oc} to be fulfilled.						
Note 3: I_o levels have been derived from other parameters for information purposes. They are not settable parameters themselves.						

A.6.3.1.2.3 Test Requirements

The UE shall start to transmit the PRACH to Cell 2 less than [282] ms from the beginning of time period T2. The rate of correct handovers observed during repeated tests shall be at least 90%.

NOTE: The handover delay can be expressed as: RRC procedure delay + $T_{interrupt}$, where:

RRC procedure delay = [50] ms and is specified in clause 12 in TS 38.331 [2].

$T_{interrupt}$ = [232] ms in the test. $T_{interrupt}$ is defined in clause 6.1.1.2.2 [TS38.133].

This gives a total of [282] ms.

A.6.3.1.3 Inter-frequency handover from FR1 to FR1; unknown target cell

A.6.3.1.3.1 Test Purpose and Environment

This test is to verify the requirement for the NR FR1-NR FR1 inter frequency handover requirements specified in clause 6.1.1.2 [TS38.133].

A.6.3.1.3.2 Test Parameters

Supported test configurations are shown in table A.6.3.1.3.2-1. Both handover delay and interruption length are tested by using the parameters in table A.6.3.1.3.2-2, and A.6.3.1.3.2-3.

The test scenario comprises of two carriers and one cell on each carrier. No gap patterns are configured in the test case. The test consists of two successive time periods, with time durations of T1, T2 respectively. At the start of time duration T1, the UE does not have any timing information of cell 2. Starting T2, cell 2 becomes detectable and the UE receives a RRC handover command from the network. The start of T2 is the instant when the last TTI containing the RRC message implying handover is sent to the UE.

Table A.6.3.1.3.2-1: Inter-frequency handover from FR1 to FR1 test configurations

Config	Description
1	Source cell: NR 15 kHz SSB SCS, 10MHz bandwidth, FDD duplex mode Target cell: NR 15 kHz SSB SCS, 10MHz bandwidth, FDD duplex mode
2	Source cell: NR 15 kHz SSB SCS, 10MHz bandwidth, TDD duplex mode Target cell: NR 15 kHz SSB SCS, 10MHz bandwidth, TDD duplex mode
3	Source cell: NR 30 kHz SSB SCS, 40MHz bandwidth, TDD duplex mode Target cell: NR 30 kHz SSB SCS, 40MHz bandwidth, TDD duplex mode
Note: The UE is only required to be tested in one of the supported test configurations	

Table A.6.3.1.3.2-2: General test parameters Inter-frequency handover from FR1 to FR1

Parameter	Unit	Value	Comment
Initial conditions	Active cell	Cell 1	
	Neighbouring cell	Cell 2	
Final condition	Active cell	Cell 2	
A3-Offset	dB	-4	
Hysteresis	dB	0	
Time To Trigger	s	0	
Filter coefficient		0	L3 filtering is not used
Access Barring Information	-	Not Sent	No additional delays in random access procedure.
T1	s	5	
T2	s	≤5	

Table A.6.3.1.3.2-3: Cell specific test parameters for NR FR1-FR1 Inter frequency handover test case

Parameter	Unit	Cell 1		Cell 2	
		T1	T2	T1	T2
NR RF Channel Number		1		2	
Duplex mode	Config 1	FDD			
	Config 2,3	TDD			
TDD configuration	Config 1	Not Applicable			
	Config 2	TDDConf.1.1			
	Config 3	TDDConf.2.1			
BW _{channel}	Config 1	10: N _{RB,c} = 52			
	Config 2	10: N _{RB,c} = 52			
	Config 3	40: N _{RB,c} = 106			
BWP BW	Config 1	10: N _{RB,c} = 52			
	Config 2	10: N _{RB,c} = 52			
	Config 3	40: N _{RB,c} = 106			
DRx Cycle	ms	Not Applicable			
PDSCH Reference measurement channel	Config 1	SR.1.1 FDD			
	Config 2	SR.1.1 TDD			
	Config 3	SR2.1 TDD			
CORESET Reference Channel	Config 1	CR.1.1 FDD			
	Config 2	CR.1.1 TDD			
	Config 3	CR2.1 TDD			
OCNG Patterns		OCNG pattern 1			
SMTC configuration	Config 1,2	SMTC.1 FR1			
	Config 3	SMTC.2 FR1			
PDSCH/PDCCH subcarrier spacing	Config 1,2	15 kHz			
	Config 3	30 kHz			
PUCCH/PUSCH subcarrier spacing	Config 1,2	15 kHz			
	Config 3	30 kHz			
PRACH configuration		FR1 PRACH configuration 1			

BWP	Initial DL BWP		DLBWP.0.1			
	Dedicated DL BWP		DLBWP.1.1			
	Initial UL BWP		ULBWP.0.1			
	Dedicated UL BWP		ULBWP.1.1			
EPRE ratio of PSS to SSS		dB	0			
EPRE ratio of PBCH DMRS to SSS						
EPRE ratio of PBCH to PBCH DMRS						
EPRE ratio of PDCCH DMRS to SSS						
EPRE ratio of PDCCH to PDCCH DMRS						
EPRE ratio of PDSCH DMRS to SSS						
EPRE ratio of PDSCH to PDSCH						
EPRE ratio of OCNG DMRS to SSS(Note 1)						
EPRE ratio of OCNG to OCNG DMRS (Note 1)						
N_{oc} ^{Note2}						
N_{oc} ^{Note2}	Config 1,2	dBm/SCS	-98			
	Config 3		-95			
\hat{E}_s / I_{ot}		dB	4	4	-Infinity	5
\hat{E}_s / N_{oc}		dB	4	4	-Infinity	5
I_o ^{Note3}	Config 1,2	dBm/9.36MHz	-67.11	-67.11	-70.05	-66.59
	Config 3	dBm/38.16MHz	-62.27	-62.27	-63.96	-61.92
Propagation condition		-	AWGN			
Note 1: OCNG shall be used such that both cells are fully allocated and a constant total transmitted power spectral density is achieved for all OFDM symbols.						
Note 2: Interference from other cells and noise sources not specified in the test is assumed to be constant over subcarriers and time and shall be modelled as AWGN of appropriate power for N_{oc} to be fulfilled.						
Note 3: I_o levels have been derived from other parameters for information purposes. They are not settable parameters themselves.						

A.6.3.1.3.3 Test Requirements

The UE shall start to transmit the PRACH to Cell 2 less than [282] ms from the beginning of time period T2. The rate of correct handovers observed during repeated tests shall be at least 90%.

NOTE: The handover delay can be expressed as: RRC procedure delay + $T_{interrupt}$, where:

RRC procedure delay = [10] ms and is specified in clause 12 in TS 38.331 [2].

$T_{interrupt}$ = [272] ms in the test. $T_{interrupt}$ is defined in clause 6.1.1.2.2 [TS38.133].

This gives a total of [282] ms.

A.6.3.1.4 SA NR - E-UTRAN handover

A.6.3.1.4.1 Test Purpose and Environment

The purpose of this set of tests is to verify that the UE can make correct inter-RAT E-UTRAN handover when operating in standalone (SA) operation with PCell in FR1. This test shall verify the NR to E-UTRAN handover requirements as specified in section 6.1.2.1.

The test comprises of one NR carrier and one E-UTRA carrier. There are two cells and one cell on each carrier. Cell 1 is the NR PCell and Cell 2 is an inter-RAT E-UTRAN neighbour cell. The test consists of three successive time

periods, with time durations of T1, T2 and T3 respectively. At the start of time duration T1, the UE does not have any timing information of Cell 2. Starting T2, Cell 2 becomes detectable and the UE is expected to detect and send a measurement report. Gap pattern configuration with id #0 as specified in Table 9.1.2-1 is configured before T2 begins to enable inter-RAT frequency monitoring.

A RRC message implying handover shall be sent to the UE during period T2 after the UE has reported Event B2. The start of T3 is the instant when the last TTI containing the RRC message implying handover is sent to the UE. The handover message shall contain Cell 2 as the target cell.

Supported test configurations are shown in table A.6.3.1.4-1. General test parameters are provided in Table A.6.3.1.4-2. Cell specific test parameters for Cell 1 and Cell 2 are provided in Tables A.6.3.1.4-3 and A.6.3.1.4-4 respectively.

Table A.6.3.1.4-1: Supported test configurations for SA inter-RAT E-UTRAN handover tests

Configuration	Description
1	NR 15 kHz SSB SCS, 10MHz bandwidth, FDD duplex mode, LTE FDD
2	NR 15 kHz SSB SCS, 10MHz bandwidth, TDD duplex mode, LTE FDD
3	NR 30 kHz SSB SCS, 40MHz bandwidth, TDD duplex mode, LTE FDD
4	NR 15 kHz SSB SCS, 10MHz bandwidth, FDD duplex mode, LTE TDD
5	NR 15 kHz SSB SCS, 10MHz bandwidth, TDD duplex mode, LTE TDD
6	NR 30kHz SSB SCS, 40MHz bandwidth, TDD duplex mode, LTE TDD
Note:	The UE is only required to be tested in one of the supported test configurations

Table A.6.3.1.4-2: General test parameters for SA inter-RAT E-UTRAN handover

Parameter	Unit	Value	Comment
NR RF Channel Number		1	1 NR carrier frequency is used in the test
LTE RF Channel Number		2	1 E-UTRAN carrier frequency is used in the test
Initial conditions	Active cell	Cell 1	NR cell
	Neighbouring cell	Cell 2	E-UTRAN cell
Final condition	Active cell	Cell 2	
NR measurement quantity		SS-RSRP	
E-UTRAN measurement quantity		RSRP	
b2-Threshold1	dBm	As specified in Table A.6.3.1.4-3	Absolute NR SS-RSRP threshold for event B2
b2-Threshold2EUTRAN	dBm	-98	Absolute E-UTRAN RSRP threshold for event B2
Hysteresis	dB	0	
TimeToTrigger	s	0	
Filter coefficient		0	L3 filtering is not used
DRX		OFF	Non-DRX test
Access Barring Information	-	Not sent	No additional delays in random access procedure
Time offset between cells		3 ms	Asynchronous cells
Gap pattern configuration Id		0	As specified in Table 9.1.2-1 started before T2 starts
T1	s	5	
T2	s	≤5	

Table A.6.3.1.4-3: Cell specific test parameters for SA inter-RAT E-UTRA handover (Cell 1)

Parameter	Unit	Configuration	Cell 1		
			T1	T2	T3
RF channel number		1, 2, 3, 4, 5, 6	1		
Duplex mode		1, 4	FDD		

TDD Configuration			2, 3, 5, 6	TDD		
			2, 5	TDDConf.1.1		
			3, 6	TDDConf.1.2		
BW_{channel}		MHz	1, 4	10: $N_{\text{RB},c} = 52$ (FDD)		
			2, 5	10: $N_{\text{RB},c} = 52$ (TDD)		
			3, 6	40: $N_{\text{RB},c} = 106$ (TDD)		
PDSCH reference measurement channel			1, 4	SR.1.1 FDD		
			2, 5	SR.1.1 TDD		
			3, 6	SR.2.1 TDD		
CORSET reference channel			1, 4	CR.1.1 FDD		
			2, 5	CR.1.1 TDD		
			3, 6	CR.2.1 TDD		
OCNG pattern ^{Note1}			1, 2, 3, 4, 5, 6	OP.1		
BWP			1, 2, 3, 4, 5, 6	DLBWP.0.1		
				DLBWP.1.1		
				ULBWP.0.1		
				ULBWP.1.1		
SMTc configuration			1, 2, 3, 4, 5, 6	SMTc.1		
SSB configuration			1, 2, 4, 5	SSB.1 FR1		
			3, 6	SSB.2 FR1		
b2-Threshold1		dBm	1, 2, 4, 5	-90		
			3, 6	-87		
EPRE ratio of PSS to SSS		dB	1, 2, 3, 4, 5, 6	0		
EPRE ratio of PBCH_DMRS to SSS						
EPRE ratio of PBCH to PBCH_DMRS						
EPRE ratio of PDCCH_DMRS to SSS						
EPRE ratio of PDCCH to PDCCH_DMRS						
EPRE ratio of PDSCH_DMRS to SSS						
EPRE ratio of PDSCH to PDSCH_DMRS						
EPRE ratio of OCNG DMRS to SSS						
EPRE ratio of OCNG to OCNG DMRS						
N_{oc} ^{Note2}						
N_{oc} ^{Note2}		dBm/SCS	1, 2, 4, 5	-98		
			3, 6	-95		
\hat{E}_s/N_{oc}		dB	1, 2, 3, 4, 5, 6	0	0	0
\hat{E}_s/I_{ot} ^{Note3}		dB	1, 2, 3, 4, 5, 6	0	0	0
SS-RSRP ^{Note3}		dBm/SCS	1, 2, 4, 5	-98	-98	-98
			3, 6	-95	-95	-95
I_o ^{Note3}		dBm/9.36 MHz	1, 2, 4, 5	-67.04	-67.04	-67.04
			dBm/38.16 MHz	3, 6	-60.94	-60.94
Propagation condition			1, 2, 3, 4, 5, 6	AWGN		
Antenna Configuration and Correlation Matrix			1, 2, 3, 4, 5, 6	1x2 Low		
<p>Note 1: OCNG shall be used such that both cells are fully allocated and a constant total transmitted power spectral density is achieved for all OFDM symbols.</p> <p>Note 2: Interference from other cells and noise sources not specified in the test is assumed to be constant over subcarriers and time and shall be modelled as AWGN of appropriate power for N_{oc} to be fulfilled.</p> <p>Note 3: \hat{E}_s/I_{ot}, SS-RSRP, and I_o levels have been derived from other parameters for information purposes. They are not settable parameters themselves.</p>						

Table A.6.3.1.4-4: Cell specific test parameters for SA inter-RAT E-UTRA handover (Cell 2)

Parameter	Unit	Configuration	Cell 2		
			T1	T2	T3
RF channel number		1, 2, 3, 4, 5, 6	2		
Duplex mode		1, 2, 3	FDD		
		4, 5, 6	TDD		
TDD special subframe configuration ^{Note1}		4, 5, 6	6		
TDD uplink-downlink configuration ^{Note1}		4, 5, 6	1		
BW _{channel}	MHz	1, 2, 3, 4, 5, 6	5MHz: N _{RB,c} = 25 10MHz: N _{RB,c} = 50 20MHz: N _{RB,c} = 100		
PRACH Configuration ^{Note2}		1, 2, 3	4		
		4, 5, 6	53		
PDSCH parameters: DL Reference Measurement Channel ^{Note3}		1, 2, 3	5MHz: R.7 FDD 10MHz: R.3 FDD 20MHz: R.6 FDD		
		4, 5, 6	5MHz: R.4 TDD 10MHz: R.0 TDD 20MHz: R.3 TDD		
PCFICH/PDCCH/PHICH parameters: DL Reference Measurement Channel ^{Note3}		1, 2, 3	5MHz: R.11 FDD 10MHz: R.6 FDD 20MHz: R.10 FDD		
		4, 5, 6	5MHz: R.11 TDD 10MHz: R.6 TDD 20MHz: R.10 TDD		
OCNG Patterns ^{Note3}		1, 2, 3	5MHz: OP.20 FDD 10MHz: OP.10 FDD 20MHz: OP.17 FDD		
		4, 5, 6	5MHz: OP.9 TDD 10MHz: OP.1 TDD 20MHz: OP.7 TDD		
PBCH_RA	dB	1, 2, 3, 4, 5, 6	0		
PBCH_RB					
PSS_RA					
SSS_RA					
PCFICH_RB					
PHICH_RA					
PHICH_RB					
PDCCH_RA					
PDCCH_RB					
PDSCH_RA					
PDSCH_RB					
OCNG_RA ^{Note4}					
OCNG_RB ^{Note4}					
N _{oc} ^{Note5}					
\hat{E}_s/N_{oc}	dB	1, 2, 3, 4, 5, 6	-Infinity	7	7
\hat{E}_s/I_{ot} ^{Note6}	dB	1, 2, 3, 4, 5, 6	-Infinity	7	7
RSRP ^{Note6}	dBm/15kHz	1, 2, 3, 4, 5, 6	-Infinity	-91	-91
SCH_RP ^{Note6}	dBm/15kHz	1, 2, 3, 4, 5, 6	-Infinity	-91	-91
I _o ^{Note6}	dBm/9MHz	1, 2, 3, 4, 5, 6	-70.22	-62.43	-62.43
Propagation Condition		1, 2, 3, 4, 5, 6	AWGN		
Antenna Configuration and Correlation Matrix ^{Note7}		1, 2, 3, 4, 5, 6	1x2 Low		

Note 1: Special subframe and uplink-downlink configurations are specified in table 4.2-1 in TS 36.211.

Note 2:	PRACH configurations are specified in table 5.7.1-2 and table 5.7.1-3 in TS 36.211.
Note 3:	DL RMCs and OCNG patterns are specified in sections A 3.1 and A 3.2 of TS 36.133 respectively.
Note 4:	OCNG shall be used such that all cells are fully allocated and a constant total transmitted power spectral density is achieved for all OFDM symbols.
Note 5:	Interference from other cells and noise sources not specified in the test is assumed to be constant over subcarriers and time and shall be modelled as AWGN of appropriate power for N_{oc} to be fulfilled.
Note 6:	\hat{E}_s/I_{ot} , RSRP, SCH_RP and I_o levels have been derived from other parameters for information purposes. They are not settable parameters themselves.
Note 7:	Propagation condition and correlation matrix are defined in section B.2 in TS 36.101 [25].

A.6.3.1.4.2 Test Requirements

The UE shall start to transmit the PRACH to Cell 2 less than 85 ms from the beginning of time period T3.

The rate of correct handovers observed during repeated tests shall be at least 90%.

NOTE: The handover delay can be expressed as: RRC procedure delay + $T_{interrupt}$, where:

RRC procedure delay = 50 ms and is specified in section 6.1.2.1.

$T_{interrupt}$ = 35 ms in the test; $T_{interrupt}$ is defined in section 6.1.2.1.

This gives a total of 85 ms.

A.6.3.1.5 SA NR - E-UTRAN handover with unknown target cell

A.6.3.1.5.1 Test Purpose and Environment

The purpose of this set of tests is to verify that the UE can make correct inter-RAT E-UTRAN handover when operating in standalone (SA) operation with PCell in FR1. This test shall verify the NR to E-UTRAN handover requirements for the case when the target E-UTRAN cell is unknown as specified in section 6.1.2.1.

The test comprises of one NR carrier and one E-UTRA carrier. There are two cells and one cell on each carrier. Cell 1 is the NR PCell and Cell 2 is an inter-RAT E-UTRAN neighbour cell. The test consists of two successive time periods, with time durations of T1 and T2 respectively. At the start of time duration T1, the UE does not have any timing information of Cell 2. Starting T2, Cell 2 becomes detectable. No Gap pattern shall be configured.

A RRC message implying handover shall be sent to the UE during period T1. The start of T2 is the instant when the last TTI containing the RRC message implying handover is sent to the UE. The handover message shall contain Cell 2 as the target cell.

Supported test configurations are shown in table A.6.3.1.5-1. General test parameters are provided in Table A.6.3.1.5-2. Cell specific test parameters for Cell 1 and Cell 2 are provided in Tables A.6.3.1.5-3 and A.6.3.1.5-4 respectively.

Table A.6.3.1.5-1: Supported test configurations for SA inter-RAT E-UTRAN handover tests

Configuration	Description
1	NR 15 kHz SSB SCS, 10MHz bandwidth, FDD duplex mode, LTE FDD
2	NR 15 kHz SSB SCS, 10MHz bandwidth, TDD duplex mode, LTE FDD
3	NR 30 kHz SSB SCS, 40MHz bandwidth, TDD duplex mode, LTE FDD
4	NR 15 kHz SSB SCS, 10MHz bandwidth, FDD duplex mode, LTE TDD
5	NR 15 kHz SSB SCS, 10MHz bandwidth, TDD duplex mode, LTE TDD
6	NR 30kHz SSB SCS, 40MHz bandwidth, TDD duplex mode, LTE TDD
Note:	The UE is only required to be tested in one of the supported test configurations

Table A.6.3.1.5-2: General test parameters for SA inter-RAT E-UTRAN handover

Parameter		Unit	Value	Comment
NR RF Channel Number			1	1 NR carrier frequency is used in the test
LTE RF Channel Number			2	1 E-UTRAN carrier frequency is used in the test
Initial conditions	Active cell		Cell 1	NR cell
	Neighbouring cell		Cell 2	E-UTRAN cell
Final condition	Active cell		Cell 2	
NR measurement quantity			SS-RSRP	
E-UTRAN measurement quantity			RSRP	
b2-Threshold1		dBm	As specified in Table A.6.3.1.5-3	Absolute NR SS-RSRP threshold for event B2
b2-Threshold2EUTRAN		dBm	-98	Absolute E-UTRAN RSRP threshold for event B2
Hysteresis		dB	0	
TimeToTrigger		s	0	
Filter coefficient			0	L3 filtering is not used
DRX			OFF	Non-DRX test
Access Barring Information		-	Not sent	No additional delays in random access procedure
Time offset between cells			3 ms	Asynchronous cells
T1		s	≤5	
T2		s	1	

Table A.6.3.1.5-3: Cell specific test parameters for SA inter-RAT E-UTRA handover (Cell 1)

Parameter		Unit	Configuration	Cell 1	
				T1	T2
RF channel number			1, 2, 3, 4, 5, 6	1	
Duplex mode			1, 4	FDD	
			2, 3, 5, 6	TDD	
TDD Configuration			2, 5	TDDConf.1.1	
			3, 6	TDDConf.1.2	
BW _{channel}		MHz	1, 4	10: N _{RB,c} = 52 (FDD)	
			2, 5	10: N _{RB,c} = 52 (TDD)	
			3, 6	40: N _{RB,c} = 106 (TDD)	
PDSCH reference measurement channel			1, 4	SR.1.1 FDD	
			2, 5	SR.1.1 TDD	
			3, 6	SR.2.1 TDD	
CORSET reference channel			1, 4	CR.1.1 FDD	
			2, 5	CR.1.1 TDD	
			3, 6	CR.2.1 TDD	
OCNG pattern ^{Note1}			1, 2, 3, 4, 5, 6	OP.1	
BWP	Initial DL BWP		1, 2, 3, 4, 5, 6	DLBWP.0.1	
	Dedicated DL BWP			DLBWP.1.1	
	Initial UL BWP			ULBWP.0.1	
	Dedicated UL BWP			ULBWP.1.1	
SMTC configuration			1, 2, 3, 4, 5, 6	SMTC.1	
SSB configuration			1, 2, 4, 5	SSB.1 FR1	
			3, 6	SSB.2 FR1	
b2-Threshold1		dBm	1, 2, 4, 5	-90	
			3, 6	-87	
EPRE ratio of PSS to SSS		dB	1, 2, 3, 4, 5, 6	0	

EPRE ratio of PBCH_DMRS to SSS				
EPRE ratio of PBCH to PBCH_DMRS				
EPRE ratio of PDCCH_DMRS to SSS				
EPRE ratio of PDCCH to PDCCH_DMRS				
EPRE ratio of PDSCH_DMRS to SSS				
EPRE ratio of PDSCH to PDSCH_DMRS				
EPRE ratio of OCNG DMRS to SSS				
EPRE ratio of OCNG to OCNG DMRS				
N_{oc} ^{Note2}	dBm/15 KHz	1, 2, 3, 4, 5, 6	-98	
N_{oc} ^{Note2}	dBm/SCS	1, 2, 4, 5	-98	
		3, 6	-95	
\hat{E}_s/N_{oc}	dB	1, 2, 3, 4, 5, 6	0	0
\hat{E}_s/I_{ot} ^{Note3}	dB	1, 2, 3, 4, 5, 6	0	0
SS-RSRP ^{Note3}	dBm/SCS	1, 2, 4, 5	-98	-98
		3, 6	-95	-95
I_o ^{Note3}	dBm/9.36 MHz	1, 2, 4, 5	-67.04	-67.04
	dBm/38.16 MHz	3, 6	-60.94	-60.94
Propagation condition		1, 2, 3, 4, 5, 6	AWGN	
Antenna Configuration and Correlation Matrix		1, 2, 3, 4, 5, 6	1x2 Low	
<p>Note 1: OCNG shall be used such that both cells are fully allocated and a constant total transmitted power spectral density is achieved for all OFDM symbols.</p> <p>Note 2: Interference from other cells and noise sources not specified in the test is assumed to be constant over subcarriers and time and shall be modelled as AWGN of appropriate power for N_{oc} to be fulfilled.</p> <p>Note 3: \hat{E}_s/I_{ot}, SS-RSRP, and I_o levels have been derived from other parameters for information purposes. They are not settable parameters themselves.</p>				

Table A.6.3.1.5-4: Cell specific test parameters for SA inter-RAT E-UTRA handover (Cell 2)

Parameter	Unit	Configuration	Cell 2	
			T1	T2
RF channel number		1, 2, 3, 4, 5, 6	2	
Duplex mode		1, 2, 3	FDD	
		4, 5, 6	TDD	
TDD special subframe configuration ^{Note1}		4, 5, 6	6	
TDD uplink-downlink configuration ^{Note1}		4, 5, 6	1	
BW _{channel}	MHz	1, 2, 3, 4, 5, 6	5MHz: $N_{RB,c} = 25$ 10MHz: $N_{RB,c} = 50$ 20MHz: $N_{RB,c} = 100$	
PRACH Configuration ^{Note2}		1, 2, 3	4	
		4, 5, 6	53	
PDSCH parameters: DL Reference Measurement Channel ^{Note3}		1, 2, 3	5MHz: R.7 FDD 10MHz: R.3 FDD 20MHz: R.6 FDD	
		4, 5, 6	5MHz: R.4 TDD	

			10MHz: R.0 TDD 20MHz: R.3 TDD
PCFICH/PDCCH/PHICH parameters: DL Reference Measurement Channel ^{Note3}		1, 2, 3	5MHz: R.11 FDD 10MHz: R.6 FDD 20MHz: R.10 FDD
		4, 5, 6	5MHz: R.11 TDD 10MHz: R.6 TDD 20MHz: R.10 TDD
OCNG Patterns ^{Note3}		1, 2, 3	5MHz: OP.20 FDD 10MHz: OP.10 FDD 20MHz: OP.17 FDD
		4, 5, 6	5MHz: OP.9 TDD 10MHz: OP.1 TDD 20MHz: OP.7 TDD
PBCH_RA	dB	1, 2, 3, 4, 5, 6	0
PBCH_RB			
PSS_RA			
SSS_RA			
PCFICH_RB			
PHICH_RA			
PHICH_RB			
PDCCH_RA			
PDCCH_RB			
PDSCH_RA			
PDSCH_RB			
OCNG_RA ^{Note4}			
OCNG_RB ^{Note4}			
N_{oc} ^{Note5}	dBm/15kHz	1, 2, 3, 4, 5, 6	-98
\bar{E}_s/N_{oc}	dB	1, 2, 3, 4, 5, 6	-Infinity 7
\bar{E}_s/I_{ot} ^{Note6}	dB	1, 2, 3, 4, 5, 6	-Infinity 7
RSRP ^{Note6}	dBm/15kHz	1, 2, 3, 4, 5, 6	-Infinity -91
SCH_RP ^{Note6}	dBm/15kHz	1, 2, 3, 4, 5, 6	-Infinity -91
I_o ^{Note6}	dBm/9MHz	1, 2, 3, 4, 5, 6	-70.22 -62.43
Propagation Condition		1, 2, 3, 4, 5, 6	AWGN
Antenna Configuration and Correlation Matrix ^{Note7}		1, 2, 3, 4, 5, 6	1x2 Low
<p>Note 1: Special subframe and uplink-downlink configurations are specified in table 4.2-1 in TS 36.211.</p> <p>Note 2: PRACH configurations are specified in table 5.7.1-2 and table 5.7.1-3 in TS 36.211.</p> <p>Note 3: DL RMCs and OCNG patterns are specified in sections A 3.1 and A 3.2 of TS 36.133 respectively.</p> <p>Note 4: OCNG shall be used such that all cells are fully allocated and a constant total transmitted power spectral density is achieved for all OFDM symbols.</p> <p>Note 5: Interference from other cells and noise sources not specified in the test is assumed to be constant over subcarriers and time and shall be modelled as AWGN of appropriate power for N_{oc} to be fulfilled.</p> <p>Note 6: \bar{E}_s/I_{ot}, RSRP, SCH_RP and I_o levels have been derived from other parameters for information purposes. They are not settable parameters themselves.</p> <p>Note 7: Propagation condition and correlation matrix are defined in section B.2 in TS 36.101 [25].</p>			

A.6.3.1.5.2 Test Requirements

The UE shall start to transmit the PRACH to Cell 2 less than 165 ms from the beginning of time period T3.

The rate of correct handovers observed during repeated tests shall be at least 90%.

NOTE: The handover delay can be expressed as: RRC procedure delay + $T_{interrupt}$, where:

RRC procedure delay = 50 ms and is specified in section 6.1.2.1.

$T_{interrupt}$ = 115 ms in the test; $T_{interrupt}$ is defined in section 6.1.2.1.

This gives a total of 165 ms.

A.6.3.2 RRC Connection Mobility Control

A.6.3.2.1 SA: RRC Re-establishment

A.6.3.2.1.1 Intra-frequency RRC Re-establishment in FR1

A.6.3.2.1.1.1 Test Purpose and Environment

The purpose is to verify that the NR intra-frequency RRC re-establishment delay in FR1 with known target cell is within the specified limits. These tests will verify the requirements in clause 6.2.1.

The test parameters are given in table A.6.3.2.1.1.1-1, table A.6.3.2.1.1.1-2 and table A.6.3.2.1.1.1-3 below. The test consists of 3 successive time periods, with time duration of T1, T2 and T3 respectively. At the start of time period T2, cell 1, which is the active cell, is deactivated. The time period T3 starts after the occurrence of the radio link failure.

Table A.6.3.2.1.1.1-1: Supported test configurations

Configuration	Description
1	15 kHz SSB SCS, 10MHz bandwidth, FDD duplex mode
2	15 kHz SSB SCS, 10MHz bandwidth, TDD duplex mode
3	30 kHz SSB SCS, 40MHz bandwidth, TDD duplex mode
Note: The UE is only required to be tested in one of the supported test configurations.	

Table A.6.3.2.1.1.1-2: General test parameters for NR intra-frequency RRC Re-establishment test case in FR1

Parameter		Unit	Test configuration	Value	Comment
Initial condition	Active cell		1, 2, 3	Cell1	
	Neighbour cells		1, 2, 3	Cell2	
Final condition	Active cell		1, 2, 3	Cell2	
RF Channel Number			1, 2, 3	1	
Time offset between cells			1	3 ms	Asynchronous cells
			2	3 μ s	Synchronous cells
			3	3 μ s	Synchronous cells
N310		-	1, 2, 3	1	Maximum consecutive out-of-sync indications from lower layers
N311		-	1, 2, 3	1	Minimum consecutive in-sync indications from lower layers
T310		ms	1, 2, 3	0	Radio link failure timer; T310 is disabled
T311		ms	1, 2, 3	3000	RRC re-establishment timer
Access Barring Information		-	1, 2, 3	Not Sent	No additional delays in random access procedure.
SSB configuration			1	SSB.1 FR1	
			2	SSB.1 FR1	
			3	SSB.2 FR1	
SMTC configuration			1	SMTC pattern 2	
			2	SMTC pattern 1	
			3	SMTC pattern 1	
DRX cycle length		s	1, 2, 3	OFF	
PRACH configuration index			1, 2, 3	87	The detailed configuration is specified in TS 38.211 clause 6.3.3.2

T1	s	1, 2, 3	5	Time for the UE to detect RLF
T2	ms	1, 2, 3	200	
T3	s	1, 2, 3	2	

Table A.6.3.2.1.1-3: Cell specific test parameters for NR intra-frequency RRC Re-establishment test case in FR1

Parameter	Unit	Test configuration	Cell 1			Cell 2		
			T1	T2	T3	T1	T2	T3
TDD configuration		1	N/A			N/A		
		2	TDDConf.1.1			TDDConf.1.1		
		3	TDDConf.2.1			TDDConf.2.1		
PDSCH RMC configuration		1	SR.1.1 FDD			N/A		
		2	SR.1.1 TDD					
		3	SR.2.1 TDD					
RMSI CORESET RMC configuration		1	CR.1.1 FDD			CR.1.1 FDD		
		2	CR.1.1 TDD			CR.1.1 TDD		
		3	CR.2.1 TDD			CR.2.1 TDD		
Dedicated CORESET RMC configuration		1	CCR.1.1 FDD			CCR.1.1 FDD		
		2	CCR.1.1 TDD			CCR.1.1 TDD		
		3	CCR.2.1 TDD			CCR.2.1 TDD		
OCNG Pattern		1, 2, 3	OP.1 defined in A.3.2.1			OP.1 defined in A.3.2.1		
Initial DL BWP configuration		1, 2, 3	DLBWP.0.1			DLBWP.0.1		
Initial UL BWP configuration		1, 2, 3	ULBWP.0.1			ULBWP.0.1		
RLM-RS		1, 2, 3	SSB			SSB		
\hat{E}_s / I_{ot}	dB	1	1.54	-infinity	-infinity	-3.79	4	4
		2						
		3						
N_{oc} ^{Note2}	dBm/SCS	1	-98					
		2	-98					
		3	-95					
N_{oc} ^{Note2}	dBm/15 kHz	1	-98					
		2						
		3						
\hat{E}_s / N_{oc}	dB	1	7	-infinity	-infinity	4	4	4
		2						
		3						
SS-RSRP ^{Note3}	dBm/SCS	1	-91	-infinity	-infinity	-94	-94	-94
		2	-91	-infinity	-infinity	-94	-94	-94
		3	-88	-infinity	-infinity	-91	-91	-91
I _o	dBm/9.36 MHz	1	-60.74	-infinity	-infinity	-60.74	-64.59	-64.59
	dBm/9.36 MHz	2	-60.74	-infinity	-infinity	-60.74	-64.59	-64.59
	dBm/38.16 MHz	3	-54.65	-infinity	-infinity	-54.65	-58.50	-58.50
Propagation Condition		1, 2, 3	AWGN					
Note 1:	OCNG shall be used such that both cells are fully allocated and a constant total transmitted power spectral density is achieved for all OFDM symbols.							
Note 2:	Interference from other cells and noise sources not specified in the test is assumed to be constant over subcarriers and time and shall be modelled as AWGN of appropriate power for N_{oc} to be fulfilled.							
Note 3:	SS-RSRP levels have been derived from other parameters for information purposes. They are not settable parameters themselves.							

A.6.3.2.1.1.2 Test Requirements

The RRC re-establishment delay is defined as the time from the start of time period T3, to the moment when the UE starts to send PRACH preambles to cell 2 for sending the *RRCReestablishmentRequest* message to cell 2.

The RRC re-establishment delay to a known NR intra frequency cell shall be less than [1.6] s.

The rate of correct RRC re-establishments observed during repeated tests shall be at least 90%.

NOTE: The RRC re-establishment delay in the test is derived from the following expression:

$$T_{\text{re-establish_delay}} = T_{\text{UL_grant}} + T_{\text{UE_re-establish_delay}}$$

Where:

$T_{\text{UL_grant}}$ = It is the time required to acquire and process uplink grant from the target cell. The PRACH reception at the system simulator is used as a trigger for the completion of the test; hence $T_{\text{UL_grant}}$ is not used.

$$T_{\text{UE_re-establish_delay}} = 50 + T_{\text{identify_intra_NR}} + \sum_{i=1}^{N_{\text{freq}}-1} T_{\text{identify_inter_NR},i} + T_{\text{SI-NR}} + T_{\text{PRACH}}$$

$$N_{\text{freq}} = 1$$

$$T_{\text{identify_intra_NR}} = 200 \text{ ms}$$

$T_{\text{SI}} = [1280] \text{ ms}$; it is the time required for receiving all the relevant system information as defined in TS 38.331 for the target intra-frequency NR cell.

$T_{\text{PRACH}} = [15] \text{ ms}$; it is the additional delay caused by the random access procedure.

This gives a total of [1545] ms, allow [1.6] s in the test case.

A.6.3.2.1.2 Inter-frequency RRC Re-establishment in FR1

A.6.3.2.1.2.1 Test Purpose and Environment

The purpose is to verify that the NR inter-frequency RRC re-establishment delay in FR1 without known target cell is within the specified limits. These tests will verify the requirements in clause 6.2.1.

The test parameters are given in table A.6.3.2.1.2.1-1, table A.6.3.2.1.2.1-2 and table A.6.3.2.1.2.1-3 below. The test consists of 3 successive time periods, with time duration of T1, T2 and T3 respectively. At the start of time period T2, cell 1, which is the active cell, becomes inactive. The time period T3 starts after the occurrence of the radio link failure. During T1, the UE shall be configured with the carrier frequency of cell 2 (with RF Channel Number #2) to ensure that the UE has the context of the carrier frequency of cell 2 by the end of T1.

Table A.6.3.2.1.2.1-1: Supported test configurations

Configuration	Description of serving cell	Description of target cell
1	15 kHz SSB SCS, 10MHz bandwidth, FDD duplex mode	15 kHz SSB SCS, 10MHz bandwidth, FDD duplex mode
2	15 kHz SSB SCS, 10MHz bandwidth, TDD duplex mode	15 kHz SSB SCS, 10MHz bandwidth, TDD duplex mode
3	30 kHz SSB SCS, 40MHz bandwidth, TDD duplex mode	30 kHz SSB SCS, 40MHz bandwidth, TDD duplex mode
Note: The UE is only required to be tested in one of the supported test configurations.		

Table A.6.3.2.1.2.1-2: General test parameters for NR inter-frequency RRC Re-establishment test case in FR1

Parameter		Unit	Test configuration	Value	Comment
Initial condition	Active cell		1, 2, 3	Cell1	
	Neighbour cells		1, 2, 3	Cell2	
Final condition	Active cell		1, 2, 3	Cell2	
RF Channel Number			1, 2, 3	1, 2	
Time offset between cells			1	3 ms	Asynchronous cells
			2	3 μ s	Synchronous cells
			3	3 μ s	Synchronous cells
N310		-	1, 2, 3	1	Maximum consecutive out-of-sync indications from lower layers
N311		-	1, 2, 3	1	Minimum consecutive in-sync indications from lower layers
T310		ms	1, 2, 3	0	Radio link failure timer; T310 is disabled
T311		ms	1, 2, 3	5000	RRC re-establishment timer
Access Barring Information		-	1, 2, 3	Not Sent	No additional delays in random access procedure.
SSB configuration			1	SSB.1 FR1	
			2	SSB.1 FR1	
			3	SSB.2 FR1	
SMTC configuration			1	SMTC pattern 2	
			2	SMTC pattern 1	
			3	SMTC pattern 1	
DRX cycle length		s	1, 2, 3	OFF	
PRACH configuration index			1, 2, 3	87	The detailed configuration is specified in TS 38.211 clause 6.3.3.2
T1		s	1, 2, 3	5	
T2		ms	1, 2, 3	200	Time for the UE to detect RLF
T3		s	1, 2, 3	5	

Table A.6.3.2.1.2.1-3: Cell specific test parameters for NR inter-frequency RRC Re-establishment test case in FR1

Parameter	Unit	Test configuration	Cell 1			Cell 2		
			T1	T2	T3	T1	T2	T3
RF Channel Number		1, 2, 3	1			2		
TDD configuration		1	N/A			N/A		
		2	TDDConf.1.1			TDDConf.1.1		
		3	TDDConf.2.1			TDDConf.2.1		
PDSCH RMC configuration		1	SR.1.1 FDD			N/A		
		2	SR.1.1 TDD					
		3	SR.2.1 TDD					
RMSI CORESET RMC configuration		1	CR.1.1 FDD			CR.1.1 FDD		
		2	CR.1.1 TDD			CR.1.1 TDD		
		3	CR.2.1 TDD			CR.2.1 TDD		
Dedicated CORESET RMC configuration		1	CCR.1.1 FDD			CCR.1.1 FDD		
		2	CCR.1.1 TDD			CCR.1.1 TDD		
		3	CCR.2.1 TDD			CCR.2.1 TDD		
OCNG Pattern		1, 2, 3	OP.1 defined in A.3.2.1			OP.1 defined in A.3.2.1		
Initial DL BWP configuration		1, 2, 3	DLBWP.0			DLBWP.0		

Initial UL BWP configuration		1, 2, 3	ULBWP.0			ULBWP.0		
RLM-RS		1, 2, 3	SSB			SSB		
\hat{E}_s / I_{ot}	dB	1	4	-infinity	-infinity	-infinity	-infinity	7
		2						
		3						
N_{oc} ^{Note2}	dBm/SCS	1	-98					
		2	-98					
		3	-95					
N_{oc} ^{Note2}	dBm/15 kHz	1	-98					
		2						
		3						
\hat{E}_s / N_{oc}	dB	1	4	-infinity	-infinity	-infinity	-infinity	7
		2						
		3						
SS-RSRP ^{Note3}	dBm/SCS	1	-94	-infinity	-infinity	-infinity	-infinity	-91
		2	-94	-infinity	-infinity	-infinity	-infinity	-91
		3	-91	-infinity	-infinity	-infinity	-infinity	-88
I _o	dBm/9.36 MHz	1	-64.59	-infinity	-infinity	-infinity	-infinity	-62.26
	dBm/9.36 MHz	2	-64.59	-infinity	-infinity	-infinity	-infinity	-62.26
	dBm/38.16 MHz	3	-58.50	-infinity	-infinity	-infinity	-infinity	-57.17
Propagation Condition		1, 2, 3	AWGN					
<p>Note 1: OCNG shall be used such that both cells are fully allocated and a constant total transmitted power spectral density is achieved for all OFDM symbols.</p> <p>Note 2: Interference from other cells and noise sources not specified in the test is assumed to be constant over subcarriers and time and shall be modelled as AWGN of appropriate power for N_{oc} to be fulfilled.</p> <p>Note 3: SS-RSRP levels have been derived from other parameters for information purposes. They are not settable parameters themselves.</p>								

A.6.3.2.1.2.2 Test Requirements

The RRC re-establishment delay is defined as the time from the start of time period T3, to the moment when the UE starts to send PRACH preambles to cell 2 for sending the *RRCReestablishmentRequest* message to cell 2.

The RRC re-establishment delay to an unknown NR inter frequency cell shall be less than [3] s.

The rate of correct RRC re-establishments observed during repeated tests shall be at least 90%.

NOTE: The RRC re-establishment delay in the test is derived from the following expression:

$$T_{\text{re-establish_delay}} = T_{\text{UL_grant}} + T_{\text{UE_re-establish_delay}}$$

Where:

$T_{\text{UL_grant}}$ = It is the time required to acquire and process uplink grant from the target cell. The PRACH reception at the system simulator is used as a trigger for the completion of the test; hence $T_{\text{UL_grant}}$ is not used.

$$T_{\text{UE_re-establish_delay}} = 50 + T_{\text{identify_intra_NR}} + \sum_{i=1}^{N_{\text{freq}}-1} T_{\text{identify_inter_NR},i} + T_{\text{SI-NR}} + T_{\text{PRACH}}$$

$$N_{\text{freq}} = 2$$

$$T_{\text{identify_intra_NR}} = 800 \text{ ms}$$

$$T_{\text{identify_inter_NR}} = 800 \text{ ms}$$

$T_{SI} = [1280]$ ms; it is the time required for receiving all the relevant system information as defined in TS 38.331 for the target inter-frequency NR cell.

$T_{PRACH} = [15]$ ms; it is the additional delay caused by the random access procedure.

This gives a total of [2945] ms, allow [3] s in the test case.

A.6.3.2.2 Random Access

A.6.3.2.2.1 Contention based random access test in FR1 for NR standalone

A.6.3.2.2.1.1 Test Purpose and Environment

The purpose of this test is to verify that the behavior of the random access procedure is according to the requirements and that the PRACH power settings and timing are within specified limits. This test will verify the requirements in Clause 6.2.2.2 and Clause 7.1.2 in an AWGN model.

For this test one cell is used and configured as PCell in FR1. Supported test parameters are shown in Table A.6.3.2.2.1.1-1. UE capable of SA with PCell in FR1 needs to be tested by using the parameters in Table A.6.3.2.2.1.1-2.

Table A.6.3.2.2.1.1-1: Supported test configurations for contention based random access test in FR1 for NR standalone

Config	Description
1	NR 15 kHz SSB SCS, 10MHz bandwidth, FDD duplex mode
2	NR 30 kHz SSB SCS, 40MHz bandwidth, TDD duplex mode
Note:	The UE is only required to be tested in one of the supported test configurations depending on UE capability

Table A.6.3.2.2.1-2: General test parameters for contention based random access test in FR1 for NR Standalone

Parameter		Unit	Test-1	Comments	
SSB Configuration	Config 1		SSB pattern 1 in FR1	As defined in A.3.10, except for number of SSBs per SS-burst and SS/PBCH block index as below	
	Config 2		SSB pattern 2 in FR1		
Number of SSBs per SS-burst			2	Different from the definition in A.3.10	
SS/PBCH block index			0,1	Different from the definition in A.3.10	
Duplex Mode for Cell 2	Config 1		FDD		
	Config 2		TDD		
TDD Configuration	Config 2		TDDConf.1.2		
OCNG Pattern ^{Note 1}			OCNG pattern 1	As defined in A.3.2.1.	
PDSCH parameters ^{Note 4}	Config 1		SR.1.1 FDD	As defined in A.3.1.1.	
	Config 2		SR.2.1 TDD		
NR RF Channel Number			1		
EPRE ratio of PSS to SSS		dB	0		
EPRE ratio of PBCH_DMRS to SSS		dB			
EPRE ratio of PBCH to PBCH_DMRS		dB			
EPRE ratio of PDCCH_DMRS to SSS		dB			
EPRE ratio of PDCCH to PDCCH_DMRS		dB			
EPRE ratio of PDSCH_DMRS to SSS		dB			
EPRE ratio of PDSCH to PDSCH_DMRS		dB			
SSB with index 0	\hat{E}_s / I_{ot}		dB	3	Power of SSB with index 0 is set to be above configured <i>rsrp-ThresholdSSB</i>
	N_{oc}	Config 1	dBm/15kHz	-98	
		Config 2	dBm/15kHz	-101	
	\hat{E}_s / N_{oc}		dB	3	
SS-RSRP ^{Note 3}		dBm/ SCS	-95		
SSB with index 1	\hat{E}_s / I_{ot}		dB	-17	Power of SSB with index 1 is set to be below configured <i>rsrp-ThresholdSSB</i>
	N_{oc}	Config 1	dBm/15kHz	-98	
		Config 2	dBm/15kHz	-101	
	\hat{E}_s / N_{oc}		dB	-17	
SS-RSRP ^{Note 3}		dBm/ SCS	-115		
I _o ^{Note 2}	Config 1	dBm	-65.3/9.36MHz	For symbols without SSB index 1	
	Config 2		-62.2/38.16MHz		
ss-PBCH-BlockPower		dBm/ SCS	-5	As defined in clause 6.3.2 in TS 38.331 [2].	
Configured UE transmitted power ($P_{CMAX, f,c}$)		dBm	23	As defined in clause 6.2.4 in TS 38.101-1.	
PRACH Configuration			FR1 PRACH configuration 1	As defined in A.3.x.	
Propagation Condition		-	AWGN		
<p>Note 1: OCNG shall be used such that the cell is fully allocated and a constant total transmitted power spectral density is achieved for all OFDM symbols. The OCNG pattern is chosen during the test according to the presence of a DL reference measurement channel.</p> <p>Note 2: SS-RSRP, Es/I_{ot} and I_o levels have been derived from other parameters for information purpose. They are not settable parameters.</p> <p>Note 3: Void</p> <p>Note 4: The DL PDSCH reference measurement channel is used in the test only when a downlink transmission dedicated to the UE under test is required.</p>					

A.6.3.2.2.1.2 Test Requirements

Contention based random access is triggered by *not* explicitly assigning a random access preamble via dedicated signalling in the downlink.

A.6.3.2.2.1.2.1 Random Access Preamble Transmission

To test the UE behavior specified in Subclause 6.2.2.2.1.1 the System Simulator shall receive the Random Access Preamble which belongs to one of the Random Access Preambles associated with the SSB with index 0, which has SS-RSRP above the configured *rsrp-ThresholdSSB*.

In addition, the power applied to all preambles shall be in accordance with what is specified in Subclause 6.2.2.2. The power of the first preamble shall be -30 dBm with an accuracy specified in clause 6.3.4.2 of TS 38.101-1 [18]. The relative power applied to additional preambles shall have an accuracy specified in clause 6.3.4.3 of TS 38.101-1 [18].

The transmit timing of all PRACH transmissions shall be within the accuracy specified in Subclause 7.1.2.

A.6.3.2.2.1.2.2 Random Access Response Reception

To test the UE behavior specified in Subclause 6.2.2.2.1.2 the System Simulator shall transmit a Random Access Response containing a Random Access Preamble identifier corresponding to the transmitted Random Access Preamble after 5 preambles have been received by the System Simulator. In response to the first 4 preambles, the System Simulator shall transmit a Random Access Response *not* corresponding to the transmitted Random Access Preamble.

The UE may stop monitoring for Random Access Response(s) and shall transmit the msg3 if the Random Access Response contains a Random Access Preamble identifier corresponding to the transmitted Random Access Preamble.

The UE shall again perform the Random Access Resource selection procedure specified in clause 5.1.2 in TS38.321 [7], and transmit with the calculated PRACH transmission power when the backoff time expires if all received Random Access Responses contain Random Access Preamble identifiers that do not match the transmitted Random Access Preamble.

In addition, the power applied to all preambles shall be in accordance with what is specified in Subclause 6.2.2.2. The power of the first preamble shall be -30 dBm with an accuracy specified in clause 6.3.4.2 of TS 38.101-1 [18]. The relative power applied to additional preambles shall have an accuracy specified in clause 6.3.4.3 of TS 38.101-1 [18].

The transmit timing of all PRACH transmissions shall be within the accuracy specified in Subclause 7.1.2.

A.6.3.2.2.1.2.3 No Random Access Response Reception

To test the UE behavior specified in subclause 6.2.2.2.1.3 the System Simulator shall transmit a Random Access Response containing a Random Access Preamble identifier corresponding to the transmitted Random Access Preamble after 5 preambles have been received by the System Simulator. The System Simulator shall *not* respond to the first 4 preambles.

The UE shall again perform the Random Access Resource selection procedure specified in clause 5.1.2 in TS38.321 [7], and transmit with the calculated PRACH transmission power when the backoff time expires if no Random Access Response is received within the RA Response window.

In addition, the power applied to all preambles shall be in accordance with what is specified in Subclause 6.2.2.2. The power of the first preamble shall be -30 dBm with an accuracy specified in clause 6.3.4.2 of TS 38.101-1 [18]. The relative power applied to additional preambles shall have an accuracy specified in clause 6.3.4.3 of TS 38.101-1 [18].

The transmit timing of all PRACH transmissions shall be within the accuracy specified in Subclause 7.1.2.

A.6.3.2.2.1.2.4 Receiving a NACK on msg3

To test the UE behavior specified in subclause 6.2.2.2.1.4 the System Simulator shall NACK *all* UE msg3 following a successful Random Access Response.

The UE shall re-transmit the msg3 upon the reception of a NACK on msg3 until the maximum number of HARQ re-transmissions is reached.

A.6.3.2.2.1.2.5 Reception of an Incorrect Message over Temporary C-RNTI

To test the UE behavior specified in Subclause 6.2.2.2.1.5 the System Simulator shall send a message addressed to the temporary C-RNTI with a UE Contention Resolution Identity included in the MAC control element *not* matching the CCCH SDU transmitted in msg3 uplink message.

The UE shall again perform the Random Access Resource selection procedure specified in clause 5.1.2 in TS38.321 [7], and transmit with the calculated PRACH transmission power when the backoff time expires unless the received message includes a UE Contention Resolution Identity MAC control element and the UE Contention Resolution Identity included in the MAC control element matches the CCCH SDU transmitted in the uplink message.

A.4.3.2.2.1.2.6 Reception of a Correct Message over Temporary C-RNTI

To test the UE behavior specified in Subclause 6.2.2.2.1.5 the System Simulator shall send a message addressed to the temporary C-RNTI with a UE Contention Resolution Identity included in the MAC control element matching the CCCH SDU transmitted in the msg3 uplink message.

The UE shall send ACK if the Contention Resolution is successful.

A.6.3.2.2.1.2.7 Contention Resolution Timer expiry

To test the UE behavior specified in Subclause 6.2.2.2.1.6 the System Simulator shall *not* send a response to a msg3.

The UE shall again perform the Random Access Resource selection procedure specified in clause 5.1.2 in TS38.321 [7], and transmit with the calculated PRACH transmission power when the backoff time expires if the Contention Resolution Timer expires.

A.6.3.2.2.2 Non-Contention based random access test in FR1 for NR standalone

A.6.3.2.2.2.1 Test Purpose and Environment

The purpose of this test is to verify that the behavior of the random access procedure is according to the requirements and that the PRACH power settings and timing are within specified limits. This test will verify the requirements in Clause 6.2.2.2 and Clause 7.1.2 in an AWGN model.

For this test one cell is used and configured as PCell in FR1. Supported test parameters are shown in Table A.6.3.2.2.2.1-1. UE capable of SA with PCell in FR1 needs to be tested by using the parameters in Table A.6.3.2.2.2.1-2 for SSB-based non-contention based random access test (Test 1) and CSI-RS-based non-contention based random access test (Test 2).

Table A.6.3.2.2.2.1-1: Supported test configurations for non-contention based random access test in FR1 for NR standalone

Config	Description
1	NR 15 kHz SSB SCS, 10MHz bandwidth, FDD duplex mode
2	NR 30 kHz SSB SCS, 40MHz bandwidth, TDD duplex mode
Note:	The UE is only required to be tested in one of the supported test configurations depending on UE capability

Table A.6.3.2.2.1-2: General test parameters for non-contention based random access test in FR1 for NR Standalone

Parameter		Unit	Test-1	Test-2	Comments	
SSB Configuration	Config 1		SSB pattern 1 in FR1	SSB pattern 1 in FR1	As defined in A.3.10, except for number of SSBs per SS-burst and SS/PBCH block index as below	
	Config 2		SSB pattern 2 in FR1	SSB pattern 2 in FR1		
Number of SSBs per SS-burst			2	2	Different from the definition in A.3.10	
SS/PBCH block index			0,1	0,1	Different from the definition in A.3.10	
CSI-RS Configuration	Config 1		N/A	CSI-RS.1.1 FDD	As defined in A.3.1.4	
	Config 2			CSI-RS.2.1 TDD		
Duplex Mode for Cell 2	Config 1		FDD	FDD		
	Config 2		TDD	TDD		
TDD Configuration	Config 2		TDDConf.1.2	TDDConf.1.2		
OCNG Pattern ^{Note 1}			OCNG pattern 1	OCNG pattern 1	As defined in A.3.2.1.	
PDSCH parameters ^{Note 4}	Config 1		SR.1.1 FDD	SR.1.1 FDD	As defined in A.3.1.1.	
	Config 2		SR.2.1 TDD	SR.2.1 TDD		
NR RF Channel Number			1	1		
EPRE ratio of PSS to SSS		dB	0	0		
EPRE ratio of PBCH_DMRS to SSS		dB				
EPRE ratio of PBCH to PBCH_DMRS		dB				
EPRE ratio of PDCCH_DMRS to SSS		dB				
EPRE ratio of PDCCH to PDCCH_DMRS		dB				
EPRE ratio of PDSCH_DMRS to SSS		dB				
EPRE ratio of PDSCH to PDSCH_DMRS		dB				
SSB with index 0	\hat{E}_s / I_{ot}	dB	3	3	Power of SSB with index 0 is set to be above configured <i>rsrp-ThresholdSSB</i>	
	N_{oc}	Config 1	dBm/15kHz	-98		-98
		Config 2		-101		-101
	\hat{E}_s / N_{oc}	dB	3	3		
SS-RSRP ^{Note 3}		dBm/ SCS	-95	-95		
SSB with index 1	\hat{E}_s / I_{ot}	dB	-17	-17	Power of SSB with index 1 is set to be below configured <i>rsrp-ThresholdSSB</i>	
	N_{oc}	Config 1	dBm/15kHz	-98		-98
		Config 2		-101		-101
	\hat{E}_s / N_{oc}	dB	-17	-17		
SS-RSRP ^{Note 3}		dBm/ SCS	-115	-115		
I_0 ^{Note 2}	Config 1	dBm	-65.3/9.36MHz	-65.3/9.36MHz	For symbols without SSB index 1	
	Config 2		-62.2/38.16MHz	-62.2/38.16MHz		
ss-PBCH-BlockPower		dBm/ SCS	-5	-5	As defined in clause 6.3.2 in TS 38.331 [2].	
Configured UE transmitted power ($P_{CMAX, f,c}$)		dBm	23	23	As defined in clause 6.2.4 in TS 38.101-1.	
PRACH Configuration			FR1 PRACH configuration 2	FR1 PRACH configuration 3	As defined in A.3.8.2.	
Propagation Condition		-	AWGN	AWGN		
<p>Note 1: OCNG shall be used such that the cell is fully allocated and a constant total transmitted power spectral density is achieved for all OFDM symbols. The OCNG pattern is chosen during the test according to the presence of a DL reference measurement channel.</p>						

Note 2:	SS-RSRP, Es/lot and lo levels have been derived from other parameters for information purpose. They are not settable parameters.
Note 3:	Void
Note 4:	The DL PDSCH reference measurement channel is used in the test only when a downlink transmission dedicated to the UE under test is required.

A.6.3.2.2.2.2 Test Requirements

Non-Contention based random access is triggered by explicitly assigning a random access preamble via dedicated signalling in the downlink. In the test, the non-contention based random access procedure is not initialized for Other SI requested from UE or beam failure recovery.

A.6.3.2.2.2.2.1 SSB-based Random Access Preamble Transmission

In Test-1, to test the UE behavior specified in Subclause 6.2.2.2.2.1 for SSB-based Random Access Preamble transmission, with the contention-free Random Access Resources and the contention-free PRACH occasions associated with SSBs configured, the System Simulator shall receive the Random Access Preamble which has the Preamble Index associated with the SSB with index 0.

In addition, the System Simulator shall receive the Random Access Preamble on the PRACH occasion which belongs to the PRACH occasions corresponding to the SSB with index 0, and the selected PRACH occasion shall belong to the PRACH occasions permitted by the restrictions given by the *ra-ssb-OccasionMaskIndex*.

In addition, the power applied to all preambles shall be in accordance with what is specified in Subclause 6.2.2.2. The power of the first preamble shall be -30 dBm with an accuracy specified in clause 6.3.4.2 of TS 38.101-1 [18]. The relative power applied to additional preambles shall have an accuracy specified in clause 6.3.4.3 of TS 38.101-1 [18].

The transmit timing of all PRACH transmissions shall be within the accuracy specified in Subclause 7.1.2.

A.6.3.2.2.2.2.2 CSI-RS-based Random Access Preamble Transmission

In Test-2, to test the UE behavior specified in Subclause 6.2.2.2.2.1 for CSI-RS-based Random Access Preamble transmission, with the contention-free Random Access Resources and the contention-free PRACH occasions associated with CSI-RSs configured, the System Simulator shall receive the Random Access Preamble which has the Preamble Index associated with the CSI-RS configured.

In addition, the System Simulator shall receive the Random Access Preamble on the PRACH occasion which belongs to the PRACH occasions corresponding to the CSI-RS configured, and the selected PRACH occasion shall belong to the PRACH occasions permitted by the restrictions given by the *ra-OccasionList*.

In addition, the power applied to all preambles shall be in accordance with what is specified in Subclause 6.2.2.2. The power of the first preamble shall be -30 dBm with an accuracy specified in clause 6.3.4.2 of TS 38.101-1 [18]. The relative power applied to additional preambles shall have an accuracy specified in clause 6.3.4.3 of TS 38.101-1 [18].

The transmit timing of all PRACH transmissions shall be within the accuracy specified in Subclause 7.1.2.

A.6.3.2.2.2.2.3 Random Access Response Reception

To test the UE behavior specified in Subclause 6.2.2.2.2.2 the System Simulator shall transmit a Random Access Response containing a Random Access Preamble identifier corresponding to the transmitted Random Access Preamble after 5 preambles have been received by the System Simulator. In response to the first 4 preambles, the System Simulator shall transmit a Random Access Response *not* corresponding to the transmitted Random Access Preamble.

The UE may stop monitoring for Random Access Response(s) if the Random Access Response contains a Random Access Preamble identifier corresponding to the transmitted Random Access Preamble.

The UE shall again perform the Random Access Resource selection procedure specified in clause 5.1.2 in TS38.321 [7], and transmit with the calculated PRACH transmission power if all received Random Access Responses contain Random Access Preamble identifiers that do not match the transmitted Random Access Preamble.

In addition, the power applied to all preambles shall be in accordance with what is specified in Subclause 6.2.2.2. The power of the first preamble shall be -30 dBm with an accuracy specified in clause 6.3.4.2 of TS 38.101-1 [18]. The relative power applied to additional preambles shall have an accuracy specified in clause 6.3.4.3 of TS 38.101-1 [18].

The transmit timing of all PRACH transmissions shall be within the accuracy specified in Subclause 7.1.2.

A.6.3.2.2.2.4 No Random Access Response Reception

To test the UE behavior specified in subclause 6.2.2.2.3 the System Simulator shall transmit a Random Access Response containing a Random Access Preamble identifier corresponding to the transmitted Random Access Preamble after 5 preambles have been received by the System Simulator. The System Simulator shall *not* respond to the first 4 preambles.

The UE shall again perform the Random Access Resource selection procedure specified in clause 5.1.2 in TS38.321 [7], and transmit with the calculated PRACH transmission power when the backoff time expires if no Random Access Response is received within the RA Response window configured in *RACH-ConfigCommon*.

In addition, the power applied to all preambles shall be in accordance with what is specified in Subclause 6.2.2.2. The power of the first preamble shall be -30 dBm with an accuracy specified in clause 6.3.4.2 of TS 38.101-1 [18]. The relative power applied to additional preambles shall have an accuracy specified in clause 6.3.4.3 of TS 38.101-1 [18].

The transmit timing of all PRACH transmissions shall be within the accuracy specified in Subclause 7.1.2.

A.6.3.2.3 SA: RRC Connection Release with Redirection

A.6.3.2.3.1 Redirection from NR in FR1 to NR in FR1

A.6.3.2.3.1.1 Test Purpose and Environment

This test is to verify RRC connection release with redirection from NR to NR requirements specified in clause 6.2.3.2.1.

A.6.3.2.3.1.2 Test Parameters

Supported test configurations are shown in table A.6.3.2.3.1.2-1. The time delay is tested by using the parameters in table A.6.3.2.3.1.2-2, and A.6.3.2.3.1.2-3.

The test consists of two successive time periods, with time duration of T1, and T2 respectively. The “*RRCConnectionRelease*” message containing the relevant system information of Cell 2 shall be sent to the UE during period T1 and the start of T2 is the instant when the last TTI containing the RRC message is sent to the UE. Prior to time duration T2, the UE shall not have any timing information of Cell 2. Cell 2 is powered up at the beginning of the T2.

Table A.6.3.2.3.1.2-1: Redirection from NR to NR test configurations

Config	Description
1	Source cell: NR 15 kHz SSB SCS, 10MHz bandwidth, FDD duplex mode Target cell: NR 15 kHz SSB SCS, 10MHz bandwidth, FDD duplex mode
2	Source cell: NR 15 kHz SSB SCS, 10MHz bandwidth, TDD duplex mode Target cell: NR 15 kHz SSB SCS, 10MHz bandwidth, TDD duplex mode
3	Source cell: NR 30 kHz SSB SCS, 40MHz bandwidth, TDD duplex mode Target cell: NR 30 kHz SSB SCS, 40MHz bandwidth, TDD duplex mode
Note: The UE is only required to be tested in one of the supported test configurations	

Table A.6.3.2.3.1.2-2: General test parameters for Redirection from NR to NR test case

Parameter	Unit	Value	Comment
Initial conditions	Active cell	Cell 1	
	Neighbouring cell	Cell 2	
Final condition	Active cell	Cell 2	
Filter coefficient		0	L3 filtering is not used
Access Barring Information	-	Not Sent	No additional delays in random access procedure.
Time offset between cells		3 μ s	Synchronous cells
T1	s	5	
T2	s	1	

Table A.6.3.2.3.1.2-3: Cell specific test parameters for Redirection from NR to NR test case

Parameter	Unit	Cell 1		Cell 2	
		T1	T2	T1	T2
NR RF Channel Number		1		2	
Duplex mode	Config 1	FDD			
	Config 2,3	TDD			
TDD configuration	Config 1	Not Applicable			
	Config 2	TDDConf.1.1			
	Config 3	TDDConf.2.1			
BW _{channel}	Config 1	10: N _{RB,c} = 52			
	Config 2	10: N _{RB,c} = 52			
	Config 3	40: N _{RB,c} = 106			
BWP BW	Config 1	10: N _{RB,c} = 52			
	Config 2	10: N _{RB,c} = 52			
	Config 3	40: N _{RB,c} = 106			
DRx Cycle	ms	Not Applicable			
PDSCH Reference measurement channel	Config 1	SR.1.1 FDD			
	Config 2	SR.1.1 TDD			
	Config 3	SR.2.1 TDD			
CORESET Reference Channel	Config 1	CR.1.1 FDD			
	Config 2	CR.1.1 TDD			

		Config 3	CR2.1 TDD			
OCNG Patterns			OCNG pattern 1			
SMTC configuration	Config 1,2		SMTC.1 FR1			
	Config 3		SMTC.2 FR1			
PDSCH/PDCCH subcarrier spacing	Config 1,2	kHz	15 kHz			
	Config 3		30 kHz			
PUCCH/PUSCH subcarrier spacing	Config 1,2	kHz	15 kHz			
	Config 3		30 kHz			
PRACH configuration			FR1 PRACH configuration 1			
BWP configuraiton	Initial DL BWP		DLBWP.0.1			
	Dedicated DL BWP		DLBWP.1.1			
	Initial UL BWP		ULBWP.0.1			
	Dedicated UL BWP		ULBWP.1.1			
EPRE ratio of PSS to SSS		dB	0			
EPRE ratio of PBCH DMRS to SSS						
EPRE ratio of PBCH to PBCH DMRS						
EPRE ratio of PDCCH DMRS to SSS						
EPRE ratio of PDCCH to PDCCH DMRS						
EPRE ratio of PDSCH DMRS to SSS						
EPRE ratio of PDSCH to PDSCH						
EPRE ratio of OCNG DMRS to SSS(Note 1)						
EPRE ratio of OCNG to OCNG DMRS (Note 1)						
N_{oc} ^{Note2}		dBm/15kHz	-98			
N_{oc} ^{Note2}	Config 1,2	dBm/SCS	-98			
	Config 3		-95			
\hat{E}_s/I_{ot}		dB	4	4	-infinity	4
\hat{E}_s/N_{oc}		dB	4	4	-infinity	4
I_o ^{Note3}	Config 1,2	dBm/9.36MHz	-67.11	-67.11	-70.05	-67.11
	Config 3	dBm/38.16MHz	-62.27	-62.27	-63.96	-62.27
Propagation condition		-	AWGN			
Note 1: OCNG shall be used such that both cells are fully allocated and a constant total transmitted power spectral density is achieved for all OFDM symbols.						
Note 2: Interference from other cells and noise sources not specified in the test is assumed to be constant over subcarriers and time and shall be modelled as AWGN of appropriate power for N_{oc} to be fulfilled.						
Note 3: I_o levels have been derived from other parameters for information purposes. They are not settable parameters themselves.						

A.6.3.2.3.1.3 Test Requirements

The UE shall start to transmit the PRACH to Cell 2 less than [960] ms from the beginning of time period T2.

The rate of correct RRC connection release redirection to NR observed during repeated tests shall be at least 90%.

NOTE: The redirection delay can be expressed as:

$$T_{\text{connection_release_redirect_NR}} = T_{\text{RRC_procedure_delay}} + T_{\text{identify-NR}} + T_{\text{SI-NR}} + T_{\text{RACH}}$$

where:

$T_{\text{RRC_procedure_delay}} = [110]$ ms and is specified in clause 12 in TS 38.331 [2].

$T_{\text{identify-NR}} = [680]$ ms in the test.

$T_{\text{SI-NR}} = 0$ ms is assumed, since the UE is provided with the SI (including MIB and all relevant SIBs) of the target NR cell before the RRC connection is released by the old NR cell.

$T_{\text{RACH}} = [170]$ ms in the test.

This gives a total of [960] ms.

A.6.3.2.3.2 Redirection from NR in FR1 to E-UTRAN

A.6.3.2.3.2.1 Test Purpose and Environment

This test is to verify RRC connection release with redirection from NR to E-UTRAN requirements specified in clause 6.2.3.2.2.

A.6.3.2.3.2.2 Test Parameters

Supported test configurations are shown in table A.6.3.2.3.2.2-1. The time delay is tested by using the parameters in table A.6.3.2.3.2.2-2, A.6.3.2.3.2.2-3 and A.6.3.2.3.2.2-4.

The test consists of two successive time periods, with time duration of T1, and T2 respectively. The “*RRCConnectionRelease*” message containing the relevant system information of Cell 2 shall be sent to the UE during period T1 and the start of T2 is the instant when the last TTI containing the RRC message is sent to the UE. Prior to time duration T2, the UE shall not have any timing information of Cell 2. Cell 2 is powered up at the beginning of the T2.

Table A.6.3.2.3.2.2-1: Redirection from NR to E-UTRAN test configurations

Configuration	Description
1	NR 15 kHz SSB SCS, 10MHz bandwidth, FDD duplex mode, LTE FDD
2	NR 15 kHz SSB SCS, 10MHz bandwidth, TDD duplex mode, LTE FDD
3	NR 30 kHz SSB SCS, 40MHz bandwidth, TDD duplex mode, LTE FDD
4	NR 15 kHz SSB SCS, 10MHz bandwidth, FDD duplex mode, LTE TDD
5	NR 15 kHz SSB SCS, 10MHz bandwidth, TDD duplex mode, LTE TDD
6	NR 30kHz SSB SCS, 40MHz bandwidth, TDD duplex mode, LTE TDD
Note:	The UE is only required to be tested in one of the supported test configurations

Table A.6.3.2.3.2.2-2: General test parameters for Redirection from NR to E-UTRAN test case

Parameter	Unit	Value	Comment
Initial conditions	Active cell	Cell 1	
	Neighbouring cell	Cell 2	
Final condition	Active cell	Cell 2	
Filter coefficient		0	L3 filtering is not used
Access Barring Information	-	Not Sent	No additional delays in random access procedure.
Time offset between cells		3 μ s	Synchronous cells
T1	s	5	
T2	s	1	

Table A.6.3.2.3.2.2-3: Cell specific test parameters for Redirection from NR to E-UTRAN (cell 1)

Parameter	Unit	Cell 1	
		T1	T2

RF Channel Number			1
Duplex mode	Config 1		FDD
	Config 2,3		TDD
TDD configuration	Config 1		Not Applicable
	Config 2		TDDConf.1.1
	Config 3		TDDConf.2.1
BW _{channel}	Config 1	MHz	10: N _{RB,c} = 52
	Config 2		10: N _{RB,c} = 52
	Config 3		40: N _{RB,c} = 106
BWP BW	Config 1	MHz	10: N _{RB,c} = 52
	Config 2		10: N _{RB,c} = 52
	Config 3		40: N _{RB,c} = 106
DRx Cycle		ms	Not Applicable
PDSCH Reference measurement channel	Config 1		SR.1.1 FDD
	Config 2		SR.1.1 TDD
	Config 3		SR2.1 TDD
CORESET Reference Channel	Config 1		CR.1.1 FDD
	Config 2		CR.1.1 TDD
	Config 3		CR2.1 TDD
OCNG Patterns			OCNG pattern 1
SMTc configuration	Config 1,2		SMTc.1 FR1
	Config 3		SMTc.2 FR1
PDSCH/PDCCH subcarrier spacing	Config 1,2	kHz	15 kHz
	Config 3		30 kHz
PUCCH/PUSCH subcarrier spacing	Config 1,2	kHz	15 kHz
	Config 3		30 kHz
PRACH configuration			FR1 PRACH configuration 1
BWP configuraiton	Initial DL BWP		DLBWP.0.1
	Dedicated DL BWP		DLBWP.1.1
	Initial UL BWP		ULBWP.0.1
	Dedicated UL BWP		ULBWP.1.1
EPRE ratio of PSS to SSS		dB	0
EPRE ratio of PBCH DMRS to SSS			
EPRE ratio of PBCH to PBCH DMRS			
EPRE ratio of PDCCH DMRS to SSS			
EPRE ratio of PDCCH to PDCCH DMRS			
EPRE ratio of PDSCH DMRS to SSS			
EPRE ratio of PDSCH to PDSCH			
EPRE ratio of OCNG DMRS to SSS(Note 1)			
EPRE ratio of OCNG to OCNG DMRS (Note 1)			

N_{oc} ^{Note2}		dBm/15kHz z	-98	
N_{oc} ^{Note2}	Config 1,2	dBm/SCS	-98	
	Config 3		-95	
\hat{E}_s/I_{ot}		dB	4	4
\hat{E}_s/N_{oc}		dB	4	4
I_o ^{Note3}	Config 1,2	dBm/ 9.36MHz	-67.11	-67.11
	Config 3	dBm/ 38.16MHz	-62.27	-62.27
Propagation condition		-	AWGN	
Note 1: OCNG shall be used such that both cells are fully allocated and a constant total transmitted power spectral density is achieved for all OFDM symbols.				
Note 2: Interference from other cells and noise sources not specified in the test is assumed to be constant over subcarriers and time and shall be modelled as AWGN of appropriate power for N_{oc} to be fulfilled.				
Note 3: I_o levels have been derived from other parameters for information purposes. They are not settable parameters themselves.				

Table A.6.3.2.3.2.2-4: Cell specific test parameters for Redirection from NR to E-UTRAN (cell 2)

Parameter	Unit	Configuration	Cell 2	
			T1	T2
RF channel number		1, 2, 3, 4, 5, 6	2	
Duplex mode		1, 2, 3	FDD	
		4, 5, 6	TDD	
TDD special subframe configuration ^{Note1}		4, 5, 6	6	
TDD uplink-downlink configuration ^{Note1}		4, 5, 6	1	
$BW_{channel}$	MHz	1, 2, 3, 4, 5, 6	5MHz: $N_{RB,c} = 25$ 10MHz: $N_{RB,c} = 50$ 20MHz: $N_{RB,c} = 100$	
PRACH Configuration ^{Note2}		1, 2, 3	4	
		4, 5, 6	53	
PDSCH parameters: DL Reference Measurement Channel ^{Note3}		1, 2, 3	5MHz: R.7 FDD 10MHz: R.3 FDD 20MHz: R.6 FDD	
		4, 5, 6	5MHz: R.4 TDD 10MHz: R.0 TDD 20MHz: R.3 TDD	
PCFICH/PDCCH/PHICH parameters: DL Reference Measurement Channel ^{Note3}		1, 2, 3	5MHz: R.11 FDD 10MHz: R.6 FDD 20MHz: R.10 FDD	
		4, 5, 6	5MHz: R.11 TDD 10MHz: R.6 TDD 20MHz: R.10 TDD	
OCNG Patterns ^{Note3}		1, 2, 3	5MHz: OP.20 FDD 10MHz: OP.10 FDD 20MHz: OP.17 FDD	
		4, 5, 6	5MHz: OP.9 TDD 10MHz: OP.1 TDD 20MHz: OP.7 TDD	
PBCH_RA	dB	1, 2, 3, 4, 5, 6	0	
PBCH_RB				
PSS_RA				
SSS_RA				

PCFICH_RB			
PHICH_RA			
PHICH_RB			
PDCCH_RA			
PDCCH_RB			
PDSCH_RA			
PDSCH_RB			
OCNG_RA ^{Note4}			
OCNG_RB ^{Note4}			
N_{oc} ^{Note5}	dBm/15kHz	1, 2, 3, 4, 5, 6	-98
\hat{E}_s/N_{oc}	dB	1, 2, 3, 4, 5, 6	-Infinity
\hat{E}_s/I_{ot} ^{Note6}	dB	1, 2, 3, 4, 5, 6	-Infinity
RSRP ^{Note6}	dBm/15kHz	1, 2, 3, 4, 5, 6	-Infinity
SCH_RP ^{Note6}	dBm/15kHz	1, 2, 3, 4, 5, 6	-Infinity
I_o ^{Note6}	dBm/9MHz	1, 2, 3, 4, 5, 6	-70.22
Propagation Condition		1, 2, 3, 4, 5, 6	AWGN
<p>Note 1: Special subframe and uplink-downlink configurations are specified in table 4.2-1 in TS 36.211.</p> <p>Note 2: PRACH configurations are specified in table 5.7.1-2 and table 5.7.1-3 in TS 36.211.</p> <p>Note 3: DL RMCs and OCNG patterns are specified in sections A 3.1 and A 3.2 of TS 36.133 respectively.</p> <p>Note 4: OCNG shall be used such that all cells are fully allocated and a constant total transmitted power spectral density is achieved for all OFDM symbols.</p> <p>Note 5: Interference from other cells and noise sources not specified in the test is assumed to be constant over subcarriers and time and shall be modelled as AWGN of appropriate power for N_{oc} to be fulfilled.</p> <p>Note 6: \hat{E}_s/I_{ot}, RSRP, SCH_RP and I_o levels have been derived from other parameters for information purposes. They are not settable parameters themselves.</p> <p>Note 7: Propagation condition and correlation matrix are defined in section B.2 in TS 36.101 [25].</p>			

A.6.3.2.3.2.3 Test Requirements

The UE shall start to transmit the PRACH to Cell 2 less than [925] ms from the beginning of time period T2. The rate of correct RRC connection release redirection to E-UTRAN observed during repeated tests shall be at least 90%.

NOTE: The redirection delay can be expressed as:

$$T_{\text{connection_release_redirect_E-UTRA}} = T_{\text{RRC_procedure_delay}} + T_{\text{identify-E-UTRA}} + T_{\text{SI-E-UTRA}} + T_{\text{RACH}},$$

where:

$T_{\text{RRC_procedure_delay}} = [110]$ ms and is specified in clause 12 in TS 38.331 [2].

$T_{\text{identify-NR}} = [800]$ ms in the test.

$T_{\text{SI-NR}} = 0$ ms is assumed, since the UE is provided with the SI (including MIB and all relevant SIBs) of the target E-UTRAN cell before the RRC connection is released by the old NR cell.

$T_{\text{RACH}} = [15]$ ms in the test.

This gives a total of [925] ms.

A.6.4 Timing

A.6.4.1 UE transmit timing

A.6.4.1.1 NR UE Transmit Timing Test for FR1

A.6.4.1.1.1 Test Purpose and environment

The purpose of this test is to verify that the UE can follow frame timing change of the connected gNodeB and that the UE initial transmit timing accuracy, maximum amount of timing change in one adjustment, minimum and maximum adjustment rate are within the specified limits. This test will verify the requirements in clause 7.1.2.

Supported test configurations are shown in Table 6.4.1.1.1-1

Table A.6.4.1.1.1-1: Supported test configurations for FR1 PCell

Configuration	Description
1	LTE FDD, NR SCS 15 kHz, BW 10 MHz, FDD
2	LTE FDD, NR SCS 15 kHz, BW 10 MHz, TDD
3	LTE FDD, NR SCS 30 kHz, BW 40 MHz, TDD
4	LTE FDD, NR SCS 15 kHz, BW 10 MHz, FDD
5	LTE FDD, NR SCS 15 kHz, BW 10 MHz, TDD
6	LTE FDD, NR SCS 30 kHz, BW 40 MHz, TDD
Note:	The UE is only required to pass in one of the supported test configurations in FR1

For this test a single NR cell is used. Table A.6.4.1.1.1-2 defines the parameters to be configured and strength of the transmitted signals. The transmit timing is verified by the UE transmitting SRS using the configuration defined in Table A.6.4.1.1.1-3.

Table A.6.4.1.1.1-2: Cell Specific Test Parameters for UL Transmit Timing test

Parameter	Unit	Config	Test1	Test2
E-UTRA Channel Number		1,2,3,4,5,6	1	1
NR Channel Number		1,2,3,4,5,6	2	2
TDD configuration		1,4	Not Applicable	
		2,5	TDDConf.1.1	
		3,6	TDDConf.1.2	
BW _{channel}	MHz	1,4	10: N _{RB,c} = 52	
		2,5	10: N _{RB,c} = 52	
		3,6	40: N _{RB,c} = 106	
Initial BWP Configuration		1,2,3,4,5,6	DLBWP.0.1 ULBWP.0.1	
Dedicated BWP Configuration		1,2,3,4,5,6	DLBWP.1.1 ULBWP.1.1	
DRx Cycle	ms	1,2,3,4,5,6	N/A	DRX.5 ^{Note5}
PDSCH Reference measurement channel		1,4	SR.1.1 FDD	
		2,5	SR.1.1 TDD	
		3,6	SR.2.1 TDD	
RMSI CORESET Reference Channel		1,4	CR.1.1 FDD	
		2,5	CR.1.1 TDD	

		3,6	CR.2.1 TDD	
Dedicated CORESET Reference Channel		1,4	CCR.1.1 FDD	
		2,5	CCR.1.1 TDD	
		3,6	CCR.2.1 TDD	
OCNG Patterns		1,2,3,4,5,6	OP.1	
SSB configuration		1,2,4,5	SSB.1 FR1	
		3,6	SSB.2 FR1	
SMTTC configuration		1,2,4,5	SMTTC.1	
		3,6	SMTTC.1	
EPRE ratio of PSS to SSS	dB	1,2,3,4,5,6	0	0
EPRE ratio of PBCH DMRS to SSS				
EPRE ratio of PBCH to PBCH DMRS				
EPRE ratio of PDCCH DMRS to SSS				
EPRE ratio of PDCCH to PDCCH DMRS				
EPRE ratio of PDSCH DMRS to SSS				
EPRE ratio of PDSCH to PDSCH				
EPRE ratio of OCNG DMRS to SSS(Note 1)				
EPRE ratio of OCNG to OCNG DMRS (Note 1)				
N_{oc}^{Note2}	dBm/15 kHz	1,2,3,4,5,6	-98	-98
N_{oc}^{Note2}	dBm/SCS	1,2,4,5	-98	-98
		3,6	-95	-95
\hat{E}_s / I_{ot}		1,2,3,4,5,6	3	3
\hat{E}_s / N_{oc}		1,2,3,4,5,6	3	3
SS-RSRP ^{Note3}	dBm/SCS	1,2,4,5	-95	-95
		3,6	-92	-92
I_o^{Note3}	dBm/9.36MHz	1,2,4,5	-65.2	-65.2
	dBm/38.1MHz	3,6	-59.2	-59.2
Propagation condition		1,2,3,4,5,6	AWGN	
SRS Config		1,2,3,4,5,6	Config1 ^{Note6}	Config2 ^{Note6}
<p>Note 1: OCNG shall be used such that both cells are fully allocated and a constant total transmitted power spectral density is achieved for all OFDM symbols.</p> <p>Note 2: Interference from other cells and noise sources not specified in the test is assumed to be constant over subcarriers and time and shall be modelled as AWGN of appropriate power for N_{oc} to be fulfilled.</p> <p>Note 3: SS-RSRP and I_o levels have been derived from other parameters for information purposes. They are not settable parameters themselves.</p> <p>Note 4: SS-RSRP minimum requirements are specified assuming independent interference and noise at each receiver antenna port.</p> <p>Note 5: DRx related parameters are given in Table A.3.3.4-1</p> <p>Note 6: SRS configs are given in Table A.6.4.1.1.1-3</p>				

Table A.6.4.1.1.1-3: SRS Configuration for Timing Accuracy Test

	Field	Config1	Config 2	Comments
SRS-ResourceSet	srs-ResourceSetId	0	0	
	srs-ResourceIdList	0	0	
	resourceType	Periodic	Periodic	
	Usage	Codebook	Codebook	
	SRS-ResourceSetId	0	0	
SRS-Resource	nrofSRS-Ports	Port1	Port1	
	transmissionComb	n2	n2	
	combOffset-n2	0	0	
	cyclicShift-n2	0	0	
	resourceMapping startPosition	0	0	
	resourceMapping nrofSymbols	n1	n1	
	resourceMapping repetitionFactor	n1	n1	
	freqDomainPosition	0	0	
	freqDomainShift	0	0	
	freqHopping c-SRS	sl1	sl1	
	freqHopping b-SRS	0	0	
	freqHopping b-hop	0	0	
	groupOrSequenceHopping	Neither	Neither	
	resourceType	Periodic	Periodic	
	periodicityAndOffset-p	sl1	sl640	Offset to align with DRx periodicity
	sequenceId	0	0	Any 10 bit number

Table A.6.4.1.1.1-4: Void**A.6.4.1.1.2 Test requirements**

The test sequence shall be carried out in RRC_CONNECTED for every test case.

Following will be the test sequence for this test

- 1) Setup NR PCell according to parameters given in Table A.6.4.1.1.1-1.
- 2) After connection set up with the cell, the test equipment will verify that the timing of the NR cell is within $(N_{TA} + N_{TA_offset}) \pm T_e$ of the first detected path of DL SSB.

- a. The N_{TA} offset value (in T_c units) is 25600 for FR1 and 13792 for FR2
 - b. The T_e values depend on the DL and UL SCS for which the test is being run and are given in Table 7.1.2-1
- 3) The test system shall adjust the timing of the DL path by values given in Table A.6.4.1.1.2-1

Table A.6.4.1.1.2-1: Adjustment Value for DL Timing

SCS of SSB signals (KHz)	Adjustment Value	
	Test1	Test2
15	$+64 \cdot 64 T_c$	$+32 \cdot 64 T_c$
30	$+32 \cdot 64 T_c$	$+16 \cdot 64 T_c$
120	$+16 \cdot 64 T_c$	$+8 \cdot 64 T_c$
240	$+8 \cdot 64 T_c$	$+4 \cdot 64 T_c$

- 4) The test system shall verify that the adjustment step size and the adjustment rate shall be according to requirements specified in Section 7.1.2 Table 7.1.2-3. This will only be done for Test1.
- 5) The test system shall verify that the UE transmit timing offset stays within $(N_{TA} + N_{TA_offset}) \pm T_e$ of the first detected path of DL SSB. For Test 2 and Test 4 the UE transmit timing offset shall be verified for the first transmission in the DRX cycle immediately after DL timing adjustment

A.6.4.2 UE timer accuracy

A.6.4.3 Timing advance

A.6.4.3.1 SA FR1 timing advance adjustment accuracy

A.6.4.3.1.1 Test Purpose and Environment

The purpose of the test is to verify UE Timing Advance adjustment delay and accuracy requirement defined in clause 7.3.

A.6.4.3.1.2 Test Parameters

Supported test configurations are shown in table A.6.4.3.1.2-1. Both timing advance adjustment delay and accuracy are tested by using the parameters in table A.6.4.3.1.2-2, A.6.4.3.1.2-3 and A.6.4.3.1.2-4.

In all test cases, single cell is used. Each test consists of two successive time periods, with time duration of T1 and T2 respectively. In each time period, timing advance commands are sent to the UE and Sounding Reference Signals (SRS), as specified in table A.6.4.3.1.2-3, are sent from the UE and received by the test equipment. By measuring the reception of the SRS, the transmit timing, and hence the timing advance adjustment accuracy, can be.

During time period T1, the test equipment shall send one message with a Timing Advance Command MAC Control Element, as specified in Clause 6.1.3.4 in TS 38.321 [7]. The Timing Advance Command value shall be set to 31, which according to Clause 4.2 in TS 38.213 results in zero adjustment of the Timing Advance. In this way, a reference value for the timing advance used by the UE is established.

During time period T2, the test equipment shall send a sequence of messages with Timing Advance Command MAC Control Elements, with Timing Advance Command value specified in table A.6.4.3.1.2-2. This value shall result in changes of the timing advance used by the UE, and the accuracy of the change shall then be measured, using the SRS sent from the UE.

As specified in Clause 7.3.2.1, the UE adjusts its uplink timing at slot $n+k$ for a timing advance command received in slot n . This delay must be taken into account when measuring the timing advance adjustment accuracy, via the SRS sent from the UE.

The UE Time Alignment Timer, described in Clause 5.2 in TS 38.321, shall be configured so that it does not expire in the duration of the test.

Table A.6.4.3.1.2-1: Timing advance supported test configurations

Config	Description
1	NR 15 kHz SSB SCS, 10MHz bandwidth, FDD duplex mode
2	NR 15 kHz SSB SCS, 10MHz bandwidth, TDD duplex mode
3	NR 30 kHz SSB SCS, 40MHz bandwidth, TDD duplex mode
Note:	The UE is only required to be tested in one of the supported test configurations

Table A.6.4.3.1.2-2: General test parameters for timing advance

Parameter	Unit	Value	Comment
RF channel number		1	
Initial DL BWP		DLBWP.0.1	As specified in Table A.3.9.2.1-1
Dedicated DL BWP		DLBWP.1.1	As specified in Table A.3.9.2.2-1
Initial UL BWP		ULBWP.0.1	As specified in Table A.3.9.3.1-1
Dedicated UL BWP		ULBWP.1.1	As specified in Table A.3.9.3.2-1
Timing Advance Command (T_A) value during T1		31	$N_{TA_new} = N_{TA_old}$ for the purpose of establishing a reference value from which the timing advance adjustment accuracy can be measured during T2
Timing Advance Command (T_A) value during T2		39	$N_{TA_new} = N_{TA_old} + 8192 * T_c$ (based on equation in TS 38.213 [3] section 4.2)
T1	s	5	
T2	s	5	

Table A.6.4.3.1.2-3: Cell specific test parameters for timing advance

Parameter		Unit	Test1	
			T1	T2
Duplex mode	Config 1		FDD	
	Config 2,3		TDD	
TDD configuration	Config 1		Not Applicable	
	Config 2		TDDConf.1.1	
	Config 3		TDDConf.2.1	
BW _{channel}	Config 1	MHz	10: N _{RB,c} = 52	
	Config 2		10: N _{RB,c} = 52	
	Config 3		40: N _{RB,c} = 106	
BWP BW	Config 1	MHz	10: N _{RB,c} = 52	
	Config 2		10: N _{RB,c} = 52	
	Config 3		40: N _{RB,c} = 106	
DRx Cycle		ms	Not Applicable	
PDSCH Reference measurement channel	Config 1		SR.1.1 FDD	
	Config 2		SR.1.1 TDD	
	Config 3		SR2.1 TDD	
CORESET Reference Channel	Config 1		CR.1.1 FDD	

	Config 2		CR.1.1 TDD
	Config 3		CR2.1 TDD
OCNG Patterns			OCNG pattern 1
SMTC configuration	Config 1,2		SMTC.1 FR1
	Config 3		SMTC.2 FR1
PDSCH/PDCCH subcarrier spacing	Config 1,2	kHz	15 kHz
	Config 3		30 kHz
PUCCH/PUSCH subcarrier spacing	Config 1,2	kHz	15 kHz
	Config 3		30 kHz
EPRE ratio of PSS to SSS		dB	0
EPRE ratio of PBCH DMRS to SSS			
EPRE ratio of PBCH to PBCH DMRS			
EPRE ratio of PDCCH DMRS to SSS			
EPRE ratio of PDCCH to PDCCH DMRS			
EPRE ratio of PDSCH DMRS to SSS			
EPRE ratio of PDSCH to PDSCH			
EPRE ratio of OCNG DMRS to SSS(Note 1)			
EPRE ratio of OCNG to OCNG DMRS (Note 1)			
N_{oc}^{Note2}		dBm/15kHz	-98
N_{oc}^{Note2}	Config 1,2		-98
	Config 3	dBm/SCS	-95
\hat{E}_s / I_{ot}		dB	3
\hat{E}_s / N_{oc}		dB	3
I_o^{Note3}	Config 1,2	dBm/9.36MHz	-67.57
	Config 3	dBm/38.16MHz	-62.58
Propagation condition		-	AWGN
Note 1: OCNG shall be used such that both cells are fully allocated and a constant total transmitted power spectral density is achieved for all OFDM symbols.			
Note 2: Interference from other cells and noise sources not specified in the test is assumed to be constant over subcarriers and time and shall be modelled as AWGN of appropriate power for N_{oc} to be fulfilled.			
Note 3: I_o levels have been derived from other parameters for information purposes. They are not settable parameters themselves.			

Table A.6.4.3.1.2-4: Sounding Reference Symbol Configuration for timing advance

Field		Value	Comment
c-SRS	Config 1,2	12	Frequency hopping is disabled
	Config 3	24	
b-SRS		0	
b-hop		0	
freqDomainPosition		0	Frequency domain position of SRS
freqDomainShift		0	
groupOrSequenceHopping		neither	No group or sequence hopping
SRS-PeriodicityAndOffset		sl5=0	Once every 5 slots
pathlossReferenceRS		ssb-Index=0	SSB #0 is used for SRS path loss estimation
usage		nonCodebook	Non-codebook based UL transmission
startPosition		0	resourceMapping setting. SRS on last symbol of slot, and 1symbols for SRS without repetition.
nrofSymbols		n1	
repetitionFactor		n1	
combOffset-n2		0	transmissionComb setting
cyclicShift-n2		0	
nrofSRS-Ports		port1	Number of antenna ports used for SRS transmission
Note: For further information see clause 6.3.2 in TS 38.331 [2].			

A.6.4.3.1.3 Test Requirements

The UE shall apply the signalled Timing Advance value to the transmission timing at the designated activation time i.e. k slots after the reception of the timing advance command, where:

$k = 4$ for Config 1, 2, and

$k = 7$ for Config 3

The Timing Advance adjustment accuracy shall be within the limits specified in clause 7.3.2.2.

The rate of correct Timing Advance adjustments observed during repeated tests shall be at least 90%.

A.6.5 Signaling characteristics

A.6.5.1 Radio link Monitoring

In the following section, any uplink signal transmitted by the UE is used for detecting the In-/Out-of-Sync state of the UE. In terms of measurement, the uplink signal is verified on the basis of the UE output power:

For intra-band contiguous carrier aggregation, transmit OFF power is measured as the mean power per component carrier.

For UE with multiple transmit antennas, transmit OFF power is measured as the mean power at each transmit connector.

- UE output power higher than Transmit OFF power [-50] dBm (as defined in TS 38.101-1 [18]) means uplink signal
- UE output power equal to or less than Transmit OFF power [-50] dBm (as defined in TS 38.101-1 [18]) means no uplink signal.

A.6.5.1.1 Radio Link Monitoring Out-of-sync Test for FR1 PCell configured with SSB-based RLM RS in non-DRX mode

A.6.5.1.1.1 Test Purpose and Environment

The purpose of this test is to verify that the UE properly detects the out of sync and in sync for the purpose of monitoring downlink radio link quality of the PCell. This test will partly verify the FR1 radio link monitoring requirements in clause 8.1.

Supported test configurations are shown in table A.6.5.1.1.1-1. The test parameters are given in Tables A.6.5.1.1.1-2, A.6.5.1.1.1-3, and A.6.5.1.1.1-4 below. There is one cell (Cell 1), which is the active NR cell, in the test. The test consists of three successive time periods, with time duration of T1, T2 and T3 respectively. Figure A.6.5.1.1.1-1 shows the variation of the downlink SNR in the active cell to emulate out-of-sync and in-sync states. Prior to the start of the time duration T1, the UE shall be fully synchronized to Cell 1. The UE shall be configured for periodic CSI reporting with a reporting periodicity of 5 ms. The UE is configured to perform inter-frequency measurements using Gap Pattern ID #0 (40ms) in test 1.

Table A.6.5.1.1.1-1: Supported test configurations for FR1 PCell

Configuration	Description
1	FDD, SSB SCS 15 KHz, data SCS 15KHz, BW 10MHz
2	TDD, SSB SCS 15 KHz, data SCS 15KHz, BW 10MHz
3	TDD, SSB SCS 30 KHz, data SCS 30KHz, BW 40MHz
Note:	The UE is only required to pass in one of the supported test configurations in FR1

Table A.6.5.1.1.1-2: General test parameters for FR1 out-of-sync testing in non-DRX mode

Parameter	Unit	Value
		Test 1
Active PCell		Cell 1
RF Channel Number		1
Duplex mode	Config 1	FDD
	Config 2, 3	TDD
BW _{channel}	Config 1	10: N _{RB,c} = 52
	Config 2	10: N _{RB,c} = 52
	Config 3	40: N _{RB,c} = 106
DL initial BWP configuration	Config 1, 2, 3	DLBWP.0.1
DL dedicated BWP configuration	Config 1, 2, 3	DLBWP.1.1
UL initial BWP configuration	Config 1, 2, 3	ULBWP.0.1
UL dedicated BWP configuration	Config 1, 2, 3	ULBWP.1.1
TDD Configuration	Config 1	Not Applicable
	Config 2	TDDConf.1.1
	Config 3	TDDConf.2.1
CORESET Reference Channel	Config 1	CR.1.1 FDD
	Config 2	CR.1.1 TDD
	Config 3	CR.2.1 TDD
SSB Configuration	Config 1	SSB.1 FR1
	Config 2	SSB.1 FR1
	Config 3	SSB.2 FR1
SMTc Configuration	Config 1, 2	SMTc.1

	Config 3		SMTC.1
PDSCH/PDCCH subcarrier spacing	Config 1, 2		15 KHz
	Config 3		30 KHz
PRACH Configuration	Config 1, 2		Table A.3.8.2.4-1
	Config 3		Table A.3.8.2.4-1
SSB index assigned as RLM RS			0
OCNG parameters			OP.1
CP length			Normal
Correlation Matrix and Antenna Configuration			2x2 Low
Out of sync transmission parameters	DCI format		1-0
	Number of Control OFDM symbols		2
	Aggregation level	CCE	8
	Ratio of hypothetical PDCCH RE energy to average SSS RE energy	dB	4
	Ratio of hypothetical PDCCH DMRS energy to average SSS RE energy	dB	4
	DMRS precoder granularity		REG bundle size
	REG bundle size		6
DRX			<i>OFF</i>
Gap pattern ID			<i>gp0</i>
Layer 3 filtering			<i>Enabled</i>
T310 timer		ms	0
T311 timer		ms	1000
N310			1
N311			1
CSI-RS configuration	Config 1, 4		[CSI-RS.1.3 FDD]
	Config 2, 5		[CSI-RS.1.3 TDD]
	Config 3, 6		[CSI-RS.2.3 TDD]
T1		s	1
T2		s	0.6
T3		s	0.6
D1		s	0.44
Note 1: All configurations are assigned to the UE prior to the start of time period T1.			
Note 2: UE-specific PDCCH is not transmitted after T1 starts.			

Table A.6.5.1.1-3: Cell specific test parameters for FR1 (Cell 1) for out-of-sync radio link monitoring tests in non-DRX mode

Parameter		Unit	Test 1		
			T1	T2	T3
EPRE ratio of PDCCH DMRS to SSS		dB	4		
EPRE ratio of PDCCH to PDCCH DMRS		dB	0		
EPRE ratio of PBCH DMRS to SSS		dB	0		
EPRE ratio of PBCH to PBCH DMRS		dB			
EPRE ratio of PSS to SSS		dB			
EPRE ratio of PDSCH DMRS to SSS		dB			
EPRE ratio of PDSCH to PDSCH DMRS		dB			
EPRE ratio of OCNG DMRS to SSS		dB			
EPRE ratio of OCNG to OCNG DMRS		dB			
SNR	Config 1	dB			
	Config 2		1	-7	-15
	Config 3		1	-7	-15
N_{oc}	Config 1	dBm/ 15KH z	-98		
	Config 2		-98		
	Config 3		-98		
Propagation condition			TDL-C 300ns 100Hz		
<p>Note 1: OCNG shall be used such that the resources in Cell 1 are fully allocated and a constant total transmitted power spectral density is achieved for all OFDM symbols.</p> <p>Note 2: The signal contains PDCCH for UEs other than the device under test as part of OCNG.</p> <p>Note 3: SNR levels correspond to the signal to noise ratio over the SSS REs.</p> <p>Note 4: The SNR in time periods T1, T2 and T3 is denoted as SNR1, SNR2 and SNR3 respectively in Figure A.6.5.1.1.1-1.</p> <p>Note 5: The SNR values are specified for testing a UE which supports 2RX on at least one band. For testing of a UE which supports 4RX on all bands, the SNR during T3 is A.3.6.</p>					

Table A.6.5.1.1-4: Measurement gap configuration for out-of-sync tests in non-DRX mode

Field	Test 1
	Value
gapOffset	0
<p>Note: Ensure that RLM RS is partially overlapped with measurement gap</p>	

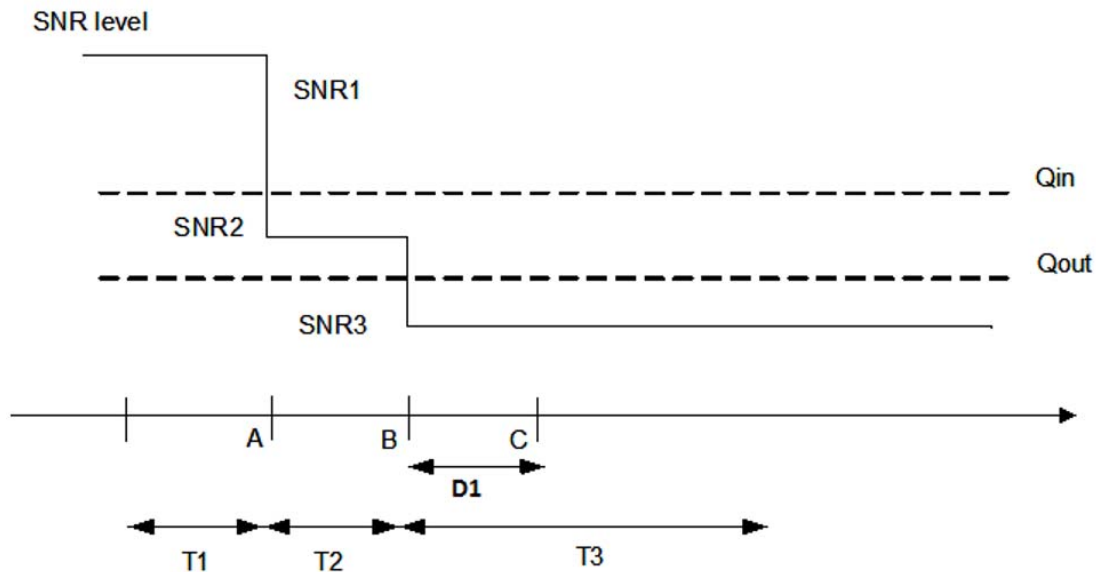

Figure A.6.5.1.1.1-1: SNR variation for out-of-sync testing

A.6.5.1.1.2 Test Requirements

The UE behavior in each test during time durations T1, T2 and T3 shall be as follows:

During the period from time point A to time point B the UE shall transmit uplink signal at least in all uplink slots configured for CSI transmission according to the configured periodic CSI reporting.

The UE shall stop transmitting uplink signal no later than time point C (D1 second after the start of the time duration T3).

The rate of correct events observed during repeated tests shall be at least 90%.

A.6.5.1.2 Radio Link Monitoring In-sync Test for FR1 PCell configured with SSB-based RLM RS in non-DRX mode

A.6.5.1.2.1 Test Purpose and Environment

The purpose of this test is to verify that the UE properly detects the out of sync and in sync for the purpose of monitoring downlink radio link quality of the PCell. This test will partly verify the FR1 radio link monitoring requirements in clause 8.1.

Supported test configurations are shown in table A.6.5.1.2.1-1. The test parameters are given in Tables A.6.5.1.2.1-2, and A.6.5.1.2.1-3 below. There is one cell (Cell 1), which is the active cell, in the test. The test consists of five successive time periods, with time duration of T1, T2, T3, T4 and T5 respectively. Figure A.6.5.1.2.1-1 shows the variation of the downlink SNR in the active cell to emulate out-of-sync and in-sync states. Prior to the start of the time duration T1, the UE shall be fully synchronized to Cell 1. Prior to the start of the time duration T1, the UE shall be fully synchronized to Cell 1. The UE shall be configured for periodic CSI reporting with a reporting periodicity of 5 ms.

Table A.6.5.1.2.1-1: Supported test configurations for FR1 PCell

Configuration	Description
1	FDD, SSB SCS 15 KHz, data SCS 15KHz, BW 10MHz
2	TDD, SSB SCS 15 KHz, data SCS 15KHz, BW 10MHz
3	TDD, SSB SCS 30 KHz, data SCS 30KHz, BW 40MHz
Note:	The UE is only required to pass in one of the supported test configurations in FR1

Table A.6.5.1.2.1-2: General test parameters for FR1 in-sync testing in non-DRX mode

Parameter		Unit	Value
Active PCell			Test 1
RF Channel Number			Cell 1
Duplex mode			1
Duplex mode	Config 1		FDD
	Config 2, 3		TDD
BW _{channel}	Config 1	MHz	10: N _{RB,c} = 52
	Config 2		10: N _{RB,c} = 52
	Config 3		40: N _{RB,c} = 106
DL initial BWP configuration	Config 1, 2, 3		DLBWP.0.1
DL dedicated BWP configuration	Config 1, 2, 3		DLBWP.1.1
UL initial BWP configuration	Config 1, 2, 3		ULBWP.0.1
UL dedicated BWP configuration	Config 1, 2, 3		ULBWP.1.1
TDD Configuration	Config 1		Not Applicable
	Config 2		TDDConf.1.1
	Config 3		TDDConf.2.1
CORESET Reference Channel	Config 1		CR.1.1 FDD
	Config 2		CR.1.1 TDD
	Config 3		CR.2.1 TDD
SSB Configuration	Config 1		SSB.1 FR1
	Config 2		SSB.1 FR1
	Config 3		SSB.2 FR1
SMTC Configuration	Config 1, 2		SMTC.1
	Config 3		SMTC.1
PDSCH/PDCCH subcarrier spacing	Config 1, 2		15 KHz
	Config 3		30 KHz
PRACH Configuration	Config 1, 2		Table A.3.8.2.4-1
	Config 3		Table A.3.8.2.4-1
SSB index assigned as RLM RS			0
OCNG parameters			OP.1
CP length			Normal
Correlation Matrix and Antenna Configuration			2x2 Low
In sync transmission parameters	DCI format		1-0
	Number of Control OFDM symbols		2
	Aggregation level	CCE	4
	Ratio of hypothetical PDCCH RE energy to average SSS RE energy	dB	0

	Ratio of hypothetical PDCCH DMRS energy to average SSS RE energy	dB	0
	DMRS precoder granularity		REG bundle size
	REG bundle size		6
Out of sync transmission parameters	DCI format		1-0
	Number of Control OFDM symbols		2
	Aggregation level	CCE	8
	Ratio of hypothetical PDCCH RE energy to average SSS RE energy	dB	4
	Ratio of hypothetical PDCCH DMRS energy to average SSS RE energy	dB	4
	DMRS precoder granularity		REG bundle size
	REG bundle size		6
	DRX		
Gap pattern ID			N.A.
Layer 3 filtering			<i>Enabled</i>
T310 timer		ms	2000
T311 timer		ms	1000
N310			1
N311			1
CSI-RS configuration	Config 1		[CSI-RS.1.3 FDD]
	Config 2		[CSI-RS.1.3 TDD]
	Config 3		[CSI-RS.2.3 TDD]
T1		s	0.5
T2		s	0.4
T3		s	1.46
T4		s	0.4
T5		s	1
D1		s	0.42
Note 1: All configurations are assigned to the UE prior to the start of time period T1.			
Note 2: UE-specific PDCCH is not transmitted after T1 starts.			

Table A.6.5.1.2.1-3: Cell specific test parameters for FR1 (Cell 1) for in-sync radio link monitoring tests in non-DRX mode

Parameter		Unit	Test 1				
			T1	T2	T3	T4	T5
EPRE ratio of PDCCH DMRS to SSS		dB	4				
EPRE ratio of PDCCH to PDCCH DMRS		dB	0				
EPRE ratio of PBCH DMRS to SSS		dB	0				
EPRE ratio of PBCH to PBCH DMRS		dB					
EPRE ratio of PSS to SSS		dB					
EPRE ratio of PDSCH DMRS to SSS		dB					
EPRE ratio of PDSCH to PDSCH DMRS		dB					
EPRE ratio of OCNG DMRS to SSS		dB					
EPRE ratio of OCNG to OCNG DMRS		dB					
SNR	Config 1	dB	1	-7	-15	-4.5	1
	Config 2		1	-7	-15	-4.5	1
	Config 3		1	-7	-15	-4.5	1
N_{oc}	Config 1	dBm/ 15 KHz	-98				
	Config 2		-98				
	Config 3		-98				
Propagation condition			TDL-C 300ns 100Hz				
<p>Note 1: OCNG shall be used such that the resources in Cell 1 are fully allocated and a constant total transmitted power spectral density is achieved for all OFDM symbols.</p> <p>Note 2: The signal contains PDCCH for UEs other than the device under test as part of OCNG.</p> <p>Note 3: SNR levels correspond to the signal to noise ratio over the SSS REs.</p> <p>Note 4: The SNR in time periods T1, T2, T3, T4 and T5 is denoted as SNR1, SNR2, SNR3, SNR4 and SNR5 respectively in Figure A.6.5.1.2.1-1.</p> <p>Note 5: The SNR values are specified for testing a UE which supports 2RX on at least one band. For testing of a UE which supports 4RX on all bands, the SNR during T3 and T4 is modified as specified in section A.3.6.</p>							

Table A.6.5.1.2.1-4: Void

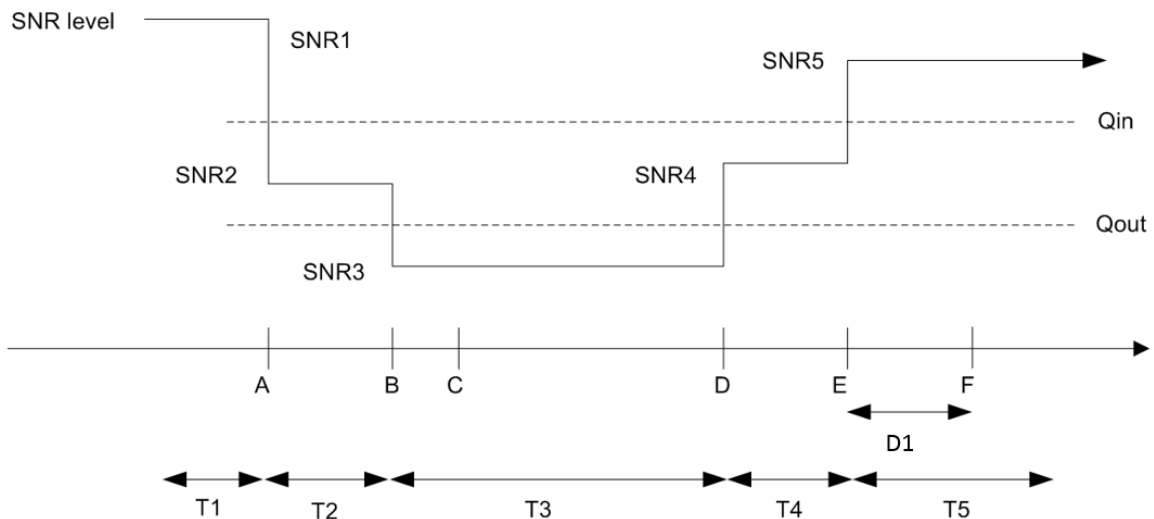

Figure A.6.5.1.2.1-1: SNR variation for in-sync testing

A.6.5.1.2.2 Test Requirements

The UE behaviour in each test during time durations T1, T2, T3, T4 and T5 shall be as follows:

During the period from time point A to time point F (D1 second after the start of time duration T5) the UE shall transmit uplink signal at least in all uplink slots configured for CSI transmission according to the configured periodic CSI reporting.

The rate of correct events observed during repeated tests shall be at least 90%.

A.6.5.1.3 Radio Link Monitoring Out-of-sync Test for FR1 PCell configured with SSB-based RLM RS in DRX mode

A.6.5.1.3.1 Test Purpose and Environment

The purpose of this test is to verify that the UE properly detects the out of sync and in sync for the purpose of monitoring downlink radio link quality of the PCell when DRX is used. This test will partly verify the FR1 radio link monitoring requirements in clause 8.1.

Supported test configurations are shown in table A.6.5.1.3.1-1. The test parameters are given in Tables A.6.5.1.3.1-2, and A.6.5.1.3.1-3. There is one cell (Cell 1), which is the active NR cell, in the test. The test consists of three successive time periods, with time duration of T1, T2 and T3 respectively. Figure A.6.5.1.3.1-1 shows the variation of the downlink SNR in the active cell to emulate out-of-sync and in-sync states. Prior to the start of the time duration T1, the UE shall be fully synchronized to Cell 1. The UE shall be configured for periodic CSI reporting with a reporting periodicity of 5 ms. In the test, DRX configuration is enabled and DRX inactivity timer has already been expired, i.e. UE tries to decode PDCCH and to send periodic CSI during the period when On-duration timer is running. Time alignment timers shall be set to “infinity” so that UL timing alignment is maintained during the test. The UE is configured to perform inter-frequency measurements using Gap Pattern ID #0 (40ms) in test 2.

Table A.6.5.1.3.1-1: Supported test configurations for FR1 PCell

Configuration	Description
1	FDD, SSB SCS 15 KHz, data SCS 15KHz, BW 10MHz
2	TDD, SSB SCS 15 KHz, data SCS 15KHz, BW 10MHz
3	TDD, SSB SCS 30 KHz, data SCS 30KHz, BW 40MHz
Note:	The UE is only required to pass in one of the supported test configurations in FR1

Table A.6.5.1.3.1-2: General test parameters for FR1 out-of-sync testing in DRX mode

Parameter		Unit	Value Test 1
Active PCell			Cell 1
RF Channel Number			1
Duplex mode	Config 1		FDD
	Config 2, 3		TDD
BW _{channel}	Config 1	MHz	10: N _{RB,c} = 52
	Config 2		10: N _{RB,c} = 52
	Config 3		40: N _{RB,c} = 106
DL initial BWP configuration	Config 1, 2, 3		DLBWP.0.1
DL dedicated BWP configuration	Config 1, 2, 3		DLBWP.1.1
UL initial BWP configuration	Config 1, 2, 3		ULBWP.0.1

UL dedicated BWP configuration	Config 1, 2, 3		ULBWP.1.1
TDD Configuration	Config 1		Not Applicable
	Config 2		TDDConf.1.1
	Config 3		TDDConf.2.1
CORESET Reference Channel	Config 1		CR.1.1 FDD
	Config 2		CR.1.1 TDD
	Config 3		CR.2.1 TDD
SSB Configuration	Config 1		SSB.1 FR1
	Config 2		SSB.1 FR1
	Config 3		SSB.2 FR1
SMTTC Configuration	Config 1, 2		SMTTC.1
	Config 3		SMTTC.1
PDSCH/PDCCH subcarrier spacing	Config 1, 2		15 KHz
	Config 3		30 KHz
PRACH Configuration	Config 1, 2		Table A.3.8.2.4-1
	Config 3		Table A.3.8.2.4-1
SSB index assigned as RLM RS			0
OCNG parameters			OP.1
CP length			Normal
Correlation Matrix and Antenna Configuration			2x2 Low
Out of sync transmission parameters	DCI format		1-0
	Number of Control OFDM symbols		2
	Aggregation level	CCE	8
	Ratio of hypothetical PDCCH RE energy to average SSS RE energy	dB	4
	Ratio of hypothetical PDCCH DMRS energy to average SSS RE energy	dB	4
	DMRS precoder granularity		REG bundle size
	REG bundle size		6
DRX Configuration			[DRX.4]
Gap pattern ID			N.A.
Layer 3 filtering			<i>Enabled</i>
T310 timer	ms		0
T311 timer	ms		1000
N310			1
N311			1
CSI-RS configuration	Config 1		[CSI-RS.1.3 FDD]
	Config 2		[CSI-RS.1.3 TDD]
	Config 3		[CSI-RS.2.3 TDD]
T1	s		4
T2	s		7
T3	s		7
D1	s		6.44
Note 1: All configurations are assigned to the UE prior to the start of time period T1.			
Note 2: UE-specific PDCCH is not transmitted after T1 starts.			

Table A.6.5.1.3.1-3: Cell specific test parameters for FR1 (Cell 1) for out-of-sync radio link monitoring tests in DRX mode

Parameter		Unit	Test 1		
			T1	T2	T3
EPRE ratio of PDCCH DMRS to SSS		dB	4		
EPRE ratio of PDCCH to PDCCH DMRS		dB	0		
EPRE ratio of PBCH DMRS to SSS		dB	0		
EPRE ratio of PBCH to PBCH DMRS		dB			
EPRE ratio of PSS to SSS		dB			
EPRE ratio of PDSCH DMRS to SSS		dB			
EPRE ratio of PDSCH to PDSCH DMRS		dB			
EPRE ratio of OCNG DMRS to SSS		dB			
EPRE ratio of OCNG to OCNG DMRS		dB			
SNR	Config 1	dB			
	Config 2		1	-7	-15
	Config 3		1	-7	-15
N_{oc}	Config 1	dBm/15 KHz	-98		
	Config 2		-98		
	Config 3		-98		
Propagation condition			TDL-C 300ns 100Hz		
<p>Note 1: OCNG shall be used such that the resources in Cell 1 are fully allocated and a constant total transmitted power spectral density is achieved for all OFDM symbols.</p> <p>Note 2: The signal contains PDCCH for UEs other than the device under test as part of OCNG.</p> <p>Note 3: SNR levels correspond to the signal to noise ratio over the SSS REs.</p> <p>Note 4: The SNR in time periods T1, T2 and T3 is denoted as SNR1, SNR2 and SNR3 respectively in Figure A.6.5.1.3.1-1.</p> <p>Note 5: The SNR values are specified for testing a UE which supports 2RX on at least one band. For testing of a UE which supports 4RX on all bands, the SNR during T3 is A.3.6.</p>					

Table A.6.5.1.3.1-4: Void**Table A.6.5.1.3.1-5: Void****Table A.6.5.1.3.1-6: Void**

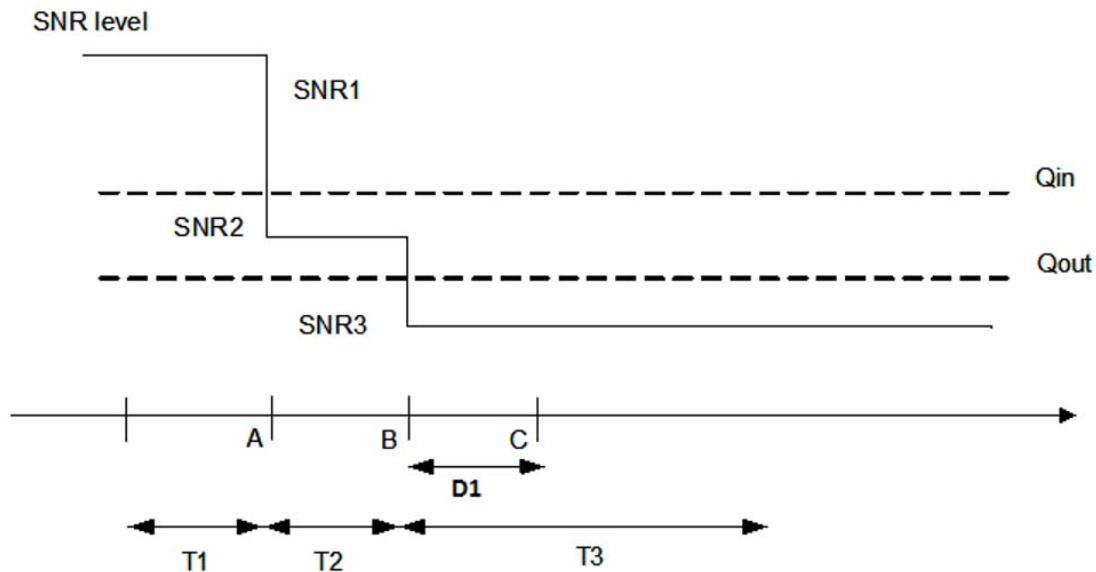

Figure A.6.5.1.3.1-1: SNR variation for out-of-sync testing

A.6.5.1.3.2 Test Requirements

The UE behavior in each test during time durations T1, T2 and T3 shall be as follows:

During the period from time point A to time point B the UE shall transmit uplink signal at least in all uplink slots configured for CSI transmission according to the configured periodic CSI reporting.

The UE shall stop transmitting uplink signal no later than time point C (D1 second after the start of the time duration T3).

The rate of correct events observed during repeated tests shall be at least 90%.

A.6.5.1.4 Radio Link Monitoring In-sync Test for FR1 PCell configured with SSB-based RLM RS in DRX mode

A.6.5.1.4.1 Test Purpose and Environment

The purpose of this test is to verify that the UE properly detects the out of sync and in sync for the purpose of monitoring downlink radio link quality of the PCell when DRX is used. This test will partly verify the FR1 radio link monitoring requirements in clause 8.1.

Supported test configurations are shown in table A.6.5.1.4.1-1. The test parameters are given in Tables A.6.5.1.4.1-2, and A.6.5.1.4.1-3. There is one cell (Cell 1), which is the active NR cell, in the test. The test consists of five successive time periods, with time duration of T1, T2, T3, T4 and T5 respectively. Figure A.6.5.1.4.1-1 shows the variation of the downlink SNR in the active cell to emulate out-of-sync and in-sync states. Prior to the start of the time duration T1, the UE shall be fully synchronized to Cell 1. The UE shall be configured for periodic CSI reporting with a reporting periodicity of 5 ms. In the test, DRX configuration is enabled and DRX inactivity timer has already been expired, i.e. UE tries to decode PDCCH and to send periodic CSI during the period when On-duration timer is running. Time alignment timers shall be set to “infinity” so that UL timing alignment is maintained during the test.

Table A.6.5.1.4.1-1: Supported test configurations for FR1 PCell

Configuration	Description
1	FDD, SSB SCS 15 KHz, data SCS 15KHz, BW 10MHz
2	TDD, SSB SCS 15 KHz, data SCS 15KHz, BW 10MHz
3	TDD, SSB SCS 30 KHz, data SCS 30KHz, BW 40MHz
Note:	The UE is only required to pass in one of the supported test configurations in FR1

Table A.6.5.1.4.1-2: General test parameters for FR1 in-sync testing in DRX mode

Parameter		Unit	Value Test 1
Active PCell			Cell 1
RF Channel Number			1
Duplex mode	Config 1		FDD
	Config 2, 3		TDD
BW _{channel}	Config 1	MHz	10: N _{RB,c} = 52
	Config 2		10: N _{RB,c} = 52
	Config 3		40: N _{RB,c} = 106
DL initial BWP configuration	Config 1, 2, 3		DLBWP.0.1
DL dedicated BWP configuration	Config 1, 2, 3		DLBWP.1.1
UL initial BWP configuration	Config 1, 2, 3		ULBWP.0.1
UL dedicated BWP configuration	Config 1, 2, 3		ULBWP.1.1
TDD Configuration	Config 1		Not Applicable
	Config 2		TDDConf.1.1
	Config 3		TDDConf.2.1
CORESET Reference Channel	Config 1		CR.1.1 FDD
	Config 2		CR.1.1 TDD
	Config 3		CR.2.1 TDD
SSB Configuration	Config 1		SSB.1 FR1
	Config 2		SSB.1 FR1
	Config 3		SSB.2 FR1
SMTTC Configuration	Config 1, 2		SMTTC.1
	Config 3		SMTTC.1
PDSCH/PDCCH subcarrier spacing	Config 1, 2		15 KHz
	Config 3		30 KHz
PRACH Configuration	Config 1, 2		Table A.3.8.2.4-1
	Config 3		Table A.3.8.2.4-1
SSB index assigned as RLM RS			0
OCNG parameters			OP.1
CP length			Normal
Correlation Matrix and Antenna Configuration			2x2 Low
In sync transmission parameters	DCI format		1-0
	Number of Control OFDM symbols		2
	Aggregation level	CCE	4
	Ratio of hypothetical PDCCH RE energy to average SSS RE energy	dB	0

	Ratio of hypothetical PDCCH DMRS energy to average SSS RE energy	dB	0
	DMRS precoder granularity		REG bundle size
	REG bundle size		6
Out of sync transmission parameters	DCI format		1-0
	Number of Control OFDM symbols		2
	Aggregation level	CCE	8
	Ratio of hypothetical PDCCH RE energy to average SSS RE energy	dB	4
	Ratio of hypothetical PDCCH DMRS energy to average SSS RE energy	dB	4
	DMRS precoder granularity		REG bundle size
	REG bundle size		6
DRX Configuration			Table A.3.3.3-1
Gap pattern ID			N.A.
Layer 3 filtering			<i>Enabled</i>
T310 timer		ms	2000
T311 timer		ms	1000
N310			1
N311			1
CSI-RS configuration	Config 1		[CSI-RS.1.3 FDD]
	Config 2		[CSI-RS.1.3 TDD]
	Config 3		[CSI-RS.2.3 TDD]
T1		s	4
T2		s	1.6
T3		s	1.36
T4		s	0.4
T5		s	1.4
D1		s	1
Note 1: All configurations are assigned to the UE prior to the start of time period T1.			
Note 2: UE-specific PDCCH is not transmitted after T1 starts.			

Table A.6.5.1.4.1-3: Cell specific test parameters for FR1 (Cell 1) for in-sync radio link monitoring tests in DRX mode

Parameter		Unit	Test 1				
			T1	T2	T3	T4	T5
EPRE ratio of PDCCH DMRS to SSS		dB	4				
EPRE ratio of PDCCH to PDCCH DMRS		dB	0				
EPRE ratio of PBCH DMRS to SSS		dB	0				
EPRE ratio of PBCH to PBCH DMRS		dB					
EPRE ratio of PSS to SSS		dB					
EPRE ratio of PDSCH DMRS to SSS		dB					
EPRE ratio of PDSCH to PDSCH DMRS		dB					
EPRE ratio of OCNG DMRS to SSS		dB					
EPRE ratio of OCNG to OCNG DMRS		dB					
SNR	Config 1	dB	1	-7	-15	-4.5	1
	Config 2		1	-7	-15	-4.5	1
	Config 3		1	-7	-15	-4.5	1
N_{oc}	Config 1	dBm/15 KHz	-98				
	Config 2		-98				
	Config 3		-98				
Propagation condition			TDL-C 300ns 100Hz				
<p>Note 1: OCNG shall be used such that the resources in Cell 1 are fully allocated and a constant total transmitted power spectral density is achieved for all OFDM symbols.</p> <p>Note 2: The signal contains PDCCH for UEs other than the device under test as part of OCNG.</p> <p>Note 3: SNR levels correspond to the signal to noise ratio over the SSS REs.</p> <p>Note 4: The SNR in time periods T1, T2, T3, T4 and T5 is denoted as SNR1, SNR2, SNR3, SNR4 and SNR5 respectively in Figure A.6.5.1.4.1-1.</p> <p>Note 5: The SNR values are specified for testing a UE which supports 2RX on at least one band. For testing of a UE which supports 4RX on all bands, the SNR during T3 and T4 is modified as specified in section A.3.6.</p>							

Table A.6.5.1.4.1-4: Void

Table A.6.5.1.4.1-5: Void

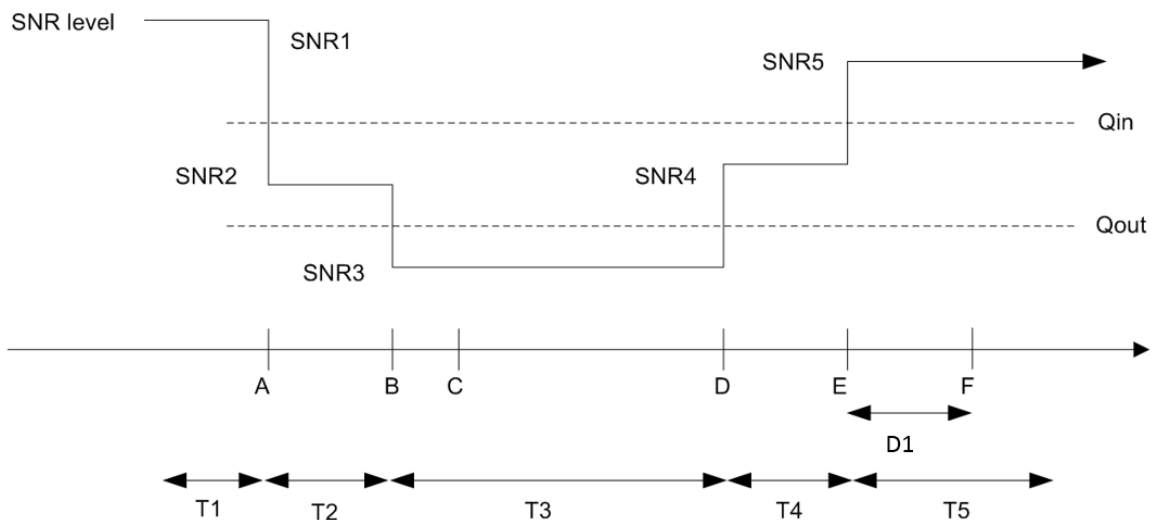

Figure A.6.5.1.4.1-1: SNR variation for in-sync testing.

A.6.5.1.4.2 Test Requirements

The UE behaviour in each test during time durations T1, T2, T3, T4 and T5 shall be as follows:

During the period from time point A to time point F (D1 second after the start of time duration T5) the UE shall transmit uplink signal at least in all uplink slots configured for CSI transmission according to the configured periodic CSI reporting.

The rate of correct events observed during repeated tests shall be at least 90%.

A.6.5.1.5 Radio Link Monitoring Out-of-sync Test for FR1 PCell configured with CSI-RS-based RLM in non-DRX mode

A.6.5.1.5.1 Test Purpose and Environment

The purpose of this test is to verify that the UE properly detects the out of sync for the purpose of monitoring downlink CSI-RS based radio link quality of the PCell when no DRX is used. This test will partly verify the FR1 PCell CSI-RS Out-of-sync radio link monitoring requirements in clause 8.1.

The test parameters are given in Tables A.6.5.1.5.1-1, A.6.5.1.5.1-2, and A.6.5.1.5.1-3 below. There is one cell, cell 1 which is the PCell, in the test. The test consists of three successive time periods, with time duration of T1, T2 and T3 respectively. Figure A.6.5.1.5.1-1 shows the variation of the downlink SNR in the PCell to emulate out-of-sync and in-sync states. Prior to the start of the time duration T1, the UE shall be fully synchronized to cell 1. The UE shall be configured for periodic CSI reporting with a reporting periodicity of [5] or [10] ms. In the test, DRX configuration is not enabled. The UE is configured to perform inter-frequency measurements using GP ID #0 (40ms) in test2.

Table A.6.5.1.5.1-1: Supported test configurations for FR1 PCell

Configuration	Description
1	FDD duplex mode, 15 kHz SSB SCS, 10MHz bandwidth
2	TDD duplex mode, 15 kHz SSB SCS, 10MHz bandwidth
3	TDD duplex mode, 30kHz SSB SCS, 40MHz bandwidth
Note:	The UE is only required to pass in one of the supported test configurations in FR1

Table A.6.5.1.5.1-2: General test parameters for FR1 PCell for CSI-RS out-of-sync testing in non-DRX mode

Parameter	Unit	Value	
		Test 1	Test 2
Active PCell		Cell 1	Cell 1
RF Channel Number		1	1
Duplex mode	Config 1	FDD	FDD
	Config 2, 3	TDD	TDD
TDD Configuration	Config 1	Not Applicable	Not Applicable
	Config 2	[TDDConf.1.1]	[TDDConf.1.1]
	Config 3	[TDDConf.1.2]	[TDDConf.1.2]
CORESET Reference Channel	Config 1	[CR. 1.1 FDD]	[CR. 1.1 FDD]
	Config 2	[CR. 1.1 TDD]	[CR. 1.1 TDD]
	Config 3	[CR. 2.1 TDD]	[CR. 2.1 TDD]
SSB Configuration	Config 1	TBD (Note: periodicity is 20ms)	TBD (Note: periodicity is 20ms)
	Config 2	TBD (Note: periodicity is 20ms)	TBD (Note: periodicity is 20ms)
	Config 3	TBD (Note: periodicity is 20ms)	TBD (Note: periodicity is 20ms)
	Config 1, 2	FR1 pattern 1	FR1 pattern 1

SMTC Configuration	Config 3		FR1 pattern 2	FR1 pattern 2
PDSCH/PDCCH subcarrier spacing	Config 1, 2		15 KHz	15 KHz
	Config 3		30 KHz	30 KHz
csi-RS-Index assigned as RLM RS			[0]	[0]
OCNG parameters			TBD	TBD
CP length			Normal	Normal
Correlation Matrix and Antenna Configuration			[2x2 Low]	[2x2 Low]
Out of sync transmission parameters	DCI format		1-0	1-0
	Number of Control OFDM symbols		2	2
	Aggregation level	CC E	8	8
	Ratio of hypothetical PDCCH RE energy to average CSI-RS RE energy	dB	4	4
	Ratio of hypothetical PDCCH DMRS energy to average CSI-RS RE energy	dB	4	4
	DMRS precoder granularity		REG bundle size	REG bundle size
	REG bundle size		6	6
DRX			OFF	OFF
Gap pattern ID			[N.A.]	*[gp0]
Layer 3 filtering			Enabled	Enabled
T310 timer		ms	0	0
T311 timer		ms	1000	1000
N310			1	1
N311			1	1
NZP CSI-RS configuration			[ResourceId 1]	[ResourceId 0]
ZP CSI-RS configuration			TBD	TBD
CSI-IM configuration			TBD	TBD
Periodic CSI reporting			PUCCH	PUCCH
CSI reporting periodicity	Config 1, 2	slot	[5]	[5]
	Config 3		[10]	[10]
T1		s	1	1
T2		s	0.4	0.4
T3		s	[0.6]	[0.6]
D1		s	[0.24]	[0.44]
Note 1: UE-specific PDCCH is not transmitted after T1 starts.				

Table A.6.5.1.5.1-3: Cell specific test parameters for FR1 for CSI-RS out-of-sync radio link monitoring in non-DRX mode

Parameter		Unit	Test 1			Test 2		
			T1	T2	T3	T1	T2	T3
PDCCH_beta		dB	4			4		
PDCCH_DMRS_beta		dB	4			4		
PBCH_beta		dB	0			0		
PSS_beta		dB						
SSS_beta		dB						
PDSCH_beta		dB						
OCNG_beta		dB						
SNR	Config 1	dB	TBD	TBD	TBD	TBD	TBD	TBD
	Config 2		TBD	TBD	TBD	TBD	TBD	TBD
	Config 3		TBD	TBD	TBD	TBD	TBD	TBD
N_{oc}	Config 1	dBm/ 15K Hz	[-98]			[-98]		
	Config 2		[-98]			[-98]		
	Config 3		[-98]			[-98]		
Propagation condition			[TDL-C 300ns 100Hz]			[TDL-C 300ns 100Hz]		
<p>Note 1: OCNG shall be used such that the resources in Cell 1 are fully allocated and a constant total transmitted power spectral density is achieved for all OFDM symbols.</p> <p>Note 2: The uplink resources for CSI reporting are assigned to the UE prior to the start of time period T1.</p> <p>Note 3: NZP CSI-RS resource set configuration for CSI reporting are assigned to the UE prior to the start of time period T1.</p> <p>Note 4: Measurement gap configuration is assigned to the UE prior to the start of time period T1.</p> <p>Note 5: The timers and layer 3 filtering related parameters are configured prior to the start of time period T1.</p> <p>Note 6: The signal contains PDCCH for UEs other than the device under test as part of OCNG.</p> <p>Note 7: SNR levels correspond to the signal to noise ratio over the SSS REs.</p> <p>Note 8: The SNR in time periods T1, T2 and T3 is denoted as SNR1, SNR2 and SNR3 respectively in figure A.6.5.1.5.1-1.</p> <p>Note 9: The SNR values are specified for testing a UE which supports 2RX on at least one band. For testing of a UE which supports 4RX on all bands, the SNR during T3 is [A.3.6].</p>								

Table A.6.5.1.5.1-3: Measurement gap configuration for FR1 CSI-RS out-of-sync radio link monitoring in non-DRX mode

Field	Test 2
	Value
gapOffset	[0]
<p>Note 1: E-UTRAN PCell and PSCell are SFN-synchronous and frame boundary aligned. (Ensure that RLM RS is partially overlapped with measurement gap)</p>	

Table A.6.5.1.5.1-4: NZP-CSI-RS resource configuration for FR1 CSI-RS out-of-sync radio link monitoring in non-DRX mode

Field	ResourceId 0	ResourceId 1
	Value	Value
frequencyDomainAllocation ^{Note 2}	row1	row2
startingRB	0	0
nrofRBs	Note 2	Note 2
Note 1: TS 38.211 [6] table 7.4.1.5.3-1		
Note 2: nrofRBs is derived based on the Configuration in Table A.6.5.1.5.1-1		

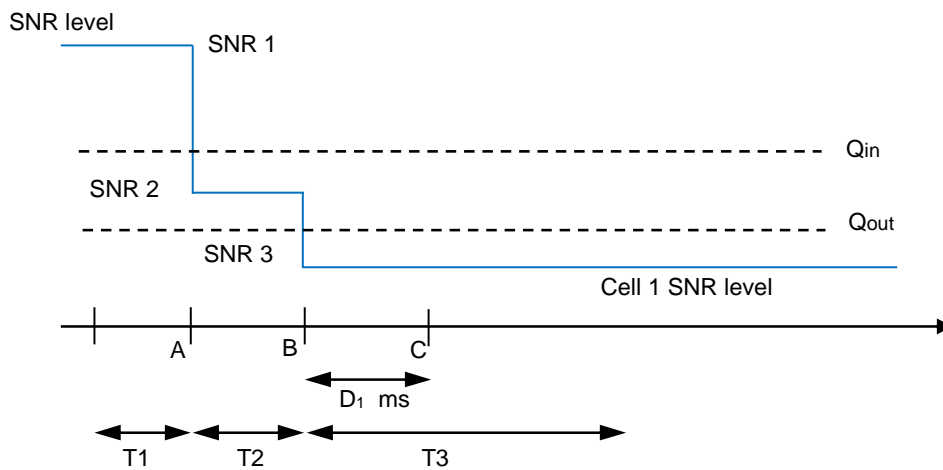

Figure A.6.5.1.5.1-1: SNR variation for CSI-RS out-of-sync testing

A.6.5.1.5.2 Test Requirements

The UE behaviour during time durations T1, T2, and T3 shall be as follows:

During time durations T1, T2 and T3, the UE shall transmit uplink signal at least in all subframes configured for CSI transmission on Cell 1.

During the period from time point A to time point B the UE shall transmit uplink signal in Cell 1 at least in all uplink slots configured for CSI transmission according to the configured periodic CSI reporting for Cell 1.

The UE shall stop transmitting uplink signal in Cell 1 no later than time point C ($D_1 = [\text{TBD}]$ ms after the start of the time duration T3) on the PCell.

The rate of correct events observed during repeated tests shall be at least 90%.

A.6.5.1.6 Radio Link Monitoring In-sync Test for FR1 PCell configured with CSI-RS-based RLM in non-DRX mode

A.6.5.1.6.1 Test Purpose and Environment

The purpose of this test is to verify that the UE properly detects the in sync for the purpose of monitoring downlink CSI-RS based radio link quality of the PCell when no DRX is used. This test will partly verify the FR1 PCell CSI-RS In-sync radio link monitoring requirements in clause 8.1.

The test parameters are given in Tables A.6.5.1.6.1-1, A.6.5.1.6.1-2, A.6.5.1.6.1-3, A.6.5.1.6.1-4, A.6.5.1.6.1-5, and A.6.5.1.6.1-6 below. There is one cells, cell 1 which is the PCell, in the test. The test consists of five successive time periods, with time duration of T1, T2, T3, T4 and T5 respectively. Figure A.6.5.1.6.1-1 shows the variation of the downlink SNR in the PCell to emulate out-of-sync and in-sync states. Prior to the start of the time duration T1, the UE shall be fully synchronized to cell 1. The UE shall be configured for periodic CSI reporting with a reporting periodicity of [5] or [10] ms. In the test, DRX configuration is not enabled. The UE is configured to perform inter-frequency measurements using GP ID #0 (40ms) in test 4.

Table A.6.5.1.6.1-1: Supported test configurations for FR1 PCell

Configuration	Description
1	FDD duplex mode, 15 kHz SSB SCS, 10MHz bandwidth
2	TDD duplex mode, 15 kHz SSB SCS, 10MHz bandwidth
3	TDD duplex mode, 30kHz SSB SCS, 40MHz bandwidth
Note: The UE is only required to pass in one of the supported test configurations in FR1	

Table A.6.5.1.6.1-2: General test parameters for FR1 PCell for CSI-RS in-sync testing in non-DRX mode

Parameter	Unit	Value	
		Test 3	Test 4
Active PCell		Cell 1	Cell 1
RF Channel Number		1	1
Duplex mode	Config 1	FDD	FDD
	Config 2, 3	TDD	TDD
TDD Configuration	Config 1	Not Applicable	Not Applicable
	Config 2	[TDDConf.1.1]	[TDDConf.1.1]
	Config 3	[TDDConf.1.2]	[TDDConf.1.2]
CORESET Reference Channel	Config 1	[CR. 1.1 FDD]	[CR. 1.1 FDD]
	Config 2	[CR. 1.1 TDD]	[CR. 1.1 TDD]
	Config 3	[CR. 2.1 TDD]	[CR. 2.1 TDD]
SSB Configuration	Config 1	TBD (Note: periodicity is 20ms)	TBD (Note: periodicity is 20ms)
	Config 2	TBD (Note: periodicity is 20ms)	TBD (Note: periodicity is 20ms)
	Config 3	TBD (Note: periodicity is 20ms)	TBD (Note: periodicity is 20ms)
SMTC Configuration	Config 1, 2	FR1 pattern 1	FR1 pattern 1
	Config 3	FR1 pattern 2	FR1 pattern 2
PDSCH/PDCC H subcarrier spacing	Config 1, 2	15 KHz	15 KHz
	Config 3	30 KHz	30 KHz
csi-RS-Index assigned as RLM RS		[0]	[0]
OCNG parameters		TBD	TBD
CP length		Normal	Normal
Correlation Matrix and Antenna Configuration		[2x2 Low]	[2x2 Low]
DCI format		1-0	1-0

Out of sync transmission parameters	Number of Control OFDM symbols		2	2
	Aggregation level	CC E	8	8
	Ratio of hypothetical PDCCH RE energy to average CSI-RS RE energy	dB	4	4
	Ratio of hypothetical PDCCH DMRS energy to average CSI-RS RE energy	dB	4	4
	DMRS precoder granularity		REG bundle size	REG bundle size
	REG bundle size		6	6
In sync transmission parameters	DCI format		1-0	1-0
	Number of Control OFDM symbols		2	2
	Aggregation level	CC E	4	4
	Ratio of hypothetical PDCCH RE energy to average CSI-RS RE energy	dB	0	0
	Ratio of hypothetical PDCCH DMRS energy to average CSI-RS RE energy	dB	0	0
	DMRS precoder granularity		REG bundle size	REG bundle size
	REG bundle size		6	6
DRX			OFF	OFF
Gap pattern ID			[N.A.]	*[gp0]
Layer 3 filtering			Enabled	Enabled
T310 timer	ms		0	0
T311 timer	ms		1000	1000
N310			1	1
N311			1	1
NZP CSI-RS configuration			[ResourceId 1]	[ResourceId 0]
ZP CSI-RS configuration			TBD	TBD
CSI-IM configuration			TBD	TBD
Periodic CSI reporting			PUCCH	PUCCH
CSI reporting periodicity	Config 1, 2	slot	[5]	[5]
	Config 3		[10]	[10]
T1	s		1	1
T2	s		0.4	0.4
T3	s		[0.6]	[0.6]
D1	s		[0.24]	[0.44]
Note 1: UE-specific PDCCH is not transmitted after T1 starts.				

Table A.6.5.1.6.1-3: Cell specific test parameters for FR1 for CSI-RS in-sync radio link monitoring in non-DRX mode

Parameter		Unit	Test 3			Test 4		
			T1	T2	T3	T1	T2	T3
PDCCH_beta		dB	4			4		
PDCCH_DMRS_beta		dB	4			4		
PBCH_beta		dB	0			0		
PSS_beta		dB						
SSS_beta		dB						
PDSCH_beta		dB						
OCNG_beta		dB						
SNR	Config 1	dB	TBD	TBD	TBD	TBD	TBD	TBD
	Config 2		TBD	TBD	TBD	TBD	TBD	TBD
	Config 3		TBD	TBD	TBD	TBD	TBD	TBD
N_{oc}	Config 1	dBm/ 15K Hz	[-98]			[-98]		
	Config 2		[-98]			[-98]		
	Config 3		[-98]			[-98]		
Propagation condition			[TDL-C 300ns 100Hz]			[TDL-C 300ns 100Hz]		
<p>Note 1: OCNG shall be used such that the resources in Cell 1 are fully allocated and a constant total transmitted power spectral density is achieved for all OFDM symbols.</p> <p>Note 2: The uplink resources for CSI reporting are assigned to the UE prior to the start of time period T1.</p> <p>Note 3: NZP CSI-RS resource set configuration for CSI reporting are assigned to the UE prior to the start of time period T1.</p> <p>Note 4: Measurement gap configuration is assigned to the UE prior to the start of time period T1.</p> <p>Note 5: The timers and layer 3 filtering related parameters are configured prior to the start of time period T1.</p> <p>Note 6: The signal contains PDCCH for UEs other than the device under test as part of OCNG.</p> <p>Note 7: SNR levels correspond to the signal to noise ratio over the SSS REs.</p> <p>Note 8: The SNR in time periods T1, T2 and T3 is denoted as SNR1, SNR2 and SNR3 respectively in figure A.6.5.1.6.1-1.</p> <p>Note 9: The SNR values are specified for testing a UE which supports 2RX on at least one band. For testing of a UE which supports 4RX on all bands, the SNR during T3 is [A.3.6].</p>								

Table A.6.5.1.6.1-3: Measurement gap configuration for FR1 CSI-RS in-sync radio link monitoring in non-DRX mode

Field	Test 4
	Value
gapOffset	[0]
Note 1: RLM RS is partially overlapped with measurement gap	

Table A.6.5.1.6.1-4: NZP-CSI-RS resource configuration for FR1 CSI-RS in-sync radio link monitoring in non-DRX mode

Field	ResourceId 0	ResourceId 1
	Value	Value
frequencyDomainAllocation ^{Note 2}	row1	row2
startingRB	0	0
nrofRBs	Note 2	Note 2
Note 1: TS 38.211 [6] table 7.4.1.5.3-1		
Note 2: nrofRBs is derived based on the Configuration in Table A.4.5.1.6.1-1		

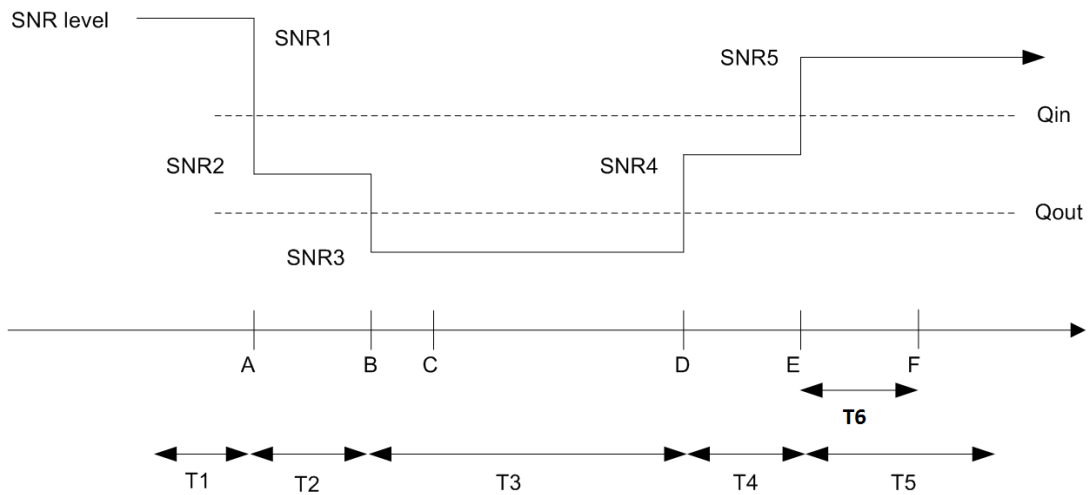

Figure A.6.5.1.6.1-1: SNR variation for CSI-RS in-sync testing

A.6.5.1.6.2 Test Requirements

The UE behaviour in each test during time durations T1, T2, T3, T4 and T5 shall be as follows:

During the period from time point A to time point F (T6 second after the start of time duration T5) the UE shall transmit uplink signal at least in all uplink slots configured for CSI transmission according to the configured periodic CSI reporting on the PCell.

The rate of correct events observed during repeated tests shall be at least 90%.

A.6.5.1.7 Radio Link Monitoring Out-of-sync Test for FR1 PCell configured with CSI-RS-based RLM in DRX mode

A.6.5.1.7.1 Test Purpose and Environment

The purpose of this test is to verify that the UE properly detects the out of sync for the purpose of monitoring downlink CSI-RS based radio link quality of the PCell when DRX is used. This test will partly verify the FR1 PCell CSI-RS Out-of-sync radio link monitoring requirements in clause 8.1.

The test parameters are given in Tables A.6.5.1.7.1-1, A.6.5.1.7.1-2, and A.6.5.1.7.1-3 below. There is one cell, cell 1 is the PCell, in the test. The test consists of three successive time periods, with time duration of T1, T2 and T3 respectively. Figure A.6.5.1.7.1-1 shows the variation of the downlink SNR in the PCell to emulate out-of-sync and in-sync states. Prior to the start of the time duration T1, the UE shall be fully synchronized to cell 1. The UE shall be configured for periodic CSI reporting with a reporting periodicity of [5] or [10] ms. In the test, DRX configuration is enabled in PCell and DRX inactivity timer has already been expired, i.e. UE tries to decode PDCCH and to send periodic CQI during the period when On-duration timer is running. Time alignment timers shall be set to “infinity” so that UL timing alignment is maintained during the test. The UE is configured to perform inter-frequency measurements using GP ID #0 (40ms) in test 6.

Table A.6.5.1.7.1-1: Supported test configurations for FR1 PCell

Configuration	Description
1	FDD duplex mode, 15 kHz SSB SCS, 10MHz bandwidth
2	TDD duplex mode, 15 kHz SSB SCS, 10MHz bandwidth
3	TDD duplex mode, 30kHz SSB SCS, 40MHz bandwidth
Note: The UE is only required to pass in one of the supported test configurations in FR1	

Table A.6.5.1.7.1-2: General test parameters for FR1 PCell for CSI-RS out-of-sync testing in DRX mode

Parameter	Unit	Value	
		Test 5	Test 6
Active PCell		Cell 1	Cell 1
RF Channel Number		1	1
Duplex mode	Config 1	FDD	FDD
	Config 2, 3	TDD	TDD
TDD Configuration	Config 1	Not Applicable	Not Applicable
	Config 2	[TDDConf.1.1]	[TDDConf.1.1]
	Config 3	[TDDConf.1.2]	[TDDConf.1.2]
CORESET Reference Channel	Config 1	[CR. 1.1 FDD]	[CR. 1.1 FDD]
	Config 2	[CR. 1.1 TDD]	[CR. 1.1 TDD]
	Config 3	[CR. 2.1 TDD]	[CR. 2.1 TDD]
SSB Configuration	Config 1	TBD (Note: periodicity is 20ms)	TBD (Note: periodicity is 20ms)
	Config 2	TBD (Note: periodicity is 20ms)	TBD (Note: periodicity is 20ms)
	Config 3	TBD (Note: periodicity is 20ms)	TBD (Note: periodicity is 20ms)
SMTC Configuration	Config 1, 2	FR1 pattern 1	FR1 pattern 1
	Config 3	FR1 pattern 2	FR1 pattern 2
PDSCH/PDCCH subcarrier spacing	Config 1, 2	15 KHz	15 KHz
	Config 3	30 KHz	30 KHz
csi-RS-Index assigned as RLM RS		[0]	[0]
OCNG parameters		TBD	TBD
CP length		Normal	Normal
Correlation Matrix and Antenna Configuration		[2x2 Low]	[2x2 Low]
DCI format		1-0	1-0
	Number of Control OFDM symbols	2	2
	Aggregation level	8	8
	CC E		

Out of sync transmission parameters	Ratio of hypothetical PDCCH RE energy to average CSI-RS RE energy	dB	4	4
	Ratio of hypothetical PDCCH DMRS energy to average CSI-RS RE energy	dB	4	4
	DMRS precoder granularity		REG bundle size	REG bundle size
	REG bundle size		6	6
DRX			640	640
Gap pattern ID			[N.A.]	*[gp0]
Layer 3 filtering			Enabled	Enabled
T310 timer		ms	0	0
T311 timer		ms	1000	1000
N310			1	1
N311			1	1
NZP CSI-RS configuration			[ResourceId 1]	[ResourceId 0]
ZP CSI-RS configuration			TBD	TBD
CSI-IM configuration			TBD	TBD
Periodic CSI reporting			PUCCH	PUCCH
CSI reporting periodicity	Config 1, 2	slot	[5]	[5]
	Config 3		[10]	[10]
T1		s	1	1
T2		s	0.4	0.4
T3		s	[0.6]	[0.6]
D1		s	[0.24]	[0.44]
Note 1: UE-specific PDCCH is not transmitted after T1 starts.				

Table A.6.5.1.7.1-3: Cell specific test parameters for FR1 for CSI-RS out-of-sync radio link monitoring in DRX mode

Parameter		Unit	Test 5			Test 6		
			T1	T2	T3	T1	T2	T3
PDCCH_beta		dB	4			4		
PDCCH_DMRS_beta		dB	4			4		
PBCH_beta		dB	0			0		
PSS_beta		dB						
SSS_beta		dB						
PDSCH_beta		dB						
OCNG_beta		dB						
SNR	Config 1	dB	TBD	TBD	TBD	TBD	TBD	TBD
	Config 2		TBD	TBD	TBD	TBD	TBD	TBD
	Config 3		TBD	TBD	TBD	TBD	TBD	TBD
N_{oc}	Config 1	dBm/ 15K Hz	[-98]			[-98]		
	Config 2		[-98]			[-98]		
	Config 3		[-98]			[-98]		
Propagation condition			[TDL-C 300ns 100Hz]			[TDL-C 300ns 100Hz]		
<p>Note 1: OCNG shall be used such that the resources in Cell 1 are fully allocated and a constant total transmitted power spectral density is achieved for all OFDM symbols.</p> <p>Note 2: The uplink resources for CSI reporting are assigned to the UE prior to the start of time period T1.</p> <p>Note 3: NZP CSI-RS resource set configuration for CSI reporting are assigned to the UE prior to the start of time period T1.</p> <p>Note 4: Measurement gap configuration is assigned to the UE prior to the start of time period T1.</p> <p>Note 5: The timers and layer 3 filtering related parameters are configured prior to the start of time period T1.</p> <p>Note 6: The signal contains PDCCH for UEs other than the device under test as part of OCNG.</p> <p>Note 7: SNR levels correspond to the signal to noise ratio over the SSS REs.</p> <p>Note 8: The SNR in time periods T1, T2 and T3 is denoted as SNR1, SNR2 and SNR3 respectively in figure A.6.5.1.7.1-1.</p> <p>Note 9: The SNR values are specified for testing a UE which supports 2RX on at least one band. For testing of a UE which supports 4RX on all bands, the SNR during T3 is [A.3.6].</p>								

Table A.6.5.1.7.1-3: Measurement gap configuration for FR1 CSI-RS out-of-sync radio link monitoring in DRX mode

Field	Test 6
	Value
gapOffset	[0]
<p>Note 1: E-UTRAN PCell and PSCell are SFN-synchronous and frame boundary aligned. (Ensure that RLM RS is partially overlapped with measurement gap)</p>	

Table A.6.5.1.7.1-4: NZP-CSI-RS resource configuration for FR1 CSI-RS out-of-sync radio link monitoring in DRX mode

Field	ResourceId 0	ResourceId 1
	Value	Value
frequencyDomainAllocation ^{Note 1}	row1	row2
startingRB	0	0
nrofRBs	Note 2	Note 2
Note 1: TS 38.211 [6] table 7.4.1.5.3-1		
Note 2: nrofRBs is derived based on the Configuration in Table A.4.5.1.7.1-1		

Table A.6.5.1.7.1-5: DRX-Configuration for FR1 CSI-RS out-of-sync radio link monitoring in DRX mode.

Field	Test 5	Test 6
	Value	Value
drx-onDurationTimer	[ms6]	[ms6]
drx-InactivityTimer	[ms1]	[ms1]
drx-RetransmissionTimerDL	[sl1]	[sl1]
drx-RetransmissionTimerUL	[sl1]	[sl1]
longDRX-CycleStartOffset	[ms640]	[ms40]
shortDRX	disable	disable

Table A.6.5.1.7.1-6: TimeAlignmentTimer -Configuration for FR1 CSI-RS out-of-sync radio link monitoring in DRX mode.

Field		Test 5	Test 6
		Value	Value
TimeAlignmentTimer		infinity	infinity
periodicityAndOffset in SchedulingRequestResourceConfig	Config 1, 2	[sl5]	[sl5]
	Config 3	[sl10]	[sl10]

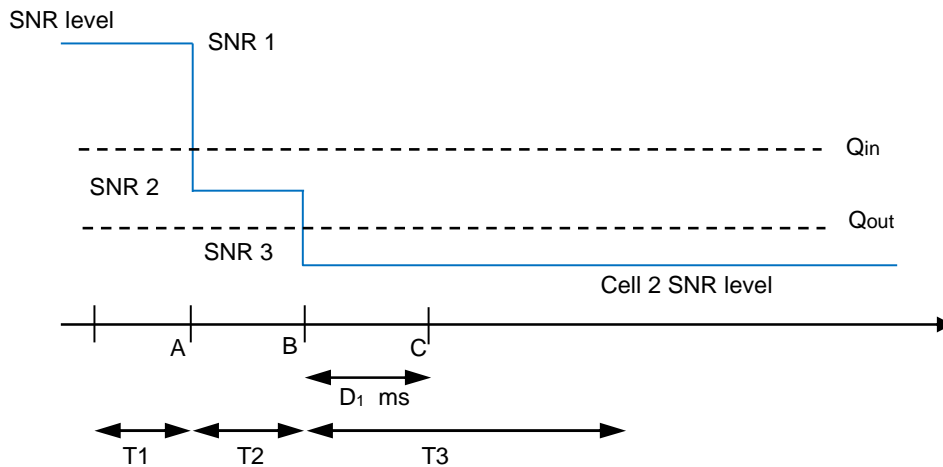

Figure A.6.5.1.7.1-1: SNR variation for CSI-RS out-of-sync testing

A.6.5.1.7.2 Test Requirements

The UE behaviour during time durations T1, T2, and T3 shall be as follows:

During time durations T1, T2 and T3, the UE shall transmit uplink signal at least in all subframes configured for CSI transmission on PCell.

During the period from time point A to time point B the UE shall transmit uplink signal in Cell 1 (PCell) at least in all uplink slots configured for CSI transmission according to the configured periodic CSI reporting for Cell 1.

The UE shall stop transmitting uplink signal in Cell 1 (PCell) no later than time point C ($D_1 = [\text{TBD}]$ ms) after the start of the time duration T3) on the PCell.

The rate of correct events observed during repeated tests shall be at least 90%.

A.6.5.1.8 Radio Link Monitoring In-sync Test for FR1 PCell configured with CSI-RS-based RLM in DRX mode

A.6.5.1.8.1 Test Purpose and Environment

The purpose of this test is to verify that the UE properly detects the in sync for the purpose of monitoring downlink CSI-RS based radio link quality of the PCell when DRX is used. This test will partly verify the FR1 PCell CSI-RS In-sync radio link monitoring requirements in clause 8.1.

The test parameters are given in Tables A.6.5.1.8.1-1, A.6.5.1.8.1-2, A.6.5.1.8.1-3 and A.6.5.1.8.1-4 below. There is one cells, cell 1 which is the PCell, in the test. The test consists of five successive time periods, with time duration of T1, T2, T3, T4 and T5 respectively. Figure A.6.5.1.8.1-1 shows the variation of the downlink SNR in the PCell to emulate out-of-sync and in-sync states. Prior to the start of the time duration T1, the UE shall be fully synchronized to cell 1. The UE shall be configured for periodic CSI reporting with a reporting periodicity of [5] or [10] ms. In the test, DRX configuration is not enabled. The UE is configured to perform inter-frequency measurements using GP ID #0 (40ms) in test 7.

Table A.6.5.1.8.1-1: Supported test configurations for FR1 PSCell

Configuration	Description
1	FDD duplex mode, 15 kHz SSB SCS, 10MHz bandwidth
2	TDD duplex mode, 15 kHz SSB SCS, 10MHz bandwidth
3	TDD duplex mode, 30kHz SSB SCS, 40MHz bandwidth
Note: The UE is only required to pass in one of the supported test configurations in FR1	

Table A.6.5.1.8.1-2: General test parameters for FR1 PCell for CSI-RS in-sync testing in non-DRX mode

Parameter	Unit	Value	
		Test 7	Test 8
Active PCell		Cell 1	Cell 1
RF Channel Number		1	1
Duplex mode	Config 1	FDD	FDD
	Config 2, 3	TDD	TDD
TDD Configuration	Config 1	Not Applicable	Not Applicable
	Config 2	[TDDConf.1.1]	[TDDConf.1.1]
	Config 3	[TDDConf.1.2]	[TDDConf.1.2]
CORESET Reference Channel	Config 1	[CR. 1.1 FDD]	[CR. 1.1 FDD]
	Config 2	[CR. 1.1 TDD]	[CR. 1.1 TDD]
	Config 3	[CR. 2.1 TDD]	[CR. 2.1 TDD]
SSB Configuration	Config 1	TBD (Note: periodicity is 20ms)	TBD (Note: periodicity is 20ms)
	Config 2	TBD (Note: periodicity is 20ms)	TBD (Note: periodicity is 20ms)
	Config 3	TBD (Note: periodicity is 20ms)	TBD (Note: periodicity is 20ms)
SMTC Configuration	Config 1, 2	FR1 pattern 1	FR1 pattern 1
	Config 3	FR1 pattern 2	FR1 pattern 2
PDSCH/PDCC H subcarrier spacing	Config 1, 2	15 KHz	15 KHz
	Config 3	30 KHz	30 KHz
csi-RS-Index assigned as RLM RS		[0]	[0]
OCNG parameters		TBD	TBD
CP length		Normal	Normal
Correlation Matrix and Antenna Configuration		[2x2 Low]	[2x2 Low]
Out of sync transmission parameters	DCI format		1-0
	Number of Control OFDM symbols		2
	Aggregation level	CC E	8
	Ratio of hypothetical PDCCH RE energy to average CSI-RS RE energy	dB	4
	Ratio of hypothetical PDCCH DMRS energy to average CSI-RS RE energy	dB	4
	DMRS precoder granularity		REG bundle size
	REG bundle size		6
DCI format		1-0	1-0

In sync transmission parameters	Number of Control OFDM symbols		2	2
	Aggregation level	CC E	4	4
	Ratio of hypothetical PDCCH RE energy to average CSI-RS RE energy	dB	0	0
	Ratio of hypothetical PDCCH DMRS energy to average CSI-RS RE energy	dB	0	0
	DMRS precoder granularity		REG bundle size	REG bundle size
	REG bundle size		6	6
DRX			640	640
Gap pattern ID			[N.A.]	*[gp0]
Layer 3 filtering			<i>Enabled</i>	<i>Enabled</i>
T310 timer	ms		0	0
T311 timer	ms		1000	1000
N310			1	1
N311			1	1
NZP CSI-RS configuration			[ResourceId 1]	[ResourceId 0]
ZP CSI-RS configuration			TBD	TBD
CSI-IM configuration			TBD	TBD
Periodic CSI reporting			PUCCH	PUCCH
CSI reporting periodicity	Config 1, 2, 4, 5	slot	[5]	[5]
	Config 3, 6		[10]	[10]
T1		s	1	1
T2		s	0.4	0.4
T3		s	[0.6]	[0.6]
D1		s	[0.24]	[0.44]
Note 1: UE-specific PDCCH is not transmitted after T1 starts.				

Table A.6.5.1.8.1-3: Cell specific test parameters for FR1 for CSI-RS in-sync radio link monitoring in non-DRX mode

Parameter		Unit	Test 7			Test 8		
			T1	T2	T3	T1	T2	T3
PDCCH_beta		dB	4			4		
PDCCH_DMRS_beta		dB	4			4		
PBCH_beta		dB	0			0		
PSS_beta		dB						
SSS_beta		dB						
PDSCH_beta		dB						
OCNG_beta		dB						
SNR	Config 1	dB	TBD	TBD	TBD	TBD	TBD	TBD
	Config 2		TBD	TBD	TBD	TBD	TBD	TBD
	Config 3		TBD	TBD	TBD	TBD	TBD	TBD
N_{oc}	Config 1	dBm/ 15K Hz	[-98]			[-98]		
	Config 2		[-98]			[-98]		
	Config 3		[-98]			[-98]		
Propagation condition			[TDL-C 300ns 100Hz]			[TDL-C 300ns 100Hz]		
<p>Note 1: OCNG shall be used such that the resources in Cell 1 are fully allocated and a constant total transmitted power spectral density is achieved for all OFDM symbols.</p> <p>Note 2: The uplink resources for CSI reporting are assigned to the UE prior to the start of time period T1.</p> <p>Note 3: NZP CSI-RS resource set configuration for CSI reporting are assigned to the UE prior to the start of time period T1.</p> <p>Note 4: Measurement gap configuration is assigned to the UE prior to the start of time period T1.</p> <p>Note 5: The timers and layer 3 filtering related parameters are configured prior to the start of time period T1.</p> <p>Note 6: The signal contains PDCCH for UEs other than the device under test as part of OCNG.</p> <p>Note 7: SNR levels correspond to the signal to noise ratio over the SSS REs.</p> <p>Note 8: The SNR in time periods T1, T2 and T3 is denoted as SNR1, SNR2 and SNR3 respectively in figure A.6.5.1.8.1-1.</p> <p>Note 9: The SNR values are specified for testing a UE which supports 2RX on at least one band. For testing of a UE which supports 4RX on all bands, the SNR during T3 is [A.3.6].</p>								

Table A.6.5.1.8.1-3: Measurement gap configuration for FR1 CSI-RS in-sync radio link monitoring in non-DRX mode

Field	Test 8
	Value
gapOffset	[0]
Note 1: RLM RS is partially overlapped with measurement gap	

Table A.6.5.1.8.1-4: NZP-CSI-RS resource configuration for FR1 CSI-RS in-sync radio link monitoring in non-DRX mode

Field	ResourceId 0	ResourceId 1
	Value	Value
frequencyDomainAllocation ^{Note 1}	row1	row2
startingRB	0	0
nrofRBs	Note 2	Note 2
Note 1: TS 38.211 [6] table 7.4.1.5.3-1		
Note 2: nrofRBs is derived based on the Configuration in Table A.4.5.1.8.1-1		

Table A.6.5.1.8.1-5: DRX-Configuration for FR1 CSI-RS in-sync radio link monitoring in DRX mode

Field	Test 5 Value	Test 6 Value
	drx-onDurationTimer	[ms6]
drx-InactivityTimer	[ms1]	[ms1]
drx-RetransmissionTimerDL	[sl1]	[sl1]
drx-RetransmissionTimerUL	[sl1]	[sl1]
longDRX-CycleStartOffset	[ms640]	[ms40]
shortDRX	disable	disable

Table A.6.5.1.8.1-6: TimeAlignmentTimer -Configuration for FR1 CSI-RS in-sync radio link monitoring in DRX mode

Field		Test 5 Value	Test 6 Value
		TimeAlignmentTimer	infinity
periodicityAndOffset in SchedulingRequestResourceConfig	Config 1, 2	[sl5]	[sl5]
	Config 3	[sl10]	[sl10]

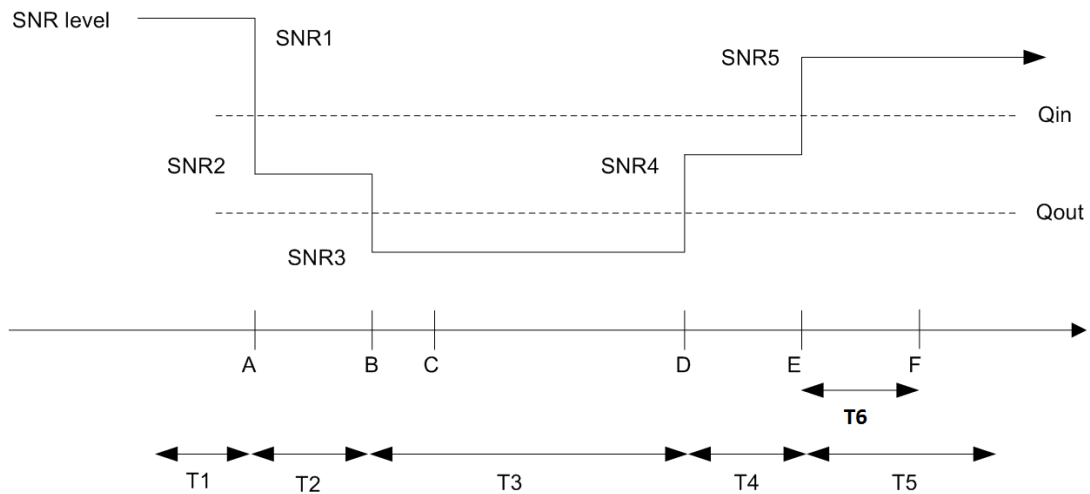

Figure A.6.5.1.8.1-1: SNR variation for CSI-RS in-sync testing

A.6.5.1.8.2 Test Requirements

The UE behaviour in each test during time durations T1, T2, T3, T4 and T5 shall be as follows:

During the period from time point A to time point F (T6 second after the start of time duration T5) the UE shall transmit uplink signal at least in all uplink slots configured for CSI transmission according to the configured periodic CSI reporting on the PCell.

The rate of correct events observed during repeated tests shall be at least 90%.

A.6.5.2 Interruption

A.6.5.2.1 Interruptions during measurements on deactivated NR SCC in FR1

A.6.5.2.1.1 Test Purpose and Environment

The purpose of this test is to verify that the UE missed ACK/NACK rate does not exceed the limits at NR PSCell interruptions during the measurement on the deactivated NR SCC. This test will verify the missed ACK/NACK rate for PCell in standalone NR specified in section 8.2.2.2. Supported test configurations are shown in table A.6.5.2.1.1-1.

The general test parameters and NR cell specific test parameters are given in Table A.6.5.2.1.1-2 and A.6.5.2.1.1-3 below. In the test there are two cells: Cell1 and Cell2. Cell1 is PCell, Cell2 is an NR deactivated SCell. Cell1 shall be configured as PCell and Cell2 shall be configured as SCell.

The test consists of one time period, with duration of T1. Prior to the start of the time duration T1, the UE is connected to Cell1 and Cell2. The point in time at which the RRC message including *measCycleSCell* or *allowInterruptions* for the deactivated NR SCells is received at the UE antenna connector defines the start of time period T1. During T1, PCell is continuously scheduled in DL.

Table A.6.5.2.1.1-1: Interruptions during measurements on deactivated NR SCC supported test configurations

Config	Description
1	NR 15 kHz SSB SCS, 10MHz bandwidth, FDD – FDD duplex mode
2	NR 15 kHz SSB SCS, 10MHz bandwidth, TDD – TDD duplex mode
3	NR 15 kHz SSB SCS, 10MHz bandwidth, TDD – FDD duplex mode
4	NR 15 kHz SSB SCS, 10MHz bandwidth, FDD – TDD duplex mode
5	NR 30kHz SSB SCS, 40MHz bandwidth, TDD – TDD duplex mode
Note: The UE is only required to be tested in one of the supported test configurations	

Table A.6.5.2.1.1-2: General test parameters for interruptions during measurements on deactivated NR SCC in standalone NR

Parameter	Unit	Value	Comment
RF Channel Number		1, 2	Two NR RF channels
Active PCell		Cell1	PCell on NR RF channel number 1.
Configured deactivated SCell		Cell2	Deactivated SCell on NR RF channel number 2.
CP length		Normal	Applicable to Cell1 and Cell 2
DRX		OFF	
Measurement gap pattern Id		OFF	
SCell measurement cycle (measCycleSCell)	ms	640	
T1	s	10	

Table A.6.5.2.1.1-3: NR cell specific test parameters for interruptions during measurements on deactivated NR SCC in standalone NR

Parameter		Unit	Cell1	Cell2
Frequency Range			FR1	FR1
Duplex mode	Config 1		FDD	FDD
	Config 2,5		TDD	TDD
	Config 3		TDD	FDD
	Config 4		FDD	TDD
TDD configuration	Config 1		Not Applicable	Not Applicable
	Config 2		TDDConf.1.1	TDDConf.1.1
	Config 3		TDDConf.1.1	Not Applicable
	Config 4		Not Applicable	TDDConf.1.1
	Config 5		TDDConf.1.2	TDDConf.1.2
BW _{channel}	Config 1,2,3,4		10 MHz: N _{RB,c} = 52	10 MHz: N _{RB,c} = 52
	Config 5		40 MHz: N _{RB,c} = 106	40 MHz: N _{RB,c} = 106
Initial BWP Configuration			DLBWP.0.2 ^{Note6}	
PDSCH Reference measurement channel	Config 1		SR.1.1 FDD	SR.1.1 FDD
	Config 2		SR.1.1 TDD	SR.1.1 TDD
	Config 3		SR.1.1 TDD	SR.1.1 FDD
	Config 4		SR.1.1 FDD	SR.1.1 TDD
	Config 5		SR.2.1 TDD	SR.2.1 TDD
RMSI CORESET parameters	Config 1		CR.1.1 FDD	CR.1.1 FDD
	Config 2		CR.1.1 TDD	CR.1.1 TDD
	Config 3		CR.1.1 TDD	CR.1.1 FDD
	Config 4		CR.1.1 FDD	CR.1.1 TDD
	Config 5		CR.2.1 TDD	CR.2.1 TDD
Dedicated CORESET parameters	Config 1,4		CCR.1.1 FDD	CCR.1.1 FDD
	Config 2,5		CCR.1.1 TDD	CCR.1.1 TDD
	Config 3,6		CCR.1.1 TDD	CCR.1.1 FDD

			CCR.1.1 FDD	CCR.1.1 TDD
			CCR.2.1 TDD	CCR.2.1 TDD
OCNG Patterns			OP.1	OP.1
SMTC Configuration			SMTC.1	SMTC.1
SSB Configuration	Config 1,2,4,5		SSB.1 FR1	SSB.1 FR1
	Config 3,6		SSB.2 FR1	SSB.2 FR1
Correlation Matrix and Antenna Configuration			1x2 Low	1x2 Low
EPRE ratio of PSS to SSS		dB	0	0
EPRE ratio of PBCH DMRS to SSS				
EPRE ratio of PBCH to PBCH DMRS				
EPRE ratio of PDCCH DMRS to SSS				
EPRE ratio of PDCCH to PDCCH DMRS				
EPRE ratio of PDSCH DMRS to SSS				
EPRE ratio of PDSCH to PDSCH				
EPRE ratio of OCNG DMRS to SSS(Note 1)				
EPRE ratio of OCNG to OCNG DMRS (Note 1)				
N_{oc} ^{Note 2}		dBm/15 kHz	[-104]	[-104]
SS-RSRP ^{Note 3}		dBm/15 kHz	[-87]	[-87]
\hat{E}_s/I_{ot}		dB	17	17
\hat{E}_s/N_{oc}		dB	17	17
N_{oc} ^{Note 2}	Config 1,2,4,5	dBm/S	[-104]	[-104]
	Config 3,6		[-101]	[-101]
I_o ^{Note 3}	Config 1,2,4,5	dBm/9.36MHz	[-59]	[-59]
	Config 3,6	dBm/38.16MHz	[-61.9]	[-61.9]
Time offset to cell1 ^{Note 4}		μ s	33	33
Time offset to cell2 ^{Note 5}		μ s	-	3
Propagation Condition			AWGN	AWGN
<p>Note 1: OCNG shall be used such that both cells are fully allocated and a constant total transmitted power spectral density is achieved for all OFDM symbols.</p> <p>Note 2: Interference from other cells and noise sources not specified in the test is assumed to be constant over subcarriers and time and shall be modeled as AWGN of appropriate power for N_{oc} to be fulfilled.</p> <p>Note 3: SS-RSRP and I_o levels have been derived from other parameters for information purposes. They are not settable parameters themselves.</p> <p>Note 4: Receive time difference of signals received between subframe timing boundary of E-UTRA PCell and slot timing boundary of PSCell at the UE antenna connector including time alignment error between the two cells</p> <p>Note 5: Receive time difference between slot boundaries of signals received from the two cells at the UE antenna connector including time alignment error between the two cells.</p> <p>Note 6: For unpaired spectrum, a DL BWP is linked with an UL BWP. DLBWP.0.2 is linked with ULBWP.0.2 defined in TS 38.213 [3] section 12.</p>				

A.6.5.2.1.2 Test Requirements

The UE shall be continuously scheduled on PCell during the entire length of T1. During the time duration T1 the UE shall transmit at least 99.5% of ACK/NACK on PCell.

The UE is only allowed to cause interruptions immediately before and immediately after an SMTC. Each interruption on PCell shall not exceed the value defined in Table A.6.5.2.1.2-1 if the PCell is not in the same band as the deactivated SCell or Table A.6.5.2.1.2-2 if the PCell is in the same band as the deactivated SCell.

Table A.6.5.2.1.2-1: Interruption duration if the PCell is not in the same band as the deactivated SCell

μ	NR Slot length (ms)	Interruption length
0	1	1
1	0.5	1

Table A.6.5.2.1.2-2: Interruption duration if the PCell is in the same band as the deactivated SCell

μ	NR Slot length (ms)	Interruption length
0	1	1 + SMTC duration
1	0.5	2 + SMTC duration

The rate of correct events observed during repeated tests shall be at least 90%.

A.6.5.3 SCell Activation and Deactivation Delay

A.6.5.3.1 SCell Activation and deactivation of known SCell in FR1 in non-DRX for 160ms SCell measurement cycle

A.6.5.3.1.1 Test Purpose and Environment

The purpose of this test is to verify that the SCell activation and deactivation times are within the requirements stated in section 8.3, when the SCell in FR1 is known by the UE at the time of activation.

The supported test configurations are shown in table A.6.5.3.1.1-1 below. The test parameters are given in Tables A.6.5.3.1.1-2 and cell-specific parameters in A.6.5.3.1.1-3 below. The test consists of three successive time periods, with duration of T1, T2 and T3, respectively. There are two NR carriers, each with one cell. Both cells have constant signal levels throughout the test. Before the test starts the UE is connected to Cell 1, but is not aware of Cell2. The UE is only monitoring the PCC. The UE shall be continuously scheduled in the PCell throughout the whole test.

At the beginning of T1 the UE receives an RRC message by which the SCell (Cell 2) becomes configured on radio channel 2. The UE now starts monitoring the SCC. The test equipment sends a MAC message for activation of the SCell.

The point in time at which the MAC message is received at the UE antenna connector, in slot # denoted n, defines the start of time period T2. The UE shall be able to report valid CSI in PCell for the activated SCell at latest in slot $(n+T_{\text{HARQ}}+T_{\text{activation_time}}+T_{\text{CSI_Reporting}})$, as defined in section 8.3. The UE shall start reporting CSI in PCell in slot $(n+T_{\text{HARQ}}+3\text{ms})$ and shall report CQI index 0 (out-of-range) until the SCell activation has been completed. Any PCell interruption due to activation of SCell shall occur in the slot $(n+1+[T_{\text{HARQ}}]+3\text{ms})$ to $(n+1+[T_{\text{HARQ}}+3\text{ms}]+T_{\text{SSB_max}}+T_{\text{SMTC_duration}})$, as defined in section 8.3.

Time period T3 starts when a MAC message for deactivation of SCell, sent from the test equipment to the UE in a slot # denoted m, is received at the UE antenna connector. The UE shall carry out deactivation of the SCell in a slot $(n+[T_{\text{HARQ}}+3\text{ms}])$, as defined in section 8.3, and any PCell interruption due to the deactivation shall occur in the slot $(n+1+[T_{\text{HARQ}}])$ to $(n+1+[T_{\text{HARQ}}+3\text{ms}])$, as defined in section 8.3.

The test equipment verifies that potential interruption is carried out in the correct time span by monitoring ACK/NACK sent in PCell during activation and deactivation of SCell, respectively.

The test equipment verifies the activation time by counting the slots from the time when the SCell activation command is sent until a CSI report with other than CQI index 0 is received.

The test equipment verifies the deactivation time by counting the slots from the time when the SCell deactivation command is sent until CQI reporting for SCell is discontinued.

Table A.6.5.3.1.1-1: known FR1 SCell activation in non-DRX for 160ms SCell measurement cycle supported test configurations

Config	Description
1	NR 15 kHz SSB SCS, 10MHz bandwidth, FDD duplex mode
2	NR 15 kHz SSB SCS, 10MHz bandwidth, TDD duplex mode
3	NR 30kHz SSB SCS, 40MHz bandwidth, TDD duplex mode
Note: The UE is only required to be tested in one of the supported test configurations	

Table A.6.5.3.1.1-2: General test parameters for known FR1 SCell activation case, 160ms SCell measurement cycle

Parameter	Unit	Value	Comment
RF Channel Number		1,2	Two NR radio channel (1, 2) are used for this test
Active PCell		Cell 1	Primary cell on NR RF channel number 1.
Configured deactivated SCell		Cell 2	Configured deactivated secondary cell on NR RF channel number 2
CP length		Normal	
DRX		OFF	Continuous monitoring of primary cell
CQI/PMI periodicity and offset configuration index		0	CQI reporting for SCell every second subframe
Cell-individual offset for cells on NR channel number	dB	0	Individual offset for cells on primary component carrier.
SCell measurement cycle (measCycleSCell)	ms	160	
Cell2 timing offset to cell1	μs	0	
Time alignment error between cell2 and cell1	μs	≤ Time alignment error as specified in 3GPP TS 38.104 [13] clause 6.5.3.1.	The value of time alignment error depends upon the type of carrier aggregation.
T1	s	[7]	During this time the PSCell shall be known and the SCell configured and detected.
T2	s	[1]	During this time the UE shall activate the SCell.
T3	s	[1]	During this time the UE shall deactivate the SCell.
T _{HARQ}	ms	TBD	the timing between DL data transmission and acknowledgement as specified in 38.321 [7]
T _{CSI_Reporting}	ms	[2]	the delay uncertainty in acquiring the first available CSI reporting resources as specified in 38.331 [2]

Table A.6.5.3.1.1-3: Cell specific test parameters for known FR1 SCell activation case, 160ms SCell measurement cycle

Parameter	Unit	T1		T2		T3	
		Cell 1	Cell 2	Cell 1	Cell 2	Cell 1	Cell 2
Duplex mode	Config 1	FDD					
	Config 2,3	TDD					
TDD configuration	Config 1	Not applicable					
	Config 2	TDDConf.1.1					
	Config 3	TDDConf.1.2					

BW _{channel}	Config 1,2	MHz	10: N _{RB,c} = 52					
	Config 3		40: N _{RB,c} = 106					
Initial BWP configuration			[DLBWP.0.2]					
TCI state			TCI.State.0					
PDSCH Reference measurement channel	Config 1		SR.1.1 FDD	-	SR.1.1 FDD	-	SR.1.1 FDD	-
	Config 2		SR.1.1 TDD	-	SR.1.1 TDD	-	SR.1.1 TDD	-
	Config 3		SR2.1 TDD	-	SR2.1 TDD	-	SR2.1 TDD	-
Dedicated CORESET parameters	Config 1		CCR.1.1 FDD	-	CCR.1.1 FDD	-	CCR.1.1 FDD	-
	Config 2		CCR.1.1 TDD	-	CCR.1.1 TDD	-	CCR.1.1 TDD	-
	Config 3		CCR2.1 TDD	-	CCR2.1 TDD	-	CCR2.1 TDD	-
RMSI CORESET parameters	Config 1		CR.1.1 FDD	-	CR.1.1 FDD	-	CR.1.1 FDD	-
	Config 2		CR.1.1 TDD	-	CR.1.1 TDD	-	CR.1.1 TDD	-
	Config 3		CR2.1 TDD	-	CR2.1 TDD	-	CR2.1 TDD	-
OCNG Patterns			OP.1					
SSB Configuration	Config 1,2		SSB.1 FR1					
	Config 3		SSB.2 FR1					
SMTc configuration			SMTc.1 FR1					
EPRE ratio of PSS to SSS		dB	0					
EPRE ratio of PBCH DMRS to SSS								
EPRE ratio of PBCH to PBCH DMRS								
EPRE ratio of PDCCH DMRS to SSS								
EPRE ratio of PDCCH to PDCCH DMRS								
EPRE ratio of PDSCH DMRS to SSS								
EPRE ratio of PDSCH to PDSCH								
EPRE ratio of OCNG DMRS to SSS(Note 1)								
EPRE ratio of OCNG to OCNG DMRS (Note 1)								
N _{oc} ^{Note2}	Config 1,2,4,5	dBm/15KHz	[-104]					
	Config 3,6		[-101]					
\hat{E}_s / I_{ot}		dB	[17]					
\hat{E}_s / N_{oc}		dB	[17]					
SS-RSRP ^{Note3}	Config 1,2,4,5	dBm/SCS	[-87]					
	Config 3,6		[-84]					
SCH_RP ^{Note 3}		dBm/15 kHz	[-87]					
Propagation condition		-	AWGN					
Note 1: OCNG shall be used such that both cells are fully allocated and a constant total transmitted power spectral density is achieved for all OFDM symbols.								

Note 2:	Interference from other cells and noise sources not specified in the test is assumed to be constant over subcarriers and time and shall be modelled as AWGN of appropriate power for N_{oc} to be fulfilled.
Note 3:	SS-RSRP and SCH_RP levels have been derived from other parameters for information purposes. They are not settable parameters themselves.
Note 4:	The uplink resources for CSI reporting are assigned to the UE prior to the start of time period T2.]

A.6.5.3.1.2 Test Requirements

During T2 the UE shall send the first CSI report for SCell in a slot ($n+T_{HARQ}+3ms$).

During T2 the UE shall start sending CSI reports for SCell with non-zero CQI index at latest in a slot ($n+T_{HARQ}+T_{activation_time}+T_{CSI_Reporting}$), $T_{activation_time} = [3ms+T_{SMTC_SCell}+2ms]$, as defined in section 8.3.

During T3 the UE shall stop sending CSI reports for SCell at latest in a slot ($n+ [T_{HARQ}+3ms]$), as defined in section 8.3.

During T2 interruption of PCell / PSCell during SCell activation shall not happen outside the slot ($n+1+[T_{HARQ}]$) to ($n+1+[T_{HARQ}+3ms+T_{SSB_max}+T_{SMTC_duration}]$), as defined in section 8.3.

During T3 interruption of PCell / PSCell during SCell deactivation shall not happen outside the slot ($n+1+[T_{HARQ}]$) to ($m+1+[T_{HARQ}+3ms]$), as defined in section 8.3.

The interruption on any activated serving cell shall not be more than the values specified for SA in Section 8.2.2.2.2.

All of the above test requirements shall be fulfilled in order for the observed SCell activation delay and SCell deactivation delay to be counted as correct. The rate of correct observed SCell activation delay and SCell deactivation delay during repeated tests shall be at least 90%.

NOTE: During T2 if there are no uplink resources for reporting the valid CSI in a slot ($n+T_{HARQ}+T_{activation_time}+T_{CSI_Reporting}$) as defined in section 8.3 then the UE shall use the next available uplink resource for reporting the corresponding valid CSI.

A.6.5.3.2 SCell Activation and deactivation of known SCell in FR1 in non-DRX for 320ms SCell measurement cycle

A.6.5.3.2.1 Test Purpose and Environment

The purpose of this test case is the same as for the test defined in section A.6.5.3.1.1. The supported test configurations are the same as defined in section A.6.5.3.1.1. The test parameters are the same except those described in the following section. The listed parameter values in Tables A.6.5.3.2.1-1 will replace the values of corresponding parameters in Tables A.4.5.3.1.1-1.

Table A.6.5.3.2.1-1: General test parameters for known FR1 SCell activation case, 320ms SCell measurement cycle

Parameter	Unit	Value	Comment
SCell measurement cycle (measCycleSCell)	ms	320	

A.6.5.3.2.2 Test Requirements

The test requirements defined in section A.6.5.3.1.2 shall apply to this test case, except $T_{activation_time}$ will be replaced with the value $[T_{SMTC_MAX}+T_{SMTC_SCell}+5ms]$.

A.6.5.3.3 SCell Activation and deactivation of unknown SCell in FR1 in non-DRX

A.6.5.3.3.1 Test Purpose and Environment

The purpose of this test is to verify that the SCell activation and deactivation times are within the requirements stated in section 8.3, when the SCell in FR1 is unknown by the UE at the time of activation.

The supported test configurations are the same as defined in section A.6.5.3.1.1. The test parameters are the same except those described in the following section. The listed parameter values in Tables A.6.5.3.3.1-1 will replace the values of corresponding parameters in Tables A.6.5.3.1.1-1. The test consists of three successive time periods, with duration of T1, T2 and T3, respectively. There are two NR carriers, each with one cell. Both cells have constant signal levels throughout the test. Before the test starts the UE is connected to Cell 1, but is not aware of Cell2. The UE is only monitoring the PCC. The UE shall be continuously scheduled in the PCell throughout the whole test.

At the beginning of T1 the UE receives an RRC message by which the SCell (Cell 2) becomes configured on radio channel 2. The UE now starts monitoring the SCC. The test equipment sends a MAC message for activation of the SCell.

The point in time at which the MAC message is received at the UE antenna connector, in slot # denoted n, defines the start of time period T2. The UE shall be able to report valid CSI in PCell for the activated SCell at latest in slot $(n+T_{\text{HARQ}}+T_{\text{activation_time}}+T_{\text{CSI_Reporting}})$, as defined in section 8.3. The UE shall start reporting CSI in PCell in slot $(n+T_{\text{HARQ}}+3\text{ms})$ and shall report CQI index 0 (out-of-range) until the SCell activation has been completed. Any PCell interruption due to activation of SCell shall occur in the slot $(n+1+[T_{\text{HARQ}}]+3\text{ms})$ to $(n+1+[T_{\text{HARQ}}+3\text{ms}+2*T_{\text{SSB_max}}+2*T_{\text{SMTC_duration}}])$, as defined in section 8.3.

Time period T3 starts when a MAC message for deactivation of SCell, sent from the test equipment to the UE in a slot # denoted m, is received at the UE antenna connector. The UE shall carry out deactivation of the SCell in a slot $(n+[T_{\text{HARQ}}+3\text{ms}])$, as defined in section 8.3, and any PCell interruption due to the deactivation shall occur in the slot $(n+1+[T_{\text{HARQ}}])$ to $(n+1+[T_{\text{HARQ}}+3\text{ms}])$, as defined in section 8.3.

The test equipment verifies that potential interruption is carried out in the correct time span by monitoring ACK/NACK sent in PCell during activation and deactivation of SCell, respectively.

The test equipment verifies the activation time by counting the slots from the time when the SCell activation command is sent until a CSI report with other than CQI index 0 is received.

The test equipment verifies the deactivation time by counting the slots from the time when the SCell deactivation command is sent until CQI reporting for SCell is discontinued.

Table A.6.5.3.3.1-1: General test parameters for unknown FR1 SCell activation case, 160ms SCell measurement cycle

Parameter	Unit	Value	Comment
T1	ms	[100]	During this time the PSCell shall be known and the SCell configured, but not detected.

A.6.5.3.3.2 Test Requirements

The test requirements defined in section A.6.5.3.1.2 shall apply to this test case, except $T_{\text{activation_time}}$ will be replaced with the value $[3\text{ms}+2*T_{\text{SMTC_MAX}}+2*T_{\text{SMTC_SCell}}+2\text{ms}]$ as defined in section 8.3.

A.6.5.4 UE UL carrier RRC reconfiguration Delay

A.6.5.4.1 UE UL carrier RRC reconfiguration Delay

Table A.6.5.4.1-1 - Table A.6.5.4.1-4 : Void

A.6.5.4.1.1 Test Purpose and Environment

The purpose of this test is to verify that when the UE receives a RRC message implying NR UL or Supplementary UL carrier configuration, the UE shall be ready to start transmission on the newly configured carrier within the time limits specified in section 8.4.2 and 8.4.3 for configuring and deconfiguring, respectively.

There are two cells: FR1 PCell (cell 1) and FR1 SCell (cell 2). Both NR uplink and supplementary uplink are broadcast by *ServingCellConfigCommonSIB*. The test parameters for PCell and SCell are given in Table A.6.5.4.1.1-1, Table A.6.5.4.1.1-2, Table A.6.5.4.1.1-3 and Table A.6.5.4.1.1-4 below. In test 1, the test consists of three time periods, with duration of T1, T2 and T3 respectively. During time duration T1, NR uplink of cell 2 is configured to UE. At the start of T2, a supplementary uplink of cell 2 is configured to UE through *RRCReconfiguration*, then UE shall start transmission both on the NR uplink and supplementary uplink. At the start of T3, the supplementary uplink is released through *RRCReconfiguration*.

In test 2, the test consists of three time periods, with duration of T1, T2 and T3 respectively. During time duration T1, supplementary uplink on cell 2 is configured to UE. At the start of T2, a NR uplink is configured to UE through *RRCReconfiguration*, then UE shall start transmission both on the NR uplink and supplementary uplink. At the start of T3, the NR uplink is released through *RRCReconfiguration*.

Table A.6.5.4.1.1-1: Supported test configurations

Configuration	PSCell (Cell 1)	SCell (Cell 2)
1	15 kHz SSB SCS, 10MHz bandwidth, FDD duplex mode	DL and UL: 15kHz SSB SCS, 10MHz bandwidth, FDD duplex mode; SUL: 15kHz SCS, 10MHz bandwidth, SUL duplex mode
2	15 kHz SSB SCS, 10MHz bandwidth, FDD duplex mode	DL and UL: 15kHz SSB SCS, 10MHz bandwidth, TDD duplex mode; SUL: 15kHz SCS, 10MHz bandwidth, SUL duplex mode
3	15 kHz SSB SCS, 10MHz bandwidth, FDD duplex mode	DL and UL: 30kHz SSB SCS, 40MHz bandwidth, TDD duplex mode; SUL: 30kHz SCS, 40MHz bandwidth, SUL duplex mode
4	15 kHz SSB SCS, 10MHz bandwidth, TDD duplex mode	DL and UL: 15kHz SSB SCS, 10MHz bandwidth, FDD duplex mode; SUL: 15kHz SCS, 10MHz bandwidth, SUL duplex mode
5	15 kHz SSB SCS, 10MHz bandwidth, TDD duplex mode	DL and UL: 15kHz SSB SCS, 10MHz bandwidth, TDD duplex mode; SUL: 15kHz SCS, 10MHz bandwidth, SUL duplex mode
6	15 kHz SSB SCS, 10MHz bandwidth, TDD duplex mode	DL and UL: 30kHz SSB SCS, 40MHz bandwidth, TDD duplex mode; SUL: 30kHz SCS, 40MHz bandwidth, SUL duplex mode
7	30 kHz SSB SCS, 40MHz bandwidth, TDD duplex mode	DL and UL: 15kHz SSB SCS, 10MHz bandwidth, FDD duplex mode; SUL: 15kHz SCS, 10MHz bandwidth, SUL duplex mode
8	30 kHz SSB SCS, 40MHz bandwidth, TDD duplex mode	DL and UL: 15kHz SSB SCS, 10MHz bandwidth, TDD duplex mode; SUL: 15kHz SCS, 10MHz bandwidth, SUL duplex mode
9	30 kHz SSB SCS, 40MHz bandwidth, TDD duplex mode	DL and UL: 30kHz SSB SCS, 40MHz bandwidth, TDD duplex mode; SUL: 30kHz SCS, 40MHz bandwidth, SUL duplex mode
Note:	The UE is only required to be tested in one of the supported test configurations	

Table A.6.5.4.1.1-2: General test parameters for NR standalone UE UL carrier RRC reconfiguration Delay on Pcell

Parameter	Unit	Test configuration	Value	Comment
RF Channel Number		Config 1,2,3, 4, 5, 6, 7, 8, 9	1, 2	Three radio channels are used for these two tests.
Active cell		Config 1,2,3, 4, 5, 6, 7, 8, 9	Cell 1: FR1 PCell Cell 2: FR1 SCell	E-UTRAN PCell on RF channel number 1 FR1 SCell on RF channel number 2
CP length		Config 1,2,3, 4, 5, 6, 7, 8, 9	Normal	
DRX		Config 1,2,3, 4, 5, 6, 7, 8, 9	OFF	
Measurement gap pattern Id		Config 1,2,3, 4, 5, 6, 7, 8, 9	OFF	
Filter coefficient		Config 1,2,3, 4, 5, 6, 7, 8, 9	0	L3 filtering is not used
T1	s	Config 1,2,3, 4, 5, 6, 7, 8, 9	5	
T2	s	Config 1,2,3, 4, 5, 6, 7, 8, 9	5	
T3	s	Config 1,2,3, 4, 5, 6, 7, 8, 9	5	

Table A.6.5.4.1.1-3: NR Cell specific test parameters for NR standalone UE UL carrier RRC reconfiguration Delay on PCell (Cell 1)

Parameter	Unit	Test Configuration	Test 1			Test 2		
			T1	T2	T3	T1	T2	T3
Channel number		Conf 1, 2, 3, 4, 5, 6, 7, 8, 9	2			2		
TDD configuration		Conf 1, 2, 3	N/A			N/A		
		Conf 4, 5, 6	TDD Conf.1.1			TDD Conf.1.1		
		Conf 7, 8, 9	TDD Conf.2.1			TDD Conf.2.1		
BW _{channel}	MHz	Conf 1, 2, 3	10: N _{RB,c} = 52			10: N _{RB,c} = 52		
		Conf 4, 5, 6	10: N _{RB,c} = 52			10: N _{RB,c} = 52		
		Conf 7, 8, 9	40: N _{RB,c} = 106			40: N _{RB,c} = 106		
PDSCH reference measurement channel as defined in A.3.1.1		Conf 1, 2, 3	SR.1.1 FDD			SR.1.1 FDD		
		Conf 4, 5, 6	SR.1.1 TDD			SR.1.1 TDD		
		Conf 7, 8, 9	SR.2.1 TDD			SR.2.1 TDD		
RMSI CORESET reference measurement channel as defined in A.3.1.2		Conf 1, 2, 3	CR.1.1 FDD			CR.1.1 FDD		
		Conf 4, 5, 6	CR.1.1 TDD			CR.1.1 TDD		
		Conf 7, 8, 9	CR.2.1 TDD			CR.2.1 TDD		
RMC CORESET reference measurement channel as defined in A.3.1.3		Conf 1, 2, 3	CCR.1.1 FDD			CCR.1.1 FDD		
		Conf 4, 5, 6	CCR.1.1 TDD			CCR.1.1 TDD		
		Conf 7, 8, 9	CCR.2.1 TDD			CCR.2.1 TDD		
OCNG Pattern ^{Note 1}		Conf 1, 2, 3, 4, 5, 6, 7, 8, 9	OP.1			OP.1		
SSB configuration		Conf 1, 2, 3, 4, 5, 6	SSB.1 FR1			SSB.1 FR1		
		Conf 7, 8, 9	SSB.2 FR1			SSB.2 FR1		
SMTc configuration		Conf 1, 2, 3, 4, 5, 6, 7, 8, 9	SMTc.1			SMTc.1		
DL initial BWP configuration		Conf 1, 2, 3, 4, 5, 6, 7, 8, 9	DLBWP.0.1			DLBWP.0.1		

DL dedicated BWP configuration		Conf 1, 2, 3, 4, 5, 6, 7, 8, 9	DLBWP.1.1			DLBWP.1.1		
UL dedicated BWP configuration		Conf 1, 2, 3, 4, 5, 6, 7, 8, 9	ULBWP.1.1			ULBWP.1.1		
EPRE ratio of PSS to SSS	dB	Conf 1, 2, 3, 4, 5, 6, 7, 8, 9	0			0		
EPRE ratio of PBCH_DMRS to SSS								
EPRE ratio of PBCH to PBCH_DMRS								
EPRE ratio of PDCCH_DMRS to SSS								
EPRE ratio of PDCCH to PDCCH_DMRS								
EPRE ratio of PDSCH_DMRS to SSS								
EPRE ratio of PDSCH to PDSCH_DMRS								
EPRE ratio of OCNG DMRS to SSS								
EPRE ratio of OCNG to OCNG DMRS								
N_{oc} Note 2	dBm / 15kHz	Conf 1, 2, 3, 4, 5, 6, 7, 8, 9	-102			-102		
	dBm/SCS	Conf 1,2,3,4,5,6	-102			-102		
		Conf 7,8,9	-99			-99		
\hat{E}_s / N_{oc}	dB	Conf 1, 2, 3, 4, 5, 6, 7, 8, 9	16	16	16	16	16	16
\hat{E}_s / I_{ot} Note 3	dB	Conf 1, 2, 3, 4, 5, 6, 7, 8, 9	16	16	16	16	16	16
SS-RSRP Note 3	dBm/SCS	Conf 1,2,3,4,5,6	-86	-86	-86	-86	-86	-86
		Conf 7,8,9	-83	-83	-83	-83	-83	-83
I_o Note 3	dBm/9.36 MHz	Conf 1,2,3,4,5,6	-57.9	-57.9	-57.9	-57.9	-57.9	-57.9
	dBm/38.16 MHz	Conf 7,8,9	-51.8	-51.8	-51.8	-51.8	-51.8	-51.8
Propagation Condition		Conf 1, 2, 3, 4, 5, 6, 7, 8, 9	AWGN			AWGN		
Antenna configuration		Conf 1, 2, 3, 4, 5, 6, 7, 8, 9	1 x 2			1 x 2		
NOTE 1: OCNG shall be used such that both cells are fully allocated, and a constant total transmitted power spectral density is achieved for all OFDM symbols.								
NOTE 2: Interference from other cells and noise sources not specified in the test is assumed to be constant over subcarriers and time and shall be modelled as AWGN of appropriate power for N_{oc} to be fulfilled.								
NOTE 3: \hat{E}_s / I_{ot} , I_o , and SS-RSRP levels have been derived from other parameters for information purposes. They are not settable parameters themselves.								

Table A.6.5.4.1.1-4: NR Cell specific test parameters for NR standalone UE UL carrier RRC reconfiguration Delay on SCell (Cell 2)

Parameter	Unit	Test Configuration	Test 1			Test 2		
			T1	T2	T3	T1	T2	T3
Channel number		Conf 1, 2, 3, 4, 5, 6, 7, 8, 9	3			3		
TDD configuration		Conf 1, 4, 7	N/A			N/A		
		Conf 2, 5, 8	TDDConf.1.1			TDDConf.1.1		
		Conf 3, 6, 9	TDDConf.2.1			TDDConf.2.1		
BW _{channel}	MHz	Conf 1, 4, 7	10: N _{RB,c} = 52			10: N _{RB,c} = 52		
		Conf 2, 5, 8	10: N _{RB,c} = 52			10: N _{RB,c} = 52		
		Conf 3, 6, 9	40: N _{RB,c} = 106			40: N _{RB,c} = 106		
PUSCH parameters for NR UL carrier		Conf 1, 4, 7	[TBD]	[TBD]	[TBD]	N/A	[TBD]	N/A
		Conf 2, 5, 8	[TBD]	[TBD]	[TBD]	N/A	[TBD]	N/A
		Conf 3, 6, 9	[TBD]	[TBD]	[TBD]	N/A	[TBD]	N/A
PUCCH parameters For NR UL carrier		Conf 1, 4, 7	[TBD]	[TBD]	[TBD]	N/A	[TBD]	N/A
		Conf 2, 5, 8	[TBD]	[TBD]	[TBD]	N/A	[TBD]	N/A
		Conf 3, 6, 9	[TBD]	[TBD]	[TBD]	N/A	[TBD]	N/A
PUSCH parameters for supplementary UL		Conf 1, 4, 7	N/A	[TBD]	N/A	[TBD]	[TBD]	[TBD]
		Conf 2, 5, 8	N/A	[TBD]	N/A	[TBD]	[TBD]	[TBD]
		Conf 3, 6, 9	N/A	[TBD]	N/A	[TBD]	[TBD]	[TBD]
PUCCH parameters for supplementary UL		Conf 1, 4, 7	N/A	[TBD]	N/A	[TBD]	[TBD]	[TBD]
		Conf 2, 5, 8	N/A	[TBD]	N/A	[TBD]	[TBD]	[TBD]
		Conf 3, 6, 9	N/A	[TBD]	N/A	[TBD]	[TBD]	[TBD]
PDSCH reference measurement channel as defined in A.3.1.1		Conf 1, 4, 7	SR.1.1 FDD			SR.1.1 FDD		
		Conf 2, 5, 8	SR.1.1 TDD			SR.1.1 TDD		
		Conf 3, 6, 9	SR.2.1 TDD			SR.2.1 TDD		
RMSI CORESET reference measurement channel as defined in A.3.1.2		Conf 1, 4, 7	CR.1.1 FDD			CR.1.1 FDD		
		Conf 2, 5, 8	CR.1.1 TDD			CR.1.1 TDD		
		Conf 3, 6, 9	CR.2.1 TDD			CR.2.1 TDD		
RMC CORESET reference measurement channel as defined in A.3.1.3		Conf 1, 4, 7	CCR.1.1 FDD			CCR.1.1 FDD		
		Conf 2, 5, 8	CCR.1.1 TDD			CCR.1.1 TDD		
		Conf 3, 6, 9	CCR.2.1 TDD			CCR.2.1 TDD		
OCNG Pattern ^{Note 1}		Conf 1, 2, 3	OP.1			OP.1		
SSB configuration		Conf 1, 2, 4, 5, 7, 8	SSB.1 FR1			SSB.1 FR1		
		Conf 3, 6, 9	SSB.2 FR1			SSB.2 FR1		
SMTTC configuration		Conf 1, 2, 3, 4, 5, 6, 7, 8, 9	SMTTC.1			SMTTC.1		
DL initial BWP configuration		Conf 1, 2, 3, 4, 5, 6, 7, 8, 9	DLBWP.0.1			DLBWP.0.1		
DL dedicated BWP configuration		Conf 1, 2, 3, 4, 5, 6, 7, 8, 9	DLBWP.1.1			DLBWP.1.1		
UL dedicated BWP configuration		Conf 1, 2, 3, 4, 5, 6, 7, 8, 9	ULBWP.1.1			ULBWP.1.1		
EPRE ratio of PSS to SSS	dB	Conf 1, 2, 3, 4, 5, 6, 7, 8, 9	0			0		
EPRE ratio of PBCH_DMRS to SSS								
EPRE ratio of PBCH to PBCH_DMRS								

EPRE ratio of PDCCH_DMRS to SSS								
EPRE ratio of PDCCH to PDCCH_DMRS								
EPRE ratio of PDSCH_DMRS to SSS								
EPRE ratio of PDSCH to PDSCH_DMRS								
EPRE ratio of OCNG DMRS to SSS								
EPRE ratio of OCNG to OCNG DMRS								
N_{oc} Note 2	dBm / 15kHz	Conf 1, 2, 3, 4, 5, 6, 7, 8, 9	-102			-102		
	dBm/ SCS	Conf 1, 2, 4, 5, 7, 8	-102			-102		
		Conf 3, 6, 9	-99			-99		
\hat{E}_s / N_{oc}	dB	Conf 1, 2, 3, 4, 5, 6, 7, 8, 9	16	16	16	16	16	16
\hat{E}_s / I_{ot} Note 3	dB	Conf 1, 2, 3, 4, 5, 6, 7, 8, 9	16	16	16	16	16	16
SS-RSRP Note 3	dBm/ SCS	Conf 1, 2, 4, 5, 7, 8	-86	-86	-86	-86	-86	-86
		Conf 3, 6, 9	-83	-83	-83	-83	-83	-83
I_o Note 3	dBm/ 9.36 MHz	Conf 1, 2, 4, 5, 7, 8	-57.9	-57.9	-57.9	-57.9	-57.9	-57.9
	dBm/ 38.16 MHz	Conf 3, 6, 9	-51.8	-51.8	-51.8	-51.8	-51.8	-51.8
Propagation Condition		Conf 1, 2, 3, 4, 5, 6, 7, 8, 9	AWGN			AWGN		
Antenna configuration		Conf 1, 2, 3, 4, 5, 6, 7, 8, 9	1 x 2			1 x 2		
NOTE 1: OCNG shall be used such that both cells are fully allocated, and a constant total transmitted power spectral density is achieved for all OFDM symbols.								
NOTE 2: Interference from other cells and noise sources not specified in the test is assumed to be constant over subcarriers and time and shall be modelled as AWGN of appropriate power for N_{oc} to be fulfilled.								
NOTE 3: \hat{E}_s / I_{ot} , I_o , and SS-RSRP levels have been derived from other parameters for information purposes. They are not settable parameters themselves.								

A.6.5.4.1.2 Test Requirements

In test 1 the UE shall be ready to start transmission on the supplementary uplink carrier on SCell within [20]ms from the start of T2.

In test 1 the UE shall stop the transmission on the supplementary uplink carrier on SCell within [20]ms from the start of T3.

In test 2 the UE shall be ready to start transmission on the NR uplink carrier on SCell within [20]ms from the start of T2.

In test 2 the UE shall stop the transmission on the NR uplink carrier on SCell within [20]ms from the start of T3.

All of the above test requirements shall be fulfilled in order for the observed UE UL carrier configuration delay and UE UL carrier release delay to be counted as correct. The rate of correct observed UE UL carrier configuration delay and UE UL carrier release delay during repeated tests shall be at least 90%.

A.6.5.4.2 Test Requirements

In test 1 the UE shall be ready to start transmission on the supplementary uplink carrier on SCell within [20]ms from the start of T2.

In test 1 the UE shall stop the transmission on the supplementary uplink carrier on SCell within [20]ms from the start of T3.

In test 2 the UE shall be ready to start transmission on the NR uplink carrier on SCell within [20]ms from the start of T2.

In test 2 the UE shall stop the transmission on the NR uplink carrier on SCell within [20]ms from the start of T3.

All of the above test requirements shall be fulfilled in order for the observed UE UL carrier configuration delay and UE UL carrier release delay to be counted as correct. The rate of correct observed UE UL carrier configuration delay and UE UL carrier release delay during repeated tests shall be at least 90%.

A.6.5.5 Beam Failure Detection and Link recovery procedures

A.6.5.5.1 Beam Failure Detection and Link Recovery Test for FR1 PCell configured with SSB-based BFD and LR in non-DRX mode

Editor's note: It is open whether BFD can be based on SSB. This test case will be updated accordingly.

A.6.5.5.1.1 Test Purpose and Environment

The purpose of this test is to verify that the UE properly detects SSB-based beam failure in the set q_0 configured for a serving cell and that the UE performs correct SSB-based link recovery based on beam candidate set q_1 . The purpose is to test the downlink monitoring for beam failure detection within the UEs active DL BWP, during the evaluation period, and link recovery, when no DRX is used. This test will partly verify the SSB based beam failure detection and link recovery for an FR1 serving cell requirements in clause 8.5.

The test parameters are given in Tables A.6.5.5.1.1-1, A.6.5.5.1.1-2, A.6.5.5.1.1-3 and A.6.5.5.1.1-4 below. There is one cell, cell 1 which is the active cell, in the test. The test consists of five successive time periods, with time duration of T1, T2, T3, T4 and T5 respectively. Figure A.6.5.5.1.1-1 shows the variation of the downlink SNR of the SSB in set q_0 in the active cell to emulate SSB based beam failure. Figure A.6.5.5.1.1-1 additionally shows the variation of the downlink SNR of the SSB in set q_1 of the candidate beam used for link recovery. Prior to the start of the time duration T1, the UE shall be fully synchronized to cell 1. The UE shall be configured for periodic CSI reporting with a reporting periodicity of [2] ms. In the test, DRX configuration is not enabled. The UE is configured to perform inter-frequency measurements using GP ID #0 (40ms) in test 2.

Table A.6.5.5.1.1-1: Supported test configurations for FR1 PCell

Configuration	Description
1	FDD duplex mode, 15 kHz SSB SCS, 10MHz bandwidth
2	TDD duplex mode, 15 kHz SSB SCS, 10MHz bandwidth
3	TDD duplex mode, 30kHz SSB SCS, 40MHz bandwidth
Note:	The UE is only required to pass in one of the supported test configurations in FR1

Table A.6.5.5.1.1-2: General test parameters for FR1 PCell for SSB-based beam failure detection and link recovery testing in non-DRX mode

Parameter		Unit	Value		Comment
			Test 1	Test 2	
Active PCell			Cell 1	Cell 1	
RF Channel Number			1	1	
Duplex mode	Config 1		FDD	FDD	
	Config 2, 3		TDD	TDD	
TDD Configuration	Config 1		Not Applicable	Not Applicable	
	Config 2		[TDDConf.1.1]	[TDDConf.1.1]	
	Config 3		[TDDConf.1.2]	[TDDConf.1.2]	
CORESET Reference Channel	Config 1		[CR. 1.1 FDD]	[CR. 1.1 FDD]	
	Config 2		[CR. 1.1 TDD]	[CR. 1.1 TDD]	
	Config 3		[CR. 2.1 TDD]	[CR. 2.1 TDD]	
SSB Configuration	Config 1		TBD (Note: periodicity is 20ms)	TBD (Note: periodicity is 20ms)	
	Config 2		TBD (Note: periodicity is 20ms)	TBD (Note: periodicity is 20ms)	
	Config 3		TBD (Note: periodicity is 20ms)	TBD (Note: periodicity is 20ms)	
SMTC Configuration	Config 1, 2		FR1 pattern 1	FR1 pattern 1	
	Config 3		FR1 pattern 2	FR1 pattern 2	
PDSCH/PDCCH subcarrier spacing	Config 1, 2		15 KHz	15 KHz	
	Config 3		30 KHz	30 KHz	
csi-RS-Index assigned as RLM RS			[0]	[0]	
OCNG parameters			TBD	TBD	
CP length			Normal	Normal	
Correlation Matrix and Antenna Configuration			[2x2 Low]	[2x2 Low]	
Beam failure detection transmission parameters	DCI format		1-0	1-0	
	Number of Control OFDM symbols		2	2	
	Aggregation level	CC	8	8	
	Ratio of hypothetical PDCCH RE energy to average CSI-RS RE energy	dB	0	0	

	Ratio of hypothetical PDCCH DMRS energy to average CSI-RS RE energy	dB	0	0	
	DMRS precoder granularity		REG bundle size	REG bundle size	
	REG bundle size		6	6	
DRX			OFF	OFF	
Gap pattern ID			[N.A.]	*[gp0]	
ssb-Index			2	2	Number of SSB indexes used for beam failure detection
rInSyncOutOfSync Threshold			absent	absent	When the field is absent, the UE applies the value 0. (Table 8.1.1-1).
rsrp-ThresholdSSB			TBD	TBD	Threshold used for $Q_{out_LR_SSB}$
powerControlOffsetSS			NA	NA	Used for deriving rsrp-ThresholdCSI-RS
beamFailureInstanceMaxCount			n2	n2	see TS 38.321 [7], section 5.17
beamFailureDetectionTimer			pbfd4	pbfd4	see TS 38.321 [7], section 5.17
ZP CSI-RS configuration			TBD	TBD	
CSI-IM configuration			TBD	TBD	
Periodic CSI reporting			PUCCH	PUCCH	
CSI reporting periodicity	Config 1, 2	slot	[5]	[5]	
	Config 3		[10]	[10]	
T1		s	1	1	During this time the the UE shall be fully synchronized to cell 1
T2		s	0.4	0.4	
T3		s	[0.6]	[0.6]	
D1		s	[0.24]	[0.44]	
Note 1: UE-specific PDCCH is not transmitted after T1 starts.					

Table A.6.5.5.1.1-3: Cell specific test parameters for FR1 PCell for SSB-based beam failure detection and link recovery testing in non-DRX mode

Parameter	Unit	Test 1 and Test 2					Test 1 and Test 2					
		SSB of set q_0					SSB of set q_1					
		T1	T2	T3	T4	T5	T1	T2	T3	T4	T5	
PDCCH_beta	dB	4					4					
PDCCH_DMRS_beta	dB	4					4					
PBCH_beta	dB	0					0					
PSS_beta	dB											
SSS_beta	dB											
PDSCH_beta	dB											
OCNG_beta	dB											
SNR	Config 1	dB	TBD	TBD	TBD	TBD	TBD	TBD	TBD	TBD	TBD	
	Config 2		TBD	TBD	TBD	TBD	TBD	TBD	TBD	TBD	TBD	
	Config 3		TBD	TBD	TBD	TBD	TBD	TBD	TBD	TBD	TBD	
N_{oc}	Config 1	dBm/	[-98]					[-98]				
	Config 2	15K	[-98]					[-98]				
	Config 3	Hz	[-98]					[-98]				
Propagation condition		[TDL-C 300ns 100Hz]					[TDL-C 300ns 100Hz]					
Note 1:	OCNG shall be used such that the resources in Cell 1 are fully allocated and a constant total transmitted power spectral density is achieved for all OFDM symbols.											
Note 2:	The uplink resources for CSI reporting are assigned to the UE prior to the start of time period T1.											
Note 3:	NZP CSI-RS resource set configuration for CSI reporting are assigned to the UE prior to the start of time period T1.											
Note 4:	Measurement gap configuration is assigned to the UE prior to the start of time period T1.											
Note 5:	The timers and layer 3 filtering related parameters are configured prior to the start of time period T1.											
Note 6:	The signal contains PDCCH for UEs other than the device under test as part of OCNG.											
Note 7:	SNR levels correspond to the signal to noise ratio over the SSS REs.											
Note 8:	The SNR in time periods T1, T2, T3, T4 and T5 is denoted as SNR1, SNR2 and SNR3 respectively in figure A.6.5.5.1.1-1.											
Note 9:	The SNR values are specified for testing a UE which supports 2RX on at least one band. For testing of a UE which supports 4RX on all bands, the SNR during T3 is [A.3.6].											

Table A.6.5.5.1.1-4: Measurement gap configuration for FR1 PCell for SSB-based beam failure detection and link recovery testing in non-DRX mode

Field	Test 2
	Value
gapOffset	[0]

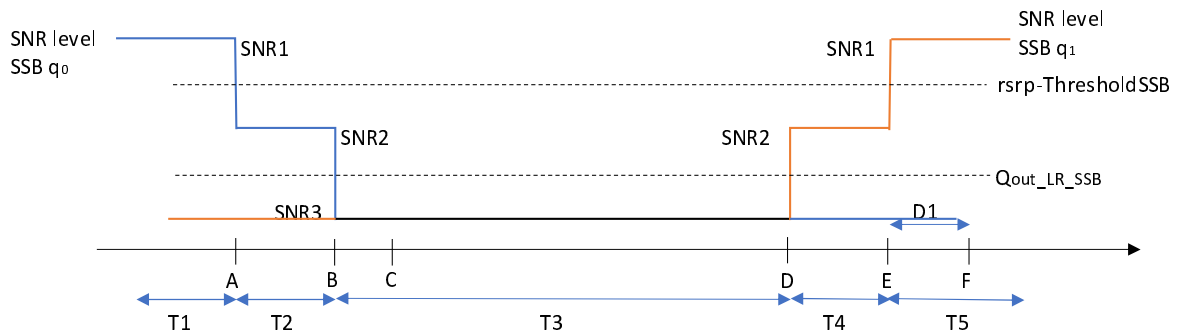

Figure A.6.5.5.1.1-1: SNR variation SSB for SSB-based beam failure detection and link recovery testing in non-DRX mode

A.6.5.5.1.2 Test Requirements

The UE behaviour during time durations T1, T2, T3, T4 and T5 shall be as follows:

During the time duration T1 and T2, the UE shall transmit uplink signal at least in all subframes configured for CSI transmission on Cell 1.

During the period from time point A to time point B the UE shall transmit uplink signal in Cell 1 in all uplink slots configured for CSI transmission according to the configured periodic CSI reporting for Cell 1.

During T3 the UE shall detect beam failure and initiate link recovery. During T4 and T5 the UE measures and evaluates beam candidate from beam candidate set q_1 .

No later than time point F occurring no later than $D1 = [\text{TBD}]$ ms after the start of T5, the UE shall transmit preamble on a beam associated with the candidate beam set q_1 .

Test is concluded once the test equipment has received the initial preamble transmission from the UE. The rate of correct events observed during repeated tests shall be at least 90%.

A.6.5.5.2 Beam Failure Detection and Link Recovery Test for FR1 PCell configured with SSB-based BFD and LR in DRX mode

Editor's note: It is open whether BFD can be based on SSB. This test case will be updated accordingly.

A.6.5.5.2.1 Test Purpose and Environment

The purpose of this test is to verify that the UE properly detects SSB-based beam failure in the set q_0 configured for a serving cell and that the UE performs correct SSB-based link recovery based on beam candidate set q_1 . The purpose is to test the downlink monitoring for beam failure detection within the UE's active DL BWP, during the evaluation period, and link recovery, when DRX is used. This test will partly verify the SSB based beam failure detection and link recovery for an FR1 serving cell requirements in clause 8.5.

The test parameters are given in Tables A.6.5.5.2.1-1, A.6.5.5.2.1-2, A.6.5.5.2.1-3, A.6.5.5.2.1-4 and A.6.5.5.2.1-5 below. There is one cell, cell 1 which is the active cell, in the test. The test consists of five successive time periods, with time duration of T1, T2, T3, T4 and T5 respectively. Figure A.6.5.5.2.1-1 shows the variation of the downlink SNR of the SSB in set q_0 in the active cell to emulate SSB based beam failure. Figure A.6.5.5.2.1-1 additionally shows the variation of the downlink SNR of the SSB in set q_1 of the candidate beam used for link recovery. Prior to the start of the time duration T1, the UE shall be fully synchronized to cell 1. The UE shall be configured for periodic CSI reporting with a reporting periodicity of [2] ms. In the test, DRX configuration is enabled in PCell and DRX inactivity timer has already expired, i.e. UE tries to decode PDCCH and to send periodic CQI during the period when On-duration timer is running. Time alignment timers shall be set to "infinity" so that UL timing

alignment is maintained during the test. The UE is configured to perform inter-frequency measurements using GP ID #0 (40ms) in test 2.

Table A.6.5.5.2.1-1: Supported test configurations for FR1 PCell

Configuration	Description
1	FDD duplex mode, 15 kHz SSB SCS, 10MHz bandwidth
2	TDD duplex mode, 15 kHz SSB SCS, 10MHz bandwidth
3	TDD duplex mode, 30kHz SSB SCS, 40MHz bandwidth
Note: The UE is only required to pass in one of the supported test configurations in FR1	

Table A.6.5.5.2.1-2: General test parameters for FR1 PCell for SSB-based beam failure detection and link recovery testing in DRX mode

Parameter	Unit	Value		Comment
		Test 1	Test 2	
Active PCell		Cell 1	Cell 1	
RF Channel Number		1	1	
Duplex mode	Config 1	FDD	FDD	
	Config 2, 3	TDD	TDD	
TDD Configuration	Config 1	Not Applicable	Not Applicable	
	Config 2	[TDDConf.1.1]	[TDDConf.1.1]	
	Config 3	[TDDConf.1.2]	[TDDConf.1.2]	
CORESET Reference Channel	Config 1	[CR. 1.1 FDD]	[CR. 1.1 FDD]	
	Config 2	[CR. 1.1 TDD]	[CR. 1.1 TDD]	
	Config 3	[CR. 2.1 TDD]	[CR. 2.1 TDD]	
SSB Configuration	Config 1	TBD (Note: periodicity is 20ms)	TBD (Note: periodicity is 20ms)	
	Config 2	TBD (Note: periodicity is 20ms)	TBD (Note: periodicity is 20ms)	
	Config 3	TBD (Note: periodicity is 20ms)	TBD (Note: periodicity is 20ms)	
SMTC Configuration	Config 1, 2	FR1 pattern 1	FR1 pattern 1	
	Config 3	FR1 pattern 2	FR1 pattern 2	
PDSCH/PDCCH subcarrier spacing	Config 1, 2	15 KHz	15 KHz	
	Config 3	30 KHz	30 KHz	
csi-RS-Index assigned as RLM RS		[0]	[0]	
OCNG parameters		TBD	TBD	
CP length		Normal	Normal	
Correlation Matrix and Antenna Configuration		[2x2 Low]	[2x2 Low]	
	DCI format	1-0	1-0	

Beam failure detection transmission parameters	Number of Control OFDM symbols		2	2	
	Aggregation level	CC E	8	8	
	Ratio of hypothetical PDCCH RE energy to average CSI-RS RE energy	dB	0	0	
	Ratio of hypothetical PDCCH DMRS energy to average CSI-RS RE energy	dB	0	0	
	DMRS precoder granularity		REG bundle size	REG bundle size	
	REG bundle size		6	6	
DRX			640	640	
Gap pattern ID			[N.A.]	*[gp0]	
ssb-Index			2	2	Number of SSB indexes used for beam failure detection
rlmInSyncOutOfSync Threshold			absent	absent	When the field is absent, the UE applies the value 0. (Table 8.1.1-1).
rsrp-ThresholdSSB			TBD	TBD	Threshold used for $Q_{out_LR_SSB}$
powerControlOffsetSS			NA	NA	Used for deriving rsrp-ThresholdCSI-RS
beamFailureInstanceMaxCount			[n2]	[n2]	see TS 38.321 [7], section 5.17
beamFailureDetectionTimer			[pbfd4]	[pbfd4]	see TS 38.321 [7], section 5.17
ZP CSI-RS configuration			TBD	TBD	
CSI-IM configuration			TBD	TBD	
Periodic CSI reporting			PUCCH	PUCCH	
CSI reporting periodicity	Config 1, 2	slot	[5]	[5]	
	Config 3		[10]	[10]	
T1		s	1	1	During this time the the UE shall be fully synchronized to cell 1
T2		s	0.4	0.4	
T3		s	[0.6]	[0.6]	
D1		s	[0.24]	[0.44]	

Note 1: UE-specific PDCCH is not transmitted after T1 starts.

Table A.6.5.5.2.1-3: Cell specific test parameters for FR1 PCell for SSB-based beam failure detection and link recovery testing in DRX mode

Parameter	Unit	Test 1 and Test 2					Test 1 and Test 2					
		SSB of set q_0					SSB of set q_1					
		T1	T2	T3	T4	T5	T1	T2	T3	T4	T5	
PDCCH_beta	dB	4					4					
PDCCH_DMRS_beta	dB	4					4					
PBCH_beta	dB	0					0					
PSS_beta	dB											
SSS_beta	dB											
PDSCH_beta	dB											
OCNG_beta	dB											
SNR	Config 1	dB	TBD	TBD	TBD	TBD	TBD	TBD	TBD	TBD	TBD	
	Config 2		TBD	TBD	TBD	TBD	TBD	TBD	TBD	TBD	TBD	
	Config 3		TBD	TBD	TBD	TBD	TBD	TBD	TBD	TBD	TBD	
N_{oc}	Config 1	dBm/	[-98]					[-98]				
	Config 2	15K	[-98]					[-98]				
	Config 3	Hz	[-98]					[-98]				
Propagation condition		[TDL-C 300ns 100Hz]					[TDL-C 300ns 100Hz]					
<p>Note 1: OCNG shall be used such that the resources in Cell 1 are fully allocated and a constant total transmitted power spectral density is achieved for all OFDM symbols.</p> <p>Note 2: The uplink resources for CSI reporting are assigned to the UE prior to the start of time period T1.</p> <p>Note 3: NZP CSI-RS resource set configuration for CSI reporting are assigned to the UE prior to the start of time period T1.</p> <p>Note 4: Measurement gap configuration is assigned to the UE prior to the start of time period T1.</p> <p>Note 5: The timers and layer 3 filtering related parameters are configured prior to the start of time period T1.</p> <p>Note 6: The signal contains PDCCH for UEs other than the device under test as part of OCNG.</p> <p>Note 7: SNR levels correspond to the signal to noise ratio over the SSS REs.</p> <p>Note 8: The SNR in time periods T1, T2, T3, T4 and T5 is denoted as SNR1, SNR2 and SNR3 respectively in figure A.6.5.5.2.1-1.</p> <p>Note 9: The SNR values are specified for testing a UE which supports 2RX on at least one band. For testing of a UE which supports 4RX on all bands, the SNR during T3 is [A.3.6].</p>												

Table A.6.5.5.2.1-4: Measurement gap configuration for FR1 PCell for SSB-based beam failure detection and link recovery testing in DRX mode

Field	Test 2
	Value
gapOffset	[0]

Table A.6.5.5.2.1-5: DRX-Configuration for FR1 PCell for SSB-based beam failure detection and link recovery testing in DRX mode.

Field	Test 5	Test 6
	Value	Value
drx-onDurationTimer	[ms6]	[ms6]
drx-InactivityTimer	[ms1]	[ms1]
drx-RetransmissionTimerDL	[sl1]	[sl1]
drx-RetransmissionTimerUL	[sl1]	[sl1]
longDRX-CycleStartOffset	[ms640]	[ms40]
shortDRX	disable	disable

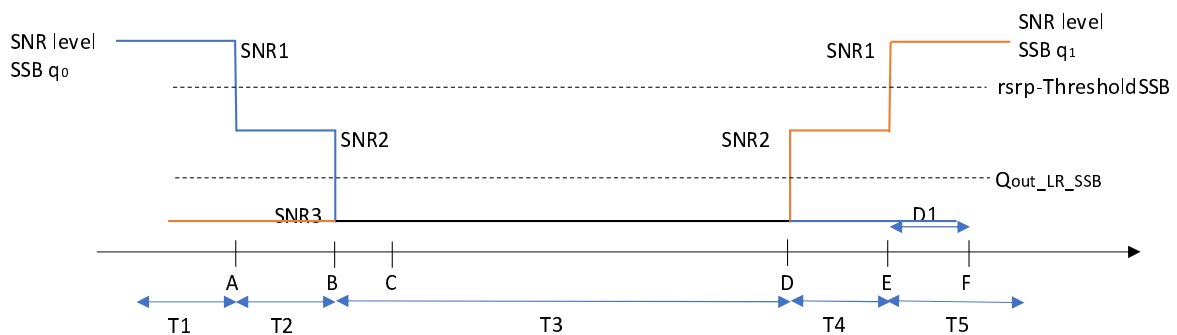

Figure A.6.5.5.2.1-1: SNR variation for SSB-based beam failure detection and link recovery testing in non-DRX mode

A.6.5.5.2.2 Test Requirements

The UE behaviour during time durations T1, T2, T3, T4 and T5 shall be as follows:

During the time duration T1 and T2, the UE shall transmit uplink signal at least in all subframes configured for CSI transmission on Cell 1.

During the period from time point A to time point B the UE shall transmit uplink signal in Cell 1 in all uplink slots configured for CSI transmission according to the configured periodic CSI reporting for Cell 1.

During T3 the UE shall detect beam failure and initiate link recovery. During T4 and T5 the UE measures and evaluates beam candidate from beam candidate set q_1 .

No later than time point F occurring no later than $D1 = [\text{TBD}]$ ms after the start of T5, the UE shall transmit preamble on a beam associated with the candidate beam set q_1 .

Test is concluded once the test equipment has received the initial preamble transmission from the UE. The rate of correct events observed during repeated tests shall be at least 90%.

A.6.5.5.3 Beam Failure Detection and Link Recovery Test for FR1 PCell configured with CSI-RS-based BFD and LR in non-DRX mode

A.6.5.5.3.1 Test Purpose and Environment

The purpose of this test is to verify that the UE properly detects CSI-RS-based beam failure in the set q_0 configured for a serving cell and that the UE performs correct CSI-RS-based link recovery based on beam candidate set q_1 . The

purpose is to test the downlink monitoring for beam failure detection within the UEs active DL BWP, during the evaluation period, and link recovery, when no DRX is used. This test will partly verify the CSI-RS based beam failure detection and link recovery for an FR1 serving cell requirements in clause 8.5.

The test parameters are given in Tables A.6.5.5.3.1-1, A.6.5.5.3.1-2, A.6.5.5.3.1-3, A.6.5.5.3.1-4 and A.6.5.5.3.1-5 below. There is one cell, cell 1 which is the active cell, in the test. The test consists of five successive time periods, with time duration of T1, T2, T3, T4 and T5 respectively. Figure A.6.5.5.3.1-1 shows the variation of the downlink SNR of the CSI-RS in set q_0 in the active cell to emulate CSI-RS based beam failure. Figure A.6.5.5.3.1-1 additionally shows the variation of the downlink SNR of the CSI-RS in set q_1 of the candidate beam used for link recovery. Prior to the start of the time duration T1, the UE shall be fully synchronized to cell 1. The UE shall be configured for periodic CSI reporting with a reporting periodicity of [2] ms. In the test, DRX configuration is not enabled. The UE is configured to perform inter-frequency measurements using GP ID #0 (40ms) in test 2.

Table A.6.5.5.3.1-1: Supported test configurations for FR1 PCell

Configuration	Description
1	FDD duplex mode, 15 kHz SSB SCS, 10MHz bandwidth
2	TDD duplex mode, 15 kHz SSB SCS, 10MHz bandwidth
3	FDD duplex mode, 30kHz SSB SCS, 40MHz bandwidth
4	TDD duplex mode, 30kHz SSB SCS, 40MHz bandwidth

Note: The UE is only required to pass in one of the supported test configurations in FR1

Table A.6.5.5.3.1-2: General test parameters for FR1 PCell for CSI-RS-based beam failure detection and link recovery testing in non-DRX mode

Parameter	Unit	Value		Comment
		Test 1	Test 2	
Active PCell		Cell 1	Cell 1	
RF Channel Number		1	1	
Duplex mode	Config 1, 3	FDD	FDD	
	Config 2, 4	TDD	TDD	
TDD Configuration	Config 1, 3	Not Applicable	Not Applicable	
	Config 2	[TDDConf.1.1]	[TDDConf.1.1]	
	Config 4	[TDDConf.1.2]	[TDDConf.1.2]	
CORESET Reference Channel	Config 1	[CR. 1.1 FDD]	[CR. 1.1 FDD]	A.3.1.2
	Config 2	[CR. 1.1 TDD]	[CR. 1.1 TDD]	
	Config 3	[CR. 2.1 FDD]	[CR. 2.1 FDD]	
	Config 4	[CR. 2.1 TDD]	[CR. 2.1 TDD]	
SSB Configuration	Config 1	SSB.1 FR1	SSB.1 FR1	A.3.10
	Config 2	SSB.1 FR1	SSB.1 FR1	
	Config 3	SSB.2 FR1	SSB.2 FR1	
	Config 4	SSB.2 FR1	SSB.2 FR1	
SMTC Configuration	Config 1, 2	FR1 pattern 1	FR1 pattern 1	A.3.11
	Config 3, 4	FR1 pattern 2	FR1 pattern 2	
PDSCH/PDCCH subcarrier spacing	Config 1, 2	15 KHz	15 KHz	
	Config 3, 4	30 KHz	30 KHz	

csi-RS-Index assigned as beam failure RS			[0]	[0]	
OCNG parameters			TBD	TBD	A.3.2.1
CP length			Normal	Normal	
Correlation Matrix and Antenna Configuration			[2x2 Low]	[2x2 Low]	
Beam failure detection transmission parameters	DCI format		1-0	1-0	
	Number of Control OFDM symbols		2	2	
	Aggregation level	CC E	8	8	
	Ratio of hypothetical PDCCH RE energy to average CSI-RS RE energy	dB	0	0	
	Ratio of hypothetical PDCCH DMRS energy to average CSI-RS RE energy	dB	0	0	
	DMRS precoder granularity		REG bundle size	REG bundle size	
	REG bundle size		6	6	
DRX			OFF	OFF	
Gap pattern ID			[N.A.]	*[gp0]	
csi-RS-Index			2	2	Number of SSB indexes used for beam failure detection
rlmInSyncOutOfSync Threshold			absent	absent	When the field is absent, the UE applies the value 0. (Table 8.1.1-1).
rsrp-ThresholdSSB			TBD	TBD	Threshold used for $Q_{out_LR_SSB}$
powerControlOffsetSS			db0	db0	Used for deriving rsrp-ThresholdCSI-RS
beamFailureInstanceMaxCount			n2	n2	see TS 38.321 [7], section 5.17
beamFailureDetectionTimer			pbfd4	pbfd4	see TS 38.321 [7], section 5.17
NZP CSI-RS configuration			[ResourceId 1]	[ResourceId 0]	
ZP CSI-RS configuration			TBD	TBD	
Periodic CSI reporting			PUCCH	PUCCH	

CSI reporting periodicity	Config 1, 2	slot	[5]	[5]	
	Config 3		[10]	[10]	
T1		s	1	1	During this time the the UE shall be fully synchronized to cell 1
T2		s	0.4	0.4	
T3		s	[TBD]	[TBD]	
D1		s	[0.24]	[0.44]	
Note 1: UE-specific PDCCH is not transmitted after T1 starts.					

Table A.6.5.5.3.1-3: Cell specific test parameters for FR1 PCell for CSI-RS-based beam failure detection and link recovery testing in non-DRX mode

Parameter	Unit	Test 1 and Test 2					Test 1 and Test 2					
		CSI-RS of set q ₀					CSI-RS of set q ₁					
		T1	T2	T3	T4	T5	T1	T2	T3	T4	T5	
EPRE ratio of PSS to SSS	dB	0					0					
EPRE ratio of PBCH DMRS to SSS	dB											
EPRE ratio of PBCH to PBCH DMRS	dB											
EPRE ratio of PDCCH DMRS to SSS	dB											
EPRE ratio of PDCCH to PDCCH DMRS	dB											
EPRE ratio of PDSCH DMRS to SSS	dB											
EPRE ratio of PDSCH to PDSCH DMRS	dB											
EPRE ratio of OCNG DMRS to SSS(Note 1)	dB											
EPRE ratio of OCNG to OCNG DMRS (Note 1)	dB											
SNR_C SI-RS	Config 1	dB	TBD	TBD	TBD	TBD	TBD	TBD	TBD	TBD	TBD	
	Config 2		TBD	TBD	TBD	TBD	TBD	TBD	TBD	TBD	TBD	
	Config 3		TBD	TBD	TBD	TBD	TBD	TBD	TBD	TBD	TBD	
N _{oc}	Config 1	dBm/	[-98]					[-98]				
	Config 2	15K	[-98]					[-98]				
	Config 3	Hz	[-98]					[-98]				
SS-RSRP Note 3		dBm /SC S										
Ês/lot												
Ês/Noc												
lo	config 1, 2	dBm/										
		9.36 MHz										

	Config 3, 4	dBm/38.1 MHz		
Propagation condition			[TDLC300]	[TDLC300]
Note 1:	OCNG shall be used such that the resources in Cell 1 are fully allocated and a constant total transmitted power spectral density is achieved for all OFDM symbols.			
Note 2:	SS-RSRP and I_0 levels have been derived from other parameters for information purposes. They are not settable parameters themselves.			

Table A.6.5.5.3.1-4: Measurement gap configuration for FR1 PCell for CSI-RS-based beam failure detection and link recovery testing in non-DRX mode

Field	Test 2
	Value
gapOffset	[0]

Table A.6.5.5.3.1-5: NZP-CSI-RS resource configuration for FR1 PCell for CSI-RS-based beam failure detection and link recovery testing in non-DRX mode

Field	ResourceId 0	ResourceId 1
	Value	Value
frequencyDomainAllocation ^{Note 1}	row1	row2
startingRB	0	0
nrofRBs	Note 2	Note 2
Note 1: TS 38.211 [6] table 7.4.1.5.3-1 Note 2: nrofRBs is derived based on the Configuration in Table A.4.5.1.7.1-1		

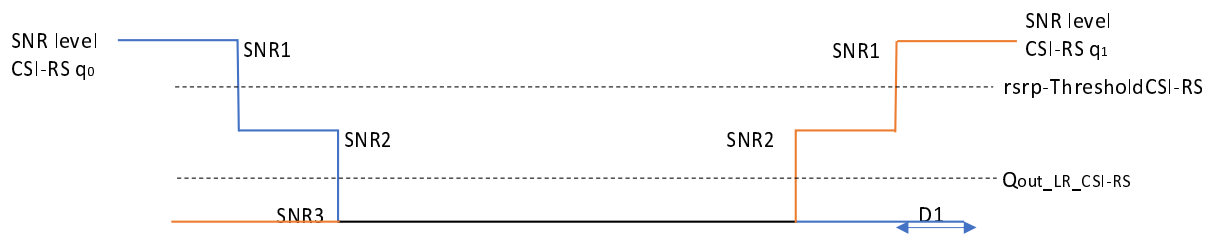

Figure A.6.5.5.3.1-1: SNR variation SSB for CSI-rs-based beam failure detection and link recovery testing in non-DRX mode

A.6.5.5.3.2 Test Requirements

The UE behaviour during time durations T1, T2, T3, T4 and T5 shall be as follows:

During the time duration T1 and T2, the UE shall transmit uplink signal at least in all subframes configured for CSI transmission on Cell 1.

During the period from time point A to time point B the UE shall transmit uplink signal in Cell 1 in all uplink slots configured for CSI transmission according to the configured periodic CSI reporting for Cell 1.

During T3 the shall detect beam failure and initiate link recovery. During T4 and T5 the UE measures and evaluate beam candidate from beam candidate set q_1 .

No later than time point F occurring no later than $D1 = [TBD]$ ms after the start of T5, the UE shall transmit preamble on a beam associated with the candidate beam set q_1 .

Test is concluded once the test equipment has received the initial preamble transmission from the UE. The rate of correct events observed during repeated tests shall be at least 90%.

A.6.5.5.4 Beam Failure Detection and Link Recovery Test for FR1 PCell configured with CSI-RS-based BFD and LR in DRX mode

A.6.5.5.4.1 Test Purpose and Environment

The purpose of this test is to verify that the UE properly detects CSI-RS-based beam failure in the set q_0 configured for a serving cell and that the UE performs correct CSI-RS-based link recovery based on beam candidate set q_1 . The purpose is to test the downlink monitoring for beam failure detection within the UEs active DL BWP, during the evaluation period, and link recovery, when DRX is used. This test will partly verify the CSI-RS based beam failure detection and link recovery for an FR1 serving cell requirements in clause 8.5.

The test parameters are given in Tables A.6.5.5.4.1-1, A.6.5.5.4.1-2, A.6.5.5.4.1-3, A.6.5.5.4.1-4, A.6.5.5.4.1-5 and A.x.x.1.4.1-6 below. There is one cell, cell 1 which is the active cell, in the test. The test consists of five successive time periods, with time duration of T1, T2, T3, T4 and T5 respectively. Figure A.6.5.5.4.1-1 shows the variation of the downlink SNR of the CSI-RS in set q_0 in the active cell to emulate CSI-RS based beam failure. Figure A.6.5.5.4.1-1 additionally shows the variation of the downlink SNR of the CSI-RS in set q_1 of the candidate beam used for link recovery. Prior to the start of the time duration T1, the UE shall be fully synchronized to cell 1. The UE shall be configured for periodic CSI reporting with a reporting periodicity of [2] ms. In the test, DRX configuration is enabled in PCell and DRX inactivity timer has already been expired, i.e. UE tries to decode PDCCH and to send periodic CQI during the period when On-duration timer is running. Time alignment timers shall be set to "infinity" so that UL timing alignment is maintained during the test. The UE is configured to perform inter-frequency measurements using GP ID #0 (40ms) in test 2.

Table A.6.5.5.4.1-1: Supported test configurations for FR1 PCell

Configuration	Description
1	FDD duplex mode, 15 kHz SSB SCS, 10MHz bandwidth
2	TDD duplex mode, 15 kHz SSB SCS, 10MHz bandwidth
3	FDD duplex mode, 30kHz SSB SCS, 40MHz bandwidth
4	TDD duplex mode, 30kHz SSB SCS, 40MHz bandwidth
Note:	The UE is only required to pass in one of the supported test configurations in FR1

Table A.6.5.5.4.1-2: General test parameters for FR1 PCell for CSI-RS-based beam failure detection and link recovery testing in DRX mode

Parameter		Unit	Value		Comment
			Test 1	Test 2	
Active PCell			Cell 1	Cell 1	
RF Channel Number			1	1	
Duplex mode	Config 1, 3		FDD	FDD	
	Config 2, 4		TDD	TDD	
TDD Configuration	Config 1, 3		Not Applicable	Not Applicable	
	Config 2		[TDDConf.1.1]	[TDDConf.1.1]	

CORESET Reference Channel	Config 3		[TDDConf.1.2]	[TDDConf.1.2]	
	Config 1		[CR. 1.1 FDD]	[CR. 1.1 FDD]	A.3.1.2
	Config 2		[CR. 1.1 TDD]	[CR. 1.1 TDD]	
	Config 3		[CR. 2.1 FDD]	[CR. 2.1 FDD]	
SSB Configuration	Config 4		[CR. 2.1 TDD]	[CR. 2.1 TDD]	
	Config 1		SSB.1 FR1	SSB.1 FR1	A.3.10
	Config 2		SSB.1 FR1	SSB.1 FR1	
	Config 3		SSB.2 FR1	SSB.2 FR1	A.3.11
SMT-Configuration	Config 4		SSB.2 FR1	SSB.2 FR1	
	Config 1, 2		FR1 pattern 1	FR1 pattern 1	
PDSCH/PDCCH subcarrier spacing	Config 3, 4		FR1 pattern 2	FR1 pattern 2	
	Config 1, 2		15 KHz	15 KHz	
csi-RS-Index assigned as Beam Failure RS	Config 3, 4		30 KHz	30 KHz	
			[0]	[0]	
OCNG parameters			TBD	TBD	A.3.2.1
CP length			Normal	Normal	
Correlation Matrix and Antenna Configuration			[2x2 Low]	[2x2 Low]	
Beam failure detection transmission parameters	DCI format		1-0	1-0	
	Number of Control OFDM symbols		2	2	
	Aggregation level	CC	8	8	
	Ratio of hypothetical PDCCH RE energy to average CSI-RS RE energy	dB	0	0	
	Ratio of hypothetical PDCCH DMRS energy to average CSI-RS RE energy	dB	0	0	
	DMRS precoder granularity		REG bundle size	REG bundle size	
	REG bundle size		6	6	
DRX			640	640	
Gap pattern ID			[N.A.]	*[gp0]	
csi-RS-Index			2	2	Number of SSB indexes used for beam failure detection

rInSyncOutOfSyncThreshold			absent	absent	When the field is absent, the UE applies the value 0. (Table 8.1.1-1).
rsrp-ThresholdSSB			TBD	TBD	Threshold used for $Q_{out_LR_SSB}$
powerControlOffsetSS			db0	db0	Used for deriving rsrp-ThresholdCSI-RS
beamFailureInstanceMaxCount			[n2]	[n2]	see TS 38.321 [7], section 5.17
beamFailureDetectionTimer			[pbfd4]	[pbfd4]	see TS 38.321 [7], section 5.17
NZP CSI-RS configuration			[ResourceId 1]	[ResourceId 0]	
ZP CSI-RS configuration			TBD	TBD	
Periodic CSI reporting			PUCCH	PUCCH	
CSI reporting periodicity	Config 1, 2	slot	[5]	[5]	
	Config 3		[10]	[10]	
T1		s	1	1	During this time the the UE shall be fully synchronized to cell 1
T2		s	0.4	0.4	
T3		s	[TBD]	[TBD]	
D1		s	[0.24]	[0.44]	
Note 1: UE-specific PDCCH is not transmitted after T1 starts.					

Table A.6.5.4.1-3: Cell specific test parameters for FR1 PCell for CSI-RS-based beam failure detection and link recovery testing in DRX mode

Parameter	Unit	Test 1 and Test 2					Test 1 and Test 2					
		CSI-RS of set q_0					CSI-RS of set q_1					
		T1	T2	T3	T4	T5	T1	T2	T3	T4	T5	
EPRE ratio of PSS to SSS	dB	0					0					
EPRE ratio of PBCH DMRS to SSS	dB											
EPRE ratio of PBCH to PBCH DMRS	dB											
EPRE ratio of PDCCH DMRS to SSS	dB											
EPRE ratio of PDCCH to PDCCH DMRS	dB											
EPRE ratio of PDSCH DMRS to SSS	dB											
EPRE ratio of PDSCH to PDSCH DMRS	dB											
EPRE ratio of OCNG DMRS to SSS ^(Note 1)	dB											
EPRE ratio of OCNG to OCNG DMRS ^(Note 1)	dB											
SNR _C SI-RS	Config 1	dB	TBD	TBD	TBD	TBD	TBD	TBD	TBD	TBD	TBD	
	Config 2		TBD	TBD	TBD	TBD	TBD	TBD	TBD	TBD	TBD	
	Config 3		TBD	TBD	TBD	TBD	TBD	TBD	TBD	TBD	TBD	
N_{oc}	Config 1	dBm/	[-98]					[-98]				
	Config 2	15K	[-98]					[-98]				
	Config 3	Hz	[-98]					[-98]				
SS-RSRP ^{Note 3}		dBm /SC S										
\hat{E}_s/I_{ot}												
\hat{E}_s/N_{oc}												
I _o	config 1, 2	dBm/										
	Config 3, 4	9.36 MHz dBm/ 38.1 MHz										
Propagation condition			[TDLC300]					[TDLC300]				
Note 1:	OCNG shall be used such that the resources in Cell 1 are fully allocated and a constant total transmitted power spectral density is achieved for all OFDM symbols.											
Note 2:	SS-RSRP and I _o levels have been derived from other parameters for information purposes. They are not settable parameters themselves.											

Table A.6.5.5.4.1-4: Measurement gap configuration for FR1 PCell for CSI-RS-based beam failure detection and link recovery testing in DRX mode

Field	Test 2
	Value
gapOffset	[0]

Table A.6.5.5.4.1-5: NZP-CSI-RS resource configuration for FR1 PCell for CSI-RS-based beam failure detection and link recovery testing in DRX mode

Field	ResourceId 0	ResourceId 1
	Value	Value
frequencyDomainAllocation ^{Note 1}	row1	row2
startingRB	0	0
nrofRBs	Note 2	Note 2
Note 1: TS 38.211 [6] table 7.4.1.5.3-1 Note 2: nrofRBs is derived based on the Configuration in Table A.4.5.1.7.1-1		

Table A.6.5.5.4.1-6: DRX-Configuration for FR1 PCell for SSB-based beam failure detection and link recovery testing in DRX mode.

Field	Test 5	Test 6
	Value	Value
drx-onDurationTimer	[ms6]	[ms6]
drx-InactivityTimer	[ms1]	[ms1]
drx-RetransmissionTimerDL	[sl1]	[sl1]
drx-RetransmissionTimerUL	[sl1]	[sl1]
longDRX-CycleStartOffset	[ms640]	[ms40]
shortDRX	disable	disable

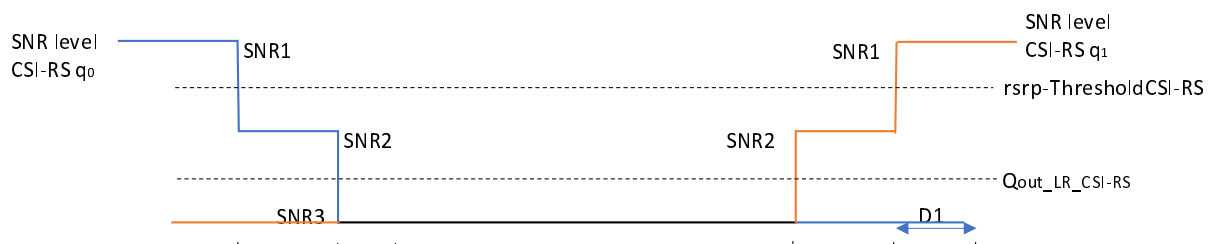

Figure A.6.5.5.4.1-1: SNR variation SSB for CSI-rs-based beam failure detection and link recovery testing in DRX mode

A.6.5.5.4.2 Test Requirements

The UE behaviour during time durations T1, T2, T3, T4 and T5 shall be as follows:

During the time duration T1 and T2, the UE shall transmit uplink signal at least in all subframes configured for CSI transmission on Cell 1.

During the period from time point A to time point B the UE shall transmit uplink signal in Cell 1 in all uplink slots configured for CSI transmission according to the configured periodic CSI reporting for Cell 1.

During T3 the shall detect beam failure and initiate link recovery. During T4 and T5 the UE measures and evaluate beam candidate from beam candidate set q_1 .

No later than time point F occurring no later than $D1 = [\text{TBD}]$ ms after the start of T5, the UE shall transmit preamble on a beam associated with the candidate beam set q_1 .

Test is concluded once the test equipment has received the initial preamble transmission from the UE. The rate of correct events observed during repeated tests shall be at least 90%.

A.6.5.6 Active BWP switch delay

A.6.5.6.1 DCI-based and Timer-based Active BWP Switch

A.6.5.6.1.1 NR FR1- NR FR1 DL active BWP switch of PCell with non-DRX in SA

A.6.5.6.1.1.1 Test Purpose and Environment

The purpose of this test is to verify the DL BWP switch delay requirement defined in section 8.6, and interruption requirement on other active serving cell defined in section 8.2.2.2.5.

The supported test configurations are shown in Table A.6.5.6.1.1.1-1 below. The test scenario comprises of one NR PCell (Cell 1) and one NR SCell (Cell 2) as given in Table A.6.5.6.1.1.1-2. NR Cell-specific parameters is specified in Table A.6.5.6.1.1.1-3 below.

PDCCHs indicating new transmissions shall be sent continuously on PCell (Cell 1) to ensure that the UE would have ACK/NACK sending except for the time duration when BWP is switching on Cell 1 and the time duration of T2.

PDCCHs indicating new transmissions shall be sent continuously on SCell (Cell 2) to ensure that the UE will have ACK/NACK sending.

Before the test starts,

- UE is connected to Cell 1 (PCell) on radio channel 1 (PCC), and Cell 2 (SCell) on radio channel 2 (SCC).
- UE is configured with 2 different UE-specific bandwidth parts for PCell, BWP-1 and BWP-2, in Cell 1 before starting the test. BWP-1 and BWP-2 always include bandwidth of the initial DL BWP and SSB.
- UE is indicated in *firstActiveDownlinkBWP-Id* that the active DL BWP is BWP-1 in PCell.
- UE is configured with a *bwp-InactivityTimer* timer value for PCell.

All cells have constant signal levels throughout the test.

The test consists of 3 successive time periods, with durations of T1, T2, and T3, respectively.

During T1,

Time period T1 starts when a DCI format 1_1 command for PCell DL BWP switch, sent from the test equipment to the UE, is received at the UE side in PCell's slot # denoted i . The UE shall switch its bandwidth part from BWP-1 to BWP-2.

The UE shall be able to receive PDSCH no later than at PCell's slot $(i + T_{BWPswitchDelay})$ as defined in section 8.6 and starts to report valid ACK/NACK for the PCell no later than at slot $(i + T_{BWPswitchDelay} + kI)$. The UE shall be continuously scheduled on PCell's BWP-2 no later than slot $(i + T_{BWPswitchDelay})$.

The starting time of SCell (Cell 2) interruption due to BWP switch on PCell shall occur within the BWP switch delay.

During T2, the test equipment won't transmit DCI format for PDSCH reception on PCell(Cell 1).

During T3,

The time period T3 starts from the slot # j immediately after the slot wherein *bwp-InactivityTimer* timer expires. The UE should switch its bandwidth part from BWP-2 back to the default bandwidth part – BWP-1.

The UE shall be able to receive PDSCH no later than PCell's slot ($j+T_{BWPswitchDelay}$) as defined in section 8.6 and starts to report valid ACK/NACK for the SCell at latest at slot ($j+T_{BWPswitchDelay}+kI$). The UE shall be continuously scheduled on SCell's BWP-1 no later than slot ($j+T_{BWPswitchDelay}$).

The starting time of SCell (Cell 2) interruption due to BWP switch of PCell shall occur within the BWP switch delay.

The test equipment verifies the DL BWP switch time in PCell by counting the slots from the time when the BWP switch command is received or *bwp-InactivityTimer* timer expires till an ACK is received.

The test equipment verifies that potential interruption to SCell is carried out in the correct time span by monitoring ACK/NACK sent in SCell during BWP switch of PCell, respectively.

Table A.6.5.6.1.1-1: DL BWP switch supported test configurations

Config	Description
1	NR 15 kHz SSB SCS, 10MHz bandwidth, FDD -FDD duplex mode
2	NR 15 kHz SSB SCS, 10MHz bandwidth, TDD – TDD duplex mode
3	NR 15 kHz SSB SCS, 10MHz bandwidth, TDD – FDD duplex mode
4	NR 15 kHz SSB SCS, 10MHz bandwidth, FDD – TDD duplex mode
5	NR 30kHz SSB SCS, 40MHz bandwidth, TDD - TDD duplex mode
Note 1: The UE is only required to be tested in one of the supported test configurations	

Table A.6.5.6.1.1-2: General test parameters for DL BWP switch in SA

Parameter	Unit	Value	Comment
NR RF Channel Number		2	Two NR radio channel is used for this test
Active PCell		Cell 1	PCell on RF channel number 1.
Active SCell		Cell 2	SCell on RF channel number 2.
CP length		Normal	
DRX		OFF	For both PCell and SCell
<i>bwp-InactivityTimer</i>	ms	[200]	
Cell-individual offset for cells on RF channel number 1	dB	0	Individual offset for cells on PCC.
Cell-individual offset for cells on RF channel number 2	dB	0	Individual offset for cells on SCC.
Cell2 timing offset to cell1	µs	3	Time alignment error as specified in TS 38.104 [13] clause 6.5.3.1.
T1	s	[0.2]	
T2	s	[0.2]	
T3	s	[0.2]	

Table A6.5.6.1.1-3: NR Cell specific test parameters for DL BWP switch in SA

Parameter	Unit	Cell 1	Cell2
Frequency Range		FR1	FR1
Duplex mode	Config 1	FDD	FDD
	Config 2,5	TDD	TDD

	Config 3		TDD	FDD
	Config 4		FDD	TDD
TDD configuration	Config 1		Not Applicable	Not Applicable
	Config 2		TDDConf.1.1	TDDConf.1.1
	Config 3		TDDConf.1.1	Not Applicable
	Config 4		Not Applicable	TDDConf.1.1
	Config 5		TDDConf.1.2	TDDConf.1.2
BW _{channel}	Config 1,2,3,4		10 MHz: N _{RB,c} = 52	10 MHz: N _{RB,c} = 52
	Config 5		40 MHz: N _{RB,c} = 106	40 MHz: N _{RB,c} = 106
Active BWP ID			1, 2	3
Initial BWP Configuration			DLBWP.0.2 ^{Note4}	
Active BWP-1 Configuration			DLBWP.1.1 ^{Note4}	-
Active BWP-2 Configuration			DLBWP.1.3 ^{Note4}	-
PDSCH Reference measurement channel	Config 1		SR.1.1 FDD	SR.1.1 FDD
	Config 2		SR.1.1 TDD	SR.1.1 TDD
	Config 3		SR.1.1 TDD	SR.1.1 FDD
	Config 4		SR.1.1 FDD	SR.1.1 TDD
	Config 5		SR.2.1 TDD	SR.2.1 TDD
RMSI CORESET parameters	Config 1		CR.1.1 FDD	CR.1.1 FDD
	Config 2		CR.1.1 TDD	CR.1.1 TDD
	Config 3		CR.1.1 TDD	CR.1.1 FDD
	Config 4		CR.1.1 FDD	CR.1.1 TDD
	Config 5		CR.2.1 TDD	CR.2.1 TDD
Dedicated CORESET parameters	Config 1		CCR.1.1 FDD	CCR.1.1 FDD
	Config 2		CCR.1.1 TDD	CCR.1.1 TDD
	Config 3		CCR.1.1 TDD	CCR.1.1 FDD
	Config 4		CCR.1.1 FDD	CCR.1.1 TDD
	Config 5		CCR.2.1 TDD	CCR.2.1 TDD
OCNG Patterns			OP.1	
SSB Configuration	Config 1,2,3,4		SSB.1 FR1	
	Config 5		SSB.2 FR1	
SMT Configuration			SMT.1	
Correlation Matrix and Antenna Configuration			1x2 Low	
EPRE ratio of PSS to SSS		dB		
EPRE ratio of PBCH DMRS to SSS				
EPRE ratio of PBCH to PBCH DMRS				
EPRE ratio of PDCCH DMRS to SSS				
EPRE ratio of PDCCH to PDCCH DMRS				
EPRE ratio of PDSCH DMRS to SSS			0	0
EPRE ratio of PDSCH to PDSCH				
EPRE ratio of OCNG DMRS to SSS(Note 1)				
EPRE ratio of OCNG to OCNG DMRS (Note 1)				
N _{oc} ^{Note 2}	Config 1,2,3,4	dBm/SCS	[-104]	[-104]
	Config 5		[-110]	[-110]
N _{oc} ^{Note 2}		dBm/15KH z	[-104]	[-104]
SS-RSRP ^{Note 3}	Config 1,2,3,4	dBm/SCS	[-87]	[-87]
	Config 5		[-90]	[-90]
\hat{E}_s/I_{ot}		dB	[17]	[17]
\hat{E}_s/N_{oc}		dB	[17]	[17]
I _o ^{Note3}	Config 1,2,3,4	dBm/ 9.36MHz	[-59]	[-59]
	Config 5	dBm/ 38.16MHz	[-61.9]	[-61.9]

Propagation Condition		AWGN	AWGN
<p>Note 1: OCNG shall be used such that both cells are fully allocated and a constant total transmitted power spectral density is achieved for all OFDM symbols.</p> <p>Note 2: Interference from other cells and noise sources not specified in the test is assumed to be constant over subcarriers and time and shall be modelled as AWGN of appropriate power for N_{oc} to be fulfilled.</p> <p>Note 3 SS-RSRP and I_0 levels have been derived from other parameters for information purposes. They are not settable parameters themselves.</p> <p>Note 4: For unpaired spectrum, a DL BWP is linked with an UL BWP. DLBWP.0.2 is linked with ULBWP.0.2; DLBWP.1.1 is linked with ULBWP.1.1; DLBWP.1.3 is linked with ULBWP.1.3 defined in TS 38.213 [3] section 12.</p>			

A.6.5.6.1.1.2 Test Requirements

During T1, the UE shall start to send the ACK for SCell in a slot $(i + T_{BWPswitchDelay} + kI)$.

During T3, the UE shall start to send the ACK for SCell in a slot $(j + T_{BWPswitchDelay} + kI)$.

Where, kI is the timing between DL data receiving and acknowledgement as specified in [7].

Depending on UE capability *bwp-SwitchingDelay* [2], UE shall finish BWP switch within the time duration $T_{BWPswitchDelay}$ defined in Table 8.6.2-1.

All of the above test requirements shall be fulfilled in order for the observed PCell active BWP switch delay to be counted as correct.

The rate of correct events observed during repeated tests shall be at least 90%.

During T1 and T3, the start time of SCell interruption during PCell active BWP switch shall not happen outside the BWP switch delay.

The interruption of SCell shall not be longer than the interruption duration specified for active BWP switch in Section 8.2.2.5.

All of the above test requirements shall be fulfilled in order for the observed PCell active BWP switch interruption to be counted as correct.

The rate of correct events observed during repeated tests shall be at least 90%.

NOTE: During T1, T3 if there are no uplink resources for reporting the ACK in a slot $(i + T_{BWPswitchDelay} + kI)$, $(j + T_{BWPswitchDelay} + kI)$, then the UE shall use the next available uplink resource for reporting the corresponding ACK.

A.6.5.6.1.2 NR FR1 DL active BWP switch with non-DRX in SA

A.6.5.6.1.2.1 Test Purpose and Environment

The purpose of this test is to verify the DL BWP switch delay requirement defined in TS38.133 section 8.6. Supported test configurations are shown in Table A.6.5.6.1.2.1-1.

The test scenario comprises of one NR cell (Cell 1) as given in Table A.6.5.6.1.2.1-2. Cell-specific parameters of the NR cell are specified in Table A.6.5.6.1.2.1-3 below.

PDCCHs indicating new transmissions shall be sent continuously on Cell 1 to ensure that the UE will have ACK/NACK sending.

Before the test starts,

- UE is connected to Cell 1 on radio channel 1.
- UE is configured with 2 different UE-specific bandwidth parts, BWP-1 and BWP-2 before starting the test. BWP-1 and BWP-2 always include bandwidth of the initial DL BWP and SSB.

- UE is indicated in *firstActiveDownlinkBWP-Id* that the active DL BWP is BWP-1.
- UE is configured with a *bwp-InactivityTimer* timer value for Cell1.

All cells have constant signal levels throughout the test.

The test consists of 3 successive time periods, with durations of T1, T2, and T3, respectively.

During T1,

Time period T1 starts when a DCI format 1_1 command for DL BWP switch, sent from the test equipment to the UE, is received at the UE side in Cell1's slot # denoted i . The UE shall switch its bandwidth part from BWP-1 to BWP-2.

The UE shall be able to receive PDSCH at Cell1's slot $(i+T_{BWPswitchDelay})$ as defined in section 8.6 and starts to report valid ACK/NACK for the Cell1 no later than at slot $(i+T_{BWPswitchDelay}+kI)$. The UE shall be continuously scheduled on Cell1's BWP-2 starting from slot $(i+T_{BWPswitchDelay})$.

During T2, the test equipment won't transmit DCI format for PDSCH reception on Cell1.

During T3,

The time period T3 starts from the slot # j immediately after the slot wherein *bwp-InactivityTimer* timer expires. The UE shall switch its bandwidth part from BWP-2 back to the default bandwidth part – BWP-1.

The UE shall be able to receive PDSCH at Cell1's slot $(j+T_{BWPswitchDelay})$ as defined in section 8.6 and starts to report valid ACK/NACK for the Cell1 at latest at slot $(j+T_{BWPswitchDelay}+kI)$. The UE shall be continuously scheduled on Cell1's BWP-1 starting from slot $(j+T_{BWPswitchDelay})$.

The test equipment verifies the DL BWP switch time by counting the slots from the time when the BWP switch command is received or *bwp-InactivityTimer* timer expires till an ACK is received.

Table A.6.5.6.1.2.1-1: DL BWP switch supported test configurations

Config	Description
1	NR 15 kHz SSB SCS, 10MHz bandwidth, FDD duplex mode
2	NR 15 kHz SSB SCS, 10MHz bandwidth, TDD duplex mode
3	NR 30kHz SSB SCS, 40MHz bandwidth, TDD duplex mode
Note 1:	The UE is only required to be tested in one of the supported test configurations.
Note 2:	A UE which fulfils the requirements in test case A.6.5.6.1.1 can skip the test cases in A.4.5.6.1.2.

Table A.6.5.6.1.2.1-2: General test parameters for DL BWP switch in SA

Parameter	Unit	Value	Comment
NR RF Channel Number		1	One NR radio channel is used for this test
Active Cell		Cell 1	Cell1 on RF channel number 1.
CP length		Normal	
DRX		OFF	
<i>bwp-InactivityTimer</i>	ms	[200]	
T1	s	[0.2]	
T2	s	[0.2]	
T3	s	[0.2]	

Table A.6.5.6.1.2.1-3: NR Cell specific test parameters for DL BWP switch in SA

Parameter	Unit	Cell 2
Frequency Range		FR1
Duplex mode	Config 1	FDD
	Config 2,3	TDD

TDD configuration	Config 1		Not Applicable
	Config 2		TDDConf.1.1
	Config 3		TDDConf.1.2
BW_{channel}	Config 1		10 MHz: $N_{RB,c} = 52$
	Config 2		10 MHz: $N_{RB,c} = 52$
	Config 3		40 MHz: $N_{RB,c} = 106$
Active BWP ID			1, 2
Initial DL BWP Configuration	Config 1,2,3		DLBWP.0.2 ^{Note 4}
Active DL BWP-1 Configuration	Config 1,2,3		DLBWP.1.1 ^{Note 4}
Active DL BWP-2 Configuration	Config 1,2,3		DLBWP.1.3 ^{Note 4}
Initial UL BWP Configuration	Config 1,2,3		ULBWP.0.2 ^{Note 4}
Active UL BWP-1 Configuration	Config 1,2,3		ULBWP.1.1 ^{Note 4}
Active UL BWP-2 Configuration	Config 1,2,3		ULBWP.1.3 ^{Note 4}
PDSCH Reference measurement channel	Config 1		SR.1.1 FDD
	Config 2		SR.1.1 TDD
	Config 3		SR.2.1 TDD
RMSI CORESET parameters	Config 1		CR.1.1 FDD
	Config 2		CR.1.1 TDD
	Config 3		CR.2.1 TDD
Dedicated CORESET parameters	Config 1		CCR.1.1 FDD
	Config 2		CCR.1.1 TDD
	Config 3		CCR.2.1 TDD
OCNG Patterns			OP.1
SSB Configuration	Config 1,2		SSB.1 FR1
	Config 3		SSB.2 FR1
SMTTC Configuration			SMTTC.1
Correlation Matrix and Antenna Configuration			1x2 Low
EPRE ratio of PSS to SSS		dB	0
EPRE ratio of PBCH DMRS to SSS			
EPRE ratio of PBCH to PBCH DMRS			
EPRE ratio of PDCCH DMRS to SSS			
EPRE ratio of PDCCH to PDCCH DMRS			
EPRE ratio of PDSCH DMRS to SSS			
EPRE ratio of PDSCH to PDSCH			
EPRE ratio of OCNG DMRS to SSS(Note 1)			
EPRE ratio of OCNG to OCNG DMRS (Note 1)			
N_{oc} ^{Note 2}	Config 1,2		
	Config 3		
N_{oc} ^{Note 2}		dBm/15kHz	[-104]
SS-RSRP ^{Note 3}	Config 1,2	dBm/SCS	[-87]
	Config 3		
\hat{E}_s/I_{ot}		dB	[17]
\hat{E}_s/N_{oc}		dB	[17]
I_o ^{Note 3}	Config 1,2	dBm/9.36MHz	[-59]
	Config 3	dBm/38.16MHz	[-61.9]
Propagation Condition			AWGN

Note 1:	OCNG shall be used such that both cells are fully allocated and a constant total transmitted power spectral density is achieved for all OFDM symbols.
Note 2:	Interference from other cells and noise sources not specified in the test is assumed to be constant over subcarriers and time and shall be modelled as AWGN of appropriate power for N_{oc} to be fulfilled.
Note 3:	SS-RSRP and l_0 levels have been derived from other parameters for information purposes. They are not settable parameters themselves.
Note 4:	For unpaired spectrum, a DL BWP is linked with an UL BWP. DLBWP.0.2 is linked with ULBWP.0.2; DLBWP.1.1 is linked with ULBWP.1.1; DLBWP.1.3 is linked with ULBWP.1.3 defined in clause 12 of TS 38.213 [3].

A.6.5.6.1.2.2 Test Requirements

During T1, the UE shall start to send the ACK for Cell1 in a slot $(i+T_{BWPswitchDelay}+kI)$.

During T3, the UE shall start to send the ACK for Cell1 in a slot $(j+T_{BWPswitchDelay}+kI)$.

Where, kI is the timing between DL data receiving and acknowledgement as specified in [7].

Depending on UE capability *bwp-SwitchingDelay* [2], UE shall finish BWP switch within the time duration $T_{BWPswitchDelay}$ defined in Table 8.6.2-1.

All of the above test requirements shall be fulfilled in order for the observed PSCell active BWP switch delay to be counted as correct.

The rate of correct events observed during repeated tests shall be at least 90%.

NOTE: During T1, T3 if there are no uplink resources for reporting the ACK in a slot $(i+T_{BWPswitchDelay}+kI)$, $(j+T_{BWPswitchDelay}+kI)$, then the UE shall use the next available uplink resource for reporting the corresponding ACK.

A.6.5.6.2 RRC-based Active BWP Switch

A.6.5.6.2.1 NR FR1- NR FR1 DL active BWP switch of PCell with non-DRX in SA

A.6.5.6.2.1.1 Test Purpose and Environment

The purpose of this test is to verify the DL BWP switch delay requirement for RRC-based BWP switch defined in section 8.6. Supported test configurations are shown in Table A.6.5.6.2.1.1-1.

The test scenario comprises of one NR PCell (Cell 1) as given in Table A.6.5.6.2.1.1-2. Cell-specific parameters of NR PCell are specified in Table A.6.5.6.2.1.1-3 below.

PDCCHs indicating new transmissions shall be sent continuously on PCell (Cell 1) to ensure that the UE will have ACK/NACK sending.

Before the test starts,

- UE is connected to Cell 1 (PCell) on radio channel 1 (PCC).
- UE has bandwidth part BWP-1 in its RRC-configuration for Cell 1 (PCell).
- UE is indicated in *firstActiveDownlinkBWP-Id* that the active DL BWP is BWP-1 in PCell.

All cells have constant signal levels throughout the test.

The test consists of 1 time period, with duration of T1.

During T1,

Time period T1 starts when a *RRCReconfiguration* with bandwidth part configuration BWP-2, sent from the test equipment to the UE, is received at the UE side in PCell's slot # denoted i . The UE shall switch its bandwidth part from BWP-1 to BWP-2.

The UE shall be able to receive PDSCH at PCell's slot $(i+X)$ as defined in section 8.6 and starts to report valid ACK/NACK for the PCell no later than at slot $(i+X+kI)$. The UE shall be continuously scheduled on PCell's BWP-2 starting from slot $(i+X)$.

The test equipment verifies the DL BWP switch time in PCell by counting the slots from the time when the RRC Reconfiguration message including BWP switch command is received till an ACK is received.

Table A.6.5.6.2.1.1-1: DL BWP switch supported test configurations

Config	Description
1	NR 15 kHz SSB SCS, 10MHz bandwidth, FDD duplex mode
2	NR 15 kHz SSB SCS, 10MHz bandwidth, TDD duplex mode
3	NR 30kHz SSB SCS, 40MHz bandwidth, TDD duplex mode
4	NR 15 kHz SSB SCS, 10MHz bandwidth, FDD duplex mode
5	NR 15 kHz SSB SCS, 10MHz bandwidth, TDD duplex mode
6	NR 30kHz SSB SCS, 40MHz bandwidth, TDD duplex mode

Note 1: The UE is only required to be tested in one of the supported test configurations

Table A.6.5.6.2.1.1-2: General test parameters for DL BWP switch in synchronous EN-DC

Parameter	Unit	Value	Comment
NR RF Channel Number		1	One NR radio channel is used for this test
Active PCell		Cell 1	PCell on RF channel number 1.
CP length		Normal	
DRX		OFF	
Cell-individual offset for cells on RF channel number 1	dB	0	Individual offset for cells on PCC.
T1	s	[0.2]	

Table A.6.5.6.2.1.1-3: NR Cell specific test parameters for DL BWP switch in synchronous EN-DC

Parameter	Unit	Cell 1
Frequency Range		FR1
Duplex mode	Config 1,4	FDD
	Config 2,3,5,6	TDD
TDD configuration	Config 1,4	Not Applicable
	Config 2,5	TDDConf.1.1
	Config 3,6	TDDConf.1.2
BW _{channel}	Config 1,4	10 MHz: N _{RB,c} = 52
	Config 2,5	10 MHz: N _{RB,c} = 52
	Config 3,6	40 MHz: N _{RB,c} = 106
Active BWP ID		1, 2
Initial BWP Configuration	Config 1,4	DLBWP.0.2
	Config 2,5	
	Config 3,6	
Active BWP-0 Configuration	Config 1,4	NA
	Config 2,5	
	Config 3,6	
Active BWP-1 Configuration	Config 1,4	DLBWP.1.3
	Config 2,5	
	Config 3,6	
Active BWP-2 Configuration	Config 1,4	DLBWP.1.1
	Config 2,5	
	Config 3,6	

PDSCH Reference measurement channel	Config 1,4		SR.1.1 FDD
	Config 2,5		SR.1.1 TDD
	Config 3,6		SR2.1 TDD
RMSI CORESET parameters	Config 1,4		CR.1.1 FDD
	Config 2,5		CR.1.1 TDD
	Config 3,6		CR2.1 TDD
Dedicated CORESET parameters	Config 1,4		CCR.1.1 FDD
	Config 2,5		CCR.1.1 TDD
	Config 3,6		CCR.2.1 TDD
OCNG Patterns			OP.1
SSB Configuration	Config 1,2,4,5		SSB.1 FR1
	Config 3,6		SSB.2 FR1
SMTTC Configuration			SMTTC.1
Antenna Configuration			1x2
Propagation Condition			AWGN
EPRE ratio of PSS to SSS		dB	0
EPRE ratio of PBCH DMRS to SSS			
EPRE ratio of PBCH to PBCH DMRS			
EPRE ratio of PDCCH DMRS to SSS			
EPRE ratio of PDCCH to PDCCH DMRS			
EPRE ratio of PDSCH DMRS to SSS			
EPRE ratio of PDSCH to PDSCH			
EPRE ratio of OCNG DMRS to SSS(Note 1)			
EPRE ratio of OCNG to OCNG DMRS (Note 1)			
N_{oc} ^{Note 2}			
SS-RSRP ^{Note 3}		dBm/15 kHz	[-87]
\dot{E}_s/I_{ot}		dB	17
\dot{E}_s/N_{oc}		dB	17
I_o ^{Note3}	Config 1,2,4,5	dBm/9.36MHz	TBD
	Config 3,6	dBm/38.16MHz	TBD
Note 1: OCNG shall be used such that both cells are fully allocated and a constant total transmitted power spectral density is achieved for all OFDM symbols.			
Note 2: Interference from other cells and noise sources not specified in the test is assumed to be constant over subcarriers and time and shall be modelled as AWGN of appropriate power for N_{oc} to be fulfilled.			
Note 3 SS-RSRP and I_o levels have been derived from other parameters for information purposes. They are not settable parameters themselves.			
Note 4: Note 4: For unpaired spectrum, a DL BWP is linked with an UL BWP. DLBWP.0.2 is linked with ULBWP.0.2; DLBWP.1.1 is linked with ULBWP.1.1; DLBWP.1.3 is linked with ULBWP.1.3 defined in TS 38.213 [3] section 12.			

A.6.5.6.2.2 Test Requirements

During T1, the UE shall start to send the ACK for PCell in a slot ($i+X+kI$).

All of the above test requirements shall be fulfilled in order for the observed PCell active BWP switch delay to be counted as correct.

The rate of correct events observed during repeated tests shall be at least 90%.

The rate of correct events observed during repeated tests shall be at least 90%.

NOTE: During T1, if there are no uplink resources for reporting the ACK in a slot ($i+X+kI$), then the UE shall use the next available uplink resource for reporting the corresponding ACK.

Editor's note: FFS value of X, k1 for type 1 and type 2 UE.

A.6.6 Measurement procedure

A.6.6.1 Intra-frequency Measurements

A.6.6.1.1 SA event triggered reporting tests without gap under non-DRX

A.6.6.1.1.1 Test purpose and Environment

The purpose of this test is to verify that the UE makes correct reporting of an event. This test will partly verify the intra-frequency cell search requirements in clause 9.2.5.1 and 9.2.5.2.

A.6.6.1.1.2 Test parameters

Two cells are deployed in the test, which are FR1 PCell (Cell 1) and a FR1 neighbour cell (Cell 2) on the same frequency as the PCell. The test parameters for PCell and neighbour cell are given in Table A.6.6.1.1.1-1 and A.6.6.1.1.1-2 below. In the measurement control information a measurement object is configured for the frequency of the PCell, and it is indicated to the UE that event-triggered reporting with Event A3 is used. The test consists of two successive time periods, with time duration of T1, and T2 respectively. During time duration T1, the UE shall not have any timing information of Cell 2.

Table A.6.6.1.1.1-1: Supported test configurations

Configuration	Description
1	15 kHz SSB SCS, 10MHz bandwidth, FDD duplex mode
2	15 kHz SSB SCS, 10MHz bandwidth, TDD duplex mode
3	30 kHz SSB SCS, 40MHz bandwidth, TDD duplex mode
Note:	The UE is only required to be tested in one of the supported test configurations.

Table A.6.6.1.1.2-2: General test parameters for SA intra-frequency event triggered reporting without gap for FR1

Parameter	Unit	Test configuration	Value	Comment
Active cell		1, 2, 3	Cell 1	
Neighbour cell		1, 2, 3	Cell 2	Cell to be identified.
RF Channel Number		1, 2, 3	1: Cell 1 and Cell 2	
SSB configuration		1	SSB.1 FR1	
		2	SSB.1 FR1	
		3	SSB.2 FR1	
SMTC configuration		1	SMTC.2	
		2	SMTC.1	
		3	SMTC.1	
A3-Offset	dB	1, 2, 3	-4.5	
CP length		1, 2, 3	Normal	
Hysteresis	dB	1, 2, 3	0	
Time To Trigger	s	1, 2, 3	0	
Filter coefficient		1, 2, 3	0	L3 filtering is not used
DRX		1, 2, 3		OFF
Time offset between PCell and PSCell		1, 2, 3	3 μ s	Synchronous EN-DC
Time offset between serving and neighbour cells		1	3 ms	Asynchronous cells. The timing of Cell 3 is 3ms later than the timing of Cell 2.
		2	3 μ s	Synchronous cells
		3	3 μ s	Synchronous cells

T1	s	1, 2, 3	5	
T2	s	1, 2, 3	5	

Table A.6.6.1.1.2-3: NR Cell specific test parameters for SA intra-frequency event triggered reporting without gap for FR1

Parameter	Unit	Test configuration	Cell 1		Cell 2	
			T1	T2	T1	T2
TDD configuration		1	TDDConf.3.1		TDDConf.3.1	
		2	N/A		N/A	
		3	TDDConf.3.1		TDDConf.3.1	
PDSCH RMC configuration		1	SR.1.1 FDD		N/A	
		2	SR.1.1 TDD			
		3	SR.2.1 TDD			
RMSI CORESET RMC configuration		1	CR.1.1 FDD		CR.1.1 FDD	
		2	CR.1.1 TDD		CR.1.1 TDD	
		3	CR.2.1 TDD		CR.2.1 TDD	
Dedicated CORESET RMC configuration		1	CCR.1.1 FDD		CCR.1.1 FDD	
		2	CCR.1.1 TDD		CCR.1.1 TDD	
		3	CCR.2.1 TDD		CCR.2.1 TDD	
OCNG Patterns		1, 2, 3	OP.1		OP.1	
Initial BWP configuration		1, 2, 3	DLBWP.0.1 ULBWP.0.1		DLBWP.0.1 ULBWP.0.1	
Active DL BWP configuration		1, 2, 3	DLBWP.1.1		DLBWP.1.1	
Active UL BWP configuration		1, 2, 3	ULBWP.1.1		ULBWP.1.1	
RLM-RS		1, 2, 3	SSB		SSB	
N_{oc} ^{Note 2}	dBm/SCS	1	-98			
		2	-98			
		3	-95			
N_{oc} ^{Note 2}	dBm/15 KHz	1	-98			
		2				
		3				
\hat{E}_s/I_{ot}	dB	1	4	-1.46	-Infinity	-1.46
		2				
		3				
\hat{E}_s/N_{oc}	dB	1	4	4	-Infinity	4
		2				
		3				
SS-RSRP ^{Note 3}	dBm/SCS KHz	1	-94	-94	-Infinity	-94
		2	-94	-94	-Infinity	-94
		3	-91	-91	-Infinity	-91
I _o	dBm/9.36 MHz	1	-64.60	-62.25	-Infinity	-62.25
	dBm/9.36 MHz	2	-64.60	-62.25	-Infinity	-62.25
	dBm/38.16 MHz	3	-58.50	-56.16	-Infinity	-56.16
Propagation Condition		1, 2, 3	AWGN			
<p>Note 1: The resources for uplink transmission are assigned to the UE prior to the start of time period T2.</p> <p>Note 2: Interference from other cells and noise sources not specified in the test is assumed to be constant over subcarriers and time and shall be modelled as AWGN of appropriate power for N_{oc} to be fulfilled.</p> <p>Note 3: SS-RSRP levels have been derived from other parameters for information purposes. They are not settable parameters themselves.</p>						

A.6.6.1.1.3 Test Requirements

The UE shall send one Event A3 triggered measurement report, with a measurement reporting delay less than 800 ms from the beginning of time period T2. The UE is not required to read the neighbour cell SSB index in this test.

The UE shall not send event triggered measurement reports, as long as the reporting criteria are not fulfilled.

The rate of correct events observed during repeated tests shall be at least 90%.

NOTE: The actual overall delays measured in the test may be up to $2 \times TTI_{DCCH}$ higher than the measurement reporting delays above because of TTI insertion uncertainty of the measurement report in DCCH.

A.6.6.1.2 SA event triggered reporting tests without gap under DRX

A.6.6.1.2.1 Test purpose and Environment

The purpose of this test is to verify that the UE makes correct reporting of an event. This test will partly verify the intra-frequency cell search requirements in clause 9.2.5.1 and 9.2.5.2.

A.6.6.1.2.2 Test parameters

Two cells are deployed in the test, which are FR1 PCell (Cell 1) and a FR1 neighbour cell (Cell 2) on the same frequency as the PCell. The test parameters for PCell are given in Table A.6.6.1.2.2-1, A.6.6.1.2.2-2 and A.6.6.1.2.2-3 below. In the measurement control information a measurement object is configured for the frequency of the PCell, and it is indicated to the UE that event-triggered reporting with Event A3 is used. The test consists of two successive time periods, with time duration of T1, and T2 respectively. During time duration T1, the UE shall not have any timing information of Cell 2.

Table A.6.6.1.2.2-1: Supported test configurations

Configuration	Description
1	15 kHz SSB SCS, 10MHz bandwidth, FDD duplex mode
2	15 kHz SSB SCS, 10MHz bandwidth, TDD duplex mode
3	30 kHz SSB SCS, 40MHz bandwidth, TDD duplex mode
Note: The UE is only required to be tested in one of the supported test configurations.	

Table A.6.6.1.2.2-2: General test parameters for SA intra-frequency event triggered reporting without gap for PCell in FR1 with DRX

Parameter	Unit	Test configuration	Value		Comment
			Test 1	Test 2	
Active cell		1, 2, 3	Cell 1		
Neighbour cell		1, 2, 3	Cell 2		Cell to be identified.
RF Channel Number		1, 2, 3	1: Cell 1 and Cell 2		
SSB configuration		1	SSB.1 FR1		
		2	SSB.1 FR1		
		3	SSB.2 FR1		
SMTC configuration		1	SMTC.2		
		2	SMTC.1		
		3	SMTC.1		

A3-Offset	dB	1, 2, 3	-4.5		
CP length		1, 2, 3	Normal		
Hysteresis	dB	1, 2, 3	0		
Time To Trigger	s	1, 2, 3	0		
Filter coefficient		1, 2, 3	0		L3 filtering is not used
DRX		1, 2, 3	DRX.1	DRX.2	
Time offset between PCell and PSCell		1, 2, 3	3 μ s		Synchronous EN-DC
Time offset between serving and neighbour cells		1	3 μ s		Synchronous cells
		2	3 ms		Asynchronous cells. The timing of Cell 3 is 3ms later than the timing of Cell 2.
		3	3 μ s		Synchronous cells
T1	s	1, 2, 3	5		
T2	s	1, 2, 3	5	10	

Table A.6.6.1.2.2-3: NR Cell specific test parameters for SA intra-frequency event triggered reporting without gap for PCell in FR1 with DRX

Parameter	Unit	Test configuration	Cell 1		Cell 2	
			T1	T2	T1	T2
TDD configuration		1	TDDConf.3.1		TDDConf.3.1	
		2	N/A		N/A	
		3	TDDConf.3.1		TDDConf.3.1	
PDSCH RMC configuration		1	SR.1.1 FDD		N/A	
		2	SR.1.1 TDD			
		3	SR.2.1 TDD			
RMSI CORESET RMC configuration		1	CR.1.1 FDD		CR.1.1 FDD	
		2	CR.1.1 TDD		CR.1.1 TDD	
		3	CR.2.1 TDD		CR.2.1 TDD	
Dedicated CORESET RMC configuration		1	CCR.1.1 FDD		CCR.1.1 FDD	
		2	CCR.1.1 TDD		CCR.1.1 TDD	
		3	CCR.2.1 TDD		CCR.2.1 TDD	
OCNG Patterns		1, 2, 3	OP.1		OP.1	
Initial BWP configuration		1, 2, 3	DLBWP.0.1 ULBWP.0.1		DLBWP.0.1 ULBWP.0.1	
Active DL BWP configuration		1, 2, 3	DLBWP.1.1		DLBWP.1.1	
Active UL BWP configuration		1, 2, 3	ULBWP.1.1		ULBWP.1.1	
RLM-RS		1, 2, 3	SSB		SSB	
N_{oc} Note 2	dBm/SCS	1			-98	
		2			-98	
		3			-95	
N_{oc} Note 2	dBm/15 KHz	1			-98	
		2				
		3				
\hat{E}_s/I_{ot}	dB	1	4	-1.46	-Infinity	-1.46
		2				
		3				
\hat{E}_s/N_{oc}	dB	1	4	4	-Infinity	4
		2				
		3				
SS-RSRP Note 3	dBm/SCS KHz	1	-94	-94	-Infinity	-94
		2	-94	-94	-Infinity	-94
		3	-91	-91	-Infinity	-91

Io	dBm/9.36 MHz	1	-64.60	-62.25	-Infinity	-62.25
	dBm/9.36 MHz	2	-64.60	-62.25	-Infinity	-62.25
	dBm/38.16 MHz	3	-58.50	-56.16	-Infinity	-56.16
Propagation Condition		1, 2, 3	AWGN			
Note 1:	The resources for uplink transmission are assigned to the UE prior to the start of time period T2.					
Note 2:	Interference from other cells and noise sources not specified in the test is assumed to be constant over subcarriers and time and shall be modelled as AWGN of appropriate power for N_{oc} to be fulfilled.					
Note 3:	SS-RSRP levels have been derived from other parameters for information purposes. They are not settable parameters themselves.					

A.6.6.1.2.3 Test Requirements

In test 1, the UE shall send one Event A3 triggered measurement report, with a measurement reporting delay less than 920 ms from the beginning of time period T2. The UE is not required to read the neighbour cell SSB index in this test.

In test 2, the UE shall send one Event A3 triggered measurement report, with a measurement reporting delay less than 6400 ms from the beginning of time period T2. The UE is not required to read the neighbour cell SSB index in this test.

The UE shall not send event triggered measurement reports, as long as the reporting criteria are not fulfilled.

The rate of correct events observed during repeated tests shall be at least 90%.

NOTE: The actual overall delays measured in the test may be up to $2xTTI_{DCCH}$ higher than the measurement reporting delays above because of TTI insertion uncertainty of the measurement report in DCCH.

A.6.6.1.3 SA event triggered reporting tests with per-UE gaps under non-DRX

A.6.6.1.3.1 Test purpose and Environment

The purpose of this test is to verify that the UE makes correct reporting of an event. This test will partly verify the intra-frequency cell search requirements in clause 9.2.6.2 and 9.2.6.3.

A.6.6.1.3.2 Test parameters

Two cells are deployed in the test, which are FR1 PCell (Cell 1) and a FR1 neighbour cell (Cell 2) on the same frequency as the PCell. The test parameters for PCell are given in Table A.6.6.1.3.1-1 and A.6.6.1.3.1-2 below. In the measurement control information a measurement object is configured for the frequency of the PCell, and it is indicated to the UE that event-triggered reporting with Event A3 is used. The test consists of two successive time periods, with time duration of T1, and T2 respectively. During time duration T1, the UE shall not have any timing information of Cell 2.

There are two BWPs configured in Cell 1, BWP1 which contains the cell defining SSB, and BWP2 which does not contain any SSB of Cell 1. During the whole test, BWP2 is always scheduled as the active BWP for the UE.

Table A.6.6.1.3.2-1: Supported test configurations

Configuration	Description
1	15 kHz SSB SCS, 10MHz bandwidth, FDD duplex mode
2	15 kHz SSB SCS, 10MHz bandwidth, TDD duplex mode
3	30 kHz SSB SCS, 40MHz bandwidth, TDD duplex mode
Note:	The UE is only required to be tested in one of the supported test configurations.

Table A.6.6.1.3.2-2: General test parameters for SA intra-frequency event triggered reporting with per-UE gaps for PCell in FR1

Parameter	Unit	Test configuration	Value	Comment
Active cell		1, 2, 3	Cell 1	
Neighbour cell		1, 2, 3	Cell 2	Cell to be identified.
RF Channel Number		1, 2, 3	1: Cell 1 and Cell 2	
Measurement gap type		1, 2, 3	Per-UE gaps	
Measurement gap repetition periodicity	ms	1, 2, 3	40	
Measurement gap length	ms	1, 2, 3	6	
Measurement gap offset	ms	1, 2, 3	39	
SSB configuration		1	SSB.1 FR1	
		2	SSB.1 FR1	
		3	SSB.2 FR1	
SMTC configuration		1	SMTC.2	
		2	SMTC.1	
		3	SMTC.1	
CSI-RS parameters		1	CSI-RS.1.2 FDD	
		2	CSI-RS.1.2 TDD	
		3	CSI-RS.2.2 TDD	
A3-Offset	dB	1, 2, 3	-4.5	
CP length		1, 2, 3	Normal	
Hysteresis	dB	1, 2, 3	0	
Time To Trigger	s	1, 2, 3	0	
Filter coefficient		1, 2, 3	0	L3 filtering is not used
DRX	ms	1, 2, 3		OFF
Time offset between PCell and PSCell		1, 2, 3	3 μ s	Synchronous EN-DC
Time offset between serving and neighbour cells		1	3 ms	Asynchronous cells. The timing of Cell 3 is 3ms later than the timing of Cell 2.
		2	3 μ s	Synchronous cells
		3	3 μ s	Synchronous cells
T1	s	1, 2, 3	5	
T2	s	1, 2, 3	5	

Table A.6.6.1.3.2-3: NR Cell specific test parameters for SA intra-frequency event triggered reporting with per-UE gaps for PCell in FR1

Parameter	Unit	Test configuration	Cell 1		Cell 2	
			T1	T2	T1	T2
TDD configuration		1	TDDConf.3.1		TDDConf.3.1	
		2	N/A		N/A	
		3	TDDConf.3.1		TDDConf.3.1	
PDSCH RMC configuration		1	SR.1.1 FDD		N/A	
		2	SR.1.1 TDD			
		3	SR.2.1 TDD			
RMSI CORESET RMC configuration		1	CR.1.1 FDD		CR.1.1 FDD	
		2	CR.1.1 TDD		CR.1.1 TDD	
		3	CR.2.1 TDD		CR.2.1 TDD	
Dedicated CORESET RMC configuration		1	CCR.1.1 FDD		CCR.1.1 FDD	
		2	CCR.1.1 TDD		CCR.1.1 TDD	
		3	CCR.2.1 TDD		CCR.2.1 TDD	

OCNG Patterns		1, 2, 3	OP.1		OP.1	
Initial BWP configuration		1, 2, 3	DLBWP.0.1 ULBWP.0.1		DLBWP.0.1 ULBWP.0.1	
Active DL BWP configuration		1, 2, 3	DLBWP.1.2		DLBWP.1.1	
Active UL BWP configuration		1, 2, 3	ULBWP.1.1		ULBWP.1.1	
RLM-RS		1, 2, 3	CSI-RS		SSB	
N_{oc} Note 2	dBm/SCS	1	-98			
		2	-98			
		3	-95			
N_{oc} Note 2	dBm/15 KHz	1	-98			
		2				
		3				
\hat{E}_s/I_{ot}	dB	1	4	-1.46	-Infinity	-1.46
		2				
		3				
\hat{E}_s/N_{oc}	dB	1	4	4	-Infinity	4
		2				
		3				
SS-RSRP Note 3	dBm/SCS KHz	1	-94	-94	-Infinity	-94
		2	-94	-94	-Infinity	-94
		3	-91	-91	-Infinity	-91
I _o	dBm/9.36 MHz	1	-64.60	-62.25	-Infinity	-62.25
	dBm/9.36 MHz	2	-64.60	-62.25	-Infinity	-62.25
	dBm/38.16 MHz	3	-58.50	-56.16	-Infinity	-56.16
Propagation Condition		1, 2, 3	AWGN			
Note 1:	The resources for uplink transmission are assigned to the UE prior to the start of time period T2.					
Note 2:	Interference from other cells and noise sources not specified in the test is assumed to be constant over subcarriers and time and shall be modelled as AWGN of appropriate power for N_{oc} to be fulfilled.					
Note 3:	SS-RSRP levels have been derived from other parameters for information purposes. They are not settable parameters themselves.					

A.6.6.1.3.3 Test Requirements

The UE shall send one Event A3 triggered measurement report, with a measurement reporting delay less than 800 ms from the beginning of time period T2. The UE is not required to read the neighbour cell SSB index in this test.

The UE shall not send event triggered measurement reports, as long as the reporting criteria are not fulfilled.

The rate of correct events observed during repeated tests shall be at least 90%.

NOTE: The actual overall delays measured in the test may be up to $2xTTI_{DCC}$ higher than the measurement reporting delays above because of TTI insertion uncertainty of the measurement report in DCCH.

A.6.6.1.4 SA event triggered reporting tests with per-UE gaps under DRX

A.6.6.1.4.1 Test purpose and Environment

The purpose of this test is to verify that the UE makes correct reporting of an event. This test will partly verify the intra-frequency cell search requirements in clause 9.2.6.2 and 9.2.6.3.

A.6.6.1.4.2 Test parameters

Two cells are deployed in the test, which are FR1 PCell (Cell 1) and a FR1 neighbour cell (Cell 2) on the same frequency as the PCell. The test parameters for PCell are given in Table A.6.6.1.4.2-1, A.6.6.1.4.2-2 and A.6.6.1.4.2-3 below. In the measurement control information a measurement object is configured for the frequency of the PCell, and it is indicated to the UE that event-triggered reporting with Event A3 is used. The test consists of two successive time periods, with time duration of T1, and T2 respectively. During time duration T1, the UE shall not have any timing information of Cell 2.

There are two BWPs configured in Cell 1, BWP1 which contains the cell defining SSB, and BWP2 which does not contain any SSB of Cell 1. During the whole test, BWP2 is always scheduled as the active BWP for the UE.

Table A.6.6.1.4.2-1: Supported test configurations

Configuration	Description
1	15 kHz SSB SCS, 10MHz bandwidth, FDD duplex mode
2	15 kHz SSB SCS, 10MHz bandwidth, TDD duplex mode
3	30 kHz SSB SCS, 40MHz bandwidth, TDD duplex mode
Note: The UE is only required to be tested in one of the supported test configurations.	

Table A.6.6.1.4.2-2: General test parameters for SA intra-frequency event triggered reporting with per-UE gaps for PCell in FR1 with DRX

Parameter	Unit	Test configuration	Value		Comment
			Test 1	Test 2	
Active cell		1, 2, 3	Cell 1		
Neighbour cell		1, 2, 3	Cell 2		Cell to be identified.
RF Channel Number		1, 2, 3	1: Cell 1 and Cell 2		
Measurement gap type		1, 2, 3	Per-UE gaps		
Measurement gap repetition periodicity	ms	1, 2, 3	40		
Measurement gap length	ms	1, 2, 3	6		
Measurement gap offset	ms	1, 2, 3	39		
SSB configuration		1	SSB.1 FR1		
		2	SSB.1 FR1		
		3	SSB.2 FR1		
SMTC configuration		1	SMTC.2		
		2	SMTC.1		
		3	SMTC.1		
CSI-RS parameters		1	CSI-RS.1.2 FDD		
		2	CSI-RS.1.2 TDD		
		3	CSI-RS.2.2 TDD		
A3-Offset	dB	1, 2, 3	-4.5		
CP length		1, 2, 3	Normal		
Hysteresis	dB	1, 2, 3	0		
Time To Trigger	s	1, 2, 3	0		
Filter coefficient		1, 2, 3	0		L3 filtering is not used
DRX		1, 2, 3	DRX.1	DRX.2	
Time offset between PCell and PSCell		1, 2, 3	3 μ s		Synchronous EN-DC
Time offset between serving and neighbour cells		1	3 ms		Asynchronous cells. The timing of Cell 3 is 3ms later than the timing of Cell 2.
		2	3 μ s		Synchronous cells
		3	3 μ s		Synchronous cells

T1	s	1, 2, 3	5		
T2	s	1, 2, 3	5	10	

Table A.6.6.1.4.2-3: NR Cell specific test parameters for SA intra-frequency event triggered reporting with per-UE gaps for PCell in FR1 with DRX

Parameter	Unit	Test configuration	Cell 1		Cell 2	
			T1	T2	T1	T2
TDD configuration		1	TDDConf.3.1		TDDConf.3.1	
		2	N/A		N/A	
		3	TDDConf.3.1		TDDConf.3.1	
PDSCH RMC configuration		1	SR.1.1 FDD		N/A	
		2	SR.1.1 TDD			
		3	SR.2.1 TDD			
RMSI CORESET RMC configuration		1	CR.1.1 FDD		CR.1.1 FDD	
		2	CR.1.1 TDD		CR.1.1 TDD	
		3	CR.2.1 TDD		CR.2.1 TDD	
Dedicated CORESET RMC configuration		1	CCR.1.1 FDD		CCR.1.1 FDD	
		2	CCR.1.1 TDD		CCR.1.1 TDD	
		3	CCR.2.1 TDD		CCR.2.1 TDD	
OCNG Patterns		1, 2, 3	OP.1		OP.1	
Initial BWP configuration		1, 2, 3	DLBWP.0.1 ULBWP.0.1		DLBWP.0.1 ULBWP.0.1	
Active DL BWP configuration		1, 2, 3	DLBWP.1.2		DLBWP.1.1	
Active UL BWP configuration		1, 2, 3	ULBWP.1.1		ULBWP.1.1	
RLM-RS		1, 2, 3	CSI-RS		SSB	
N_{oc} ^{Note 2}	dBm/SCS	1	-98			
		2	-98			
		3	-95			
N_{oc} ^{Note 2}	dBm/15 KHz	1	-98			
		2				
		3				
\hat{E}_s/I_{ot}	dB	1	4	-1.46	-Infinity	-1.46
		2				
		3				
\hat{E}_s/N_{oc}	dB	1	4	4	-Infinity	4
		2				
		3				
SS-RSRP ^{Note 3}	dBm/SCS KHz	1	-94	-94	-Infinity	-94
		2	-94	-94	-Infinity	-94
		3	-91	-91	-Infinity	-91
I _o	dBm/9.36 MHz	1	-64.60	-62.25	-Infinity	-62.25
	dBm/9.36 MHz	2	-64.60	-62.25	-Infinity	-62.25
	dBm/38.16 MHz	3	-58.50	-56.16	-Infinity	-56.16
Propagation Condition		1, 2, 3	AWGN			

Note 1: Table A.6.6.1.4.2-1 The resources for uplink transmission are assigned to the UE prior to the start of time period T2.

Note 2: Table A.6.6.1.4.2-1 Interference from other cells and noise sources not specified in the test is assumed to be constant over subcarriers and time and shall be modelled as AWGN of appropriate power for N_{oc} to be fulfilled.

Note 3: Table A.6.6.1.4.2-1 SS-RSRP levels have been derived from other parameters for information purposes. They are not settable parameters themselves.

Table A.6.6.1.4.2-4: Void**Table A.6.6.1.4.2-5: Void****A.6.6.1.4.3 Test Requirements**

In test 1, the UE shall send one Event A3 triggered measurement report, with a measurement reporting delay less than 920 ms from the beginning of time period T2. The UE is not required to read the neighbour cell SSB index in this test.

In test 2, the UE shall send one Event A3 triggered measurement report, with a measurement reporting delay less than 6400 ms from the beginning of time period T2. The UE is not required to read the neighbour cell SSB index in this test.

The UE shall not send event triggered measurement reports, as long as the reporting criteria are not fulfilled.

The rate of correct events observed during repeated tests shall be at least 90%.

NOTE: The actual overall delays measured in the test may be up to $2xTTI_{DCCH}$ higher than the measurement reporting delays above because of TTI insertion uncertainty of the measurement report in DCCH.

A.6.6.1.5 SA event triggered reporting tests without gap under non-DRX with SSB index reading**A.6.6.1.5.1 Test purpose and Environment**

The purpose of this test is to verify that the UE makes correct reporting of an event. This test will partly verify the FDD intra-frequency cell search requirements in clause 9.2.5.1 and 9.2.5.2.

A.6.6.1.5.2 Test parameters

Two cells are deployed in the test, which are FR1 PCell (Cell 1) and a FR1 neighbour cell (Cell 2) on the same frequency as the PCell. The test parameters for FDD PCell and neighbour cell are given in Table A.6.6.1.5.2-1 and A.6.6.1.5.2-2 below. In the measurement control information a measurement object is configured for the frequency of the PCell, and it is indicated to the UE that event-triggered reporting with Event A3 is used. The test consists of two successive time periods, with time duration of T1, and T2 respectively. During time duration T1, the UE shall not have any timing information of Cell 2.

Table A.6.6.1.5.2-1: Supported test configurations

Configuration	Description
1	15 kHz SSB SCS, 10MHz bandwidth, FDD duplex mode
Note:	The UE is only required to be tested in one of the supported test configurations.

Table A.6.6.1.5.2-2: General test parameters for SA intra-frequency event triggered reporting without gap for FDD PCell in FR1 with SSB index reading

Parameter	Unit	Test configuration	Value	Comment
Active cell		1	Cell 1	
Neighbour cell		1	Cell 2	Cell to be identified.
RF Channel Number		1	1: Cell 1 and Cell 2	
SSB configuration		1	SSB.1 FR1	
SMTC configuration		1	SMTC.2	
A3-Offset	dB	1	-4.5	
CP length		1	Normal	
Hysteresis	dB	1	0	
Time To Trigger	s	1	0	
Filter coefficient		1	0	L3 filtering is not used
DRX	ms	1		OFF
Time offset between PCell and PSCell		1	3 μ s	Synchronous EN-DC
Time offset between serving and neighbour cells		1	3 ms	Asynchronous cells. The timing of Cell 3 is 3ms later than the timing of Cell 2.
T1	s	1	5	
T2	s	1	5	

Table A.6.6.1.5.2-3: NR Cell specific test parameters for SA intra-frequency event triggered reporting without gap for FDD PCell in FR1 with SSB index reading

Parameter	Unit	Test configuration	Cell 1		Cell 2	
			T1	T2	T1	T2
TDD configuration		1	N/A		N/A	
PDSCH RMC configuration		1	SR.1.1 FDD		N/A	
RMSI CORESET RMC configuration		1	CR.1.1 FDD		CR.1.1 FDD	
Dedicated CORESET RMC configuration		1	CCR.1.1 FDD		CCR.1.1 FDD	
OCNG Patterns		1	OP.1		OP.1	
Initial BWP configuration		1	DLBWP.0.1 ULBWP.0.1		DLBWP.0.1 ULBWP.0.1	
Active DL BWP configuration		1	DLBWP.1.1		DLBWP.1.1	
Active UL BWP configuration		1	ULBWP.1.1		ULBWP.1.1	
RLM-RS		1	SSB		SSB	
N_{oc} Note 2	dBm/SCS	1	-98			
N_{oc} Note 2	dBm/15 KHz	1	-98			
\hat{E}_s/I_{ot}	dB	1	4	-1.46	-Infinity	-1.46
\hat{E}_s/N_{oc}	dB	1	4	4	-Infinity	4
SS-RSRP Note 3	dBm/SCS KHz	1	-94	-94	-Infinity	-94
Io	dBm/9.36 MHz	1	-64.60	-62.25	-Infinity	-62.25
Propagation Condition		1	AWGN			

Note 1:	The resources for uplink transmission are assigned to the UE prior to the start of time period T2.
Note 2:	Interference from other cells and noise sources not specified in the test is assumed to be constant over subcarriers and time and shall be modelled as AWGN of appropriate power for N_{oc} to be fulfilled.
Note 3:	SS-RSRP levels have been derived from other parameters for information purposes. They are not settable parameters themselves.

A.6.6.1.5.3 Test Requirements

The UE shall send one Event A3 triggered measurement report, with a measurement reporting delay less than 920 ms from the beginning of time period T2. The UE is required to read the neighbour cell SSB index and report the acquired SSB index in this test.

The UE shall not send event triggered measurement reports, as long as the reporting criteria are not fulfilled.

The rate of correct events observed during repeated tests shall be at least 90%.

NOTE: The actual overall delays measured in the test may be up to $2xTTI_{DCCH}$ higher than the measurement reporting delays above because of TTI insertion uncertainty of the measurement report in DCCH.

A.6.6.1.6 SA event triggered reporting tests with per-UE gaps under non-DRX with SSB index reading

A.6.6.1.6.1 Test purpose and Environment

The purpose of this test is to verify that the UE makes correct reporting of an event. This test will partly verify the FDD intra-frequency cell search requirements in clause 9.2.6.2 and 9.2.6.3.

A.6.6.1.6.2 Test parameters

Two cells are deployed in the test, which are FR1 PCell (Cell 1) and a FR1 neighbour cell (Cell 2) on the same frequency as the PCell. The test parameters for FDD PCell and neighbour cell are given in Table A.6.6.1.6.2-1 and A.6.6.1.6.2-2 below. In the measurement control information a measurement object is configured for the frequency of the PCell, and it is indicated to the UE that event-triggered reporting with Event A3 is used. The test consists of two successive time periods, with time duration of T1, and T2 respectively. During time duration T1, the UE shall not have any timing information of Cell 2.

There are two BWPs configured in Cell 1, BWP1 which contains the cell defining SSB, and BWP2 which does not contain any SSB of Cell 1. During the whole test, BWP2 is always scheduled as the active BWP for the UE.

Table A.6.6.1.6.2-1: Supported test configurations

Configuration	Description
1	15 kHz SSB SCS, 10MHz bandwidth, FDD duplex mode
Note:	The UE is only required to be tested in one of the supported test configurations.

Table A.6.6.1.6.2-2: General test parameters for SA intra-frequency event triggered reporting with gap for FDD PCell in FR1 with SSB index reading

Parameter	Unit	Test configuration	Value	Comment
Active cell		1	Cell 1	
Neighbour cell		1	Cell 2	Cell to be identified.
RF Channel Number		1	1: Cell 1 and Cell 2	
Measurement gap type		1	Per-UE gaps	
Measurement gap repetition periodicity	ms	1	40	
Measurement gap length	ms	1	6	
Measurement gap offset	ms	1	39	
SSB configuration		1	SSB.1 FR1	
SMTC configuration		1	SMTC.2	
CSI-RS parameters		1	CSI-RS.1.2 FDD	
A3-Offset	dB	1	-4.5	
CP length		1	Normal	
Hysteresis	dB	1	0	
Time To Trigger	s	1	0	
Filter coefficient		1	0	L3 filtering is not used
DRX	ms	1		OFF
Time offset between PCell and PSCell		1	3 μ s	Synchronous EN-DC
Time offset between serving and neighbour cells		1	3 ms	Asynchronous cells. The timing of Cell 3 is 3ms later than the timing of Cell 2.
T1	s	1	5	
T2	s	1	5	

Table A.6.6.1.6.2-3: NR Cell specific test parameters for SA intra-frequency event triggered reporting with gap for FDD PCell in FR1 with SSB index reading

Parameter	Unit	Test configuration	Cell 1		Cell 2	
			T1	T2	T1	T2
TDD configuration		1	N/A		N/A	
PDSCH RMC configuration		1	SR.1.1 FDD		N/A	
RMSI CORESET RMC configuration		1	CR.1.1 FDD		CR.1.1 FDD	
Dedicated CORESET RMC configuration		1	CCR.1.1 FDD		CCR.1.1 FDD	
OCNG Patterns		1	OP.1		OP.1	
Initial BWP configuration		1	DLBWP.0.1 ULBWP.0.1		DLBWP.0.1 ULBWP.0.1	
Active DL BWP configuration		1	DLBWP.1.2		DLBWP.1.1	
Active UL BWP configuration		1	ULBWP.1.1		ULBWP.1.1	
RLM-RS		1	CSI-RS		SSB	
N_{oc} Note 2	dBm/SCS	1	-98			
N_{oc} Note 2	dBm/15 KHz	1	-98			
\hat{E}_s/I_{ot}	dB	1	4	-1.46	-Infinity	-1.46

\hat{E}_s / N_{oc}	dB	1	4	4	-Infinity	4
SS-RSRP ^{Note 3}	dBm/SCS KHz	1	-94	-94	-Infinity	-94
lo	dBm/9.36 MHz	1	-64.60	-62.25	-Infinity	-62.25
Propagation Condition		1	AWGN			
<p>Note 1: The resources for uplink transmission are assigned to the UE prior to the start of time period T2.</p> <p>Note 2: Interference from other cells and noise sources not specified in the test is assumed to be constant over subcarriers and time and shall be modelled as AWGN of appropriate power for N_{oc} to be fulfilled.</p> <p>Note 3: SS-RSRP levels have been derived from other parameters for information purposes. They are not settable parameters themselves.</p>						

A.6.6.1.6.3 Test Requirements

The UE shall send one Event A3 triggered measurement report, with a measurement reporting delay less than 920 ms from the beginning of time period T2. The UE is required to read the neighbour cell SSB index and report the acquired SSB index in this test.

The UE shall not send event triggered measurement reports, as long as the reporting criteria are not fulfilled.

The rate of correct events observed during repeated tests shall be at least 90%.

NOTE: The actual overall delays measured in the test may be up to $2xTTI_{DCC}$ higher than the measurement reporting delays above because of TTI insertion uncertainty of the measurement report in DCC.

A.6.6.2 Inter-frequency Measurements

A.6.6.2.1 SA event triggered reporting tests for FR1 without SSB time index detection when DRX is not used

A.6.6.2.1.1 Test Purpose and Environment

The purpose of this test is to verify that the UE makes correct reporting of an event. This test will partly verify the SA inter-frequency NR cell search requirements in clause 9.3.4.

In this test, there are two cells: NR cell 1 as PCell in FR1 on NR RF channel 1 and NR cell 2 as neighbour cell in FR1 on NR RF channel 2. The test parameters are given in Tables A.6.6.2.1.1-1, A.6.6.2.1.1-2 and A.6.6.2.1.1-3.

In test 1 measurement gap pattern configuration # 0 as defined in Table A.6.6.2.1.1-2 is provided for UE that does not support per-FR gap and in test 2 measurement gap pattern configuration #4 as defined in Table A.6.6.2.1.1-2 is provided for UE that supports per-FR gap.

In the measurement control information, it is indicated to the UE that event-triggered reporting with Event A3 is used. The test consists of two successive time periods, with time duration of T1, and T2 respectively. During time duration T1, the UE shall not have any timing information of NR cell 2.

Table A.6.6.2.1.1-1: SA event triggered reporting tests without SSB index reading for FR1-FR1

Config	Description
1	NR 15 kHz SSB SCS, 10MHz bandwidth, FDD duplex mode
2	NR 15 kHz SSB SCS, 10MHz bandwidth, TDD duplex mode
3	NR 30kHz SSB SCS, 40MHz bandwidth, TDD duplex mode
Note 1: The UE is only required to be tested in one of the supported test configurations	
Note 2: target NR cell has the same SCS, BW and duplex mode as NR serving cell	

Table A.6.6.2.1.1-2: General test parameters for SA inter-frequency event triggered reporting for FR1 without SSB time index detection

Parameter	Unit	Test configuration	Value		Comment
			Test 1	Test 2	
NR RF Channel Number		Config 1,2,3	1, 2		Two FR1 NR carrier frequencies is used.
Active cell		Config 1,2,3	NR cell 1 (Pcell)		NR Cell 1 is on NR RF channel number 1.
Neighbour cell		Config 1,2,3	NR cell2		NR cell 2 is on NR RF channel number 2.
Gap Pattern Id		Config 1,2,3	0	4	As specified in clause 9.1.2-1.
Measurement gap offset		Config 1,2,3	39	19	
SMTC-SSB parameters		Config 1	SSB.1 FR1		As specified in clause A.3.10.1
		Config 2	SSB.1 FR1		As specified in clause A.3.10.1
		Config 3	SSB.2 FR1		As specified in clause A.3.10.1
A3-Offset	dB	Config 1,2,3	-6		
Hysteresis	dB	Config 1,2,3	0		
CP length		Config 1,2,3	Normal		
TimeToTrigger	s	Config 1,2,3	0		
Filter coefficient		Config 1,2,3	0		L3 filtering is not used
DRX		Config 1,2,3	OFF		DRX is not used
Time offset between serving and neighbour cells		Config 1	3ms		Asynchronous cells. The timing of Cell 2 is 3ms later than the timing of Cell 1.
		Config 2,3	3μs		Synchronous cells.
T1	s	Config 1,2,3	5		
T2	s	Config 1,2,3	TBD	TBD	

Table A.6.6.2.1.1-3: Cell specific test parameters for SA inter-frequency event triggered reporting for FR1 without SSB time index detection

Parameter	Unit	Test configuration	Cell 1		Cell 2	
			T1	T2	T1	T2
NR RF Channel Number		Config 1,2,3	1		2	
Duplex mode		Config 1	FDD			
		Config 2,3	TDD			
TDD configuration		Config 1	Not Applicable			
		Config 2	TDDConf.1.1			
		Config 3	TDDConf.2.1			
BW _{channel}	MHz	Config 1,2	10: N _{RB,c} = 52			
		Config 3	40: N _{RB,c} = 106			
BWP BW	MHz	Config 1,2	10: N _{RB,c} = 52			
		Config 3	40: N _{RB,c} = 106			
Initial DL BWP Initial UL BWP		Config 1, 2, 3	DLBWP.0.1		NA	
			ULBWP.0.1		NA	

BWP configuration	Dedicated DL BWP			DLBWP.1.1	NA	
	Dedicated UL BWP			ULBWP.1.1	NA	
OCNG Patterns defined in A.3.2.1.1 (OP.1)			Config 1,2,3	OP.1	OP.1	
PDSCH Reference measurement channel			Config 1	SR.1.1 FDD	-	
			Config 2	SR.1.1 TDD		
			Config 3	SR2.1 TDD		
CORESET Reference Channel			Config 1	CR.1.1 FDD	-	
			Config 2	CR.1.1 TDD		
			Config 3	CR2.1 TDD		
SMTC configuration defined in A.3.11.1 and A.3.11. 2			Config 1	SMTC.2		
			Config 2, 3	SMTC.1		
PDSCH/PDCCH subcarrier spacing		kHz	Config 1,2	15		
			Config 3	30		
EPRE ratio of PSS to SSS			Config 1,2,3	0	0	
EPRE ratio of PBCH DMRS to SSS						
EPRE ratio of PBCH to PBCH DMRS						
EPRE ratio of PDCCH DMRS to SSS						
EPRE ratio of PDCCH to PDCCH DMRS						
EPRE ratio of PDSCH DMRS to SSS						
EPRE ratio of PDSCH to PDSCH						
EPRE ratio of OCNG DMRS to SSS(Note 1)						
EPRE ratio of OCNG to OCNG DMRS (Note 1)						
N_{oc} ^{Note2}	dBm/15 kHz			-98		
N_{oc} ^{Note2}	dBm/S CS	Config 1,2		-98		
		Config 3		-95		
SS-RSRP ^{Note 3}	dBm/S CS	Config 1,2	-94	-94	-Infinity	-91
		Config 3	-91	-91	-Infinity	-88
\hat{E}_s/I_{α}	dB	Config 1,2,3,4,5,6	4	4	-Infinity	7
\hat{E}_s/N_{oc}	dB	Config 1,2,3	4	4	-Infinity	7
I_o ^{Note3}	dBm/9.36MHz	Config 1,2	-67.11	-67.11	-Infinity	-65.38
	dBm/38.16MHz	Config 3	-62.27	-62.27	-Infinity	-61.06
Propagation Condition			Config 1,2,3	AWGN		
<p>Note 1: OCNG shall be used such that both cells are fully allocated and a constant total transmitted power spectral density is achieved for all OFDM symbols.</p> <p>Note 2: Interference from other cells and noise sources not specified in the test is assumed to be constant over subcarriers and time and shall be modelled as AWGN of appropriate power for N_{oc} to be fulfilled.</p> <p>Note 3: SS-RSRP and I_o levels have been derived from other parameters for information purposes. They are not settable parameters themselves.</p> <p>Note 4: SS-RSRP minimum requirements are specified assuming independent interference and noise at each receiver antenna port.</p>						

A.6.6.2.1.2 Test Requirements

In test 1 with per-UE gap, the UE shall send one Event A3 triggered measurement report, with a measurement reporting delay less than [TBD] ms from the beginning of time period T2. The UE shall not send event triggered measurement reports, as long as the reporting criteria are not fulfilled. The rate of correct events observed during repeated tests shall be at least 90%.

In test 2 with per-FR gap, the UE shall send one Event A3 triggered measurement report, with a measurement reporting delay less than [TBD] ms from the beginning of time period T2. The UE shall not send event triggered measurement reports, as long as the reporting criteria are not fulfilled. The rate of correct events observed during repeated tests shall be at least 90%.

In test 1 and 2 UE is not required to report SSB time index.

NOTE: The actual overall delays measured in the test may be up to $2xTTI_{DCCCH}$ higher than the measurement reporting delays above because of TTI insertion uncertainty of the measurement report in DCCCH.

A.6.6.2.2 SA event triggered reporting tests for FR1 without SSB time index detection when DRX is used

A.6.6.2.2.1 Test Purpose and Environment

The purpose of this test is to verify that the UE makes correct reporting of an event. This test will partly verify the SA inter-frequency NR cell search requirements in clause 9.3.4.

In this test, there are two cells: NR cell 1 as PCell in FR1 on NR RF channel 1 and NR cell 2 as neighbour cell in FR1 on NR RF channel 2. The test parameters are given in Tables A.6.6.2.2.1-1, A.6.6.2.2.1-2 and A.6.6.2.2.1-3.

In test 1&2 measurement gap pattern configuration # 0 as defined in Table A.6.6.2.2.1-2 is provided for UE that does not support per-FR gap and in test 3&4 measurement gap pattern configuration #4 as defined in Table A.6.6.2.2.1-2 is provided for UE that supports per-FR gap.

In the measurement control information, it is indicated to the UE that event-triggered reporting with Event A3 is used. The test consists of two successive time periods, with time duration of T1, and T2 respectively. During time duration T1, the UE shall not have any timing information of NR cell 2.

UE needs to be provided at least once every 500ms with new Timing Advance Command MAC control element to restart the Time alignment timer to keep UE uplink time alignment. Furthermore UE is allocated with PUSCH resource at every DRX cycle.

Table A.6.6.2.2.1-1: SA event triggered reporting tests without SSB index reading for FR1-FR1

Config	Description
1	NR 15 kHz SSB SCS, 10MHz bandwidth, FDD duplex mode
2	NR 15 kHz SSB SCS, 10MHz bandwidth, TDD duplex mode
3	NR 30kHz SSB SCS, 40MHz bandwidth, TDD duplex mode
Note 1:	The UE is only required to be tested in one of the supported test configurations
Note 2:	target NR cell has the same SCS, BW and duplex mode as NR serving cell

Table A.6.6.2.1-2: General test parameters for SA inter-frequency event triggered reporting for FR1 without SSB time index detection

Parameter	Unit	Test configuration	Value				Comment
			Test 1	Test 2	Test 3	Test 4	
NR RF Channel Number		Config 1,2,3	1, 2				Two FR1 NR carrier frequencies is used.
Active cell		Config 1,2,3	NR cell 1 (Pcell)				NR Cell 1 is on NR RF channel number 1.
Neighbour cell		Config 1,2,3	NR cell2				NR cell 2 is on NR RF channel number 2.
Gap Pattern Id		Config 1,2,3	0		2		As specified in clause 9.1.2-1.
Measurement gap offset		Config 1,2,3	39		39		
SMTC-SSB parameters		Config 1	SSB.1 FR1				As specified in clause A.3.10.1
		Config 2	SSB.1 FR1				As specified in clause A.3.10.1
		Config 3	SSB.2 FR1				As specified in clause A.3.10.1
A3-Offset	dB	Config 1,2,3	-6				
Hysteresis	dB	Config 1,2,3	0				
CP length		Config 1,2,3	Normal				
TimeToTrigger	s	Config 1,2,3	0				
Filter coefficient		Config 1,2,3	0				L3 filtering is not used
DRX		Config 1,2,3	DRX .1	DRX .2	DRX .1	DRX .2	DRX is used
Time offset between serving and neighbour cells		Config 1	3ms				Asynchronous cells. The timing of Cell 2 is 3ms later than the timing of Cell 1.
		Config 2,3	3μs				Synchronous cells.
T1	s	Config 1,2,3	5				
T2	s	Config 1,2,3	TBD	TBD	TBD	TBD	

Table A.6.6.2.1-3: Cell specific test parameters for SA inter-frequency event triggered reporting for FR1 without SSB time index detection

Parameter	Unit	Test configuration	Cell 1		Cell 2	
			T1	T2	T1	T2
NR RF Channel Number		Config 1,2,3	1		2	
Duplex mode		Config 1	FDD			
		Config 2,3	TDD			
TDD configuration		Config 1	Not Applicable			
		Config 2	TDDConf.1.1			
		Config 3	TDDConf.2.1			
BW _{channel}	MHz	Config 1,2	10: N _{RB,c} = 52			
		Config 3	40: N _{RB,c} = 106			
BWP BW	MHz	Config 1,2	10: N _{RB,c} = 52			
		Config 3	40: N _{RB,c} = 106			
	Initial DL BWP	Config 1, 2, 3	DLBWP.0.1		NA	

BWP configuration	Initial UL BWP		Config 1, 2, 3	ULBWP.0.1	NA		
	Dedicated DL BWP			DLBWP.1.1	NA		
	Dedicated UL BWP			ULBWP.1.1	NA		
OCNG Patterns defined in A.3.2.1.1 (OP.1)			Config 1,2,3	OP.1	OP.1		
PDSCH Reference measurement channel			Config 1	SR.1.1 FDD	-		
			Config 2	SR.1.1 TDD			
			Config 3	SR2.1 TDD			
CORESET Reference Channel			Config 1	CR.1.1 FDD	-		
			Config 2	CR.1.1 TDD			
			Config 3	CR2.1 TDD			
SMTC configuration defined in A.3.11.1 and A.3.11. 2			Config 1	SMTC.2			
			Config 2, 3	SMTC.1			
PDSCH/PDCCH subcarrier spacing		kHz	Config 1,2	15			
			Config 3	30			
EPRE ratio of PSS to SSS			Config 1,2,3	0	0		
EPRE ratio of PBCH DMRS to SSS							
EPRE ratio of PBCH to PBCH DMRS							
EPRE ratio of PDCCH DMRS to SSS							
EPRE ratio of PDCCH to PDCCH DMRS							
EPRE ratio of PDSCH DMRS to SSS							
EPRE ratio of PDSCH to PDSCH							
EPRE ratio of OCNG DMRS to SSS(Note 1)							
EPRE ratio of OCNG to OCNG DMRS (Note 1)							
N_{oc} ^{Note2}	dBm/15 kHz						Config 1,2,3
N_{oc} ^{Note2}	dBm/S CS		Config 1,2	-98			
			Config 3	-95			
SS-RSRP ^{Note 3}		dBm/S CS	Config 1,2	-94	-94	-Infinity	-91
			Config 3	-91	-91	-Infinity	-88
\hat{E}_s/I_{ot}		dB	Config 1,2,3,4,5,6	4	4	-Infinity	7
\hat{E}_s/N_{oc}		dB	Config 1,2,3	4	4	-Infinity	7
I_o ^{Note3}		dBm/9.36MHz	Config 1,2	-67.11	-67.11	-Infinity	-65.38
		dBm/38.16MHz	Config 3	-62.27	-62.27	-Infinity	-61.06
Propagation Condition			Config 1,2,3	AWGN			

Note 1:	OCNG shall be used such that both cells are fully allocated and a constant total transmitted power spectral density is achieved for all OFDM symbols.
Note 2:	Interference from other cells and noise sources not specified in the test is assumed to be constant over subcarriers and time and shall be modelled as AWGN of appropriate power for N_{oc} to be fulfilled.
Note 3:	SS-RSRP and Io levels have been derived from other parameters for information purposes. They are not settable parameters themselves.
Note 4:	SS-RSRP minimum requirements are specified assuming independent interference and noise at each receiver antenna port.

Table A.6.6.2.2.1-4: DRX-Configuration for SA inter-frequency event triggered reporting without SSB time index detection

Field	Test1&3	Test2&4	Comment
	Value	Value	
drx-onDurationTimer	ms1	ms1	As specified in clause 6.3.2 in TS 38.331 [2]
drx-InactivityTimer	ms1	ms1	
drx-RetransmissionTimerDL	sl1	sl1	
drx-RetransmissionTimerUL	sl1	sl1	
drx-LongCycleStartOffset	ms40	Ms640	
shortDRX	disable	disable	

Table A.6.6.2.2.1-5: *TimeAlignmentTimer* -Configuration SA inter-frequency event triggered reporting without SSB time index detection

Field	Value	Comment
TimeAlignmentTimer	ms500	As specified in clause 6.3.2 in TS 38.331 [2]

A.6.6.2.2.2 Test Requirements

In test 1 with per-UE gap, the UE shall send one Event A3 triggered measurement report, with a measurement reporting delay less than [TBD] ms from the beginning of time period T2. The UE shall not send event triggered measurement reports, as long as the reporting criteria are not fulfilled. The rate of correct events observed during repeated tests shall be at least 90%.

In test 2 with per-FR gap, the UE shall send one Event A3 triggered measurement report, with a measurement reporting delay less than [TBD] ms from the beginning of time period T2. The UE shall not send event triggered measurement reports, as long as the reporting criteria are not fulfilled. The rate of correct events observed during repeated tests shall be at least 90%.

In test 3 with per-UE gap, the UE shall send one Event A3 triggered measurement report, with a measurement reporting delay less than [TBD] ms from the beginning of time period T2. The UE shall not send event triggered measurement reports, as long as the reporting criteria are not fulfilled. The rate of correct events observed during repeated tests shall be at least 90%.

In test 4 with per-FR gap, the UE shall send one Event A3 triggered measurement report, with a measurement reporting delay less than [TBD] ms from the beginning of time period T2. The UE shall not send event triggered measurement reports, as long as the reporting criteria are not fulfilled. The rate of correct events observed during repeated tests shall be at least 90%.

In test 1, 2, 3 and 4 UE is not required to report SSB time index.

NOTE: The actual overall delays measured in the test may be up to $2xTTI_{DCC}$ higher than the measurement reporting delays above because of TTI insertion uncertainty of the measurement report in DCC.

A.6.6.2.3 SA event triggered reporting tests for FR1 with SSB time index detection when DRX is not used

A.6.6.2.3.1 Test Purpose and Environment

The purpose of this test is to verify that the UE makes correct reporting of an event. This test will partly verify the SA inter-frequency NR cell search requirements in clause 9.3.4.

In this test, there are two cells: NR cell 1 as PCell in FR1 on NR RF channel 1 and NR cell 2 as neighbour cell in FR1 on NR RF channel 2. The test parameters are given in Tables A.6.6.2.3.1-1, A.6.6.2.3.1-2 and A.6.6.2.3.1-3. In test 1 measurement gap pattern configuration # 0 as defined in Table A.6.6.2.3.1-2 is provided for UE that does not support per-FR gap and in test 2 measurement gap pattern configuration #4 as defined in Table A.6.6.2.3.1-2 is provided for UE that supports per-FR gap..

In the measurement control information, it is indicated to the UE that event-triggered reporting with Event A3 is used. The test consists of two successive time periods, with time duration of T1, and T2 respectively. During time duration T1, the UE shall not have any timing information of NR cell 2.

Table A. 6.6.2.3.1-1 SA event triggered reporting tests with SSB index reading for FR1-FR1

Config	Description
1	NR 15 kHz SSB SCS, 10MHz bandwidth, FDD duplex mode
2	NR 15 kHz SSB SCS, 10MHz bandwidth, TDD duplex mode
3	NR 30kHz SSB SCS, 40MHz bandwidth, TDD duplex mode
Note 1:	The UE is only required to be tested in one of the supported test configurations
Note 2:	target NR cell has the same SCS, BW and duplex mode as NR serving cell

Table A. 6.6.2.3.1-2: General test parameters for SA inter-frequency event triggered reporting for FR1 with SSB time index detection

Parameter	Unit	Test configuration	Value		Comment
			Test 1	Test 2	
NR RF Channel Number		Config 1,2,3	1, 2		Two FR1 NR carrier frequencies is used.
Active cell		Config 1,2,3	NR cell 1 (Pcell)		NR Cell 1 is on NR RF channel number 1.
Neighbour cell		Config 1,2,3	NR cell2		NR cell 2 is on NR RF channel number 2.
Gap Pattern Id		Config 1,2,3	0	2	As specified in clause 9.1.2-1.
Measurement gap offset		Config 1,2,3	39	39	
SMTC-SSB parameters		Config 1	SSB.1 FR1		As specified in clause A.3.10.1
		Config 2	SSB.1 FR1		As specified in clause A.3.10.1
		Config 3	SSB.2 FR1		As specified in clause A.3.10.1
A3-Offset	dB	Config 1,2,3	-6		
Hysteresis	dB	Config 1,2,3	0		
CP length		Config 1,2,3	Normal		
TimeToTrigger	s	Config 1,2,3	0		
Filter coefficient		Config 1,2,3	0		L3 filtering is not used
DRX		Config 1,2,3	OFF		DRX is not used
Time offset between serving and neighbour cells		Config 1	3ms		Asynchronous cells. The timing of Cell 2 is 3ms later than the timing of Cell 1.
		Config 2,3	3μs		Synchronous cells.
T1	s	Config 1,2,3	5		
T2	s	Config 1,2,3	TBD	TBD	

Table A. 6.6.2.3.1-3: Cell specific test parameters for SA inter-frequency event triggered reporting for FR1 with SSB time index detection

Parameter	Unit	Test configuration	Cell 1		Cell 2	
			T1	T2	T1	T2
NR RF Channel Number		Config 1,2,3	1		2	
Duplex mode		Config 1	FDD			
		Config 2,3	TDD			
TDD configuration		Config 1	Not Applicable			
		Config 2	TDDConf.1.1			
		Config 3	TDDConf.2.1			
BW _{channel}	MHz	Config 1,2	10: N _{RB,c} = 52			
		Config 3	40: N _{RB,c} = 106			
BWP BW	MHz	Config 1,2	10: N _{RB,c} = 52			
		Config 3	40: N _{RB,c} = 106			
Initial DL BWP		Config 1, 2, 3	DLBWP.0.1		NA	
			ULBWP.0.1		NA	

BWP configuration	Dedicated DL BWP			DLBWP.1.1		NA	
	Dedicated UL BWP			ULBWP.1.1		NA	
OCNG Patterns defined in A.3.2.1.1 (OP.1)			Config 1,2,3	OP.1		OP.1	
PDSCH Reference measurement channel			Config 1	SR.1.1 FDD		-	
			Config 2	SR.1.1 TDD			
			Config 3	SR2.1 TDD			
CORESET Reference Channel			Config 1	CR.1.1 FDD		-	
			Config 2	CR.1.1 TDD			
			Config 3	CR2.1 TDD			
SMTC configuration defined in A.3.11.1 and A.3.11.2			Config 1	SMTC.2			
			Config 2, 3	SMTC.1			
PDSCH/PDCCH subcarrier spacing		kHz	Config 1,2	15			
			Config 3	30			
EPRE ratio of PSS to SSS			Config 1,2,3	0		0	
EPRE ratio of PBCH DMRS to SSS							
EPRE ratio of PBCH to PBCH DMRS							
EPRE ratio of PDCCH DMRS to SSS							
EPRE ratio of PDCCH to PDCCH DMRS							
EPRE ratio of PDSCH DMRS to SSS							
EPRE ratio of PDSCH to PDSCH							
EPRE ratio of OCNG DMRS to SSS(Note 1)							
EPRE ratio of OCNG to OCNG DMRS (Note 1)							
N_{oc} ^{Note2}	dBm/15 kHz		-98				
N_{oc} ^{Note2}	dBm/S CS	Config 1,2	-98				
		Config 3	-95				
SS-RSRP ^{Note 3}	dBm/S CS	Config 1,2	-94	-94	-Infinity	-91	
		Config 3	-91	-91	-Infinity	-88	
\hat{E}_s/I_{α}	dB	Config 1,2,3	4	4	-Infinity	7	
\hat{E}_s/N_{oc}	dB	Config 1,2,3	4	4	-Infinity	7	
I_o ^{Note3}	dBm/9.36MHz	Config 1,2	-67.11	-67.11	-Infinity	-65.38	
	dBm/38.16MHz	Config 3	-62.27	-62.27	-Infinity	-61.06	
Propagation Condition			Config 1,2,3	AWGN			
<p>Note 1: OCNG shall be used such that both cells are fully allocated and a constant total transmitted power spectral density is achieved for all OFDM symbols.</p> <p>Note 2: Interference from other cells and noise sources not specified in the test is assumed to be constant over subcarriers and time and shall be modelled as AWGN of appropriate power for N_{oc} to be fulfilled.</p> <p>Note 3: SS-RSRP and I_o levels have been derived from other parameters for information purposes. They are not settable parameters themselves.</p> <p>Note 4: SS-RSRP minimum requirements are specified assuming independent interference and noise at each receiver antenna port.</p>							

A.6.6.2.3.2 Test Requirements

In test 1 with per-UE gap, the UE shall send one Event A3 triggered measurement report, with a measurement reporting delay less than [TBD] ms from the beginning of time period T2. The UE shall not send event triggered measurement reports, as long as the reporting criteria are not fulfilled. The rate of correct events observed during repeated tests shall be at least 90%.

In test 2 with per-FR gap, the UE shall send one Event A3 triggered measurement report, with a measurement reporting delay less than [TBD] ms from the beginning of time period T2. The UE shall not send event triggered measurement reports, as long as the reporting criteria are not fulfilled. The rate of correct events observed during repeated tests shall be at least 90%.

In test 1 and 2 UE is required to report SSB time index.

NOTE: The actual overall delays measured in the test may be up to $2xTTI_{DCCCH}$ higher than the measurement reporting delays above because of TTI insertion uncertainty of the measurement report in DCCCH.

A.6.6.2.4 SA event triggered reporting tests for FR1 with SSB time index detection when DRX is used

A.6.6.2.4.1 Test Purpose and Environment

The purpose of this test is to verify that the UE makes correct reporting of an event. This test will partly verify the SA inter-frequency NR cell search requirements in clause 9.3.4.

In this test, there are two cells: NR cell 1 as PCell in FR1 on NR RF channel 1 and NR cell 2 as neighbour cell in FR1 on NR RF channel 2. The test parameters are given in Tables A.6.6.2.4.1-1, A.6.6.2.4.1-2 and A.6.6.2.4.1-3.

In test 1&2 measurement gap pattern configuration # 0 as defined in Table A.6.6.2.4.1-2 is provided for UE that does not support per-FR gap and in test 3&4 measurement gap pattern configuration #4 as defined in Table A.6.6.2.4.1-2 is provided for UE that supports per-FR gap.

In the measurement control information, it is indicated to the UE that event-triggered reporting with Event A3 is used. The test consists of two successive time periods, with time duration of T1, and T2 respectively. During time duration T1, the UE shall not have any timing information of NR cell 2.

UE needs to be provided at least once every 500ms with new Timing Advance Command MAC control element to restart the Time alignment timer to keep UE uplink time alignment. Furthermore UE is allocated with PUSCH resource at every DRX cycle.

Table A.6.6.2.4.1-1: SA event triggered reporting tests with SSB index reading for FR1-FR1

Config	Description
1	NR 15 kHz SSB SCS, 10MHz bandwidth, FDD duplex mode
2	NR 15 kHz SSB SCS, 10MHz bandwidth, TDD duplex mode
3	NR 30kHz SSB SCS, 40MHz bandwidth, TDD duplex mode
Note 1: The UE is only required to be tested in one of the supported test configurations	
Note 2: target NR cell has the same SCS, BW and duplex mode as NR serving cell	

Table A.6.6.2.4.1-2: General test parameters for SA inter-frequency event triggered reporting for FR1 with SSB time index detection

Parameter	Unit	Test configuration	Value				Comment
			Test 1	Test 2	Test 3	Test 4	
NR RF Channel Number		Config 1,2,3	1, 2				Two FR1 NR carrier frequencies is used.
Active cell		Config 1,2,3	NR cell 1 (Pcell)				NR Cell 1 is on NR RF channel number 1.
Neighbour cell		Config 1,2,3	NR cell2				NR cell 2 is on NR RF channel number 2.
Gap Pattern Id		Config 1,2,3	0		2		As specified in clause 9.1.2-1.
Measurement gap offset		Config 1,2,3	39		39		
SMTC-SSB parameters		Config 1	SSB.1 FR1				As specified in clause A.3.10.1
		Config 2	SSB.1 FR1				As specified in clause A.3.10.1
		Config 3	SSB.2 FR1				As specified in clause A.3.10.1
A3-Offset	dB	Config 1,2,3	-6				
Hysteresis	dB	Config 1,2,3	0				
CP length		Config 1,2,3	Normal				
TimeToTrigger	s	Config 1,2,3	0				
Filter coefficient		Config 1,2,3	0				L3 filtering is not used
DRX		Config 1,2,3	DRX .1	DRX .2	DRX .1	DRX .2	DRX is used
Time offset between serving and neighbour cells		Config 1	3ms				Asynchronous cells. The timing of Cell 2 is 3ms later than the timing of Cell 1.
		Config 2,3	3µs				Synchronous cells.
T1	s	Config 1,2,3	5				
T2	s	Config 1,2,3	TBD	TBD	TBD	TBD	

Table A.6.6.2.4.1-3: Cell specific test parameters for SA inter-frequency event triggered reporting for FR1 with SSB time index detection

Parameter	Unit	Test configuration	Cell 1		Cell 2	
			T1	T2	T1	T2
NR RF Channel Number		Config 1,2,3	1		2	
Duplex mode		Config 1	FDD			
		Config 2,3	TDD			
TDD configuration		Config 1	Not Applicable			
		Config 2	TDDConf.1.1			
		Config 3	TDDConf.2.1			
BW _{channel}	MHz	Config 1,2	10: N _{RB,c} = 52			
		Config 3	40: N _{RB,c} = 106			
BWP BW	MHz	Config 1,2	10: N _{RB,c} = 52			
		Config 3	40: N _{RB,c} = 106			
	Initial DL BWP	Config 1, 2, 3	DLBWP.0.1		NA	
	Initial UL BWP		ULBWP.0.1		NA	

BWP configuration	Dedicated DL BWP			DLBWP.1.1		NA	
	Dedicated UL BWP			ULBWP.1.1		NA	
OCNG Patterns defined in A.3.2.1.1 (OP.1)			Config 1,2,3	OP.1		OP.1	
PDSCH Reference measurement channel			Config 1	SR.1.1 FDD		-	
			Config 2	SR.1.1 TDD			
			Config 3	SR2.1 TDD			
CORESET Reference Channel			Config 1	CR.1.1 FDD		-	
			Config 2	CR.1.1 TDD			
			Config 3	CR2.1 TDD			
SMTC configuration defined in A.3.11.1 and A.3.11. 2			Config 1	SMTC.2			
			Config 2, 3	SMTC.1			
PDSCH/PDCCH subcarrier spacing		kHz	Config 1,2	15			
			Config 3	30			
EPRE ratio of PSS to SSS			Config 1,2,3	0		0	
EPRE ratio of PBCH DMRS to SSS							
EPRE ratio of PBCH to PBCH DMRS							
EPRE ratio of PDCCH DMRS to SSS							
EPRE ratio of PDCCH to PDCCH DMRS							
EPRE ratio of PDSCH DMRS to SSS							
EPRE ratio of PDSCH to PDSCH							
EPRE ratio of OCNG DMRS to SSS(Note 1)							
EPRE ratio of OCNG to OCNG DMRS (Note 1)							
N_{oc} ^{Note2}	dBm/15 kHz						
N_{oc} ^{Note2}	dBm/S CS	Config 1,2	-98				
		Config 3	-95				
SS-RSRP ^{Note 3}	dBm/S CS	Config 1,2	-94	-94	-Infinity	-91	
		Config 3	-91	-91	-Infinity	-88	
\hat{E}_s/I_{ot}	dB	Config 1,2,3	4	4	-Infinity	7	
\hat{E}_s/N_{oc}	dB	Config 1,2,3	4	4	-Infinity	7	
I_o ^{Note3}	dBm/9.36MHz	Config 1,2	-67.11	-67.11	-Infinity	-	
	dBm/38.16MHz	Config 3	-62.27	-62.27	-Infinity	-61.06	
Propagation Condition			Config 1,2,3	AWGN			
<p>Note 1: OCNG shall be used such that both cells are fully allocated and a constant total transmitted power spectral density is achieved for all OFDM symbols.</p> <p>Note 2: Interference from other cells and noise sources not specified in the test is assumed to be constant over subcarriers and time and shall be modelled as AWGN of appropriate power for N_{oc} to be fulfilled.</p> <p>Note 3: SS-RSRP and I_o levels have been derived from other parameters for information purposes. They are not settable parameters themselves.</p> <p>Note 4: SS-RSRP minimum requirements are specified assuming independent interference and noise at each receiver antenna port.</p>							

A.6.6.2.4.2 Test Requirements

In test 1 with per-UE gap, the UE shall send one Event A3 triggered measurement report, with a measurement reporting delay less than [TBD] ms from the beginning of time period T2. The UE shall not send event triggered measurement reports, as long as the reporting criteria are not fulfilled. The rate of correct events observed during repeated tests shall be at least 90%.

In test 2 with per-FR gap, the UE shall send one Event A3 triggered measurement report, with a measurement reporting delay less than [TBD] ms from the beginning of time period T2. The UE shall not send event triggered measurement reports, as long as the reporting criteria are not fulfilled. The rate of correct events observed during repeated tests shall be at least 90%.

In test 3 with per-UE gap, the UE shall send one Event A3 triggered measurement report, with a measurement reporting delay less than [TBD] ms from the beginning of time period T2. The UE shall not send event triggered measurement reports, as long as the reporting criteria are not fulfilled. The rate of correct events observed during repeated tests shall be at least 90%.

In test 4 with per-FR gap, the UE shall send one Event A3 triggered measurement report, with a measurement reporting delay less than [TBD] ms from the beginning of time period T2. The UE shall not send event triggered measurement reports, as long as the reporting criteria are not fulfilled. The rate of correct events observed during repeated tests shall be at least 90%.

In test 1, 2, 3 and 4 UE is required to report SSB time index.

NOTE: The actual overall delays measured in the test may be up to $2xTTI_{DCCH}$ higher than the measurement reporting delays above because of TTI insertion uncertainty of the measurement report in DCCH.

A.6.6.3 Inter-RAT Measurements

A.6.6.3.1 SA NR - E-UTRAN event-triggered reporting in non-DRX in FR1

A.6.6.3.1.1 Test Purpose and Environment

The purpose of this set of tests is to verify that the UE makes correct event-triggered reporting of inter-RAT E-UTRAN measurements when operating in standalone (SA) operation with PCell in FR1. This test shall partly verify the cell search and measurement requirements in Clauses 9.4.2 and 9.4.3.

In each test there are two cells: Cell 1 and Cell 2. Cell 1 is the NR PCell and Cell 2 is an inter-RAT E-UTRAN inter-RAT neighbour cell. In the measurement control information from the PCell it is indicated to the UE that event-triggered reporting with Event B2 (PCell becomes worse than threshold1 and inter RAT neighbour becomes better than threshold2) is to be used. Each test consists of two consecutive time periods, with durations T1 and T2, respectively. Prior to the start of time duration T1, the UE shall be fully synchronized to Cell 1. During T1, the UE shall not have any information on Cell 2.

Supported test configurations are shown in table A.6.6.3.1.1-1. General test parameters are provided in Table A.6.6.3.1.1-2 below. Test parameters for Cell 1 and Cell 2, valid for both time duration T1 and T2, are provided in Tables A.6.6.3.1.1-3 and A.6.6.3.1.1-4, respectively.

Table A.6.6.3.1.1-1: Supported test configurations in SA inter-RAT E-UTRAN event triggered reporting in non-DRX with PCell in FR1

Configuration	Description
1	NR 15 kHz SSB SCS, 10MHz bandwidth, FDD duplex mode, LTE FDD
2	NR 15 kHz SSB SCS, 10MHz bandwidth, TDD duplex mode, LTE FDD
3	NR 30 kHz SSB SCS, 40MHz bandwidth, TDD duplex mode, LTE FDD
4	NR 15 kHz SSB SCS, 10MHz bandwidth, FDD duplex mode, LTE TDD
5	NR 15 kHz SSB SCS, 10MHz bandwidth, TDD duplex mode, LTE TDD
6	NR 30kHz SSB SCS, 40MHz bandwidth, TDD duplex mode, LTE TDD
Note:	The UE is only required to be tested in one of the supported test configurations

Table A.6.6.3.1.1-2: General test parameters for SA inter-RAT E-UTRAN event triggered reporting in non-DRX with PCell in FR1

Parameter	Unit	Value	Comment
NR RF Channel Number		1	1 NR carrier frequency is used in the test
LTE RF Channel Number		1	1 LTE carrier frequency is used in the test
Channel Bandwidth	MHz	As specified in Tables A.6.6.3.1.1-2 and A.6.6.3.1.1-3.	
Active cell		Cell 1	Cell 1 is on RF channel number 1
Neighbour cell		Cell 2	Cell 2 is on RF channel number 2
Gap Pattern Id		0	As specified in Clause Table 9.1.2-1. Per-UE gap pattern.
NR measurement quantity		SS-RSRP	Measurement quantity for Cell 1
Inter-RAT E-UTRAN measurement quantity		RSRP	Measurement quantity for Cell 2
b2-Threshold1	dBm	Note 1	SS-RSRP threshold for SS-RSRP measurement on cell1 for event B2
b2-Threshold2EUTRA	dBm	-95	E-UTRAN RSRP threshold for SS-RSRP measurement on cell1 for event B2
Hysteresis	dB	0	
TimeToTrigger	s	0	
Filter coefficient		0	L3 filtering is not used
DRX		OFF	OFF
T1	s	5	
T2	s	5	
Note 1: Values are defined in Table A.6.6.3.1.1-3			

Table A.6.6.3.1.1-3: PCell specific test parameters for SA inter-RAT E-UTRA event triggered reporting in non-DRX with PCell in FR1

Parameter		Unit	Configuration	Cell 1	
				T1	T2
RF channel number			1, 2, 3, 4, 5, 6	1	
Duplex mode			1, 2, 3	FDD	
			4, 5, 6	TDD	
TDD Configuration	SCS=15 KHz		2, 5	TDDConf.1.1	
	SCS=30 KHz		3, 6	TDDConf.1.2	
BW _{channel}		MHz	1, 4	10: N _{RB,c} = 52 (FDD)	
			2, 5	10: N _{RB,c} = 52 (TDD)	
			3, 6	40: N _{RB,c} = 106 (TDD)	
PDSCH reference measurement channel			1, 4	SR.1.1 FDD	
			2, 5	SR.1.1 TDD	
			3, 6	SR.2.1 TDD	
CORSET reference channel			1, 4	CR.1.1 FDD	
			2, 5	CR.1.1 TDD	
			3, 6	CR.2.1 TDD	
BWP configurations	Initial DL BWP		1, 2, 3, 4, 5, 6	DLBWP.0.1	

	Dedicated DL BWP		1, 2, 3, 4, 5, 6	DLBWP.1.1	
	Initial UL BWP		1, 2, 3, 4, 5, 6	ULBWP.0.1	
	Dedicated UL BWP		1, 2, 3, 4, 5, 6	ULBWP.1.1	
OCNG pattern ^{Note1}			1, 2, 3, 4, 5, 6	OP.1	
SMTTC configuration			1, 2, 3, 4, 5, 6	SMTTC.1	
SSB configuration			1, 2, 4, 5	SSB.1 FR1	
			3, 6	SSB.2 FR1	
b2-Threshold1	dBm		1, 2, 4, 5	-89	
			3, 6	-86	
EPRE ratio of PSS to SSS		dB	1, 2, 3, 4, 5, 6	0	
EPRE ratio of PBCH_DMRS to SSS					
EPRE ratio of PBCH to PBCH_DMRS					
EPRE ratio of PDCCH_DMRS to SSS					
EPRE ratio of PDCCH to PDCCH_DMRS					
EPRE ratio of PDSCH_DMRS to SSS					
EPRE ratio of PDSCH to PDSCH_DMRS					
EPRE ratio of OCNG DMRS to SSS					
EPRE ratio of OCNG to OCNG DMRS					
N_{oc} ^{Note2}	dBm/15 KHz		1, 2, 3, 4, 5, 6	-104	
N_{oc} ^{Note2}	dBm/SCS		1, 2, 4, 5	-104	
			3, 6	-101	
\hat{E}_s/N_{oc}	dB		1, 2, 3, 4, 5, 6	17	7
\hat{E}_s/I_{ot} ^{Note3}	dB		1, 2, 3, 4, 5, 6	17	7
SS-RSRP ^{Note3}	dBm/SCS		1, 2, 4, 5	-87	-97
			3, 6	-84	-94
SSB_RP ^{Note3}	dBm/SCS		1, 2, 4, 5	-87	-97
			3, 6	-84	-94
I_o ^{Note3}	dBm/9.36 MHz		1, 2, 4, 5	-58.96	-68.26
	dBm/38.16 MHz		3, 6	-52.87	-62.17
Propagation condition			1, 2, 3, 4, 5, 6	ETU70	
Antenna Configuration and Correlation Matrix			1, 2, 3, 4, 5, 6	1x2 Low	
<p>Note 1: OCNG shall be used such that both cells are fully allocated and a constant total transmitted power spectral density is achieved for all OFDM symbols.</p> <p>Note 2: Interference from other cells and noise sources not specified in the test is assumed to be constant over subcarriers and time and shall be modelled as AWGN of appropriate power for N_{oc} to be fulfilled.</p> <p>Note 3: \hat{E}_s/I_{ot}, SS-RSRP, SSB_RP and I_o levels have been derived from other parameters for information purposes. They are not settable parameters themselves.</p>					

Table A.6.6.3.1.1-4: E-UTRAN neighbour cell specific test parameters for SA inter-RAT E-UTRAN event triggered reporting in non-DRX with PCell in FR1

Parameter	Unit	Configuration	Cell 2	
			T1	T2
RF channel number		1, 2, 3, 4, 5, 6	1	
Duplex mode		1, 2, 3	FDD	
		4, 5, 6	TDD	
TDD special subframe configuration ^{Note1}		4, 5, 6	6	
TDD uplink-downlink configuration ^{Note1}		4, 5, 6	1	
BW _{channel}	MHz	1, 2, 3, 4, 5, 6	5MHz: $N_{RB,c} = 25$ 10MHz: $N_{RB,c} = 50$	

PDSCH parameters: DL Reference Measurement Channel ^{Note2}		1, 2, 3	20MHz: $N_{RB,c} = 100$ 5MHz: R.7 FDD 10MHz: R.3 FDD 20MHz: R.6 FDD	
		4, 5, 6	5MHz: R.4 TDD 10MHz: R.0 TDD 20MHz: R.3 TDD	
PCFICH/PDCCH/PHICH parameters: DL Reference Measurement Channel ^{Note2}		1, 2, 3	5MHz: R.11 FDD 10MHz: R.6 FDD 20MHz: R.10 FDD	
		4, 5, 6	5MHz: R.11 TDD 10MHz: R.6 TDD 20MHz: R.10 TDD	
OCNG Patterns ^{Note2}		1, 2, 3	5MHz: OP.20 FDD 10MHz: OP.10 FDD 20MHz: OP.17 FDD	
		4, 5, 6	5MHz: OP.9 TDD 10MHz: OP.1 TDD 20MHz: OP.7 TDD	
PBCH_RA	dB	1, 2, 3, 4, 5, 6	0	
PBCH_RB				
PSS_RA				
SSS_RA				
PCFICH_RB				
PHICH_RA				
PHICH_RB				
PDCCH_RA				
PDCCH_RB				
PDSCH_RA				
PDSCH_RB				
OCNG_RA ^{Note3}				
OCNG_RB ^{Note3}				
N_{oc} ^{Note4}	dBm/15kHz	1, 2, 3, 4, 5, 6	-104	
\hat{E}_s/N_{oc}	dB	1, 2, 3, 4, 5, 6	-Infinity	17
\hat{E}_s/I_{ot} ^{Note5}	dB	1, 2, 3, 4, 5, 6	-Infinity	17
RSRP ^{Note5}	dBm/15kHz	1, 2, 3, 4, 5, 6	-Infinity	-87
SCH_RP ^{Note5}	dBm/15kHz	1, 2, 3, 4, 5, 6	-Infinity	-87
I_o ^{Note5}	dBm/9MHz	1, 2, 3, 4, 5, 6	$-76.22+10\log(N_{RB,c}/50)$	$-59.13+10\log(N_{RB,c}/50)$
Propagation Condition		1, 2, 3, 4, 5, 6	ETU70	
Antenna Configuration and Correlation Matrix		1, 2, 3, 4, 5, 6	1x2 Low	
<p>Note 1: Special subframe and uplink-downlink configurations are specified in table 4.2-1 in TS 36.211.</p> <p>Note 2: DL RMCs and OCNG patterns are specified in sections A 3.1 and A 3.2 of TS 36.133 respectively.</p> <p>Note 3: OCNG shall be used such that all cells are fully allocated and a constant total transmitted power spectral density is achieved for all OFDM symbols.</p> <p>Note 4: Interference from other cells and noise sources not specified in the test is assumed to be constant over subcarriers and time and shall be modelled as AWGN of appropriate power for N_{oc} to be fulfilled.</p> <p>Note 5: \hat{E}_s/I_{ot}, RSRP, SCH_RP and I_o levels have been derived from other parameters for information purposes. They are not settable parameters themselves.</p>				

A.6.6.3.1.2 Test Requirements

The UE shall send one Event B2 triggered measurement report for Cell 2 to the PCell, with a measurement reporting delay less than 3.84s from the start of period T2. The measurement reporting delay is defined as the time from the beginning of time period T2 to the moment when the UE sends the measurement report on PUSCH.

The UE shall not send event-triggered measurement reports as long as the reporting criteria is not fulfilled.

The rate of correct events observed during repeated tests shall be at least 90%.

A.6.6.3.2 SA NR - E-UTRAN event-triggered reporting in DRX in FR1

A.6.6.3.2.1 Test Purpose and Environment

The purpose of this set of tests is to verify that the UE makes correct event-triggered reporting of inter-RAT E-UTRAN measurements when operating in standalone (SA) operation with PCell in FR1 when DRX is used. This test shall partly verify the cell search and measurement requirements in Clauses 9.4.2 and 9.4.3. There are two test cases. In test 1 the UE shall be configured with DRX cycle of 40 ms. In test 2 the UE shall be configured with DRX cycle of 640 ms.

In each test there are two cells: Cell 1 and Cell 2. Cell 1 is the NR PCell and Cell 2 is an inter-RAT E-UTRAN inter-RAT neighbour cell. In the measurement control information from the PCell it is indicated to the UE that event-triggered reporting with Event B2 (PCell becomes worse than threshold1 and inter RAT neighbour becomes better than threshold2) is to be used. Each test consists of two consecutive time periods, with durations T1 and T2, respectively. Prior to the start of time duration T1, the UE shall be fully synchronized to Cell 1. During T1, the UE shall not have any information on Cell 2.

In each test the UE shall be provided at least once every 500ms with new Timing Advance Command MAC control element to restart the Time alignment timer to keep UE uplink time alignment. Furthermore the UE shall be allocated with PUSCH resource at every DRX cycle.

Supported test configurations are shown in table A.6.6.3.2.1-1. General test parameters are provided in Table A.6.6.3.2.1-2 below. Test parameters for Cell 1 and Cell 2, valid for both time duration T1 and T2, are provided in Tables A.6.6.3.2.1-3 and A.6.6.3.2.1-4, respectively.

Table A.6.6.3.2.1-1: Supported test configurations in SA inter-RAT E-UTRAN event triggered reporting in DRX with PCell in FR1

Configuration	Description
1	NR 15 kHz SSB SCS, 10MHz bandwidth, FDD duplex mode, LTE FDD
2	NR 15 kHz SSB SCS, 10MHz bandwidth, TDD duplex mode, LTE FDD
3	NR 30 kHz SSB SCS, 40MHz bandwidth, TDD duplex mode, LTE FDD
4	NR 15 kHz SSB SCS, 10MHz bandwidth, FDD duplex mode, LTE TDD
5	NR 15 kHz SSB SCS, 10MHz bandwidth, TDD duplex mode, LTE TDD
6	NR 30kHz SSB SCS, 40MHz bandwidth, TDD duplex mode, LTE TDD
Note:	The UE is only required to be tested in one of the supported test configurations

Table A.6.6.3.2.1-2: General test parameters for SA inter-RAT E-UTRAN event triggered reporting in DRX with PCell in FR1

Parameter	Unit	Test 1		Test 2		Comment
		Value				
NR RF Channel Number		1				1 NR carrier frequency is used in the test
LTE RF Channel Number		2				1 LTE carrier frequency is used in the test
Channel Bandwidth	MHz	As specified in Tables A.6.6.3.2.1-2 and A.6.6.3.2.1-3.				
Active cell		Cell 1				Cell 1 is on RF channel number 1
Neighbour cell		Cell 2				Cell 2 is on RF channel number 2
Gap Pattern Id		0				As specified in Clause Table 9.1.2-1. Per-UE gap pattern.
NR measurement quantity		SS-RSRP				Measurement quantity for Cell 1
Inter-RAT E-UTRAN measurement quantity		RSRP				Measurement quantity for Cell 2
b2-Threshold1	dBm	Note 1				SS-RSRP threshold for SS-RSRP measurement on cell1 for event B2
b2-Threshold2EUTRA	dBm	-95				E-UTRAN RSRP threshold for SS-RSRP measurement on cell1 for event B2
Hysteresis	dB	0				
TimeToTrigger	s	0				
Filter coefficient		0				L3 filtering is not used
DRX		DRX.1	DRX.2			DRX cycle configurations DRX.1 and DRX.2 are defined in Table A.3.3.1-1 and Table A.3.3.2-1 respectively.
T1	s	5				
T2	s	5	15			
Note 1: Values are defined in Table A.6.6.3.2.1-3						

Table A.6.6.3.2.1-3: PCell specific test parameters for SA inter-RAT E-UTRA event triggered reporting in DRX with PCell in FR1

Parameter		Unit	Configuration	Cell 1	
				T1	T2
RF channel number			1, 2, 3, 4, 5, 6	1	
Duplex mode			1, 2, 3	FDD	
			4, 5, 6	TDD	
TDD Configuration	SCS=15 KHz		2, 5	TDDConf.1.1	
	SCS=30 KHz		3, 6	TDDConf.2.1	
BW _{channel}		MHz	1, 4	10: N _{RB,c} = 52 (FDD)	
			2, 5	10: N _{RB,c} = 52 (TDD)	
			3, 6	40: N _{RB,c} = 106 (TDD)	
PDSCH reference measurement channel			1, 4	SR.1.1 FDD	
			2, 5	SR.1.1 TDD	
			3, 6	SR.2.1 TDD	
CORSET reference channel			1, 4	CR.1.1 FDD	
			2, 5	CR.1.1 TDD	
			3, 6	CR.2.1 TDD	
BWP configurations	Initial DL BWP		1, 2, 3, 4, 5, 6	DLBWP.0.1	
	Dedicated DL BWP		1, 2, 3, 4, 5, 6	DLBWP.1.1	
	Initial UL BWP		1, 2, 3, 4, 5, 6	ULBWP.0.1	
	Dedicated UL BWP		1, 2, 3, 4, 5, 6	ULBWP.1.1	
OCNG pattern ^{Note1}			1, 2, 3, 4, 5, 6	OP.1	
SMTC configuration			1, 2, 3, 4, 5, 6	SMTC.1	
SSB configuration			1, 2, 4, 5	SSB.1 FR1	
			3, 6	SSB.2 FR1	
b2-Threshold1		dBm	1, 2, 4, 5	-89	

		3, 6	-86	
EPRE ratio of PSS to SSS	dB	1, 2, 3, 4, 5, 6	0	
EPRE ratio of PBCH_DMRS to SSS				
EPRE ratio of PBCH to PBCH_DMRS				
EPRE ratio of PDCCH_DMRS to SSS				
EPRE ratio of PDCCH to PDCCH_DMRS				
EPRE ratio of PDSCH_DMRS to SSS				
EPRE ratio of PDSCH to PDSCH_DMRS				
EPRE ratio of OCNG DMRS to SSS				
EPRE ratio of OCNG to OCNG DMRS				
N_{oc} ^{Note2}	dBm/15 KHz	1, 2, 3, 4, 5, 6	-104	
N_{oc} ^{Note2}	dBm/SCS	1, 2, 4, 5	-104	
		3, 6	-101	
\bar{E}_s/N_{oc}	dB	1, 2, 3, 4, 5, 6	17	7
\bar{E}_s/I_{ot} ^{Note3}	dB	1, 2, 3, 4, 5, 6	17	7
SS-RSRP ^{Note3}	dBm/SCS	1, 2, 4, 5	-87	-97
		3, 6	-84	-94
SSB_RP ^{Note3}	dBm/SCS	1, 2, 4, 5	-87	-97
		3, 6	-84	-94
I_o ^{Note3}	dBm/9.36 MHz	1, 2, 4, 5	-58.96	-68.26
	dBm/38.16 MHz	3, 6	-52.87	-62.17
Propagation condition		1, 2, 3, 4, 5, 6	ETU70	
Antenna Configuration and Correlation Matrix		1, 2, 3, 4, 5, 6	1x2 Low	
<p>Note 1: OCNG shall be used such that both cells are fully allocated and a constant total transmitted power spectral density is achieved for all OFDM symbols.</p> <p>Note 2: Interference from other cells and noise sources not specified in the test is assumed to be constant over subcarriers and time and shall be modelled as AWGN of appropriate power for N_{oc} to be fulfilled.</p> <p>Note 3: \bar{E}_s/I_{ot}, SS-RSRP, SSB_RP and I_o levels have been derived from other parameters for information purposes. They are not settable parameters themselves.</p>				

Table A.6.6.3.2.1-4: E-UTRAN neighbour cell specific test parameters for SA inter-RAT E-UTRAN event triggered reporting in DRX with PCell in FR1

Parameter	Unit	Configuration	Cell 2	
			T1	T2
RF channel number		1, 2, 3, 4, 5, 6	2	
Duplex mode		1, 2, 3	FDD	
		4, 5, 6	TDD	
TDD special subframe configuration ^{Note1}		4, 5, 6	6	
TDD uplink-downlink configuration ^{Note1}		4, 5, 6	1	
$BW_{channel}$	MHz	1, 2, 3, 4, 5, 6	5MHz: $N_{RB,c} = 25$ 10MHz: $N_{RB,c} = 50$ 20MHz: $N_{RB,c} = 100$	
PDSCH parameters: DL Reference Measurement Channel ^{Note2}		1, 2, 3	5MHz: R.7 FDD 10MHz: R.3 FDD 20MHz: R.6 FDD	
		4, 5, 6	5MHz: R.4 TDD 10MHz: R.0 TDD 20MHz: R.3 TDD	

PCFICH/PDCCH/PHICH parameters: DL Reference Measurement Channel ^{Note2}		1, 2, 3	5MHz: R.11 FDD 10MHz: R.6 FDD 20MHz: R.10 FDD	
		4, 5, 6	5MHz: R.11 TDD 10MHz: R.6 TDD 20MHz: R.10 TDD	
OCNG Patterns ^{Note2}		1, 2, 3	5MHz: OP.20 FDD 10MHz: OP.10 FDD 20MHz: OP.17 FDD	
		4, 5, 6	5MHz: OP.9 TDD 10MHz: OP.1 TDD 20MHz: OP.7 TDD	
PBCH_RA	dB	1, 2, 3, 4, 5, 6	0	
PBCH_RB				
PSS_RA				
SSS_RA				
PCFICH_RB				
PHICH_RA				
PHICH_RB				
PDCCH_RA				
PDCCH_RB				
PDSCH_RA				
PDSCH_RB				
OCNG_RA ^{Note3}				
OCNG_RB ^{Note3}				
N_{oc} ^{Note4}	dBm/15kHz	1, 2, 3, 4, 5, 6	-104	
\hat{E}_s/N_{oc}	dB	1, 2, 3, 4, 5, 6	-Infinity	17
\hat{E}_s/I_{ot} ^{Note5}	dB	1, 2, 3, 4, 5, 6	-Infinity	17
RSRP ^{Note5}	dBm/15kHz	1, 2, 3, 4, 5, 6	-Infinity	-87
SCH_RP ^{Note5}	dBm/15kHz	1, 2, 3, 4, 5, 6	-Infinity	-87
I_o ^{Note5}	dBm/9MHz	1, 2, 3, 4, 5, 6	$-76.22+10\log(N_{RB,c}/50)$	$-59.13+10\log(N_{RB,c}/50)$
Propagation Condition ^{Note6}		1, 2, 3, 4, 5, 6	ETU70	
Antenna Configuration and Correlation Matrix ^{Note6}		1, 2, 3, 4, 5, 6	1x2 Low	
<p>Note 1: Special subframe and uplink-downlink configurations are specified in table 4.2-1 in TS 36.211.</p> <p>Note 2: DL RMCs and OCNG patterns are specified in sections A 3.1 and A 3.2 of TS 36.133 respectively.</p> <p>Note 3: OCNG shall be used such that all cells are fully allocated and a constant total transmitted power spectral density is achieved for all OFDM symbols.</p> <p>Note 4: Interference from other cells and noise sources not specified in the test is assumed to be constant over subcarriers and time and shall be modelled as AWGN of appropriate power for N_{oc} to be fulfilled.</p> <p>Note 5: \hat{E}_s/I_{ot}, RSRP, SCH_RP and I_o levels have been derived from other parameters for information purposes. They are not settable parameters themselves.</p> <p>Note 6: Propagation condition and correlation matrix are defined in section B.2 in TS 36.101 [25].</p>				

A.6.6.3.2.2 Test Requirements

In test 1, the UE shall send one Event B2 triggered measurement report for Cell 2 to the PCell, with a measurement reporting delay less than 3.84s from the start of period T2. The measurement reporting delay is defined as the time from the beginning of time period T2 to the moment when the UE sends the measurement report on PUSCH.

In test 2, the UE shall send one Event B2 triggered measurement report for Cell 2 to the PCell, with a measurement reporting delay less than 12.8s from the start of period T2. The measurement reporting delay is defined as the time from the beginning of time period T2 to the moment when the UE sends the measurement report on PUSCH.

The UE shall not send event-triggered measurement reports as long as the reporting criteria is not fulfilled.

The rate of correct events observed during repeated tests shall be at least 90%.

A.6.7 Measurement Performance requirements

A.6.7.1 SS-RSRP

A.6.7.1.1 SA: intra-frequency case measurement accuracy with FR1 serving cell and FR1 target cell

A.6.7.1.1.1 Test Purpose and Environment

The purpose of this test is to verify that the SS-RSRP measurement accuracy is within the specified limits. This test will verify the requirements in Sections 10.1.2.1.1 and 10.1.2.1.2 for intra frequency measurements.

A.6.7.1.1.2 Test parameters

In this set of test cases all cells are on the same carrier frequency. Supported test configurations are shown in table A.6.7.1.1.2-1. Both absolute and relative accuracy of SS-RSRP intra frequency measurements are tested by using the parameters in A.6.7.1.1.2-2. In all test cases, Cell 1 is the PCell, and Cell 2 the target cell.

Table A.6.7.1.1.2-1: SS-RSRP Intra frequency SS-RSRP supported test configurations

Config	Description
1	NR 15 kHz SSB SCS, 10MHz bandwidth, FDD duplex mode
2	NR 15 kHz SSB SCS, 10MHz bandwidth, TDD duplex mode
3	NR 30kHz SSB SCS, 40MHz bandwidth, TDD duplex mode
Note: The UE is only required to be tested in one of the supported test configurations	

Table A.6.7.1.1.2-2: SS-RSRP Intra frequency test parameters

Parameter		Unit	Test 1		Test 2		Test 3	
			Cell 1	Cell 2	Cell 1	Cell 2	Cell 1	Cell 2
SSB ARFCN			freq1		freq1		freq1	
Duplex mode	Config 1		FDD					
	Config 2,3		TDD					
TDD configuration	Config 1		Not Applicable					
	Config 2		TDDConf.1.1					
	Config 3		TDDConf.2.1					
BW _{channel}	Config 1	MHz	10: N _{RB,c} = 52					
	Config 2		10: N _{RB,c} = 52					
	Config 3		40: N _{RB,c} = 106					
BWP BW	Config 1		10: N _{RB,c} = 52					
	Config 2		10: N _{RB,c} = 52					
	Config 3		40: N _{RB,c} = 106					
Downlink initial BWP configuration			DLBWP.0.1					
Downlink dedicated BWP configuration			DLBWP.1.1					
Uplink initial BWP configuration			ULBWP.0.1					
Uplink dedicated BWP configuration			ULBWP.1.1					
DRX Cycle		ms	Not Applicable					
PDSCH Reference measurement channel	Config 1		SR.1.1 FDD	-	SR.1.1 FDD	-	SR.1.1 FDD	-
	Config 2		SR.1.1 TDD	-	SR.1.1 TDD	-	SR.1.1 TDD	-

	Config 3		SR2.1 TDD		SR2.1 TDD		SR2.1 TDD	
RMSI CORESET Reference Channel	Config 1		CR.1.1 FDD		CR.1.1 FDD		CR.1.1 FDD	
	Config 2		CR.1.1 TDD	-	CR.1.1 TDD	-	CR.1.1 TDD	-
	Config 3		CR2.1 TDD		CR2.1 TDD		CR2.1 TDD	
Control channel RMC	Config 1		CCR.1.1 FDD		CCR.1.1 FDD		CCR.1.1 FDD	
	Config 2		CCR.1.1 TDD	-	CCR.1.1 TDD	-	CCR.1.1 TDD	-
	Config 3		CCR2.1 TDD		CCR2.1 TDD		CCR2.1 TDD	
SSB configuration	Config 1		SSB 1 FR1		SSB 1 FR1		SSB 1 FR1	
	Config 2		SSB 1 FR1	-	SSB 1 FR1	-	SSB 1 FR1	-
	Config 3		SSB 2 FR1		SSB 2 FR1		SSB 2 FR1	
SMTC configuration			SMTC.1					
OCNG Patterns			OCNG pattern 1					
PDSCH/PDCCH subcarrier spacing	Config 1,2	kHz	15 kHz					
	Config 3		30kHz					
EPRE ratio of PSS to SSS		dB	0	0	0	0	0	0
EPRE ratio of PBCH DMRS to SSS								
EPRE ratio of PBCH to PBCH DMRS								
EPRE ratio of PDCCH DMRS to SSS								
EPRE ratio of PDCCH to PDCCH DMRS								
EPRE ratio of PDSCH DMRS to SSS								
EPRE ratio of PDSCH to PDSCH								
EPRE ratio of OCNG DMRS to SSS(Note 1)								
EPRE ratio of OCNG to OCNG DMRS (Note 1)								
N_{oc} Note2	Config 1,2	NR_FDD_FR1_A, NR_TDD_FR1_A	-106			-88		-116
		NR_FDD_FR1_B						-115.5
		NR_TDD_FR1_C						-115
		NR_FDD_FR1_D, NR_TDD_FR1_D						-114.5
		NR_FDD_FR1_E, NR_TDD_FR1_E						-114
		NR_FDD_FR1_G						-113
		NR_FDD_FR1_H						-112.5
	Config 3	NR_FDD_FR1_A, NR_TDD_FR1_A	-113			-94		-116
		NR_FDD_FR1_B						-115.5
		NR_TDD_FR1_C						-115
		NR_FDD_FR1_D, NR_TDD_FR1_D						-114.5
		NR_FDD_FR1_E, NR_TDD_FR1_E						-114
		NR_FDD_FR1_G						-113
		NR_FDD_FR1_H						-113

N_{oc} Note2	Config 1,2	NR_FDD_FR1_H	dBm/SCS	-106		-88		-112.5					
		Same as Noc/15kHz											
	Config 3	NR_FDD_FR1_A, NR_TDD_FR1_A		-110		-91		-113					
		NR_FDD_FR1_B						-112.5					
		NR_TDD_FR1_C						-112					
		NR_FDD_FR1_D, NR_TDD_FR1_D						-111.5					
		NR_FDD_FR1_E, NR_TDD_FR1_E						-111					
		NR_FDD_FR1_G						-110					
		NR_FDD_FR1_H						-109.5					
\hat{E}_s/I_{ot}			dB	2.5	-6	2.5	-6	0.46	-5.76				
\hat{E}_s/N_{oc}			dB	6	1	6	1	3	-1				
SS- RSRP ^{Note3}	Config 1,2	NR_FDD_FR1_A, NR_TDD_FR1_A	dBm/SCS	-100		-105		-82		-87		-113	-117
		NR_FDD_FR1_B										-112.5	-116.5
		NR_TDD_FR1_C										-112	-116
		NR_FDD_FR1_D, NR_TDD_FR1_D										-111.5	-115.5
		NR_FDD_FR1_E, NR_TDD_FR1_E										-111	-115
		NR_FDD_FR1_G										-110	-114
		NR_FDD_FR1_H										-109.5	-113.5
	Config 3	NR_FDD_FR1_A, NR_TDD_FR1_A		-106		-109		-85		-90		-110	-114
		NR_FDD_FR1_B										-109.5	-113.5
		NR_TDD_FR1_C										109	-113
		NR_FDD_FR1_D, NR_TDD_FR1_D										-	-
		NR_FDD_FR1_E, NR_TDD_FR1_E										108.55	-112.5
		NR_FDD_FR1_G										-108	-112
		NR_FDD_FR1_H										-107	-111
I_o ^{Note3}			dBm/ 9.36MHz	-70.09		-52.09		-82.26					
Config 1,2	NR_FDD_FR1_A, NR_TDD_FR1_A	-81.76											
	NR_FDD_FR1_B	-81.26											
	NR_TDD_FR1_C	-80.76											
	NR_FDD_FR1_D, NR_TDD_FR1_D	-80.26											
	NR_FDD_FR1_E, NR_TDD_FR1_E	-79.26											
	NR_FDD_FR1_G	-78.76											
	NR_FDD_FR1_H	-78.76											
Config 3	NR_FDD_FR1_A, NR_TDD_FR1_A	-70.99		-51.99		-76.16							
	NR_FDD_FR1_B					-75.66							
	NR_TDD_FR1_C					-75.16							
	NR_FDD_FR1_D, NR_TDD_FR1_D					-74.66							
	NR_FDD_FR1_E, NR_TDD_FR1_E					-74.16							
	NR_FDD_FR1_G					-73.16							
	NR_FDD_FR1_H					-72.66							

Propagation condition	-	AWGN
Antenna configuration		1x2
Note 1:	OCNG shall be used such that both cells are fully allocated and a constant total transmitted power spectral density is achieved for all OFDM symbols.	
Note 2:	Interference from other cells and noise sources not specified in the test is assumed to be constant over subcarriers and time and shall be modelled as AWGN of appropriate power for N_{oc} to be fulfilled.	
Note 3:	SS-RSRP and I_o levels have been derived from other parameters for information purposes. They are not settable parameters themselves.	
Note 4:	SS-RSRP minimum requirements are specified assuming independent interference and noise at each receiver antenna port.	

A.6.7.1.1.3 Test Requirements

The SS-RSRP measurement accuracy for cell 1 and cell 2 shall fulfil absolute requirement in section 10.1.2.1.1 and relative requirement in section 10.1.2.1.2.

A.6.7.1.2 SA inter-frequency case measurement accuracy with FR1 serving cell and FR1 target cell

A.6.7.1.2.1 Test Purpose and Environment

The purpose of this test is to verify that the SS-RSRP measurement accuracy is within the specified limits. This test will verify the requirements in Sections 10.1.4.1.1 and 10.1.4.1.2 for intra frequency measurements with the testing configurations for NR cells in Table A.6.7.1.2.1-1.

Table A.6.7.1.2.1-1: Applicable NR configurations for FR1 inter-frequency SS-RSRP accuracy test

Config	Description
1	NR 15 kHz SSB SCS, 10MHz bandwidth, FDD duplex mode
2	NR 15 kHz SSB SCS, 10MHz bandwidth, TDD duplex mode
3	NR 30kHz SSB SCS, 40MHz bandwidth, TDD duplex mode

A.6.7.1.2.2 Test parameters

In this set of test cases there are two cells in the test, PCell (Cell 1) and a FR1 neighbour cell (Cell 2) on a different frequency than the PCell. The test parameters for the Cell 1 and Cell 2 are given in Table A.6.7.1.2.2-1 below. Both absolute and relative accuracy of RSRP intra frequency measurements are tested by using the parameters in Table A.6.7.1.2.2-1. The inter frequency measurements are supported by a measurement gap.

Table A.6.7.1.2.2-1: SS-RSRP inter-frequency test parameters

Parameter		Unit	Test 1		Test 2	
			Cell 1	Cell 2	Cell 1	Cell 2
SSB ARFCN			freq1	freq2	freq1	freq2
BW _{channel}	Config 1, 4	MHz	10: N _{RB,c} = 52		10: N _{RB,c} = 52	
	Config 2, 3, 5, 6		40: N _{RB,c} = 106		40: N _{RB,c} = 106	
Gap pattern Id			0		0	
PDSCH Reference measurement channel	Config 1, 4		SR.1.1 FDD	-	SR.1.1 FDD	-
	Config 2, 5		SR.1.1 TDD		SR.1.1 TDD	
	Config 3, 6		SR.2.1 FDD		SR.2.1 FDD	
PDCCH Reference measurement channel	Config 1, 4		CR.1.1 FDD		CR.1.1 FDD	
	Config 2, 5		CR.1.1 TDD		CR.1.1 TDD	
	Config 3, 6		CR.2.1 FDD		CR.2.1 FDD	
OCNG Patterns			OP.1	OP.1	OP.1	OP.1
SMTc configuration			SMTc.1 FR1		SMTc.1 FR1	

		Config 3,6		SMTC.2 FR1		SMTC.2 FR1								
PBCH_RA		Config 1~6	dB	0	0	0	0							
PBCH_RB														
PSS_RA														
SSS_RA														
PBCH_DMRS_RA														
PBCH_DMRS_RB														
PDCCH_RA														
PDCCH_RB														
PDSCH_RA														
PDSCH_RB														
OCNG_RA ^{Note1}														
OCNG_RB ^{Note1}														
N_{oc} ^{Note2}	Config 1~6							NR_FDD_FR1_A	dBm/15kHz z	-94.65	N_{oc} for freq2 + 8dB	TBD		
		NR_TDD_FR1_A	TBD											
		NR_FDD_FR1_B	TBD											
		NR_TDD_FR1_C	TBD											
		NR_FDD_FR1_D	TBD											
		NR_TDD_FR1_D	TBD											
		NR_FDD_FR1_E	TBD											
		NR_TDD_FR1_E	TBD											
N_{oc} ^{Note2}	Config 1, 2, 4, 5	NR_FDD_FR1_A	dBm/SSB SCS	-94.65	N_{oc} for freq2 + 8dB	TBD								
		NR_TDD_FR1_A				TBD								
		NR_FDD_FR1_B				TBD								
		NR_TDD_FR1_C				TBD								
		NR_FDD_FR1_D				TBD								
		NR_TDD_FR1_D				TBD								
		NR_FDD_FR1_E				TBD								
		NR_TDD_FR1_E				TBD								
	Config 3, 6	NR_FDD_FR1_G		TBD										
		NR_FDD_FR1_H		TBD										
		NR_FDD_FR1_A		-91.65	N_{oc} for freq2 + 8dB	TBD								
		NR_TDD_FR1_A				TBD								
		NR_FDD_FR1_B				TBD								
		NR_TDD_FR1_C				TBD								
NR_FDD_FR1_D	TBD													
NR_TDD_FR1_D	TBD													
\hat{E}_s/I_{ot}			dB	10	10	13	-4							
		SS- RSRPN ^{ote3}						Config 1, 2, 4, 5	NR_FDD_FR1_A	dBm/SCS	-84.65	RSRP for Cell 2 + 25dB	TBD	
									NR_TDD_FR1_A				TBD	
									NR_FDD_FR1_B				TBD	
									NR_TDD_FR1_C				TBD	
									NR_FDD_FR1_D				TBD	
									NR_TDD_FR1_D				TBD	
									NR_FDD_FR1_E				TBD	
									NR_TDD_FR1_E				TBD	
		Config 3, 6						NR_FDD_FR1_G	TBD					
								NR_FDD_FR1_H	TBD					
								NR_FDD_FR1_A	-81.65	RSRP for Cell 2 + 25dB	TBD			
								NR_TDD_FR1_A			TBD			
								NR_FDD_FR1_B			TBD			
NR_TDD_FR1_C	TBD													

		NR_FDD_FR1_D				TBD	
		NR_TDD_FR1_D				TBD	
		NR_FDD_FR1_E				TBD	
		NR_TDD_FR1_E				TBD	
		NR_FDD_FR1_G				TBD	
		NR_FDD_FR1_H				TBD	
I _o Note3	Config 1, 2, 4, 5	NR_FDD_FR1_A	dBm/ 9.36MHz	-56.28	TBD		
		NR_TDD_FR1_A			TBD		
		NR_FDD_FR1_B			TBD		
		NR_TDD_FR1_C			TBD		
		NR_FDD_FR1_D			TBD		
		NR_TDD_FR1_D			TBD		
		NR_FDD_FR1_E			TBD		
		NR_TDD_FR1_E			TBD		
	NR_FDD_FR1_G	TBD					
	NR_FDD_FR1_H	TBD					
	Config 3, 6	NR_FDD_FR1_A	dBm/ 38.16MHz	-50.19	TBD		
		NR_TDD_FR1_A			TBD		
		NR_FDD_FR1_B			TBD		
		NR_TDD_FR1_C			TBD		
NR_FDD_FR1_D		TBD					
NR_TDD_FR1_D		TBD					
NR_FDD_FR1_E		TBD					
NR_TDD_FR1_E		TBD					
NR_FDD_FR1_G	TBD						
NR_FDD_FR1_H	TBD						
\hat{E}_s/N_{oc}			dB	10	10	13	-4
Propagation condition			-	AWGN		AWGN	
<p>Note 1: OCNG shall be used such that both cells are fully allocated and a constant total transmitted power spectral density is achieved for all OFDM symbols.</p> <p>Note 2: Interference from other cells and noise sources not specified in the test is assumed to be constant over subcarriers and time and shall be modelled as AWGN of appropriate power for N_{oc} to be fulfilled.</p> <p>Note 3: RSRP and I_o levels have been derived from other parameters for information purposes. They are not settable parameters themselves.</p> <p>Note 4: RSRP minimum requirements are specified assuming independent interference and noise at each receiver antenna port.</p>							

A.6.7.1.2.3 Test Requirements

The SS-RSRP measurement accuracy for Cell 1 and Cell 2 shall fulfil the Absolute requirement in section 10.1.4.1.1 and Relative requirement in section 10.1.4.1.2.

A.6.7.1.3 Void

A.6.7.2 SS-RSRQ

A.6.7.2.1 SA: Intra-frequency measurement accuracy with FR1 serving cell and FR1 target cell

A.6.7.2.1.1 Test Purpose and Environment

The purpose of this test is to verify that the SS-RSRQ measurement accuracy is within the specified limits. This test will verify the requirements in Clause 10.1.7.1.1.

A.6.7.2.1.2 Test Parameters

In this test case all cells are on the same carrier frequency. Supported test configuration are shown in Table A.6.7.2.1.2-1. The absolute accuracy of SS-RSRQ intra-frequency measurement is test by using the parameters in Table A.6.7.2.1.2-2. In all test cases, Cell 1 is the PCell and Cell 2 is the target cell.

Table A.6.7.2.1.2-1: SS-RSRQ Intra frequency SS-RSRQ supported test configurations

Config	Description
1	NR 15 kHz SSB SCS, 10MHz bandwidth, FDD duplex mode
2	NR 15 kHz SSB SCS, 10MHz bandwidth, TDD duplex mode
3	NR 30 kHz SSB SCS, 40MHz bandwidth, TDD duplex mode
Note: The UE is only required to be tested in one of the supported test configurations	

Table A.6.7.2.1.2-2: SS-RSRQ Intra frequency test parameters

Parameter		Unit	Test 1		Test 2		Test 3	
			Cell 1	Cell 2	Cell 1	Cell 2	Cell 1	Cell 2
SSB ARFCN			freq1		freq1		freq1	
Duplex mode	Config 1		FDD					
	Config 2,3		TDD					
TDD configuration	Config 1		Not Applicable					
	Config 2		TDDConf.1.1					
	Config 3		TDDConf.2.1					
BW _{channel}	Config 1	MHz	10: N _{RB,c} = 52					
	Config 2		10: N _{RB,c} = 52					
	Config 3		40: N _{RB,c} = 106					
BWP configuration	Initial DL BWP		DLBWP.0.1					
	Dedicated DL BWP		DLBWP.1.1					
	Initial UL BWP		ULBWP.0.1					
	Dedicated UL BWP		ULBWP.1.1					
DRX Cycle		ms	Not Applicable					
PDSCH Reference measurement channel	Config 1		SR.1.1 FDD		SR.1.1 FDD		SR.1.1 FDD	
	Config 2		SR.1.1 TDD	-	SR.1.1 TDD	-	SR.1.1 TDD	-
	Config 3		SR2.1 TDD		SR2.1 TDD		SR2.1 TDD	
RMSI CORESET Reference Channel	Config 1		CR.1.1 FDD		CR.1.1 FDD		CR.1.1 FDD	
	Config 2		CR.1.1 TDD	-	CR.1.1 TDD	-	CR.1.1 TDD	
	Config 3		CR.2.1 TDD		CR.2.1 TDD		CR.2.1 TDD	
Control Channel RMC	Config 1		CCR.1.1 FDD		CCR.1.1 FDD		CCR.1.1 FDD	
	Config 2		CCR.1.1 TDD	-	CCR.1.1 TDD	-	CCR.1.1 TDD	-

	Config 3		CCR.2.1 TDD		CCR.2.1 TDD		CCR.2.1 TDD	
OCNG Patterns			OP. 1					
SS-RSSI-Measurement			Not Applicable					
SMTC configuration			SMTC.1					
SSB configuration	Config 1,2		SSB.1 FR1					
	Config 3		SSB.2 FR1					
PDSCH/PDCCH subcarrier spacing	Config 1,2	kHz	15 kHz					
	Config 3		30kHz					
EPRE ratio of PSS to SSS		dB	0	0	0	0	0	0
EPRE ratio of PBCH DMRS to SSS								
EPRE ratio of PBCH to PBCH DMRS								
EPRE ratio of PDCCH DMRS to SSS								
EPRE ratio of PDCCH to PDCCH DMRS								
EPRE ratio of PDSCH DMRS to SSS								
EPRE ratio of PDSCH to PDSCH								
EPRE ratio of OCNG DMRS to SSS(Note 1)								
EPRE ratio of OCNG to OCNG DMRS (Note 1)								
N_{oc} Note2	NR_FDD_FR1_A, NR_TDD_FR1_A	dBm/15kHz z	-91	[-110.05]	[-120]			
	NR_FDD_FR1_B				[-119.5]			
	NR_TDD_FR1_C				[-119]			
	NR_FDD_FR1_D, NR_TDD_FR1_D				[-118.5]			
	NR_FDD_FR1_E, NR_TDD_FR1_E				[-118]			
	NR_FDD_FR1_G				[-117]			
	NR_FDD_FR1_H				[-116.5]			
								Same as N_{oc} for 15kHz
N_{oc} Note2	Config 1,2	dBm/SCS	-88	[-107.05]	[-117]			
	Config 3				[-116.5]			
					[-116]			
					[-115.5]			
					[-115]			
					[-114]			
					[-113.5]			
\hat{E}_s/I_{ot}		dB	-1.76		-4.7		-5.46	-5.46
\hat{E}_s/N_{oc}		dB	3	3	-2.9	-2.9	-4	-4
SS-RSRP ^{Not e3}	Config 1,2	NR_FDD_FR1_A, NR_TDD_FR1_A	-88	-88	[-112.95]	[-112.95]	[-124]	[-124]
		NR_FDD_FR1_B					[-123.5]	[-123.5]
		NR_TDD_FR1_C					[-123]	[-123]
		NR_FDD_FR1_D, NR_TDD_FR1_D					[-122.5]	[-122.5]
		NR_FDD_FR1_E, NR_TDD_FR1_E					[-122]	[-122]
		NR_FDD_FR1_G					[-121]	[-121]
		NR_FDD_FR1_H					[-120.5]	[-120.5]
	Config 3	NR_FDD_FR1_A, NR_TDD_FR1_A	-85	-85			[-121]	[-121]

		NR_FDD_FR1_B						[-120.5]	[-120.5]
		NR_TDD_FR1_C						[-120]	[-120]
		NR_FDD_FR1_D, NR_TDD_FR1_D				[-109.95]	[-109.95]	[-119.5]	[-119.5]
		NR_FDD_FR1_E, NR_TDD_FR1_E						[-119]	[-119]
		NR_FDD_FR1_G						[-118]	[-118]
		NR_FDD_FR1_H						[-117.5]	[-117.5]
	SS-RSRQ ^{Note3}	NR_FDD_FR1_A, NR_TDD_FR1_A	dB	-14.77	-14.77	-16.76	-16.76	[-17.34]	[-17.34]
		NR_FDD_FR1_B							
		NR_TDD_FR1_C							
		NR_FDD_FR1_D, NR_TDD_FR1_D							
		NR_FDD_FR1_E, NR_TDD_FR1_E							
		NR_FDD_FR1_G							
	NR_FDD_FR1_H								
I _o ^{Note3}	Config 1,2	NR_FDD_FR1_A, NR_TDD_FR1_A	dBm/ 9.36MHz	-56			[-79]	[-89.5]	
		NR_FDD_FR1_B							
		NR_TDD_FR1_C							
		NR_FDD_FR1_D, NR_TDD_FR1_D							
		NR_FDD_FR1_E, NR_TDD_FR1_E							
		NR_FDD_FR1_G							
	NR_FDD_FR1_H								
	Config 3	NR_FDD_FR1_A, NR_TDD_FR1_A	dBm/ 38.16MHz	-50.00			[-73]	[-83.41]	
		NR_FDD_FR1_B							
		NR_TDD_FR1_C							
		NR_FDD_FR1_D, NR_TDD_FR1_D							
		NR_FDD_FR1_E, NR_TDD_FR1_E							
		NR_FDD_FR1_G							
		NR_FDD_FR1_H							
Propagation condition			-	AWGN	AWGN	AWGN	AWGN	AWGN	AWGN
Antenna configuration				1x2	1x2	1x2	1x2	1x2	1x2
<p>Note 1: OCNG shall be used such that both cells are fully allocated and a constant total transmitted power spectral density is achieved for all OFDM symbols.</p> <p>Note 2: Interference from other cells and noise sources not specified in the test is assumed to be constant over subcarriers and time and shall be modelled as AWGN of appropriate power for N_{oc} to be fulfilled.</p> <p>Note 3: SS-RSRQ, SS-RSRP, and I_o levels have been derived from other parameters for information purposes. They are not settable parameters themselves.</p> <p>Note 4: SS-RSRQ, SS-RSRP minimum requirements are specified assuming independent interference and noise at each receiver antenna port.</p> <p>Note 5: NR operating band groups are as defined in Section 3.5.2.</p>									

A.6.7.2.1.3 Test Requirements

The SS-RSRQ measurement accuracy shall fulfil the requirements in section 10.1.7.1.1.

A.6.7.2.2 SA Inter-frequency measurement accuracy with FR1 serving cell and FR1 target cell

A.6.7.2.2.1 Test Purpose and Environment

The purpose of this test is to verify that the SS-RSRQ measurement accuracy is within the specified limits. This test will verify the requirements in Clause 10.1.9.1.1 and 10.1.9.1.2.

A.6.7.2.2.2 Test Parameters

In this test case the two cells (i.e., Cell 1 and Cell 2) are on different carrier frequencies and measurement gaps are provided. Supported test configurations are shown in Table A.6.7.2.2.2-1. Both absolute accuracy and relative accuracy requirements of SS-RSRQ inter-frequency measurement are tested by using test parameters in Table A.6.7.2.2.2-2. In all test cases, Cell 1 is the PCell and Cell 2 is target cell.

Table A.6.7.2.2.2-1: SS-RSRQ Inter frequency SS-RSRQ supported test configurations

Config	Description
1	NR 15 kHz SSB SCS, 10MHz bandwidth, FDD duplex mode
2	NR 15 kHz SSB SCS, 10MHz bandwidth, TDD duplex mode
3	NR 30kHz SSB SCS, 40MHz bandwidth, TDD duplex mode
Note: The UE is only required to be tested in one of the supported test configurations	

Table A.6.7.2.2.2-2: SS-RSRQ Inter frequency test parameters

Parameter		Unit	Test 1		Test 2		Test 3	
			Cell 1	Cell 2	Cell 1	Cell 2	Cell 1	Cell 2
SSB ARFCN			freq1	freq2	freq1	freq2	freq1	freq2
Duplex mode	Config 1		FDD					
	Config 2,3		TDD					
TDD configuration	Config 1		Not Applicable					
	Config 2		TDDConf.1.1					
	Config 3		TDDConf.2.1					
BW _{channel}	Config 1	MHz	10: N _{RB,c} = 52					
	Config 2		10: N _{RB,c} = 52					
	Config 3		40: N _{RB,c} = 106					
BWP BW	Config 1		10: N _{RB,c} = 52					
	Config 2		10: N _{RB,c} = 52					
	Config 3		40: N _{RB,c} = 106					
DRX Cycle		ms	Not Applicable					
PDSCH Reference measurement channel	Config 1,4		SR.1.1 FDD	-	SR.1.1 FDD	-	SR.1.1 FDD	-
	Config 2,5		SR.1.1 TDD		SR.1.1 TDD		SR.1.1 TDD	
	Config 3,6		SR2.1 TDD		SR2.1 TDD		SR2.1 TDD	
RMSI CORESET Reference Channel	Config 1		CR.1.1 FDD	-	R.1.1 FDD	-	CR.1.1 FDD	
	Config 2		CR.1.1 TDD		CR.1.1 TDD		CR.1.1 TDD	
	Config 3		CR2.1 TDD		CR2.1 TDD		CR2.1 TDD	

Dedicated CORESET Reference Channel	Config 1		CCR.1 .1 FDD		CCR.1 1 FDD		CCR.1 1 FDD	
	Config 2		CCR.1 .1 TDD	-	CCR.1 1 TDD	-	CCR.1 1 TDD	-
	Config 3		CCR2. 1 TDD		CCR2.1 TDD		CCR2. 1 TDD	
OCNG Patterns			OCNG pattern 1					
SMTTC configuration	Config 1,2		SMTTC pattern 1					
	Config 3		SMTTC pattern 2					
SSB configuration	Config 1,2		SSB pattern 1 in FR1					
	Config 3		SSB pattern 2 in FR1					
PDSCH/PDCCH subcarrier spacing	Config 1,2	kHz	15 kHz					
	Config 3		30 kHz					
EPRE ratio of PSS to SSS		dB	0	0	0	0	0	0
EPRE ratio of PBCH DMRS to SSS								
EPRE ratio of PBCH to PBCH DMRS								
EPRE ratio of PDCCH DMRS to SSS								
EPRE ratio of PDCCH to PDCCH DMRS								
EPRE ratio of PDSCH DMRS to SSS								
EPRE ratio of PDSCH to PDSCH								
EPRE ratio of OCNG DMRS to SSS(Note 1)								
EPRE ratio of OCNG to OCNG DMRS (Note 1)								
N_{oc} Note2	Config 1,2	NR_FDD_FR1_A	dBm/15kHz	-80.18	TBD	TBD	TBD	TBD
		NR_TDD_FR1_A						
		NR_FDD_FR1_B						
		NR_TDD_FR1_C						
		NR_FDD_FR1_D						
		NR_TDD_FR1_D						
		NR_FDD_FR1_E						
NR_TDD_FR1_E								
NR_FDD_FR1_G	TBD							
NR_FDD_FR1_H								
N_{oc} Note2	Config 3	NR_FDD_FR1_A	dBm/15kHz	-86.27	TBD	TBD	TBD	TBD
		NR_TDD_FR1_A						
		NR_FDD_FR1_B						
		NR_TDD_FR1_C						
		NR_FDD_FR1_D						
		NR_TDD_FR1_D						
		NR_FDD_FR1_E						
NR_TDD_FR1_E								
NR_FDD_FR1_G	TBD							
NR_FDD_FR1_H								
N_{oc} Note2	Config 1,2	NR_FDD_FR1_A	dBm/15kHz	-80.18	TBD	TBD	TBD	TBD
		NR_TDD_FR1_A						
		NR_FDD_FR1_B						
		NR_TDD_FR1_C						
		NR_FDD_FR1_D						
		NR_TDD_FR1_D						
		NR_FDD_FR1_E						
	NR_TDD_FR1_E							
	NR_FDD_FR1_G	TBD						
	NR_FDD_FR1_H							
	Config 3	NR_FDD_FR1_A	dBm/15kHz	-83.27	TBD	TBD	TBD	TBD
NR_TDD_FR1_A								
NR_FDD_FR1_B								
NR_TDD_FR1_C								
NR_FDD_FR1_D	TBD							
NR_TDD_FR1_D								

		NR_FDD_FR1_E NR_TDD_FR1_E						TBD	
		NR_FDD_FR1_G NR_FDD_FR1_H						TBD	
								TBD	
			dB		-1.75		TBD	TBD	TBD
			dB		-1.75		TBD	TBD	TBD
SS- RSRP ^{Note3}	Config 1,2	NR_FDD_FR1_A	dBm/SCS	-81.93	-81.93	TBD	TBD	TBD	TBD
		NR_TDD_FR1_A						TBD	TBD
		NR_FDD_FR1_B						TBD	TBD
		NR_TDD_FR1_C						TBD	TBD
		NR_FDD_FR1_D						TBD	TBD
		NR_TDD_FR1_D						TBD	TBD
	NR_FDD_FR1_E	TBD		TBD					
	NR_TDD_FR1_E	TBD		TBD					
	NR_FDD_FR1_G	TBD		TBD					
	NR_FDD_FR1_H	TBD		TBD					
	Config 3	NR_FDD_FR1_A		-85.02	-85.02	TBD	TBD	TBD	TBD
		NR_TDD_FR1_A		TBD	TBD				
		NR_FDD_FR1_B		TBD	TBD				
		NR_TDD_FR1_C		TBD	TBD				
NR_FDD_FR1_D		TBD	TBD						
NR_TDD_FR1_D		TBD	TBD						
NR_FDD_FR1_E		TBD	TBD						
NR_TDD_FR1_E		TBD	TBD						
NR_FDD_FR1_G	TBD	TBD							
NR_FDD_FR1_H	TBD	TBD							
SS-RSRQ ^{Note3}		NR_FDD_FR1_A	dB	-14.77	-14.77	TBD	TBD	TBD	TBD
		NR_TDD_FR1_A						TBD	TBD
		NR_FDD_FR1_B						TBD	TBD
		NR_TDD_FR1_C						TBD	TBD
		NR_FDD_FR1_D						TBD	TBD
		NR_TDD_FR1_D						TBD	TBD
		NR_FDD_FR1_E						TBD	TBD
		NR_TDD_FR1_E						TBD	TBD
I _o ^{Note3}	Config 1,2	NR_FDD_FR1_A	dBm/SCS	-50		TBD	TBD	TBD	TBD
		NR_TDD_FR1_A						TBD	TBD
		NR_FDD_FR1_B						TBD	TBD
		NR_TDD_FR1_C						TBD	TBD
		NR_FDD_FR1_D						TBD	TBD
		NR_TDD_FR1_D						TBD	TBD
		NR_FDD_FR1_E						TBD	TBD
	NR_TDD_FR1_E	TBD		TBD					
	Config 3	NR_FDD_FR1_A		-50		TBD	TBD	TBD	TBD
		NR_TDD_FR1_A		TBD	TBD				
		NR_FDD_FR1_B		TBD	TBD				
		NR_TDD_FR1_C		TBD	TBD				
		NR_FDD_FR1_D		TBD	TBD				
		NR_TDD_FR1_D		TBD	TBD				
NR_FDD_FR1_E		TBD	TBD						
NR_TDD_FR1_E	TBD	TBD							
NR_FDD_FR1_G	TBD	TBD							
NR_FDD_FR1_H	TBD	TBD							

Propagation condition	-	AWG N	AWGN	AWGN	AWGN	AWG N	AWG N
Note 1:	OCNG shall be used such that both cells are fully allocated and a constant total transmitted power spectral density is achieved for all OFDM symbols.						
Note 2:	Interference from other cells and noise sources not specified in the test is assumed to be constant over subcarriers and time and shall be modelled as AWGN of appropriate power for N_{oc} to be fulfilled.						
Note 3:	SS-RSRQ, SS-RSRP, and I_0 levels have been derived from other parameters for information purposes. They are not settable parameters themselves.						
Note 4:	SS-RSRQ, SS-RSRP minimum requirements are specified assuming independent interference and noise at each receiver antenna port.						
Note 5:	NR operating band groups are as defined in Section 3.5.2.						

A.6.7.2.2.3 Test Requirements

The SS-RSRQ measurement accuracy shall fulfil the requirements in section 10.1.9.1.1 and 10.1.9.1.2.

A.6.7.3 SS-SINR

A.6.7.3.1 Intra-frequency case

A.6.7.3.1.1 Test Purpose and Environment

The purpose of this test is to verify that the SS-SINR measurement accuracy is within the specified limits. This test will verify the requirements in Clause 10.1.12.1.1.

A.6.7.3.1.2 Test Parameters

In this test case all cells are on the same carrier frequency. Supported test configuration are shown in Table A.6.7.3.1.2-1. The absolute accuracy of SS-SINR intra-frequency measurement is test by using the parameters in Table A.6.7.3.1.2-2. In all test cases, Cell 1 is the PCell and Cell 2 is the target cell.

Table A.6.7.3.1.2-1: SS-SINR Intra frequency SS-SINR supported test configurations

Config	Description
1	NR 15 kHz SSB SCS, 10MHz bandwidth, FDD duplex mode
2	NR 15 kHz SSB SCS, 10MHz bandwidth, TDD duplex mode
3	NR 30 kHz SSB SCS, 40MHz bandwidth, TDD duplex mode
Note:	The UE is only required to be tested in one of the supported test configurations

Table A.6.7.3.1.2-2: SS-SINR Intra frequency test parameters

Parameter		Unit	Test 1		Test 2	
			Cell 1	Cell 2	Cell 1	Cell 2
SSB ARFCN			freq1		freq1	
Duplex mode	Config 1		FDD			
	Config 2,3		TDD			
TDD configuration	Config 1		Not Applicable			
	Config 2		TDDConf.1.1			
	Config 3		TDDConf.2.1			
Downlink initial BWP configuration			DLBWP.0.1			
Downlink dedicated BWP configuration			DLBWP.1.1			
Uplink initial BWP configuration			ULBWP.0.1			
Uplink dedicated BWP configuration			ULBWP.1.1			
DRX Cycle configuration		ms	Not Applicable			

TRS configuration			TRS.2.1 TDD				
TCI state			TCI.State.0				
PDSCH Reference measurement channel	Config 1		SR.1.1 FDD		SR.1.1 FDD		
	Config 2		SR.1.1 TDD	-	SR.1.1 TDD	-	
	Config 3		SR.2.1 TDD		SR.2.1 TDD		
RMSI CORESET Reference Channel	Config 1		CR.1.1 FDD		CR.1.1 FDD		
	Config 2		CR.1.1 TDD	-	CR.1.1 TDD		
	Config 3		CR.2.1 TDD		CR.2.1 TDD		
Dedicated CORESET Reference Channel	Config 1		CCR.1.1 FDD		CCR.1.1 FDD		
	Config 2		CCR.1.1 TDD	-	CCR.1.1 TDD	-	
	Config 3		CCR.2.1 TDD		CCR.2.1 TDD		
OCNG Patterns			OP.1				
SS-RSSI-Measurement			Not Applicable				
SMTc configuration			SMTc.1				
SSB configuration	Config 1,2		SSB.1 FR1				
	Config 3		SSB.2 FR1				
PDSCH/PDCCH subcarrier spacing	Config 1,2	kHz	15				
	Config 3		30				
EPRE ratio of PSS to SSS		dB	0	0	0	0	
EPRE ratio of PBCH DMRS to SSS							
EPRE ratio of PBCH to PBCH DMRS							
EPRE ratio of PDCCH DMRS to SSS							
EPRE ratio of PDCCH to PDCCH DMRS							
EPRE ratio of PDSCH DMRS to SSS							
EPRE ratio of PDSCH to PDSCH							
EPRE ratio of OCNG DMRS to SSS(Note 1)							
EPRE ratio of OCNG to OCNG DMRS (Note 1)							
N_{oc} ^{Note2}	NR_FDD_FR1_A, NR_TDD_FR1_A	dBm/15kHz _z	TBD	TBD			
	NR_FDD_FR1_B			TBD			
	NR_TDD_FR1_C			TBD			
	NR_FDD_FR1_D, NR_TDD_FR1_D			TBD			
	NR_FDD_FR1_E, NR_TDD_FR1_E			TBD			
	NR_FDD_FR1_G			TBD			
	NR_FDD_FR1_H			TBD			
N_{oc} ^{Note2}	Config 1,2	dBm/SCS	TBD	Same as Noc for 15kHz			
	Config 3			TBD			
				NR_FDD_FR1_A, NR_TDD_FR1_A	TBD		
				NR_FDD_FR1_B, NR_TDD_FR1_C, NR_FDD_FR1_D, NR_TDD_FR1_D	TBD		

		NR_FDD_FR1_E, NR_TDD_FR1_E				TBD	
		NR_FDD_FR1_G, NR_FDD_FR1_H				TBD	
						TBD	
\hat{E}_s / I_{ot}			dB	[5]	[-3.19]	[-5.46]	[-5.46]
\hat{E}_s / N_{oc}			dB	TBD	TBD	TBD	TBD
SS-RSRP ^{Not e3}	Config 1,2	NR_FDD_FR1_A, NR_TDD_FR1_A	dBm/SCS	TBD	TBD	TBD	TBD
		NR_FDD_FR1_B, NR_TDD_FR1_C				TBD	TBD
		NR_FDD_FR1_D, NR_TDD_FR1_D				TBD	TBD
		NR_FDD_FR1_E, NR_TDD_FR1_E				TBD	TBD
		NR_FDD_FR1_G, NR_FDD_FR1_H				TBD	TBD
		NR_FDD_FR1_A, NR_TDD_FR1_A				TBD	TBD
	Config 3	NR_FDD_FR1_B, NR_TDD_FR1_C		TBD	TBD		
		NR_FDD_FR1_D, NR_TDD_FR1_D		TBD	TBD		
		NR_FDD_FR1_E, NR_TDD_FR1_E		TBD	TBD		
		NR_FDD_FR1_G, NR_FDD_FR1_H		TBD	TBD		
		NR_FDD_FR1_A, NR_TDD_FR1_A		TBD	TBD		
		NR_FDD_FR1_B, NR_TDD_FR1_C		TBD	TBD		
		NR_FDD_FR1_D, NR_TDD_FR1_D		TBD	TBD		
		NR_FDD_FR1_E, NR_TDD_FR1_E		TBD	TBD		
NR_FDD_FR1_G, NR_FDD_FR1_H	TBD	TBD					
SS-SINR ^{Note3}		NR_FDD_FR1_A, NR_TDD_FR1_A	dB	[5]	[-3.19]	[-5.46]	[-5.46]
		NR_FDD_FR1_B, NR_TDD_FR1_C					
		NR_FDD_FR1_D, NR_TDD_FR1_D					
		NR_FDD_FR1_E, NR_TDD_FR1_E					
		NR_FDD_FR1_G, NR_FDD_FR1_H					
		NR_FDD_FR1_A, NR_TDD_FR1_A					
		NR_FDD_FR1_B, NR_TDD_FR1_C					
		NR_FDD_FR1_D, NR_TDD_FR1_D					
I _o ^{Note3}	Config 1,2	NR_FDD_FR1_A, NR_TDD_FR1_A	dBm/ 9.36MHz	TBD	TBD	TBD	TBD
		NR_FDD_FR1_B, NR_TDD_FR1_C				TBD	TBD
		NR_FDD_FR1_D, NR_TDD_FR1_D				TBD	TBD
		NR_FDD_FR1_E, NR_TDD_FR1_E				TBD	TBD
		NR_FDD_FR1_G, NR_FDD_FR1_H				TBD	TBD
		NR_FDD_FR1_A, NR_TDD_FR1_A				TBD	TBD
	Config 3	NR_FDD_FR1_B, NR_TDD_FR1_C		TBD	TBD		
		NR_FDD_FR1_D, NR_TDD_FR1_D		TBD	TBD		
		NR_FDD_FR1_E, NR_TDD_FR1_E		TBD	TBD		
		NR_FDD_FR1_G, NR_FDD_FR1_H		TBD	TBD		
		NR_FDD_FR1_A, NR_TDD_FR1_A		TBD	TBD		
		NR_FDD_FR1_B, NR_TDD_FR1_C		TBD	TBD		
		NR_FDD_FR1_D, NR_TDD_FR1_D		TBD	TBD		
		NR_FDD_FR1_E, NR_TDD_FR1_E		TBD	TBD		
Propagation condition			-	AWGN			

Antenna configuration	-	1x2
Note 1:	OCNG shall be used such that both cells are fully allocated and a constant total transmitted power spectral density is achieved for all OFDM symbols.	
Note 2:	Interference from other cells and noise sources not specified in the test is assumed to be constant over subcarriers and time and shall be modelled as AWGN of appropriate power for N_{oc} to be fulfilled.	
Note 3:	SS-SINR, SS-RSRP, and l_0 levels have been derived from other parameters for information purposes. They are not settable parameters themselves.	
Note 4:	SS-SINR, SS-RSRP minimum requirements are specified assuming independent interference and noise at each receiver antenna port.	
Note 5:	NR operating band groups are as defined in Section 3.5.2.	

A.6.7.3.1.3 Test Requirements

The SS-SINR measurement accuracy shall fulfil the requirements in section 10.1.12.1.1.

A.6.7.3.2 SA Inter-frequency measurement accuracy with FR1 serving cell and FR1 target cell

A.6.7.3.2.1 Test Purpose and Environment

The purpose of this test is to verify that the SS-SINR measurement accuracy is within the specified limits. This test will verify the requirements in Clause 10.1.14.1.1 and 10.1.14.1.2.

A.6.7.3.2.2 Test Parameters

In this test case the two cells (i.e., Cell 1 and Cell 2) are on different carrier frequencies and measurement gaps are provided. Supported test configurations are shown in Table A.6.7.3.2.2-1. Both absolute accuracy and relative accuracy requirements of SS-SINR inter-frequency measurement are tested by using test parameters in Table A.6.7.3.2.2-2. In all test cases, Cell 1 is the PCell and Cell 2 is target cell.

Table A.6.7.3.2.2-1: SS-SINR Inter frequency SS-SINR supported test configurations

Config	Description
1	NR 15 kHz SSB SCS, 10MHz bandwidth, FDD duplex mode
2	NR 15 kHz SSB SCS, 10MHz bandwidth, TDD duplex mode
3	NR 30 kHz SSB SCS, 40MHz bandwidth, TDD duplex mode
Note:	The UE is only required to be tested in one of the supported test configurations

Table A.6.7.3.2.2-2: SS-SINR Inter frequency test parameters

Parameter		Unit	Test 1		Test 2		Test 3	
			Cell 1	Cell 2	Cell 1	Cell 2	Cell 1	Cell 2
SSB ARFCN			freq1	freq2	freq1	freq2	freq1	freq2
Duplex mode	Config 1		FDD					
	Config 2,3		TDD					
TDD configuration	Config 1		Not Applicable					
	Config 2		TDDConf.1.1					
	Config 3		TDDConf.2.1					
Downlink initial BWP configuration			DLBWP.0.1					
Downlink dedicated BWP configuration			DLBWP.1.1					
Uplink initial BWP configuration			ULBWP.0.1					
Uplink dedicated BWP configuration			ULBWP.1.1					
DRX Cycle configuration		ms	Not Applicable					

TRS configuration			TRS.2.1 TDD				
TCI state			TCI.State.0				
PDSCH Reference measurement channel	Config 1		SR.1.1 FDD	-	SR.1.1 FDD	-	SR.1.1 FDD
	Config 2		SR.1.1 TDD	-	SR.1.1 TDD	-	SR.1.1 TDD
	Config 3		SR2.1 TDD	-	SR2.1 TDD	-	SR2.1 TDD
RMSI CORESET Reference Channel	Config 1		CR.1.1 FDD	-	R.1.1 FDD	-	CR.1.1 FDD
	Config 2		CR.1.1 TDD	-	CR.1.1 TDD	-	CR.1.1 TDD
	Config 3		CR2.1 TDD	-	CR2.1 TDD	-	CR2.1 TDD
Dedicated CORESET Reference Channel	Config 1		CCR.1 .1 FDD	-	CCR.1. 1 FDD	-	CCR.1. 1 FDD
	Config 2		CCR.1 .1 TDD	-	CCR.1. 1 TDD	-	CCR.1. 1 TDD
	Config 3		CCR2. 1 TDD	-	CCR2.1 TDD	-	CCR2. 1 TDD
OCNG Patterns			OP.1				
SS-RSSI-Measurement			Not Applicable				
SMTC configuration			SMTC.1				
SSB configuration	Config 1,2		SSB.1 FR1				
	Config 3		SSB.2 FR1				
PDSCH/PDCCH subcarrier spacing	Config 1,2	kHz	15				
	Config 3		30				
EPRE ratio of PSS to SSS							
EPRE ratio of PBCH DMRS to SSS							
EPRE ratio of PBCH to PBCH DMRS							
EPRE ratio of PDCCH DMRS to SSS							
EPRE ratio of PDCCH to PDCCH DMRS							
EPRE ratio of PDSCH DMRS to SSS							
EPRE ratio of PDSCH to PDSCH							
EPRE ratio of OCNG DMRS to SSS(Note 1)							
EPRE ratio of OCNG to OCNG DMRS (Note 1)							
N_{oc} ^{Note2}	Config 1,2	NR_FDD_FR1_A	dBm/15kHz	TBD	TBD	TBD	TBD
		NR_TDD_FR1_A					TBD
		NR_FDD_FR1_B					TBD
		NR_TDD_FR1_C					TBD
		NR_FDD_FR1_D					TBD
		NR_TDD_FR1_D					TBD
		NR_FDD_FR1_E					TBD
NR_TDD_FR1_E	TBD						
N_{oc} ^{Note2}	Config 3	NR_FDD_FR1_A	dBm/15kHz	TBD	TBD	TBD	TBD
		NR_TDD_FR1_A					TBD
		NR_FDD_FR1_B					TBD
		NR_TDD_FR1_C					TBD
		NR_FDD_FR1_D					TBD
		NR_TDD_FR1_D					TBD
		NR_FDD_FR1_E					TBD
NR_TDD_FR1_E	TBD						

		NR_FDD_FR1_G						TBD	
		NR_FDD_FR1_H						TBD	
N_{oc} ^{Note2}	Config 1,2	NR_FDD_FR1_A	dBm/15kHz	TBD	TBD	TBD	TBD	TBD	
		NR_TDD_FR1_A						TBD	
		NR_FDD_FR1_B						TBD	
		NR_TDD_FR1_C						TBD	
		NR_FDD_FR1_D						TBD	
		NR_TDD_FR1_D						TBD	
	NR_FDD_FR1_E	TBD							
	NR_TDD_FR1_E	TBD							
	NR_FDD_FR1_G	TBD							
	NR_FDD_FR1_H	TBD							
	Config 3	NR_FDD_FR1_A						TBD	
		NR_TDD_FR1_A						TBD	
		NR_FDD_FR1_B						TBD	
		NR_TDD_FR1_C						TBD	
NR_FDD_FR1_D		TBD							
NR_TDD_FR1_D		TBD							
NR_FDD_FR1_E		TBD							
NR_TDD_FR1_E		TBD							
NR_FDD_FR1_G	TBD								
NR_FDD_FR1_H	TBD								
\hat{E}_s / I_{ot}			dB	[-1.75]	[-1.75]	[20]	[20]	[-4.0]	[-4.0]
\hat{E}_s / N_{oc}			dB	TBD	TBD	TBD	TBD	TBD	TBD
SS-RSRP ^{Note3}	Config 1,2	NR_FDD_FR1_A	dBm/SCS	TBD	TBD	TBD	TBD	TBD	TBD
		NR_TDD_FR1_A						TBD	TBD
		NR_FDD_FR1_B						TBD	TBD
		NR_TDD_FR1_C						TBD	TBD
		NR_FDD_FR1_D						TBD	TBD
		NR_TDD_FR1_D						TBD	TBD
	NR_FDD_FR1_E	TBD						TBD	
	NR_TDD_FR1_E	TBD						TBD	
	NR_FDD_FR1_G	TBD						TBD	
	NR_FDD_FR1_H	TBD						TBD	
	Config 3	NR_FDD_FR1_A						TBD	
		NR_TDD_FR1_A						TBD	
		NR_FDD_FR1_B						TBD	
		NR_TDD_FR1_C						TBD	
NR_FDD_FR1_D		TBD							
NR_TDD_FR1_D		TBD							
NR_FDD_FR1_E		TBD							
NR_TDD_FR1_E		TBD							
NR_FDD_FR1_G	TBD								
NR_FDD_FR1_H	TBD								
SS-SINR ^{Note3}		NR_FDD_FR1_A	dB	[-1.75]	[-1.75]	[20]	[20]	[-4.0]	[-4.0]
		NR_TDD_FR1_A							
		NR_FDD_FR1_B							
		NR_TDD_FR1_C							
		NR_FDD_FR1_D							
		NR_TDD_FR1_D							
		NR_FDD_FR1_E							
		NR_TDD_FR1_E							
	NR_FDD_FR1_G								
	NR_FDD_FR1_H								
I_o ^{Note3}	Config 1,2	NR_FDD_FR1_A	dBm/ 9.36MHz	TBD	TBD	TBD	TBD	TBD	TBD
		NR_TDD_FR1_A						TBD	TBD
		NR_FDD_FR1_B						TBD	TBD

		NR_TDD_FR1_C				TBD	TBD
		NR_FDD_FR1_D				TBD	TBD
		NR_TDD_FR1_D					
		NR_FDD_FR1_E				TBD	TBD
		NR_TDD_FR1_E					
	NR_FDD_FR1_G	TBD	TBD				
	NR_FDD_FR1_H	TBD	TBD				
	Config 3	dBm/ 38.16MHz	NR_FDD_FR1_A	TBD	TBD	TBD	TBD
			NR_TDD_FR1_A				
			NR_FDD_FR1_B			TBD	TBD
			NR_TDD_FR1_C			TBD	TBD
			NR_FDD_FR1_D			TBD	TBD
NR_TDD_FR1_D							
NR_FDD_FR1_E	TBD	TBD					
NR_TDD_FR1_E							
NR_FDD_FR1_G	TBD	TBD					
NR_FDD_FR1_H	TBD	TBD					
Propagation condition			-	AWGN			
Antenna configuration			-	1x2			
<p>Note 1: OCNG shall be used such that both cells are fully allocated and a constant total transmitted power spectral density is achieved for all OFDM symbols.</p> <p>Note 2: Interference from other cells and noise sources not specified in the test is assumed to be constant over subcarriers and time and shall be modelled as AWGN of appropriate power for N_{oc} to be fulfilled.</p> <p>Note 3: SS-SINR, SS-RSRP, and I_o levels have been derived from other parameters for information purposes. They are not settable parameters themselves.</p> <p>Note 4: SS-SINR, SS-RSRP minimum requirements are specified assuming independent interference and noise at each receiver antenna port.</p> <p>Note 5: NR operating band groups are as defined in Section 3.5.2.</p>							

A.6.7.3.2.3 Test Requirements

The SS-SINR measurement accuracy shall fulfil the requirements in section 10.1.14.1.1 and 10.1.14.1.2.

A.6.7.4 L1-RSRP measurement for beam reporting

A.6.7.4.1 SSB based L1-RSRP measurement

A.6.7.4.1.1 Test Purpose and Environment

The purpose of this test is to verify that the L1-RSRP measurement accuracy is within the specified limits. This test will verify the requirements in Sections 9.5.2 and section 10.1.19.1 for L1-RSRP measurements based on SSB with the testing configurations for NR cells in Table A.6.7.4.1.1-1.

Table A.6.7.4.1.1-1: Applicable NR configurations for FR1 SSB based L1-RSRP test

Config	Description
1	NR 15 kHz SSB SCS, 10MHz bandwidth, FDD duplex mode
2	NR 15 kHz SSB SCS, 10MHz bandwidth, TDD duplex mode
3	NR 30kHz SSB SCS, 40MHz bandwidth, TDD duplex mode
Note:	The UE is only required to be tested in one of the supported test configurations

A.6.7.4.1.2 Test parameters

In this set of test cases there one cell in the test, PCell (Cell 1). The test parameters for the Cell 1 are given in Table A.6.7.4.1.2-1 below. The absolute and relative accuracy of L1-RSRP measurements are tested by using the parameters in Table A.6.7.4.1.2-1.

There is no measurement gap configured in the test. Before the test, UE is configured one SSB resource set with two SSB resources. UE is configured to perform RLM, BFD and L1-RSRP measurement based on the SSB resources 0 and 1.

Table A.6.7.4.1.2-1: FR1 SSB based L1-RSRP test parameters

Parameter	Config	Unit	Test 1	Test 2	
SSB GSCN	1~3		freq1	freq1	
Duplex mode	1		FDD	FDD	
	2		TDD	TDD	
	3		TDD	TDD	
TDD Configuration	1		N/A	N/A	
	2		TDDConf.1.1	TDDConf.1.1	
	3		TDDConf.2.1	TDDConf.2.1	
BW _{channel}	1	MHz	10: N _{RB,c} = 52	10: N _{RB,c} = 52	
	2		10: N _{RB,c} = 52	10: N _{RB,c} = 52	
	3		40: N _{RB,c} = 106	40: N _{RB,c} = 106	
PDSCH Reference measurement channel	1		SR.1.1 FDD	SR.1.1 FDD	
	2		SR.1.1 TDD	SR.1.1 TDD	
	3		SR.2.1 TDD	SR.2.1 TDD	
RMSI CORESET Reference Channel	1		CR.1.1 FDD	CR.1.1 FDD	
	2		CR.1.1 TDD	CR.1.1 TDD	
	3		CR.2.1 TDD	CR.2.1 TDD	
Dedicated CORESET Reference Channel	1		CCR.1.1 FDD	CCR.1.1 FDD	
	2		CCR.1.1 TDD	CCR.1.1 TDD	
	3		CCR.2.1 TDD	CCR.2.1 TDD	
SSB configuration	1		SSB.3 FR1	SSB.3 FR1	
	2		SSB.3 FR1	SSB.3 FR1	
	3		SSB.4 FR1	SSB.4 FR1	
OCNG Patterns	1~3		OP.1	OP.1	
Initial BWP Configuration	1~3		DLBWP.0.1 ULBWP.0.1	DLBWP.0.1 ULBWP.0.1	
Dedicated BWP configuration	1~3		DLBWP.1.1 ULBWP.1.1	DLBWP.1.1 ULBWP.1.1	
SMTTC configuration	1~3		SMTTC.1	SMTTC.1	
reportConfigType	1~3		periodic	periodic	
reportQuantity	1~3		ssb-Index-RSRP	ssb-Index-RSRP	
Number of reported RS	1~3		2	2	
L1-RSRP reporting period	1~3		slot80	slot80	
EPRE ratio of PSS to SSS	1~3	dB	0	0	
EPRE ratio of PBCH DMRS to SSS					
EPRE ratio of PBCH to PBCH DMRS					
EPRE ratio of PDCCH DMRS to SSS					
EPRE ratio of PDCCH to PDCCH DMRS					
EPRE ratio of PDSCH DMRS to SSS					
EPRE ratio of PDSCH to PDSCH DMRS					
EPRE ratio of OCNG DMRS to SSS ^{Note 1}					
EPRE ratio of OCNG to OCNG DMRS ^{Note 1}					
N_{oc} Note2	NR_FDD_FR1_A, NR_TDD_FR1_A	1~3	dBm/15kHz	-94.65	-117
	NR_FDD_FR1_B				-116.5
	NR_TDD_FR1_C				-116
	NR_FDD_FR1_D, NR_TDD_FR1_D				-115.5
	NR_FDD_FR1_E, NR_TDD_FR1_E				-115

	NR_FDD_FR1_G				-114	
	NR_FDD_FR1_H				-113.5	
N_{oc} Note2	NR_FDD_FR1_A, NR_TDD_FR1_A	1,2	dBm/SSB SCS	-94.65	-117	
	NR_FDD_FR1_B				-116.5	
	NR_TDD_FR1_C				-116	
	NR_FDD_FR1_D, NR_TDD_FR1_D				-115.5	
	NR_FDD_FR1_E, NR_TDD_FR1_E				-115	
	NR_FDD_FR1_G				-114	
	NR_FDD_FR1_H	-113.5				
	NR_FDD_FR1_A, NR_TDD_FR1_A	3		-91.65	-114	
	NR_FDD_FR1_B				-113.5	
	NR_TDD_FR1_C				-114	
	NR_FDD_FR1_D, NR_TDD_FR1_D				-112.5	
	NR_FDD_FR1_E, NR_TDD_FR1_E				-112	
	NR_FDD_FR1_G				-111	
	NR_FDD_FR1_H	-110.5				
\hat{E}_s/I_{ot}	1~3	dB	10	-3		
SSB RSRP Note3	NR_FDD_FR1_A, NR_TDD_FR1_A	1,2	dBm/SSB SCS	-84.65	-120	
	NR_FDD_FR1_B				-119.5	
	NR_TDD_FR1_C				-119	
	NR_FDD_FR1_D, NR_TDD_FR1_D				-118.5	
	NR_FDD_FR1_E, NR_TDD_FR1_E				-118	
	NR_FDD_FR1_G				-117	
	NR_FDD_FR1_H	-116.5				
	NR_FDD_FR1_A, NR_TDD_FR1_A	3		-81.65	-117	
	NR_FDD_FR1_B				-116.5	
	NR_TDD_FR1_C				-116	
	NR_FDD_FR1_D, NR_TDD_FR1_D				-115.5	
	NR_FDD_FR1_E, NR_TDD_FR1_E				-115	
	NR_FDD_FR1_G				-114	
	NR_FDD_FR1_H	-113.5				
I_o Note3	NR_FDD_FR1_A, NR_TDD_FR1_A	1,2	dBm/9.36 MHz	-56.28	-87.28	
	NR_FDD_FR1_B				-86.78	
	NR_TDD_FR1_C				-86.28	
	NR_FDD_FR1_D, NR_TDD_FR1_D				-85.78	
	NR_FDD_FR1_E, NR_TDD_FR1_E				-85.28	
	NR_FDD_FR1_G				-84.28	
	NR_FDD_FR1_H	-83.78				
	NR_FDD_FR1_A, NR_TDD_FR1_A	3		dBm/38.16 MHz	-50.19	-81.19
	NR_FDD_FR1_B					-80.69
	NR_TDD_FR1_C					-80.19
NR_FDD_FR1_D, NR_TDD_FR1_D	-79.69					

	NR_FDD_FR1_E, NR_TDD_FR1_E				-79.19
	NR_FDD_FR1_G				-78.19
	NR_FDD_FR1_H				-77.69
\hat{E}_s/N_{oc}	1~3	dB	10		-3
Propagation condition	1~3		AWGN		AWGN
Note 1:	OCNG shall be used such that both cells are fully allocated and a constant total transmitted power spectral density is achieved for all OFDM symbols.				
Note 2:	Interference from other cells and noise sources not specified in the test is assumed to be constant over subcarriers and time and shall be modelled as AWGN of appropriate power for N_{oc} to be fulfilled.				
Note 3:	RSRP and I_0 levels have been derived from other parameters for information purposes. They are not settable parameters themselves.				
Note 4:	RSRP minimum requirements are specified assuming independent interference and noise at each receiver antenna port.				

A.6.7.4.1.3 Test Requirements

For at least one reported L1-RSRP during 480ms, the accuracy for SSB#0 and SSB#1 of Cell 1 shall fulfil the requirements in sections 10.1.19.1.

A.6.7.4.2 CSI-RS based L1-RSRP measurement on resource set with repetition off

A.6.7.4.2.1 Test Purpose and Environment

The purpose of this test is to verify that the L1-RSRP measurement accuracy is within the specified limits. This test will verify the requirements in Sections 9.5.3 and section 10.1.19.2 for L1-RSRP measurements based on CSI-RS with the testing configurations for NR cells in Table A.6.7.4.2.1-1.

Table A.6.7.4.2.1-1: Applicable NR configurations for FR1 CSI-RS based L1-RSRP test

Config	Description
1	NR 15 kHz CSI-RS SCS, 10MHz bandwidth, FDD duplex mode
2	NR 15 kHz CSI-RS SCS, 10MHz bandwidth, TDD duplex mode
3	NR 30kHz CSI-RS SCS, 40MHz bandwidth, TDD duplex mode
Note:	The UE is only required to be tested in one of the supported test configurations

A.6.7.4.2.2 Test parameters

In this set of test cases there are one cell in the test, PCell (Cell 1). The test parameters for the Cell 1 are given in Table A.6.7.4.2.2-1 below. The absolute and relative accuracy of L1-RSRP measurements are tested by using the parameters in Table A.6.7.4.2.2-1.

There is no measurement gap configured in the test. Before the test, UE is configured one CSI-RS resource set with two CSI-RS resources. UE is configured to perform RLM and BFD based on SSB 0 and 1. CSI-RS is not transmitted in the same OFDM symbols as SSB.

Table A.6.7.4.2.2-1: FR1 CSI-RS based L1-RSRP test parameters

Parameter	Config	Unit	Test 1	Test 2	
SSB GSCN	1~3		freq1	freq1	
Duplex mode	1		FDD	FDD	
	2		TDD	TDD	
	3		TDD	TDD	
TDD Configuration	1		N/A	N/A	
	2		TDDConf.1.1	TDDConf.1.1	
	3		TDDConf.2.1	TDDConf.2.1	
BW _{channel}	1	MHz	10: N _{RB,c} = 52	10: N _{RB,c} = 52	
	2		10: N _{RB,c} = 52	10: N _{RB,c} = 52	
	3		40: N _{RB,c} = 106	40: N _{RB,c} = 106	
PDSCH Reference measurement channel	1		SR.1.1 FDD	SR.1.1 FDD	
	2		SR.1.1 TDD	SR.1.1 TDD	
	3		SR.2.1 TDD	SR.2.1 TDD	
RMSI CORESET Reference Channel	1		CR.1.1 FDD	CR.1.1 FDD	
	2		CR.1.1 TDD	CR.1.1 TDD	
	3		CR.2.1 TDD	CR.2.1 TDD	
Dedicated CORESET Reference Channel	1		CCR.1.1 FDD	CCR.1.1 FDD	
	2		CCR.1.1 TDD	CCR.1.1 TDD	
	3		CCR.2.1 TDD	CCR.2.1 TDD	
SSB configuration	1		SSB.1 FR1	SSB.1 FR1	
	2		SSB.1 FR1	SSB.1 FR1	
	3		SSB.2 FR1	SSB.2 FR1	
OCNG Patterns	1~3		OP.1	OP.1	
Initial BWP Configuration	1~3		DLBWP.0.1 ULBWP.0.1	DLBWP.0.1 ULBWP.0.1	
Dedicated BWP configuration	1~3		DLBWP.1.1 ULBWP.1.1	DLBWP.1.1 ULBWP.1.1	
SMTTC configuration	1~3		SMTTC.1	SMTTC.1	
CSI-RS	1		CSI-RS 1.2 FDD	CSI-RS 1.2 FDD	
	2		CSI-RS 1.2 TDD	CSI-RS 1.2 TDD	
	3		CSI-RS 2.2 TDD	CSI-RS 2.2 FDD	
reportConfigType	1~3		periodic	periodic	
reportQuantity	1~3		cri-RSRP	cri-RSRP	
Number of reported RS	1~3		2	2	
L1-RSRP reporting period	1~3		slot80	slot80	
EPRE ratio of PSS to SSS	1~3	dB	0	0	
EPRE ratio of PBCH DMRS to SSS					
EPRE ratio of PBCH to PBCH DMRS					
EPRE ratio of PDCCH DMRS to SSS					
EPRE ratio of PDCCH to PDCCH DMRS					
EPRE ratio of PDSCH DMRS to SSS					
EPRE ratio of PDSCH to PDSCH DMRS					
EPRE ratio of OCNG DMRS to SSS ^{Note 1}					
EPRE ratio of OCNG to OCNG DMRS ^{Note 1}					
N _{oc} Note2					NR_FDD_FR1_A, NR_TDD_FR1_A
	NR_FDD_FR1_B	-116.5			
	NR_TDD_FR1_C	-116			
	NR_FDD_FR1_D, NR_TDD_FR1_D	-115.5			
	NR_FDD_FR1_E, NR_TDD_FR1_E	-115			
	NR_FDD_FR1_G	-114			

N_{oc} Note2	NR_FDD_FR1_H	1,2	dBm/CSI-RS SCS	-94.65	-113.5	
	NR_FDD_FR1_A, NR_TDD_FR1_A				-117	
	NR_FDD_FR1_B				-116.5	
	NR_TDD_FR1_C				-116	
	NR_FDD_FR1_D, NR_TDD_FR1_D				-115.5	
	NR_FDD_FR1_E, NR_TDD_FR1_E				-115	
	NR_FDD_FR1_G	-114				
	NR_FDD_FR1_H	-113.5				
	NR_FDD_FR1_A, NR_TDD_FR1_A	3		-91.65	-114	
	NR_FDD_FR1_B				-113.5	
	NR_TDD_FR1_C				-114	
	NR_FDD_FR1_D, NR_TDD_FR1_D				-112.5	
	NR_FDD_FR1_E, NR_TDD_FR1_E				-112	
	NR_FDD_FR1_G				-111	
NR_FDD_FR1_H	-110.5					
\hat{E}_s/I_{ot}	1~3	dB	10	-3		
CSI-RS RSRP Note3	NR_FDD_FR1_A, NR_TDD_FR1_A	1,2	dBm/CSI-RS SCS	-84.65	-120	
	NR_FDD_FR1_B				-119.5	
	NR_TDD_FR1_C				-119	
	NR_FDD_FR1_D, NR_TDD_FR1_D				-118.5	
	NR_FDD_FR1_E, NR_TDD_FR1_E				-118	
	NR_FDD_FR1_G				-117	
	NR_FDD_FR1_H	-116.5				
	NR_FDD_FR1_A, NR_TDD_FR1_A	3		-81.65	-117	
	NR_FDD_FR1_B				-116.5	
	NR_TDD_FR1_C				-116	
	NR_FDD_FR1_D, NR_TDD_FR1_D				-115.5	
	NR_FDD_FR1_E, NR_TDD_FR1_E				-115	
	NR_FDD_FR1_G				-114	
	NR_FDD_FR1_H	-113.5				
I_o Note3	NR_FDD_FR1_A, NR_TDD_FR1_A	1,2	dBm/9.36 MHz	-56.28	-87.28	
	NR_FDD_FR1_B				-86.78	
	NR_TDD_FR1_C				-86.28	
	NR_FDD_FR1_D, NR_TDD_FR1_D				-85.78	
	NR_FDD_FR1_E, NR_TDD_FR1_E				-85.28	
	NR_FDD_FR1_G				-84.28	
	NR_FDD_FR1_H	-83.78				
	NR_FDD_FR1_A, NR_TDD_FR1_A	3		dBm/38.16 MHz	-50.19	-81.19
	NR_FDD_FR1_B					-80.69
	NR_TDD_FR1_C					-80.19
NR_FDD_FR1_D, NR_TDD_FR1_D	-79.69					

	NR_FDD_FR1_E, NR_TDD_FR1_E				-79.19
	NR_FDD_FR1_G				-78.19
	NR_FDD_FR1_H				-77.69
\hat{E}_s/N_{oc}	1~3	dB	10		-3
Propagation condition	1~3		AWGN		AWGN
Note 1:	OCNG shall be used such that both cells are fully allocated and a constant total transmitted power spectral density is achieved for all OFDM symbols.				
Note 2:	Interference from other cells and noise sources not specified in the test is assumed to be constant over subcarriers and time and shall be modelled as AWGN of appropriate power for N_{oc} to be fulfilled.				
Note 3:	RSRP and I_o levels have been derived from other parameters for information purposes. They are not settable parameters themselves.				
Note 4:	RSRP minimum requirements are specified assuming independent interference and noise at each receiver antenna port.				

A.6.7.4.2.3 Test Requirements

The L1-RSRP measurement accuracy for CSI-RS#0 and CSI-RS#1 of Cell 1 shall fulfil the requirements in sections 10.1.19.2.

A.7 NR standalone tests with one or more NR cells in FR2

A.7.1 SA: RRC_IDLE state mobility

A.7.1.1 Cell re-selection to NR

A.7.1.1.1 Cell reselection to FR2 intra-frequency NR case

A.7.1.1.1.1 Test Purpose and Environment

This test is to verify the requirement for the intra frequency NR cell reselection requirements specified in clause 4.2.2.3.

A.7.1.1.1.2 Test Parameters

The test scenario comprises of 1 NR carrier and 2 cells as given in tables A.7.1.1.1.2-1, A.7.1.1.1.2-2 and A.7.1.1.1.2-3. The test consists of three successive time periods, with time duration of T1, T2, and T3 respectively. Only cell 1 is already identified by the UE prior to the start of the test. Cell 1 and cell 2 belong to different tracking areas. Furthermore, UE has not registered with network for the tracking area containing cell 2.

Table A.7.1.1.1.2-1: Supported test configurations

Configuration	Description
1	120 kHz SSB SCS, 100MHz bandwidth, TDD duplex mode
2	240 kHz SSB SCS, 100MHz bandwidth, TDD duplex mode
Note:	The UE is only required to be tested in one of the supported test configurations.

Table A.7.1.1.1.2-2: General test parameters for intra frequency NR cell re-selection test case

Parameter		Unit	Test configuration	Value	Comment
Initial condition	Active cell		1, 2	Cell1	
	Neighbour cells		1, 2	Cell2	
T2 end condition	Active cell		1, 2	Cell2	
	Neighbour cells		1, 2	Cell1	
Final condition	Visited cell		1, 2	Cell1	
RF Channel Number			1, 2	1	
Time offset between cells			1, 2	3 μ s	Synchronous cells
Access Barring Information		-	1, 2	Not Sent	No additional delays in random access procedure.
SSB configuration			1	SSB.1 FR2	
			2	SSB.2 FR2	
SMTC configuration			1, 2	SMTC pattern 1	
DRX cycle length		s	1, 2	1.28	The value shall be used for all cells in the test.
PRACH configuration index			1, 2	87	The detailed configuration is specified in TS 38.211 clause 6.3.3.2
rangeToBestCell			1, 2	Not configured	
T1		s	1, 2	[>7]	During T1, Cell 2 shall be powered off, and during the off time the physical cell identity shall be changed, The intention is to ensure that Cell 2 has not been detected by the UE prior to the start of period T2
T2		s	1, 2	[135]	T2 needs to be defined so that cell re-selection reaction time is taken into account.
T3		s	1, 2	[35]	T3 needs to be defined so that cell re-selection reaction time is taken into account.

Table A.7.1.1.1.2-3: Cell specific test parameters for intra frequency NR cell re-selection test case in AWGN

Parameter	Unit	Test configuration	Cell 1			Cell 2		
			T1	T2	T3	T1	T2	T3
TDD configuration		1, 2	TDDConf.3.1			TDDConf.3.1		
PDSCH RMC configuration		1	SR.3.1 TDD			N/A		
		2	SR.3.1 TDD					
RMSI CORESET RMC configuration		1	CR.3.1 TDD			CR.3.1 TDD		
		2	CR.3.1 TDD			CR.3.1 TDD		
Dedicated CORESET RMC configuration		1	CCR.3.1 TDD			CCR.3.1 TDD		
		2	CCR.3.1 TDD			CCR.3.1 TDD		
OCNG Pattern		1, 2	OP.1 defined in A.3.2.1			OP.1 defined in A.3.2.1		
Initial DL BWP configuration		1, 2	DLBWP.0.1			DLBWP.0.1		
Initial UL BWP configuration		1, 2	ULBWP.0.1			ULBWP.0.1		
RLM-RS		1, 2	SSB			SSB		
Qrxlevmin	dBm/SCS	1	T-140			T-140		
		2	-137			-137		
Pcompensation	dB	1, 2	0			0		
Qhysts	dB	1, 2	0			0		
Qoffset _{s, n}	dB	1, 2	0			0		
Cell_selection_and_reselection_quality_measurement		1, 2	SS-RSRP			SS-RSRP		
AoA setup		1, 2	TSetup 1 defined in A.3.15.1			Setup 1 defined in A.3.15.1		
\hat{E}_s / I_{ot}	dB	1	T17	T-3.09	T2.83	-infinity	T2.83	T-3.09
		2						
N_{oc} ^{Note2}	dBm/SCS	1	T-98					
		2	T-95					
N_{oc} ^{Note2}	dBm/15 kHz	1	T-107					
		2						
\hat{E}_s / N_{oc}	dB	1	17	14	17	-infinity	T17	T14
		2						
SS-RSRP ^{Note3}	dBm/SCS	1	T-81	T-84	T-81	-infinity	T-81	T-84
		2	T-78	T-81	T-78	-infinity	T-78	T-81
I _o	dBm/95.04 MHz	1	T-51.93	T-50.19	T-50.19	-infinity	T-50.19	T-50.19
		2	-51.93	-50.19	-50.19	-infinity	-50.19	-50.19
Treselection	s	1, 2	0	0	0	0	0	0
Sintrasearch	dB	1, 2	Not sent			Not sent		
Propagation Condition		1, 2	AWGN					
<p>Note 1: OCNG shall be used such that both cells are fully allocated and a constant total transmitted power spectral density is achieved for all OFDM symbols.</p> <p>Note 2: Interference from other cells and noise sources not specified in the test is assumed to be constant over subcarriers and time and shall be modelled as AWGN of appropriate power for N_{oc} to be fulfilled.</p> <p>Note 3: SS-RSRP levels have been derived from other parameters for information purposes. They are not settable parameters themselves.</p>								

A.7.1.1.1.3 Test Requirements

The cell reselection delay to a newly detectable cell is defined as the time from the beginning of time period T2, to the moment when the UE camps on Cell 2, and starts to send preambles on the PRACH for sending the RRC CONNECTION REQUEST message to perform a Tracking Area Update procedure on Cell 2.

The cell re-selection delay to a newly detectable cell shall be less than [130] s.

The cell reselection delay to an already detected cell is defined as the time from the beginning of time period T3, to the moment when the UE camps on cell 1, and starts to send preambles on the PRACH for sending the RRC CONNECTION REQUEST message to perform a Tracking Area Update procedure on cell 1.

The cell re-selection delay to an already detected cell shall be less than [27] s.

The rate of correct cell reselections observed during repeated tests shall be at least 90%.

NOTE: The cell re-selection delay to a newly detectable cell can be expressed as: $T_{\text{detect, NR_Intra}} + T_{\text{SI-NR}}$, and to an already detected cell can be expressed as: $T_{\text{evaluate, NR_intra}} + T_{\text{SI-NR}}$.

Where:

$T_{\text{detect, NR_Intra}}$ See Table 4.2.2.3-1 in clause 4.2.2.3

$T_{\text{evaluate, NR_intra}}$ See Table 4.2.2.3-1 in clause 4.2.2.3

$T_{\text{SI-NR}}$ Maximum repetition period of relevant system info blocks that needs to be received by the UE to camp on a cell; 1280 ms is assumed in this test case.

This gives a total of [129.28] s, allow [130] s for the cell re-selection delay to a newly detectable cell and [26.88] s for the cell re-selection delay to an already detected cell in the test case, which we allow [27] s.

A.7.1.1.2 Cell reselection to FR2 inter-frequency NR case

A.7.1.1.2.1 Test Purpose and Environment

This test is to verify the requirement for the inter frequency NR cell reselection requirements specified in clause 4.2.2.4.

A.7.1.1.2.2 Test Parameters

The test scenario comprises of 2 cells on 2 different NR carriers respectively as given in tables A.7.1.1.2.2-1, A.7.1.1.2.2-2 and A.7.1.1.2.2-3. The test consists of three successive time periods, with time duration of T1, T2, and T3 respectively. Both cell 1 and cell 2 are already identified by the UE prior to the start of the test. Cell 1 and cell 2 belong to different tracking areas and cell 2 is of higher priority than cell 1. Furthermore, UE has not registered with network for the tracking area containing cell 2.

Table A.7.1.1.2.2-1: Supported test configurations

Configuration	Description for serving cell	Description for target cell
1	120 kHz SSB SCS, 100MHz bandwidth, TDD duplex mode	120 kHz SSB SCS, 100MHz bandwidth, TDD duplex mode
2	240 kHz SSB SCS, 100MHz bandwidth, TDD duplex mode	240 kHz SSB SCS, 100MHz bandwidth, TDD duplex mode
Note: The UE is only required to be tested in one of the supported test configurations.		

Table A.7.1.1.2.2-2: General test parameters for FR2 inter frequency NR cell re-selection test case

Parameter		Unit	Test configuration	Value	Comment
Initial condition	Active cell		1, 2	Cell2	The UE camps on cell 2 in the initial phase and during T1 period the UE reselects to cell 1
T1 end condition	Active cell		1, 2	Cell1	The UE shall perform reselection to cell 1 during T1
	Neighbour cells		1, 2	Cell2	
T3 end condition	Active cell		1, 2	Cell2	The UE shall perform reselection to cell 2 with higher priority during T3
RF Channel Number			1, 2	1, 2	
Time offset between cells			1, 2	3 μ s	Synchronous cells
Access Barring Information		-	1, 2	Not Sent	No additional delays in random access procedure.
SSB configuration			1	SSB.1 FR2	
			2	SSB.2 FR2	
SMTC configuration			1, 2	SMTC pattern 1	
DRX cycle length		s	1, 2	1.28	The value shall be used for all cells in the test.
PRACH configuration index			1, 2	87	The detailed configuration is specified in TS 38.211 clause 6.3.3.2
rangeToBestCell			1, 2	Not configured	
T1		s	1, 2	[35	T1 needs to be defined so that cell re-selection reaction time is taken into account.
T2		s	1, 2	[>7	During T2, cell 2 shall be powered off, and during the off time the physical cell identity shall be changed. The intention is to ensure that cell 2 has not been detected by the UE prior to the start of period T3.
T3		s	1, 2	[95	T3 needs to be defined so that cell re-selection reaction time is taken into account.

Table A.7.1.1.2.2-3: Cell specific test parameters for FR2 inter frequency NR cell re-selection test case in AWGN

Parameter	Unit	Test configuration	Cell 1			Cell 2		
			T1	T2	T3	T1	T2	T3
TDD configuration		1, 2	TDDConf.3.1			TDDConf.3.1		
PDSCH RMC configuration		1, 2	SR.3.1 TDD			N/A		
RMSI CORESET parameters		1, 2	CR.3.1 TDD			CR.3.1 TDD		
RMSI CORESET RMC configuration		1, 2	CCR.3.1 TDD			CCR.3.1 TDD		
OCNG Pattern		1, 2	OP.1 defined in A.3.2.1			OP.1 defined in A.3.2.1		
Initial DL BWP configuration		1, 2	DLBWP.0.1			DLBWP.0.1		
Initial UL BWP configuration		1, 2	ULBWP.0.1			ULBWP.0.1		
RLM-RS		1, 2	SSB			SSB		
Qrxlevmin	dBm/SCS	1	-140			-140		
		2	-137			-137		
Pcompensation	dB	1, 2	0			0		
Qhysts	dB	1, 2	0			0		
Qoffsets _{s, n}	dB	1, 2	0			0		
Cell_selection_and_reselection_quality_measurement		1, 2	SS-RSRP			SS-RSRP		
AoA setup		1, 2	Setup 1 defined in A.3.15.1			Setup 1 defined in A.3.15.1		
\hat{E}_s / I_{ot}	dB	1	15	15	15	-3	-infinity	13
		2						
N_{oc} ^{Note2}	dBm/SCS	1	T-98					
		2	T-95					
N_{oc} ^{Note2}	dBm/15 kHz	1	T-107					
		2						
\hat{E}_s / N_{oc}	dB	1	T15	T15	T15	T-3	-infinity	T13
		2						
SS-RSRP ^{Note3}	dBm/SCS	1	T-83	T-83	T-83	T-101	-infinity	T-85
		2	T-80	T-80	T-80	T-98	-infinity	T-82
Io	dBm/95.04 MHz	1	T-53.88	-53.88	-53.88	T-67.25	-infinity	T-55.80
		2	-53.88	-53.88	-53.88	-67.25	-infinity	-55.80
Treselection	s	1, 2	0	0	0	0	0	0
Snoninrasearch	dB	1, 2	50			Not sent		
Thresh _{x, high}	dB	1, 2	48			48		
Thresh _{servng, low}	dB	1, 2	44			44		
Thresh _{x, low}	dB	1, 2	50			50		
Propagation Condition		1, 2	AWGN					
Note 1:	OCNG shall be used such that both cells are fully allocated and a constant total transmitted power spectral density is achieved for all OFDM symbols.							
Note 2:	Interference from other cells and noise sources not specified in the test is assumed to be constant over subcarriers and time and shall be modelled as AWGN of appropriate power for N_{oc} to be fulfilled.							
Note 3:	SS-RSRP levels have been derived from other parameters for information purposes. They are not settable parameters themselves.							

A.7.1.1.2.3 Test Requirements

The cell reselection delay to a higher priority cell is defined as the time from the beginning of time period T3, to the moment when the UE camps again on cell 2, and starts to send preambles on the PRACH for sending the RRC CONNECTION REQUEST message to perform a Tracking Area Update procedure on cell 2.

The cell re-selection delay to a higher priority cell shall be less than [87] s.

The cell reselection delay to a lower priority cell is defined as the time from the beginning of time period T1, to the moment when the UE camps on cell 1, and starts to send preambles on the PRACH for sending the RRC CONNECTION REQUEST message to perform a Tracking Area Update procedure on cell 1.

The cell re-selection delay to a lower priority cell shall be less than [27] s.

The rate of correct cell reselections observed during repeated tests shall be at least 90%.

NOTE: The cell re-selection delay to a higher priority cell can be expressed as: $T_{\text{higher_priority_search}} + T_{\text{evaluate, NR_inter}} + T_{\text{SI-NR}}$, and to a lower priority cell can be expressed as: $T_{\text{evaluate, NR_inter}} + T_{\text{SI-NR}}$.

Where:

$T_{\text{higher_priority_search}}$	See clause 4.2.2.7
$T_{\text{evaluate, NR_inter}}$	See Table 4.2.2.4-1 in clause 4.2.2.4
$T_{\text{SI-NR}}$	Maximum repetition period of relevant system info blocks that needs to be received by the UE to camp on a cell; 1280 ms is assumed in this test case.

This gives a total of [86.88] s, allow [87] s for the cell re-selection delay to a higher priority cell and [26.88] s for the cell re-selection delay to a lower priority cell in the test case, which we allow [27] s.

A.7.2 SA: RRC_INACTIVE state mobility

A.7.3 RRC_CONNECTED state mobility

A.7.3.1 Handover

A.7.3.1.1 Inter-frequency handover from FR1 to FR2; unknown target cell

A.7.3.1.1.1 Test Purpose and Environment

This test is to verify the requirement for the NR FR1-NR FR2 inter frequency handover requirements specified in clause 6.1.1.5 [TS38.133 v15.2.1].

A.7.3.1.1.2 Test Parameters

Supported test configurations are shown in table A.7.3.1.2-1. Both handover delay and interruption length are tested by using the parameters in table A.7.3.1.1.2-2, and A.7.3.1.1.2-3.

The test scenario comprises of two carriers and one cell on each carrier. No gap patterns are configured in the test case. The test consists of two successive time periods, with time durations of T1, T2 respectively. At the start of time duration T1, the UE does not have any timing information of cell 2. Starting T2, cell 2 becomes detectable and the UE receives a RRC handover command from the network. The start of T2 is the instant when the last TTI containing the RRC message implying handover is sent to the UE.

Table A.7.3.1.1.2-1: Inter-frequency handover from FR1 to FR2 test configurations

Config	Description
1	Source cell: NR 15 kHz SSB SCS, 10 MHz bandwidth, FDD duplex mode Target cell: NR 120 kHz SSB SCS, 100 MHz bandwidth, TDD duplex mode
2	Source cell: NR 15 kHz SSB SCS, 10 MHz bandwidth, TDD duplex mode Target cell: NR 120 kHz SSB SCS, 100 MHz bandwidth, TDD duplex mode
3	Source cell: NR 30 kHz SSB SCS, 40 MHz bandwidth, TDD duplex mode Target cell: NR 120 kHz SSB SCS, 100 MHz bandwidth, TDD duplex mode
Note: The UE is only required to be tested in one of the supported test configurations	

Table A.7.3.1.1.2-2: General test parameters Inter-frequency handover from FR1 to FR2

Parameter	Unit	Value	Comment
Initial conditions	Active cell	Cell 1	
	Neighbouring cell	Cell 2	
Final condition	Active cell	Cell 2	
A4-Offset	dB	[TBD]	
Hysteresis	dB	0	
Time To Trigger	s	0	
Filter coefficient		0	L3 filtering is not used
Access Barring Information	-	Not Sent	No additional delays in random access procedure.
Time offset between cells		3 μ s	Synchronous cells
T1	s	5	
T2	s	≤ 10	

Table A.7.3.1.1.2-3: Cell specific test parameters for NR FR1-FR2 Inter frequency handover test case

Parameter	Unit	Cell 1		Cell 2	
		T1	T2	T1	T2
NR RF Channel Number		1		2	

Duplex mode	Config 1		FDD	TDD
	Config 2,3		TDD	TDD
TDD configuration	Config 1		Not Applicable	TDDConf.3.1
	Config 2		TDDConf.1.1	TDDConf.3.1
	Config 3		TDDConf.2.1	TDDConf.3.1
BW _{channel}	Config 1	MHz	10: N _{RB,c} = 52	100: N _{RB,c} = 66
	Config 2		10: N _{RB,c} = 52	100: N _{RB,c} = 66
	Config 3		40: N _{RB,c} = 106	100: N _{RB,c} = 66
BWP BW	Config 1	MHz	10: N _{RB,c} = 52	100: N _{RB,c} = 66
	Config 2		10: N _{RB,c} = 52	100: N _{RB,c} = 66
	Config 3		40: N _{RB,c} = 106	100: N _{RB,c} = 66
DRx Cycle		ms	Not Applicable	
PDSCH Reference measurement channel	Config 1		SR.1.1 FDD	SR3.1 TDD
	Config 2		SR.1.1 TDD	SR3.1 TDD
	Config 3		SR2.1 TDD	SR3.1 TDD
CORESET Reference Channel	Config 1		CR.1.1 FDD	CR3.1 TDD
	Config 2		CR.1.1 TDD	CR3.1 TDD
	Config 3		CR2.1 TDD	CR3.1 TDD
OCNG Patterns			OCNG pattern 1	
SMTC configuration	Config 1,2		SMTC.1 FR1	SMTC.1 FR2
	Config 3		SMTC.2 FR1	SMTC.1 FR2
PDSCH/PDCCH subcarrier spacing	Config 1,2	kHz	15 kHz	120 kHz
	Config 3		30 kHz	120 kHz
PUCCH/PUSCH subcarrier spacing	Config 1,2	kHz	15 kHz	120 kHz
	Config 3		30 kHz	120 kHz
PRACH configuration			FR1 PRACH configuration 1	FR2 PRACH configuration 1
TRS configuration	Config 1		N/A	TRS.2.1 TDD
	Config 2		N/A	TRS.2.1 TDD
	Config 3		N/A	TRS.2.1 TDD
TCI configuration			N/A	CSI-RS.Config.0
BWP configuraiton	Initial DL BWP		DLBWP.0.1	DLBWP.0.1
	Dedicated DL BWP		DLBWP.1.1	DLBWP.1.1
	Initial UL BWP		ULBWP.0.1	ULBWP.0.1
	Dedicated UL BWP		ULBWP.1.1	ULBWP.1.1
EPRE ratio of PSS to SSS		dB	0	0
EPRE ratio of PBCH DMRS to SSS				
EPRE ratio of PBCH to PBCH DMRS				
EPRE ratio of PDCCH DMRS to SSS				
EPRE ratio of PDCCH to PDCCH DMRS				
EPRE ratio of PDSCH DMRS to SSS				
EPRE ratio of PDSCH to PDSCH				

EPRE ratio of OCNG DMRS to SSS(Note 1)						
EPRE ratio of OCNG to OCNG DMRS (Note 1)						
N_{oc} ^{Note2}		dBm/15kHz	TBD		TBD	
N_{oc} ^{Note2}	Config 1,2	dBm/SCS	TBD		TBD	
	Config 3		TBD		TBD	
\hat{E}_s / I_{ot}		dB	TBD	TBD	-Infinity	TBD
\hat{E}_s / N_{oc}		dB	TBD	TBD	-Infinity	TBD
I_o ^{Note3}	Config 1,2	dBm/BW	TBD	TBD	TBD	TBD
	Config 3	dBm/BW	TBD	TBD	TBD	TBD
Propagation condition		-	AWGN			
<p>Note 1: OCNG shall be used such that both cells are fully allocated and a constant total transmitted power spectral density is achieved for all OFDM symbols.</p> <p>Note 2: Interference from other cells and noise sources not specified in the test is assumed to be constant over subcarriers and time and shall be modelled as AWGN of appropriate power for N_{oc} to be fulfilled.</p> <p>Note 3: I_o levels have been derived from other parameters for information purposes. They are not settable parameters themselves.</p> <p>Note 4: Equivalent power received by an antenna with 0dBi gain at the centre of the quiet zone</p> <p>Note 5: As observed with 0dBi gain antenna at the centre of the quiet zone</p>						

A.7.3.1.1.3 Test Requirements

The UE shall start to transmit the PRACH to Cell 2 less than [722] ms from the beginning of time period T2. The rate of correct handovers observed during repeated tests shall be at least 90%.

NOTE: The handover delay can be expressed as: RRC procedure delay + $T_{interrupt}$, where:

RRC procedure delay = [10] ms and is specified in clause 12 in TS 38.331 [2].

$T_{interrupt}$ = [712] ms in the test. $T_{interrupt}$ is defined in clause 6.1.1.5.2 [TS38.133].

This gives a total of [722] ms.

A.7.3.1.2 Intra-frequency handover from FR2 to FR2; unknown target cell

A.7.3.1.2.1 Test Purpose and Environment

This test is to verify the requirement for the NR FR2-NR FR2 intra frequency handover requirements specified in clause 6.1.1.4 [TS38.133 v15.2.1].

A.7.3.1.2.2 Test Parameters

Supported test configurations are shown in table A.7.3.1.2.2-1. Both handover delay and interruption length are tested by using the parameters in table A.7.3.1.2.2-2, and A.7.3.1.2.2-3.

The test scenario comprises of carriers and one cell on each carrier. No gap patterns are configured in the test case. The test consists of two successive time periods, with time durations of T1, T2 respectively. At the start of time duration T1, the UE does not have any timing information of cell 2. Starting T2, cell 2 becomes detectable and the UE receives a RRC handover command from the network. The start of T2 is the instant when the last TTI containing the RRC message implying handover is sent to the UE.

Table A.7.3.1.2.2-1: Intra-frequency handover from FR2 to FR2 test configurations

Config	Description
1	Source cell: NR 120 kHz SSB SCS, 100 MHz bandwidth, TDD duplex mode Target cell: NR 120 kHz SSB SCS, 100 MHz bandwidth, TDD duplex mode

Table A.7.3.1.2.2-2: General test parameters Intra-frequency handover from FR2 to FR2

Parameter	Unit	Value	Comment
Initial conditions	Active cell	Cell 1	
	Neighbouring cell	Cell 2	
Final condition	Active cell	Cell 2	
A4-Offset	dB	[TBD]	
Hysteresis	dB	0	
Time To Trigger	s	0	
Filter coefficient		0	L3 filtering is not used
Access Barring Information	-	Not Sent	No additional delays in random access procedure.
Time offset between cells		3 μ s	Synchronous cells
T1	s	5	
T2	s	≤ 10	

Table A.7.3.1.2.2-3: Cell specific test parameters for NR FR2-FR2 Intra frequency handover test case

Parameter	Unit	Cell 1		Cell 2	
		T1	T2	T1	T2
NR RF Channel Number		1		1	
Duplex mode		TDD			
TDD configuration		TDDConf.3.1			
BW _{channel}	MHz	100: N _{RB,c} = 66			
BWP BW	MHz	100: N _{RB,c} = 66			
DRx Cycle	ms	Not Applicable			
PDSCH Reference measurement channel		SR3.1 TDD			
CORESET Reference Channel		CR3.1 TDD			
OCNG Patterns		OCNG pattern 1			
SMTC configuration		SMTC.1 FR2			
PDSCH/PDCCH subcarrier spacing	kHz	120 kHz			
PUCCH/PUSCH subcarrier spacing	kHz	120 kHz			
PRACH configuration		FR2 PRACH configuration 1			
TRS configuration		TRS.2.1 TDD			
TCI configuration		CSI-RS.Config.0			
BWP configuraiton	Initial DL BWP	DLBWP.0.1			
	Dedicated DL BWP	DLBWP.1.1			
	Initial UL BWP	ULBWP.0.1			
	Dedicated UL BWP	ULBWP.1.1			
EPRE ratio of PSS to SSS	dB	0		0	
EPRE ratio of PBCH DMRS to SSS					
EPRE ratio of PBCH to PBCH DMRS					
EPRE ratio of PDCCH DMRS to SSS					
EPRE ratio of PDCCH to PDCCH DMRS					
EPRE ratio of PDSCH DMRS to SSS					
EPRE ratio of PDSCH to PDSCH					
EPRE ratio of OCNG DMRS to SSS(Note 1)					
EPRE ratio of OCNG to OCNG DMRS (Note 1)					

N_{oc} Note2		dBm/15kHz z	TBD		TBD	
N_{oc} Note2	Config 1,2	dBm/SCS	TBD		TBD	
	Config 3		TBD		TBD	
\hat{E}_s / I_{ot}		dB	TBD	TBD	TBD	TBD
\hat{E}_s / N_{oc}		dB	TBD	TBD	TBD	TBD
I_0 Note3	Config 1,2	dBm/ BW	TBD	TBD	TBD	TBD
	Config 3	dBm/ BW	TBD	TBD	TBD	TBD
Propagation condition		-	AWGN			
<p>Note 1: OCNG shall be used such that both cells are fully allocated and a constant total transmitted power spectral density is achieved for all OFDM symbols.</p> <p>Note 2: Interference from other cells and noise sources not specified in the test is assumed to be constant over subcarriers and time and shall be modelled as AWGN of appropriate power for N_{oc} to be fulfilled.</p> <p>Note 3: I_0 levels have been derived from other parameters for information purposes. They are not settable parameters themselves.</p> <p>Note 4: Equivalent power received by an antenna with 0dBi gain at the centre of the quiet zone</p> <p>Note 5: As observed with 0dBi gain antenna at the centre of the quiet zone</p>						

A.7.3.1.2.3 Test Requirements

The UE shall start to transmit the PRACH to Cell 2 less than [382] ms from the beginning of time period T2. The rate of correct handovers observed during repeated tests shall be at least 90%.

NOTE: The handover delay can be expressed as: RRC procedure delay + $T_{interrupt}$, where:

RRC procedure delay = [10] ms and is specified in clause 12 in TS 38.331 [2].

$T_{interrupt}$ = [372] ms in the test. $T_{interrupt}$ is defined in clause 6.1.1.4.2 [TS38.133].

This gives a total of [382] ms.

A.7.3.1.3 Inter-frequency handover from FR2 to FR2; unknown target cell

A.7.3.1.3.1 Test Purpose and Environment

This test is to verify the requirement for the NR FR2-NR FR2 inter frequency handover requirements specified in clause 6.1.1.4 [TS38.133 v15.2.1].

A.7.3.1.3.2 Test Parameters

Supported test configurations are shown in table A.7.3.1.3.2-1. Both handover delay and interruption length are tested by using the parameters in table A.7.3.1.3.2-2, and A.7.3.1.3.2-3.

The test scenario comprises of carriers and one cell on each carrier. No gap patterns are configured in the test case. The test consists of two successive time periods, with time durations of T1, T2 respectively. At the start of time duration T1, the UE does not have any timing information of cell 2. Starting T2, cell 2 becomes detectable and the UE receives a RRC handover command from the network. The start of T2 is the instant when the last TTI containing the RRC message implying handover is sent to the UE.

Table A.7.3.1.3.2-1: Inter-frequency handover from FR2 to FR2 test configurations

Config	Description
1	Source cell: NR 120 kHz SSB SCS, 100 MHz bandwidth, TDD duplex mode Target cell: NR 120 kHz SSB SCS, 100 MHz bandwidth, TDD duplex mode

Table A.7.3.1.3.2-2: General test parameters Inter-frequency handover from FR2 to FR2

Parameter	Unit	Value	Comment
Initial conditions	Active cell	Cell 1	
	Neighbouring cell	Cell 2	
Final condition	Active cell	Cell 2	
A4-Offset	dB	[TBD]	
Hysteresis	dB	0	
Time To Trigger	s	0	
Filter coefficient		0	L3 filtering is not used
Access Barring Information	-	Not Sent	No additional delays in random access procedure.
Time offset between cells		3 μ s	Synchronous cells
T1	s	5	
T2	s	≤ 10	

Table A.7.3.1.3.2-3: Cell specific test parameters for NR FR2-FR2 Inter frequency handover test case

Parameter	Unit	Cell 1		Cell 2	
		T1	T2	T1	T2
NR RF Channel Number		1		2	
Duplex mode		TDD			
TDD configuration		TDDConf.3.1			
BW _{channel}	MHz	100: N _{RB,c} = 66			
BWP BW	MHz	100: N _{RB,c} = 66			
DRx Cycle	ms	Not Applicable			
PDSCH Reference measurement channel		SR3.1 TDD			
CORESET Reference Channel		CR3.1 TDD			
OCNG Patterns		OCNG pattern 1			
SMTC configuration		SMTC.1 FR2			
PDSCH/PDCCH subcarrier spacing	kHz	120 kHz			
PUCCH/PUSCH subcarrier spacing	kHz	120 kHz			
PRACH configuration		FR2 PRACH configuration 1			
TRS configuration		TRS.2.1 TDD			
TCI configuration		CSI-RS.Config.0			
BWP configuraiton	Initial DL BWP	DLBWP.0.1			
	Dedicated DL BWP	DLBWP.1.1			
	Initial UL BWP	ULBWP.0.1			
	Dedicated UL BWP	ULBWP.1.1			
EPRE ratio of PSS to SSS	dB	0		0	
EPRE ratio of PBCH DMRS to SSS					
EPRE ratio of PBCH to PBCH DMRS					
EPRE ratio of PDCCH DMRS to SSS					
EPRE ratio of PDCCH to PDCCH DMRS					
EPRE ratio of PDSCH DMRS to SSS					
EPRE ratio of PDSCH to PDSCH					
EPRE ratio of OCNG DMRS to SSS(Note 1)					
EPRE ratio of OCNG to OCNG DMRS (Note 1)					

N_{oc} ^{Note2}		dBm/15kHz z	TBD		TBD	
N_{oc} ^{Note2}	Config 1,2	dBm/SCS	TBD		TBD	
	Config 3		TBD		TBD	
\hat{E}_s / I_{ot}		dB	TBD	TBD	TBD	TBD
\hat{E}_s / N_{oc}		dB	TBD	TBD	TBD	TBD
I_o ^{Note3}	Config 1,2	dBm/ BW	TBD	TBD	TBD	TBD
	Config 3	dBm/ BW	TBD	TBD	TBD	TBD
Propagation condition		-	AWGN			
<p>Note 1: OCNG shall be used such that both cells are fully allocated and a constant total transmitted power spectral density is achieved for all OFDM symbols.</p> <p>Note 2: Interference from other cells and noise sources not specified in the test is assumed to be constant over subcarriers and time and shall be modelled as AWGN of appropriate power for N_{oc} to be fulfilled.</p> <p>Note 3: I_o levels have been derived from other parameters for information purposes. They are not settable parameters themselves.</p> <p>Note 4: Equivalent power received by an antenna with 0dBi gain at the centre of the quiet zone</p> <p>Note 5: As observed with 0dBi gain antenna at the centre of the quiet zone</p>						

A.7.3.1.3.3 Test Requirements

The UE shall start to transmit the PRACH to Cell 2 less than [702] ms from the beginning of time period T2. The rate of correct handovers observed during repeated tests shall be at least 90%.

NOTE: The handover delay can be expressed as: RRC procedure delay + $T_{interrupt}$, where:

RRC procedure delay = [10] ms and is specified in clause 12 in TS 38.331 [2].

$T_{interrupt}$ = [692] ms in the test. $T_{interrupt}$ is defined in clause 6.1.1.4.2 [TS38.133].

This gives a total of [702] ms.

A.7.3.2 RRC Connection Mobility Control

A.7.3.2.1 SA: RRC Re-establishment

A.7.3.2.1.1 Intra-frequency RRC Re-establishment in FR2

A.7.3.2.1.1.1 Test Purpose and Environment

The purpose is to verify that the NR intra-frequency RRC re-establishment delay in FR2 without known target cell is within the specified limits. These tests will verify the requirements in clause 6.2.1.

The test parameters are given in table A.7.3.2.1.1.1-1, table A.7.3.2.1.1.1-2 and table A.7.3.2.1.1.1-3 below. The test consists of 3 successive time periods, with time duration of T1, T2 and T3 respectively. At the start of time period T2, cell 1, which is the active cell, becomes inactive. The time period T3 starts after the occurrence of the radio link failure.

Table A.7.3.2.1.1.1-1: Supported test configurations

Config	Description
1	NR 120 kHz SSB SCS, 100MHz bandwidth, TDD duplex mode
Note:	The UE is only required to be tested in one of the supported test configurations depending on UE capability

Table A.7.3.2.1.1-2: General test parameters for NR intra-frequency RRC Re-establishment test case in FR2

Parameter		Unit	Test configuration	Value	Comment
Initial condition	Active cell		1	Cell1	
	Neighbour cells		1	Cell2	
Final condition	Active cell		1	Cell2	
RF Channel Number			1	1	
			1	3 μ s	Synchronous cells
N310		-	1	1	Maximum consecutive out-of-sync indications from lower layers
N311		-	1	1	Minimum consecutive in-sync indications from lower layers
T310		ms	1	0	Radio link failure timer; T310 is disabled
T311		ms	1	5000	RRC re-establishment timer
Access Barring Information		-	1	Not Sent	No additional delays in random access procedure.
SSB configuration			1	SSB.1 FR2	
SMTC configuration			1	SMTC pattern 1	
DRX cycle length		s	1	OFF	
PRACH configuration index			1	87	The detailed configuration is specified in TS 38.211 clause 6.3.3.2
T1		s	1	5	
T2		ms	1	1600	Time for the UE to detect RLF
T3		s	1	6	

Table A.7.3.2.1.1-3: Cell specific test parameters for NR intra-frequency RRC Re-establishment test case in FR2

Parameter	Unit	Test configuration	Cell 1			Cell 2		
			T1	T2	T3	T1	T2	T3
TDD configuration		1	TDDConf.3.1			TDDConf.3.1		
		1	SR.3.1 TDD			N/A		
RMSI CORESET RMC configuration		1	CR.3.1 FDD			CR.3.1 FDD		
Dedicated CORESET RMC configuration		1	CCR.3.1 FDD			CCR.3.1 FDD		
TRS configuration		1	TRS.2.1 TDD			N/A		
TCI state		1	CSI-RS.Config.0			N/A		
OCNG Pattern		1	OP.1 defined in A.3.2.1			OP.1 defined in A.3.2.1		
Initial DL BWP configuration		1	DLBWP.0.1			DLBWP.0.1		
Initial UL BWP configuration		1	ULBWP.0.1			ULBWP.0.1		
RLM-RS		1	SSB			SSB		
AoA setup		1	Setup 1 defined in A.3.15.1			Setup 1 defined in A.3.15.1		
\hat{E}_s/I_{ot}	dB	1	1.81	-infinity	-infinity	-3.64	5	5
N_{oc} ^{Note2}	dBm/SCS	1	-98					
N_{oc} ^{Note2}	dBm/15 kHz	1	-98					
\hat{E}_s/N_{oc}	dB	1	8	-infinity	-infinity	5	5	5
SS-RSRP ^{Note3}	dBm/SCS	1	-90	-infinity	-infinity	-93	-93	-93
Io	dBm/95.04 MHz	1	-58.81	-infinity	-infinity	-58.81	-62.82	-62.82
Propagation Condition		1	AWGN					
<p>Note 1: OCNG shall be used such that both cells are fully allocated and a constant total transmitted power spectral density is achieved for all OFDM symbols.</p> <p>Note 2: Interference from other cells and noise sources not specified in the test is assumed to be constant over subcarriers and time and shall be modelled as AWGN of appropriate power for N_{oc} to be fulfilled.</p> <p>Note 3: SS-RSRP levels have been derived from other parameters for information purposes. They are not settable parameters themselves.</p>								

A.7.3.2.1.1.2 Test Requirements

The RRC re-establishment delay is defined as the time from the start of time period T3, to the moment when the UE starts to send PRACH preambles to cell 2 for sending the *RRCReestablishmentRequest* message to cell 2.

The RRC re-establishment delay to an unknown NR intra frequency cell shall be less than [6] s.

The rate of correct RRC re-establishments observed during repeated tests shall be at least 90%.

NOTE: The RRC re-establishment delay in the test is derived from the following expression:

$$T_{\text{re-establish_delay}} = T_{\text{UL_grant}} + T_{\text{UE_re-establish_delay}}$$

Where:

$T_{\text{UL_grant}}$ = It is the time required to acquire and process uplink grant from the target cell. The PRACH reception at the system simulator is used as a trigger for the completion of the test; hence $T_{\text{UL_grant}}$ is not used.

$$T_{UE_re-establish_delay} = 50 + T_{identify_intra_NR} + \sum_{i=1}^{N_{freq}-1} T_{identify_inter_NR,i} + T_{SI-NR} + T_{PRACH}$$

$$N_{freq} = 2$$

$$T_{identify_intra_NR} = 1600 \text{ ms}$$

$$T_{identify_inter_NR} = 2080 \text{ ms}$$

T_{SI} = [1280] ms; it is the time required for receiving all the relevant system information as defined in TS 38.331 [2] for the target intra-frequency NR cell.

T_{PRACH} = [15] ms; it is the additional delay caused by the random access procedure.

This gives a total of [5025] ms, allow [6] s in the test case.

A.7.3.2.1.2 Inter-frequency RRC Re-establishment in FR2

A.7.3.2.1.2.1 Test Purpose and Environment

The purpose is to verify that the NR inter-frequency RRC re-establishment delay in FR2 without known target cell is within the specified limits. These tests will verify the requirements in clause 6.2.1.

The test parameters are given in table A.7.3.2.1.2.1-1, table A.7.3.2.1.2.1-2 and table A.7.3.2.1.2.1-3 below. The test consists of 3 successive time periods, with time duration of T1, T2 and T3 respectively. At the start of time period T2, cell 1, which is the active cell, becomes inactive. The time period T3 starts after the occurrence of the radio link failure. During T1, the UE shall be configured with the carrier frequency of cell 2 (with RF Channel Number #2) to ensure that the UE has the context of the carrier frequency of cell 2 by the end of T1.

Table A.7.3.2.1.2.1-1: Supported test configurations

Config	Description
1	NR 120 kHz SSB SCS, 100MHz bandwidth, TDD duplex mode
Note:	The UE is only required to be tested in one of the supported test configurations depending on UE capability

Table A.7.3.2.1.2.1-2: General test parameters for NR inter-frequency RRC Re-establishment test case in FR2

Parameter		Unit	Test configuration	Value	Comment
Initial condition	Active cell		1	Cell1	
	Neighbour cells		1	Cell2	
Final condition	Active cell		1	Cell2	
RF Channel Number			1	1, 2	
			1	3 μ s	Synchronous cells
N310		-	1	1	Maximum consecutive out-of-sync indications from lower layers
N311		-	1	1	Minimum consecutive in-sync indications from lower layers
T310		ms	1	0	Radio link failure timer; T310 is disabled
T311		ms	1	5000	RRC re-establishment timer
Access Barring Information		-	1	Not Sent	No additional delays in random access procedure.
SSB configuration			1	SSB.1 FR2	
			1	SMTC pattern 1	
DRX cycle length		s	1	OFF	
PRACH configuration index			1	87	The detailed configuration is specified in TS 38.211 clause 6.3.3.2
T1		s	1	5	
T2		ms	1	1600	Time for the UE to detect RLF
T3		s	1	6	

Table A.7.3.2.1.2.1-3: Cell specific test parameters for NR inter-frequency RRC Re-establishment test case in FR2

Parameter	Unit	Test configuration	Cell 1			Cell 2		
			T1	T2	T3	T1	T2	T3
TDD configuration		1	TDDConf.3.1			TDDConf.3.1		
		1	SR.3.1 TDD			N/A		
RMSI CORESET RMC configuration		1	CR.3.1 FDD			CR.3.1 FDD		
Dedicated CORESET RMC configuration		1	CCR.3.1 FDD			CCR.3.1 FDD		
TRS configuration		1	TRS.2.1 TDD			N/A		
TCI state		1	CSI-RS.Config.0			N/A		
OCNG Pattern		1	OP.1 defined in A.3.2.1			OP.1 defined in A.3.2.1		
Initial DL BWP configuration		1	DLBWP.0.1			DLBWP.0.1		
Initial UL BWP configuration		1	ULBWP.0.1			ULBWP.0.1		
RLM-RS		1	SSB			SSB		
AoA setup		1	Setup 1 defined in A.3.15.1			Setup 1 defined in A.3.15.1		
\hat{E}_s/I_{ot}	dB	1	5	-infinity	-infinity	-infinity	-infinity	8
N_{oc} ^{Note2}	dBm/SCS	1	-98					
N_{oc} ^{Note2}	dBm/15 kHz	1	-98					
\hat{E}_s/N_{oc}	dB	1	5	-infinity	-infinity	-infinity	-infinity	8
SS-RSRP ^{Note3}	dBm/SCS	1	-93	-infinity	-infinity	-infinity	-infinity	-90
Io	dBm/95.04 MHz	1	-62.82	-infinity	-infinity	-infinity	-infinity	-60.37
Propagation Condition		1	AWGN					
<p>Note 1: OCNG shall be used such that both cells are fully allocated and a constant total transmitted power spectral density is achieved for all OFDM symbols.</p> <p>Note 2: Interference from other cells and noise sources not specified in the test is assumed to be constant over subcarriers and time and shall be modelled as AWGN of appropriate power for N_{oc} to be fulfilled.</p> <p>Note 3: SS-RSRP levels have been derived from other parameters for information purposes. They are not settable parameters themselves.</p>								

A.7.3.2.1.2.2 Test Requirements

The RRC re-establishment delay is defined as the time from the start of time period T3, to the moment when the UE starts to send PRACH preambles to cell 2 for sending the *RRCReestablishmentRequest* message to cell 2.

The RRC re-establishment delay to an unknown NR inter frequency cell shall be less than [6] s.

The rate of correct RRC re-establishments observed during repeated tests shall be at least 90%.

NOTE: The RRC re-establishment delay in the test is derived from the following expression:

$$T_{\text{re-establish_delay}} = T_{\text{UL_grant}} + T_{\text{UE_re-establish_delay}}$$

Where:

$T_{\text{UL_grant}}$ = It is the time required to acquire and process uplink grant from the target cell. The PRACH reception at the system simulator is used as a trigger for the completion of the test; hence $T_{\text{UL_grant}}$ is not used.

$$T_{UE_re-establish_delay} = 50 + T_{identify_intra_NR} + \sum_{i=1}^{N_{freq}-1} T_{identify_inter_NR,i} + T_{SI-NR} + T_{PRACH}$$

$$N_{freq} = 2$$

$$T_{identify_intra_NR} = 1600 \text{ ms}$$

$$T_{identify_inter_NR} = 2080 \text{ ms}$$

$T_{SI} = [1280]$ ms; it is the time required for receiving all the relevant system information as defined in TS 38.331 [2] for the target inter-frequency NR cell.

$T_{PRACH} = [15]$ ms; it is the additional delay caused by the random access procedure.

This gives a total of [5025] ms, allow [6] s in the test case.

A.7.3.2.2 Random Access

A.7.3.2.2.1 Contention based random access test in FR2 for NR Standalone

A.7.3.2.2.1.1 Test Purpose and Environment

The purpose of this test is to verify that the behavior of the random access procedure is according to the requirements and that the PRACH power settings and timing are within specified limits. This test will verify the requirements in Clause 6.2.2.2 and Clause 7.1.2 in an AWGN model.

For this test one cell is used, with the configuration of Cell 1 configured as PCell or SCell in FR2. Supported test parameters are shown in Table A.7.3.2.2.1.1-1. UE capable of SA with PCell or SCell in FR2 needs to be tested by using the parameters in Table A.7.3.2.2.1.1-2 and Table A.7.3.2.2.1.1-3.

Table A.7.3.2.2.1.1-1: Supported test configurations for contention based random access test in FR2 for NR Standalone

Config	Description
1	NR PSCell/SCell 120 kHz SSB SCS, 100MHz bandwidth, TDD duplex mode
Note:	The UE is only required to be tested in one of the supported test configurations depending on UE capability

Table A.7.3.2.2.1-1-2: General test parameters for contention based random access test in FR2 for NR Standalone

Parameter		Unit	Test-1	Comments
SSB Configuration	Config 1,2		SSB pattern 1 in FR2	As defined in A.3.10, except for for number of SSBs per SS-burst and SS/PBCH block index as below
Number of SSBs per SS-burst			2	Different from the definition in A.3.10
SS/PBCH block index			0,1	Different from the definition in A.3.10
Duplex Mode for Cell 2	Config 1,2		TDD	
TDD Configuration	Config 1,2		TDDConf.3.1	
OCNG Pattern ^{Note 1}			OCNG pattern 1	As defined in A.3.2.1.
PDSCH parameters _{Note 2}	Config 1,2		SR3.1 TDD	As defined in A.3.1.1.
NR RF Channel Number			1	
EPRE ratio of PSS to SSS		dB	0	
EPRE ratio of PBCH_DMRS to SSS		dB		
EPRE ratio of PBCH to PBCH_DMRS		dB		
EPRE ratio of PDCCH_DMRS to SSS		dB		
EPRE ratio of PDCCH to PDCCH_DMRS		dB		
EPRE ratio of PDSCH_DMRS to SSS		dB		
EPRE ratio of PDSCH to PDSCH_DMRS		dB		
<p>Note 1: OCNG shall be used such that the cell is fully allocated and a constant total transmitted power spectral density is achieved for all OFDM symbols. The OCNG pattern is chosen during the test according to the presence of a DL reference measurement channel.</p> <p>Note 2: The DL PDSCH reference measurement channel is used in the test only when a downlink transmission dedicated to the UE under test is required.</p>				

Table A.7.3.2.2.1.1-3: OTA-related test parameters for contention based random access test in FR2 for NR Standalone

Parameter		Unit	Test-1	Comments	
AoA setup			TBD	As defined in A.x.	
SSB with index 0	\hat{E}_s / I_{ot}	dB	3	SSB with index 0 is signalled to be above configured <i>rsrp-ThresholdSSB</i>	
	N_{oc}	Config 1,2	dBm/15kHz		TBD
	\hat{E}_s / N_{oc}		dB		3
	SS-RSRP ^{Note 2}		dBm/ SCS		TBD
SSB with index 1	\hat{E}_s / I_{ot}	dB	-17	SSB with index 1 is signalled to be below configured <i>rsrp-ThresholdSSB</i>	
	N_{oc}	Config 1,2	dBm/15kHz		TBD
	\hat{E}_s / N_{oc}		dB		-17
	SS-RSRP ^{Note 2}		dBm/ SCS		TBD
I_o ^{Note 1}	Config 1,2	dBm	TBD	For symbols without SSB index 1	
ss-PBCH-BlockPower		dBm/ SCS	TBD	As defined in clause 6.3.2 in TS 38.331 [2].	
Configured UE transmitted power ($P_{CMAX, f, c}$)		dBm	TBD	As defined in clause 6.2.4 in TS 38.101-2.	
PRACH Configuration			FR2 PRACH configuration 1	As defined in A.3.8.3.	
Propagation Condition		-	AWGN		
Note 1: I_o level has been derived from other parameters for information purpose. It is not a settable parameter.					
Note 2: RSRP level has been derived from other parameters for information purposes. It is not a settable parameter.					

A.7.3.2.2.1.2 Test Requirements

Contention based random access is triggered by *not* explicitly assigning a random access preamble via dedicated signalling in the downlink.

A.7.3.2.2.1.2.1 Random Access Preamble Transmission

To test the UE behavior specified in Subclause 6.2.2.2.1.1 the System Simulator shall receive the Random Access Preamble which belongs to one of the Random Access Preambles associated with the SSB with index 0, which has SS-RSRP above the configured *rsrp-ThresholdSSB*.

In addition, the power applied to all preambles shall be in accordance with what is specified in Subclause 6.2.2.2. The power of the first preamble shall be [TBD] dBm with an accuracy specified in clause 6.3.4.2 of TS 38.101-2 [19]. The relative power applied to additional preambles shall have an accuracy specified in clause 6.3.4.3 of TS 38.101-2 [19].

The transmit timing of all PRACH transmissions shall be within the accuracy specified in Subclause 7.1.2.

A.7.3.2.2.1.2.2 Random Access Response Reception

To test the UE behavior specified in Subclause 6.2.2.2.1.2 the System Simulator shall transmit a Random Access Response containing a Random Access Preamble identifier corresponding to the transmitted Random Access Preamble after 5 preambles have been received by the System Simulator. In response to the first 4 preambles, the System Simulator shall transmit a Random Access Response *not* corresponding to the transmitted Random Access Preamble.

The UE may stop monitoring for Random Access Response(s) and shall transmit the msg3 if the Random Access Response contains a Random Access Preamble identifier corresponding to the transmitted Random Access Preamble.

The UE shall again perform the Random Access Resource selection procedure specified in clause 5.1.2 in TS38.321 [7], and transmit with the calculated PRACH transmission power when the backoff time expires if all received Random Access Responses contain Random Access Preamble identifiers that do not match the transmitted Random Access Preamble.

In addition, the power applied to all preambles shall be in accordance with what is specified in Subclause 6.2.2.2. The power of the first preamble shall be [TBD] dBm with an accuracy specified in clause 6.3.4.2 of TS 38.101-2 [19]. The relative power applied to additional preambles shall have an accuracy specified in clause 6.3.4.3 of TS 38.101-2 [19].

The transmit timing of all PRACH transmissions shall be within the accuracy specified in Subclause 7.1.2.

A.7.3.2.2.1.2.3 No Random Access Response Reception

To test the UE behavior specified in subclause 6.2.2.2.1.3 the System Simulator shall transmit a Random Access Response containing a Random Access Preamble identifier corresponding to the transmitted Random Access Preamble after 5 preambles have been received by the System Simulator. The System Simulator shall *not* respond to the first 4 preambles.

The UE shall again perform the Random Access Resource selection procedure specified in clause 5.1.2 in TS38.321 [7], and transmit with the calculated PRACH transmission power when the backoff time expires if no Random Access Response is received within the RA Response window.

In addition, the power applied to all preambles shall be in accordance with what is specified in Subclause 6.2.2.2. The power of the first preamble shall be [TBD] dBm with an accuracy specified in clause 6.3.4.2 of TS 38.101-2 [19]. The relative power applied to additional preambles shall have an accuracy specified in clause 6.3.4.3 of TS 38.101-2 [19].

The transmit timing of all PRACH transmissions shall be within the accuracy specified in Subclause 7.1.2.

A.7.3.2.2.1.2.4 Receiving a NACK on msg3

To test the UE behavior specified in subclause 6.2.2.2.1.4 the System Simulator shall NACK *all* UE msg3 following a successful Random Access Response.

The UE shall re-transmit the msg3 upon the reception of a NACK on msg3 until the maximum number of HARQ re-transmissions is reached.

A.7.3.2.2.1.2.5 Reception of an Incorrect Message over Temporary C-RNTI

To test the UE behavior specified in Subclause 6.2.2.2.1.5 the System Simulator shall send a message addressed to the temporary C-RNTI with a UE Contention Resolution Identity included in the MAC control element *not* matching the CCCH SDU transmitted in msg3 uplink message.

The UE shall again perform the Random Access Resource selection procedure specified in clause 5.1.2 in TS38.321 [7], and transmit with the calculated PRACH transmission power when the backoff time expires unless the received message includes a UE Contention Resolution Identity MAC control element and the UE Contention Resolution Identity included in the MAC control element matches the CCCH SDU transmitted in the uplink message.

A.7.3.2.2.1.2.6 Reception of a Correct Message over Temporary C-RNTI

To test the UE behavior specified in Subclause 6.2.2.2.1.5 the System Simulator shall send a message addressed to the temporary C-RNTI with a UE Contention Resolution Identity included in the MAC control element matching the CCCH SDU transmitted in the msg3 uplink message.

The UE shall send ACK if the Contention Resolution is successful.

A.7.3.2.2.1.2.7 Contention Resolution Timer expiry

To test the UE behavior specified in Subclause 6.2.2.2.1.6 the System Simulator shall *not* send a response to a msg3.

The UE shall again perform the Random Access Resource selection procedure specified in clause 5.1.2 in TS38.321 [7], and transmit with the calculated PRACH transmission power when the backoff time expires if the Contention Resolution Timer expires.

A.7.3.2.2.2 Non-contention based random access test in FR2 for NR Standalone

A.7.3.2.2.2.1 Test Purpose and Environment

The purpose of this test is to verify that the behavior of the random access procedure is according to the requirements and that the PRACH power settings and timing are within specified limits. This test will verify the requirements in Clause 6.2.2.2 and Clause 7.1.2 in an AWGN model.

For this test one cell is used, with the configuration of Cell 1 configured as PCell or SCell in FR2. Supported test parameters are shown in Table A.7.3.2.2.2.1-1. UE capable of SA with PCell or SCell in FR2 needs to be tested by using the parameters in Table A.7.3.2.2.2.1-2 for SSB-based non-contention based random access test (Test 1) and CSI-RS-based non-contention based random access test (Test 2).

Table A.7.3.2.2.2.1-1: Supported test configurations for non-contention based random access test in FR2 for NR Standalone

Config	Description
1	NR PSCell/SCell 120 kHz SSB SCS, 100MHz bandwidth, TDD duplex mode
Note:	The UE is only required to be tested in one of the supported test configurations depending on UE capability

Table A.7.3.2.2.2.1-2: General test parameters for non-contention based random access test in FR2 for NR Standalone

Parameter		Unit	Test-1	Test-2	Comments
SSB Configuration	Config 1,2		SSB pattern 1 in FR2	SSB pattern 1 in FR2	As defined in A.3.10, except of Number of SSBs per SS-burst and SS/PBCH block index as below
Number of SSBs per SS-burst			2	2	Different from the definition in A.3.10
SS/PBCH block index			0,1	0,1	Different from the definition in A.3.10
CSI-RS Configuration	Config 1,2		N/A	CSI-RS.3.1 TDD	As defined in A.3.1.4
Duplex Mode for Cell 2	Config 1,2		TDD	TDD	
TDD Configuration	Config 1,2		TDDConf.3.1	TDDConf.3.1	
OCNG Pattern ^{Note 1}			OCNG pattern 1	OCNG pattern 1	As defined in A.3.2.1.
PDSCH parameters ^{Note 2}	Config 1,2		SR3.1 TDD	SR3.1 TDD	As defined in A.3.1.1.
NR RF Channel Number			1	1	
EPRE ratio of PSS to SSS		dB	0	0	
EPRE ratio of PBCH_DMRS to SSS		dB			
EPRE ratio of PBCH to PBCH_DMRS		dB			
EPRE ratio of PDCCH_DMRS to SSS		dB			
EPRE ratio of PDCCH to PDCCH_DMRS		dB			
EPRE ratio of PDSCH_DMRS to SSS		dB			

EPRE ratio of PDSCH to PDSCH_DMRS	dB			
Note 1: OCNG shall be used such that the cell is fully allocated and a constant total transmitted power spectral density is achieved for all OFDM symbols. The OCNG pattern is chosen during the test according to the presence of a DL reference measurement channel.				
Note 2: The DL PDSCH reference measurement channel is used in the test only when a downlink transmission dedicated to the UE under test is required.				

Table A.7.3.2.2.1-3: OTA-related test parameters for non-contention based random access test in FR2 for NR Standalone

Parameter		Unit	Test-1	Test-2	Comments	
AoA setup			TBD	TBD	As defined in A.x.	
SSB with index 0	\hat{E}_s / I_{ot}	dB	3	3	SSB with index 0 is signalled to be above configured <i>rsrp-ThresholdSSB</i>	
	N_{oc}	Config 1,2	TBD	TBD		
	\hat{E}_s / N_{oc}		3	3		
	SS-RSRP	Note 2	TBD	TBD		
SSB with index 1	\hat{E}_s / I_{ot}	dB	-17	-17	SSB with index 1 is signalled to be below configured <i>rsrp-ThresholdSSB</i>	
	N_{oc}	Config 1,2	TBD	TBD		
	\hat{E}_s / N_{oc}		-17	-17		
	SS-RSRP	Note 2	TBD	TBD		
I_o	Note 1	Config 1,2	dBm	TBD	TBD	For symbols without SSB index 1
ss-PBCH-BlockPower			dBm/ SCS	TBD	TBD	As defined in clause 6.3.2 in TS 38.331 [2].
Configured UE transmitted power ($P_{C_{MAX, f, c}}$)			dBm	TBD	TBD	As defined in clause 6.2.4 in TS 38.101-2.
PRACH Configuration			FR2 PRACH configuration 2	FR2 PRACH configuration 3	As defined in A.3.8.3.	
Propagation Condition			-	AWGN	AWGN	
Note 1: I_o level has been derived from other parameters for information purpose. It is not a settable parameter.						
Note 2: RSRP level has been derived from other parameters for information purposes. It is not a settable parameter.						

A.7.3.2.2.2 Test Requirements

Non-Contention based random access is triggered by explicitly assigning a random access preamble via dedicated signalling in the downlink. In the test, the non-contention based random access procedure is not initialized for Other SI requested from UE or beam failure recovery.

A.7.3.2.2.2.1 SSB-based Random Access Preamble Transmission

In Test-1, to test the UE behavior specified in Subclause 6.2.2.2.1 for SSB-based Random Access Preamble transmission, with the contention-free Random Access Resources and the contention-free PRACH occasions associated with SSBs configured, the System Simulator shall receive the Random Access Preamble which has the Preamble Index associated with the SSB with index 0.

In addition, the System Simulator shall receive the Random Access Preamble on the PRACH occasion which belongs to the PRACH occasions corresponding to the SSB with index 0, and the selected PRACH occasion shall belong to the PRACH occasions permitted by the restrictions given by the *ra-ssb-OccasionMaskIndex*.

In addition, the power applied to all preambles shall be in accordance with what is specified in Subclause 6.2.2.2. The power of the first preamble shall be [TBD] dBm with an accuracy specified in clause 6.3.4.2 of TS 38.101-2

[19]. The relative power applied to additional preambles shall have an accuracy specified in clause 6.3.4.3 of TS 38.101-2 [19].

The transmit timing of all PRACH transmissions shall be within the accuracy specified in Subclause 7.1.2.

A.7.3.2.2.2.2 CSI-RS-based Random Access Preamble Transmission

In Test-1, to test the UE behavior specified in Subclause 6.2.2.2.1 for CSI-RS-based Random Access Preamble transmission, with the contention-free Random Access Resources and the contention-free PRACH occasions associated with CSI-RSs configured, the System Simulator shall receive the Random Access Preamble which has the Preamble Index associated with the CSI-RS configured.

In addition, the System Simulator shall receive the Random Access Preamble on the PRACH occasion which belongs to the PRACH occasions corresponding to the CSI-RS configured, and the selected PRACH occasion shall belong to the PRACH occasions permitted by the restrictions given by the *ra-OccasionList*.

In addition, the power applied to all preambles shall be in accordance with what is specified in Subclause 6.2.2.2. The power of the first preamble shall be [TBD] dBm with an accuracy specified in clause 6.3.4.2 of TS 38.101-2 [19]. The relative power applied to additional preambles shall have an accuracy specified in clause 6.3.4.3 of TS 38.101-2 [19].

The transmit timing of all PRACH transmissions shall be within the accuracy specified in Subclause 7.1.2.

A.7.3.2.2.2.3 Random Access Response Reception

To test the UE behavior specified in Subclause 6.2.2.2.2 the System Simulator shall transmit a Random Access Response containing a Random Access Preamble identifier corresponding to the transmitted Random Access Preamble after 5 preambles have been received by the System Simulator. In response to the first 4 preambles, the System Simulator shall transmit a Random Access Response *not* corresponding to the transmitted Random Access Preamble.

The UE may stop monitoring for Random Access Response(s) if the Random Access Response contains a Random Access Preamble identifier corresponding to the transmitted Random Access Preamble.

The UE shall again perform the Random Access Resource selection procedure specified in clause 5.1.2 in TS38.321 [7], and transmit with the calculated PRACH transmission power if all received Random Access Responses contain Random Access Preamble identifiers that do not match the transmitted Random Access Preamble.

In addition, the power applied to all preambles shall be in accordance with what is specified in Subclause 6.2.2.2. The power of the first preamble shall be [TBD] dBm with an accuracy specified in clause 6.3.4.2 of TS 38.101-2 [19]. The relative power applied to additional preambles shall have an accuracy specified in clause 6.3.4.3 of TS 38.101-2 [19].

The transmit timing of all PRACH transmissions shall be within the accuracy specified in Subclause 7.1.2.

A.7.3.2.2.2.4 No Random Access Response Reception

To test the UE behavior specified in subclause 6.2.2.2.3 the System Simulator shall transmit a Random Access Response containing a Random Access Preamble identifier corresponding to the transmitted Random Access Preamble after 5 preambles have been received by the System Simulator. The System Simulator shall *not* respond to the first 4 preambles.

The UE shall again perform the Random Access Resource selection procedure specified in clause 5.1.2 in TS38.321 [7], and transmit with the calculated PRACH transmission power when the backoff time expires if no Random Access Response is received within the RA Response window configured in *RACH-ConfigCommon*.

In addition, the power applied to all preambles shall be in accordance with what is specified in Subclause 6.2.2.2. The power of the first preamble shall be [TBD] dBm with an accuracy specified in clause 6.3.4.2 of TS 38.101-2

[19]. The relative power applied to additional preambles shall have an accuracy specified in clause 6.3.4.3 of TS 38.101-2 [19].

The transmit timing of all PRACH transmissions shall be within the accuracy specified in Subclause 7.1.2.

A.7.3.2.3 SA: RRC Connection Release with Redirection

A.7.3.2.3.1 Redirection from NR in FR2 to NR in FR2

A.7.3.2.3.1.1 Test Purpose and Environment

This test is to verify RRC connection release with redirection from NR to NR requirements specified in clause 6.2.3.2.1.

A.7.3.2.3.1.2 Test Parameters

Supported test configurations are shown in table A.7.3.2.3.1.2-1. The time delay is tested by using the parameters in table A.7.3.2.3.1.2-2, and A.7.3.2.3.1.2-3.

The test consists of two successive time periods, with time duration of T1, and T2 respectively. The “*RRCConnectionRelease*” message containing the relevant system information of Cell 2 shall be sent to the UE during period T1 and the start of T2 is the instant when the last TTI containing the RRC message is sent to the UE. Prior to time duration T2, the UE shall not have any timing information of Cell 2. Cell 2 is powered up at the beginning of the T2.

Table A.7.3.2.3.1.2-1: Redirection from NR to NR test configurations

Config	Description
1	Source cell: NR 120 kHz SSB SCS, 100 MHz bandwidth, TDD duplex mode Target cell: NR 120 kHz SSB SCS, 100 MHz bandwidth, TDD duplex mode

Table A.7.3.2.3.1.2-2: General test parameters for Redirection from NR to NR test case

Parameter	Unit	Value	Comment
Initial conditions	Active cell	Cell 1	
	Neighbouring cell	Cell 2	
Final condition	Active cell	Cell 2	
Filter coefficient		0	L3 filtering is not used
Access Barring Information	-	Not Sent	No additional delays in random access procedure.
Time offset between cells		3 μ s	Synchronous cells
T1	s	5	
T2	s	3	

Table A.7.3.2.3.1.2-3: Cell specific test parameters for Redirection from NR to NR test case

Parameter	Unit	Cell 1		Cell 2	
		T1	T2	T1	T2
NR RF Channel Number		1		2	
Duplex mode		TDD			
TDD configuration		TDDConf.3.1			
BW _{channel}	MHz	100: N _{RB,c} = 66			
BWP BW	MHz	100: N _{RB,c} = 66			
DRx Cycle	ms	Not Applicable			
PDSCH Reference measurement channel		SR3.1 TDD			
CORESET Reference Channel		CR3.1 TDD			
OCNG Patterns		OCNG pattern 1			

SMTC configuration			SMTC.1 FR2			
PDSCH/PDCCH subcarrier spacing		kHz	120 kHz			
PUCCH/PUSCH subcarrier spacing		kHz	120 kHz			
PRACH configuration			FR2 PRACH configuration 1			
TRS configuration			TRS.2.1 TDD			
TCI configuration			TBD			
BWP configuraiton	Initial DL BWP		DLBWP.0.1			
	Dedicated DL BWP		DLBWP.1.1			
	Initial UL BWP		ULBWP.0.1			
	Dedicated UL BWP		ULBWP.1.1			
EPRE ratio of PSS to SSS		dB	0		0	
EPRE ratio of PBCH DMRS to SSS						
EPRE ratio of PBCH to PBCH DMRS						
EPRE ratio of PDCCH DMRS to SSS						
EPRE ratio of PDCCH to PDCCH DMRS						
EPRE ratio of PDSCH DMRS to SSS						
EPRE ratio of PDSCH to PDSCH						
EPRE ratio of OCNG DMRS to SSS(Note 1)						
EPRE ratio of OCNG to OCNG DMRS (Note 1)						
N_{oc}^{Note2}						
N_{oc}^{Note2}	Config 1,2	dBm/SCS	TBD		TBD	
	Config 3		TBD		TBD	
\hat{E}_s/I_{ot}		dB	TBD	TBD	TBD	TBD
\hat{E}_s/N_{oc}		dB	TBD	TBD	TBD	TBD
I_o^{Note3}	Config 1,2	dBm/BW	TBD	TBD	TBD	TBD
	Config 3	dBm/BW	TBD	TBD	TBD	TBD
Propagation condition		-	AWGN			
Note 1: OCNG shall be used such that both cells are fully allocated and a constant total transmitted power spectral density is achieved for all OFDM symbols.						
Note 2: Interference from other cells and noise sources not specified in the test is assumed to be constant over subcarriers and time and shall be modelled as AWGN of appropriate power for N_{oc} to be fulfilled.						
Note 3: I_o levels have been derived from other parameters for information purposes. They are not settable parameters themselves.						
Note 4: Equivalent power received by an antenna with 0dBi gain at the centre of the quiet zone						
Note 5: As observed with 0dBi gain antenna at the centre of the quiet zone						

A.7.3.2.3.1.3 Test Requirements

The UE shall start to transmit the PRACH to Cell 2 less than [2040] ms from the beginning of time period T2.

The rate of correct RRC connection release redirection to NR observed during repeated tests shall be at least 90%.

NOTE: The redirection delay can be expressed as:

$$T_{\text{connection_release_redirect_NR}} = T_{\text{RRC_procedure_delay}} + T_{\text{identify-NR}} + T_{\text{SI-NR}} + T_{\text{RACH}},$$

where:

$T_{\text{RRC_procedure_delay}} = [110]$ ms and is specified in clause 12 in TS 38.331 [2].

$T_{\text{identify-NR}} = [1760]$ ms in the test.

$T_{SI-NR} = 0$ ms is assumed, since the UE is provided with the SI (including MIB and all relevant SIBs) of the target NR cell before the RRC connection is released by the old NR cell.

$T_{RACH} = [170]$ ms in the test.

This gives a total of [2040] ms.

A.7.4 Timing

A.7.4.1 UE transmit timing

A.7.4.1.1 NR UE Transmit Timing Test for FR2

A.7.4.1.1.1 Test Purpose and environment

The purpose of this test is to verify that the UE can follow frame timing change of the connected gNodeB and that the UE initial transmit timing accuracy, maximum amount of timing change in one adjustment, minimum and maximum adjustment rate are within the specified limits. This test will verify the requirements in clause 7.1.2.

Supported test configurations are shown in Table 7.4.1.1.1-1.

Table A.7.4.1.1-1: Supported test configurations for FR2 PCell

Configuration	Description
1	LTE FDD, NR TDD, SSB SCS 240 kHz, data SCS 120kHz, BW 100MHz
2	LTE TDD, NR TDD, SSB SCS 240 kHz, data SCS 120kHz, BW 100MHz

For this test a single NR cell is used. Table A.7.4.1.1-2 defines the parameters to be configured and strength of the transmitted signals. The transmit timing is verified by the UE transmitting SRS using the configuration defined in Table A.7.4.1.1-3.

Table A.7.4.1.1-2: Cell Specific Test Parameters for UL Transmit Timing test

Parameter	Unit	Config	Test1	Test2
E-UTRA Channel Number		1,2	1	1
NR Channel Number		1,2	2	2
TDD configuration		1	TDDConf.1.2	
$BW_{channel}$	MHz	1,2	100: NRB,c = 66	
Initial BWP Configuration		1,2	DLBWP.0.1 ULBWP.0.1	
Dedicated BWP Configuration		1,2	DLBWP.1.1 ULBWP.1.1	
TRS Configuration		1,2	TRS.2.1 TDD	
TCI State		1,2	CSI-RS.Config.0	
DRx Cycle	ms	1,2	N/A	3DRX.5 ^{Note5}
PDSCH Reference measurement channel		1,2	SR.3.1 TDD	

RMSI CORESET Reference Channel		1,2	CR.3.1 TDD	
Dedicated CORESET Reference Channel		1,2	CCR.3.1 TDD	
OCNG Patterns		1,2	OP.1	
SSB Configuration		1,2	SSB.2 FR2	
SMTC configuration		1,2	SMTC.2	
TCI configuration		1,2	TBD	
TRS configuration		1,2	TBD	
EPRE ratio of PSS to SSS	dB	1,2	0	0
EPRE ratio of PBCH DMRS to SSS				
EPRE ratio of PBCH to PBCH DMRS				
EPRE ratio of PDCCH DMRS to SSS				
EPRE ratio of PDCCH to PDCCH DMRS				
EPRE ratio of PDSCH DMRS to SSS				
EPRE ratio of PDSCH to PDSCH				
EPRE ratio of OCNG DMRS to SSS(Note 1)				
EPRE ratio of OCNG to OCNG DMRS (Note 1)				
N_{oc} ^{Note2}				
N_{oc} ^{Note2}	dBm/SCS	1,2	TBD	TBD
\hat{E}_s/I_{ot}		1,2	3	3
\hat{E}_s/N_{oc}		1,2	3	3
SS-RSRP ^{Note3}	dBm/SCS	1,2	TBD	TBD
I_o ^{Note3}	dBm/95MHz	1,2	TBD	TBD
Propagation condition		1,2	AWGN	
SRS Config		1,2	Config1 ^{Note6}	Config2 ^{Note6}
<p>Note 1: OCNG shall be used such that both cells are fully allocated and a constant total transmitted power spectral density is achieved for all OFDM symbols.</p> <p>Note 2: Interference from other cells and noise sources not specified in the test is assumed to be constant over subcarriers and time and shall be modelled as AWGN of appropriate power for N_{oc} to be fulfilled.</p> <p>Note 3: SS-RSRP and I_o levels have been derived from other parameters for information purposes. They are not settable parameters themselves.</p>				

Note 4:	SS-RSRP minimum requirements are specified assuming independent interference and noise at each receiver antenna port.
Note 5:	DRx related parameters are given in Table A.3.3.4-1
Note 6:	SRS configs are given in Table A.7.4.1.1.1-3

Table A.7.4.1.1.1-3: SRS Configuration for Timing Accuracy Test

	Field	Config1	Config 2	Comments
SRS-ResourceSet	srs-ResourceSetId	0	0	
	srs-ResourceSetList	0	0	
	resourceType	Periodic	Periodic	
	Usage	Codebook	Codebook	
	SRS-ResourceSetId	0	0	
SRS-Resource	nrofSRS-Ports	Port1	Port1	
	transmissionComb	n2	n2	
	combOffset-n2	0	0	
	cyclicShift-n2	0	0	
	resourceMapping startPosition	0	0	
	resourceMapping nrofSymbols	n1	n1	
	resourceMapping repetitionFactor	n1	n1	
	freqDomainPosition	0	0	
	freqDomainShift	0	0	
	freqHopping c-SRS	sl1	sl1	
	freqHopping b-SRS	0	0	
	freqHopping b-hop	0	0	
	groupOrSequenceHopping	Neither	Neither	
	resourceType	Periodic	Periodic	
	periodicityAndOffset-p	sl1	sl640	Offset to align with DRx periodicity
	sequenceId	0	0	Any 10 bit number

Table A.7.4.1.1.1-4: Void**A.7.4.1.1.2 Test requirements**

The test sequence shall be carried out in RRC_CONNECTED for every test case.

Following will be the test sequence for this test:

- 1) Setup NR PCell according to parameters given in Table A.7.4.1.1.1-1.
- 2) After connection set up with the cell, the test equipment will verify that the timing of the NR cell is within $(N_{TA} + N_{TA_offset}) \pm T_e$ of the first detected path of DL SSB.
 - a. The N_{TA} offset value (in T_c units) is 25600 for FR1 and 13792 for FR2
 - b. The T_e values depend on the DL and UL SCS for which the test is being run and are given in Table 7.1.2-1
- 3) The test system shall adjust the timing of the DL path by values given in Table A.7.4.1.1.2-1

Table A.7.4.1.1.2-1 Adjustment Value for DL Timing

SCS of SSB signals (KHz)	Adjustment Value	
	Test1	Test2
15	+64*64T _c	+32*64T _c
30	+32*64T _c	+16*64T _c
120	+16*64T _c	+8*64T _c
240	+8*64T _c	+4*64T _c

- 4) The test system shall verify that the adjustment step size and the adjustment rate shall be according to requirements specified in Section 7.1.2 Table 7.1.2-3. This will only be done for Test1.
- 5) The test system shall verify that the UE transmit timing offset stays within $(N_{TA} + N_{TA_offset}) \pm T_e$ of the first detected path of DL SSB. For Test 2 and Test 4 the UE transmit timing offset shall be verified for the first transmission in the DRX cycle immediately after DL timing adjustment.

A.7.4.2 UE timer accuracy

A.7.4.3 Timing advance

A.7.4.3.1 SA FR2 timing advance adjustment accuracy

A.7.4.3.1.1 Test Purpose and Environment

The purpose of the test is to verify UE Timing Advance adjustment delay and accuracy requirement defined in clause 7.3.

A.7.4.3.1.2 Test Parameters

Supported test configurations are shown in table A.7.4.3.1.2-1. Both timing advance adjustment delay and accuracy are tested by using the parameters in table A.7.4.3.1.2-2, A.7.4.3.1.2-3 and A.7.4.3.1.2-4.

In all test cases, single cell is used. Each test consists of two successive time periods, with time duration of T1 and T2 respectively. In each time period, timing advance commands are sent to the UE and Sounding Reference Signals (SRS), as specified in table A.7.4.3.1.2-3, are sent from the UE and received by the test equipment. By measuring the reception of the SRS, the transmit timing, and hence the timing advance adjustment accuracy, can be measured.

During time period T1, the test equipment shall send one message with a Timing Advance Command MAC Control Element, as specified in Clause 6.1.3.4 in TS 38.321 [7]. The Timing Advance Command value shall be set to 31, which according to Clause 4.2 in TS 38.213 results in zero adjustment of the Timing Advance. In this way, a reference value for the timing advance used by the UE is established.

During time period T2, the test equipment shall send a sequence of messages with Timing Advance Command MAC Control Elements, with Timing Advance Command value specified in table A.7.4.3.1.2-2. This value shall result in changes of the timing advance used by the UE, and the accuracy of the change shall then be measured, using the SRS sent from the UE.

As specified in Clause 7.3.2.1, the UE adjusts its uplink timing at slot n+k for a timing advance command received in slot n. This delay must be taken into account when measuring the timing advance adjustment accuracy, via the SRS sent from the UE.

The UE Time Alignment Timer, described in Clause 5.2 in TS 38.321, shall be configured so that it does not expire in the duration of the test.

Table A.7.4.3.1.2-1: Timing advance supported test configurations

Config	Description
1	NR 120 kHz SSB SCS, 100MHz bandwidth, TDD duplex mode

Table A.7.4.3.1.2-2: General test parameters for timing advance

Parameter	Unit	Value	Comment
RF channel number		1	
Initial DL BWP		DLBWP.0.1	As specified in Table A.3.9.2.1-1
Dedicated DL BWP		DLBWP.1.1	As specified in Table A.3.9.2.2-1
Initial UL BWP		ULBWP.0.1	As specified in Table A.3.9.3.1-1
Dedicated UL BWP		ULBWP.1.1	As specified in Table A.3.9.3.2-1
Timing Advance Command (T_A) value during T1		31	$N_{TA_new} = N_{TA_old}$ for the purpose of establishing a reference value from which the timing advance adjustment accuracy can be measured during T2
Timing Advance Command (T_A) value during T2		39	$N_{TA_new} = N_{TA_old} + 8192 * T_c$ (based on equation in TS 38.213 [3] section 4.2)
T1	s	5	
T2	s	5	

Table A.7.4.3.1.2-3: Cell specific test parameters for timing advance

Parameter	Unit	Test1	
		T1	T2
Duplex mode		TDD	
TDD configuration		TDDConf.3.1	
$BW_{channel}$	MHz	100: $N_{RB,c} = 66$	
BWP BW	MHz	100: $N_{RB,c} = 66$	
DRx Cycle	ms	Not Applicable	
PDSCH Reference measurement channel		SR.3.1 TDD	
CORESET Reference Channel		CR.3.1 TDD	
OCNG Patterns		OCNG pattern 1	
TRS configuration		TRS.2.1 TDD	
TCI configuration		CSI-RS.Config.0	
SMTc configuration		SMTc.1 FR2	
PDSCH/PDCCH subcarrier spacing	kHz	120 kHz	
PUCCH/PUSCH subcarrier spacing	kHz	120 kHz	
EPRE ratio of PSS to SSS	dB	0	
EPRE ratio of PBCH DMRS to SSS			
EPRE ratio of PBCH to PBCH DMRS			
EPRE ratio of PDCCH DMRS to SSS			
EPRE ratio of PDCCH to PDCCH DMRS			
EPRE ratio of PDSCH DMRS to SSS			
EPRE ratio of PDSCH to PDSCH			
EPRE ratio of OCNG DMRS to SSS(Note 1)			
EPRE ratio of OCNG to OCNG DMRS (Note 1)			
UE orientation around TBD axis and TBD axis	degrees	TBD	
N_{oc}^{Note2}	dBm/15kHz	TBD	
N_{oc}^{Note2}	dBm/SCS	TBD	
\hat{E}_s / I_{ot}	dB	TBD	

\hat{E}_s / N_{oc}	dB	TBD
$I_{o\text{Note3}}$	dBm/ 95.04MHz	TBD
Propagation condition	-	AWGN
Note 1: OCNG shall be used such that both cells are fully allocated and a constant total transmitted power spectral density is achieved for all OFDM symbols.		
Note 2: Interference from other cells and noise sources not specified in the test is assumed to be constant over subcarriers and time and shall be modelled as AWGN of appropriate power for N_{oc} to be fulfilled.		
Note 3: I_o levels have been derived from other parameters for information purposes. They are not settable parameters themselves.		
Note 4: Equivalent power received by an antenna with 0dBi gain at the centre of the quiet zone		
Note 5: As observed with 0dBi gain antenna at the centre of the quiet zone		

Table A.7.4.3.1.2-4: Sounding Reference Symbol Configuration for timing advance

Field	Value	Comment
c-SRS	16	Frequency hopping is disabled
b-SRS	0	
b-hop	0	
freqDomainPosition	0	Frequency domain position of SRS
freqDomainShift	0	
groupOrSequenceHopping	neither	No group or sequence hopping
SRS-PeriodicityAndOffset	sl5=0	Once every 5 slots
pathlossReferenceRS	ssb-Index=0	SSB #0 is used for SRS path loss estimation
usage	nonCodebook	Non-codebook based UL transmission
startPosition	0	resourceMapping setting. SRS on last symbol of slot, and 1symbols for SRS without repetition.
nrofSymbols	n1	
repetitionFactor	n1	transmissionComb setting
combOffset-n2	0	
cyclicShift-n2	0	
nrofSRS-Ports	port1	Number of antenna ports used for SRS transmission
Note: For further information see clause 6.3.2 in TS 38.331 [2].		

A.7.4.3.1.3 Test Requirements

The UE shall apply the signalled Timing Advance value to the transmission timing at the designated activation time i.e. k slots after the reception of the timing advance command, where $k = 24$.

The Timing Advance adjustment accuracy shall be within the limits specified in clause 7.3.2.2.

The rate of correct Timing Advance adjustments observed during repeated tests shall be at least 90%.

A.7.5 Signaling characteristics

A.7.5.1 Radio link Monitoring

In the following section, any uplink signal transmitted by the UE is used for detecting the In-/Out-of-Sync state of the UE. In terms of measurement, the uplink signal is verified on the basis of the UE output power:

Editor note: The metric for the detection of the UE UL transmitted signal by the TE is FFS.

A.7.5.1.1 Radio Link Monitoring Out-of-sync Test for FR2 PCell configured with SSB-based RLM RS in non-DRX mode

A.7.5.1.1.1 Test Purpose and Environment

The purpose of this test is to verify that the UE properly detects the out of sync and in sync for the purpose of monitoring downlink radio link quality of the PCell. This test will partly verify the FR2 radio link monitoring requirements in clause 8.1.

Supported test configurations are shown in table A.7.5.1.1.1-1. The test parameters are given in Tables A.7.5.1.1.1-2, A.7.5.1.1.1-3, and A.7.5.1.1.1-4 below. There is one cell (Cell 1), which is the active NR cell, in the test. The test consists of three successive time periods, with time duration of T1, T2 and T3 respectively. Figure A.7.5.1.1.1-1 shows the variation of the downlink SNR in the active cell to emulate out-of-sync and in-sync states. Prior to the start of the time duration T1, the UE shall be fully synchronized to Cell 1. The UE shall be configured for periodic CSI reporting with a reporting periodicity of 5 ms. The UE is configured to perform inter-frequency measurements using Gap Pattern ID #0 (40ms) in test 1.

Table A.7.5.1.1.1-1: Supported test configurations for FR2 PCell

Configuration	Description
1	TDD, SSB SCS 120 KHz, data SCS 120KHz, BW 100MHz
Note:	The UE is only required to pass in one of the supported test configurations in FR2

Table A.7.5.1.1.1-2: General test parameters for FR2 out-of-sync testing in non-DRX mode

Parameter		Unit	Value
			Test 1
Active PCell			Cell 1
RF Channel Number			1
Duplex mode	Config 1		TDD
BW _{channel}	Config 1		100: N _{RB,c} = 66
DL initial BWP configuration	Config 1		DLBWP.0.1
DL dedicated BWP configuration	Config 1		DLBWP.1.1
UL initial BWP configuration	Config 1		ULBWP.0.1
UL dedicated BWP configuration	Config 1		ULBWP.1.1
TDD Configuration	Config 1		TBD
CORESET Reference Channel	Config 1		CR.3.1 TDD
SSB Configuration	Config 1		SSB.1 FR2
SMTC Configuration	Config 1		SMTC.1
PDSCH/PDCCH subcarrier spacing	Config 1		120 KHz
PRACH Configuration	Config 1		Table A.3.8.3.4
SSB index assigned as RLM RS	Config 1		0,1
TCI Configuration	Config 1		TBD
OCNG parameters			OP.1
CP length			Normal
Correlation Matrix and Antenna Configuration			2x2 Low
Out of sync transmission parameters	DCI format		1-0
	Number of Control OFDM symbols		2
	Aggregation level	CCE	8
	Ratio of hypothetical PDCCH RE energy to average SSS RE energy	dB	4
	Ratio of hypothetical PDCCH DMRS energy to average SSS RE energy	dB	4
	DMRS precoder granularity		REG bundle size
	REG bundle size		6
DRX			OFF
Gap pattern ID			gp0
Layer 3 filtering			Enabled
T310 timer		ms	0
T311 timer		ms	1000
N310			1
N311			1
CSI-RS configuration	Config 1		[CSI-RS.3.3 TDD]
T1		s	[1]
T2		s	[10]
T3		s	[12]
D1		s	[9.64]
Note 1: All configurations are assigned to the UE prior to the start of time period T1.			
Note 2: UE-specific PDCCH is not transmitted after T1 starts.			

Table A.7.5.1.1.1-3: OTA related cell specific test parameters for FR2 (Cell 1) for out-of-sync radio link monitoring tests in non-DRX mode

Parameter		Unit	Test 1		
			T1	T2	T3
ssb-Index 0 AoA Configuration	Config 1		TBD		
ssb-Index 1 AoA Configuration	Config 1		TBD		
EPRE ratio of PDCCH DMRS to SSS		dB	4		
EPRE ratio of PDCCH to PDCCH DMRS		dB	0		
EPRE ratio of PBCH DMRS to SSS		dB	0		
EPRE ratio of PBCH to PBCH DMRS		dB			
EPRE ratio of PSS to SSS		dB			
EPRE ratio of PDSCH DMRS to SSS		dB			
EPRE ratio of PDSCH to PDSCH DMRS		dB			
EPRE ratio of OCNG DMRS to SSS		dB			
EPRE ratio of OCNG to OCNG DMRS		dB			
ssb-Index 0 SNR	Config 1	dB	1	-7	-15
ssb-Index 1 SNR	Config 1		1	-15	-15
N_{oc}	Config 1	dBm/15 KHz	-98		
Propagation condition			TDL-A 30ns 75Hz		
Note 1: OCNG shall be used such that the resources in Cell 1 are fully allocated and a constant total transmitted power spectral density is achieved for all OFDM symbols. Note 2: The signal contains PDCCH for UEs other than the device under test as part of OCNG. Note 3: SNR levels correspond to the signal to noise ratio over the SSS REs. Note 4: The SNR values are specified for testing a UE which supports 2RX on at least one band. For testing of a UE which supports 4RX on all bands, the SNR during T3 is A.3.6.					

Table A.7.5.1.1.1-4: Measurement gap configuration for out-of-sync tests in non-DRX mode

Field	Test 1
	Value
gapOffset	[0

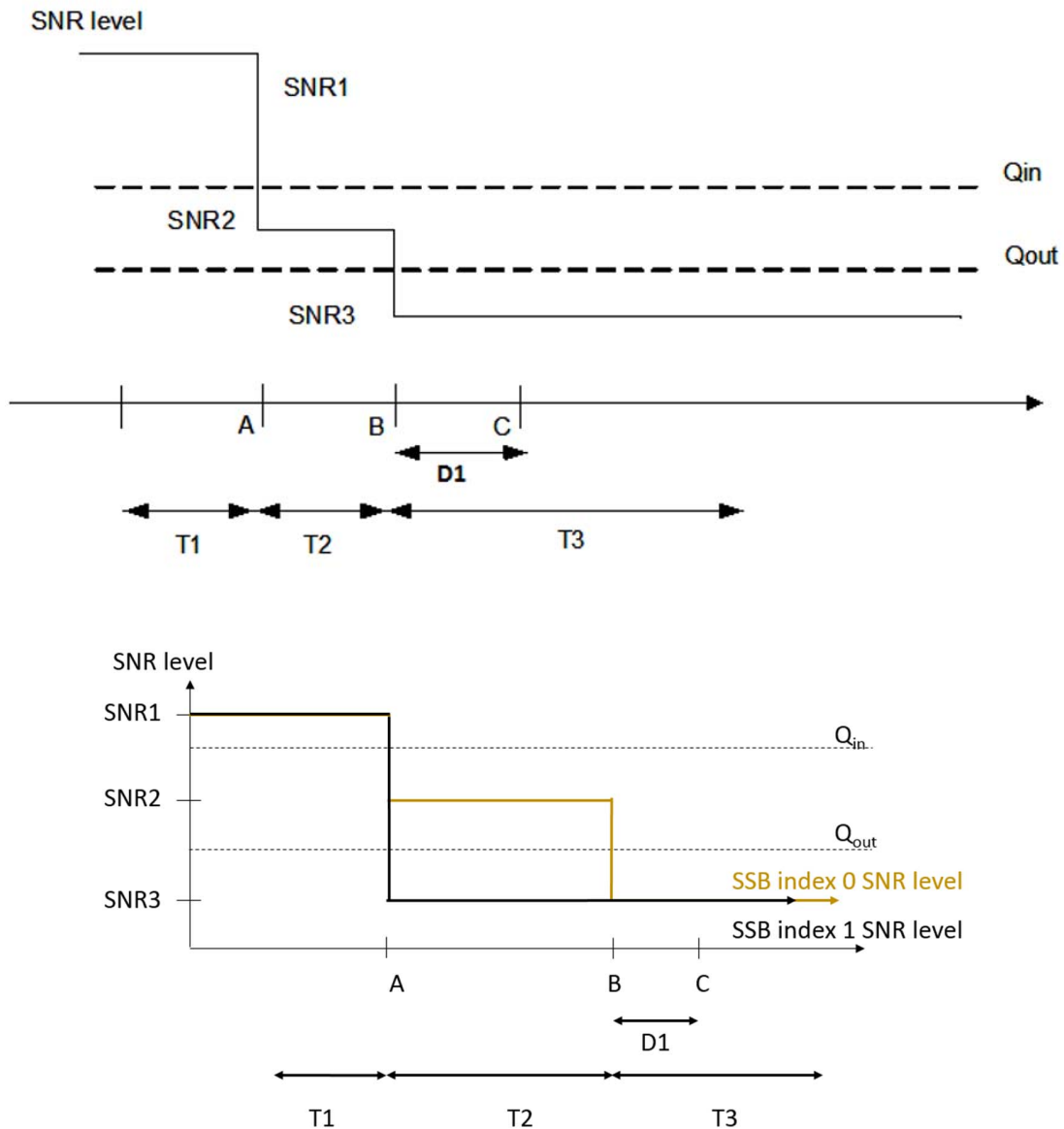

Figure A.7.5.1.1.1-1: SNR variation for out-of-sync testing

A.7.5.1.1.2 Test Requirements

The UE behavior in each test during time durations T1, T2 and T3 shall be as follows:

During the period from time point A to time point B the UE shall transmit uplink signal at least in all uplink slots configured for CSI transmission according to the configured periodic CSI reporting.

The UE shall stop transmitting uplink signal no later than time point C (D1 second after the start of the time duration T3).

The rate of correct events observed during repeated tests shall be at least 90%.

A.7.5.1.2 Radio Link Monitoring In-sync Test for FR2 PCell configured with SSB-based RLM RS in non-DRX mode

A.7.5.1.2.1 Test Purpose and Environment

The purpose of this test is to verify that the UE properly detects the out of sync and in sync for the purpose of monitoring downlink radio link quality of the PCell. This test will partly verify the FR2 radio link monitoring requirements in clause 8.1.

Supported test configurations are shown in table A.7.5.1.2.1-1. The test parameters are given in Tables A.7.5.1.2.1-2, and A.7.5.1.2.1-3 below. There is one cell (Cell 1), which is the active cell, in the test. The test consists of five successive time periods, with time duration of T1, T2, T3, T4 and T5 respectively. Figure A.7.5.1.2.1-1 shows the variation of the downlink SNR in the active cell to emulate out-of-sync and in-sync states. Prior to the start of the time duration T1, the UE shall be fully synchronized to Cell 1. Prior to the start of the time duration T1, the UE shall be fully synchronized to Cell 1. The UE shall be configured for periodic CSI reporting with a reporting periodicity of 5 ms.

Table A.7.5.1.2.1-1: Supported test configurations for FR2 PCell

Configuration	Description
1	TDD, SSB SCS 120 KHz, data SCS 120KHz, BW 100MHz
Note:	The UE is only required to pass in one of the supported test configurations in FR2

Table A.7.5.1.2.1-2: General test parameters for FR2 in-sync testing in non-DRX mode

Parameter		Unit	Value
			Test 1
Active PCell			Cell 1
RF Channel Number			1
Duplex mode	Config 1		TDD
BW _{channel}	Config 1		100: N _{RB,c} = 66
DL initial BWP configuration	Config 1		DLBWP.0.1
DL dedicated BWP configuration	Config 1		DLBWP.1.1
UL initial BWP configuration	Config 1		ULBWP.0.1
UL dedicated BWP configuration	Config 1		ULBWP.1.1
TDD Configuration	Config 1		TBD
CORESET Reference Channel	Config 1		CR.3.1 TDD
SSB Configuration	Config 1		SSB.1 FR2
SMTTC Configuration	Config 1		TBD (Note SMTTC periodicity =160ms)
PDSCH/PDCCH subcarrier spacing	Config 1		120 KHz
PRACH Configuration	Config 1		Table A.3.8.3.4
SSB index assigned as RLM RS	Config 1		0,1
TCI Configuration	Config 1		TBD
OCNG parameters			OP.1
CP length			Normal
Correlation Matrix and Antenna Configuration			2x2 Low
	DCI format		1-0
	Number of Control OFDM symbols		2

In sync transmission parameters	Aggregation level	CCE	4
	Ratio of hypothetical PDCCH RE energy to average SSS RE energy	dB	0
	Ratio of hypothetical PDCCH DMRS energy to average SSS RE energy	dB	0
	DMRS precoder granularity		REG bundle size
	REG bundle size		6
Out of sync transmission parameters	DCI format		1-0
	Number of Control OFDM symbols		2
	Aggregation level	CCE	8
	Ratio of hypothetical PDCCH RE energy to average SSS RE energy	dB	4
	Ratio of hypothetical PDCCH DMRS energy to average SSS RE energy	dB	4
	DMRS precoder granularity		REG bundle size
	REG bundle size		6
DRX			<i>OFF</i>
Gap pattern ID			N.A.
Layer 3 filtering			<i>Enabled</i>
T310 timer		ms	[6000]
T311 timer		ms	1000
N310			1
N311			1
CSI-RS configuration	Config 1		[CSI-RS.3.3 TDD]
T1		s	[0.5]
T2		s	[2]
T3		s	[1.86]
T4		s	[0.02]
T5		s	[7]
D1		s	[6.5]
Note 1: All configurations are assigned to the UE prior to the start of time period T1.			
Note 2: UE-specific PDCCH is not transmitted after T1 starts.			

Table A.7.5.1.2.1-3: OTA related cell specific test parameters for FR2 (Cell 1) for in-sync radio link monitoring tests in non-DRX mode

Parameter		Unit	Test 1				
			T1	T2	T3	T4	T5
ssb-Index 0 AoA Configuration	Config 1		TBD				
ssb-Index 1 AoA Configuration	Config 1		TBD				
EPRE ratio of PDCCH DMRS to SSS		dB	4				
EPRE ratio of PDCCH to PDCCH DMRS		dB	0				
EPRE ratio of PBCH DMRS to SSS		dB	0				
EPRE ratio of PBCH to PBCH DMRS		dB					
EPRE ratio of PSS to SSS		dB					
EPRE ratio of PDSCH DMRS to SSS		dB					
EPRE ratio of PDSCH to PDSCH DMRS		dB					
EPRE ratio of OCNG DMRS to SSS		dB					
EPRE ratio of OCNG to OCNG DMRS		dB					
ssb-Index 0 SNR	Config 1	dB	1	-7	-15	-4.5	1
ssb-Index 1 SNR	Config 1		1	-15	-15	-15	-15
N_{oc}	Config 1	dBm/1 5KHz	-98				
Propagation condition			TDL-A 30ns 75Hz				
<p>Note 1: OCNG shall be used such that the resources in Cell 1 are fully allocated and a constant total transmitted power spectral density is achieved for all OFDM symbols.</p> <p>Note 2: The signal contains PDCCH for UEs other than the device under test as part of OCNG.</p> <p>Note 3: SNR levels correspond to the signal to noise ratio over the SSS REs.</p> <p>Note 4: The SNR values are specified for testing a UE which supports 2RX on at least one band. For testing of a UE which supports 4RX on all bands, the SNR during T3 is A.3.6.</p>							

Table A.7.5.1.2.1-4: Void

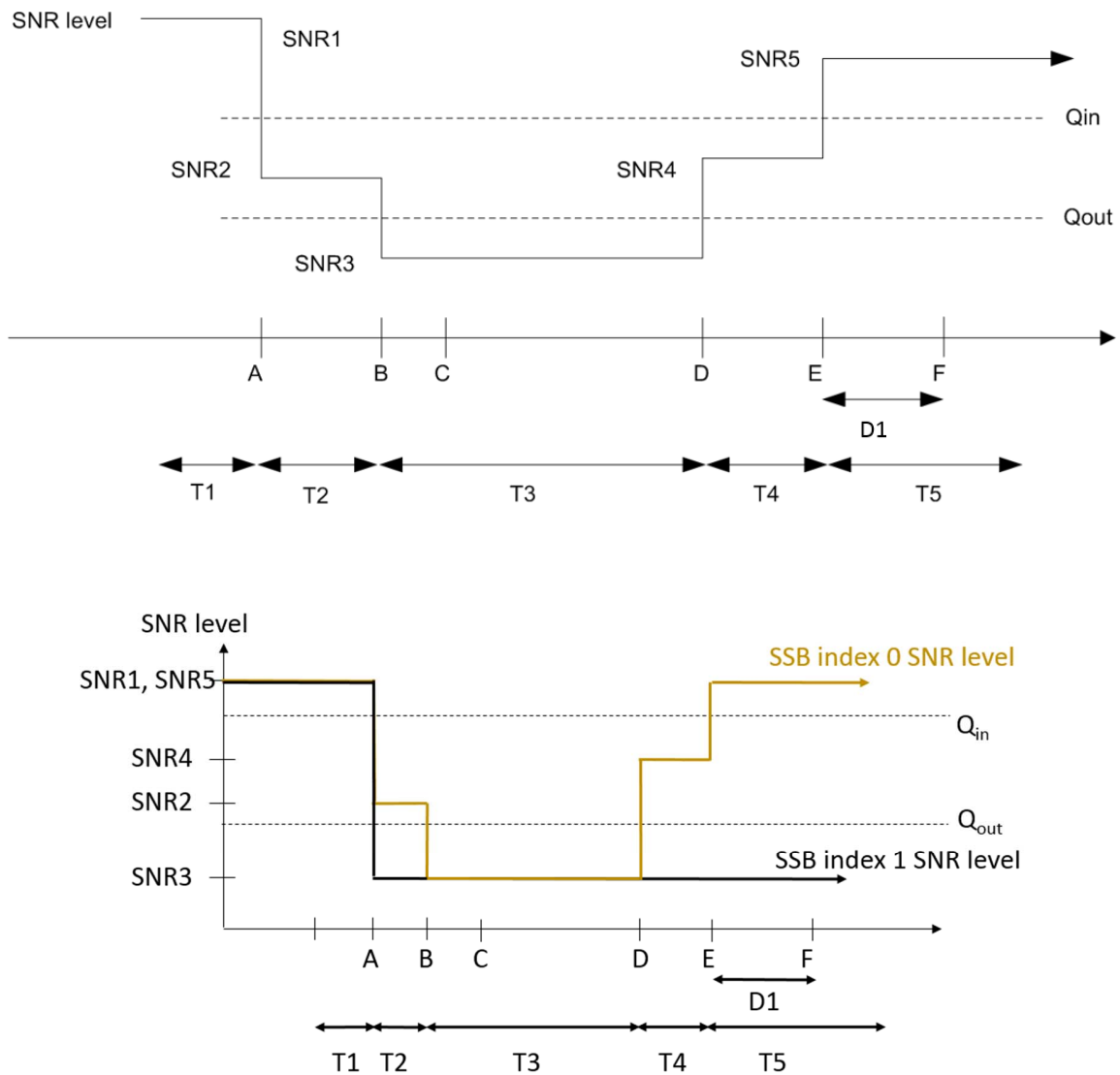

Figure A.7.5.1.2.1-1: SNR variation for in-sync testing

A.7.5.1.2.2 Test Requirements

The UE behaviour in each test during time durations T1, T2, T3, T4 and T5 shall be as follows:

During the period from time point A to time point F (D1 second after the start of time duration T5) the UE shall transmit uplink signal at least in all uplink slots configured for CSI transmission according to the configured periodic CSI reporting.

The rate of correct events observed during repeated tests shall be at least 90%.

A.7.5.1.3 Radio Link Monitoring Out-of-sync Test for FR2 PCell configured with SSB-based RLM RS in DRX mode

A.7.5.1.3.1 Test Purpose and Environment

The purpose of this test is to verify that the UE properly detects the out of sync and in sync for the purpose of monitoring downlink radio link quality of the PCell when DRX is used. This test will partly verify the FR2 radio link monitoring requirements in clause 8.1.

Supported test configurations are shown in table A.7.5.1.3.1-1. The test parameters are given in Tables A.7.5.1.3.1-2, and A.7.5.1.3.1-3. There is one cell (Cell 1), which is the active NR cell, in the test. The test consists of three successive time periods, with time duration of T1, T2 and T3 respectively. Figure A.7.5.1.3.1-1 shows the variation of the downlink SNR in the active cell to emulate out-of-sync and in-sync states. Prior to the start of the time duration T1, the UE shall be fully synchronized to Cell 1. The UE shall be configured for periodic CSI reporting with a reporting periodicity of 5 ms. In the test, DRX configuration is enabled and DRX inactivity timer has already been expired, i.e. UE tries to decode PDCCH and to send periodic CSI during the period when On-duration timer is running. Time alignment timers shall be set to “infinity” so that UL timing alignment is maintained during the test.

Table A.7.5.1.3.1-1: Supported test configurations for FR2 PCell

Configuration	Description
1	TDD, SSB SCS 120 KHz, data SCS 120KHz, BW 100MHz
Note:	The UE is only required to pass in one of the supported test configurations in FR2

Table A.7.5.1.3.1-2: General test parameters for FR2 out-of-sync testing in DRX mode

Parameter		Unit	Value Test 1
Active PCell			Cell 1
RF Channel Number			1
Duplex mode	Config 1		TDD
BW _{channel}	Config 1		100: N _{RB,c} = 66
DL initial BWP configuration	Config 1		DLBWP.0.1
DL dedicated BWP configuration	Config 1		DLBWP.1.1
UL initial BWP configuration	Config 1		ULBWP.0.1
UL dedicated BWP configuration	Config 1		ULBWP.1.1
TDD Configuration	Config 1		TBD
CORESET Reference Channel	Config 1		CR.3.1 TDD
SSB Configuration	Config 1		SSB.1 FR2
SMTC Configuration	Config 1		SMTC.1
PDSCH/PDCCH subcarrier spacing	Config 1		120 KHz
PRACH Configuration	Config 1		Table A.3.8.3.4
SSB index assigned as RLM RS	Config 1		0,1
TCI Configuration	Config 1		TBD
OCNG parameters			OP.1
CP length			Normal
Correlation Matrix and Antenna Configuration			2x2 Low
	DCI format		1-0
	Number of Control OFDM symbols		2

Out of sync transmission parameters	Aggregation level	CCE	8
	Ratio of hypothetical PDCCH RE energy to average SSS RE energy	dB	4
	Ratio of hypothetical PDCCH DMRS energy to average SSS RE energy	dB	4
	DMRS precoder granularity		REG bundle size
	REG bundle size		6
DRX Configuration			[DRX.3]
Gap pattern ID			N.A.
Layer 3 filtering			Enabled
T310 timer		ms	0
T311 timer		ms	1000
N310			1
N311			1
CSI-RS configuration	Config 1		[CSI-RS.3.3 TDD]
T1		s	[1]
T2		s	[15]
T3		s	[15]
D1		s	[14.44]
Note 1: All configurations are assigned to the UE prior to the start of time period T1.			
Note 2: UE-specific PDCCH is not transmitted after T1 starts.			

Table A.7.5.1.3.1-3: OTA related cell specific test parameters for FR2 (Cell 1) for out-of-sync radio link monitoring tests in DRX mode

Parameter		Unit	Test 1		
			T1	T2	T3
ssb-Index 0 AoA Configuration	Config 1		TBD		
ssb-Index 1 AoA Configuration	Config 1		TBD		
EPRE ratio of PDCCH DMRS to SSS		dB	4		
EPRE ratio of PDCCH to PDCCH DMRS		dB	0		
EPRE ratio of PBCH DMRS to SSS		dB	0		
EPRE ratio of PBCH to PBCH DMRS		dB			
EPRE ratio of PSS to SSS		dB			
EPRE ratio of PDSCH DMRS to SSS		dB			
EPRE ratio of PDSCH to PDSCH DMRS		dB			
EPRE ratio of OCNG DMRS to SSS		dB			
EPRE ratio of OCNG to OCNG DMRS		dB			
ssb-Index 0 SNR	Config 1	dB	1	-7	-15
ssb-Index 1 SNR	Config 1		1	-15	-15
N_{oc}	Config 1	dBm/15K Hz	-98		
Propagation condition			TDL-A 30ns 75Hz		
Note 1: OCNG shall be used such that the resources in Cell 1 are fully allocated and a constant total transmitted power spectral density is achieved for all OFDM symbols.					
Note 2: The signal contains PDCCH for UEs other than the device under test as part of OCNG.					
Note 3: SNR levels correspond to the signal to noise ratio over the SSS REs.					
Note 4: The SNR values are specified for testing a UE which supports 2RX on at least one band. For testing of a UE which supports 4RX on all bands, the SNR during T3 is A.3.6.					

Table A.7.5.1.3.1-4: Void

Table A.7.5.1.3.1-5: Void

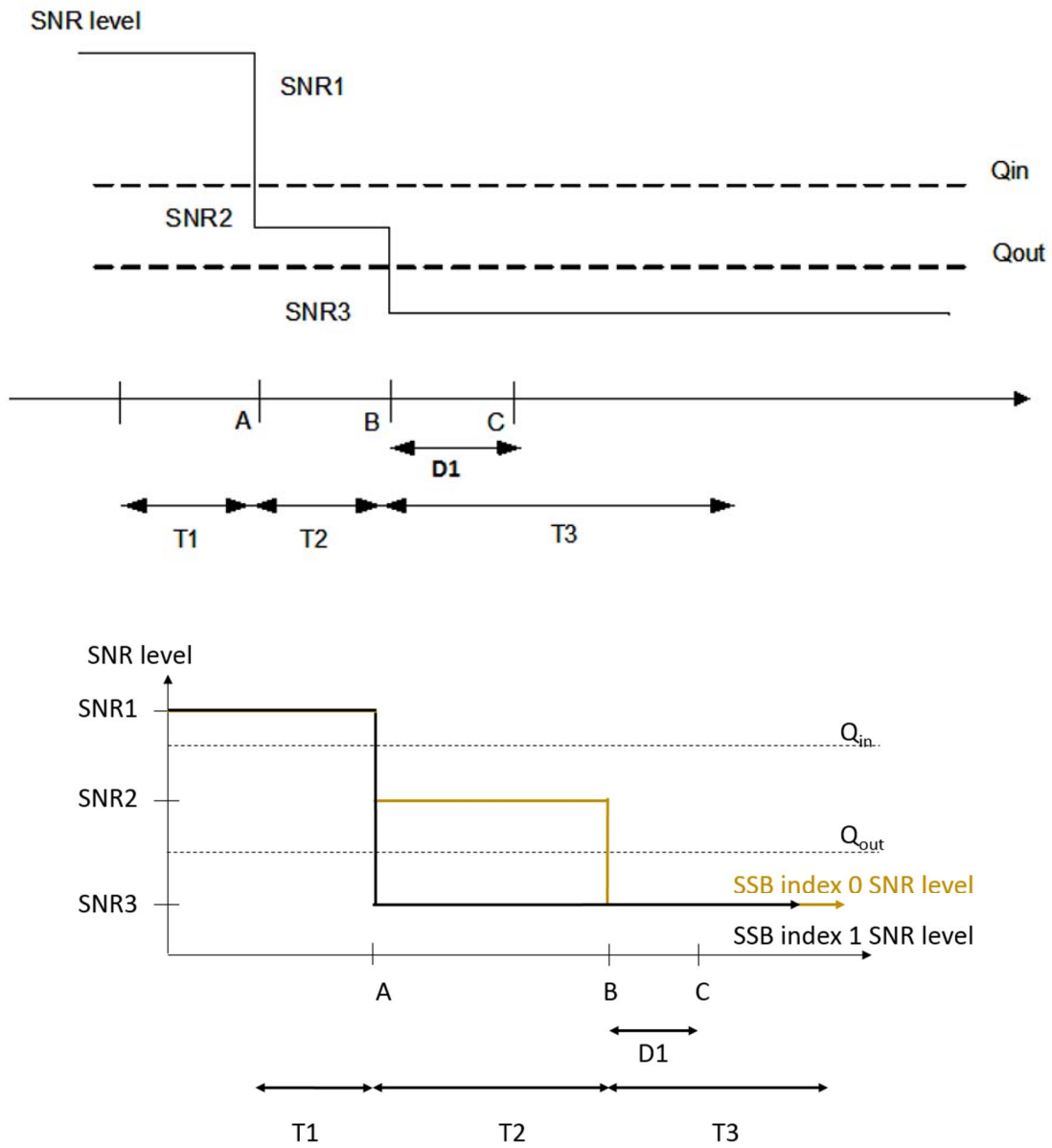

Figure A.7.5.1.3.1-1: SNR variation for out-of-sync testing

A.7.5.1.3.2 Test Requirements

The UE behavior in each test during time durations T1, T2 and T3 shall be as follows:

During the period from time point A to time point B the UE shall transmit uplink signal at least in all uplink slots configured for CSI transmission according to the configured periodic CSI reporting.

The UE shall stop transmitting uplink signal no later than time point C (D1 second after the start of the time duration T3).

The rate of correct events observed during repeated tests shall be at least 90%.

A.7.5.1.4 Radio Link Monitoring In-sync Test for FR2 PCell configured with SSB-based RLM RS in DRX mode

A.7.5.1.4.1 Test Purpose and Environment

The purpose of this test is to verify that the UE properly detects the out of sync and in sync for the purpose of monitoring downlink radio link quality of the PCell when DRX is used. This test will partly verify the FR2 radio link monitoring requirements in clause 8.1.

Supported test configurations are shown in table A.7.5.1.4.1-1. The test parameters are given in Tables A.7.5.1.4.1-2, and A.7.5.1.4.1-3. There is one cell (Cell 1), which is the active NR cell, in the test. The test consists of five successive time periods, with time duration of T1, T2, T3, T4 and T5 respectively. Figure A.7.5.1.4.1-1 shows the variation of the downlink SNR in the active cell to emulate out-of-sync and in-sync states. Prior to the start of the time duration T1, the UE shall be fully synchronized to Cell 1. The UE shall be configured for periodic CSI reporting with a reporting periodicity of 5 ms. In the test, DRX configuration is enabled and DRX inactivity timer has already been expired, i.e. UE tries to decode PDCCH and to send periodic CSI during the period when On-duration timer is running. Time alignment timers shall be set to “infinity” so that UL timing alignment is maintained during the test.

Editor note: AoA setting needs to be updated.

Table A.7.5.1.4.1-1: Supported test configurations for FR2 PCell

Configuration	Description
1	TDD, SSB SCS 120 KHz, data SCS 120KHz, BW 100MHz
Note: The UE is only required to pass in one of the supported test configurations in FR2	

Table A.7.5.1.4.1-2: General test parameters for FR2 in-sync testing in DRX mode

Parameter		Unit	Value
			Test 1
Active PCell			Cell 1
RF Channel Number			1
Duplex mode	Config 1		TDD
BW _{channel}	Config 1		100: N _{RB,c} = 66
DL initial BWP configuration	Config 1		DLBWP.0.1
DL dedicated BWP configuration	Config 1		DLBWP.1.1
UL initial BWP configuration	Config 1		ULBWP.0.1
UL dedicated BWP configuration	Config 1		ULBWP.1.1
TDD Configuration	Config 1		TBD
CORESET Reference Channel	Config 1		CR.3.1 TDD
SSB Configuration	Config 1		SSB.1 FR2
SMTc Configuration	Config 1		TBD (SMTc periodicity = 160ms)
PDSCH/PDCCH subcarrier spacing	Config 1		120 KHz
PRACH Configuration	Config 1		Table A.3.8.3.4

SSB index assigned as RLM RS	Config 1		0,1
TCI Configuration	Config 1		TBD
OCNG parameters			OP.1
CP length			Normal
Correlation Matrix and Antenna Configuration			2x2 Low
In sync transmission parameters	DCI format		1-0
	Number of Control OFDM symbols		2
	Aggregation level	CCE	4
	Ratio of hypothetical PDCCH RE energy to average SSS RE energy	dB	0
	Ratio of hypothetical PDCCH DMRS energy to average SSS RE energy	dB	0
	DMRS precoder granularity		REG bundle size
	REG bundle size		6
Out of sync transmission parameters	DCI format		1-0
	Number of Control OFDM symbols		2
	Aggregation level	CCE	8
	Ratio of hypothetical PDCCH RE energy to average SSS RE energy	dB	4
	Ratio of hypothetical PDCCH DMRS energy to average SSS RE energy	dB	4
	DMRS precoder granularity		REG bundle size
	REG bundle size		6
DRX Configuration			[DRX.3]
Gap pattern ID			N.A.
Layer 3 filtering			<i>Enabled</i>
T310 timer		ms	[6000]
T311 timer		ms	1000
N310			1
N311			1
CSI-RS configuration	Config 1		[CSI-RS.3.3 TDD]
T1		s	[4]
T2		s	[6]
T3		s	[5.54]
T4		s	[0.02]
T5		s	[7]
D1		s	[6.5]
Note 1: All configurations are assigned to the UE prior to the start of time period T1.			
Note 2: UE-specific PDCCH is not transmitted after T1 starts.			

Table A.7.5.1.4.1-3: OTA related cell specific test parameters for FR2 (Cell 1) for in-sync radio link monitoring test in DRX mode

Parameter		Unit	Test 1				
			T1	T2	T3	T4	T5
ssb-Index 0 AoA Configuration	Config 1		TBD				
ssb-Index 1 AoA Configuration	Config 1		TBD				
EPRE ratio of PDCCH DMRS to SSS		dB	4				
EPRE ratio of PDCCH to PDCCH DMRS		dB	0				
EPRE ratio of PBCH DMRS to SSS		dB	0				
EPRE ratio of PBCH to PBCH DMRS		dB					
EPRE ratio of PSS to SSS		dB					
EPRE ratio of PDSCH DMRS to SSS		dB					
EPRE ratio of PDSCH to PDSCH DMRS		dB					
EPRE ratio of OCNG DMRS to SSS		dB					
EPRE ratio of OCNG to OCNG DMRS		dB					
ssb-Index 0 SNR	Config 1	dB	1	-7	-15	-4.5	1
ssb-Index 1 SNR	Config 1		1	-15	-15	-15	-15
N_{oc}	Config 1	dBm/1 5KHz	-98				
Propagation condition			TDL-A 30ns 75Hz				
<p>Note 1: OCNG shall be used such that the resources in Cell 1 are fully allocated and a constant total transmitted power spectral density is achieved for all OFDM symbols.</p> <p>Note 2: The signal contains PDCCH for UEs other than the device under test as part of OCNG.3</p> <p>Note 3: SNR levels correspond to the signal to noise ratio over the SSS REs.</p> <p>Note 4: The SNR values are specified for testing a UE which supports 2RX on at least one band. For testing of a UE which supports 4RX on all bands, the SNR during T3 is A.3.6.</p>							

Table A.7.5.1.4.1-4: Void

Table A.7.5.1.4.1-5: Void

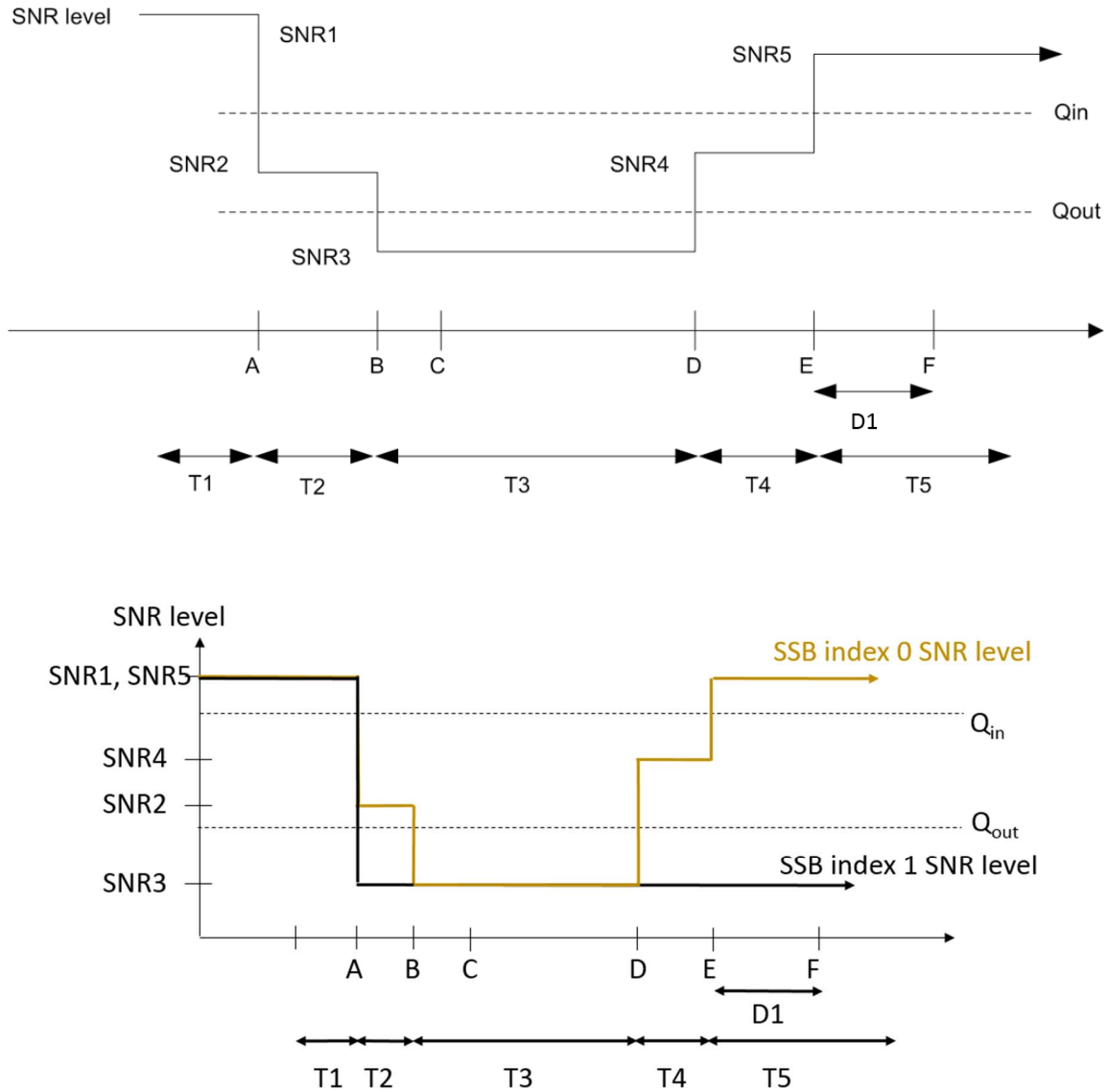

Figure A.7.5.1.4.1-1: SNR variation for in-sync testing

A.7.5.1.4.2 Test Requirements

The UE behaviour in each test during time durations T1, T2, T3, T4 and T5 shall be as follows:

During the period from time point A to time point F (D1 second after the start of time duration T5) the UE shall transmit uplink signal at least in all uplink slots configured for CSI transmission according to the configured periodic CSI reporting.

The rate of correct events observed during repeated tests shall be at least 90%.

A.7.5.1.5 Radio Link Monitoring Out-of-sync Test for FR2 PCell configured with CSI-RS-based RLM in non-DRX mode

A.7.5.1.5.1 Test Purpose and Environment

The purpose of this test is to verify that the UE properly detects the out of sync for the purpose of monitoring downlink CSI-RS based radio link quality of the PCell when no DRX is used. This test will partly verify the FR2 PCell CSI-RS Out-of-sync radio link monitoring requirements in clause 8.1.

The test parameters are given in Tables A.7.5.1.5.1-1, A.7.5.1.5.1-2, and A.7.5.1.5.1-3 below. There is one cell, cell 1 which is the PCell, in the test. The test consists of three successive time periods, with time duration of T1, T2 and T3 respectively. Figure A.7.5.1.5.1-1 shows the variation of the downlink SNR in the PCell to emulate out-of-sync and in-sync states. Prior to the start of the time duration T1, the UE shall be fully synchronized to cell 1. The UE shall be configured for periodic CSI reporting with a reporting periodicity of [10] ms. In the test, DRX configuration is not enabled. The UE is configured to perform inter-frequency measurements using GP ID #0 (40ms) in test2.

Table A.7.5.1.5.1-1: Supported test configurations for FR2 PCell

Configuration	Description
1	TDD duplex mode, 120 kHz SSB SCS, 100MHz bandwidth

Table A.7.5.1.5.1-2: General test parameters for FR2 PCell for CSI-RS out-of-sync testing in non-DRX mode

Parameter		Unit	Value	
			Test 1	Test 2
Active PCell			Cell 1	Cell 1
RF Channel Number			1	1
Duplex mode	Config 1		TDD	TDD
TDD Configuration	Config 1		[TDDConf.3.1]	[TDDConf.3.1]
CORESET Reference Channel	Config 1		[CR. 3.1 TDD]	[CR. 3.1 TDD]
SSB Configuration	Config 1		TBD (Note: periodicity is 20ms)	TBD (Note: periodicity is 20ms)
SMTC Configuration	Config 1		TDD	TDD
PDSCH/PDCC H subcarrier spacing	Config 1		120 KHz	120 KHz
csi-RS-Index assigned as RLM RS			[0]	[0]
OCNG parameters			TBD	TBD
CP length			Normal	Normal
Correlation Matrix and Antenna Configuration			[2x2 Low]	[2x2 Low]
	DCI format		1-0	1-0
	Number of Control OFDM symbols		2	2
	Aggregation level	CC E	8	8

Out of sync transmission parameters	Ratio of hypothetical PDCCH RE energy to average CSI-RS RE energy	dB	4	4
	Ratio of hypothetical PDCCH DMRS energy to average CSI-RS RE energy	dB	4	4
	DMRS precoder granularity		REG bundle size	REG bundle size
	REG bundle size		6	6
DRX			<i>OFF</i>	<i>OFF</i>
Gap pattern ID			[N.A.]	*[gp0]
Layer 3 filtering			<i>Enabled</i>	<i>Enabled</i>
T310 timer		ms	0	0
T311 timer		ms	1000	1000
N310			1	1
N311			1	1
NZP CSI-RS configuration			[ResourceId 1]	[ResourceId 0]
ZP CSI-RS configuration			TBD	TBD
CSI-IM configuration			TBD	TBD
Periodic CSI reporting			PUCCH	PUCCH
CSI reporting periodicity	Config 1	slot	[10]	[10]
T1		s	1	1
T2		s	0.4	0.4
T3		s	[0.6]	[0.6]
D1		s	[0.24]	[0.44]
Note 1: UE-specific PDCCH is not transmitted after T1 starts.				

Table A.7.5.1.5.1-3: Cell specific test parameters for FR2 for CSI-RS out-of-sync radio link monitoring in non-DRX mode

Parameter		Unit	Test 1			Test 2		
			T1	T2	T3	T1	T2	T3
PDCCH_beta		dB	4			4		
PDCCH_DMRS_beta		dB	4			4		
PBCH_beta		dB	0			0		
PSS_beta		dB						
SSS_beta		dB						
PDSCH_beta		dB						
OCNG_beta		dB						
SNR	Config 1	dB	TBD	TBD	TBD	TBD	TBD	TBD
N_{oc}	Config 1	dBm/15K Hz	[-98]			[-98]		
Propagation condition			[TDL-C 300ns 100Hz]			[TDL-C 300ns 100Hz]		
<p>Note 1: OCNG shall be used such that the resources in Cell 1 are fully allocated and a constant total transmitted power spectral density is achieved for all OFDM symbols.</p> <p>Note 2: The uplink resources for CSI reporting are assigned to the UE prior to the start of time period T1.</p> <p>Note 3: NZP CSI-RS resource set configuration for CSI reporting are assigned to the UE prior to the start of time period T1.</p> <p>Note 4: Measurement gap configuration is assigned to the UE prior to the start of time period T1.</p> <p>Note 5: The timers and layer 3 filtering related parameters are configured prior to the start of time period T1.</p> <p>Note 6: The signal contains PDCCH for UEs other than the device under test as part of OCNG.</p> <p>Note 7: SNR levels correspond to the signal to noise ratio over the SSS REs.</p> <p>Note 8: The SNR in time periods T1, T2 and T3 is denoted as SNR1, SNR2 and SNR3 respectively in figure A.7.5.1.5.1-1.</p> <p>Note 9: The SNR values are specified for testing a UE which supports 2RX on at least one band. For testing of a UE which supports 4RX on all bands, the SNR during T3 is [A.3.6].</p>								

Table A.7.5.1.5.1-3: Measurement gap configuration for FR2 CSI-RS out-of-sync radio link monitoring in non-DRX mode

Field	Test 2
	Value
gapOffset	[0]
Note 1: RLM RS is partially overlapped with measurement gap	

Table A.7.5.1.5.1-4: NZP-CSI-RS resource configuration for FR2 CSI-RS out-of-sync radio link monitoring in non-DRX mode

Field	Resource 0	Resource 1
	Value	Value
frequencyDomainAllocation ^{Note 2}	row1	row2
startingRB	0	0
nrofRBs	Note 2	Note 2
<p>Note 1: TS 38.211 [6] table 7.4.1.5.3-1</p> <p>Note 2: nrofRBs is derived based on the Configuration in Table A.7.5.1.5.1-1</p>		

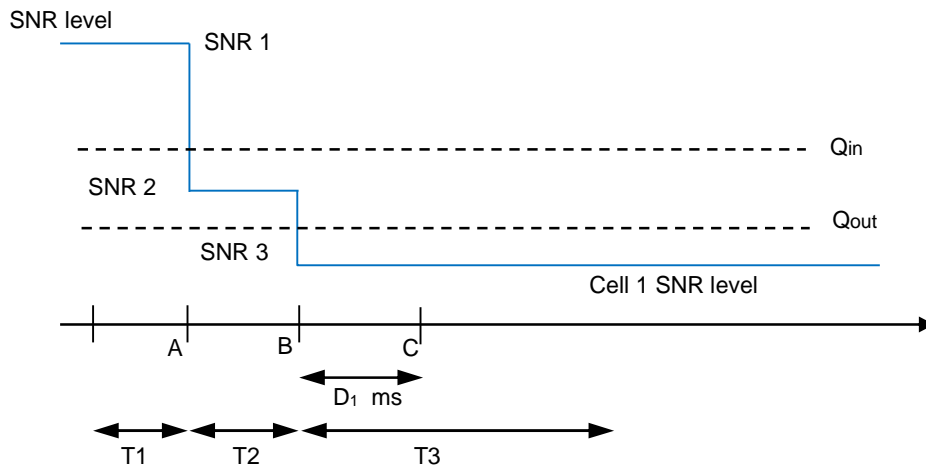

Figure A.7.5.1.5.1-1: SNR variation for CSI-RS out-of-sync testing

A.7.5.1.5.2 Test Requirements

The UE behaviour during time durations T1, T2, and T3 shall be as follows:

During time durations T1, T2 and T3, the UE shall transmit uplink signal at least in all subframes configured for CSI transmission on Cell 1.

During the period from time point A to time point B the UE shall transmit uplink signal in Cell 1 at least in all uplink slots configured for CSI transmission according to the configured periodic CSI reporting for Cell 1.

The UE shall stop transmitting uplink signal in Cell 1 no later than time point C ($D_1 = [\text{TBD}]$ ms after the start of the time duration T3) on the PCell.

The rate of correct events observed during repeated tests shall be at least 90%.

A.7.5.1.6 Radio Link Monitoring In-sync Test for FR2 PCell configured with CSI-RS-based RLM in non-DRX mode

A.7.5.1.6.1 Test Purpose and Environment

The purpose of this test is to verify that the UE properly detects the in sync for the purpose of monitoring downlink CSI-RS based radio link quality of the PCell when no DRX is used. This test will partly verify the FR2 PCell CSI-RS In-sync radio link monitoring requirements in clause 8.1.

The test parameters are given in Tables A.7.5.1.6.1-1, A.7.5.1.6.1-2, A.7.5.1.6.1-3, A.7.5.1.6.1-4, A.7.5.1.6.1-5, and A.7.5.1.6.1-6 below. There is one cells, cell 1 which is the PCell, in the test. The test consists of five successive time periods, with time duration of T1, T2, T3, T4 and T5 respectively. Figure A.7.5.1.6.1-1 shows the variation of the downlink SNR in the PCell to emulate out-of-sync and in-sync states. Prior to the start of the time duration T1, the UE shall be fully synchronized to cell 1. The UE shall be configured for periodic CSI reporting with a reporting periodicity of [10] ms. In the test, DRX configuration is not enabled. The UE is configured to perform inter-frequency measurements using GP ID #0 (40ms) in test 4.

Table A.7.5.1.6.1-1: Supported test configurations for FR2 PCell

Configuration	Description
1	TDD duplex mode, 120 kHz SSB SCS, 100MHz bandwidth

Table A.7.5.1.6.1-2: General test parameters for FR2 PCell for CSI-RS in-sync testing in non-DRX mode

Parameter		Unit	Value	
			Test 3	Test 4
Active PCell			Cell 1	Cell 1
RF Channel Number			1	1
Duplex mode	Config 1		TDD	TDD
TDD Configuration	Config 1		[TDDConf.3.1]	[TDDConf.3.1]
CORESET Reference Channel	Config 1		[CR. 3.1 TDD]	[CR. 3.1 TDD]
SSB Configuration	Config 1		TBD (Note: periodicity is 20ms)	TBD (Note: periodicity is 20ms)
SMT-C Configuration	Config 1		TDD	TDD
PDSCH/PDCCH subcarrier spacing	Config 1		120 KHz	120 KHz
csi-RS-Index assigned as RLM RS			[0]	[0]
OCNG parameters			TBD	TBD
CP length			Normal	Normal
Correlation Matrix and Antenna Configuration			[2x2 Low]	[2x2 Low]
Out of sync transmission parameters	DCI format		1-0	1-0
	Number of Control OFDM symbols		2	2
	Aggregation level	CC E	8	8
	Ratio of hypothetical PDCCH RE energy to average CSI-RS RE energy	dB	4	4
	Ratio of hypothetical PDCCH DMRS energy to average CSI-RS RE energy	dB	4	4
	DMRS precoder granularity		REG bundle size	REG bundle size
	REG bundle size		6	6
In sync transmission parameters	DCI format		1-0	1-0
	Number of Control OFDM symbols		2	2
	Aggregation level	CC E	4	4
	Ratio of hypothetical PDCCH RE energy to average CSI-RS RE energy	dB	0	0
	Ratio of hypothetical PDCCH DMRS energy to average CSI-RS RE energy	dB	0	0

	DMRS precoder granularity		REG bundle size	REG bundle size
	REG bundle size		6	6
DRX			OFF	OFF
Gap pattern ID			[N.A.]	*[gp0]
Layer 3 filtering			Enabled	Enabled
T310 timer	ms		0	0
T311 timer	ms		1000	1000
N310			1	1
N311			1	1
NZP CSI-RS configuration			[ResourceId 1]	[ResourceId 0]
ZP CSI-RS configuration			TBD	TBD
CSI-IM configuration			TBD	TBD
Periodic CSI reporting			PUCCH	PUCCH
CSI reporting periodicity	Config 1	slot	[10]	[10]
T1		s	1	1
T2		s	0.4	0.4
T3		s	[0.6]	[0.6]
D1		s	[0.24]	[0.44]
Note 1: UE-specific PDCCH is not transmitted after T1 starts.				

Table A.7.5.1.6.1-3: Cell specific test parameters for FR2 for CSI-RS in-sync radio link monitoring in non-DRX mode

Parameter	Unit	Test 3			Test 4			
		T1	T2	T3	T1	T2	T3	
PDCCH_beta	dB	4			4			
PDCCH_DMRS_beta	dB	4			4			
PBCH_beta	dB	0			0			
PSS_beta	dB							
SSS_beta	dB							
PDSCH_beta	dB							
OCNG_beta	dB							
SNR	Config 1	dB	TBD	TBD	TBD	TBD	TBD	
N_{oc}	Config 1	dBm/15K Hz	[-98]			[-98]		
Propagation condition			[TDL-C 300ns 100Hz]			[TDL-C 300ns 100Hz]		
Note 1:	OCNG shall be used such that the resources in Cell 1 are fully allocated and a constant total transmitted power spectral density is achieved for all OFDM symbols.							
Note 2:	The uplink resources for CSI reporting are assigned to the UE prior to the start of time period T1.							
Note 3:	NZP CSI-RS resource set configuration for CSI reporting are assigned to the UE prior to the start of time period T1.							
Note 4:	Measurement gap configuration is assigned to the UE prior to the start of time period T1.							
Note 5:	The timers and layer 3 filtering related parameters are configured prior to the start of time period T1.							
Note 6:	The signal contains PDCCH for UEs other than the device under test as part of OCNG.							
Note 7:	SNR levels correspond to the signal to noise ratio over the SSS REs.							
Note 8:	The SNR in time periods T1, T2 and T3 is denoted as SNR1, SNR2 and SNR3 respectively in figure A.7.5.1.6.1-1.							
Note 9:	The SNR values are specified for testing a UE which supports 2RX on at least one band. For testing of a UE which supports 4RX on all bands, the SNR during T3 is [A.3.6].							

Table A.7.5.1.6.1-3: Measurement gap configuration for FR2 CSI-RS in-sync radio link monitoring in non-DRX mode

Field	Test 4
	Value
gapOffset	[0]
Note 1: RLM RS is partially overlapped with measurement gap	

Table A.7.5.1.6.1-4: NZP-CSI-RS resource configuration for FR2 CSI-RS in-sync radio link monitoring in non-DRX mode

Field	Resource 0	Resource 1
	Value	Value
frequencyDomainAllocation ^{Note 2}	row1	row2
startingRB	0	0
nrofRBs	Note 2	Note 2
Note 1: TS 38.211 [6] table 7.4.1.5.3-1		
Note 2: nrofRBs is derived based on the Configuration in Table A.4.7.1.6.1-1		

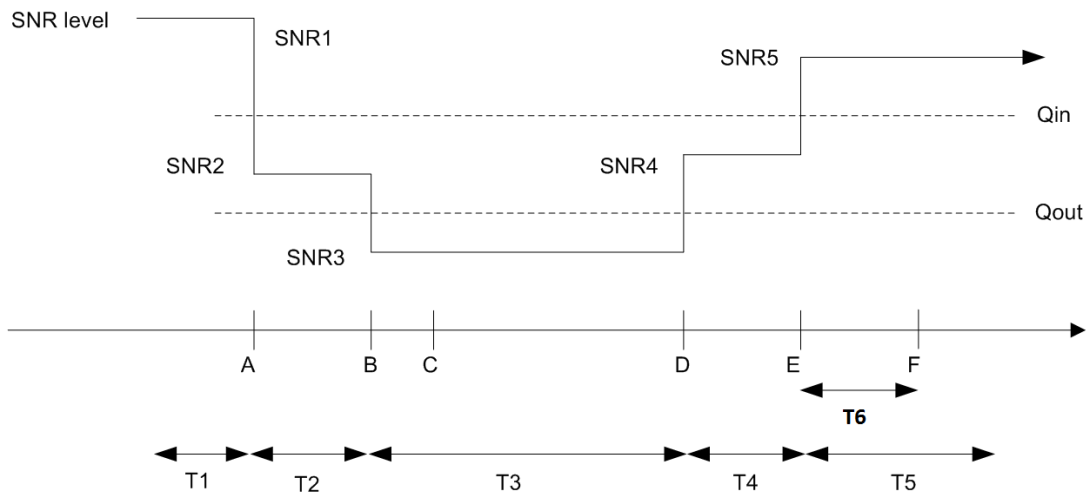

Figure A.7.5.1.6.1-1: SNR variation for CSI-RS in-sync testing

A.7.5.1.6.2 Test Requirements

The UE behaviour in each test during time durations T1, T2, T3, T4 and T5 shall be as follows:

During the period from time point A to time point F (T6 second after the start of time duration T5) the UE shall transmit uplink signal at least in all uplink slots configured for CSI transmission according to the configured periodic CSI reporting on the PCell.

The rate of correct events observed during repeated tests shall be at least 90%.

A.7.5.1.7 Radio Link Monitoring Out-of-sync Test for FR2 PCell configured with CSI-RS-based RLM in DRX mode

A.7.5.1.7.1 Test Purpose and Environment

The purpose of this test is to verify that the UE properly detects the out of sync for the purpose of monitoring downlink CSI-RS based radio link quality of the PCell when DRX is used. This test will partly verify the FR2 PCell CSI-RS Out-of-sync radio link monitoring requirements in clause 8.1.

The test parameters are given in Tables A.7.5.1.7.1-1, A.7.5.1.7.1-2, and A.7.5.1.7.1-3 below. There is one cell, cell 1 is the PCell, in the test. The test consists of three successive time periods, with time duration of T1, T2 and T3 respectively. Figure A.7.5.1.7.1-1 shows the variation of the downlink SNR in the PCell to emulate out-of-sync and in-sync states. Prior to the start of the time duration T1, the UE shall be fully synchronized to cell 1. The UE shall be configured for periodic CSI reporting with a reporting periodicity of [10] ms. In the test, DRX configuration is enabled in PCell and DRX inactivity timer has already been expired, i.e. UE tries to decode PDCCH and to send periodic CQI during the period when On-duration timer is running. Time alignment timers shall be set to “infinity” so that UL timing alignment is maintained during the test. The UE is configured to perform inter-frequency measurements using GP ID #0 (40ms) in test 6.

Table A.7.5.1.7.1-1: Supported test configurations for FR2 PCell

Configuration	Description
1	TDD duplex mode, 120 kHz SSB SCS, 100MHz bandwidth

Table A.7.5.1.7.1-2: General test parameters for FR2 PCell for CSI-RS out-of-sync testing in DRX mode

Parameter	Unit	Value	
		Test 5	Test 6
Active PCell		Cell 1	Cell 1
RF Channel Number		1	1
Duplex mode	Config 1	TDD	TDD
TDD Configuration	Config 1	[TDDConf.3.1]	[TDDConf.3.1]
CORESET Reference Channel	Config 1	[CR. 3.1 TDD]	[CR. 3.1 TDD]
SSB Configuration	Config 1	TBD (Note: periodicity is 20ms)	TBD (Note: periodicity is 20ms)
SMTC Configuration	Config 1	TDD	TDD
PDSCH/PDCCH subcarrier spacing	Config 1	120 KHz	120 KHz
csi-RS-Index assigned as RLM RS		[0]	[0]
OCNG parameters		TBD	TBD
CP length		Normal	Normal
Correlation Matrix and Antenna Configuration		[2x2 Low]	[2x2 Low]
	DCI format	1-0	1-0
	Number of Control OFDM symbols	2	2
	Aggregation level	CC E	8

Out of sync transmission parameters	Ratio of hypothetical PDCCH RE energy to average CSI-RS RE energy	dB	4	4
	Ratio of hypothetical PDCCH DMRS energy to average CSI-RS RE energy	dB	4	4
	DMRS precoder granularity		REG bundle size	REG bundle size
	REG bundle size		6	6
DRX			640	640
Gap pattern ID			[N.A.]	*[gp0]
Layer 3 filtering			Enabled	Enabled
T310 timer		ms	0	0
T311 timer		ms	1000	1000
N310			1	1
N311			1	1
NZP CSI-RS configuration			[ResourceId 1]	[ResourceId 0]
ZP CSI-RS configuration			TBD	TBD
CSI-IM configuration			TBD	TBD
Periodic CSI reporting			PUCCH	PUCCH
CSI reporting periodicity	Config 1	slot	[10]	[10]
T1		s	1	1
T2		s	0.4	0.4
T3		s	[0.6]	[0.6]
D1		s	[0.24]	[0.44]
Note 1: UE-specific PDCCH is not transmitted after T1 starts.				

Table A.7.5.1.7.1-3: Cell specific test parameters for FR2 for CSI-RS out-of-sync radio link monitoring in DRX mode

Parameter	Unit	Test 5			Test 6			
		T1	T2	T3	T1	T2	T3	
PDCCH_beta	dB	4			4			
PDCCH_DMRS_beta	dB	4			4			
PBCH_beta	dB	0			0			
PSS_beta	dB							
SSS_beta	dB							
PDSCH_beta	dB							
OCNG_beta	dB							
SNR	Config 1	dB	TBD	TBD	TBD	TBD	TBD	TBD
N_{oc}	Config 1	dBm/15K Hz	[-98]			[-98]		
Propagation condition			[TDL-C 300ns 100Hz]			[TDL-C 300ns 100Hz]		
Note 1:	OCNG shall be used such that the resources in Cell 1 are fully allocated and a constant total transmitted power spectral density is achieved for all OFDM symbols.							
Note 2:	The uplink resources for CSI reporting are assigned to the UE prior to the start of time period T1.							
Note 3:	NZP CSI-RS resource set configuration for CSI reporting are assigned to the UE prior to the start of time period T1.							
Note 4:	Measurement gap configuration is assigned to the UE prior to the start of time period T1.							
Note 5:	The timers and layer 3 filtering related parameters are configured prior to the start of time period T1.							
Note 6:	The signal contains PDCCH for UEs other than the device under test as part of OCNG.							
Note 7:	SNR levels correspond to the signal to noise ratio over the SSS REs.							
Note 8:	The SNR in time periods T1, T2 and T3 is denoted as SNR1, SNR2 and SNR3 respectively in figure A.7.5.1.7.1-1.							
Note 9:	The SNR values are specified for testing a UE which supports 2RX on at least one band. For testing of a UE which supports 4RX on all bands, the SNR during T3 is [A.3.6].							

Table A.7.5.1.7.1-3: Measurement gap configuration for FR2 CSI-RS out-of-sync radio link monitoring in DRX mode

Field	Test 6
	Value
gapOffset	[0]
Note 1: RLM RS is partially overlapped with measurement gap	

Table A.7.5.1.7.1-4: NZP-CSI-RS resource configuration for FR2 CSI-RS out-of-sync radio link monitoring in DRX mode

Field	ResourceId 0	ResourceId 1
	Value	Value
frequencyDomainAllocation ^{Note 1}	row1	row2
startingRB	0	0
nrofRBs	Note 2	Note 2
Note 1: TS 38.211 [6] table 7.4.1.5.3-1		
Note 2: nrofRBs is derived based on the Configuration in Table A.7.5.1.7.1-1		

Table A.7.5.1.7.1-5: DRX-Configuration for FR2 CSI-RS out-of-sync radio link monitoring in DRX mode.

Field	Test 5	Test 6
	Value	Value
drx-onDurationTimer	[ms6]	[ms6]
drx-InactivityTimer	[ms1]	[ms1]
drx-RetransmissionTimerDL	[sl1]	[sl1]
drx-RetransmissionTimerUL	[sl1]	[sl1]
longDRX-CycleStartOffset	[ms640]	[ms40]
shortDRX	disable	disable

Table A.7.5.1.7.1-6: TimeAlignmentTimer -Configuration for FR2 CSI-RS out-of-sync radio link monitoring in DRX mode.

Field		Test 5	Test 6
		Value	Value
TimeAlignmentTimer		infinity	infinity
periodicityAndOffset in SchedulingRequestResourceConfig	Config 1	[sl5]	[sl5]

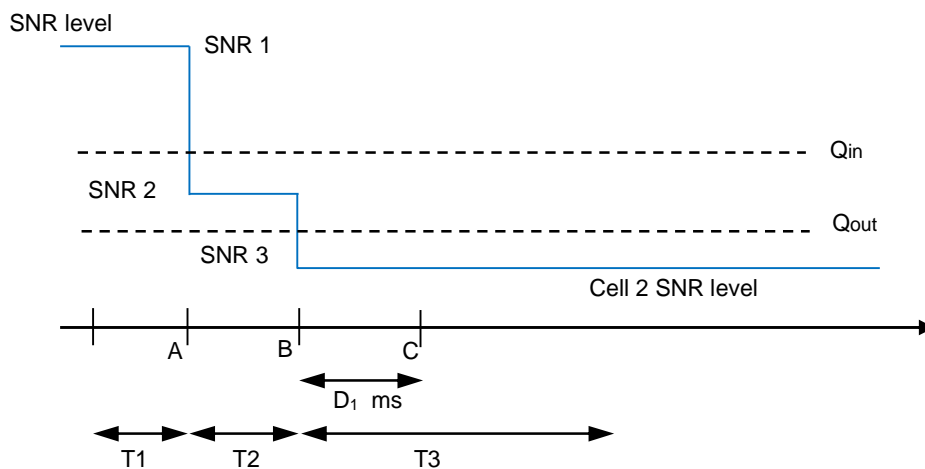
**Figure A.7.5.1.7.1-1: SNR variation for CSI-RS out-of-sync testing**

A.7.5.1.7.2 Test Requirements

The UE behaviour during time durations T_1 , T_2 , and T_3 shall be as follows:

During time durations T_1 , T_2 and T_3 , the UE shall transmit uplink signal at least in all subframes configured for CSI transmission on PCell.

During the period from time point A to time point B the UE shall transmit uplink signal in Cell 1 (PCell) at least in all uplink slots configured for CSI transmission according to the configured periodic CSI reporting for Cell 1.

The UE shall stop transmitting uplink signal in Cell 1 (PCell) no later than time point C ($D_1 = [\text{TBD}]$ ms) after the start of the time duration T3) on the PCell.

The rate of correct events observed during repeated tests shall be at least 90%.

A.7.5.1.8 Radio Link Monitoring In-sync Test for FR2 PCell configured with CSI-RS-based RLM in DRX mode

A.7.5.1.8.1 Test Purpose and Environment

The purpose of this test is to verify that the UE properly detects the in sync for the purpose of monitoring downlink CSI-RS based radio link quality of the PCell when DRX is used. This test will partly verify the FR2 PCell CSI-RS In-sync radio link monitoring requirements in clause 8.1.

The test parameters are given in Tables A.7.5.1.8.1-1, A.7.5.1.8.1-2, A.7.5.1.8.1-3 and A.7.5.1.8.1-4 below. There is one cells, cell 1 which is the PCell, in the test. The test consists of five successive time periods, with time duration of T1, T2, T3, T4 and T5 respectively. Figure A.7.5.1.8.1-1 shows the variation of the downlink SNR in the PCell to emulate out-of-sync and in-sync states. Prior to the start of the time duration T1, the UE shall be fully synchronized to cell 1. The UE shall be configured for periodic CSI reporting with a reporting periodicity of [10] ms. In the test, DRX configuration is not enabled. The UE is configured to perform inter-frequency measurements using GP ID #0 (40ms) in test 7.

Table A.7.5.1.8.1-1: Supported test configurations for FR2 PSCell

Configuration	Description
1	TDD duplex mode, 120 kHz SSB SCS, 100MHz bandwidth

Table A.7.5.1.8.1-2: General test parameters for FR2 PCell for CSI-RS in-sync testing in non-DRX mode

Parameter		Unit	Value	
			Test 7	Test 8
Active PCell			Cell 1	Cell 1
RF Channel Number			1	1
Duplex mode	Config 1		TDD	TDD
TDD Configuration	Config 1		[TDDConf.3.1]	[TDDConf.3.1]
CORESET Reference Channel	Config 1		[CR. 3.1 TDD]	[CR. 3.1 TDD]
SSB Configuration	Config 1		TBD (Note: periodicity is 20ms)	TBD (Note: periodicity is 20ms)
SMTc Configuration	Config 1		TDD	TDD
PDSCH/PDCC H subcarrier spacing	Config 1		120 KHz	120 KHz
csi-RS-Index assigned as RLM RS			[0]	[0]
OCNG parameters			TBD	TBD
CP length			Normal	Normal
Correlation Matrix and Antenna Configuration			[2x2 Low]	[2x2 Low]
	DCI format		1-0	1-0
	Number of Control OFDM symbols		2	2

Out of sync transmission parameters	Aggregation level	CC E	8	8
	Ratio of hypothetical PDCCH RE energy to average CSI-RS RE energy	dB	4	4
	Ratio of hypothetical PDCCH DMRS energy to average CSI-RS RE energy	dB	4	4
	DMRS precoder granularity		REG bundle size	REG bundle size
	REG bundle size		6	6
In sync transmission parameters	DCI format		1-0	1-0
	Number of Control OFDM symbols		2	2
	Aggregation level	CC E	4	4
	Ratio of hypothetical PDCCH RE energy to average CSI-RS RE energy	dB	0	0
	Ratio of hypothetical PDCCH DMRS energy to average CSI-RS RE energy	dB	0	0
	DMRS precoder granularity		REG bundle size	REG bundle size
	REG bundle size		6	6
DRX			640	640
Gap pattern ID			[N.A.]	*[gp0]
Layer 3 filtering			<i>Enabled</i>	<i>Enabled</i>
T310 timer		ms	0	0
T311 timer		ms	1000	1000
N310			1	1
N311			1	1
NZP CSI-RS configuration			[ResourceId 1]	[ResourceId 0]
ZP CSI-RS configuration			TBD	TBD
CSI-IM configuration			TBD	TBD
Periodic CSI reporting			PUCCH	PUCCH
CSI reporting periodicity	Config 1	slot	[10]	[10]
T1		s	1	1
T2		s	0.4	0.4
T3		s	[0.6]	[0.6]
D1		s	[0.24]	[0.44]
Note 1: UE-specific PDCCH is not transmitted after T1 starts.				

Table A.7.5.1.8.1-3: Cell specific test parameters for FR2 for CSI-RS in-sync radio link monitoring in non-DRX mode

Parameter		Unit	Test 7			Test 8		
			T1	T2	T3	T1	T2	T3
PDCCH_beta		dB	4			4		
PDCCH_DMRS_beta		dB	4			4		
PBCH_beta		dB	0			0		
PSS_beta		dB						
SSS_beta		dB						
PDSCH_beta		dB						
OCNG_beta		dB						
SNR	Config 1	dB	TBD	TBD	TBD	TBD	TBD	TBD
N_{oc}	Config 1	dBm/15K Hz	[-98]			[-98]		
Propagation condition			[TDL-C 300ns 100Hz]			[TDL-C 300ns 100Hz]		
<p>Note 1: OCNG shall be used such that the resources in Cell 1 are fully allocated and a constant total transmitted power spectral density is achieved for all OFDM symbols.</p> <p>Note 2: The uplink resources for CSI reporting are assigned to the UE prior to the start of time period T1.</p> <p>Note 3: NZP CSI-RS resource set configuration for CSI reporting are assigned to the UE prior to the start of time period T1.</p> <p>Note 4: Measurement gap configuration is assigned to the UE prior to the start of time period T1.</p> <p>Note 5: The timers and layer 3 filtering related parameters are configured prior to the start of time period T1.</p> <p>Note 6: The signal contains PDCCH for UEs other than the device under test as part of OCNG.</p> <p>Note 7: SNR levels correspond to the signal to noise ratio over the SSS REs.</p> <p>Note 8: The SNR in time periods T1, T2 and T3 is denoted as SNR1, SNR2 and SNR3 respectively in figure A.7.5.1.8.1-1.</p> <p>Note 9: The SNR values are specified for testing a UE which supports 2RX on at least one band. For testing of a UE which supports 4RX on all bands, the SNR during T3 is [A.3.6].</p>								

Table A.7.5.1.8.1-3: Measurement gap configuration for FR2 CSI-RS in-sync radio link monitoring in non-DRX mode

Field	Test 8
	Value
gapOffset	[0]
Note 1: RLM RS is partially overlapped with measurement gap	

Table A.7.5.1.8.1-4: NZP-CSI-RS resource configuration for FR2 CSI-RS in-sync radio link monitoring in non-DRX mode

Field	ResourceId 0	ResourceId 1
	Value	Value
frequencyDomainAllocation ^{Note 1}	row1	row2
startingRB	0	0
nrofRBs	Note 2	Note 2
<p>Note 1: TS 38.211 [6] table 7.4.1.5.3-1</p> <p>Note 2: nrofRBs is derived based on the Configuration in Table A.7.5.1.8.1-1</p>		

Table A.7.5.1.8.1-5: DRX-Configuration for FR2 CSI-RS in-sync radio link monitoring in DRX mode.

Field	Test 5	Test 6
	Value	Value
drx-onDurationTimer	[ms6]	[ms6]
drx-InactivityTimer	[ms1]	[ms1]
drx-RetransmissionTimerDL	[sl1]	[sl1]
drx-RetransmissionTimerUL	[sl1]	[sl1]
longDRX-CycleStartOffset	[ms640]	[ms40]
shortDRX	disable	disable

Table A.7.5.1.8.1-6: TimeAlignmentTimer -Configuration for FR2 CSI-RS in-sync radio link monitoring in DRX mode

Field		Test 5	Test 6
		Value	Value
TimeAlignmentTimer		infinity	infinity
periodicityAndOffset in SchedulingRequestResourceConfig	Config 1	[sl5]	[sl5]

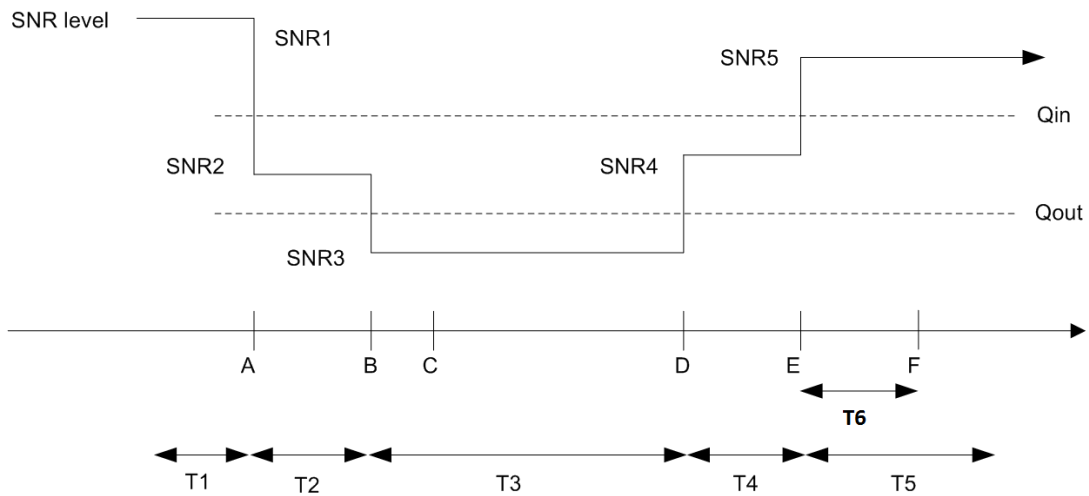

Figure A.7.5.1.8.1-1: SNR variation for CSI-RS in-sync testing

A.7.5.1.8.2 Test Requirements

The UE behaviour in each test during time durations T1, T2, T3, T4 and T5 shall be as follows:

During the period from time point A to time point F (T6 second after the start of time duration T5) the UE shall transmit uplink signal at least in all uplink slots configured for CSI transmission according to the configured periodic CSI reporting on the PCell.

The rate of correct events observed during repeated tests shall be at least 90%.

A.7.5.2 Interruption

A.7.5.2.1 Interruptions during measurements on deactivated NR SCC in FR2

A.7.5.2.1.1 Test Purpose and Environment

The purpose of this test is to verify that the UE missed ACK/NACK rate does not exceed the limits at NR PSCell interruptions during the measurement on the deactivated NR SCC. This test will verify the missed ACK/NACK rate for PCell in standalone NR specified in section 8.2.2.2. Supported test configurations are shown in table A.7.5.2.1.1-1.

The general test parameters and NR cell specific test parameters are given in Table A.7.5.2.1.1-2 and A.7.5.2.1.1-3 below. In the test there are two cells: Cell1 and Cell2. Cell1 is PCell, Cell2 is an NR deactivated SCell. Cell1 shall be configured as PCell and Cell2 shall be configured as SCell.

The test consists of one time period, with duration of T1. Prior to the start of the time duration T1, the UE is connected to Cell1 and Cell2. The point in time at which the RRC message including *measCycleSCell* or *allowInterruptions* for the deactivated NR SCells is received at the UE antenna connector, defines the start of time period T1. During T1, PCell is continuously scheduled in DL.

Table A.7.5.2.1.1-1: Interruptions during measurements on deactivated NR SCC supported test configurations

Config	Description
1	NR 120 kHz SSB SCS, 100MHz bandwidth, TDD – TDD duplex mode
Note:	The UE is only required to be tested in one of the supported test configurations

Table A.7.5.2.1.1-2: General test parameters for interruptions during measurements on deactivated NR SCC in standalone NR

Parameter	Unit	Value	Comment
RF Channel Number		1, 2	Two NR RF channels
Active PCell		Cell1	PCell on NR RF channel number 1.
Configured deactivated SCell		Cell2	Deactivated SCell on NR RF channel number 2.
CP length		Normal	Applicable to Cell1 and Cell 2
DRX		OFF	
Measurement gap pattern Id		OFF	
SCell measurement cycle (<i>measCycleSCell</i>)	ms	640	
T1	s	10	

Table A.7.5.2.1.1-3: NR cell specific test parameters for interruptions during measurements on deactivated NR SCC in standalone NR

Parameter		Unit	Cell1	Cell2
Frequency Range			FR2	
Duplex mode			TDD	
TDD configuration			TDDConf.3.1	
BW _{channel}			100 MHz: N _{RB,c} = 66	
Initial DL BWP Configuration			DLBWP.0.2 ^{Note4}	
Initial UL BWP Configuration			ULBWP.0.2 ^{Note6}	
PDSCH Reference measurement channel			SR.3.1 TDD	
RMSI CORESET parameters			CR.3.1 TDD	
Dedicated CORESET parameters			CCR.3.1 TDD	
OCNG Patterns			OP.1	
SMTTC Configuration			SMTTC.1	
SSB Configuration			SSB.1 FR2	
TCI State			TRS.2.1 TDD	
TRS Configuration			TCI.State.0	
Correlation Matrix and Antenna Configuration			1x2 Low	
EPRE ratio of PSS to SSS		dB	0	0
EPRE ratio of PBCH DMRS to SSS				
EPRE ratio of PBCH to PBCH DMRS				
EPRE ratio of PDCCH DMRS to SSS				
EPRE ratio of PDCCH to PDCCH DMRS				
EPRE ratio of PDSCH DMRS to SSS				
EPRE ratio of PDSCH to PDSCH				
EPRE ratio of OCNG DMRS to SSS(Note 1)				
EPRE ratio of OCNG to OCNG DMRS (Note 1)				
\bar{E}_s/N_{oc}		dB	17	17
Time offset to cell1 ^{Note 2}		μ s	33	33
Time offset to cell2 ^{Note 3}		μ s	-	3
Propagation Condition			AWGN	
<p>Note 1: OCNG shall be used such that both cells are fully allocated and a constant total transmitted power spectral density is achieved for all OFDM symbols.</p> <p>Note 2: Receive time difference of signals received between subframe timing boundary of E-UTRA PCell and slot timing boundary of PSCell at the UE antenna connector including time alignment error between the two cells</p> <p>Note 3: Receive time difference between slot boundaries of signals received from the two cells at the UE antenna connector including time alignment error between the two cells.</p> <p>Note 4: For unpaired spectrum, a DL BWP is linked with an UL BWP. DLBWP.0.2 is linked with ULBWP.0.2 defined in TS 38.213 [3] section 12.</p>				

Table A.7.5.2.1.1-4: OTA related test parameters for interruptions during measurements on deactivated NR SCC in standalone NR

Parameter		Unit	Cell 1	Cell 2
Angle of arrival configuration			According to table A.3.15	According to table A.3.15
	NR_TDD_FR2_A	dBm/15kHz	TBD	TBD
	NR_TDD_FR2_B			

N_{oc} ^{Note1}	NR_TDD_FR2_F			
	NR_TDD_FR2_G			
	NR_TDD_FR2_T			
	NR_TDD_FR2_Y			
N_{oc} ^{Note1}	NR_TDD_FR2_A	dBm/SCS	TBD	TBD
	NR_TDD_FR2_B			
	NR_TDD_FR2_F			
	NR_TDD_FR2_G			
	NR_TDD_FR2_T			
SS-RSRP ^{Note2}	NR_TDD_FR2_A	dBm/120KH z ^{Note3}	TBD	TBD
	NR_TDD_FR2_B			
	NR_TDD_FR2_F			
	NR_TDD_FR2_G			
	NR_TDD_FR2_T			
\hat{E}_s/I_{ot}	NR_TDD_FR2_A	dB	TBD	TBD
	NR_TDD_FR2_B			
	NR_TDD_FR2_F			
	NR_TDD_FR2_G			
	NR_TDD_FR2_T			
I_o ^{Note2}	NR_TDD_FR2_A	dBm/95.04 MHz ^{Note4}	TBD	TBD
	NR_TDD_FR2_B			
	NR_TDD_FR2_F			
	NR_TDD_FR2_G			
	NR_TDD_FR2_T			
NR_TDD_FR2_Y				
<p>Note 1: Interference from other cells and noise sources not specified in the test is assumed to be constant over subcarriers and time and shall be modelled as AWGN of appropriate power for N_{oc} to be fulfilled.</p> <p>Note 2: SS-RSRP and I_o levels have been derived from other parameters for information purposes. They are not settable parameters themselves.</p> <p>Note 3: SS-RSRP minimum requirements are specified assuming independent interference and noise at each receiver antenna port.</p> <p>Note 4: Equivalent power received by an antenna with 0dBi gain at the centre of the quiet zone</p> <p>Note 5: As observed with 0dBi gain antenna at the centre of the quiet zone</p>				

A.7.5.2.1.2 Test Requirements

The UE shall be continuously scheduled on PCell during the entire length of T1. During the time duration T1 the UE shall transmit at least 99.5% of ACK/NACK on PCell. The UE is only allowed to cause interruptions immediately before and immediately after an SMTC. Each interruption on PCell shall not exceed the value defined in Table A.7.5.2.1.2-1 if the PCell is not in the same band as the deactivated SCell or Table A.7.5.2.1.2-2 if the PCell is in the same band as the deactivated SCell.

Table A.7.5.2.1.2-1: Interruption duration if the PCell is not in the same band as the deactivated SCell

μ	NR Slot length (ms)	Interruption length
3	0.125	4

Table A.7.5.2.1.2-2: Interruption duration if the PCell is in the same band as the deactivated SCell

μ	NR Slot length (ms)	Interruption length
3	0.125	4 + SMTC duration

The rate of correct events observed during repeated tests shall be at least 90%.

A.7.5.3 SCell Activation and Deactivation Delay

A.7.5.3.1 SCell Activation and deactivation for SCell in FR2 intra-band in non-DRX

A.7.5.3.1.1 Test Purpose and Environment

The purpose of this test case is the same as for the test defined in section A.6.5.3.1.1 except the PCell and SCell are in FR2 intra-band.

The supported test configurations are shown in table A.7.5.3.1.1-1 below. The general test parameters are the same as defined in Table A.6.5.3.1.1-2 except those described in Tables A.7.5.3.1.1-2, and cell specific test parameters are described in Tables A.7.5.3.1.1-3. OTA related test parameters are shown in table A.7.5.3.1.1-4 below.

Table A.7.5.3.1.1-1: Supported test configurations for FR2 SCell activation case

Configuration	Description
1	NR 120 kHz SSB SCS, 100MHz bandwidth, TDD duplex mode
Note: The UE is only required to pass in one of the supported test configurations	

Table A.7.5.3.1.1-2: General test parameters for FR2 SCell activation case

Parameter	Unit	Value	Comment
RF Channel Number		1	One NR radio channel is used for this test, cell 1 and cell2 use the same RF channel.

Table A.7.5.3.1.1-3: Cell specific test parameters for FR2 SCell activation case

Parameter ^{Note 5}	Unit	T1		T2		T3	
		Cell 1	Cell 2	Cell 1	Cell 2	Cell 1	Cell 2
SSB ARFCN		freq2		freq2		freq2	
Duplex mode		TDD		TDD		TDD	
TDD configuration		TDDConf.3.1		TDDConf.3.1		TDDConf.3.1	
Downlink initial BWP Configuration		DLBWP.0.1		DLBWP.0.1		DLBWP.0.1	
Downlink dedicated BWP Configuration		DLBWP.1.1		DLBWP.1.1		DLBWP.1.1	
Uplink initial BWP configuration		ULBWP.0.1		ULBWP.0.1		ULBWP.0.1	
Uplink dedicated BWP configuration		ULBWP.1.1		ULBWP.1.1		ULBWP.1.1	
TRS configuration		TRS.2.1 TDD		TRS.2.1 TDD		TRS.2.1 TDD	
TCI state		TCI.State.0		TCI.State.0		TCI.State.0	
BW _{channel}	MHz	100: N _{RB,c} = 66		100: N _{RB,c} = 66		100: N _{RB,c} = 66	
PDSCH Reference measurement channel		SR.3.1 TDD	-	SR.3.1 TDD	-	SR.3.1 TDD	-
RMSI CORESET Parameters		CR.3.1 TDD	-	CR.3.1 TDD	-	CR.3.1 TDD	-
Dedicated CORESET Parameters		CCR.3. 1 TDD	-	CCR.3. 1 TDD	-	CCR.3. 1 TDD	-
OCNG Patterns		OP.1					
SSB Configuration		SSB.1 FR2					
SMTC Configuration		SMTC.1 FR2					
EPRE ratio of PSS to SSS	dB	0					
EPRE ratio of PBCH_DMRS to SSS							
EPRE ratio of PBCH to PBCH_DMRS							
EPRE ratio of PDCCH_DMRS to SSS							
EPRE ratio of PDCCH to PDCCH_DMRS							
EPRE ratio of PDSCH_DMRS to SSS							
EPRE ratio of PDSCH to PDSCH_DMRS							
EPRE ratio of OCNG DMRS to SSS ^{Note 1}							
EPRE ratio of OCNG to OCNG DMRS ^{Note 1}							
\hat{E}_s/N_{oc}	dB	TBD	TBD	TBD	TBD	TBD	TBD
Propagation conditions		AWGN					
<p>Note 1: OCNG shall be used such that both cells are fully allocated and a constant total transmitted power spectral density is achieved for all OFDM symbols.</p> <p>Note 2: Interference from other cells and noise sources not specified in the test is assumed to be constant over subcarriers and time and shall be modelled as AWGN of appropriate power for N_{oc} to be fulfilled.</p> <p>Note 3: SS-RSRP and I_o levels have been derived from other parameters for information purposes. They are not settable parameters themselves.</p> <p>Note 4: SS-RSRP minimum requirements are specified assuming independent interference and noise at each receiver antenna port.</p> <p>Note 5: All parameters apply for configuration 1 and 2</p>							

Table A.7.5.3.1.1-4: OTA related test parameters for FR2 SCell activation case

Parameter	Unit	T1		T2		T3	
		Cell 1	Cell 2	Cell 1	Cell 2	Cell 1	Cell 2
Angle of arrival configuration		According to table A.X.X		According to table A.X.X		According to table A.X.X	
N_{oc} ^{Note1}	NR_TDD_FR2_A	dBm/15kHz	TBD	TBD	TBD	TBD	TBD
	NR_TDD_FR2_B						
	NR_TDD_FR2_F						
	NR_TDD_FR2_G						
	NR_TDD_FR2_T						

SS-RSRP ^{Note2}	NR_TDD_FR2_Y	dBm/SCS ^{Note3}	TBD	TBD	TBD	TBD	TBD	TBD
	NR_TDD_FR2_A							
	NR_TDD_FR2_B							
	NR_TDD_FR2_F							
	NR_TDD_FR2_G							
	NR_TDD_FR2_T							
\hat{E}_s/I_{ot}	dB	TBD	TBD	TBD	TBD	TBD	TBD	
I _o ^{Note2}	NR_TDD_FR2_A	dBm/95.04 MHz ^{Note4}	TBD	TBD	TBD	TBD	TBD	
	NR_TDD_FR2_B							
	NR_TDD_FR2_F							
	NR_TDD_FR2_G							
	NR_TDD_FR2_T							
	NR_TDD_FR2_Y							
<p>Note 1: Interference from other cells and noise sources not specified in the test is assumed to be constant over subcarriers and time and shall be modelled as AWGN of appropriate power for N_{oc} to be fulfilled.</p> <p>Note 2: SS-RSRP and I_o levels have been derived from other parameters for information purposes. They are not settable parameters themselves.</p> <p>Note 3: SS-RSRP minimum requirements are specified assuming independent interference and noise at each receiver antenna port.</p> <p>Note 4: Equivalent power received by an antenna with 0dBi gain at the centre of the quiet zone</p> <p>Note 5: As observed with 0dBi gain antenna at the centre of the quiet zone</p>								

A.7.5.3.1.2 Test Requirements

The test requirements defined in section A.6.5.3.1.2 shall apply to this test case, except T_{activation_time} will be replaced with the value [T_{SMTc_SCell} + 5ms] as defined in section 8.3.

A.7.5.3.2 SCell Activation and deactivation for FR1+FR2 inter-band with target SCell in FR2 in non-DRX

A.7.5.3.2.1 Test Purpose and Environment

The purpose of this test case is the same as for the test defined in section A.7.5.3.1.1 except the PCell is in FR1 and SCell is in FR2.

The supported test configurations are the same as defined in Table A.7.5.3.2.1-1. The general test parameters are the same as defined in Table A.6.5.3.1.1-2. And cell specific test parameters are described in Tables A.7.5.3.2.1-2. OTA related test parameters are the same as defined in Table A.7.5.3.1.1-4.

Table A.7.5.3.2.1-1: Supported test configurations for FR2 SCell activation case

Configuration	Description
1	PCell: 15 kHz SSB SCS, 10MHz bandwidth, FDD duplex mode Target SCell: 120 kHz SSB SCS, 100MHz bandwidth, TDD duplex mode
2	PCell: 15 kHz SSB SCS, 10MHz bandwidth, TDD duplex mode Target SCell: 120 kHz SSB SCS, 100MHz bandwidth, TDD duplex mode
3	PCell: 30kHz SSB SCS, 40MHz bandwidth, TDD duplex mode Target SCell: 120 kHz SSB SCS, 100MHz bandwidth, TDD duplex mode
Note: The UE is only required to pass in one of the supported test configurations	

Table A.7.5.3.2.1-2: Cell specific test parameters for FR2 SCell activation case

Parameter ^{Note 5}	Unit	T1		T2		T3	
		Cell 1	Cell 2	Cell 1	Cell 2	Cell 1	Cell 2
SSB ARFCN		Freq1	Freq2	Freq1	Freq2	Freq1	Freq2

Duplex mode	Config 1		FDD	TDD	FDD	TDD	FDD	TDD
	Config 2,3		TDD					
TDD configuration	Config 1		Not Applicable	TDDConf.3.1	Not Applicable	TDDConf.3.1	Not Applicable	TDDConf.3.1
	Config 2,3		TDDConf.1.1		TDDConf.1.1		TDDConf.1.1	
Downlink initial BWP Configuration	Config 1,2,3		DLBWP.0.1					
Downlink dedicated BWP Configuration	Config 1,2,3		DLBWP.1.1	DLBWP.1.1	DLBWP.1.1	DLBWP.1.1	DLBWP.1.1	DLBWP.1.1
Uplink initial BWP configuration	Config 1,2,3		ULBWP.0.1	ULBWP.0.1	ULBWP.0.1	ULBWP.0.1	ULBWP.0.1	ULBWP.0.1
Uplink dedicated BWP configuration	Config 1,2,3		ULBWP.1.1	ULBWP.1.1	ULBWP.1.1	ULBWP.1.1	ULBWP.1.1	ULBWP.1.1
TRS configuration	Config 1,2,3		N/A	TRS.2.1 TDD	N/A	TRS.2.1 TDD	N/A	TRS.2.1 TDD
TCI state	Config 1,2,3		TCI.State.0	TCI.State.0	TCI.State.0	TCI.State.0	TCI.State.0	TCI.State.0
BW _{channel}	Config 1,2	MHz	10: N _{RB,c} = 52	100: N _{RB,c} = 66	10: N _{RB,c} = 52	100: N _{RB,c} = 66	10: N _{RB,c} = 52	100: N _{RB,c} = 66
	Config 3		40: N _{RB,c} = 106		40: N _{RB,c} = 106		40: N _{RB,c} = 106	
PDSCH Reference measurement channel	Config 1		SR.1.1 FDD	-	SR.1.1 FDD	-	SR.1.1 FDD	-
	Config 2		SR.1.1 TDD		SR.1.1 TDD		SR.1.1 TDD	
	Config 3		SR.2.1 TDD		SR.2.1 TDD		SR.2.1 TDD	
RMSI CORESET Parameters	Config 1		CR.1.1 FDD	-	CR.1.1 FDD	-	CR.1.1 FDD	-
	Config 2		CR.1.1 TDD		CR.1.1 TDD		CR.1.1 TDD	
	Config 3		CR.2.1 TDD		CR.2.1 TDD		CR.2.1 TDD	
Dedicated CORESET Parameters	Config 1		CCR.1.1 FDD	-	CCR.1.1 FDD	-	CCR.1.1 FDD	-
	Config 2		CCR.1.1 TDD		CCR.1.1 TDD		CCR.1.1 TDD	
	Config 3		CCR.2.1 TDD		CCR.2.1 TDD		CCR.2.1 TDD	
OCNG Patterns			OP.1					
SSB configuration	Config 1,2		SSB.1 FR1	SSB.3 FR2	SSB.1 FR1	SSB.3 FR2	SSB.1 FR1	SSB.3 FR2
	Config 3		SSB.2 FR1		SSB.2 FR1		SSB.2 FR1	
SMTC configuration			SMTC.1					
EPRE ratio of PSS to SSS		dB	0					
EPRE ratio of PBCH_DMRS to SSS								
EPRE ratio of PBCH to PBCH_DMRS								
EPRE ratio of PDCCH_DMRS to SSS								
EPRE ratio of PDCCH to PDCCH_DMRS								
EPRE ratio of PDSCH_DMRS to SSS								
EPRE ratio of PDSCH to PDSCH_DMRS								
EPRE ratio of OCNG DMRS to SSS ^{Note 1}								
EPRE ratio of OCNG to OCNG DMRS ^{Note 1}								

\hat{E}_s/N_{oc}	dB	TBD	TBD	TBD	TBD	TBD	TBD
Propagation conditions		AWGN					
Note 1:	OCNG shall be used such that both cells are fully allocated and a constant total transmitted power spectral density is achieved for all OFDM symbols.						
Note 2:	Interference from other cells and noise sources not specified in the test is assumed to be constant over subcarriers and time and shall be modelled as AWGN of appropriate power for N_{oc} to be fulfilled.						
Note 3:	SS-RSRP and I_o levels have been derived from other parameters for information purposes. They are not settable parameters themselves.						
Note 4:	SS-RSRP minimum requirements are specified assuming independent interference and noise at each receiver antenna port.						
Note 5:	All parameters apply for configuration 1 and 2						

A.7.5.3.2.2 Test Requirements

The test requirements defined in section A.7.5.3.1.2 shall apply to this test case, except $T_{\text{activation_time}}$ will be replaced with the value $[25 * T_{\text{SMTC_SCell}} + 5\text{ms}]$ as defined in section 8.3.

A.7.5.4 UE UL carrier RRC reconfiguration Delay

A.7.5.5 Beam Failure Detection and Link recovery procedures

A.7.5.5.1 Beam Failure Detection and Link Recovery Test for FR2 PCell configured with SSB-based BFD and LR in non-DRX mode

Editor's note: It is open whether BFD can be based on SSB. This test case will be updated accordingly.

A.7.5.5.1.1 Test Purpose and Environment

The purpose of this test is to verify that the UE properly detects SSB-based beam failure in the set q_0 configured for a serving cell and that the UE performs correct SSB-based link recovery based on beam candidate set q_1 . The purpose is to test the downlink monitoring for beam failure detection within the UEs active DL BWP, during the evaluation period, and link recovery, when no DRX is used. This test will partly verify the SSB based beam failure detection and link recovery for an FR2 serving cell requirements in clause 8.5.

The test parameters are given in Tables A.7.5.5.1.1-1, A.7.5.5.1.1-2, A.7.5.5.1.1-3 and A.7.5.5.1.1-4 below. There is one cell, cell 1 which is the active cell, in the test. The test consists of five successive time periods, with time duration of T1, T2, T3, T4 and T5 respectively. Figure A.7.5.5.1.1-1 shows the variation of the downlink SNR of the SSB in set q_0 in the active cell to emulate SSB based beam failure. Figure A.7.5.5.1.1-1 additionally shows the variation of the downlink SNR of the SSB in set q_1 of the candidate beam used for link recovery. Prior to the start of the time duration T1, the UE shall be fully synchronized to cell 1. The UE shall be configured for periodic CSI reporting with a reporting periodicity of [2] ms. In the test, DRX configuration is not enabled. The UE is configured to perform inter-frequency measurements using GP ID #0 (40ms) in test 2.

Table A.7.5.5.1.1-1: Supported test configurations for FR2 PCell

Configuration	Description
1	TDD duplex mode, 120 kHz SSB SCS, 100MHz bandwidth
2	TDD duplex mode, 240 kHz SSB SCS, 100MHz bandwidth
Note:	The UE is only required to pass in one of the supported test configurations in FR2

Table A.7.5.5.1.1-2: General test parameters for FR2 PCell for SSB-based beam failure detection and link recovery testing in non-DRX mode

Parameter	Unit	Value		Comment	
		Test 1	Test 2		
Active PCell		Cell 1	Cell 1		
RF Channel Number		1	1		
Duplex mode	Config 1	TDD	TDD		
	Config 2	TDD	TDD		
TDD Configuration	Config 1	[TDDConf.3.1]	[TDDConf.3.1]		
	Config 2	[TDDConf.3.1]	[TDDConf.3.1]		
CORESET Reference Channel	Config 1	[CR. 3.1 TDD]	[CR. 3.1 TDD]		
	Config 2	[CR. 3.1 TDD]	[CR. 3.1 TDD]		
SSB Configuration	Config 1	TBD (Note: periodicity is 20ms)	TBD (Note: periodicity is 20ms)		
	Config 2	TBD (Note: periodicity is 20ms)	TBD (Note: periodicity is 20ms)		
SMTC Configuration	Config 1	TDD	TDD		
	Config 2	TDD	TDD		
PDSCH/PDCCH subcarrier spacing	Config 1	120 KHz	120 KHz		
	Config 2	120 KHz	120 KHz		
csi-RS-Index assigned as RLM RS		[0]	[0]		
OCNG parameters		TBD	TBD		
CP length		Normal	Normal		
Correlation Matrix and Antenna Configuration		[2x2 Low]	[2x2 Low]		
Beam failure detection transmission parameters	DCI format		1-0		
	Number of Control OFDM symbols		2		
	Aggregation level	CC E	8	8	
	Ratio of hypothetical PDCCH RE energy to average CSI-RS RE energy	dB	0	0	
	Ratio of hypothetical PDCCH DMRS energy to average CSI-RS RE energy	dB	0	0	

	DMRS precoder granularity		REG bundle size	REG bundle size	
	REG bundle size		6	6	
DRX			OFF	OFF	
Gap pattern ID			[N.A.]	*[gp0]	
ssb-Index			2	2	Number of SSB indexes used for beam failure detection
rlmInSyncOutOfSync Threshold			absent	absent	When the field is absent, the UE applies the value 0. (Table 8.1.1-1).
rsrp-ThresholdSSB			TBD	TBD	Threshold used for $Q_{out_LR_SSB}$
powerControlOffsetSS			NA	NA	Used for deriving rsrp-ThresholdCSI-RS
beamFailureInstanceMaxCount			[n2]	[n2]	see TS 38.321 [7], section 5.17
beamFailureDetectionTimer			[pbf4]	[pbf4]	see TS 38.321 [7], section 5.17
ZP CSI-RS configuration			TBD	TBD	
CSI-IM configuration			TBD	TBD	
Periodic CSI reporting			PUCCH	PUCCH	
CSI reporting periodicity	Config 1, 2	slot	[5]	[5]	
	Config 3		[10]	[10]	
T1		s	1	1	During this time the the UE shall be fully synchronized to cell 1
T2		s	0.4	0.4	
T3		s	[0.6]	[0.6]	
D1		s	[0.24]	[0.44]	
Note 1: UE-specific PDCCH is not transmitted after T1 starts.					

Table A.7.5.5.1.1-3: Cell specific test parameters for FR2 PCell for SSB-based beam failure detection and link recovery testing in non-DRX mode

Parameter	Unit	Test 1 and Test 2					Test 1 and Test 2					
		SSB of set q_0					SSB of set q_1					
		T1	T2	T3	T4	T5	T1	T2	T3	T4	T5	
PDCCH_beta	dB	4					4					
PDCCH_DMRS_beta	dB	4					4					
PBCH_beta	dB	0					0					
PSS_beta	dB											
SSS_beta	dB											
PDSCH_beta	dB											
OCNG_beta	dB											
SNR	Config 1	dB	TBD	TBD	TBD	TBD	TBD	TBD	TBD	TBD	TBD	
	Config 2		TBD	TBD	TBD	TBD	TBD	TBD	TBD	TBD	TBD	
	Config 3		TBD	TBD	TBD	TBD	TBD	TBD	TBD	TBD	TBD	
N_{oc}	Config 1	dBm/	[-98]					[-98]				
	Config 2	15K	[-98]					[-98]				
	Config 3	Hz	[-98]					[-98]				
Propagation condition		[TDL-C 300ns 100Hz]					[TDL-C 300ns 100Hz]					
Note 1:	OCNG shall be used such that the resources in Cell 1 are fully allocated and a constant total transmitted power spectral density is achieved for all OFDM symbols.											
Note 2:	The uplink resources for CSI reporting are assigned to the UE prior to the start of time period T1.											
Note 3:	NZP CSI-RS resource set configuration for CSI reporting are assigned to the UE prior to the start of time period T1.											
Note 4:	Measurement gap configuration is assigned to the UE prior to the start of time period T1.											
Note 5:	The timers and layer 3 filtering related parameters are configured prior to the start of time period T1.											
Note 6:	The signal contains PDCCH for UEs other than the device under test as part of OCNG.											
Note 7:	SNR levels correspond to the signal to noise ratio over the SSS REs.											
Note 8:	The SNR in time periods T1, T2, T3, T4 and T5 is denoted as SNR1, SNR2 and SNR3 respectively in figure A.7.5.5.1.1-1.											
Note 9:	The SNR values are specified for testing a UE which supports 2RX on at least one band. For testing of a UE which supports 4RX on all bands, the SNR during T3 is [A.3.6].											

Table A.7.5.5.1.1-4: Measurement gap configuration for FR2 PCell for SSB-based beam failure detection and link recovery testing in non-DRX mode

Field	Test 2
	Value
gapOffset	[0]

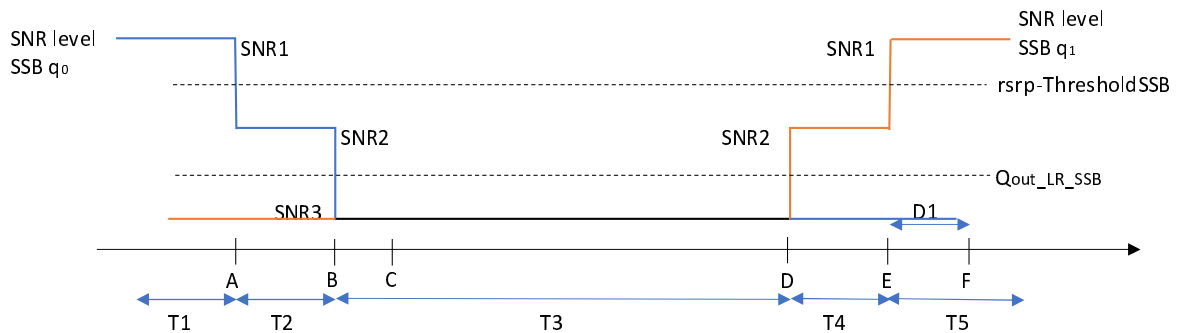

Figure A.7.5.5.1.1-1: SNR variation SSB for SSB-based beam failure detection and link recovery testing in non-DRX mode

A.7.5.5.1.2 Test Requirements

The UE behaviour during time durations T1, T2, T3, T4 and T5 shall be as follows:

During the time duration T1 and T2, the UE shall transmit uplink signal at least in all subframes configured for CSI transmission on Cell 1.

During the period from time point A to time point B the UE shall transmit uplink signal in Cell 1 in all uplink slots configured for CSI transmission according to the configured periodic CSI reporting for Cell 1.

During T3 the UE shall detect beam failure and initiate link recovery. During T4 and T5 the UE measures and evaluates beam candidate from beam candidate set q_1 .

No later than time point F occurring no later than $D1 = [\text{TBD}]$ ms after the start of T5, the UE shall transmit preamble on a beam associated with the candidate beam set q_1 .

Test is concluded once the test equipment has received the initial preamble transmission from the UE. The rate of correct events observed during repeated tests shall be at least 90%.

A.7.5.5.2 Beam Failure Detection and Link Recovery Test for FR2 PCell configured with SSB-based BFD and LR in DRX mode

Editor's note: It is open whether BFD can be based on SSB. This test case will be updated accordingly.

A.7.5.5.2.1 Test Purpose and Environment

The purpose of this test is to verify that the UE properly detects SSB-based beam failure in the set q_0 configured for a serving cell and that the UE performs correct SSB-based link recovery based on beam candidate set q_1 . The purpose is to test the downlink monitoring for beam failure detection within the UE's active DL BWP, during the evaluation period, and link recovery, when DRX is used. This test will partly verify the SSB based beam failure detection and link recovery for an FR2 serving cell requirements in clause 8.5.

The test parameters are given in Tables A.7.5.5.2.1-1, A.7.5.5.2.1-2, A.7.5.5.2.1-3, A.7.5.5.2.1-4 and A.7.5.5.2.1-5 below. There is one cell, cell 1 which is the active cell, in the test. The test consists of five successive time periods, with time duration of T1, T2, T3, T4 and T5 respectively. Figure A.7.5.5.2.1-1 shows the variation of the downlink SNR of the SSB in set q_0 in the active cell to emulate SSB based beam failure. Figure A.7.5.5.2.1-1 additionally shows the variation of the downlink SNR of the SSB in set q_1 of the candidate beam used for link recovery. Prior to the start of the time duration T1, the UE shall be fully synchronized to cell 1. The UE shall be configured for periodic CSI reporting with a reporting periodicity of [2] ms. In the test, DRX configuration is enabled in PCell and DRX inactivity timer has already been expired, i.e. UE tries to decode PDCCH and to send periodic CQI during the period when On-duration timer is running. Time alignment timers shall be set to "infinity" so that UL timing

alignment is maintained during the test. The UE is configured to perform inter-frequency measurements using GP ID #0 (40ms) in test 2.

Table A.7.5.5.2.1-1: Supported test configurations for FR2 PCell

Configuration	Description
1	TDD duplex mode, 120 kHz SSB SCS, 100MHz bandwidth
2	TDD duplex mode, 240 kHz SSB SCS, 100MHz bandwidth
Note: The UE is only required to pass in one of the supported test configurations in FR2	

Table A.7.5.5.2.1-2: General test parameters for FR2 PCell for SSB-based beam failure detection and link recovery testing in DRX mode

Parameter	Unit	Value		Comment
		Test 1	Test 2	
Active PCell		Cell 1	Cell 1	
RF Channel Number		1	1	
Duplex mode	Config 1	TDD	TDD	
	Config 2	TDD	TDD	
TDD Configuration	Config 1	[TDDConf.3.1]	[TDDConf.3.1]	
	Config 2	[TDDConf.3.1]	[TDDConf.3.1]	
CORESET Reference Channel	Config 1	[CR. 3.1 TDD]	[CR. 3.1 TDD]	
	Config 2	[CR. 3.1 TDD]	[CR. 3.1 TDD]	
SSB Configuration	Config 1	TBD (Note: periodicity is 20ms)	TBD (Note: periodicity is 20ms)	
	Config 2	TBD (Note: periodicity is 20ms)	TBD (Note: periodicity is 20ms)	
SMTC Configuration	Config 1	TDD	TDD	
	Config 2	TDD	TDD	
PDSCH/PDCCH subcarrier spacing	Config 1	120 KHz	120 KHz	
	Config 2	120 KHz	120 KHz	
csi-RS-Index assigned as RLM RS		[0]	[0]	
OCNG parameters		TBD	TBD	
CP length		Normal	Normal	
Correlation Matrix and Antenna Configuration		[2x2 Low]	[2x2 Low]	
	DCI format		1-0	
	Number of Control OFDM symbols		2	
	Aggregation level	CC E	8	8

Beam failure detection transmission parameters	Ratio of hypothetical PDCCH RE energy to average CSI-RS RE energy	dB	0	0	
	Ratio of hypothetical PDCCH DMRS energy to average CSI-RS RE energy	dB	0	0	
	DMRS precoder granularity		REG bundle size	REG bundle size	
	REG bundle size		6	6	
DRX			640	640	
Gap pattern ID			[N.A.]	*[gp0]	
ssb-Index			2	2	Number of SSB indexes used for beam failure detection
rlmInSyncOutOfSync Threshold			absent	absent	When the field is absent, the UE applies the value 0. (Table 8.1.1-1).
rsrp-ThresholdSSB			TBD	TBD	Threshold used for $Q_{out_LR_SSB}$
powerControlOffsetSS			NA	NA	Used for deriving $rsrp_ThresholdCSI-RS$
beamFailureInstanceMaxCount			[n2]	[n2]	see TS 38.321 [7], section 5.17
beamFailureDetectionTimer			[pbfd4]	[pbfd4]	see TS 38.321 [7], section 5.17
ZP CSI-RS configuration			TBD	TBD	
CSI-IM configuration			TBD	TBD	
Periodic CSI reporting			PUCCH	PUCCH	
CSI reporting periodicity	Config 1, 2	slot	[5]	[5]	
	Config 3		[10]	[10]	
T1		s	1	1	During this time the the UE shall be fully synchronized to cell 1
T2		s	0.4	0.4	
T3		s	[0.6]	[0.6]	
D1		s	[0.24]	[0.44]	
Note 1: UE-specific PDCCH is not transmitted after T1 starts.					

Table A.7.5.5.2.1-3: Cell specific test parameters for FR2 PCell for SSB-based beam failure detection and link recovery testing in DRX mode

Parameter	Unit	Test 1 and Test 2					Test 1 and Test 2					
		SSB of set q_0					SSB of set q_1					
		T1	T2	T3	T4	T5	T1	T2	T3	T4	T5	
PDCCH_beta	dB	4					4					
PDCCH_DMRS_beta	dB	4					4					
PBCH_beta	dB	0					0					
PSS_beta	dB											
SSS_beta	dB											
PDSCH_beta	dB											
OCNG_beta	dB											
SNR	Config 1	dB	TBD	TBD	TBD	TBD	TBD	TBD	TBD	TBD	TBD	
	Config 2		TBD	TBD	TBD	TBD	TBD	TBD	TBD	TBD	TBD	
	Config 3		TBD	TBD	TBD	TBD	TBD	TBD	TBD	TBD	TBD	
N_{oc}	Config 1	dBm/	[-98]					[-98]				
	Config 2	15K	[-98]					[-98]				
	Config 3	Hz	[-98]					[-98]				
Propagation condition		[TDL-C 300ns 100Hz]					[TDL-C 300ns 100Hz]					
Note 1:	OCNG shall be used such that the resources in Cell 1 are fully allocated and a constant total transmitted power spectral density is achieved for all OFDM symbols.											
Note 2:	The uplink resources for CSI reporting are assigned to the UE prior to the start of time period T1.											
Note 3:	NZP CSI-RS resource set configuration for CSI reporting are assigned to the UE prior to the start of time period T1.											
Note 4:	Measurement gap configuration is assigned to the UE prior to the start of time period T1.											
Note 5:	The timers and layer 3 filtering related parameters are configured prior to the start of time period T1.											
Note 6:	The signal contains PDCCH for UEs other than the device under test as part of OCNG.											
Note 7:	SNR levels correspond to the signal to noise ratio over the SSS REs.											
Note 8:	The SNR in time periods T1, T2, T3, T4 and T5 is denoted as SNR1, SNR2 and SNR3 respectively in figure A.7.5.5.2.1-1.											
Note 9:	The SNR values are specified for testing a UE which supports 2RX on at least one band. For testing of a UE which supports 4RX on all bands, the SNR during T3 is [A.3.6].											

Table A.7.5.5.2.1-4: Measurement gap configuration for FR2 PCell for SSB-based beam failure detection and link recovery testing in DRX mode

Field	Test 2
	Value
gapOffset	[0]

Table A.7.5.5.2.1-5: DRX-Configuration for FR2 PCell for SSB-based beam failure detection and link recovery testing in DRX mode.

Field	Test 5	Test 6
	Value	Value
drx-onDurationTimer	[ms6]	[ms6]
drx-InactivityTimer	[ms1]	[ms1]
drx-RetransmissionTimerDL	[sl1]	[sl1]
drx-RetransmissionTimerUL	[sl1]	[sl1]
longDRX-CycleStartOffset	[ms640]	[ms40]
shortDRX	disable	disable

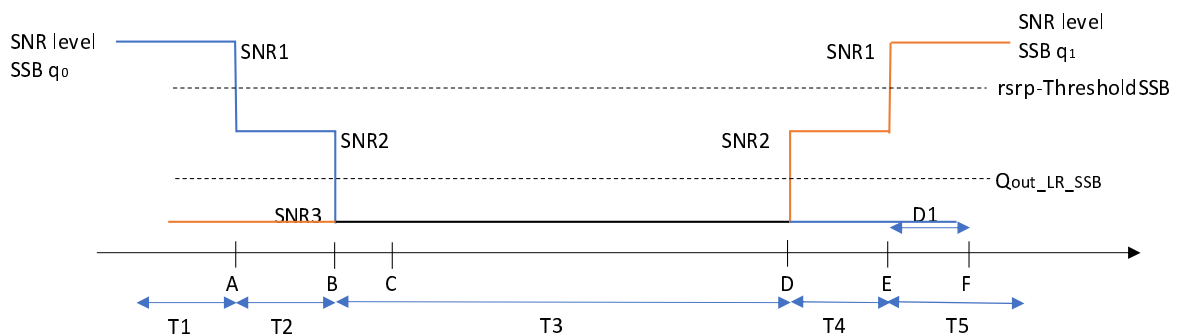

Figure A.7.5.5.2.1-1: SNR variation for SSB-based beam failure detection and link recovery testing in non-DRX mode

A.7.5.5.2.2 Test Requirements

The UE behaviour during time durations T1, T2, T3, T4 and T5 shall be as follows:

During the time duration T1 and T2, the UE shall transmit uplink signal at least in all subframes configured for CSI transmission on Cell 1.

During the period from time point A to time point B the UE shall transmit uplink signal in Cell 1 in all uplink slots configured for CSI transmission according to the configured periodic CSI reporting for Cell 1.

During T3 the shall detect beam failure and initiate link recovery. During T4 and T5 the UE measures and evaluate beam candidate from beam candidate set q_1 .

No later than time point F occurring no later than $D1 = [TBD]$ ms after the start of T5, the UE shall transmit preamble on a beam associated with the candidate beam set q_1 .

Test is concluded once the test equipment has received the initial preamble transmission from the UE. The rate of correct events observed during repeated tests shall be at least 90%.

A.7.5.5.3 Beam Failure Detection and Link Recovery Test for FR2 PCell configured with CSI-RS-based BFD and LR in non-DRX mode

A.7.5.5.3.1 Test Purpose and Environment

The purpose of this test is to verify that the UE properly detects CSI-RS-based beam failure in the set q_0 configured for a serving cell and that the UE performs correct CSI-RS-based link recovery based on beam candidate set q_1 . The purpose is to test the downlink monitoring for beam failure detection within the UEs active DL BWP, during the evaluation period, and link recovery, when no DRX is used. This test will partly verify the CSI-RS based beam failure detection and link recovery for an FR2 serving cell requirements in clause 8.5.

The test parameters are given in Tables A.7.5.5.3.1-1, A.7.5.5.3.1-2, A.7.5.5.3.1-3, A.7.5.5.3.1-4 and A.7.5.5.3.1-5 below. There is one cell, cell 1 which is the active cell, in the test. The test consists of five successive time periods, with time duration of T1, T2, T3, T4 and T5 respectively. Figure A.7.5.5.3.1-1 shows the variation of the downlink SNR of the CSI-RS in set q_0 in the active cell to emulate CSI-RS based beam failure. Figure A.7.5.5.3.1-1 additionally shows the variation of the downlink SNR of the CSI-RS in set q_1 of the candidate beam used for link recovery. Prior to the start of the time duration T1, the UE shall be fully synchronized to cell 1. The UE shall be configured for periodic CSI reporting with a reporting periodicity of [2] ms. In the test, DRX configuration is not enabled. The UE is configured to perform inter-frequency measurements using GP ID #0 (40ms) in test 2.

Table A.7.5.5.3.1-1: Supported test configurations for FR2 PCell

Configuration	Description
1	TDD duplex mode, 120 kHz SSB SCS, 100MHz bandwidth

Table A.7.5.5.3.1-2: General test parameters for FR2 PCell for CSI-RS-based beam failure detection and link recovery testing in non-DRX mode

Parameter		Unit	Value		Comment
			Test 1	Test 2	
Active PCell			Cell 1	Cell 1	
RF Channel Number			1	1	
Duplex mode	Config 1		TDD	TDD	
TDD Configuration	Config 1		[TDDConf.3.1]	[TDDConf.3.1]	
CORESET Reference Channel	Config 1		[CR. 3.1 TDD]	[CR. 3.1 TDD]	A.3.1.2
SSB Configuration	Config 1		SSB.1 FR2	SSB.1 FR2	A.3.10
SMTTC Configuration	Config 1		SMTTC.1	SMTTC.1	A.3.11
PDSCH /PDCC H subcarrier spacing	Config 1		120KHz	120KHz	

csi-RS-Index assigned as beam failure RS			[0]	[0]	
OCNG parameters			TBD	TBD	A.3.2.1
CP length			Normal	Normal	
Correlation Matrix and Antenna Configuration			[2x2 Low]	[2x2 Low]	
Beam failure detection transmission parameters	DCI format		1-0	1-0	
	Number of Control OFDM symbols		2	2	
	Aggregation level	CC E	8	8	
	Ratio of hypothetical PDCCH RE energy to average CSI-RS RE energy	dB	0	0	
	Ratio of hypothetical PDCCH DMRS energy to average CSI-RS RE energy	dB	0	0	
	DMRS precoder granularity		REG bundle size	REG bundle size	
	REG bundle size		6	6	
DRX			OFF	OFF	
Gap pattern ID			[N.A.]	*[gp0]	
csi-RS-Index			2	2	Number of SSB indexes used for beam failure detection
rlmInSyncOutOfSync Threshold			absent	absent	When the field is absent, the UE applies the value 0. (Table 8.1.1-1).
rsrp-ThresholdSSB			TBD	TBD	Threshold used for $Q_{out_LR_SSB}$
powerControlOffsetSS			NA	NA	Used for deriving $rsrp-ThresholdCSI-RS$
beamFailureInstanceMaxCount			[n2]	[n2]	see TS 38.321 [7], section 5.17
beamFailureDetectionTimer			[pbfd4]	[pbfd4]	see TS 38.321 [7], section 5.17
ZP CSI-RS configuration			TBD	TBD	
CSI-IM configuration			TBD	TBD	
Periodic CSI reporting			PUCCH	PUCCH	
	Config 1, 2	slot	[5]	[5]	

CSI reporting periodicity	Config 3		[10]	[10]	
T1		s	1	1	During this time the the UE shall be fully synchronized to cell 1
T2		s	0.4	0.4	
T3		s	[TBD]	[TBD]	
D1		s	[0.24]	[0.44]	
Note 1: UE-specific PDCCH is not transmitted after T1 starts.					

Table A.7.5.5.3.1-3: Cell specific test parameters for FR2 PCell for CSI-RS-based beam failure detection and link recovery testing in non-DRX mode

Parameter	Unit	Test 1 and Test 2					Test 1 and Test 2					
		CSI-RS of set q_0					CSI-RS of set q_1					
		T1	T2	T3	T4	T5	T1	T2	T3	T4	T5	
EPRE ratio of PSS to SSS	dB											
EPRE ratio of PBCH DMRS to SSS	dB											
EPRE ratio of PBCH to PBCH DMRS	dB											
EPRE ratio of PDCCH DMRS to SSS	dB											
EPRE ratio of PDCCH to PDCCH DMRS	dB											
EPRE ratio of PDSCH DMRS to SSS	dB											
EPRE ratio of PDSCH to PDSCH DMRS	dB											
EPRE ratio of OCNG DMRS to SSS ^(Note 1)	dB											
EPRE ratio of OCNG to OCNG DMRS ^(Note 1)	dB											
SNR_C SI-RS	Config 1	dB	TBD	TBD	TBD	TBD	TBD	TBD	TBD	TBD	TBD	
	Config 2		TBD	TBD	TBD	TBD	TBD	TBD	TBD	TBD	TBD	
	Config 3		TBD	TBD	TBD	TBD	TBD	TBD	TBD	TBD	TBD	
N_{oc}	Config 1	dBm/	[-98]					[-98]				
	Config 2	15K	[-98]					[-98]				
	Config 3	Hz	[-98]					[-98]				
SS-RSRP ^{Note 3}		dBm /SC S										
\hat{E}_s/I_{ot}												
\hat{E}_s/N_{oc}												
I _o	config 1, 2	dBm/										
	Config 3, 4	9.36 MHz dBm/ 38.1 MHz										
Propagation condition			[TDLA30-75]					[TDLA30-75]				
Note 1:	OCNG shall be used such that the resources in Cell 1 are fully allocated and a constant total transmitted power spectral density is achieved for all OFDM symbols.											
Note 2:	SS-RSRP and I _o levels have been derived from other parameters for information purposes. They are not settable parameters themselves.											

Table A.7.5.5.3.1-4: Measurement gap configuration for FR2 PCell for CSI-RS-based beam failure detection and link recovery testing in non-DRX mode

Field	Test 2
	Value
gapOffset	[0]

Table A.7.5.5.3.1-5: NZP-CSI-RS resource configuration for FR2 PCell for CSI-RS-based beam failure detection and link recovery testing in non-DRX mode

Field	ResourceId 0	ResourceId 1
	Value	Value
frequencyDomainAllocation ^{Note 1}	row1	row2
startingRB	0	0
nrofRBs	Note 2	Note 2
Note 1: TS 38.211 [6] table 7.4.1.5.3-1		
Note 2: nrofRBs is derived based on the Configuration in Table A.4.5.1.7.1-1		

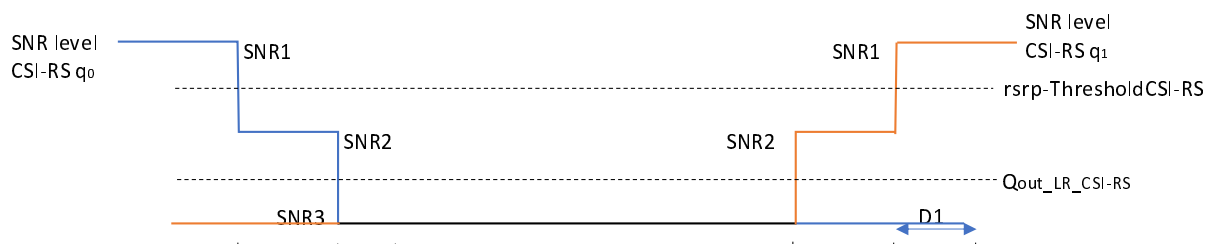

Figure A.7.5.5.3.1-1: SNR variation SSB for CSI-RS based beam failure detection and link recovery testing in non-DRX mode

A.7.5.5.3.2 Test Requirements

The UE behaviour during time durations T1, T2, T3, T4 and T5 shall be as follows:

During the time duration T1 and T2, the UE shall transmit uplink signal at least in all subframes configured for CSI transmission on Cell 1.

During the period from time point A to time point B the UE shall transmit uplink signal in Cell 1 in all uplink slots configured for CSI transmission according to the configured periodic CSI reporting for Cell 1.

During T3 the shall detect beam failure and initiat link recovery. During T4 and T5 the UE measures and evaluate beam candidate from beam candidate set q₁.

No later than time point F occurring no later than D1 = [TBD] ms after the start of T5, the UE shall transmit preamble on a beam associated with the candidate beam set q₁.

Test is concluded once the test equipment has received the initial preamble transmission from the UE. The rate of correct events observed during repeated tests shall be at least 90%.

A.7.5.5.4 Beam Failure Detection and Link Recovery Test for FR2 PCell configured with CSI-RS-based BFD and LR in DRX mode

A.7.5.5.4.1 Test Purpose and Environment

The purpose of this test is to verify that the UE properly detects CSI-RS-based beam failure in the set q_0 configured for a serving cell and that the UE performs correct CSI-RS-based link recovery based on beam candidate set q_1 . The purpose is to test the downlink monitoring for beam failure detection within the UEs active DL BWP, during the evaluation period, and link recovery, when DRX is used. This test will partly verify the CSI-RS based beam failure detection and link recovery for an FR2 serving cell requirements in clause 8.5.

The test parameters are given in Tables A.7.5.5.4.1-1, A.7.5.5.4.1-2, A.7.5.5.4.1-3, A.7.5.5.4.1-4, A.7.5.5.4.1-5 and A.7.5.5.4.1-6 below. There is one cell, cell 1 which is the active cell, in the test. The test consists of five successive time periods, with time duration of T1, T2, T3, T4 and T5 respectively. Figure A.7.5.5.4.1-1 shows the variation of the downlink SNR of the CSI-RS in set q_0 in the active cell to emulate CSI-RS based beam failure. Figure A.7.5.5.4.1-1 additionally shows the variation of the downlink SNR of the CSI-RS in set q_1 of the candidate beam used for link recovery. Prior to the start of the time duration T1, the UE shall be fully synchronized to cell 1. The UE shall be configured for periodic CSI reporting with a reporting periodicity of [2] ms. In the test, DRX configuration is enabled in PCell and DRX inactivity timer has already been expired, i.e. UE tries to decode PDCCH and to send periodic CQI during the period when On-duration timer is running. Time alignment timers shall be set to “infinity” so that UL timing alignment is maintained during the test. The UE is configured to perform inter-frequency measurements using GP ID #0 (40ms) in test 2.

Table A.7.5.5.4.1-1: Supported test configurations for FR2 PCell

Configuration	Description
1	TDD duplex mode, 120 kHz SSB SCS, 100MHz bandwidth

Table A.4.5.1.1.1-2: General test parameters for FR2 PCell for CSI-RS-based beam failure detection and link recovery testing in DRX mode

Parameter		Unit	Value		Comment
			Test 1	Test 2	
Active PCell			Cell 1	Cell 1	
RF Channel Number			1	1	
Duplex mode	Config 1		TDD	TDD	
TDD Configuration	Config 1		[TDDConf.3.1]	[TDDConf.3.1]	
CORESET Reference Channel	Config 1		[CR. 3.1 TDD]	[CR. 3.1 TDD]	A.3.1.2
SSB Configuration	Config 1		SSB.1 FR2	SSB.1 FR2	A.3.10
SMTTC Configuration	Config 1		SMTTC.1	SMTTC.1	A.3.11

PDSCH /PDCCH subcarrier spacing	Config 1		120 KHz	120 KHz	
csi-RS-Index assigned as RLM RS			[0]	[0]	
OCNG parameters			TBD	TBD	A.3.2.1
CP length			Normal	Normal	
Correlation Matrix and Antenna Configuration			[2x2 Low]	[2x2 Low]	
Beam failure detection transmission parameters	DCI format		1-0	1-0	
	Number of Control OFDM symbols		2	2	
	Aggregation level	CC E	8	8	
	Ratio of hypothetical PDCCH RE energy to average CSI-RS RE energy	dB	0	0	
	Ratio of hypothetical PDCCH DMRS energy to average CSI-RS RE energy	dB	0	0	
	DMRS precoder granularity		REG bundle size	REG bundle size	
	REG bundle size		6	6	
DRX			640	640	
Gap pattern ID			[N.A.]	*[gp0]	
csi-RS-Index			2	2	Number of SSB indexes used for beam failure detection
rlmInSyncOutOfSync Threshold			absent	absent	When the field is absent, the UE applies the value 0. (Table 8.1.1-1).
rsrp-ThresholdSSB			TBD	TBD	Threshold used for $Q_{out_LR_SSB}$
powerControlOffsetSS			NA	NA	Used for deriving $rsrp_ThresholdCSI-RS$
beamFailureInstanceMaxCount			[n2]	[n2]	see TS 38.321 [7], section 5.17
beamFailureDetectionTimer			[pbfd4]	[pbfd4]	see TS 38.321 [7], section 5.17
ZP CSI-RS configuration			TBD	TBD	

CSI-IM configuration			TBD	TBD	
Periodic CSI reporting			PUCCH	PUCCH	
CSI reporting periodicity	Config 1, 2	slot	[5]	[5]	
	Config 3		[10]	[10]	
T1		s	1	1	During this time the the UE shall be fully synchronized to cell 1
T2		s	0.4	0.4	
T3		s	[TBD]	[TBD]	
D1		s	[0.24]	[0.44]	
Note 1: UE-specific PDCCH is not transmitted after T1 starts.					

Table A.7.5.4.1-3: Cell specific test parameters for FR2 PCell for CSI-RS-based beam failure detection and link recovery testing in DRX mode

Parameter	Unit	Test 1 and Test 2					Test 1 and Test 2					
		CSI-RS of set q_0					CSI-RS of set q_1					
		T1	T2	T3	T4	T5	T1	T2	T3	T4	T5	
EPRE ratio of PSS to SSS	dB	0					0					
EPRE ratio of PBCH DMRS to SSS	dB											
EPRE ratio of PBCH to PBCH DMRS	dB											
EPRE ratio of PDCCH DMRS to SSS	dB											
EPRE ratio of PDCCH to PDCCH DMRS	dB											
EPRE ratio of PDSCH DMRS to SSS	dB											
EPRE ratio of PDSCH to PDSCH DMRS	dB											
EPRE ratio of OCNG DMRS to SSS ^(Note 1)	dB											
EPRE ratio of OCNG to OCNG DMRS ^(Note 1)	dB											
SNR _C SI-RS	Config 1	dB	TBD	TBD	TBD	TBD	TBD	TBD	TBD	TBD	TBD	
	Config 2		TBD	TBD	TBD	TBD	TBD	TBD	TBD	TBD	TBD	
	Config 3		TBD	TBD	TBD	TBD	TBD	TBD	TBD	TBD	TBD	
N_{oc}	Config 1	dBm/	[-98]					[-98]				
	Config 2	15K	[-98]					[-98]				
	Config 3	Hz	[-98]					[-98]				
SS-RSRP ^{Note 3}		dBm /SC S										
\hat{E}_s/I_{ot}												
\hat{E}_s/N_{oc}												
I _o	config 1, 2	dBm/										
	Config 3, 4	9.36 MHz dBm/ 38.1 MHz										
Propagation condition			[TDLA30-75]					[TDLA30-75]				
Note 1:	OCNG shall be used such that the resources in Cell 1 are fully allocated and a constant total transmitted power spectral density is achieved for all OFDM symbols.											
Note 2:	SS-RSRP and I _o levels have been derived from other parameters for information purposes. They are not settable parameters themselves.											

Table A.7.5.5.4.1-4: Measurement gap configuration for FR2 PCell for CSI-RS-based beam failure detection and link recovery testing in DRX mode

Field	Test 2
	Value
gapOffset	[0]

Table A.7.5.5.4.1-5: NZP-CSI-RS resource configuration for FR2 PCell for CSI-RS-based beam failure detection and link recovery testing in DRX mode

Field	ResourceId 0	ResourceId 1
	Value	Value
frequencyDomainAllocation ^{Note 1}	row1	row2
startingRB	0	0
nrofRBs	Note 2	Note 2
Note 1: TS 38.211 [6] table 7.4.1.5.3-1 Note 2: nrofRBs is derived based on the Configuration in Table A.4.5.1.7.1-1		

Table A.7.5.5.4.1-6: DRX-Configuration for FR2 PCell for SSB-based beam failure detection and link recovery testing in DRX mode.

Field	Test 5	Test 6
	Value	Value
drx-onDurationTimer	[ms6]	[ms6]
drx-InactivityTimer	[ms1]	[ms1]
drx-RetransmissionTimerDL	[sl1]	[sl1]
drx-RetransmissionTimerUL	[sl1]	[sl1]
longDRX-CycleStartOffset	[ms640]	[ms40]
shortDRX	disable	disable

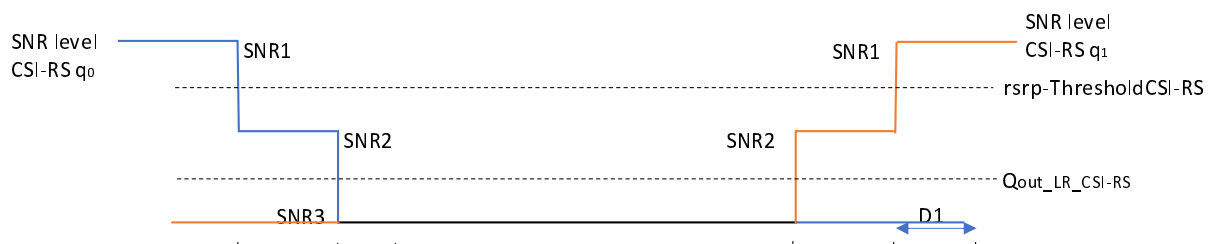

Figure A.7.5.5.4.1-1: SNR variation SSB for CSI-RS-based beam failure detection and link recovery testing in DRX mode

A.7.5.5.4.2 Test Requirements

The UE behaviour during time durations T1, T2, T3, T4 and T5 shall be as follows:

During the time duration T1 and T2, the UE shall transmit uplink signal at least in all subframes configured for CSI transmission on Cell 1.

During the period from time point A to time point B the UE shall transmit uplink signal in Cell 1 in all uplink slots configured for CSI transmission according to the configured periodic CSI reporting for Cell 1.

During T3 the shall detect beam failure and initiate link recovery. During T4 and T5 the UE measures and evaluate beam candidate from beam candidate set q_1 .

No later than time point F occurring no later than $D1 = [\text{TBD}]$ ms after the start of T5, the UE shall transmit preamble on a beam associated with the candidate beam set q_1 .

Test is concluded once the test equipment has received the initial preamble transmission from the UE. The rate of correct events observed during repeated tests shall be at least 90%.

A.7.5.6 Active BWP switch delay

A.7.5.6.1 DCI-based and Timer-based Active BWP Switch

A.7.5.6.1.1 NR FR2- NR FR2 DL active BWP switch of PCell with non-DRX in SA

A.7.5.6.1.1.1 Test Purpose and Environment

The purpose of this test is to verify the DL BWP switch delay requirement defined in TS38.133 section 8.6, and interruption requirement on other active serving cell defined in TS38.133 section 8.2.2.2.5.

The supported test configurations are shown in Table A.7.5.6.1.1.1-1 below. The test scenario comprises of one NR PCell (Cell 1) and one NR SCell (Cell 2) as given in Table A.7.5.6.1.1.1-2. NR Cell-specific parameters are specified in Table A.7.5.6.1.1.1-3 below. OTA related test parameters are shown in table A.7.5.6.1.1.1-4 below.

PDCCHs indicating new transmissions shall be sent continuously on PCell (Cell 1) to ensure that the UE would have ACK/NACK sending except for the time duration when BWP is switching on Cell 1 and the time duration of T2.

PDCCHs indicating new transmissions shall be sent continuously on SCell (Cell 2) to ensure that the UE will have ACK/NACK sending.

Before the test starts,

UE is connected to Cell 1 (PCell) on radio channel 1 (PCC), and Cell 2 (SCell) on radio channel 2 (SCC).

UE is configured with 2 different UE-specific bandwidth parts for PCell, BWP-1 and BWP-2, in Cell 1 before starting the test. BWP-1 and BWP-2 always include bandwidth of the initial DL BWP and SSB.

UE is indicated in firstActiveDownlinkBWP-Id that the active DL BWP is BWP-1 in PCell.

UE is configured with a bwp-InactivityTimer timer value for PCell.

All cells have constant signal levels throughout the test.

The test consists of 3 successive time periods, with durations of T1, T2, and T3, respectively.

During T1,

Time period T1 starts when a DCI format 1_1 command for PCell DL BWP switch, sent from the test equipment to the UE, is received at the UE side in PCell's slot # denoted i . The UE shall switch its bandwidth part from BWP-1 to BWP-2.

The UE shall be able to receive PDSCH no later than at PCell's slot $(i + T_{BWPswitchDelay})$ as defined in section 8.6 and starts to report valid ACK/NACK for the PCell no later than at slot $(i + T_{BWPswitchDelay} + kI)$. The UE shall be continuously scheduled on PCell's BWP-2 no later than slot $(i + T_{BWPswitchDelay})$.

The starting time of SCell (Cell 2) interruption due to BWP switch on PCell shall occur within the BWP switch delay.

During T2, the test equipment won't transmit DCI format for PDSCH reception on PCell(Cell 1).

During T3,

The time period T3 starts from the slot # j immediately after the slot wherein *bwp-InactivityTimer* timer expires. The UE should switch its bandwidth part from BWP-2 back to the default bandwidth part – BWP-1.

The UE shall be able to receive PDSCH no later than PCell's slot ($j+T_{BWPswitchDelay}$) as defined in section 8.6 and starts to report valid ACK/NACK for the PSCell at latest at slot ($j+T_{BWPswitchDelay}+kI$). The UE shall be continuously scheduled on PSCell's BWP-1 no later than slot ($j+T_{BWPswitchDelay}$).

The starting time of SCell (Cell 2) interruption due to BWP switch of PCell shall occur within the BWP switch delay.

The test equipment verifies the DL BWP switch time in PCell by counting the slots from the time when the BWP switch command is received or *bwp-InactivityTimer* timer expires till an ACK is received.

The test equipment verifies that potential interruption to SCell is carried out in the correct time span by monitoring ACK/NACK sent in SCell during BWP switch of PCell, respectively.

Table A.7.5.6.1.1-1: DL BWP switch supported test configurations

Config	Description
1	NR 120 kHz SSB SCS, 100MHz bandwidth, TDD -TDD duplex mode
Note 1: The UE is only required to be tested in one of the supported test configurations	

Table A.7.5.6.1.1-2: General test parameters for DL BWP switch in SA

Parameter	Unit	Value	Comment
NR RF Channel Number		2	Two NR radio channel is used for this test
Active PCell		Cell 1	PCell on RF channel number 1.
Active SCell		Cell 2	SCell on RF channel number 2.
CP length		Normal	
DRX		OFF	For both PCell and PSCell
<i>bwp-InactivityTimer</i>	ms	[200]	
Cell-individual offset for cells on RF channel number 1	dB	0	Individual offset for cells on PCC.
Cell-individual offset for cells on RF channel number 2	dB	0	Individual offset for cells on PSCC.
Cell2 timing offset to cell1	μs	3	Time alignment error as specified in 3GPP TS 38.104 [13] clause 6.5.3.1.
T1	s	[0.2]	
T2	s	[0.2]	
T3	s	[0.2]	

Table A7.5.6.1.1-3: NR Cell specific test parameters for DL BWP switch in SA

Parameter	Unit	Cell 1	Cell2
Frequency Range		FR2	FR2
Duplex mode		TDD	
TDD configuration		TDDConf.3.1	
BW _{channel}		100 MHz: N _{RB,c} = 66	
Active BWP ID		1, 2	3
Downlink initial BWP Configuration		[DLBWP.0.2]	
Uplink initial BWP Configuration		[ULBWP.0.2]	
Downlink active BWP-1 Configuration		[DLBWP.1.3]	-
Downlink active BWP-2 Configuration		[DLBWP.1.3]	-
Uplink active BWP-1 Configuration		[ULBWP.1.3]	-
Uplink active BWP-2 Configuration		[ULBWP.1.3]	-
PDSCH Reference measurement channel		SR.3.1 TDD	
TRS configuration		TRS.2.1 TDD	
TCI state		TCI.State.0	
RMSI CORESET parameters		CR.3.1 TDD	
Dedicated CORESET parameters		CCR.3.1 TDD	
OCNG Patterns		OP.1	
SSB Configuration		SSB.1 FR2	
SMTc Configuration		SMTc.1	
Correlation Matrix and Antenna Configuration		1x2 Low	
EPRE ratio of PSS to SSS	dB	0	0
EPRE ratio of PBCH DMRS to SSS			
EPRE ratio of PBCH to PBCH DMRS			
EPRE ratio of PDCCH DMRS to SSS			
EPRE ratio of PDCCH to PDCCH DMRS			
EPRE ratio of PDSCH DMRS to SSS			
EPRE ratio of PDSCH to PDSCH			
EPRE ratio of OCNG DMRS to SSS(Note 1)			
EPRE ratio of OCNG to OCNG DMRS (Note 1)			
\bar{E}_s/N_{oc}	dB	[17]	[17]
Propagation Condition		AWGN	AWGN

Note 1: OCNG shall be used such that both cells are fully allocated and a constant total transmitted power spectral density is achieved for all OFDM symbols.

Table A.7.5.6.1.1-4: OTA related test parameters for BWP switching test case

Parameter	Unit	Cell 1	Cell 2
Angle of arrival configuration		According to table A.X.X	According to table A.X.X
N_{oc} ^{Note1}	NR_TDD_FR2_A	TBD	TBD
	NR_TDD_FR2_B		
	NR_TDD_FR2_F		
	NR_TDD_FR2_G		
	NR_TDD_FR2_T		
	NR_TDD_FR2_Y		

N_{oc} ^{Note1}	NR_TDD_FR2_A	dBm/SCS ^{Note3}	TBD	TBD
	NR_TDD_FR2_B			
	NR_TDD_FR2_F			
	NR_TDD_FR2_G			
	NR_TDD_FR2_T			
NR_TDD_FR2_Y				
SS-RSRP ^{Note2}	NR_TDD_FR2_A	dBm/SCS ^{Note4}	TBD	TBD
	NR_TDD_FR2_B			
	NR_TDD_FR2_F			
	NR_TDD_FR2_G			
	NR_TDD_FR2_T			
NR_TDD_FR2_Y				
\hat{E}_s/I_{ot}		dB	TBD	TBD
I_o ^{Note2}	NR_TDD_FR2_A	dBm/95.04 MHz ^{Note4}	TBD	TBD
	NR_TDD_FR2_B			
	NR_TDD_FR2_F			
	NR_TDD_FR2_G			
	NR_TDD_FR2_T			
NR_TDD_FR2_Y				
<p>Note 1: Interference from other cells and noise sources not specified in the test is assumed to be constant over subcarriers and time and shall be modelled as AWGN of appropriate power for N_{oc} to be fulfilled.</p> <p>Note 2: SS-RSRP and I_o levels have been derived from other parameters for information purposes. They are not settable parameters themselves.</p> <p>Note 3: SS-RSRP minimum requirements are specified assuming independent interference and noise at each receiver antenna port.</p> <p>Note 4: Equivalent power received by an antenna with 0dBi gain at the centre of the quiet zone</p> <p>Note 5: As observed with 0dBi gain antenna at the centre of the quiet zone</p>				

A.7.5.6.1.2 Test Requirements

During T1, the UE shall start to send the ACK for PSCell in a slot $(i+T_{BWPswitchDelay}+kI)$.

During T3, the UE shall start to send the ACK for PSCell in a slot $(j+T_{BWPswitchDelay}+kI)$.

Where, kI is the timing between DL data receiving and acknowledgement as specified in [7].

Depending on UE capability *bwp-SwitchingDelay* [2], UE shall finish BWP switch within the time duration $T_{BWPswitchDelay}$ defined in Table 8.6.2-1.

All of the above test requirements shall be fulfilled in order for the observed PCell active BWP switch delay to be counted as correct.

The rate of correct events observed during repeated tests shall be at least 90%.

During T1 and T3, the start time of SCell interruption during PCell active BWP switch shall not happen outside the BWP switch delay.

The interruption of SCell shall not be longer than the interruption duration specified for active BWP switch in TS38.133 Section 8.2.2.2.5.

All of the above test requirements shall be fulfilled in order for the observed PCell active BWP switch interruption to be counted as correct.

The rate of correct events observed during repeated tests shall be at least 90%.

NOTE: During T1, T3 if there are no uplink resources for reporting the ACK in a slot $(i+Y1)$, $(j+Y2)$, then the UE shall use the next available uplink resource for reporting the corresponding ACK.

A.7.5.6.1.2 NR FR1- NR FR2 DL active BWP switch of PCell with non-DRX in SA

A.7.5.6.1.2.1 Test Purpose and Environment

The purpose of this test is to verify the DL BWP switch delay requirement defined in TS38.133 section 8.6, and interruption requirement on other active serving cell defined in TS38.133 section 8.2.2.2.5.

The supported test configurations are shown in Table A.7.5.6.1.2.1-1 below. The test scenario comprises of one NR PCell (Cell 1) and one NR SCell (Cell 2). The general parameters are given in Table A.7.5.6.1.2.1-2. NR Cell-specific parameters are specified in Table A.7.5.6.1.2.1-3 below. OTA related test parameters are shown in table A.7.5.6.1.2.1-4 below.

PDCCHs indicating new transmissions shall be sent continuously on PCell (Cell 1) to ensure that the UE would have ACK/NACK sending except for the time duration when BWP is switching on Cell 1 and the time duration of T2.

PDCCHs indicating new transmissions shall be sent continuously on SCell (Cell 2) to ensure that the UE will have ACK/NACK sending.

Before the test starts,

UE is connected to Cell 1 (PCell) on radio channel 1 (PCC), and Cell 2 (SCell) on radio channel 2 (SCC).

UE is configured with 2 different UE-specific bandwidth parts for PCell, BWP-1 and BWP-2, in Cell 1 before starting the test. BWP-1 and BWP-2 always include bandwidth of the initial DL BWP and SSB.

UE is indicated in firstActiveDownlinkBWP-Id that the active DL BWP is BWP-1 in PCell.

UE is configured with a bwp-InactivityTimer timer value for PCell.

All cells have constant signal levels throughout the test.

The test consists of 3 successive time periods, with durations of T1, T2, and T3, respectively.

During T1,

Time period T1 starts when a DCI format 1_1 command for PCell DL BWP switch, sent from the test equipment to the UE, is received at the UE side in PCell's slot # denoted i . The UE shall switch its bandwidth part from BWP-1 to BWP-2.

The UE shall be able to receive PDSCH no later than at PCell's slot $(i+T_{BWPswitchDelay})$ as defined in section 8.6 and starts to report valid ACK/NACK for the PCell no later than at slot $(i+T_{BWPswitchDelay}+k1)$. The UE shall be continuously scheduled on PCell's BWP-2 no later than slot $(i+T_{BWPswitchDelay})$.

The starting time of SCell (Cell 2) interruption due to BWP switch on PCell shall occur within the BWP switch delay.

During T2, the test equipment won't transmit DCI format for PDSCH reception on PCell(Cell 1).

During T3,

The time period T3 starts from the slot # j immediately after the slot wherein *bwp-InactivityTimer* timer expires. The UE should switch its bandwidth part from BWP-2 back to the default bandwidth part – BWP-1.

The UE shall be able to receive PDSCH no later than PCell's slot $(j+T_{BWPswitchDelay})$ as defined in section 8.6 and starts to report valid ACK/NACK for the PCell at latest at slot $(j+T_{BWPswitchDelay}+k1)$. The UE shall be continuously scheduled on PCell's BWP-1 no later than slot $(j+T_{BWPswitchDelay})$.

The starting time of SCell (Cell 2) interruption due to BWP switch of PCell shall occur within the BWP switch delay.

The test equipment verifies the DL BWP switch time in PCell by counting the slots from the time when the BWP switch command is received or *bwp-InactivityTimer* timer expires till an ACK is received.

The test equipment verifies that potential interruption to SCell is carried out in the correct time span by monitoring ACK/NACK sent in SCell during BWP switch of PCell, respectively.

Table A.7.5.6.1.1-1: DL BWP switch supported test configurations

Config	Description
1	PCell: NR 15 kHz SSB SCS, 10MHz bandwidth, FDD duplex mode SCell: NR 120 kHz SSB SCS, 100MHz bandwidth, TDD duplex mode
2	PCell: NR 15 kHz SSB SCS, 10MHz bandwidth, TDD duplex mode SCell: NR 120 kHz SSB SCS, 100MHz bandwidth, TDD duplex mode
3	PCell: NR 30 kHz SSB SCS, 10MHz bandwidth, TDD duplex mode SCell: NR 120 kHz SSB SCS, 100MHz bandwidth, TDD duplex mode
Note 1: The UE is only required to be tested in one of the supported test configurations	

Table A.7.5.6.1.1-2: General test parameters for DL BWP switch in SA

Parameter	Unit	Value	Comment
NR RF Channel Number		2	Two NR radio channel is used for this test
Active PCell		Cell 1	PCell on RF channel number 1.
Active SCell		Cell 2	SCell on RF channel number 2.
CP length		Normal	
DRX		OFF	For both PCell and PSCell
<i>bwp-InactivityTimer</i>	ms	[200]	
Cell-individual offset for cells on RF channel number 1	dB	0	Individual offset for cells on PCC.
Cell-individual offset for cells on RF channel number 2	dB	0	Individual offset for cells on PSCC.
Cell2 timing offset to cell1	μs	3	Time alignment error as specified in 3GPP TS 38.104 [13] clause 6.5.3.1.
T1	s	[0.2]	
T2	s	[0.2]	
T3	s	[0.2]	

Table A6.5.6.1.1-3: NR Cell specific test parameters for DL BWP switch in SA

Parameter	Unit	Cell 1	Cell2
Frequency Range		FR1	FR2
Duplex mode	Config 1	FDD	TDD
	Config 2,3	TDD	
TDD configuration	Config 1	Not Applicable	TDDConf.3.1
	Config 2	TDDConf.1.1	
	Config 3	TDDConf.2.1	
BW _{channel}	Config 1,2	10 MHz: N _{RB,c} = 52	100 MHz: N _{RB,c} = 66
	Config 3	40 MHz: N _{RB,c} = 106	
Active BWP ID		1, 2	3
Downlink initial BWP Configuration		[DLBWP.0.2]	
Uplink initial BWP Configuration		[ULBWP.0.2]	
Downlink active BWP-1 Configuration		[DLBWP.1.3]	-
Downlink active BWP-2 Configuration		[DLBWP.1.3]	-
Uplink active BWP-1 Configuration		[DLBWP.1.3]	-
Uplink active BWP-2 Configuration		[DLBWP.1.3]	-

PDSCH Reference measurement channel	Config 1		SR.1.1 FDD	SR.3.1 TDD
	Config 2		SR.1.1 TDD	
	Config 3		SR.2.1 TDD	
RMSI CORESET parameters	Config 1		CR.1.1 FDD	CR.3.1 TDD
	Config 2		CR.1.1 TDD	
	Config 3		CR.2.1 TDD	
Dedicated CORESET parameters	Config 1		CCR.1.1 FDD	CCR.3.1 TDD
	Config 2		CCR.1.1 TDD	
	Config 3		CCR.2.1 TDD	
OCNG Patterns			OP.1	
SSB Configuration	Config 1,2		SSB.1 FR1	SSB.1 FR2
	Config 3		SSB.2 FR1	
TRS configuration	Config 1,2,3		-	TRS.2.1 TDD
TCI state	Config 1,2,3		TCI.State.0	TCI.State.0
SMTc Configuration			SMTc.1	
Correlation Matrix and Antenna Configuration			1x2 Low	
EPRE ratio of PSS to SSS		dB	0	0
EPRE ratio of PBCH DMRS to SSS				
EPRE ratio of PBCH to PBCH DMRS				
EPRE ratio of PDCCH DMRS to SSS				
EPRE ratio of PDCCH to PDCCH DMRS				
EPRE ratio of PDSCH DMRS to SSS				
EPRE ratio of PDSCH to PDSCH				
EPRE ratio of OCNG DMRS to SSS(Note 1)				
EPRE ratio of OCNG to OCNG DMRS (Note 1)				
\hat{E}_s/N_{oc}		dB	[17]	[17]
N_{oc} ^{Note2}	Config 1,2	dBm/15kHz ^{Note4}	[-104]	Defined in Table A.7.5.6.1.1-4
	Config 3		[-101]	
\hat{E}_s/I_{ot}		dB	[17]	Defined in Table A.7.5.6.1.1-4
SS-RSRP ^{Note3}	Config 1,2	dBm/SCS	[-87]	Defined in Table A.7.5.6.1.1-4
	Config 3		[-84]	
SCH_RP ^{Note 3}		dBm/15 kHz	[-87]	Defined in Table A.7.5.6.1.1-4
Propagation Condition			AWGN	AWGN
<p>Note 1: OCNG shall be used such that both cells are fully allocated and a constant total transmitted power spectral density is achieved for all OFDM symbols.</p> <p>Note 2: Interference from other cells and noise sources not specified in the test is assumed to be constant over subcarriers and time and shall be modelled as AWGN of appropriate power for N_{oc} to be fulfilled.</p> <p>Note 3: SS-RSRP and SCH_RP levels have been derived from other parameters for information purposes. They are not settable parameters themselves.</p>				

Table A.7.5.6.1.1-4: OTA related test parameters for BWP switching test case

Parameter		Unit	Cell 2
Angle of arrival configuration			According to table A.X.X
N_{oc} ^{Note1}	NR_TDD_FR2_A	dBm/15kHz	TBD
	NR_TDD_FR2_B		
	NR_TDD_FR2_F		
	NR_TDD_FR2_G		
	NR_TDD_FR2_T		
	NR_TDD_FR2_Y		

SS-RSRP ^{Note2}	NR_TDD_FR2_A	dBm/SCS ^{Note3}	TBD
	NR_TDD_FR2_B		
	NR_TDD_FR2_F		
	NR_TDD_FR2_G		
	NR_TDD_FR2_Y		
\hat{E}_s/I_{ot}		dB	TBD
I _o ^{Note2}	NR_TDD_FR2_A	dBm/95.04 MHz ^{Note4}	TBD
	NR_TDD_FR2_B		
	NR_TDD_FR2_F		
	NR_TDD_FR2_G		
	NR_TDD_FR2_Y		
<p>Note 1: Interference from other cells and noise sources not specified in the test is assumed to be constant over subcarriers and time and shall be modelled as AWGN of appropriate power for N_{oc} to be fulfilled.</p> <p>Note 2: SS-RSRP and I_o levels have been derived from other parameters for information purposes. They are not settable parameters themselves.</p> <p>Note 3: SS-RSRP minimum requirements are specified assuming independent interference and noise at each receiver antenna port.</p> <p>Note 4: Equivalent power received by an antenna with 0dBi gain at the centre of the quiet zone</p>			

A.7.5.6.1.2 Test Requirements

During T1, the UE shall start to send the ACK for PSCell in a slot $(i+T_{BWPswitchDelay}+kI)$.

During T3, the UE shall start to send the ACK for PSCell in a slot $(j+T_{BWPswitchDelay}+kI)$.

Where, kI is the timing between DL data receiving and acknowledgement as specified in [7].

Depending on UE capability *bwp-SwitchingDelay* [2], UE shall finish BWP switch within the time duration $T_{BWPswitchDelay}$ defined in Table 8.6.2-1.

All of the above test requirements shall be fulfilled in order for the observed PCell active BWP switch delay to be counted as correct.

The rate of correct events observed during repeated tests shall be at least 90%.

During T1 and T3, the start time of SCell interruption during PCell active BWP switch shall not happen outside the BWP switch delay.

The interruption of SCell shall not be longer than the interruption duration specified for active BWP switch in TS38.133 Section 8.2.2.2.5.

All of the above test requirements shall be fulfilled in order for the observed PCell active BWP switch interruption to be counted as correct.

The rate of correct events observed during repeated tests shall be at least 90%.

NOTE: During T1, T3 if there are no uplink resources for reporting the ACK in a slot $(i+Y1)$, $(j+Y2)$, then the UE shall use the next available uplink resource for reporting the corresponding ACK.

A.7.5.6.2 RRC-based Active BWP Switch

A.7.5.6.2.1 NR FR2- NR FR2 DL active BWP switch of PCell with non-DRX in SA

A.7.5.6.2.1.1 Test Purpose and Environment

The purpose of this test is to verify the DL BWP switch delay requirement for RRC-based BWP switch defined in section 8.6. Supported test configurations are shown in Table A.7.5.6.2.1.1-1.

The test scenario comprises of one NR PCell (Cell 1) as given in Table A.7.5.6.2.1.1-2. Cell-specific parameters of NR PCell are specified in Table A.7.5.6.2.1.1-3 below.

PDCCHs indicating new transmissions shall be sent continuously on PCell (Cell 1) to ensure that the UE will have ACK/NACK sending.

Before the test starts,

- UE is connected to Cell 1 (PCell) on radio channel 1 (PCC).
- UE has bandwidth part BWP-1 in its RRC-configuration for Cell 1 (PCell).
- UE is indicated in *firstActiveDownlinkBWP-Id* that the active DL BWP is BWP-1 in PCell.

All cells have constant signal levels throughout the test.

The test consists of 1 time period, with duration of T1.

During T1,

Time period T1 starts when a *RRCReconfiguration* with bandwidth part configuration BWP-2, sent from the test equipment to the UE, is received at the UE side in PCell's slot # denoted i . The UE shall switch its bandwidth part from BWP-1 to BWP-2.

The UE shall be able to receive PDSCH at PCell's slot $(i+X)$ as defined in section 8.6 and starts to report valid ACK/NACK for the PCell no later than at slot $(i+X+kI)$. The UE shall be continuously scheduled on PCell's BWP-2 starting from slot $(i+X)$.

The test equipment verifies the DL BWP switch time in PCell by counting the slots from the time when the RRC Reconfiguration message including BWP switch command is received till an ACK is received.

Table A.7.5.6.2.1.1-1: DL BWP switch supported test configurations

Config	Description
1	NR 120 kHz SSB SCS, 100MHz bandwidth, TDD duplex mode
2	NR 120 kHz SSB SCS, 100MHz bandwidth, TDD duplex mode
Note 1: The UE is only required to be tested in one of the supported test configurations	

Table A.7.5.6.2.1.1-2: General test parameters for DL BWP switch in synchronous EN-DC

Parameter	Unit	Value	Comment
NR RF Channel Number		1	One NR radio channel is used for this test
Active PCell		Cell 1	PCell on RF channel number 1.
CP length		Normal	
DRX		OFF	
Cell-individual offset for cells on RF channel number 1	dB	0	Individual offset for cells on PCC.
T1	s	[0.2]	

Table A.7.5.6.2.1.1-3: NR Cell specific test parameters for DL BWP switch in synchronous EN-DC

Parameter	Unit	Cell 1
Frequency Range		FR2
Duplex mode		TDD
TDD configuration		TDDConf.3.1
BW_{channel}		100 MHz: $N_{RB,c} = 66$
Active BWP ID		1, 2
Initial BWP Configuration		DLBWP.0.2
Active BWP-1 Configuration		DLBWP.1.3
Active BWP-2 Configuration		DLBWP.1.1
PDSCH Reference measurement channel		SR.3.1 TDD
RMSI CORESET parameters		CR.3.1 TDD
Dedicated CORESET parameters		CCR.3.1 TDD
OCNG Patterns		OP.1
SSB Configuration		SSB.1 FR2
SMTC Configuration		SMTC.1
TCI State		TBD
TRS Configuration		TBD
Antenna Configuration		1x2
Propagation Condition		AWGN
EPRE ratio of PSS to SSS	dB	0
EPRE ratio of PBCH DMRS to SSS		
EPRE ratio of PBCH to PBCH DMRS		
EPRE ratio of PDCCH DMRS to SSS		
EPRE ratio of PDCCH to PDCCH DMRS		
EPRE ratio of PDSCH DMRS to SSS		
EPRE ratio of PDSCH to PDSCH		
EPRE ratio of OCNG DMRS to SSS(Note 1)		
EPRE ratio of OCNG to OCNG DMRS (Note 1)		
<p>Note 1: OCNG shall be used such that both cells are fully allocated and a constant total transmitted power spectral density is achieved for all OFDM symbols.</p> <p>Note 2: Interference from other cells and noise sources not specified in the test is assumed to be constant over subcarriers and time and shall be modelled as AWGN of appropriate power for N_{oc} to be fulfilled.</p> <p>Note 3: SS-RSRP and I_0 levels have been derived from other parameters for information purposes. They are not settable parameters themselves.</p> <p>Note 4: For unpaired spectrum, a DL BWP is linked with an UL BWP. DLBWP.0.2 is linked with ULBWP.0.2; DLBWP.1.1 is linked with ULBWP.1.1; DLBWP.1.3 is linked with ULBWP.1.3 defined in TS 38.213 [3] section 12.</p>		

A.7.5.6.2.2.2 Test Requirements

During T1, the UE shall start to send the ACK for PCell in a slot $(i+X+kI)$.

All of the above test requirements shall be fulfilled in order for the observed PCell active BWP switch delay to be counted as correct.

The rate of correct events observed during repeated tests shall be at least 90%.

The rate of correct events observed during repeated tests shall be at least 90%.

NOTE: During T1, if there are no uplink resources for reporting the ACK in a slot $(i+X+kI)$, then the UE shall use the next available uplink resource for reporting the corresponding ACK.

Editor's note: FFS value of X, kI for type 1 and type 2 UE.

A.7.6 Measurement procedure

A.7.6.1 Intra-frequency Measurements

A.7.6.1.1 SA event triggered reporting test without gap under non-DRX

A.7.6.1.1.1 Test purpose and Environment

The purpose of this test is to verify that the UE makes correct reporting of an event. This test will partly verify the TDD intra-frequency cell search requirements in clause 9.2.5.1 and 9.2.5.2. Supported test configurations are shown in table A.7.6.1.1.1-1.

Table A.7.6.1.1.1-1: supported test configurations

Configuration	Description
1	120 kHz SSB SCS, 100MHz bandwidth, TDD duplex mode
2	240 kHz SSB SCS, 100MHz bandwidth, TDD duplex mode
Note: The UE is only required to be tested in one of the supported test configurations.	

There are two cells in the test, PCell (Cell 1) and a FR2 neighbour cell (Cell 2) on the same frequency as the PCell. The test parameters for the Cell 1 and Cell 2 are given in Table A.7.6.1.1.1-1 and A.7.6.1.1.1-2 below.

In the measurement control information a measurement object is configured for the frequency of the PCell, and it is indicated to the UE that event-triggered reporting with Event A3 is used.

The test consists of two successive time periods, with time duration of T1, and T2 respectively. During time duration T1, the UE shall not have any timing information of Cell 2.

Table A.7.6.1.1.1-2: General test parameters for intra-frequency event triggered reporting for SA with TDD PCell in FR2 without gap without DRX

Parameter	Unit	Config	Value	Comment
Active cell		1, 2	PCell (Cell 1)	
Neighbour cell		1, 2	Cell 2	Cell to be identified.
RF Channel Number		1, 2	1: Cell 1 and Cell 2	One TDD carrier frequency is used for the NR cells.
SMTC configuration		1, 2	SMTC.1	
A3-Offset	dB	1, 2	-6	
CP length		1, 2	Normal	
Hysteresis	dB	1, 2	0	
Time To Trigger	s	1, 2	0	
Filter coefficient		1, 2	0	L3 filtering is not used
DRX		1, 2	OFF	
Time offset between Cell 1 and Cell 2		1, 2	3 μ s	Synchronous EN-DC
Time offset between Cell 2 and Cell 3		1, 2	3 μ s	Synchronous cells
T1	s	1, 2	5	
T2	s	1, 2	5	

Table A.7.6.1.1.1-3: NR Cell specific test parameters for intra-frequency event triggered reporting for SA with TDD PCell in FR2 without gap without DRX

Parameter	Unit	Config	Cell 1		Cell 2	
			T1	T2	T1	T2
TDD configuration		1, 2	TDDConf.3.1		TDDConf.3.1	

Initial BWP configuration		1, 2	DLBWP.0.1 ULBWP.0.1	DLBWP.0.1 ULBWP.0.1
Active DL BWP configuration		1, 2	DLBWP.1.1	DLBWP.1.1
Active UL BWP configuration		1, 2	ULBWP.1.1	ULBWP.1.1
RLM-RS		1, 2	SSB	SSB
PDSCH RMC configuration		1, 2	SR.3.1 TDD	N/A
RMSI CORESET RMC configuration		1, 2	CR.3.1 TDD	CR.3.1 TDD
Dedicated CORESET RMC configuration		1, 2	CCR.3.1 TDD	CCR.3.1 TDD
TRS configuration		1, 2	TRS.2.1 TDD	N/A
TCI state		1, 2	CSI-RS.Config.0	N/A
OCNG Patterns		1, 2	OP.1	OP.1
SSB		1	SSB.1 FR2	SSB.1 FR2
		2	SSB.2 FR2	SSB.2 FR2
Propagation Condition		1, 2	AWGN	

Table A.7.6.1.1.1-4: NR OTA Cell specific test parameters for intra-frequency event triggered reporting for SA with TDD PCell in FR2 without gap without DRX

Parameter	Unit	Config	Cell 2		Cell 3	
			T1	T2	T1	T2
AoA setup		1, 2	A.3.8.x			
\hat{E}_s / I_{ot}	dB	1, 2	TBD	TBD	TBD	TBD
N_{oc} <small>Note 2</small>	dBm/15 KHz	1, 2	TBD			
N_{oc} <small>Note 2</small>	dBm/SCS	1	TBD			
		2	TBD			
SS-RSRP	dBm/SCS	1	TBD	TBD	TBD	TBD
		2	TBD	TBD	TBD	TBD
\hat{E}_s / N_{oc}	dB	1, 2	TBD	TBD	TBD	TBD
I_o	dBm/95.04MHz	1, 2	TBD		TBD	
<p>Note 1: The resources for uplink transmission are assigned to the UE prior to the start of time period T2.</p> <p>Note 2: Interference from other cells and noise sources not specified in the test is assumed to be constant over subcarriers and time and shall be modelled as AWGN of appropriate power for N_{oc} to be fulfilled.</p> <p>Note 3: SS-RSRP levels have been derived from other parameters for information purposes. They are not settable parameters themselves.</p>						

A.7.6.1.1.2 Test Requirements

In the test, the UE shall send one Event A3 triggered measurement report, with a measurement reporting delay less than X ms from the beginning of time period T2, where X is

- 2.4s for a UE supporting power class 1,
- 1.44s for a UE supporting power class 2 or 3,
- [1.44s] for a UE supporting power class 4

The UE is not required to read the neighbour cell SSB index in this test.

The UE shall not send event triggered measurement reports, as long as the reporting criteria are not fulfilled.

The rate of correct events observed during repeated tests shall be at least 90%.

NOTE: The actual overall delays measured in the test may be up to $2xTTI_{DCCCH}$ higher than the measurement reporting delays above because of TTI insertion uncertainty of the measurement report in DCCCH.

A.7.6.1.2 SA event triggered reporting test without gap under DRX

A.7.6.1.2.1 Test purpose and Environment

The purpose of this test is to verify that the UE makes correct reporting of an event. This test will partly verify the TDD intra-frequency cell search requirements in clause 9.2.5.1 and 9.2.5.2. Supported test configurations are shown in table A.7.6.1.2.1-1.

Table A.7.6.1.2.1-1: supported test configurations

Configuration	Description
1	120 kHz SSB SCS, 100MHz bandwidth, TDD duplex mode
2	240 kHz SSB SCS, 100MHz bandwidth, TDD duplex mode
Note: The UE is only required to be tested in one of the supported test configurations.	

There are two cells in the test, PCell (Cell 1) and a FR2 neighbour cell (Cell 2) on the same frequency as the PCell. The test parameters for the Cell 1 and Cell 2 are given in Table A.7.6.1.2.1-2 ~ 6.

In the measurement control information a measurement object is configured for the frequency of the PCell, and it is indicated to the UE that event-triggered reporting with Event A3 is used.

The test consists of two successive time periods, with time duration of T1, and T2 respectively. During time duration T1, the UE shall not have any timing information of Cell 2.

Table A.7.6.1.2.1-2: General test parameters for intra-frequency event triggered reporting for SA with TDD PCell in FR2 without gap with DRX

Parameter	Unit	Config	Value		Comment
			Test 1	Test 2	
Active cell		1, 2	PCell (Cell 1)		
Neighbour cell		1, 2	Cell 2		Cell to be identified.
RF Channel Number		1, 2	1: Cell 1 and Cell 2		One TDD carrier frequency is used for the NR cells.
SMTC configuration		1, 2	SMTC.1		
A3-Offset	dB	1, 2	-6		
CP length		1, 2	Normal		
Hysteresis	dB	1, 2	0		
Time To Trigger	s	1, 2	0		
Filter coefficient		1, 2	0		L3 filtering is not used
DRX		1, 2	ODRX.1	DRX.2	DRX related parameters are defined in Table A.7.6.1.2.1-5
Time offset between Cell 1 and Cell 2		1, 2	3 μ s		Synchronous EN-DC
Time offset between Cell 2 and Cell 3		1, 2	3 μ s		Synchronous cells
T1	s	1, 2	5		
T2	s	1, 2	10	TBD	

Table A.7.6.1.2.1-3: NR Cell specific test parameters for intra-frequency event triggered reporting for SA with TDD PCell in FR2 without gap with DRX

Parameter	Unit	Config	Cell 1		Cell 2	
			T1	T2	T1	T2
TDD configuration		1, 2	TDDConf.3.1		TDDConf.3.1	
Initial BWP configuration		1, 2	DLBWP.0.1 ULBWP.0.1		DLBWP.0.1 ULBWP.0.1	
Active DL BWP configuration		1, 2	DLBWP.1.1		DLBWP.1.1	
Active UL BWP configuration		1, 2	ULBWP.1.1		ULBWP.1.1	
RLM-RS		1, 2	SSB		SSB	
PDSCH RMC configuration		1, 2	SR.3.1 TDD		N/A	
RMSI CORESET RMC configuration		1, 2	CR.3.1 TDD		CR.3.1 TDD	
Dedicated CORESET RMC configuration		1, 2	CCR.3.1 TDD		CCR.3.1 TDD	
TRS configuration		1, 2	TRS.2.1 TDD		N/A	
TCI state		1, 2	CSI-RS.Config.0		N/A	
OCNG Patterns		1, 2	OP.1		OP.1	
SSB		1	SSB.1 FR2		SSB.1 FR2	
		2	SSB.2 FR2		SSB.2 FR2	
Propagation Condition		1, 2	AWGN			

Table A.7.6.1.2.1-4: NR OTA Cell specific test parameters for intra-frequency event triggered reporting for SA with TDD PCell in FR2 without gap with DRX

Parameter	Unit	Config	Cell 2		Cell 3	
			T1	T2	T1	T2
AoA setup		1, 2	A.3.8.x			
\hat{E}_s/I_{ot}	dB	1, 2	TBD	TBD	TBD	TBD
N_{oc} Note 2	dBm/15 KHz	1, 2	TBD			
N_{oc} Note 2	dBm/SCS	1	TBD			
		2	TBD			
SS-RSRP	dBm/SCS	1	TBD	TBD	TBD	TBD
		2	TBD	TBD	TBD	TBD
\hat{E}_s/N_{oc}	dB	1, 2	TBD	TBD	TBD	TBD
I_o	dBm/95.04MHz	1, 2	TBD		TBD	
Note 1:	The resources for uplink transmission are assigned to the UE prior to the start of time period T2.					
Note 2:	Interference from other cells and noise sources not specified in the test is assumed to be constant over subcarriers and time and shall be modelled as AWGN of appropriate power for N_{oc} to be fulfilled.					
Note 3:	SS-RSRP levels have been derived from other parameters for information purposes. They are not settable parameters themselves.					

Table A.7.6.1.2.1-5: Void**Table A.7.6.1.2.1-6: Void****A.7.6.1.2.2 Test Requirements**

In test 1, the UE shall send one Event A3 triggered measurement report, with a measurement reporting delay less than X ms from the beginning of time period T2, where X is

- 7.2s for a UE supporting power class 1,
- 4.32s for a UE supporting power class 2 or 3,
- [4.32s] for a UE supporting power class 4

In test 2, the UE shall send one Event A3 triggered measurement report, with a measurement reporting delay less than X ms from the beginning of time period T2, where X is

- 51.2s for a UE supporting power class 1,
- 30.72s for a UE supporting power class 2 or 3,
- [30.72s] for a UE supporting power class 4

The UE is not required to read the neighbour cell SSB index in this test.

The UE shall not send event triggered measurement reports, as long as the reporting criteria are not fulfilled.

The rate of correct events observed during repeated tests shall be at least 90%.

NOTE: The actual overall delays measured in the test may be up to $2xTTI_{DCCH}$ higher than the measurement reporting delays above because of TTI insertion uncertainty of the measurement report in DCCH.

A.7.6.1.3 SA event triggered reporting test with per-UE gaps under non-DRX**A.7.6.1.3.1 Test purpose and Environment**

The purpose of this test is to verify that the UE makes correct reporting of an event. This test will partly verify the TDD intra-frequency cell search requirements in clause 9.2.5.1 and 9.2.5.2. Supported test configurations are shown in table A.7.6.1.3.1-1.

Table A.7.6.1.3.1-1: supported test configurations

Configuration	Description
1	120 kHz SSB SCS, 100MHz bandwidth, TDD duplex mode
2	240 kHz SSB SCS, 100MHz bandwidth, TDD duplex mode
Note: The UE is only required to be tested in one of the supported test configurations.	

There are two cells in the test, PCell (Cell 1) and a FR2 neighbour cell (Cell 2) on the same frequency as the PCell. The test parameters for the Cell 1 and Cell 2 are given in Table A.7.6.1.3.1-2 ~ 4 below.

There are two BWPs configured in Cell 1, BWP1 which contains the cell defining SSB, and BWP2 which does not contain any SSB of Cell 1. During the whole test, BWP2 is always scheduled as the active BWP for the UE.

In the measurement control information a measurement object is configured for the frequency of the PCell, and it is indicated to the UE that event-triggered reporting with Event A3 is used.

The test consists of two successive time periods, with time duration of T1, and T2 respectively. During time duration T1, the UE shall not have any timing information of Cell 2.

Table A.7.6.1.3.1-2: General test parameters for intra-frequency event triggered reporting for SA with TDD PCell in FR2 with per-UE gaps without DRX

Parameter	Unit	Config	Value	Comment
Active cell		1, 2	PCell (Cell 1)	
Neighbour cell		1, 2	Cell 2	Cell to be identified.
RF Channel Number		1, 2	1: Cell 1 and Cell 2	One TDD carrier frequency is used for the NR cells.
Gap type		1, 2	Per-UE gaps	
Measurement gap repetition periodicity	ms	1, 2	40	
Measurement gap length	ms	1, 2	6	
Measurement gap offset	ms	1, 2	39	
SMTC configuration		1, 2	SMTC.1	
CSI-RS parameters		1, 2	CSI-RS.3.2 TDD	
A3-Offset	dB	1, 2	-6	
CP length		1, 2	Normal	
Hysteresis	dB	1, 2	0	
Time To Trigger	s	1, 2	0	
Filter coefficient		1, 2	0	L3 filtering is not used
DRX		1, 2	OFF	
Time offset between Cell 1 and Cell 2		1, 2	3 μ s	Synchronous EN-DC
Time offset between Cell 2 and Cell 3		1, 2	3 μ s	Synchronous cells
T1	s	1, 2	5	
T2	s	1, 2	5	

Table A.7.6.1.3.1-3: NR Cell specific test parameters for intra-frequency event triggered reporting for SA with TDD PCell in FR2 with per-UE gaps without DRX

Parameter	Unit	Config	Cell 1		Cell 2	
			T1	T2	T1	T2
TDD configuration		1, 2	TDDConf.3.1		TDDConf.3.1	
Initial BWP configuration		1, 2	DLBWP.0.1 ULBWP.0.1		DLBWP.0.1 ULBWP.0.1	
Active DL BWP configuration		1, 2	DLBWP.1.2		DLBWP.1.1	
Active UL BWP configuration		1, 2	ULBWP.1.2		ULBWP.1.1	
RLM-RS		1, 2	CSI-RS		CSSB	
PDSCH RMC configuration		1, 2	SR.3.1 TDD		N/A	
RMSI CORESET RMC configuration		1, 2	CR.3.1 TDD		CR.3.1 TDD	
Dedicated CORESET RMC configuration		1, 2	CCR.3.1 TDD		CCR.3.1 TDD	
TRS configuration		1, 2	TRS.2.1 TDD		N/A	
TCI state		1, 2	CSI-RS.Config.0		N/A	
OCNG Patterns		1, 2	OP.1		OP.1	
SSB		1	SSB.1 FR2		SSB.1 FR2	

		2	SSB.2 FR2	SSB.2 FR2
Propagation Condition		1, 2	AWGN	

Table A.7.6.1.3.1-4: NR OTA Cell specific test parameters for intra-frequency event triggered reporting for SA with TDD PCell in FR2 with per-UE gaps without DRX

Parameter	Unit	Config	Cell 2		Cell 3	
			T1	T2	T1	T2
AoA setup		1, 2	A.3.8.x			
\hat{E}_s/I_{ot}	dB	1, 2	TBD	TBD	TBD	TBD
N_{oc} Note 2	dBm/15 KHz	1, 2	TBD			
N_{oc} Note 2	dBm/SCS	1	TBD			
		2	TBD			
SS-RSRP	dBm/SCS	1	TBD	TBD	TBD	TBD
		2	TBD	TBD	TBD	TBD
\hat{E}_s/N_{oc}	dB	1, 2	TBD	TBD	TBD	TBD
I_o	dBm/95.04MHz	1, 2	TBD		TBD	
Note 1:	The resources for uplink transmission are assigned to the UE prior to the start of time period T2.					
Note 2:	Interference from other cells and noise sources not specified in the test is assumed to be constant over subcarriers and time and shall be modelled as AWGN of appropriate power for N_{oc} to be fulfilled.					
Note 3:	SS-RSRP levels have been derived from other parameters for information purposes. They are not settable parameters themselves.					

A.7.6.1.3.2 Test Requirements

In the test, the UE shall send one Event A3 triggered measurement report, with a measurement reporting delay less than X ms from the beginning of time period T2, where X is

- 3.2s for a UE supporting power class 1,
- 1.92s for a UE supporting power class 2 or 3,
- [1.92s] for a UE supporting power class 4

The UE is not required to read the neighbour cell SSB index in this test.

The UE shall not send event triggered measurement reports, as long as the reporting criteria are not fulfilled.

The rate of correct events observed during repeated tests shall be at least 90%.

NOTE: The actual overall delays measured in the test may be up to $2 \times TTI_{DCCH}$ higher than the measurement reporting delays above because of TTI insertion uncertainty of the measurement report in DCCH.

A.7.6.1.4 SA event triggered reporting test with per-UE gaps under DRX

A.7.6.1.4.1 Test purpose and Environment

The purpose of this test is to verify that the UE makes correct reporting of an event. This test will partly verify the TDD intra-frequency cell search requirements in clause 9.2.5.1 and 9.2.5.2. Supported test configurations are shown in table A.7.6.1.4.1-1.

Table A.7.6.1.4.1-1: supported test configurations

Configuration	Description
1	120 kHz SSB SCS, 100MHz bandwidth, TDD duplex mode
2	240 kHz SSB SCS, 100MHz bandwidth, TDD duplex mode
Note: The UE is only required to be tested in one of the supported test configurations.	

There are two cells in the test, PCell (Cell 1) and a FR2 neighbour cell (Cell 2) on the same frequency as the PCell. The test parameters for the Cell 1 and Cell 2 are given in Table A.7.6.1.4.1-1 and A.7.6.1.4.1-2 below.

There are two BWPs configured in Cell 1, BWP1 which contains the cell defining SSB, and BWP2 which does not contain any SSB of Cell 1. During the whole test, BWP2 is always scheduled as the active BWP for the UE.

In the measurement control information a measurement object is configured for the frequency of the PCell, and it is indicated to the UE that event-triggered reporting with Event A3 is used.

The test consists of two successive time periods, with time duration of T1, and T2 respectively. During time duration T1, the UE shall not have any timing information of Cell 2.

Table A.7.6.1.4.1-2: General test parameters for intra-frequency event triggered reporting for SA with TDD PCell in FR2 with per-UE gaps with DRX

Parameter	Unit	Config	Value		Comment
			Test 1	Test 2	
Active cell		1, 2	PCell (Cell 1)		
Neighbour cell		1, 2	Cell 2		Cell to be identified.
RF Channel Number		1, 2	1: Cell 1 and Cell 2		One TDD carrier frequency is used for the NR cells.
Gap type		1, 2	Per-UE gaps		
Measurement gap repetition periodicity	ms	1, 2	40		
Measurement gap length	ms	1, 2	6		
Measurement gap offset	ms	1, 2	39		
SMTC configuration		1, 2	SMTC.1		
CSI-RS parameters		1, 2	CSI-RS.3.2 TDD		
A3-Offset	dB	1, 2	-6		
CP length		1, 2	Normal		
Hysteresis	dB	1, 2	0		
Time To Trigger	s	1, 2	0		
Filter coefficient		1, 2	0		L3 filtering is not used
DRX		1, 2	ODRX.1	DRX.2	DRX related parameters are defined in Table A.7.6.1.2.1-5
Time offset between Cell 1 and Cell 2		1, 2	3 μ s		Synchronous EN-DC
Time offset between Cell 2 and Cell 3		1, 2	3 μ s		Synchronous cells
T1	s	1, 2	5		
T2	s	1, 2	10	TBD	

Table A.7.6.1.4.1-3: NR Cell specific test parameters for intra-frequency event triggered reporting for SA with TDD PCell in FR2 with per-UE gaps with DRX

Parameter	Unit	Config	Cell 1		Cell 2	
			T1	T2	T1	T2
TDD configuration		1, 2	TDDConf.3.1		TDDConf.3.1	
Initial BWP configuration		1, 2	DLBWP.0.1 ULBWP.0.1		DLBWP.0.1 ULBWP.0.1	
Active DL BWP configuration		1, 2	DLBWP.1.2		DLBWP.1.1	
Active UL BWP configuration		1, 2	ULBWP.1.2		ULBWP.1.1	
RLM-RS		1, 2	SCSI-RS		SSB	
PDSCH RMC configuration		1, 2	SR.3.1 TDD		N/A	
RMSI CORESET RMC configuration		1, 2	CR.3.1 TDD		CR.3.1 TDD	
Dedicated CORESET RMC configuration		1, 2	CCR.3.1 TDD		CCR.3.1 TDD	
TRS configuration		1, 2	TRS.2.1 TDD		N/A	
TCI state		1, 2	CSI-RS.Config.0		N/A	
OCNG Patterns		1, 2	OP.1		OP.1	
SSB		1	SSB.1 FR2		SSB.1 FR2	
		2	SSB.2 FR2		SSB.2 FR2	
Propagation Condition		1, 2	AWGN			

Table A.7.6.1.4.1-4: NR OTA Cell specific test parameters for intra-frequency event triggered reporting for SA with TDD PCell in FR2 with per-UE gaps with DRX

Parameter	Unit	Config	Cell 2		Cell 3	
			T1	T2	T1	T2
AoA setup		1, 2	A.3.8.x			
\hat{E}_s/I_{ot}	dB	1, 2	TBD	TBD	TBD	TBD
N_{oc} Note 2	dBm/15 KHz	1, 2	TBD			
N_{oc} Note 2	dBm/SCS	1	TBD			
		2	TBD			
SS-RSRP	dBm/SCS	1	TBD	TBD	TBD	TBD
		2	TBD	TBD	TBD	TBD
\hat{E}_s/N_{oc}	dB	1, 2	TBD	TBD	TBD	TBD
I_o	dBm/95.04MHz	1, 2	TBD		TBD	
Note 1:	The resources for uplink transmission are assigned to the UE prior to the start of time period T2.					
Note 2:	Interference from other cells and noise sources not specified in the test is assumed to be constant over subcarriers and time and shall be modelled as AWGN of appropriate power for N_{oc} to be fulfilled.					
Note 3:	SS-RSRP levels have been derived from other parameters for information purposes. They are not settable parameters themselves.					

Table A.7.6.1.4.1-5: Void**Table A.7.6.1.4.1-6:Void****A.7.6.1.4.2 Test Requirements**

In test 1, the UE shall send one Event A3 triggered measurement report, with a measurement reporting delay less than X ms from the beginning of time period T2, where X is

- 7.2s for a UE supporting power class 1,
- 4.32s for a UE supporting power class 2 or 3,
- TBD for a UE supporting power class 4

In test 2, the UE shall send one Event A3 triggered measurement report, with a measurement reporting delay less than X ms from the beginning of time period T2, where X is

- 51.2s for a UE supporting power class 1,
- 30.72s for a UE supporting power class 2 or 3,
- [30.72s] for a UE supporting power class 4

The UE is not required to read the neighbour cell SSB index in this test.

The UE shall not send event triggered measurement reports, as long as the reporting criteria are not fulfilled.

The rate of correct events observed during repeated tests shall be at least 90%.

NOTE: The actual overall delays measured in the test may be up to $2xTTI_{DCCH}$ higher than the measurement reporting delays above because of TTI insertion uncertainty of the measurement report in DCCH.

A.7.6.2 Inter-frequency Measurements**A.7.6.2.1 SA event triggered reporting tests For FR2 without SSB time index detection when DRX is not used (PCell in FR2)****A.7.6.2.1.1 Test Purpose and Environment**

The purpose of this test is to verify that the UE makes correct reporting of an event. This test will partly verify the SA inter-frequency NR cell search requirements in clause 9.3.4.

In this test, there are two cells: NR cell 1 as PCell in FR2 on NR RF channel 1 and NR cell 2 as neighbour cell in FR2 on NR RF channel 2. The test parameters and configurations are given in Tables A.7.6.2.1.1-1, A.7.6.2.1.1-2, and A.7.6.2.1.1-3. The TCI status for cell2 is defined in table [TBD] and TRS configuration for cell2 is defined in table [TBD].

In test 1 measurement gap pattern configuration # 0 as defined in Table A.7.6.2.1.1-2 is provided for UE that does not support per-FR gap and in test 2 measurement gap pattern configuration #13 as defined in Table A.7.6.2.1.1-2 is provided for UE that supports per-FR gap.

In the measurement control information, it is indicated to the UE that event-triggered reporting with Event A3 is used. The test consists of two successive time periods, with time duration of T1, and T2 respectively. During time duration T1, the UE shall not have any timing information of NR cell 2.

Supported test configurations are shown in table A.7.6.2.1.1-1.

Table A.7.6.2.1.1-1 SA event triggered reporting tests without SSB index reading for FR2-FR2

Config	Description
1	120 kHz SSB SCS, 100MHz bandwidth, TDD duplex mode
Note 1: target NR cell has the same SCS, BW and duplex mode as NR serving cell	

Table A.7.6.2.1.1-1: General test parameters for SA inter-frequency event triggered reporting for FR2 without SSB time index detection

Parameter	Unit	Test configuration	Value		Comment
			Test 1	Test 2	
NR RF Channel Number		Config 1	1, 2		Two FR1 NR carrier frequencies is used.
Active cell		Config 1	NR cell 1 (Pcell)		NR Cell 1 is on NR RF channel number 1.
Neighbour cell		Config 1	NR cell 2		NR cell 2 is on NR RF channel number 2.
Gap Pattern Id		Config 1	0	13	As specified in clause 9.1.2-1.
Measurement gap offset		Config 1	39	39	
SMTC-SSB parameters		Config 1	SSB.3 FR2		As specified in clause A.3.10.2
A3-Offset	dB	Config 1	-6		
Hysteresis	dB	Config 1	0		
CP length		Config 1	Normal		
TimeToTrigger	s	Config 1	0		
Filter coefficient		Config 1	0		L3 filtering is not used
DRX		Config 1	OFF		DRX is not used
Time offset between serving and neighbour cells		Config 1	3μs		Synchronous cells.
T1	s	Config 1	5		
T2	s	Config 1	TBD	TBD	

Table A.7.6.2.1.1-3: Cell specific test parameters for SA inter-frequency event triggered reporting for FR2 without SSB time index detection

Parameter		Unit	Test configuration	Cell 1		Cell 1	
				T1	T2	T1	T2
NR RF Channel Number			Config 1	1		2	
Duplex mode			Config 1	TDD		TDD	
TDD configuration			Config 1	TDDConf.3.1		TDDConf.3.1	
BW _{channel}		MHz	Config 1	100: N _{RB,c} = 66		100: N _{RB,c} = 66	
BWP BW		MHz	Config 1	100: N _{RB,c} = 66		100: N _{RB,c} = 66	
BWP configuration	Initial DL BWP		Config 1	DLBWP.0.1		N/A	
	Dedicated DL BWP			DLBWP.1.1		N/A	
	Dedicated UL BWP			ULBWP.1.1		N/A	
OCNG Patterns defined in A.3.2.1.1 (OP.1)			Config 1	OP.1		OP.1	

PDSCH Reference measurement channel		Config 1	SR.3.1 TDD	-		
CORESET Reference Channel		Config 1	CR.3.1 TDD	-		
SMTC configuration defined in A.3.11.1 and A.3.11.2		Config 1	SMTC.1	SMTC.1		
PDSCH/PDCCH subcarrier spacing	kHz	Config 1	120	120		
EPRE ratio of PSS to SSS		Config 1	0	0		
EPRE ratio of PBCH DMRS to SSS						
EPRE ratio of PBCH to PBCH DMRS						
EPRE ratio of PDCCH DMRS to SSS						
EPRE ratio of PDCCH to PDCCH DMRS						
EPRE ratio of PDSCH DMRS to SSS						
EPRE ratio of PDSCH to PDSCH						
EPRE ratio of OCNG DMRS to SSS(Note 1)						
EPRE ratio of OCNG to OCNG DMRS (Note 1)						
UE orientation around TBD axis and TBD axis	degrees	Config 1	NA	TBD		
Relative difference in angle of arrival of cell 3 relative to cell 2	degrees	Config 1	NA	NA	TBD	
N_{oc} Note2	dBm/15 kHz Note5		-98	-98		
N_{oc} Note2	dBm/S CS Note4	Config 1	-89	-89		
SS-RSRP Note 3	dBm/S CS Note5	Config 1	-85	-85	-Infinity	-82
\hat{E}_s / I_{ot}	dB	Config 1	4	4	-Infinity	7
\hat{E}_s / N_{oc}	dB	Config 1	4	4	-Infinity	7
I_o Note3	dBm/95 .04 MHz Note5	Config 1	-57.55	-57.55	-Infinity	-56.00
Propagation Condition		Config 1	AWGN			
<p>Note 1: OCNG shall be used such that both cells are fully allocated and a constant total transmitted power spectral density is achieved for all OFDM symbols.</p> <p>Note 2: Interference from other cells and noise sources not specified in the test is assumed to be constant over subcarriers and time and shall be modelled as AWGN of appropriate power for N_{oc} to be fulfilled.</p> <p>Note 3: SS-RSRP and I_o levels have been derived from other parameters for information purposes. They are not settable parameters themselves.</p> <p>Note 4: SS-RSRP minimum requirements are specified assuming independent interference and noise at each receiver antenna port.</p> <p>Note 5: Equivalent power received by an antenna with 0dBi gain at the centre of the quiet zone</p> <p>Note 6: As observed with 0dBi gain antenna at the centre of the quiet zone</p>						

A.7.6.2.1.2 Test Requirements

In test 1 with per-UE gap, the UE shall send one Event A3 triggered measurement report, with a measurement reporting delay less than [TBD] ms from the beginning of time period T2. The UE shall not send event triggered measurement reports, as long as the reporting criteria are not fulfilled. The rate of correct events observed during repeated tests shall be at least 90%.

In test 2 with per-FR gap, the UE shall send one Event A3 triggered measurement report, with a measurement reporting delay less than [TBD] ms from the beginning of time period T2. The UE shall not send event triggered measurement reports, as long as the reporting criteria are not fulfilled. The rate of correct events observed during repeated tests shall be at least 90%.

In test 1 and 2 UE is not required to report SSB time index.

NOTE: The actual overall delays measured in the test may be up to $2xTTI_{DCCCH}$ higher than the measurement reporting delays above because of TTI insertion uncertainty of the measurement report in DCCCH.

A.7.6.2.2 SA event triggered reporting tests For FR2 without SSB time index detection when DRX is used (PCell in FR2)

A.7.6.2.2.1 Test Purpose and Environment

The purpose of this test is to verify that the UE makes correct reporting of an event. This test will partly verify the SA inter-frequency NR cell search requirements in clause 9.3.4.

In this test, there are two cells: NR cell 1 as PCell in FR2 on NR RF channel 1 and NR cell 2 as neighbour cell in FR2 on NR RF channel 2. The test parameters and configurations are given in Tables A.7.6.2.2.1-1, A.7.6.2.2.1-2, and A.7.6.2.2.1-3. The TCI status for cell2 is defined in table [TBD] and TRS configuration for cell2 is defined in table [TBD].

In test 1&2 measurement gap pattern configuration # 0 as defined in Table A.7.6.2.2.1-2 is provided for UE that does not support per-FR gap and in test 3&4 measurement gap pattern configuration #13 as defined in Table A.7.6.2.2.1-2 is provided for UE that supports per-FR gap.

In the measurement control information, it is indicated to the UE that event-triggered reporting with Event A3 is used. The test consists of two successive time periods, with time duration of T1, and T2 respectively. During time duration T1, the UE shall not have any timing information of NR cell 2.

Supported test configurations are shown in table A.7.6.2.2.1-1.

UE needs to be provided at least once every 500ms with new Timing Advance Command MAC control element to restart the Time alignment timer to keep UE uplink time alignment. Furthermore UE is allocated with PUSCH resource at every DRX cycle.

Table A.7.6.2.2.1-1 SA event triggered reporting tests without SSB index reading for FR2-FR2

Config	Description
1	120 kHz SSB SCS, 100MHz bandwidth, TDD duplex mode
Note 1: target NR cell has the same SCS, BW and duplex mode as NR serving cell	

Table A.7.6.2.1-1: General test parameters for SA inter-frequency event triggered reporting for FR2 without SSB time index detection

Parameter	Unit	Test configuration	Value				Comment
			Test 1	Test 2	Test 3	Test 4	
NR RF Channel Number		Config 1	1, 2				Two FR1 NR carrier frequencies is used.
Active cell		Config 1	NR cell 1 (Pcell)				NR Cell 1 is on NR RF channel number 1.
Neighbour cell		Config 1	NR cell 2				NR cell 2 is on NR RF channel number 2.
Gap Pattern Id		Config 1	0		13		As specified in clause 9.1.2-1.
Measurement gap offset		Config 1	39		39		
SMTC-SSB parameters		Config 1	SSB.3 FR2				As specified in clause A.3.10.2
A3-Offset	dB	Config 1	-6				
Hysteresis	dB	Config 1	0				
CP length		Config 1	Normal				
TimeToTrigger	s	Config 1	0				
Filter coefficient		Config 1	0				L3 filtering is not used
DRX		Config 1	DRX .1	DRX .2	DRX .1	DRX .2	DRX is used
Time offset between serving and neighbour cells		Config 1	3 μ s				Synchronous cells.
T1	s	Config 1	5				
T2	s	Config 1	TBD	TBD	TBD	TBD	

Table A.7.6.2.1-3: Cell specific test parameters for CA inter-frequency event triggered reporting without SSB time index detection

Parameter		Unit	Test configuration	Cell 1		Cell 2	
				T1	T2	T1	T2
NR RF Channel Number			Config 1	1		2	
TDD configuration			Config 1	TDDConf.3.1		TDDConf.3.1	
Duplex mode			Config 1	TDD		TDD	
BW _{channel}		MHz	Config 1	100: N _{RB,c} = 66		100: N _{RB,c} = 66	
BWP BW		MHz	Config 1	100: N _{RB,c} = 66		100: N _{RB,c} = 66	
BWP configuration	Initial DL BWP		Config 1	DLBWP.0.1		N/A	
	Dedicated DL BWP			DLBWP.1.1		N/A	
	Dedicated UL BWP			ULBWP.1.1		N/A	
OCNG Patterns defined in A.3.2.1.1 (OP.1)			Config 1	OP.1		OP.1	
PDSCH Reference measurement channel			Config 1	SR.3.1 TDD		-	
CORESET Reference Channel			Config 1	CR.3.1 TDD		-	
SMTC configuration defined in A.3.11.1 and A.3.11.2			Config 1	SMTC.1		SMTC.1	

PDSCH/PDCCH subcarrier spacing	kHz	Config 1	120		120	
EPRE ratio of PSS to SSS		Config 1	0		0	
EPRE ratio of PBCH DMRS to SSS						
EPRE ratio of PBCH to PBCH DMRS						
EPRE ratio of PDCCH DMRS to SSS						
EPRE ratio of PDCCH to PDCCH DMRS						
EPRE ratio of PDSCH DMRS to SSS						
EPRE ratio of PDSCH to PDSCH						
EPRE ratio of OCNG DMRS to SSS(Note 1)						
EPRE ratio of OCNG to OCNG DMRS (Note 1)						
UE orientation around TBD axis and TBD axis	degrees					
Relative difference in angle of arrival of cell 3 relative to cell 2	degrees	Config 1	NA		NA	TBD
N_{oc} Note2	dBm/15 kHz Note5		-98		-98	
N_{oc} Note2	dBm/S CS Note4	Config 1	-89		-89	
SS-RSRP Note 3	dBm/S CS Note5	Config 1	-85	-85	-Infinity	-82
\hat{E}_s/I_{ot}	dB	Config 1	4	4	-Infinity	7
\hat{E}_s/N_{oc}	dB	Config 1	4	4	-Infinity	7
I_o Note3	dBm/95 .04 MHz Note5	Config 1	-57.55	-57.55	-Infinity	-56.00
Propagation Condition		Config 1	AWGN			
<p>Note 1: OCNG shall be used such that both cells are fully allocated and a constant total transmitted power spectral density is achieved for all OFDM symbols.</p> <p>Note 2: Interference from other cells and noise sources not specified in the test is assumed to be constant over subcarriers and time and shall be modelled as AWGN of appropriate power for N_{oc} to be fulfilled.</p> <p>Note 3: SS-RSRP and I_o levels have been derived from other parameters for information purposes. They are not settable parameters themselves.</p> <p>Note 4: SS-RSRP minimum requirements are specified assuming independent interference and noise at each receiver antenna port.</p> <p>Note 5: Equivalent power received by an antenna with 0dBi gain at the centre of the quiet zone</p> <p>Note 6: As observed with 0dBi gain antenna at the centre of the quiet zone</p>						

A.7.6.2.2.2 Test Requirements

In test 1 with per-UE gap, the UE shall send one Event A3 triggered measurement report, with a measurement reporting delay less than [TBD] ms from the beginning of time period T2. The UE shall not send event triggered

measurement reports, as long as the reporting criteria are not fulfilled. The rate of correct events observed during repeated tests shall be at least 90%.

In test 2 with per-FR gap, the UE shall send one Event A3 triggered measurement report, with a measurement reporting delay less than [TBD] ms from the beginning of time period T2. The UE shall not send event triggered measurement reports, as long as the reporting criteria are not fulfilled. The rate of correct events observed during repeated tests shall be at least 90%.

In test 3 with per-UE gap, the UE shall send one Event A3 triggered measurement report, with a measurement reporting delay less than [TBD] ms from the beginning of time period T2. The UE shall not send event triggered measurement reports, as long as the reporting criteria are not fulfilled. The rate of correct events observed during repeated tests shall be at least 90%.

In test 4 with per-FR gap, the UE shall send one Event A3 triggered measurement report, with a measurement reporting delay less than [TBD] ms from the beginning of time period T2. The UE shall not send event triggered measurement reports, as long as the reporting criteria are not fulfilled. The rate of correct events observed during repeated tests shall be at least 90%.

In test 1, 2, 3 and 4 UE is not required to report SSB time index.

NOTE: The actual overall delays measured in the test may be up to $2xTTI_{DCCCH}$ higher than the measurement reporting delays above because of TTI insertion uncertainty of the measurement report in DCCCH.

A.7.6.2.3 SA event triggered reporting tests For FR2 with SSB time index detection when DRX is not used (PCell in FR2)

A.7.6.2.3.1 Test Purpose and Environment

The purpose of this test is to verify that the UE makes correct reporting of an event. This test will partly verify the SA inter-frequency NR cell search requirements in clause 9.3.4.

In this test, there are two cells: NR cell 1 as PCell in FR2 on NR RF channel 1 and NR cell 2 as neighbour cell in FR2 on NR RF channel 2. The test parameters and configurations are given in Tables A.7.6.2.3.1-1, A.7.6.2.3.1-2, and A.7.6.2.3.1-3. The TCI status for cell2 is defined in table [TBD] and TRS configuration for cell2 is defined in table [TBD].

In test 1 measurement gap pattern configuration # 0 as defined in Table A.7.6.2.3.1-2 is provided for UE that does not support per-FR gap and in test 2 measurement gap pattern configuration #13 as defined in Table A.7.6.2.3.1-2 is provided for UE that supports per-FR gap.

In the measurement control information, it is indicated to the UE that event-triggered reporting with Event A3 is used. The test consists of two successive time periods, with time duration of T1, and T2 respectively. During time duration T1, the UE shall not have any timing information of NR cell 2.

Supported test configurations are shown in table A.7.6.2.3.1-1.

Table A.7.6.2.3.1-1 SA event triggered reporting tests with SSB index reading for FR2-FR2

Config	Description
1	120 kHz SSB SCS, 100MHz bandwidth, TDD duplex mode
Note 1:	target NR cell has the same SCS, BW and duplex mode as NR serving cell

Table A.7.6.2.3.1-1: General test parameters for SA inter-frequency event triggered reporting for FR2 with SSB time index detection

Parameter	Unit	Test configuration	Value		Comment
			Test 1	Test 2	
NR RF Channel Number		Config 1	1, 2		Two FR1 NR carrier frequencies is used.
Active cell		Config 1	NR cell 1 (Pcell)		NR Cell 1 is on NR RF channel number 1.
Neighbour cell		Config 1	NR cell 2		NR cell 2 is on NR RF channel number 2.
Gap Pattern Id		Config 1	0	13	As specified in clause 9.1.2-1.
Measurement gap offset		Config 1	39	39	
SMTC-SSB parameters		Config 1	SSB.3 FR2		As specified in clause A.3.10.2
A3-Offset	dB	Config 1	-6		
Hysteresis	dB	Config 1	0		
CP length		Config 1	Normal		
TimeToTrigger	s	Config 1	0		
Filter coefficient		Config 1	0		L3 filtering is not used
DRX		Config 1	OFF		DRX is not used
Time offset between serving and neighbour cells		Config 1	3µs		Synchronous cells.
T1	s	Config 1	5		
T2	s	Config 1	TBD	TBD	

Table A.7.6.2.3.1-3: Cell specific test parameters for SA inter-frequency event triggered reporting for FR2 with SSB time index detection

Parameter		Unit	Test configuration	Cell 1		Cell 2	
				T1	T2	T1	T2
NR RF Channel Number			Config 1	1		2	
Duplex mode			Config 1	TDD		TDD	
TDD configuration			Config 1	TDDConf.3.1		TDDConf.3.1	
BW _{channel}		MHz	Config 1	100: N _{RB,c} = 66		100: N _{RB,c} = 66	
BWP BW		MHz	Config 1	100: N _{RB,c} = 66		100: N _{RB,c} = 66	
BWP configuration	Initial DL BWP		Config 1	DLBWP.0.1		N/A	
	Dedicated DL BWP			DLBWP.1.1		N/A	
	Dedicated UL BWP			ULBWP.1.1		N/A	
OCNG Patterns defined in A.3.2.1.1 (OP.1)			Config 1	OP.1		OP.1	
PDSCH Reference measurement channel			Config 1	SR.3.1 TDD		-	
CORESET Reference Channel			Config 1	CR.3.1 TDD		-	
SMTC configuration defined in A.3.11.1 and A.3.11.2			Config 1	SMTC.1		SMTC.1	

PDSCH/PDCCH subcarrier spacing	kHz	Config 1	120		120	
EPRE ratio of PSS to SSS		Config 1	0		0	
EPRE ratio of PBCH DMRS to SSS						
EPRE ratio of PBCH to PBCH DMRS						
EPRE ratio of PDCCH DMRS to SSS						
EPRE ratio of PDCCH to PDCCH DMRS						
EPRE ratio of PDSCH DMRS to SSS						
EPRE ratio of PDSCH to PDSCH						
EPRE ratio of OCNG DMRS to SSS(Note 1)						
EPRE ratio of OCNG to OCNG DMRS (Note 1)						
UE orientation around TBD axis and TBD axis	degrees					
Relative difference in angle of arrival of cell 3 relative to cell 2	degrees	Config 1	NA		NA	TBD
N_{oc} Note2	dBm/15 kHz Note5		-98		-98	
N_{oc} Note2	dBm/S CS Note4	Config 1	-89		-89	
SS-RSRP Note 3	dBm/S CS Note5	Config 1	-85	-85	-Infinity	-82
\hat{E}_s/I_{ot}	dB	Config 1	4	4	-Infinity	7
\hat{E}_s/N_{oc}	dB	Config 1	4	4	-Infinity	7
I_o Note3	dBm/95 .04 MHz Note5	Config 1	-57.55	-57.55	-Infinity	-56.00
Propagation Condition		Config 1	AWGN			
<p>Note 1: OCNG shall be used such that both cells are fully allocated and a constant total transmitted power spectral density is achieved for all OFDM symbols.</p> <p>Note 2: Interference from other cells and noise sources not specified in the test is assumed to be constant over subcarriers and time and shall be modelled as AWGN of appropriate power for N_{oc} to be fulfilled.</p> <p>Note 3: SS-RSRP and I_o levels have been derived from other parameters for information purposes. They are not settable parameters themselves.</p> <p>Note 4: SS-RSRP minimum requirements are specified assuming independent interference and noise at each receiver antenna port.</p> <p>Note 5: Equivalent power received by an antenna with 0dBi gain at the centre of the quiet zone</p> <p>Note 6: As observed with 0dBi gain antenna at the centre of the quiet zone</p>						

A.7.6.2.3.2 Test Requirements

In test 1 with per-UE gap, the UE shall send one Event A3 triggered measurement report, with a measurement reporting delay less than [TBD] ms from the beginning of time period T2. The UE shall not send event triggered

measurement reports, as long as the reporting criteria are not fulfilled. The rate of correct events observed during repeated tests shall be at least 90%.

In test 2 with per-FR gap, the UE shall send one Event A3 triggered measurement report, with a measurement reporting delay less than [TBD] ms from the beginning of time period T2. The UE shall not send event triggered measurement reports, as long as the reporting criteria are not fulfilled. The rate of correct events observed during repeated tests shall be at least 90%.

In test 1 and 2 UE is required to report SSB time index.

NOTE: The actual overall delays measured in the test may be up to $2 \times TTI_{DCCCH}$ higher than the measurement reporting delays above because of TTI insertion uncertainty of the measurement report in DCCCH.

A.7.6.2.4 SA event triggered reporting tests For FR2 with SSB time index detection when DRX is used (PCell in FR2)

A.7.6.2.4.1 Test Purpose and Environment

The purpose of this test is to verify that the UE makes correct reporting of an event. This test will partly verify the SA inter-frequency NR cell search requirements in clause 9.3.4.

In this test, there are two cells: NR cell 1 as PCell in FR2 on NR RF channel 1 and NR cell 2 as neighbour cell in FR2 on NR RF channel 2. The test parameters and configurations are given in Tables A.7.6.2.4.1-1, A.7.6.2.4.1-2, and A.7.6.2.4.1-3. The TCI status for cell2 is defined in table [TBD] and TRS configuration for cell2 is defined in table [TBD].

In test 1&2 measurement gap pattern configuration # 0 as defined in Table A.7.6.2.4.1-2 is provided for UE that does not support per-FR gap and in test 3&4 measurement gap pattern configuration #13 as defined in Table A.7.6.2.4.1-2 is provided for UE that supports per-FR gap.

In the measurement control information, it is indicated to the UE that event-triggered reporting with Event A3 is used. The test consists of two successive time periods, with time duration of T1, and T2 respectively. During time duration T1, the UE shall not have any timing information of NR cell 2.

Supported test configurations are shown in table A.7.6.2.4.1-1.

UE needs to be provided at least once every 500ms with new Timing Advance Command MAC control element to restart the Time alignment timer to keep UE uplink time alignment. Furthermore UE is allocated with PUSCH resource at every DRX cycle.

Table A.7.6.2.4.1-1: SA event triggered reporting tests with SSB index reading for FR2-FR2

Config	Description
1	120 kHz SSB SCS, 100MHz bandwidth, TDD duplex mode
Note 1:	target NR cell has the same SCS, BW and duplex mode as NR serving cell

Table A.7.6.2.4.1-1: General test parameters for SA inter-frequency event triggered reporting for FR2 with SSB time index detection

Parameter	Unit	Test configuration	Value				Comment
			Test 1	Test 2	Test 3	Test 4	
NR RF Channel Number		Config 1	1, 2				Two FR1 NR carrier frequencies is used.
Active cell		Config 1	NR cell 1 (Pcell)				NR Cell 1 is on NR RF channel number 1.
Neighbour cell		Config 1	NR cell 2				NR cell 2 is on NR RF channel number 2.
Gap Pattern Id		Config 1	0		13		As specified in clause 9.1.2-1.
Measurement gap offset		Config 1	39		39		
SMTC-SSB parameters		Config 1	SSB.3 FR2				As specified in clause A.3.10.2
A3-Offset	dB	Config 1	-6				
Hysteresis	dB	Config 1	0				
CP length		Config 1	Normal				
TimeToTrigger	s	Config 1	0				
Filter coefficient		Config 1	0				L3 filtering is not used
DRX		Config 1	DRX .1	DRX .2	DRX .1	DRX .2	DRX is used
Time offset between serving and neighbour cells		Config 1	3 μ s				Synchronous cells.
T1	s	Config 1	5				
T2	s	Config 1	TBD	TBD	TBD	TBD	

Table A.7.6.2.4.1-3: Cell specific test parameters for CA inter-frequency event triggered reporting with SSB time index detection

Parameter		Unit	Test configuration	Cell 1		Cell 2	
				T1	T2	T1	T2
NR RF Channel Number			Config 1	1		2	
Duplex mode			Config 1	TDD		TDD	
TDD configuration			Config 1	TDDConf.3.1		TDDConf.3.1	
BW _{channel}		MHz	Config 1	100: N _{RB,c} = 66		100: N _{RB,c} = 66	
BWP BW		MHz	Config 1	100: N _{RB,c} = 66		100: N _{RB,c} = 66	
BWP configuration	Initial DL BWP		Config 1	DLBWP.0.1		N/A	
	Dedicated DL BWP			DLBWP.1.1		N/A	
	Dedicated UL BWP			ULBWP.1.1		N/A	
OCNG Patterns defined in A.3.2.1.1 (OP.1)			Config 1	OP.1		OP.1	
PDSCH Reference measurement channel			Config 1	SR.3.1 TDD		-	
CORESET Reference Channel			Config 1	CR.3.1 TDD		-	
SMTC configuration defined in A.3.11.1 and A.3.11.2			Config 1	SMTC.1		SMTC.1	

PDSCH/PDCCH subcarrier spacing	kHz	Config 1	120		120	
EPRE ratio of PSS to SSS		Config 1	0		0	
EPRE ratio of PBCH DMRS to SSS						
EPRE ratio of PBCH to PBCH DMRS						
EPRE ratio of PDCCH DMRS to SSS						
EPRE ratio of PDCCH to PDCCH DMRS						
EPRE ratio of PDSCH DMRS to SSS						
EPRE ratio of PDSCH to PDSCH						
EPRE ratio of OCNG DMRS to SSS(Note 1)						
EPRE ratio of OCNG to OCNG DMRS (Note 1)						
UE orientation around TBD axis and TBD axis	degrees					
Relative difference in angle of arrival of cell 3 relative to cell 2	degrees	Config 1	NA		NA	TBD
N_{oc} Note2	dBm/15 kHz Note5		-98		-98	
N_{oc} Note2	dBm/S CS Note4	Config 1	-89		-89	
SS-RSRP Note 3	dBm/S CS Note5	Config 1	-85	-85	-Infinity	-82
\hat{E}_s / I_{ot}	dB	Config 1	4	4	-Infinity	7
\hat{E}_s / N_{oc}	dB	Config 1	4	4	-Infinity	7
I_o Note3	dBm/95 .04 MHz Note5	Config 1	-57.55	-57.55	-Infinity	-56.00
Propagation Condition		Config 1	AWGN			
<p>Note 1: OCNG shall be used such that both cells are fully allocated and a constant total transmitted power spectral density is achieved for all OFDM symbols.</p> <p>Note 2: Interference from other cells and noise sources not specified in the test is assumed to be constant over subcarriers and time and shall be modelled as AWGN of appropriate power for N_{oc} to be fulfilled.</p> <p>Note 3: SS-RSRP and I_o levels have been derived from other parameters for information purposes. They are not settable parameters themselves.</p> <p>Note 4: SS-RSRP minimum requirements are specified assuming independent interference and noise at each receiver antenna port.</p> <p>Note 5: Equivalent power received by an antenna with 0dBi gain at the centre of the quiet zone</p> <p>Note 6: As observed with 0dBi gain antenna at the centre of the quiet zone</p>						

A.7.6.2.4.2 Test Requirements

In test 1 with per-UE gap, the UE shall send one Event A3 triggered measurement report, with a measurement reporting delay less than [TBD] ms from the beginning of time period T2. The UE shall not send event triggered

measurement reports, as long as the reporting criteria are not fulfilled. The rate of correct events observed during repeated tests shall be at least 90%.

In test 2 with per-FR gap, the UE shall send one Event A3 triggered measurement report, with a measurement reporting delay less than [TBD] ms from the beginning of time period T2. The UE shall not send event triggered measurement reports, as long as the reporting criteria are not fulfilled. The rate of correct events observed during repeated tests shall be at least 90%.

In test 3 with per-UE gap, the UE shall send one Event A3 triggered measurement report, with a measurement reporting delay less than [TBD] ms from the beginning of time period T2. The UE shall not send event triggered measurement reports, as long as the reporting criteria are not fulfilled. The rate of correct events observed during repeated tests shall be at least 90%.

In test 4 with per-FR gap, the UE shall send one Event A3 triggered measurement report, with a measurement reporting delay less than [TBD] ms from the beginning of time period T2. The UE shall not send event triggered measurement reports, as long as the reporting criteria are not fulfilled. The rate of correct events observed during repeated tests shall be at least 90%.

In test 1, 2, 3 and 4 UE is required to report SSB time index.

NOTE: The actual overall delays measured in the test may be up to $2xTTI_{DCCCH}$ higher than the measurement reporting delays above because of TTI insertion uncertainty of the measurement report in DCCCH.

A.7.6.2.5 SA event triggered reporting tests for FR2 without SSB time index detection when DRX is not used (PCell in FR1)

A.7.6.2.5.1 Test Purpose and Environment

The purpose of this test is to verify that the UE makes correct reporting of an event. This test will partly verify the SA inter-frequency NR cell search requirements in clause 9.3.4.

In this test, there are two cells: NR cell 1 as PCell in FR1 on NR RF channel 2 and NR cell 2 as neighbour cell in FR2 on NR RF channel 2. The test parameters and configurations are given in Tables A.7.6.2.5.1-1, A.7.6.2.5.1-2, and A.7.6.2.5.1-3. The TCI status for cell2 is defined in table [TBD] and TRS configuration for cell2 is defined in table [TBD].

In test 1 measurement gap pattern configuration # 0 as defined in Table A.7.6.2.5.1-2 is provided for a UE that does not support per-FR gap and in test 2 measurement gap pattern configuration #13 as defined in Table A.7.6.2.5.1-2 is provided for UE that support per-FR gap.

In the measurement control information, it is indicated to the UE that event-triggered reporting with Event A3 is used. The test consists of two successive time periods, with time duration of T1, and T2 respectively. During time duration T1, the UE shall not have any timing information of NR cell 3.

Supported test configurations are shown in table A.7.6.2.5.1-1.

Table A.7.6.2.5.1-1 SA event triggered reporting tests without SSB index reading for FR1-FR2

Config	Description of serving cell	Description of target cell
1	NR 15 kHz SSB SCS, 10MHz bandwidth, FDD duplex mode	120 kHz SSB SCS,
2	NR 15 kHz SSB SCS, 10MHz bandwidth, TDD duplex mode	100MHz bandwidth, TDD
3	NR 30kHz SSB SCS, 40MHz bandwidth, TDD duplex mode	duplex mode
Note:	The UE is only required to be tested in one of the supported test configurations	

Table A.7.6.2.5.1-2: General test parameters for SA inter-frequency event triggered reporting for FR2 without SSB time index detection

Parameter	Unit	Test configuration	Value		Comment
			Test 1	Test 2	
NR RF Channel Number		Config 1,2,3	1, 2		Two NR carrier frequencies is used.
Active cell		Config 1,2,3	NR cell 1 (Pcell)		NR Cell 1 is on NR RF channel number 1.
Neighbour cell		Config 1,2,3	NR cell 2		NR cell 2 is on NR RF channel number 2.
Gap Pattern Id		Config 1,2,3	0	13	As specified in clause 9.1.2-1.
Measurement gap offset		Config 1,2,3	39	39	
SMTC-SSB parameters on NR RF Channel 1		Config 1	SSB.1 FR1		As specified in clause A.3.10.1
		Config 2	SSB.1 FR1		As specified in clause A.3.10.1
		Config 3	SSB.2 FR1		As specified in clause A.3.10.1
SMTC-SSB parameters on NR RF Channel 2		Config 1,2,3	SSB.3 FR2		As specified in clause A.3.10.2
<i>offsetMO</i>	dB	Config 1,2,3	6		
Hysteresis	dB	Config 1,2,3	0		
<i>a4-Threshold</i>	dBm	Config 1,2,3	TBD		
CP length		Config 1,2,3	Normal		
TimeToTrigger	s	Config 1,2,3	0		
Filter coefficient		Config 1,2,3	0		L3 filtering is not used
DRX		Config 1,2,3	OFF		DRX is not used
Time offset between serving and neighbour cells		Config 1	3ms		Asynchronous cells. The timing of Cell 2 is 3ms later than the timing of Cell 1.
		Config 2,3	3μs		Synchronous cells.
T1	s	Config 1,2,3	5		
T2	s	Config 1,2,3	TBD	TBD	

Table A.7.6.2.5.1-3: Cell specific test parameters for SA inter-frequency event triggered reporting for FR2 without SSB time index detection

Parameter	Unit	Test configuration	Cell 1		Cell 2	
			T1	T2	T1	T2
NR RF Channel Number		Config 1,2,3	1		2	
Duplex mode		Config 1	FDD		TDD	
		Config 2,3	TDD		TDD	
TDD configuration		Config 1	Not Applicable		TDDConf.3.1	
		Config 2	TDDConf.1.1		TDDConf.3.1	
		Config 3	TDDConf.2.1		TDDConf.3.1	
BW _{channel}	MHz	Config 1	10: N _{RB,c} = 52		100: N _{RB,c} = 66	
		Config 2	10: N _{RB,c} = 52		100: N _{RB,c} = 66	
		Config 3	40: N _{RB,c} = 106		100: N _{RB,c} = 66	
BWP BW	MHz	Config 1	10: N _{RB,c} = 52		100: N _{RB,c} = 66	

			Config 2	10: $N_{RB,c} = 52$	100: $N_{RB,c} = 66$	
			Config 3	40: $N_{RB,c} = 106$	100: $N_{RB,c} = 66$	
BWP configuration	Initial DL BWP		Config 1,2,3	DLBWP.0.1	N/A	
	Dedicated DL BWP			DLBWP.1.1	N/A	
	Dedicated UL BWP			ULBWP.1.1	N/A	
OCNG Patterns defined in A.3.2.1.1 (OP.1)			Config 1,2,3	OP.1	OP.1	
PDSCH Reference measurement channel			Config 1	SR.1.1 FDD	-	
			Config 2	SR.1.1 TDD		
			Config 3	SR2.1 TDD		
CORESET Reference Channel			Config 1	CR.1.1 FDD	-	
			Config 2	CR.1.1 TDD		
			Config 3	CR2.1 TDD		
SMTC configuration defined in A.3.11.1 and A.3.11.2			Config 1	SMTC.2	SMTC.2	
			Config 2,3	SMTC.1	SMTC.1	
PDSCH/PDCCH subcarrier spacing	kHz		Config 1,2	15	120	
			Config 3	30	120	
EPRE ratio of PSS to SSS		Config 1,2,3	0	0	0	
EPRE ratio of PBCH DMRS to SSS						
EPRE ratio of PBCH to PBCH DMRS						
EPRE ratio of PDCCH DMRS to SSS						
EPRE ratio of PDCCH to PDCCH DMRS						
EPRE ratio of PDSCH DMRS to SSS						
EPRE ratio of PDSCH to PDSCH						
EPRE ratio of OCNG DMRS to SSS(Note 1)						
EPRE ratio of OCNG to OCNG DMRS (Note 1)						
UE orientation around TBD axis and TBD axis	degrees	Config 1,2,3	NA	TBD		
Relative difference in angle of arrival of cell 3 relative to cell 2	degrees	Config 1,2,3	NA	NA	TBD	
N_{oc} Note2	dBm/15 kHz Note5		NA	TBD		
N_{oc} Note2	dBm/S CS Note4	Config 1,2	NA	NA		
		Config 3	NA	NA		
SS-RSRP Note 3	dBm/S CS Note5	Config 1,2	NA	NA	TBD	TBD
		Config 3	NA	NA	TBD	TBD
\hat{E}_s / I_{ot}	dB	Config 1,2,3	NA	NA	TBD	TBD
\hat{E}_s / N_{oc}	dB	Config 1,2,3	NA	NA	TBD	TBD
I_o Note3	dBm/9.36MHz	Config 1,2	NA	NA	-	-

	dBm/38 .16MHz	Config 3	NA	NA	-	-
	dBm/95 .04 MHz Note5	Config 1,2,3	-	-	TBD	TBD
Propagation Condition		Config 1,2,3	AWGN			
Note 1:	OCNG shall be used such that both cells are fully allocated and a constant total transmitted power spectral density is achieved for all OFDM symbols.					
Note 2:	Interference from other cells and noise sources not specified in the test is assumed to be constant over subcarriers and time and shall be modelled as AWGN of appropriate power for N_{oc} to be fulfilled.					
Note 3:	SS-RSRP and I_o levels have been derived from other parameters for information purposes. They are not settable parameters themselves.					
Note 4:	SS-RSRP minimum requirements are specified assuming independent interference and noise at each receiver antenna port.					
Note 5:	Equivalent power received by an antenna with 0dBi gain at the centre of the quiet zone					
Note 6:	As observed with 0dBi gain antenna at the centre of the quiet zone					

A.7.6.2.5.2 Test Requirements

In test 1 with per-UE gap, the UE shall send one Event A4 triggered measurement report, with a measurement reporting delay less than [TBD] ms from the beginning of time period T2. The UE shall not send event triggered measurement reports, as long as the reporting criteria are not fulfilled. The rate of correct events observed during repeated tests shall be at least 90%.

In test 2 with per-FR gap, the UE shall send one Event A4 triggered measurement report, with a measurement reporting delay less than [TBD] ms from the beginning of time period T2. The UE shall not send event triggered measurement reports, as long as the reporting criteria are not fulfilled. The rate of correct events observed during repeated tests shall be at least 90%.

In test 1 and 2 UE is not required to report SSB time index.

NOTE: The actual overall delays measured in the test may be up to $2xTTI_{DCC}$ higher than the measurement reporting delays above because of TTI insertion uncertainty of the measurement report in DCC.

A.7.6.2.6 SA event triggered reporting tests for FR2 without SSB time index detection when DRX is used (PCell in FR1)

A.7.6.2.6.1 Test Purpose and Environment

The purpose of this test is to verify that the UE makes correct reporting of an event. This test will partly verify the SA inter-frequency NR cell search requirements in clause 9.3.4.

In this test, there are two cells: NR cell 1 as PCell in FR1 on NR RF channel 2 and NR cell 2 as neighbour cell in FR2 on NR RF channel 2. The test parameters and configurations are given in Tables A.7.6.2.6.1-1, A.7.6.2.6.1-2, and A.7.6.2.6.1-3. The TCI status for cell2 is defined in table [TBD] and TRS configuration for cell2 is defined in table [TBD].

In test 1&2 measurement gap pattern configuration # 0 as defined in Table A.7.6.2.6.1-2 is provided for a UE that does not support per-FR gap and in test 3&4 measurement gap pattern configuration #13 as defined in Table A.7.6.2.6.1-2 is provided for UE that support per-FR gap.

In the measurement control information, it is indicated to the UE that event-triggered reporting with Event A3 is used. The test consists of two successive time periods, with time duration of T1, and T2 respectively. During time duration T1, the UE shall not have any timing information of NR cell 3.

Supported test configurations are shown in table A.7.6.2.6.1-1.

UE needs to be provided at least once every 500ms with new Timing Advance Command MAC control element to restart the Time alignment timer to keep UE uplink time alignment. Furthermore UE is allocated with PUSCH resource at every DRX cycle.

Table A.7.6.2.6.1-1: SA event triggered reporting tests without SSB index reading for FR1-FR2

Config	Description of serving cell	Description of target cell
1	NR 15 kHz SSB SCS, 10MHz bandwidth, FDD duplex mode	120 kHz SSB SCS, 100MHz bandwidth, TDD duplex mode
2	NR 15 kHz SSB SCS, 10MHz bandwidth, TDD duplex mode	
3	NR 30kHz SSB SCS, 40MHz bandwidth, TDD duplex mode	
Note: The UE is only required to be tested in one of the supported test configurations		

Table A.7.6.2.6.1-2: General test parameters for SA inter-frequency event triggered reporting for FR2 without SSB time index detection

Parameter	Unit	Test configuration	Value				Comment
			Test 1	Test 2	Test 3	Test 4	
NR RF Channel Number		Config 1,2,3	1, 2				Two NR carrier frequencies is used.
Active cell		Config 1,2,3	NR cell 1 (Pcell)				NR Cell 1 is on NR RF channel number 1.
Neighbour cell		Config 1,2,3	NR cell 2				NR cell 2 is on NR RF channel number 2.
Gap Pattern Id		Config 1,2,3	0		13		As specified in clause 9.1.2-1.
Measurement gap offset		Config 1,2,3	39		39		
SMTC-SSB parameters on NR RF Channel 1		Config 1	SSB.1 FR1				As specified in clause A.3.10.1
		Config 2	SSB.1 FR1				As specified in clause A.3.10.1
		Config 3	SSB.2 FR1				As specified in clause A.3.10.1
SMTC-SSB parameters on NR RF Channel 2		Config 1,2,3	SSB.3 FR2				As specified in clause A.3.10.2
<i>offsetMO</i>	dB	Config 1,2,3	6				
Hysteresis	dB	Config 1,2,3	0				
<i>a4-Threshold</i>	dBm	Config 1,2,3	TBD				
CP length		Config 1,2,3	Normal				
TimeToTrigger	s	Config 1,2,3	0				
Filter coefficient		Config 1,2,3	0				L3 filtering is not used
DRX		Config 1,2,3	DRX .1	DRX .2	DRX .1	DRX .2	DRX is used
Time offset between serving and neighbour cells		Config 1	3ms				Asynchronous cells. The timing of Cell 2 is 3ms later than the timing of Cell 1.
		Config 2,3	3μs				Synchronous cells.
T1	s	Config 1,2,3	5				
T2	s	Config 1,2,3	TBD		TBD		

Table A.7.6.2.6.1-3: Cell specific test parameters for SA inter-frequency event triggered reporting for FR2 without SSB time index detection

Parameter		Unit	Test configuration	Cell 1		Cell 2	
				T1	T2	T1	T2
NR RF Channel Number			Config 1,2,3	1		2	
Duplex mode			Config 1	FDD		TDD	
			Config 2,3	TDD		TDD	
TDD configuration			Config 1	Not Applicable		TDDConf.3.1	
			Config 2	TDDConf.1.1		TDDConf.3.1	
			Config 3	TDDConf.2.1		TDDConf.3.1	
BW _{channel}		MHz	Config 1	10: N _{RB,c} = 52		100: N _{RB,c} = 66	
			Config 2	10: N _{RB,c} = 52		100: N _{RB,c} = 66	
			Config 3	40: N _{RB,c} = 106		100: N _{RB,c} = 66	
BWP BW		MHz	Config 1	10: N _{RB,c} = 52		100: N _{RB,c} = 66	
			Config 2	10: N _{RB,c} = 52		100: N _{RB,c} = 66	
			Config 3	40: N _{RB,c} = 106		100: N _{RB,c} = 66	
BWP configuration	Initial DL BWP		Config 1,2,3	DLBWP.0.1		N/A	
	Dedicated DL BWP			DLBWP.1.1		N/A	
	Dedicated UL BWP			ULBWP.1.1		N/A	
OCNG Patterns defined in A.3.2.1.1 (OP.1)			Config 1,2,3	OP.1		OP.1	
PDSCH Reference measurement channel			Config 1	SR.1.1 FDD		-	
			Config 2	SR.1.1 TDD			
			Config 3	SR2.1 TDD			
CORESET Reference Channel			Config 1	CR.1.1 FDD		-	
			Config 2	CR.1.1 TDD			
			Config 3	CR2.1 TDD			
SMTC configuration defined in A.3.11.1 and A.3.11.2			Config 1	SMTC.2		SMTC.2	
			Config 2,3	SMTC.1		SMTC.1	
PDSCH/PDCCH subcarrier spacing		kHz	Config 1,2	15		120	
			Config 3	30		120	
EPRE ratio of PSS to SSS			Config 1,2,3	0		0	
EPRE ratio of PBCH DMRS to SSS							
EPRE ratio of PBCH to PBCH DMRS							
EPRE ratio of PDCCH DMRS to SSS							
EPRE ratio of PDCCH to PDCCH DMRS							
EPRE ratio of PDSCH DMRS to SSS							
EPRE ratio of PDSCH to PDSCH							
EPRE ratio of OCNG DMRS to SSS(Note 1)							
EPRE ratio of OCNG to OCNG DMRS (Note 1)							
UE orientation around TBD axis and TBD axis		degrees	Config 1,2,3	NA		TBD	

Relative difference in angle of arrival of cell 3 relative to cell 2	degrees	Config 1,2,3	NA		NA	TBD
N_{oc} ^{Note2}	dBm/15 kHz Note5		NA		TBD	
N_{oc} ^{Note2}	dBm/S CS Note4	Config 1,2	NA		TBD	
		Config 3	NA		TBD	
SS-RSRP ^{Note 3}	dBm/S CS Note5	Config 1,2	NA	NA	TBD	TBD
		Config 3	NA	NA	TBD	TBD
\hat{E}_s / I_{ot}	dB	Config 1,2,3	NA	NA	TBD	TBD
\hat{E}_s / N_{oc}	dB	Config 1,2,3	NA	NA	TBD	TBD
I_o ^{Note3}	dBm/9.36MHz	Config 1,2	NA	NA	-	-
	dBm/38.16MHz	Config 3	NA	NA	-	-
	dBm/95.04 MHz Note5	Config 1,2,3	-	-	TBD	TBD
Propagation Condition		Config 1,2,3	AWGN			
<p>Note 1: OCNG shall be used such that both cells are fully allocated and a constant total transmitted power spectral density is achieved for all OFDM symbols.</p> <p>Note 2: Interference from other cells and noise sources not specified in the test is assumed to be constant over subcarriers and time and shall be modelled as AWGN of appropriate power for N_{oc} to be fulfilled.</p> <p>Note 3: SS-RSRP and I_o levels have been derived from other parameters for information purposes. They are not settable parameters themselves.</p> <p>Note 4: SS-RSRP minimum requirements are specified assuming independent interference and noise at each receiver antenna port.</p> <p>Note 5: Equivalent power received by an antenna with 0dBi gain at the centre of the quiet zone</p> <p>Note 6: As observed with 0dBi gain antenna at the centre of the quiet zone</p>						

A.7.6.2.6.2 Test Requirements

In test 1 with per-UE gap, the UE shall send one Event A4 triggered measurement report, with a measurement reporting delay less than [TBD] ms from the beginning of time period T2. The UE shall not send event triggered measurement reports, as long as the reporting criteria are not fulfilled. The rate of correct events observed during repeated tests shall be at least 90%.

In test 2 with per-FR gap, the UE shall send one Event A4 triggered measurement report, with a measurement reporting delay less than [TBD] ms from the beginning of time period T2. The UE shall not send event triggered measurement reports, as long as the reporting criteria are not fulfilled. The rate of correct events observed during repeated tests shall be at least 90%.

In test 3 with per-UE gap, the UE shall send one Event A4 triggered measurement report, with a measurement reporting delay less than [TBD] ms from the beginning of time period T2. The UE shall not send event triggered measurement reports, as long as the reporting criteria are not fulfilled. The rate of correct events observed during repeated tests shall be at least 90%.

In test 4 with per-FR gap, the UE shall send one Event A4 triggered measurement report, with a measurement reporting delay less than [TBD] ms from the beginning of time period T2. The UE shall not send event triggered measurement reports, as long as the reporting criteria are not fulfilled. The rate of correct events observed during repeated tests shall be at least 90%.

In test 1, 2, 3 and 4 UE is not required to report SSB time index.

NOTE: The actual overall delays measured in the test may be up to $2 \times TTI_{DCCH}$ higher than the measurement reporting delays above because of TTI insertion uncertainty of the measurement report in DCCH.

A.7.6.2.7 SA event triggered reporting tests for FR2 with SSB time index detection when DRX is not used (PCell in FR1)

A.7.6.2.7.1 Test Purpose and Environment

The purpose of this test is to verify that the UE makes correct reporting of an event. This test will partly verify the SA inter-frequency NR cell search requirements in clause 9.3.4.

In this test, there are two cells: NR cell 1 as PCell in FR1 on NR RF channel 2 and NR cell 2 as neighbour cell in FR2 on NR RF channel 2. The test parameters and configurations are given in Tables A.7.6.2.7.1-1, A.7.6.2.7.1-2, and A.7.6.2.7.1-3. The TCI status for cell2 is defined in table [TBD] and TRS configuration for cell2 is defined in table [TBD].

In test 1 measurement gap pattern configuration # 0 as defined in Table A.7.6.2.7.1-2 is provided for a UE that does not support per-FR gap and in test 2 measurement gap pattern configuration #13 as defined in Table A.7.6.2.7.1-2 is provided for UE that support per-FR gap.

In the measurement control information, it is indicated to the UE that event-triggered reporting with Event A3 is used. The test consists of two successive time periods, with time duration of T1, and T2 respectively. During time duration T1, the UE shall not have any timing information of NR cell 3.

Supported test configurations are shown in table A.7.6.2.7.1-1.

Table A.7.6.2.7.1-1: SA event triggered reporting tests with SSB index reading for FR1-FR2

Config	Description of serving cell	Description of target cell
1	NR 15 kHz SSB SCS, 10MHz bandwidth, FDD duplex mode	120 kHz SSB SCS, 100MHz bandwidth, TDD duplex mode
2	NR 15 kHz SSB SCS, 10MHz bandwidth, TDD duplex mode	
3	NR 30kHz SSB SCS, 40MHz bandwidth, TDD duplex mode	
Note: The UE is only required to be tested in one of the supported test configurations		

Table A.7.6.2.7.1-2: General test parameters for SA inter-frequency event triggered reporting for FR2 with SSB time index detection

Parameter	Unit	Test configuration	Value		Comment
			Test 1	Test 2	
NR RF Channel Number		Config 1,2,3	1, 2		Two NR carrier frequencies is used.
Active cell		Config 1,2,3	NR cell 1 (Pcell)		NR Cell 1 is on NR RF channel number 1.
Neighbour cell		Config 1,2,3	NR cell 2		NR cell 2 is on NR RF channel number 2.
Gap Pattern Id		Config 1,2,3	0	13	As specified in clause 9.1.2-1.
Measurement gap offset		Config 1,2,3	39	39	
SMTC-SSB parameters on NR RF Channel 1		Config 1	SSB.1 FR1		As specified in clause A.3.10.1
		Config 2	SSB.1 FR1		As specified in clause A.3.10.1

		Config 3	SSB.2 FR1		As specified in clause A.3.10.1
SMTC-SSB parameters on NR RF Channel 2		Config 1,2,3	SSB.3 FR2		As specified in clause A.3.10.2
<i>offsetMO</i>	dB	Config 1,2,3	6		
Hysteresis	dB	Config 1,2,3	0		
<i>a4-Threshold</i>	dBm	Config 1,2,3,4,5,6	TBD		
CP length		Config 1,2,3	Normal		
TimeToTrigger	s	Config 1,2,3	0		
Filter coefficient		Config 1,2,3	0		L3 filtering is not used
DRX		Config 1,2,3	OFF		DRX is not used
Time offset between serving and neighbour cells		Config 1	3ms		Asynchronous cells. The timing of Cell 2 is 3ms later than the timing of Cell 1.
		Config 2,3	3μs		Synchronous cells.
T1	s	Config 1,2,3	5		
T2	s	Config 1,2,3	TBD	TBD	

Table A.7.6.2.7.1-3: Cell specific test parameters for SA inter-frequency event triggered reporting for FR2 with SSB time index detection

Parameter		Unit	Test configuration	Cell 1		Cell 2	
				T1	T2	T1	T2
NR RF Channel Number			Config 1,2,3	1		2	
Duplex mode			Config 1	FDD		TDD	
			Config 2,3	TDD		TDD	
TDD configuration			Config 1	Not Applicable		TDDConf.3.1	
			Config 2	TDDConf.1.1		TDDConf.3.1	
			Config 3	TDDConf.2.1		TDDConf.3.1	
BW _{channel}		MHz	Config 1	10: N _{RB,c} = 52		100: N _{RB,c} = 66	
			Config 2	10: N _{RB,c} = 52		100: N _{RB,c} = 66	
			Config 3	40: N _{RB,c} = 106		100: N _{RB,c} = 66	
BWP BW		MHz	Config 1	10: N _{RB,c} = 52		100: N _{RB,c} = 66	
			Config 2	10: N _{RB,c} = 52		100: N _{RB,c} = 66	
			Config 3	40: N _{RB,c} = 106		100: N _{RB,c} = 66	
BWP configuration	Initial DL BWP		Config 1,2,3	DLBWP.0.1		N/A	
	Dedicated DL BWP			DLBWP.1.1		N/A	
	Dedicated UL BWP			ULBWP.1.1		N/A	
OCNG Patterns defined in A.3.2.1.1 (OP.1)			Config 1,2,3	OP.1		OP.1	
PDSCH Reference measurement channel			Config 1	SR.1.1 FDD		-	
			Config 2	SR.1.1 TDD			
			Config 3	SR2.1 TDD			
CORESET Reference Channel			Config 1	CR.1.1 FDD		-	
			Config 2	CR.1.1 TDD			
			Config 3	CR2.1 TDD			
SMTC configuration defined in A.3.11.1 and A.3.11.2			Config 1	SMTC.2		SMTC.2	
			Config 2,3	SMTC.1		SMTC.1	
		kHz	Config 1,2	15		120	

PDSCH/PDCCH subcarrier spacing		Config 3	30	120		
EPRE ratio of PSS to SSS		Config 1,2,3	0	0		
EPRE ratio of PBCH DMRS to SSS						
EPRE ratio of PBCH to PBCH DMRS						
EPRE ratio of PDCCH DMRS to SSS						
EPRE ratio of PDCCH to PDCCH DMRS						
EPRE ratio of PDSCH DMRS to SSS						
EPRE ratio of PDSCH to PDSCH						
EPRE ratio of OCNG DMRS to SSS(Note 1)						
EPRE ratio of OCNG to OCNG DMRS (Note 1)						
UE orientation around TBD axis and TBD axis	degrees	Config 1,2,3	NA	TBD		
Relative difference in angle of arrival of cell 3 relative to cell 2	degrees	Config 1,2,3	NA	NA	TBD	
N_{oc} Note2	dBm/15 kHz Note5		NA	NA		
N_{oc} Note2	dBm/S CS Note4	Config 1,2	NA	NA		
		Config 3	NA	NA		
SS-RSRP Note 3	dBm/S CS Note5	Config 1,2	NA	NA	TBD	TBD
		Config 3	NA	NA	TBD	TBD
\hat{E}_s / I_{ot}	dB	Config 1,2,3	NA	NA	TBD	TBD
\hat{E}_s / N_{oc}	dB	Config 1,2,3	NA	NA	TBD	TBD
I_o Note3	dBm/9.36MHz	Config 1,2	NA	NA	-	-
	dBm/38.16MHz	Config 3	NA	NA	-	-
	dBm/95.04 MHz Note5	Config 1,2,3	-	-	TBD	TBD
Propagation Condition		Config 1,2,3	AWGN			
<p>Note 1: OCNG shall be used such that both cells are fully allocated and a constant total transmitted power spectral density is achieved for all OFDM symbols.</p> <p>Note 2: Interference from other cells and noise sources not specified in the test is assumed to be constant over subcarriers and time and shall be modelled as AWGN of appropriate power for N_{oc} to be fulfilled.</p> <p>Note 3: SS-RSRP and I_o levels have been derived from other parameters for information purposes. They are not settable parameters themselves.</p> <p>Note 4: SS-RSRP minimum requirements are specified assuming independent interference and noise at each receiver antenna port.</p> <p>Note 5: Equivalent power received by an antenna with 0dBi gain at the centre of the quiet zone</p> <p>Note 6: As observed with 0dBi gain antenna at the centre of the quiet zone</p>						

A.7.6.2.7.2 Test Requirements

In test 1 with per-UE gap, the UE shall send one Event A4 triggered measurement report, with a measurement reporting delay less than [TBD] ms from the beginning of time period T2. The UE shall not send event triggered measurement reports, as long as the reporting criteria are not fulfilled. The rate of correct events observed during repeated tests shall be at least 90%.

In test 2 with per-FR gap, the UE shall send one Event A4 triggered measurement report, with a measurement reporting delay less than [TBD] ms from the beginning of time period T2. The UE shall not send event triggered measurement reports, as long as the reporting criteria are not fulfilled. The rate of correct events observed during repeated tests shall be at least 90%.

In test 1 and 2 UE is required to report SSB time index.

NOTE: The actual overall delays measured in the test may be up to $2xTTI_{DCCCH}$ higher than the measurement reporting delays above because of TTI insertion uncertainty of the measurement report in DCCCH.

A.7.6.2.8 SA event triggered reporting tests for FR2 with SSB time index detection when DRX is used (PCell in FR1)

A.7.6.2.8.1 Test Purpose and Environment

The purpose of this test is to verify that the UE makes correct reporting of an event. This test will partly verify the SA inter-frequency NR cell search requirements in clause 9.3.4.

In this test, there are two cells: NR cell 1 as PCell in FR1 on NR RF channel 2 and NR cell 2 as neighbour cell in FR2 on NR RF channel 2. The test parameters and configurations are given in Tables A.7.6.2.8.1-1, A.7.6.2.8.1-2, and A.7.6.2.8.1-3. The TCI status for cell2 is defined in table [TBD] and TRS configuration for cell2 is defined in table [TBD].

In test 1&2 measurement gap pattern configuration # 0 as defined in Table A.7.6.2.8.1-2 is provided for a UE that does not support per-FR gap and in test 3&4 measurement gap pattern configuration #13 as defined in Table A.7.6.2.8.1-2 is provided for UE that support per-FR gap.

In the measurement control information, it is indicated to the UE that event-triggered reporting with Event A3 is used. The test consists of two successive time periods, with time duration of T1, and T2 respectively. During time duration T1, the UE shall not have any timing information of NR cell 3.

Supported test configurations are shown in table A.7.6.2.8.1-1.

UE needs to be provided at least once every 500ms with new Timing Advance Command MAC control element to restart the Time alignment timer to keep UE uplink time alignment. Furthermore UE is allocated with PUSCH resource at every DRX cycle.

Table A.7.6.2.8.1-1: SA event triggered reporting tests with SSB index reading for FR1-FR2

Config	Description of serving cell	Description of target cell
1	NR 15 kHz SSB SCS, 10MHz bandwidth, FDD duplex mode	120 kHz SSB SCS, 100MHz bandwidth, TDD duplex mode
2	NR 15 kHz SSB SCS, 10MHz bandwidth, TDD duplex mode	
3	NR 30kHz SSB SCS, 40MHz bandwidth, TDD duplex mode	
Note: The UE is only required to be tested in one of the supported test configurations		

Table A.7.6.2.8.1-2: General test parameters for SA inter-frequency event triggered reporting for FR2 with SSB time index detection

Parameter	Unit	Test configuration	Value				Comment
			Test 1	Test 2	Test 3	Test 4	
NR RF Channel Number		Config 1,2,3	1, 2				Two NR carrier frequencies is used.
Active cell		Config 1,2,3	NR cell 1 (Pcell)				NR Cell 1 is on NR RF channel number 1.
Neighbour cell		Config 1,2,3	NR cell 2				NR cell 2 is on NR RF channel number 2.
Gap Pattern Id		Config 1,2,3	0		13		As specified in clause 9.1.2-1.
Measurement gap offset		Config 1,2,3	39		39		
SMTC-SSB parameters on NR RF Channel 1		Config 1	SSB.1 FR1				As specified in clause A.3.10.1
		Config 2	SSB.1 FR1				As specified in clause A.3.10.1
		Config 3	SSB.2 FR1				As specified in clause A.3.10.1
SMTC-SSB parameters on NR RF Channel 2		Config 1,2,3	SSB.3 FR2				As specified in clause A.3.10.2
<i>offsetMO</i>	dB	Config 1,2,3	6				
Hysteresis	dB	Config 1,2,3	0				
<i>a4-Threshold</i>	dBm	Config 1,2,3	TBD				
CP length		Config 1,2,3	Normal				
TimeToTrigger	s	Config 1,2,3	0				
Filter coefficient		Config 1,2,3	0				L3 filtering is not used
DRX		Config 1,2,3	DRX .1	DRX .2	DRX .1	DRX .2	DRX is used
Time offset between serving and neighbour cells		Config 1	3ms				Asynchronous cells. The timing of Cell 2 is 3ms later than the timing of Cell 1.
		Config 2,3	3μs				Synchronous cells.
T1	s	Config 1,2,3	5				
T2	s	Config 1,2,3	TBD		TBD		

Table A.7.6.2.8.1-3: Cell specific test parameters for SA inter-frequency event triggered reporting for FR2 with SSB time index detection

Parameter	Unit	Test configuration	Cell 1		Cell 2	
			T1	T2	T1	T2
NR RF Channel Number		Config 1,2,3	1		2	
Duplex mode		Config 1	FDD		TDD	
		Config 2,3	TDD		TDD	
TDD configuration		Config 1	Not Applicable		TDDConf.3.1	
		Config 2	TDDConf.1.1		TDDConf.3.1	
		Config 3	TDDConf.2.1		TDDConf.3.1	
BW _{channel}	MHz	Config 1	10: N _{RB,c} = 52		100: N _{RB,c} = 66	
		Config 2	10: N _{RB,c} = 52		100: N _{RB,c} = 66	
		Config 3	40: N _{RB,c} = 106		100: N _{RB,c} = 66	

BWP BW		MHz	Config 1	10: $N_{RB,c} = 52$		100: $N_{RB,c} = 66$	
			Config 2	10: $N_{RB,c} = 52$		100: $N_{RB,c} = 66$	
			Config 3	40: $N_{RB,c} = 106$		100: $N_{RB,c} = 66$	
BWP configuration	Initial DL BWP	Config 1,2,3	DLBWP.0.1		N/A		
	Dedicated DL BWP		DLBWP.1.1		N/A		
	Dedicated UL BWP		ULBWP.1.1		N/A		
OCNG Patterns defined in A.3.2.1.1 (OP.1)		Config 1,2,3	OP.1		OP.1		
PDSCH Reference measurement channel		Config 1	SR.1.1 FDD		-		
		Config 2	SR.1.1 TDD				
		Config 3	SR2.1 TDD				
CORESET Reference Channel		Config 1	CR.1.1 FDD		-		
		Config 2	CR.1.1 TDD				
		Config 3	CR2.1 TDD				
SMTC configuration defined in A.3.11.1 and A.3.11.2		Config 1	SMTC.2		SMTC.2		
		Config 2,3	SMTC.1		SMTC.1		
PDSCH/PDCCH subcarrier spacing		kHz	Config 1,2	15		120	
			Config 3	30		120	
EPRE ratio of PSS to SSS		Config 1,2,3	0		0		
EPRE ratio of PBCH DMRS to SSS							
EPRE ratio of PBCH to PBCH DMRS							
EPRE ratio of PDCCH DMRS to SSS							
EPRE ratio of PDCCH to PDCCH DMRS							
EPRE ratio of PDSCH DMRS to SSS							
EPRE ratio of PDSCH to PDSCH							
EPRE ratio of OCNG DMRS to SSS(Note 1)							
EPRE ratio of OCNG to OCNG DMRS (Note 1)							
UE orientation around TBD axis and TBD axis							Config 1,2,3
Relative difference in angle of arrival of cell 3 relative to cell 2		Config 1,2,3	NA		NA	TBD	
N_{oc} Note2		dBm/15 kHz Note5	NA		NA		
N_{oc} Note2							
N_{oc} Note2		dBm/S CS Note4	Config 1,2	NA		NA	
			Config 3	NA		NA	
SS-RSRP Note 3		dBm/S CS Note5	Config 1,2	NA	NA	TBD	TBD
			Config 3	NA	NA	TBD	TBD
\hat{E}_s/I_{ot}		Config 1,2,3	NA	NA	TBD	TBD	
\hat{E}_s/N_{oc}		Config 1,2,3	NA	NA	TBD	TBD	
I_{o} Note3		Config 1,2	NA	NA	-	-	

	dBm/38 .16MHz	Config 3	NA	NA	-	-
	dBm/95 .04 MHz Note5	Config 1,2,3	-	-	TBD	TBD
Propagation Condition		Config 1,2,3	AWGN			
Note 1:	OCNG shall be used such that both cells are fully allocated and a constant total transmitted power spectral density is achieved for all OFDM symbols.					
Note 2:	Interference from other cells and noise sources not specified in the test is assumed to be constant over subcarriers and time and shall be modelled as AWGN of appropriate power for N_{oc} to be fulfilled.					
Note 3:	SS-RSRP and I_0 levels have been derived from other parameters for information purposes. They are not settable parameters themselves.					
Note 4:	SS-RSRP minimum requirements are specified assuming independent interference and noise at each receiver antenna port.					
Note 5:	Equivalent power received by an antenna with 0dBi gain at the centre of the quiet zone					
Note 6:	As observed with 0dBi gain antenna at the centre of the quiet zone					

A.7.6.2.8.2 Test Requirements

In test 1 with per-UE gap, the UE shall send one Event A4 triggered measurement report, with a measurement reporting delay less than [TBD] ms from the beginning of time period T2. The UE shall not send event triggered measurement reports, as long as the reporting criteria are not fulfilled. The rate of correct events observed during repeated tests shall be at least 90%.

In test 2 with per-FR gap, the UE shall send one Event A4 triggered measurement report, with a measurement reporting delay less than [TBD] ms from the beginning of time period T2. The UE shall not send event triggered measurement reports, as long as the reporting criteria are not fulfilled. The rate of correct events observed during repeated tests shall be at least 90%.

In test 3 with per-UE gap, the UE shall send one Event A4 triggered measurement report, with a measurement reporting delay less than [TBD] ms from the beginning of time period T2. The UE shall not send event triggered measurement reports, as long as the reporting criteria are not fulfilled. The rate of correct events observed during repeated tests shall be at least 90%.

In test 4 with per-FR gap, the UE shall send one Event A4 triggered measurement report, with a measurement reporting delay less than [TBD] ms from the beginning of time period T2. The UE shall not send event triggered measurement reports, as long as the reporting criteria are not fulfilled. The rate of correct events observed during repeated tests shall be at least 90%.

In test 1, 2, 3 and 4 UE is required to report SSB time index.

NOTE: The actual overall delays measured in the test may be up to $2xTTI_{DCCH}$ higher than the measurement reporting delays above because of TTI insertion uncertainty of the measurement report in DCCH.

A.7.7 Measurement Performance requirements

A.7.7.1 SS-RSRP

A.7.7.1.1 SA intra-frequency case measurement accuracy with FR2 serving cell and FR2 target cell

A.7.7.1.1.1 Test Purpose and Environment

The purpose of this test is to verify that the SS-RSRP measurement accuracy is within the specified limits. This test will verify the requirements in Sections 10.1.2.1 and 10.1.2.1.1 for intra-frequency measurements.

A.7.7.1.1.2 Test parameters

In this set of test cases all cells are on the same carrier frequency. Supported test configurations are shown in table A.7.7.1.1.2-1. Both absolute and relative accuracy of SS-RSRP intra frequency measurements are tested by using the parameters in Table A.7.7.1.1.2-2 and A.7.7.1.1.2-3. In all test cases, Cell 1 is the PCell and Cell 2 the target cell. The TCI status for Cell 1 is defined in Table [TBD] and TRS configuration for Cell 1 is defined in Table [TBD].

Table A.7.7.1.1.2-1: SS-RSRP Intra frequency SS-RSRP supported test configurations

Configuration	Description
1	120 kHz SSB SCS, 100MHz bandwidth, TDD duplex mode

Table A.7.7.1.1.2-2: SS-RSRP Intra frequency general test parameters

Parameter	Unit	Test 1		Test 2		Test 3	
		Cell 1	Cell 2	Cell 1	Cell 2	Cell 1	Cell 2
SSB ARFCN		freq1		freq1		freq1	
Duplex mode		TDD		TDD		TDD	
TDD configuration		TDDConf.3.1		TDDConf.3.1		TDDConf.3.1	
BW _{channel}	MHz	100: N _{RB,c} = 66		100: N _{RB,c} = 66		100: N _{RB,c} = 66	
Downlink initial BWP configuration		DLBW P.0.1	-	DLBW P.0.1	-	DLBW P.0.1	-
Downlink dedicated BWP configuration		DLBW P.1.1	-	DLBW P.1.1	-	DLBW P.1.1	-
Uplink initial BWP configuration		ULBW P.0.1	-	ULBW P.0.1	-	ULBW P.0.1	-
Uplink dedicated BWP configuration		ULBW P.1.1	-	ULBW P.1.1	-	ULBW P.1.1	-
DRX cycle configuration		Not applicable	-	Not applicable	-	Not applicable	-
TRS configuration		TRS.2.1 TDD	-	TRS.2.1 TDD	-	TRS.2.1 TDD	-
TCI state		TCI.State.0	-	TCI.State.0	-	TCI.State.0	-
PDSCH Reference measurement channel		SR.3.1 TDD	-	SR.3.1 TDD	-	SR.3.1 TDD	-
RMSI CORESET Reference Channel		CR.3.1 TDD	-	CR.3.1 TDD	-	CR.3.1 TDD	-
Control channel RMC		CCR.3.1 TDD	-	CCR.3.1 TDD	-	CCR.3.1 TDD	-
OCNG Patterns		OP.1	OP.1	OP.1	OP.1	OP.1	OP.1
SSB configuration		SSB.1 FR2	SSB.1 FR2	SSB.1 FR2	SSB.1 FR2	SSB.1 FR2	SSB.1 FR2
SMTc configuration		SMTc.1	SMTc.1	SMTc.1	SMTc.1	SMTc.1	SMTc.1
PDSCH/PDCCH subcarrier spacing	kHz	120	120	120	120	120	120
EPRE ratio of PSS to SSS	dB	0	0	0	0	0	0
EPRE ratio of PBCH_DMRS to SSS							
EPRE ratio of PBCH to PBCH_DMRS							
EPRE ratio of PDCCH_DMRS to SSS							
EPRE ratio of PDCCH to PDCCH_DMRS							
EPRE ratio of PDSCH_DMRS to SSS							
EPRE ratio of PDSCH to PDSCH_DMRS							
EPRE ratio of OCNG DMRS to SSS ^{Note 1}							
EPRE ratio of OCNG to OCNG DMRS ^{Note 1}							

\hat{E}_s / N_{oc}	dB	6	1	6	1	3	-1
Propagation conditions		AWGN					
<p>Note 1: OCNG shall be used such that both cells are fully allocated and a constant total transmitted power spectral density is achieved for all OFDM symbols.</p> <p>Note 2: Interference from other cells and noise sources not specified in the test is assumed to be constant over subcarriers and time and shall be modelled as AWGN of appropriate power for N_{oc} to be fulfilled.</p> <p>Note 3: SS-RSRP and I_o levels have been derived from other parameters for information purposes. They are not settable parameters themselves.</p> <p>Note 4: SS-RSRP minimum requirements are specified assuming independent interference and noise at each receiver antenna port.</p>							

Table A.7.7.1.1.2-3: SS-RSRP Intra frequency OTA related test parameters

Parameter		Unit	Test 1		Test 2		Test 3	
			Cell 1	Cell 2	Cell 1	Cell 2	Cell 1	Cell 2
Angle of arrival configuration			According to section TBD		According to section TBD		According to section TBD	
N_{oc} ^{Note1}	NR_TDD_FR2_A	dBm/15kHz ^{Note4}	TBD		TBD		TBD	
	NR_TDD_FR2_B						TBD	
	NR_TDD_FR2_F						TBD	
	NR_TDD_FR2_G						TBD	
	NR_TDD_FR2_T						TBD	
	NR_TDD_FR2_Y						TBD	
N_{oc} ^{Note1}	NR_TDD_FR2_A	dBm/SCS ^{Note3}	TBD		TBD		TBD	
	NR_TDD_FR2_B						TBD	
	NR_TDD_FR2_F						TBD	
	NR_TDD_FR2_G						TBD	
	NR_TDD_FR2_T						TBD	
	NR_TDD_FR2_Y						TBD	
SS-RSRP ^{Note2}	NR_TDD_FR2_A	dBm/SCS ^{Note4}	TBD	TBD	TBD	TBD	TBD	TBD
	NR_TDD_FR2_B						TBD	TBD
	NR_TDD_FR2_F						TBD	TBD
	NR_TDD_FR2_G						TBD	TBD
	NR_TDD_FR2_T						TBD	TBD
	NR_TDD_FR2_Y						TBD	TBD
\hat{E}_s / I_{ot}		dB	TBD	TBD	TBD	TBD	TBD	TBD
I_o ^{Note2}	NR_TDD_FR2_A	dBm/95.04 MHz ^{Note4}	TBD		TBD		TBD	
	NR_TDD_FR2_B						TBD	
	NR_TDD_FR2_F						TBD	
	NR_TDD_FR2_G						TBD	
	NR_TDD_FR2_T						TBD	
	NR_TDD_FR2_Y						TBD	
<p>Note 1: Interference from other cells and noise sources not specified in the test is assumed to be constant over subcarriers and time and shall be modelled as AWGN of appropriate power for N_{oc} to be fulfilled.</p> <p>Note 2: SS-RSRP and I_o levels have been derived from other parameters for information purposes. They are not settable parameters themselves.</p> <p>Note 3: SS-RSRP minimum requirements are specified assuming independent interference and noise at each receiver antenna port.</p> <p>Note 4: Equivalent power received by an antenna with 0dBi gain at the centre of the quiet zone</p> <p>Note 5: As observed with 0dBi gain antenna at the centre of the quiet zone</p>								

A.7.7.1.1.3 Test Requirements

The SS-RSRP measurement accuracy shall fulfil the absolute accuracy requirements in sections 10.1.3.1.1 and relative accuracy requirements in section 10.1.3.1.2.

A.7.7.1.2 SA inter-frequency case measurement accuracy with FR2 serving cell and FR2 target cell

A.7.7.1.2.1 Test Purpose and Environment

The purpose of this test is to verify that the SS-RSRP measurement accuracy is within the specified limits. This test will verify the requirements in Sections 10.1.5.1.1 and 10.1.5.1.2 for intra frequency measurements with the testing configurations for NR cells in Table A.7.7.1.2.1-1.

Table A.7.7.1.2.1-1: Applicable NR configurations for FR2 inter-frequency SS-RSRP accuracy test

Configuration	Description
1	120 kHz SSB SCS, 100MHz bandwidth, TDD duplex mode
2	240 kHz SSB SCS, 100MHz bandwidth, TDD duplex mode

A.7.7.1.2.2 Test parameters

In this set of test cases there are two cells in the test, PCell (Cell 1) and a FR2 neighbour cell (Cell 2) on a different frequency than the PCell. The test parameters and applicability for Cell 1 are defined in A.3.7.2. The test parameters for the Cell 1 and Cell 2 are given in Table A.7.7.1.2.2-1 and Table A.7.7.1.2.2-2 below. Both absolute and relative accuracy of RSRP intra frequency measurements are tested by using the parameters in Table A.7.7.1.2.2-1 and Table A.7.7.1.2.2-1. The inter frequency measurements are supported by a measurement gap. The TCI status for Cell 1 is defined in Table [TBD] and TRS configuration for Cell 1 is defined in Table [TBD].

Table A.7.7.1.2.2-1: SS-RSRP inter-frequency test parameters

Parameter	Config	Unit	Test 1		Test 2	
			Cell 1	Cell 2	Cell 1	Cell 2
SSB ARFCN	1~2		freq1	freq2	freq1	freq2
BW _{channel}	1~2		100: N _{RB,c} = 66		100: N _{RB,c} = 66	
Duplex mode	1~2		TDD	TDD	TDD	TDD
TDD configuration	1~2		TDDConf.3.1		TDDConf.3.1	
PDSCH Reference measurement channel	1~2		SR.3.1 TDD	-	SR.3.1 TDD	-
RMSI CORESET Reference Channel	1~2		CR.3.1 TDD	-	CR.3.1 TDD	-
Dedicated CORESET Reference Channel	1~2		CCR.3.1 TDD	-	CCR.3.1 TDD	-
SSB configuration	1		SSB.1 FR2		SSB.1 FR2	
	2		SSB.2 FR2		SSB.2 FR2	
OCNG Patterns	1~2		OP.1		OP.1	
DL BWP	1~2		DLBWP.1.1		DLBWP.1.1	
UL BWP	1~2		ULBWP.1.1		ULBWP.1.1	
SMTc configuration	1~2		SMTc.1		SMTc.1	
EPRE ratio of PSS to SSS	1~2	dB	0	0	0	0
EPRE ratio of PBCH DMRS to SSS						
EPRE ratio of PBCH to PBCH DMRS						
EPRE ratio of PDCCH DMRS to SSS						

EPRE ratio of PDCCH to PDCCH DMRS						
EPRE ratio of PDSCH DMRS to SSS						
EPRE ratio of PDSCH to PDSCH DMRS						
EPRE ratio of OCNG DMRS to SSS ^{Note 1}						
EPRE ratio of OCNG to OCNG DMRS ^{Note 1}						
Propagation condition	1~2	-	AWGN		AWGN	
<p>Note 1: OCNG shall be used such that both cells are fully allocated and a constant total transmitted power spectral density is achieved for all OFDM symbols.</p> <p>Note 2: Interference from other cells and noise sources not specified in the test is assumed to be constant over subcarriers and time and shall be modelled as AWGN of appropriate power for N_{oc} to be fulfilled.</p>						

Table A.7.7.1.2.2-2: SS-RSRP inter-frequency OTA test parameters

Parameter		Config	Unit	Test 1		Test 2		
				Cell 1	Cell 2	Cell 1	Cell 2	
N_{oc}	NR_TDD_FR2_A	1~2	dBm/15 kHz	TBD	TBD	TBD	TBD	
	NR_TDD_FR2_B						TBD	
	NR_TDD_FR2_F						TBD	
	NR_TDD_FR2_G						TBD	
	NR_TDD_FR2_T						TBD	
	NR_TDD_FR2_Y						TBD	
N_{oc}	NR_TDD_FR2_A	1	dBm/SS B SCS	TBD	TBD	TBD	TBD	
	NR_TDD_FR2_B						TBD	
	NR_TDD_FR2_F						TBD	
	NR_TDD_FR2_G						TBD	
	NR_TDD_FR2_T						TBD	
	NR_TDD_FR2_Y						TBD	
	NR_TDD_FR2_A	2		TBD	TBD	TBD	TBD	TBD
	NR_TDD_FR2_B							TBD
	NR_TDD_FR2_F							TBD
	NR_TDD_FR2_G							TBD
	NR_TDD_FR2_T							TBD
	NR_TDD_FR2_Y							TBD
\hat{E}_s/I_{ot}		1~2	dB	TBD	TBD	TBD	TBD	
SS-RSRP ^{Note1}	NR_TDD_FR2_A	1	dBm/SC S	TBD	TBD	TBD	TBD	
	NR_TDD_FR2_B						TBD	
	NR_TDD_FR2_F						TBD	
	NR_TDD_FR2_G						TBD	
	NR_TDD_FR2_T						TBD	
	NR_TDD_FR2_Y						TBD	
	NR_TDD_FR2_A	2		TBD	TBD	TBD	TBD	TBD
	NR_TDD_FR2_B							TBD
	NR_TDD_FR2_F							TBD
	NR_TDD_FR2_G							TBD
	NR_TDD_FR2_T							TBD
	NR_TDD_FR2_Y							TBD

I _o ^{Note1}	NR_TDD_FR2_A	1~2	dBm/ 95.04M Hz	TBD		TBD	
	NR_TDD_FR2_B					TBD	
	NR_TDD_FR2_F					TBD	
	NR_TDD_FR2_G					TBD	
	NR_TDD_FR2_T					TBD	
	NR_TDD_FR2_Y					TBD	
\hat{E}_s / N_{oc}		1~2	dB	TBD	TBD	TBD	TBD
<p>Note 1: RSRP and I_o levels have been derived from other parameters for information purposes. They are not settable parameters themselves.</p> <p>Note 2: RSRP minimum requirements are specified assuming independent interference and noise at each receiver antenna port.</p>							

A.7.7.1.2.3 Test Requirements

The SS-RSRP measurement accuracy for Cell 1 and Cell 2 shall fulfil the Absolute requirements in sections 10.1.5.1.1 and Relative requirements in section 10.1.5.1.2.

A.7.7.1.3 SA inter-frequency measurement accuracy with FR1 serving cell and FR2 target cell

A.7.7.1.3.1 Test Purpose and Environment

The purpose of this test is to verify that the SS-RSRP measurement accuracy is within the specified limits. This test will verify the requirements in Sections 10.1.5.1.1 for inter-frequency measurements with the testing configurations in Table A.7.7.1.3.1-1.

Table A.7.7.1.3.1-1: Applicable NR configurations for FR1 inter-frequency SS-RSRP accuracy test

Config	Description of serving cell	Description of target cell
1	LTE FDD, NR 15 kHz SSB SCS, 10MHz bandwidth, FDD duplex mode	120 kHz SSB SCS, 100MHz bandwidth, TDD duplex mode
2	LTE FDD, NR 15 kHz SSB SCS, 10MHz bandwidth, TDD duplex mode	
3	LTE FDD, NR 30kHz SSB SCS, 40MHz bandwidth, TDD duplex mode	

A.7.7.1.3.2 Test parameters

In this set of test cases there are two cells in the test, PCell (Cell 1) and a FR2 neighbour cell (Cell 2) on a different frequency than the PCell. The test parameters for the Cell 1 and Cell 2 are given in Table A.7.7.1.3.2-1 and Table A.7.7.1.3.2-2 below. Both absolute and relative accuracy of RSRP intra frequency measurements are tested by using the parameters in Table A.7.7.1.3.2-1 and Table A.7.7.1.3.2-2. The inter frequency measurements are supported by a measurement gap.

Table A.7.7.1.3.2-1: SS-RSRP inter-frequency test parameters

Parameter	Config	Unit	Test 1		Test 2	
			Cell 1	Cell 2	Cell 1	Cell 2
SSB ARFCN	1~3		freq1	freq2	freq1	freq2
BW _{channel}	1	MHz	10: N _{RB,c} = 52	100: N _{RB,c} = 66	10: N _{RB,c} = 52	100: N _{RB,c} = 66
	2		10: N _{RB,c} = 52		10: N _{RB,c} = 52	
	3		40: N _{RB,c} = 106		40: N _{RB,c} = 106	
Duplex mode	1		FDD	TDD	FDD	TDD
	2		TDD		TDD	
	3		TDD		TDD	
TDD configuration	1		N/A	TDDConf. 3.1	N/A	TDDConf. 3.1
	2		TDDConf. 1.1		TDDConf. 1.1	
	3		TDDConf. 2.1		TDDConf. 2.1	
PDSCH Reference measurement channel	1		SR.1.1 FDD	-	SR.1.1 FDD	-
	2		SR.1.1 TDD		SR.1.1 TDD	
	3		SR.2.1 FDD		SR.2.1 FDD	
RMSI CORESET Reference Channel	1		CR.1.1 FDD	-	CR.1.1 FDD	-
	2		CR.1.1 TDD		CR.1.1 TDD	
	3		CR.2.1 FDD		CR.2.1 FDD	
Dedicated CORESET Reference Channel	1		CCR.1.1 FDD	-	CCR.1.1 FDD	-
	2		CCR.1.1 TDD		CCR.1.1 TDD	
	3		CCR.2.1 TDD		CCR.2.1 TDD	
SSB configuration	1		SSB.1 FR1	SSB.1 FR2	SSB.1 FR1	SSB.1 FR2
	2		SSB.1 FR1		SSB.1 FR1	
	3		SSB.2 FR1		SSB.2 FR1	
OCNG Patterns	1~3		OP.1		OP.1	
DL BWP	1~3		DLBWP.1		DLBWP.1	
UL BWP	1~3		ULBWP.1		ULBWP.1	
SMTC configuration	1~3		SMTC.1		SMTC.1	
EPRE ratio of PSS to SSS	1~3	dB	0	0	0	0
EPRE ratio of PBCH DMRS to SSS						
EPRE ratio of PBCH to PBCH DMRS						
EPRE ratio of PDCCH DMRS to SSS						
EPRE ratio of PDCCH to PDCCH DMRS						
EPRE ratio of PDSCH DMRS to SSS						
EPRE ratio of PDSCH to PDSCH DMRS						
EPRE ratio of OCNG DMRS to SSS ^{Note 1}						
EPRE ratio of OCNG to OCNG DMRS ^{Note 1}						
Propagation condition						
<p>Note 1: OCNG shall be used such that both cells are fully allocated and a constant total transmitted power spectral density is achieved for all OFDM symbols.</p> <p>Note 2: Interference from other cells and noise sources not specified in the test is assumed to be constant over subcarriers and time and shall be modelled as AWGN of appropriate power for N_{oc} to be fulfilled.</p>						

Table A.7.7.1.3.2-2: SS-RSRP inter-frequency OTA related test parameters

Parameter		Config	Unit	Test 1		Test 2		
				Cell 1	Cell 2	Cell 1	Cell 2	
N_{oc} Note2	NR_FDD_FR1_A, NR_TDD_FR1_A	1~3	dBm/15 kHz	TBD		TBD	TBD	
	NR_FDD_FR1_B						TBD	
	NR_TDD_FR1_C						TBD	
	NR_FDD_FR1_D, NR_TDD_FR1_D						TBD	
	NR_FDD_FR1_E, NR_TDD_FR1_E						TBD	
	NR_FDD_FR1_G						TBD	
	NR_FDD_FR1_H						TBD	
N_{oc} Note2	NR_FDD_FR1_A, NR_TDD_FR1_A	1,2,4,5	dBm/SS B SCS	TBD	TBD	TBD	TBD	
	NR_FDD_FR1_B						TBD	
	NR_TDD_FR1_C						TBD	
	NR_FDD_FR1_D, NR_TDD_FR1_D						TBD	
	NR_FDD_FR1_E, NR_TDD_FR1_E						TBD	
	NR_FDD_FR1_G						TBD	
	NR_FDD_FR1_H						TBD	
	NR_FDD_FR1_A, NR_TDD_FR1_A	3		TBD	TBD	TBD	TBD	TBD
	NR_FDD_FR1_B							TBD
	NR_TDD_FR1_C							TBD
	NR_FDD_FR1_D, NR_TDD_FR1_D							TBD
	NR_FDD_FR1_E, NR_TDD_FR1_E							TBD
	NR_FDD_FR1_G							TBD
	NR_FDD_FR1_H							TBD
\hat{E}_s / I_{ot}	1~3	dB	TBD	TBD	TBD	TBD		
SS- RSR pNote3	NR_FDD_FR1_A, NR_TDD_FR1_A	1,2,4,5	dBm/SC S	TBD	TBD	TBD	TBD	
	NR_FDD_FR1_B						TBD	
	NR_TDD_FR1_C						TBD	
	NR_FDD_FR1_D, NR_TDD_FR1_D						TBD	
	NR_FDD_FR1_E, NR_TDD_FR1_E						TBD	
	NR_FDD_FR1_G						TBD	
	NR_FDD_FR1_H						TBD	
	NR_FDD_FR1_A, NR_TDD_FR1_A	3		TBD	TBD	TBD	TBD	TBD
	NR_FDD_FR1_B							TBD
	NR_TDD_FR1_C							TBD
	NR_FDD_FR1_D, NR_TDD_FR1_D							TBD
	NR_FDD_FR1_E, NR_TDD_FR1_E							TBD
	NR_FDD_FR1_G							TBD
	NR_FDD_FR1_H							TBD

Io ^{Note3}	NR_FDD_FR1_A, NR_TDD_FR1_A	1,2,4,5	dBm/ 9.36MHz	N/A		TBD	
	NR_FDD_FR1_B					TBD	
	NR_TDD_FR1_C					TBD	
	NR_FDD_FR1_D, NR_TDD_FR1_D					TBD	
	NR_FDD_FR1_E, NR_TDD_FR1_E					TBD	
	NR_FDD_FR1_G					TBD	
	NR_FDD_FR1_H					TBD	
	NR_FDD_FR1_A, NR_TDD_FR1_A	3	dBm/ 38.16M Hz	N/A		TBD	
	NR_FDD_FR1_B					TBD	
	NR_TDD_FR1_C					TBD	
	NR_FDD_FR1_D, NR_TDD_FR1_D					TBD	
	NR_FDD_FR1_E, NR_TDD_FR1_E					TBD	
	NR_FDD_FR1_G					TBD	
	NR_FDD_FR1_H	TBD					
	NR_TDD_FR2_A	1~3	dBm/ 95.04M Hz	N/A	TBD	TBD	
NR_TDD_FR2_B	TBD						
NR_TDD_FR2_F	TBD						
NR_TDD_FR2_G	TBD						
NR_TDD_FR2_T	TBD						
NR_TDD_FR2_Y	TBD						
\hat{E}_s / N_{oc}	1~3	dB	TBD	TBD	TBD	TBD	
<p>Note 1: RSRP and Io levels have been derived from other parameters for information purposes. They are not settable parameters themselves.</p> <p>Note 2: RSRP minimum requirements are specified assuming independent interference and noise at each receiver antenna port.</p>							

A.7.7.1.3.3 Test Requirements

The SS-RSRP measurement accuracy for Cell 2 shall fulfil the Absolute requirement in section 10.1.5.1.1.

A.7.7.2 SS-RSRQ

A.7.7.2.1 SA Intra-frequency measurement accuracy with FR2 serving cell and FR2 TDD target cell

A.7.7.2.1.1 Test Purpose and Environment

The purpose of this test is to verify that the SS-RSRQ measurement accuracy is within the specified limits. This test will verify the requirements in Clause 10.1.8.1.1.

A.7.7.2.1.2 Test Parameters

In this test case all cells are on the same carrier frequency. Supported test configurations are shown in Table A.7.7.2.1.2-1. . The absolute accuracy of SS-RSRQ intra-frequency measurement is test by using the parameters in Table A.7.7.2.1.2-2 and Table A.7.7.2.1.2-3. In all test cases, Cell 1 is the PCell and Cell 2 the target cell.

Table A.7.7.2.1.2-1: SS-RSRQ Intra frequency SS-RSRQ supported test configurations

Configuration	Description
1	120 kHz SSB SCS, 100MHz bandwidth, TDD duplex mode

Table A.7.7.2.1.2-2: SS-RSRQ Intra frequency test parameters

Parameter	Unit	Test 1		Test 2		Test 3	
		Cell 1	Cell 2	Cell 1	Cell 2	Cell 1	Cell 2
SSB ARFCN		FFreq1		FFreq1		FFreq1	
Duplex mode		TDD		TDD		TDD	
TDD configuration		TDDConf.3.1		TDDConf.3.1		TDDConf.3.1	
BW _{channel}	MHz	100: N _{RB,c} = 66		100: N _{RB,c} = 66		100: N _{RB,c} = 66	
BWP configuration	Initial DL BWP	DLBWP.0.1					
	Dedicated DL BWP	DLBWP.1.1					
	Initial UL BWP	ULBWP.0.1					
	Dedicated UL BWP	ULBWP.1.1					
TRS configuration		TRS.2.1 TDD		TRS.2.1 TDD		TRS.2.1 TDD	
TCI state		TCI.State.0		TCI.State.0		TCI.State.0	
PDSCH Reference measurement channel		SR.3.1 TDD		SR.3.1 TDD		SR.3.1 TDD	
RMSI CORESET Reference Channel		CR.3.1 TDD	-	CR.3.1 TDD	-	CR.3.1 TDD	
DControl channel RMC		CCR.3.1 TDD	-	CCR.3.1 TDD	-	CCR.3.1 TDD	-
OCNG Patterns		OP.1	OP.1	OP.1	OP.1	OP.1	OP.1
SMTc configuration		SMTc.1					
SSB configuration		SSB.1 FR2	SSB.1 FR2	SSB.1 FR2	SSB.1 FR2	SSB.1 FR2	SSB.1 FR2
PDSCH/PDCCH subcarrier spacing	kHz	120	120	120	120	120	120
SS-RSSI-Measurement		Not Applicable					
EPRE ratio of PSS to SSS							
EPRE ratio of PBCH_DMRS to SSS							
EPRE ratio of PBCH to PBCH_DMRS							
EPRE ratio of PDCCH_DMRS to SSS							
EPRE ratio of PDCCH to PDCCH_DMRS							
EPRE ratio of PDSCH_DMRS to SSS							
EPRE ratio of PDSCH to PDSCH_DMRS							
EPRE ratio of OCNG DMRS to SSS ^{Note 1}							
EPRE ratio of OCNG to OCNG DMRS ^{Note 1}							
\hat{E}_s / N_{oc}	dB	3	3	-2.9	-2.9	-4	-4
Note 1:	OCNG shall be used such that both cells are fully allocated and a constant total transmitted power spectral density is achieved for all OFDM symbols.						
Note 2:	Interference from other cells and noise sources not specified in the test is assumed to be constant over subcarriers and time and shall be modelled as AWGN of appropriate power for N_{oc} to be fulfilled.						
Note 3:	SS-RSRQ, SS-RSRP, and I _o levels have been derived from other parameters for information purposes. They are not settable parameters themselves.						
Note 4:	SS-RSRQ and SS-RSRP minimum requirements are specified assuming independent interference and noise at each receiver antenna port.						

Table A.7.7.2.1.2-3: SS-RSRQ Intra frequency OTA related test parameters

Parameter	Unit	Test 1		Test 2		Test 3	
		Cell 1	Cell 2	Cell 1	Cell 2	Cell 1	Cell 2
Angle of arrival configuration		According to section A.3.15.x		According to section A.3.15.x		According to section A.3.15.x	
N_{oc} ^{Note1}	NR_TDD_FR2_A	dBm/15kHz ^{Note4}	TBD	TBD	TBD	TBD	TBD
	NR_TDD_FR2_B						
	NR_TDD_FR2_F						
	NR_TDD_FR2_G						

	NR_TDD_FR2_T							TBD
	NR_TDD_FR2_Y							TBD
N_{oc} ^{Note1}	NR_TDD_FR2_A	dBm/SCS ^{Note3}	TBD	TBD	TBD	TBD	TBD	TBD
	NR_TDD_FR2_B							TBD
	NR_TDD_FR2_F							TBD
	NR_TDD_FR2_G							TBD
	NR_TDD_FR2_T							TBD
	NR_TDD_FR2_Y							TBD
SS-RSRP ^{Note2}	NR_TDD_FR2_A	dBm/SCS ^{Note4}	TBD	TBD	TBD	TBD	TBD	TBD
	NR_TDD_FR2_B							TBD
	NR_TDD_FR2_F							TBD
	NR_TDD_FR2_G							TBD
	NR_TDD_FR2_T							TBD
	NR_TDD_FR2_Y							TBD
SS-RSRQ ^{Note2}	NR_TDD_FR2_A	dB	TBD	TBD	TBD	TBD	TBD	TBD
	NR_TDD_FR2_B							TBD
	NR_TDD_FR2_F							TBD
	NR_TDD_FR2_G							TBD
	NR_TDD_FR2_T							TBD
	NR_TDD_FR2_Y							TBD
\hat{E}_s/I_{ot}		dB	TBD	TBD	TBD	TBD	TBD	TBD
I_o ^{Note2}	NR_TDD_FR2_A	dBm/95.04 MHz ^{Note4}	TBD	TBD	TBD	TBD	TBD	TBD
	NR_TDD_FR2_B							TBD
	NR_TDD_FR2_F							TBD
	NR_TDD_FR2_G							TBD
	NR_TDD_FR2_T							TBD
	NR_TDD_FR2_Y							TBD
<p>Note 1: Interference from other cells and noise sources not specified in the test is assumed to be constant over subcarriers and time and shall be modelled as AWGN of appropriate power for N_{oc} to be fulfilled.</p> <p>Note 2: SS-RSRQ, SS-RSRP, and I_o levels have been derived from other parameters for information purposes. They are not settable parameters themselves.</p> <p>Note 3: SS-RSRQ and SS-RSRP minimum requirements are specified assuming independent interference and noise at each receiver antenna port.</p> <p>Note 4: Equivalent power received by an antenna with 0dBi gain at the centre of the quiet zone</p> <p>Note 5: As observed with 0dBi gain antenna at the centre of the quiet zone</p> <p>Note 6: NR operating band groups are as defined in Section 3.5.2.</p>								

A.7.7.2.1.3 Test Requirements

The SS-RSRQ measurement accuracy shall fulfil the requirements in section 10.1.8.1.1.

A.7.7.2.2 SA Inter-frequency measurement accuracy with FR2 serving cell and FR2 TDD target cell

A.7.7.2.2.1 Test Purpose and Environment

The purpose of this test is to verify that the SS-RSRQ measurement accuracy is within the specified limits. This test will verify the requirements in Clause 10.1.9.1.1 and 10.1.9.1.2 for inter-frequency measurement.

A.7.7.2.2.2 Test Parameters

In this test case the two cells (i.e., Cell 1 and Cell 2) are on different carrier frequencies and measurement gaps are provided. Supported test configurations are shown in Table A.7.7.2.2-1. Both absolute accuracy and relative accuracy requirements of SS-RSRQ inter-frequency measurement are tested by using test parameters in Table A.7.7.2.2-2 and Table A.7.7.2.2-3. In all test cases, Cell 1 is the PCell and Cell 2 is target cell.

Table A.5.7.2.2-1: SS-RSRQ Inter frequency SS-RSRQ supported test configurations

Configuration	Description
1	120 kHz SSB SCS, 100MHz bandwidth, TDD duplex mode

Table A.5.7.2.2-2: SS-RSRQ Inter frequency general test parameters

Parameter	Unit	Test 1		Test 2		Test 3	
		Cell 1	Cell 2	Cell 1	Cell 2	Cell 1	Cell 2
SSB ARFCN		freq1	freq2	freq1	freq2	freq1	freq2
Duplex mode		TDD		TDD		TDD	
TDD configuration		TDDConf.3.1		TDDConf.3.1		TDDConf.3.1	
$BW_{channel}$	MHz	100: $N_{RB,c} = 66$		100: $N_{RB,c} = 66$		100: $N_{RB,c} = 66$	
PDSCH Reference measurement channel		SR.3.1 TDD	-	SR.3.1 TDD	-	SR.3.1 TDD	-
RMSI CORESET Reference Channel		CR.3.1 TDD	-	CR.3.1 TDD	-	CR.3.1 TDD	-
OCNG Patterns		OP.1	OP.1	OP.1	OP.1	OP.1	OP.1
SMTC configuration		SMTC. 1 FR2	SMTC. 1 FR2	SMTC. 1 FR2	SMTC. 1 FR2	SMTC. 1 FR2	SMTC. 1 FR2
PDSCH/PDCCH subcarrier spacing	kHz	120	120	120	120	120	120
EPRE ratio of PSS to SSS	dB	0	0	0	0	0	0
EPRE ratio of PBCH_DMRS to SSS							
EPRE ratio of PBCH to PBCH_DMRS							
EPRE ratio of PDCCH_DMRS to SSS							
EPRE ratio of PDCCH to PDCCH_DMRS							
EPRE ratio of PDSCH_DMRS to SSS							
EPRE ratio of PDSCH to PDSCH_DMRS							
EPRE ratio of OCNG DMRS to SSS ^{Note 1}							
\hat{E}_s / N_{oc}	dB	TBD	TBD	TBD	TBD	TBD	TBD
<p>Note 1: OCNG shall be used such that both cells are fully allocated and a constant total transmitted power spectral density is achieved for all OFDM symbols.</p> <p>Note 2: Interference from other cells and noise sources not specified in the test is assumed to be constant over subcarriers and time and shall be modelled as AWGN of appropriate power for N_{oc} to be fulfilled.</p> <p>Note 3: SS-RSRQ, SS-RSRP and I_0 levels have been derived from other parameters for information purposes. They are not settable parameters themselves.</p> <p>Note 4: SS-RSRQ and SS-RSRP minimum requirements are specified assuming independent interference and noise at each receiver antenna port.</p>							

Table A.5.7.2.2-3: SS-RSRQ Inter frequency OTA related test parameters

Parameter	Unit	Test 1		Test 2		Test 3	
		Cell 1	Cell 2	Cell 1	Cell 2	Cell 1	Cell 2
UE orientation around TBD axis and TBD axis	degrees	TBD		TBD		TBD	
Relative difference in angle of arrival of cell 2 relative to cell 1	degrees	NA	TBD	NA	0	NA	0
N_{oc} ^{Note1}	NR_TDD_FR2_A	dBm/15kHz ^{Note4}	TBD	TBD	TBD	TBD	
	NR_TDD_FR2_B					TBD	
	NR_TDD_FR2_F					TBD	
	NR_TDD_FR2_G					TBD	
	NR_TDD_FR2_T					TBD	

N_{oc} ^{Note1}	NR_TDD_FR2_Y	dBm/SCS ^{Note3}	TBD	TBD	TBD	TBD	
	NR_TDD_FR2_A					TBD	
	NR_TDD_FR2_B					TBD	
	NR_TDD_FR2_F					TBD	
	NR_TDD_FR2_G					TBD	
	NR_TDD_FR2_T					TBD	
SS-RSRP ^{Note2}	NR_TDD_FR2_A	dBm/SCS ^{Note4}	TBD	TBD	TBD	TBD	TBD
	NR_TDD_FR2_B					TBD	TBD
	NR_TDD_FR2_F					TBD	TBD
	NR_TDD_FR2_G					TBD	TBD
	NR_TDD_FR2_T					TBD	TBD
	NR_TDD_FR2_Y					TBD	TBD
SS-RSRQ ^{Note2}	NR_TDD_FR2_A	dB	TBD	TBD	TBD	TBD	TBD
	NR_TDD_FR2_B					TBD	TBD
	NR_TDD_FR2_F					TBD	TBD
	NR_TDD_FR2_G					TBD	TBD
	NR_TDD_FR2_T					TBD	TBD
	NR_TDD_FR2_Y					TBD	TBD
\hat{E}_s/I_{ot}		dB	TBD	TBD	TBD	TBD	TBD
I_o ^{Note2}	NR_TDD_FR2_A	dBm/95.04 MHz ^{Note4}	TBD	TBD	TBD	TBD	
	NR_TDD_FR2_B					TBD	
	NR_TDD_FR2_F					TBD	
	NR_TDD_FR2_G					TBD	
	NR_TDD_FR2_T					TBD	
	NR_TDD_FR2_Y					TBD	
<p>Note 1: Interference from other cells and noise sources not specified in the test is assumed to be constant over subcarriers and time and shall be modelled as AWGN of appropriate power for N_{oc} to be fulfilled.</p> <p>Note 2: SS-RSRQ, SS-RSRP, and I_o levels have been derived from other parameters for information purposes. They are not settable parameters themselves.</p> <p>Note 3: SS-RSRQ and SS-RSRP minimum requirements are specified assuming independent interference and noise at each receiver antenna port.</p> <p>Note 4: Equivalent power received by an antenna with 0dBi gain at the centre of the quiet zone</p> <p>Note 5: As observed with 0dBi gain antenna at the centre of the quiet zone</p> <p>Note 6: NR operating band groups are as defined in Section 3.5.2.</p>							

A.7.7.2.2.3 Test Requirements

The SS-RSRQ measurement accuracy shall fulfil the requirements in section 10.1.9.1.1 and 10.1.9.1.2.

A.7.7.3 SS-SINR

A.7.7.3.1 SA intra-frequency case measurement accuracy with FR2 serving cell and FR2 target cell

A.7.7.3.1.1 Test Purpose and Environment

The purpose of this test is to verify that the SS-SINR measurement accuracy is within the specified limits. This test will verify the requirements in Clause 10.1.13.1.1.

A.7.7.3.1.2 Test Parameters

In this test case all cells are on the same carrier frequency. Supported test configurations are shown in Table A.7.7.3.1.2-1. . The absolute accuracy of SS-SINR intra-frequency measurement is test by using the parameters in Table A.7.7.3.1.2-2 and Table A.7.7.3.1.2-3. In all test cases, Cell 1 is the PCell and Cell 2 the target cell. The TCI status for Cell 1 is defined in Table [TBD] and TRS configuration for Cell 1 is defined in Table [TBD].

Table A.7.7.3.1.2-1: SS-SINR Intra frequency SS-SINR supported test configurations

Configuration	Description
1	120 kHz SSB SCS, 100MHz bandwidth, TDD duplex mode

Table A.7.7.3.1.2-2: SS-SINR Intra frequency test parameters

Parameter	Unit	Test 1		Test 2		Test 3	
		Cell 1	Cell 2	Cell 1	Cell 2	Cell 1	Cell 2
SSB ARFCN		Freq2		Freq2		Freq2	
Duplex mode		TDD		TDD		TDD	
TDD configuration		TDDConf.3.1		TDDConf.3.1		TDDConf.3.1	
BW _{channel}	MHz	100: N _{RB,c} = 66		100: N _{RB,c} = 66		100: N _{RB,c} = 66	
Downlink initial BWP configuration		DLBWP.0.1					
Downlink dedicated BWP configuration		DLBWP.1.1					
Uplink initial BWP configuration		ULBWP.0.1					
Uplink dedicated BWP configuration		ULBWP.1.1					
DRX cycle configuration	ms	Not applicable					
TRS configuration		TRS.2.1 TDD					
TCI state		TCI.State.0					
PDSCH Reference measurement channel		SR.3.1 TDD		SR.3.1 TDD		SR.3.1 TDD	
RMSI CORESET Reference Channel		CR.3.1 TDD	-	CR.3.1 TDD	-	CR.3.1 TDD	
Dedicated RMSI CORESET Reference Channel		CCR.3 .1 TDD	-	CCR.3 .1 TDD	-	CCR.3 .1 TDD	-
OCNG Patterns		OP.1	OP.1	OP.1	OP.1	OP.1	OP.1
SMTc configuration		SMTc.1					
SSB configuration		SSB.1 FR2	SSB.1 FR2	SSB.1 FR2	SSB.1 FR2	SSB.1 FR2	SSB.1 FR2
PDSCH/PDCCH subcarrier spacing	kHz	120	120	120	120	120	120
SS-RSSI-Measurement		Not Applicable					
EPRE ratio of PSS to SSS							
EPRE ratio of PBCH_DMRS to SSS							
EPRE ratio of PBCH to PBCH_DMRS							
EPRE ratio of PDCCH_DMRS to SSS							
EPRE ratio of PDCCH to PDCCH_DMRS							
EPRE ratio of PDSCH_DMRS to SSS							
EPRE ratio of PDSCH to PDSCH_DMRS							
EPRE ratio of OCNG DMRS to SSS ^{Note 1}							
EPRE ratio of OCNG to OCNG DMRS ^{Note 1}							
\hat{E}_s / N_{oc}	dB	TBD	TBD	TBD	TBD	TBD	TBD
Note 1:	OCNG shall be used such that both cells are fully allocated and a constant total transmitted power spectral density is achieved for all OFDM symbols.						
Note 2:	Interference from other cells and noise sources not specified in the test is assumed to be constant over subcarriers and time and shall be modelled as AWGN of appropriate power for N_{oc} to be fulfilled.						
Note 3:	SS-SINR, SS-RSRP, and I _o levels have been derived from other parameters for information purposes. They are not settable parameters themselves.						
Note 4:	SS-SINR and SS-RSRP minimum requirements are specified assuming independent interference and noise at each receiver antenna port.						

Table A.7.7.3.1.2-3: SS-SINR Intra frequency OTA related test parameters

Parameter		Unit	Test 1		Test 2		Test 3	
			Cell 1	Cell 2	Cell 1	Cell 2	Cell 1	Cell 2
Angle of arrival configuration			According to section A.3.8.X		According to section A.3.8.X		According to section A.3.8.X	
N_{oc} ^{Note1}	NR_TDD_FR2_A	dBm/15kHz ^{Note4}	TBD		TBD		TBD	
	NR_TDD_FR2_B						TBD	
	NR_TDD_FR2_F						TBD	
	NR_TDD_FR2_G						TBD	
	NR_TDD_FR2_T						TBD	
N_{oc} ^{Note1}	NR_TDD_FR2_A	dBm/SCS ^{Note3}	TBD		TBD		TBD	
	NR_TDD_FR2_B						TBD	
	NR_TDD_FR2_F						TBD	
	NR_TDD_FR2_G						TBD	
	NR_TDD_FR2_T						TBD	
SS-RSRP ^{Note2}	NR_TDD_FR2_A	dBm/SCS ^{Note4}	TBD	TBD	TBD	TBD	TBD	TBD
	NR_TDD_FR2_B						TBD	TBD
	NR_TDD_FR2_F						TBD	TBD
	NR_TDD_FR2_G						TBD	TBD
	NR_TDD_FR2_T						TBD	TBD
SS-SINR ^{Note2}	NR_TDD_FR2_A	dB	TBD	TBD	TBD	TBD	TBD	TBD
	NR_TDD_FR2_B						TBD	TBD
	NR_TDD_FR2_F						TBD	TBD
	NR_TDD_FR2_G						TBD	TBD
	NR_TDD_FR2_T						TBD	TBD
\hat{E}_s / I_{ot}	NR_TDD_FR2_A	dB	TBD	TBD	TBD	TBD	TBD	TBD
	NR_TDD_FR2_B						TBD	TBD
	NR_TDD_FR2_F						TBD	TBD
	NR_TDD_FR2_G						TBD	TBD
	NR_TDD_FR2_T						TBD	TBD
I_o ^{Note2}	NR_TDD_FR2_A	dBm/95.04 MHz ^{Note4}	TBD		TBD		TBD	
	NR_TDD_FR2_B						TBD	
	NR_TDD_FR2_F						TBD	
	NR_TDD_FR2_G						TBD	
	NR_TDD_FR2_T						TBD	
NR_TDD_FR2_Y	TBD							
<p>Note 1: Interference from other cells and noise sources not specified in the test is assumed to be constant over subcarriers and time and shall be modelled as AWGN of appropriate power for N_{oc} to be fulfilled.</p> <p>Note 2: SS-SINR, SS-RSRP, and I_o levels have been derived from other parameters for information purposes. They are not settable parameters themselves.</p> <p>Note 3: SS-SINR and SS-RSRP minimum requirements are specified assuming independent interference and noise at each receiver antenna port.</p> <p>Note 4: Equivalent power received by an antenna with 0dBi gain at the centre of the quiet zone</p> <p>Note 5: As observed with 0dBi gain antenna at the centre of the quiet zone</p> <p>Note 6: NR operating band groups are as defined in Section 3.5.2.</p>								

A.7.7.3.1.3 Test Requirements

The SS-SINR measurement accuracy shall fulfil the requirements in section 10.1.13.1.1.

A.7.7.3.2 SA Inter-frequency measurement accuracy with FR2 serving cell and FR2 TDD target cell

A.7.7.3.2.1 Test Purpose and Environment

The purpose of this test is to verify that the SS-SINR measurement accuracy is within the specified limits. This test will verify the requirements in Clause 10.1.15.1.1 and 10.1.15.1.2 for inter-frequency measurement.

A.7.7.3.2.2 Test Parameters

In this test case the two cells (i.e., Cell 1 and Cell 2) are on different carrier frequencies and measurement gaps are provided. Supported test configurations are shown in Table A.7.7.3.2.2-1. Both absolute accuracy and relative accuracy requirements of SS-SINR inter-frequency measurement are tested by using test parameters in Table A.7.7.3.2.2-2 and Table A.7.7.3.2.2-3. In all test cases, Cell 1 is the PCell and Cell 2 is target cell. The TCI status for Cell 1 is defined in Table [TBD] and TRS configuration for Cell 1 is defined in Table [TBD].

Table A.7.7.3.2.2-1: SS-SINR Inter frequency SS-SINR supported test configurations

Configuration	Description
1	120 kHz SSB SCS, 100MHz bandwidth, TDD duplex mode

Table A.7.7.3.2.2-2: SS-SINR Inter frequency general test parameters

Parameter	Unit	Test 1		Test 2		Test 3	
		Cell 1	Cell 2	Cell 1	Cell 2	Cell 1	Cell 2
SSB ARFCN		freq1	freq2	freq1	freq2	freq1	freq2
Duplex mode		TDD		TDD		TDD	
TDD configuration		TDDConf.3.1		TDDConf.3.1		TDDConf.3.1	
BW _{channel}	MHz	100: N _{RB,c} = 66		100: N _{RB,c} = 66		100: N _{RB,c} = 66	
Downlink initial BWP configuration		DLBWP.0.1					
Downlink dedicated BWP configuration		DLBWP.1.1					
Uplink initial BWP configuration		ULBWP.0.1					
Uplink dedicated BWP configuration		ULBWP.1.1					
DRX cycle configuration	ms	Not applicable					
TRS configuration		TRS.2.1 TDD					
TCI state		TCI.State.0					
PDSCH Reference measurement channel		SR.3.1 TDD	-	SR.3.1 TDD	-	SR.3.1 TDD	-
RMSI CORESET Reference Channel		CR.3.1 TDD	-	CR.3.1 TDD	-	CR.3.1 TDD	-
OCNG Patterns		OP.1	OP.1	OP.1	OP.1	OP.1	OP.1
SMTC configuration		SMTC. 1 FR2	SMTC. 1 FR2	SMTC. 1 FR2	SMTC. 1 FR2	SMTC. 1 FR2	SMTC. 1 FR2
PDSCH/PDCCH subcarrier spacing	kHz	120	120	120	120	120	120
EPRE ratio of PSS to SSS	dB	0	0	0	0	0	0
EPRE ratio of PBCH_DMRS to SSS							
EPRE ratio of PBCH to PBCH_DMRS							
EPRE ratio of PDCCH_DMRS to SSS							
EPRE ratio of PDCCH to PDCCH_DMRS							
EPRE ratio of PDSCH_DMRS to SSS							
EPRE ratio of PDSCH to PDSCH_DMRS							
EPRE ratio of OCNG DMRS to SSS ^{Note 1}	dB	TBD	TBD	TBD	TBD	TBD	TBD
\hat{E}_s/N_{oc}							
Note 1:	OCNG shall be used such that both cells are fully allocated and a constant total transmitted power spectral density is achieved for all OFDM symbols.						
Note 2:	Interference from other cells and noise sources not specified in the test is assumed to be constant over subcarriers and time and shall be modelled as AWGN of appropriate power for N_{oc} to be fulfilled.						
Note 3:	SS-SINR, SS-RSRP and I _o levels have been derived from other parameters for information purposes. They are not settable parameters themselves.						
Note 4:	SS-SINR and SS-RSRP minimum requirements are specified assuming independent interference and noise at each receiver antenna port.						

Table A.7.7.3.2.2-3: SS-SINR Inter frequency OTA related test parameters

Parameter	Unit	Test 1		Test 2		Test 3	
		Cell 1	Cell 2	Cell 1	Cell 2	Cell 1	Cell 2
UE orientation around TBD axis and TBD axis	degrees	TBD		TBD		TBD	
Relative difference in angle of arrival of cell 2 relative to cell 1	degrees	NA	TBD	NA	0	NA	0
N_{oc} ^{Note1}	NR_TDD_FR2_A	dBm/15kHz ^{Note4}	TBD	TBD	TBD	TBD	
	NR_TDD_FR2_B					TBD	
	NR_TDD_FR2_F					TBD	
	NR_TDD_FR2_G					TBD	
	NR_TDD_FR2_T					TBD	

N_{oc} ^{Note1}	NR_TDD_FR2_Y	dBm/SCS ^{Note3}	TBD	TBD	TBD	TBD	
	NR_TDD_FR2_A					TBD	
	NR_TDD_FR2_B					TBD	
	NR_TDD_FR2_F					TBD	
	NR_TDD_FR2_G					TBD	
	NR_TDD_FR2_T					TBD	
SS-RSRP ^{Note2}	NR_TDD_FR2_Y	dBm/SCS ^{Note4}	TBD	TBD	TBD	TBD	TBD
	NR_TDD_FR2_A						TBD
	NR_TDD_FR2_B						TBD
	NR_TDD_FR2_F						TBD
	NR_TDD_FR2_G						TBD
	NR_TDD_FR2_T						TBD
SS-SINR ^{Note2}	NR_TDD_FR2_Y	dB	TBD	TBD	TBD	TBD	TBD
	NR_TDD_FR2_A						TBD
	NR_TDD_FR2_B						TBD
	NR_TDD_FR2_F						TBD
	NR_TDD_FR2_G						TBD
	NR_TDD_FR2_T						TBD
\hat{E}_s / I_{ot}		dB	TBD	TBD	TBD	TBD	TBD
I_o ^{Note2}	NR_TDD_FR2_Y	dBm/95.04 MHz ^{Note4}	TBD	TBD	TBD	TBD	
	NR_TDD_FR2_A					TBD	
	NR_TDD_FR2_B					TBD	
	NR_TDD_FR2_F					TBD	
	NR_TDD_FR2_G					TBD	
	NR_TDD_FR2_T					TBD	
<p>Note 1: Interference from other cells and noise sources not specified in the test is assumed to be constant over subcarriers and time and shall be modelled as AWGN of appropriate power for N_{oc} to be fulfilled.</p> <p>Note 2: SS-SINR, SS-RSRP, and I_o levels have been derived from other parameters for information purposes. They are not settable parameters themselves.</p> <p>Note 3: SS-SINR and SS-RSRP minimum requirements are specified assuming independent interference and noise at each receiver antenna port.</p> <p>Note 4: Equivalent power received by an antenna with 0dBi gain at the centre of the quiet zone</p> <p>Note 5: As observed with 0dBi gain antenna at the centre of the quiet zone</p> <p>Note 6: NR operating band groups are as defined in Section 3.5.2.</p>							

A.7.7.3.2.3 Test Requirements

The SS-SINR measurement accuracy shall fulfil the requirements in section 10.1.15.1.1 and 10.1.15.1.2.

A.7.7.4 L1-RSRP measurement for beam reporting

A.7.7.4.1 SSB based L1-RSRP measurement

A.7.7.4.1.1 Test Purpose and Environment

The purpose of this test is to verify that the L1-RSRP measurement accuracy is within the specified limits. This test will verify the requirements in Sections 9.5.2 and section 10.1.20.1 for L1-RSRP measurements based on SSB with the testing configurations for NR cells in Table A.7.7.4.1.1-1.

The AoA setup for this test is Setup 1 as defined in section A.3.15.

Table A.7.7.4.1.1-1: Applicable NR configurations for FR1 SSB based L1-RSRP test

Config	Description
1	LTE FDD, NR 120 kHz SSB SCS, 100MHz bandwidth, TDD duplex mode
2	LTE FDD, NR 240 kHz SSB SCS, 100MHz bandwidth, TDD duplex mode
Note:	The UE is only required to be tested in one of the supported test configurations

A.7.7.4.1.2 Test parameters

In this set of test cases there are two cells in the test, PCell (Cell 1). The test parameters for the Cell 1 are given in Table A.7.7.4.1.2-1 and Table A.7.7.4.1.2-2 below. The absolute and relative accuracy of L1-RSRP measurements are tested by using the parameters in Table A.7.7.4.1.2-1 and Table A.7.7.4.1.2-2.

There is no measurement gap configured in the test. Before the test, UE is configured one SSB resource set with two SSB resources. UE is configured to perform RLM, BFD and L1-RSRP measurement based on the SSB resources 0 and 1. The TCI status for Cell 2 is defined in Table [TBD] and TRS configuration for Cell 2 is defined in Table [TBD].

Table A.7.7.4.1.2-1: FR2 SSB based L1-RSRP general test parameters

Parameter	Config	Unit	Test 1	Test 2
SSB GSCN	1~2		freq1	freq1
Duplex mode	1~2		TDD	TDD
TDD Configuration	1~2		TDDConf.3.1	TDDConf.3.1
$BW_{channel}$	1~2	MHz	100: $N_{RB,c} = 66$	100: $N_{RB,c} = 66$
PDSCH Reference measurement channel	1~2		SR.3.1 TDD	SR.3.1 TDD
RMSI CORESET Reference Channel	1~2		CR.3.1 TDD	CR.3.1 TDD
Dedicated CORESET Reference Channel	1~2		CCR.3.1 TDD	CCR.3.1 TDD
SSB configuration	1		SSB.1 FR2	SSB.1 FR2
	2		SSB.2 FR2	SSB.2 FR2
OCNG Patterns	1~2		OP.1	OP.1
Initial BWP Configuration	1~2		DLBWP.0.1	DLBWP.0.1
			ULBWP.0.1	ULBWP.0.1
Dedicated BWP configuration	1~2		DLBWP.1.3	DLBWP.1.3
			ULBWP.1.3	ULBWP.1.3
TRS Configuration	1~2		TRS.2.1 TDD	TRS.2.1 TDD
TCI Configuration	1~2		TCI.State.2	TCI.State.2
SMTC configuration	1~2		SMTC.1	SMTC.1
reportConfigType	1~2		periodic	periodic
reportQuantity	1~2		ssb-Index-RSRP	ssb-Index-RSRP
Number of reported RS	1~2		2	2
L1-RSRP reporting period	1~2		Tslot640	Tslot640
Propagation condition	1~2		AWGN	AWGN
EPRE ratio of PSS to SSS	1~2	dB	0	0
EPRE ratio of PBCH DMRS to SSS				
EPRE ratio of PBCH to PBCH DMRS				
EPRE ratio of PDCCH DMRS to SSS				
EPRE ratio of PDCCH to PDCCH DMRS				
EPRE ratio of PDSCH DMRS to SSS				
EPRE ratio of PDSCH to PDSCH DMRS				
EPRE ratio of OCNG DMRS to SSS ^{Note 1}				
EPRE ratio of OCNG to OCNG DMRS ^{Note 1}				
<p>Note 1: OCNG shall be used such that both cells are fully allocated and a constant total transmitted power spectral density is achieved for all OFDM symbols.</p> <p>Note 2: Interference from other cells and noise sources not specified in the test is assumed to be constant over subcarriers and time and shall be modelled as AWGN of appropriate power for N_{oc} to be fulfilled.</p>				

Table A.7.7.4.1.2-2: FR2 SSB based L1-RSRP OTA related test parameters

	Parameter	Config	Unit	Test 1	Test 2
N_{oc} Note1	NR_TDD_FR2_A	1~2	dBm/15kHz	TBD	TBD
	NR_TDD_FR2_B				TBD
	NR_TDD_FR2_F				TBD
	NR_TDD_FR2_G				TBD
	NR_TDD_FR2_T				TBD
	NR_TDD_FR2_Y				TBD
N_{oc} Note1	NR_TDD_FR2_A	1	dBm/SSB SCS	TBD	TBD
	NR_TDD_FR2_B				TBD
	NR_TDD_FR2_F				TBD

	NR_TDD_FR2_G				TBD	
	NR_TDD_FR2_T				TBD	
	NR_TDD_FR2_Y				TBD	
	NR_TDD_FR2_A	2		TBD	TBD	
	NR_TDD_FR2_B				TBD	
	NR_TDD_FR2_F				TBD	
	NR_TDD_FR2_G				TBD	
	NR_TDD_FR2_T				TBD	
	NR_TDD_FR2_Y				TBD	
	NR_TDD_FR2_A				TBD	
	NR_TDD_FR2_B				TBD	
	NR_TDD_FR2_F				TBD	
	NR_TDD_FR2_G				TBD	
	NR_TDD_FR2_T				TBD	
	NR_TDD_FR2_Y				TBD	
	NR_TDD_FR2_A	1		TBD	TBD	
	NR_TDD_FR2_B				TBD	
	NR_TDD_FR2_F				TBD	
	NR_TDD_FR2_G				TBD	
	NR_TDD_FR2_T				TBD	
	NR_TDD_FR2_Y				TBD	
	NR_TDD_FR2_A				2	
	NR_TDD_FR2_B	TBD				
	NR_TDD_FR2_F	TBD				
	NR_TDD_FR2_G	TBD				
	NR_TDD_FR2_T	TBD				
	NR_TDD_FR2_Y	TBD				
	NR_TDD_FR2_A	1		TBD		
	NR_TDD_FR2_B				TBD	
	NR_TDD_FR2_F				TBD	
	NR_TDD_FR2_G				TBD	
	NR_TDD_FR2_T				TBD	
	NR_TDD_FR2_Y				TBD	
	NR_TDD_FR2_A				2	
	NR_TDD_FR2_B	TBD				
	NR_TDD_FR2_F	TBD				
	NR_TDD_FR2_G	TBD				
	NR_TDD_FR2_T	TBD				
	NR_TDD_FR2_Y	TBD				
	NR_TDD_FR2_A					
	NR_TDD_FR2_B				TBD	
	NR_TDD_FR2_F				TBD	
	NR_TDD_FR2_G				TBD	
	NR_TDD_FR2_T				TBD	
	NR_TDD_FR2_Y				TBD	
	\hat{E}_s/I_{ot}	1~2	dB	TBD	TBD	
SSB RSRP Note1	NR_TDD_FR2_A	1	dBm/SSB SCS	TBD	TBD	
	NR_TDD_FR2_B				TBD	
	NR_TDD_FR2_F				TBD	
	NR_TDD_FR2_G				TBD	
	NR_TDD_FR2_T				TBD	
	NR_TDD_FR2_Y				TBD	
	NR_TDD_FR2_A				2	TBD
	NR_TDD_FR2_B	TBD				
	NR_TDD_FR2_F	TBD				
	NR_TDD_FR2_G	TBD				
	NR_TDD_FR2_T	TBD				
	NR_TDD_FR2_Y	TBD				
	NR_TDD_FR2_A	1		dBm/95.04M Hz		
	NR_TDD_FR2_B				TBD	
NR_TDD_FR2_F	TBD					
NR_TDD_FR2_G	TBD					
NR_TDD_FR2_T	TBD					
NR_TDD_FR2_Y	TBD					
NR_TDD_FR2_A	2		TBD		TBD	
NR_TDD_FR2_B		TBD				
NR_TDD_FR2_F		TBD				
NR_TDD_FR2_G		TBD				
NR_TDD_FR2_T		TBD				
NR_TDD_FR2_Y		TBD				
\hat{E}_s/N_{oc}		1~2			dB	TBD
Note 1: RSRP and I _o levels have been derived from other parameters for information purposes. They are not settable parameters themselves.						
Note 2: RSRP minimum requirements are specified assuming independent interference and noise at each receiver antenna port.						

A.7.7.4.1.3 Test Requirements

For at least one reported L1-RSRP during 480ms, the accuracy for SSB#0 and SSB#1 of Cell 1 shall fulfil the requirements in sections 10.1.20.1. The reported L1-RSRP value shall include the Rx antenna gain in the range of TBD.

A.7.7.4.2 CSI-RS based L1-RSRP measurement on resource set with repetition off

A.7.7.4.2.1 Test Purpose and Environment

The purpose of this test is to verify that the L1-RSRP measurement accuracy is within the specified limits. This test will verify the requirements in Sections 9.5.3 and section 10.1.20.2 for L1-RSRP measurements based on CSI-RS with the testing configurations for NR cells in Table A.7.7.4.2.1-1.

The AoA setup for this test is Setup 1 as defined in section A.3.15.

Table A.7.7.4.2.1-1: Applicable NR configurations for FR1 CSI-RS based L1-RSRP test

Config	Description
1	NR 120 kHz CSI-RS SCS, 100MHz bandwidth, TDD duplex mode
Note:	The UE is only required to be tested in one of the supported test configurations

A.7.7.4.2.2 Test parameters

In this set of test cases there are one cell in the test, PCell (Cell 1). The test parameters for the Cell 1 are given in Table A.7.7.4.2.2-1 and Table A.7.7.4.2.2-2 below. The absolute and relative accuracy of L1-RSRP measurements are tested by using the parameters in Table A.7.7.4.2.2-1 and Table A.7.7.4.2.2-2.

There is no measurement gap configured in the test. Before the test, UE is configured one CSI-RS resource set with two CSI-RS resources. UE is configured to perform RLM and BFD based on SSB 0 and 1. CSI-RS is not transmitted in the same OFDM symbols as SSB. The TCI status for Cell 2 is defined in Table [TBD] and TRS configuration for Cell 2 is defined in Table [TBD].

Table A.7.7.4.2.2-1: FR2 CSI-RS based L1-RSRP general test parameters

Parameter	Config	Unit	Test 1	Test 2
SSB GSCN	1		freq1	freq1
Duplex mode	1		TDD	TDD
TDD Configuration	1		TDDConf.3.1	TDDConf.3.1
$BW_{channel}$	1	MHz	100: $N_{RB,c} = 66$	100: $N_{RB,c} = 66$
PDSCH Reference measurement channel	1		SR.3.1 TDD	SR.3.1 TDD
RMSI CORESET Reference Channel	1		CR.3.1 TDD	CR.3.1 TDD
Dedicated CORESET Reference Channel	1		CCR.3.1 TDD	CCR.3.1 TDD
SSB configuration	1		SSB.1 FR2	SSB.1 FR2
OCNG Patterns	1		OP.1	OP.1
Initial BWP Configuration	1		DLBWP.0.1 ULBWP.0.1	DLBWP.0.1 ULBWP.0.1
Dedicated BWP configuration	1		DLBWP.1.3 ULBWP.1.3	DLBWP.1.3 ULBWP.1.3
TRS Configuration	1		TRS.2.1 TDD	TRS.2.1 TDD
TCI Configuration	1		TCI.State.2	TCI.State.2
SMTC configuration	1		SMTC.1	SMTC.1
CSI-RS	1		CSI-RS.3.2 TDD	CSI-RS.3.2 TDD
reportConfigType	1		periodic	periodic
reportQuantity	1		cri-RSRP	cri-RSRP
Number of reported RS	1		2	2
L1-RSRP reporting period	1		slot80	slot80
Propagation condition	1		AWGN	AWGN
EPRE ratio of PSS to SSS	1	dB	0	0
EPRE ratio of PBCH DMRS to SSS				
EPRE ratio of PBCH to PBCH DMRS				
EPRE ratio of PDCCH DMRS to SSS				
EPRE ratio of PDCCH to PDCCH DMRS				
EPRE ratio of PDSCH DMRS to SSS				
EPRE ratio of PDSCH to PDSCH DMRS				
EPRE ratio of OCNG DMRS to SSS ^{Note 1}				
EPRE ratio of OCNG to OCNG DMRS ^{Note 1}				
<p>Note 1: OCNG shall be used such that both cells are fully allocated and a constant total transmitted power spectral density is achieved for all OFDM symbols.</p> <p>Note 2: Interference from other cells and noise sources not specified in the test is assumed to be constant over subcarriers and time and shall be modelled as AWGN of appropriate power for N_{oc} to be fulfilled.</p>				

Table A.7.7.4.2.2-2: FR2 CSI-RS based L1-RSRP OTA related test parameters

Parameter	Config	Unit	Test 1	Test 2
N_{oc} Note2	NR_TDD_FR2_A	dBm/15kHz	TBD	TBD
	NR_TDD_FR2_B			TBD
	NR_TDD_FR2_F			TBD
	NR_TDD_FR2_G			TBD
	NR_TDD_FR2_T			TBD
	NR_TDD_FR2_Y			TBD
	NR_TDD_FR2_A	dBm/CSI-RS SCS	TBD	TBD
	NR_TDD_FR2_B			TBD

N_{oc} Note2	NR_TDD_FR2_F				TBD
	NR_TDD_FR2_G				TBD
	NR_TDD_FR2_T				TBD
	NR_TDD_FR2_Y				TBD
\hat{E}_s/I_{ot}		1	dB	TBD	TBD
CSI-RS RSRP Note3	NR_TDD_FR2_A	1	dBm/CSI-RS SCS	TBD	TBD
	NR_TDD_FR2_B				TBD
	NR_TDD_FR2_F				TBD
	NR_TDD_FR2_G				TBD
	NR_TDD_FR2_T				TBD
	NR_TDD_FR2_Y				TBD
l_o Note3	NR_TDD_FR2_A	1	dBm/95.04M Hz	TBD	TBD
	NR_TDD_FR2_B				TBD
	NR_TDD_FR2_F				TBD
	NR_TDD_FR2_G				TBD
	NR_TDD_FR2_T				TBD
	NR_TDD_FR2_Y				TBD
\hat{E}_s/N_{oc}		1	dB	TBD	TBD
Note 1: RSRP and l_o levels have been derived from other parameters for information purposes. They are not settable parameters themselves.					
Note 2: RSRP minimum requirements are specified assuming independent interference and noise at each receiver antenna port.					

A.7.7.4.2.3 Test Requirements

The L1-RSRP measurement accuracy for CSI-RS#0 and CSI-RS#1 of Cell 1 shall fulfil the requirements in sections 10.1.20.2. The reported L1-RSRP value shall include the Rx antenna gain in the range of TBD.

A.8 E-UTRA standalone tests for NR RRM

Editor notes: All NR RRM tests under E-UTRA standalone operations are included in this Annex. All EN-DC related NR RRM tests are in A.6

A.8.1 E-UTRA – NR Inter-RAT SFTD Measurement Delay

A.8.1.1 E-UTRA – NR Inter-RAT SFTD Measurement Delay in non-DRX

A.8.1.1.1 Test Purpose and Environment

The purpose of this test is to partly verify that measurement reporting delay for SFTD between E-UTRA PCell and inter-RAT NR neighbour cell in FR1 is within the requirements stated in 3GPP TS 36.133 [15] Sections 8.1.2.4.25 and 8.1.2.4.26 for E-UTRA FDD and TDD, respectively, when no measurement gaps are provided and no DRX is configured.

The tests consist of a single time period of duration T1. Two carriers are used in the tests: one E-UTRA carrier with the PCell (Cell 1), and one NR carrier with the NR neighbour cell (Cell 2).

Prior to the start of time duration T1, the UE is connected to Cell 1 and configured to carry out intra-frequency measurements only. The point in time at which the UE receives, at the UE antenna connector(s), a RRC message containing a measurement configuration for SFTD measurements on RF channel 2 defines the start of time duration T1. Following the start of T1 the UE shall detect Cell 2, determine the SFN and frame time difference of Cell 2 relative to Cell 1, and send a measurement report.

The supported test configurations are listed in Table A.8.1.1.1-1 below. Test parameters and cell-specific parameters for the NR cell are provided in Tables A.8.1.1.1-2 and A.8.1.1.1-3 below, respectively. Cell-specific parameters for the E-UTRA cell are provided in Table A.3.7.2.1-1 in Clause A.3.7.2.1.

Table A.8.1.1.1-1: Applicable E-UTRA and NR configurations for inter-RAT SFTD measurement delay test

Config	Description
1	LTE FDD, NR 15 kHz SSB SCS, 10MHz bandwidth, FDD duplex mode
2	LTE FDD, NR 15 kHz SSB SCS, 10MHz bandwidth, TDD duplex mode
3	LTE FDD, NR 30kHz SSB SCS, 40MHz bandwidth, TDD duplex mode
4	LTE TDD, NR 15 kHz SSB SCS, 10MHz bandwidth, FDD duplex mode
5	LTE TDD, NR 15 kHz SSB SCS, 10MHz bandwidth, TDD duplex mode
6	LTE TDD, NR 30kHz SSB SCS, 40MHz bandwidth, TDD duplex mode
Note:	The UE is only required to be tested in one of the supported test configurations

Table A.8.1.1.1-2: Applicable E-UTRA and NR configurations for inter-RAT SFTD measurement delay test

Parameter	Unit	Test configuration	Value		Comment
			Test 1	Test 2	
E-UTRA RF Channel Number		Config 1,2,3,4,5,6	1		One E-UTRAN TDD carrier frequencies is used.
NR RF Channel Number		Config 1,2,3,4,5,6	1		One NR FR1 carrier frequencies is used.
Active cell		Config 1,2,3,4,5,6	Cell 1		Cell 1 is on E-UTRA RF channel number 1.
Neighbour cell		Config 1,2,3,4,5,6	Cell 2		Cell 2 is on NR RF channel number 1.
SMTC-SSB parameters		Config 1,4	SSB.1 FR1		As specified in clause A.3.10.1
		Config 2,5	SSB.1 FR1		As specified in clause A.3.10.1
		Config 3,6	SSB.2 FR1		As specified in clause A.3.10.1
CP length		Config 1,2,3,4,5,6	Normal		Applicable to both cells.
DRX		Config 1,2,3,4,5,6	OFF		DRX is not used
Frame time offset between serving and neighbour cells	ms	Config 1,2,3,4	3	7	Asynchronous cells. The timing of Cell 2 relative to the timing of Cell 1.
	µs	Config 5,6	3		Synchronous cells.
SFN offset between serving and neighbour cells		Config 1,2,3,4,5,6	0	1	SFN of Cell 2 relative to SFN of Cell 1.
T1	s	Config 1,2,3,4,5,6	1		

Table A.8.1.1-3: Cell specific test parameters for Cell 2 in inter-RAT SFTD measurement delay test

Parameter	Unit	Test configuration	Cell 2
NR RF Channel Number		Config 1,2,3,4,5,6	1
Duplex mode		Config 1,4	FDD
		Config 2,3,5,6	TDD
BW _{channel}	MHz	Config 1,4	10: N _{RB,c} = 52
		Config 2,5	10: N _{RB,c} = 52
		Config 3,6	40: N _{RB,c} = 106
TDD configuration		Config 2,5	TDDConf.1.1
		Config 3,6	TDDConf.2.1
OCNG Pattern defined in A.3.2.1.1		Config 1,2,3,4,5,6	OP.1
SMTC configuration defined in A.3.2.11.1 and A.3.2.11.2		Config 1,4	SMTC.2
		Config 2,3,5,6	SMTC.1
PDSCH/PDCCH subcarrier spacing	kHz	Config 1,2,4,5	15
		Config 3,6	30
EPRE ratio of PSS to SSS	dB	Config 1,2,3,4,5,6	0
EPRE ratio of PBCH DMRS to SSS	dB		
EPRE ratio of PBCH to PBCH DMRS	dB		
EPRE ratio of OCNG DMRS to SSS ^{Note 1}	dB		
EPRE ratio of OCNG to OCNG DMRS ^{Note 1}	dB		
N _{oc} ^{Note2}	dBm/15kHz		-98
N _{oc} ^{Note2}	dBm/SCS	Config 1,2,4,5	-98
		Config 3,6	-95
SS-RSRP ^{Note 3, 4}	dBm/SCS	Config 1,2,4,5	-94
		Config 3,6	-91
\hat{E}_s/I_{ot}	dB	Config 1,2,3,4,5,6	4
\hat{E}_s/N_{oc}	dB	Config 1,2,3,4,5,6	4
I _o ^{Note 3}	dBm/9.36MHz	Config 1,2,4,5	-67.11
	dBm/38.16MHz	Config 3,6	-62.27
Propagation Condition		Config 1,2,3,4,5,6	AWGN
<p>Note 1: OCNG shall be used such that the cell is fully allocated and a constant total transmitted power spectral density is achieved for all OFDM symbols.</p> <p>Note 2: Interference from other cells and noise sources not specified in the test is assumed to be constant over subcarriers and time and shall be modelled as AWGN of appropriate power for N_{oc} to be fulfilled.</p> <p>Note 3: SS-RSRP and I_o levels have been derived from other parameters for information purposes. They are not settable parameters themselves.</p> <p>Note 4: SS-RSRP minimum requirements are specified assuming independent interference and noise at each receiver antenna port.</p>			

A.8.1.1.2 Test Requirements

Following the start of T1, the UE shall detect Cell 2 and determine the relative time difference between Cell 1 and Cell 2. At latest at $T_{\text{RRC_procedure_delay}} + T_{\text{measure_SFTD1}}$ after the beginning of time duration T1, the UE shall send a measurement report on SFTD between Cell 1 and Cell 2.

The observed rate of successful SFTD reports in repeated tests shall be at least 90%.

NOTE: The actual overall delays measured in the test may be up to $2 \times TTI_{\text{DCCCH}}$ longer than the measurement reporting delays above due to TTI insertion uncertainty of the measurement report in DCCCH.

A.8.1.2 E-UTRA – NR Inter-RAT SFTD Measurement Delay in DRX

A.8.1.2.1 Test Purpose and Environment

The purpose of this test is to partly verify that measurement reporting delay for SFTD between E-UTRA PCell and inter-RAT NR neighbour cell in FR1 is within the requirements stated in 3GPP TS 36.133 [15] Sections 8.1.2.4.25 and 8.1.2.4.26 for E-UTRA FDD and TDD, respectively, when no measurement gaps are provided and DRX is configured.

The tests consist of a single time period of duration T1. Two carriers are used in the tests: one E-UTRA carrier with the PCell (Cell 1), and one NR carrier with the NR neighbour cell (Cell 2).

Prior to the start of time duration T1, the UE is connected to Cell 1 and configured to carry out intra-frequency measurements only. The point in time at which the UE receives, at the UE antenna connector(s), a RRC message containing a measurement configuration for SFTD measurements on RF channel 2 defines the start of time duration T1. Following the start of T1 the UE shall detect Cell 2, determine the SFN and frame time difference of Cell 2 relative to Cell 1, and send a measurement report.

The supported test configurations are listed in Table A.8.1.2.1-1 below. Test parameters are provided in Tables A.8.1.2.1-2 and A.8.1.2.1-3 below. Cell-specific parameters for the E-UTRA and NR cells are provided in Table A.3.7.2.1-1 in Clause A.3.7.2.1, and Table A.8.1.1.1-3 in Clause A.8.1.1.1, respectively.

Table A.8.1.2.1-1: Applicable E-UTRA and NR configurations for inter-RAT SFTD measurement delay test in DRX

Config	Description
1	LTE FDD, NR 15 kHz SSB SCS, 10MHz bandwidth, FDD duplex mode
2	LTE FDD, NR 15 kHz SSB SCS, 10MHz bandwidth, TDD duplex mode
3	LTE FDD, NR 30kHz SSB SCS, 40MHz bandwidth, TDD duplex mode
4	LTE TDD, NR 15 kHz SSB SCS, 10MHz bandwidth, FDD duplex mode
5	LTE TDD, NR 15 kHz SSB SCS, 10MHz bandwidth, TDD duplex mode
6	LTE TDD, NR 30kHz SSB SCS, 40MHz bandwidth, TDD duplex mode
Note:	The UE is only required to be tested in one of the supported test configurations

Table A.8.1.2.1-2: Applicable E-UTRA and NR configurations for inter-RAT SFTD measurement delay test in DRX

Parameter	Unit	Test configuration	Value		Comment
			Test 1	Test 2	
E-UTRA RF Channel Number		Config 1,2,3,4,5,6	1		One E-UTRAN TDD carrier frequencies is used.
NR RF Channel Number		Config 1,2,3,4,5,6	1		One NR FR1 carrier frequencies is used.
Active cell		Config 1,2,3,4,5,6	Cell 1		Cell 1 is on E-UTRA RF channel number 1.
Neighbour cell		Config 1,2,3,4,5,6	Cell 2		Cell 2 is on NR RF channel number 1.
SMTC-SSB parameters		Config 1,4	SSB.1 FR1		As specified in clause A.3.10.1
		Config 2,5	SSB.1 FR1		As specified in clause A.3.10.1
		Config 3,6	SSB.2 FR1		As specified in clause A.3.10.1
CP length		Config 1,2,3,4,5,6	Normal		Applicable to both cells.
DRX		Config 1,2,3,4,5,6	ON		DRX configuration as provided in Table A.8.X.2.1-3 below
Frame time offset between serving and neighbour cells	ms	Config 1,2,3,4	3	7	Asynchronous cells. The timing of Cell 2 relative to the timing of Cell 1.
	µs	Config 5,6	3		Synchronous cells.
SFN offset between serving and neighbour cells		Config 1,2,3,4,5,6	0	1	SFN of Cell 2 relative to SFN of Cell 1.
T1	s	Config 1,2,3,4,5,6	1		

Table A.8.1.2.1-3: DRX-Configuration for inter-RAT SFTD measurement delay test in DRX

Parameter	Value
onDurationTimer	psf2
drx-InactivityTimer	psf2
drx-RetransmissionTimer	psf16
longDRX-CycleStartOffset	sf160, 0
shortDRX	disabled
TimeAlignmentTimer	infinity
Note:	For further information see clause 6.3.2 in TS 36.331 [16].

A.8.1.2.2 Test Requirements

Following the start of T1, the UE shall detect Cell 2 and determine the relative time difference between Cell 1 and Cell 2. At latest at the earliest DRX activity time following upon $T_{\text{RRC_procedure_delay}} + T_{\text{measure_SFTD1}}$ from the beginning of time duration T1, the UE shall send a measurement report on SFTD between Cell 1 and Cell 2.

The observed rate of successful SFTD reports in repeated tests shall be at least 90%.

NOTE: The actual overall delays measured in the test may be up to $2 \times TTI_{\text{DCC}}H$ longer than the measurement reporting delays above due to TTI insertion uncertainty of the measurement report in DCC.

A.8.1.3 SFTD accuracy

A.8.1.3.1 Test Purpose and Environment

The purpose of this set of tests is to verify that the SFTD measurement accuracy is within the specified limits. This test will verify the requirements as specified in section 9.1.27 in TS 36.133 [15] for inter-RAT FR1 SFTD measurements.

A.8.1.3.2 Test Requirements

Supported test configurations are shown in Table A.8.1.3.2-1. In this set of test cases there are two cells on different carriers. Cell 1 is E-UTRAN PCell and Cell 2 is inter-RAT NR FR1 target cell. The test parameters of cell 1 are given in section A.8.1.3.2-2. The test parameters of cell 2 are given in Table A.8.1.3.2-3. The SFTD between PCell and target cell shall be set by the test equipment to one of the time differences in Table A.8.1.3.2-4.

Table A.8.1.3.2-1: Supported test configurations for SFTD accuracy

Configuration	Description
1	NR 15 kHz SSB SCS, 10MHz bandwidth, FDD duplex mode, LTE FDD
2	NR 15 kHz SSB SCS, 10MHz bandwidth, TDD duplex mode, LTE FDD
3	NR 30 kHz SSB SCS, 40MHz bandwidth, TDD duplex mode, LTE FDD
4	NR 15 kHz SSB SCS, 10MHz bandwidth, FDD duplex mode, LTE TDD
5	NR 15 kHz SSB SCS, 10MHz bandwidth, TDD duplex mode, LTE TDD
6	NR 30kHz SSB SCS, 40MHz bandwidth, TDD duplex mode, LTE TDD

Note: The UE is only required to be tested in one of the supported test configurations

Table A.8.1.3.2-2: Test parameters for SFTD accuracy (Cell 1)

Parameter	Unit	Test 1
E-UTRA RF Channel Number		1
Duplex mode		FDD or TDD
TDD special subframe configuration ^{Note1}		6
TDD uplink-downlink configuration ^{Note1}		1
BW _{channel}		5MHz: N _{RB,c} = 25 10MHz: N _{RB,c} = 50 20MHz: N _{RB,c} = 100
PDSCH parameters: DL Reference Measurement Channel ^{Note2}		5MHz: R.7 FDD 10MHz: R.3 FDD 20MHz: R.6 FDD 5MHz: R.4 TDD 10MHz: R.0 TDD 20MHz: R.3 TDD
PCFICH/PDCCH/PHICH parameters: DL Reference Measurement Channel ^{Note2}		5MHz: R.11 FDD 10MHz: R.6 FDD 20MHz: R.10 FDD 5MHz: R.11 TDD 10MHz: R.6 TDD 20MHz: R.10 TDD
OCNG Patterns ^{Note2}		5MHz: OP.20 FDD 10MHz: OP.10 FDD 20MHz: OP.17 FDD 5MHz: OP.9 TDD 10MHz: OP.1 TDD 20MHz: OP.7 TDD
PBCH_RA	dB	0
PBCH_RB	dB	
PSS_RA	dB	
SSS_RA	dB	
PCFICH_RB	dB	

PHICH_RA	dB	
PHICH_RB	dB	
PDCCH_RA	dB	
PDCCH_RB	dB	
PDSCH_RA	dB	
PDSCH_RB	dB	
OCNG_RA ^{Note3}	dB	
OCNG_RB ^{Note3}	dB	
N_{oc} ^{Note4}	dBm/15 kHz	-104
\bar{E}_s/N_{oc}	dB	-3
\bar{E}_s/I_{ot}	dB	-3
RSRP ^{Note5}	dBm/15 kHz	-107
SCH_RP ^{Note5}	dBm/15 kHz	-107
I_o ^{Note5}	dBm/Ch BW	-74.45 +10log ($N_{RB,c}/50$)
Propagation Condition		AWGN
Antenna Configuration		1x2
<p>Note 1: Special subframe and uplink-downlink configurations are specified in table 4.2-1 in TS 36.211.</p> <p>Note 2: DL RMCs and OCNG patterns are specified in sections A 3.1 and A 3.2 of TS 36.133 respectively.</p> <p>Note 3: OCNG shall be used such that all cells are fully allocated and a constant total transmitted power spectral density is achieved for all OFDM symbols.</p> <p>Note 4: Interference from other cells and noise sources not specified in the test is assumed to be constant over subcarriers and time and shall be modelled as AWGN of appropriate power for N_{oc} to be fulfilled.</p> <p>Note 5: E_s/I_{ot}, RSRP, SCH_RP and I_o levels have been derived from other parameters for information purposes. They are not settable parameters themselves.</p>		

Table A.8.1.3.2-3: Test parameters for SFTD accuracy (Cell 2)

Parameter	Config	Unit	Test 1
SSB GSCN	1~6		freq1
Duplex mode	1,4		FDD
	2,5		TDD
	3,6		TDD
TDD Configuration	1,4		N/A
	2,5		TDDConf.1.1
	3,6		TDDConf.2.1
$BW_{channel}$	1,4	MHz	10: $N_{RB,c} = 52$
	2,5		10: $N_{RB,c} = 52$
	3,6		40: $N_{RB,c} = 106$
PDSCH Reference measurement channel	1,4		SR.1.1 FDD
	2,5		SR.1.1 TDD
	3,6		SR.2.1 TDD
RMSI CORESET Reference Channel	1,4		CR.1.1 FDD
	2,5		CR.1.1 TDD
	3,6		CR.2.1 TDD
RMC CORESET Reference Channel	1,4		CCR.1.1 FDD
	2,5		CCR.1.1 TDD
	3,6		CCR.2.1 TDD
SSB configuration	1,4		SSB.1 FR1
	2,5		SSB.1 FR1
	3,6		SSB.2 FR1
SMTc configuration	1~6		SMTc.1
DL BWP configuration	1~6		DLBWP.1.1
UL BWP configuration	1~6		ULBWP.1.1
OCNG Patterns	1~6		OP.1
EPRE ratio of PSS to SSS	1~6	dB	0
EPRE ratio of PBCH DMRS to SSS			

EPRE ratio of PBCH to PBCH DMRS				
EPRE ratio of PDCCH DMRS to SSS				
EPRE ratio of PDCCH to PDCCH DMRS				
EPRE ratio of PDSCH DMRS to SSS				
EPRE ratio of PDSCH to PDSCH DMRS				
EPRE ratio of OCNG DMRS to SSS ^{Note 1}				
EPRE ratio of OCNG to OCNG DMRS Note 1				
N_{oc} ^{Note2}	NR_FDD_FR1_A, NR_TDD_FR1_A	1~6	dBm/15kHz	-104
	NR_FDD_FR1_B			
	NR_TDD_FR1_C			
	NR_FDD_FR1_D, NR_TDD_FR1_D			
	NR_FDD_FR1_E, NR_TDD_FR1_E			
	NR_FDD_FR1_G			
	NR_FDD_FR1_H			
N_{oc} ^{Note2}	NR_FDD_FR1_A, NR_TDD_FR1_A	1,2,4,5	dBm/SSB SCS	-104
	NR_FDD_FR1_B			
	NR_TDD_FR1_C			
	NR_FDD_FR1_D, NR_TDD_FR1_D			
	NR_FDD_FR1_E, NR_TDD_FR1_E			
	NR_FDD_FR1_G			
	NR_FDD_FR1_H			
	NR_FDD_FR1_A, NR_TDD_FR1_A	3,6		-101
	NR_FDD_FR1_B			
	NR_TDD_FR1_C			
	NR_FDD_FR1_D, NR_TDD_FR1_D			
	NR_FDD_FR1_E, NR_TDD_FR1_E			
	NR_FDD_FR1_G			
	NR_FDD_FR1_H			
\hat{E}_s/I_{ot}		1~6	dB	-3
\hat{E}_s/N_{oc}		1~6	dB	-3
SS-RSRP ^{Note3}	NR_FDD_FR1_A, NR_TDD_FR1_A	1,2,4,5	dBm/SCS	-107
	NR_FDD_FR1_B			
	NR_TDD_FR1_C			
	NR_FDD_FR1_D, NR_TDD_FR1_D			
	NR_FDD_FR1_E, NR_TDD_FR1_E			
	NR_FDD_FR1_G			
	NR_FDD_FR1_H			
	NR_FDD_FR1_A, NR_TDD_FR1_A	3,6		-104
	NR_FDD_FR1_B			
	NR_TDD_FR1_C			
	NR_FDD_FR1_D, NR_TDD_FR1_D			
	NR_FDD_FR1_D, NR_TDD_FR1_D			
	NR_FDD_FR1_D, NR_TDD_FR1_D			
	NR_TDD_FR1_D			

	NR_FDD_FR1_E, NR_TDD_FR1_E			
	NR_FDD_FR1_G			
	NR_FDD_FR1_H			
I _o ^{Note3}	NR_FDD_FR1_A, NR_TDD_FR1_A	1,2,4,5	dBm/9.36 MHz	-74.28
	NR_FDD_FR1_B			
	NR_TDD_FR1_C			
	NR_FDD_FR1_D, NR_TDD_FR1_D			
	NR_FDD_FR1_E, NR_TDD_FR1_E			
	NR_FDD_FR1_G			
	NR_FDD_FR1_H	3,6	dBm/38.16 MHz	-68.18
	NR_FDD_FR1_A, NR_TDD_FR1_A			
	NR_FDD_FR1_B			
	NR_TDD_FR1_C			
	NR_FDD_FR1_D, NR_TDD_FR1_D			
	NR_FDD_FR1_E, NR_TDD_FR1_E			
	NR_FDD_FR1_G			
	NR_FDD_FR1_H			
Propagation condition		1~6		AWGN
Antenna configuration		1~6		1x2
<p>Note 1: OCNG shall be used such that both cells are fully allocated and a constant total transmitted power spectral density is achieved for all OFDM symbols.</p> <p>Note 2: Interference from other cells and noise sources not specified in the test is assumed to be constant over subcarriers and time and shall be modelled as AWGN of appropriate power for N_{oc} to be fulfilled.</p> <p>Note 3: SS-RSRP and I_o levels have been derived from other parameters for information purposes. They are not settable parameters themselves.</p> <p>Note 4: SS-RSRP minimum requirements are specified assuming independent interference and noise at each receiver antenna port.</p>				

Table A.8.1.3.2-4: Timing offsets for SFTD accuracy test

Configuration	SFN offset between PCell and PSCell	Frame boundary offset between PCell and PSCell (Ts)
1	100	-122000
2	300	-60540
3	500	1000
4	700	62540
5	900	124000

A.8.1.3.3 Test Requirements

The SFTD reported by the UE consists of 2 elements, SFN offset and frame boundary offset between PCell and inter-RAT NR target cell. The reported SFTD accuracy shall fulfil the requirement in section 9.1.27 in TS 36.133 [15].

Annex B (normative): Conditions for RRM requirements applicability for operating bands

B.1 Conditions for NR RRC_IDLE state mobility

B.1.1 Introduction

In Annex B.1, the following conditions are specified:

- UE conditions which shall apply for UE intra-frequency measurements procedures and requirements in Section 4,
- UE conditions which shall apply for UE inter-frequency measurements procedures and requirements in Section 4.

B.1.2 Conditions for measurements on NR intra-frequency cells for cell re-selection

This section defines the following conditions for NR intra-frequency measurements performed based on SSBs for cell re-selection: SSB_{RP} and SSB \hat{E}_s/I_{ot} , applicable for a corresponding operating band.

The conditions are defined in Table B.1.2-1 for FR1 NR cells.

The conditions are defined in Table B.1.2-2 for FR2 NR cells.

Table B.1.2-1: Conditions for intra-frequency cell re-selection in FR1

Parameter	NR operating band groups ^{Note1}	Minimum SSB _{RP}		SSB \hat{E}_s/I_{ot}
		dBm / SCS _{SSB}		dB
		SCS _{SSB} = 15 kHz	SCS _{SSB} = 30 kHz	
Conditions	NR_FDD_FR1_A, NR_TDD_FR1_A	-124	-121	≥ -4
	NR_FDD_FR1_B	-123.5	-120.5	
	NR_TDD_FR1_C	-123	-120	
	NR_FDD_FR1_D, NR_TDD_FR1_D	-122.5	-119.5	
	NR_FDD_FR1_E, NR_TDD_FR1_E	-122	-119	
	NR_FDD_FR1_G	-121	-118	
	NR_FDD_FR1_H	-120.5	-117.5	

NOTE 1: NR operating band groups are defined in Section 3.5.2.

Table B.1.2-2: Conditions for intra-frequency cell re-selection in FR2

Parameter	NR operating band groups ^{Note1}	Minimum SSB _{RP}		SSB \hat{E}_s/I_{ot}
		dBm / SCS _{SSB}		dB
		SCS _{SSB} = 120 kHz	SCS _{SSB} = 240 kHz	
Conditions	NR_TDD_FR2_A	TBD	TBD	TBD
	NR_TDD_FR2_B	TBD	TBD	
	NR_TDD_FR2_F	TBD	TBD	
	NR_TDD_FR2_G	TBD	TBD	
	NR_TDD_FR2_T	TBD	TBD	
	NR_TDD_FR2_Y	TBD	TBD	

NOTE 1: NR operating band groups are defined in Section 3.5.3.

B.1.3 Conditions for measurements on NR inter-frequency cells for cell re-selection

This section defines the following conditions for NR inter-frequency measurements performed based on SSBs for cell re-selection: SSB_{RP} and SSB \hat{E}_s/I_{ot} , applicable for a corresponding operating band.

The conditions defined in Table B.1.2-1 for FR1 NR intra-frequency cell re-selection shall also apply for FR1 NR inter-frequency cells in this section.

The conditions defined in Table B.1.2-2 for FR2 NR intra-frequency cell re-selection shall also apply for FR2 NR inter-frequency cells in this section.

B.2 Conditions for UE measurements procedures and performance requirements in RRC_CONNECTED state

B.2.1 Introduction

In Annex B.2, the following conditions are specified:

- UE conditions which shall apply for UE intra-frequency measurements procedures and requirements in Section 9,
 UE conditions which shall apply for UE inter-frequency measurements procedures and requirements in Section 9,
- UE conditions which shall apply for UE intra-frequency measurements performance requirements in Section 10,
- UE conditions which shall apply for UE inter-frequency measurements performance requirements in Section 10.
- The conditions for RRC connection release with redirection to NR requirements in Section 6.2.3.2.1.

B.2.2 Conditions for NR intra-frequency measurements

This section defines the following conditions for NR intra-frequency measurements and corresponding procedures performed based on SSBs: SSB_{RP} and SSB \hat{E}_s/I_{ot} , applicable for a corresponding operating band.

The conditions are defined in Table B.2.2-1 for FR1 NR cells.

The conditions are defined in Table B.2.2-2 for FR2 NR cells.

Table B.2.2-1: Conditions for intra-frequency measurements in FR1

Parameter	NR operating band groups ^{Note1}	Minimum SSB _{RP}		SSB \hat{E}_s/I_{ot}
		dBm / SCS _{SSB}		
		SCS _{SSB} = 15 kHz	SCS _{SSB} = 30 kHz	dB
Conditions	NR_FDD_FR1_A, NR_TDD_FR1_A	-127	-124	≥ -6
	NR_FDD_FR1_B	-126.5	-123.5	
	NR_TDD_FR1_C	-126	-123	
	NR_FDD_FR1_D, NR_TDD_FR1_D	-125.5	-122.5	
	NR_FDD_FR1_E, NR_TDD_FR1_E	-125	-122	
	NR_FDD_FR1_G	-124	-121	
	NR_FDD_FR1_H	-123.5	-120.5	

NOTE 1: NR operating band groups are defined in Section 3.5.2.

Table B.2.2-2: Conditions for intra-frequency measurements in FR2

Parameter	NR operating band groups ^{Note1}	Minimum SSB _{RP}		SSB Ês/lot
		dBm / SCS _{SSB}		dB
		SCS _{SSB} = 120 kHz	SCS _{SSB} = 240 kHz	
Conditions	NR_TDD_FR2_A	TBD	TBD	TBD
	NR_TDD_FR2_B	TBD	TBD	
	NR_TDD_FR2_F	TBD	TBD	
	NR_TDD_FR2_G	TBD	TBD	
	NR_TDD_FR2_T	TBD	TBD	
	NR_TDD_FR2_Y	TBD	TBD	

NOTE 1: NR operating band groups are defined in Section 3.5.3.

B.2.3 Conditions for NR inter-frequency measurements

This section defines the following conditions for NR inter-frequency measurements and corresponding procedures performed based on SSBs: SSB_{RP} and SSB Ês/lot, applicable for a corresponding operating band.

The conditions are defined in Table B.2.3-1 for FR1 NR cells.

The conditions are defined in Table B.2.3-2 for FR2 NR cells.

Table B.2.3-1: Conditions for inter-frequency measurements in FR1

Parameter	NR operating band groups ^{Note1}	Minimum SSB _{RP}		SSB Ês/lot
		dBm / SCS _{SSB}		dB
		SCS _{SSB} = 15 kHz	SCS _{SSB} = 30 kHz	
Conditions	NR_FDD_FR1_A, NR_TDD_FR1_A	-125	-122	≥ -4
	NR_FDD_FR1_B	-124.5	-121.5	
	NR_TDD_FR1_C	-124	-121	
	NR_FDD_FR1_D, NR_TDD_FR1_D	-124.5	-120.5	
	NR_FDD_FR1_E, NR_TDD_FR1_E	-123	-120	
	NR_FDD_FR1_G	-122	-119	
	NR_FDD_FR1_H	-121.5	-118.5	

NOTE 1: NR operating band groups are defined in Section 3.5.2.

Table B.2.3-2: Conditions for inter-frequency measurements in FR2

Parameter	NR operating band groups ^{Note1}	Minimum SSB _{RP}		SSB Ês/lot
		dBm / SCS _{SSB}		dB
		SCS _{SSB} = 120 kHz	SCS _{SSB} = 240 kHz	
Conditions	NR_TDD_FR2_A	TBD	TBD	TBD
	NR_TDD_FR2_B	TBD	TBD	
	NR_TDD_FR2_F	TBD	TBD	
	NR_TDD_FR2_G	TBD	TBD	
	NR_TDD_FR2_T	TBD	TBD	
	NR_TDD_FR2_Y	TBD	TBD	

NOTE 1: NR operating band groups are defined in Section 3.5.3.

B.2.4 Conditions for NR L1-RSRP reporting

B.2.4.1 Conditions for SSB based L1-RSRP reporting

This section defines the following conditions for NR L1-RSRP measurement reporting and corresponding procedures performed based on SSBs: SSB_{RP} and SSB Ês/lot, applicable for a corresponding operating band.

The conditions are defined in Table B.2.4.1-1 for FR1 NR cells.

The conditions are defined in Table B.2.4.1-2 for FR2 NR cells.

Table B.2.4.1-1: Conditions for intra-frequency measurements in FR1

Parameter	NR operating band groups ^{Note1}	Minimum SSB _{RP}		SSB \hat{E}_s/lot
		dBm / SCS _{SSB}		dB
		SCS _{SSB} = 15 kHz	SCS _{SSB} = 30 kHz	
Conditions	NR_FDD_FR1_A, NR_TDD_FR1_A	-127	-124	≥ -3
	NR_FDD_FR1_B	-126.5	-123.5	
	NR_TDD_FR1_C	-126	-123	
	NR_FDD_FR1_D, NR_TDD_FR1_D	-125.5	-122.5	
	NR_FDD_FR1_E, NR_TDD_FR1_E	-125	-122	
	NR_FDD_FR1_G	-124	-121	
	NR_FDD_FR1_H	-123.5	-120.5	

NOTE 1: NR operating band groups are defined in Section 3.5.2.

Table B.2.4.1-2: Conditions for intra-frequency measurements in FR2

Parameter	NR operating band groups ^{Note1}	Minimum SSB _{RP}		SSB \hat{E}_s/lot
		dBm / SCS _{SSB}		dB
		SCS _{SSB} = 120 kHz	SCS _{SSB} = 240 kHz	
Conditions	NR_TDD_FR2_A	TBD	TBD	TBD
	NR_TDD_FR2_B	TBD	TBD	
	NR_TDD_FR2_F	TBD	TBD	
	NR_TDD_FR2_G	TBD	TBD	
	NR_TDD_FR2_T	TBD	TBD	
	NR_TDD_FR2_Y	TBD	TBD	

NOTE 1: NR operating band groups are defined in Section 3.5.3.

B.2.4.2 Conditions for CSI-RS based L1-RSRP reporting

This section defines the following conditions for NR L1-RSRP measurement reporting and corresponding procedures performed based on CSI-RS: CSI-RS_{RP} and CSI-RS \hat{E}_s/lot , applicable for a corresponding operating band.

The conditions are defined in Table B.2.4.2-1 for FR1 NR cells.

The conditions are defined in Table B.2.4.2-2 for FR2 NR cells.

Table B.2.4.2-1: Conditions for intra-frequency measurements in FR1

Parameter	NR operating band groups ^{Note1}	Minimum CSI-RS RSRP		CSI-RS \hat{E}_s/lot
		dBm / SCS _{SSB}		dB
		SCS _{SSB} = 15 kHz	SCS _{SSB} = 30 kHz	
Conditions	NR_FDD_FR1_A, NR_TDD_FR1_A	-127	-124	≥ -3
	NR_FDD_FR1_B	-126.5	-123.5	
	NR_TDD_FR1_C	-126	-123	
	NR_FDD_FR1_D, NR_TDD_FR1_D	-125.5	-122.5	
	NR_FDD_FR1_E, NR_TDD_FR1_E	-125	-122	
	NR_FDD_FR1_G	-124	-121	
	NR_FDD_FR1_H	-123.5	-120.5	

NOTE 1: NR operating band groups are defined in Section 3.5.2.

Table B.2.4.2-2: Conditions for intra-frequency measurements in FR2

Parameter	NR operating band groups ^{Note1}	Minimum CSI-RS_RSRP		CSI-RS Ês/lot
		dBm / SCS _{SSB}		dB
		SCS _{SSB} = 120 kHz	SCS _{SSB} = 240 kHz	
Conditions	NR_TDD_FR2_A	TBD	TBD	TBD
	NR_TDD_FR2_B	TBD	TBD	
	NR_TDD_FR2_F	TBD	TBD	
	NR_TDD_FR2_G	TBD	TBD	
	NR_TDD_FR2_T	TBD	TBD	
	NR_TDD_FR2_Y	TBD	TBD	

NOTE 1: NR operating band groups are defined in Section 3.5.3.

B.2.5 Conditions for RRC connection release with redirection to NR

This section defines the following conditions for RRC connection release with redirection to NR: SSB_RP and SSB Ês/lot, applicable for a corresponding operating band.

The conditions are defined in Table B.2.5-1 for FR1 NR cells.

The conditions are defined in Table B.2.5-2 for FR2 NR cells.

Table B.2.5-1: Conditions for for RRC connection release with redirection to NR in FR1

Parameter	NR operating band groups ^{Note1}	Minimum SSB_RP		SSB Ês/lot
		dBm / SCS _{SSB}		dB
		SCS _{SSB} = 15 kHz	SCS _{SSB} = 30 kHz	
Conditions	NR_FDD_FR1_A, NR_TDD_FR1_A	-125	-122	≥ -4
	NR_FDD_FR1_B	-124.5	-121.5	
	NR_TDD_FR1_C	-124	-121	
	NR_FDD_FR1_D, NR_TDD_FR1_D	-124.5	-120.5	
	NR_FDD_FR1_E, NR_TDD_FR1_E	-123	-120	
	NR_FDD_FR1_G	-122	-119	
	NR_FDD_FR1_H	-121.5	-118.5	

NOTE 1: NR operating band groups are defined in Section 3.5.2.

Table B.2.5-2: Conditions for RRC connection release with redirection to NR in FR2

Parameter	NR operating band groups ^{Note1}	Minimum SSB_RP		SSB Ês/lot
		dBm / SCS _{SSB}		dB
		SCS _{SSB} = 120 kHz	SCS _{SSB} = 240 kHz	
Conditions	NR_TDD_FR2_A	TBD	TBD	TBD
	NR_TDD_FR2_B	TBD	TBD	
	NR_TDD_FR2_F	TBD	TBD	
	NR_TDD_FR2_G	TBD	TBD	
	NR_TDD_FR2_T	TBD	TBD	
	NR_TDD_FR2_Y	TBD	TBD	

NOTE 1: NR operating band groups are defined in Section 3.5.3.

B.3 RRM Requirements Exceptions

B.3.1 Introduction

Annex B.3 covers exceptions for side conditions based on receiver sensitivity for CA, DC, and SUL.

B.3.2 Receiver sensitivity relaxation for CA

B.3.2.1 Receiver sensitivity relaxation for UE supporting CA in FR1

For a UE supporting inter-band carrier aggregation configuration with uplink in NR band, if there is a relaxation of receiver sensitivity $\Delta R_{IB,c} > 0$ dB as defined in TS 38.101-1 [18, Section 7.3A.3], the relevant side conditions specifying received power levels (SSB_RP and Io) shall be increased by the amount $\Delta = \Delta R_{IB,c}$ defined for the corresponding downlink NR bands.

For a UE supporting CA configuration in FR1, the requirement in this section applies for both SC and CA operation.

B.3.2.2 Receiver sensitivity relaxation for UE configured with CA in FR1

B.3.2.2.1 Inter-band carrier aggregation

For a UE configured with inter-band carrier aggregation with active uplink in NR band, if there is a relaxation of receiver sensitivity $\Delta R_{IB,c} > 0$ dB as defined in TS 38.101-1 [18, Section 7.3A.3], the relevant side conditions specifying received power levels (SSB_RP and Io) shall be increased by the amount $\Delta = \Delta R_{IB,c}$ defined for the corresponding downlink NR bands.

If the relaxation Δ specified in this section applies, then the relaxation specified in Section B.3.2.1 should not be applied.

B.3.2.2.2 Reference sensitivity exceptions due to UL harmonic interference for CA

In this section, requirements exceptions are described for the UE configured with a band in FR1 when it is impacted by UL harmonic interference from another band in FR1 of the same CA configuration.

A relevant side condition (SSB_RP and Io) in a requirement shall be increased by the amount $\Delta = L2 - L1$, where L1 is the reference sensitivity level specified in TS 38.101-1 [18, Section 7.3.2], and L2 is the reference sensitivity level based on the requirements in TS 38.101-1 [18, Section 7.3A.4], when the following conditions are fulfilled,

- corresponding downlink component carriers on different NR bands are configured with CA and active,
- the uplink is configured in the NR low operating band and is active,
- the uplink configuration is as specified in TS 38.101-1 [18, Section 7.3A.4], and
- the exception requirements specified in TS 38.101-1 [18, Section 7.3A.4] apply.

If the relaxation Δ specified in this section applies, then the relaxation specified in Section B.3.2.1 should not be applied.

B.3.2.2.3 Reference sensitivity exceptions due to intermodulation interference due to 2UL CA

In this section, requirements exceptions are described for the UE with an inter-band carrier aggregation with uplink assigned to two NR bands.

A relevant side condition (SSB_RP and Io) in a requirement shall be increased by the amount $\Delta = L2 - L1$, where L1 is the reference sensitivity level specified in TS 38.101-1 [18, Section 7.3.2], and L2 is the reference sensitivity level based on the requirements in TS 38.101-1 [18, Section 7.3A.5], when the following conditions are fulfilled,

- corresponding downlink component carriers on different bands are configured with CA and active,
- uplinks are assigned to two NR bands,
- the exception requirements specified in TS 38.101-1 [18, Section 7.3A.5] apply.

If the relaxation Δ specified in this section applies, then the relaxation specified in Section B.3.2.1 should not be applied.

B.3.2.3 Receiver sensitivity relaxation for UE supporting CA in FR2

Editor's note: TBD

B.3.2.4 Receiver sensitivity relaxation for UE configured with CA in FR2

B.3.2.4.1 Intra-band contiguous carrier aggregation

For a UE configured with intra-band contiguous carrier aggregation in NR band in FR2, if there is a relaxation of receiver sensitivity $\Delta R_{IB} > 0$ dB as defined in TS 38.101-2 [19, Section 7.3A.2.1] depending on the aggregated channel bandwidth, the relevant side conditions specifying received power levels (SSB_RP and I_o) shall be increased by the amount $\Delta = \Delta R_{IB}$ defined for the corresponding downlink NR bands.

B.3.2.4.2 Intra-band non-contiguous carrier aggregation

For a UE configured with intra-band non-contiguous carrier aggregation in NR band in FR2, if there is a relaxation of receiver sensitivity $\Delta R_{IB} > 0$ dB as defined in TS 38.101-2 [19, Section 7.3A.2.1] depending on the aggregated channel bandwidth, the relevant side conditions specifying received power levels (SSB_RP and I_o) shall be increased by the amount $\Delta = \Delta R_{IB}$ defined for the corresponding downlink NR bands.

B.3.3 Receiver sensitivity relaxation for DC

Editor's note: TBD

B.3.4 Receiver sensitivity relaxation for SUL

B.3.4.1 Receiver sensitivity relaxation for UE supporting SUL in FR1

For a UE supporting a SUL configuration in FR1, if there is a relaxation of receiver sensitivity $\Delta R_{IB,c} > 0$ dB as defined in TS 38.101-1 [18, Section 7.3C.3], the relevant side conditions specifying received power levels (SSB_RP and I_o) shall be increased by the amount $\Delta = \Delta R_{IB,c}$ defined for the corresponding downlink NR bands.

For a UE supporting a SUL configuration in FR1, the requirement in this section applies for both SC and SUL operation.

B.3.4.2 Receiver sensitivity relaxation for UE configured with SUL in FR1

B.3.4.2.1 Reference sensitivity exceptions due to UL harmonic interference for SUL

In this section, requirements exceptions are described for the UE with a band in FR1 when it is impacted by UL harmonic interference from another band in FR1 of the same SUL configuration.

A relevant side condition (SSB_RP and I_o) in a requirement shall be increased by the amount $\Delta = L2 - L1$, where $L1$ is the reference sensitivity level specified in TS 38.101-1 [18, Section 7.3.2], and $L2$ is the reference sensitivity level based on the requirements in TS 38.101-1 [18, Section 7.3C.2], when the following conditions are fulfilled,

- a downlink component carrier is configured in NR band and is active,
- the uplink is configured in the NR low operating band and is active,
- the uplink configuration is as specified in TS 38.101-1 [18, Section 7.3C.2], and
- the exception requirements specified in TS 38.101-1 [18, Section 7.3C.2] apply.

If the relaxation Δ specified in this section applies, then the relaxation specified in Section B.3.4.1 should not be applied.

Annex C (informative): Change history

Change history							
Date	Meeting	TDoc	CR	Rev	Cat	Subject/Comment	New version
2017-05	RAN4#83	R4-1706324				Specification skeleton	0.0.1
2017-09						Email approved	0.1.0
2017-09	RAN4-NR AH #3	R4-1709413				Capture TPs approved in the meeting	0.2.0
2017-10	RAN4#84 -Bis	R4-1711985				Capture TPs approved in the meeting	0.3.0
2017-12	RAN4#85	R4-1714546				Capture TPs approved in RAN4#85	0.4.0
2017-12	RAN#78	RP-172407				v1.0.0 submitted for plenary approval	1.0.0
2017-12	RAN#78					Approved by plenary – Rel-15 spec under change control	15.0.0
2018-03	RAN#79	RP-180264	0032		B	CR to TS38.133	15.1.0
2018-06	RAN#80	RP-181075	0037		B	CR to TS 38.133: Implementation of endorsed draft CRs from RAN4 #86bis and RAN4 #87	15.2.0
2018-09	RAN#81	RP-181896	0043		B	CR to TS 38.133: Implementation of endorsed draft CRs from RAN4-AH-1807 and RAN4 #88	15.3.0
2018-12	RAN#82	RP-182763	0057	3	B	CR to TS 38.133: Implementation of endorsed draft CRs from RAN4-88bis and RAN4-89	15.4.0
2019-03	RAN#83	RP-190569	0064	1	B	CR to TS 38.133: Implementation of endorsed draft CRs from RAN4#90	15.5.0

History

Document history		
V15.2.0	July 2018	Publication
V15.3.0	October 2018	Publication
V15.4.0	April 2019	Publication
V15.5.0	July 2019	Publication