

# ETSI TS 138 305 V16.1.0 (2020-07)



**5G;  
NG Radio Access Network (NG-RAN);  
Stage 2 functional specification of User Equipment (UE)  
positioning in NG-RAN  
(3GPP TS 38.305 version 16.1.0 Release 16)**



---

Reference

RTS/TSGR-0238305vg10

---

Keywords

5G

**ETSI**

650 Route des Lucioles  
F-06921 Sophia Antipolis Cedex - FRANCE

Tel.: +33 4 92 94 42 00 Fax: +33 4 93 65 47 16

Siret N° 348 623 562 00017 - NAF 742 C  
Association à but non lucratif enregistrée à la  
Sous-Préfecture de Grasse (06) N° 7803/88

---

**Important notice**

The present document can be downloaded from:

<http://www.etsi.org/standards-search>

The present document may be made available in electronic versions and/or in print. The content of any electronic and/or print versions of the present document shall not be modified without the prior written authorization of ETSI. In case of any existing or perceived difference in contents between such versions and/or in print, the prevailing version of an ETSI deliverable is the one made publicly available in PDF format at [www.etsi.org/deliver](http://www.etsi.org/deliver).

Users of the present document should be aware that the document may be subject to revision or change of status.

Information on the current status of this and other ETSI documents is available at

<https://portal.etsi.org/TB/ETSIDeliverableStatus.aspx>

If you find errors in the present document, please send your comment to one of the following services:

<https://portal.etsi.org/People/CommitteeSupportStaff.aspx>

---

**Copyright Notification**

No part may be reproduced or utilized in any form or by any means, electronic or mechanical, including photocopying and microfilm except as authorized by written permission of ETSI.

The content of the PDF version shall not be modified without the written authorization of ETSI.

The copyright and the foregoing restriction extend to reproduction in all media.

© ETSI 2020.

All rights reserved.

**DECT™**, **PLUGTESTS™**, **UMTS™** and the ETSI logo are trademarks of ETSI registered for the benefit of its Members.

**3GPP™** and **LTE™** are trademarks of ETSI registered for the benefit of its Members and of the 3GPP Organizational Partners.

**oneM2M™** logo is a trademark of ETSI registered for the benefit of its Members and of the oneM2M Partners.

**GSM®** and the GSM logo are trademarks registered and owned by the GSM Association.

---

## Intellectual Property Rights

### Essential patents

IPRs essential or potentially essential to normative deliverables may have been declared to ETSI. The information pertaining to these essential IPRs, if any, is publicly available for **ETSI members and non-members**, and can be found in ETSI SR 000 314: "*Intellectual Property Rights (IPRs); Essential, or potentially Essential, IPRs notified to ETSI in respect of ETSI standards*", which is available from the ETSI Secretariat. Latest updates are available on the ETSI Web server (<https://ipr.etsi.org/>).

Pursuant to the ETSI IPR Policy, no investigation, including IPR searches, has been carried out by ETSI. No guarantee can be given as to the existence of other IPRs not referenced in ETSI SR 000 314 (or the updates on the ETSI Web server) which are, or may be, or may become, essential to the present document.

### Trademarks

The present document may include trademarks and/or tradenames which are asserted and/or registered by their owners. ETSI claims no ownership of these except for any which are indicated as being the property of ETSI, and conveys no right to use or reproduce any trademark and/or tradename. Mention of those trademarks in the present document does not constitute an endorsement by ETSI of products, services or organizations associated with those trademarks.

---

## Legal Notice

This Technical Specification (TS) has been produced by ETSI 3rd Generation Partnership Project (3GPP).

The present document may refer to technical specifications or reports using their 3GPP identities. These shall be interpreted as being references to the corresponding ETSI deliverables.

The cross reference between 3GPP and ETSI identities can be found under <http://webapp.etsi.org/key/queryform.asp>.

---

## Modal verbs terminology

In the present document "**shall**", "**shall not**", "**should**", "**should not**", "**may**", "**need not**", "**will**", "**will not**", "**can**" and "**cannot**" are to be interpreted as described in clause 3.2 of the [ETSI Drafting Rules](#) (Verbal forms for the expression of provisions).

"**must**" and "**must not**" are **NOT** allowed in ETSI deliverables except when used in direct citation.

# Contents

Intellectual Property Rights .....	2
Legal Notice .....	2
Modal verbs terminology.....	2
Foreword.....	10
1 Scope .....	11
2 References .....	11
3 Definitions, symbols and abbreviations .....	13
3.1 Definitions .....	13
3.2 Abbreviations .....	13
4 Main concepts and requirements .....	15
4.1 Assumptions and Generalities .....	15
4.2 Role of UE Positioning Methods.....	16
4.3 Standard UE Positioning Methods .....	16
4.3.1 Introduction.....	16
4.3.2 Network-assisted GNSS methods .....	17
4.3.3 OTDOA positioning .....	17
4.3.4 Enhanced Cell ID methods .....	18
4.3.5 Barometric pressure sensor positioning .....	18
4.3.6 WLAN positioning .....	18
4.3.7 Bluetooth positioning.....	18
4.3.8 TBS positioning .....	18
4.3.9 Motion sensor positioning .....	19
4.3.10 NR Enhanced Cell ID methods.....	19
4.3.11 Multi-RTT positioning.....	19
4.3.12 DL-AoD positioning .....	19
4.3.13 DL-TDOA positioning.....	19
4.3.14 UL-TDOA positioning.....	20
4.3.15 UL-AoA.....	20
5 NG-RAN UE Positioning Architecture .....	20
5.1 Architecture .....	20
5.2 UE Positioning Operations .....	21
5.3 NG-RAN Positioning Operations.....	23
5.3.1 General NG-RAN Positioning Operations.....	23
5.3.2 OTDOA Positioning Support.....	23
5.3.3 Assistance Information Broadcast Support.....	23
5.3.4 NR RAT-Dependent Positioning Support.....	23
5.4 Functional Description of Elements Related to UE Positioning in NG-RAN .....	23
5.4.1 User Equipment (UE) .....	23
5.4.2 gNB.....	24
5.4.3 ng-eNB.....	24
5.4.4 Location Management Function (LMF) .....	24
6 Signalling protocols and interfaces .....	24
6.1 Network interfaces supporting positioning operations .....	24
6.1.1 General LCS control plane architecture.....	24
6.1.2 NR-Uu interface.....	25
6.1.3 LTE-Uu interface.....	25
6.1.4 NG-C interface.....	25
6.1.5 NLS interface .....	25
6.1.6 F1 interface .....	25
6.2 UE-terminated protocols .....	25
6.2.1 LTE Positioning Protocol (LPP).....	25
6.2.2 Radio Resource Control (RRC) for NR .....	26

6.2.3	Radio Resource Control (RRC) for LTE .....	26
6.2.4	Medium Access Control (MAC) for NR.....	26
6.3	NG-RAN Node terminated protocols.....	26
6.3.1	NR Positioning Protocol A (NRPPa).....	26
6.3.2	NG Application Protocol (NGAP).....	27
6.4	Signalling between an LMF and UE .....	27
6.4.1	Protocol Layering .....	27
6.4.2	LPP PDU Transfer.....	27
6.5	Signalling between an LMF and NG-RAN node .....	29
6.5.1	Protocol Layering .....	29
6.5.2	NRPPa PDU Transfer for UE Positioning .....	29
6.5.3	NRPPa PDU Transfer for Positioning Support.....	30
6.5.4	NRPPa PDU Transfer for Assistance Information Broadcast.....	31
6.6	Void.....	33
7	General NG-RAN UE Positioning procedures.....	33
7.1	General LPP procedures for UE Positioning.....	33
7.1.1	LPP procedures.....	33
7.1.2	Positioning procedures.....	33
7.1.2.1	Capability transfer.....	33
7.1.2.2	Assistance data transfer.....	33
7.1.2.3	Location information transfer.....	33
7.1.2.4	Multiple transactions.....	33
7.1.2.5	Sequence of procedures.....	33
7.1.2.6	Error handling .....	34
7.1.2.7	Abort .....	34
7.2	General NRPPa Procedures for UE Positioning.....	34
7.2.1	NRPPa procedures .....	34
7.2.2	NRPPa transaction types.....	35
7.2.2.1	Location information transfer.....	35
7.3	Service Layer Support using combined LPP and NRPPa Procedures .....	35
7.3.1	General.....	35
7.3.2	NI-LR and MT-LR Service Support .....	35
7.3.3	MO-LR Service Support.....	36
7.4	General RRC procedures for UE Positioning.....	37
7.4.1	NR RRC Procedures .....	37
7.4.1.1	Location Measurement Indication.....	37
7.4.2	LTE RRC Procedures .....	38
7.4.2.1	Inter-frequency RSTD measurement indication.....	38
7.5	Procedures for Broadcast of Assistance Data .....	38
7.5.1	General.....	38
7.5.2	Broadcast Procedures.....	38
8	Positioning methods and Supporting Procedures.....	40
8.1	GNSS positioning methods .....	40
8.1.1	General.....	40
8.1.2	Information to be transferred between NG-RAN/5GC Elements .....	41
8.1.2.1	Information that may be transferred from the LMF to UE.....	41
8.1.2.1.1	Reference Time .....	42
8.1.2.1.2	Reference Location.....	42
8.1.2.1.3	Ionospheric Models .....	42
8.1.2.1.4	Earth Orientation Parameters.....	42
8.1.2.1.5	GNSS-GNSS Time Offsets .....	43
8.1.2.1.6	Differential GNSS Corrections.....	43
8.1.2.1.7	Ephemeris and Clock Models.....	43
8.1.2.1.8	Real-Time Integrity .....	43
8.1.2.1.9	Data Bit Assistance.....	43
8.1.2.1.10	Acquisition Assistance .....	43
8.1.2.1.11	Almanac.....	43
8.1.2.1.12	UTC Models .....	43
8.1.2.1.13	RTK Reference Station Information.....	43
8.1.2.1.14	RTK Auxiliary Station Data.....	44

8.1.2.1.15	RTK Observations .....	44
8.1.2.1.16	RTK Common Observation Information .....	44
8.1.2.1.17	GLONASS RTK Bias Information .....	44
8.1.2.1.18	RTK MAC Correction Differences .....	44
8.1.2.1.19	RTK Residuals .....	44
8.1.2.1.20	RTK FKP Gradients .....	45
8.1.2.1.21	SSR Orbit Corrections .....	45
8.1.2.1.22	SSR Clock Corrections .....	45
8.1.2.1.23	SSR Code Bias .....	45
8.1.2.1.24	SSR Phase Bias .....	45
8.1.2.1.25	SSR STEC Corrections .....	45
8.1.2.1.26	SSR Gridded Correction .....	45
8.1.2.1.27	SSR URA .....	45
8.1.2.1.28	SSR Correction Points .....	46
8.1.2.1a	Recommendations for grouping of assistance data to support different RTK service levels .....	46
8.1.2.2	Information that may be transferred from the UE to LMF .....	48
8.1.2.2.1	GNSS Measurement Information .....	48
8.1.2.2.1.1	UE-based mode .....	48
8.1.2.2.1.2	UE-assisted mode .....	48
8.1.2.2.2	Additional Non-GNSS Related Information .....	49
8.1.3	Assisted-GNSS Positioning Procedures .....	49
8.1.3.1	Capability Transfer Procedure .....	49
8.1.3.2	Assistance Data Transfer Procedure .....	49
8.1.3.2.1	LMF initiated Assistance Data Delivery .....	49
8.1.3.2.1a	LMF initiated Periodic Assistance Data Delivery .....	49
8.1.3.2.2	UE initiated Assistance Data Transfer .....	50
8.1.3.2.2a	UE initiated Periodic Assistance Data Transfer .....	51
8.1.3.3	Location Information Transfer Procedure .....	52
8.1.3.3.1	LMF initiated Location Information Transfer Procedure .....	52
8.1.3.3.2	UE-initiated Location Information Delivery Procedure .....	52
8.2	OTDOA positioning .....	53
8.2.1	General .....	53
8.2.2	Information to be transferred between NG-RAN/5GC Elements .....	53
8.2.2.1	Information that may be transferred from the LMF to UE .....	53
8.2.2.2	Information that may be transferred from the ng-eNB to LMF .....	53
8.2.2.3	Information that may be transferred from the UE to LMF .....	54
8.2.3	OTDOA Positioning Procedures .....	54
8.2.3.1	Capability Transfer Procedure .....	54
8.2.3.2	Assistance Data Transfer Procedure .....	54
8.2.3.2.1	Assistance Data Transfer between LMF and UE .....	54
8.2.3.2.1.1	LMF initiated Assistance Data Delivery .....	54
8.2.3.2.1.2	UE initiated Assistance Data Transfer .....	55
8.2.3.2.2	Assistance Data Delivery between LMF and ng-eNB .....	55
8.2.3.2.2.1	LMF-initiated assistance data delivery to the LMF .....	55
8.2.3.3	Location Information Transfer Procedure .....	56
8.2.3.3.1	LMF-initiated Location Information Transfer Procedure .....	56
8.2.3.3.2	UE-initiated Location Information Delivery procedure .....	57
8.3	Enhanced cell ID positioning methods .....	57
8.3.1	General .....	57
8.3.2	Information to be transferred between NG-RAN/5GC Elements .....	58
8.3.2.1	Information that may be transferred from the LMF to UE .....	58
8.3.2.2	Information that may be transferred from the ng-eNB to LMF .....	58
8.3.2.3	Information that may be transferred from the gNB to LMF .....	58
8.3.2.4	Information that may be transferred from the UE to LMF .....	59
8.3.3	Downlink E-CID Positioning Procedures .....	59
8.3.3.1	Capability Transfer Procedure .....	59
8.3.3.2	Assistance Data Transfer Procedure .....	59
8.3.3.3	Location Information Transfer Procedure .....	59
8.3.3.3.1	LMF-initiated Location Information Transfer .....	59
8.3.3.3.2	UE-initiated Location Information Delivery procedure .....	60
8.3.4	Uplink E-CID Positioning Procedures .....	60
8.3.4.1	Capability Transfer Procedure .....	60

8.3.4.2	Assistance Data Transfer Procedure.....	61
8.3.4.3	Position Measurement Procedure.....	61
8.3.4.3.1	LMF-initiated Position Measurement.....	61
8.4	Barometric pressure sensor positioning.....	61
8.4.2	Information to be transferred between NG-RAN/5GC Elements.....	62
8.4.2.1	Information that may be transferred from the LMF to UE.....	62
8.4.2.1.1	Barometric pressure sensor assistance data.....	62
8.4.2.2	Information that may be transferred from the UE to LMF.....	62
8.4.2.2.1	Standalone mode.....	62
8.4.2.2.2	UE-assisted mode.....	63
8.4.2.2.3	UE-based mode.....	63
8.4.3	Barometric Pressure Sensor Positioning Procedures.....	63
8.4.3.1	Capability Transfer Procedure.....	63
8.4.3.2	Assistance Data Transfer Procedure.....	63
8.4.3.2.1	LMF initiated Assistance Data Delivery.....	63
8.4.3.2.2	UE initiated Assistance Data Transfer.....	63
8.4.3.3	Location Information Transfer Procedure.....	64
8.4.3.3.1	LMF initiated Location Information Transfer Procedure.....	64
8.4.3.3.2	UE-initiated Location Information Delivery Procedure.....	65
8.5	WLAN positioning.....	65
8.5.1	General.....	65
8.5.2	Information to be transferred between NG-RAN/5GC Elements.....	65
8.5.2.1	Information that may be transferred from the LMF to UE.....	66
8.5.2.1.1	WLAN AP BSSID.....	66
8.5.2.1.2	WLAN AP SSID.....	66
8.5.2.1.3	WLAN AP Type Data.....	66
8.5.2.1.4	WLAN AP Location.....	66
8.5.2.2	Information that may be transferred from the UE to LMF.....	66
8.5.2.2.1	Standalone mode.....	67
8.5.2.2.2	UE-assisted mode.....	67
8.5.2.2.3	UE-based mode.....	67
8.5.3	WLAN Positioning Procedures.....	67
8.5.3.1	Capability Transfer Procedure.....	67
8.5.3.2	Assistance Data Transfer Procedure.....	67
8.5.3.2.1	LMF initiated Assistance Data Delivery.....	67
8.5.3.2.2	UE initiated Assistance Data Transfer.....	67
8.5.3.3	Location Information Transfer Procedure.....	68
8.5.3.3.1	LMF initiated Location Information Transfer Procedure.....	68
8.5.3.3.2	UE-initiated Location Information Delivery Procedure.....	69
8.6	Bluetooth positioning.....	69
8.6.2	Information to be transferred between NG-RAN/5GC Elements.....	69
8.6.2.1	Information that may be transferred from the LMF to UE.....	69
8.6.2.2	Information that may be transferred from the UE to LMF.....	69
8.6.2.2.1	Standalone mode.....	70
8.6.2.2.2	UE-assisted mode.....	70
8.6.3	Bluetooth Positioning Procedures.....	70
8.6.3.1	Capability Transfer Procedure.....	70
8.6.3.2	Assistance Data Transfer Procedure.....	70
8.6.3.3	Location Information Transfer Procedure.....	70
8.6.3.3.1	LMF initiated Location Information Transfer Procedure.....	70
8.6.3.3.2	UE-initiated Location Information Delivery Procedure.....	71
8.7	TBS positioning.....	71
8.7.1	General.....	71
8.7.2	Information to be transferred between NG-RAN/5GC Elements.....	72
8.7.2.1	Information that may be transferred from the LMF to UE.....	72
8.7.2.1.1	Acquisition Assistance.....	72
8.7.2.1.2	Almanac.....	72
8.7.2.2	Information that may be transferred from the UE to LMF.....	72
8.7.2.2.1	Standalone mode.....	72
8.7.2.2.2	UE-assisted mode.....	73
8.7.2.2.3	UE-based mode.....	73
8.7.3	TBS Positioning Procedures.....	73

8.7.3.1	Capability Transfer Procedure .....	73
8.7.3.2	Assistance Data Transfer Procedure.....	73
8.7.3.2.1	LMF initiated Assistance Data Delivery .....	73
8.7.3.2.2	UE initiated Assistance Data Transfer.....	73
8.7.3.3	Location Information Transfer Procedure .....	74
8.7.3.3.1	LMF initiated Location Information Transfer Procedure .....	74
8.7.3.3.2	UE-initiated Location Information Delivery Procedure .....	75
8.8	Motion sensor positioning method .....	75
8.8.1	General.....	75
8.8.2	Information to be transferred between NG-RAN/5GC Elements .....	75
8.8.2.1	General .....	75
8.8.2.2	Information that may be transferred from the UE to LMF .....	75
8.8.2.2.1	UE-assisted, UE-based, Standalone mode .....	75
8.8.2.2.2	UE Displacement and Movement Information .....	76
8.8.2.3	Information that may be transferred from the LMF to the UE .....	76
8.8.3	Motion Sensors Location Information Transfer Procedure.....	76
8.8.3.1	General .....	76
8.8.3.2	LMF initiated Location Information Transfer Procedure .....	76
8.8.3.3	UE-initiated Location Information Delivery Procedure .....	76
8.9	NR Enhanced cell ID positioning methods .....	77
8.9.1	General.....	77
8.9.2	Information to be transferred between NG-RAN/5GC Elements .....	77
8.9.2.1	Information that may be transferred from the LMF to UE.....	77
8.9.2.2	Information that may be transferred from the UE to LMF .....	77
8.9.3	NR E-CID Positioning Procedures .....	77
8.9.3.1	Capability Transfer Procedure .....	78
8.9.3.2	Assistance Data Transfer Procedure.....	78
8.9.3.3	Location Information Transfer Procedure .....	78
8.9.3.3.1	LMF-initiated Location Information Transfer from UE .....	78
8.9.3.3.2	UE-initiated Location Information Delivery procedure .....	78
8.10	Multi-RTT positioning .....	79
8.10.1	General.....	79
8.10.2	Information to be transferred between NG-RAN/5GC Elements .....	79
8.10.2.1	Information that may be transferred from the LMF to UE.....	79
8.10.2.2	Information that may be transferred from the UE to LMF.....	79
8.10.2.3	Information that may be transferred from the gNB to LMF.....	79
8.10.2.4	Information that may be transferred from the LMF to gNBs .....	80
8.10.3	Multi-RTT Positioning Procedures.....	81
8.10.3.1	Procedures between LMF and UE .....	81
8.10.3.1.1	Capability Transfer Procedure.....	81
8.10.3.1.2	Assistance Data Transfer Procedure .....	81
8.10.3.1.2.1	Assistance Data Transfer between LMF and UE.....	81
8.10.3.1.2.1.1	LMF initiated Assistance Data Delivery .....	81
8.10.3.1.2.1.2	UE initiated Assistance Data Transfer .....	82
8.10.3.1.3	Location Information Transfer Procedure .....	82
8.10.3.1.3.1	LMF-initiated Location Information Transfer Procedure .....	82
8.10.3.1.3.2	UE-initiated Location Information Delivery procedure .....	83
8.10.3.2	Procedures between LMF and gNB .....	83
8.10.3.2.1	Assistance Data Delivery between LMF and gNB .....	83
8.10.3.2.2	Location Information Transfer/Assistance Data Transfer Procedure .....	84
8.10.3.2.3	Positioning Activation/Deactivation Procedure.....	85
8.10.4	Sequence of Procedure for Multi-RTT positioning .....	86
8.11	DL-AoD positioning.....	88
8.11.1	General.....	88
8.11.2	Information to be transferred between NG-RAN/5GC Elements .....	88
8.11.2.1	Information that may be transferred from the LMF to UE.....	88
8.11.2.2	Information that may be transferred from the UE to LMF.....	89
8.11.2.3	Information that may be transferred from the gNB to LMF.....	89
8.11.3	DL-AoD Positioning Procedures .....	89
8.11.3.1	Procedures between LMF and UE .....	89
8.11.3.1.1	Capability Transfer Procedure.....	89
8.11.3.1.2	Assistance Data Transfer Procedure.....	89



8.11.3.1.2.1	LMF initiated Assistance Data Delivery .....	89
8.11.3.1.2.2	UE initiated Assistance Data Transfer .....	90
8.11.3.1.3	Location Information Transfer Procedure .....	90
8.11.3.1.3.1	LMF-initiated Location Information Transfer Procedure .....	90
8.11.3.1.3.2	UE-initiated Location Information Delivery procedure .....	91
8.11.3.2	Procedures between LMF and gNB .....	91
8.11.3.2.1	Assistance Data Delivery procedure .....	91
8.11.3.2.1.1	LMF-initiated assistance data delivery to the LMF .....	91
8.12	DL-TDOA positioning .....	92
8.12.1	General .....	92
8.12.2	Information to be transferred between NG-RAN/5GC Elements .....	92
8.12.2.1	Information that may be transferred from the LMF to UE .....	92
8.12.2.2	Information that may be transferred from the UE to LMF .....	93
8.12.2.3	Information that may be transferred from the gNB to LMF .....	93
8.12.3	DL-TDOA Positioning Procedures .....	93
8.12.3.1	Procedures between LMF and UE .....	93
8.12.3.1.1	Capability Transfer Procedure .....	93
8.12.3.1.2	Assistance Data Transfer Procedure .....	94
8.12.3.1.2.1	LMF initiated Assistance Data Delivery .....	94
8.12.3.1.2.2	UE initiated Assistance Data Transfer .....	94
8.12.3.1.3	Location Information Transfer Procedure .....	95
8.12.3.1.3.1	LMF-initiated Location Information Transfer Procedure .....	95
8.12.3.1.3.2	UE-initiated Location Information Delivery procedure .....	95
8.12.3.2	Procedures between LMF and gNB .....	96
8.12.3.2.1	Assistance Data Delivery procedure .....	96
8.12.3.2.1.1	LMF-initiated assistance data delivery to the LMF .....	96
8.13	UL-TDOA positioning .....	96
8.13.1	General .....	96
8.13.2	Information to be transferred between NG-RAN/5GC Elements .....	96
8.13.2.0	Assistance Data that may be transferred from the gNB to the LMF .....	97
8.13.2.1	Configuration Data that may be transferred from the gNB to the LMF .....	97
8.13.2.2	Location Information that may be transferred from the gNBs to LMF .....	97
8.13.2.3	Information that may be transferred from the LMF to gNBs .....	97
8.13.3	UL-TDOA Positioning Procedures .....	98
8.13.3.1	Capability Transfer Procedure .....	98
8.13.3.2	Assistance Data Transfer Procedure .....	98
8.13.3.2.1	Assistance Data Delivery between LMF and gNB .....	98
8.13.3.3	Location Information Transfer/Assistance Data Transfer Procedure .....	99
8.13.3.3a	Positioning Activation/Deactivation Procedure .....	100
8.13.3.4	Sequence of Procedure for UL-TDOA positioning .....	101
8.14	UL-AoA positioning .....	103
8.14.1	General .....	103
8.14.2	Information to be transferred between NG-RAN/5GC Elements .....	103
8.14.2.0	Assistance Data that may be transferred from the gNB to the LMF .....	103
8.14.2.1	Configuration Data that may be transferred from the gNB to the LMF .....	103
8.14.2.2	Location Information that may be transferred from the gNBs to LMF .....	103
8.14.2.3	Information that may be transferred from the LMF to gNB .....	104
8.14.3	UL-AoA Positioning Procedures .....	104
8.14.3.1	Capability Transfer Procedure .....	104
8.14.3.2	Assistance Data Transfer Procedure .....	105
8.14.3.2.1	Assistance Data Delivery between LMF and gNB .....	105
8.14.3.3	Location Information Transfer/Assistance Data Transfer Procedure .....	106
8.14.3.3a	Positioning Activation/Deactivation Procedure .....	107
8.14.3.4	Sequence of Procedure for UL-AoA positioning .....	108
<b>Annex A (informative):</b>	<b>Use of LPP with SUPL .....</b>	<b>110</b>
A.1	SUPL 2.0 Positioning Methods and Positioning Protocols .....	110
A.2	SUPL 2.0 and NR Architecture .....	111
A.3	LPP session procedures using SUPL .....	112
A.4	Procedures combining C-plane and U-plane operations .....	113
<b>Annex B (informative):</b>	<b>Change history .....</b>	<b>115</b>

History .....116

---

# Foreword

This Technical Specification has been produced by the 3rd Generation Partnership Project (3GPP).

The contents of the present document are subject to continuing work within the TSG and may change following formal TSG approval. Should the TSG modify the contents of the present document, it will be re-released by the TSG with an identifying change of release date and an increase in version number as follows:

Version x.y.z

where:

- x the first digit:
  - 1 presented to TSG for information;
  - 2 presented to TSG for approval;
  - 3 or greater indicates TSG approved document under change control.
- y the second digit is incremented for all changes of substance, i.e. technical enhancements, corrections, updates, etc.
- z the third digit is incremented when editorial only changes have been incorporated in the document.

---

# 1 Scope

The present document specifies the stage 2 of the UE Positioning function of NG-RAN which provides the mechanisms to support or assist the calculation of the geographical position of a UE. UE position knowledge can be used, for example, in support of Radio Resource Management functions, as well as location-based services for operators, subscribers, and third-party service providers. The purpose of this stage 2 specification is to define the NG-RAN UE Positioning architecture, functional entities and operations to support positioning methods. This description is confined to the NG-RAN Access Stratum. It does not define or describe how the results of the UE position calculation can be utilised in the Core Network (e.g., LCS) or in NG-RAN (e.g., RRM).

UE Positioning may be considered as a network-provided enabling technology consisting of standardised service capabilities that enable the provision of location applications. The application(s) may be service provider specific. The description of the numerous and varied possible location applications which are enabled by this technology is outside the scope of the present document. However, clarifying examples of how the functionality being described may be used to provide specific location services may be included.

This stage 2 specification covers the NG-RAN positioning methods, state descriptions, and message flows to support UE Positioning.

---

# 2 References

The following documents contain provisions which, through reference in this text, constitute provisions of the present document.

- References are either specific (identified by date of publication, edition number, version number, etc.) or non-specific.
- For a specific reference, subsequent revisions do not apply.
- For a non-specific reference, the latest version applies. In the case of a reference to a 3GPP document (including a GSM document), a non-specific reference implicitly refers to the latest version of that document *in the same Release as the present document*.

- [1] 3GPP TR 21.905: "Vocabulary for 3GPP Specifications".
- [2] 3GPP TS 23.501 "System Architecture for the 5G System; Stage 2".
- [3] 3GPP TS 22.071: "Location Services (LCS); Service description, Stage 1".
- [4] 3GPP TS 23.032: "Universal Geographical Area Description (GAD)".
- [5] IS-GPS-200, Revision D, Navstar GPS Space Segment/Navigation User Interfaces, March 7<sup>th</sup>, 2006.
- [6] IS-GPS-705, Navstar GPS Space Segment/User Segment L5 Interfaces, September 22, 2005.
- [7] IS-GPS-800, Navstar GPS Space Segment/User Segment L1C Interfaces, September 4, 2008.
- [8] Galileo OS Signal in Space ICD (OS SIS ICD), Draft 0, Galileo Joint Undertaking, May 23<sup>rd</sup>, 2006.
- [9] Global Navigation Satellite System GLONASS Interface Control Document, Version 5, 2002.
- [10] IS-QZSS, Quasi Zenith Satellite System Navigation Service Interface Specifications for QZSS, Ver.1.0, June 17, 2008.
- [11] Specification for the Wide Area Augmentation System (WAAS), US Department of Transportation, Federal Aviation Administration, DTFA01-96-C-00025, 2001.
- [12] RTCM 10402.3, RTCM Recommended Standards for Differential GNSS Service (v.2.3), August 20, 2001.

- [13] 3GPP TS 36.331: "Evolved Universal Terrestrial Radio Access (E-UTRA); Radio Resource Control (RRC); Protocol specification".
- [14] 3GPP TS 38.331: "NR Radio Resource Control (RRC) protocol specification".
- [15] OMA-AD-SUPL-V2\_0: "Secure User Plane Location Architecture Approved Version 2.0".
- [16] OMA-TS-ULP-V2\_0\_4: "UserPlane Location Protocol Approved Version 2.0.4".
- [17] 3GPP TS 36.214: "Evolved Universal Terrestrial Radio Access (E-UTRA); Physical layer – Measurements".
- [18] 3GPP TS 36.302: "Evolved Universal Terrestrial Radio Access (E-UTRA); Services provided by the physical layer".
- [19] 3GPP TS 36.355: "Evolved Universal Terrestrial Radio Access (E-UTRA); LTE Positioning Protocol (LPP)".
- [20] BDS-SIS-ICD-B1I-3.0: "BeiDou Navigation Satellite System Signal In Space Interface Control Document Open Service Signal B1I (Version 3.0)", February, 2019.
- [21] IEEE 802.11: "Wireless LAN Medium Access Control (MAC) and Physical Layer (PHY) Specifications"
- [22] Bluetooth Special Interest Group: "Bluetooth Core Specification v4.2", December 2014.
- [23] ATIS-0500027: "Recommendations for Establishing Wide Scale Indoor Location Performance", May 2015.
- [24] 3GPP TS 36.211: "Evolved Universal Terrestrial Radio Access (E-UTRA); Physical channels and modulation".
- [25] 3GPP TS 36.305: "Stage 2 functional specification of User Equipment (UE) positioning in E-UTRA".
- [26] 3GPP TS 23.502: "Procedures for the 5G System; Stage 2".
- [27] 3GPP TS 38.455: "NG-RAN; NR Positioning Protocol A (NRPPa)".
- [28] 3GPP TS 29.518: "5G System; Access and Mobility Management Services; Stage 3".
- [29] 3GPP TS 24.501: "Non-Access-Stratum (NAS) protocol for 5G System (5GS); Stage 3".
- [30] 3GPP TS 38.413: "NG-RAN; NG Application Protocol (NGAP)".
- [31] RTCM 10403.3, "RTCM Recommended Standards for Differential GNSS Services (v.3.3)", October 7, 2016.
- [32] 3GPP TS 38.133: "NR; Requirements for support of radio resource management".
- [33] 3GPP TS 29.572: "Location Management Services; Stage 3".
- [34] BDS-SIS-ICD-B1C-1.0: "BeiDou Navigation Satellite System Signal In Space Interface Control Document Open Service Signal B1C (Version 1.0)", December, 2017
- [35] 3GPP TS 23.273: "5G System (5GS) Location Services (LCS); Stage 2".
- [36] IS-QZSS-L6-001, Quasi-Zenith Satellite System Interface Specification – Centimetre Level Augmentation Service, Cabinet Office, November 5, 2018.
- [37] 3GPP TS 38.215: "NR; Physical layer – Measurements".
- [38] 3GPP TS 38.401: "3rd Generation Partnership Project; Technical Specification Group Radio Access Network; NG-RAN; Architecture description".
- [39] 3GPP TS 38.321: "NR; Medium Access Control (MAC) protocol specification".

## 3 Definitions, symbols and abbreviations

### 3.1 Definitions

For the purposes of the present document, the terms and definitions given in TR 21.905 [1] and the following apply. A term defined in the present document takes precedence over the definition of the same term, if any, in TR 21.905 [1].

As used in this document, the suffixes "-based" and "-assisted" refer respectively to the node that is responsible for making the positioning calculation (and which may also provide measurements) and a node that provides measurements (but which does not make the positioning calculation). Thus, an operation in which measurements are provided by the UE to the LMF to be used in the computation of a position estimate is described as "UE-assisted" (and could also be called "LMF-based"), while one in which the UE computes its own position is described as "UE-based".

**Transmission Point (TP):** A set of geographically co-located transmit antennas (e.g. antenna array (with one or more antenna elements)) for one cell, part of one cell or one DL-PRS-only TP. Transmission Points can include base station (ng-eNB or gNB) antennas, remote radio heads, a remote antenna of a base station, an antenna of a DL-PRS-only TP, etc. One cell can include one or multiple transmission points. For a homogeneous deployment, each transmission point may correspond to one cell.

**Reception Point (RP):** A set of geographically co-located receive antennas (e.g. antenna array (with one or more antenna elements)) for one cell, part of one cell or one UL-SRS-only RP. Reception Points can include base station (ng-eNB or gNB) antennas, remote radio heads, a remote antenna of a base station, an antenna of a UL-SRS-only RP, etc. One cell can include one or multiple reception points. For a homogeneous deployment, each reception point may correspond to one cell.

**PRS-only TP:** A TP which only transmits PRS signals for PRS-based TBS positioning and is not associated with a cell.

**Transmission-Reception Point (TRP):** A set of geographically co-located antennas (e.g. antenna array (with one or more antenna elements)) supporting TP and/or RP functionality.

### 3.2 Abbreviations

For the purposes of the present document, the abbreviations given in TR 21.905 [1] and the following apply. An abbreviation defined in the present document takes precedence over the definition of the same abbreviation, if any, in TR 21.905 [1].

5GC	5G Core Network
5GS	5G System
A-AoA	Azimuth of Arrival
ADR	Accumulated Delta Range
AoA	Angle of Arrival
AP	Access Point
ARP	Antenna Reference Point
BDS	BeiDou Navigation Satellite System
BSSID	Basic Service Set Identifier
CID	Cell-ID (positioning method)
CLAS	Centimetre Level Augmentation Service
DL-AoD	Downlink Angle-of-Departure
DL-PRS	Downlink Positioning Reference Signal
DL-TDOA	Downlink Time Difference Of Arrival
E-SMLC	Enhanced Serving Mobile Location Centre
E-CID	Enhanced Cell-ID (positioning method)
ECEF	Earth-Centered, Earth-Fixed
ECI	Earth-Centered-Inertial
EGNOS	European Geostationary Navigation Overlay Service
E-UTRAN	Evolved Universal Terrestrial Radio Access Network
FDMA	Frequency Division Multiple Access
FKP	Flächenkorrekturparameter (Engl: Area Correction Parameters)
GAGAN	GPS Aided Geo Augmented Navigation
GLONASS	GLobal'naya NAVigatsionnaya Sputnikovaya Sistema (Engl.: Global Navigation Satellite System)

GMLC	Gateway Mobile Location Centre
GNSS	Global Navigation Satellite System
GPS	Global Positioning System
GRS80	Geodetic Reference System 1980
HESSID	Homogeneous Extended Service Set Identifier
LCS	LoCation Services
LMF	Location Management Function
LPP	LTE Positioning Protocol
MAC	Master Auxiliary Concept
MBS	Metropolitan Beacon System
MO-LR	Mobile Originated Location Request
MT-LR	Mobile Terminated Location Request
Multi-RTT	Multi-Round Trip Time
NG-C	NG Control plane
NG-AP	NG Application Protocol
NI-LR	Network Induced Location Request
N-RTK	Network – Real-Time Kinematic
NRPPa	NR Positioning Protocol A
OTDOA	Observed Time Difference Of Arrival
PDU	Protocol Data Unit
posSIB	Positioning SIB
PPP	Precise Point Positioning
PPP-RTK	Precise Point Positioning – Real-Time Kinematic
PRS	Positioning Reference Signal (for E-UTRA)
QZSS	Quasi-Zenith Satellite System
RP	Reception Point
RRM	Radio Resource Management
RSRP	Reference Signal Received Power
RSSI	Received Signal Strength Indicator
RSTD	Reference Signal Time Difference
RTK	Real-Time Kinematic
SBAS	Space Based Augmentation System
SET	SUPL Enabled Terminal
SIB	System Information Block
SLP	SUPL Location Platform
SRS	Sounding Reference Signal
SSID	Service Set Identifier
SSR	State Space Representation
STEC	Slant TEC
SUPL	Secure User Plane Location
T <sub>ADV</sub>	Timing Advance
TBS	Terrestrial Beacon System
TEC	Total Electron Content
TP	Transmission Point
TRP	Transmission-Reception Point
UE	User Equipment
UL-AoA	Uplink Angle of Arrival
UL-RTOA	Uplink Relative Time of Arrival
UL-SRS	Uplink Sounding Reference Signal
UL-TDOA	Uplink Time Difference of Arrival
URA	User Range Accuracy
WAAS	Wide Area Augmentation System
WGS-84	World Geodetic System 1984
WLAN	Wireless Local Area Network
Z-AoA	Zenith Angles of Arrival

## 4 Main concepts and requirements

### 4.1 Assumptions and Generalities

The stage 1 description of LCS at the service level is provided in TS 22.071 [3]; the stage 2 LCS functional description, including the LCS system architecture and message flows, is provided in TS 23.501 [2], TS 23.502 [26] and TS 23.273 [35].

Positioning functionality provides a means to determine the geographic position and/or velocity of the UE based on measuring radio signals. The position information may be requested by and reported to a client (e.g., an application) associated with the UE, or by a client within or attached to the core network. The position information shall be reported in standard formats, such as those for cell-based or geographical co-ordinates, together with the estimated errors (uncertainty) of the position and velocity of the UE and, if available, the positioning method (or the list of the methods) used to obtain the position estimate.

Restrictions on the geographic shape encoded within the 'position information' parameter may exist for certain LCS client types. The 5GS, including NG-RAN, shall comply with any shape restrictions defined in 5GS and, in a particular country, with any shape restrictions defined for a specific LCS client type in relevant national standards. For example, in the US, national standard J-STD-036-C-2 restricts the geographic shape for an emergency services LCS client to minimally either an "ellipsoid point" or an "ellipsoid point with uncertainty circle" as defined in TS 23.032 [4].

It shall be possible for the majority of the UEs within a network to use the LCS feature without compromising the radio transmission or signalling capabilities of the NG-RAN.

The uncertainty of the position measurement shall be network-implementation-dependent, at the choice of the network operator. The uncertainty may vary between networks as well as from one area within a network to another. The uncertainty may be hundreds of metres in some areas and only a few metres in others. In the event that a particular position measurement is provided through a UE-assisted process, the uncertainty may also depend on the capabilities of the UE. In some jurisdictions, there is a regulatory requirement for location service accuracy that is part of an emergency service. Further details of the accuracy requirements can be found in TS 22.071 [3].

The uncertainty of the position information is dependent on the method used, the position of the UE within the coverage area and the activity of the UE. Several design options of the NG-RAN system (e.g., size of cell, adaptive antenna technique, pathloss estimation, timing accuracy, ng-eNB and gNB surveys) shall allow the network operator to choose a suitable and cost-effective UE positioning method for their market.

There are many different possible uses for the positioning information. The positioning functions may be used internally by the 5GS, by value-added network services, by the UE itself or through the network, and by "third party" services. The feature may also be used by an emergency service (which may be mandated or "value-added"), but the location service is not exclusively for emergencies.

Design of the NG-RAN positioning capability as documented in this specification includes position methods, protocols and procedures that are either adapted from capabilities already supported for E-UTRAN, UTRAN and GERAN, or created separately from first principles. In contrast to GERAN and UTRAN but similarly to E-UTRAN, the NG-RAN positioning capabilities are intended to be forward compatible to other access types and other position methods, in an effort to reduce the amount of additional positioning support needed in the future. This goal also extends to user plane location solutions such as OMA SUPL ([15], [16]), for which NG-RAN positioning capabilities are intended to be compatible where appropriate.

As a basis for the operation of UE Positioning in NG-RAN, the following assumptions apply:

- both TDD and FDD will be supported;
- the provision of the UE Positioning function in NG-RAN and 5GC is optional through support of the specified method(s) in the ng-eNB, gNB and the LMF;
- UE Positioning is applicable to any target UE, whether or not the UE supports LCS, but with restrictions on the use of certain positioning methods depending on UE capability (e.g. as defined within the LPP protocol);
- the positioning information may be used for internal system operations to improve system performance;



- the UE Positioning architecture and functions shall include the option to accommodate several techniques of measurement and processing to ensure evolution to follow changing service requirements and to take advantage of advancing technology.

## 4.2 Role of UE Positioning Methods

The NG-RAN may utilise one or more positioning methods in order to determine the position of an UE.

Positioning the UE involves two main steps:

- signal measurements; and
- position estimate and optional velocity computation based on the measurements.

The signal measurements may be made by the UE or by the serving ng-eNB or gNB. The basic signals measured for terrestrial position methods are typically the LTE or NR radio transmissions; however, other methods may make use of other transmissions such as general radio navigation signals including those from Global Navigation Satellites Systems (GNSSs).

The positioning function should not be limited to a single method or measurement. That is, it should be capable of utilising other standard methods and measurements, as such methods and measurements are available and appropriate, to meet the required service needs of the location service client. This additional information could consist of readily available E-UTRAN or NG-RAN measurements.

The position estimate computation may be made by the UE or by the LMF.

## 4.3 Standard UE Positioning Methods

### 4.3.1 Introduction

The standard positioning methods supported for NG-RAN access are:

- network-assisted GNSS methods;
- observed time difference of arrival (OTDOA) positioning based on LTE signals;
- enhanced cell ID methods based on LTE signals;
- WLAN positioning;
- Bluetooth positioning;
- terrestrial beacon system (TBS) positioning;
- sensor based methods:
  - barometric Pressure Sensor;
  - motion sensor.
- NR enhanced cell ID methods (NR E-CID) based on NR signals;
- Multi-Round Trip Time Positioning (Multi-RTT based on NR signals);
- Downlink Angle-of-Departure (DL-AoD) based on NR signals;
- Downlink Time Difference of Arrival (DL-TDOA) based on NR signals;
- Uplink Time Difference of Arrival (UL-TDOA) based on NR signals;
- Uplink Angle of Arrival (UL-AoA), including the Azimuth of Arrival (A-AoA) and the Zenith of Arrival (Z-AoA) based on NR signals.

Hybrid positioning using multiple methods from the list of positioning methods above is also supported.

Standalone mode (e.g. autonomous, without network assistance) using one or more methods from the list of positioning methods above is also supported.

These positioning methods may be supported in UE-based, UE-assisted/LMF-based, and NG-RAN node assisted versions. Table 4.3.1-1 indicates which of these versions are supported in this version of the specification for the standardised positioning methods.

**Table 4.3.1-1: Supported versions of UE positioning methods**

Method	UE-based	UE-assisted, LMF-based	NG-RAN node assisted	SUPL
A-GNSS	Yes	Yes	No	Yes (UE-based and UE-assisted)
OTDOA <sup>Note 1, Note 2</sup>	No	Yes	No	Yes (UE-assisted)
E-CID <sup>Note 4</sup>	No	Yes	Yes	Yes for E-UTRA (UE-assisted)
Sensor	Yes	Yes	No	No
WLAN	Yes	Yes	No	Yes
Bluetooth	No	Yes	No	No
TBS <sup>Note 5</sup>	Yes	Yes	No	Yes (MBS)
DL-TDOA	Yes	Yes	No	No
DL-AoD	Yes	Yes	No	No
Multi-RTT	No	Yes	Yes	No
NR E-CID	No	Yes	Yes	No
UL-TDOA	No	No	Yes	No
UL-AoA	No	No	Yes	No
NOTE 1: This includes TBS positioning based on PRS signals. NOTE 2: In this version of the specification only OTDOA based on LTE signals is supported. NOTE 3: Void NOTE 4: This includes Cell-ID for NR method. NOTE 5: In this version of the specification only for TBS positioning based on MBS signals. NOTE 6: Void				

Sensor, WLAN, Bluetooth, and TBS positioning methods based on MBS signals are also supported in standalone mode, as described in the corresponding clauses.

## 4.3.2 Network-assisted GNSS methods

These methods make use of UEs that are equipped with radio receivers capable of receiving GNSS signals. In 3GPP specifications the term GNSS encompasses both global and regional/augmentation navigation satellite systems.

Examples of global navigation satellite systems include GPS, Modernized GPS, Galileo, GLONASS, and BeiDou Navigation Satellite System (BDS). Regional navigation satellite systems include Quasi Zenith Satellite System (QZSS) while the many augmentation systems, listed in 8.1.1, are classified under the generic term of Space Based Augmentation Systems (SBAS) and provide regional augmentation services.

In this concept, different GNSSs (e.g. GPS, Galileo, etc.) can be used separately or in combination to determine the location of a UE.

The operation of the network-assisted GNSS methods is described in clause 8.1.

## 4.3.3 OTDOA positioning

The OTDOA positioning method makes use of the measured timing of downlink signals received from multiple TPs, comprising eNBs, ng-eNBs and PRS-only TPs, at the UE. The UE measures the timing of the received signals using assistance data received from the positioning server, and the resulting measurements are used to locate the UE in relation to the neighbouring TPs.

The operation of the OTDOA method is described in clause 8.2.

#### 4.3.4 Enhanced Cell ID methods

In the Cell ID (CID) positioning method, the position of an UE is estimated with the knowledge of its serving ng-eNB, gNB and cell. The information about the serving ng-eNB, gNB and cell may be obtained by paging, registration, or other methods.

Enhanced Cell ID (E-CID) based on LTE signals positioning refers to techniques which use additional UE measurements and/or NG-RAN radio resource and other measurements to improve the UE location estimate.

Although E-CID based on LTE signals positioning may utilise some of the same measurements as the measurement control system in the RRC protocol, the UE generally is not expected to make additional measurements for the sole purpose of positioning; i.e., the positioning procedures do not supply a measurement configuration or measurement control message, and the UE reports the measurements that it has available rather than being required to take additional measurement actions.

In cases with a requirement for close time coupling between UE and ng-eNB measurements (e.g.,  $T_{ADV}$  type 1 and UE E-UTRA Rx-Tx time difference), the ng-eNB configures the appropriate RRC measurements and is responsible for maintaining the required coupling between the measurements.

In the case of a serving gNB, E-CID based on LTE signals positioning can be supported using E-UTRA measurements provided by a UE to the serving gNB.

The operation of the Enhanced Cell ID based on LTE signals method is described in clause 8.3.

#### 4.3.5 Barometric pressure sensor positioning

The barometric pressure sensor method makes use of barometric sensors to determine the vertical component of the position of the UE. The UE measures barometric pressure, optionally aided by assistance data, to calculate the vertical component of its location or to send measurements to the positioning server for position calculation.

This method should be combined with other positioning methods to determine the 3D position of the UE.

The operation of the Barometric pressure sensor positioning method is described in clause 8.4.

#### 4.3.6 WLAN positioning

The WLAN positioning method makes use of the WLAN measurements (AP identifiers and optionally other measurements) and databases to determine the location of the UE. The UE measures received signals from WLAN [21] access points, optionally aided by assistance data, to send measurements to the positioning server for position calculation. Using the measurement results and a references database, the location of the UE is calculated.

Alternatively, the UE makes use of WLAN measurements and optionally WLAN AP assistance data provided by the positioning server, to determine its location.

The operation of the WLAN positioning method is described in clause 8.5.

#### 4.3.7 Bluetooth positioning

The Bluetooth positioning method makes use of Bluetooth measurements (beacon identifiers and optionally other measurements) to determine the location of the UE. The UE measures received signals from Bluetooth [22] beacons. Using the measurement results and a references database, the location of the UE is calculated. The Bluetooth methods may be combined with other positioning methods (e.g. WLAN) to improve positioning accuracy of the UE.

The operation of the Bluetooth positioning method is described in clause 8.6.

#### 4.3.8 TBS positioning

A Terrestrial Beacon System (TBS) consists of a network of ground-based transmitters, broadcasting signals only for positioning purposes. The current type of TBS positioning signals are the MBS (Metropolitan Beacon System) signals [23] and Positioning Reference Signals (PRS) (TS 36.211 [24]). The UE measures received TBS signals, optionally aided by assistance data, to calculate its location or to send measurements to the positioning server for position calculation.

The operation of the TBS positioning method based on MBS signals is described in clause 8.7.

TBS positioning based on PRS signals is part of OTDOA positioning and described in clause 8.2.

### 4.3.9 Motion sensor positioning

The motion sensor method makes use of different sensors such as accelerometers, gyros, magnetometers, to calculate the displacement of UE. The UE estimates a relative displacement based upon a reference position and/or reference time. UE sends a report comprising the determined relative displacement which can be used to determine the absolute position.

This method should be used with other positioning methods for hybrid positioning.

The operation of the sensor positioning method is described in clause 8.8.

### 4.3.10 NR Enhanced Cell ID methods

NR Enhanced Cell ID (NR E-CID) positioning refers to techniques which use additional UE measurements and/or NR radio resource and other measurements to improve the UE location estimate.

Although NR E-CID positioning may utilise some of the same measurements as the measurement control system in the RRC protocol, the UE generally is not expected to make additional measurements for the sole purpose of positioning; i.e., the positioning procedures do not supply a measurement configuration or measurement control message, and the UE reports the measurements that it has available rather than being required to take additional measurement actions.

The operation of the NR Enhanced Cell ID method is described in clause 8.9.

### 4.3.11 Multi-RTT positioning

The Multi-RTT positioning method makes use of the UE Rx-Tx time difference measurements and DL-PRS-RSRP of downlink signals received from multiple TRPs, measured by the UE and the measured gNB Rx-Tx time difference measurements and UL-SRS-RSRP at multiple TRPs of uplink signals transmitted from UE.

The UE measures the UE Rx-Tx time difference measurements (and optionally DL-PRS-RSRP of the received signals) using assistance data received from the positioning server, and the TRPs measure the gNB Rx-Tx time difference measurements (and optionally UL-SRS-RSRP of the received signals) using assistance data received from the positioning server. The measurements are used to determine the RTT at the positioning server which are used to estimate the location of the UE.

The operation of the Multi-RTT positioning method is described in clause 8.10.

### 4.3.12 DL-AoD positioning

The DL-AoD positioning method makes use of the measured DL-PRS-RSRP of downlink signals received from multiple TPs, at the UE. The UE measures the DL-PRS-RSRP of the received signals using assistance data received from the positioning server, and the resulting measurements are used along with other configuration information to locate the UE in relation to the neighbouring TPs.

The operation of the DL-AoD positioning method is described in clause 8.11.

### 4.3.13 DL-TDOA positioning

The DL-TDOA positioning method makes use of the DL RSTD (and optionally DL-PRS-RSRP) of downlink signals received from multiple TPs, at the UE. The UE measures the DL RSTD (and optionally DL-PRS-RSRP) of the received signals using assistance data received from the positioning server, and the resulting measurements are used along with other configuration information to locate the UE in relation to the neighbouring TPs.

The operation of the DL-TDOA positioning method is described in clause 8.12.

### 4.3.14 UL-TDOA positioning

The UL-TDOA positioning method makes use of the UL-RTOA (and optionally UL-SRS-RSRP) at multiple RPs of uplink signals transmitted from UE. The RPs measure the UL-RTOA (and optionally UL-SRS-RSRP) of the received signals using assistance data received from the positioning server, and the resulting measurements are used along with other configuration information to estimate the location of the UE.

The operation of the UL-TDOA positioning method is described in clause 8.13.

### 4.3.15 UL-AoA

The UL-AoA positioning method makes use of the measured azimuth and zenith of arrival at multiple RPs of uplink signals transmitted from the UE. The RPs measure A-AoA and Z-AoA of the received signals using assistance data received from the positioning server, and the resulting measurements are used along with other configuration information to estimate the location of the UE.

The operation of the UL-AoA positioning method is described in clause 8.14.

---

## 5 NG-RAN UE Positioning Architecture

### 5.1 Architecture

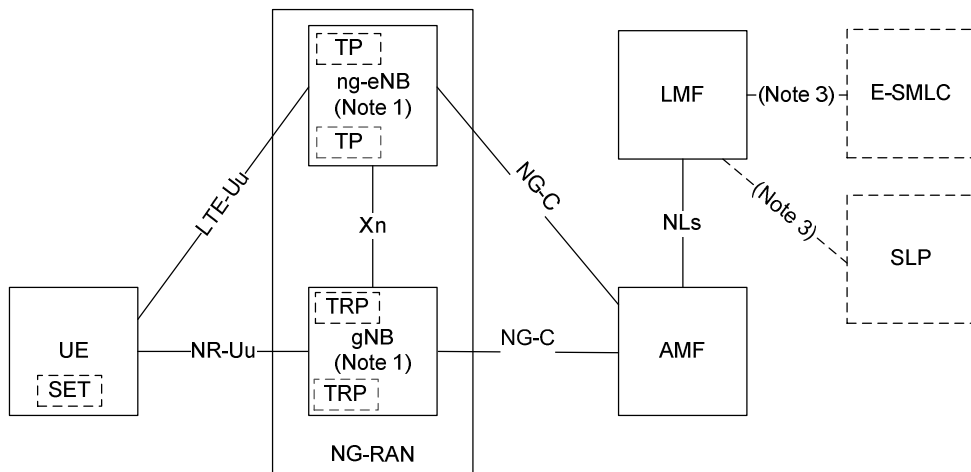
Figure 5.1-1 shows the architecture in 5GS applicable to positioning of a UE with NR or E-UTRA access.

The AMF receives a request for some location service associated with a particular target UE from another entity (e.g., GMLC or UE) or the AMF itself decides to initiate some location service on behalf of a particular target UE (e.g., for an IMS emergency call from the UE) as described in TS 23.502 [26] and TS 23.273 [35]. The AMF then sends a location services request to an LMF. The LMF processes the location services request which may include transferring assistance data to the target UE to assist with UE-based and/or UE-assisted positioning and/or may include positioning of the target UE. The LMF then returns the result of the location service back to the AMF (e.g., a position estimate for the UE). In the case of a location service requested by an entity other than the AMF (e.g., a GMLC or UE), the AMF returns the location service result to this entity.

An NG-RAN node may control several TRPs/TPs, such as remote radio heads, or DL-PRS-only TPs for support of PRS-based TBS.

An LMF may have a proprietary signalling connection to an E-SMLC which may enable an LMF to access information from E-UTRAN (e.g. to support the OTDOA for E-UTRA positioning method using downlink measurements obtained by a target UE of signals from eNBs and/or PRS-only TPs in E-UTRAN). Details of the signalling interaction between an LMF and E-SMLC are outside the scope of this specification.

An LMF may have a proprietary signalling connection to an SLP. The SLP is the SUPL entity responsible for positioning over the user plane. Further details of user-plane positioning are provided in [15][16]. Details of the signalling interaction between an LMF and SLP are outside the scope of this specification.



**Figure 5.1-1: UE Positioning Architecture applicable to NG-RAN**

NOTE 1: The gNB and ng-eNB may not always both be present.

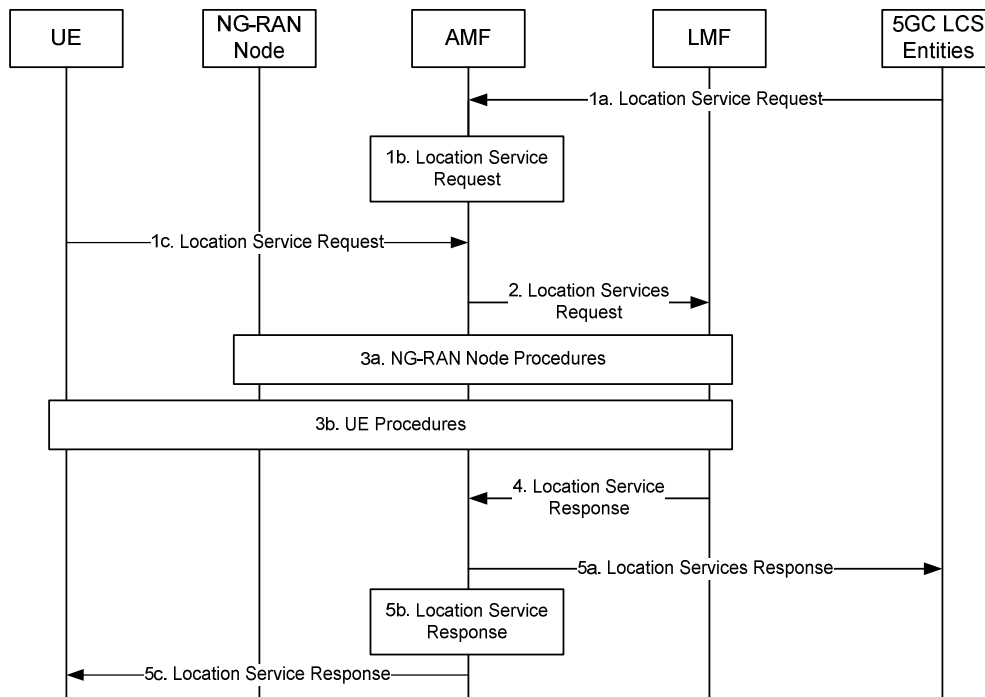
NOTE 2: Void

NOTE 3: Proprietary interface possible.

## 5.2 UE Positioning Operations

To support positioning of a target UE and delivery of location assistance data to a UE with NG-RAN access in 5GS, location related functions are distributed as shown in the architecture in Figure 5.1-1 and as clarified in greater detail in TS 23.501 [2] and TS 23.273 [35]. The overall sequence of events applicable to the UE, NG-RAN and LMF for any location service is shown in Figure 5.2-1.

Note that when the AMF receives a Location Service Request in case of the UE is in CM-IDLE state, the AMF performs a network triggered service request as defined in TS 23.502 [26] and TS 23.273 [35] in order to establish a signalling connection with the UE and assign a specific serving gNB or ng-eNB. The UE is assumed to be in connected mode before the beginning of the flow shown in the Figure 5.2-1; that is, any signalling that might be required to bring the UE to connected mode prior to step 1a is not shown. The signalling connection may, however, be later released (e.g. by the NG-RAN node as a result of signalling and data inactivity) while positioning is still ongoing.



**Figure 5.2-1: Location Service Support by NG-RAN**

- 1a. Either: some entity in the 5GC (e.g. GMLC) requests some location service (e.g. positioning) for a target UE to the serving AMF.
- 1b. Or: the serving AMF for a target UE determines the need for some location service (e.g. to locate the UE for an emergency call).
- 1c. Or: the UE requests some location service (e.g. positioning or delivery of assistance data) to the serving AMF at the NAS level.
2. The AMF transfers the location service request to an LMF.
- 3a. The LMF instigates location procedures with the serving and possibly neighbouring ng-eNB or gNB in the NG-RAN – e.g. to obtain positioning measurements or assistance data.
- 3b. In addition to step 3a or instead of step 3a, the LMF instigates location procedures with the UE – e.g. to obtain a location estimate or positioning measurements or to transfer location assistance data to the UE.
4. The LMF provides a location service response to the AMF and includes any needed results – e.g. success or failure indication and, if requested and obtained, a location estimate for the UE.
- 5a. If step 1a was performed, the AMF returns a location service response to the 5GC entity in step 1a and includes any needed results – e.g. a location estimate for the UE.
- 5b. If step 1b occurred, the AMF uses the location service response received in step 4 to assist the service that triggered this in step 1b (e.g. may provide a location estimate associated with an emergency call to a GMLC).
- 5c. If step 1c was performed, the AMF returns a location service response to the UE and includes any needed results – e.g. a location estimate for the UE.

Location procedures applicable to NG-RAN occur in steps 3a and 3b in Figure 5.2-1 and are defined in greater detail in this specification. Other steps in Figure 5.2-1 are applicable only to the 5GC and are described in greater detail and in TS 23.502 [26] and TS 23.273 [35].

Steps 3a and 3b can involve the use of different position methods to obtain location related measurements for a target UE and from these compute a location estimate and possibly additional information like velocity. Positioning methods supported in this release are summarized in clause 4.3 and described in detail in clause 8.

The case that the NG-RAN node functions as an LCS client is not supported in this version of the specification.

## 5.3 NG-RAN Positioning Operations

### 5.3.1 General NG-RAN Positioning Operations

Separately from location service support for particular UEs, an LMF may interact with elements in the NG-RAN in order to obtain measurement information to help assist one or more position methods for all UEs. An LMF may also interact with NG-RAN node to provide assistance data information for broadcasting.

### 5.3.2 OTDOA Positioning Support

An LMF can interact with any ng-eNB reachable from any of the AMFs with signalling access to the LMF in order to obtain location related information to support the OTDOA for E-UTRA positioning method, including PRS-based TBS for E-UTRA. The information can include timing information for the TP in relation to either absolute GNSS time or timing of other TPs and information about the supported cells and TPs including PRS schedule.

Signalling access between the LMF and ng-eNB may be via any AMF with signalling access to both the LMF and ng-eNB. In the case of an ng-eNB with no signalling access to an AMF, signalling access between the LMF and ng-eNB may be via any AMF with signalling access to both the LMF and a gNB with signalling access to the ng-eNB.

### 5.3.3 Assistance Information Broadcast Support

An LMF can interact with any NG-RAN node reachable from any of the AMFs with signalling access to the LMF in order to provide assistance data information for broadcasting. The information can include positioning System Information Blocks (posSIBs) together with assistance information meta data and broadcast periodicity.

Signalling access between the LMF and NG-RAN node is via any AMF with signalling access to both the LMF and NG-RAN node.

### 5.3.4 NR RAT-Dependent Positioning Support

An LMF can interact with any gNB reachable from any of the AMFs with signalling access to the LMF in order to obtain location related information to support the NR RAT-Dependent positioning methods. The information can include timing information for the TRP in relation to either absolute GNSS time or timing of other TRPs and information about the supported cells and TRPs including PRS schedule.

Signalling access between the LMF and gNB may be via any AMF with signalling access to both the LMF and gNB.

## 5.4 Functional Description of Elements Related to UE Positioning in NG-RAN

### 5.4.1 User Equipment (UE)

The UE may make measurements of downlink signals from NG-RAN and other sources such as E-UTRAN, different GNSS and TBS systems, WLAN access points, Bluetooth beacons, UE barometric pressure and motion sensors. The measurements to be made will be determined by the chosen positioning method.

The UE may also contain LCS applications, or access an LCS application either through communication with a network accessed by the UE or through another application residing in the UE. This LCS application may include the needed measurement and calculation functions to determine the UE's position with or without network assistance. This is outside of the scope of this specification.

The UE may also, for example, contain an independent positioning function (e.g., GPS) and thus be able to report its position, independent of the NG-RAN transmissions. The UE with an independent positioning function may also make use of assistance information obtained from the network.



## 5.4.2 gNB

The gNB is a network element of NG-RAN that may provide measurement information for a target UE and communicates this information to an LMF.

To support NR RAT-Dependent positioning, the gNB may provide measurement results for position estimation and makes measurements of radio signals for a target UE and communicates these measurements to an LMF. A gNB may serve several TRPs, including for example remote radio heads, and UL-SRS only RPs and DL-PRS-only TPs.

A gNB may broadcast assistance data information, received from an LMF, in positioning System Information messages.

## 5.4.3 ng-eNB

The ng-eNB is a network element of NG-RAN that may provide measurement results for position estimation and makes measurements of radio signals for a target UE and communicates these measurements to an LMF.

The ng-eNB makes its measurements in response to requests from the LMF (on demand or periodically).

An ng-eNB may serve several TPs, including for example remote radio heads and PRS-only TPs for PRS-based TBS positioning for E-UTRA.

An ng-eNB may broadcast assistance data information, received from an LMF, in positioning System Information messages.

## 5.4.4 Location Management Function (LMF)

The LMF manages the support of different location services for target UEs, including positioning of UEs and delivery of assistance data to UEs. The LMF may interact with the serving gNB or serving ng-eNB for a target UE in order to obtain position measurements for the UE, including uplink measurements made by an NG-RAN and downlink measurements made by the UE that were provided to an NG-RAN as part of other functions such as for support of handover.

The LMF may interact with a target UE in order to deliver assistance data if requested for a particular location service, or to obtain a location estimate if that was requested.

The LMF may interact with multiple NG-RAN nodes to provide assistance data information for broadcasting. The assistance data information for broadcast may optionally be segmented and/or ciphered by the LMF. The LMF may also interact with AMFs to provide ciphering key data information to the AMF as described in greater detail in TS 23.273 [35].

For positioning of a target UE, the LMF decides on the position methods to be used, based on factors that may include the LCS Client type, the required QoS, UE positioning capabilities, gNB positioning capabilities and ng-eNB positioning capabilities. The LMF then invokes these positioning methods in the UE, serving gNB and/or serving ng-eNB. The positioning methods may yield a location estimate for UE-based position methods and/or positioning measurements for UE-assisted and network-based position methods. The LMF may combine all the received results and determine a single location estimate for the target UE (hybrid positioning). Additional information like accuracy of the location estimate and velocity may also be determined.

---

# 6 Signalling protocols and interfaces

## 6.1 Network interfaces supporting positioning operations

### 6.1.1 General LCS control plane architecture

The general LCS control plane architecture in the 5GS applicable to a target UE with NG-RAN access is defined in TS 23.501 [2] and TS 23.273 [35].

## 6.1.2 NR-Uu interface

The NR-Uu interface, connecting the UE to the gNB over the air, is used as one of several transport links for the NR positioning protocol(s) for a target UE with NR access to NG-RAN.

## 6.1.3 LTE-Uu interface

The LTE-Uu interface, connecting the UE to the ng-eNB over the air, is used as one of several transport links for the LTE positioning protocol(s) for a target UE with LTE access to NG-RAN.

## 6.1.4 NG-C interface

The NG-C interface between the gNB and the AMF and between the ng-eNB and the AMF is transparent to all UE-positioning-related procedures. It is involved in these procedures only as a transport link for the NR positioning protocol(s).

For gNB related positioning procedures, the NG-C interface transparently transports both positioning requests from the LMF to the gNB and positioning results from the gNB to the LMF.

For ng-eNB related positioning procedures, the NG-C interface transparently transports both positioning requests from the LMF to the ng-eNB and positioning results from the ng-eNB to the LMF.

For delivery of broadcast assistance data information, the NG-C interface transparently transports both the assistance data information from the LMF to the NG-RAN node for broadcasting and the feedback information on assistance information broadcasting from the NG-RAN node to the LMF. The NG-C interface is also used by an AMF to transparently transport ciphering keys via NG-RAN node to UEs using a NAS message. The ciphering keys are used to decipher broadcast assistance data information, if the broadcast assistance data information is ciphered.

## 6.1.5 NLs interface

The NLs interface, between the LMF and the AMF, is transparent to all UE related, gNB related and ng-eNB related positioning procedures. It is used only as a transport link for the LTE Positioning Protocols LPP and NRPPa.

## 6.1.6 F1 interface

The F1 interface is used to support the exchange of positioning information between the gNB-DU and the gNB-CU; it is also used as a transport link for the LPP.

# 6.2 UE-terminated protocols

## 6.2.1 LTE Positioning Protocol (LPP)

The LTE Positioning Protocol (LPP) is terminated between a target device (the UE in the control-plane case or SET in the user-plane case) and a positioning server (the LMF in the control-plane case or SLP in the user-plane case). It may use either the control- or user-plane protocols as underlying transport. In this specification, only control plane use of LPP is defined. User plane support of LPP is defined in [15] and [16].

LPP messages are carried as transparent PDUs across intermediate network interfaces using the appropriate protocols (e.g., NGAP over the NG-C interface, NAS/RRC over the LTE-Uu and NR-Uu interfaces). The LPP protocol is intended to enable positioning for NR and LTE using a multiplicity of different position methods, while isolating the details of any particular positioning method and the specifics of the underlying transport from one another.

The protocol operates on a transaction basis between a target device and a server, with each transaction taking place as an independent procedure. More than one such procedure may be in progress at any given moment. An LPP procedure may involve a request/response pairing of messages or one or more "unsolicited" messages. Each procedure has a single objective (e.g., transfer of assistance data, exchange of LPP related capabilities, or positioning of a target device according to some QoS and use of one or more positioning methods). Multiple procedures, in series and/or in parallel, can be used to achieve more complex objectives (e.g., positioning of a target device in association with transfer of assistance data and exchange of LPP related capabilities). Multiple procedures also enable more than one positioning

attempt to be ongoing at the same time (e.g., to obtain a coarse location estimate with low delay while a more accurate location estimate is being obtained with higher delay).

An LPP session is defined between a positioning server and the target device, the details of its relation with transactions are described in clause 4.1.2 of TS 36.355 [19].

For the 3GPP 5GS Control Plane solution defined in TS 23.501 [2], TS 23.502 [26] and TS 23.273 [35], the UE is the target device and the LMF is the server. For SUPL 2.0 support, the SUPL Enabled Terminal (SET) is the target device and the SUPL Location Platform (SLP) is the server. The operations controlled through LPP are described further in clause 7.1.

LPP defined data structures for assistance data information are reused for supporting RRC broadcast of assistance data information which are embedded in positioning SIBs. This enables broadcast assistance data using the same data structures which are used for point to point location.

## 6.2.2 Radio Resource Control (RRC) for NR

The RRC protocol for NR is terminated between the gNB and the UE. It provides transport for LPP messages over the NR-Uu interface.

In addition to providing transport for LPP messages over the NR-Uu interface, it supports transfer of measurements that may be used for positioning purposes through the existing measurement systems specified in TS 38.331 [14].

The RRC protocol for NR also supports broadcasting of assistance data via positioning System Information messages.

The RRC protocol for NR is also used to configure UEs with a sounding reference signal (SRS) to support NG-RAN measurements for NR positioning.

## 6.2.3 Radio Resource Control (RRC) for LTE

The RRC protocol for LTE is terminated between the ng-eNB and the UE. In addition to providing transport for LPP messages over the LTE-Uu interface, it supports transfer of measurements that may be used for positioning purposes through the existing measurement systems specified in TS 36.331 [13].

The RRC protocol for LTE also supports broadcasting of assistance data via positioning System Information messages.

## 6.2.4 Medium Access Control (MAC) for NR

The MAC protocol for NR supports activation and deactivation of configured semi-persistent SRS resource sets as specified in TS 38.321 [39] to support NG-RAN measurements for NR positioning.

# 6.3 NG-RAN Node terminated protocols

## 6.3.1 NR Positioning Protocol A (NRPPa)

The NR Positioning Protocol A (NRPPa) carries information between the NG-RAN Node and the LMF. It is used to support the following positioning functions:

- E-CID for E-UTRA where measurements are transferred from the ng-eNB to the LMF.
- Data collection from ng-eNB's for support of OTDOA positioning for E-UTRA.
- Cell-ID and Cell Portion ID retrieval from gNB's for support of NR Cell ID positioning method.
- Exchange of information between LMF and NG-RAN node for the purpose of assistance data broadcasting.
- NR Multi-RTT where measurements are transferred from the gNB to the LMF.
- NR UL-AoA where measurements are transferred from the gNB to the LMF.
- NR UL-TDOA where measurements are transferred from the gNB to the LMF.

- Data collection from gNBs for support of DL-TDOA, DL-AoD, Multi-RTT, UL-TDOA, UL-AoA.

The NRPPa protocol is transparent to the AMF. The AMF routes the NRPPa PDUs transparently based on a Routing ID corresponding to the involved LMF over NG-C interface without knowledge of the involved NRPPa transaction. It carries the NRPPa PDUs over NG-C interface either in UE associated mode or non-UE associated mode.

In case of a split gNB, the NRPPa protocol is terminated at the gNB-CU.

### 6.3.2 NG Application Protocol (NGAP)

The NGAP protocol, terminated between the AMF and the NG-RAN Node, is used as transport for LPP and NRPPa messages over the NG-C interface. The NGAP protocol is also used to instigate and terminate NG-RAN Node related positioning procedures.

## 6.4 Signalling between an LMF and UE

### 6.4.1 Protocol Layering

Figure 6.4.1-1 shows the protocol layering used to support transfer of LPP messages between an LMF and UE. The LPP PDU is carried in NAS PDU between the AMF and the UE.

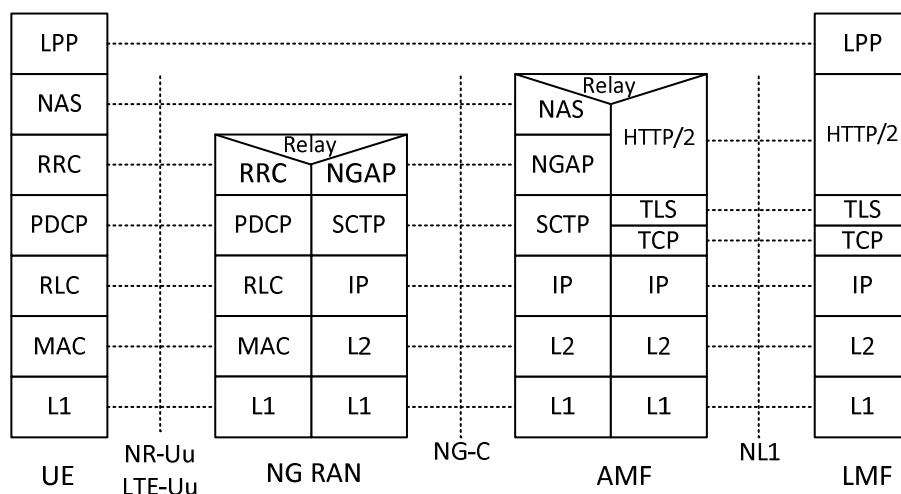
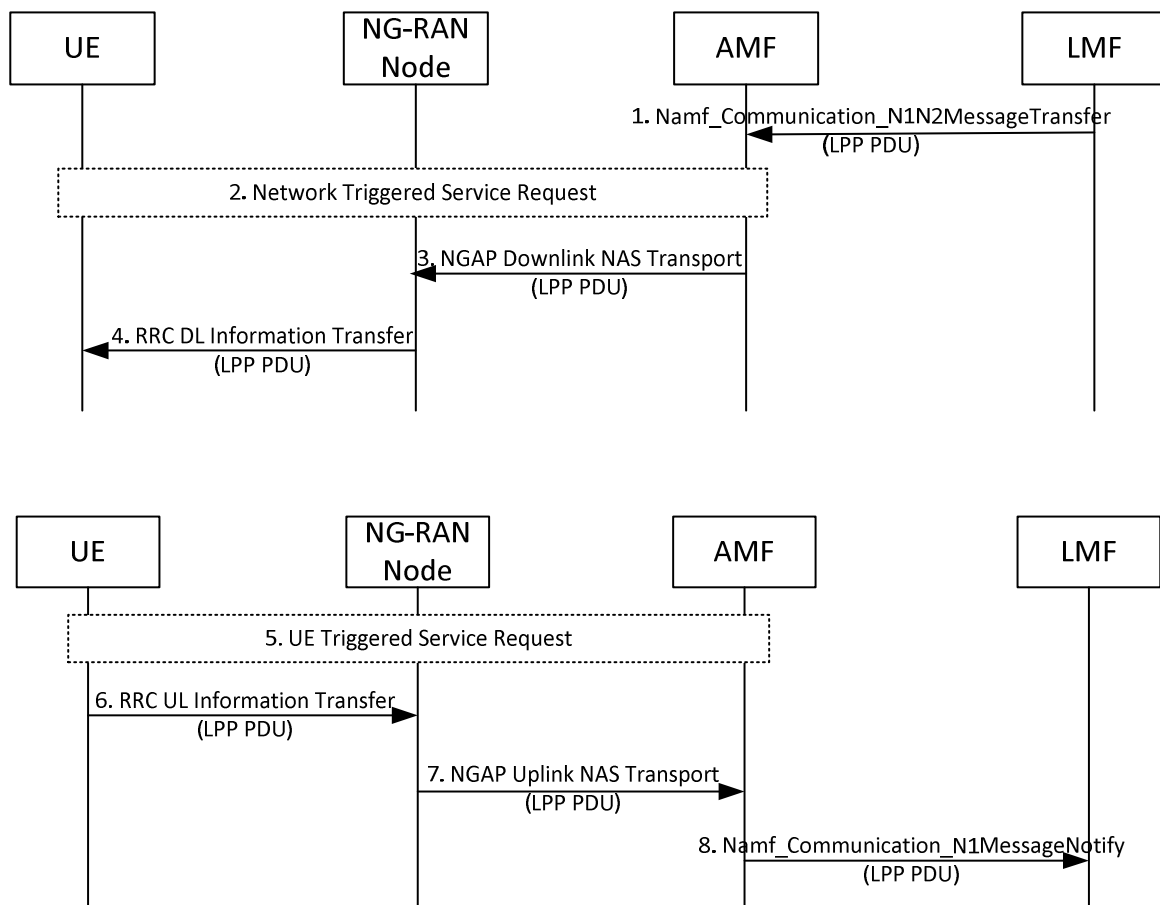


Figure 6.4.1-1: Protocol Layering for LMF to UE Signalling

### 6.4.2 LPP PDU Transfer

Figure 6.4.2-1 shows the transfer of an LPP PDU between an LMF and UE, in the network- and UE-triggered cases. These two cases may occur separately or as parts of a single more complex operation.



**Figure 6.4.2-1: LPP PDU transfer between LMF and UE (network- and UE-triggered cases)**

- Steps 1 to 4 may occur before, after, or at the same time as steps 5 to 8. Steps 1 to 4 and steps 5 to 8 may also be repeated. Steps 1 to 4 are triggered when the LMF needs to send an LPP message to the UE as part of some LPP positioning activity. The LMF then invokes the `Namf_Communication_N1N2MessageTransfer` service operation towards the AMF to request the transfer of a LPP PDU to the UE. The service operation includes the LPP PDU together with the LCS Correlation ID in the N1 Message Container as defined in TS 29.518 [29].
- If the UE is in CM-IDLE state (e.g. if the NG connection was previously released due to data and signalling inactivity), the AMF initiates a network triggered service request as defined in TS 23.502 [26] in order to establish a signalling connection with the UE and assign a serving NG-RAN node.
- The AMF includes the LPP PDU in the payload container of a DL NAS Transport message, and a Routing Identifier identifying the LMF in the Additional Information of the DL NAS Transport message defined in TS 24.501 [29]. The AMF then sends the DL NAS Transport message to the serving NG-RAN Node in an NGAP Downlink NAS Transport message defined in TS 38.413 [30]. The AMF need not retain state information for this transfer; it can treat any response in step 7 as a separate non-associated transfer.
- The NG-RAN Node forwards the DL NAS Transport message to the UE in an RRC DL Information Transfer message.
- Steps 5 to 8 are triggered when the UE needs to send an LPP PDU to the LMF as part of some LPP positioning activity. If the UE is in CM-IDLE state, the UE instigates a UE triggered service request as defined in TS 23.502 [26] in order to establish a signalling connection with the AMF and assign a serving NG-RAN node.
- The UE includes the LPP PDU in the payload container of an UL NAS Transport message, and the Routing Identifier, which has been received in step 4, in the Additional Information of the UL NAS Transport message defined in TS 24.501 [29]. The UE then sends the UL NAS Transport message to the serving NG-RAN node in an RRC UL Information Transfer message.

7. The NG-RAN node forwards the UL NAS Transport Message to the AMF in an NGAP Uplink NAS Transport message.
8. The AMF invokes the Namf\_Communication\_N1MessageNotify service operation towards the LMF indicated by the Routing Identifier received in step 7. The service operation includes the LPP PDU received in step 7 together with the LCS Correlation ID in the N1 Message Container as defined in TS 29.518 [28].

## 6.5 Signalling between an LMF and NG-RAN node

### 6.5.1 Protocol Layering

Figure 6.5.1-1 shows the protocol layering used to support transfer of NRPPa PDUs between an LMF and NG-RAN Node.

The NRPPa protocol is transparent to the AMF. The AMF routes the NRPPa PDUs transparently based on a Routing ID which corresponds to the involved LMF node over the NG interface without knowledge of the involved NRPPa transaction. It carries the NRPPa PDUs over NG interface either in UE associated mode or non-UE associated mode.

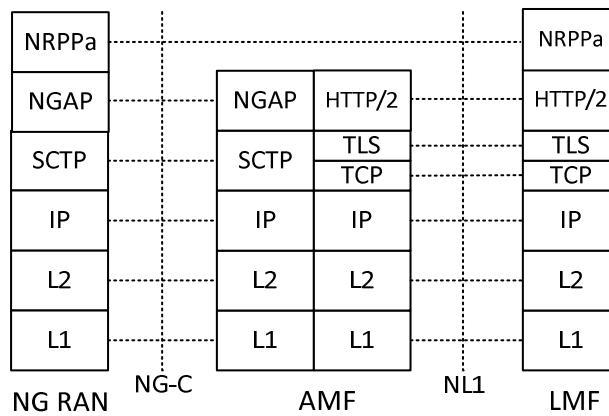
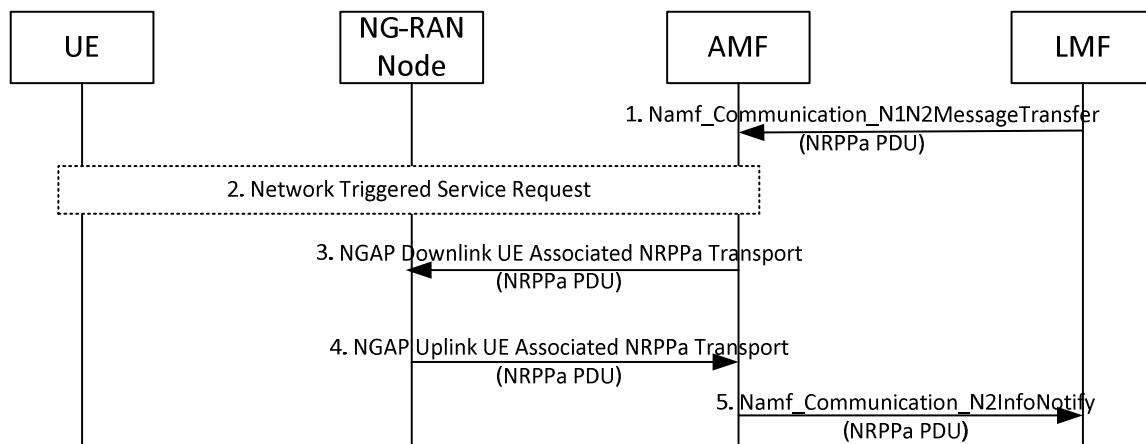


Figure 6.5.1-1: Protocol Layering for LMF to NG-RAN Signalling

### 6.5.2 NRPPa PDU Transfer for UE Positioning

Figure 6.5.2-1 shows NRPPa PDU transfer between an LMF and NG-RAN Node to support positioning of a particular UE.

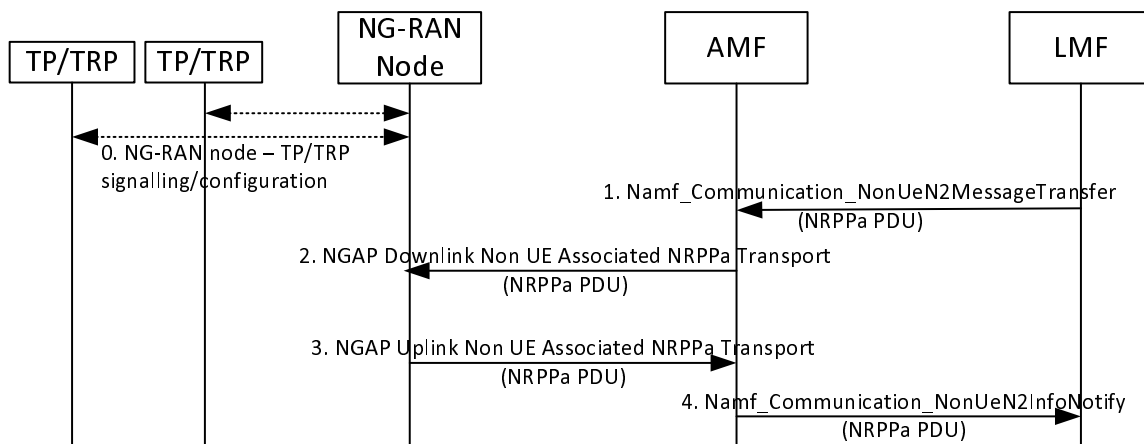


**Figure 6.5.2-1: NRPPa PDU Transfer between an LMF and NG-RAN node for UE Positioning**

- Steps 1 to 3 are triggered when the LMF needs to send an NRPPa message to the serving NG-RAN Node for a target UE as part of a NRPPa positioning activity. The LMF then invokes the `Namf_Communication_N1N2MessageTransfer` service operation towards the AMF to request the transfer of a NRPPa PDU to the serving NG-RAN Node for the UE. The service operation includes the NRPPa PDU together with the LCS Correlation ID in the N2 Message Container as defined in TS 29.518 [28].
- If the UE is in CM-IDLE state (e.g. if the NG connection was previously released due to data and signalling inactivity), the AMF performs a network triggered service request as defined in TS 23.502 [26] in order to establish a signalling connection with the UE and assign a serving NG-RAN Node.
- The AMF forwards the NRPPa PDU to the serving NG-RAN Node in an NGAP Downlink UE Associated NRPPa Transport message over the NG signalling connection corresponding to the UE and includes the Routing ID related to the LMF. The AMF need not retain state information for this transfer – e.g. can treat any response in step 4 as a separate non-associated transfer.
- Steps 4 and 5 are triggered when a serving NG-RAN Node needs to send an NRPPa message to the LMF for a target UE as part of an NRPPa positioning activity. The NG-RAN Node then sends an NRPPa PDU to the AMF in an NGAP Uplink UE Associated NRPPa Transport message and includes the Routing ID received in step 3.
- The AMF invokes the `Namf_Communication_N2InfoNotify` service operation towards the LMF indicated by the Routing ID received in step 4. The service operation includes the NRPPa PDU received in step 4 together with the LCS Correlation ID in the N2 Info Container as defined in TS 29.518 [28]. Steps 1 to 5 may be repeated.

### 6.5.3 NRPPa PDU Transfer for Positioning Support

Figure 6.5.3-1 shows NRPPa PDU transfer between an LMF and NG-RAN Node when related to gathering data from the NG-RAN Node for positioning support for all UEs.



**Figure 6.5.3-1: NRPPa PDU Transfer between an LMF and NG-RAN for obtaining NG-RAN Data**

0. An ng-eNB in the NG-RAN may communicate with several TPs (including PRS-only TPs in case of PRS-based TBS is supported) to configure TPs, obtain TP configuration information, etc.

A gNB in the NG-RAN may communicate with several TRPs (including PRS-only TPs) to configure TRPs, obtain TRP configuration information, etc.

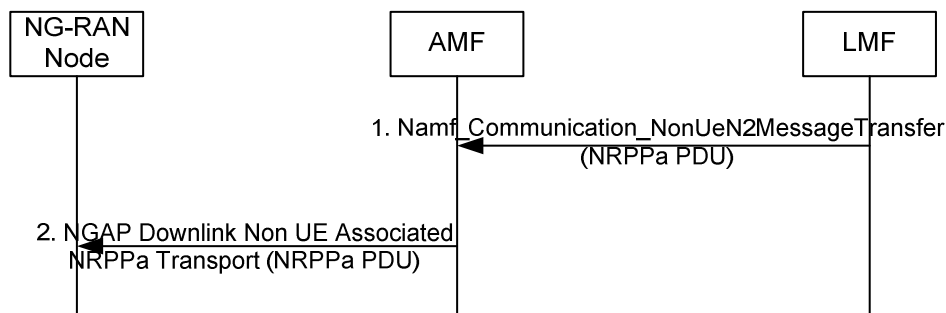
NOTE: NG-RAN-TP/TPR signalling and configuration is outside the scope of this specification.

- Steps 1 and 2 are triggered when the LMF needs to send an NRPPa message to an NG-RAN Node to obtain data related to the NG-RAN Node, and possibly associated TPs. The LMF invokes the `Namf_Communication_NonUeN2MessageTransfer` service operation towards the AMF to request the transfer of a NRPPa PDU to a NG-RAN node (gNB or ng-eNB) in the NG-RAN. The service operation includes the target NG-RAN node identity and the NRPPa PDU in the N2 Information Container as defined in TS 29.518 [28].
- The AMF forwards the NRPPa PDU to the identified NG-RAN Node in an NGAP Downlink Non UE Associated NRPPa Transport message and includes a Routing ID identifying the LMF. The AMF need not retain state information for this transfer – e.g. can treat any response in step 3 as a separate non-associated transfer.
- Steps 3 and 4 are triggered when an NG-RAN Node needs to send an NRPPa PDU to an LMF containing data applicable to the NG-RAN Node, and possibly associated TPs. The NG-RAN Node then sends an NRPPa PDU to the AMF in an NGAP Uplink Non UE Associated NRPPa Transport message and includes the Routing ID received in step 2.
- The AMF invokes the `Namf_Communication_NonUeN2InfoNotify` service operation towards the LMF indicated by the Routing Identifier received in step 3. The service operation includes the NRPPa PDU received in step 3 in the N2 Info Container as defined in TS 29.518 [28]. Steps 1 to 4 may be repeated.

## 6.5.4 NRPPa PDU Transfer for Assistance Information Broadcast

Figure 6.5.4-1 shows NRPPa PDU transfer between an LMF and NG-RAN node to support broadcast of assistance data.

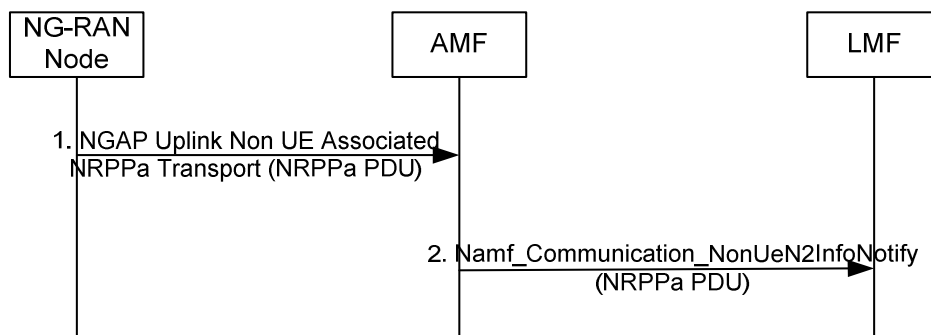




**Figure 6.5.4-1: NRPPa PDU Transfer between an LMF and NG-RAN Node for providing assistance information for broadcasting.**

1. Step 1 is triggered when the LMF needs to send new or updated assistance information to an NG-RAN node for broadcasting in positioning system information messages. The LMF invokes the `Namf_Communication_NonUeN2MessageTransfer` service operation towards the AMF to request the transfer of a NRPPa PDU to a NG-RAN node (gNB or ng-eNB) in the NG-RAN. The service operation includes the target NG-RAN node identity and the NRPPa PDU in the N2 Information Container as defined in TS 29.518 [28].
2. The AMF forwards the NRPPa PDU to the identified NG-RAN node in an NGAP Downlink Non UE Associated NRPPa Transport message and includes the Routing ID identifying the LMF. The AMF need not retain state information for this transfer.

Figure 6.5.4-2 shows NRPPa PDU transfer between an NG-RAN node and LMF for providing feedback to the LMF on assistance data broadcasting.



**Figure 6.5.4-2: NRPPa PDU Transfer between an NG-RAN node and LMF for providing feedback on assistance data broadcasting.**

1. Step 1 is triggered when an NG-RAN node needs to send an NRPPa PDU to an LMF for providing feedback on assistance data broadcasting. Step 1 may only be triggered if the procedure in Figure 6.5.4-1 has already been performed. The NG-RAN node sends an NRPPa PDU to the AMF in an NGAP Uplink Non UE Associated NRPPa Transport message. The NG-RAN node includes the previously received Routing ID related to the LMF (Figure 6.5.4-1).
2. The AMF invokes the `Namf_Communication_NonUeN2InfoNotify` service operation towards the LMF indicated by the Routing identifier received at step 1. The service operation includes the NRPPa PDU received in step 1 in the N2 Info Container as defined in TS 29.518 [28].

## 6.6 Void

---

# 7 General NG-RAN UE Positioning procedures

## 7.1 General LPP procedures for UE Positioning

### 7.1.1 LPP procedures

Positioning procedures in the NG-RAN are modelled as transactions of the LPP protocol using the procedures defined in this specification. A procedure consists of a single operation of one of the following types:

- Exchange of positioning capabilities;
- Transfer of assistance data;
- Transfer of location information (positioning measurements and/or position estimate);
- Error handling;
- Abort.

Parallel transactions are permitted (i.e. a new LPP transaction may be initiated, while another one is outstanding).

As described in clause 6.2.1, the protocol operates between a "target" and a "server". In the control-plane context, these entities are the UE and LMF respectively; in the SUPL context they are the SET and the SLP. A procedure may be initiated by either the target or the server.

### 7.1.2 Positioning procedures

#### 7.1.2.1 Capability transfer

The capability transfer procedure between a "target" and a "server" is specified in clause 7.1.2.1 of TS 36.305 [25].

#### 7.1.2.2 Assistance data transfer

The assistance data transfer procedure between a "target" and a "server" is specified in clause 7.1.2.2 of TS 36.305 [25].

#### 7.1.2.3 Location information transfer

The location information transfer procedure between a "target" and a "server" is specified in clause 7.1.2.3 of TS 36.305 [25].

#### 7.1.2.4 Multiple transactions

Multiple LPP transactions may be in progress simultaneously as specified in clause 7.1.2.4 of TS 36.305 [25].

#### 7.1.2.5 Sequence of procedures

LPP procedures are not required to occur in any fixed order, in order to provide greater flexibility in positioning. Thus, a UE may request assistance data at any time in order to comply with a previous request for location measurements from the LMF; an LMF may instigate more than one request for location information (e.g., measurements or a location estimate) in case location results from a previous request were not adequate for the requested QoS; and the target device may transfer capability information to the server at any time if not already performed.

Despite the flexibility allowed by LPP, it is expected that procedures will normally occur in the following order:

1. Capability Transfer;

2. Assistance Data Transfer;
3. Location Information Transfer (measurements and/or location estimate).

Specific examples for each positioning method are shown in clause 8.

### 7.1.2.6 Error handling

The error handling procedure is specified in clause 7.1.2.6 of TS 36.305 [25].

### 7.1.2.7 Abort

The abort procedure is specified in clause 7.1.2.7 of TS 36.305 [25].

## 7.2 General NRPPa Procedures for UE Positioning

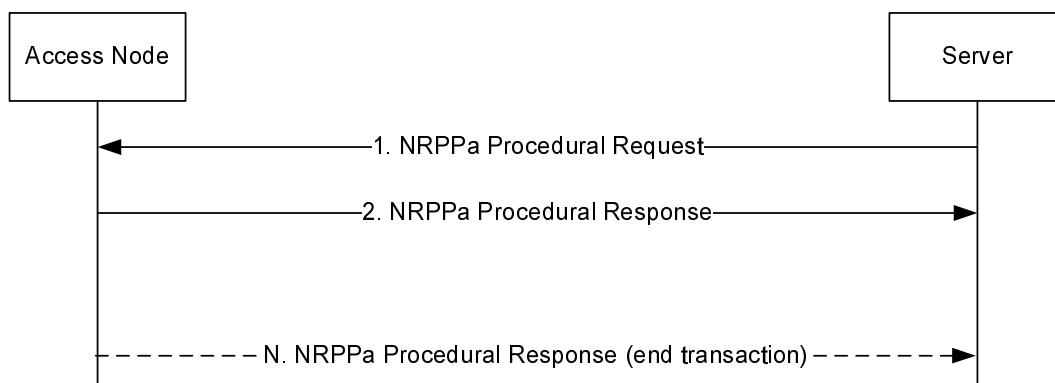
### 7.2.1 NRPPa procedures

Positioning and data acquisition transactions between a LMF and NG-RAN node are modelled by using procedures of the NRPPa protocol. There are two types of NRPPa procedures:

- UE associated procedure, i.e. transfer of information for a particular UE (e.g. positioning measurements);
- Non UE associated procedure, i.e. transfer of information applicable to the NG-RAN node and associated TRPs (e.g. gNB/ng-eNB/TRP timing information).

Parallel transactions between the same LMF and NG-RAN node are supported; i.e. a pair of LMF and NG-RAN node may have more than one instance of an NRPPa procedure in execution at the same time.

For possible extensibility, the protocol is considered to operate between a generic "access node" (e.g. gNB, ng-eNB) and a "server" (e.g. LMF). A procedure is only initiated by the server.



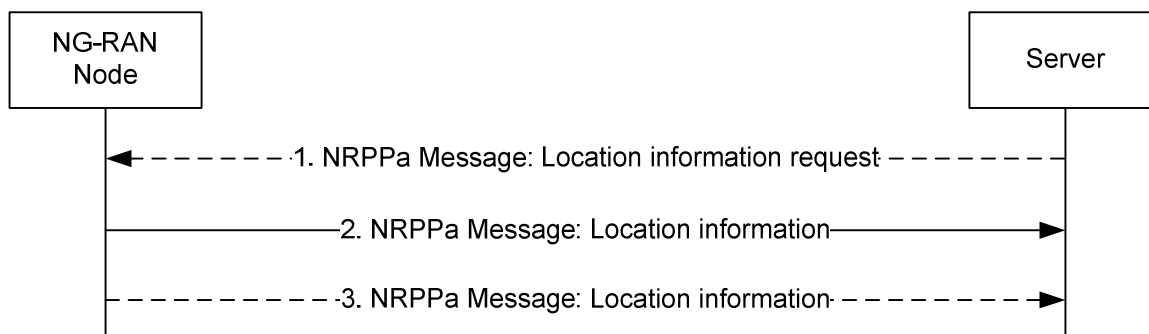
**Figure 7.2.1-1: A single NRPPa transaction**

Figure 7.2.1-1 shows a single NRPPa transaction. The transaction is terminated in step 2 in the case of a non UE associated procedure. For a UE associated procedure to gather information concerning the access node, additional responses may be allowed (e.g. sending of updated information periodically and/or whenever there is some significant change). In this case, the transaction may be ended after some additional responses. In the NRPPa protocol, the described transaction may be realized by the execution of one procedure defined as a request and a response, followed by one or several procedures initiated by the NG-RAN node (each procedure defined as a single message) to realize the additional responses. The Correlation ID, as specified in TS 29.572 [33], included by the LMF when it invokes the `Namf_Communication_N1N2MessageTransfer` AMF service operation to transfer the NRPPa PDU may be used by the LMF to identify the target UE positioning session.

## 7.2.2 NRPPa transaction types

### 7.2.2.1 Location information transfer

The term "location information" applies both to an actual position estimate and to values used in computing position (e.g., radio measurements or positioning measurements). It is delivered in response to a request.



**Figure 7.2.2-1: Location information transfer**

1. The server sends a request for location related information to the NG-RAN node, and indicates the type of location information needed and associated QoS. The request may refer to a particular UE.
2. In response to step 1, the NG-RAN Node transfers location related information to the server. The location related information transferred should match the location related information requested in step 1.
3. If requested in step 1, the NG-RAN node may transfer additional location related information to the server in one or more additional NRPPa messages when the positioning method is E-CID for E-UTRA.

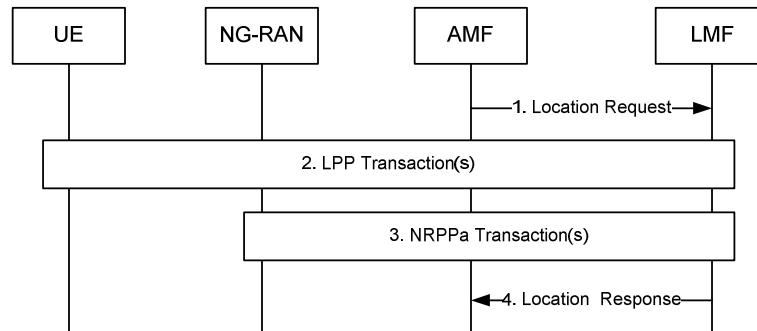
## 7.3 Service Layer Support using combined LPP and NRPPa Procedures

### 7.3.1 General

As described in TS 23.502 [26] and TS 23.273 [35], UE-positioning-related services can be instigated from the 5GC for an NI-LR or MT-LR location service, or from the UE in case of an MO-LR location service. The complete sequence of operations in the 5GC is defined in TS 23.502 [26] and TS 23.273 [35]. This clause defines the overall sequences of operations that occur in the LMF, NG-RAN and UE as a result of the 5GC operations.

### 7.3.2 NI-LR and MT-LR Service Support

Figure 7.3.2-1 shows the sequence of operations for an NI-LR or MT-LR location service, starting at the point where the AMF initiates the service in the LMF.

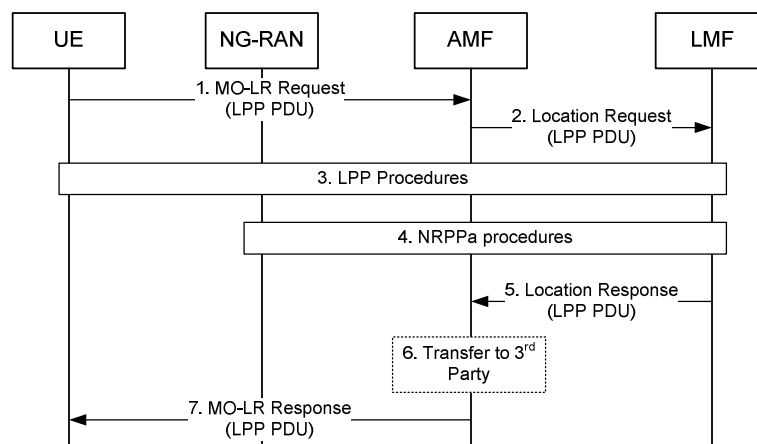


**Figure 7.3.2-1: UE Positioning Operations to support an MT-LR or NI-LR**

1. The AMF sends a location request to the LMF for a target UE and may include associated QoS.
2. The LMF may obtain location related information from the UE and/or from the serving NG-RAN Node. In the former case, the LMF instigates one or more LPP procedures to transfer UE positioning capabilities, provide assistance data to the UE and/or obtain location information from the UE. The UE may also instigate one or more LPP procedures after the first LPP message is received from the LMF (e.g., to request assistance data from the LMF).
3. If the LMF needs location related information for the UE from the NG-RAN, the LMF instigates one or more NRPPa procedures. Step 3 is not necessarily serialised with step 2; if the LMF and NG-RAN Node have the information to determine what procedures need to take place for the location service, step 3 could precede or overlap with step 2.
4. The LMF returns a location response to the AMF with any location estimate obtained as a result of steps 2 and 3.

### 7.3.3 MO-LR Service Support

Figure 7.3.3-1 shows the sequence of operations for an MO-LR service, starting at the point where an LCS Client in the UE or the user has requested some location service (e.g., retrieval of the UE's location or transfer of the UE's location to a third party).



**Figure 7.3.3-1: UE Positioning Operations to support an MO-LR**

1. The UE sends an MO-LR Request included in a UL NAS TRANSPORT message as specified in TS 24.501 [29] to the AMF. The MO-LR request may carry an LPP PDU to instigate one or more LPP procedures to transfer capabilities, request assistance data, request location information and/or transfer location information.
2. The AMF invokes the Nlmf Determine Location Request service operation towards the LMF as specified in TS 29.572 [33] and includes any LPP PDU received in step 1.

3. The LMF may obtain location related information from the UE and/or from the serving NG-RAN node. In the former case or if an immediate response is needed to any LPP procedure instigated by the UE in step 1 (e.g., a request for assistance data), the LMF instigates one or more LPP procedures to transfer UE positioning capabilities, provide assistance data to the UE and/or obtain location information from the UE. The UE may also instigate further LPP procedures after the first LPP message is received from the LMF (e.g., to request assistance data or to request further assistance data).
4. If the LMF needs location related information for the UE from the NG-RAN, the LMF instigates one or more NRPPa procedures. Step 4 may also precede step 3 or occur in parallel with it.
5. The LMF invokes the Nlmf Determine Location Response service operation towards the AMF as specified in TS 29.572 [33] which includes any location estimate obtained as a result of steps 3 and 4, and/or with a final LPP message (e.g., that could provide a location estimate to the UE if requested by the UE in step 1).
6. If the UE requested location transfer to a third party the AMF transfers the location received from the LMF in step 5 to the third party as defined in TS 23.273 [35].
7. The AMF sends an MO-LR Response included in a DL NAS TRANSPORT message as specified in TS 24.501 [33], carrying any final LPP PDU that was received in step 5.

## 7.4 General RRC procedures for UE Positioning

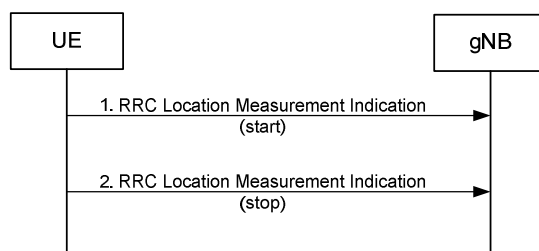
### 7.4.1 NR RRC Procedures

NR RRC supports the following positioning related procedures:

- Location Measurement Indication.

#### 7.4.1.1 Location Measurement Indication

The location measurement indication procedure is used by the UE to request measurement gaps for OTDOA RSTD measurements, or for subframe and slot timing detection for inter-RAT E-UTRA RSTD measurements.



**Figure 7.4.1.1-1: Location measurement indication procedure**

**Precondition:** The UE served by a gNB has received a LPP message from an LMF requesting inter-RAT RSTD measurements for OTDOA positioning.

1. If the UE requires measurement gaps for performing the requested location measurements while measurement gaps are either not configured or not sufficient, or if the UE needs gaps to acquire the subframe and slot timing of the target E-UTRA system before requesting measurement gaps for the inter-RAT RSTD measurements (see TS 38.133 [32]), the UE sends an RRC Location Measurement Indication message to the serving gNB. The message indicates that the UE is going to start location measurements, or that the UE is going to acquire subframe and slot timing of the target E-UTRA system, and includes information required for the gNB to configure the appropriate measurement gaps. When the gNB has configured the required measurement gaps the UE performs the location measurements or timing acquisition procedures.
2. When the UE has completed the location procedures which required measurement gaps, the UE sends another RRC Location Measurement Indication message to the serving gNB. The message indicates that the UE has completed the location measurements or timing acquisition procedures.

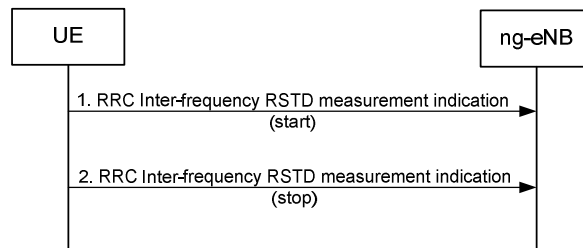
## 7.4.2 LTE RRC Procedures

LTE RRC supports the following positioning related procedures:

- Inter-frequency RSTD measurement indication.

### 7.4.2.1 Inter-frequency RSTD measurement indication

The Inter-frequency RSTD measurement indication procedure is used by the UE to request measurement gaps for OTDOA RSTD measurements.



**Figure 7.4.2.1-1: Inter-frequency RSTD measurement indication procedure**

**Precondition:** The UE served by an ng-eNB has received a LPP message from an LMF requesting inter-frequency RSTD measurements for OTDOA positioning.

1. If the UE requires measurement gaps for performing the requested inter-frequency RSTD measurements for OTDOA positioning while measurement gaps are either not configured or not sufficient, the UE sends an RRC Inter-frequency RSTD Measurement Indication message to the serving ng-eNB. The message indicates that the UE is going to start inter-frequency RSTD measurements and includes information required for the ng-eNB to configure the appropriate measurement gaps. When the ng-eNB has configured the required measurement gaps the UE performs the inter-frequency RSTD measurements.
2. When the UE has completed the inter-frequency RSTD measurements which required measurement gaps, the UE sends another RRC Inter-frequency RSTD Measurement Indication message to the serving ng-eNB. The message indicates that the UE has completed the inter-frequency RSTD measurements.

## 7.5 Procedures for Broadcast of Assistance Data

### 7.5.1 General

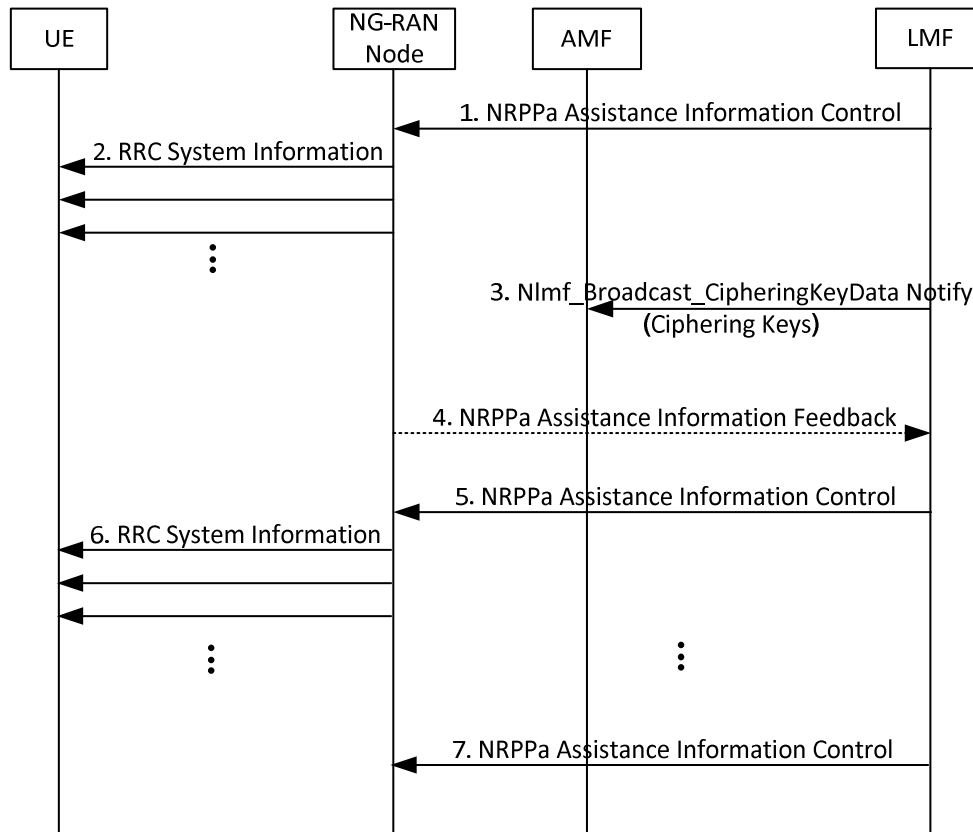
Positioning assistance data can be included in positioning System Information Blocks (posSIBs) as described in TS 36.331 [13], TS 38.331 [14] and TS 36.355 [19]. The posSIBs are carried in RRC System Information (SI) messages. The mapping of posSIBs (assistance data) to SI messages is flexibly configurable and provided to the UE in SIB1 for NG-RAN node TS 36.331 [13], TS 38.331 [14].

The UE may request posSI by means of on-demand SI request in RRC\_IDLE/RRC\_INACTIVE and also request posSIBs by means of on-demand SI request in RRC\_CONNECTED as described in TS 38.331 [14].

For each assistance data element, a separate posSIB-type is defined in TS 36.355 [19]. Each posSIB may be ciphered by the LMF using the 128-bit Advanced Encryption Standard (AES) algorithm (with counter mode) as described in TS 36.355 [19], either with the same or different ciphering key. The posSIBs which exceed the maximum size limit defined in TS 36.331 [13], TS 38.331 [14] shall be segmented by the LMF.

### 7.5.2 Broadcast Procedures

The general procedures for broadcast of positioning assistance data and delivery of ciphering keys to UEs is described in TS 23.273 [35]. This clause defines the overall sequences of operations that occur in the LMF, NG-RAN node and UE.



**Figure 7.5.2-1: Procedures to support broadcast of assistance data.**

1. The LMF sends an NRPPa Assistance Information Control message to the NG-RAN node with an indication to start broadcasting assistance information. The message includes one or more System Information groups, where each group contains the broadcast periodicity and one or more posSIB types together with meta data to be scheduled in the same SI message. Each posSIB type may be ciphered and/or segmented at the LMF. The meta data may include an indication whether the posSIB type in the System Information group is ciphered or not, as well as an indication of an applicable GNSS type.
2. The NG-RAN node includes the received System Information groups in RRC System Information Messages and corresponding scheduling information in SIB1 as described in TS 36.331 [13], TS 38.331 [14]. The UE applies the system information acquisition procedure according to TS 36.331 [13], TS 38.331 [14] for acquiring the assistance data information that is broadcasted.
3. If the posSIB types were ciphered by the LMF, the LMF invokes the Nlmf\_Broadcast\_CipheringKeyData Notify service operation towards the AMF carrying one or more ciphering keys. For each ciphering key, the LMF includes a ciphering key value, a ciphering key identifier, a validity period, a set of applicable tracking areas, and a set of applicable posSIB types. The AMF may then distribute successfully stored ciphering keys and their validity times and validity areas to suitably subscribed UEs using a mobility management message as described in TS 23.273 [35]. The LMF repeats this procedure whenever a ciphering key changes.
4. At any time after Step 1, the NG-RAN node may send a NRPPa Assistance Information Feedback message to the LMF providing feedback on assistance information broadcasting. The message may include an assistance information failure list indicating that certain posSIB types could not be configured for broadcasting by the NG-RAN node.
5. If the assistance information in a System Information group changes, the LMF provides updated information in a NRPPa Assistance Information Control message.
6. The NG-RAN node replaces the previously stored System Information groups with the new information received at Step 5 and includes the new System Information groups in RRC System Information Messages.



7. If the LMF wants to abort the broadcast of a System Information Group, it sends a NRPPa Assistance Information Control message to the NG-RAN node including an indication to stop broadcasting the assistance information.

---

## 8 Positioning methods and Supporting Procedures

### 8.1 GNSS positioning methods

#### 8.1.1 General

A navigation satellite system provides autonomous geo-spatial positioning with either global or regional coverage. Augmentation systems, such as SBAS, are navigation satellite systems that provide regional coverage to augment the navigation systems with global coverage.

By definition, GNSS refers to satellite constellations that achieve global coverage, however, in 3GPP specifications the term GNSS is used to encompass global, regional, and augmentation satellite systems. The following GNSSs are supported in this version of the specification:

- GPS and its modernization [5], [6], [7]; (global coverage)
- Galileo [8]; (global coverage)
- GLONASS [9]; (global coverage)
- Satellite Based Augmentation Systems (SBAS), including WAAS, EGNOS, MSAS, and GAGAN [11]; (regional coverage)
- Quasi-Zenith Satellite System (QZSS) [10]; (regional coverage)
- BeiDou Navigation Satellite System (BDS) [20] [34]. (global coverage)

Each global GNSS can be used individually or in combination with others, including regional navigation systems and augmentation systems. When used in combination, the effective number of navigation satellite signals would be increased:

- extra satellites can improve availability (of satellites at a particular location) and results in an improved ability to work in areas where satellite signals can be obscured, such as in urban canyons;
- extra satellites and signals can improve reliability, i.e., with extra measurements the data redundancy is increased, which helps identify any measurement outlier problems;
- extra satellites and signals can improve accuracy due to improved measurement geometry and improved ranging signals from modernized satellites.

When GNSS is designed to inter-work with the NG-RAN, the network assists the UE GNSS receiver to improve the performance in several respects. These performance improvements will:

- reduce the UE GNSS start-up and acquisition times; the search window can be limited and the measurements speed up significantly;
- increase the UE GNSS sensitivity; positioning assistance messages are obtained via NG-RAN so the UE GNSS receiver can operate also in low SNR situations when it is unable to demodulate GNSS satellite signals;
- allow the UE to consume less handset power than with stand-alone GNSS; this is due to rapid start-up times as the GNSS receiver can be in idle mode when it is not needed;
- allow the UE to compute its position with a better accuracy; RTK corrections (for N-RTK) and GNSS physical models (for SSR/PPP) are obtained via NG-RAN so the UE can use these assistance data, together with its own measurements, i.e., code and carrier phase measurements, to enable computation of a position with a high accuracy.

The network-assisted GNSS methods rely on signalling between UE GNSS receivers (possibly with reduced complexity) and a continuously operating GNSS reference receiver network, which has clear sky visibility of the same GNSS constellation as the assisted UEs. Two assisted modes are supported:

- *UE-Assisted*: The UE performs GNSS measurements (pseudo-ranges, pseudo Doppler, carrier phase ranges, etc.) and sends these measurements to the LMF where the position calculation takes place, possibly using additional measurements from other (non GNSS) sources;
- *UE-Based*: The UE performs GNSS measurements and calculates its own location, possibly using additional measurements from other (non GNSS) sources and assistance data from the LMF.

The assistance data content may vary depending on whether the UE operates in UE-Assisted or UE-Based mode.

The assistance data signalled to the UE can be broadly classified into:

- *data assisting the measurements*: e.g. reference time, visible satellite list, satellite signal Doppler, code phase, Doppler and code phase search windows;
- *data providing means for position calculation*: e.g. reference time, reference position, satellite ephemeris, clock corrections, code and carrier phase measurements from a GNSS reference receiver or network of receivers;
- *data increasing the position accuracy*: e.g. satellite code biases, satellite orbit corrections, satellite clock corrections, atmospheric models, RTK residuals, gradients.

A UE with GNSS measurement capability may also operate in an autonomous (standalone) mode. In autonomous mode the UE determines its position based on signals received from GNSS without assistance from the network.

## 8.1.2 Information to be transferred between NG-RAN/5GC Elements

This clause defines the information that may be transferred between LMF and UE.

### 8.1.2.1 Information that may be transferred from the LMF to UE

Table 8.1.2.1-1 lists assistance data for both UE-assisted and UE-based modes that may be sent from the LMF to the UE.

- NOTE: The provision of these assistance data elements and the usage of these elements by the UE depend on the NG-RAN/5GC and UE capabilities, respectively.

**Table 8.1.2.1-1: Information that may be transferred from the LMF to UE**

<b>Assistance Data</b>
Reference Time
Reference Location
Ionospheric Models
Earth Orientation Parameters
GNSS-GNSS Time Offsets
Differential GNSS Corrections
Ephemeris and Clock Models
Real-Time Integrity
Data Bit Assistance
Acquisition Assistance
Almanac
UTC Models
RTK Reference Station Information
RTK Auxiliary Station Data
RTK Observations
RTK Common Observation Information
GLONASS RTK Bias Information
RTK MAC Correction Differences
RTK Residuals
RTK FKP Gradients
SSR Orbit Corrections
SSR Clock Corrections
SSR Code Bias
SSR Phase Bias
SSR STEC Corrections
SSR Gridded Correction
SSR URA
SSR Correction Points

#### 8.1.2.1.1 Reference Time

Reference Time assistance provides the GNSS receiver with coarse or fine GNSS time information. The specific GNSS system times (e.g., GPS, Galileo, GLONASS, BDS system time) shall be indicated with a GNSS ID.

In case of coarse time assistance only, the Reference Time provides an estimate of the current GNSS system time (where the specific GNSS is indicated by a GNSS ID). The LMF should achieve an accuracy of  $\pm 3$  seconds for this time including allowing for the transmission delay between LMF and UE.

In case of fine time assistance, the Reference Time provides the relation between GNSS system time (where the specific GNSS is indicated by a GNSS ID) and NG-RAN air-interface timing.

#### 8.1.2.1.2 Reference Location

Reference Location assistance provides the GNSS receiver with an a priori estimate of its location (e.g., obtained via Cell-ID, OTDOA positioning, etc.) together with its uncertainty.

The geodetic reference frame shall be WGS-84, as specified in TS 23.032 [4].

#### 8.1.2.1.3 Ionospheric Models

Ionospheric Model assistance provides the GNSS receiver with parameters to model the propagation delay of the GNSS signals through the ionosphere. Ionospheric Model parameters as specified by GPS [5], Galileo [8], QZSS [10], and BDS [20] [34] may be provided.

#### 8.1.2.1.4 Earth Orientation Parameters

Earth Orientation Parameters (EOP) assistance provides the GNSS receiver with parameters needed to construct the ECEF-to-ECI coordinate transformation as specified by GPS [5].

#### 8.1.2.1.5 GNSS-GNSS Time Offsets

GNSS-GNSS Time Offsets assistance provides the GNSS receiver with parameters to correlate GNSS time (where the specific GNSS is indicated by a GNSS-1 ID) of one GNSS with other GNSS time (where the specific GNSS is indicated by a GNSS-2 ID). GNSS-GNSS Time Offsets parameters as specified by GPS [5], Galileo [8], GLONASS [9], QZSS [10], and BDS [20] [34] may be provided.

#### 8.1.2.1.6 Differential GNSS Corrections

Differential GNSS Corrections assistance provides the GNSS receiver with pseudo-range and pseudo-range-rate corrections to reduce biases in GNSS receiver measurements as specified in [12]. The specific GNSS for which the corrections are valid is indicated by a GNSS-ID.

#### 8.1.2.1.7 Ephemeris and Clock Models

Ephemeris and Clock Models assistance provides the GNSS receiver with parameters to calculate the GNSS satellite position and clock offsets. The various GNSSs use different model parameters and formats, and all parameter formats as defined by the individual GNSSs are supported by the signalling.

#### 8.1.2.1.8 Real-Time Integrity

Real-Time Integrity assistance provides the GNSS receiver with information about the health status of a GNSS constellation (where the specific GNSS is indicated by a GNSS ID).

#### 8.1.2.1.9 Data Bit Assistance

Data Bit Assistance provides the GNSS receiver with information about data bits or symbols transmitted by a GNSS satellite at a certain time (where the specific GNSS is indicated by a GNSS ID). This information may be used by the UE for sensitivity assistance (data wipe-off) and time recovery.

#### 8.1.2.1.10 Acquisition Assistance

Acquisition Assistance provides the GNSS receiver with information about visible satellites, reference time, expected code-phase, expected Doppler, search windows (i.e., code and Doppler uncertainty) and other information of the GNSS signals (where the specific GNSS is indicated by a GNSS ID) to enable a fast acquisition of the GNSS signals.

#### 8.1.2.1.11 Almanac

Almanac assistance provides the GNSS receiver with parameters to calculate the coarse (long-term) GNSS satellite position and clock offsets. The various GNSSs use different model parameters and formats, and all parameter formats as defined by the individual GNSSs are supported by the signalling.

#### 8.1.2.1.12 UTC Models

UTC Models assistance provides the GNSS receiver with parameters needed to relate GNSS system time (where the specific GNSS is indicated by a GNSS ID) to Universal Coordinated Time. The various GNSSs use different model parameters and formats, and all parameter formats as defined by the individual GNSSs are supported by the signalling.

#### 8.1.2.1.13 RTK Reference Station Information

RTK Reference Station Information provides the GNSS receiver with the Earth-Centered, Earth-Fixed (ECEF) coordinates of the Reference Station's installed antenna's ARP, and the height of the ARP above the survey monument. Additionally, this assistance data provides information about the antenna type installed at the reference site.

NOTE: With the MAC N-RTK technique this assistance data is used to provide information regarding the Master Reference Station (see clause 8.1.2.1a).

#### 8.1.2.1.14 RTK Auxiliary Station Data

RTK Auxiliary Station Data provides the GNSS receiver with the location for all Auxiliary Reference Stations (see clause 8.1.2.1a) within the assistance data. These values are expressed as relative geodetic coordinates (latitude, longitude, and height) with respect to a Master Reference Station (see clause 8.1.2.1a) and based on the GRS80 ellipsoid. This type of assistance data is relevant only with the MAC N-RTK technique [31].

#### 8.1.2.1.15 RTK Observations

RTK Observations provides the GNSS receiver with all primary observables (pseudo-range, phase-range, phase-range rate (Doppler), and carrier-to-noise ratio) generated at the Reference Station for each GNSS signal. The signal generation from the reference station is in compliance with [31]: as an example, the phase measurements of different signals in the same band must be phased aligned. More examples can be found in [31].

The pseudo-range is the distance between the satellite and GNSS receiver antennas, expressed in metres, equivalent to the difference of the time of reception (expressed in the time frame of the GNSS receiver) and the time of transmission (expressed in the time frame of the satellite) of a distinct satellite signal.

The phase-range measurement is a measurement of the range between a satellite and receiver expressed in units of cycles of the carrier frequency. This measurement is more precise than the pseudo-range (of the order of millimetres), but it is ambiguous by an unknown integer number of wavelengths.

The phase-range rate is the rate at which the phase-range between a satellite and a GNSS receiver changes over a particular period of time.

The carrier-to-noise ratio is the ratio of the received modulated carrier signal power to the noise power after the GNSS receiver filters.

NOTE: With the MAC N-RTK technique this assistance data is used to provide raw observables recorded at the Master Reference Station (see clause 8.1.2.1a).

#### 8.1.2.1.16 RTK Common Observation Information

RTK Common Observation Information provides the GNSS receiver with common information applicable to any GNSS, e.g. clock steering indicator. This assistance data is always used together GNSS RTK Observations (see clause 8.1.2.1.15).

#### 8.1.2.1.17 GLONASS RTK Bias Information

RTK Bias Information provides the GNSS receiver with information which is intended to compensate for the first-order inter-frequency phase-range biases introduced by the reference receiver code-phase biases. This information is applicable only for GLONASS FDMA signals. In the case that the MAC Network RTK method is used, GLONASS RTK Bias Information defines the code-phase biases related to the Master Reference Station [31].

#### 8.1.2.1.18 RTK MAC Correction Differences

RTK MAC Correction Differences provides the GNSS receiver with information about ionospheric (dispersive) and geometric (non-dispersive) corrections generated between a Master Reference Station and its Auxiliary Reference Stations [31].

#### 8.1.2.1.19 RTK Residuals

RTK Residuals provides the GNSS receiver with network error models generated for the interpolated corrections disseminated in Network RTK techniques. With sufficient redundancy in the RTK network, the location server process can provide an estimate for residual interpolation errors. Such quality estimates may be used by the target UE to optimize the performance of RTK solutions. The values may be considered by the target UE as a priori estimates only, with sufficient tracking data available the target UE might be able to judge residual geometric and ionospheric errors itself. According to [31], RTK Residual error information should be transmitted every 10-60 seconds.

#### 8.1.2.1.20 RTK FKP Gradients

RTK FKP Gradients provides the GNSS receiver with horizontal gradients for the geometric (troposphere and satellite orbits) and ionospheric signal components in the observation space. According to [31], RTK FKP gradient information should be typically transmitted every 10-60 seconds.

#### 8.1.2.1.21 SSR Orbit Corrections

SSR Orbit Corrections provides the GNSS receiver with parameters for orbit corrections in radial, along-track and cross-track components. These orbit corrections are used to compute a satellite position correction, to be combined with satellite position calculated from broadcast ephemeris (see clause 8.1.2.1.7).

#### 8.1.2.1.22 SSR Clock Corrections

SSR Clock Corrections provides the GNSS receiver with parameters to compute the GNSS satellite clock correction applied to the broadcast satellite clock (see clause 8.1.2.1.7). A polynomial of order 2 describes the clock differences for a certain time period: clock offset, drift, and drift rate.

#### 8.1.2.1.23 SSR Code Bias

SSR Code Bias provides the GNSS receiver with the Code Biases that must be added to the pseudo range measurements of the corresponding code signal to get corrected pseudo ranges. SSR Code Bias contains absolute values, but also enables the alternative use of Differential Code Biases by setting one of the biases to zero. A UE can consistently use signals for which a code bias is transmitted. It is not reliable for a UE to use a signal without retrieving a corresponding code bias from the assistance data message.

#### 8.1.2.1.24 SSR Phase Bias

SSR Phase Bias provides the GNSS receiver with the GNSS signal phase bias that are added to the carrier phase measurements of the corresponding signal to get corrected phase ranges. An indicator used to count events when phase bias is discontinuous is provided. An optional indicator is also provided to indicate whether fixed, widelane fixed or float PPP-RTK positioning modes are supported on a per signal basis.

NOTE 1: On the UE side, phase bias corrections of appropriate type are needed to restore the integer nature of the phase ambiguities in PPP-RTK. Their absence will affect the quality of the positioning solution and prevent a fast convergence time.

NOTE 2: PPP-RTK Fixed position mode corresponds to the UE fixing the carrier phase ambiguity to an integer value. The PPP-RTK Widelane Fixed positioning mode corresponds to forming the widelane combination of carrier phase measurements and fixing the resulting ambiguity as an integer value. In PPP-RTK Float positioning mode the carrier phase ambiguity is not treated as an integer value.

#### 8.1.2.1.25 SSR STEC Corrections

SSR STEC Corrections provides the GNSS receiver with the parameters to compute the ionosphere slant delay correction based on a variable order polynomial on a per satellite basis and applied to the code and phase measurements.

#### 8.1.2.1.26 SSR Gridded Correction

SSR Gridded Corrections provides the GNSS receiver with STEC residuals and Troposphere delays at a series of correction points and expressed as hydrostatic and wet vertical delays.

NOTE: The final ionosphere slant delay (STEC) consists of the polynomial part provided in SSR STEC Correction and the residual part provided in SSR Gridded Corrections.

#### 8.1.2.1.27 SSR URA

SSR URA provides the receiver with information about the estimated accuracy of the corrections for each satellite.

### 8.1.2.1.28 SSR Correction Points

The SSR Correction Points provides a list of correction point coordinates or an array of correction points ("grid") for which the SSR Gridded Corrections are valid.

### 8.1.2.1a Recommendations for grouping of assistance data to support different RTK service levels

This clause provides recommendations for the different high-accuracy GNSS service levels: RTK, N-RTK, PPP and PPP-RTK.

The high-accuracy GNSS methods can be classified as:

- *Single base RTK service*: RTK is a technique that uses carrier-based ranging measurements i.e., phase-range to improve the positioning accuracy in a differential approach. The basic concept is to reduce and remove errors common to a Reference Station, with known position, and UE pair. When only pseudo ranges (code-based measurements) are used to compute the UE location, this method is known as DGNSS (Differential GNSS).

**Table 8.1.2.1a-1: Single base RTK service: Specific information that may be transferred from the LMF to the UE**

Assistance Data
RTK Reference Station Information
RTK Observations
RTK Common Observation Information
GLONASS RTK Bias Information (if GLONASS data is transmitted)
Ephemeris and Clock (if UE did not acquire the navigation message)

- *Non-Physical Reference Station Network RTK service*: In this approach the target UE receives synthetic observations from a fictitious Reference Station. The Network RTK software at the location server is performing the error estimation and creates a virtual Reference Station close to the initial location of the target device (provided a priori to the location server). The target UE interprets and uses the data just as if it had come from a single, real Reference Station. Additionally, the target UE can also receive network information such as RTK Network Residuals (see clause 8.1.2.1.19) or even FKP gradients (see clause 8.1.2.1.20).

**Table 8.1.2.1a-2: Non-Physical Reference Station Network RTK service: Specific information that may be transferred from the LMF to the UE**

Assistance Data
RTK Reference Station Information
RTK Observations
RTK Common Observation Information
GLONASS RTK Bias Information (if GLONASS data is transmitted)
RTK Residuals
RTK FKP Gradients
Ephemeris and Clock (if UE did not acquire the navigation message)

- *MAC Network RTK service*: In MAC network RTK, a group of Reference Stations are used and one of them is chosen as a Master station. The other stations are then called Auxiliary stations. In this service, the location server sends full raw observations and coordinate information for a single Reference Station, the Master Station. For all auxiliary stations in the network (or a suitable subset of stations) the information is provided to the UE in a highly compact form: their reduced ambiguity-levelled observations, coordinate differences (to the Master Station observations and coordinates), and network residuals. Two Reference Stations are said to be on a common ambiguity level if the integer ambiguities for each phase range (satellite-receiver pair) have been removed (or adjusted) so that the integer ambiguities cancel when double-differences (involving two receivers and two satellites) are formed during processing. The maintenance of a common ambiguity level at a specific set of stations rather than across the whole GNSS network will lead to a grouping in network clusters or subnetworks of all ambiguity-levelled Reference Stations. If one network has only one subnetwork, this indicates

that an ambiguity level throughout the whole network is established. When subnetworks are predefined, the assistance data can be broadcast to all UEs located in the assigned sub-network. More details on the usage of subnetworks can be found in [31].

**Table 8.1.2.1a-3: MAC Network RTK service: Specific Information that may be transferred from the LMF to the UE**

Assistance Data
RTK Reference Station Information
RTK Auxiliary Station Data
RTK Observations
RTK Common Observation Information
GLONASS RTK Bias Information (if GLONASS data is transmitted)
RTK MAC Correction Differences
RTK Residuals
Ephemeris and Clock (if UE did not acquire the navigation message)

- *FKP Network RTK service*: With the concept of FKP, horizontal gradients of distance-dependent errors like ionosphere, troposphere and orbits are derived from a network of GNSS Reference Stations and transmitted to a target device together with raw or correction data of a corresponding Reference Station (physical or non physical). The target UE may use the gradients to compute the effect of the distance-dependent errors for its own position.

**Table 8.1.2.1a-4: FKP Network RTK service: Information that may be transferred from the LMF to the UE**

Assistance Data
RTK Reference Station Information
RTK Observations
RTK Common Observation Information
GLONASS RTK Bias Information (if GLONASS data is transmitted)
RTK Residuals
RTK FKP Gradients
Ephemeris and Clock (if UE did not acquire the navigation message)

- *PPP service*: This concept uses precise satellite orbit and clock parameters derived from global networks of Reference Stations as well as atmospheric models to perform single station positioning [31]. Compared to RTK and Network RTK, PPP is not a differential technique as there is no baseline limitation. When the orbits and clocks assistance data elements are provided in real-time, with no latency, the method is called Real-Time PPP.

**Table 8.1.2.1a-5: SSR PPP service: Information that may be transferred from the LMF to the UE**

Assistance Data
SSR Orbit Corrections
SSR Clock corrections
SSR Code Bias
Ephemeris and Clock (if UE did not acquire the navigation message)

- *PPP-RTK service*: This concept uses precise satellite orbits and clock parameters, the satellite signal biases derived from global networks of Reference Stations as well as ionosphere and troposphere corrections to perform single station positioning IS-QZSS-L6-001 [36]. Therefore, PPP-RTK services compensate the global and local corrections for a more accurate location information. Compared to PPP, PPP-RTK requires the UE to be located within the region covered by the ionosphere and troposphere corrections.



**Table 8.1.2.1a-6: SSR PPP-RTK service: Information that may be transferred from the LMF to the UE**

Assistance Data
SSR Orbit Corrections
SSR Clock corrections
SSR Code Bias
Ephemeris and Clock (if UE did not acquire the navigation message)
SSR Phase Bias
SSR STEC Corrections
SSR Gridded Correction
SSR URA
SSR Correction Points

### 8.1.2.2 Information that may be transferred from the UE to LMF

The information that may be signalled from UE to the LMF is listed in table 8.1.2.2-1.

**Table 8.1.2.2-1: Information that may be transferred from UE to the LMF**

Information	UE-assisted	UE-based/ standalone
Latitude/Longitude/Altitude, together with uncertainty shape	No	Yes
Velocity, together with uncertainty shape	No	Yes
Reference Time, possibly together with GNSS to NG-RAN time association and uncertainty	Yes	Yes
Indication of used positioning methods in the fix	No	Yes
Code phase measurements, also called pseudorange	Yes	No
Doppler measurements	Yes	No
Carrier phase measurements, also called Accumulated Delta Range (ADR)	Yes	No
Carrier-to-noise ratio of the received signal	Yes	No
Measurement quality parameters for each measurement	Yes	No
Additional, non-GNSS related measurement information	Yes	No

#### 8.1.2.2.1 GNSS Measurement Information

The GNSS measurement information reported from the UE to the LMF depends on the GNSS mode (i.e., UE-based, autonomous (standalone), or UE-assisted).

##### 8.1.2.2.1.1 UE-based mode

In UE-based or standalone mode, the GNSS receiver reports the latitude, longitude and possibly altitude, together with an estimate of the location uncertainty, if available.

If requested by the LMF and supported by the UE, the GNSS receiver may report its velocity, possibly together with an estimate of the uncertainty, if available.

If requested by the LMF and supported by the UE, the GNSS receiver may report the relation between GNSS system time (where the specific GNSS is indicated by a GNSS ID; the specific GNSS system time may be selected by the UE) and NG-RAN air-interface timing. This information may be used by the LMF to assist other UEs in the network.

The UE should also report an indication of which GNSSs and possibly other location methods have been used to calculate a fix.

##### 8.1.2.2.1.2 UE-assisted mode

In UE-assisted mode, the GNSS receiver reports the Code Phase and Doppler measurements together with associated quality estimates. These measurements enable the LMF to calculate the location of the UE, possibly using other measurements and data.

If requested by the LMF and supported by the UE, the GNSS receiver may report Carrier Phase measurements (also called Accumulated Delta Range), together with associated quality measurements, if available.

If requested by the LMF and supported by the UE, the GNSS receiver may report the relation between GNSS system time (where the specific GNSS is indicated by a GNSS ID; the specific GNSS system time may be selected by the UE) and NG-RAN air-interface timing. This information may be used by the LMF to assist other UEs in the network.

#### 8.1.2.2.2 Additional Non-GNSS Related Information

Additional non-GNSS measurements performed by NG-RAN or UE may be used by the LMF or UE to calculate or verify a location estimate. This information may include OTDOA positioning measurements, pathloss and signal strength related measurements, etc.

### 8.1.3 Assisted-GNSS Positioning Procedures

#### 8.1.3.1 Capability Transfer Procedure

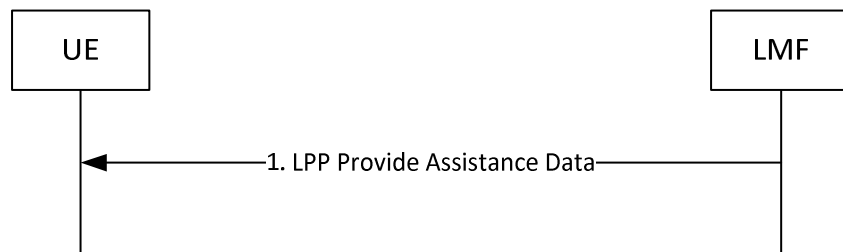
The Capability Transfer procedure for Assisted-GNSS positioning is described in clause 7.1.2.1.

#### 8.1.3.2 Assistance Data Transfer Procedure

The purpose of this procedure is to enable the LMF to provide assistance data to the UE (e.g., as part of a positioning procedure) and the UE to request assistance data from the LMF (e.g., as part of a positioning procedure). In the case of high-accuracy GNSS positioning techniques (e.g., RTK), the LMF can provide unsolicited periodic assistance data to the UE and the UE can request periodic assistance data from the LMF.

##### 8.1.3.2.1 LMF initiated Assistance Data Delivery

Figure 8.1.3.2.1-1 shows the Assistance Data Delivery operations for the network-assisted GNSS method when the procedure is initiated by the LMF.



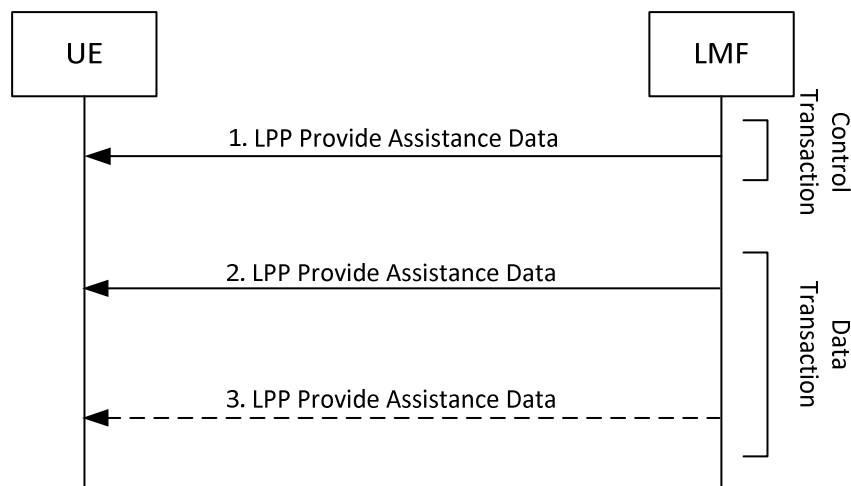
**Figure 8.1.3.2.1-1: LMF-initiated Assistance Data Delivery Procedure**

- (1) The LMF determines that assistance data needs to be provided to the UE (e.g., as part of a positioning procedure) and sends an LPP Provide Assistance Data message to the UE. This message may include any of the GNSS assistance data defined in clause 8.1.2.1.

##### 8.1.3.2.1a LMF initiated Periodic Assistance Data Delivery

The Periodic Assistance Data Delivery procedure allows the server to provide unsolicited periodic assistance data to the target and is shown in Figure 8.1.3.2.1a-1.

**NOTE:** In this version of the specification, periodic assistance data delivery is supported for HA GNSS (e.g., RTK) positioning only.

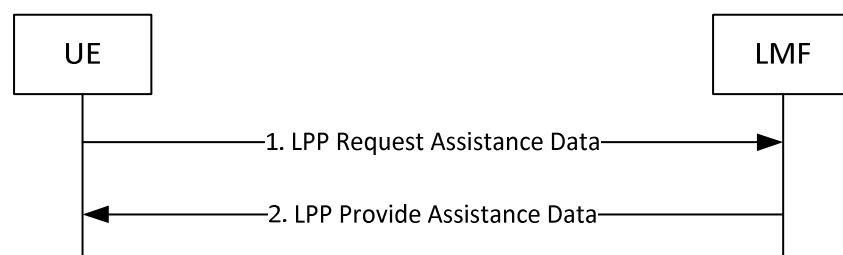


**Figure 8.1.3.2.1a-1: LPP Periodic Assistance data delivery procedure**

- (1) The LMF determines that assistance data needs to be provided to the UE and sends an LPP Provide Assistance Data message to the UE. This message includes information to identify the type of periodic assistance data and a duration for ending the assistance data delivery. The message indicates the end of the control transaction.
- (2) When the first periodic message is available, the LMF sends an unsolicited LPP Provide Assistance Data message to the UE containing the periodic assistance data announced in step (1).
- (3) The LMF may continue to send further LPP Provide Assistance Data messages to the target containing the periodic assistance data announced in step (1) when each additional periodicity condition occurs. When the duration for ending the periodic assistance data transfer occurs, the last LPP Provide Assistance Data message transferred indicates the end of transaction. Additionally, the session can be ended on request by the UE or by the LMF with the help of an Abort message.

### 8.1.3.2.2 UE initiated Assistance Data Transfer

Figure 8.1.3.2.2-1 shows the Assistance Data Transfer operations for the network-assisted GNSS method when the procedure is initiated by the UE.



**Figure 8.1.3.2.2-1: UE-initiated Assistance Data Transfer Procedure**

- (1) The UE determines that certain A-GNSS assistance data are desired (e.g., as part of a positioning procedure when the LMF provided assistance data are not sufficient for the UE to fulfil the request) and sends a LPP Request Assistance Data message to the LMF. This request includes an indication of which specific A-GNSS assistance data are requested for each GNSS, possibly together with additional information (e.g., for which GNSS signal types, or satellites, or times the assistance is requested, etc.). Additional information concerning the UE's approximate location and serving and neighbour cells may also be provided in the Request Assistance Data message and/or in an accompanying Provide Location Information message to help the LMF provide appropriate

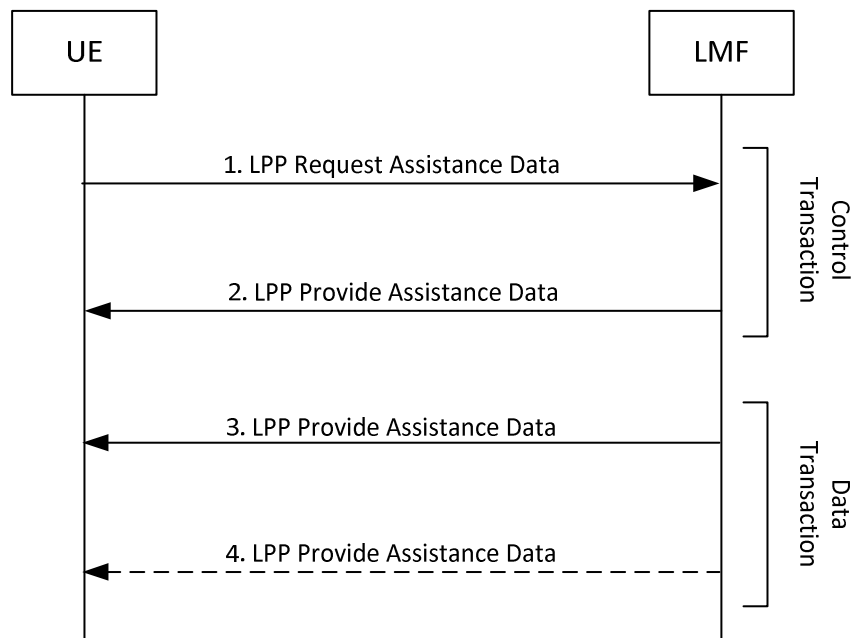
assistance data. This additional data may include the UE's last known location if available, the cell IDs of the UE serving NG-RAN node and possibly neighbour NG-RAN nodes, as well as E-UTRA E-CID measurements.

- (2) The LMF provides the requested assistance data in a LPP Provide Assistance Data message, if available at the LMF. The entire set of assistance data may be delivered in one or several LPP messages, e.g., one message per GNSS. In this case, this step may be repeated by the LMF several times. If any of the UE requested assistance data in step (1) are not provided in step 2, the UE shall assume that the requested assistance data are not supported, or currently not available at the LMF. If none of the UE requested assistance data in step (1) can be provided by the LMF, return any information that can be provided in an LPP message of type Provide Assistance Data which includes a cause indication for the not provided assistance data.

### 8.1.3.2.2a UE initiated Periodic Assistance Data Transfer

Figure 8.1.3.2.2a-1 shows the Periodic Assistance Data Transfer operations for the high-accuracy GNSS methods (e.g., RTK) when the procedure is initiated by the UE.

NOTE: In this version of the specification, periodic assistance data transfer is supported for HA GNSS (e.g., RTK) positioning only.



**Figure 8.1.3.2.2a-1: UE-initiated Periodic Assistance Data Transfer Procedure**

- (1) The UE determines that periodic assistance data are desired and sends a LPP Request Assistance Data message to the LMF. This request includes an indication of which specific assistance data are requested together with additional information such as desired periodicity for sending the assistance data and a duration for ending the periodic assistance data delivery session.
- (2) The LMF responds with a LPP Provide Assistance Data message to the UE. If the UE request can be supported, the message contains information which may confirm or redefine the type of assistance data or periodicity parameters requested at step (1). This response indicates the end of the control transaction.
- (3) When available, the LMF provides the requested assistance data in a LPP Provide Assistance Data message to the UE. If any of the requested assistance data in step (1) or redefined in step (2) are not provided the UE assumes that the requested assistance data are not supported, or currently not available at the LMF.
- (4) The LMF may transmit one or more additional LPP Provide Assistance Data messages to the UE containing further periodic assistance data confirmed or redefined in step (2). When the duration for ending the periodic assistance data transfer occur, the last LPP Provide Assistance Data message transferred indicates the end of the

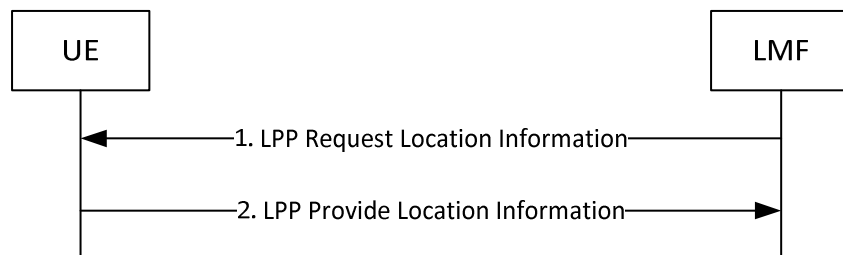
transaction. Additionally, the periodic assistance data delivery session can be ended on request by the UE or by the LMF with the help of an Abort message.

### 8.1.3.3 Location Information Transfer Procedure

The purpose of this procedure is to enable the LMF to request position measurements or location estimate from the UE, or to enable the UE to provide location measurements to the LMF for position calculation.

#### 8.1.3.3.1 LMF initiated Location Information Transfer Procedure

Figure 8.1.3.3.1-1 shows the Location Information Transfer operations for the network-assisted GNSS method when the procedure is initiated by the LMF.

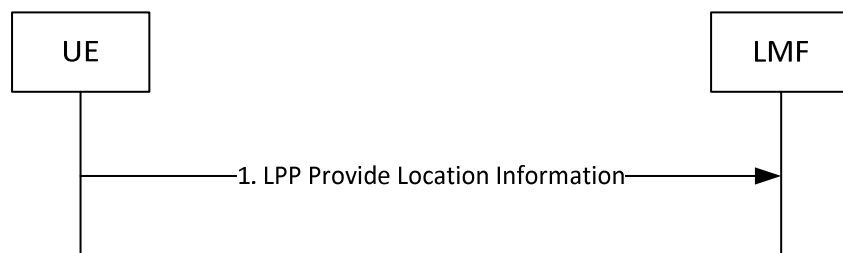


**Figure 8.1.3.3.1-1: LMF-initiated Location Information Transfer Procedure**

- (1) The LMF sends a LPP Request Location Information message to the UE for invocation of A-GNSS positioning. This request includes positioning instructions such as the GNSS mode (UE-assisted, UE-based, UE-based preferred but UE-assisted allowed, UE-assisted preferred, but UE-based allowed, standalone), positioning methods (GPS, Galileo, GLONASS, BDS, etc. and possibly non-GNSS methods, such as OTDOA positioning or E-CID positioning), specific UE measurements requested if any, such as fine time assistance measurements, velocity, carrier phase, multi-frequency measurements, and quality of service parameters (accuracy, response time).
- (2) The UE performs the requested measurements and possibly calculates its own location. The UE sends an LPP Provide Location Information message to the LMF before the Response Time provided in step (1) elapsed. If the UE is unable to perform the requested measurements, or if the Response Time provided in step 1 elapsed before any of the requested measurements have been obtained, the UE returns any information that can be provided in an LPP message of type Provide Location Information which includes a cause indication for the not provided location information.

#### 8.1.3.3.2 UE-initiated Location Information Delivery Procedure

Figure 8.1.3.3.2-1 shows the Location Information delivery operations for the UE-assisted GNSS method when the procedure is initiated by the UE.



**Figure 8.1.3.3.2-1: UE-initiated Location Information Delivery Procedure**

- (1) The UE sends an LPP Provide Location Information message to the LMF. The Provide Location Information message may include any UE measurements (GNSS pseudo-ranges, carrier phase-ranges, and other measurements) already available at the UE.

## 8.2 OTDOA positioning

### 8.2.1 General

In this version of the specification, only OTDOA based on LTE signals is supported.

In the OTDOA positioning method, the UE position is estimated based on measurements taken at the UE of downlink radio signals from multiple E-UTRA TPs (possibly including PRS-only E-UTRA TPs from a PRS-based TBS), along with knowledge of the geographical coordinates of the measured TPs and their relative downlink timing.

The UE while connected to a gNB may require measurement gaps to perform the OTDOA measurements from E-UTRA TPs. The UE may request measurement gaps from a gNB using the procedure described in clause 7.4.1.1. If the UE is not aware of the SFN of at least one E-UTRA TP in the OTDOA assistance data, the UE may use autonomous gaps to acquire SFN of the E-UTRA OTDOA reference cell prior to requesting measurement gaps for performing the requested E-UTRA RSTD measurements.

The UE while connected to a ng-eNB may require measurement gaps to perform inter-frequency RSTD measurements for OTDOA from E-UTRA TPs (see TS 38.133 [32]). The UE may request measurement gaps from a ng-eNB using the procedure described in clause 7.4.2.1.

The specific positioning techniques used to estimate the UE's location from this information are beyond the scope of this specification.

### 8.2.2 Information to be transferred between NG-RAN/5GC Elements

This clause defines the information that may be transferred between LMF and UE/ng-eNB.

#### 8.2.2.1 Information that may be transferred from the LMF to UE

The following assistance data may be transferred from the LMF to the UE:

- Physical cell IDs (PCIs), global cell IDs (GCIs), and TP IDs of candidate E-UTRA TPs for measurement;
- Timing relative to the reference E-UTRA TP of candidate E-UTRA TPs;
- PRS configuration of candidate E-UTRA TPs;
- If known, the SFN timing offset between the serving NR cell and the E-UTRA assistance data reference cell.

NOTE: The LMF can provide the UE with a list of E-UTRA TP candidates for measurement, even if the LMF does not know the SFN or frame timing of the E-UTRA TPs.

#### 8.2.2.2 Information that may be transferred from the ng-eNB to LMF

The following assistance data may be transferred from the ng-eNB to the LMF:

- PCI, GCI, and TP IDs of the TPs served by the ng-eNB;
- Timing information of TPs served by the ng-eNB;
- PRS configuration of the TPs served by the ng-eNB;
- Geographical coordinates of the TPs served by the ng-eNB.

An ng-eNB may provide assistance data relating only to itself and served TPs via NRPPa signalling, although assistance data from several ng-eNBs and served TPs may be acquired through other mechanisms, see NOTE below.

NOTE: The assistance data described in this clause are not necessarily transferred only from the ng-eNB, and in some deployment options may not be delivered from the ng-eNB at all; they may also be delivered to the LMF through OA&M or other mechanisms external to the NG-RAN. In addition, in cases where assistance data are delivered from the ng-eNB, how the ng-eNB acquires the data is outside the scope of this specification.

### 8.2.2.3 Information that may be transferred from the UE to LMF

The information that may be signalled from UE to the LMF is listed in Table 8.2.2.3-1. The individual UE measurements are defined in TS 36.214 [17].

**Table 8.2.2.3-1: Information that may be transferred from UE to the LMF**

Information	Measurements
Downlink Measurement Results List for EUTRA TPs	Physical cell IDs
	Global cell IDs
	TP IDs
	Downlink timing measurements
Information used to compute a reference time corresponding to the downlink timing measurements to allow correlation of downlink timing measurements with motion information independently obtained from motion sensors	Delta SFN for each E-UTRA neighbour cell

## 8.2.3 OTDOA Positioning Procedures

The procedures described in this clause support OTDOA positioning measurements obtained by the UE and provided to the LMF using LPP.

In this version of the specification only the UE-assisted OTDOA positioning is supported.

### 8.2.3.1 Capability Transfer Procedure

The Capability Transfer procedure for OTDOA positioning is described in clause 7.1.2.1.

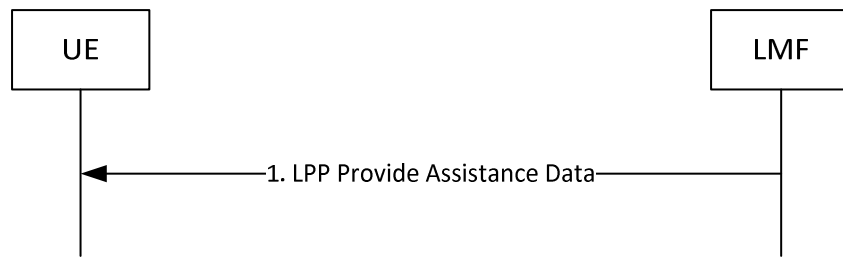
### 8.2.3.2 Assistance Data Transfer Procedure

#### 8.2.3.2.1 Assistance Data Transfer between LMF and UE

The purpose of this procedure is to enable the LMF to provide assistance data to the UE (e.g., as part of a positioning procedure) and the UE to request assistance data from the LMF (e.g., as part of a positioning procedure).

##### 8.2.3.2.1.1 LMF initiated Assistance Data Delivery

Figure 8.2.3.2.1.1-1 shows the Assistance Data Delivery operations for the OTDOA positioning method when the procedure is initiated by the LMF.

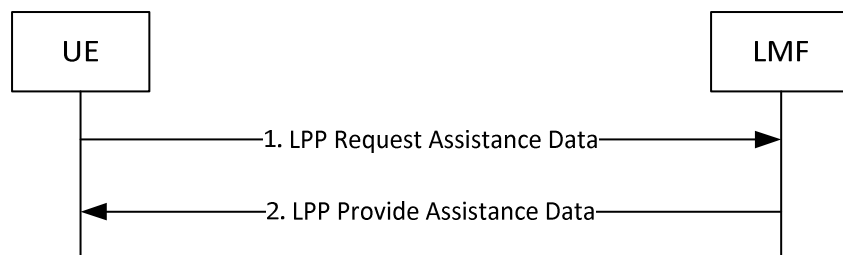


**Figure 8.2.3.2.1.1-1: LMF-initiated Assistance Data Delivery Procedure**

- (1) The LMF determines that assistance data needs to be provided to the UE (e.g., as part of a positioning procedure) and sends an LPP Provide Assistance Data message to the UE. This message may include any of the OTDOA positioning assistance data defined in clause 8.2.2.1.

#### 8.2.3.2.1.2 UE initiated Assistance Data Transfer

Figure 8.2.3.2.1.2-1 shows the Assistance Data Transfer operations for the OTDOA positioning method when the procedure is initiated by the UE.



**Figure 8.2.3.2.1.2-1: UE-initiated Assistance Data Transfer Procedure**

- (1) The UE determines that certain OTDOA positioning assistance data are desired (e.g., as part of a positioning procedure when the LMF provided assistance data are not sufficient for the UE to fulfil the request) and sends an LPP Request Assistance Data message to the LMF. This request includes an indication of which specific OTDOA assistance data are requested. Additional information concerning the UE's approximate location and serving and neighbour cells may also be provided in the Request Assistance Data message and/or in an accompanying Provide Location Information message to help the LMF provide appropriate assistance data. This additional data may include the UE's last known location if available, the cell IDs of the UE serving NG-RAN node and possibly neighbour NG-RAN nodes, as well as E-UTRA E-CID measurements.
- (2) The LMF provides the requested assistance in an LPP Provide Assistance Data message, if available at the LMF. If any of the UE requested assistance data in step (1) are not provided in step 2, the UE shall assume that the requested assistance data are not supported, or currently not available at the LMF. If none of the UE requested assistance data in step (1) can be provided by the LMF, return any information that can be provided in an LPP message of type Provide Assistance Data which includes a cause indication for the not provided assistance data.

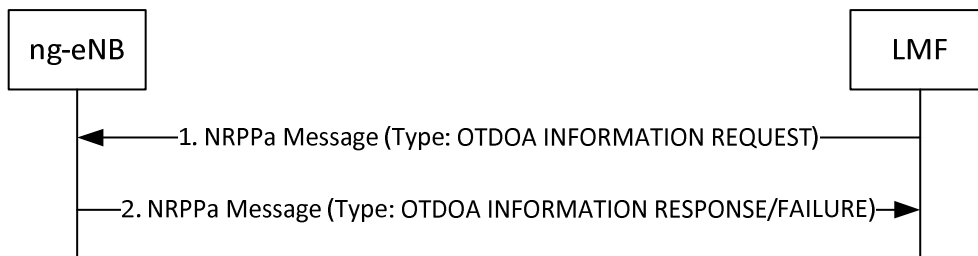
#### 8.2.3.2.2 Assistance Data Delivery between LMF and ng-eNB

The purpose of this procedure is to enable the ng-eNB to provide assistance data to the LMF, for subsequent delivery to the UE using the procedures of clause 8.2.3.2.1 or for use in the calculation of positioning estimates at the LMF.

##### 8.2.3.2.2.1 LMF-initiated assistance data delivery to the LMF

Figure 8.2.3.2.2.1-1 shows the Assistance Data Delivery operation from the ng-eNB to the LMF for the OTDOA positioning method, in the case that the procedure is initiated by the LMF.





**Figure 8.2.3.2.1-1: LMF-initiated Assistance Data Delivery Procedure**

- (1) The LMF determines that certain OTDOA positioning assistance data are desired (e.g., as part of a periodic update or as triggered by OAM) and sends an NRPPa OTDOA INFORMATION REQUEST message to the ng-eNB. This request includes an indication of which specific OTDOA assistance data are requested.
- (2) The ng-eNB provides the requested assistance in an NRPPa OTDOA INFORMATION RESPONSE message, if available at the ng-eNB. If the ng-eNB is not able to provide any information, it returns an OTDOA INFORMATION FAILURE message indicating the cause of the failure.

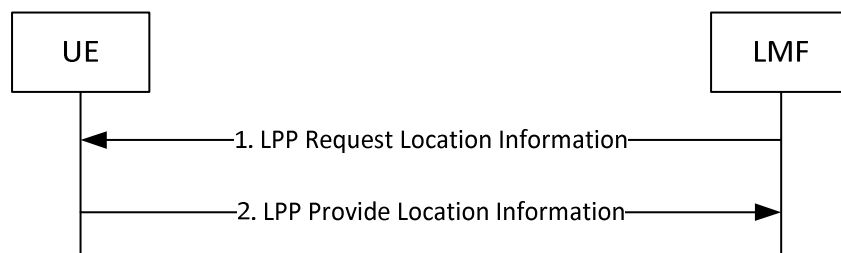
Editor's Note: Additional information on OTDOA supporting procedures may be included later, e.g., based on clause 8.4 in 36.305 with appropriate changes for NG-RAN.

### 8.2.3.3 Location Information Transfer Procedure

The purpose of this procedure is to enable the LMF to request position measurements from the UE, or to enable the UE to provide location measurements to the LMF for position calculation.

#### 8.2.3.3.1 LMF-initiated Location Information Transfer Procedure

Figure 8.2.3.3.1-1 shows the Location Information Transfer operations for the OTDOA positioning method when the procedure is initiated by the LMF.

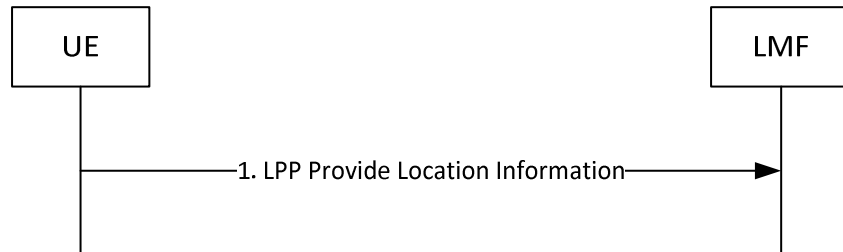


**Figure 8.2.3.3.1-1: LMF-initiated Location Information Transfer Procedure**

- (1) The LMF sends an LPP Request Location Information message to the UE. This request includes indication of OTDOA measurements requested, including any needed measurement configuration information, and required response time.
- (2) The UE obtains OTDOA measurements as requested in step 1. The UE then sends an LPP Provide Location Information message to the LMF, before the Response Time provided in step (1) elapsed, and includes the obtained OTDOA measurements. If the UE is unable to perform the requested measurements, or the Response Time elapsed before any of the requested measurements were obtained, the UE returns any information that can be provided in an LPP message of type Provide Location Information which includes a cause indication for the not provided location information.

### 8.2.3.3.2 UE-initiated Location Information Delivery procedure

Figure 8.2.3.3.2-1 shows the Location Information Delivery procedure operations for the OTDOA positioning method when the procedure is initiated by the UE.



**Figure 8.2.3.3.2-1: UE-initiated Location Information Delivery Procedure.**

- (1) The UE sends an LPP Provide Location Information message to the LMF. The Provide Location Information message may include any UE OTDOA measurements already available at the UE.

## 8.3 Enhanced cell ID positioning methods

### 8.3.1 General

In the Cell ID (CID) positioning method, the UE position is estimated with the knowledge of the geographical coordinates of its serving ng-eNB or gNB.

Enhanced Cell ID (E-CID) positioning refers to techniques which use UE and/or NG-RAN radio resource related measurements to improve the UE location estimate.

In this version of the specification, only E-CID based on LTE signals is supported.

- NOTE:** For E-CID positioning methods the UE reports only the measurements that it has available rather than being required to take additional measurement actions. Therefore, the measurement gap request procedure described in clause 7.4.1.1 is not applicable for E-CID positioning methods.

E-CID measurements for E-UTRA may include [17, 18]:

UE measurements (TS 36.214 [17], TS 36.302 [18]):

- E-UTRA Reference signal received power (RSRP);
- E-UTRA Reference Signal Received Quality (RSRQ);
- UE E-UTRA Rx – Tx time difference;
- GERAN RSSI;
- UTRAN CPICH RSCP;
- UTRAN CPICH  $E_c/I_0$ ;
- WLAN RSSI.

E-UTRAN measurements (TS 36.214 [17], TS 36.302 [18]):

- ng-eNB Rx – Tx time difference;
- Timing Advance ( $T_{ADV}$ ):
- Type1:  $T_{ADV} = (\text{ng-eNB Rx – Tx time difference}) + (\text{UE E-UTRA Rx – Tx time difference})$ ;

- Type2:  $T_{ADV} = \text{ng-eNB Rx} - \text{Tx}$  time difference;
- Angle of Arrival (AoA).

Various techniques exist to use these measurements to estimate the location of the UE. The specific techniques are beyond the scope of this specification.

## 8.3.2 Information to be transferred between NG-RAN/5GC Elements

This clause defines the information that may be transferred between LMF and UE/NG-RAN node.

### 8.3.2.1 Information that may be transferred from the LMF to UE

UE-assisted Enhanced Cell-ID location does not require any assistance data to be transferred from the LMF to the UE.

UE-Based Enhanced Cell-ID location is not supported in this version of the specification.

### 8.3.2.2 Information that may be transferred from the ng-eNB to LMF

The information that may be signalled from ng-eNB to the LMF is listed in table 8.3.2.2-1.

**Table 8.3.2.2-1: Information that may be transferred from ng-eNB to the LMF**

Information
Timing Advance ( $T_{ADV}$ )
Angle of Arrival (AoA)
E-UTRA Measurement Results List:
- Evolved Cell Global Identifier (ECGI)/Physical Cell ID
- E-UTRA Reference signal received power (RSRP)
- E-UTRA Reference Signal Received Quality (RSRQ)
GERAN Measurement Results List:
- Base Station Identity Code (BSIC)
- ARFCN of Base Station Control Channel (BCCH)
- Received Signal Strength Indicator (RSSI)
UTRA Measurement Results List:
- UTRAN Physical ID
- Common Pilot Channel Received Signal Code Power (RSCP)
- Common Pilot Channel $E_c/I_o$
WLAN Measurement Results List:
- WLAN Received Signal Strength Indicator (RSSI)
- SSID
- BSSID
- HESSID
- Operating Class
- Country Code
- WLAN Channel(s)
- WLAN Band

### 8.3.2.3 Information that may be transferred from the gNB to LMF

The information that may be signalled from gNB to the LMF is listed in table 8.3.2.3-1.

**Table 8.3.2.3-1: Information that may be transferred from gNB to the LMF**

Information
E-UTRA Measurement Results List:
- Evolved Cell Global Identifier (ECGI)/Physical Cell ID
- E-UTRA Reference signal received power (RSRP)
- E-UTRA Reference Signal Received Quality (RSRQ)
NR Measurement Results List:
- Cell Global Identifier /Physical Cell ID
- Cell Portion ID

### 8.3.2.4 Information that may be transferred from the UE to LMF

The information that may be signalled from UE to the LMF is listed in table 8.3.2.4-1.

**Table 8.3.2.4-1: Information that may be transferred from UE to the LMF**

Information	UE-assisted
Evolved Cell Global Identifier (ECGI)/Physical Cell ID	Yes
E-UTRA Reference signal received power (RSRP)	Yes
E-UTRA Reference Signal Received Quality (RSRQ)	Yes
UE E-UTRA Rx – Tx time difference	Yes

## 8.3.3 Downlink E-CID Positioning Procedures

The procedures described in this clause support E-CID related measurements obtained by the UE and provided to the LMF using LPP. The term "downlink" is intended to indicate that from the LMF perspective the involved measurements are provided by the UE; this set of procedures might also be considered as "UE-assisted, LMF-based E-CID".

### 8.3.3.1 Capability Transfer Procedure

The Capability Transfer procedure for E-CID positioning is described in clause 7.1.2.1.

### 8.3.3.2 Assistance Data Transfer Procedure

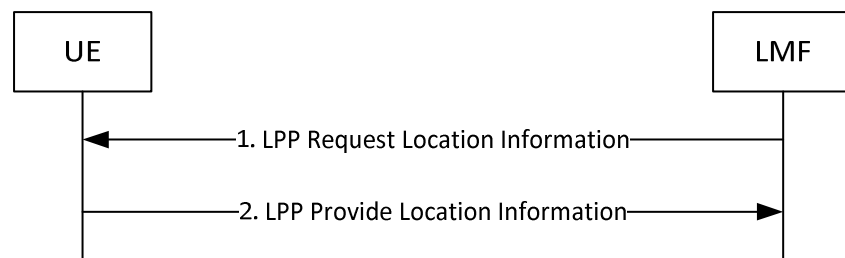
Assistance data transfer is not required for E-CID positioning.

### 8.3.3.3 Location Information Transfer Procedure

The purpose of this procedure is to enable the LMF to request position measurements from the UE, or to enable the UE to provide location measurements to the LMF for position calculation.

#### 8.3.3.3.1 LMF-initiated Location Information Transfer

Figure 8.3.3.3-1 shows the Location Information Transfer operations for the E-CID method when the procedure is initiated by the LMF.

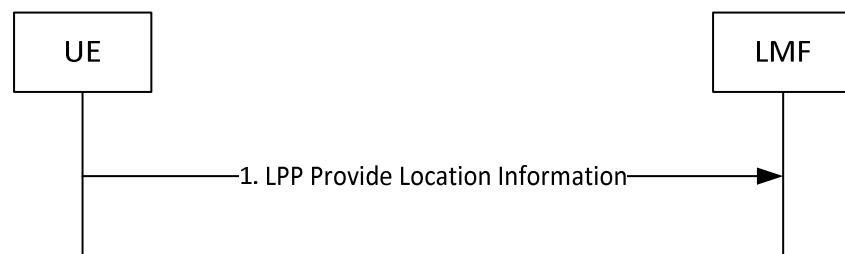


**Figure 8.3.3.3-1: LMF-initiated Location Information Transfer Procedure.**

- (1) The LMF sends a LPP Request Location Information message to the UE for invocation of E-CID positioning. This request includes the E-CID measurements requested by the LMF and supported by the UE as listed in Table 8.3.2.4-1 together with a required response time.
- (2) The UE performs the requested measurements and sends an LPP Provide Location Information message to the LMF before the Response Time provided in step (1) elapsed. If the UE is unable to perform the requested measurements, or if the Response Time provided in step 1 elapsed before any of the requested measurements have been obtained, the UE returns any information that can be provided in an LPP message of type Provide Location Information which includes a cause indication for the not provided location information.

#### 8.3.3.3.2 UE-initiated Location Information Delivery procedure

Figure 8.3.3.3.2-1 shows the Location Information Delivery procedure operations for the E-CID method when the procedure is initiated by the UE.



**Figure 8.3.3.3.2-1: UE-initiated Location Information Delivery Procedure.**

- (1) The UE sends an LPP Provide Location Information message to the LMF. The Provide Location Information message may include any UE measurements already available at the UE.

### 8.3.4 Uplink E-CID Positioning Procedures

The procedures described in this clause support E-CID related measurements obtained by the NG-RAN node and provided to the LMF using NRPPa. The term "uplink" is intended to indicate that from the LMF point of view, the involved measurements are provided by the NG-RAN node; this set of procedures might also be considered as "NG-RAN node-assisted E-CID". An example of this uplink E-CID positioning method for E-UTRA is AoA+T<sub>ADV</sub>.

#### 8.3.4.1 Capability Transfer Procedure

The Capability Transfer procedure is not applicable to uplink E-CID positioning not using E-UTRA T<sub>ADV</sub> type 1. For uplink E-CID positioning using E-UTRA T<sub>ADV</sub> type 1, the Capability Transfer procedure for E-CID positioning is described in clause 7.1.2.1.

### 8.3.4.2 Assistance Data Transfer Procedure

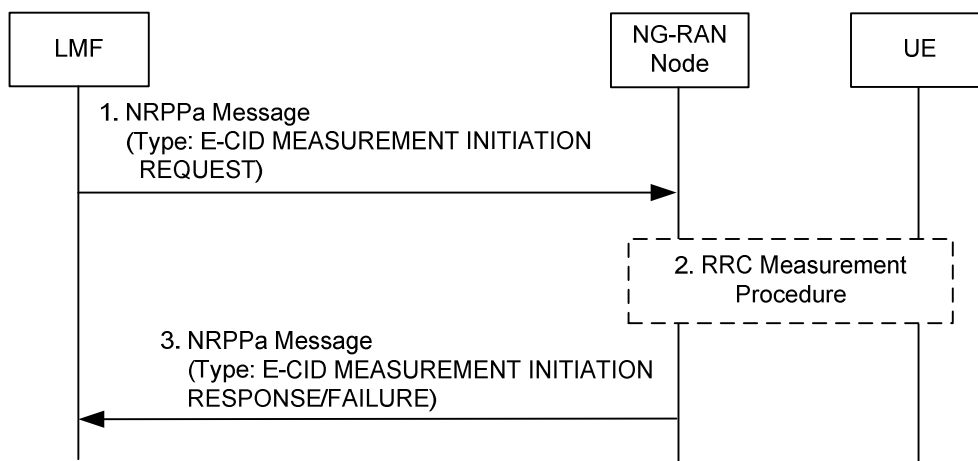
The assistance data transfer procedure is not applicable to uplink E-CID positioning.

### 8.3.4.3 Position Measurement Procedure

The purpose of this procedure is to enable the LMF to request position measurements from the NG-RAN node.

#### 8.3.4.3.1 LMF-initiated Position Measurement

Figure 8.3.4.3.1-1 shows the position measurement operations for the uplink E-CID method when the procedure is initiated by the LMF.



**Figure 8.3.4.3.1-1: LMF-initiated Position Measurement Procedure**

- (1) The LMF sends a NRPPa E-CID MEASUREMENT INITIATION REQUEST message to the NG-RAN node. This request includes indication of E-CID measurements requested and whether the result is expected only once or periodically.
- (2) If the LMF in step (1) requested UE measurements (e.g., E-UTRA RSRP, E-UTRA RSRQ measurements, etc.), the NG-RAN node may configure the UE to report the measurement information requested as specified in TS 36.331 [13], TS 38.331 [14].
- (3) If the result is expected only once and the NG-RAN node initiates at least one of the E-CID measurements as requested, the NG-RAN node sends an NRPPa E-CID MEASUREMENT INITIATION RESPONSE to the LMF, which includes the obtained E-CID measurements. If the result is expected periodically and the NG-RAN node is able to initiate at least one of the E-CID measurements as requested, the NG-RAN node sends an NRPPa E-CID MEASUREMENT INITIATION RESPONSE to the LMF, which does not include any result. The NG-RAN node reports then the obtained measurements by initiating the E-CID Measurement Report procedure, with the requested periodicity. If the NG-RAN node is unable to initiate any of the requested measurements as requested from the LMF, or is unable to instigate any of the required RRC procedures to obtain the requested measurements from the UE, the NG-RAN node sends an NRPPa E-CID MEASUREMENT INITIATION FAILURE message providing the error reason. If the failure occurs during a periodic reporting, the NG-RAN node sends an NRPPa E-CID MEASUREMENT FAILURE INDICATION message.

## 8.4 Barometric pressure sensor positioning

### 8.4.1 General

In the barometric pressure sensor positioning method, the UE vertical component of the position is estimated by combining the measured atmospheric pressure and a reference atmospheric pressure. This is accomplished through

barometric sensors measuring atmospheric pressure at the UE, and applying a height determination algorithm using the reference atmospheric pressure.

Three positioning modes are supported:

- *UE-Assisted*: The UE performs barometric pressure sensor measurements with or without assistance from the network and sends these measurements to the LMF where the vertical component of the position calculation may take place, possibly using additional measurements from other sources;
- *UE-Based*: The UE performs barometric pressure sensor measurements and calculates its own vertical component of the position, possibly using additional measurements from other sources.
- *Standalone*: The UE performs barometric pressure sensor measurements and calculates its own vertical component of the position, possibly using additional measurements from other sources, without network assistance.

## 8.4.2 Information to be transferred between NG-RAN/5GC Elements

This clause defines the information that may be transferred between LMF and UE.

### 8.4.2.1 Information that may be transferred from the LMF to UE

Table 8.4.2.1-1 lists assistance data for both UE-assisted and UE-based modes that may be sent from the LMF to the UE.

NOTE: The provision of these assistance data elements and the usage of these elements by the UE depend on the NG-RAN/5GC and UE capabilities, respectively.

**Table 8.4.2.1-1: Information that may be transferred from the LMF to UE**

Assistance Data
Reference pressure
Additional reference data

#### 8.4.2.1.1 Barometric pressure sensor assistance data

The barometric pressure sensor assistance data may include reference pressure, along with other reference data, such as the reference point where the reference barometric pressure is valid and reference temperature at the reference point.

### 8.4.2.2 Information that may be transferred from the UE to LMF

The information that may be signalled from the UE to the LMF is summarized in Table 8.4.2.2-1.

**Table 8.4.2.2-1: Information that may be transferred from UE to the LMF**

Information	UE-assisted	UE-based/ Standalone
UE position estimate with uncertainty shape	No	Yes
Indication of used positioning methods in the fix	No	Yes
Timestamp	Yes	Yes
Barometric pressure sensor measurements	Yes	No

#### 8.4.2.2.1 Standalone mode

In Standalone mode, the UE reports the vertical component of the position, together with an estimate of the location uncertainty, if available.

The UE should also report an indication of which positioning method(s) have been used to calculate a fix.

#### 8.4.2.2.2 UE-assisted mode

In UE-assisted mode, the UE reports the barometric pressure sensor measurements together with associated quality estimates. These measurements enable the LMF to calculate the vertical component of the location of the UE, possibly using other measurements and data.

If requested by the LMF and supported by the UE, the UE may report barometric pressure sensor measurements together with associated quality measurements, if available.

#### 8.4.2.2.3 UE-based mode

In UE-based mode, the UE reports the vertical component of the position, together with an estimate of the location uncertainty, if available.

The UE should also report an indication of which positioning method(s) have been used to calculate a fix.

### 8.4.3 Barometric Pressure Sensor Positioning Procedures

#### 8.4.3.1 Capability Transfer Procedure

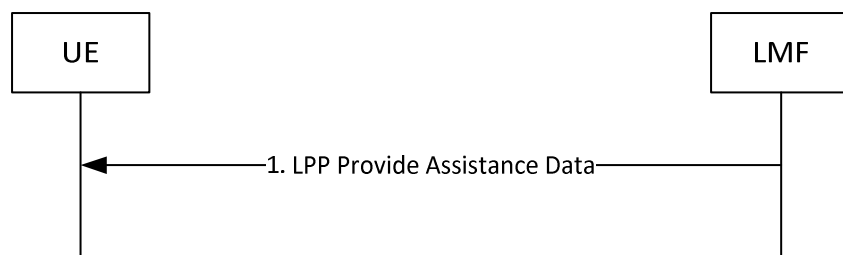
The Capability Transfer procedure for Barometric Pressure Sensor positioning is described in clause 7.1.2.1.

#### 8.4.3.2 Assistance Data Transfer Procedure

The purpose of this procedure is to enable the LMF to provide assistance data to the UE (e.g., as part of a positioning procedure) and the UE to request assistance data from the LMF (e.g., as part of a positioning procedure).

##### 8.4.3.2.1 LMF initiated Assistance Data Delivery

Figure 8.4.3.2.1-1 shows the Assistance Data Delivery operations for the network-assisted barometric pressure sensor method when the procedure is initiated by the LMF.



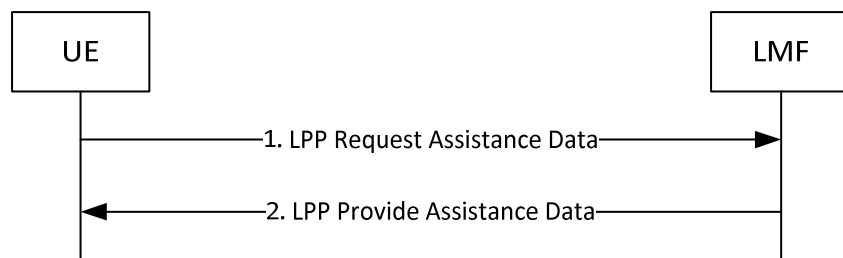
**Figure 8.4.3.2.1-1: LMF-initiated Assistance Data Delivery Procedure**

- (1) The LMF determines that assistance data needs to be provided to the UE (e.g., as part of a positioning procedure) and sends an LPP Provide Assistance Data message to the UE. This message may include any of the barometric pressure sensor assistance data defined in clause 8.4.2.1.

##### 8.4.3.2.2 UE initiated Assistance Data Transfer

Figure 8.4.3.2.2-1 shows the Assistance Data Transfer operations for the network-assisted Barometric pressure sensor method when the procedure is initiated by the UE.





**Figure 8.4.3.2.2-1: UE-initiated Assistance Data Transfer Procedure**

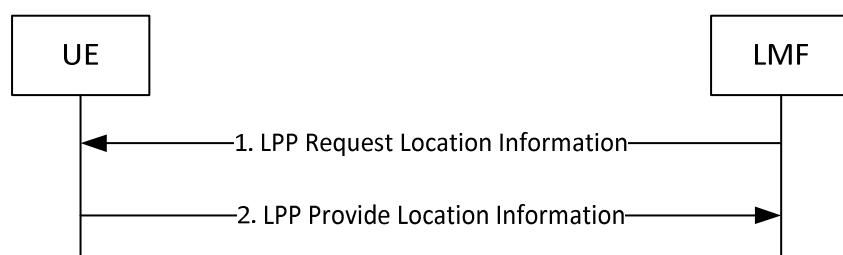
- (1) The UE determines that certain barometric pressure sensor assistance data is desired (e.g., as part of a positioning procedure when the LMF provided assistance data are not sufficient for the UE to fulfil the request) and sends a LPP Request Assistance Data message to the LMF. This request includes an indication of which specific barometric pressure sensor assistance data is requested.
- (2) The LMF provides the requested assistance data in a LPP Provide Assistance Data message, if available at the LMF. The entire set of assistance data may be delivered in one or several LPP messages. In this case, this step may be repeated by the LMF several times. If any of the UE requested assistance data in step (1) are not provided in step 2, the UE shall assume that the requested assistance data are not supported, or currently not available at the LMF. If none of the UE requested assistance data in step (1) can be provided by the LMF, return any information that can be provided in an LPP message of type Provide Assistance Data which includes a cause indication for the not provided assistance data.

### 8.4.3.3 Location Information Transfer Procedure

The purpose of this procedure is to enable the LMF to request barometric pressure sensor measurements or position estimate from the UE, or to enable the UE to provide barometric pressure sensor measurements to the LMF for position calculation.

#### 8.4.3.3.1 LMF initiated Location Information Transfer Procedure

Figure 8.4.3.3.1-1 shows the Location Information Transfer operations when the procedure is initiated by the LMF.



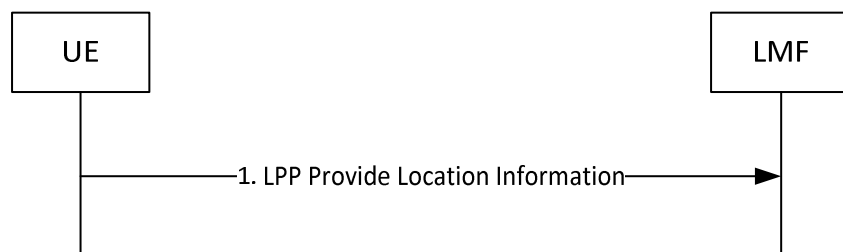
**Figure 8.4.3.3.1-1: LMF-initiated Location Information Transfer Procedure**

- (1) The LMF sends a LPP Request Location Information message to the UE for invocation of barometric pressure sensor positioning. This request includes positioning instructions such as the positioning mode (UE-assisted, UE-based, standalone), specific requested UE measurements if any, and quality of service parameters (accuracy, response time).
- (2) The UE performs the requested measurements and possibly calculates its own position. The UE sends an LPP Provide Location Information message to the LMF before the Response Time provided in step (1) elapsed. If the UE is unable to perform the requested measurements, or if the Response Time provided in step 1 elapsed before any of the requested measurements have been obtained, the UE returns any information that can be provided in

an LPP message of type Provide Location Information which includes a cause indication for the not provided location information.

#### 8.4.3.3.2 UE-initiated Location Information Delivery Procedure

Figure 8.4.3.3.2-1 shows the Location Information delivery operations for the barometric pressure sensor method when the procedure is initiated by the UE.



**Figure 8.4.3.3.2-1: UE-initiated Location Information Delivery Procedure**

- (1) The UE sends an LPP Provide Location Information message to the LMF. The Provide Location Information message may include UE barometric pressure sensor measurements or location estimate already available at the UE.

## 8.5 WLAN positioning

### 8.5.1 General

In the WLAN positioning method, the UE position is estimated with the knowledge of geographical coordinate of reference WLAN access points. This is accomplished by collecting a certain amount of measurements from UE's WLAN receivers, and applying a location determination algorithm using databases of the estimated position's references points.

The UE WLAN measurements may include:

- WLAN Received Signal Strength (RSSI);
- Round Trip Time (RTT) between WLAN Access Point and the UE.

Three positioning modes are supported:

- *Standalone:*  
The UE performs WLAN position measurements and location computation, without network assistance.
- *UE-assisted:*  
The UE provides WLAN position measurements with or without assistance from the network to the LMF for computation of a location estimate by the network.
- *UE-based:*  
The UE performs WLAN position measurements and computation of a location estimate with network assistance.

### 8.5.2 Information to be transferred between NG-RAN/5GC Elements

This clause defines the information that may be transferred between LMF and UE.

### 8.5.2.1 Information that may be transferred from the LMF to UE

Table 8.5.2.1-1 lists assistance data for both UE-assisted and UE-based modes that may be sent from the LMF to the UE.

NOTE: The provision of these assistance data elements and the usage of these elements by the UE depend on the NG-RAN/5GC and UE capabilities, respectively.

**Table 8.5.2.1-1: Information that may be transferred from the LMF to UE**

Assistance Data
<b>WLAN AP List</b>
BSSID
SSID
AP Type Data <sup>(1)</sup>
AP Location
NOTE 1: WLAN AP Type Data may include WLAN Type (e.g., 802.11a/b/g/n/ac/ad, etc.), transmit power, antenna gain, coverage area, etc.

#### 8.5.2.1.1 WLAN AP BSSID

This assistance data provides the BSSID of the WLAN access point [21].

#### 8.5.2.1.2 WLAN AP SSID

This assistance data provides the SSID of the WLAN access point [21].

#### 8.5.2.1.3 WLAN AP Type Data

This assistance data provides additional information about the access point and may include WLAN Type (e.g., 802.11a/b/g/n/ac/ad, etc.), transmit power, antenna gain, coverage area, etc. [21]

#### 8.5.2.1.4 WLAN AP Location

This assistance data provides the location (possibly including altitude information) of the access point [21].

### 8.5.2.2 Information that may be transferred from the UE to LMF

The information that may be signalled from the UE to the LMF is summarized in Table 8.5.2.2-1.

**Table 8.5.2.2-1: Information that may be transferred from the UE to the LMF**

Information	UE-Assisted	UE-based/ Standalone
<b>WLAN Location Information</b>		
BSSID	Yes	No
SSID	Yes	No
Received Signal Strength (RSSI)	Yes	No
Round Trip Time (RTT)	Yes	No
Time Stamp	Yes	No
Measurement characteristics	Yes	No
<b>UE Location Information</b>		
UE position estimate with uncertainty shape	No	Yes
Position Time Stamp	No	Yes
Location Source (method(s) used to compute location)	No	Yes

### 8.5.2.2.1 Standalone mode

In Standalone mode, the UE reports the latitude, longitude and possibly altitude, together with an estimate of the location uncertainty, if available.

The UE should also report an indication of WLAN method and possibly other positioning methods used to calculate a fix.

### 8.5.2.2.2 UE-assisted mode

In UE-assisted mode, the UE should report:

- The BSSID/SSID of the measured WLAN access points, and associated RSSI or RTT.

### 8.5.2.2.3 UE-based mode

In UE-based mode, the UE reports the latitude, longitude, and possibly altitude, together with an estimate of the location uncertainty, if available.

The UE should also report an indication that WLAN method is used and possibly other positioning methods used to calculate the fix.

## 8.5.3 WLAN Positioning Procedures

### 8.5.3.1 Capability Transfer Procedure

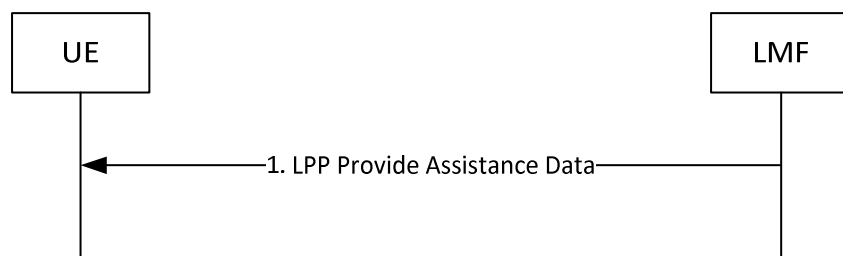
The Capability Transfer procedure for WLAN positioning is described in clause 7.1.2.1.

### 8.5.3.2 Assistance Data Transfer Procedure

The purpose of this procedure is to enable the UE to request assistance data from the LMF (e.g., as part of a positioning procedure) and the LMF to provide assistance data to the UE (e.g., as part of a positioning procedure).

#### 8.5.3.2.1 LMF initiated Assistance Data Delivery

Figure 8.5.3.2.1-1 shows the Assistance Data Delivery operations for the network-assisted WLAN method when the procedure is initiated by the LMF.

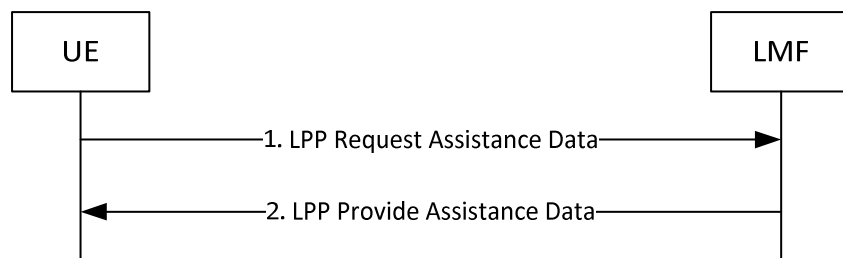


**Figure 8.5.3.2.1: LMF-initiated Assistance Data Delivery Procedure**

- (1) The LMF determines that assistance data needs to be provided to the UE (e.g., as part of a positioning procedure) and sends an LPP Provide Assistance Data message to the UE. This message may include any of the WLAN assistance data defined in clause 8.5.2.1.

#### 8.5.3.2.2 UE initiated Assistance Data Transfer

Figure 8.5.3.2.2-1 shows the Assistance Data Transfer operations for the network-assisted WLAN method when the procedure is initiated by the UE.



**Figure 8.5.3.2.2-1: UE-initiated Assistance Data Transfer Procedure**

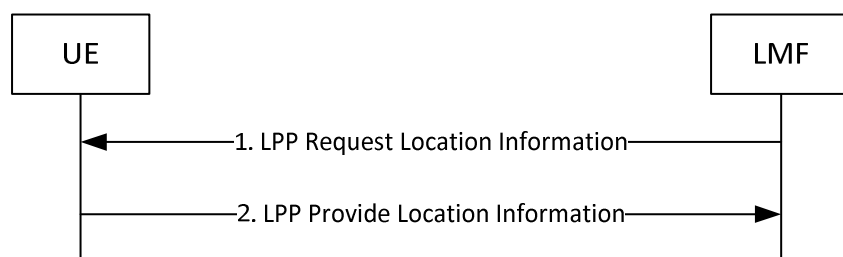
- (1) The UE determines that certain WLAN assistance data is desired (e.g., as part of a positioning procedure when the LMF provided assistance data are not sufficient for the UE to fulfil the request) and sends a LPP Request Assistance Data message to the LMF. This request includes an indication of which specific WLAN assistance data is requested.
- (2) The LMF provides the requested assistance data in a LPP Provide Assistance Data message, if available at the LMF. The entire set of assistance data may be delivered in one or several LPP messages. In this case, this step may be repeated by the LMF several times. If any of the UE requested assistance data in step (1) are not provided in step 2, the UE shall assume that the requested assistance data are not supported, or currently not available at the LMF. If none of the UE requested assistance data in step (1) can be provided by the LMF, return any information that can be provided in an LPP message of type Provide Assistance Data which includes a cause indication for the not provided assistance data.

### 8.5.3.3 Location Information Transfer Procedure

The purpose of this procedure is to enable the LMF to request position measurements or location estimate from the UE, or to enable the UE to provide location measurements to the LMF for position calculation.

#### 8.5.3.3.1 LMF initiated Location Information Transfer Procedure

Figure 8.5.3.3.1-1 shows the Location Information Transfer operations for the WLAN method when the procedure is initiated by the LMF.

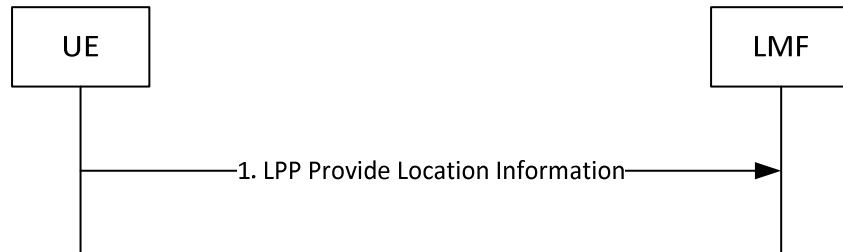


**Figure 8.5.3.3.1-1: LMF-initiated Location Information Transfer Procedure**

- (1) The LMF sends a LPP Request Location Information message to the UE for invocation of WLAN positioning. This request includes positioning instructions such as the positioning mode (UE-assisted, UE-based, Standalone), specific requested UE measurements if any, and quality of service parameters (accuracy, response time).
- (2) The UE performs the requested measurements and possibly calculates its own location. The UE sends an LPP Provide Location Information message to the LMF before the Response Time provided in step (1) elapsed. If the UE is unable to perform the requested measurements, or if the Response Time provided in step 1 elapsed before any of the requested measurements have been obtained, the UE returns any information that can be provided in an LPP message of type Provide Location Information which includes a cause indication for the not provided location information.

### 8.5.3.3.2 UE-initiated Location Information Delivery Procedure

Figure 8.5.3.3.2-1 shows the Location Information delivery operations for the WLAN method when the procedure is initiated by the UE.



**Figure 8.5.3.3.2-1: UE-initiated Location Information Delivery Procedure**

- (1) The UE sends an LPP Provide Location Information message to the LMF. The Provide Location Information message may include UE WLAN information or location estimate already available at the UE.

## 8.6 Bluetooth positioning

### 8.6.1 General

In the Bluetooth positioning method, the UE position is estimated with the knowledge of geographical coordinate of reference Bluetooth beacons. This is accomplished by collecting a certain amount of measurements from UE's Bluetooth receiver, and applying a location determination algorithm using databases of the estimated position's references points.

The UE Bluetooth measurements may include:

- Bluetooth beacon's Received Signal Strength (RSSI).

Two positioning modes are supported:

- *Standalone*:  
The UE performs Bluetooth position measurements and location computation.
- *UE-assisted*:  
The UE provides Bluetooth position measurements without assistance from the network to the LMF for computation of a location estimate by the network.

### 8.6.2 Information to be transferred between NG-RAN/5GC Elements

This clause defines the information that may be transferred between LMF and UE.

#### 8.6.2.1 Information that may be transferred from the LMF to UE

Bluetooth positioning does not require any assistance data to be transferred from the LMF to the UE.

#### 8.6.2.2 Information that may be transferred from the UE to LMF

The information that may be signalled from the UE to the LMF is summarized in Table 8.6.2.2-1.

**Table 8.6.2.2-1: Information that may be transferred from the UE to the LMF**

Information	UE-Assisted	Standalone
<b>Bluetooth Location Information</b>		
MAC Address	Yes	No
Received Signal Strength (RSSI)	Yes	No
Time Stamp	Yes	No
Measurement characteristics	Yes	No
<b>UE Location Information</b>		
UE position estimate with uncertainty shape	No	Yes
Position Time Stamp	No	Yes
Location Source (method(s) used to compute location)	No	Yes

#### 8.6.2.2.1 Standalone mode

In Standalone mode, the UE reports the latitude, longitude and possibly altitude, together with an estimate of the location uncertainty, if available.

The UE should also report an indication of Bluetooth method and possibly other location methods have been used to calculate a fix.

#### 8.6.2.2.2 UE-assisted mode

In UE-assisted mode, the UE should report:

- The MAC addresses of the measured Bluetooth beacons and associated RSSI.

### 8.6.3 Bluetooth Positioning Procedures

#### 8.6.3.1 Capability Transfer Procedure

The Capability Transfer procedure for Bluetooth positioning is described in clause 7.1.2.1.

#### 8.6.3.2 Assistance Data Transfer Procedure

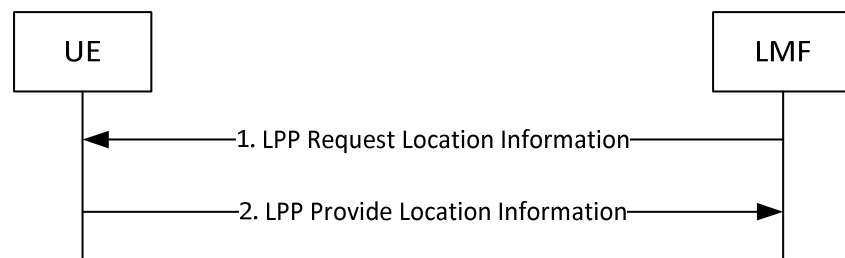
Assistance data transfer is not required for Bluetooth positioning.

#### 8.6.3.3 Location Information Transfer Procedure

The purpose of this procedure is to enable the LMF to request position measurements or location estimate from the UE, or to enable the UE to provide location measurements to the LMF for position calculation.

##### 8.6.3.3.1 LMF initiated Location Information Transfer Procedure

Figure 8.6.3.3.1-1 shows the Location Information Transfer operations for the Bluetooth method when the procedure is initiated by the LMF.

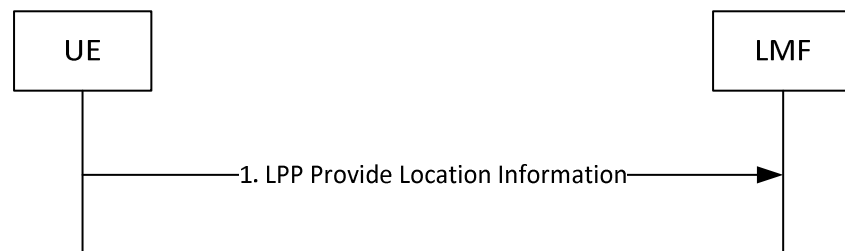


**Figure 8.6.3.3.1-1: LMF-initiated Location Information Transfer Procedure**

- (1) The LMF sends a LPP Request Location Information message to the UE for invocation of Bluetooth positioning. This request includes positioning instructions such as the positioning mode (UE-assisted, Standalone), specific requested UE measurements if any, and quality of service parameters (accuracy, response time).
- (2) The UE performs the requested measurements and possibly calculates its own location. The UE sends an LPP Provide Location Information message to the LMF before the Response Time provided in step (1) elapsed. If the UE is unable to perform the requested measurements, or if the Response Time provided in step 1 elapsed before any of the requested measurements have been obtained, the UE returns any information that can be provided in an LPP message of type Provide Location Information which includes a cause indication for the not provided location information.

### 8.6.3.3.2 UE-initiated Location Information Delivery Procedure

Figure 8.6.3.3.2-1 shows the Location Information delivery operations for the Bluetooth method when the procedure is initiated by the UE.



**Figure 8.6.3.3.2-1: UE-initiated Location Information Delivery Procedure**

- (1) The UE sends an LPP Provide Location Information message to the LMF. The Provide Location Information message may include UE Bluetooth information or location estimate already available at the UE.

## 8.7 TBS positioning

### 8.7.1 General

Terrestrial Beacon Systems (TBS) is the standard generic term for a network of ground-based transmitters broadcasting signals for geo-spatial positioning with wide-area or regional coverage. The following TBSs are supported in this version of the specification:

- Metropolitan Beacon Systems (MBS).

NOTE: PRS-based TBS is part of downlink OTDOA positioning and described in clause 8.2.

Three positioning modes are supported:



- *UE-Assisted*: The UE performs TBS measurements with or without assistance from the network, and sends these measurements to the LMF where the position calculation takes place, possibly using additional measurements from other (non-TBS) sources;
- *UE-Based*: The UE performs TBS measurements and calculates its own location, possibly using additional measurements from other (non-TBS) sources.
- *Standalone*: The UE performs TBS measurements and calculates its own location, possibly using additional measurements from other (non-TBS) sources, without network assistance.

## 8.7.2 Information to be transferred between NG-RAN/5GC Elements

This clause defines the information that may be transferred between LMF and UE.

### 8.7.2.1 Information that may be transferred from the LMF to UE

Table 8.7.2.1-1 lists assistance data for both UE-assisted and UE-based modes that may be sent from the LMF to the UE.

NOTE: The provision of these assistance data elements and the usage of these elements by the UE depend on the NG-RAN/5GC and UE capabilities, respectively.

**Table 8.7.2.1-1: Information that may be transferred from the LMF to UE**

Assistance Data
Acquisition assistance
Almanac

#### 8.7.2.1.1 Acquisition Assistance

Acquisition assistance provides the MBS receiver with information about visible beacons, PN Codes, and other information of the MBS signals to enable a fast acquisition of the MBS signals.

#### 8.7.2.1.2 Almanac

Almanac assistance provides the MBS receiver with MBS beacon parameters that can be used to determine the UE position.

### 8.7.2.2 Information that may be transferred from the UE to LMF

The information that may be signalled from the UE to the LMF is summarized in Table 8.7.2.2-1.

**Table 8.7.2.2-1: Information that may be transferred from UE to the LMF**

Information	UE-assisted	UE-based/ Standalone
UE position estimate with uncertainty shape	No	Yes
Timestamp	Yes	Yes
Indication of used positioning methods in the fix	No	Yes
TBS measurements (code phase (MBS))	Yes	No
Measurement quality parameters for each measurement	Yes	No

#### 8.7.2.2.1 Standalone mode

In Standalone mode, the UE reports the latitude, longitude and possibly altitude, together with an estimate of the location uncertainty, if available.

The UE should also report an indication that TBS method is used and possibly other positioning methods used to calculate the fix.

### 8.7.2.2.2 UE-assisted mode

In UE-assisted mode, the UE reports the TBS associated measurements, together with associated quality estimates. These measurements enable the LMF to calculate the location of the UE, possibly using other measurements and data.

### 8.7.2.2.3 UE-based mode

In UE-based mode, the UE reports the latitude and longitude, together with an estimate of the location uncertainty, if available.

The UE should also report an indication that TBS method is used and possibly other positioning methods used to calculate the fix.

## 8.7.3 TBS Positioning Procedures

### 8.7.3.1 Capability Transfer Procedure

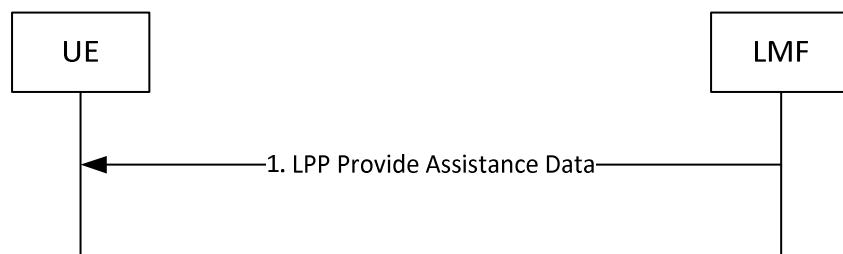
The Capability Transfer procedure for TBS positioning is described in clause 7.1.2.1.

### 8.7.3.2 Assistance Data Transfer Procedure

The purpose of this procedure is to enable the LMF to provide assistance data to the UE (e.g., as part of a positioning procedure) and the UE to request assistance data from the LMF (e.g., as part of a positioning procedure).

#### 8.7.3.2.1 LMF initiated Assistance Data Delivery

Figure 8.7.3.2.1-1 shows the Assistance Data Delivery operations for the network-assisted TBS method when the procedure is initiated by the LMF.

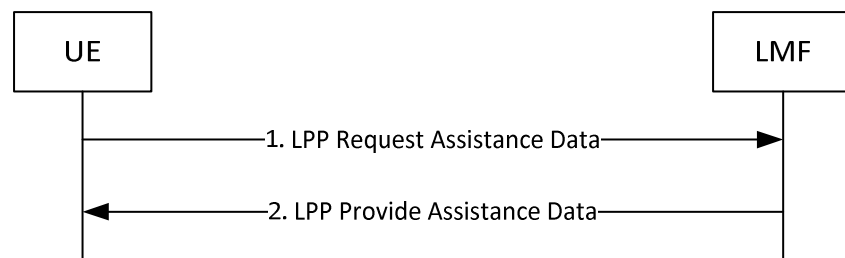


**Figure 8.7.3.2.1-1: LMF-initiated Assistance Data Delivery Procedure**

- (1) The LMF determines that assistance data needs to be provided to the UE (e.g., as part of a positioning procedure) and sends an LPP Provide Assistance Data message to the UE. This message may include any of the TBS assistance data defined in clause 8.7.2.1.

#### 8.7.3.2.2 UE initiated Assistance Data Transfer

Figure 8.7.3.2.2-1 shows the Assistance Data Transfer operations for the network-assisted TBS method when the procedure is initiated by the UE.



**Figure 8.7.3.2.2-1: UE-initiated Assistance Data Transfer Procedure**

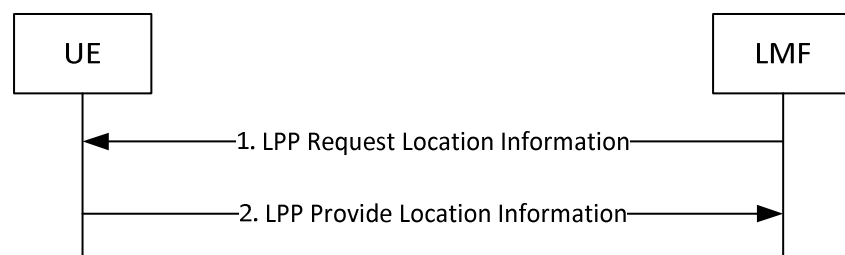
- (1) The UE determines that certain TBS assistance data is desired (e.g., when the LMF provided assistance data are not sufficient for the UE to fulfil the request) and sends a LPP Request Assistance Data message to the LMF. This request includes an indication of which specific TBS assistance data is requested.
- (2) The LMF provides the requested assistance data in a LPP Provide Assistance Data message, if available at the LMF. The entire set of assistance data may be delivered in one or several LPP messages. In this case, this step may be repeated by the LMF several times. If any of the UE requested assistance data in step (1) are not provided in step 2, the UE shall assume that the requested assistance data are not supported, or currently not available at the LMF. If none of the UE requested assistance data in step (1) can be provided by the LMF, return any information that can be provided in an LPP message of type Provide Assistance Data which includes a cause indication for the not provided assistance data.

### 8.7.3.3 Location Information Transfer Procedure

The purpose of this procedure is to enable the LMF to request position measurements or location estimate from the UE, or to enable the UE to provide location measurements to the LMF for position calculation.

#### 8.7.3.3.1 LMF initiated Location Information Transfer Procedure

Figure 8.7.3.3.1-1 shows the Location Information Transfer operations for the TBS method when the procedure is initiated by the LMF.

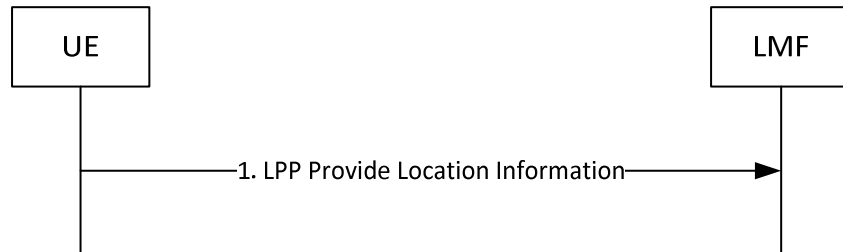


**Figure 8.7.3.3.1-1: LMF-initiated Location Information Transfer Procedure**

- (1) The LMF sends a LPP Request Location Information message to the UE for invocation of TBS positioning. This request includes positioning instructions such as the positioning mode (UE-assisted, UE-based, Standalone), specific requested UE measurements if any, and quality of service parameters (accuracy, response time).
- (2) The UE performs the requested measurements and possibly calculates its own location. The UE sends an LPP Provide Location Information message to the LMF before the Response Time provided in step (1) elapsed. If the UE is unable to perform the requested measurements, or if the Response Time provided in step 1 elapsed before any of the requested measurements have been obtained, the UE returns any information that can be provided in an LPP message of type Provide Location Information which includes a cause indication for the not provided location information.

### 8.7.3.3.2 UE-initiated Location Information Delivery Procedure

Figure 8.7.3.3.2-1 shows the Location Information delivery operations for the TBS method when the procedure is initiated by the UE.



**Figure 8.7.3.3.2-1: UE-initiated Location Information Delivery Procedure**

- (1) The UE sends an LPP Provide Location Information message to the LMF. The Provide Location Information message may include UE TBS measurements or location estimate already available at the UE.

## 8.8 Motion sensor positioning method

### 8.8.1 General

Motion sensors can be used to estimate the location of the UE. With the combination of other positioning methods (hybrid) a more accurate position of the UE can be computed. UE using one or more motion sensors provides the movement information. The movement information comprises displacement results estimated as an ordered series of points.

The positioning modes supported are UE-Assisted, UE-Based, and Standalone.

### 8.8.2 Information to be transferred between NG-RAN/5GC Elements

#### 8.8.2.1 General

This clause defines the information (e.g., assistance data, position and/or measurement data) that may be transferred between NG-RAN/5GC elements.

#### 8.8.2.2 Information that may be transferred from the UE to LMF

The information transferred from the UE to the LMF consists of capability information and location measurements or UE position. The supported information elements are given in Table 8.8.2.2-1.

**Table 8.8.2.2-1: Sensor Measurement Information that may be transferred from UE to the LMF**

Information	UE-assisted	UE-based/ Standalone
Displacement Timestamp	Yes	Yes
Displacement Information	Yes	Yes
Reference Position	Yes	Yes
Reference Time	Yes	Yes

#### 8.8.2.2.1 UE-assisted, UE-based, Standalone mode

In the UE-assisted, UE-Based, and Standalone mode, the UE reports, displacement information, displacement timestamp, reference position and reference time.

### 8.8.2.2.2 UE Displacement and Movement Information

The UE may report movement and displacement information which comprises an ordered series of direction, distance travelled by the target device and the time intervals when these measurements are taken.

### 8.8.2.3 Information that may be transferred from the LMF to the UE

In this release, no information, e.g. assistance data is transferred to the UE.

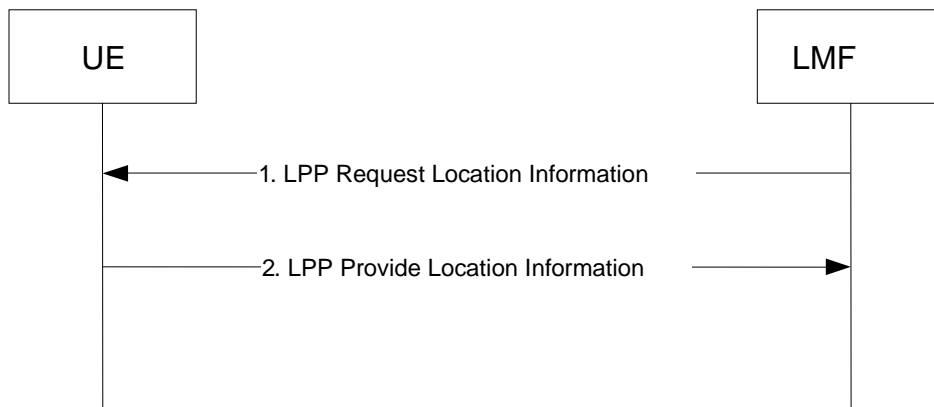
## 8.8.3 Motion Sensors Location Information Transfer Procedure

### 8.8.3.1 General

The purpose of this procedure is to enable the LMF to request additional sensor measurements or to enable the UE to provide sensor measurements to the LMF for position calculation.

### 8.8.3.2 LMF initiated Location Information Transfer Procedure

Figure 8.8.3.2-1 shows the Location Information Transfer operations when the procedure is initiated by the LMF.

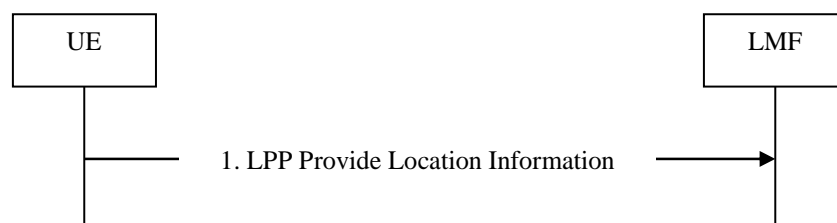


**Figure 8.8.3.2-1: LMF-initiated Location Information Transfer Procedure**

- (1) The LMF sends a LPP Request Location Information message to the UE for invocation of motion sensor positioning. This request includes positioning instructions such as the positioning mode, specific requested UE measurements if any, and quality of service parameters (accuracy, response time).
- (2) The UE performs the requested measurements. The UE sends an LPP Provide Location Information message to the LMF before the Response Time provided in step (1) elapsed. If the UE is unable to perform the requested measurements, or if the Response Time provided in step 1 elapsed before any of the requested measurements have been obtained, the UE returns any information that can be provided in an LPP message of type Provide Location Information which includes a cause indication for the not provided location information.

### 8.8.3.3 UE-initiated Location Information Delivery Procedure

Figure 8.8.3.3-1 shows the Location Information delivery operations for motion sensor method when the procedure is initiated by the UE.



**Figure 8.8.3.3-1: UE-initiated Location Information Delivery Procedure**

- (1) The UE sends an LPP Provide Location Information message to the LMF. The Provide Location Information message may include UE sensor measurements or location estimate already available at the UE.

## 8.9 NR Enhanced cell ID positioning methods

### 8.9.1 General

NR Enhanced Cell ID (NR E-CID) positioning refers to techniques which use UE and/or NR radio resource related measurements to improve the UE location estimate.

**NOTE:** For NR E-CID positioning methods the UE reports only the measurements that it has available rather than being required to take additional measurement actions. Therefore, the measurement gap request procedure described in clause 7.4.1.1 is not applicable for NR E-CID positioning methods.

NR E-CID measurements may include:

UE measurements (TS 38.215 [37]):

- SS Reference signal received power (SS-RSRP);
- SS Reference Signal Received Quality (SS-RSRQ);
- CSI Reference signal received power (CSI-RSRP);
- CSI Reference Signal Received Quality (CSI-RSRQ).

The UE measurements above may be aggregated at cell level, or measured per SSB or CSI-RS resource.

Various techniques exist to use these measurements to estimate the location of the UE. The specific techniques are beyond the scope of this specification.

### 8.9.2 Information to be transferred between NG-RAN/5GC Elements

This clause defines the information that may be transferred between LMF and UE.

#### 8.9.2.1 Information that may be transferred from the LMF to UE

UE-assisted NR Enhanced Cell-ID location does not require any assistance data to be transferred from the LMF to the UE.

UE-Based NR Enhanced Cell-ID location is not supported in this version of the specification.

#### 8.9.2.2 Information that may be transferred from the UE to LMF

The information that may be signalled from UE to the LMF is listed in table 8.9.2.2-1.

**Table 8.9.2.2-1: Information that may be transferred from UE to the LMF**

Information	UE-assisted
SS Reference signal received power (SS-RSRP)	Yes
SS Reference Signal Received Quality (SS-RSRQ)	Yes
CSI Reference signal received power (CSI-RSRP)	Yes
CSI Reference Signal Received Quality (CSI-RSRQ)	Yes
NR Cell Global Identifier, Physical Cell ID	Yes

### 8.9.3 NR E-CID Positioning Procedures

The procedures described in this clause support NR E-CID related measurements obtained by the UE and provided to the LMF using LPP.

### 8.9.3.1 Capability Transfer Procedure

The Capability Transfer procedure for NR E-CID positioning is described in clause 7.1.2.1.

### 8.9.3.2 Assistance Data Transfer Procedure

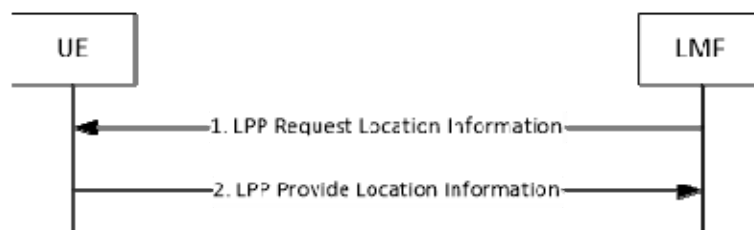
Assistance data transfer is not required for NR E-CID positioning.

### 8.9.3.3 Location Information Transfer Procedure

The purpose of this procedure is to enable the LMF to request position measurements from the UE, or to enable the UE to provide location measurements to the LMF for position calculation.

#### 8.9.3.3.1 LMF-initiated Location Information Transfer from UE

Figure 8.9.3.3-1 shows the Location Information Transfer operations for the NR E-CID method from UE when the procedure is initiated by the LMF.



**Figure 8.9.3.3.1-1: LMF-initiated Location Information Transfer Procedure.**

- (1) The LMF sends a LPP Request Location Information message to the UE for invocation of NR E-CID positioning. This request includes the NR E-CID measurements requested by the LMF and supported by the UE as listed in Table 8.9.2.2-1 together with a required response time.
- (2) The UE performs the requested measurements and sends an LPP Provide Location Information message to the LMF before the Response Time provided in step (1) elapsed. If the UE is unable to perform the requested measurements, or if the Response Time provided in step 1 elapsed before any of the requested measurements have been obtained, the UE returns any information that can be provided in an LPP message of type Provide Location Information which includes a cause indication for the not provided location information.

#### 8.9.3.3.2 UE-initiated Location Information Delivery procedure

Figure 8.9.3.3.2-1 shows the Location Information Delivery procedure operations for the NR E-CID method when the procedure is initiated by the UE.



**Figure 8.9.3.3.2-1: UE-initiated Location Information Delivery Procedure.**

- (1) The UE sends an LPP Provide Location Information message to the LMF. The Provide Location Information message may include any UE measurements already available at the UE.

## 8.10 Multi-RTT positioning

### 8.10.1 General

In the Multi-RTT positioning method, the UE position is estimated based on measurements performed at both, UE and TRPs. The measurements performed at the UE and TRPs are UE/gNB Rx-Tx time difference measurements (and optionally DL-PRS-RSRP and UL-SRS-RSRP) of DL-PRS and UL-SRS, which are used by an LMF to determine the RTTs.

The UE may require measurement gaps to perform the Multi-RTT measurements from NR TRPs. The UE may request measurement gaps from a gNB using the procedure described in clause 7.4.1.1.

### 8.10.2 Information to be transferred between NG-RAN/5GC Elements

This clause defines the information that may be transferred between LMF and UE/gNB.

#### 8.10.2.1 Information that may be transferred from the LMF to UE

The information that may be transferred from the LMF to the UE are listed in Table 8.10.2.1-1.

**Table 8.10.2.1-1: Information that may be transferred from LMF to the UE**

Information
Physical cell IDs (PCIs), global cell IDs (GCIs), and TRP IDs of candidate NR TRPs for measurement
Timing relative to the serving (reference) TRP of candidate NR TRPs
DL-PRS configuration of candidate NR TRPs
SSB information of the TRPs (the time/frequency occupancy of SSBs)

#### 8.10.2.2 Information that may be transferred from the UE to LMF

The information that may be signalled from UE to the LMF is listed in Table 8.10.2.2-1. The individual UE measurements are defined in TS 38.215 [37].

**Table 8.10.2.2-1: Information that may be transferred from UE to the LMF**

Information
PCI, GCI, and TRP ID for each measurement
DL-PRS-RSRP measurement
UE Rx-Tx time difference measurement
Time stamp of the measurement
Quality for each measurement

#### 8.10.2.3 Information that may be transferred from the gNB to LMF

The assistance data that may be transferred from gNB to the LMF is listed in Table 8.10.2.3-1.



**Table 8.10.2.3-1: Assistance data that may be transferred from gNB to the LMF**

Information
PCI, GCI, and TRP IDs of the TRPs served by the gNB
Timing information of TRPs served by the gNB
DL-PRS configuration of the TRPs served by the gNB
SSB information of the TRPs (the time/frequency occupancy of SSBs)
Spatial direction information of the DL-PRS Resources of the TRPs served by the gNB
Geographical coordinates of the TRPs served by the gNB (include a transmission reference location for each DL-PRS Resource ID, reference location for the transmitting antenna of the reference TRP, relative locations for transmitting antennas of other TRPs)

The configuration data for a target UE that may be transferred from the serving gNB to the LMF is listed in Table 8.10.2.3-2.

**Table 8.10.2.3-2: UL information/UE configuration data that may be transferred from serving gNB to the LMF**

UE configuration data
UE SRS configuration

The measurement results that may be signalled from gNBs to the LMF is listed in Table 8.10.2.3-3.

**Table 8.10.2.3-3: Measurement results that may be transferred from gNBs to the LMF**

Measurement results
PCI, GCI, and TRP ID of the measurement
gNB Rx-Tx time difference measurement
UL-SRS-RSRP
UL Angle of Arrival (azimuth and elevation)
Time stamp of the measurement
Quality for each measurement

#### 8.10.2.4 Information that may be transferred from the LMF to gNBs

The requested UL-SRS transmission characteristics information that may be signalled from the LMF to the gNB is listed in Table 8.10.2.4-1.

**Table 8.10.2.4-1: Requested UL-SRS transmission characteristics information that may be transferred from LMF to gNB.**

Information
Number Of Transmissions/duration for which the UL-SRS is requested
Bandwidth
Resource type (periodic, semi-persistent)
Pathloss reference: <ul style="list-style-type: none"> <li>- PCI, SSB Index</li> <li>- DL-PRS ID, DL-PRS Resource Set ID, DL-PRS Resource ID</li> </ul>
Spatial relation info <ul style="list-style-type: none"> <li>- PCI, SSB Index</li> <li>- DL-PRS ID, DL-PRS Resource Set ID, DL-PRS Resource ID</li> </ul>

The TRP measurement request information that may be signalled from the LMF to the gNBs is listed in Table 8.10.2.4-2.

**Table 8.10.2.4-2: TRP Measurement request information that may be transferred from LMF to gNBs.**

Information
PCI, GCI, and TRP ID of the TRP to receive UL-SRS
UE-SRS configuration
UL timing information together with timing uncertainty of candidate TRPs (search window), for reception of SRS by candidate TRPs
Start time, duration and report characteristics for the measurements

The UL-SRS activation/deactivation request information that may be signalled from the LMF to the gNB is listed in Table 8.10.2.4-3.

**Table 8.10.2.4-3: Requested UL-SRS activation/deactivation information that may be transferred from LMF to gNB.**

Information
SP UL-SRS: - Activation or Deactivation request - Positioning SRS Resource Set ID which is to be activated/deactivated - Spatial relation for Resource ID <sub>i</sub>

### 8.10.3 Multi-RTT Positioning Procedures

The procedures described in this clause support Multi-RTT positioning measurements obtained by the UE and TRPs/gNB.

#### 8.10.3.1 Procedures between LMF and UE

##### 8.10.3.1.1 Capability Transfer Procedure

The Capability Transfer procedure for Multi-RTT positioning is described in clause 7.1.2.1.

##### 8.10.3.1.2 Assistance Data Transfer Procedure

###### 8.10.3.1.2.1 Assistance Data Transfer between LMF and UE

The purpose of this procedure is to enable the LMF to provide assistance data to the UE (e.g., as part of a positioning procedure) and the UE to request assistance data from the LMF (e.g., as part of a positioning procedure).

###### 8.10.3.1.2.1.1 LMF initiated Assistance Data Delivery

Figure 8.10.3.1.2.1.1-1 shows the Assistance Data Delivery operations for the Multi-RTT positioning method when the procedure is initiated by the LMF.

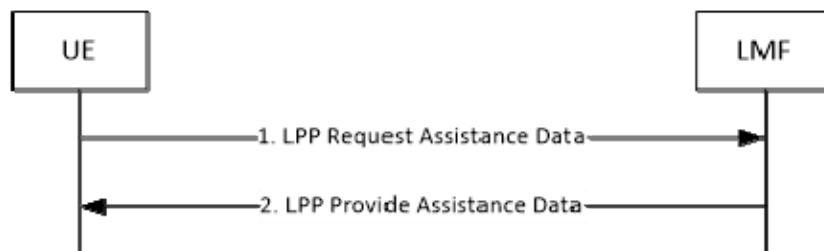


**Figure 8.10.3.1.2.1.1-1: LMF-initiated Assistance Data Delivery Procedure**

- (1) The LMF determines that assistance data needs to be provided to the UE (e.g., as part of a positioning procedure) and sends an LPP Provide Assistance Data message to the UE. This message may include any of the Multi-RTT positioning assistance data defined in Table 8.10.2.1-1.

#### 8.10.3.1.2.1.2 UE initiated Assistance Data Transfer

Figure 8.10.3.1.2.1.2-1 shows the Assistance Data Transfer operations for the Multi-RTT positioning method when the procedure is initiated by the UE.



**Figure 8.10.3.1.2.1.2-1: UE-initiated Assistance Data Transfer Procedure**

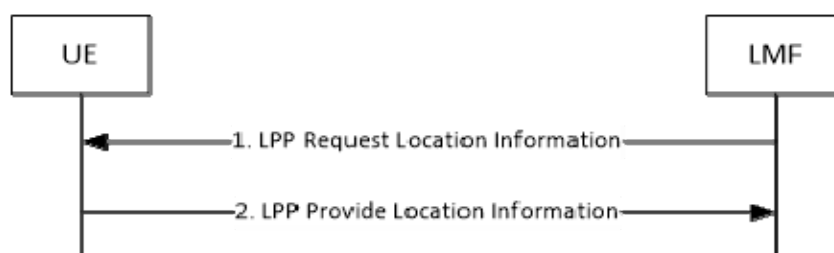
- (1) The UE determines that certain Multi-RTT positioning assistance data are desired (e.g., as part of a positioning procedure when the LMF provided assistance data are not sufficient for the UE to fulfil the request) and sends an LPP Request Assistance Data message to the LMF. This request includes an indication of which specific Multi-RTT assistance data are requested. Additional information concerning the UE's approximate location and serving and neighbour cells may also be provided in the Request Assistance Data message and/or in an accompanying Provide Location Information message to help the LMF provide appropriate assistance data. This additional data may include the UE's last known location if available, the cell IDs of the UE serving NG-RAN node and possibly neighbour NG-RAN nodes, as well as NR E-CID measurements.
- (2) The LMF provides the requested assistance in an LPP Provide Assistance Data message, if available at the LMF. If any of the UE requested assistance data in step (1) are not provided in step 2, the UE shall assume that the requested assistance data are not supported, or currently not available at the LMF. If none of the UE requested assistance data in step (1) can be provided by the LMF, return any information that can be provided in an LPP message of type Provide Assistance Data which includes a cause indication for the not provided assistance data.

#### 8.10.3.1.3 Location Information Transfer Procedure

The purpose of this procedure is to enable the LMF to request position measurements from the UE, or to enable the UE to provide location measurements to the LMF for position calculation.

##### 8.10.3.1.3.1 LMF-initiated Location Information Transfer Procedure

Figure 8.10.3.1.3.1-1 shows the Location Information Transfer operations for the Multi-RTT positioning method when the procedure is initiated by the LMF.

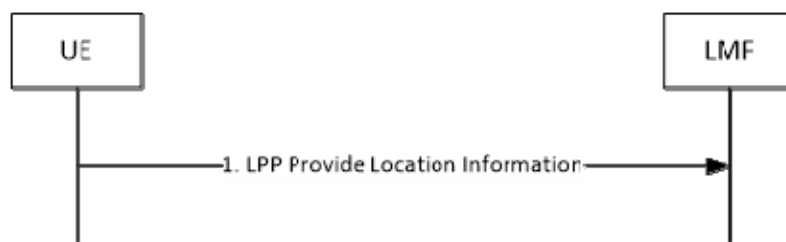


**Figure 8.10.3.1.3.1-1: LMF-initiated Location Information Transfer Procedure**

- (1) The LMF sends an LPP Request Location Information message to the UE. This request includes indication of Multi-RTT measurements requested, including any needed measurement configuration information, and required response time.
- (2) The UE obtains Multi-RTT measurements as requested in step 1. The UE then sends an LPP Provide Location Information message to the LMF, before the Response Time provided in step (1) elapsed, and includes the obtained Multi-RTT measurements. If the UE is unable to perform the requested measurements, or the Response Time elapsed before any of the requested measurements were obtained, the UE returns any information that can be provided in an LPP message of type Provide Location Information which includes a cause indication for the not provided location information.

8.10.3.1.3.2 UE-initiated Location Information Delivery procedure

Figure 8.10.3.1.3.2-1 shows the Location Information Delivery procedure operations for the Multi-RTT positioning method when the procedure is initiated by the UE.



**Figure 8.10.3.1.3.2-1: UE-initiated Location Information Delivery Procedure.**

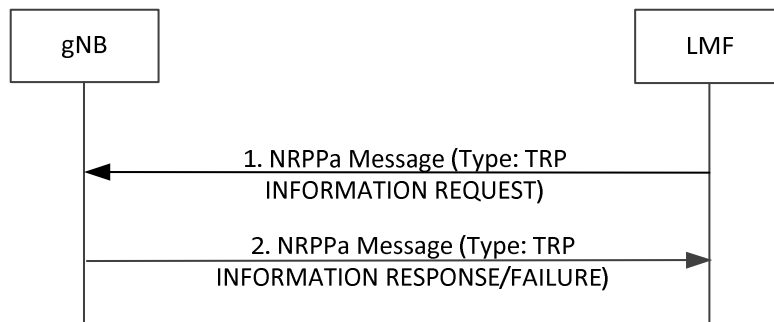
- (1) The UE sends an LPP Provide Location Information message to the LMF. The Provide Location Information message may include any UE Multi-RTT measurements already available at the UE.

8.10.3.2 Procedures between LMF and gNB

8.10.3.2.1 Assistance Data Delivery between LMF and gNB

The purpose of these procedures is to enable the gNB to provide assistance data described in Table 8.10.2.3-1 to the LMF, for subsequent delivery to the UE using the procedures of clause 8.10.3.1.2.1 or for use in the calculation of positioning estimates at the LMF or enable the LMF to request UL-SRS configuration information from the serving gNB of a target UE.

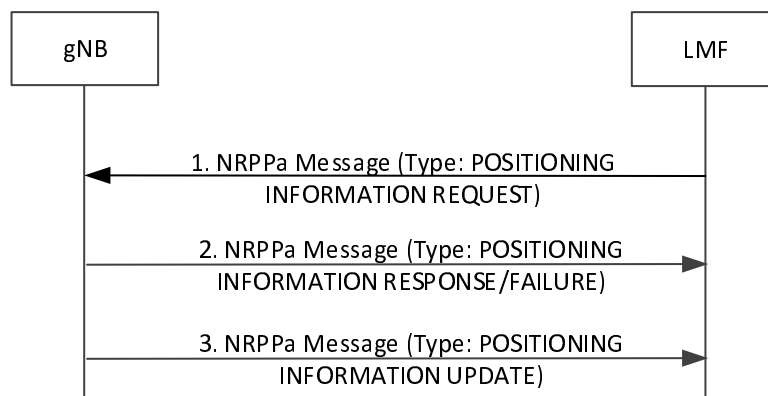
Figure 8.10.3.2.1-1 shows the TRP Information Exchange operation from the gNB to the LMF for the Multi-RTT positioning method.



**Figure 8.10.3.2.1-1: LMF-initiated TRP Information Exchange Procedure**

- (1) The LMF determines that certain TRP configuration information is desired (e.g., as part of a periodic update or as triggered by OAM) and sends an NRPPa TRP INFORMATION REQUEST message to the gNB. This request includes an indication of which specific TRP configuration information is requested.
- (2) The gNB provides the requested TRP information in an NRPPa TRP INFORMATION RESPONSE message, if available at the gNB. If the gNB is not able to provide any information, it returns an TRP INFORMATION FAILURE message indicating the cause of the failure.

Figure 8.10.3.2.1-2 shows the UL information Delivery operation from the serving gNB to the LMF.



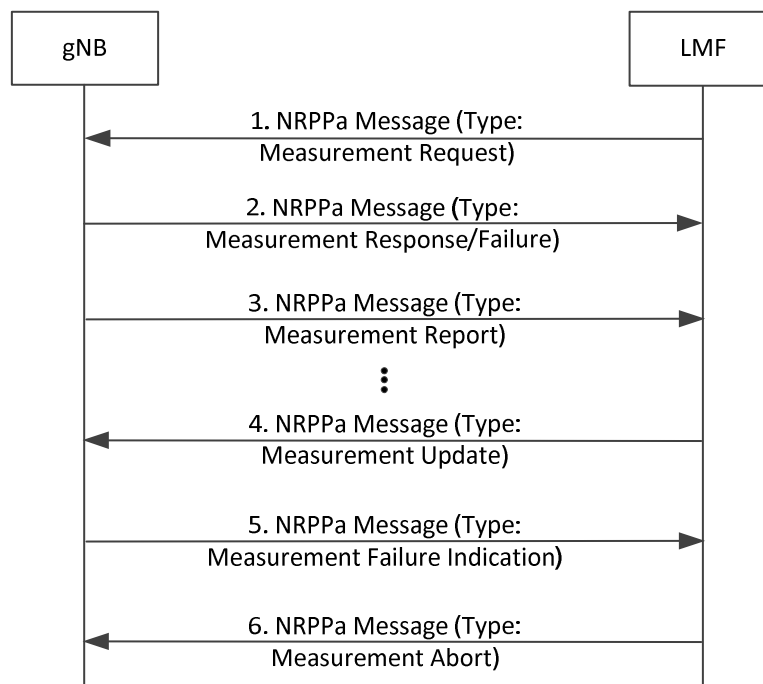
**Figure 8.10.3.2.1-2: LMF-initiated UL Information Request Procedure**

- (1) The LMF sends a NRPPa message POSITIONING INFORMATION REQUEST to the serving gNB of the target UE to request UE SRS configuration information. If the message includes the Requested UL-SRS Transmission Characteristics as listed in Table 8.10.2.4-1, the gNB should take this information into account when configuring UL-SRS transmissions for the UE.
- (2) The serving gNB determines the UE SRS configuration to be allocated for the UE and sends NRPPa message POSITIONING INFORMATION RESPONSE to the LMF that includes the UE SRS configuration defined in Table 8.10.2.3-2. If the serving gNB is not able to provide the requested information, it returns a failure message indicating the cause of the failure.
- (3) If a change has occurred in the UE SRS configuration during the UE SRS time duration requested at step 1, the gNB sends a POSITIONING INFORMATION UPDATE message to the LMF. This message contains, in the case of a change in UE SRS configuration parameters, the UE SRS configuration information for all cells with UE SRS configured, or an indication that the UE SRS configuration has been released in the UE.

### 8.10.3.2.2 Location Information Transfer/Assistance Data Transfer Procedure

The purpose of this procedure is to enable the LMF to request position measurements from a gNB for position calculation of the UE and also provide necessary assistance data to the gNB.

Figure 8.10.3.2.2-1 shows the messaging between the LMF and the gNB to perform this procedure.



**Figure 8.10.3.2.2-1: LMF-initiated Location Information Transfer Procedure**

(1) The LMF sends a NRPPa message to the selected gNB to request Multi-RTT measurement information. The message includes any information required for the gNB to perform the measurements as defined in Table 8.10.2.4-2.

(2) If the report characteristics in step 1 is set to "on demand", the gNB obtains the requested Multi-RTT measurements and returns them in a Measurement Response message to the LMF. The Measurement Response message includes the obtained Multi-RTT measurements as defined in Table 8.10.2.3-3.

If the report characteristics in step 1 is set to "periodic", the gNB replies with a Measurement Response message without including any measurements in the message. The gNB then periodically initiates the Measurement Report procedure in step 3 for the Multi-RTT measurements, with the requested reporting periodicity.

If the gNB is not able to accept the Measurement Request message in step 1, the gNB returns a failure message indicating the cause of the failure.

(3) The gNB periodically provides the Multi-RTT measurements as defined in Table 8.10.2.3-3. to the LMF if that was requested at step 1.

(4) At any time after step 2, the LMF may send a Measurement Update message to the gNB providing updated information required for the gNB to perform the Multi-RTT measurements as defined in Table 8.10.2.4-2. Upon receiving the message, the gNB overwrites the previously received measurement configuration information.

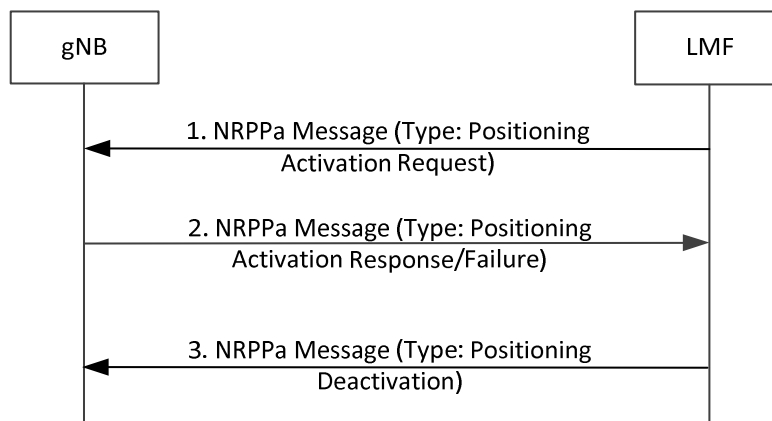
(5) If the previously requested Multi-RTT measurements can no longer be reported, the gNB notifies the LMF by sending a Measurement Failure Indication message.

(6) When the LMF wants to abort an ongoing Multi-RTT measurement it sends a Measurement Abort message to the gNB.

### 8.10.3.2.3 Positioning Activation/Deactivation Procedure

The purpose of this procedure is to enable the LMF to request activation and deactivation of UL-SRS transmission of the target UE.

Figure 8.10.3.2.3-1 shows the messaging between the LMF and the gNB to perform this procedure.

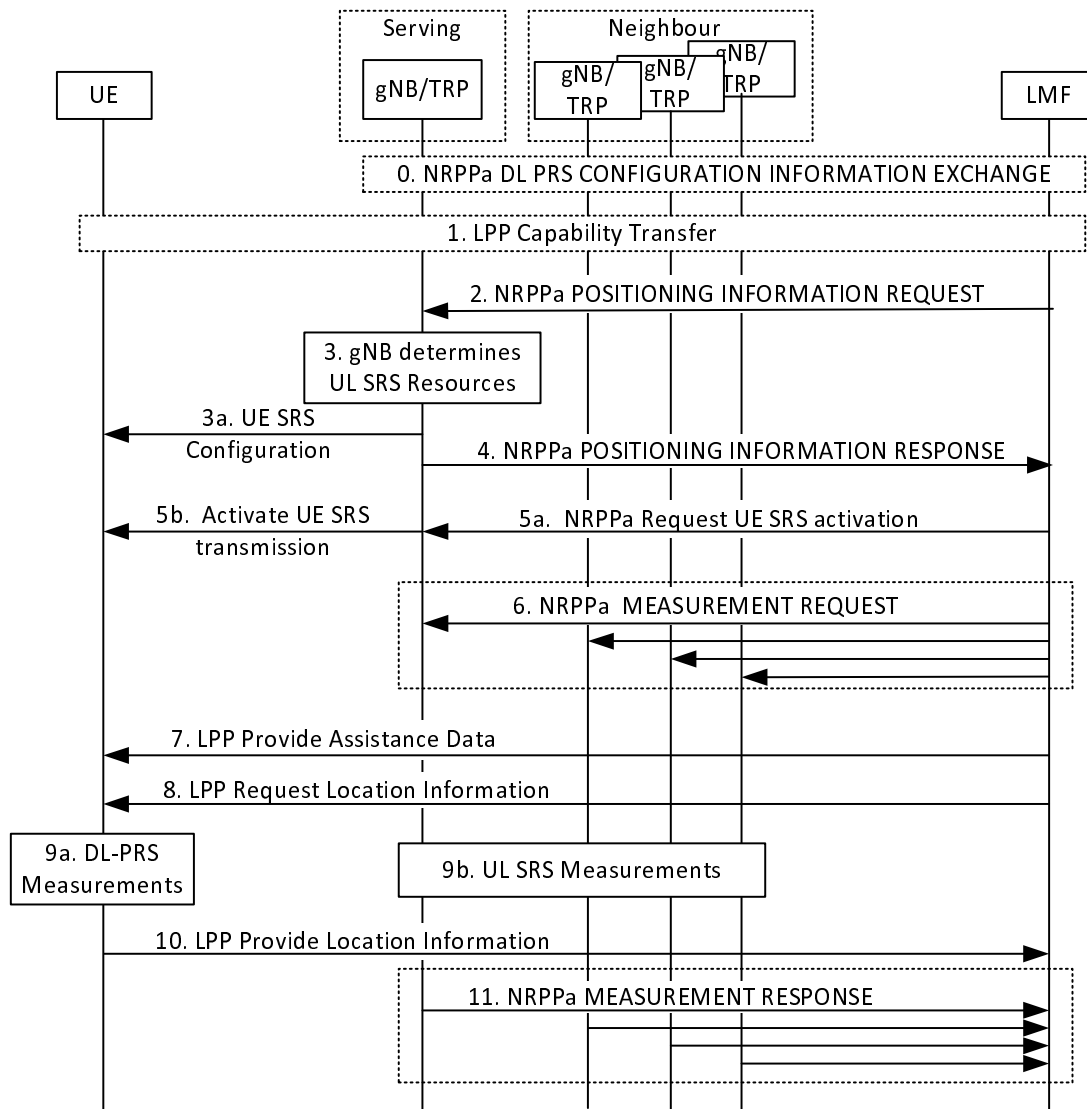


**Figure 8.10.3.2.3-1: Positioning Activation/Deactivation Procedure.**

- (1) The LMF sends a NRPPa message to the serving gNB of the target UE to request UL-SRS activation for the target UE. For a semi-persistent UL-SRS, the message includes an indication of an UL-SRS resource set to be activated and may include information that indicates the spatial relation for the semi-persistent UL-SRS resource to be activated, as listed in Table 8.10.2.4-3.
- (2) For semi-persistent UL-SRS, the serving gNB may then activate the configured semi-persistent UL-SRS resource sets by sending the SP Positioning SRS Activation/Deactivation MAC CE command as specified in TS 38.211 [39].  
If the UL-SRS has been successfully activated as requested in step 1, the gNB sends a NRPPa response message to the LMF. If the serving gNB is not able to fulfil the request from step 1, it returns a failure message indicating the cause of the failure.
- (3) If a previously activated UL-SRS should be deactivated, the LMF sends a NRPPa message to the serving gNB of the target device to request deactivation. This message includes an indication of the UL-SRS resource set to be deactivated.

## 8.10.4 Sequence of Procedure for Multi-RTT positioning

Figure 8.10.4-1 shows the messaging between the LMF, the gNBs and the UE to perform LMF-initiated Location Information Transfer Procedure for Multi-RTT.



**Figure 8.10.4-1: Multi-RTT positioning procedure**

0. The LMF may use the procedure in Figure 8.10.3.2.1-1 to obtain the TRP information required for Multi-RTT positioning.
1. The LMF may request the positioning capabilities of the target device using the LPP Capability Transfer procedure described in clause 8.10.3.1.1.
2. The LMF sends a NRPPa POSITIONING INFORMATION REQUEST message to the serving gNB to request UL information for the target device as described in Figure 8.10.3.2.1-2.
3. The serving gNB determines the resources available for UL-SRS and configures the target device with the UL-SRS resource sets at step 3a.
4. The serving gNB provides the UL-SRS configuration information to the LMF in a NRPPa POSITIONING INFORMATION RESPONSE message.

NOTE: It is up to implementation on whether SRS configuration is provided earlier than DL-PRS configuration.

5. The LMF may request activation of UE SRS transmission and sends a NRPPa SRS Activation Request message to the serving gNB of the target device as described in subclause 8.10.3.2.3. The gNB then activates the UE SRS transmission. The target device begins the UL-SRS transmission according to the time domain behavior of UL-SRS resource configuration.



6. The LMF provides the UL information to the selected gNBs in a NRPPa MEASUREMENT REQUEST message as described in clause 8.10.3.2.2. The message includes all information required to enable the gNBs/TRPs to perform the UL measurements.
7. The LMF sends a LPP Provide Assistance Data message to the target device as described in subclause 8.10.3.1.2.1. The message includes any required assistance data for the target device to perform the necessary DL-PRS measurements.
8. The LMF sends a LPP Request Location Information message to request Multi-RTT measurements.
- 9a: The target device performs the DL-PRS measurements from all gNBs provided in the assistance data at step 7.
- 9b: Each gNB configured at step 6 measures the UE SRS transmissions from the target device.
10. The target device reports the DL-PRS measurements for Multi-RTT to the LMF in a LPP Provide Location Information message.
11. Each gNB reports the UE SRS measurements to the LMF in a NRPPa Measurement Response message as described in clause 8.10.3.2.2.
12. The LMF determines the RTTs from the UE and gNB Rx-Tx time difference measurements for each gNB for which corresponding UL and DL measurements were provided at steps 10 and 11 and calculates the position of the target device.

## 8.11 DL-AoD positioning

### 8.11.1 General

In the DL-AoD positioning method, the UE position is estimated based on DL-PRS-RSRP measurements taken at the UE of downlink radio signals from multiple NR TRPs, along with knowledge of the spatial information of the downlink radio signals and geographical coordinates of the TRPs.

The UE while connected to a gNB may require measurement gaps to perform the DL-AoD measurements from NR TRPs. The UE may request measurement gaps from a gNB using the procedure described in clause 7.4.1.1.

The specific positioning techniques used to estimate the UE's location from this information are beyond the scope of this specification.

### 8.11.2 Information to be transferred between NG-RAN/5GC Elements

This clause defines the information that may be transferred between LMF and UE/gNB.

#### 8.11.2.1 Information that may be transferred from the LMF to UE

The information that may be transferred from the LMF to the UE are listed in table 8.11.2.1-1.

**Table 8.11.2.1-1: Information that may be transferred from LMF to the UE**

Information	UE-assisted	UE-based
Physical cell IDs (PCIs), global cell IDs (GCIs), and TRP IDs of candidate NR TRPs for measurement	Yes	Yes
Timing relative to the serving (reference) TRP of candidate NR TRPs	Yes	Yes
DL-PRS configuration of candidate NR TRPs	Yes	Yes
SSB information of the TRPs (the time/frequency occupancy of SSBs)	Yes	Yes
Spatial direction information (e.g. azimuth, elevation etc.) of the DL-PRS Resources of the TRPs served by the gNB	No	Yes
Geographical coordinates of the TRPs served by the gNB (include a transmission reference location for each DL-PRS Resource ID, reference location for the transmitting antenna of the reference TRP, relative locations for transmitting antennas of other TRPs)	No	Yes

### 8.11.2.2 Information that may be transferred from the UE to LMF

The information that may be signalled from UE to the LMF is listed in Table 8.11.2.2-1. The individual UE measurements are defined in TS 38.215 [37].

**Table 8.11.2.2-1: Information that may be transferred from UE to the LMF**

Information	UE-assisted	UE-based
Latitude/Longitude/Altitude, together with uncertainty shape	No	Yes
PCI, GCI, and TRP ID for each measurement	Yes	No
DL-PRS-RSRP measurement	Yes	No
Time stamp of the measurements	Yes	No
Time stamp of location estimate	No	Yes
DL-PRS receive beam index	Yes	No

### 8.11.2.3 Information that may be transferred from the gNB to LMF

The assistance data that may be transferred from gNB to the LMF is listed in table 8.11.2.3-1.

**Table 8.11.2.3-1: Assistance data that may be transferred from gNB to the LMF**

Information
PCI, GCI, and TRP IDs of the TRPs served by the gNB
Timing information of TRPs served by the gNB
DL-PRS configuration of the TRPs served by the gNB
SSB information of the TRPs (the time/frequency occupancy of SSBs)
Spatial direction information (e.g. azimuth, elevation etc.) of the DL-PRS Resources of the TRPs served by the gNB
Geographical coordinates of the TRPs served by the gNB (include a transmission reference location for each DL-PRS Resource ID, reference location for the transmitting antenna of the reference TRP, relative locations for transmitting antennas of other TRPs)

## 8.11.3 DL-AoD Positioning Procedures

The procedures described in this clause support UE-assisted and UE-based DL-AoD.

### 8.11.3.1 Procedures between LMF and UE

#### 8.11.3.1.1 Capability Transfer Procedure

The Capability Transfer procedure for DL-AoD positioning is described in clause 7.1.2.1.

#### 8.11.3.1.2 Assistance Data Transfer Procedure

The purpose of this procedure is to enable the LMF to provide assistance data to the UE (e.g., as part of a positioning procedure) and the UE to request assistance data from the LMF (e.g., as part of a positioning procedure).

##### 8.11.3.1.2.1 LMF initiated Assistance Data Delivery

Figure 8.11.3.1.2.1-1 shows the Assistance Data Delivery operations for the DL-AoD positioning method when the procedure is initiated by the LMF.

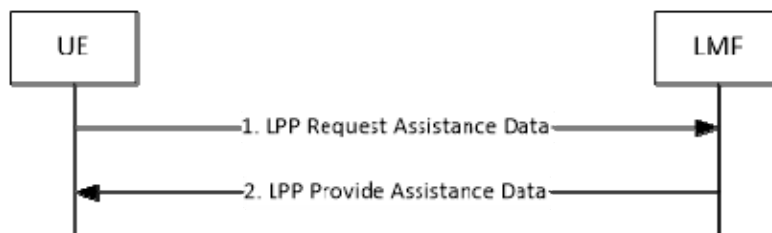


**Figure 8.11.3.1.2.1-1: LMF-initiated Assistance Data Delivery Procedure**

- (1) The LMF determines that assistance data needs to be provided to the UE (e.g., as part of a positioning procedure) and sends an LPP Provide Assistance Data message to the UE. This message may include any of the DL-AoD positioning assistance data defined in Table 8.11.2.1-1.

#### 8.11.3.1.2.2 UE initiated Assistance Data Transfer

Figure 8.11.3.1.2.2-1 shows the Assistance Data Transfer operations for the DL-AoD positioning method when the procedure is initiated by the UE.



**Figure 8.11.3.1.2.2-1: UE-initiated Assistance Data Transfer Procedure**

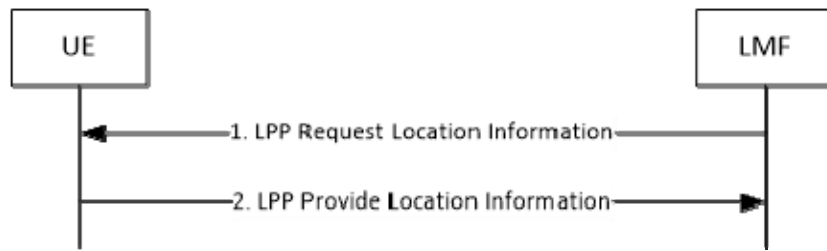
- (1) The UE determines that certain DL-AoD positioning assistance data are desired (e.g., as part of a positioning procedure when the LMF provided assistance data are not sufficient for the UE to fulfil the request) and sends an LPP Request Assistance Data message to the LMF. This request includes an indication of which specific DL-AoD assistance data are requested. Additional information concerning the UE's approximate location and serving and neighbour cells may also be provided in the Request Assistance Data message and/or in an accompanying Provide Location Information message to help the LMF provide appropriate assistance data. This additional data may include the UE's last known location if available, the cell IDs of the UE serving NG-RAN node and possibly neighbour NG-RAN nodes, as well as NR E-CID measurements.
- (2) The LMF provides the requested assistance in an LPP Provide Assistance Data message, if available at the LMF. If any of the UE requested assistance data in step (1) are not provided in step 2, the UE shall assume that the requested assistance data are not supported, or currently not available at the LMF. If none of the UE requested assistance data in step (1) can be provided by the LMF, return any information that can be provided in an LPP message of type Provide Assistance Data which includes a cause indication for the not provided assistance data.

#### 8.11.3.1.3 Location Information Transfer Procedure

The purpose of this procedure is to enable the LMF to request location estimate from the UE, or to enable the UE to provide location measurements to the LMF for position calculation.

##### 8.11.3.1.3.1 LMF-initiated Location Information Transfer Procedure

Figure 8.11.3.1.3.1-1 shows the Location Information Transfer operations for the DL-AoD positioning method when the procedure is initiated by the LMF.

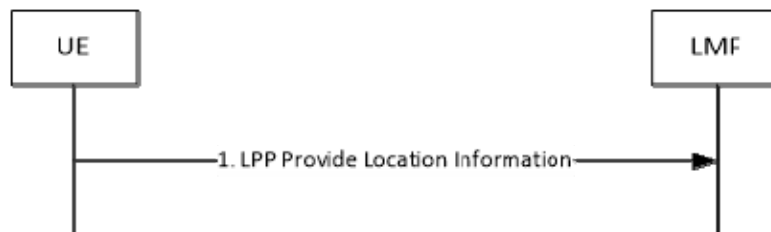


**Figure 8.11.3.1.3.1-1: LMF-initiated Location Information Transfer Procedure**

- (1) The LMF sends an LPP Request Location Information message to the UE. This request includes indication of DL-AoD measurements requested, including any needed measurement configuration information, and required response time.
- (2) The UE obtains DL-AoD measurements as requested in step 1. The UE then sends an LPP Provide Location Information message to the LMF, before the Response Time provided in step (1) elapsed, and includes the obtained DL-PRS-RSRP measurements. If the UE is unable to perform the requested measurements, or the Response Time elapsed before any of the requested measurements were obtained, the UE returns any information that can be provided in an LPP message of type Provide Location Information which includes a cause indication for the not provided location information.

#### 8.11.3.1.3.2 UE-initiated Location Information Delivery procedure

Figure 8.11.3.1.3.2-1 shows the Location Information Delivery procedure operations for the DL-AoD positioning method when the procedure is initiated by the UE.



**Figure 8.11.3.1.3.2-1: UE-initiated Location Information Delivery Procedure.**

- (1) The UE sends an LPP Provide Location Information message to the LMF. The Provide Location Information message may include any UE DL-AoD measurements already available at the UE.

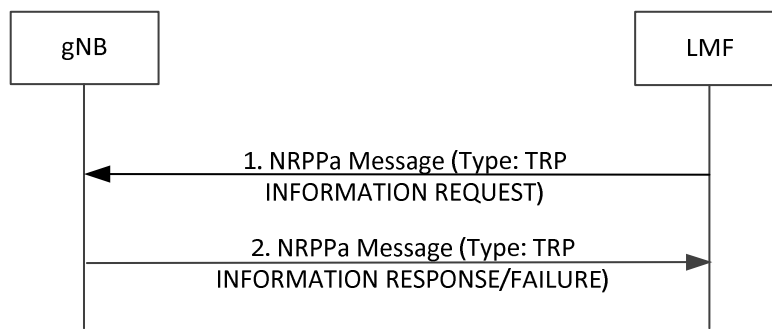
### 8.11.3.2 Procedures between LMF and gNB

#### 8.11.3.2.1 Assistance Data Delivery procedure

The purpose of this procedure is to enable the gNB to provide assistance data described in Table 8.11.2.3-1 to the LMF, for subsequent delivery to the UE using the procedures of clause 8.11.3.1.2 or for use in the calculation of positioning estimates at the LMF.

##### 8.11.3.2.1.1 LMF-initiated assistance data delivery to the LMF

Figure 8.11.3.2.1.1-1 shows the TRP Information Exchange operation from the gNB to the LMF for the DL-AoD positioning method.



**Figure 8.11.3.2.1.1-1: LMF-initiated TRP Information Exchange Procedure**

- (1) The LMF determines that certain TRP configuration information is desired (e.g., as part of a periodic update or as triggered by OAM) and sends an NRPPa TRP INFORMATION REQUEST message to the gNB. This request includes an indication of which specific TRP configuration information is requested.
- (2) The gNB provides the requested TRP information in an NRPPa TRP INFORMATION RESPONSE message, if available at the gNB. If the gNB is not able to provide any information, it returns an TRP INFORMATION FAILURE message indicating the cause of the failure.

## 8.12 DL-TDOA positioning

### 8.12.1 General

In the DL-TDOA positioning method, the UE position is estimated based on DL RSTD (and optionally DL-PRS-RSRP) measurements taken at the UE of downlink radio signals from multiple NR TRPs, along with knowledge of the geographical coordinates of the TRPs and their relative downlink timing.

The UE while connected to a gNB may require measurement gaps to perform the DL-TDOA measurements from NR TRPs. The UE may request measurement gaps from a gNB using the procedure described in clause 7.4.1.1.

The specific positioning techniques used to estimate the UE's location from this information are beyond the scope of this specification.

### 8.12.2 Information to be transferred between NG-RAN/5GC Elements

This clause defines the information that may be transferred between LMF and UE/gNB.

#### 8.12.2.1 Information that may be transferred from the LMF to UE

The information that may be transferred from the LMF to the UE are listed in table 8.12.2.1-1.

**Table 8.12.2.1-1: Information that may be transferred from LMF to the UE**

Information	UE-assisted	UE-based
Physical cell IDs (PCIs), global cell IDs (GCIs), and TRP IDs of candidate NR TRPs for measurement	Yes	Yes
Timing relative to the serving (reference) TRP of candidate NR TRPs	Yes	Yes
DL-PRS configuration of candidate NR TRPs	Yes	Yes
SSB information of the TRPs (the time/frequency occupancy of SSBs)	Yes	Yes
Spatial direction information (e.g. azimuth, elevation etc.) of the DL-PRS Resources of the TRPs served by the gNB	No	Yes
Geographical coordinates of the TRPs served by the gNB (include a transmission reference location for each DL-PRS Resource ID, reference location for the transmitting antenna of the reference TRP, relative locations for transmitting antennas of other TRPs)	No	Yes
Fine Timing relative to the serving (reference) TRP of candidate NR TRPs	No	Yes

### 8.12.2.2 Information that may be transferred from the UE to LMF

The information that may be signalled from UE to the LMF is listed in Table 8.12.2.2-1. The individual UE measurements are defined in TS 38.215 [37].

**Table 8.12.2.2-1: Information that may be transferred from UE to the LMF**

Information	UE-assisted	UE-based
Latitude/Longitude/Altitude, together with uncertainty shape	No	Yes
PCI, GCI, and TRP ID for each measurement	Yes	No
DL RSTD measurement	Yes	No
DL-PRS-RSRP measurement	Yes	No
Time stamp of the measurements	Yes	No
Time stamp of location estimate	No	Yes
Quality for each measurement	Yes	No

### 8.12.2.3 Information that may be transferred from the gNB to LMF

The assistance data that may be transferred from gNB to the LMF is listed in Table 8.12.2.3-1.

**Table 8.12.2.3-1: Assistance data that may be transferred from gNB to the LMF**

Information
PCI, GCI, and TRP IDs of the TRPs served by the gNB
Timing information of TRPs served by the gNB
DL-PRS configuration of the TRPs served by the gNB
SSB information of the TRPs (the time/frequency occupancy of SSBs)
Spatial direction information (e.g. azimuth, elevation etc.) of the DL-PRS Resources of the TRPs served by the gNB
Geographical coordinates of the TRPs served by the gNB (include a transmission reference location for each DL-PRS Resource ID, reference location for the transmitting antenna of the reference TRP, relative locations for transmitting antennas of other TRPs)

## 8.12.3 DL-TDOA Positioning Procedures

The procedures described in this clause support UE-assisted and UE-based DL-TDOA.

### 8.12.3.1 Procedures between LMF and UE

#### 8.12.3.1.1 Capability Transfer Procedure

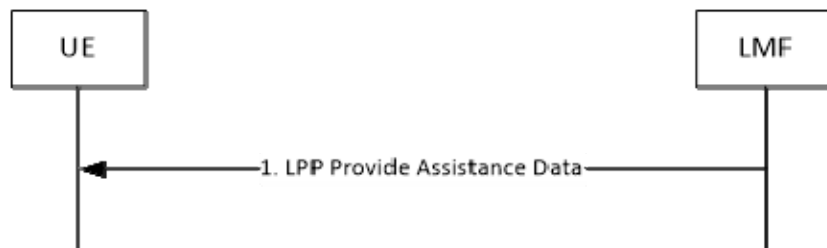
The Capability Transfer procedure for DL-TDOA positioning is described in clause 7.1.2.1.

### 8.12.3.1.2 Assistance Data Transfer Procedure

The purpose of this procedure is to enable the LMF to provide assistance data to the UE (e.g., as part of a positioning procedure) and the UE to request assistance data from the LMF (e.g., as part of a positioning procedure).

#### 8.12.3.1.2.1 LMF initiated Assistance Data Delivery

Figure 8.12.3.1.2.1-1 shows the Assistance Data Delivery operations for the DL-TDOA positioning method when the procedure is initiated by the LMF.

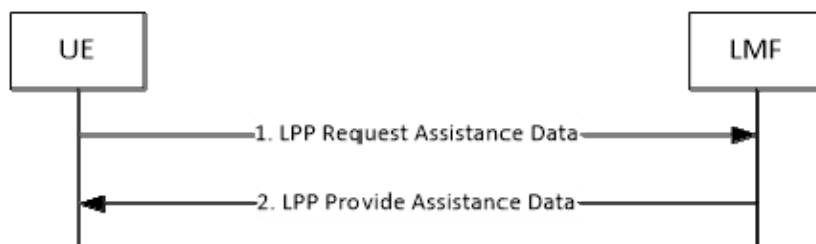


**Figure 8.12.3.1.2.1-1: LMF-initiated Assistance Data Delivery Procedure**

- (1) The LMF determines that assistance data needs to be provided to the UE (e.g., as part of a positioning procedure) and sends an LPP Provide Assistance Data message to the UE. This message may include any of the DL-TDOA positioning assistance data defined in Table 8.12.2.1-1.

#### 8.12.3.1.2.2 UE initiated Assistance Data Transfer

Figure 8.12.3.1.2.2-1 shows the Assistance Data Transfer operations for the DL-TDOA positioning method when the procedure is initiated by the UE.



**Figure 8.12.3.1.2.2-1: UE-initiated Assistance Data Transfer Procedure**

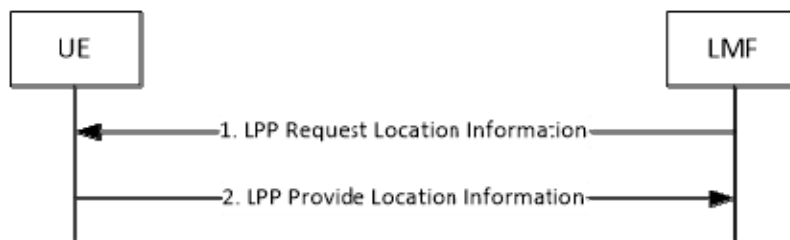
- (1) The UE determines that certain DL-TDOA positioning assistance data are desired (e.g., as part of a positioning procedure when the LMF provided assistance data are not sufficient for the UE to fulfil the request) and sends an LPP Request Assistance Data message to the LMF. This request includes an indication of which specific DL-TDOA assistance data are requested. Additional information concerning the UE's approximate location and serving and neighbour cells may also be provided in the Request Assistance Data message and/or in an accompanying Provide Location Information message to help the LMF provide appropriate assistance data. This additional data may include the UE's last known location if available, the cell IDs of the UE serving NG-RAN node and possibly neighbour NG-RAN nodes, as well as NR E-CID measurements.
- (2) The LMF provides the requested assistance in an LPP Provide Assistance Data message, if available at the LMF. If any of the UE requested assistance data in step (1) are not provided in step 2, the UE shall assume that the requested assistance data are not supported, or currently not available at the LMF. If none of the UE requested assistance data in step (1) can be provided by the LMF, return any information that can be provided in an LPP message of type Provide Assistance Data which includes a cause indication for the not provided assistance data.

### 8.12.3.1.3 Location Information Transfer Procedure

The purpose of this procedure is to enable the LMF to request location estimate from the UE, or to enable the UE to provide location measurements to the LMF for position calculation.

#### 8.12.3.1.3.1 LMF-initiated Location Information Transfer Procedure

Figure 8.12.3.1.3.1-1 shows the Location Information Transfer operations for the DL-TDOA positioning method when the procedure is initiated by the LMF.

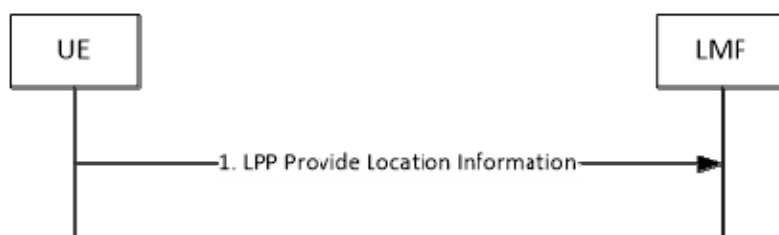


**Figure 8.12.3.1.3.1-1: LMF-initiated Location Information Transfer Procedure**

- (1) The LMF sends an LPP Request Location Information message to the UE. This request includes indication of DL-TDOA measurements requested, including any needed measurement configuration information, and required response time.
- (2) The UE obtains DL-TDOA measurements as requested in step 1. The UE then sends an LPP Provide Location Information message to the LMF, before the Response Time provided in step (1) elapsed, and includes the obtained DL RSTD measurements and, optionally, the DL-PRS-RSRP measurements. If the UE is unable to perform the requested measurements, or the Response Time elapsed before any of the requested measurements were obtained, the UE returns any information that can be provided in an LPP message of type Provide Location Information which includes a cause indication for the not provided location information.

#### 8.12.3.1.3.2 UE-initiated Location Information Delivery procedure

Figure 8.12.3.1.3.2-1 shows the Location Information Delivery procedure operations for the DL-TDOA positioning method when the procedure is initiated by the UE.



**Figure 8.12.3.1.3.2-1: UE-initiated Location Information Delivery Procedure.**

- (1) The UE sends an LPP Provide Location Information message to the LMF. The Provide Location Information message may include any UE DL-TDOA measurements and, optionally, the DL-PRS-RSRP measurements already available at the UE.



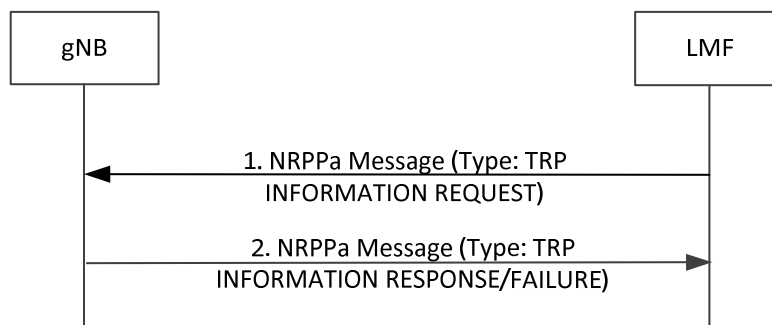
## 8.12.3.2 Procedures between LMF and gNB

### 8.12.3.2.1 Assistance Data Delivery procedure

The purpose of this procedure is to enable the gNB to provide assistance data to the LMF, for subsequent delivery to the UE using the procedures of clause 8.12.3.1.2 or for use in the calculation of positioning estimates at the LMF.

#### 8.12.3.2.1.1 LMF-initiated assistance data delivery to the LMF

Figure 8.12.3.2.1.1-1 shows the TRP Information Exchange operation from the gNB to the LMF for the DL-TDOA positioning method.



**Figure 8.12.3.2.1.1-1: LMF-initiated TRP Information Exchange Procedure**

- (1) The LMF determines that certain TRP configuration information is desired (e.g., as part of a periodic update or as triggered by OAM) and sends an NRPPa TRP INFORMATION REQUEST message to the gNB. This request includes an indication of which specific TRP configuration information is requested.
- (2) The gNB provides the requested TRP information in an NRPPa TRP INFORMATION RESPONSE message, if available at the gNB. If the gNB is not able to provide any information, it returns an TRP INFORMATION FAILURE message indicating the cause of the failure.

## 8.13 UL-TDOA positioning

### 8.13.1 General

In the UL-TDOA positioning method, the UE position is estimated based on UL-RTOA (and optionally UL-SRS-RSRP) measurements taken at different TRPs of uplink radio signals from UE, along with other configuration information.

The specifics of any UL-TDOA positioning methods or techniques used to estimate the UE's location from these measurements are beyond the scope of this specification.

In order to obtain uplink measurements, the TRPs need to know the characteristics of the SRS signal transmitted by the UE for the time period required to perform uplink measurement. These characteristics should be static over the periodic transmission of SRS during the uplink measurements. Hence, the LMF will indicate to the serving gNB the need to direct the UE to transmit SRS signals for uplink positioning. It is up to the serving gNB to make the final decision on resources to be assigned and to communicate this SRS configuration information back to the LMF so that LMF can forward the SRS configuration to the TRPs. The gNB may decide (e.g., in case no resources are available) to configure no resources for the UE and report the empty resource configuration to the LMF.

### 8.13.2 Information to be transferred between NG-RAN/5GC Elements

This clause defines the information that may be transferred between LMF and gNB/TRPs.

### 8.13.2.0 Assistance Data that may be transferred from the gNB to the LMF

The assistance data that may be transferred from the gNB to the LMF is listed in Table 8.13.2.0-1.

**Table 8.13.2.0-1: Assistance data that may be transferred from gNB to the LMF**

Information
PCI, GCI, and TRP IDs of the TRPs served by the gNB
SSB information of the TRPs (the time/frequency occupancy of SSBs)
Geographical coordinates of the TRPs served by the gNB (include reference location for the receiving antenna of the reference TRP, relative locations for receiving antennas of other TRPs)

### 8.13.2.1 Configuration Data that may be transferred from the gNB to the LMF

The configuration data for a target UE that may be transferred from the serving gNB to the LMF is listed in Table 8.13.2.1-1.

**Table 8.13.2.1-1: UE configuration data that may be transferred from serving gNB to the LMF**

UE configuration data
UE SRS configuration

### 8.13.2.2 Location Information that may be transferred from the gNBs to LMF

The information that may be transferred from gNBs to the LMF include measurement results listed in Table 8.13.2.2-1. The individual measurements are defined in TS 38.215 [37].

**Table 8.13.2.2-1: Measurement results that may be transferred from gNBs to the LMF**

Measurement results
PCI, GCI, and TRP ID of the measurement
UL-RTOA
UL-SRS-RSRP
Time stamp of the measurement
Quality for each measurement

### 8.13.2.3 Information that may be transferred from the LMF to gNBs

The requested UL-SRS transmission characteristics information that may be signalled from the LMF to the gNB is listed in Table 8.13.2.3-1.

**Table 8.13.2.3-1: Requested UL-SRS transmission characteristics information that may be transferred from LMF to gNB.**

Information
Number Of Transmissions/duration for which the UL-SRS is requested
Bandwidth
Resource type (periodic, semi-persistent)
Pathloss reference: <ul style="list-style-type: none"> <li>- PCI, SSB Index, SSB configuration (time/frequency occupancy of SSBs)</li> <li>- DL-PRS ID, DL-PRS Resource Set ID, DL-PRS Resource ID</li> </ul>
Spatial relation info <ul style="list-style-type: none"> <li>- PCI, SSB Index, SSB configuration (time/frequency occupancy of SSBs)</li> <li>- DL-PRS ID, DL-PRS Resource Set ID, DL-PRS Resource ID</li> </ul>

The TRP measurement request information that may be signalled from the LMF to the gNB is listed in table 8.13.2.3-2.

**Table 8.13.2.3-2: TRP Measurement request information that may be transferred from LMF to gNB.**

Information
PCI, GCI, and TRP ID of the TRP to receive UL-SRS
UE-SRS configuration
UL timing information together with timing uncertainty of candidate TRPs (search window), for reception of SRS by candidate TRPs
Start time, duration and report characteristics for the measurements

The UL-SRS activation/deactivation request information that may be signalled from the LMF to the gNB is listed in Table 8.13.2.3-3.

**Table 8.13.2.3-3: Requested UL-SRS activation/deactivation information that may be transferred from LMF to gNB.**

Information
SP UL-SRS: - Activation or Deactivation request - Positioning SRS Resource Set ID which is to be activated/deactivated - Spatial relation for Resource ID <sub>i</sub>

### 8.13.3 UL-TDOA Positioning Procedures

The procedures described in this clause support UL-TDOA positioning measurements obtained by the gNB and provided to the LMF using NRPPa.

#### 8.13.3.1 Capability Transfer Procedure

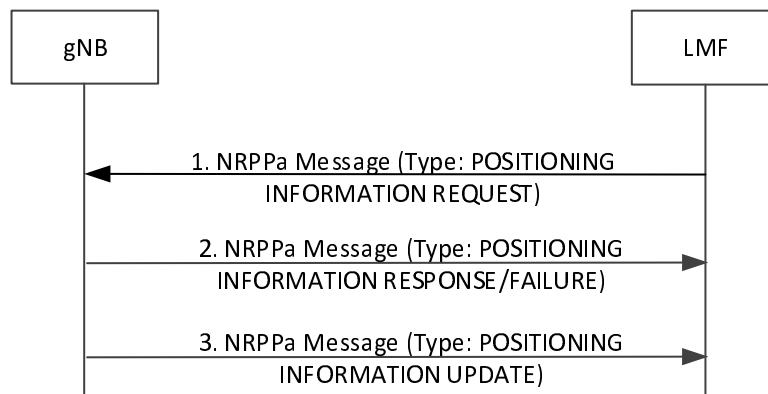
The Capability Transfer procedure for UL-TDOA positioning is described in clause 7.1.2.1.

#### 8.13.3.2 Assistance Data Transfer Procedure

##### 8.13.3.2.1 Assistance Data Delivery between LMF and gNB

The purpose of these procedures is to enable the gNB to provide assistance data described in Table 8.13.2.0-1 to the LMF, for subsequent delivery to the gNB using the procedures of clause 8.13.3.3 or for use in the calculation of positioning estimates at the LMF or enable the LMF to request UL-SRS configuration information from the serving gNB of a target UE.

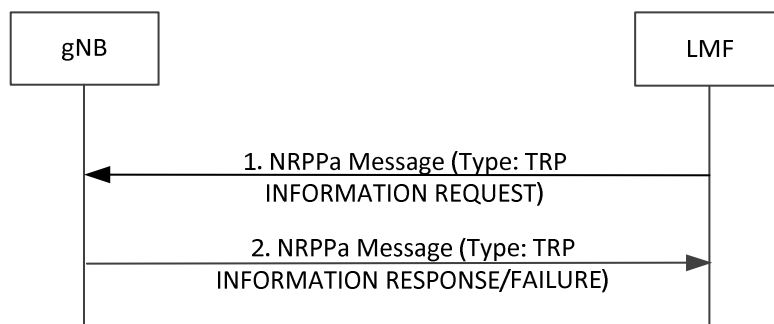
Figure 8.13.3.2.1-1 shows the UL information Delivery operation from the serving gNB to the LMF.



**Figure 8.13.3.2.1-1: LMF-initiated UL Information Request Procedure**

- (1) The LMF sends a NRPPa message POSITIONING INFORMATION REQUEST to the serving gNB of the target UE to request UE SRS configuration information. If the message includes the Requested UL-SRS Transmission Characteristics as listed in Table 8.13.2.3-1, the gNB should take this information into account when configuring UL-SRS transmissions for the UE.
- (2) The serving gNB determines the UE SRS configuration to be allocated for the UE and sends NRPPa message POSITIONING INFORMATION RESPONSE to the LMF that includes the UE SRS configuration defined in Table 8.13.2.1-1. If the serving gNB is not able to provide the requested information, it returns a failure message indicating the cause of the failure.
- (3) If a change has occurred in the UE SRS configuration during the UE SRS time duration requested at step 1, the gNB sends a POSITIONING INFORMATION UPDATE message to the LMF. This message contains, in the case of a change in UE SRS configuration parameters, the UE SRS configuration information for all cells with UE SRS configured, or an indication that the UE SRS configuration has been released in the UE.

Figure 8.13.3.2.1-2 shows the TRP Information Exchange operation from the gNB to the LMF for the UL-TDOA positioning method.



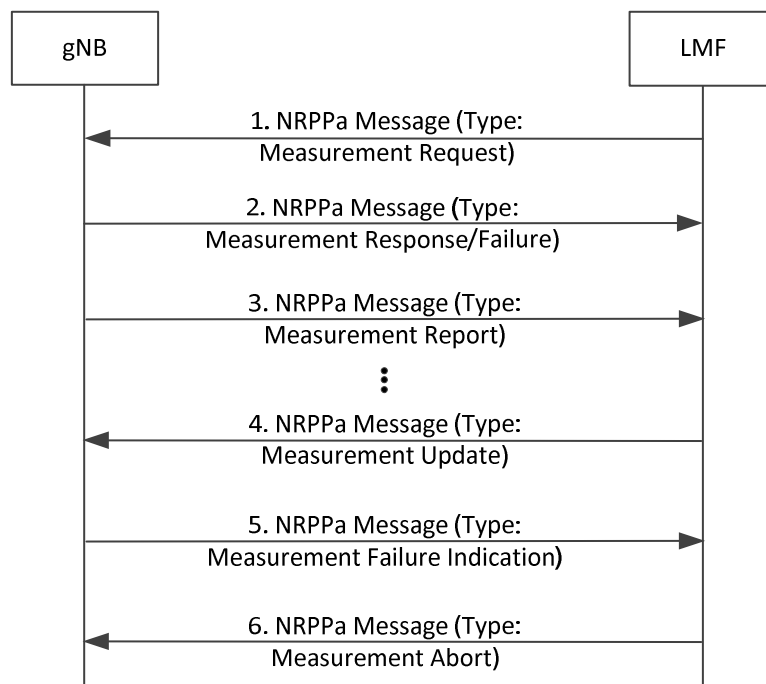
**Figure 8.13.3.2.1-2: LMF-initiated TRP Information Exchange Procedure**

- (1) The LMF determines that certain TRP configuration information is desired (e.g., as part of a periodic update or as triggered by OAM) and sends an NRPPa TRP INFORMATION REQUEST message to the gNB. This request includes an indication of which specific TRP configuration information is requested.
- (2) The gNB provides the requested TRP information in an NRPPa TRP INFORMATION RESPONSE message, if available at the gNB. If the gNB is not able to provide any information, it returns an TRP INFORMATION FAILURE message indicating the cause of the failure.

### 8.13.3.3 Location Information Transfer/Assistance Data Transfer Procedure

The purpose of this procedure is to enable the LMF to request position measurements from a gNB for position calculation of the UE and also provide necessary assistance data to the gNB.

Figure 8.13.3.3-1 shows the messaging between the LMF and the gNB to perform this procedure.



**Figure 8.13.3.3-1: LMF-initiated Location Information Transfer Procedure**

(1) The LMF sends a NRPPa message to the selected gNB to request UL-TDOA measurement information. The message includes any information required for the gNB to perform the measurements as defined in Table 8.13.2.3-2.

(2) If the report characteristics in step 1 is set to "on demand", the gNB obtains the requested UL-TDOA measurements and returns them in a Measurement Response message to the LMF. The Measurement Response message includes the obtained UL-TDOA measurements as defined in Table 8.13.2.2-1.

If the report characteristics in step 1 is set to "periodic", the gNB replies with a Measurement Response message without including any measurements in the message. The gNB then periodically initiates the Measurement Report procedure in step 3 for the UL-TDOA measurements, with the requested reporting periodicity.

If the gNB is not able to accept the Measurement Request message in step 1, the gNB returns a failure message indicating the cause of the failure.

(3) The gNB periodically provides the UL-TDOA measurements as defined in Table 8.13.2.2-1 to the LMF if that was requested at step 1.

(4) At any time after step 2, the LMF may send a Measurement Update message to the gNB providing updated information required for the gNB to perform the UL-TDOA measurements as defined in Table 8.13.2.3-2. Upon receiving the message, the gNB overwrites the previously received measurement configuration information.

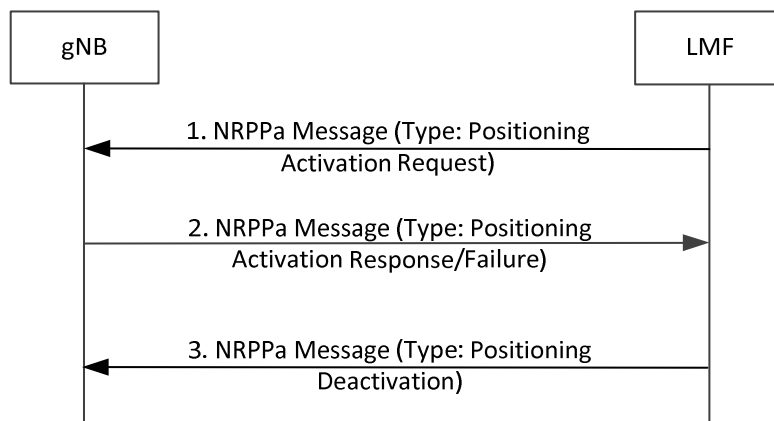
(5) If the previously requested UL-TDOA measurements can no longer be reported, the gNB notifies the LMF by sending a Measurement Failure Indication message.

(6) When the LMF wants to abort an ongoing UL-TDOA measurement it sends a Measurement Abort message to the gNB.

### 8.13.3.3a Positioning Activation/Deactivation Procedure

The purpose of this procedure is to enable the LMF to request activation and deactivation of UL-SRS transmission of the target UE.

Figure 8.13.3.3a-1 shows the messaging between the LMF and the gNB to perform this procedure.

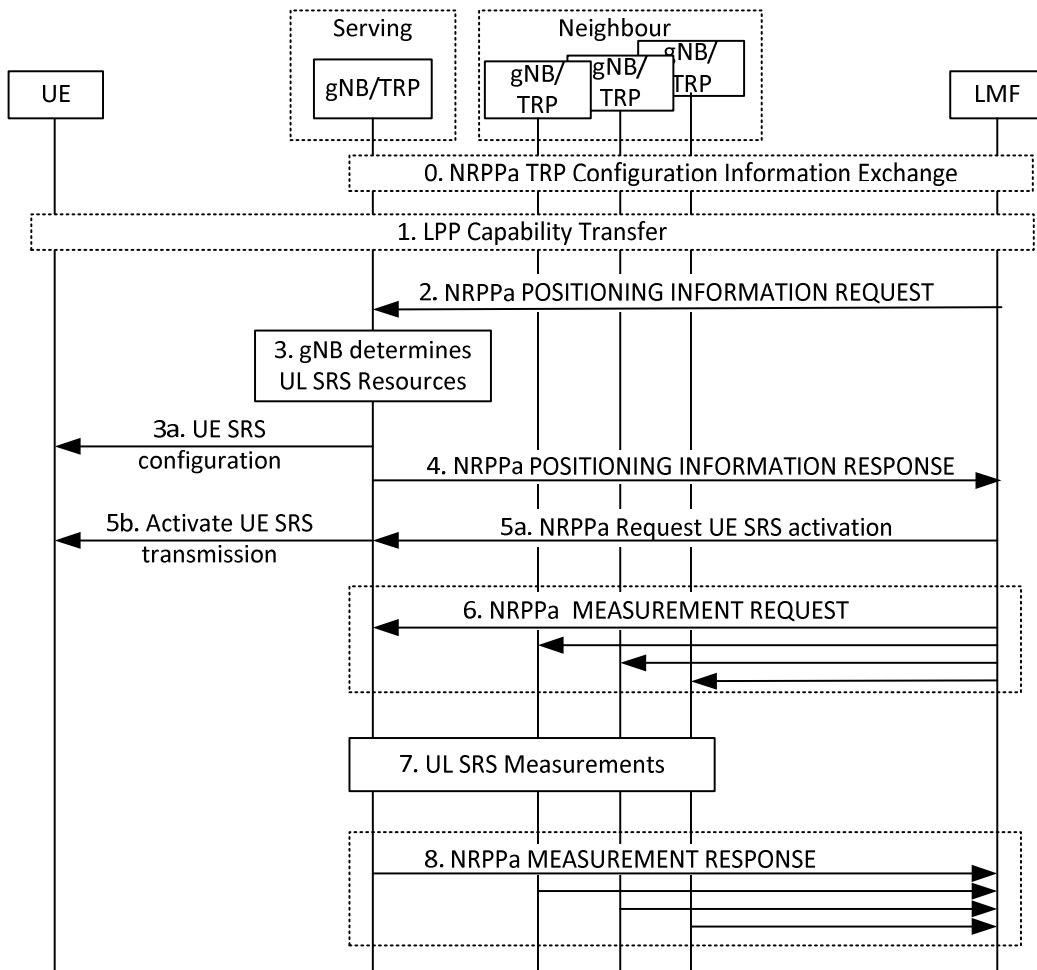


**Figure 8.13.3.3a-1: Positioning Activation/Deactivation Procedure.**

- (1) The LMF sends a NRPPa message to the serving gNB of the target UE to request UL-SRS activation for the target UE. For a semi-persistent UL-SRS, the message includes an indication of an UL-SRS resource set to be activated and may include information that indicates the spatial relation for the semi-persistent UL-SRS resource to be activated, as listed in Table 8.13.2.3-3.
- (2) For semi-persistent UL-SRS, the serving gNB may then activate the configured semi-persistent UL-SRS resource sets by sending the SP Positioning SRS Activation/Deactivation MAC CE command as specified in TS 38.211 [39].  
If the UL-SRS has been successfully activated as requested in step 1, the gNB sends a NRPPa response message to the LMF. If the serving gNB is not able to fulfil the request from step 1, it returns a failure message indicating the cause of the failure.
- (3) If a previously activated UL-SRS should be deactivated, the LMF sends a NRPPa message to the serving gNB of the target device to request deactivation. This message includes an indication of the UL-SRS resource set to be deactivated.

#### 8.13.3.4 Sequence of Procedure for UL-TDOA positioning

Figure 8.13.3.4-1 shows the messaging between the LMF, the gNBs and the UE to perform UL-TDOA procedure.



**Figure 8.13.3.4-1: UL-TDOA positioning procedure**

0. The LMF may use the procedure in Figure 8.13.3.2.1-2 to obtain the TRP information required for UL-TDOA positioning.
1. The LMF may request the positioning capabilities of the target device using the LPP Capability Transfer procedure as described in clause 8.13.3.1.
2. The LMF sends a NRPPa POSITIONING INFORMATION REQUEST message to the serving gNB to request UL-SRS configuration information for the target device as described in Figure 8.13.3.2.1-1.
3. The serving gNB determines the resources available for UL-SRS and configures the target device with the UL-SRS resource sets at step 3a.
4. The serving gNB provides the UL information to the LMF in a NRPPa POSITIONING INFORMATION RESPONSE message.
5. The LMF may request activation of UE SRS transmission and sends a NRPPa SRS Activation Request message to the serving gNB of the target device as described in subclause 8.13.3.3a. The gNB then activates the UL-SRS transmission. The target device begins the UL-SRS transmission according to the time domain behavior of UL-SRS resource configuration.
6. The LMF provides the UL-SRS configuration to the selected gNBs in a NRPPa MEASUREMENT REQUEST message as described in clause 8.13.3.3. The message includes all information required to enable the gNBs/TRPs to perform the UL measurements.
7. Each gNB configured at step 6 measures the UL-SRS transmissions from the target device.

8. Each gNB reports the UL-SRS measurements to the LMF in a NRPPa Measurement Response message as described in clause 8.13.3.3.

## 8.14 UL-AoA positioning

### 8.14.1 General

In the UL-AoA positioning method, the UE position is estimated based on UL-AoA (and optionally UL-SRS-RSRP) of uplink radio signals taken at different TRPs, along with other configuration information.

The specific of any UL-AoA positioning methods or techniques used to estimate the UE's location from these measurements are beyond the scope of this specification.

In order to obtain uplink measurements, the TRPs need to know the characteristics of the SRS signal transmitted by the UE for the time period required to calculate uplink measurement. These characteristics should be static over the periodic transmission of SRS during the uplink measurements. Hence, the LMF will indicate to the serving gNB the need to direct the UE to transmit SRS signals for uplink positioning. It is up to the gNB to make the final decision on resources to be assigned and to communicate this configuration information back to the LMF so that LMF can configure the TRPs. The gNB may decide (e.g., in case no resources are available) to configure no resources for the UE and fail the corresponding NRPPa procedure.

### 8.14.2 Information to be transferred between NG-RAN/5GC Elements

This clause defines the information that may be transferred between LMF and gNB/TRPs.

#### 8.14.2.0 Assistance Data that may be transferred from the gNB to the LMF

The assistance data that may be transferred from the gNB to the LMF is listed in Table 8.14.2.0-1.

**Table 8.14.2.0-1: Assistance data that may be transferred from gNB to the LMF**

Information
PCI, GCI, and TRP IDs of the TRPs served by the gNB
SSB information of the TRPs (the time/frequency occupancy of SSBs)
Geographical coordinates of the TRPs served by the gNB (include reference location for the receiving antenna of the reference TRP, relative locations for receiving antennas of other TRPs)

#### 8.14.2.1 Configuration Data that may be transferred from the gNB to the LMF

The configuration data for a target UE that may be transferred from the serving gNB to the LMF is listed in Table 8.14.2.1-1.

**Table 8.14.2.1-1: UE configuration data that may be transferred from serving gNB to the LMF**

UE configuration data
UE SRS configuration

#### 8.14.2.2 Location Information that may be transferred from the gNBs to LMF

The information that may be transferred from gNBs to the LMF include measurement results are listed in Table 8.14.2.2-1. The individual measurements are defined in TS 38.215 [37].



**Table 8.14.2.2-1: Measurement results that may be transferred from gNBs to the LMF**

Measurement results
PCI, GCI, and TRP ID of the measurement
UL Angle of Arrival (azimuth and elevation)
UL-SRS-RSRP
Time stamp of the measurement
Quality for each measurement

### 8.14.2.3 Information that may be transferred from the LMF to gNB

The requested UL-SRS transmission characteristics information that may be signalled from the LMF to the gNB is listed in Table 8.14.2.3-1.

**Table 8.14.2.3-1: Requested UL-SRS transmission characteristics information that may be transferred from LMF to gNB.**

Information
Number Of Transmissions/duration for which the UL-SRS is requested
Bandwidth
Resource type (periodic, semi-persistent)
Pathloss reference: <ul style="list-style-type: none"> <li>- PCI, SSB Index, SSB configuration (time/frequency occupancy of SSBs)</li> <li>- DL-PRS ID, DL-PRS Resource Set ID, DL-PRS Resource ID</li> </ul>
Spatial relation info <ul style="list-style-type: none"> <li>- PCI, SSB Index, SSB configuration (time/frequency occupancy of SSBs)</li> <li>- DL-PRS ID, DL-PRS Resource Set ID, DL-PRS Resource ID</li> </ul>

The TRP measurement request information that may be signalled from the LMF to the gNB is listed in table 8.14.2.3-2.

**Table 8.14.2.3-2: TRP Measurement request information that may be transferred from LMF to gNB.**

Information
PCI, GCI, and TRP ID of the TRP to receive UL-SRS
UE-SRS configuration
UL timing information together with timing uncertainty of candidate TRPs (search window), for reception of SRS by candidate TRPs
Start time, duration and report characteristics for the measurements

The UL-SRS activation/deactivation request information that may be signalled from the LMF to the gNB is listed in Table 8.14.2.3-3.

**Table 8.14.2.3-3: Requested UL-SRS activation/deactivation information that may be transferred from LMF to gNB.**

Information
SP UL-SRS: <ul style="list-style-type: none"> <li>- Activation or Deactivation request</li> <li>- Positioning SRS Resource Set ID which is to be activated/deactivated</li> <li>- Spatial relation for Resource ID<sub>i</sub></li> </ul>

## 8.14.3 UL-AoA Positioning Procedures

The procedures described in this clause support UL-AoA positioning measurements obtained by the gNB and provided to the LMF using NRPPa.

### 8.14.3.1 Capability Transfer Procedure

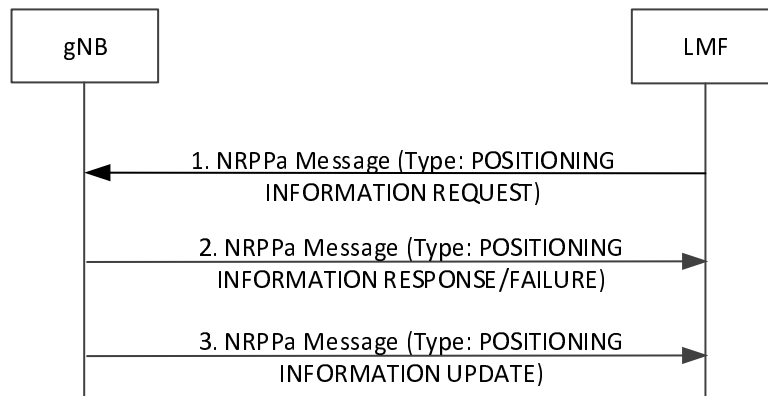
The Capability Transfer procedure for UL-AoA positioning is described in clause 7.1.2.1.

## 8.14.3.2 Assistance Data Transfer Procedure

### 8.14.3.2.1 Assistance Data Delivery between LMF and gNB

The purpose of these procedures is to enable the gNB to provide assistance data described in Table 8.14.2.0-1 to the LMF, for subsequent delivery to the gNB using the procedures of clause 8.14.3.3 or for use in the calculation of positioning estimates at the LMF or enable the LMF to request UL-SRS configuration information from the serving gNB of a target UE.

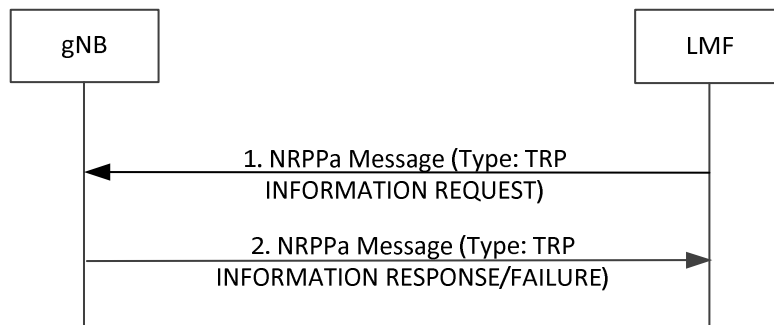
Figure 8.14.3.2.1-1 shows the UL information Delivery operation from the serving gNB to the LMF.



**Figure 8.14.3.2.1-1: LMF-initiated UL Information Request Procedure**

- (1) The LMF sends a NRPPa message POSITIONING INFORMATION REQUEST to the serving gNB of the target UE to request UE SRS configuration information. If the message includes the Requested UL-SRS Transmission Characteristics as listed in Table 8.14.2.3-1, the gNB should take this information into account when configuring UL-SRS transmissions for the UE.
- (2) The serving gNB determines the UE SRS configuration to be allocated for the UE and sends NRPPa message POSITIONING INFORMATION RESPONSE to the LMF that includes the UE SRS configuration defined in Table 8.14.2.1-1. If the serving gNB is not able to provide the requested information, it returns a failure message indicating the cause of the failure.
- (3) If a change has occurred in the UE SRS configuration during the UE SRS time duration requested at step 1, the gNB sends a POSITIONING INFORMATION UPDATE message to the LMF. This message contains, in the case of a change in UE SRS configuration parameters, the UE SRS configuration information for all cells with UE SRS configured, or an indication that the UE SRS configuration has been released in the UE.

Figure 8.14.3.2.1-2 shows the TRP Information Exchange operation from the gNB to the LMF for the UL-AoA positioning method.



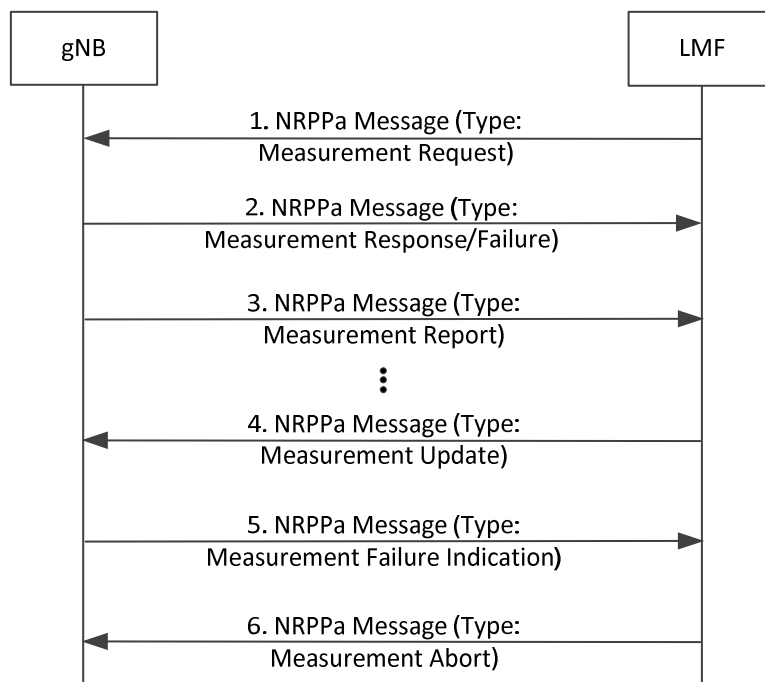
**Figure 8.14.3.2.1-2: LMF-initiated TRP Information Exchange Procedure**

- (1) The LMF determines that certain TRP configuration information is desired (e.g., as part of a periodic update or as triggered by OAM) and sends an NRPPa TRP INFORMATION REQUEST message to the gNB. This request includes an indication of which specific TRP configuration information is requested.
- (2) The gNB provides the requested TRP information in an NRPPa TRP INFORMATION RESPONSE message, if available at the gNB. If the gNB is not able to provide any information, it returns an TRP INFORMATION FAILURE message indicating the cause of the failure.

**8.14.3.3 Location Information Transfer/Assistance Data Transfer Procedure**

The purpose of this procedure is to enable the LMF to request position measurements from a gNB for position calculation of the UE and also provide necessary assistance data to the gNB.

Figure 8.14.3.3-1 shows the messaging between the LMF and the gNB to perform this procedure.



**Figure 8.14.3.3-1: LMF-initiated Location Information Transfer Procedure**

- (1) The LMF sends a NRPPa message to the selected gNB to request UL-AoA measurement information. The message includes any information required for the gNB to perform the measurements as defined in Table 8.14.2.3-2.
- (2) If the report characteristics in step 1 is set to "on demand", the gNB obtains the requested UL-AoA measurements and returns them in a Measurement Response message to the LMF. The Measurement Response message includes the obtained UL-AoA measurements as defined in Table 8.14.2.2-1.

If the report characteristics in step 1 is set to "periodic", the gNB replies with a Measurement Response message without including any measurements in the message. The gNB then periodically initiates the Measurement Report procedure in step 3 for the UL-AoA measurements, with the requested reporting periodicity.

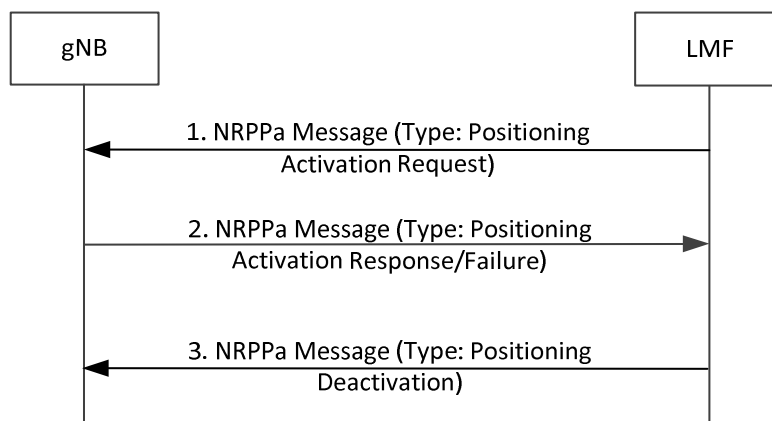
If the gNB is not able to accept the Measurement Request message in step 1, the gNB returns a failure message indicating the cause of the failure.

- (3) The gNB periodically provides the UL-AoA measurements as defined in Table 8.14.2.2-1 to the LMF if that was requested at step 1.
- (4) At any time after step 2, the LMF may send a Measurement Update message to the gNB providing updated information required for the gNB to perform the UL-AoA measurements as defined in Table 8.14.2.3-2. Upon receiving the message, the gNB overwrites the previously received measurement configuration information.
- (5) If the previously requested UL-AoA measurements can no longer be reported, the gNB notifies the LMF by sending a Measurement Failure Indication message.
- (6) When the LMF wants to abort an ongoing UL-AoA measurement it sends a Measurement Abort message to the gNB.

### 8.14.3.3a Positioning Activation/Deactivation Procedure

The purpose of this procedure is to enable the LMF to request activation and deactivation of UL-SRS transmission of the target UE.

Figure 8.14.3.3a-1 shows the messaging between the LMF and the gNB to perform this procedure.



**Figure 8.14.3.3a-1: Positioning Activation/Deactivation Procedure.**

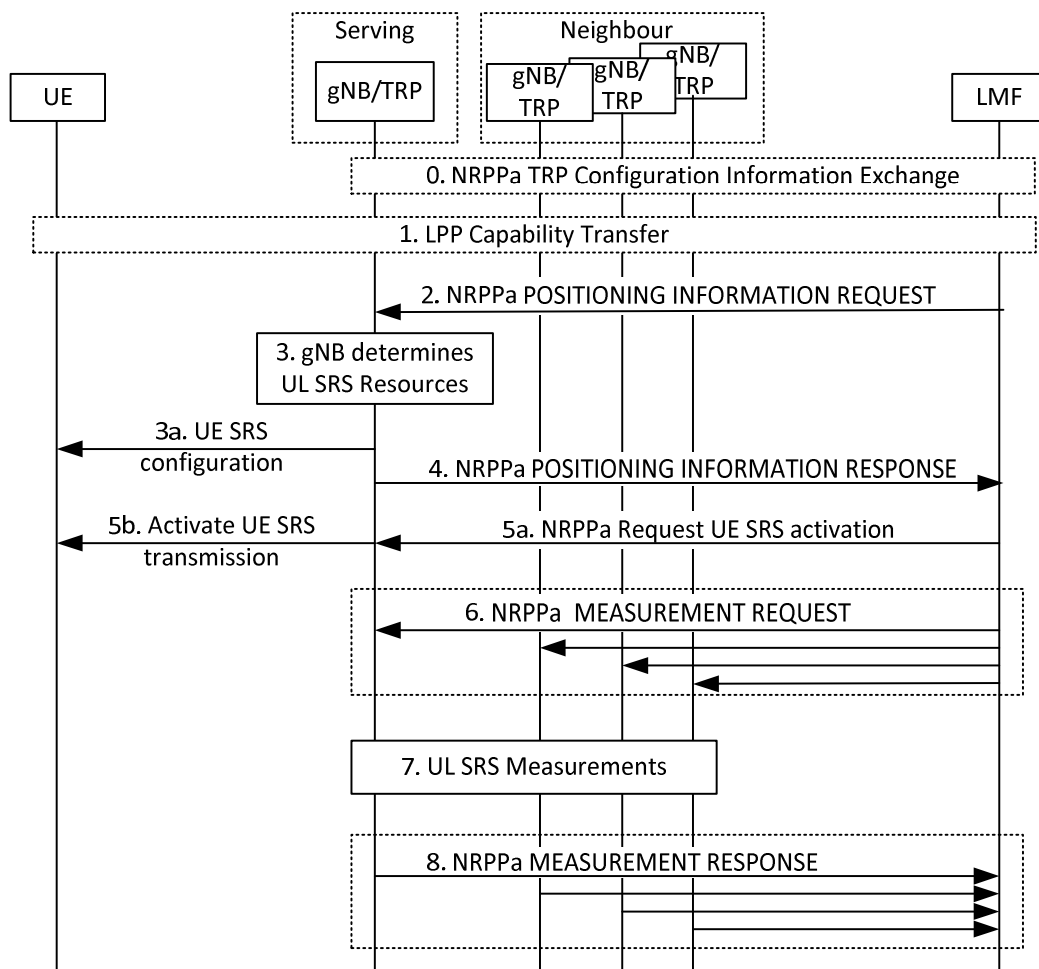
- (1) The LMF sends a NRPPa message to the serving gNB of the target UE to request UL-SRS activation for the target UE. For a semi-persistent UL-SRS, the message includes an indication of an UL-SRS resource set to be activated and may include information that indicates the spatial relation for the semi-persistent UL-SRS resource to be activated, as listed in Table 8.14.2.3-3.
- (2) For semi-persistent UL-SRS, the serving gNB may then activate the configured semi-persistent UL-SRS resource sets by sending the SP Positioning SRS Activation/Deactivation MAC CE command as specified in TS 38.211 [39].

If the UL-SRS has been successfully activated as requested in step 1, the gNB sends a NRPPa response message to the LMF. If the serving gNB is not able to fulfil the request from step 1, it returns a failure message indicating the cause of the failure.

- (3) If a previously activated UL-SRS should be deactivated, the LMF sends a NRPPa message to the serving gNB of the target device to request deactivation. This message includes an indication of the UL-SRS resource set to be deactivated.

### 8.14.3.4 Sequence of Procedure for UL-AoA positioning

Figure 8.14.3.4-1 shows the messaging between the LMF, the gNBs and the UE to perform UL-AoA procedure.



**Figure 8.14.3.4-1: UL-AoA positioning procedure**

0. The LMF may use the procedure in Figure 8.14.3.2.1-2 to obtain the TRP information required for UL-AoA positioning.
1. The LMF may request the positioning capabilities of the target device using the LPP Capability Transfer procedure as described in clause 8.14.3.1.
2. The LMF sends a NRPPa POSITIONING INFORMATION REQUEST message to the serving gNB to request UL-SRS configuration information for the target device as described in Figure 8.14.3.2.1-1.
3. The serving gNB determines the resources available for UL-SRS and configures the target device with the UL-SRS resource sets at step 3a.

4. The serving gNB provides the UL-SRS configuration information to the LMF in a NRPPa POSITIONING INFORMATION RESPONSE message.
5. The LMF may request activation of UE SRS transmission and sends a NRPPa SRS Activation Request message to the serving gNB of the target device as described in subclause 8.14.3.3a. The gNB then activates the UL-SRS transmission. The target device begins the UL-SRS transmission according to the time domain behavior of UL-SRS resource configuration.
6. The LMF provides the UL-SRS configuration to the selected gNBs in a NRPPa MEASUREMENT REQUEST message as described in clause 8.14.3.3. The message includes all information required to enable the gNBs/TRPs to perform the UL measurements.
7. Each gNB configured at step 6 measures the UL-SRS transmissions from the target device.
8. Each gNB reports the UL-SRS measurements to the LMF in a NRPPa Measurement Response message as described in clause 8.14.3.3.

## Annex A (informative): Use of LPP with SUPL

The design goal of LPP is to enable it to be used in user plane location solutions such as OMA SUPL ([15], [16]) and this informative annex shows how LPP can be used in SUPL 2.0.

### A.1 SUPL 2.0 Positioning Methods and Positioning Protocols

The following table shows how the 3GPP positioning protocols are supported in SUPL 2.0.

**Table A.1-1: SUPL support of positioning methods**

Positioning Protocol:	RRLP (GSM/GPRS/WCDMA/ LTE/WLAN/WiMAX)	RRC (WCDMA)	LPP (NR/LTE)
Positioning Method:			
A-GPS (A-GANSS) SET Assisted	✓	✓	✓
A-GPS (A-GANSS) SET Based	✓	✓	✓
Autonomous GPS/GANSS	✓	✓	✓
Enhanced Cell ID <sup>NOTE 1</sup>	✓	✓	✓ <sup>NOTE 2</sup>
Enhanced Observed Time Difference (E-OTD)	✓ (GSM only)	NA	NA
Observed Time Difference of Arrival (OTDOA) <sup>NOTE 1, NOTE 3</sup>	NA	✓	✓
Sensors	NA	✓ <sup>NOTE 5</sup>	✓
WLAN	NA	✓	✓
Bluetooth	NA	✓	✓
TBS <sup>NOTE 4</sup>	NA	✓	✓

NOTE 1: Excludes methods based on NR signals.  
 NOTE 2: For LPP, NR CID is supported.  
 NOTE 3: This includes TBS positioning based on PRS signals, which is only supported in LPP (LTE).  
 NOTE 4: TBS positioning based on MBS signals.  
 NOTE 5: Only barometric pressure sensor is supported.

NOTE: What is referred to in the SUPL specifications as "Enhanced Cell ID", is a UE-Assisted positioning mode, where the neighbouring cell measurements are carried at the SUPL layer (in the SUPL\_POS\_INIT for example) and does not include methods based on NR signals. The ASN.1 container for this mode is defined as follows:

```
LteCellInformation ::= SEQUENCE {
  cellGlobalIdEUTRA      CellGlobalIdEUTRA,
  physCellId             PhysCellId,
  trackingAreaCode       TrackingAreaCode,
  rsrpResult              RSRP-Range OPTIONAL,
  rsrqResult              RSRQ-Range OPTIONAL,
  ta                      INTEGER(0..1282) OPTIONAL, -- Currently used Timing Advance value (N_TA/16 as per [3GPP
36.213])
  measResultListEUTRA    MeasResultListEUTRA OPTIONAL, --Neighbour measurements
  ...,
  earfcn                  INTEGER(0..65535) OPTIONAL, -- see Table 37
  earfcn-ext              INTEGER (65536..262143) OPTIONAL, -- see Table 37
  rsrpResult-ext          RSRP-Range-Ext OPTIONAL,
  rsrqResult-ext          RSRQ-Range-Ext OPTIONAL,
  rs-sinrResult           RS-SINR-Range OPTIONAL,
  servingInformation5G    ServingInformation5G OPTIONAL
}

MeasResultListEUTRA ::= SEQUENCE (SIZE (1..maxCellReport)) OF MeasResultEUTRA
```

```

MeasResultEUTRA ::= SEQUENCE {
  physCellId PhysCellId,
  cgi-Info SEQUENCE {
    cellGlobalId CellGlobalIdEUTRA,
    trackingAreaCode TrackingAreaCode
  } OPTIONAL,
  measResult SEQUENCE {
    rsrpResult RSRP-Range OPTIONAL, -- Mapping to measured values
    rsrqResult RSRQ-Range OPTIONAL, -- in 3GPP TS 36.133
    . . . ,
    earfcn INTEGER(0..65535) OPTIONAL, -- see Table 37
  }
  earfcn-ext INTEGER (65536..262143) OPTIONAL, -- see Table 37
  rsrpResult-ext RSRP-Range-Ext OPTIONAL,
  rsrqResult-ext RSRQ-Range-Ext OPTIONAL,
  rs-sinrResult RS-SINR-Range OPTIONAL,
  neighbourInformation5G NeighbourInformation5G OPTIONAL
}

```

The IE "MeasResultListEUTRA" mirrors the equivalent IE from the RRC specification:

```

MeasResultEUTRA ::= SEQUENCE {
  physCellId PhysCellId,
  cgi-Info SEQUENCE {
    cellGlobalId CellGlobalIdEUTRA,
    trackingAreaCode TrackingAreaCode,
    plmn-IdentityList PLMN-IdentityList2 OPTIONAL,
  } OPTIONAL,
  measResult SEQUENCE {
    rsrpResult RSRP-Range OPTIONAL,
    rsrqResult RSRQ-Range OPTIONAL,
    . . . ,
    [[ additionalSI-Info-r9 AdditionalSI-Info-r9 OPTIONAL
    ]],
    [[ primaryPLMN-Suitable-r12 ENUMERATED {true} OPTIONAL,
    measResult-v1250 RSRQ-Range-v1250 OPTIONAL
    ]],
    [[ rs-sinr-Result-r13 RS-SINR-Range-r13 OPTIONAL,
    cgi-Info-v1310 SEQUENCE {
      freqBandIndicator-r13 FreqBandIndicator-r11 OPTIONAL,
      multiBandInfoList-r13 MultiBandInfoList-r11 OPTIONAL,
      freqBandIndicatorPriority-r13 ENUMERATED {true} OPTIONAL
    } OPTIONAL
    ]],
    [[
    measResult-v1360 RSRP-Range-v1360 OPTIONAL
    ]],
    [[
    cgi-Info-5GC-r15 SEQUENCE (SIZE (1..maxPLMN-r11)) OF CellAccessRelatedInfo-5GC-
    r15 OPTIONAL
    ]],
  }
}

```

It should be noted that in addition to the container provided by SUPL itself, E-CID positioning methods (excludes E-CID and CID for NR signals) defined within LPP proper can be supported in SUPL, via tunnelling LPP as shown in this annex (in the same manner that A-GNSS, OTDOA, Barometric Pressure Sensors, WLAN, Bluetooth and TBS are supported).

## A.2 SUPL 2.0 and NR Architecture

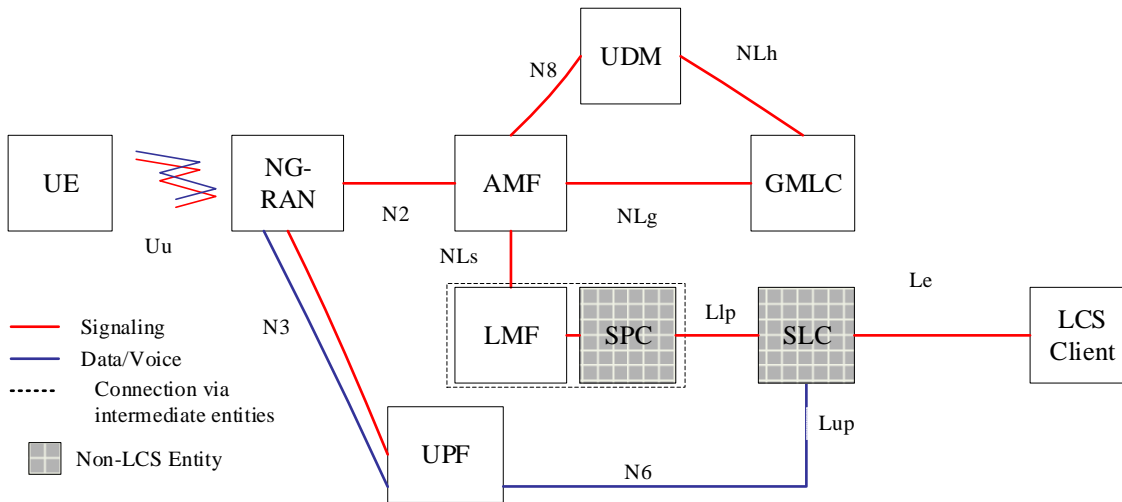
This clause describes interworking between the control-plane LCS architecture, as defined in the main body of this specification, and SUPL 2.0. Similarly, to the E-SMLC in the LTE architecture (TS 36.305 [25]), the LMF either includes or has an interface to an SPC function, as defined in OMA SUPL V2.0 ([15], [16]). It can thus provide a consistent set of positioning methods for deployments utilizing both control-plane and user-plane.

The interworking does not enable use of user-plane signalling for part of a control-plane positioning session. The user plane in the interworking here is not intended as an alternative path for control-plane signalling that would be needed between UE and NG-RAN for mechanisms such as A-GPS in a standalone control-plane solution.



This interworking does enable the SPC to retrieve measurements (e.g., GNSS-to-RAN time relations) from the NG-RAN.

The underlying architecture is shown in Figure A.2-1 (TS 23.501 [2]). Note that, for interworking between user-plane and control-plane positioning, no new interfaces need to be defined as compared to those in the figure, assuming the SPC is either integrated in the LMF or attached to it with a proprietary interface.

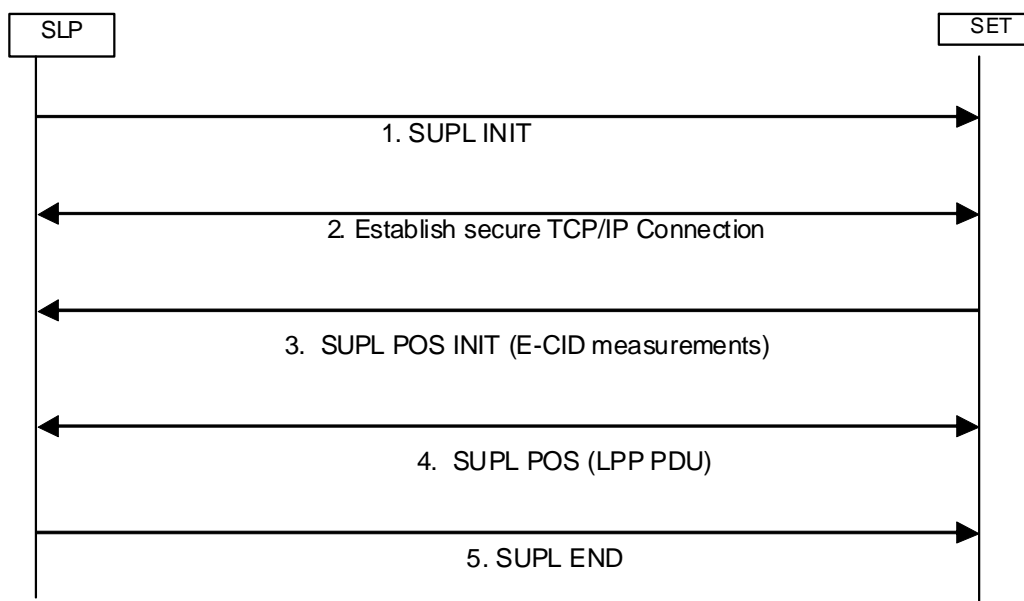


**Figure A.2-1: System reference architecture reference for Location Services in reference point representation**

The Lup and Llp interfaces shown in this architecture are part of the user-plane solution only and are not required for control-plane positioning.

### A.3 LPP session procedures using SUPL

This clause indicates how an LPP session relates to the SUPL message set. Figure A.3-1 shows how SUPL and LPP can be combined within a SUPL positioning session. Step 4 here is repeated to exchange multiple LPP messages between the SLP and SET.



**Figure A.3-1: LPP session over SUPL**

For positioning operations which take place entirely within an LPP session (step 4 in Figure A.3-1), the flow of LPP messages can be the same as in the control-plane version of LPP; the role of the (LPP) target is taken by the target SET, and that of the (LPP) server by the SLP. An example LPP flow, including exchange of capabilities, request and delivery of assistance data, and request and delivery of positioning information, is shown in Figure A.3-2.

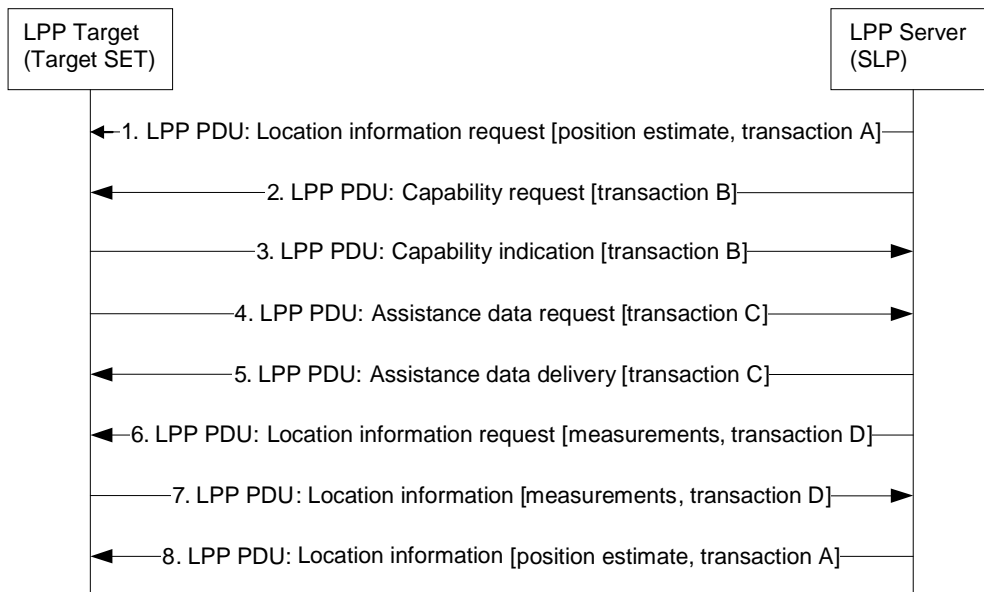


Figure A.3-2: LPP session over SUPL

### A.4 Procedures combining C-plane and U-plane operations

Since SUPL by definition is carried over the user plane, it is not applicable to operations terminating at the NG-RAN. SUPL operations must take place in combination with control-plane procedures over NRPPa.

This situation could arise in the case of UE-assisted OTDOA, for example, in which the SLP needs to provide the UE (in a SUPL session) with assistance data supplied by the NG-RAN. This clause uses a UE-assisted OTDOA positioning operation as an example.

Although the positioning server in this operation is the SLP, the existence of an interface to the LMF means that the SLP can communicate with the LMF via the SPC. In particular, this means that assistance data that was delivered to the LMF via NRPPa can be transferred over to the SLP for delivery to the UE via LPP over SUPL.

There are several ways to realise this general behaviour. In the simplest case, the LMF could be supplied with the necessary assistance data in advance, so that it can be supplied to the SLP without any actual NRPPa procedures taking place in real time (and possibly even before the positioning transaction begins).

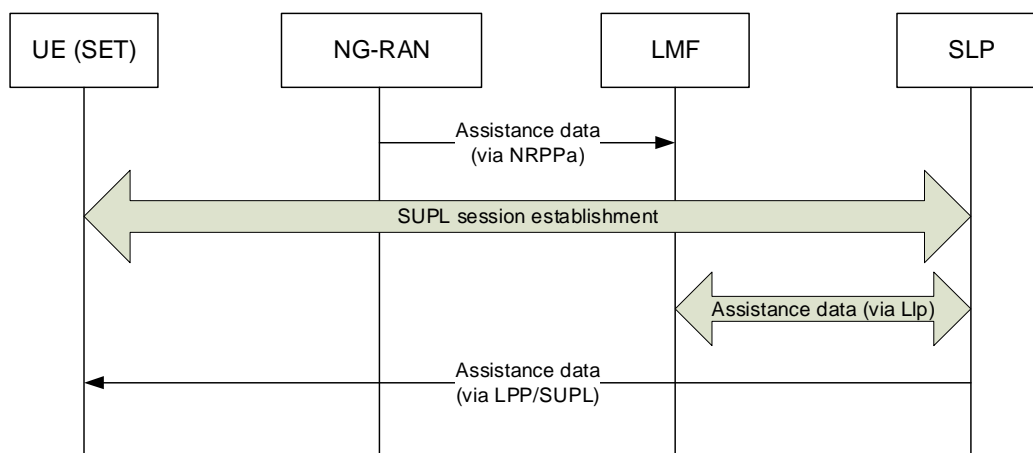
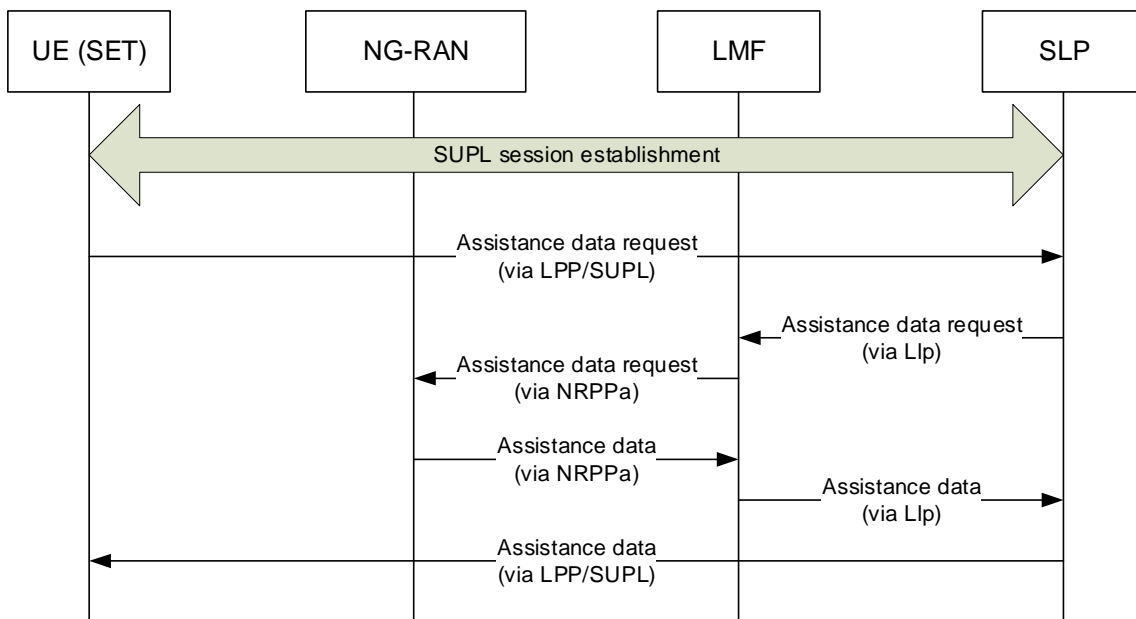


Figure A.4-1: Transfer of OTDOA assistance data to UE via SUPL

In the event that the LMF does not have the required assistance data available, it would need to retrieve them from the NG-RAN once it was made aware that they were needed.



**Figure A.4-2: Transfer to the UE via SUPL of OTDOA assistance data not already available at the LMF**

In both cases, it should be noted that the retrieval of the assistance data is transparent to the UE and to the actual SUPL session. This model is parallel to the approach used with A-GNSS, in which assistance data such as satellite ephemerides are retrieved from sources entirely external to the cellular network. For purposes of LPP over SUPL, the delivery of assistance data to the SLP can be viewed as an independent external process.

The delivery of assistance data to the UE, however, takes place through the same mechanisms as control-plane LPP, transported through SUPL.

## Annex B (informative): Change history

Change history							
Date	Meeting	TDoc	CR	Rev	Cat	Subject/Comment	New version
08/2017	RAN2#99	R2-1709477				Skeleton for TS 38.305	0.0.1
03/2018	RAN2#101	R2-1803804					0.1.0
03/2018	RAN#79	RP-180171				Submitted for Information in RAN#79	1.0.0
05/2018	RAN2#102	R2-1808695					1.1.0
05/2018	RAN2#102	R2-1809137					1.2.0
06/2018	RP-80	RP-180689				Submitted for Approval in RAN#80	2.0.0
06/2018						Upgraded to Rel-15 after plenary approval	15.0.0
09/2018	RP-81	RP-181939	0001	-	F	Signalling between an LMF and NG-RAN node/UE	15.1.0
	RP-81	RP-181942	0002	1	F	Gaps for positioning measurements	15.1.0
12/2018	RP-82	RP-182655	0006	-	F	Addition of RTK Assistance Data	15.2.0
	RP-82	RP-182656	0007	1	F	Capture use of motion information from motion sensors	15.2.0
03/2019	RP-83	RP-190544	0008	2	F	CR to 38.305 on use of positioning measurement gaps for subframe and slot timing detection towards E-UTRA	15.3.0
06/2019	RP-84	RP-191374	0009	2	F	Minor restructuring of sensor references and addition of sensor methods (IMU)	15.4.0
	RP-84	RP-191374	0010	3	F	Adding missing reference for autonomous and measurements gaps for Inter-RAT RSTD measurements	15.4.0
	RP-84	RP-191376	0011	4	F	Update of OMA SUPL information	15.4.0
	RP-84	RP-191378	0012	4	F	UE Identifier for routing message between Core Network Nodes and RAN	15.4.0
12/2019	RP-86	RP-192938	0014	2	F	Correction on the EUTRAN terminology	15.5.0
	RP-86	RP-192935	0015	2	F	Corrections for Positioning Architecture	15.5.0
	RP-86	RP-192935	0016	-	F	Corrections of terminology for stage 2	15.5.0
03/2020	RP-87	RP-200357	0013	1	B	Introduction of B1C signal in BDS system in A-GNSS	16.0.0
	RP-87	RP-200345	0017	3	B	Introduction of NR positioning	16.0.0
07/2020	RP-88	RP-201161	0019	2	A	Clarification on UE Positioning Architecture	16.1.0
	RP-88	RP-201175	0021	1	A	CR to clarify the meaning of GNSS term in 38.305 Rel-16	16.1.0
	RP-88	RP-201190	0024	1	F	Update B1I signal ICD file to v3.0 in BDS system in A-GNSS	16.1.0
	RP-88	RP-201175	0025	2	F	Corrections to NR Positioning	16.1.0

---

# History

<b>Document history</b>		
V16.1.0	July 2020	Publication