

ETSI TS 138 323 V17.0.0 (2022-05)



**5G;
NR;
Packet Data Convergence Protocol (PDCP) specification
(3GPP TS 38.323 version 17.0.0 Release 17)**



Reference

RTS/TSGR-0238323vh00

Keywords

5G

ETSI

650 Route des Lucioles
F-06921 Sophia Antipolis Cedex - FRANCE

Tel.: +33 4 92 94 42 00 Fax: +33 4 93 65 47 16

Siret N° 348 623 562 00017 - APE 7112B
Association à but non lucratif enregistrée à la
Sous-Préfecture de Grasse (06) N° w061004871

Important notice

The present document can be downloaded from:

<http://www.etsi.org/standards-search>

The present document may be made available in electronic versions and/or in print. The content of any electronic and/or print versions of the present document shall not be modified without the prior written authorization of ETSI. In case of any existing or perceived difference in contents between such versions and/or in print, the prevailing version of an ETSI deliverable is the one made publicly available in PDF format at www.etsi.org/deliver.

Users of the present document should be aware that the document may be subject to revision or change of status.

Information on the current status of this and other ETSI documents is available at

<https://portal.etsi.org/TB/ETSIDeliverableStatus.aspx>

If you find errors in the present document, please send your comment to one of the following services:

<https://portal.etsi.org/People/CommitteeSupportStaff.aspx>

If you find a security vulnerability in the present document, please report it through our
Coordinated Vulnerability Disclosure Program:

<https://www.etsi.org/standards/coordinated-vulnerability-disclosure>

Notice of disclaimer & limitation of liability

The information provided in the present deliverable is directed solely to professionals who have the appropriate degree of experience to understand and interpret its content in accordance with generally accepted engineering or other professional standard and applicable regulations.

No recommendation as to products and services or vendors is made or should be implied.

No representation or warranty is made that this deliverable is technically accurate or sufficient or conforms to any law and/or governmental rule and/or regulation and further, no representation or warranty is made of merchantability or fitness for any particular purpose or against infringement of intellectual property rights.

In no event shall ETSI be held liable for loss of profits or any other incidental or consequential damages.

Any software contained in this deliverable is provided "AS IS" with no warranties, express or implied, including but not limited to, the warranties of merchantability, fitness for a particular purpose and non-infringement of intellectual property rights and ETSI shall not be held liable in any event for any damages whatsoever (including, without limitation, damages for loss of profits, business interruption, loss of information, or any other pecuniary loss) arising out of or related to the use of or inability to use the software.

Copyright Notification

No part may be reproduced or utilized in any form or by any means, electronic or mechanical, including photocopying and microfilm except as authorized by written permission of ETSI.

The content of the PDF version shall not be modified without the written authorization of ETSI.

The copyright and the foregoing restriction extend to reproduction in all media.

© ETSI 2022.
All rights reserved.

Intellectual Property Rights

Essential patents

IPRs essential or potentially essential to normative deliverables may have been declared to ETSI. The declarations pertaining to these essential IPRs, if any, are publicly available for **ETSI members and non-members**, and can be found in ETSI SR 000 314: "*Intellectual Property Rights (IPRs); Essential, or potentially Essential, IPRs notified to ETSI in respect of ETSI standards*", which is available from the ETSI Secretariat. Latest updates are available on the ETSI Web server (<https://ipr.etsi.org/>).

Pursuant to the ETSI Directives including the ETSI IPR Policy, no investigation regarding the essentiality of IPRs, including IPR searches, has been carried out by ETSI. No guarantee can be given as to the existence of other IPRs not referenced in ETSI SR 000 314 (or the updates on the ETSI Web server) which are, or may be, or may become, essential to the present document.

Trademarks

The present document may include trademarks and/or tradenames which are asserted and/or registered by their owners. ETSI claims no ownership of these except for any which are indicated as being the property of ETSI, and conveys no right to use or reproduce any trademark and/or tradename. Mention of those trademarks in the present document does not constitute an endorsement by ETSI of products, services or organizations associated with those trademarks.

DECT™, **PLUGTESTS™**, **UMTS™** and the ETSI logo are trademarks of ETSI registered for the benefit of its Members. **3GPP™** and **LTE™** are trademarks of ETSI registered for the benefit of its Members and of the 3GPP Organizational Partners. **oneM2M™** logo is a trademark of ETSI registered for the benefit of its Members and of the oneM2M Partners. **GSM®** and the GSM logo are trademarks registered and owned by the GSM Association.

Legal Notice

This Technical Specification (TS) has been produced by ETSI 3rd Generation Partnership Project (3GPP).

The present document may refer to technical specifications or reports using their 3GPP identities. These shall be interpreted as being references to the corresponding ETSI deliverables.

The cross reference between 3GPP and ETSI identities can be found under <http://webapp.etsi.org/key/queryform.asp>.

Modal verbs terminology

In the present document "**shall**", "**shall not**", "**should**", "**should not**", "**may**", "**need not**", "**will**", "**will not**", "**can**" and "**cannot**" are to be interpreted as described in clause 3.2 of the [ETSI Drafting Rules](#) (Verbal forms for the expression of provisions).

"**must**" and "**must not**" are **NOT** allowed in ETSI deliverables except when used in direct citation.

Contents

Intellectual Property Rights	2
Legal Notice	2
Modal verbs terminology.....	2
Foreword.....	6
1 Scope	7
2 References	7
3 Definitions and abbreviations.....	8
3.1 Definitions	8
3.2 Abbreviations	8
4 General	9
4.1 Introduction	9
4.2 Architecture	9
4.2.1 PDCP structure	9
4.2.2 PDCP entities.....	10
4.3 Services	12
4.3.1 Services provided to upper layers	12
4.3.2 Services expected from lower layers	12
4.4 Functions	12
5 Procedures	13
5.1 PDCP entity handling.....	13
5.1.1 PDCP entity establishment	13
5.1.2 PDCP entity re-establishment	13
5.1.3 PDCP entity release	15
5.1.4 PDCP entity suspend	15
5.1.5 PDCP entity reconfiguration.....	15
5.2 Data transfer	16
5.2.1 Transmit operation.....	16
5.2.2 Receive operation	17
5.2.2.1 Actions when a PDCP Data PDU is received from lower layers	17
5.2.2.2 Actions when a <i>t-Reordering</i> expires.....	18
5.2.2.3 Actions when the value of <i>t-Reordering</i> is reconfigured	19
5.2.3 Sidelink transmit operation.....	19
5.2.4 Sidelink receive operation	19
5.3 SDU discard	19
5.4 Status reporting	19
5.4.1 Transmit operation.....	19
5.4.2 Receive operation	20
5.5 Data recovery	20
5.6 Data volume calculation.....	21
5.7 Robust header compression and decompression	22
5.7.1 Supported header compression protocols and profiles.....	22
5.7.2 Configuration of ROHC.....	22
5.7.3 Protocol parameters	22
5.7.4 Header compression using ROHC.....	23
5.7.5 Header decompression using ROHC	23
5.7.6 PDCP Control PDU for interspersed ROHC feedback	23
5.7.6.1 Transmit Operation	23
5.7.6.2 Receive Operation.....	24
5.8 Cipherring and decipherring	24
5.9 Integrity protection and verification.....	24
5.10 Handling of unknown, unforeseen, and erroneous protocol data	25
5.11 PDCP duplication.....	26
5.11.1 Activation/Deactivation of PDCP duplication.....	26

5.11.2	Duplicate PDU discard	26
5.12	Ethernet header compression and decompression	26
5.12.1	Supported header compression protocols	26
5.12.2	Configuration of EHC.....	26
5.12.3	Protocol parameters	27
5.12.4	Header compression using EHC	27
5.12.5	Header decompression using EHC	27
5.12.6	PDCP Control PDU for EHC feedback	27
5.12.6.1	Transmit Operation	27
5.12.6.2	Receive Operation.....	27
5.12.7	Simultaneous configuration of ROHC and EHC	27
5.13	Uplink data switching.....	28
5.14	Uplink Data compression and decompression.....	28
5.14.1	UDC protocol.....	28
5.14.2	Configuration of UDC	29
5.14.3	UDC header	29
5.14.4	Uplink data compression	29
5.14.5	PDCP Control PDU for UDC feedback	29
5.14.6	Pre-defined dictionary.....	29
5.14.7	UDC buffer reset procedure.....	30
5.14.8	UDC checksum error handling	30
6	Protocol data units, formats, and parameters.....	30
6.1	Protocol data units	30
6.1.1	Data PDU.....	30
6.1.2	Control PDU	30
6.2	Formats.....	30
6.2.1	General.....	30
6.2.2	Data PDU.....	31
6.2.2.1	Data PDU for SRBs	31
6.2.2.2	Data PDU for DRBs and MRBs with 12 bits PDCP SN.....	31
6.2.2.3	Data PDU for DRBs and MRBs with 18 bits PDCP SN.....	32
6.2.2.4	Data PDU for sidelink DRBs for groupcast and broadcast, for the sidelink SRB0 and for the sidelink SRB4	32
6.2.2.5	Data PDU for sidelink SRBs for unicast.....	33
6.2.2.6	Data PDU for sidelink DRBs for unicast with 12 bits PDCP SN.....	33
6.2.2.7	Data PDU for sidelink DRBs for unicast with 18 bits PDCP SN.....	34
6.2.3	Control PDU	35
6.2.3.1	Control PDU for PDCP status report	35
6.2.3.2	Control PDU for interspersed ROHC feedback	36
6.2.3.3	Control PDU for EHC feedback.....	36
6.2.3.4	PDCP Control PDU for UDC feedback packet.....	36
6.3	Parameters	36
6.3.1	General.....	36
6.3.2	PDCP SN.....	37
6.3.3	Data.....	37
6.3.4	MAC-I	37
6.3.5	COUNT	37
6.3.6	R	38
6.3.7	D/C.....	38
6.3.8	PDU type	38
6.3.9	FMC.....	38
6.3.10	Bitmap	38
6.3.11	Interspersed ROHC feedback	39
6.3.12	SDU Type	39
6.3.13	K _{NRP-sess} ID	39
6.3.14	FE.....	39
7	State variables, constants, and timers.....	39
7.1	State variables	39
7.2	Constants	40
7.3	Timers	40

Annex A (normative):	Ethernet Header Compression (EHC) protocol.....	42
A.1	EHC principle.....	42
A.2	EHC packet format and parameters.....	43
A.2.1	EHC packet format.....	43
A.2.1.1	EHC Full Header packet and EHC Compressed Header packet.....	43
A.2.1.2	EHC feedback packet.....	44
A.2.2	Parameters	45
A.2.2.1	F/C	45
A.2.2.2	CID	45
Annex B (normative):	Uplink Data Compression Protocol.....	46
B.1	UDC general description	46
B.2	UDC packet format and parameters	46
B.2.1	UDC Header and UDC Data Block format	46
B.2.2	UDC parameters	46
B.2.2.1	FU	46
B.2.2.2	FR	46
B.2.2.3	Checksum	47
B.2.3	An example of UDC Checksum calculation.....	47
Annex C (informative):	Change history	48
History		49

Foreword

This Technical Specification has been produced by the 3rd Generation Partnership Project (3GPP).

The contents of the present document are subject to continuing work within the TSG and may change following formal TSG approval. Should the TSG modify the contents of the present document, it will be re-released by the TSG with an identifying change of release date and an increase in version number as follows:

Version x.y.z

where:

- x the first digit:
 - 1 presented to TSG for information;
 - 2 presented to TSG for approval;
 - 3 or greater indicates TSG approved document under change control.
- y the second digit is incremented for all changes of substance, i.e. technical enhancements, corrections, updates, etc.
- z the third digit is incremented when editorial only changes have been incorporated in the document.

1 Scope

The present document provides the description of the Packet Data Convergence Protocol (PDCP).

2 References

The following documents contain provisions which, through reference in this text, constitute provisions of the present document.

- References are either specific (identified by date of publication, edition number, version number, etc.) or non-specific.
- For a specific reference, subsequent revisions do not apply.
- For a non-specific reference, the latest version applies. In the case of a reference to a 3GPP document (including a GSM document), a non-specific reference implicitly refers to the latest version of that document *in the same Release as the present document*.

- [1] 3GPP TR 21.905: "Vocabulary for 3GPP Specifications".
- [2] 3GPP TS 38.300: "NG Radio Access Network; Overall description".
- [3] 3GPP TS 38.331: "NR Radio Resource Control (RRC); Protocol Specification".
- [4] 3GPP TS 38.321: "NR Medium Access Control (MAC) protocol specification".
- [5] 3GPP TS 38.322: "NR Radio Link Control (RLC) protocol specification".
- [6] 3GPP TS 33.501: "Security Architecture and Procedures for 5G System".
- [7] IETF RFC 5795: "The RObust Header Compression (ROHC) Framework".
- [8] IETF RFC 3095: "RObust Header Compression (ROHC): Framework and four profiles: RTP, UDP, ESP and uncompressed".
- [9] IETF RFC 4815: "RObust Header Compression (ROHC): Corrections and Clarifications to RFC 3095".
- [10] IETF RFC 6846: "RObust Header Compression (ROHC): A Profile for TCP/IP (ROHC-TCP)".
- [11] IETF RFC 5225: "RObust Header Compression (ROHC) Version 2: Profiles for RTP, UDP, IP, ESP and UDP Lite".
- [12] 3GPP TS 36.321: "Evolved Universal Terrestrial Radio Access (E-UTRA) Medium Access Control (MAC) protocol specification".
- [13] 3GPP TS 23.287: "Architecture enhancements for 5G System (5GS) to support Vehicle-to-Everything (V2X) services".
- [14] 3GPP TS 33.536: "Security Aspect of 3GPP Support for Advanced V2X Services".
- [15] IEEE Standard 802.3™-2018: "Ethernet".
- [16] 3GPP TS 24.587: "Vehicle-to-Everything (V2X) services in 5G System (5GS), Stage 3".
- [17] 3GPP TS 33.401: "3GPP System Architecture Evolution (SAE); Security Architecture".
- [18] 3GPP TS 23.304: "Proximity based Services (ProSe) in the 5G System (5GS)".
- [19] IETF RFC 1951: "DEFLATE Compressed Data Format Specification version 1.3".

- [20] IETF RFC 3485: "The Session Initiation Protocol (SIP) and Session Description Protocol (SDP) Static Dictionary for Signaling Compression (SigComp)".
- [21] IETF RFC 1979: "PPP Deflate Protocol".

3 Definitions and abbreviations

3.1 Definitions

For the purposes of the present document, the terms and definitions given in TR 21.905 [1] and the following apply. A term defined in the present document takes precedence over the definition of the same term, if any, in TR 21.905 [1].

AM DRB: a data radio bearer which utilizes RLC AM.

AM MRB: an MRB associated with at least one AM RLC bearer for PTP transmission.

DAPS bearer: a bearer whose radio protocols are located in both the source gNB and the target gNB during DAPS handover to use both source gNB and target gNB resources.

MBS Radio Bearer: a radio bearer that is configured for MBS delivery.

Non-split bearer: a bearer whose radio protocols are located in either the MgNB or the SgNB to use MgNB or SgNB resource, respectively.

NR sidelink communication: AS functionality enabling at least V2X communication as defined in TS 23.287 [13], between two or more nearby UEs, using NR technology but not traversing any network node.

PDCP data volume: the amount of data available for transmission in a PDCP entity.

Sidelink discovery: AS functionality enabling 5G ProSe UE-to-Network Relay Discovery or 5G ProSe Direct Discovery as defined in TS 23.304 [18], using NR technology but not traversing any network node.

Split bearer: in dual connectivity, a bearer whose radio protocols are located in both the MgNB and the SgNB to use both MgNB and SgNB resources.

Split secondary RLC entity: in dual connectivity, the RLC entity other than the primary RLC entity which is responsible for split bearer operation. If the PDCP entity is associated with two RLC entities, the split secondary RLC entity is the RLC entity other than the primary RLC entity. If the PDCP entity is associated with more than two RLC entities, the split secondary RLC entity is configured by upper layers.

UM DRB: a data radio bearer which utilizes RLC UM.

UM MRB: an MRB associated with only RLC UM.

3.2 Abbreviations

For the purposes of the present document, the abbreviations given in TR 21.905 [1] and the following apply. An abbreviation defined in the present document takes precedence over the definition of the same abbreviation, if any, in TR 21.905 [1].

AM	Acknowledged Mode
CID	Context Identifier
DAPS	Dual Active Protocol Stack
DRB	Data Radio Bearer carrying user plane data
EHC	Ethernet Header Compression
FIFO	First In First Out
gNB	NR Node B
HFN	Hyper Frame Number
IETF	Internet Engineering Task Force
IP	Internet Protocol
MAC	Medium Access Control

MAC-I	Message Authentication Code for Integrity
MBS	Multicast/Broadcast Services
MRB	MBS Radio Bearer
MTCH	MBS Traffic Channel
PDCP	Packet Data Convergence Protocol
PDU	Protocol Data Unit
RB	Radio Bearer
RFC	Request For Comments
RLC	Radio Link Control
ROHC	RObust Header Compression
RRC	Radio Resource Control
RTP	Real Time Protocol
SAP	Service Access Point
SCCH	Sidelink Control Channel
SDU	Service Data Unit
SLRB	Sidelink Radio Bearer carrying NR sidelink communication
SN	Sequence Number
SRB	Signalling Radio Bearer carrying control plane data
STCH	Sidelink Traffic Channel
TCP	Transmission Control Protocol
UDC	Uplink Data Compression
UDP	User Datagram Protocol
UE	User Equipment
UM	Unacknowledged Mode
X-MAC	Computed MAC-I

4 General

4.1 Introduction

The present document describes the functionality of the PDCP.

4.2 Architecture

4.2.1 PDCP structure

Figure 4.2.1.1 represents one possible structure for the PDCP sublayer; it should not restrict implementation. The figure is based on the radio interface protocol architecture defined in TS 38.300 [2].

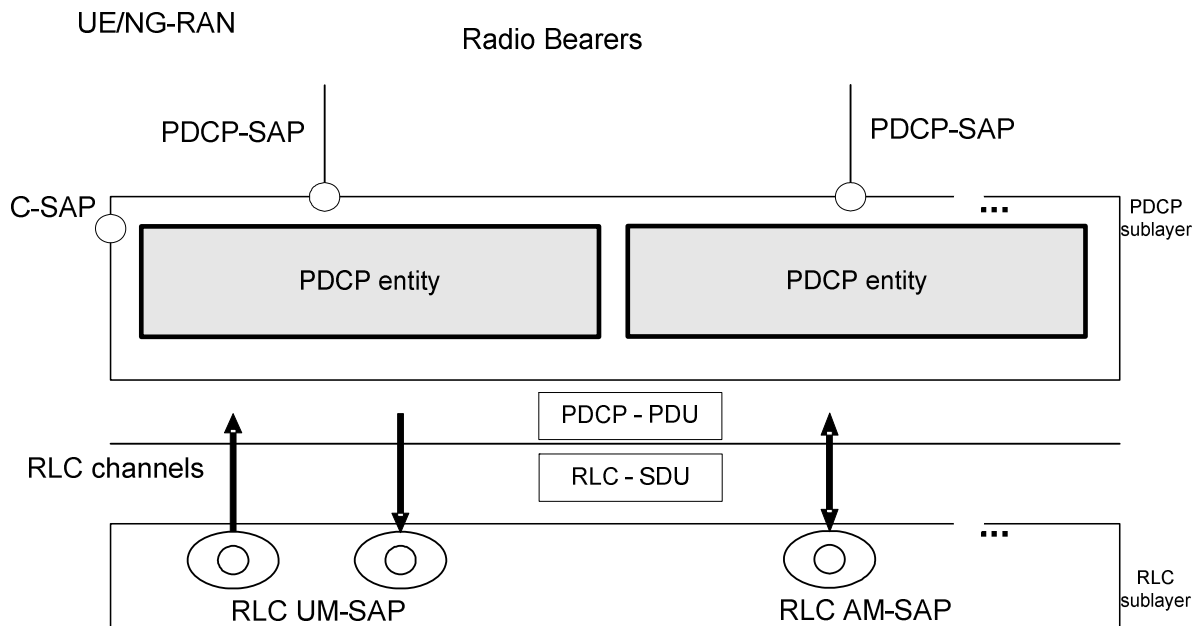

Figure 4.2.1-1: PDCP layer, structure view

The PDCP sublayer is configured by upper layers TS 38.331 [3]. The PDCP sublayer is used for RBs mapped on DCCH, DTCH, MTCH, SCCH, and STCH type of logical channels. The PDCP sublayer is not used for any other type of logical channels.

Each RB (except for SRB0 for Uu interface) is associated with one PDCP entity. Each PDCP entity is associated with one, two, three, four, six, or eight RLC entities depending on the RB characteristic (e.g. uni-directional/bi-directional or split/non-split) or RLC mode:

- For split bearers, each PDCP entity is associated with two UM RLC entities (for same direction), four UM RLC entities (two for each direction), or two AM RLC entities;
- For RBs configured with PDCP duplication, each PDCP entity is associated with N UM RLC entities (for same direction), $2 \times N$ UM RLC entities (N for each direction), or N AM RLC entities, where $2 \leq N \leq 4$;
- For DAPS bearers, each PDCP entity is associated with two UM RLC entities (for same direction, one for source and one for target cell), four UM RLC entities (two for each direction on source cell and target cell), or two AM RLC entities (one for source cell and one for target cell);
- For UM MRBs, each PDCP entity is associated with one UM RLC entity (for MTCH or for downlink DTCH), two UM RLC entities (one for MTCH and one for downlink DTCH, or one for downlink DTCH and one for uplink DTCH), or three UM RLC entities (one for MTCH, one for downlink DTCH, and one for uplink DTCH);
- For AM MRBs, each PDCP entity is associated with one AM RLC entity (for downlink DTCH and uplink DTCH), or one UM RLC entity (for MTCH) and one AM RLC entity (for downlink DTCH and uplink DTCH);
- Otherwise, each PDCP entity is associated with one UM RLC entity, two UM RLC entities (one for each direction), or one AM RLC entity.

4.2.2 PDCP entities

The PDCP entities are located in the PDCP sublayer. Several PDCP entities may be defined for a UE. Each PDCP entity is carrying the data of one radio bearer. A PDCP entity is associated either to the control plane or the user plane depending on which radio bearer it is carrying data for.

Figure 4.2.2-1 represents the functional view of the PDCP entity for the PDCP sublayer; it should not restrict implementation. The figure is based on the radio interface protocol architecture defined in TS 38.300 [2].

For split bearers and DAPS bearers, routing is performed in the transmitting PDCP entity.

A PDCP entity associated with DRB/MRB can be configured by upper layers TS 38.331 [3] to use header compression or uplink data compression (UDC). In this version of the specification, the robust header compression protocol (ROHC), the Ethernet header compression protocol (EHC) and UDC are supported. Each header compression protocol is independently configured for a DRB/MRB.

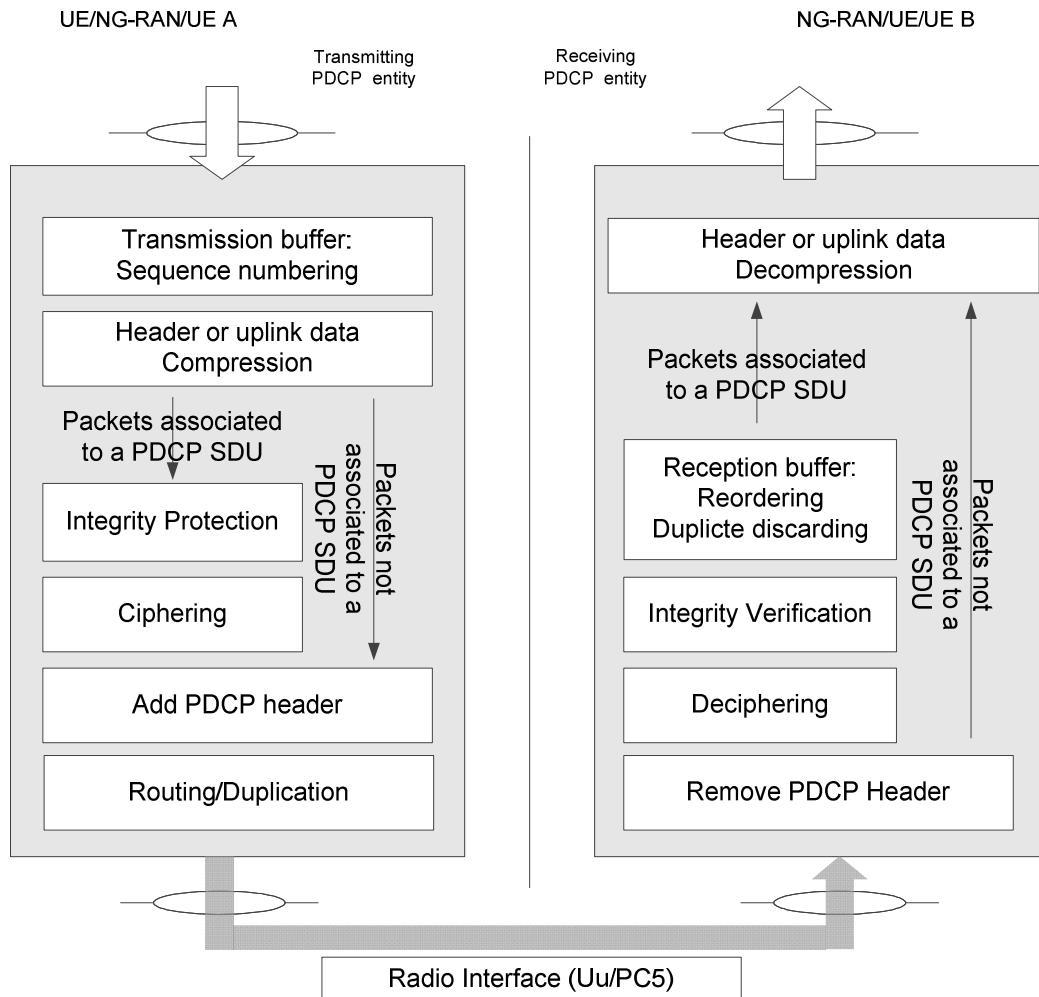

Figure 4.2.2-1: PDCP layer, functional view

Figure 4.2.2-2 represents the functional view of the PDCP entity associated with the DAPS bearer for the PDCP sublayer; it should not restrict implementation. The figure is based on the radio interface protocol architecture defined in TS 38.300 [2].

For DAPS bearers, the PDCP entity is configured with two sets of security functions and keys and two sets of header compression protocols.

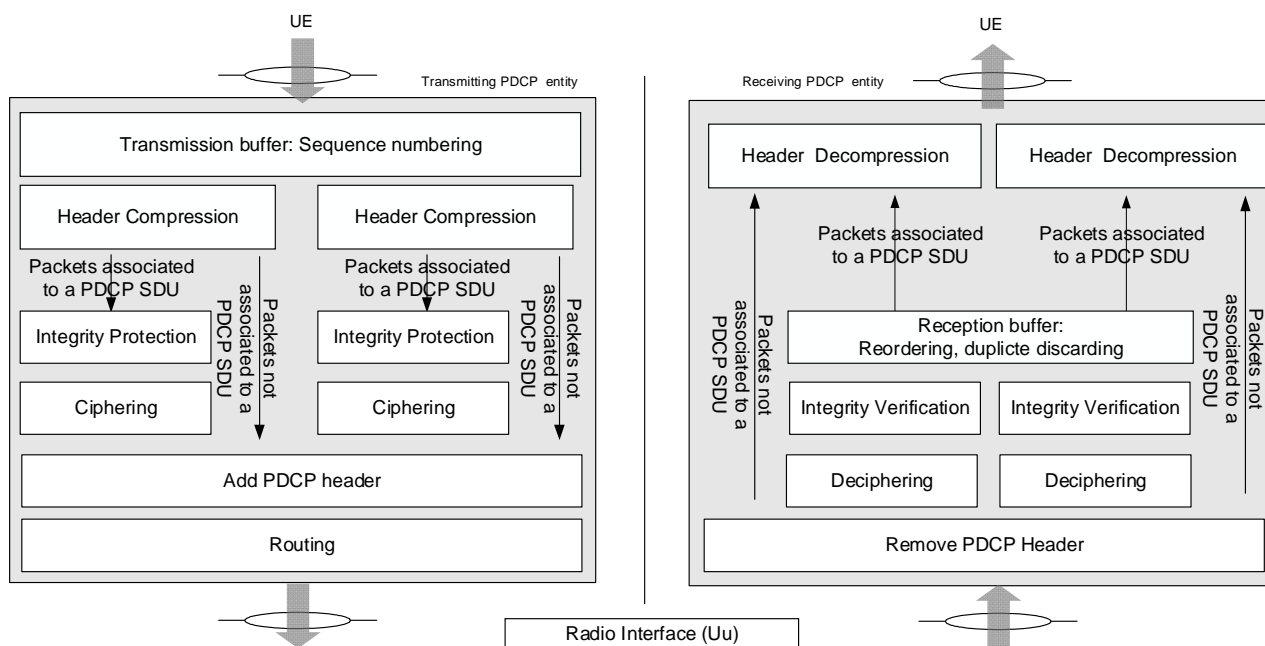

Figure 4.2.2-2: PDCP layer associated with DAPS bearer, functional view

4.3 Services

4.3.1 Services provided to upper layers

The PDCP layer provides its services to the RRC or SDAP layers. The following services are provided by PDCP to upper layers:

- transfer of user plane data;
- transfer of control plane data;
- header compression;
- uplink data compression;
- ciphering;
- integrity protection.

The maximum supported size of a PDCP SDU is 9000 bytes. The maximum supported size of a PDCP Control PDU is 9000 bytes.

4.3.2 Services expected from lower layers

A PDCP entity expects the following services from lower layers per RLC entity (for a detailed description see TS 38.322 [5]):

- acknowledged data transfer service, including indication of successful delivery of PDCP PDUs;
- unacknowledged data transfer service.

4.4 Functions

The PDCP layer supports the following functions:

- transfer of data (user plane or control plane);

- maintenance of PDCP SNs;
- header compression and decompression using the ROHC protocol;
- header compression and decompression using the EHC protocol;
- uplink data compression and decompression using the UDC protocol;
- ciphering and deciphering;
- integrity protection and integrity verification;
- timer based SDU discard;
- for split bearers and DAPS bearer, routing;
- duplication;
- reordering and in-order delivery;
- out-of-order delivery;
- duplicate discarding.

5 Procedures

5.1 PDCP entity handling

5.1.1 PDCP entity establishment

When upper layers request a PDCP entity establishment for a radio bearer for Uu or PC5 interface; or for NR sidelink communication for groupcast and broadcast or for sidelink SRB4, when receiving the first PDCP PDU, and there is not yet a corresponding PDCP entity, the UE shall:

- establish a PDCP entity for the radio bearer;
- set the state variables of the PDCP entity to initial values;
- follow the procedures in clause 5.2.

5.1.2 PDCP entity re-establishment

When upper layers request a PDCP entity re-establishment, the UE shall additionally perform once the procedures described in this clause for Uu or PC5 interface. After performing the procedures in this clause, the UE shall follow the procedures in clause 5.2.

When upper layers request a PDCP entity re-establishment, the transmitting PDCP entity shall:

- for UM DRBs and AM DRBs, reset the ROHC protocol for uplink and start with an IR state in U-mode (as defined in RFC 3095 [8] and RFC 4815 [9]) if *drb-ContinueROHC* is not configured in TS 38.331 [3];
- for UM DRBs and AM DRBs, reset the EHC protocol for uplink if *drb-ContinueEHC-UL* is not configured in TS 38.331 [3];
- for AM DRBs, reset the UDC compression buffer to all zeros and prefill the dictionary if *drb-ContinueUDC* is not configured in TS 38.331 [3];
- for SRBs and UM DRBs, set TX_NEXT to the initial value;
- for SRBs, discard all stored PDCP SDUs and PDCP PDUs;

- apply the ciphering algorithm and key provided by upper layers during the PDCP entity re-establishment procedure;
- apply the integrity protection algorithm and key provided by upper layers during the PDCP entity re-establishment procedure;
- for UM DRBs, for each PDCP SDU already associated with a PDCP SN but for which a corresponding PDU has not previously been submitted to lower layers, and;
- for AM DRBs for Uu interface whose PDCP entities were suspended, from the first PDCP SDU for which the successful delivery of the corresponding PDCP Data PDU has not been confirmed by lower layers, for each PDCP SDU already associated with a PDCP SN:
 - consider the PDCP SDUs as received from upper layer;
 - perform transmission of the PDCP SDUs in ascending order of the COUNT value associated to the PDCP SDU prior to the PDCP re-establishment without restarting the *discardTimer*, as specified in clause 5.2.1;
- for AM DRBs whose PDCP entities were not suspended, from the first PDCP SDU for which the successful delivery of the corresponding PDCP Data PDU has not been confirmed by lower layers, perform retransmission or transmission of all the PDCP SDUs already associated with PDCP SNs in ascending order of the COUNT values associated to the PDCP SDU prior to the PDCP entity re-establishment as specified below:
 - perform header compression of the PDCP SDU using ROHC as specified in the clause 5.7.4 and/or using EHC as specified in the clause 5.12.4;
 - If *drb-ContinueUDC* is configured and if the PDCP SDU has been compressed before:
 - submit the PDCP SDU previously compressed to integrity protection and ciphering function;
 - else:
 - perform uplink data compression of the PDCP SDU as specified in clause 5.14.4, and submit the PDCP SDU to integrity protection and ciphering function;
 - perform integrity protection and ciphering of the PDCP SDU using the COUNT value associated with this PDCP SDU as specified in the clause 5.9 and 5.8;
 - submit the resulting PDCP Data PDU to lower layer, as specified in clause 5.2.1.

When upper layers request a PDCP entity re-establishment, the receiving PDCP entity shall:

- process the PDCP Data PDUs that are received from lower layers due to the re-establishment of the lower layers, as specified in the clause 5.2.2.1;
- for SRBs, discard all stored PDCP SDUs and PDCP PDUs;
- for SRBs, UM DRBs and UM MRBs, if *t-Reordering* is running:
 - stop and reset *t-Reordering*;
- for UM DRBs and UM MRBs, deliver all stored PDCP SDUs to the upper layers in ascending order of associated COUNT values after performing header decompression;
- for AM DRBs and AM MRBs for Uu interface, perform header decompression using ROHC for all stored PDCP SDUs if *drb-ContinueROHC* is not configured in TS 38.331 [3];
- for AM DRBs for PC5 interface, perform header decompression using ROHC for all stored PDCP IP SDUs;
- for AM DRBs and AM MRBs for Uu interface, perform header decompression using EHC for all stored PDCP SDUs if *drb-ContinueEHC-DL* is not configured in TS 38.331 [3];
- for UM DRBs, AM DRBs, UM MRBs and AM MRBs, reset the ROHC protocol for downlink and start with NC state in U-mode (as defined in RFC 3095 [8] and RFC 4815 [9]) if *drb-ContinueROHC* is not configured in TS 38.331 [3];

- for UM DRBs, AM DRBs, UM MRBs and AM MRBs, reset the EHC protocol for downlink if *drb-ContinueEHC-DL* is not configured in TS 38.331 [3];
- for SRBs, UM DRBs and UM MRBs, set *RX_NEXT* and *RX_DELIV* to the initial value;
- apply the ciphering algorithm and key provided by upper layers during the PDCP entity re-establishment procedure;
- apply the integrity protection algorithm and key provided by upper layers during the PDCP entity re-establishment procedure.

NOTE: After PDCP re-establishment on a sidelink SRB/DRB, UE determines when to transmit and receive with the new key and discard the old key as specified in TS 33.536 [14].

5.1.3 PDCP entity release

When upper layers request a PDCP entity release for a radio bearer for Uu or PC5 interface, the UE shall:

- discard all stored PDCP SDUs and PDCP PDUs in the transmitting PDCP entity;
- for UM DRBs, AM DRBs, UM MRBs and AM MRBs, deliver the PDCP SDUs stored in the receiving PDCP entity to upper layers in ascending order of associated *COUNT* values after performing header decompression, if not decompressed before;
- release the PDCP entity for the radio bearer.

NOTE: For NR sidelink communication for groupcast and broadcast or for sidelink SRB4, the receiving PDCP entity release for an SLRB is up to UE implementation.

5.1.4 PDCP entity suspend

When upper layers request a PDCP entity suspend, the transmitting PDCP entity shall:

- set *TX_NEXT* to the initial value;
- discard all stored PDCP PDUs;

When upper layers request a PDCP entity suspend, the receiving PDCP entity shall:

- if *t-Reordering* is running:
 - stop and reset *t-Reordering*;
 - deliver all stored PDCP SDUs to the upper layers in ascending order of associated *COUNT* values after performing header decompression;
- set *RX_NEXT* and *RX_DELIV* to the initial value.

5.1.5 PDCP entity reconfiguration

When upper layers reconfigure the PDCP entity to configure DAPS, the UE shall:

- establish a ciphering function for the radio bearer and apply the ciphering algorithm and key provided by upper layers for the ciphering function;
- establish an integrity protection function for the radio bearer and apply the integrity protection algorithm and key provided by upper layers for the integrity protection function;
- establish a header compression protocol for the radio bearer and apply the header compression configuration provided by upper layers for the header compression protocol.

When upper layers reconfigure the PDCP entity to release DAPS, the UE shall:

- release the ciphering function associated to the released RLC entity for the radio bearer;

- release the integrity protection function associated to the released RLC entity for the radio bearer;
- release the header compression protocol associated to the released RLC entity for the radio bearer.

NOTE 1: The state variables which control the transmission and reception operation should not be reset, and the timers including *t-Reordering* and *discardTimer* keep running during PDCP entity reconfiguration procedure.

NOTE 2: Before releasing the header compression protocol associated to the released RLC entity, how to handle all stored PDCP SDUs received from the released RLC entity is left up to UE implementation.

NOTE 3: No special handling for the header compression protocol is defined to avoid potential security issue (e.g. keystream reuse) for DAPS handover with no security key change.

5.2 Data transfer

5.2.1 Transmit operation

At reception of a PDCP SDU from upper layers, the transmitting PDCP entity shall:

- start the *discardTimer* associated with this PDCP SDU (if configured).

For a PDCP SDU received from upper layers, the transmitting PDCP entity shall:

- associate the COUNT value corresponding to TX_NEXT to this PDCP SDU;

NOTE 1: Associating more than half of the PDCP SN space of contiguous PDCP SDUs with PDCP SNs, when e.g., the PDCP SDUs are discarded or transmitted without acknowledgement, may cause HFN desynchronization problem. How to prevent HFN desynchronization problem is left up to UE implementation.

- perform header compression of the PDCP SDU using ROHC as specified in the clause 5.7.4 and/or using EHC as specified in the clause 5.12.4;
- perform uplink data compression of the PDCP SDU as specified in clause 5.14.4;
- perform integrity protection, and ciphering using the TX_NEXT as specified in the clause 5.9 and 5.8, respectively;
- set the PDCP SN of the PDCP Data PDU to TX_NEXT modulo $2^{[pdcp-SN-SizeUL]}$;
- increment TX_NEXT by one;
- submit the resulting PDCP Data PDU to lower layer as specified below.

When submitting a PDCP PDU to lower layer, the transmitting PDCP entity shall:

- if the transmitting PDCP entity is associated with one RLC entity:
 - submit the PDCP PDU to the associated RLC entity;
- else, if the transmitting PDCP entity is associated with at least two RLC entities:
 - if the PDCP duplication is activated for the RB:
 - if the PDCP PDU is a PDCP Data PDU:
 - duplicate the PDCP Data PDU and submit the PDCP Data PDU to the associated RLC entities activated for PDCP duplication;
 - else:
 - submit the PDCP Control PDU to the primary RLC entity;
 - else (i.e. the PDCP duplication is deactivated for the RB or the RB is a DAPS bearer):

- if the split secondary RLC entity is configured; and
- if the total amount of PDCP data volume and RLC data volume pending for initial transmission (as specified in TS 38.322 [5]) in the primary RLC entity and the split secondary RLC entity is equal to or larger than *ul-DataSplitThreshold*:
 - submit the PDCP PDU to either the primary RLC entity or the split secondary RLC entity;
- else, if the transmitting PDCP entity is associated with the DAPS bearer:
 - if the uplink data switching has not been requested:
 - submit the PDCP PDU to the RLC entity associated with the source cell;
 - else:
 - if the PDCP PDU is a PDCP Data PDU:
 - submit the PDCP Data PDU to the RLC entity associated with the target cell;
 - else:
 - if the PDCP Control PDU is associated with source cell:
 - submit the PDCP Control PDU to the RLC entity associated with the source cell;
 - else:
 - submit the PDCP Control PDU to the RLC entity associated with the target cell;
 - else:
 - submit the PDCP PDU to the primary RLC entity.

NOTE 2: If the transmitting PDCP entity is associated with two RLC entities, the UE should minimize the amount of PDCP PDUs submitted to lower layers before receiving request from lower layers and minimize the PDCP SN gap between PDCP PDUs submitted to two associated RLC entities to minimize PDCP reordering delay in the receiving PDCP entity.

5.2.2 Receive operation

5.2.2.1 Actions when a PDCP Data PDU is received from lower layers

In this clause, following definitions are used:

- HFN(State Variable): the HFN part (i.e. the number of most significant bits equal to HFN length) of the State Variable;
- SN(State Variable): the SN part (i.e. the number of least significant bits equal to PDCP SN length) of the State Variable;
- RCVD_SN: the PDCP SN of the received PDCP Data PDU, included in the PDU header;
- RCVD_HFN: the HFN of the received PDCP Data PDU, calculated by the receiving PDCP entity;
- RCVD_COUNT: the COUNT of the received PDCP Data PDU = [RCVD_HFN, RCVD_SN].

At reception of a PDCP Data PDU from lower layers, the receiving PDCP entity shall determine the COUNT value of the received PDCP Data PDU, i.e. RCVD_COUNT, as follows:

- if $RCVD_SN < SN(RX_DELIV) - Window_Size$:
 - $RCVD_HFN = HFN(RX_DELIV) + 1$.
- else if $RCVD_SN \geq SN(RX_DELIV) + Window_Size$:

- $RCVD_HFN = HFN(RX_DELIV) - 1$.
- else:
 - $RCVD_HFN = HFN(RX_DELIV)$;
 - $RCVD_COUNT = [RCVD_HFN, RCVD_SN]$.

After determining the COUNT value of the received PDCP Data PDU = RCVD_COUNT, the receiving PDCP entity shall:

- perform deciphering and integrity verification of the PDCP Data PDU using COUNT = RCVD_COUNT;
 - if integrity verification fails:
 - indicate the integrity verification failure to upper layer;
 - discard the PDCP Data PDU and consider it as not received;
- if $RCVD_COUNT < RX_DELIV$; or
- if the PDCP Data PDU with COUNT = RCVD_COUNT has been received before:
 - discard the PDCP Data PDU;

If the received PDCP Data PDU with COUNT value = RCVD_COUNT is not discarded above, the receiving PDCP entity shall:

- store the resulting PDCP SDU in the reception buffer;
- if $RCVD_COUNT \geq RX_NEXT$:
 - update RX_NEXT to RCVD_COUNT + 1.
- if *outOfOrderDelivery* is configured:
 - deliver the resulting PDCP SDU to upper layers after performing header decompression using EHC.
- if $RCVD_COUNT = RX_DELIV$:
 - deliver to upper layers in ascending order of the associated COUNT value after performing header decompression, if not decompressed before;
 - all stored PDCP SDU(s) with consecutively associated COUNT value(s) starting from COUNT = RX_DELIV;
 - update RX_DELIV to the COUNT value of the first PDCP SDU which has not been delivered to upper layers, with COUNT value > RX_DELIV;
- if *t-Reordering* is running, and if $RX_DELIV \geq RX_REORD$:
 - stop and reset *t-Reordering*.
- if *t-Reordering* is not running (includes the case when *t-Reordering* is stopped due to actions above), and $RX_DELIV < RX_NEXT$:
 - update RX_REORD to RX_NEXT;
 - start *t-Reordering*.

5.2.2.2 Actions when a *t-Reordering* expires

When *t-Reordering* expires, the receiving PDCP entity shall:

- deliver to upper layers in ascending order of the associated COUNT value after performing header decompression, if not decompressed before:

- all stored PDCP SDU(s) with associated COUNT value(s) < RX_REORD;
- all stored PDCP SDU(s) with consecutively associated COUNT value(s) starting from RX_REORD;
- update RX_DELIV to the COUNT value of the first PDCP SDU which has not been delivered to upper layers, with COUNT value >= RX_REORD;
- if RX_DELIV < RX_NEXT:
 - update RX_REORD to RX_NEXT;
 - start *t-Reordering*.

5.2.2.3 Actions when the value of *t-Reordering* is reconfigured

When the value of the *t-Reordering* is reconfigured by upper layers while the *t-Reordering* is running, the receiving PDCP entity shall:

- update RX_REORD to RX_NEXT;
- stop and restart *t-Reordering*.

5.2.3 Sidelink transmit operation

For sidelink transmission of the SLRB, the UE shall follow the procedures in clause 5.2.1 with following modification:

- perform the header compression using ROHC as specified in clause 5.7.4, if SDU Type is IP.

5.2.4 Sidelink receive operation

For sidelink reception of the SLRB, the UE shall follow the procedures in clause 5.2.2 with following modification:

- perform the header decompression using ROHC as specified in clause 5.7.5, if SDU Type is IP.

NOTE: For reception of sidelink SRBs except sidelink SRB3, the UE may deliver the PDCP SDU to the upper layer along with an indication whether it is PC5-S message or sidelink discovery message.

5.3 SDU discard

When the *discardTimer* expires for a PDCP SDU, or the successful delivery of a PDCP SDU is confirmed by PDCP status report, the transmitting PDCP entity shall discard the PDCP SDU along with the corresponding PDCP Data PDU. If the corresponding PDCP Data PDU has already been submitted to lower layers, the discard is indicated to lower layers.

For SRBs, when upper layers request a PDCP SDU discard, the PDCP entity shall discard all stored PDCP SDUs and PDCP PDUs.

NOTE: Discarding a PDCP SDU already associated with a PDCP SN causes a SN gap in the transmitted PDCP Data PDUs, which increases PDCP reordering delay in the receiving PDCP entity. It is up to UE implementation how to minimize SN gap after SDU discard.

5.4 Status reporting

5.4.1 Transmit operation

For AM DRBs configured by upper layers to send a PDCP status report in the uplink (*statusReportRequired* in TS 38.331 [3]), the receiving PDCP entity shall trigger a PDCP status report when:

- upper layer requests a PDCP entity re-establishment;
- upper layer requests a PDCP data recovery;

- upper layer requests a uplink data switching;
- upper layer reconfigures the PDCP entity to release DAPS and *daps-SourceRelease* is configured in TS 38.331 [3].

For UM DRBs configured by upper layers to send a PDCP status report in the uplink (*statusReportRequired* in TS 38.331 [3]), the receiving PDCP entity shall trigger a PDCP status report when:

- upper layer requests a uplink data switching.

For AM DRBs in the sidelink, the receiving PDCP entity shall trigger a PDCP status report when:

- upper layer requests a PDCP entity re-establishment.

For AM MRBs configured by upper layers to send a PDCP status report in the uplink (*statusReportRequired* in TS 38.331 [3]), the receiving PDCP entity shall trigger a PDCP status report when:

- upper layer requests a PDCP entity re-establishment;
- upper layer requests a PDCP data recovery.

If a PDCP status report is triggered, the receiving PDCP entity shall:

- compile a PDCP status report as indicated below by:
 - setting the FMC field to RX_DELIV;
 - if RX_DELIV < RX_NEXT:
 - allocating a Bitmap field of length in bits equal to the number of COUNTs from and not including the first missing PDCP SDU up to and including the last out-of-sequence PDCP SDUs, rounded up to the next multiple of 8, or up to and including a PDCP SDU for which the resulting PDCP Control PDU size is equal to 9000 bytes, whichever comes first;
 - setting in the bitmap field as '0' for all PDCP SDUs that have not been received, and optionally PDCP SDUs for which decompression have failed;
 - setting in the bitmap field as '1' for all PDCP SDUs that have been received;
- submit the PDCP status report to lower layers as the first PDCP PDU for transmission via the transmitting PDCP entity as specified in clause 5.2.1 for Uu interface and in clause 5.2.3 for PC5 interface.

5.4.2 Receive operation

For AM DRBs, when a PDCP status report is received in the downlink or in the sidelink, the transmitting PDCP entity shall:

- consider for each PDCP SDU, if any, with the bit in the bitmap set to '1', or with the associated COUNT value less than the value of FMC field as successfully delivered, and discard the PDCP SDU as specified in clause 5.3.

5.5 Data recovery

For AM DRBs, when upper layers request a PDCP data recovery for a radio bearer, the transmitting PDCP entity shall:

- perform retransmission of all the PDCP Data PDUs previously submitted to re-established or released AM RLC entities in ascending order of the associated COUNT values for which the successful delivery has not been confirmed by lower layers, following the data submission procedure in clause 5.2.1.

After performing the above procedures, the transmitting PDCP entity shall follow the procedures in clause 5.2.1.

5.6 Data volume calculation

For the purpose of MAC buffer status reporting, the transmitting PDCP entity shall consider the following as PDCP data volume:

- the PDCP SDUs for which no PDCP Data PDUs have been constructed;
- the PDCP Data PDUs that have not been submitted to lower layers;
- the PDCP Control PDUs;
- for AM DRBs, the PDCP SDUs to be retransmitted according to clause 5.1.2;
- for AM DRBs, the PDCP Data PDUs to be retransmitted according to clause 5.5.

If the transmitting PDCP entity is associated with at least two RLC entities, when indicating the PDCP data volume to a MAC entity for BSR triggering and Buffer Size calculation (as specified in TS 38.321 [4] and TS 36.321 [12]), the transmitting PDCP entity shall:

- if the PDCP duplication is activated for the RB:
 - indicate the PDCP data volume to the MAC entity associated with the primary RLC entity;
 - indicate the PDCP data volume excluding the PDCP Control PDU to the MAC entity associated with the RLC entity other than the primary RLC entity activated for PDCP duplication;
 - indicate the PDCP data volume as 0 to the MAC entity associated with RLC entity deactivated for PDCP duplication;
- else (i.e. the PDCP duplication is deactivated for the RB or the RB is a DAPS bearer):
 - if the split secondary RLC entity is configured; and
 - if the total amount of PDCP data volume and RLC data volume pending for initial transmission (as specified in TS 38.322 [5]) in the primary RLC entity and the split secondary RLC entity is equal to or larger than *ul-DataSplitThreshold*:
 - indicate the PDCP data volume to both the MAC entity associated with the primary RLC entity and the MAC entity associated with the split secondary RLC entity;
 - indicate the PDCP data volume as 0 to the MAC entity associated with RLC entity other than the primary RLC entity and the split secondary RLC entity;
 - else, if the transmitting PDCP entity is associated with the DAPS bearer:
 - if the uplink data switching has not been requested:
 - indicate the PDCP data volume to the MAC entity associated with the source cell;
 - else:
 - indicate the PDCP data volume excluding the PDCP Control PDU for interspersed ROHC feedback associated with the source cell to the MAC entity associated with the target cell;
 - indicate the PDCP data volume of PDCP Control PDU for interspersed ROHC feedback associated with the source cell to the MAC entity associated with the source cell;
- else:
 - indicate the PDCP data volume to the MAC entity associated with the primary RLC entity;
 - indicate the PDCP data volume as 0 to the MAC entity associated with the RLC entity other than the primary RLC entity.

5.7 Robust header compression and decompression

5.7.1 Supported header compression protocols and profiles

The ROHC protocol is based on the Robust Header Compression (ROHC) framework defined in RFC 5795 [7]. There are multiple ROHC algorithms, called profiles, defined for the ROHC framework. Each profile is specific to the particular network layer, transport layer or upper layer protocol combination e.g. TCP/IP and RTP/UDP/IP.

The detailed definition of the ROHC channel is specified as part of the ROHC framework defined in RFC 5795 [7]. This includes how to multiplex different flows (header compressed or not) over the ROHC channel, as well as how to associate a specific IP flow with a specific context state during initialization of the compression algorithm for that flow.

The implementation of the functionality of the ROHC framework and of the functionality of the supported header compression profiles is not covered in this specification.

In this version of the specification the support of the following profiles is described:

Table 5.7.1-1: Supported ROHC protocols and profiles

Profile Identifier	Usage	Reference
0x0000	No compression	RFC 5795
0x0001	RTP/UDP/IP	RFC 3095, RFC 4815
0x0002	UDP/IP	RFC 3095, RFC 4815
0x0003	ESP/IP	RFC 3095, RFC 4815
0x0004	IP	RFC 3843, RFC 4815
0x0006	TCP/IP	RFC 6846
0x0101	RTP/UDP/IP	RFC 5225
0x0102	UDP/IP	RFC 5225
0x0103	ESP/IP	RFC 5225
0x0104	IP	RFC 5225

5.7.2 Configuration of ROHC

PDCP entities associated with DRBs and MRBs can be configured by upper layers TS 38.331 [3] to use ROHC. Each PDCP entity carrying user plane data may be configured to use ROHC. PDCP entities associated with sidelink DRBs can be configured to use ROHC for IP SDUs. For DRBs and MRBs other than DAPS bearers, the PDCP entity uses at most one ROHC compressor instance and at most one ROHC decompressor instance. For DAPS bearers, the PDCP entity uses at most one ROHC compressor instance (i.e. use the ROHC compressor instance for source cell before uplink data switching, and use the ROHC compressor instance for target cell after uplink data switching) and at most two ROHC decompressor instances.

5.7.3 Protocol parameters

RFC 5795 [7] has configuration parameters that are mandatory and that must be configured by upper layers between compressor and decompressor peers ; these parameters define the ROHC channel. The ROHC channel is a unidirectional channel, i.e. if *rohc* is configured there is one channel for the downlink and one for the uplink, and if *uplinkOnlyROHC* is configured there is only one channel for the uplink. There is thus one set of parameters for each channel, and if *rohc* is configured the same values shall be used for both channels belonging to the same PDCP entity.

These parameters are categorized in two different groups, as defined below:

- M: Mandatory and configured by upper layers;
- N/A: Not used in this specification.

The usage and definition of the parameters shall be as specified below.

- MAX_CID (M): This is the maximum CID value that can be used. One CID value shall always be reserved for uncompressed flows. The parameter MAX_CID is configured by upper layers (*maxCID* in TS 38.331 [3]);

- LARGE_CIDS: This value is not configured by upper layers, but rather it is inferred from the configured value of MAX_CID according to the following rule:
 - If MAX_CID > 15 then LARGE_CIDS = TRUE else LARGE_CIDS = FALSE;
- PROFILES (M): Profiles are used to define which profiles are allowed to be used by the UE. The list of supported profiles is described in clause 5.7.1. The parameter PROFILES is configured by upper layers (*profiles* for uplink and downlink, *sl-RoHC-Profiles* in *SidelinkPreconfigNR* for sidelink in TS 38.331 [3]);
- FEEDBACK_FOR (N/A): This is a reference to the channel in the opposite direction between two compression endpoints and indicates to what channel any feedback sent refers to. Feedback received on one ROHC channel for this PDCP entity shall always refer to the ROHC channel in the opposite direction for this same PDCP entity;
- MRRU (N/A): ROHC segmentation is not used.

5.7.4 Header compression using ROHC

If ROHC is configured, the ROHC protocol generates two types of output packets:

- ROHC compressed packets, each associated with one PDCP SDU;
- standalone packets not associated with a PDCP SDU, i.e. interspersed ROHC feedback.

A ROHC compressed packet is associated with the same PDCP SN and COUNT value as the related PDCP SDU. The header compression is not applicable to the SDAP header and the SDAP Control PDU if included in the PDCP SDU.

For DAPS bearers, the PDCP entity shall perform the header compression for the PDCP SDU using the ROHC protocol either configured for the source cell or configured for the target cell, based on to which cell the PDCP SDU is transmitted.

Interspersed ROHC feedback are not associated with a PDCP SDU. They are not associated with a PDCP SN and are not ciphered.

NOTE 1: If the MAX_CID number of ROHC contexts are already established for the compressed flows and a new IP flow does not match any established ROHC context, the compressor should associate the new IP flow with one of the ROHC CIDs allocated for the existing compressed flows or send PDCP SDUs belonging to the IP flow as uncompressed packet.

NOTE 2: For downlink, the ROHC protocol of the target cell should maintain the IR state if operating in U-mode and O-mode during DAPS handover before release of source cell.

5.7.5 Header decompression using ROHC

If ROHC is configured by upper layers for PDCP entities associated with user plane data, the PDCP Data PDUs are decompressed by the ROHC protocol after performing deciphering as explained in clause 5.8. The header decompression is not applicable to the SDAP header and the SDAP Control PDU if included in the PDCP Data PDU.

For DAPS bearers, the PDCP entity shall perform the header decompression for the PDCP SDU using the ROHC protocol either configured for the source cell or configured for the target cell, based on from which cell the PDCP SDU is received.

5.7.6 PDCP Control PDU for interspersed ROHC feedback

5.7.6.1 Transmit Operation

When an interspersed ROHC feedback is generated by the ROHC protocol, the transmitting PDCP entity shall:

- submit to lower layers the corresponding PDCP Control PDU as specified in clause 6.2.3.2 i.e. without associating a PDCP SN, nor performing ciphering, as specified in clause 5.2.1.

5.7.6.2 Receive Operation

At reception of a PDCP Control PDU for interspersed ROHC feedback from lower layers, the receiving PDCP entity shall:

- deliver the corresponding interspersed ROHC feedback to the associated ROHC protocol without performing deciphering.

5.8 Ciphering and deciphering

The ciphering function includes both ciphering and deciphering and is performed in PDCP, if configured. The data unit that is ciphered is the MAC-I (see clause 6.3.4) and the data part of the PDCP Data PDU (see clause 6.3.3) except the SDAP header and the SDAP Control PDU if included in the PDCP SDU. The ciphering is not applicable to PDCP Control PDUs.

For downlink and uplink, the ciphering algorithm and key to be used by the PDCP entity are configured by upper layers TS 38.331 [3] and the ciphering method shall be applied as specified in TS 33.501 [6].

The ciphering function is activated/suspended/resumed by upper layers TS 38.331 [3]. When security is activated and not suspended, the ciphering function shall be applied to all PDCP Data PDUs indicated by upper layers TS 38.331 [3] for the downlink and the uplink, respectively.

For DAPS bearers, the PDCP entity shall perform the ciphering or deciphering for the PDCP SDU using the ciphering algorithm and key either configured for the source cell or configured for the target cell, based on to/from which cell the PDCP SDU is transmitted/received.

For downlink and uplink ciphering and deciphering, the parameters that are required by PDCP for ciphering are defined in TS 33.501 [6] and are input to the ciphering algorithm. The required inputs to the ciphering function include the COUNT value, and DIRECTION (direction of the transmission: set as specified in TS 33.501 [6]). The parameters required by PDCP which are provided by upper layers TS 38.331 [3] are listed below:

- BEARER (defined as the radio bearer identifier in TS 33.501 [6]. It will use the value RB identity –1 as in TS 38.331 [3]);
- KEY (the ciphering keys for the control plane and for the user plane are K_{RRCEnc} and K_{UPEnc} , respectively).

For NR sidelink communication, the ciphering algorithm and key to be used by the PDCP entity are configured by upper layers as specified in TS 24.587 [16] and the ciphering method shall be applied as specified in TS 33.536 [14].

For NR sidelink communication, the ciphering function is activated for sidelink SRBs (except for SL-SRB0) and/or sidelink DRBs for a PC5 unicast link by upper layers, as specified in TS 38.331 [3]. When security is activated for sidelink SRBs, the ciphering function shall be applied to all PDCP Data PDUs (except for carrying Direct Security Mode Command message as specified in TS 33.536 [14]) for the sidelink SRBs which belong to the PC5 unicast link. When security is activated for sidelink DRBs, the ciphering function shall be applied to all PDCP Data PDUs for the sidelink DRBs which belong to the PC5 unicast link.

For NR sidelink communication, the ciphering and deciphering function as specified in TS 33.536 [14] is applied with KEY (NRPEK), COUNT, BEARER (LSB 5 bits of LCID as specified in TS 38.321 [4]) and DIRECTION (which value shall be set is specified in TS 33.536 [14]) as input.

The ciphering and deciphering are not applied to sidelink SRB4.

5.9 Integrity protection and verification

The integrity protection function includes both integrity protection and integrity verification and is performed in PDCP, if configured. The data unit that is integrity protected is the PDU header and the data part of the PDU before ciphering. The integrity protection is always applied to PDCP Data PDUs of SRBs. The integrity protection is applied to sidelink SRB1, SRB2 and SRB3. The integrity protection is applied to PDCP Data PDUs of DRBs (including sidelink DRBs for unicast) for which integrity protection is configured. The integrity protection is not applicable to PDCP Control PDUs.

For downlink and uplink, the integrity protection algorithm and key to be used by the PDCP entity are configured by upper layers TS 38.331 [3] and the integrity protection method shall be applied as specified in TS 33.501 [6] for NR and in TS 33.401 [17] for E-UTRA/EPC.

The integrity protection function is activated/suspended/resumed by upper layers TS 38.331 [3]. When security is activated and not suspended, the integrity protection function shall be applied to all PDUs including and subsequent to the PDU indicated by upper layers TS 38.331 [3] for the downlink and the uplink, respectively.

NOTE 1: As the RRC message which activates the integrity protection function is itself integrity protected with the configuration included in this RRC message, this message needs first be decoded by RRC before the integrity protection verification could be performed for the PDU in which the message was received.

NOTE 2: As the PC5-S message which activates the integrity protection function is itself integrity protected with the configuration included in this PC5-S message, this message needs first be decoded by upper layer before the integrity protection verification could be performed for the PDU in which the message was received.

For DAPS bearers, the PDCP entity shall perform the integrity protection or verification for the PDCP SDU using the integrity protection algorithm and key either configured for the source cell or configured for the target cell, based on to/from which cell the PDCP SDU is transmitted/received.

For downlink and uplink integrity protection and verification, the parameters that are required by PDCP for integrity protection are defined in TS 33.501 [6] or TS 33.401 [17] and are input to the integrity protection algorithm. The required inputs to the integrity protection function include the COUNT value, and DIRECTION (direction of the transmission: set as specified in TS 33.501 [6] or TS 33.401 [17]). The parameters required by PDCP which are provided by upper layers TS 38.331 [3] are listed below:

- BEARER (defined as the radio bearer identifier in TS 33.501 [6] or TS 33.401 [17]. It will use the value RB identity –1 as in TS 38.331 [3]);
- KEY (the integrity protection keys for the control plane and for the user plane are K_{RRCint} and K_{UPint} , respectively).

For NR sidelink communication, the integrity protection algorithm and key to be used by the PDCP entity are configured by upper layers TS 24.587 [16] and the integrity protection method shall be applied as specified in TS 33.536 [14].

For NR sidelink communication, the integrity protection function is activated for sidelink SRBs and/or sidelink DRBs for a PC5 unicast link by upper layers, as specified in TS 38.331 [3]. When security is activated for sidelink SRBs, the integrity protection function shall be applied to all PDUs including and subsequent to the PDU for the sidelink SRBs which belong to the PC5 unicast link. When security is activated for sidelink DRBs, the integrity protection function shall be applied to all PDUs including and subsequent to the PDU for the sidelink DRBs which belong to the PC5 unicast link.

For the SLRB that needs integrity protection and verification, the parameters that are required by PDCP for integrity protection are defined in TS 33.536 [14] and are input to the integrity protection algorithm. The required inputs to the integrity protection function include the KEY (NRPIK), COUNT, BEARER (LSB 5 bits of LCID as specified in TS 38.321 [4]) and DIRECTION (which value shall be set is specified in TS 33.536 [14]).

At transmission, the UE computes the value of the MAC-I field and at reception it verifies the integrity of the PDCP Data PDU by calculating the X-MAC based on the input parameters as specified above. If the calculated X-MAC corresponds to the received MAC-I, integrity protection is verified successfully.

The integrity protection and verification are not applied to sidelink SRB4.

5.10 Handling of unknown, unforeseen, and erroneous protocol data

When a PDCP PDU that contains reserved or invalid values is received, the receiving PDCP entity shall:

- discard the received PDU.

NOTE: For NR sidelink communication for unicast, the invalid values include the invalid value of $K_{NRP-sess}$ ID.

5.11 PDCP duplication

5.11.1 Activation/Deactivation of PDCP duplication

For the PDCP entity configured with *pdcp-Duplication*, the transmitting PDCP entity shall:

- for SRBs:
 - activate the PDCP duplication;
- for DRBs:
 - if the activation of PDCP duplication is indicated for the DRB:
 - activate the PDCP duplication for the DRB;
 - if the activation of PDCP duplication is indicated for at least one associated RLC entities:
 - activate the PDCP duplication for the indicated associated RLC entities;
 - activate the PDCP duplication for the DRB;
 - if the deactivation of PDCP duplication is indicated for the DRB:
 - deactivate the PDCP duplication for the DRB;
 - if the deactivation of PDCP duplication is indicated for at least one associated RLC entities:
 - deactivate the PDCP duplication for the indicated associated RLC entities;
 - if all associated RLC entities other than the primary RLC entity are deactivated for PDCP duplication:
 - deactivate the PDCP duplication for the DRB.

5.11.2 Duplicate PDU discard

For the PDCP entity configured with *pdcp-Duplication*, the transmitting PDCP entity shall:

- if the successful delivery of a PDCP Data PDU is confirmed by one of the associated AM RLC entities:
 - indicate to the other AM RLC entities to discard the duplicated PDCP Data PDU;
- if the deactivation of PDCP duplication is indicated for the DRB:
 - indicate to the RLC entities other than the primary RLC entity to discard all duplicated PDCP Data PDUs;
- if the deactivation of PDCP duplication is indicated for at least one associated RLC entities:
 - indicate to the RLC entities deactivated for PDCP duplication to discard all duplicated PDCP Data PDUs.

5.12 Ethernet header compression and decompression

5.12.1 Supported header compression protocols

The EHC protocol is based on the Ethernet Header Compression (EHC) framework defined in Annex A.

5.12.2 Configuration of EHC

PDCP entities associated with DRBs and MRBs can be configured by upper layers TS 38.331 [3] to use EHC. Each PDCP entity carrying user plane data may be configured to use EHC. Every PDCP entity uses at most one EHC compressor instance and at most one EHC decompressor instance.

5.12.3 Protocol parameters

The usage and definition of the parameters shall be as specified below.

- MAX_CID_EHC_UL: This is the maximum CID value that can be used for uplink. One CID value shall always be reserved for uncompressed flows. The parameter MAX_CID_EHC_UL is configured by upper layers (*maxCID-EHC-UL* in TS 38.331 [3]);

5.12.4 Header compression using EHC

If EHC is configured, the EHC protocol generates two types of output packets:

- EHC compressed packets (i.e. EHC full header packets and EHC compressed header packets), each associated with one PDCP SDU;
- standalone packets not associated with a PDCP SDU, i.e. EHC feedback.

An EHC compressed packet is associated with the same PDCP SN and COUNT value as the related PDCP SDU. The header compression is not applicable to the SDAP header and the SDAP Control PDU if included in the PDCP SDU.

EHC feedback are not associated with a PDCP SDU. They are not associated with a PDCP SN and are not ciphered/integrity protected.

5.12.5 Header decompression using EHC

If EHC is configured by upper layers for PDCP entities associated with user plane data, the PDCP Data PDUs are decompressed by the EHC protocol after performing deciphering and integrity verification as explained in clause 5.8 and 5.9, respectively. The header decompression is not applicable to the SDAP header and the SDAP Control PDU if included in the PDCP Data PDU.

5.12.6 PDCP Control PDU for EHC feedback

5.12.6.1 Transmit Operation

When an EHC feedback is generated by the EHC protocol, the transmitting PDCP entity shall:

- submit to lower layers the corresponding PDCP Control PDU as specified in clause 6.2.3.3 i.e. without associating a PDCP SN, nor performing ciphering/integrity protection.

5.12.6.2 Receive Operation

At reception of a PDCP Control PDU for EHC feedback from lower layers, the receiving PDCP entity shall:

- deliver the corresponding EHC feedback to the EHC protocol without performing deciphering/integrity verification.

5.12.7 Simultaneous configuration of ROHC and EHC

If both ROHC and EHC are configured for a DRB/MRB, the ROHC header shall be located after the EHC header. Figure 5.12.7-1 shows the location of the ROHC header and the EHC header in a PDCP Data PDU.

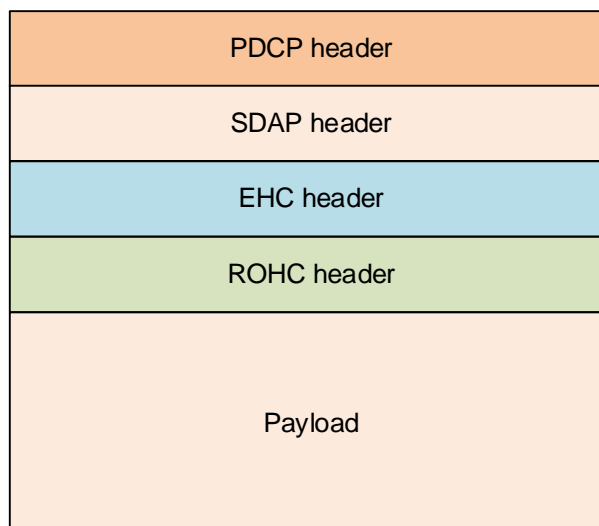

Figure 5.12.7-1: Location of ROHC header and EHC header in a PDCP Data PDU

If a PDCP SDU including non-IP Ethernet packet is received from upper layers, the EHC compressor shall bypass the ROHC compressor and submit the EHC compressed non-IP Ethernet packet to lower layers according to clause 5.2.1.

If a PDCP Data PDU including non-IP Ethernet packet is received from lower layers, the EHC decompressor shall bypass the ROHC decompressor and deliver the EHC decompressed non-IP Ethernet packet to upper layers according to clause 5.2.2.

5.13 Uplink data switching

For DAPS bearers, when upper layers request uplink data switching, the transmitting PDCP entity shall:

- for AM DRBs, from the first PDCP SDU for which the successful delivery of the corresponding PDCP Data PDU has not been confirmed by the RLC entity associated with the source cell, perform retransmission or transmission of all the PDCP SDUs already associated with PDCP SNs in ascending order of the COUNT values associated to the PDCP SDU prior to uplink data switching to the RLC entity associated with the target cell as specified below:
 - perform header compression of the PDCP SDU using ROHC as specified in the clause 5.7.4;
 - perform integrity protection and ciphering of the PDCP SDU using the COUNT value associated with this PDCP SDU as specified in the clause 5.9 and 5.8, respectively;
 - submit the resulting PDCP Data PDU to lower layer, as specified in clause 5.2.1.
- for UM DRBs, for all PDCP SDUs which have been processed by PDCP but which have not yet been submitted to lower layers, perform transmission of the PDCP SDUs in ascending order of the COUNT values to the RLC entity associated with the target cell as specified below:
 - perform header compression of the PDCP SDU using ROHC as specified in the clause 5.7.4;
 - perform integrity protection and ciphering of the PDCP SDU using the COUNT value associated with this PDCP SDU as specified in the clause 5.9 and 5.8, respectively;
 - submit the resulting PDCP Data PDU to lower layer, as specified in clause 5.2.1.

5.14 Uplink Data compression and decompression

5.14.1 UDC protocol

The UDC protocol is based on IETF RFC 1951 (DEFLATE Compressed Data Format Specification) [19].

Static Huffman coding tree defined in [19] is used as the DEFLATE compression strategy.

UDC Data Block should be byte-alignment. Z_SYNC_FLUSH is used as the DEFLATE byte-alignment with corresponding reference [21], wherein the fixed last four bytes, 0x00 0x00 0xFF 0xFF, are removed before transmission.

5.14.2 Configuration of UDC

The PDCP entities associated with DRBs can be configured by upper layers, see TS 38.331 [3], to use UDC. If UDC is configured, the UE shall apply UDC compression function (details see clause X.1) to process the received PDCP SDU from upper layers corresponding to the configured DRB. The size of compression buffer is configured by upper layer via *bufferSize*. If pre-defined dictionary is configured by upper layers, the UE shall first set the compression buffer to all zeros and then prefill the configured pre-defined dictionary in the compression buffer upon configuration of UDC. If pre-defined dictionary is not configured by upper layers, UE shall set the compression buffer to all zeros.

5.14.3 UDC header

UDC header (1 byte) is added in UDC compression function followed by UDC data block. The UDC header contains the information about whether the current PDCP SDU is compressed by UDC protocol or not. Only the compressed packets are stored in the buffer. The UDC header also contains a reset bit to inform the decompressor that the compression buffer has been reset. The validation bits (checksum) of the compression buffer are also contained in UDC header. Checksum mechanism could be used to resolve miss-match (if any) between the compression and decompression buffers. If both SDAP and UDC are configured for a DRB, the UDC header shall be located after the SDAP header. Figure 5.14.3-1 shows the location of the UDC header in a PDCP data PDU.

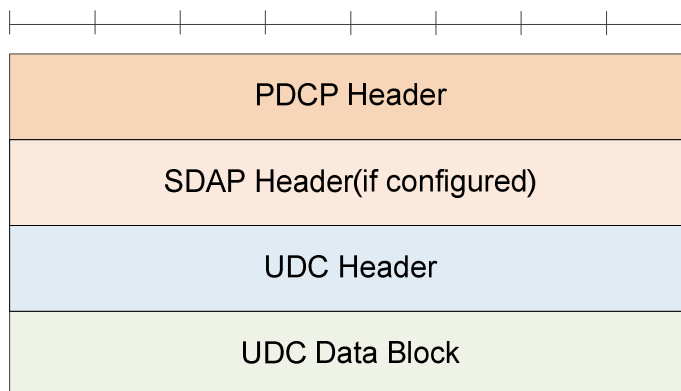

Figure 5.14.3-1: Location of UDC header in a PDCP Data PDU

5.14.4 Uplink data compression

The UDC protocol generates UDC packets, each associated with one PDCP SDU.

A UDC packet is associated with the same PDCP SN and COUNT values as the related PDCP SDU. The uplink data compression is not applicable to the SDAP header and the SDAP Control PDU if included in the PDCP Data PDU.

5.14.5 PDCP Control PDU for UDC feedback

At reception of a PDCP Control PDU for UDC feedback from lower layers, the receiving PDCP entity shall:

- deliver the corresponding UDC feedback to the UDC protocol without performing deciphering/integrity verification.

5.14.6 Pre-defined dictionary

One standard dictionary for SIP and SDP and one operator defined dictionary can be used as pre-defined dictionaries in UDC. The standard dictionary for SIP and SDP consists of the first 3468 bytes of the dictionary for SigComp defined in RFC 3485 [20]. When UDC is configured, at most one dictionary, configured by upper layers, is put into the tail of the

compression buffer. Also, the compression buffer acts as a FIFO and hence the content of the dictionary is to be totally pushed out of the compression buffer after the size of transmitted uncompressed packets compressed by UDC exceeds the compression buffer size. If the size of dictionary is larger than the compression buffer size, only the tail of the dictionary is inserted in the compression buffer.

5.14.7 UDC buffer reset procedure

UDC works on the condition that compression buffer and de-compression buffer are synchronized. UDC buffer reset mechanism is to resynchronize buffer when error is detected. For resynchronization, UE shall reset the compression buffer to all zeros.

5.14.8 UDC checksum error handling

UDC checksum error notification PDCP control PDU indicates the compression buffer and de-compression buffer are out of synchronization. When receiving the notification, the UE shall trigger UDC buffer reset procedure to resynchronize the compression buffer.

6 Protocol data units, formats, and parameters

6.1 Protocol data units

6.1.1 Data PDU

The PDCP Data PDU is used to convey one or more of followings in addition to the PDU header:

- user plane data;
- control plane data;
- a MAC-I.

6.1.2 Control PDU

The PDCP Control PDU is used to convey one of followings in addition to the PDU header:

- a PDCP status report;
- an interspersed ROHC feedback;
- an EHC feedback.

6.2 Formats

6.2.1 General

A PDCP PDU is a bit string that is byte aligned (i.e. multiple of 8 bits) in length. In the figures in clause 6.2, bit strings are represented by tables in which the most significant bit is the leftmost bit of the first line of the table, the least significant bit is the rightmost bit on the last line of the table, and more generally the bit string is to be read from left to right and then in the reading order of the lines. The bit order of each parameter field within a PDCP PDU is represented with the first and most significant bit in the leftmost bit and the last and least significant bit in the rightmost bit.

PDCP SDUs are bit strings that are byte aligned (i.e. multiple of 8 bits) in length. A compressed or uncompressed SDU is included into a PDCP Data PDU from the first bit onward.

6.2.2 Data PDU

6.2.2.1 Data PDU for SRBs

Figure 6.2.2.1-1 shows the format of the PDCP Data PDU with 12 bits PDCP SN. This format is applicable for SRBs.

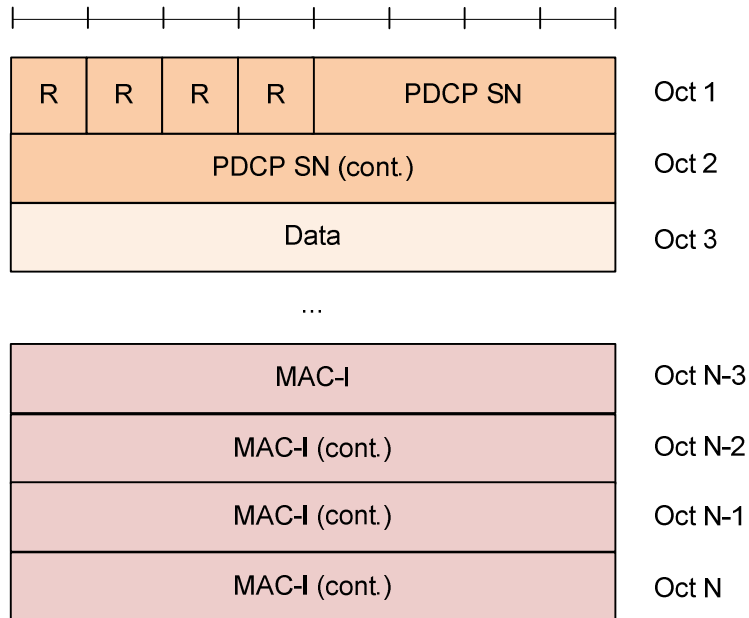

Figure 6.2.2.1-1: PDCP Data PDU format for SRBs

6.2.2.2 Data PDU for DRBs and MRBs with 12 bits PDCP SN

Figure 6.2.2.2-1 shows the format of the PDCP Data PDU with 12 bits PDCP SN. This format is applicable for UM DRBs, AM DRBs, UM MRBs and AM MRBs.

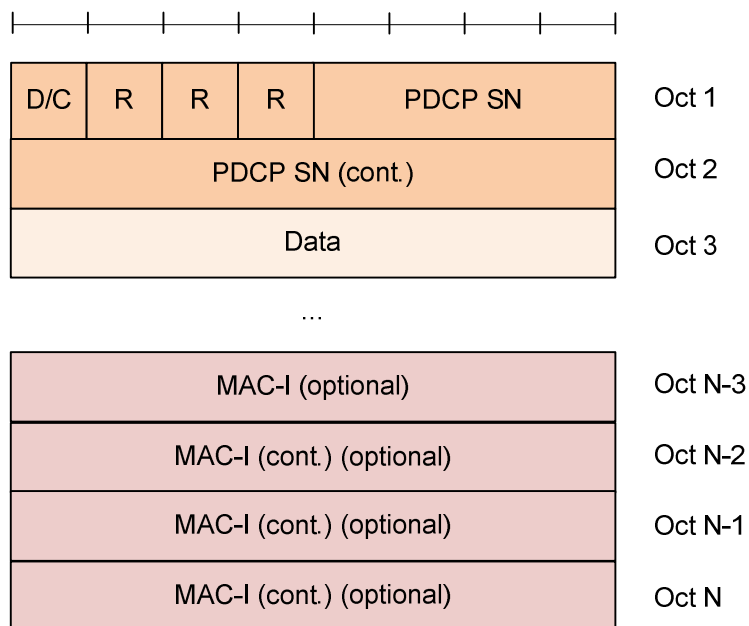

Figure 6.2.2.2-1: PDCP Data PDU format with 12 bits PDCP SN

6.2.2.3 Data PDU for DRBs and MRBs with 18 bits PDCP SN

Figure 6.2.2.3-1 shows the format of the PDCP Data PDU with 18 bits PDCP SN. This format is applicable for UM DRBs, AM DRBs, UM MRBs and AM MRBs.

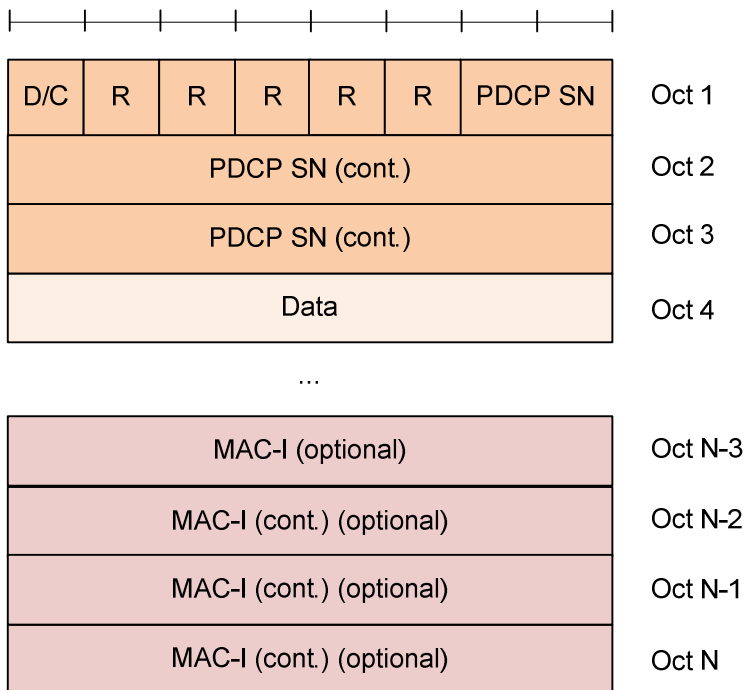

Figure 6.2.2.3-1: PDCP Data PDU format for DRBs with 18 bits PDCP SN

6.2.2.4 Data PDU for sidelink DRBs for groupcast and broadcast, for the sidelink SRB0 and for the sidelink SRB4

Figure 6.2.2.4-1 shows the format of the PDCP Data PDU with 12 bits PDCP SN. This format is applicable for sidelink DRBs for groupcast and broadcast, for the sidelink SRB0 and for the sidelink SRB4.

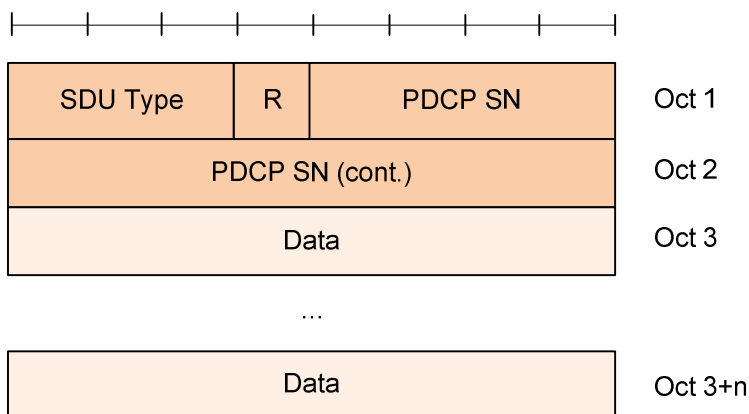

Figure 6.2.2.4-1: PDCP Data PDU format for sidelink DRBs for groupcast and broadcast, for the sidelink SRB0 and for the sidelink SRB4

NOTE: There is no control PDU for SLRBs for groupcast and broadcast. Thus, there is no D/C field in the PDCP Data PDU format for SLRBs for groupcast and broadcast. SDU type is only applicable for sidelink DRB.

6.2.2.5 Data PDU for sidelink SRBs for unicast

Figure 6.2.2.5-1 shows the format of the PDCP Data PDU with 12 bits PDCP SN. This format is applicable for sidelink SRB1, SRB2 and SRB3 for unicast.

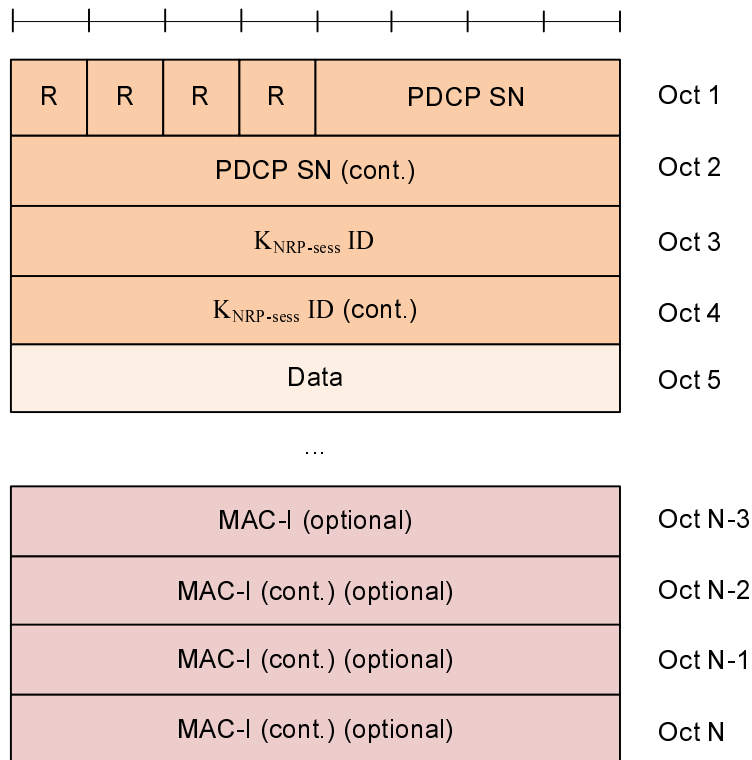

Figure 6.2.2.5-1: PDCP Data PDU format for sidelink SRB1, SRB2 and SRB3 for unicast

6.2.2.6 Data PDU for sidelink DRBs for unicast with 12 bits PDCP SN

Figure 6.2.2.6-1 shows the format of the PDCP Data PDU with 12 bits PDCP SN. This format is applicable for sidelink DRBs for unicast.

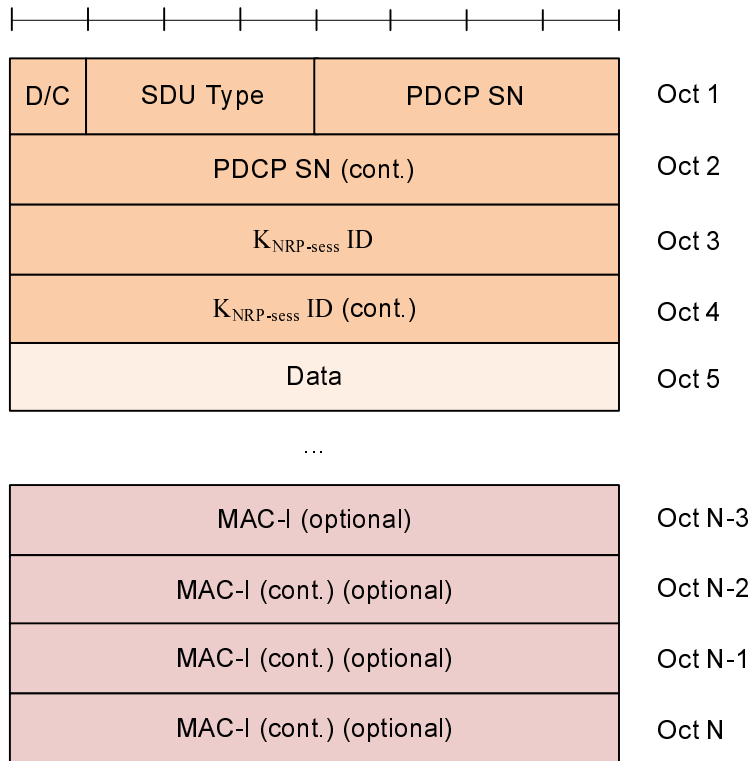

Figure 6.2.2.6-1: PDCP Data PDU format for sidelink DRBs for unicast with 12 bits PDCP SN

6.2.2.7 Data PDU for sidelink DRBs for unicast with 18 bits PDCP SN

Figure 6.2.2.7-1 shows the format of the PDCP Data PDU with 18 bits PDCP SN. This format is applicable for sidelink DRBs for unicast.

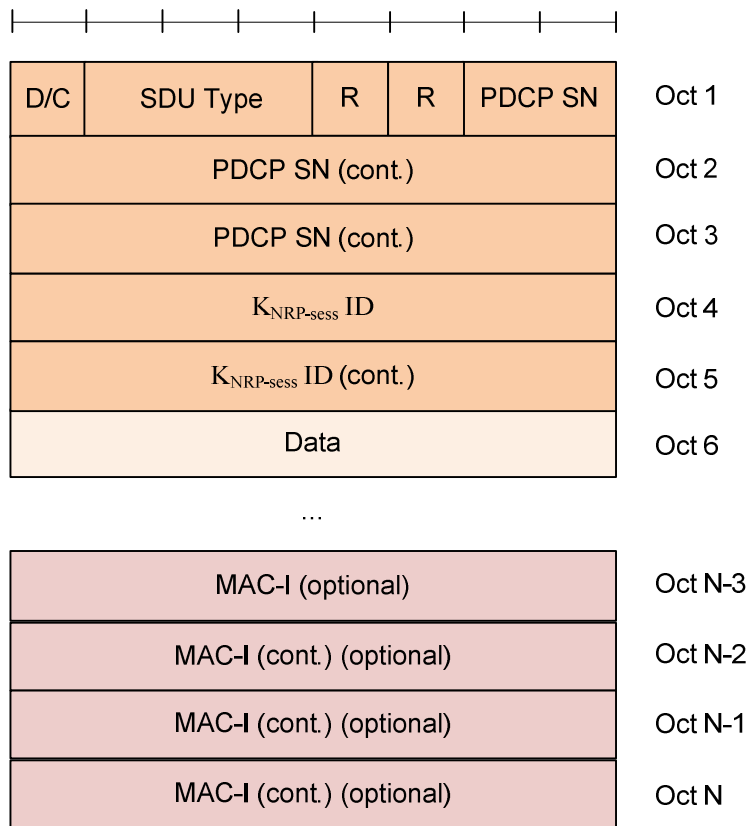

Figure 6.2.2.7-1: PDCP Data PDU format for sidelink DRBs for unicast with 18 bits PDCP SN

6.2.3 Control PDU

6.2.3.1 Control PDU for PDCP status report

Figure 6.2.3.1-1 shows the format of the PDCP Control PDU carrying one PDCP status report. This format is applicable for UM DRBs, AM DRBs (including sidelink DRBs for unicast) and AM MRBs.

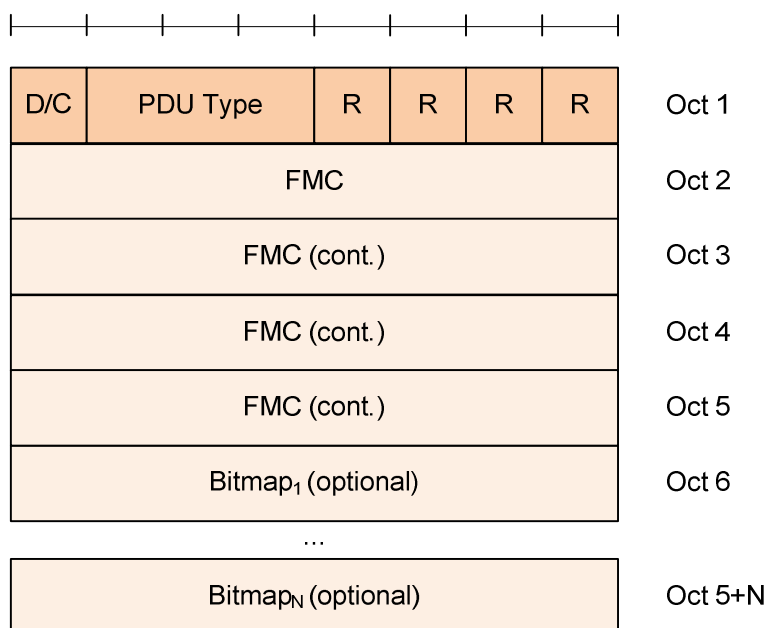

Figure 6.2.3.1-1: PDCP Control PDU format for PDCP status report

6.2.3.2 Control PDU for interspersed ROHC feedback

Figure 6.2.3.2-1 shows the format of the PDCP Control PDU carrying one interspersed ROHC feedback. This format is applicable for UM DRBs, AM DRBs (including sidelink DRBs for unicast), UM MRBs and AM MRBs.

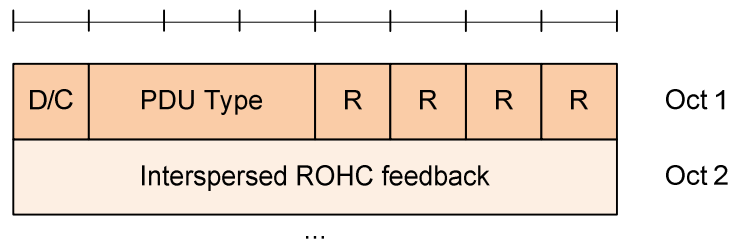

Figure 6.2.3.2-1: PDCP Control PDU format for interspersed ROHC feedback

6.2.3.3 Control PDU for EHC feedback

Figure 6.2.3.3-1 shows the format of the PDCP Control PDU carrying one EHC feedback. This format is applicable for UM DRBs, AM DRBs, UM MRBs and AM MRBs.

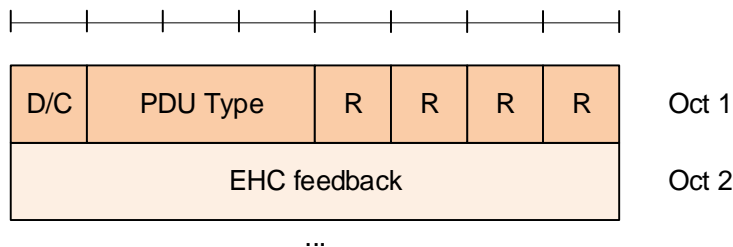

Figure 6.2.3.3-1: PDCP Control PDU format for EHC feedback

6.2.3.4 PDCP Control PDU for UDC feedback packet

Figure 6.2.3.4-1 shows the format of the PDCP Control PDU carrying one UDC feedback. This format is applicable for AM DRBs.

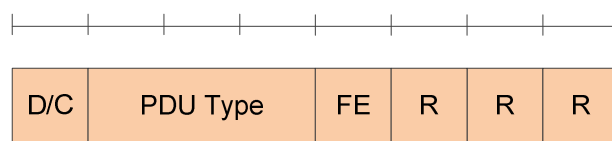

Figure 6.2.3.4-1: PDCP Control PDU format for UDC feedback

6.3 Parameters

6.3.1 General

If not otherwise mentioned in the definition of each field then the bits in the parameters shall be interpreted as follows: the left most bit string is the first and most significant and the right most bit is the last and least significant bit.

Unless otherwise mentioned, integers are encoded in standard binary encoding for unsigned integers. In all cases the bits appear ordered from MSB to LSB when read in the PDU.

6.3.2 PDCP SN

Length: 12 or 18 bits as indicated in table 6.3.2-1. The length of the PDCP SN is configured by upper layers (*pdcp-SN-SizeUL*, *pdcp-SN-SizeDL*, or *sl-PDCP-SN-Size* in TS 38.331 [3]).

Table 6.3.2-1: PDCP SN length

Length	Description
12	SRBs, UM DRBs, AM DRBs (including sidelink SRBs and sidelink DRBs), UM MRBs and AM MRBs
18	UM DRBs, AM DRBs (including sidelink DRBs for unicast), UM MRBs and AM MRBs

NOTE: For NR sidelink communication for groupcast and broadcast, only 12 bits PDCP SN length is used for the sidelink DRBs.

6.3.3 Data

Length: Variable

This field includes one of the followings:

- Uncompressed PDCP SDU (user plane data, or control plane data);
- Compressed PDCP SDU (user plane data only).

NOTE: All fields other than PDCP PDU header and MAC-I belong to Data field.

6.3.4 MAC-I

Length: 32 bits

This field carries a message authentication code calculated as specified in clause 5.9.

For SRBs for Uu interface, the MAC-I field is always present. If integrity protection is not configured, the MAC-I field is still present but should be padded with padding bits set to 0.

For sidelink SRB1, SRB2 and SRB3, the MAC-I field is present only when the sidelink SRB1, SRB2 and SRB3 are configured with integrity protection.

For DRBs (including sidelink DRBs for unicast), the MAC-I field is present only when the DRB is configured with integrity protection.

6.3.5 COUNT

Length: 32 bits

The COUNT value is composed of a HFN and the PDCP SN. The size of the HFN part in bits is equal to 32 minus the length of the PDCP SN. For MRBs, HFN with a reference SN can be provided by upper layers. If provided, the initial value of HFN is set according to the HFN and the reference SN. Otherwise, the initial value of HFN is set by UE implementation.

NOTE: For MRBs, the provisioning of HFN from the upper layer may cause HFN desynchronization. It is up to UE implementation to prevent HFN desynchronization by using the reference PDCP SN associated to the HFN.

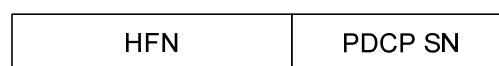

Figure 6.3.5-1: Format of COUNT

NOTE: COUNT does not wrap around.

6.3.6 R

Length: 1 bit

Reserved. In this version of the specification reserved bits shall be set to 0. Reserved bits shall be ignored by the receiver.

6.3.7 D/C

Length: 1 bit

This field indicates whether the corresponding PDCP PDU is a PDCP Data PDU or a PDCP Control PDU.

Table 6.3.7-1: D/C field

Bit	Description
0	Control PDU
1	Data PDU

6.3.8 PDU type

Length: 3 bits

This field indicates the type of control information included in the corresponding PDCP Control PDU.

Table 6.3.8-1: PDU type

Bit	Description
000	PDCP status report
001	Interspersed ROHC feedback
010	EHC feedback
011	UDC feedback
011-111	Reserved

6.3.9 FMC

Length: 32 bits

First Missing COUNT. This field indicates the COUNT value of the first missing PDCP SDU within the reordering window, i.e. RX_DELIV.

6.3.10 Bitmap

Length: Variable. The length of the bitmap field can be 0.

This field indicates which SDUs are missing and which SDUs are correctly received in the receiving PDCP entity. The bit position of Nth bit in the Bitmap is N, i.e., the bit position of the first bit in the Bitmap is 1.

Table 6.3.10-1 Bitmap

Bit	Description
0	PDCP SDU with COUNT = (FMC + bit position) modulo 2^{32} is missing.
1	PDCP SDU with COUNT = (FMC + bit position) modulo 2^{32} is correctly received.

6.3.11 Interspersed ROHC feedback

Length: Variable

This field contains one ROHC packet with only feedback, i.e. a ROHC packet that is not associated with a PDCP SDU as defined in clause 5.7.4.

6.3.12 SDU Type

Length: 3 bits

PDCP SDU type, i.e. Layer-3 Protocol Data Unit type as specified in [13]. PDCP entity may handle the SDU differently per SDU Type, e.g. ROHC is applicable to IP SDU but not Non-IP SDU.

Table 6.3.12-1: SDU Type

Bit	Description
000	IP
001	Non-IP
010-111	Reserved

6.3.13 $K_{\text{NRP-seSS}}$ ID

Length: 16 bits

$K_{\text{NRP-seSS}}$ Identity as specified in TS 33.536 [14].

For the SLRB that does not need integrity and ciphering protection, the UE shall set $K_{\text{NRP-seSS}}$ ID to "0" in the PDCP PDU header.

6.3.14 FE

Length: 1 bit

Indication of whether checksum error is detected or not. Value '1' means checksum error is detected and the UE shall reset the compression buffer.

Table 6.3.14-1: FE field

Bit	Description
0	No Error
1	Checksum Error Notification

7 State variables, constants, and timers

7.1 State variables

This clause describes the state variables used in PDCP entities in order to specify the PDCP protocol. The state variables defined in this clause are normative.

All state variables are non-negative integers, and take values from 0 to $[2^{32} - 1]$.

PDCP Data PDUs are numbered integer sequence numbers (SN) cycling through the field: 0 to $[2^{pdcp-SN-SizeUL} - 1]$ or 0 to $[2^{pdcp-SN-SizeDL} - 1]$ or 0 to $[2^{sl-PDCP-SN-Size} - 1]$.

The transmitting PDCP entity shall maintain the following state variables:

- a) TX_NEXT

This state variable indicates the COUNT value of the next PDCP SDU to be transmitted. The initial value is 0, except for SRBs configured with state variables continuation. For target SRB configured with state variables continuation, the initial value is the value stored in PDCP entity for the corresponding source SRB. For source SRB configured with state variables continuation, the initial value is the value stored in PDCP entity for the corresponding target SRB.

The receiving PDCP entity shall maintain the following state variables:

a) RX_NEXT

This state variable indicates the COUNT value of the next PDCP SDU expected to be received. The initial value is 0, except for sidelink broadcast and groupcast, for SRBs configured with state variables continuation, and for MRBs. For NR sidelink communication for broadcast and groupcast or sidelink SRB4 for broadcast and groupcast based sidelink discovery, the initial value of the SN part of RX_NEXT is $(x + 1) \text{ modulo } (2^{[sl-PDCP-SN-Size]})$, where x is the SN of the first received PDCP Data PDU. For MRBs, the initial value of the SN part of RX_NEXT is $(x + 1) \text{ modulo } (2^{[PDCP-SN-Size]})$, where x is the SN of the first received PDCP Data PDU. For target SRB configured with state variables continuation, the initial value is the value stored in PDCP entity for the corresponding source SRB. For source SRB configured with state variables continuation, the initial value is the value stored in PDCP entity for the corresponding target SRB.

NOTE: For NR sidelink communication for broadcast and groupcast or sidelink SRB4 for broadcast and groupcast based sidelink discovery, it is up to UE implementation to select the HFN part for RX_NEXT such that initial value of RX_DELIV should be a positive value.

b) RX_DELIV

This state variable indicates the COUNT value of the first PDCP SDU not delivered to the upper layers, but still waited for. The initial value is 0, except for sidelink broadcast and groupcast, for SRBs configured with state variables continuation, and for MRBs. For NR sidelink communication for broadcast and groupcast or sidelink SRB4 for broadcast and groupcast based sidelink discovery, the initial value of the SN part of RX_DELIV is $(x - 0.5 \times 2^{[sl-PDCP-SN-Size-1]}) \text{ modulo } (2^{[sl-PDCP-SN-Size]})$, where x is the SN of the first received PDCP Data PDU. For MRBs, the initial value of the SN part of RX_DELIV is set to $(x - 0.5 \times 2^{[PDCP-SN-Size-1]}) \text{ modulo } (2^{[PDCP-SN-Size]})$, where x is the SN of the first received PDCP Data PDU. For target SRB configured with state variables continuation, the initial value is the value stored in PDCP entity for the corresponding source SRB. For source SRB configured with state variables continuation, the initial value is the value stored in PDCP entity for the corresponding target SRB.

c) RX_REORD

This state variable indicates the COUNT value following the COUNT value associated with the PDCP Data PDU which triggered *t-Reordering*. For target SRB configured with state variables continuation, the initial value is the value stored in PDCP entity for the corresponding source SRB. For source SRB configured with state variables continuation, the initial value is the value stored in PDCP entity for the corresponding target SRB.

7.2 Constants

a) Window_Size

This constant indicates the size of the reordering window. The value equals to $2^{[pdcp-SN-SizeDL]-1}$ for SRB/DRB and $2^{[sl-PDCP-SN-Size]-1}$ for SLRB.

7.3 Timers

The transmitting PDCP entity shall maintain the following timers:

a) *discardTimer*

This timer is configured only for DRBs. The duration of the timer is configured by upper layers TS 38.331 [3]. In the transmitter, a new timer is started upon reception of an SDU from upper layer.

The receiving PDCP entity shall maintain the following timers:

b) *t-Reordering*

The duration of the timer is configured by upper layers TS 38.331 [3], except for the case of NR sidelink communication or sidelink SRB4. For NR sidelink communication or sidelink SRB4, the *t-Reordering* timer is

determined by the UE implementation. This timer is used to detect loss of PDCP Data PDUs as specified in clause 5.2.2. If *t-Reordering* is running, *t-Reordering* shall not be started additionally, i.e. only one *t-Reordering* per receiving PDCP entity is running at a given time.

Annex A (normative): Ethernet Header Compression (EHC) protocol

A.1 EHC principle

The Ethernet header compression (EHC) protocol compresses Ethernet header as shown in Figure A.1-1 [15]. The fields that are compressed (i.e. removed from the Ethernet header) by the EHC protocol are: DESTINATION ADDRESS, SOURCE ADDRESS, 802.1Q TAG, and LENGTH/TYPE. The fields PREAMBLE, SFD, and FCS are not transmitted in 3GPP system, and thus not considered in EHC protocol. There may be more than one 802.1Q TAG fields in the Ethernet header, and all are compressed by the EHC protocol. The padding (PAD) is not compressed by the EHC protocol.

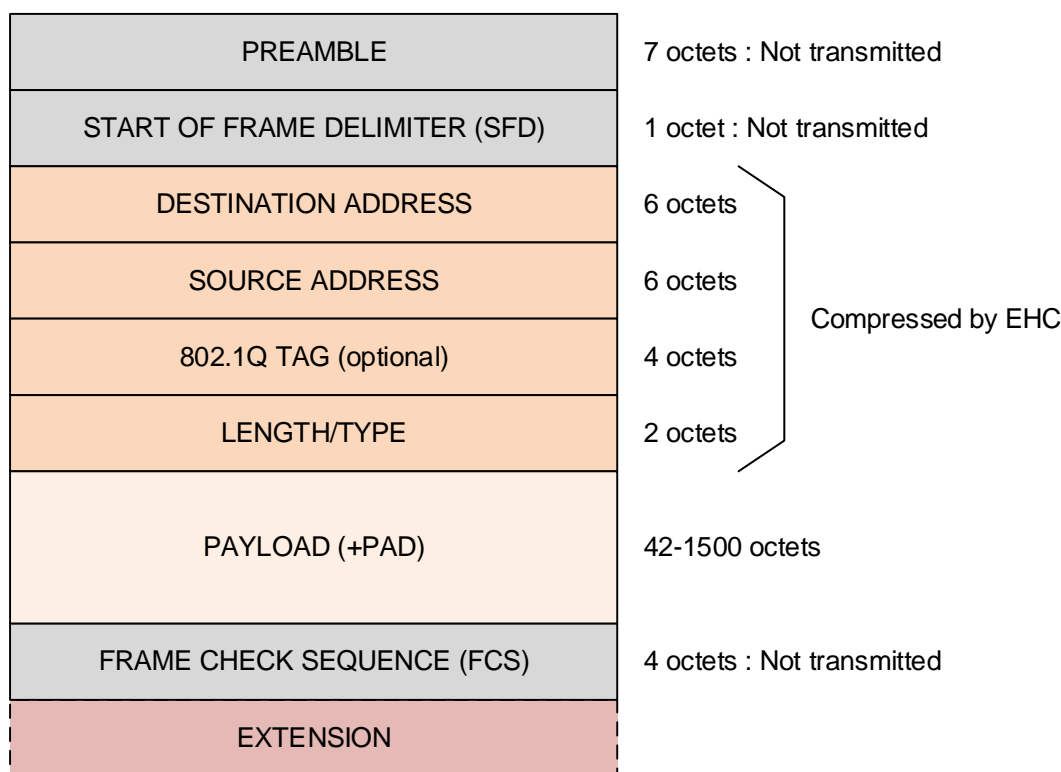

Figure A.1-1: Ethernet packet format [15]

The EHC compressor and the EHC decompressor store original header field information as a "EHC context". Each EHC context is identified by a unique identifier, called Context ID (CID). The EHC context must be synchronized between the EHC compressor and the EHC decompressor; otherwise, the EHC decompressor erroneously decompresses the "Compressed Header (CH)" packets.

For an Ethernet packet stream, the EHC compressor establishes the EHC context and associates it with the CID. Then, the EHC compressor transmits the "Full Header (FH)" packet to the EHC decompressor including the associated CID. The EHC compressor keeps transmitting the FH packets until the EHC feedback is received from the EHC decompressor.

NOTE: If the maximum number of EHC contexts are already established for the compressed flows and a new Ethernet flow does not match any established EHC context, the compressor should associate the new Ethernet flow with one of the EHC CIDs allocated for the existing compressed flows or send PDCP SDUs belonging to the Ethernet flow as uncompressed packet.

When the EHC decompressor receives the FH packet, the EHC decompressor establishes the EHC context identified by the CID, and transmits the EHC feedback to the EHC compressor to indicate that the EHC context associated with the CID is successfully established in the EHC decompressor.

After receiving the EHC feedback, the EHC compressor starts to transmit the CH packets to the EHC decompressor including the associated CID. The CH packet includes only the header fields not stored in the EHC context.

When the EHC decompressor receives the CH packet, the EHC decompressor restores original header fields based on the stored EHC context identified by the associated CID.

Figure A.1-2 represents a conceptual view of EHC operation.

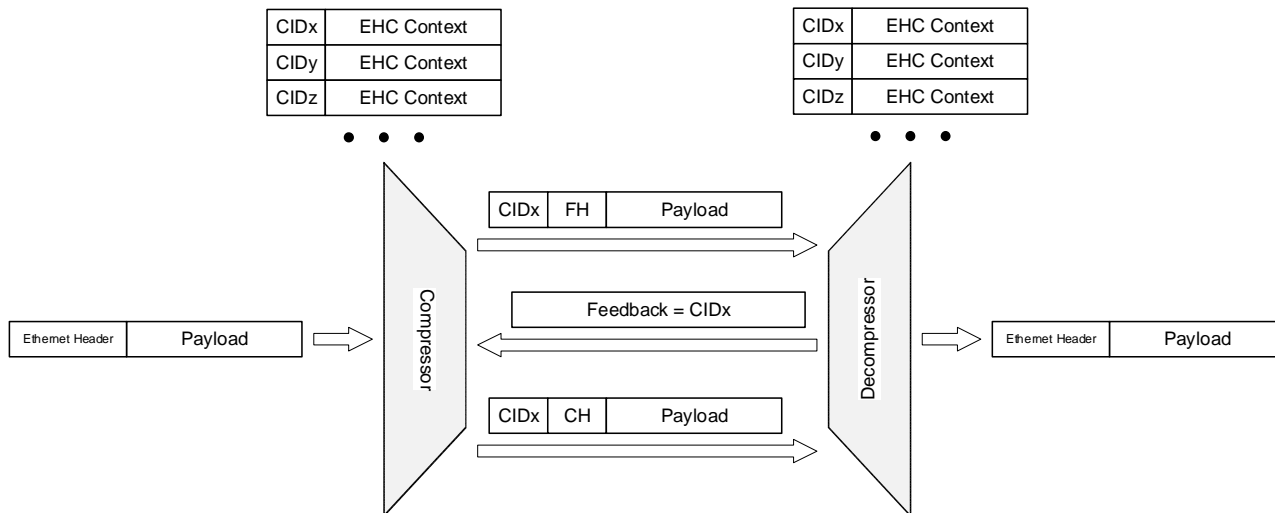

Figure A.1-2: EHC operation

A.2 EHC packet format and parameters

A.2.1 EHC packet format

A.2.1.1 EHC Full Header packet and EHC Compressed Header packet

Figure A.2.1.1-1 and Figure A.2.1.1-2 show the formats of EHC FH packet and EHC CH packet, respectively.

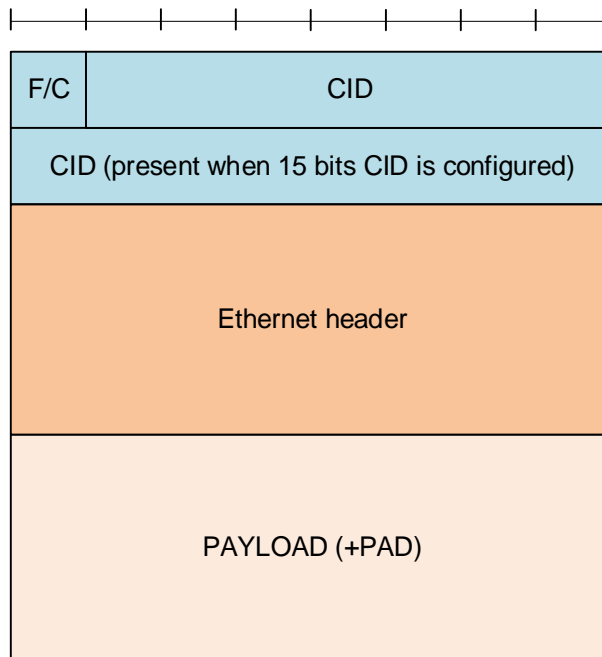

Figure A.2.1.1-1: EHC Full Header packet format

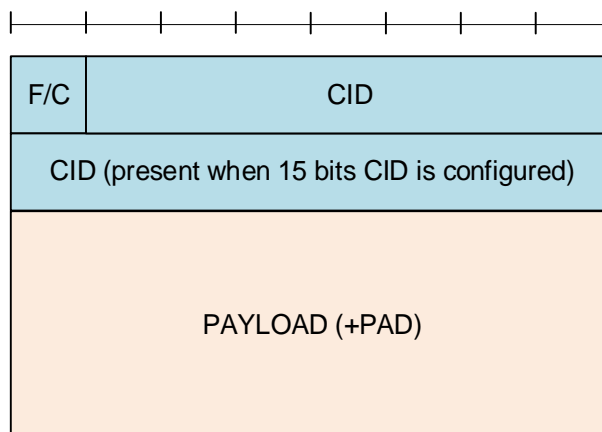

Figure A.2.1.1-2: EHC Compressed Header packet format

A.2.1.2 EHC feedback packet

Figure A.2.1.2-1 shows the format of the EHC feedback packet.

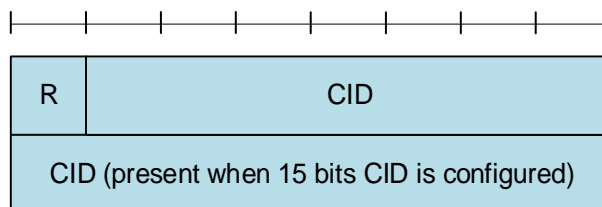

Figure A.2.1.2-1: EHC feedback packet format

A.2.2 Parameters

A.2.2.1 F/C

Length: 1 bit

This field indicates whether the corresponding EHC packet is a FH packet or a CH packet.

Table A.2.2.1-1: F/C field

Bit	Description
0	FH packet
1	CH packet

A.2.2.2 CID

Length: 7, or 15 bits. The length of the CID is configured by upper layers (*ehc-CID-Length* in TS 38.331 [3]).

The CID = "all zeros" indicates that the corresponding Ethernet header is "uncompressed". The EHC decompressor does not establish the EHC context identified by the CID = "all zeros".

Annex B (normative): Uplink Data Compression Protocol

B.1 UDC general description

A UDC packet consists of a UDC header and a UDC data block. A UDC data block contains either DEFLATE compressed blocks generated by UDC protocol or original PDCP SDU for SDU not compressed by UDC protocol; the type is specified in FU field (details see clause B.2.2.1) in UDC header. The FR field (details see clause B.2.2.2) and the Checksum field (details see clause B.2.2.3) in UDC header are used only if FU field is set to 1.

If reset procedure is triggered, after performing the reset, the FR field in UDC header of the first compressed PDU shall be set to 1.

NOTE: UE is allowed not to compress the PDCP SDUs if the UL data rate before compression is higher than what the UE is capable of.

B.2 UDC packet format and parameters

B.2.1 UDC Header and UDC Data Block format

Figure B.2.1-1 shows the format of UDC Header and UDC Data Block.

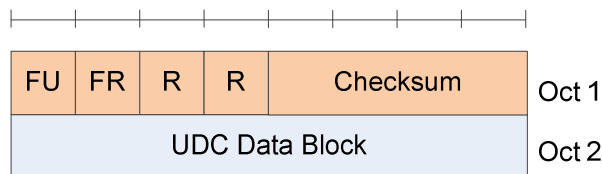

Figure B.2.1-1: UDC header format

B.2.2 UDC parameters

B.2.2.1 FU

Length: 1 bit

Indication of whether this packet is compressed by UDC protocol or not. Value '1' means the packet is compressed by UDC protocol.

Table B.2.2.1-1: FU field

Bit	Description
0	Packet is not compressed using UDC protocol
1	Packet is compressed using UDC protocol

B.2.2.2 FR

Length: 1 bit

Indication of whether UDC compression buffer is reset or not. Value '1' means this is the first compressed packet after UDC buffer reset.

Table B.2.2.2-1: FR field

Bit	Description
0	Compression buffer is not reset.
1	Compression buffer has been reset.

B.2.2.3 Checksum

Length: 4 bits

This field contains the validation bits for the compression buffer content: The checksum is calculated by the content of current compression buffer before the current packet is put into buffer.

The checksum is derived from the values of the first 4 bytes and the last 4 bytes in the whole compression buffer. The calculation is described as follows:

- Each byte is divided into two 4-bit numbers.
- The 16 4-bit numbers are added together to obtain a sum;
- The checksum is one's complement of the right-most 4 bits (i.e. 4 LSB) of the sum.

An example of checksum calculation is shown in Annex B.2.3.

B.2.3 An example of UDC Checksum calculation

The current UDC compression/decompression buffer has the following binary values for example:

Header <1,1,0,0,0,1,0,1,0,0,1,1,1,1,1,0,0,0,1,1,0,0,1,0,0,1,0,1,0,1,0,0,0,1,,
0,1,1,1,1,1,0,1,1,0,0,0,1,0,1,0,1,0,0,1,1,1,1,1,0,0,1,1,1,0,0> Tail

The sum of the first 4 bytes and the last 4 bytes can be calculated:

$1100+0101+0011+1111+0001+1001+0101+0001+0111+1101+1000+1010+1001+1111+1001+1100 = 10000110;$

And checksum value will be one's complement of the right-most 4 bits (i.e. 4 LSB) of the above sum. Hence checksum is 1001.

Annex C (informative): Change history

Change history							
Date	Meeting	TDoc	CR	Rev	Cat	Subject/Comment	New Version
2017.03	RAN2#9 7bis	R2-1703512	-	-	-	First version.	x.y.z
2017.04	RAN2#9 7bis	R2-1703916	-	-	-	Change section name "Retransmission" to "Data recovery"	0.0.1
2017.05	RAN2#9 8	R2-1704076	-	-	-	Initial draft TS capturing outcome of e-mail discussion [97bis#24]	0.0.5
2017.06	RAN2 NR AH	R2-1706868	-	-	-	Capture agreements made in RAN2#98	0.1.0
2017.08	RAN2 NR AH	R2-1707507	-	-	-	Capture agreements made in RAN2 NR AH#2	0.2.0
2017.08	RAN2#9 9	R2-1709097	-	-	-	Adding integrity protection in section 5.1.2	0.2.1
2017.08	RAN2#9 9	R2-1709753	-	-	-	Capture agreements made in RAN2#99	0.3.0
2017.09	RANP#7 7	RP-171993	-	-	-	Provided for information to RAN	1.0.0
2017.10	RAN2#9 9bis	R2-1713660	-	-	-	Capture agreements made in RAN2#99bis	1.0.1
2017.11	RAN2#1 00	R2-1714273	-	-	-	Capture agreements made in RAN2#100	1.1.0
2017.12	RP-78	RP-172335	-	-	-	Provided for approval to RAN	2.0.0
2017/12	RP-78					Upgraded to Rel-15 (MCC)	15.0.0
2018/03	RP-79	RP-180440	0002	1	F	Corrections to PDCP specification	15.1.0
2018/06	RP-80	RP-181215	0006	3	F	Corrections to PDCP specification	15.2.0
	RP-80	RP-181215	0009	1	B	Introduction of PDCP duplication	15.2.0
2018/09	RP-81	RP-181942	0011	4	F	Clarification on PDCP transmission	15.3.0
2018/12	RP-82	RP-182650	0022	1	F	Suspend and resume of security	15.4.0
	RP-82	RP-182655	0023	-	F	Introducing PDCP suspend procedure	15.4.0
	RP-82	RP-182656	0024	-	F	Clarification on ciphering MAC-I	15.4.0
2019/03	RP-83	RP-190544	0025	2	F	Correction on the PDCP re-establishment for AM DRB	15.5.0
	RP-83	RP-190540	0027	1	F	Correction on PDCP SN length	15.5.0
2019/06	RP-84	RP-191375	0031	1	F	PDCP association with RLC for RBs configured with PDCP duplication	15.6.0
2020/03	RP-87	RP-200346	0038	2	B	38.323 CR for NR V2X	16.0.0
	RP-87	RP-200352	0039	3	B	Introduction of NR IIOT	16.0.0
	RP-87	RP-200347	0042	2	B	Introduction of DAPS handover	16.0.0
2020/07	RP-88	RP-201190	0032	6	F	PDCP security issue about duplicate detection	16.1.0
	RP-88	RP-201195	0045	3	C	CR on 38.323 for NR mobility enhancement	16.1.0
	RP-88	RP-201176	0048	1	F	38.323 CR for NR V2X	16.1.0
	RP-88	RP-201181	0049	1	F	NR PDCP corrections for NR IIOT	16.1.0
2020/09	RP-89	RP-201963	0050	2	F	Correction on receive operation when both EHC and out-of-order delivery are configured for a DRB	16.2.0
	RP-89	RP-201932	0052	1	F	PDCP entity associated with AM RLC entity	16.2.0
	RP-89	RP-201927	0056	-	F	38.323 corrections on Sidelink	16.2.0
2021/03	RP-91	RP-210692	0064	1	F	Correction on PDCP transmit operation	16.3.0
2021/06	RP-92	RP-211485	0074	1	A	Correction on suspended AM DRB in PDCP re-establishment	16.4.0
	RP-92	RP-211470	0078	1	F	PDCP miscellaneous corrections	16.4.0
2021/09	RP-93	RP-212442	0080	1	F	CR for the ciphering of EHC header	16.5.0
2021/12	RP-94	RP-213342	0082	1	F	Correction to Window_Size for SLRB	16.6.0
2022/03	RP-95	RP-220495	0085	1	B	Introducing support of UP IP for EPC connected architectures using NR PDCP	17.0.0
	RP-95	RP-220491	0086	2	B	Introduction of SL Relay in 38.323	17.0.0
	RP-95	RP-220489	0087	1	B	Introduction of the support for UDC in NR	17.0.0
	RP-95	RP-220484	0088	-	B	Introduction of NR MBS into 38.323	17.0.0

History

Document history		
V17.0.0	May 2022	Publication