

ETSI TS 138 340 V17.0.0 (2022-05)



**5G;**  
**NR; Backhaul Adaptation Protocol (BAP) specification**  
**(3GPP TS 38.340 version 17.0.0 Release 17)**



---

Reference

RTS/TSGR-0238340vh00

---

Keywords

5G

**ETSI**

650 Route des Lucioles  
F-06921 Sophia Antipolis Cedex - FRANCE

Tel.: +33 4 92 94 42 00 Fax: +33 4 93 65 47 16

Siret N° 348 623 562 00017 - APE 7112B  
Association à but non lucratif enregistrée à la  
Sous-Préfecture de Grasse (06) N° w061004871

---

**Important notice**

The present document can be downloaded from:

<http://www.etsi.org/standards-search>

The present document may be made available in electronic versions and/or in print. The content of any electronic and/or print versions of the present document shall not be modified without the prior written authorization of ETSI. In case of any existing or perceived difference in contents between such versions and/or in print, the prevailing version of an ETSI deliverable is the one made publicly available in PDF format at [www.etsi.org/deliver](http://www.etsi.org/deliver).

Users of the present document should be aware that the document may be subject to revision or change of status.

Information on the current status of this and other ETSI documents is available at

<https://portal.etsi.org/TB/ETSIDeliverableStatus.aspx>

If you find errors in the present document, please send your comment to one of the following services:

<https://portal.etsi.org/People/CommitteeSupportStaff.aspx>

If you find a security vulnerability in the present document, please report it through our  
Coordinated Vulnerability Disclosure Program:

<https://www.etsi.org/standards/coordinated-vulnerability-disclosure>

---

**Notice of disclaimer & limitation of liability**

The information provided in the present deliverable is directed solely to professionals who have the appropriate degree of experience to understand and interpret its content in accordance with generally accepted engineering or other professional standard and applicable regulations.

No recommendation as to products and services or vendors is made or should be implied.

No representation or warranty is made that this deliverable is technically accurate or sufficient or conforms to any law and/or governmental rule and/or regulation and further, no representation or warranty is made of merchantability or fitness for any particular purpose or against infringement of intellectual property rights.

In no event shall ETSI be held liable for loss of profits or any other incidental or consequential damages.

Any software contained in this deliverable is provided "AS IS" with no warranties, express or implied, including but not limited to, the warranties of merchantability, fitness for a particular purpose and non-infringement of intellectual property rights and ETSI shall not be held liable in any event for any damages whatsoever (including, without limitation, damages for loss of profits, business interruption, loss of information, or any other pecuniary loss) arising out of or related to the use of or inability to use the software.

---

**Copyright Notification**

No part may be reproduced or utilized in any form or by any means, electronic or mechanical, including photocopying and microfilm except as authorized by written permission of ETSI.

The content of the PDF version shall not be modified without the written authorization of ETSI.

The copyright and the foregoing restriction extend to reproduction in all media.

© ETSI 2022.  
All rights reserved.

---

# Intellectual Property Rights

## Essential patents

IPRs essential or potentially essential to normative deliverables may have been declared to ETSI. The declarations pertaining to these essential IPRs, if any, are publicly available for **ETSI members and non-members**, and can be found in ETSI SR 000 314: "*Intellectual Property Rights (IPRs); Essential, or potentially Essential, IPRs notified to ETSI in respect of ETSI standards*", which is available from the ETSI Secretariat. Latest updates are available on the ETSI Web server (<https://ipr.etsi.org/>).

Pursuant to the ETSI Directives including the ETSI IPR Policy, no investigation regarding the essentiality of IPRs, including IPR searches, has been carried out by ETSI. No guarantee can be given as to the existence of other IPRs not referenced in ETSI SR 000 314 (or the updates on the ETSI Web server) which are, or may be, or may become, essential to the present document.

## Trademarks

The present document may include trademarks and/or tradenames which are asserted and/or registered by their owners. ETSI claims no ownership of these except for any which are indicated as being the property of ETSI, and conveys no right to use or reproduce any trademark and/or tradename. Mention of those trademarks in the present document does not constitute an endorsement by ETSI of products, services or organizations associated with those trademarks.

**DECT™**, **PLUGTESTS™**, **UMTS™** and the ETSI logo are trademarks of ETSI registered for the benefit of its Members. **3GPP™** and **LTE™** are trademarks of ETSI registered for the benefit of its Members and of the 3GPP Organizational Partners. **oneM2M™** logo is a trademark of ETSI registered for the benefit of its Members and of the oneM2M Partners. **GSM®** and the GSM logo are trademarks registered and owned by the GSM Association.

---

# Legal Notice

This Technical Specification (TS) has been produced by ETSI 3rd Generation Partnership Project (3GPP).

The present document may refer to technical specifications or reports using their 3GPP identities. These shall be interpreted as being references to the corresponding ETSI deliverables.

The cross reference between 3GPP and ETSI identities can be found under <http://webapp.etsi.org/key/queryform.asp>.

---

# Modal verbs terminology

In the present document "**shall**", "**shall not**", "**should**", "**should not**", "**may**", "**need not**", "**will**", "**will not**", "**can**" and "**cannot**" are to be interpreted as described in clause 3.2 of the [ETSI Drafting Rules](#) (Verbal forms for the expression of provisions).

"**must**" and "**must not**" are **NOT** allowed in ETSI deliverables except when used in direct citation.

# Contents

Intellectual Property Rights .....	2
Legal Notice .....	2
Modal verbs terminology.....	2
Foreword.....	5
1 Scope .....	7
2 References .....	7
3 Definitions of terms, symbols and abbreviations .....	7
3.1 Terms.....	7
3.2 Abbreviations .....	8
4 General .....	8
4.1 Introduction .....	8
4.2 Architecture .....	8
4.2.1 BAP structure.....	8
4.2.2 BAP entities .....	8
4.3 Services .....	9
4.3.1 Services provided to upper layers .....	9
4.3.2 Services expected from lower layers .....	9
4.4 Functions .....	10
4.5 Configurations .....	10
5 Procedures .....	11
5.1 BAP entity handling .....	11
5.1.1 BAP entity establishment.....	11
5.1.2 BAP entity release .....	11
5.2 Data transfer .....	11
5.2.1 Transmitting operation.....	11
5.2.1.1 General .....	11
5.2.1.2 BAP routing ID selection .....	12
5.2.1.2.1 BAP routing ID selection at IAB-node.....	12
5.2.1.2.2 BAP routing ID selection at IAB-donor-DU .....	12
5.2.1.3 Routing.....	13
5.2.1.4 Mapping to BH RLC Channel.....	14
5.2.1.4.1 Mapping to BH RLC Channel for BAP Data Packets from collocated BAP entity at IAB- node .....	14
5.2.1.4.2 Mapping to BH RLC Channel for BAP SDUs from upper layers at IAB-node .....	15
5.2.1.4.3 Mapping to BH RLC Channel at IAB-donor-DU.....	16
5.2.2 Receiving operation .....	17
5.3 Flow control .....	17
5.3.1 Flow control feedback .....	17
5.3.1.1 Transmitting operation.....	17
5.3.1.2 Receiving operation .....	18
5.3.2 Flow control polling.....	18
5.4 BH RLF related indications.....	18
5.4.1 Transmitting operation.....	18
5.4.2 Receiving operation .....	19
5.5 Handling of unknown, unforeseen, and erroneous protocol data .....	19
6 Protocol data units, formats, and parameters.....	19
6.1 Protocol data units .....	19
6.1.1 Data PDU.....	19
6.1.2 Control PDU .....	19
6.2 Formats.....	20
6.2.1 General.....	20
6.2.2 Data PDU.....	20

6.2.3	Control PDU .....	20
6.2.3.1	Control PDU for flow control feedback .....	20
6.2.3.2	Control PDU for flow control polling .....	22
6.2.3.3	Control PDU for BH RLF indication .....	22
6.2.3.4	Control PDU for BH RLF detection indication .....	22
6.2.3.5	Control PDU for BH RLF recovery indication .....	22
6.3	Parameters .....	22
6.3.1	General .....	22
6.3.2	DESTINATION .....	22
6.3.3	PATH .....	23
6.3.4	Data .....	23
6.3.5	R .....	23
6.3.6	D/C .....	23
6.3.7	PDU type .....	23
6.3.8	BH RLC channel ID .....	23
6.3.9	BAP Routing ID .....	24
6.3.10	Available Buffer Size .....	24
<b>Annex A (informative):</b>	<b>Change history .....</b>	<b>25</b>
History .....		26

---

# Foreword

This Technical Specification has been produced by the 3rd Generation Partnership Project (3GPP).

The contents of the present document are subject to continuing work within the TSG and may change following formal TSG approval. Should the TSG modify the contents of the present document, it will be re-released by the TSG with an identifying change of release date and an increase in version number as follows:

Version x.y.z

where:

- x the first digit:
  - 1 presented to TSG for information;
  - 2 presented to TSG for approval;
  - 3 or greater indicates TSG approved document under change control.
- y the second digit is incremented for all changes of substance, i.e. technical enhancements, corrections, updates, etc.
- z the third digit is incremented when editorial only changes have been incorporated in the document.

In the present document, certain modal verbs have the following meanings:

**shall** indicates a mandatory requirement to do something

**shall not** indicates an interdiction (prohibition) to do something

NOTE 1: The constructions "shall" and "shall not" are confined to the context of normative provisions, and do not appear in Technical Reports.

NOTE 2: The constructions "must" and "must not" are not used as substitutes for "shall" and "shall not". Their use is avoided insofar as possible, and they are not used in a normative context except in a direct citation from an external, referenced, non-3GPP document, or so as to maintain continuity of style when extending or modifying the provisions of such a referenced document.

**should** indicates a recommendation to do something

**should not** indicates a recommendation not to do something

**may** indicates permission to do something

**need not** indicates permission not to do something

NOTE 3: The construction "may not" is ambiguous and is not used in normative elements. The unambiguous constructions "might not" or "shall not" are used instead, depending upon the meaning intended.

**can** indicates that something is possible

**cannot** indicates that something is impossible

NOTE 4: The constructions "can" and "cannot" shall not to be used as substitutes for "may" and "need not".

**will** indicates that something is certain or expected to happen as a result of action taken by an agency the behaviour of which is outside the scope of the present document

**will not** indicates that something is certain or expected not to happen as a result of action taken by an agency the behaviour of which is outside the scope of the present document

**might** indicates a likelihood that something will happen as a result of action taken by some agency the behaviour of which is outside the scope of the present document

**might not** indicates a likelihood that something will not happen as a result of action taken by some agency the behaviour of which is outside the scope of the present document

In addition:

**is** (or any other verb in the indicative mood) indicates a statement of fact

**is not** (or any other negative verb in the indicative mood) indicates a statement of fact

NOTE 5: The constructions "is" and "is not" do not indicate requirements.

---

# 1 Scope

The present document provides description of the Backhaul Adaptation Protocol (BAP).

---

## 2 References

The following documents contain provisions which, through reference in this text, constitute provisions of the present document.

- References are either specific (identified by date of publication, edition number, version number, etc.) or non-specific.
- For a specific reference, subsequent revisions do not apply.
- For a non-specific reference, the latest version applies. In the case of a reference to a 3GPP document (including a GSM document), a non-specific reference implicitly refers to the latest version of that document *in the same Release as the present document*.

- [1] 3GPP TR 21.905: "Vocabulary for 3GPP Specifications".
- [2] 3GPP TS 38.300: "NG Radio Access Network; Overall description".
- [3] 3GPP TS 38.331: "NR Radio Resource Control (RRC); Protocol Specification".
- [4] 3GPP TS 38.322: "NR Radio Link Control (RLC) protocol specification".
- [5] 3GPP TS 38.473: "NG-RAN F1 application protocol (F1AP) protocol specification".
- [6] 3GPP TS 38.401: "NG-RAN; Architecture description".

---

## 3 Definitions of terms, symbols and abbreviations

### 3.1 Terms

For the purposes of the present document, the terms given in TR 21.905 [1] and the following apply. A term defined in the present document takes precedence over the definition of the same term, if any, in TR 21.905 [1].

**BH RLC channel:** an RLC channel between two nodes, which is used to transport backhaul packets, as defined in TS 38.300 [2].

**Boundary IAB-node:** an IAB-node with one RRC interface terminating at a different IAB-donor than the F1 interface, as defined in TS 38.401 [6].

**Egress BH RLC channel:** a BH RLC channel on which a packet is transmitted by a node.

**Egress link:** a radio link on which a packet is transmitted by a node.

**F1-terminating donor:** The IAB-donor of an IAB-node, which manages the F1 interface with this IAB-node.

**IAB-donor:** as defined in TS 38.300 [2].

**IAB-donor-DU:** as defined in TS 38.401 [6].

**IAB-node:** as defined in TS 38.300 [2].

**Ingress BH RLC channel:** a BH RLC channel on which a packet is received by a node.

**Ingress link:** a radio link on which a packet is received by a node.

**Non-F1-terminating donor:** The IAB-donor for an IAB-node, which does not have F1 interface with this IAB-node.



## 3.2 Abbreviations

For the purposes of the present document, the abbreviations given in TR 21.905 [1] and the following apply. An abbreviation defined in the present document takes precedence over the definition of the same abbreviation, if any, in TR 21.905 [1].

BH	Backhaul
DSCP	Differentiated Services Code Point
IAB	Integrated Access and Backhaul
MT	Mobile Termination
TEID	Tunnel Endpoint Identifier

## 4 General

### 4.1 Introduction

The present document describes the functionalities of BAP.

### 4.2 Architecture

#### 4.2.1 BAP structure

Figure 4.2.1-1 represents one possible structure for the BAP sublayer; it should not restrict implementation. The figure is based on the radio interface protocol architecture defined in TS 38.300 [2].

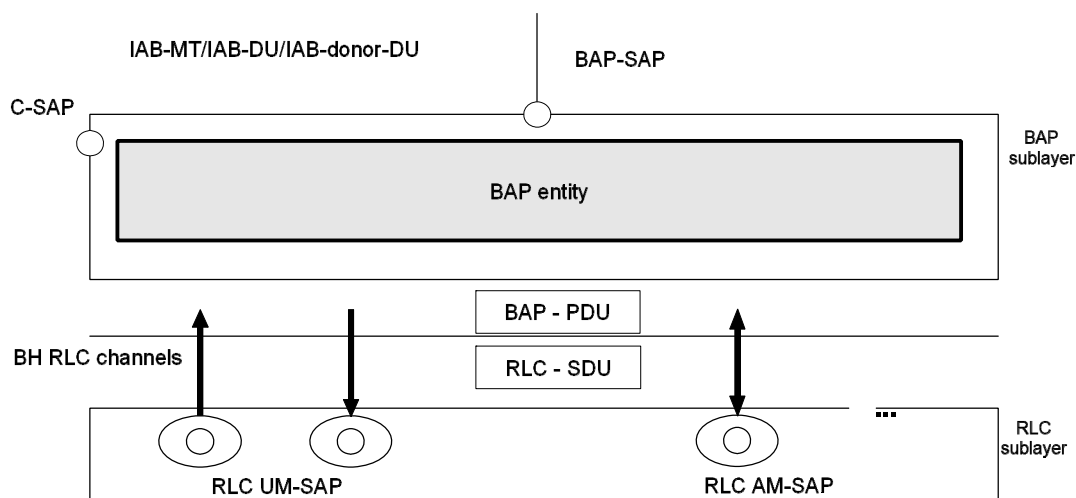

**Figure 4.2.1-1: BAP layer, structure view**

The BAP sublayer is configured by upper layers TS 38.331 [3] and TS 38.473 [5].

#### 4.2.2 BAP entities

On the IAB-node, the BAP sublayer contains one BAP entity at the MT function and a separate collocated BAP entity at the DU function. On the IAB-donor-DU, the BAP sublayer contains only one BAP entity. Each BAP entity has a transmitting part and a receiving part.

NOTE: The modelling of BAP entities does not restrict internal implementation of IAB-nodes, i.e. the exact modelling of BAP sublayer may vary for different IAB-node implementations.

The transmitting part of the BAP entity has a corresponding receiving part of a BAP entity at the IAB-node or IAB-donor-DU across the BH link.

Figure 4.2.2-1 shows one example of the functional view of the BAP sublayer. This functional view should not restrict implementation. The figure is based on the radio interface protocol architecture defined in TS 38.300 [2].

In the example of Figure 4.2.2-1, the receiving part on the BAP entity delivers BAP PDUs to the transmitting part on the collocated BAP entity. Alternatively, the receiving part may deliver BAP SDUs to the collocated transmitting part. When passing BAP SDUs, the receiving part removes the BAP header and the transmitting part adds the BAP header with the same BAP header content as carried on the BAP PDU header prior to removal. Passing BAP SDUs in this manner is therefore functionally equivalent to passing BAP PDUs, in implementation. The following specification therefore refers to the passing of BAP Data Packets.

Besides, BAP entity generates, delivers/receives BAP Control PDU(s) as described in clause 6.1.2. BAP Control PDU can only be exchanged between peer BAP entities across the BH link.

In addition to functions shown in Figure 4.2.2-1, for a boundary IAB-node, the transmitting part of the BAP entity may perform BAP header rewriting operation, in accordance with clause 5.2.1.

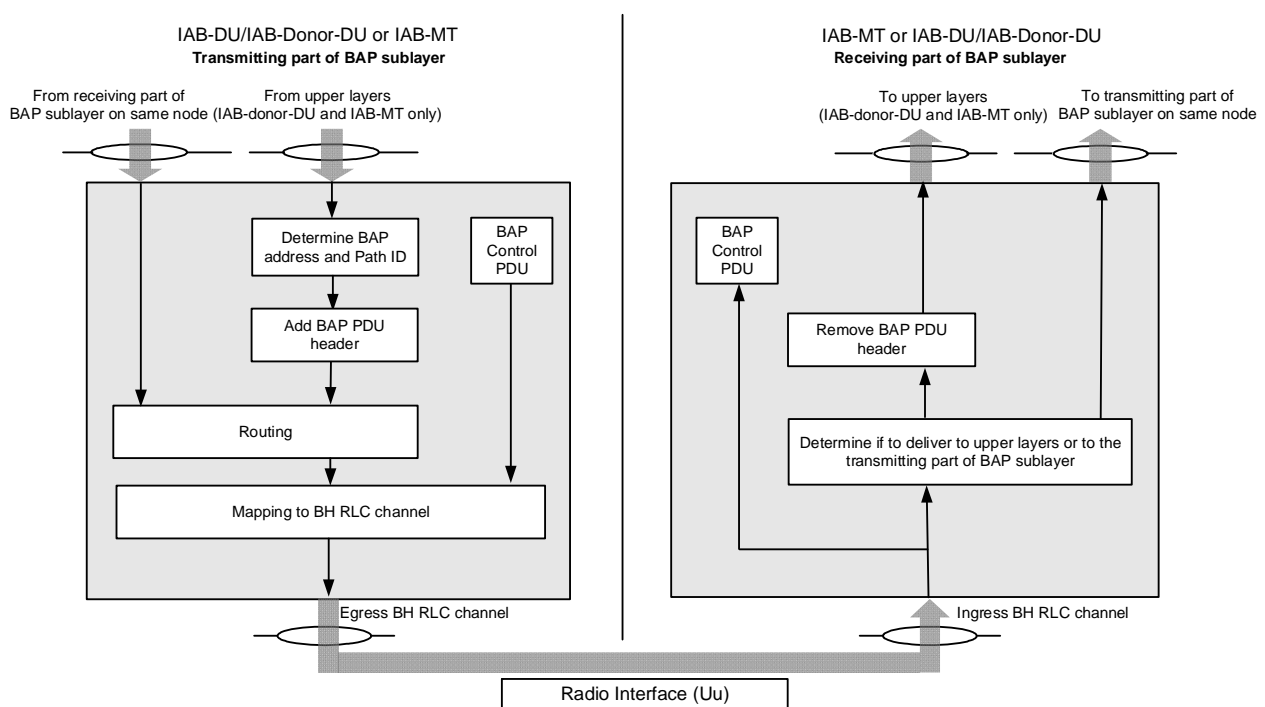

Figure 4.2.2-1. Example of functional view of BAP sublayer

## 4.3 Services

### 4.3.1 Services provided to upper layers

The following services are provided by the BAP sublayer to upper layers:

- data transfer.

### 4.3.2 Services expected from lower layers

A BAP sublayer expects the following services from lower layers per RLC entity (for a detailed description see TS 38.322 [4]):

- acknowledged data transfer service;

- unacknowledged data transfer service.

## 4.4 Functions

The BAP sublayer supports the following functions:

- Data transfer;
- Determination of BAP destination and path for packets from upper layers;
- Determination of egress BH RLC channels for packets routed to next hop;
- Routing of packets to next hop;
- BAP header rewriting;
- Differentiating traffic to be delivered to upper layers from traffic to be delivered to egress link;
- Flow control feedback and polling signalling;
- Handling of BH RLF related indications;

## 4.5 Configurations

The configuration of the BAP entity includes:

- The IAB-node's BAP address via RRC.
- The IAB-donor-DU's BAP address via F1AP.
- Mapping from next hop BAP address to downstream egress link via F1AP.
- Mapping from next hop BAP address to upstream egress link via RRC.
- Mapping from upper layer traffic to BAP routing ID in BAP header via F1AP and RRC.
- The BAP routing entries via F1AP.
- Mapping to egress BH RLC channels via F1AP and RRC.
- Flow control feedback type(s) to be provided, if any, via RRC.

BH RLC channels are configured via RRC on the IAB-MT, and via F1AP on the IAB-DU/IAB-donor-DU.

For F1AP configurations, the following mapping, which are derived from the original F1AP signaling, are used in procedure:

- Uplink Traffic to Routing ID Mapping Configuration.
- Downlink Traffic to Routing ID Mapping Configuration.
- BH Routing Configuration.
- BH RLC Channel Mapping Configuration.
- Uplink Traffic to BH RLC Channel Mapping Configuration.
- Downlink Traffic to BH RLC Channel Mapping Configuration.
- Header Rewriting Configuration.

---

## 5 Procedures

### 5.1 BAP entity handling

#### 5.1.1 BAP entity establishment

When upper layers request establishment of a BAP entity, the node shall:

- establish a BAP entity;
- follow the procedures in clause 5.

#### 5.1.2 BAP entity release

When upper layers request release of a BAP entity, the node shall:

- release the BAP entity and the related BAP configurations.

## 5.2 Data transfer

### 5.2.1 Transmitting operation

#### 5.2.1.1 General

The transmitting part of the BAP entity on the IAB-MT can receive BAP SDUs from upper layers and BAP Data Packets from the receiving part of the BAP entity on the IAB-DU of the same IAB-node, and construct BAP Data PDUs as needed (see clause 4.2.2). The transmitting part of the BAP entity on the IAB-DU can receive BAP Data Packets from the receiving part of the BAP entity on the IAB-MT of the same IAB-node, and construct BAP Data PDUs as needed (see clause 4.2.2). The transmitting part of the BAP entity on the IAB-donor-DU can receive BAP SDUs from upper layers, and construct BAP Data PDUs as needed (see clause 4.2.2).

Upon receiving a BAP SDU from upper layers, the transmitting part of the BAP entity shall:

- select a BAP address and a BAP path identity for this BAP SDU in accordance with clause 5.2.1.2;
- construct a BAP Data PDU by adding a BAP header to the BAP SDU, where the DESTINATION field is set to the selected BAP address and the PATH field is set to the selected BAP path identity, in accordance with clause 6.2.2;

When the BAP entity has a BAP Data PDU to transmit, the transmitting part of the BAP entity shall:

- for the boundary IAB-node, if the BAP Data PDU is received from the collocated BAP entity, perform the BAP header rewriting operation (if configured) in accordance with clause 5.2.1.5;
- perform routing to determine the egress link in accordance with clause 5.2.1.3;
- determine the egress BH RLC channel in accordance with clause 5.2.1.4;
- submit this BAP Data PDU to the selected egress BH RLC channel of the selected egress link.

**NOTE:** Data buffering on the transmitting part of the BAP entity, e.g., until RLC-AM entity has received an acknowledgement, is up to implementation. In case of BH RLF, the transmitting part of the BAP entity may reroute the BAP Data PDUs, which has not been acknowledged by lower layer before the BH RLF, to an alternative path in accordance with clause 5.2.1.3.

## 5.2.1.2 BAP routing ID selection

### 5.2.1.2.1 BAP routing ID selection at IAB-node

At an IAB-node, for a BAP SDU received from upper layers and to be transmitted in upstream direction, the BAP entity performs mapping to a BAP address and BAP path identity based on:

- Uplink Traffic to Routing ID Mapping Configuration, which is derived from F1AP on the IAB-node in TS 38.473 [5],
- *defaultUL-BAP-RoutingID*, which is configured by RRC on the IAB-node in TS 38.331[3].

Each entry of the Uplink Traffic to Routing ID Mapping Configuration contains:

- a traffic type specifier, which is indicated by *UL UP TNL Information IE* for F1-U packets and *Non-UP Traffic Type IE* for non-F1-U packets in TS 38.473 [5], and
- a BAP routing ID, which includes a BAP address and a BAP path identity, indicated by *BAP Routing ID IE* in *BH Information IE* in TS 38.473 [5].

At the IAB-node, for a BAP SDU received from upper layers and to be transmitted in upstream direction, the BAP entity shall:

- if the Uplink Traffic to Routing ID Mapping Configuration has not been (re)configured by F1AP after the last (re)configuration of *defaultUL-BAP-RoutingID* by RRC:
  - select the BAP address and the BAP path identity as configured by *defaultUL-BAP-RoutingID* in TS 38.331 [3] for non-F1-U packets;
- else:
  - for the BAP SDU encapsulating an F1-U packet:
    - select an entry from the Uplink Traffic to Routing ID Mapping Configuration with its traffic type specifier corresponds to the destination IP address and TEID of this BAP SDU;
  - for the BAP SDU encapsulating a non-F1-U packet:
    - select an entry from the Uplink Traffic to Routing ID Mapping Configuration with its traffic type specifier corresponds to the traffic type of this BAP SDU;
  - select the BAP address and the BAP path identity from the BAP routing ID in the entry selected above;

NOTE: Uplink Traffic to Routing ID Mapping Configuration may contain multiple entries for F1-C traffic. It is up to IAB node's implementation to decide which entry is selected.

### 5.2.1.2.2 BAP routing ID selection at IAB-donor-DU

For a BAP SDU received from upper layer at the IAB-donor-DU, the BAP entity performs mapping to a BAP address and a BAP Path identity based on:

- Downlink Traffic to Routing ID Mapping Configuration, which is derived from *IP-to-layer-2 traffic mapping Information List IE* configured on the IAB-donor-DU in TS 38.473 [5].

Each entry of the Downlink Traffic to Routing ID Mapping Configuration contains:

- a destination IP address, which is indicated by *Destination IAB TNL Address IE* in *IP header information IE*, including an IPv4 address or IPv6 address or an IPv6 address prefix,
- an IPv6 flow label, if configured, which is indicated by *IPv6 Flow Label IE* in *IP header information IE*,
- a DSCP, if configured, which is indicated by *DSCP IE* in *DS Information List IE* in *IP header information IE*, and
- a BAP routing ID, which is indicated by *BAP Routing ID IE* in *BH Information IE* in TS 38.473 [5].

At the IAB-donor-DU, for a BAP SDU received from upper layers and to be transmitted in downstream direction, the BAP entity shall:

- for the BAP SDU encapsulating an IPv6 packet:
  - select an entry from the Downlink Traffic to Routing ID Mapping Configuration which fulfils the following conditions:
    - the Destination IP address of this BAP SDU matches the destination IP address in this entry; and
    - the IPv6 Flow Label of this BAP SDU matches IPv6 flow label in this entry if configured; and
    - the DSCP of this BAP SDU matches DSCP in this entry if configured;
- for the BAP SDU encapsulating an IPv4 packet:
  - select an entry from the Downlink Traffic to Routing ID Mapping Configuration which fulfils the following conditions:
    - the Destination IP address of this BAP SDU matches the destination IP address in this entry; and
    - the DSCP of this BAP SDU matches DSCP in this entry if configured;
  - select the BAP address and the BAP path identity from the BAP routing ID in the entry selected above;

### 5.2.1.3 Routing

The BAP entity performs routing based on:

- the BH Routing Configuration derived from an F1AP message as specified in TS 38.473 [5].

Each entry of the BH Routing Configuration contains:

- a BAP Routing ID consisting of a BAP address and a BAP path identity, which is indicated by *BAP Routing ID* IE, and
- a Next Hop BAP Address which is indicated by *Next-Hop BAP Address* IE.
- a Type indicator, indicating whether the entry belongs to the non-F1-terminating donor topology, which is indicated by *Non-F1-terminating Topology Indicator* IE.

In the BH Routing Configuration, the entry configured with *Non-F1-terminating Topology Indicator* IE applies to the BAP Data PDU considered as non-F1-terminating donor topology data, and the entry not configured with *Non-F1-terminating Topology Indicator* IE only applies to the BAP Data PDU not considered as non-F1-terminating donor topology data.

For a BAP Data PDU to be transmitted, BAP entity shall:

- if the BAP Data PDU corresponds to a BAP SDU received from the upper layer, and
- if the BH Routing Configuration has not been (re)configured by F1AP after the last (re)configuration of *defaultUL-BH-RLC-Channel* by RRC:
  - select the egress link on which the egress BH RLC channel corresponding to *defaultUL-BH-RLC-Channel* is configured as specified in TS 38.331 [3] for non-F1-U packets;
- else if there is an entry in the BH Routing Configuration whose BAP address matches the DESTINATION field, whose BAP path identity is the same as the PATH field, and whose egress link corresponding to the Next Hop BAP Address is available:
  - select the egress link corresponding to the Next Hop BAP Address of the entry;

NOTE 1: An egress link is not considered to be available if the link is in BH RLF.

NOTE 2: For each combination of a BAP address and a BAP path identity, there should be at most one entry in the BH Routing Configuration. There could be multiple entries of the same BAP address in the BH Routing Configuration.

NOTE 3: An egress link may be not considered to be available for a BAP routing ID, if it is determined as congested based on the received flow control feedback, as defined in clause 5.3.1.

- else if there is at least one entry in the BH Routing Configuration whose BAP address matches the DESTINATION field, and whose egress link corresponding to the Next Hop BAP Address is available:
  - select an entry from the BH Routing Configuration whose BAP address is the same as the DESTINATION field, and whose egress link corresponding to the Next Hop BAP Address is available;
  - select the egress link corresponding to the Next Hop BAP Address of the entry selected above;
- else if, for the transmitting part of IAB-MT, at least one egress link is available, and if *Re-routing Disable Indicator* IE is not configured by F1AP:
  - if this egress link belongs to F1-terminating donor topology, and there is an entry in the BH Routing Configuration not configured with *Non-F1-terminating Topology Indicator* IE whose Next Hop BAP Address corresponds to this egress link, or
  - if this egress link belongs to non-F1-terminating donor topology, and there is an entry in the BH Routing Configuration configured with *Non-F1-terminating Topology Indicator* IE whose Next Hop BAP Address corresponds to this egress link:
    - select the egress link;
    - replace the BAP header of this BAP Data PDU, where the DESTINATION field is reset to the leftmost 10 bits of BAP Routing ID of the entry in the BH Routing Configuration (i.e. BAP address), and the PATH field is reset to the rightmost 10 bits of BAP Routing ID of the entry (i.e. BAP path identity).

#### 5.2.1.4 Mapping to BH RLC Channel

##### 5.2.1.4.1 Mapping to BH RLC Channel for BAP Data Packets from collocated BAP entity at IAB-node

For a BAP Data Packet received from the collocated BAP entity, the transmitting part of the BAP entity performs mapping to an egress BH RLC channel based on:

- BH RLC Channel Mapping Configuration, which is derived from *BAP layer BH RLC channel mapping Information List* IE, and optionally together with the *Configured BAP address* IE and the *BH RLC Channel to be Setup/Modified List* IE, as configured on the IAB-node in TS 38.473 [5],

Each entry of the BH RLC Channel Mapping Configuration contains:

- an ingress link ID, which is indicated by *Prior-Hop BAP Address* IE, or by the *Configured BAP address* IE in UE-associated F1AP message for upstream, belonging to topology indicated by *Ingress Non-F1-terminating Topology Indicator* IE in F1AP,
- an egress link ID, which is indicated by *Next-Hop BAP Address* IE, or by the *Configured BAP address* IE in UE-associated F1AP message for downstream, belonging to topology indicated by *Egress Non-F1-terminating Topology Indicator* IE in F1AP,
- an ingress BH RLC channel ID, which is indicated by *Ingress BH RLC CH ID* IE, or by the *BH RLC CH ID* IE in UE-associated F1AP message for upstream, and,
- an egress BH RLC channel ID, which is indicated by *Egress BH RLC CH ID* IE, or by the *BH RLC CH ID* IE in UE-associated F1AP message for downstream.

For a BAP Data PDU received from an ingress BH RLC channel of an ingress link and for which the egress link has been selected as specified in clause 5.2.1.3:

- if there is an entry in the BH RLC Channel Mapping Configuration, whose ingress BH RLC channel ID matches the BAP Data PDU's ingress BH RLC channel, whose ingress link ID matches the BAP Data PDU's ingress link, and whose egress link ID corresponds to the selected egress link;
  - select the egress BH RLC channel corresponding to egress BH RLC channel ID of this entry;

- else:
  - select any egress BH RLC channel on the selected egress link;

#### 5.2.1.4.2 Mapping to BH RLC Channel for BAP SDUs from upper layers at IAB-node

For a BAP SDU received from upper layers at the IAB-node, the BAP entity performs mapping to an egress BH RLC channel based on:

- Uplink Traffic to BH RLC Channel Mapping Configuration, which is derived from F1AP message, configured on the IAB-node in TS 38.473 [5],
- *defaultUL-BH-RLC-Channel*, which is configured by RRC on the IAB-node in TS 38.331[3].

Each entry of the Uplink Traffic to BH RLC Channel Mapping Configuration contains:

- a traffic type specifier, which is indicated by *UL UP TNL Information IE* for F1-U packets or *Non-UP Traffic Type IE* for non-F1-U packets in TS 38.473 [5],
- an egress link ID, which is indicated by *Next-Hop BAP address IE in BH Information IE* in TS 38.473 [5], belonging to topology indicated by *Egress Non-F1-terminating Topology Indicator IE* in F1AP, and
- an egress BH RLC channel ID, which is indicated by *BH RLC CH ID IE in BH Information IE* in TS 38.473 [5].

For a BAP SDU received from upper layers at the IAB-node and to be transmitted in upstream direction, whose egress link has been selected as specified in clause 5.2.1.3, the BAP entity shall:

- if the Uplink Traffic to BH RLC Channel Mapping Configuration has not been (re)configured by F1AP after the last (re)configuration of *defaultUL-BH-RLC-Channel* by RRC:
  - select the egress BH RLC channel corresponding to *defaultUL-BH-RLC-Channel* configured in TS 38.331 [3] for non-F1-U packets;
- else:
  - for the BAP SDU encapsulating an F1-U packet:
    - if there is an entry in the Uplink Traffic to BH RLC Channel Mapping Configuration with its traffic type specifier corresponds to the destination IP address and TEID of this BAP SDU and its egress link ID corresponding to the selected egress link;
      - select the egress BH RLC channel corresponding to the egress BH RLC channel ID of this entry;
    - else:
      - select any egress BH RLC channel on the selected egress link;
  - for the BAP SDU encapsulating a non-F1-U packet:
    - if there is an entry from the Uplink Traffic to BH RLC Channel Mapping Configuration with its traffic type specifier corresponds to the traffic type of this BAP SDU and its egress link ID corresponding to the selected egress link;
      - select the egress BH RLC channel corresponding to the egress BH RLC channel ID of this entry;
    - else:
      - select any egress BH RLC channel on the selected egress link;

**NOTE:** Uplink Traffic to BH RLC Channel Mapping Configuration may contain multiple entries for F1-C traffic. It is up to IAB node's implementation to decide which entry is selected, but the selected entry has to match the BAP routing ID selected in 5.2.1.2.1, i.e. BAP routing ID and BH RLC channel must be derived from the same *BH Information IE*.



### 5.2.1.4.3 Mapping to BH RLC Channel at IAB-donor-DU

For a BAP SDU received from upper layers at the IAB-donor-DU, the BAP entity performs mapping to an egress BH RLC channel based on:

- Downlink Traffic to BH RLC Channel Mapping Configuration, which is derived from *IP-to-layer-2 traffic mapping Information List IE*, and optionally together with the *Configured BAP address IE* and the *BH RLC Channel to be Setup/Modified List IE*, as configured on the IAB-donor-DU in TS 38.473 [5].

Each entry of the Downlink Traffic to BH RLC Channel Mapping Configuration contains:

- a destination IP address, which is indicated by *Destination IAB TNL Address IE* in *IP header information IE* including an IPv4 address or IPv6 address or an IPv6 address prefix,
- an IPv6 flow label, if configured, which is indicated by *IPv6 Flow Label IE* in *IP header information IE*,
- a DSCP, if configured, which is indicated by *DSCP IE* in *DS Information List IE* in *IP header information IE*,
- an egress link ID, which is indicated by *Next-Hop BAP Address IE* in *BH Information IE*, or by the *Configured BAP address IE* in UE-associated F1AP message, and
- an egress BH RLC channel ID, which is indicated by *Egress BH RLC CH ID IE* in *BH Information IE*, or by the *BH RLC CH ID IE* in UE-associated F1AP message.

At the IAB-donor-DU, for a BAP SDU received from upper layers and to be transmitted in downstream direction, whose egress link has been selected as specified in clause 5.2.1.3, the BAP entity shall:

- for the BAP SDU encapsulating an IPv6 packet:
  - if there is an entry in the Downlink Traffic to BH RLC Channel Mapping Configuration with its egress link ID corresponding to the selected egress link, and the entry fulfils the following conditions:
    - the Destination IP address of this BAP SDU matches the destination IP address in this entry; and
    - the IPv6 Flow Label of this BAP SDU matches IPv6 flow label in this entry if configured; and
    - the DSCP of this BAP SDU matches DSCP in this entry if configured:
      - select the egress BH RLC channel corresponding to egress BH RLC channel ID of this entry;
  - else:
    - select any egress BH RLC channel on the selected egress link;
- for the BAP SDU encapsulating an IPv4 packet:
  - if there is an entry in the Downlink Traffic to BH RLC Channel Mapping Configuration with its egress link ID corresponding to the selected egress link, and the entry fulfils the following conditions:
    - the Destination IP address of this BAP SDU matches the destination IP address in this entry; and
    - the DSCP of this BAP SDU matches DSCP in this entry if configured:
      - select the egress BH RLC channel corresponding to egress BH RLC channel ID of this entry;
  - else:
    - select any egress BH RLC channel on the selected egress link;

### 5.2.1.5 BAP header rewriting operation

The BAP entity performs BAP header rewriting based on:

- the Header Rewriting Configuration derived from an F1AP message as specified in TS 38.473 [5].

Each entry of the Header Rewriting Configuration contains:

- an Ingress Routing ID consisting of a BAP address and a BAP path identity of the BAP Data PDU, which is indicated by *Ingress BAP Routing ID IE*, and
- an Egress Routing ID consisting of a BAP address and a BAP path identity of the BAP Data PDU, which is indicated by *Egress BAP Routing ID IE*, and
- a Type indicator, indicating whether the Egress Routing ID belongs to the non-F1-terminating donor topology, which is indicated by *Non-F1-terminating Topology Indicator IE*.

For each BAP Data PDU to be considered for BAP header rewriting, the BAP entity shall:

- for the IAB-MT of boundary IAB-node, if there is an entry in the Header Rewriting Configuration configured with *Non-F1-terminating Topology Indicator IE*, whose BAP address of Ingress Routing ID matches the DESTINATION field, and whose BAP path identity of Ingress Routing ID matches the PATH field:
  - replace the BAP header of this BAP Data PDU, where the DESTINATION field is reset to the leftmost 10 bits of Egress Routing ID of the entry (i.e. BAP address), and the PATH field is reset to the rightmost 10 bits of Egress Routing ID of the entry (i.e. BAP path identity);
  - consider this BAP Data PDU as non-F1-terminating donor topology data;
- for the IAB-DU of boundary IAB-node, if the ingress link of this BAP Data PDU belongs to non-F1-terminating donor's topology of the boundary IAB-node; and
- if there is an entry in the Header Rewriting Configuration not configured with *Non-F1-terminating Topology Indicator IE*, whose BAP address of Ingress Routing ID matches the DESTINATION field, and whose BAP path identity of Ingress Routing ID matches the PATH field:
  - replace the BAP header of this BAP Data PDU, where the DESTINATION field is reset to the leftmost 10 bits of Egress Routing ID of the entry (i.e. BAP address), and the PATH field is reset to the rightmost 10 bits of Egress Routing ID of the entry (i.e. BAP path identity).

NOTE: In this specification, a BH link belongs to the topology of the IAB-donor that provides the configuration of that BH link, as specified in TS 38.331 [3].

## 5.2.2 Receiving operation

Upon receiving a BAP Data PDU from lower layer (i.e. ingress BH RLC channel), the receiving part of the BAP entity shall:

- if DESTINATION field of this BAP Data PDU matches the BAP address, which is configured for this node by the IAB-donor providing this ingress BH RLC channel configuration:
  - remove the BAP header of this BAP Data PDU and deliver the BAP SDU to upper layers;
- else:
  - deliver the BAP Data Packet to the transmitting part of the collocated BAP entity.

## 5.3 Flow control

### 5.3.1 Flow control feedback

#### 5.3.1.1 Transmitting operation

For a link, the BAP entity at the IAB-MT shall:

- when a flow control feedback is triggered due to the buffer load exceeding a certain level, or
- when a BAP Control PDU for flow control polling is received at the receiving part, the transmitting part of this BAP entity shall:

- construct a BAP Control PDU for flow control feedback per BH RLC channel, if configured by RRC, in accordance with clause 6.2.3;
- construct a BAP Control PDU for flow control feedback per BAP routing ID, if configured by RRC, in accordance with clause 6.2.3;
- if the egress BH RLC channel for the BAP Control PDU is configured as specified in TS 38.473 [5]:
  - submit the BAP Control PDU(s) to the configured egress BH RLC channel of the egress link, indicated by *Egress BH RLC CH ID* IE in *BH Information* IE associated with *Non-UP Traffic Type* IE set to *BAP control PDU* in TS 38.473 [5];
- else:
  - submit the BAP Control PDU(s) to any egress BH RLC channel of the egress link.

NOTE: The BH RLC channel(s) and BAP routing ID(s) to be included in the flow control feedback is up to IAB node implementation, once triggered.

### 5.3.1.2 Receiving operation

For a link, the BAP entity at the IAB-DU or IAB-donor-DU may:

- if the available buffer size as indicated by the received BAP Control PDU for flow control feedback per BAP routing ID is less than the *Buffer Size Threshold* IE, if configured by F1AP in TS 38.473 [5]:
- consider the BH link as congested for this BAP routing ID (for routing defined in accordance with clause 5.2.1.3).

### 5.3.2 Flow control polling

When a flow control polling is to be transmitted over an egress link, the transmitting part of the BAP entity at the IAB-DU or IAB-donor-DU:

- construct a BAP Control PDU for flow control polling in accordance with clause 6.2.3;
- if the egress BH RLC channel for the BAP Control PDU is configured as specified in TS 38.473 [5]:
  - submit this BAP Control PDU to the configured egress BH RLC channel of the egress link, indicated by *BH RLC CH ID* IE which is associated with *BAP Control PDU Channel* IE that is set to true in TS 38.473[5];
- else:
  - submit this BAP Control PDU to any egress BH RLC channel of the egress link.

## 5.4 BH RLF related indications

### 5.4.1 Transmitting operation

When a BH RLF recovery failure is detected at the IAB-MT, for each egress link associated with the IAB-DU, the transmitting part of the collocated BAP entity at the IAB-DU may:

- construct a BAP Control PDU for BH RLF indication in accordance with clause 6.2.3.3;

When BH RLF(s) occur at the IAB-MT on all the link(s) providing F1 interface over BAP, for each egress link associated with the IAB-DU, the transmitting part of the collocated BAP entity at the IAB-DU may:

- construct a BAP Control PDU for BH RLF detection indication in accordance with clause 6.2.3.4;

When BH RLF recovery is successful at the IAB-MT, for each egress link associated with the IAB-DU on which a BAP Control PDU for BH RLF detection indication was transmitted, the transmitting part of the collocated BAP entity at the IAB-DU may:

- construct a BAP Control PDU for BH RLF recovery indication in accordance with clause 6.2.3.5;

For any constructed BAP Control PDU above, the BAP entity shall:

- if the egress BH RLC channel for the BAP control PDU is configured as specified in TS 38.473 [5]:
  - submit this BAP Control PDU to the configured egress BH RLC channel of the egress link, indicated by *BH RLC CH ID* IE which is associated with *BAP Control PDU Channel* that is set to true in TS 38.473 [5];
- else:
  - submit this BAP Control PDU to any egress BH RLC channel of the egress link.

## 5.4.2 Receiving operation

Upon receiving a BAP Control PDU for BH RLF indication from lower layer (i.e. ingress BH RLC channel), the receiving part of the BAP entity shall:

- indicate to upper layers that the BH RLF indication has been received for the ingress link where this BAP Control PDU is received.

Upon receiving a BAP Control PDU for BH RLF detection indication from lower layer (i.e. ingress BH RLC channel), the receiving part of the BAP entity shall:

- consider the BH link, from which this BAP Control PDU is received as not available (for routing defined in accordance with clause 5.2.1.3).

Upon receiving a BAP Control PDU for BH RLF recovery indication from lower layer (i.e. ingress BH RLC channel), the receiving part of the BAP entity shall:

- consider the BH link, from which this BAP Control PDU is received, to be available again (for routing defined in accordance with clause 5.2.1.3).

## 5.5 Handling of unknown, unforeseen, and erroneous protocol data

When a BAP Data PDU that contains a BAP address which is not included in the configured BH Routing Configuration and is not the BAP address of this node is received; or when a BAP Control PDU that contains reserved or invalid values is received the BAP entity shall:

- discard the received BAP PDU.

---

# 6 Protocol data units, formats, and parameters

## 6.1 Protocol data units

### 6.1.1 Data PDU

The BAP Data PDU is used to convey one of the following in addition to the PDU header:

- upper layer data.

### 6.1.2 Control PDU

The BAP Control PDU is used to convey one of the following in addition to the PDU header:

- flow control feedback per BH RLC channel;

- flow control feedback per BAP routing ID;
- flow control polling;
- BH RLF related indications;

## 6.2 Formats

### 6.2.1 General

A BAP PDU is a bit string that is byte aligned (i.e. multiple of 8 bits) in length. The formats of BAP PDUs are described in clause 6.2.2, 6.2.3 and their parameters are described in clause 6.3.

### 6.2.2 Data PDU

Figure 6.2.2-1 shows the format of the BAP Data PDU.

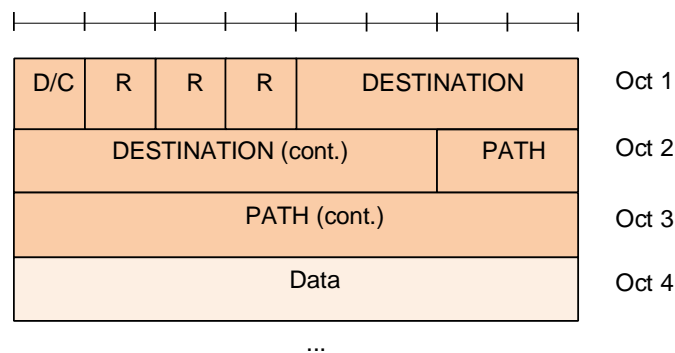

**Figure 6.2.2-1: BAP Data PDU format**

### 6.2.3 Control PDU

#### 6.2.3.1 Control PDU for flow control feedback

Figure 6.2.3.1-1 and 6.2.3.1-2 show the formats of the BAP Control PDU for flow control feedback.

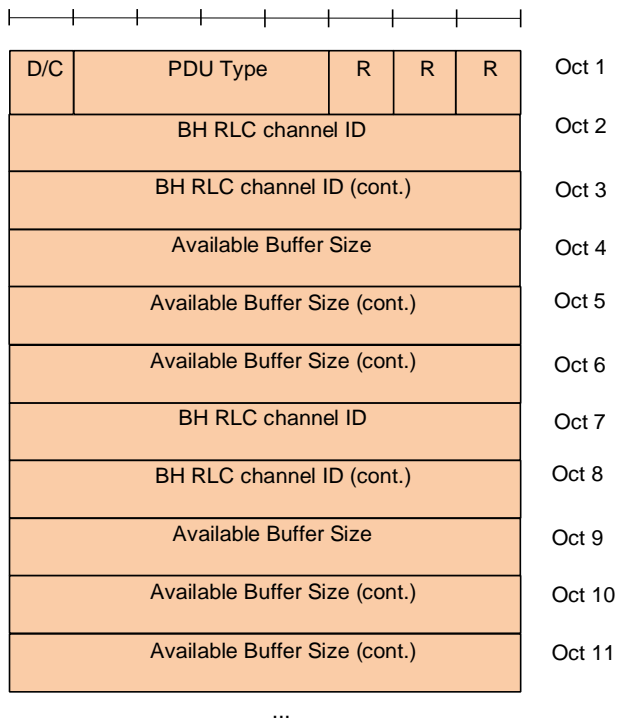

Figure 6.2.3.1-1: BAP Control PDU format for flow control feedback per BH RLC channel

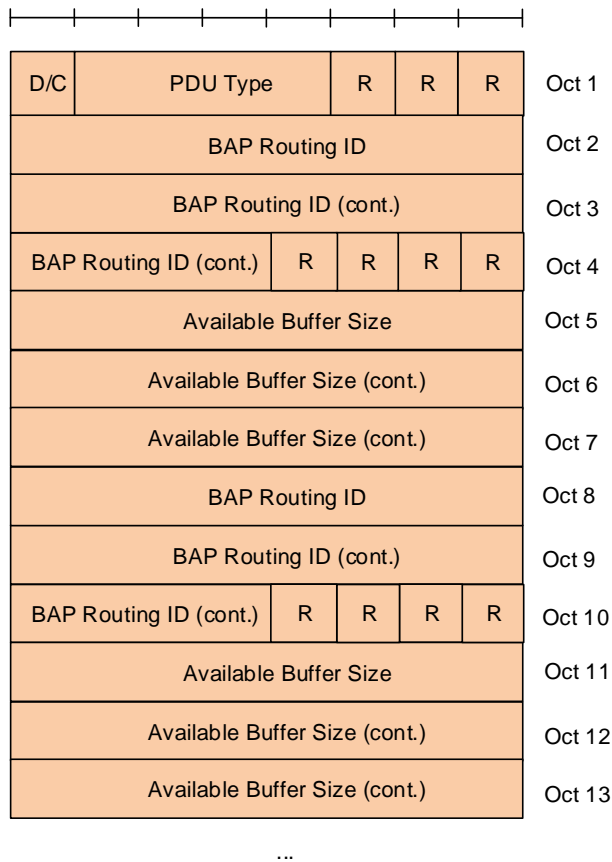
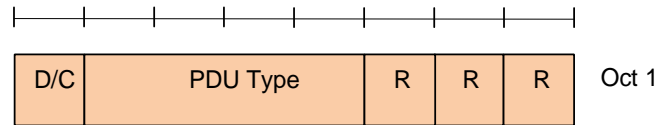

Figure 6.2.3.1-2: BAP Control PDU format for flow control feedback per BAP routing ID

### 6.2.3.2 Control PDU for flow control polling

Figure 6.2.3.2-1 shows the formats of the BAP Control PDU for flow control polling.



**Figure 6.2.3.2-1: BAP Control PDU format for flow control feedback polling**

### 6.2.3.3 Control PDU for BH RLF indication

Figure 6.2.3.3-1 shows the format of the BAP Control PDU for BH RLF indication.

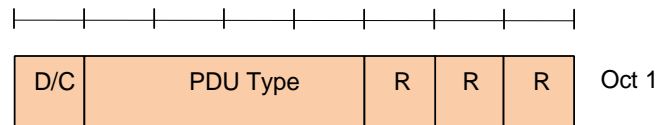

**Figure 6.2.3.3-1: BAP Control PDU format for BH RLF indication**

### 6.2.3.4 Control PDU for BH RLF detection indication

Figure 6.2.3.4-1 shows the format of the BAP Control PDU for BH RLF detection indication.

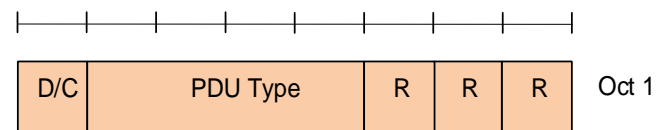

**Figure 6.2.3.4-1: BAP Control PDU format for BH RLF detection indication**

### 6.2.3.5 Control PDU for BH RLF recovery indication

Figure 6.2.3.5-1 shows the format of the BAP Control PDU for BH RLF recovery indication.

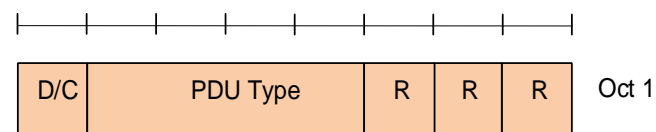

**Figure 6.2.3.5-1: BAP Control PDU format for BH RLF recovery indication**

## 6.3 Parameters

### 6.3.1 General

If not otherwise mentioned in the definition of each field, the bits in the parameters shall be interpreted as follows: the left most bit string is the first and most significant and the right most bit is the last and least significant bit.

Unless otherwise mentioned, integers are encoded in standard binary encoding for unsigned integers. In all cases the bits appear ordered from MSB to LSB when read in the PDU.

### 6.3.2 DESTINATION

Length: 10 bits.

This field carries the BAP address of the destination IAB-node or IAB-donor-DU.

### 6.3.3 PATH

Length: 10 bits.

This field carries the BAP path identity.

### 6.3.4 Data

Length: Variable

This field carries the BAP SDU (i.e. IP packet).

### 6.3.5 R

Length: 1 bit

Reserved. In this version of the specification reserved bits shall be set to 0. Reserved bits shall be ignored by the receiver.

### 6.3.6 D/C

Length: 1 bit

This field indicates whether the corresponding BAP PDU is a BAP Data PDU or a BAP Control PDU.

**Table 6.3.6-1: D/C field**

Bit	Description
0	BAP Control PDU
1	BAP Data PDU

### 6.3.7 PDU type

Length: 4 bits

This field indicates the type of control information included in the corresponding BAP Control PDU.

**Table 6.3.7-1: PDU type**

Bit	Description
0000	Flow control feedback per BH RLC channel
0001	Flow control feedback per BAP routing ID
0010	Flow control feedback polling
0011	BH RLF indication
0100	BH RLF detection indication
0101	BH RLF recovery indication
0110-1111	Reserved

### 6.3.8 BH RLC channel ID

Length: 16 bits.

This field indicates the identity of the BH RLC channel whose flow control information is provided in the flow control feedback.



### 6.3.9 BAP Routing ID

Length: 20 bits.

This field indicates BAP routing identity, for which the flow control information is provided in the flow control feedback. It contains the BAP address in the leftmost 10 bits and the BAP path identity in the rightmost 10 bits.

### 6.3.10 Available Buffer Size

Length: 24 bits.

This field indicates the maximum traffic volume the transmitter should send. The unit is kilobyte.

## Annex A (informative): Change history

Change history							
Date	Meeting	TDoc	CR	Rev	Cat	Subject/Comment	New version
10/2019	RAN2#107bis	R2-1914006				skeleton	0.0.0
10/2019	RAN2#107bis	R2-1914008				Captured agreements made before RAN2#107bis	0.1.0
02/2020	RAN2#109e	R2-2002113				Captured agreements made in RAN2#108	0.3.0
03/2020	RAN2#109e	R2-2002345				Captured agreements made in RAN2#109e	0.4.0
03/2020	RP-87	RP-200113				Version submitted for approval in RAN#87-e	1.0.0
03/2020	RP-87					Updated to Rel-16	16.0.0
07/2020	RP-88	RP-201179	0001	4	F	Miscellaneous corrections to 38.340 for IAB	16.1.0
09/2020	RP-89	RP-201923	0006	1	F	Miscellaneous corrections to 38.340 for IAB	16.2.0
	RP-89	RP-201923	0007	-	F	Corrections on flow control BAP control PDU	16.2.0
12/2020	RP-90	RP-202772	0009	1	F	Miscellaneous corrections to 38.340 for IAB	16.3.0
03/2021	RP-91	RP-210691	0012	1	F	Correction on the illustration of BAP entity	16.4.0
	RP-91	RP-210691	0014	1	F	Miscellaneous corrections to 38.340 for IAB	16.4.0
06/2021	RP-92	RP-211472	0015	2	F	Miscellaneous corrections on BAP transmitting operation and default routing	16.5.0
	RP-92	RP-211472	0018	1	F	Corrections to the handling of unknown, unforeseen, and erroneous protocol data	16.5.0
03/2022	RP-95	RP-220486	0020	2	B	Introduction of eIAB to TS 38.340	17.0.0

---

# History

<b>Document history</b>		
V17.0.0	May 2022	Publication