

ETSI TS 138 473 V15.8.0 (2020-01)



**5G;
NG-RAN;
F1 Application Protocol (F1AP)
(3GPP TS 38.473 version 15.8.0 Release 15)**



Reference

RTS/TSGR-0338473vf80

Keywords

5G

ETSI

650 Route des Lucioles
F-06921 Sophia Antipolis Cedex - FRANCE

Tel.: +33 4 92 94 42 00 Fax: +33 4 93 65 47 16

Siret N° 348 623 562 00017 - NAF 742 C
Association à but non lucratif enregistrée à la
Sous-Préfecture de Grasse (06) N° 7803/88

Important notice

The present document can be downloaded from:

<http://www.etsi.org/standards-search>

The present document may be made available in electronic versions and/or in print. The content of any electronic and/or print versions of the present document shall not be modified without the prior written authorization of ETSI. In case of any existing or perceived difference in contents between such versions and/or in print, the prevailing version of an ETSI deliverable is the one made publicly available in PDF format at www.etsi.org/deliver.

Users of the present document should be aware that the document may be subject to revision or change of status.

Information on the current status of this and other ETSI documents is available at

<https://portal.etsi.org/TB/ETSIDeliverableStatus.aspx>

If you find errors in the present document, please send your comment to one of the following services:

<https://portal.etsi.org/People/CommitteeSupportStaff.aspx>

Copyright Notification

No part may be reproduced or utilized in any form or by any means, electronic or mechanical, including photocopying and microfilm except as authorized by written permission of ETSI.

The content of the PDF version shall not be modified without the written authorization of ETSI.

The copyright and the foregoing restriction extend to reproduction in all media.

© ETSI 2020.

All rights reserved.

DECT™, **PLUGTESTS™**, **UMTS™** and the ETSI logo are trademarks of ETSI registered for the benefit of its Members.

3GPP™ and **LTE™** are trademarks of ETSI registered for the benefit of its Members and of the 3GPP Organizational Partners.

oneM2M™ logo is a trademark of ETSI registered for the benefit of its Members and of the oneM2M Partners.

GSM® and the GSM logo are trademarks registered and owned by the GSM Association.

Intellectual Property Rights

Essential patents

IPRs essential or potentially essential to normative deliverables may have been declared to ETSI. The information pertaining to these essential IPRs, if any, is publicly available for **ETSI members and non-members**, and can be found in ETSI SR 000 314: "*Intellectual Property Rights (IPRs); Essential, or potentially Essential, IPRs notified to ETSI in respect of ETSI standards*", which is available from the ETSI Secretariat. Latest updates are available on the ETSI Web server (<https://ipr.etsi.org/>).

Pursuant to the ETSI IPR Policy, no investigation, including IPR searches, has been carried out by ETSI. No guarantee can be given as to the existence of other IPRs not referenced in ETSI SR 000 314 (or the updates on the ETSI Web server) which are, or may be, or may become, essential to the present document.

Trademarks

The present document may include trademarks and/or tradenames which are asserted and/or registered by their owners. ETSI claims no ownership of these except for any which are indicated as being the property of ETSI, and conveys no right to use or reproduce any trademark and/or tradename. Mention of those trademarks in the present document does not constitute an endorsement by ETSI of products, services or organizations associated with those trademarks.

Legal Notice

This Technical Specification (TS) has been produced by ETSI 3rd Generation Partnership Project (3GPP).

The present document may refer to technical specifications or reports using their 3GPP identities. These shall be interpreted as being references to the corresponding ETSI deliverables.

The cross reference between 3GPP and ETSI identities can be found under <http://webapp.etsi.org/key/queryform.asp>.

Modal verbs terminology

In the present document "**shall**", "**shall not**", "**should**", "**should not**", "**may**", "**need not**", "**will**", "**will not**", "**can**" and "**cannot**" are to be interpreted as described in clause 3.2 of the [ETSI Drafting Rules](#) (Verbal forms for the expression of provisions).

"**must**" and "**must not**" are **NOT** allowed in ETSI deliverables except when used in direct citation.

Contents

| | |
|---|----|
| Intellectual Property Rights | 2 |
| Legal Notice | 2 |
| Modal verbs terminology..... | 2 |
| Foreword..... | 9 |
| 1 Scope | 10 |
| 2 References | 10 |
| 3 Definitions and abbreviations..... | 11 |
| 3.1 Definitions | 11 |
| 3.2 Abbreviations | 12 |
| 4 General | 12 |
| 4.1 Procedure specification principles..... | 12 |
| 4.2 Forwards and backwards compatibility..... | 13 |
| 4.3 Specification notations | 13 |
| 5 F1AP services..... | 13 |
| 6 Services expected from signalling transport..... | 14 |
| 7 Functions of F1AP | 14 |
| 8 F1AP procedures | 14 |
| 8.1 List of F1AP Elementary procedures | 14 |
| 8.2 Interface Management procedures | 15 |
| 8.2.1 Reset | 15 |
| 8.2.1.1 General | 15 |
| 8.2.1.2 Successful Operation..... | 15 |
| 8.2.1.2.1 Reset Procedure Initiated from the gNB-CU | 15 |
| 8.2.1.2.2 Reset Procedure Initiated from the gNB-DU..... | 16 |
| 8.2.1.3 Abnormal Conditions | 17 |
| 8.2.2 Error Indication..... | 17 |
| 8.2.2.1 General | 17 |
| 8.2.2.2 Successful Operation..... | 17 |
| 8.2.2.3 Abnormal Conditions | 18 |
| 8.2.3 F1 Setup | 18 |
| 8.2.3.1 General | 18 |
| 8.2.3.2 Successful Operation..... | 18 |
| 8.2.3.3 Unsuccessful Operation | 19 |
| 8.2.3.4 Abnormal Conditions | 19 |
| 8.2.4 gNB-DU Configuration Update..... | 19 |
| 8.2.4.1 General | 19 |
| 8.2.4.2 Successful Operation..... | 20 |
| 8.2.4.3 Unsuccessful Operation | 21 |
| 8.2.4.4 Abnormal Conditions | 21 |
| 8.2.5 gNB-CU Configuration Update | 21 |
| 8.2.5.1 General | 21 |
| 8.2.5.2 Successful Operation..... | 22 |
| 8.2.5.3 Unsuccessful Operation | 23 |
| 8.2.5.4 Abnormal Conditions | 23 |
| 8.2.6 gNB-DU Resource Coordination..... | 23 |
| 8.2.6.1 General | 23 |
| 8.2.6.2 Successful Operation..... | 24 |
| 8.2.7 gNB-DU Status Indication..... | 24 |
| 8.2.7.1 General | 24 |
| 8.2.7.2 Successful Operation..... | 24 |
| 8.2.7.3 Abnormal Conditions | 24 |

| | | |
|----------|--|----|
| 8.2.8 | FI Removal..... | 25 |
| 8.2.8.1 | General | 25 |
| 8.2.8.2 | Successful Operation..... | 25 |
| 8.2.8.3 | Unsuccessful Operation | 26 |
| 8.2.8.4 | Abnormal Conditions | 26 |
| 8.2.9 | Network Access Rate Reduction | 26 |
| 8.2.9.1 | General | 26 |
| 8.2.9.2 | Successful operation..... | 27 |
| 8.2.9.3 | Abnormal Conditions | 27 |
| 8.3 | UE Context Management procedures..... | 27 |
| 8.3.1 | UE Context Setup | 27 |
| 8.3.1.1 | General | 27 |
| 8.3.1.2 | Successful Operation..... | 27 |
| 8.3.1.3 | Unsuccessful Operation | 30 |
| 8.3.1.4 | Abnormal Conditions | 30 |
| 8.3.2 | UE Context Release Request (gNB-DU initiated) | 31 |
| 8.3.2.1 | General | 31 |
| 8.3.2.2 | Successful Operation..... | 31 |
| 8.3.2.3 | Abnormal Conditions | 31 |
| 8.3.3 | UE Context Release (gNB-CU initiated) | 31 |
| 8.3.3.1 | General | 31 |
| 8.3.3.2 | Successful Operation..... | 32 |
| 8.3.3.4 | Abnormal Conditions | 32 |
| 8.3.4 | UE Context Modification (gNB-CU initiated)..... | 32 |
| 8.3.4.1 | General | 32 |
| 8.3.4.2 | Successful Operation..... | 33 |
| 8.3.4.3 | Unsuccessful Operation | 37 |
| 8.3.4.4 | Abnormal Conditions | 37 |
| 8.3.5 | UE Context Modification Required (gNB-DU initiated)..... | 37 |
| 8.3.5.1 | General | 37 |
| 8.3.5.2 | Successful Operation..... | 38 |
| 8.3.5.2A | Unsuccessful Operation | 39 |
| 8.3.5.3 | Abnormal Conditions | 39 |
| 8.3.6 | UE Inactivity Notification | 39 |
| 8.3.6.1 | General | 39 |
| 8.3.6.2 | Successful Operation..... | 39 |
| 8.3.6.3 | Abnormal Conditions | 39 |
| 8.3.7 | Notify..... | 40 |
| 8.3.7.1 | General | 40 |
| 8.3.7.2 | Successful Operation..... | 40 |
| 8.3.7.3 | Abnormal Conditions | 40 |
| 8.4 | RRC Message Transfer procedures | 40 |
| 8.4.1 | Initial UL RRC Message Transfer | 40 |
| 8.4.1.1 | General | 40 |
| 8.4.1.2 | Successful operation..... | 41 |
| 8.4.1.3 | Abnormal Conditions | 41 |
| 8.4.2 | DL RRC Message Transfer..... | 41 |
| 8.4.2.1 | General | 41 |
| 8.4.2.2 | Successful operation..... | 41 |
| 8.4.2.3 | Abnormal Conditions | 42 |
| 8.4.3 | UL RRC Message Transfer..... | 42 |
| 8.4.3.1 | General | 42 |
| 8.4.3.2 | Successful operation..... | 42 |
| 8.4.3.3 | Abnormal Conditions | 43 |
| 8.4.4 | RRC Delivery Report..... | 43 |
| 8.4.4.1 | General | 43 |
| 8.4.4.2 | Successful operation..... | 43 |
| 8.4.4.3 | Abnormal Conditions | 43 |
| 8.5 | Warning Message Transmission Procedures | 43 |
| 8.5.1 | Write-Replace Warning | 43 |
| 8.5.1.1 | General | 43 |
| 8.5.1.2 | Successful Operation..... | 44 |

| | | |
|-----------|---|----|
| 8.5.1.3 | Unsuccessful Operation | 44 |
| 8.5.1.4 | Abnormal Conditions | 44 |
| 8.5.2 | PWS Cancel | 44 |
| 8.5.2.1 | General | 44 |
| 8.5.2.2 | Successful Operation..... | 45 |
| 8.5.1.3 | Unsuccessful Operation | 45 |
| 8.5.3 | PWS Restart Indication..... | 45 |
| 8.5.3.1 | General | 45 |
| 8.5.3.2 | Successful Operation..... | 46 |
| 8.5.3.3 | Abnormal Conditions | 46 |
| 8.5.4 | PWS Failure Indication..... | 46 |
| 8.5.4.1 | General | 46 |
| 8.5.4.2 | Successful Operation..... | 46 |
| 8.5.4.3 | Abnormal Conditions | 46 |
| 8.6 | System Information Procedures | 47 |
| 8.6.1 | System Information Delivery..... | 47 |
| 8.6.1.1 | General | 47 |
| 8.6.1.2 | Successful Operation..... | 47 |
| 8.6.1.3 | Abnormal Conditions | 47 |
| 8.7 | Paging procedures | 47 |
| 8.7.1 | Paging | 47 |
| 8.7.1.1 | General | 47 |
| 8.7.1.2 | Successful Operation..... | 48 |
| 8.7.1.3 | Abnormal Conditions | 48 |
| 9 | Elements for F1AP Communication | 48 |
| 9.1 | General | 48 |
| 9.2 | Message Functional Definition and Content | 49 |
| 9.2.1 | Interface Management messages | 49 |
| 9.2.1.1 | RESET | 49 |
| 9.2.1.2 | RESET ACKNOWLEDGE | 49 |
| 9.2.1.3 | ERROR INDICATION | 50 |
| 9.2.1.4 | F1 SETUP REQUEST | 50 |
| 9.2.1.5 | F1 SETUP RESPONSE | 51 |
| 9.2.1.6 | F1 SETUP FAILURE | 51 |
| 9.2.1.7 | GNB-DU CONFIGURATION UPDATE..... | 51 |
| 9.2.1.8 | GNB-DU CONFIGURATION UPDATE ACKNOWLEDGE..... | 53 |
| 9.2.1.9 | GNB-DU CONFIGURATION UPDATE FAILURE | 54 |
| 9.2.1.10 | GNB-CU CONFIGURATION UPDATE | 54 |
| 9.2.1.11 | GNB-CU CONFIGURATION UPDATE ACKNOWLEDGE | 57 |
| 9.2.1.12 | GNB-CU CONFIGURATION UPDATE FAILURE | 58 |
| 9.2.1.13 | GNB-DU RESOURCE COORDINATION REQUEST | 59 |
| 9.2.1.14 | GNB-DU RESOURCE COORDINATION RESPONSE | 59 |
| 9.2.1.15 | GNB-DU STATUS INDICATION..... | 60 |
| 9.2.1.16 | F1 REMOVAL REQUEST..... | 60 |
| 9.2.1.17 | F1 REMOVAL RESPONSE..... | 60 |
| 9.2.1.18 | F1 REMOVAL FAILURE..... | 60 |
| 9.2.1.19 | NETWORK ACCESS RATE REDUCTION | 60 |
| 9.2.2 | UE Context Management messages..... | 61 |
| 9.2.2.1 | UE CONTEXT SETUP REQUEST..... | 61 |
| 9.2.2.2 | UE CONTEXT SETUP RESPONSE..... | 64 |
| 9.2.2.3 | UE CONTEXT SETUP FAILURE..... | 66 |
| 9.2.2.4 | UE CONTEXT RELEASE REQUEST | 67 |
| 9.2.2.5 | UE CONTEXT RELEASE COMMAND | 67 |
| 9.2.2.6 | UE CONTEXT RELEASE COMPLETE | 67 |
| 9.2.2.7 | UE CONTEXT MODIFICATION REQUEST..... | 68 |
| 9.2.2.8 | UE CONTEXT MODIFICATION RESPONSE..... | 73 |
| 9.2.2.9 | UE CONTEXT MODIFICATION FAILURE..... | 76 |
| 9.2.2.10 | UE CONTEXT MODIFICATION REQUIRED..... | 76 |
| 9.2.2.11 | UE CONTEXT MODIFICATION CONFIRM | 78 |
| 9.2.2.11A | UE CONTEXT MODIFICATION REFUSE..... | 79 |
| 9.2.2.12 | UE INACTIVITY NOTIFICATION | 80 |

| | | |
|-----------|--|-----|
| 9.2.2.13 | NOTIFY | 80 |
| 9.2.3 | RRC Message Transfer messages | 81 |
| 9.2.3.1 | INITIAL UL RRC MESSAGE TRANSFER | 81 |
| 9.2.3.2 | DL RRC MESSAGE TRANSFER | 82 |
| 9.2.3.3 | UL RRC MESSAGE TRANSFER | 83 |
| 9.2.3.4 | RRC DELIVERY REPORT | 84 |
| 9.2.4 | Warning Message Transmission Messages..... | 84 |
| 9.2.4.1 | WRITE-REPLACE WARNING REQUEST | 84 |
| 9.2.4.2 | WRITE-REPLACE WARNING RESPONSE | 84 |
| 9.2.4.3 | PWS CANCEL REQUEST..... | 85 |
| 9.2.4.4 | PWS CANCEL RESPONSE..... | 86 |
| 9.2.4.5 | PWS RESTART INDICATION | 87 |
| 9.2.4.6 | PWS FAILURE INDICATION | 87 |
| 9.2.5 | System Information messages..... | 88 |
| 9.2.5.1 | SYSTEM INFORMATION DELIVERY COMMAND | 88 |
| 9.2.6 | Paging messages | 88 |
| 9.2.6.1 | PAGING | 88 |
| 9.3 | Information Element Definitions..... | 89 |
| 9.3.1 | Radio Network Layer Related IEs | 89 |
| 9.3.1.1 | Message Type | 89 |
| 9.3.1.2 | Cause..... | 89 |
| 9.3.1.3 | Criticality Diagnostics..... | 92 |
| 9.3.1.4 | gNB-CU UE F1AP ID | 92 |
| 9.3.1.5 | gNB-DU UE F1AP ID | 93 |
| 9.3.1.6 | RRC-Container..... | 93 |
| 9.3.1.7 | SRB ID | 93 |
| 9.3.1.8 | DRB ID | 93 |
| 9.3.1.9 | gNB-DU ID..... | 93 |
| 9.3.1.10 | Served Cell Information | 93 |
| 9.3.1.11 | Transmission Action Indicator | 95 |
| 9.3.1.12 | NR CGI | 95 |
| 9.3.1.13 | Time To wait..... | 95 |
| 9.3.1.14 | PLMN Identity | 96 |
| 9.3.1.15 | Transmission Bandwidth..... | 96 |
| 9.3.1.16 | Void..... | 96 |
| 9.3.1.17 | NR Frequency Info..... | 96 |
| 9.3.1.18 | gNB-DU System Information | 97 |
| 9.3.1.19 | E-UTRAN QoS | 97 |
| 9.3.1.20 | Allocation and Retention Priority | 98 |
| 9.3.1.21 | GBR QoS Information | 98 |
| 9.3.1.22 | Bit Rate | 99 |
| 9.3.1.23 | Transaction ID..... | 99 |
| 9.3.1.24 | DRX Cycle..... | 99 |
| 9.3.1.25 | CU to DU RRC Information | 100 |
| 9.3.1.26 | DU to CU RRC Information | 101 |
| 9.3.1.27 | RLC Mode..... | 103 |
| 9.3.1.28 | SUL Information | 103 |
| 9.3.1.29 | 5GS TAC | 103 |
| 9.3.1.29a | Configured EPS TAC..... | 104 |
| 9.3.1.30 | RRC Reconfiguration Complete Indicator | 104 |
| 9.3.1.31 | UL Configuration..... | 104 |
| 9.3.1.32 | C-RNTI | 104 |
| 9.3.1.33 | Cell UL Configured..... | 104 |
| 9.3.1.34 | RAT-Frequency Priority Information | 105 |
| 9.3.1.35 | LCID | 105 |
| 9.3.1.36 | Duplication activation | 105 |
| 9.3.1.37 | Slice Support List..... | 105 |
| 9.3.1.38 | S-NSSAI | 105 |
| 9.3.1.39 | UE Identity Index value | 106 |
| 9.3.1.40 | Paging DRX | 106 |
| 9.3.1.41 | Paging Priority | 106 |
| 9.3.1.42 | gNB-CU System Information..... | 106 |

| | | |
|----------|---|-----|
| 9.3.1.43 | RAN UE Paging identity | 107 |
| 9.3.1.44 | CN UE Paging Identity | 107 |
| 9.3.1.45 | QoS Flow Level QoS Parameters..... | 107 |
| 9.3.1.46 | GBR QoS Flow Information | 108 |
| 9.3.1.47 | Dynamic 5QI Descriptor | 108 |
| 9.3.1.48 | NG-RAN Allocation and Retention Priority | 109 |
| 9.3.1.49 | Non Dynamic 5QI Descriptor | 110 |
| 9.3.1.50 | Maximum Packet Loss Rate..... | 111 |
| 9.3.1.51 | Packet Delay Budget..... | 111 |
| 9.3.1.52 | Packet Error Rate | 111 |
| 9.3.1.53 | Averaging Window | 111 |
| 9.3.1.54 | Maximum Data Burst Volume | 112 |
| 9.3.1.55 | Masked IMEISV | 112 |
| 9.3.1.56 | Notification Control | 112 |
| 9.3.1.57 | RAN Area Code | 112 |
| 9.3.1.58 | PWS System Information..... | 112 |
| 9.3.1.59 | Repetition Period..... | 113 |
| 9.3.1.60 | Number of Broadcasts Requested | 113 |
| 9.3.1.61 | Void..... | 113 |
| 9.3.1.62 | SIType List..... | 113 |
| 9.3.1.63 | QoS Flow Identifier..... | 114 |
| 9.3.1.64 | Served E-UTRA Cell Information | 114 |
| 9.3.1.65 | Available PLMN List..... | 114 |
| 9.3.1.66 | RLC Failure Indication | 114 |
| 9.3.1.67 | Uplink TxDirectCurrentList Information | 114 |
| 9.3.1.68 | Service Status | 115 |
| 9.3.1.69 | RLC Status | 115 |
| 9.3.1.70 | RRC Version..... | 115 |
| 9.3.1.71 | RRC Delivery Status | 115 |
| 9.3.1.72 | QoS Flow Mapping Indication | 116 |
| 9.3.1.73 | Resource Coordination Transfer Information | 116 |
| 9.3.1.74 | E-UTRA PRACH Configuration | 116 |
| 9.3.1.75 | Resource Coordination E-UTRA Cell Information..... | 116 |
| 9.3.1.76 | Extended Available PLMN List..... | 118 |
| 9.3.1.77 | Associated SCell List | 118 |
| 9.3.1.78 | Cell Direction..... | 118 |
| 9.3.1.79 | Paging Origin | 118 |
| 9.3.1.80 | E-UTRA Transmission Bandwidth | 118 |
| 9.3.1.81 | Message Identifier..... | 119 |
| 9.3.1.82 | Serial Number | 119 |
| 9.3.1.83 | UAC Assistance Information | 120 |
| 9.3.1.84 | UAC Action | 120 |
| 9.3.1.85 | UAC reduction Indication | 121 |
| 9.3.1.86 | Additional SIB Message List | 121 |
| 9.3.1.87 | Cell Type..... | 121 |
| 9.3.2 | Transport Network Layer Related IEs | 121 |
| 9.3.2.1 | UP Transport Layer Information..... | 121 |
| 9.3.2.2 | GTP-TEID..... | 122 |
| 9.3.2.3 | Transport Layer Address..... | 122 |
| 9.3.2.4 | CP Transport Layer Information | 122 |
| 9.4 | Message and Information Element Abstract Syntax (with ASN.1)..... | 122 |
| 9.4.1 | General..... | 122 |
| 9.4.2 | Usage of private message mechanism for non-standard use..... | 123 |
| 9.4.3 | Elementary Procedure Definitions | 124 |
| 9.4.4 | PDU Definitions | 131 |
| 9.4.5 | Information Element Definitions | 167 |
| 9.4.6 | Common Definitions..... | 207 |
| 9.4.7 | Constant Definitions | 207 |
| 9.4.8 | Container Definitions..... | 214 |
| 9.5 | Message Transfer Syntax | 218 |
| 9.6 | Timers | 218 |

10 Handling of unknown, unforeseen and erroneous protocol data218

Annex A (informative): Change History219

History223

Foreword

This Technical Specification has been produced by the 3rd Generation Partnership Project (3GPP).

The contents of the present document are subject to continuing work within the TSG and may change following formal TSG approval. Should the TSG modify the contents of the present document, it will be re-released by the TSG with an identifying change of release date and an increase in version number as follows:

Version x.y.z

where:

- x the first digit:
 - 1 presented to TSG for information;
 - 2 presented to TSG for approval;
 - 3 or greater indicates TSG approved document under change control.
- y the second digit is incremented for all changes of substance, i.e. technical enhancements, corrections, updates, etc.
- z the third digit is incremented when editorial only changes have been incorporated in the document.

1 Scope

The present document specifies the 5G radio network layer signalling protocol for the F1 interface. The F1 interface provides means for interconnecting a gNB-CU and a gNB-DU of a gNB within an NG-RAN, or for interconnecting a gNB-CU and a gNB-DU of an en-gNB within an E-UTRAN. The F1 Application Protocol (F1AP) supports the functions of F1 interface by signalling procedures defined in the present document. F1AP is developed in accordance to the general principles stated in TS 38.401 [4] and TS 38.470 [2].

2 References

The following documents contain provisions which, through reference in this text, constitute provisions of the present document.

- References are either specific (identified by date of publication, edition number, version number, etc.) or non-specific.
- For a specific reference, subsequent revisions do not apply.
- For a non-specific reference, the latest version applies. In the case of a reference to a 3GPP document (including a GSM document), a non-specific reference implicitly refers to the latest version of that document *in the same Release as the present document*.

- [1] 3GPP TR 21.905: "Vocabulary for 3GPP Specifications".
- [2] 3GPP TS 38.470: "NG-RAN; F1 general aspects and principles".
- [3] 3GPP TS 38.413: "NG-RAN; NG Application Protocol (NGAP)".
- [4] 3GPP TS 38.401: "NG-RAN; Architecture Description".
- [5] ITU-T Recommendation X.691 (2002-07): "Information technology - ASN.1 encoding rules - Specification of Packed Encoding Rules (PER)".
- [6] 3GPP TS 38.300: "NR; Overall description; Stage-2".
- [7] 3GPP TS 37.340: "NR; Multi-connectivity; Overall description; Stage-2".
- [8] 3GPP TS 38.331: "NR; Radio Resource Control (RRC); Protocol specification".
- [9] 3GPP TS 36.423: "Evolved Universal Terrestrial Radio Access Network (E-UTRAN); X2 Application Protocol (X2AP)".
- [10] 3GPP TS 23.401: "General Packet Radio Service (GPRS) enhancements for Evolved Universal Terrestrial Radio Access Network (E-UTRAN) access".
- [11] 3GPP TS 23.203: "Policy and charging control architecture".
- [12] ITU-T Recommendation X.680 (07/2002): "Information technology – Abstract Syntax Notation One (ASN.1): Specification of basic notation".
- [13] ITU-T Recommendation X.681 (07/2002): "Information technology – Abstract Syntax Notation One (ASN.1): Information object specification".
- [14] 3GPP TR 25.921: (version.7.0.0): "Guidelines and principles for protocol description and error".
- [15] 3GPP TS 36.413: "Evolved Universal Terrestrial Radio Access Network (E-UTRAN); S1 Application Protocol (S1AP)".
- [16] 3GPP TS 38.321: "NR; Medium Access Control (MAC) protocol specification".
- [17] 3GPP TS 38.104: "NR; Base Station (BS) radio transmission and reception".

- [18] 3GPP TS 29.281: "General Packet Radio System (GPRS); Tunnelling Protocol User Plane (GTPv1-U) ".
- [19] 3GPP TS 38.414: "NG-RAN; NG data transport".
- [20] 3GPP TS 36.300: "Evolved Universal Terrestrial Radio Access (E-UTRA) and Evolved Universal Terrestrial Radio Access Network (E-UTRAN); Overall description; Stage 2".
- [21] 3GPP TS 23.501: "System Architecture for the 5G System".
- [22] 3GPP TS 38.472: "NG-RAN; F1 signalling transport".
- [23] 3GPP TS 23.003: "Numbering, addressing and identification".
- [24] 3GPP TS 38.304: "NR; User Equipment (UE) procedures in Idle mode and RRC Inactive state ".
- [25] 3GPP TS 36.104: "Base Station (BS) radio transmission and reception".
- [26] 3GPP TS 38.101-1: "NR; User Equipment (UE) radio transmission and reception; Part 1: Range 1 Standalone".
- [27] 3GPP TS 36.211: "Evolved Universal Terrestrial Radio Access (E-UTRA); Physical channels and modulation".
- [28] 3GPP TS 38.423: "NG-RAN; Xn application protocol (XnAP)".

3 Definitions and abbreviations

3.1 Definitions

elementary procedure: F1AP consists of Elementary Procedures (EPs). An Elementary Procedure is a unit of interaction between gNB-CU and gNB-DU. These Elementary Procedures are defined separately and are intended to be used to build up complete sequences in a flexible manner. If the independence between some EPs is restricted, it is described under the relevant EP description. Unless otherwise stated by the restrictions, the EPs may be invoked independently of each other as standalone procedures, which can be active in parallel. The usage of several F1AP EPs together is specified in stage 2 specifications (e.g., TS 38.470 [2]).

An EP consists of an initiating message and possibly a response message. Two kinds of EPs are used:

- **Class 1:** Elementary Procedures with response (success and/or failure).
- **Class 2:** Elementary Procedures without response.

For Class 1 EPs, the types of responses can be as follows:

Successful:

- A signalling message explicitly indicates that the elementary procedure successfully completed with the receipt of the response.

Unsuccessful:

- A signalling message explicitly indicates that the EP failed.
- On time supervision expiry (i.e., absence of expected response).

Successful and Unsuccessful:

- One signalling message reports both successful and unsuccessful outcome for the different included requests. The response message used is the one defined for successful outcome.

Class 2 EPs are considered always successful.

EN-DC operation: Used in this specification when the F1AP is applied for gNB-CU and gNB-DU in E-UTRAN.

gNB: as defined in TS 38.300 [6].

gNB-CU: as defined in TS 38.401 [4].

gNB-CU UE F1AP ID: as defined in TS 38.401 [4].

gNB-DU: as defined in TS 38.401 [4].

gNB-DU UE F1AP ID: as defined in TS 38.401 [4].

en-gNB: as defined in TS 37.340 [7].

UE-associated signalling: When F1AP messages associated to one UE uses the UE-associated logical F1-connection for association of the message to the UE in gNB-DU and gNB-CU.

UE-associated logical F1-connection: The UE-associated logical F1-connection uses the identities *GNB-CU UE F1AP ID* and *GNB-DU UE F1AP ID* according to the definition in TS 38.401 [4]. For a received UE associated F1AP message the gNB-CU identifies the associated UE based on the *GNB-CU UE F1AP ID* IE and the gNB-DU identifies the associated UE based on the *GNB-DU UE F1AP ID* IE. The UE-associated logical F1-connection may exist before the F1 UE context is setup in gNB-DU.

3.2 Abbreviations

For the purposes of the present document, the abbreviations given in TR 21.905 [1] and the following apply. An abbreviation defined in the present document takes precedence over the definition of the same abbreviation, if any, in TR 21.905 [1].

| | |
|---------|---|
| 5GC | 5G Core Network |
| 5QI | 5G QoS Identifier |
| AMF | Access and Mobility Management Function |
| CN | Core Network |
| CG | Cell Group |
| CGI | Cell Global Identifier |
| CP | Control Plane |
| DL | Downlink |
| EN-DC | E-UTRA-NR Dual Connectivity |
| EPC | Evolved Packet Core |
| IMEISV | International Mobile station Equipment Identity and Software Version number |
| NSSAI | Network Slice Selection Assistance Information |
| RANAC | RAN Area Code |
| RRC | Radio Resource Control |
| S-NSSAI | Single Network Slice Selection Assistance Information |
| SUL | Supplementary Uplink |
| TAC | Tracking Area Code |
| TAI | Tracking Area Identity |

4 General

4.1 Procedure specification principles

The principle for specifying the procedure logic is to specify the functional behaviour of the terminating node exactly and completely. Any rule that specifies the behaviour of the originating node shall be possible to be verified with information that is visible within the system.

The following specification principles have been applied for the procedure text in clause 8:

- The procedure text discriminates between:
 - 1) Functionality which "shall" be executed.

The procedure text indicates that the receiving node "shall" perform a certain function Y under a certain condition. If the receiving node supports procedure X but cannot perform functionality Y requested in the REQUEST message of a Class 1 EP, the receiving node shall respond with the message used to report unsuccessful outcome for this procedure, containing an appropriate cause value.

- 2) Functionality which "shall, if supported" be executed.

The procedure text indicates that the receiving node "shall, if supported," perform a certain function Y under a certain condition. If the receiving node supports procedure X, but does not support functionality Y, the receiving node shall proceed with the execution of the EP, possibly informing the requesting node about the not supported functionality.

- Any required inclusion of an optional IE in a response message is explicitly indicated in the procedure text. If the procedure text does not explicitly indicate that an optional IE shall be included in a response message, the optional IE shall not be included. For requirements on including *Criticality Diagnostics* IE, see clause 10.

4.2 Forwards and backwards compatibility

The forwards and backwards compatibility of the protocol is assured by mechanism where all current and future messages, and IEs or groups of related IEs, include ID and criticality fields that are coded in a standard format that will not be changed in the future. These parts can always be decoded regardless of the standard version.

4.3 Specification notations

For the purposes of the present document, the following notations apply:

| | |
|----------------|---|
| Procedure | When referring to an elementary procedure in the specification the Procedure Name is written with the first letters in each word in upper case characters followed by the word "procedure", e.g. Handover Preparation procedure. |
| Message | When referring to a message in the specification the MESSAGE NAME is written with all letters in upper case characters followed by the word "message", e.g. HANDOVER REQUEST message. |
| IE | When referring to an information element (IE) in the specification the <i>Information Element Name</i> is written with the first letters in each word in upper case characters and all letters in Italic font followed by the abbreviation "IE", e.g. <i>E-RAB ID</i> IE. |
| Value of an IE | When referring to the value of an information element (IE) in the specification the "Value" is written as it is specified in the specification enclosed by quotation marks, e.g. "Value". |

5 F1AP services

F1AP provides the signalling service between gNB-DU and the gNB-CU that is required to fulfil the F1AP functions described in clause 7. F1AP services are divided into two groups:

- Non UE-associated services: They are related to the whole F1 interface instance between the gNB-DU and gNB-CU utilising a non UE-associated signalling connection.
- UE-associated services: They are related to one UE. F1AP functions that provide these services are associated with a UE-associated signalling connection that is maintained for the UE in question.

Unless explicitly indicated in the procedure specification, at any instance in time one protocol endpoint shall have a maximum of one ongoing F1AP procedure related to a certain UE.

6 Services expected from signalling transport

The signalling connection shall provide in sequence delivery of F1AP messages. F1AP shall be notified if the signalling connection breaks.

7 Functions of F1AP

The functions of F1AP are described in TS 38.470 [2].

8 F1AP procedures

8.1 List of F1AP Elementary procedures

In the following tables, all EPs are divided into Class 1 and Class 2 EPs (see subclause 3.1 for explanation of the different classes):

Table 1: Class 1 procedures

| Elementary Procedure | Initiating Message | Successful Outcome | Unsuccessful Outcome |
|---|--------------------------------------|---|-------------------------------------|
| | | Response message | Response message |
| Reset | RESET | RESET ACKNOWLEDGE | |
| F1 Setup | F1 SETUP REQUEST | F1 SETUP RESPONSE | F1 SETUP FAILURE |
| gNB-DU Configuration Update | GNB-DU CONFIGURATION UPDATE | GNB-DU CONFIGURATION UPDATE ACKNOWLEDGE | GNB-DU CONFIGURATION UPDATE FAILURE |
| gNB-CU Configuration Update | GNB-CU CONFIGURATION UPDATE | GNB-CU CONFIGURATION UPDATE ACKNOWLEDGE | GNB-CU CONFIGURATION UPDATE FAILURE |
| UE Context Setup | UE CONTEXT SETUP REQUEST | UE CONTEXT SETUP RESPONSE | UE CONTEXT SETUP FAILURE |
| UE Context Release (gNB-CU initiated) | UE CONTEXT RELEASE COMMAND | UE CONTEXT RELEASE COMPLETE | |
| UE Context Modification (gNB-CU initiated) | UE CONTEXT MODIFICATION REQUEST | UE CONTEXT MODIFICATION RESPONSE | UE CONTEXT MODIFICATION FAILURE |
| UE Context Modification Required (gNB-DU initiated) | UE CONTEXT MODIFICATION REQUIRED | UE CONTEXT MODIFICATION CONFIRM | UE CONTEXT MODIFICATION REFUSE |
| Write-Replace Warning | WRITE-REPLACE WARNING REQUEST | WRITE-REPLACE WARNING RESPONSE | |
| PWS Cancel | PWS CANCEL REQUEST | PWS CANCEL RESPONSE | |
| GNB-DU RESOURCE COORDINATION | GNB-DU RESOURCE COORDINATION REQUEST | GNB-DU RESOURCE COORDINATION RESPONSE | |

Table 2: Class 2 procedures

| Elementary Procedure | Message |
|---|-------------------------------------|
| Error Indication | ERROR INDICATION |
| UE Context Release Request (gNB-DU initiated) | UE CONTEXT RELEASE REQUEST |
| Initial UL RRC Message Transfer | INITIAL UL RRC MESSAGE TRANSFER |
| DL RRC Message Transfer | DL RRC MESSAGE TRANSFER |
| UL RRC Message Transfer | UL RRC MESSAGE TRANSFER |
| UE Inactivity Notification | UE INACTIVITY NOTIFICATION |
| System Information Delivery | SYSTEM INFORMATION DELIVERY COMMAND |
| Paging | PAGING |
| Notify | NOTIFY |
| PWS Restart Indication | PWS RESTART INDICATION |
| PWS Failure Indication | PWS FAILURE INDICATION |
| gNB-DU Status Indication | GNB-DU STATUS INDICATION |
| RRC Delivery Report | RRC DELIVERY REPORT |
| Network Access Rate Reduction | NETWORK ACCESS RATE REDUCTION |

8.2 Interface Management procedures

8.2.1 Reset

8.2.1.1 General

The purpose of the Reset procedure is to initialise or re-initialise the F1AP UE-related contexts, in the event of a failure in the gNB-CU or gNB-DU. This procedure does not affect the application level configuration data exchanged during, e.g., the F1 Setup procedure.

The procedure uses non-UE associated signalling.

8.2.1.2 Successful Operation

8.2.1.2.1 Reset Procedure Initiated from the gNB-CU

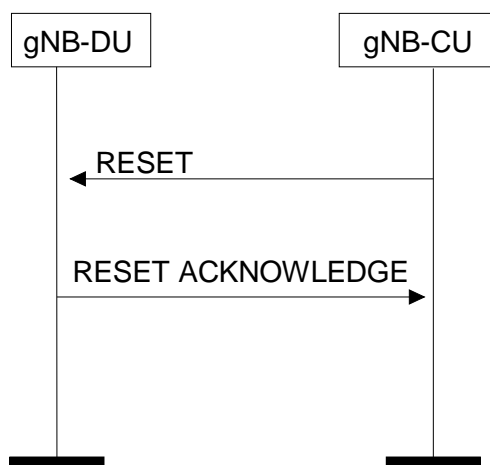

Figure 8.2.1.2.1-1: Reset procedure initiated from the gNB-CU. Successful operation

In the event of a failure at the gNB-CU, which has resulted in the loss of some or all transaction reference information, a RESET message shall be sent to the gNB-DU.

At reception of the RESET message the gNB-DU shall release all allocated resources on F1 and radio resources related to the UE association(s) indicated explicitly or implicitly in the RESET message and remove the indicated UE contexts including F1AP ID.

After the gNB-DU has released all assigned F1 resources and the UE F1AP IDs for all indicated UE associations which can be used for new UE-associated logical F1-connections over the F1 interface, the gNB-DU shall respond with the RESET ACKNOWLEDGE message. The gNB-DU does not need to wait for the release of radio resources to be completed before returning the RESET ACKNOWLEDGE message.

If the RESET message contains the *UE-associated logical F1-connection list* IE, then:

- The gNB-DU shall use the *gNB-CU UE F1AP ID* IE and/or the *gNB-DU UE F1AP ID* IE to explicitly identify the UE association(s) to be reset.
- The gNB-DU shall include in the RESET ACKNOWLEDGE message, for each UE association to be reset, the *UE-associated logical F1-connection Item* IE in the *UE-associated logical F1-connection list* IE. The *UE-associated logical F1-connection Item* IEs shall be in the same order as received in the RESET message and shall include also unknown UE-associated logical F1-connections. Empty *UE-associated logical F1-connection Item* IEs, received in the RESET message, may be omitted in the RESET ACKNOWLEDGE message.
- If the *gNB-CU UE F1AP ID* IE is included in the *UE-associated logical F1-connection Item* IE for a UE association, the gNB-DU shall include the *gNB-CU UE F1AP ID* IE in the corresponding *UE-associated logical F1-connection Item* IE in the RESET ACKNOWLEDGE message.
- If the *gNB-DU UE F1AP ID* IE is included in the *UE-associated logical F1-connection Item* IE for a UE association, the gNB-DU shall include the *gNB-DU UE F1AP ID* IE in the corresponding *UE-associated logical F1-connection Item* IE in the RESET ACKNOWLEDGE message.

Interactions with other procedures:

If the RESET message is received, any other ongoing procedure (except for another Reset procedure) on the same F1 interface related to a UE association, indicated explicitly or implicitly in the RESET message, shall be aborted.

8.2.1.2.2 Reset Procedure Initiated from the gNB-DU

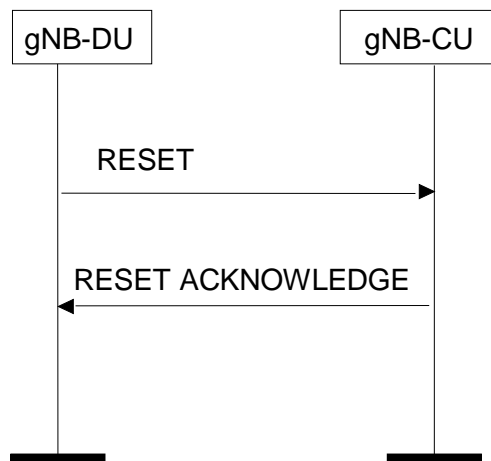

Figure 8.2.1.2.2-1: Reset procedure initiated from the gNB-DU. Successful operation

In the event of a failure at the gNB-DU, which has resulted in the loss of some or all transaction reference information, a RESET message shall be sent to the gNB-CU.

At reception of the RESET message the gNB-CU shall release all allocated resources on F1 related to the UE association(s) indicated explicitly or implicitly in the RESET message and remove the F1AP ID for the indicated UE associations.

After the gNB-CU has released all assigned F1 resources and the UE F1AP IDs for all indicated UE associations which can be used for new UE-associated logical F1-connections over the F1 interface, the gNB-CU shall respond with the RESET ACKNOWLEDGE message.

If the RESET message contains the *UE-associated logical F1-connection list* IE, then:

- The gNB-CU shall use the *gNB-CU UE FIAP ID* IE and/or the *gNB-DU UE FIAP ID* IE to explicitly identify the UE association(s) to be reset.
- The gNB-CU shall in the RESET ACKNOWLEDGE message include, for each UE association to be reset, the *UE-associated logical F1-connection Item* IE in the *UE-associated logical F1-connection list* IE. The *UE-associated logical F1-connection Item* IEs shall be in the same order as received in the RESET message and shall include also unknown UE-associated logical F1-connections. Empty *UE-associated logical F1-connection Item* IEs, received in the RESET message, may be omitted in the RESET ACKNOWLEDGE message.
- If the *gNB-CU UE FIAP ID* IE is included in the *UE-associated logical F1-connection Item* IE for a UE association, the gNB-CU shall include the *gNB-CU UE FIAP ID* IE in the corresponding *UE-associated logical F1-connection Item* IE in the RESET ACKNOWLEDGE message.
- If the *gNB-DU UE FIAP ID* IE is included in a *UE-associated logical F1-connection Item* IE for a UE association, the gNB-CU shall include the *gNB-DU UE FIAP ID* IE in the corresponding *UE-associated logical F1-connection Item* IE in the RESET ACKNOWLEDGE message.

Interactions with other procedures:

If the RESET message is received, any other ongoing procedure (except for another Reset procedure) on the same F1 interface related to a UE association, indicated explicitly or implicitly in the RESET message, shall be aborted.

8.2.1.3 Abnormal Conditions

Not applicable.

8.2.2 Error Indication

8.2.2.1 General

The Error Indication procedure is initiated by a node in order to report detected errors in one incoming message, provided they cannot be reported by an appropriate failure message.

If the error situation arises due to reception of a message utilising UE associated signalling, then the Error Indication procedure uses UE associated signalling. Otherwise the procedure uses non-UE associated signalling.

8.2.2.2 Successful Operation

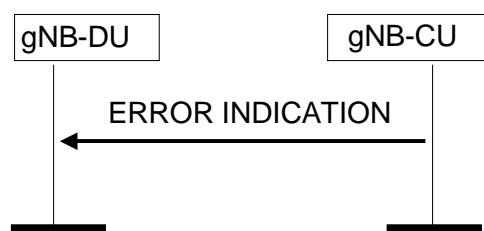

Figure 8.2.2.2-1: Error Indication procedure, gNB-CU originated. Successful operation

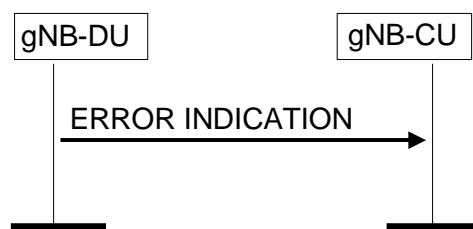

Figure 8.2.2.2-2: Error Indication procedure, gNB-DU originated. Successful operation

When the conditions defined in clause 10 are fulfilled, the Error Indication procedure is initiated by an ERROR INDICATION message sent from the receiving node.

The ERROR INDICATION message shall contain at least either the *Cause* IE or the *Criticality Diagnostics* IE. In case the Error Indication procedure is triggered by utilising UE associated signalling the *gNB-CU UE F1AP ID* IE and *gNB-DU UE F1AP ID* IE shall be included in the ERROR INDICATION message. If one or both of the *gNB-CU UE F1AP ID* IE and the *gNB-DU UE F1AP ID* IE are not correct, the cause shall be set to appropriate value, e.g., "Unknown or already allocated gNB-CU UE F1AP ID", "Unknown or already allocated gNB-DU UE F1AP ID" or "Unknown or inconsistent pair of UE F1AP ID".

8.2.2.3 Abnormal Conditions

Not applicable.

8.2.3 F1 Setup

8.2.3.1 General

The purpose of the F1 Setup procedure is to exchange application level data needed for the gNB-DU and the gNB-CU to correctly interoperate on the F1 interface. This procedure shall be the first F1AP procedure triggered for the F1-C interface instance after a TNL association has become operational.

NOTE: If F1-C signalling transport is shared among multiple F1-C interface instances, one F1 Setup procedure is issued per F1-C interface instance to be setup, i.e. several F1 Setup procedures may be issued via the same TNL association after that TNL association has become operational.

The procedure uses non-UE associated signalling.

This procedure erases any existing application level configuration data in the two nodes and replaces it by the one received. This procedure also re-initialises the F1AP UE-related contexts (if any) and erases all related signalling connections in the two nodes like a Reset procedure would do.

8.2.3.2 Successful Operation

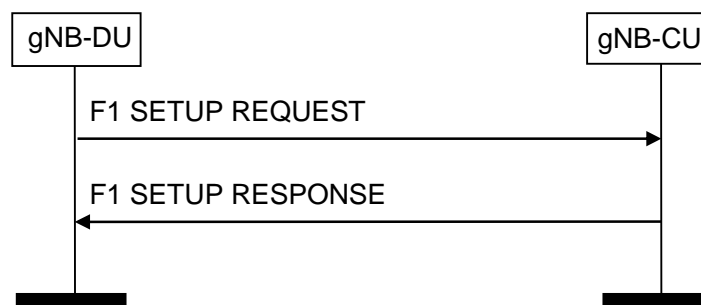

Figure 8.2.3.2-1: F1 Setup procedure: Successful Operation

The gNB-DU initiates the procedure by sending a F1 SETUP REQUEST message including the appropriate data to the gNB-CU. The gNB-CU responds with a F1 SETUP RESPONSE message including the appropriate data.

The exchanged data shall be stored in respective node and used as long as there is an operational TNL association. When this procedure is finished, the F1 interface is operational and other F1 messages may be exchanged.

If the F1 SETUP REQUEST message contains the *gNB-DU Name* IE, the gNB-CU may use this IE as a human readable name of the gNB-DU.

If the F1 SETUP REQUEST message contains the *gNB-DU Served Cells List* IE, the gNB-CU shall take into account as specified in TS 38.401 [4].

For NG-RAN, the gNB-DU shall include the *gNB-DU System Information* IE and the *TAI Slice Support List* IE.

The gNB-CU may include the *Cells to be Activated List* IE in the F1 SETUP RESPONSE message. The *Cells to be Activated List* IE includes a list of cells that the gNB-CU requests the gNB-DU to activate. The gNB-DU shall activate the cells included in the *Cells to be Activated List* IE and reconfigure the physical cell identity for cells for which the *NR PCI* IE is included.

For NG-RAN, the gNB-CU shall include the *gNB-CU System Information* IE in the F1 SETUP RESPONSE message.

For NG-RAN, the gNB-DU may include the *RAN Area Code* IE in the F1 SETUP REQUEST message. The gNB-CU may use it according to TS 38.300 [6].

For NG-RAN, the gNB-CU may include *Available PLMN List* IE, and optionally also *Extended Available PLMN List* IE, if the available PLMN(s) are different from what gNB-DU has provided in F1 SETUP REQUEST message, gNB-DU shall take this into account and only broadcast the PLMN(s) included in the received Available PLMN list(s).

The *Latest RRC Version Enhanced* IE shall be included in the F1 SETUP REQUEST message and in the F1 SETUP RESPONSE message.

If in F1 SETUP REQUEST message, the *Cell Direction* IE is present, the gNB-CU should use it to understand whether the cell is for UL or DL only. If in F1 SETUP REQUEST message, the *Cell Direction* IE is omitted in the *Served Cell Information* IE it shall be interpreted as that the Cell Direction is Bi-directional.

8.2.3.3 Unsuccessful Operation

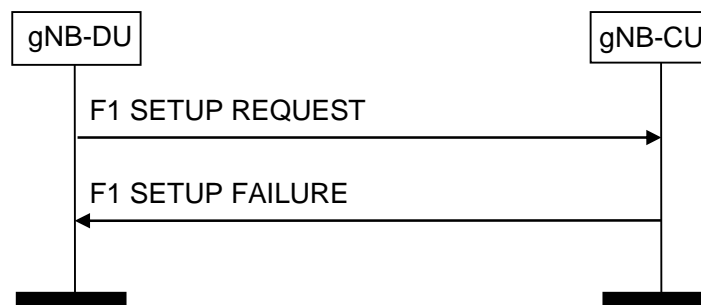

Figure 8.2.3.3-1: F1 Setup procedure: Unsuccessful Operation

If the gNB-CU cannot accept the setup, it should respond with a F1 SETUP FAILURE and appropriate cause value.

If the F1 SETUP FAILURE message includes the *Time To Wait* IE, the gNB-DU shall wait at least for the indicated time before reinitiating the F1 setup towards the same gNB-CU.

8.2.3.4 Abnormal Conditions

Not applicable.

8.2.4 gNB-DU Configuration Update

8.2.4.1 General

The purpose of the gNB-DU Configuration Update procedure is to update application level configuration data needed for the gNB-DU and the gNB-CU to interoperate correctly on the F1 interface. This procedure does not affect existing UE-related contexts, if any. The procedure uses non-UE associated signalling.

8.2.4.2 Successful Operation

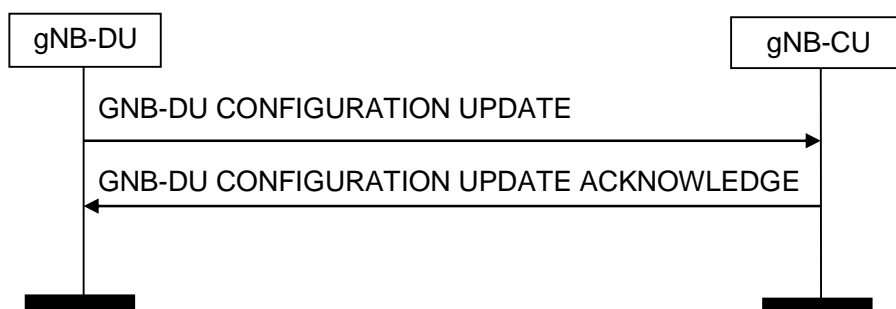

Figure 8.2.4.2-1: gNB-DU Configuration Update procedure: Successful Operation

The gNB-DU initiates the procedure by sending a GNB-DU CONFIGURATION UPDATE message to the gNB-CU including an appropriate set of updated configuration data that it has just taken into operational use. The gNB-CU responds with GNB-DU CONFIGURATION UPDATE ACKNOWLEDGE message to acknowledge that it successfully updated the configuration data. If an information element is not included in the GNB-DU CONFIGURATION UPDATE message, the gNB-CU shall interpret that the corresponding configuration data is not changed and shall continue to operate the F1-C interface with the existing related configuration data.

The updated configuration data shall be stored in both nodes and used as long as there is an operational TNL association or until any further update is performed.

If *gNB-DU ID IE* is contained in the GNB-DU CONFIGURATION UPDATE message for a newly established SCTP association, the gNB-CU will associate this association with the related gNB-DU.

If *Served Cells To Add Item IE* is contained in the GNB-DU CONFIGURATION UPDATE message, the gNB-CU shall add cell information according to the information in the *Served Cell Information IE*. For NG-RAN, the gNB-DU shall include the *gNB-DU System Information IE*.

If *Served Cells To Modify Item IE* is contained in the GNB-DU CONFIGURATION UPDATE message, the gNB-CU shall modify information of cell indicated by *Old NR CGI IE* according to the information in the *Served Cell Information IE* and overwrite the served cell information for the affected served cell. Further, if the *gNB-DU System Information IE* is present the gNB-CU shall store and replace any previous information received.

If *Served Cells To Delete Item IE* is contained in the GNB-DU CONFIGURATION UPDATE message, the gNB-CU shall delete information of cell indicated by *Old NR CGI IE*.

If *Cells Status Item IE* is contained in the GNB-DU CONFIGURATION UPDATE message, the gNB-CU shall update the information about the cells, as described in TS 38.401 [4]. If if the *Switching Off Ongoing IE* is present in the *Cells Status Item IE*, contained in the GNB-DU CONFIGURATION UPDATE message, and the corresponding *Service State IE* is set to “Out-of-Service”, the gNB-CU shall ignore the *Switching Off Ongoing IE*.

If *Cells to be Activated List Item IE* is contained in the GNB-DU CONFIGURATION UPDATE ACKNOWLEDGE message, the gNB-DU shall activate the cell indicated by *NR CGI IE* and reconfigure the physical cell identity for cells for which the *NR PCI IE* is included.

If *Cells to be Activated List Item IE* is contained in the GNB-DU CONFIGURATION UPDATE ACKNOWLEDGE message and the indicated cells are already activated, the gNB-DU shall update the cell information received in *Cells to be Activated List Item IE*.

If *Cells to be Deactivated List Item IE* is contained in the GNB-DU CONFIGURATION UPDATE ACKNOWLEDGE message, the gNB-DU shall deactivate all the cells with NR CGI listed in the IE.

If *Dedicated SI Delivery Needed UE List IE* is contained in the GNB-DU CONFIGURATION UPDATE message, the gNB-CU should take it into account when informing the UE of the updated system information via the dedicated RRC message.

For NG-RAN, the gNB-CU shall include the *gNB-CU System Information IE* in the GNB-DU CONFIGURATION UPDATE ACKNOWLEDGE message. The *SIB type to Be Updated List IE* shall contain the full list of SIBs to be broadcast.

For NG-RAN, the gNB-DU may include the *RAN Area Code* IE in the GNB-DU CONFIGURATION UPDATE message. The gNB-CU shall store and replace any previously provided *RAN Area Code* IE by the received *RAN Area Code* IE.

If *Available PLMN List* IE, and optionally also *Extended Available PLMN List* IE, is contained in GNB-DU CONFIGURATION UPDATE ACKNOWLEDGE message, the gNB-DU shall overwrite the whole available PLMN list and update the corresponding system information.

If in GNB-DU CONFIGURATION UPDATE message, the *Cell Direction* IE is present, the gNB-CU should use it to understand whether the cell is for UL or DL only. If in GNB-DU CONFIGURATION UPDATE message, the *Cell Direction* IE is omitted in the *Served Cell Information* IE it shall be interpreted as that the Cell Direction is Bi-directional.

If the GNB-DU CONFIGURATION UPDATE message includes *gNB-DU TNL Association To Remove List* IE, and the *Endpoint IP address* IE and the *Port Number* IE for both TNL endpoints of the TNL association(s) are included in the *gNB-DU TNL Association To Remove List* IE, the gNB-CU shall, if supported, consider that the TNL association(s) indicated by both received TNL endpoints will be removed by the gNB-DU. If the *Endpoint IP address* IE, or the *Endpoint IP address* IE and the *Port Number* IE for one or both of the TNL endpoints is included in the *gNB-DU TNL Association To Remove List* IE in GNB-DU CONFIGURATION UPDATE message, the gNB-CU shall, if supported, consider that the TNL association(s) indicated by the received endpoint IP address(es) will be removed by the gNB-DU.

8.2.4.3 Unsuccessful Operation

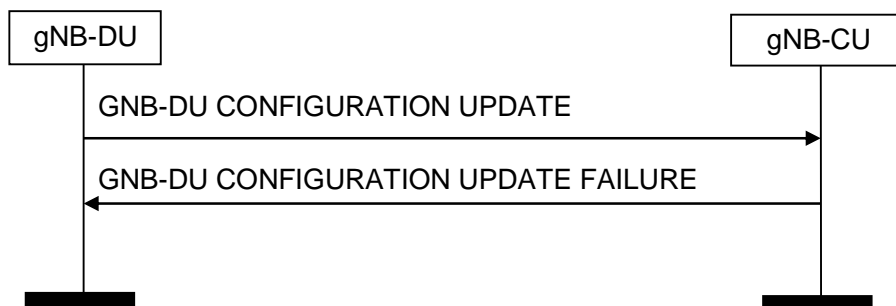

Figure 8.2.4.3-1: gNB-DU Configuration Update procedure: Unsuccessful Operation

If the gNB-CU cannot accept the update, it shall respond with a GNB-DU CONFIGURATION UPDATE FAILURE message and appropriate cause value.

If the GNB-DU CONFIGURATION UPDATE FAILURE message includes the *Time To Wait* IE, the gNB-DU shall wait at least for the indicated time before reinitiating the GNB-DU CONFIGURATION UPDATE message towards the same gNB-CU.

8.2.4.4 Abnormal Conditions

Not applicable.

8.2.5 gNB-CU Configuration Update

8.2.5.1 General

The purpose of the gNB-CU Configuration Update procedure is to update application level configuration data needed for the gNB-DU and gNB-CU to interoperate correctly on the F1 interface. This procedure does not affect existing UE-related contexts, if any. The procedure uses non-UE associated signalling.

8.2.5.2 Successful Operation

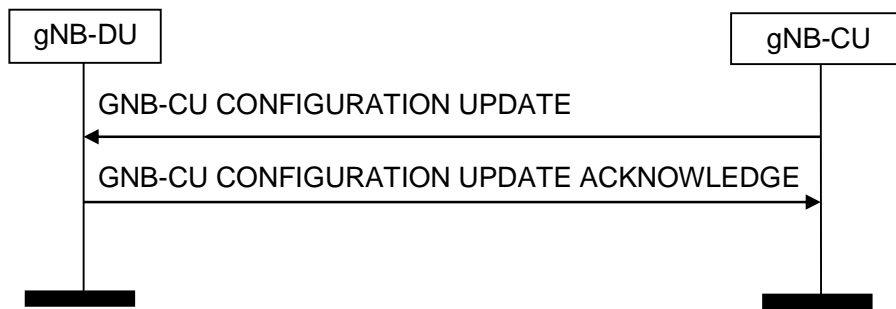

Figure 8.2.5.2-1: gNB-CU Configuration Update procedure: Successful Operation

The gNB-CU initiates the procedure by sending a GNB-CU CONFIGURATION UPDATE message including the appropriate updated configuration data to the gNB-DU. The gNB-DU responds with a GNB-CU CONFIGURATION UPDATE ACKNOWLEDGE message to acknowledge that it successfully updated the configuration data. If an information element is not included in the GNB-CU CONFIGURATION UPDATE message, the gNB-DU shall interpret that the corresponding configuration data is not changed and shall continue to operate the F1-C interface with the existing related configuration data.

The updated configuration data shall be stored in the respective node and used as long as there is an operational TNL association or until any further update is performed.

If *Cells to be Activated List Item* IE is contained in the GNB-CU CONFIGURATION UPDATE message, the gNB-DU shall activate the cell indicated by *NR CGI* IE and reconfigure the physical cell identity for which the *NR PCI* IE is included.

If *Cells to be Deactivated List Item* IE is contained in the GNB-CU CONFIGURATION UPDATE message, the gNB-DU shall deactivate the cell indicated by *NR CGI* IE.

If *Cells to be Activated List Item* IE is contained in the GNB-CU CONFIGURATION UPDATE message and the indicated cells are already activated, the gNB-DU shall update the cell information received in *Cells to be Activated List Item* IE.

If the *gNB-CU System Information* IE is contained in the gNB-CU CONFIGURATION UPDATE message, the gNB-DU shall include the *Dedicated SI Delivery Needed UE List* IE in the GNB-CU CONFIGURATION UPDATE ACKNOWLEDGE message for UEs that are unable to receive system information from broadcast.

If *Dedicated SI Delivery Needed UE List* IE is contained in the GNB-CU CONFIGURATION UPDATE ACKNOWLEDGE message, the gNB-CU should take it into account when informing the UE of the updated system information via the dedicated RRC message.

If the *gNB-CU TNL Association To Add List* IE is contained in the gNB-CU CONFIGURATION UPDATE message, the gNB-DU shall, if supported, use it to establish the TNL association(s) with the gNB-CU. The gNB-DU shall report to the gNB-CU, in the GNB-CU CONFIGURATION UPDATE ACKNOWLEDGE message, the successful establishment of the TNL association(s) with the gNB-CU as follows:

- A list of TNL address(es) with which the gNB-DU successfully established the TNL association shall be included in the *gNB-CU TNL Association Setup List* IE;
- A list of TNL address(es) with which the gNB-DU failed to establish the TNL association shall be included in the *gNB-CU TNL Association Failed To Setup List* IE.

If the GNB-CU CONFIGURATION UPDATE message includes *gNB-CU TNL Association To Remove List* IE, and the *Endpoint IP address* IE and the *Port Number* IE for both TNL endpoints of the TNL association(s) are included in the *gNB-CU TNL Association To Remove List* IE, the gNB-DU shall, if supported, initiate removal of the TNL association(s) indicated by both received TNL endpoints towards the gNB-CU. If the *Endpoint IP address* IE, or the *Endpoint IP address* IE and the *Port Number* IE for one or both of the TNL endpoints is included in the *gNB-CU TNL Association To Remove List* IE, the gNB-DU shall, if supported, initiate removal of the TNL association(s) indicated by the received endpoint IP address(es).

If the *gNB-CU TNL Association To Update List* IE is contained in the *gNB-CU CONFIGURATION UPDATE* message the gNB-DU shall, if supported, overwrite the previously stored information for the related TNL Association(s).

If the *TNL Association usage* IE is included in the *gNB-CU TNL Association To Add List* IE or the *gNB-CU TNL Association To Update List* IE, the gNB-DU node shall, if supported, use it as described in TS 38.472 [22].

For NG-RAN, the gNB-CU shall include the *gNB-CU System Information* IE in the *GNB-CU CONFIGURATION UPDATE* message. The *SIB type to Be Updated List* IE shall contain the full list of SIBs to be broadcast.

If *Protected E-UTRA Resources List* IE is contained in the *GNB-CU CONFIGURATION UPDATE* message, the gNB-DU shall protect the corresponding resource of the cells indicated by *E-UTRA Cells List* IE for spectrum sharing between E-UTRA and NR.

If the *GNB-CU CONFIGURATION UPDATE* message contains the *Protected E-UTRA Resource Indication* IE, the receiving gNB-DU should forward it to lower layers and use it for cell-level resource coordination. The gNB-DU shall consider the received *Protected E-UTRA Resource Indication* IE when expressing its desired resource allocation during gNB-DU Resource Coordination procedure. The gNB-DU shall consider the received *Protected E-UTRA Resource Indication* IE content valid until reception of a new update of the IE for the same gNB-DU.

If *Available PLMN List* IE, and optionally also *Extended Available PLMN List* IE, is contained in *GNB-CU CONFIGURATION UPDATE* message, the gNB-DU shall overwrite the whole available PLMN list and update the corresponding system information.

If *Cells Failed to be Activated Item* IE is contained in the *GNB-CU CONFIGURATION UPDATE ACKNOWLEDGE* message, the gNB-CU shall consider that the indicated cells are out-of-service as defined in TS 38.401 [4].

8.2.5.3 Unsuccessful Operation

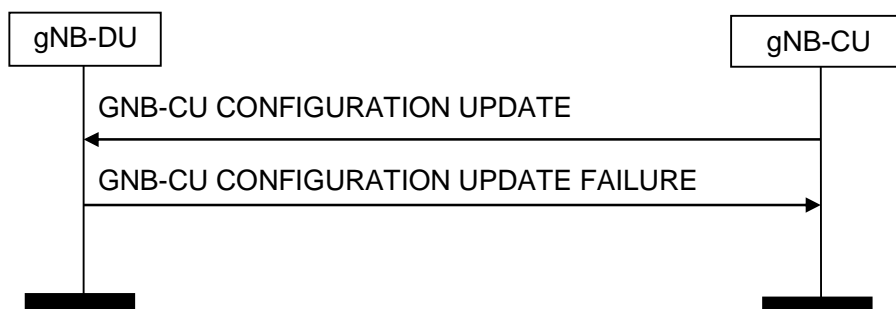

Figure 8.2.5.3-1: gNB-CU Configuration Update: Unsuccessful Operation

If the gNB-DU cannot accept the update, it shall respond with a *GNB-CU CONFIGURATION UPDATE FAILURE* message and appropriate cause value.

If the *GNB-CU CONFIGURATION UPDATE FAILURE* message includes the *Time To Wait* IE, the gNB-CU shall wait at least for the indicated time before reinitiating the *GNB-CU CONFIGURATION UPDATE* message towards the same gNB-DU.

8.2.5.4 Abnormal Conditions

Not applicable.

8.2.6 gNB-DU Resource Coordination

8.2.6.1 General

The purpose of the gNB-DU Resource Coordination procedure is to enable coordination of radio resource allocation between a gNB-CU and a gNB-DU for the purpose of spectrum sharing between E-UTRA and NR. This procedure is to be used only for the purpose of spectrum sharing between E-UTRA and NR.

The procedure uses non-UE-associated signalling.

8.2.6.2 Successful Operation

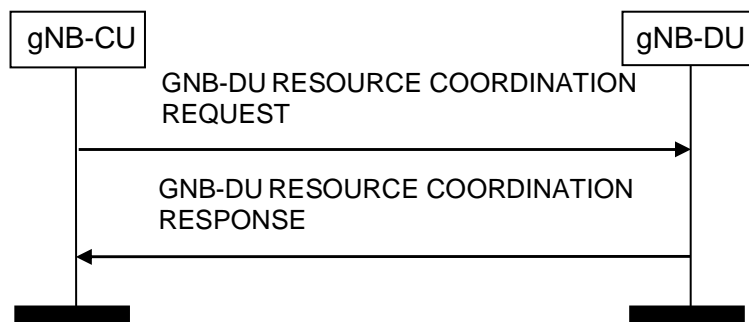

Figure 8.2.6.2-1: gNB-DU Resource Coordination, successful operation

A gNB-CU initiates the procedure by sending the GNB-DU RESOURCE COORDINATION REQUEST message to a gNB-DU over the F1 interface.

The gNB-DU extracts the *E-UTRA – NR Cell Resource Coordination Request Container* IE and it replies by sending the GNB-DU RESOURCE COORDINATION RESPONSE message.

In case of NR-initiated gNB-DU Resource Coordination procedure, the *Ignore Coordination Request Container* IE shall be present and set to “yes” and the *E-UTRA – NR Cell Resource Coordination Request Container* IE in the GNB-DU RESOURCE COORDINATION REQUEST message shall be ignored.

8.2.7 gNB-DU Status Indication

8.2.7.1 General

The purpose of the gNB-DU Status Indication procedure is informing the gNB-CU that the gNB-DU is overloaded so that overload reduction actions can be applied. The procedure uses non-UE associated signalling.

8.2.7.2 Successful Operation

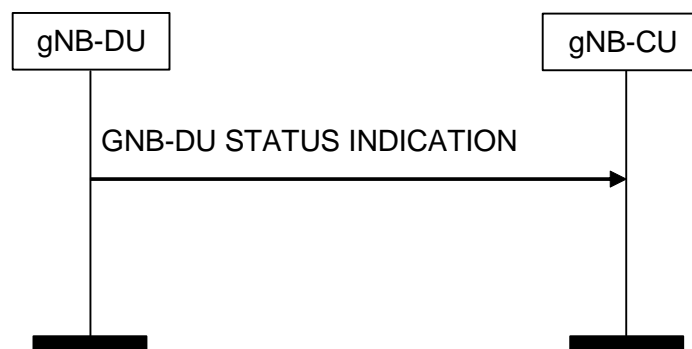

Figure 8.2.7.2-1: gNB-DU Status Indication procedure

If the *gNB-DU Overload Information* IE in the GNB-DU STATUS INDICATION message indicates that the gNB-DU is overloaded, the gNB-CU shall apply overload reduction actions until informed, with a new GNB-DU STATUS INDICATION message, that the overload situation has ceased.

The detailed overload reduction policy is up to gNB-CU implementation.

8.2.7.3 Abnormal Conditions

Void.

8.2.8 F1 Removal

8.2.8.1 General

The purpose of the F1 Removal procedure is to remove the interface instance and all related resources between the gNB-DU and the gNB-CU in a controlled manner. If successful, this procedure erases any existing application level configuration data in the two nodes.

NOTE: In case the signalling transport is shared among several F1-C interface instances, and the TNL association is still used by one or several F1-C interface instances, the initiating node should not initiate the removal of the TNL association.

The procedure uses non-UE-associated signaling.

8.2.8.2 Successful Operation

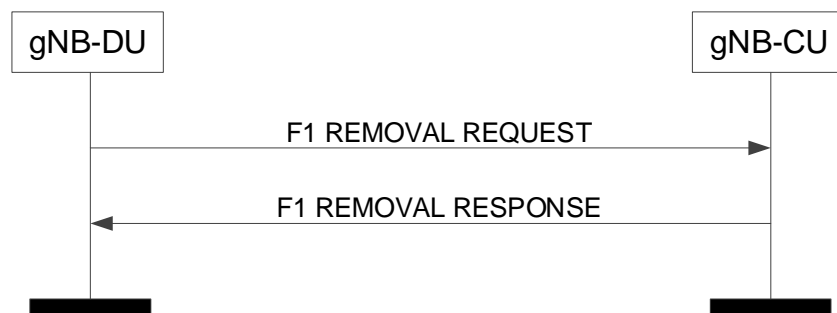

Figure 8.2.8-1: F1 Removal, gNB-DU initiated, successful operation

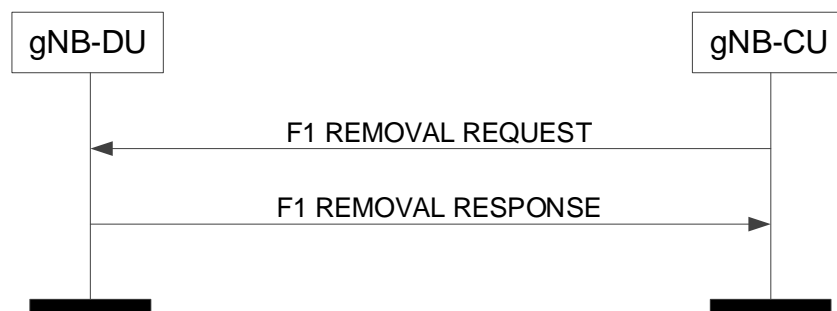

Figure 8.2.8.2-2: F1 Removal, gNB-CU initiated, successful operation

Successful F1 Removal, gNB-DU initiated

The gNB-DU initiates the procedure by sending the F1 REMOVAL REQUEST message to the gNB-CU. Upon reception of the F1 REMOVAL REQUEST message the gNB-CU shall reply with the F1 REMOVAL RESPONSE message. After receiving the F1 REMOVAL RESPONSE message, the gNB-DU may initiate removal of the TNL association towards the gNB-CU, if applicable, and may remove all resources associated with that signaling connection. The gNB-CU may then remove all resources associated with that interface instance.

Successful F1 Removal, gNB-CU initiated

The gNB-CU initiates the procedure by sending the F1 REMOVAL REQUEST message to the gNB-DU. Upon reception of the F1 REMOVAL REQUEST message the gNB-DU shall reply with the F1 REMOVAL RESPONSE message. After receiving the F1 REMOVAL RESPONSE message, the gNB-CU may initiate removal of the TNL association towards the gNB-DU, if applicable, and may remove all resources associated with that signaling connection. The gNB-DU may then remove all resources associated with that interface instance.

8.2.8.3 Unsuccessful Operation

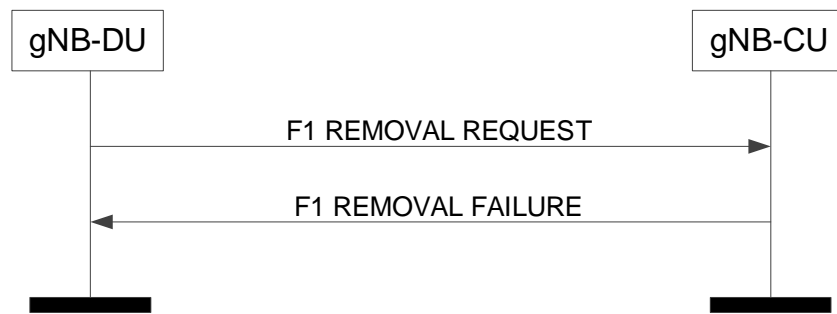

Figure 8.2.8.3-1: F1 Removal, gNB-DU initiated, unsuccessful operation

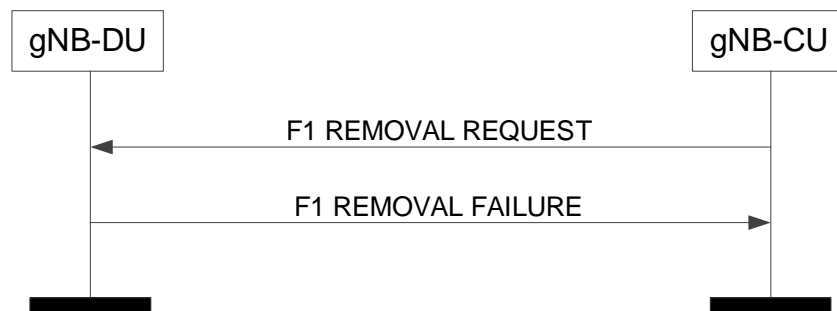

Figure 8.2.8.3-2: F1 Removal, gNB-CU initiated, unsuccessful operation

Unsuccessful F1 Removal, gNB-DU initiated

If the gNB-CU cannot accept to remove the signaling connection with the gNB-DU it shall respond with an F1 REMOVAL FAILURE message with an appropriate cause value.

Unsuccessful F1 Removal, gNB-CU initiated

If the gNB-DU cannot accept to remove the signaling connection with the gNB-CU it shall respond with an F1 REMOVAL FAILURE message with an appropriate cause value.

8.2.8.4 Abnormal Conditions

Not applicable.

8.2.9 Network Access Rate Reduction

8.2.9.1 General

The purpose of the Network Access Rate Reduction procedure is to indicate to the gNB-DU that the rate at which UEs are accessing the network need to be reduced from its current level.

The procedure uses non-UE associated signalling.

8.2.9.2 Successful operation

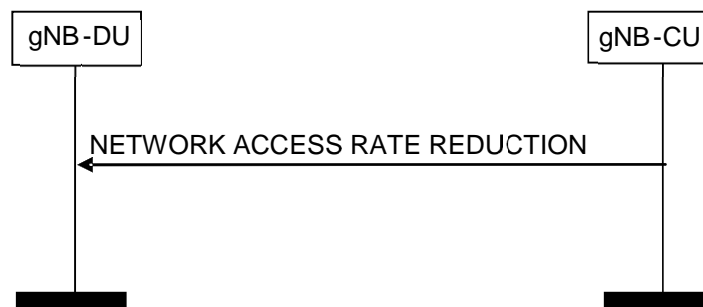

Figure 8.2.9.2-1: Network Access Rate Reduction, Successful operation

The gNB-CU initiates the procedure by sending a NETWORK ACCESS RATE REDUCTION message to the gNB-DU. When receiving the NETWORK ACCESS RATE REDUCTION message the gNB-DU should take into account the information contained in the *UAC assistance information* to set the parameters for Unified Access Barring.

8.2.9.3 Abnormal Conditions

Not applicable

8.3 UE Context Management procedures

8.3.1 UE Context Setup

8.3.1.1 General

The purpose of the UE Context Setup procedure is to establish the UE Context including, among others, SRB, and DRB configuration. The procedure uses UE-associated signalling.

8.3.1.2 Successful Operation

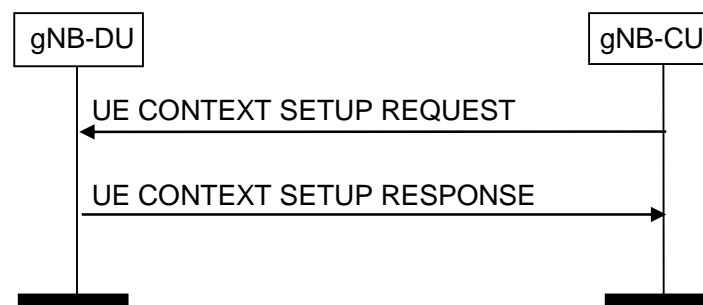

Figure 8.3.1.2-1: UE Context Setup Request procedure: Successful Operation

The gNB-CU initiates the procedure by sending UE CONTEXT SETUP REQUEST message to the gNB-DU. If the gNB-DU succeeds to establish the UE context, it replies to the gNB-CU with UE CONTEXT SETUP RESPONSE. If no UE-associated logical F1-connection exists, the UE-associated logical F1-connection shall be established as part of the procedure.

If the *UE-CapabilityRAT-ContainerList* IE is included in the UE CONTEXT SETUP REQUEST, the gNB-DU shall take this information into account for UE specific configurations.

If the *servingCellMO* IE is included in the UE CONTEXT SETUP REQUEST message, the gNB-DU shall configure *servingCellMO* for the indicated SpCell accordingly.

If the *SpCell UL Configured* IE is included in the UE CONTEXT SETUP REQUEST message, the gNB-DU shall configure UL for the indicated SpCell accordingly.

If the *SCell To Be Setup List* IE is included in the UE CONTEXT SETUP REQUEST message, the gNB-DU shall consider it as a list of candidate SCells to be set up. If the *SCell UL Configured* IE is included in the UE CONTEXT SETUP REQUEST message, the gNB-DU shall configure UL for the indicated SCell accordingly. If the *-servingCellMO* IE is included in the UE CONTEXT SETUP REQUEST message, the gNB-DU shall configure servingCellMO for the indicated SCell accordingly.

If the *DRX Cycle* IE is contained in the UE CONTEXT SETUP REQUEST message, the gNB-DU shall use the provided value from the gNB-CU.

If the *UL Configuration* IE in *DRB to Be Setup Item* IE is contained in the UE CONTEXT SETUP REQUEST message, the gNB-DU shall take it into account for UL scheduling.

If the *SRB To Be Setup List* IE is contained in the UE CONTEXT SETUP REQUEST message, the gNB-DU shall act as specified in TS 38.401 [4]. If *Duplication Indication* IE is contained in the *SRB To Be Setup List* IE, the gNB-DU shall, if supported, setup two RLC entities for the indicated SRB.

If the *DRB To Be Setup List* IE is contained in the UE CONTEXT SETUP REQUEST message, the gNB-DU shall act as specified in TS 38.401 [4]. If the *QoS Flow Mapping Indication* IE is included in the *DRB To Be Setup List* IE for a QoS flow, the gNB-DU may take it into account that only the uplink or downlink QoS flow is mapped to the indicated DRB.

If two *UL UP TNL Information* IEs are included in UE CONTEXT SETUP REQUEST message for a DRB, gNB-DU shall include two *DL UP TNL Information* IEs in UE CONTEXT SETUP RESPONSE message and setup two RLC entities for the indicated DRB. gNB-CU and gNB-DU use the *UL UP TNL Information* IEs and *DL UP TNL Information* IEs to support packet duplication for intra-gNB-DU CA as defined in TS 38.470 [2]. The first *UP TNL Information* IE of the two *UP TNL Information* IEs is for the primary path.

If *Duplication Activation* IE is included in the UE CONTEXT SETUP REQUEST message for a DRB, gNB-DU should take it into account when activating/deactivating CA based PDCP duplication for the DRB.

If *DC Based Duplication Configured* IE is included in the UE CONTEXT SETUP REQUEST message for a DRB, gNB-DU shall regard that DC based PDCP duplication is configured for this DRB if the value is set to be "true" and it should take the responsibility of PDCP duplication activation/deactivation. If *DC Based Duplication Activation* IE is included in the UE CONTEXT SETUP REQUEST message for a DRB, gNB-DU should take it into account when activating/deactivating DC based PDCP duplication for this DRB.

If *UL PDCP SN length* IE is included in the UE CONTEXT SETUP REQUEST message for a DRB, gNB-DU shall, if supported, store this information and use it for lower layer configuration.

For EN-DC operation, and if the *Subscriber Profile ID for RAT/Frequency priority* IE is received from an MeNB, the UE CONTEXT SETUP REQUEST message shall contain the *Subscriber Profile ID for RAT/Frequency priority* IE. The gNB-DU shall store the received Subscriber Profile ID for RAT/Frequency priority in the UE context and use it as defined in TS 36.300 [20].

If the *Index to RAT/Frequency Selection Priority* IE is available at the gNB-CU, the *Index to RAT/Frequency Selection Priority* IE shall be included in the UE CONTEXT SETUP REQUEST. The gNB-DU may use it for RRM purposes.

The gNB-DU shall report to the gNB-CU, in the UE CONTEXT SETUP RESPONSE message, the result for all the requested DRBs and SRBs in the following way:

- A list of DRBs which are successfully established shall be included in the *DRB Setup List* IE;
- A list of DRBs which failed to be established shall be included in the *DRB Failed to Setup List* IE;
- A list of SRBs which failed to be established shall be included in the *SRB Failed to Setup List* IE.
- A list of successfully established SRBs with logical channel identities for primary path shall be included in the *SRB Setup List* IE only if CA based PDCP duplication is initiated for the concerned SRBs.

When the gNB-DU reports the unsuccessful establishment of a DRB or SRB, the cause value should be precise enough to enable the gNB-CU to know the reason for the unsuccessful establishment.

For EN-DC operation, the gNB-CU shall include in the UE CONTEXT SETUP REQUEST the *E-UTRAN QoS* IE. The allocation of resources according to the values of the *Allocation and Retention Priority* IE included in the *E-UTRAN QoS* IE shall follow the principles described for the E-RAB Setup procedure in TS 36.413 [15].

For NG-RAN operation, the gNB-CU shall include in the UE CONTEXT SETUP REQUEST the *DRB Information* IE.

For DC operation, the *CG-ConfigInfo* IE shall be included in the *CU to DU RRC Information* IE at the gNB acting as secondary node. If the *CG-ConfigInfo* IE is included in the *UE CONTEXT SETUP REQUEST* message, the gNB-DU shall regard it as a reconfiguration with sync as defined in TS 38.331 [8].

If the *HandoverPreparationInformation* IE is included in the *CU to DU RRC Information* IE in the *UE CONTEXT SETUP REQUEST* message, the gNB-DU of the gNB acting as master node shall regard it as a reconfiguration with sync as defined in TS 38.331 [8]. The gNB-CU of the gNB acting as master node shall only initiate the *UE Context Setup* procedure for handover or secondary node addition when at least one DRB is setup for the UE. If the received *CU to DU RRC Information* IE does not include source cell group configuration, the gNB-DU shall generate the cell group configuration using full configuration. Otherwise, delta configuration is allowed.

If the gNB-CU includes the SMTC information of the measured frequency(ies) in the *MeasurementTimingConfiguration* IE of the *CU to DU RRC Information* IE that is included in the *UE CONTEXT SETUP REQUEST* message, the gNB-DU shall generate the measurement gaps based on the received SMTC information. Then the gNB-DU shall send the measurement gaps information to the gNB-CU in the *MeasGapConfig* IE of the *DU to CU RRC Information* IE that is included in the *UE CONTEXT SETUP RESPONSE* message.

For EN-DC operation, if the gNB-CU includes the *Resource Coordination Transfer Information* IE in the *UE CONTEXT SETUP REQUEST* message, the gNB-DU shall, if supported, use it for the purpose of resource coordination. If the *Ignore PRACH Configuration* IE is present and set to "true" the *E-UTRA PRACH Configuration* IE in the *UE CONTEXT SETUP REQUEST* message shall be ignored. If the gNB-CU received the MeNB Resource Coordination Information as defined in TS 36.423 [9], it shall transparently transfer it to the gNB-DU via the *Resource Coordination Transfer Container* IE in the *UE CONTEXT SETUP REQUEST* message. The gNB-DU shall use the information received in the *Resource Coordination Transfer Container* IE for reception of MeNB Resource Coordination Information at the gNB acting as secondary node as described in TS 36.423 [9]. If the *Resource Coordination E-UTRA Cell Information* IE is included in the *Resource Coordination Information* IE, the gNB-DU shall store the information replacing previously received information for the same E-UTRA cell, and use the stored information for the purpose of resource coordination.

For NGEN-DC or NE-DC operation, if the gNB-CU includes the *Resource Coordination Transfer Information* IE in the *UE CONTEXT SETUP REQUEST* message, the gNB-DU shall, if supported, use it for the purpose of resource coordination. If the gNB-CU received the MR-DC Resource Coordination Information as defined in TS 38.423 [28], it shall transparently transfer it to the gNB-DU via the *Resource Coordination Transfer Container* IE in the *UE CONTEXT SETUP REQUEST* message. The gNB-DU shall use the information received in the *Resource Coordination Transfer Container* IE for reception of MR-DC Resource Coordination Information at the gNB as described in TS 38.423 [28].

The *UEAssistanceInformation* IE shall be included in *CU to DU RRC Information* IE in the *UE CONTEXT SETUP REQUEST* message if the gNB-CU received this IE from the UE; if the *UEAssistanceInformation* IE is included in the *CU to DU RRC Information* IE in the *UE CONTEXT SETUP REQUEST* message, the gNB-DU shall, if supported, take it into account when configuring resources for the UE.

If the *Resource Coordination Transfer Container* IE is included in the *UE CONTEXT SETUP RESPONSE*, the gNB-CU shall transparently transfer this information for the purpose of resource coordination as described in TS 36.423 [9], TS 38.423 [28].

If the *Masked IMEISV* IE is contained in the *UE CONTEXT SETUP REQUEST* message the gNB-DU shall, if supported, use it to determine the characteristics of the UE for subsequent handling.

If the *SCell Failed To Setup List* IE is contained in the *UE CONTEXT SETUP RESPONSE* message, the gNB-CU shall regard the corresponding SCell(s) failed to be set up with an appropriate cause value for each SCell failed to setup.

If the *Inactivity Monitoring Request* IE is contained in the *UE CONTEXT SETUP REQUEST* message, gNB-DU may consider that the gNB-CU has requested the gNB-DU to perform UE inactivity monitoring. If the *Inactivity Monitoring Response* IE is contained in the *UE CONTEXT SETUP RESPONSE* message and set to "Not-supported", the gNB-CU shall consider that the gNB-DU does not support UE inactivity monitoring for the UE.

If the *CellGroupConfig* IE is included in the *DU to CU RRC Information* IE contained in the *UE CONTEXT SETUP RESPONSE* message, the gNB-CU shall perform RRC Reconfiguration or RRC connection resume as described in TS 38.331 [8]. The *CellGroupConfig* IE shall transparently be signaled to the UE as specified in TS 38.331 [8].

If the *Full Configuration* IE is contained in the *UE CONTEXT SETUP RESPONSE* message, the gNB-CU shall consider that the gNB-DU has generated the *CellGroupConfig* IE using full configuration.

If the *C-RNTI* IE is included in the UE CONTEXT SETUP RESPONSE, the gNB-CU shall consider that the C-RNTI has been allocated by the gNB-DU for this UE context.

The UE Context Setup Procedure is not used to configure SRB0.

If the UE CONTEXT SETUP REQUEST message contains the *RRC-Container* IE, the gNB-DU shall send the corresponding RRC message to the UE via SRB1.

If the *Notification Control* IE is included in the *DRB to Be Setup List* IE and it is set to active, the gNB-DU shall, if supported, monitor the QoS of the DRB and notify the gNB-CU if the QoS cannot be fulfilled any longer or if the QoS can be fulfilled again. The *Notification Control* IE can only be applied to GBR bearers.

If the *UL PDU Session Aggregate Maximum Bit Rate* IE is included in the *QoS Flow Level QoS Parameters* IE contained in the UE CONTEXT SETUP REQUEST message, the gNB-DU shall store the received UL PDU Session Aggregate Maximum Bit Rate and use it when enforcing uplink traffic policing for non-GBR Bearers for the concerned UE as specified in TS 23.501 [21].

The gNB-DU shall store the received gNB-DU UE Aggregate Maximum Bit Rate Uplink and use it for non-GBR Bearers for the concerned UE.

If the UE CONTEXT SETUP REQUEST message contains the *QoS Flow Mapping Indication* IE, the gNB-DU may take it into account that only the uplink or downlink QoS flow is mapped to the DRB.

If the UE CONTEXT SETUP REQUEST message contains the *New gNB-CU UE FIAP ID* IE, the gNB-DU shall, if supported, replace the value received in the *gNB-CU UE FIAP ID* IE by the value of the *New gNB-CU UE FIAP ID* and use it for further signalling.

If the *RAN UE ID* IE is contained in the UE CONTEXT SETUP REQUEST message, the gNB-DU shall store and replace any previous information received.

8.3.1.3 Unsuccessful Operation

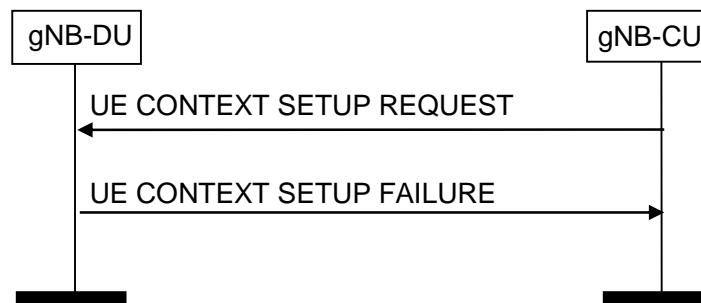

Figure 8.3.1.3-1: UE Context Setup Request procedure: unsuccessful Operation

If the gNB-DU is not able to establish an F1 UE context, or cannot even establish one bearer it shall consider the procedure as failed and reply with the UE CONTEXT SETUP FAILURE message.

If the gNB-DU is not able to accept the *SpCell ID* IE in UE CONTEXT SETUP REQUEST message, it shall reply with the UE CONTEXT SETUP FAILURE message with an appropriate cause value. Further, if the *Candidate SpCell List* IE is included in the UE CONTEXT SETUP REQUEST message and the gNB-DU is not able to accept the *SpCell ID* IE, the gNB-DU shall, if supported, include the *Potential SpCell List* IE in the UE CONTEXT SETUP FAILURE message and the gNB-CU should take this into account for selection of an opportune SpCell. The gNB-DU shall include the cells in the *Potential SpCell List* IE in a priority order, where the first cell in the list is the one most desired and the last one is the one least desired (e.g., based on load conditions). If the *Potential SpCell List* IE is present but no *Potential SpCell Item* IE is present, the gNB-CU should assume that none of the cells in the *Candidate SpCell List* IE are acceptable for the gNB-DU.

8.3.1.4 Abnormal Conditions

If the gNB-DU receives a UE CONTEXT SETUP REQUEST message containing a *E-UTRAN QoS* IE for a GBR QoS DRB but where the *GBR QoS Information* IE is not present, the gNB-DU shall report the establishment of the corresponding DRB as failed in the *DRB Failed to Setup List* IE of the UE CONTEXT SETUP RESPONSE message

with an appropriate cause value. If the gNB-DU receives a UE CONTEXT SETUP REQUEST message containing a DRB QoS IE for a GBR QoS DRB but where the *GBR QoS Flow Information IE* is not present, the gNB-DU shall report the establishment of the corresponding DRBs as failed in the *DRB Failed to Setup List IE* of the UE CONTEXT SETUP RESPONSE message with an appropriate cause value.

If the *Delay Critical IE* is included in the *Dynamic 5QI Descriptor IE* within the DRB QoS IE in the UE CONTEXT SETUP REQUEST message and is set to the value “delay critical” but the *Maximum Data Burst Volume IE* is not present, the gNB-DU shall report the establishment of the corresponding DRB as failed in the *DRB Failed to Setup List IE* of the of the UE CONTEXT SETUP RESPONSE message with an appropriate cause value.

8.3.2 UE Context Release Request (gNB-DU initiated)

8.3.2.1 General

The purpose of the UE Context Release Request procedure is to enable the gNB-DU to request the gNB-CU to release the UE-associated logical F1-connection. The procedure uses UE-associated signalling.

8.3.2.2 Successful Operation

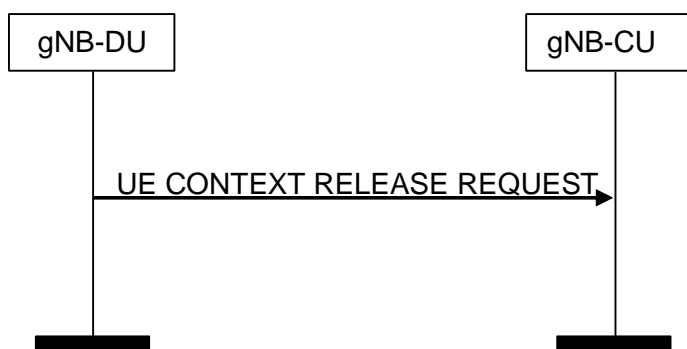

Figure 8.3.2.2-1: UE Context Release (gNB-DU initiated) procedure. Successful operation

The gNB-DU controlling a UE-associated logical F1-connection initiates the procedure by generating a UE CONTEXT RELEASE REQUEST message towards the affected gNB-CU node.

The UE CONTEXT RELEASE REQUEST message shall indicate the appropriate cause value.

Interactions with UE Context Release procedure:

The UE Context Release procedure may be initiated upon reception of a UE CONTEXT RELEASE REQUEST message.

Interactions with UE Context Setup procedure:

The UE Context Release Request procedure may be performed before the UE Context Setup procedure to request the release of an existing UE-associated logical F1-connection and related resources in the gNB-DU.

8.3.2.3 Abnormal Conditions

Not applicable.

8.3.3 UE Context Release (gNB-CU initiated)

8.3.3.1 General

The purpose of the UE Context Release procedure is to enable the gNB-CU to order the release of the UE-associated logical connection. The procedure uses UE-associated signalling.

8.3.3.2 Successful Operation

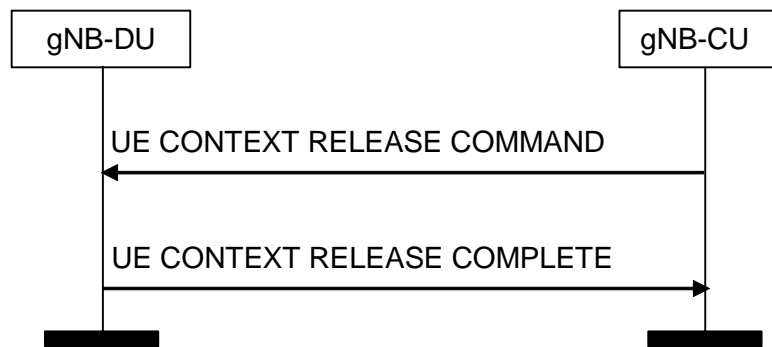

Figure 8.3.3.2-1: UE Context Release (gNB-CU initiated) procedure. Successful operation

The gNB-CU initiates the procedure by sending the UE CONTEXT RELEASE COMMAND message to the gNB-DU.

Upon reception of the UE CONTEXT RELEASE COMMAND message, the gNB-DU shall release all related signalling and user data transport resources and reply with the UE CONTEXT RELEASE COMPLETE message.

If the *old gNB-DU UE F1AP ID* IE is included in the UE CONTEXT RELEASE COMMAND message, the gNB-DU shall additionally release the UE context associated with the old gNB-DU UE F1AP ID.

If the UE CONTEXT RELEASE COMMAND message contains the *RRC-Container IE*, the gNB-DU shall send the RRC container to the UE via the SRB indicated by the *SRB ID* IE.

If the UE CONTEXT RELEASE COMMAND message includes the *Execute Duplication* IE, the gNB-DU shall perform CA based duplication, if configured, for the SRB for the included *RRC-Container* IE.

Interactions with UE Context Setup procedure:

The UE Context Release procedure may be performed before the UE Context Setup procedure to release an existing UE-associated logical F1-connection and related resources in the gNB-DU, e.g. when gNB-CU rejects UE access it shall trigger UE Context Release procedure with the cause value of UE rejection.

8.3.3.4 Abnormal Conditions

Not applicable.

8.3.4 UE Context Modification (gNB-CU initiated)

8.3.4.1 General

The purpose of the UE Context Modification procedure is to modify the established UE Context, e.g., establishing, modifying and releasing radio resources. This procedure is also used to command the gNB-DU to stop data transmission for the UE for mobility (see TS 38.401 [4]). The procedure uses UE-associated signalling.

8.3.4.2 Successful Operation

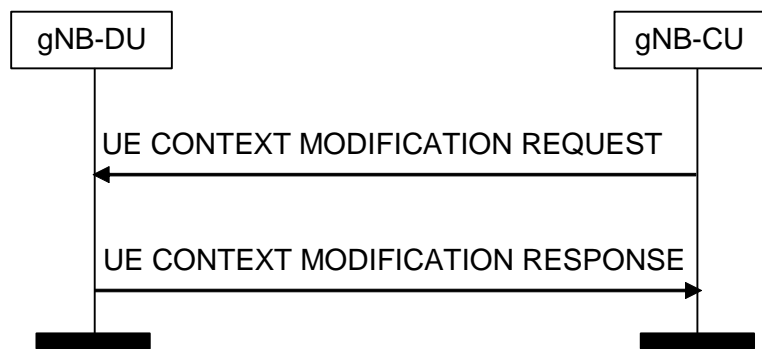

Figure 8.3.4.2-1: UE Context Modification procedure. Successful operation

The UE CONTEXT MODIFICATION REQUEST message is initiated by the gNB-CU.

Upon reception of the UE CONTEXT MODIFICATION REQUEST message, the gNB-DU shall perform the modifications, and if successful reports the update in the UE CONTEXT MODIFICATION RESPONSE message.

If the *SpCell ID* IE is included in the UE CONTEXT MODIFICATION REQUEST message, the gNB-DU shall replace any previously received value and regard it as a reconfiguration with sync as defined in TS 38.331 [8]. If the *ServCellIndex* IE is included in the UE CONTEXT MODIFICATION REQUEST message, the gNB-DU shall take this into account for the indicated SpCell. If the *SpCell UL Configured* IE is included in the UE CONTEXT MODIFICATION REQUEST message, the gNB-DU shall configure UL for the indicated SpCell accordingly. If the *servingCellMO* IE is included in the UE CONTEXT MODIFICATION REQUEST message, the gNB-DU shall configure servingCellMO for the indicated SpCell accordingly.

If the *SCell To Be Setup List* IE or *SCell To Be Removed List* IE is included in the UE CONTEXT MODIFICATION REQUEST message, the gNB-DU shall consider it as a list of candidate SCells to be set up. If the *SCell To Be Setup List* IE is included in the UE CONTEXT MODIFICATION REQUEST message and the indicated SCell(s) are already setup, the gNB-DU shall replace any previously received value. If the *SCell UL Configured* IE is included in the UE CONTEXT MODIFICATION REQUEST message, the gNB-DU shall configure UL for the indicated SCell accordingly. If the *servingCellMO* IE is included in the UE CONTEXT MODIFICATION REQUEST message, the gNB-DU shall configure servingCellMO for the indicated SCell accordingly.

If the *DRX Cycle* IE is contained in the UE CONTEXT MODIFICATION REQUEST message, the gNB-DU shall use the provided value from the gNB-CU. If the *DRX configuration indicator* IE is contained in the UE CONTEXT MODIFICATION REQUEST message and set to "release", the gNB-DU shall release DRX configuration.

If the *SRB To Be Setup List* IE is contained in the UE CONTEXT MODIFICATION REQUEST message, the gNB-DU shall act as specified in the TS 38.401 [4], and replace any previously received value. If *Duplication Indication* IE is contained in the *SRB To Be Setup List* IE, the gNB-DU shall, if supported, setup two RLC entities for the indicated SRB if the value is set to be "true", or delete the RLC entity of secondary path if the value is set to be "false".

If the *DRB To Be Setup List* IE is contained in the UE CONTEXT MODIFICATION REQUEST message, the gNB-DU shall act as specified in the TS 38.401 [4].

If two *UL UP TNL Information* IEs are included in UE CONTEXT MODIFICATION REQUEST message for a DRB, the gNB-DU shall include two *DL UP TNL Information* IEs in UE CONTEXT MODIFICATION RESPONSE message and setup two RLC entities for the indicated DRB. gNB-CU and gNB-DU use the *UL UP TNL Information* IEs and *DL UP TNL Information* IEs to support packet duplication for intra-gNB-DU CA as defined in TS 38.470 [2]. The first *UP TNL Information* IE of the two *UP TNL Information* IEs is for the primary path.

If *Duplication Activation* IE is included in the UE CONTEXT MODIFICATION REQUEST message for a DRB, the gNB-DU should take it into account when activating/deactivating CA based PDCP duplication for the DRB.

If *DC Based Duplication Configured* IE is included in the UE CONTEXT MODIFICATION REQUEST message for a DRB, the gNB-DU shall regard that DC based PDCP duplication is configured for this DRB if the value is set to be "true" and it should take the responsibility of PDCP duplication activation/deactivation. Otherwise, the gNB-DU shall regard that DC based PDCP duplication is de-configured for this DRB if the value is set to be "false", and it should stop PDCP duplication activation/deactivation by MAC CE. If *DC Based Duplication Activation* IE is included in the UE

CONTEXT MODIFICATION REQUEST message for a DRB, the gNB-DU should take it into account when activating/deactivating DC based PDCP duplication for this DRB.

For a certain DRB which was allocated with two GTP-U tunnels, if such DRB is modified and given one GTP-U tunnel via the UE Context Modification procedure, the gNB-DU shall consider that the CA based PDCP duplication for the concerned DRB is de-configured. If such UE Context Modification procedure occurs, the *Duplication Activation IE* shall not be included for the concerned DRB.

If the *UL Configuration IE* in *DRB to Be Setup Item IE* or *DRB to Be Modified Item IE* is contained in the UE CONTEXT MODIFICATION REQUEST message, the gNB-DU shall take it into account for UL scheduling.

If the ongoing reconfiguration procedure involves changes of the L1/L2 configuration at the gNB-DU signalled to the gNB-CU via the *CellGroupConfig IE*, the gNB-CU shall include the *RRC Reconfiguration Complete Indicator IE* in the UE CONTEXT MODIFICATION REQUEST message to inform the gNB-DU that the ongoing reconfiguration procedure, including *CellGroupConfig IE*, has been successfully or unsuccessfully performed. In the case that the ongoing reconfiguration procedure has failed, the gNB-DU shall continue to use the old UE configuration.

If *DL PDCP SN length IE* is included in the UE CONTEXT MODIFICATION REQUEST message for a DRB, gNB-DU shall, if supported, store this information and use it for lower layer configuration.

If *UL PDCP SN length IE* is included in the UE CONTEXT MODIFICATION REQUEST message for a DRB, gNB-DU shall, if supported, store this information and use it for lower layer configuration.

If the *RLC Failure Indication IE* is included in UE CONTEXT MODIFICATION REQUEST message, the gNB-DU should consider that the RLC entity indicated by such IE needs to be re-established when the CA-based packet duplication is active, and the gNB-DU may include the *Associated SCell List IE* in UE CONTEXT MODIFICATION RESPONSE by containing a list of SCell(s) associated with the RLC entity indicated by the *RLC Failure Indication IE*.

If the UE CONTEXT MODIFICATION REQUEST message contains the *RRC-Container IE*, the gNB-DU shall send the corresponding RRC message to the UE. If the UE CONTEXT MODIFICATION REQUEST message includes the *Execute Duplication IE*, the gNB-DU shall perform CA based duplication, if configured, for the SRB for the included *RRC-Container IE*.

If the UE CONTEXT MODIFICATION REQUEST message contains the *Transmission Action Indicator IE*, the gNB-DU shall stop or restart (if already stopped) data transmission for the UE, according to the value of this IE. It is up to gNB-DU implementation when to stop or restart the UE scheduling.

For EN-DC operation, if the *DRB to Be Setup List IE* is present in the UE CONTEXT MODIFICATION REQUEST message the gNB-CU shall include the *E-UTRAN QoS IE*. The allocation of resources according to the values of the *Allocation and Retention Priority IE* included in the *E-UTRAN QoS IE* shall follow the principles described for the E-RAB Setup procedure in TS 36.413 [15]. For NG-RAN operation, the gNB-CU shall include the *DRB Information IE* in the UE CONTEXT MODIFICATION REQUEST message.

If the gNB-CU includes the SMTC information of the measured frequency(ies) in the *MeasurementTimingConfiguration IE* of the *CU to DU RRC Information IE* that is included in the UE CONTEXT MODIFICATION REQUEST message, the gNB-DU shall generate the measurement gaps based on the received SMTC information. Then the gNB-DU shall send the measurement gaps information to the gNB-CU in the *MeasGapConfig IE* of the *DU to CU RRC Information IE* that is included in the UE CONTEXT MODIFICATION RESPONSE message.

For DC operation, if the gNB-CU includes the *CG-Config IE* in the *CU to DU RRC Information IE* that is included in the UE CONTEXT MODIFICATION REQUEST message, the gNB-DU may initiate low layer parameters coordination taking this information into account.

For EN-DC operation, if the gNB-CU includes the *Resource Coordination Transfer Information IE* in the UE CONTEXT MODIFICATION REQUEST message, the gNB-DU shall, if supported, use it for the purpose of resource coordination. If the gNB-CU received the MeNB Resource Coordination Information as defined in TS 36.423 [9], after completion of UE Context Setup procedures, the gNB-CU shall transparently transfer it to the gNB-DU via the *Resource Coordination Transfer Container IE* in the UE CONTEXT MODIFICATION REQUEST message. The gNB-DU shall use the information received in the *Resource Coordination Transfer Container IE* for reception of MeNB Resource Coordination Information at the gNB acting as secondary node as described in TS 36.423 [9]. If the *Resource Coordination E-UTRA Cell Information IE* is included in the *Resource Coordination Transfer Information IE*, the gNB-DU shall store the information replacing previously received information for the same E-UTRA cell, and use the stored information for the purpose of resource coordination. If the *Ignore PRACH Configuration IE* is present and set to "true" the *E-UTRA PRACH Configuration IE* in the UE CONTEXT MODIFICATION REQUEST message shall be ignored.

For NGEN-DC or NE-DC operation, if the gNB-CU includes the *Resource Coordination Transfer Information* IE in the UE CONTEXT MODIFICATION REQUEST message, the gNB-DU shall, if supported, use it for the purpose of resource coordination. If the gNB-CU received the MR-DC Resource Coordination Information as defined in TS 38.423 [28], after completion of UE Context Setup procedures, the gNB-CU shall transparently transfer it to the gNB-DU via the *Resource Coordination Transfer Container* IE in the UE CONTEXT MODIFICATION REQUEST message. The gNB-DU shall use the information received in the *Resource Coordination Transfer Container* IE for reception of MR-DC Resource Coordination Information at the gNB as described in TS 38.423 [28].

For EN-DC operation, and if the *Subscriber Profile ID for RAT/Frequency priority* IE is received from an MeNB, the UE CONTEXT MODIFICATION REQUEST message shall contain the *Subscriber Profile ID for RAT/Frequency priority* IE. The gNB-DU shall store the received Subscriber Profile ID for RAT/Frequency priority in the UE context and use it as defined in TS 36.300 [20].

If the *Index to RAT/Frequency Selection Priority* IE is modified at the gNB-CU, the *Index to RAT/Frequency Selection Priority* IE shall be included in the UE CONTEXT MODIFICATION REQUEST. The gNB-DU may use it for RRM purposes.

If the UE CONTEXT MODIFICATION REQUEST message contains the *Uplink TxDirectCurrentList Information* IE, the gNB-DU may take that into account when selecting L1 configuration.

The *UEAssistanceInformation* IE shall be included in *CU to DU RRC Information* IE in the UE CONTEXT MODIFICATION REQUEST message if the gNB-CU received this IE from the UE; if the *UEAssistanceInformation* IE is included in the *CU to DU RRC Information* IE in the UE CONTEXT MODIFICATION REQUEST message, the gNB-DU shall, if supported, take it into account when configuring resources for the UE.

The gNB-DU shall report to the gNB-CU, in the UE CONTEXT MODIFICATION RESPONSE message, the result for all the requested or modified DRBs and SRBs in the following way:

- A list of DRBs which are successfully established shall be included in the *DRB Setup List* IE;
- A list of DRBs which failed to be established shall be included in the *DRB Failed to be Setup List* IE;
- A list of DRBs which are successfully modified shall be included in the *DRB Modified List* IE;
- A list of DRBs which failed to be modified shall be included in the *DRB Failed to be Modified List* IE;
- A list of SRBs which failed to be established shall be included in the *SRB Failed to be Setup List* IE.
- A list of successfully established SRBs with logical channel identities for primary path shall be included in the *SRB Setup List* IE only if CA based PDCP duplication is initiated for the concerned SRBs.
- A list of successfully modified SRBs with logical channel identities for primary path shall be included in the *SRB Modified List* IE only if CA based PDCP duplication is initiated for the concerned SRBs.

When the gNB-DU reports the unsuccessful establishment of a DRB or SRB, the cause value should be precise enough to enable the gNB-CU to know the reason for the unsuccessful establishment.

If the *Resource Coordination Transfer Container* IE is included in the UE CONTEXT MODIFICATION RESPONSE, the gNB-CU shall transparently transfer this information for the purpose of resource coordination as described in TS 36.423 [9], TS 38.423 [28].

If the *CellGroupConfig* IE is included in the *DU to CU RRC Information* IE contained in the UE CONTEXT MODIFICATION RESPONSE message, the gNB-CU shall perform RRC Reconfiguration as described in TS 38.331 [8]. The *CellGroupConfig* IE shall transparently be signaled to the UE as specified in TS 38.331 [8].

If the *UE-CapabilityRAT-ContainerList* IE is included in the UE CONTEXT SETUP MODIFICATION REQUEST, the gNB-DU shall take this information into account for UE specific configurations.

If the *SCell Failed To Setup List* IE is contained in the UE CONTEXT MODIFICATION RESPONSE message, the gNB-CU shall regard the corresponding SCell(s) failed to be set up with an appropriate cause value for each SCell failed to setup.

If the *C-RNTI* IE is included in the UE CONTEXT MODIFICATION RESPONSE, the gNB-CU shall consider that the C-RNTI has been allocated by the gNB-DU for this UE context.

If the *Inactivity Monitoring Request* IE is contained in the UE CONTEXT MODIFICATION REQUEST message, gNB-DU may consider that the gNB-CU has requested the gNB-DU to perform UE inactivity monitoring. If the *Inactivity Monitoring Response* IE is contained in the UE CONTEXT MODIFICATION RESPONSE message and set to “Not-supported”, the gNB-CU shall consider that the gNB-DU does not support UE inactivity monitoring for the UE.

The UE Context Modify Procedure is not used to configure SRB0.

If the *Notification Control* IE is included in the *DRB to Be Setup List* IE or the *DRB to Be Modified List* IE and it is set to active, the gNB-DU shall, if supported, monitor the QoS of the DRB and notify the gNB-CU if the QoS cannot be fulfilled any longer or if the QoS can be fulfilled again. The *Notification Control* IE can only be applied to GBR bearers.

If the *UL PDU Session Aggregate Maximum Bit Rate* IE is included in the *QoS Flow Level QoS Parameters* IE contained in the UE CONTEXT MODIFICATION REQUEST message, the gNB-DU shall replace the received UL PDU Session Aggregate Maximum Bit Rate and use it as specified in TS 23.501 [21].

If the *gNB-DU UE Aggregate Maximum Bit Rate Uplink* IE is included in the UE CONTEXT MODIFICATION REQUEST message, the gNB-DU shall:

- replace the previously provided gNB-DU UE Aggregate Maximum Bit Rate Uplink with the new received gNB-DU UE Aggregate Maximum Bit Rate Uplink;
- use the received gNB-DU UE Aggregate Maximum Bit Rate Uplink for non-GBR Bearers for the concerned UE.

The *UL PDU Session Aggregate Maximum Bit Rate* IE shall be sent if *DRB to Be Setup List* IE is included and the gNB-CU has not previously sent it. The gNB-DU shall store and use the received gNB-DU UE Aggregate Maximum Bit Rate Uplink.

If the *RLC Status* IE is included in the UE CONTEXT MODIFICATION RESPONSE message, the gNB-CU shall assume that RLC has been reestablished at the gNB-DU and may trigger PDCP data recovery.

If the *GNB-DU Configuration Query* IE is contained in the UE CONTEXT MODIFICATION REQUEST message, gNB-DU shall include the *CellGroupConfig* IE in the *DU To CU RRC Information* IE in the UE CONTEXT MODIFICATION RESPONSE message.

If the *Bearer Type Change* IE is included in *DRB to Be Modified List* IE in the UE CONTEXT MODIFICATION REQUEST message, the gNB-DU shall either reset the lower layers or generate a new LCID for the affected bearer as specified in TS 37.340[7].

For NE-DC operation, if *NeedforGap* IE is included in the UE CONTEXT MODIFICATION REQUEST message, the gNB-DU shall generate measurement gap for the SeNB.

If the *QoS Flow Mapping Indication* IE is included in the UE CONTEXT MODIFICATION REQUEST message, the gNB-DU shall, if supported, replace any previously received value and take it into account that only the uplink or downlink QoS flow is mapped to the DRB.

If the *Full Configuration* IE is contained in the UE CONTEXT MODIFICATION REQUEST message, the gNB-DU shall generate a *CellGroupConfig* IE using full configuration and include it in the UE CONTEXT MODIFICATION RESPONSE.

If the *Full Configuration* IE is contained in the UE CONTEXT MODIFICATION RESPONSE message, the gNB-CU shall consider that the gNB-DU has generated the *CellGroupConfig* IE using full configuration.

8.3.4.3 Unsuccessful Operation

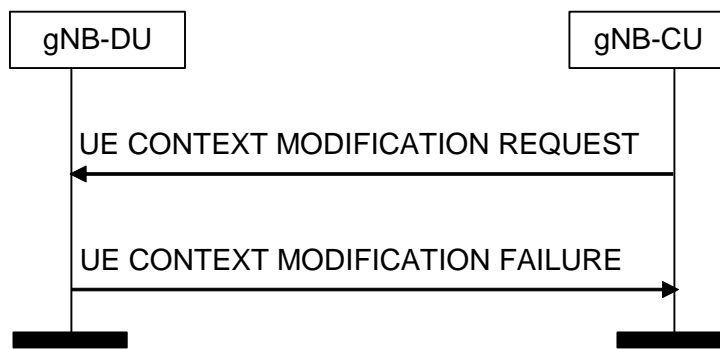

Figure 8.3.4.3-1: UE Context Modification procedure. Unsuccessful operation

In case none of the requested modifications of the UE context can be successfully performed, the gNB-DU shall respond with the UE CONTEXT MODIFICATION FAILURE message with an appropriate cause value.

If the gNB-DU is not able to accept the *SpCell ID* IE in UE CONTEXT MODIFICATION REQUEST message, it shall reply with the UE CONTEXT MODIFICATION FAILURE message.

8.3.4.4 Abnormal Conditions

If the gNB-DU receives a UE CONTEXT MODIFICATION REQUEST message containing a *E-UTRAN QoS* IE for a GBR QoS DRB but where the *GBR QoS Information* IE is not present, the gNB-DU shall report the establishment of the corresponding DRB as failed in the *DRB Failed to Setup List* IE of the UE CONTEXT MODIFICATION RESPONSE message with an appropriate cause value.

If the gNB-DU receives a UE CONTEXT MODIFICATION REQUEST message containing a *DRB QoS* IE for a GBR QoS DRB but where the *GBR QoS Flow Information* IE is not present, the gNB-DU shall report the establishment of the corresponding DRBs as failed in the *DRB Failed to Setup List* IE of the UE CONTEXT MODIFICATION RESPONSE message with an appropriate cause value.

If the *Delay Critical* IE is included in the *Dynamic 5QI Descriptor* IE within the *DRB QoS* IE in the UE CONTEXT MODIFICATION REQUEST message and is set to the value “delay critical” but the *Maximum Data Burst Volume* IE is not present, the gNB-DU shall report the establishment of the corresponding DRB as failed in the *DRB Failed to Setup List* IE of the UE CONTEXT MODIFICATION RESPONSE message with an appropriate cause value.

8.3.5 UE Context Modification Required (gNB-DU initiated)

8.3.5.1 General

The purpose of the UE Context Modification Required procedure is to modify the established UE Context, e.g., modifying and releasing radio bearer resources. The procedure uses UE-associated signalling.

8.3.5.2 Successful Operation

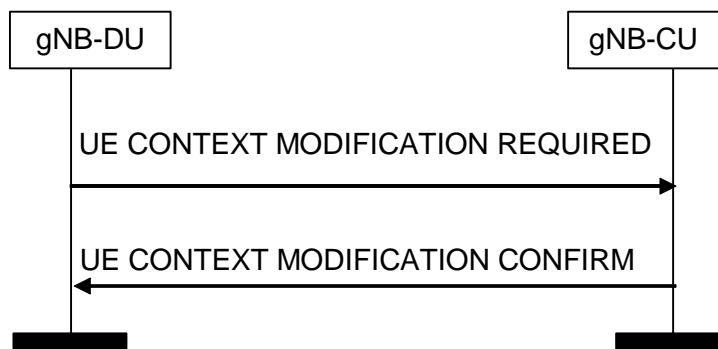

Figure 8.3.5.2-1: UE Context Modification Required procedure. Successful operation

The F1AP UE CONTEXT MODIFICATION REQUIRED message is initiated by the gNB-DU.

The gNB-CU reports the successful update of the UE context in the UE CONTEXT MODIFICATION CONFIRM message.

For a given bearer for which PDCP CA duplication was already configured, if two *DL UP TNL Information* IEs are included in UE CONTEXT MODIFICATION REQUIRED message for a DRB, the gNB-CU shall include two *UL UP TNL Information* IEs in UE CONTEXT MODIFICATION CONFIRM message. The gNB-CU and gNB-DU use the *UL UP TNL Information* IEs and *DL UP TNL Information* IEs to support packet duplication for intra-gNB-DU CA as defined in TS 38.470 [2], and the first *UP TNL Information* IE is still for the primary path.

If the *Resource Coordination Transfer Container* IE is included in the UE CONTEXT MODIFICATION REQUIRED, the gNB-CU shall transparently transfer this information for the purpose of resource coordination as described in TS 36.423 [9], TS 38.423 [28].

For EN-DC operation, if the gNB-CU includes the *Resource Coordination Transfer Information* IE in the UE CONTEXT MODIFICATION CONFIRM message, the gNB-DU shall, if supported, use it for the purpose of resource coordination. If the gNB-CU received the MeNB Resource Coordination Information as defined in TS 36.423 [9], after completion of UE Context Modification Required procedures, the gNB-CU shall transparently transfer it to the gNB-DU via the *Resource Coordination Transfer Container* IE in the UE CONTEXT MODIFICATION CONFIRM message. The gNB-DU shall use the information received in the *Resource Coordination Transfer Container* IE for reception of MeNB Resource Coordination Information at the gNB acting as secondary node as described in TS 36.423 [9]. If the *Resource Coordination E-UTRA Cell Information* IE is included in the *Resource Coordination Transfer Information* IE, the gNB-DU shall store the information replacing previously received information for the same E-UTRA cell, and use the stored information for the purpose of resource coordination. If the *Ignore PRACH Configuration* IE is present and set to "true" the *E-UTRA PRACH Configuration* IE in the UE CONTEXT MODIFICATION CONFIRM message shall be ignored.

For NGEN-DC or NE-DC operation, if the gNB-CU includes the *Resource Coordination Transfer Information* IE in the UE CONTEXT MODIFICATION CONFIRM message, the gNB-DU shall, if supported, use it for the purpose of resource coordination. If the gNB-CU received the MR-DC Resource Coordination Information as defined in TS 38.423 [28], after completion of UE Context Modification Required procedures, the gNB-CU shall transparently transfer it to the gNB-DU via the *Resource Coordination Transfer Container* IE in the UE CONTEXT MODIFICATION CONFIRM message. The gNB-DU shall use the information received in the *Resource Coordination Transfer Container* IE for reception of MR-DC Resource Coordination Information at the gNB as described in TS 38.423 [28].

If the *CellGroupConfig* IE is included in the *DU to CU RRC Information* IE contained in the UE CONTEXT MODIFICATION REQUIRED message, the gNB-CU shall perform RRC Reconfiguration as described in TS 38.331 [8]. The *CellGroupConfig* IE shall transparently be signaled to the UE as specified in TS 38.331 [8].

If the UE CONTEXT MODIFICATION CONFIRM message includes the *Execute Duplication* IE, the gNB-DU shall perform CA based duplication, if configured, for the SRB for the included *RRC-Container* IE.

If the UE CONTEXT MODIFICATION REQUIRED message contains the *RLC Status* IE, the gNB-CU shall assume that RLC has been reestablished at the gNB-DU and may trigger PDCP data recovery.

8.3.5.2A Unsuccessful Operation

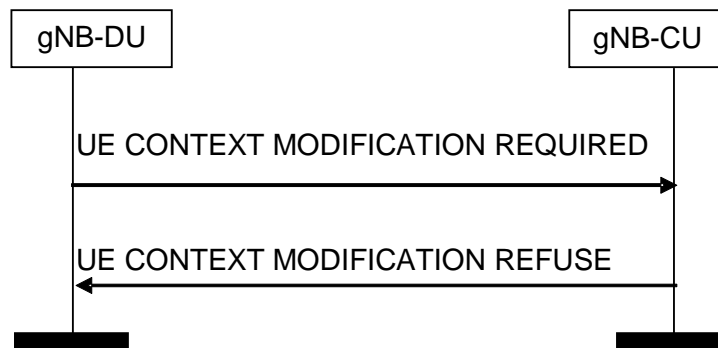

Figure 8.3.5.2A-1: UE Context Modification Required procedure. Unsuccessful operation.

In case none of the requested modifications of the UE context can be successfully performed, the gNB-CU shall respond with the UE CONTEXT MODIFICATION REFUSE message with an appropriate cause value.

8.3.5.3 Abnormal Conditions

Not applicable.

8.3.6 UE Inactivity Notification

8.3.6.1 General

This procedure is initiated by the gNB-DU to indicate the UE activity event.

The procedure uses UE-associated signalling.

8.3.6.2 Successful Operation



Figure 8.3.6.2-1: UE Inactivity Notification procedure.

The gNB-DU initiates the procedure by sending the UE INACTIVITY NOTIFICATION message to the gNB-CU.

If the *DRB ID* IE is included in the *DRB Activity Item* IE in the UE INACTIVITY NOTIFICATION message, the *DRB Activity* IE shall also be included

8.3.6.3 Abnormal Conditions

Not applicable.

8.3.7 Notify

8.3.7.1 General

The purpose of the Notify procedure is to enable the gNB-DU to inform the gNB-CU that the QoS of an already established GBR DRB cannot be fulfilled any longer or that it can be fulfilled again. The procedure uses UE-associated signalling.

8.3.7.2 Successful Operation

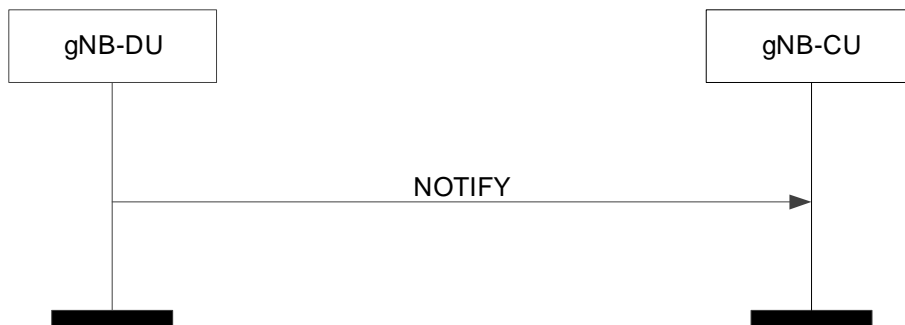

Figure 8.3.7.2-1: Notify procedure. Successful operation.

The gNB-DU initiates the procedure by sending a NOTIFY message.

The NOTIFY message shall contain the list of the GBR DRBs associated with notification control for which the QoS is not fulfilled anymore or for which the QoS is fulfilled again by the gNB-DU.

Upon reception of the NOTIFY message, the gNB-CU may identify which are the affected PDU sessions and QoS flows. The gNB-CU may inform the 5GC that the QoS for these PDU sessions or QoS flows is not fulfilled any longer or it is fulfilled again.

8.3.7.3 Abnormal Conditions

Not applicable.

8.4 RRC Message Transfer procedures

8.4.1 Initial UL RRC Message Transfer

8.4.1.1 General

The purpose of the Initial UL RRC Message Transfer procedure is to transfer the initial RRC message to the gNB-CU. The procedure uses non-UE-associated signaling.

8.4.1.2 Successful operation

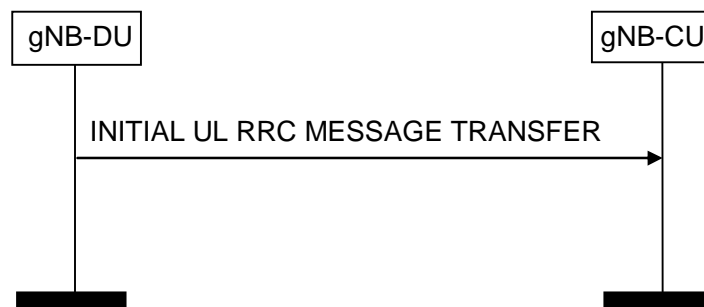

Figure 8.4.1.2-1: Initial UL RRC Message Transfer procedure.

The establishment of the UE-associated logical F1-connection shall be initiated as part of the procedure.

If the *DU to CU RRC Container* IE is not included in the INITIAL UL RRC MESSAGE TRANSFER, the gNB-CU should reject the UE under the assumption that the gNB-DU is not able to serve such UE. If the gNB-DU is able to serve the UE, the gNB-DU shall include the *DU to CU RRC Container* IE and the gNB-CU shall configure the UE as specified in TS 38.331 [8]. The gNB-DU shall not include the *ReconfigurationWithSync* field in the *CellGroupConfig* IE as defined in TS 38.331 [8] of the *DU to CU RRC Container* IE.

If the *SUL Access Indication* IE is included in the INITIAL UL RRC MESSAGE TRANSFER, the gNB-CU shall consider that the UE has performed access on SUL carrier.

If the *RRC-Container-Networksharing list* IE is included in the INITIAL UL RRC MESSAGE TRANSFER, the gNB-CU shall take it into account as specified in TS 38.401 [4].

8.4.1.3 Abnormal Conditions

Not applicable.

8.4.2 DL RRC Message Transfer

8.4.2.1 General

The purpose of the DL RRC Message Transfer procedure is to transfer an RRC message. The procedure uses UE-associated signalling.

8.4.2.2 Successful operation



Figure 8.4.2.2-1: DL RRC Message Transfer procedure

If a UE-associated logical F1-connection exists, the DL RRC MESSAGE TRANSFER message shall contain the *gNB-DU UE FIAP ID* IE, which should be used by gNB-DU to lookup the stored UE context. If no UE-associated logical F1-connection exists, the UE-associated logical F1-connection shall be established at reception of the DL RRC MESSAGE TRANSFER message.

If the *Index to RAT/Frequency Selection Priority* IE is included in the DL RRC MESSAGE TRANSFER, the gNB-DU may use it for RRM purposes.

The DL RRC MESSAGE TRANSFER message shall include, if available, the *old gNB-DU UE F1AP ID* IE so that the gNB-DU can retrieve the existing UE context in RRC connection reestablishment procedure, as defined in TS 38.401 [4].

The DL RRC MESSAGE TRANSFER message shall include, if SRB duplication is activated, the *Execute Duplication* IE, so that the gNB-DU can perform CA based duplication for the SRB.

If the gNB-DU identifies the UE-associated logical F1-connection by the *gNB-DU UE F1AP ID* IE in the DL RRC MESSAGE TRANSFER message and the *old gNB-DU UE F1AP ID* IE is included, it shall release the old gNB-DU UE F1AP ID and the related configurations associated with the old gNB-DU UE F1AP ID.

If the *UE Context not retrievable* IE set to "true" is included in the DL RRC MESSAGE TRANSFER, the DL RRC MESSAGE TRANSFER may contain the *Redirected RRC message* IE and use it as specified in TS 38.401 [4].

If the *UE Context not retrievable* IE set to "true" is included in the DL RRC MESSAGE TRANSFER, the DL RRC MESSAGE TRANSFER may contain the *PLMN Assistance Info for Network Sharing* IE, if available at the gNB-CU and may use it as specified in TS 38.401 [4].

If the DL RRC MESSAGE TRANSFER message contains the *New gNB-CU UE F1AP ID* IE, the gNB-DU shall, if supported, replace the value received in the *gNB-CU UE F1AP ID* IE by the value of the *New gNB-CU UE F1AP ID* and use it for further signalling.

Interactions with UE Context Release Request procedure:

If the *UE Context not retrievable* IE set to "true" is included in the DL RRC MESSAGE TRANSFER, the gNB-DU may trigger the UE Context Release Request procedure, as specified in TS 38.401 [4].

8.4.2.3 Abnormal Conditions

Not applicable.

8.4.3 UL RRC Message Transfer

8.4.3.1 General

The purpose of the UL RRC Message Transfer procedure is to transfer an RRC message as an UL PDCP-PDU to the gNB-CU. The procedure uses UE-associated signalling.

8.4.3.2 Successful operation



Figure 8.4.3.2-1: UL RRC Message Transfer procedure

When the gNB-DU has received from the radio interface an RRC message to which a UE-associated logical F1-connection for the UE exists, the gNB-DU shall send the UPLINK RRC TRANSFER message to the gNB-CU including the RRC message as a *RRC-Container* IE.

If the *Selected PLMN ID* IE is contained in the UL RRC MESSAGE TRANSFER message, the gNB-CU may use it as specified in TS 38.401 [4].

If the UL RRC MESSAGE TRANSFER message contains the *New gNB-DU UE FIAP ID IE*, the gNB-CU shall, if supported, replace the value received in the *gNB-DU UE FIAP ID IE* by the value of the *New gNB-DU UE FIAP ID* and use it for further signalling.

8.4.3.3 Abnormal Conditions

Not applicable.

8.4.4 RRC Delivery Report

8.4.4.1 General

The purpose of the RRC Delivery Report procedure is to transfer to the gNB-CU information about successful delivery of DL PDCP-PDUs including RRC messages. The procedure uses UE-associated signalling.

8.4.4.2 Successful operation



Figure 8.4.4.2-1: RRC Delivery Report procedure.

When the gNB-DU has successfully delivered an RRC message to the UE for which the gNB-CU has requested a delivery report, the gNB-DU shall send the RRC DELIVERY REPORT message to the gNB-CU containing the *RRC Delivery Status IE* and the *SRB ID IE*.

8.4.4.3 Abnormal Conditions

Not applicable.

8.5 Warning Message Transmission Procedures

8.5.1 Write-Replace Warning

8.5.1.1 General

The purpose of Write-Replace Warning procedure is to start or overwrite the broadcasting of warning messages. The procedure uses non UE-associated signalling.

8.5.1.2 Successful Operation

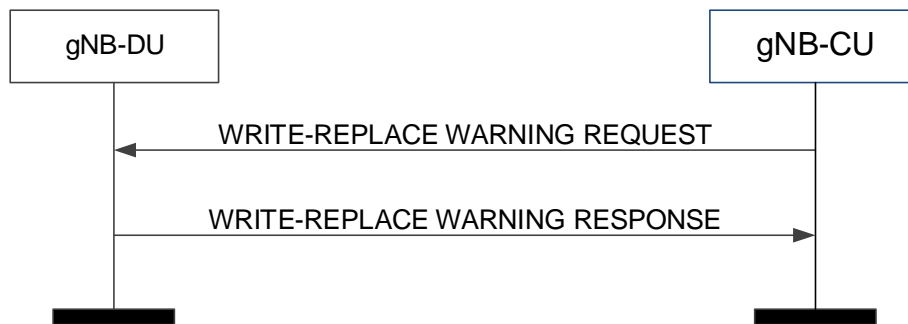

Figure 8.5.1.2-1: Write-Replace Warning procedure: successful operation

The gNB-CU initiates the procedure by sending a WRITE-REPLACE WARNING REQUEST message to the gNB-DU.

Upon receipt of the WRITE-REPLACE WARNING REQUEST message, the gNB-DU shall prioritise its resources to process the warning message.

The gNB-DU acknowledges the WRITE-REPLACE WARNING REQUEST message by sending a WRITE-REPLACE WARNING RESPONSE message to the gNB-CU.

Upon receipt of the WRITE-REPLACE WARNING REQUEST message, the gNB-DU shall include the *Dedicated SI Delivery Needed UE List* IE in the WRITE-REPLACE WARNING RESPONSE message for UEs that are unable to receive system information from broadcast.

If *Dedicated SI Delivery Needed UE List* IE is contained in the WRITE-REPLACE WARNING RESPONSE message, the gNB-CU should take it into account when informing the UE of the updated system information via the dedicated RRC message.

If the *Notification Information* IE is included in the *PWS System Information* IE in the WRITE-REPLACE WARNING REQUEST message, the gNB-DU shall use this information to avoid that duplications trigger new broadcast or replace existing broadcast.

If *Additional SIB Message List* IE is included in *PWS System Information* IE, the gNB-DU shall store all SIB message(s) in *PWS System Information* IE, and consider that the first segment of public warning message is included in *SIB message* IE, and the remaining segments are listed in *Additional SIB Message List* IE in segmentation sequence order.

8.5.1.3 Unsuccessful Operation

Not applicable.

8.5.1.4 Abnormal Conditions

Not applicable.

8.5.2 PWS Cancel

8.5.2.1 General

The purpose of the PWS Cancel procedure is to cancel an already ongoing broadcast of a warning message. The procedure uses non UE-associated signalling.

8.5.2.2 Successful Operation

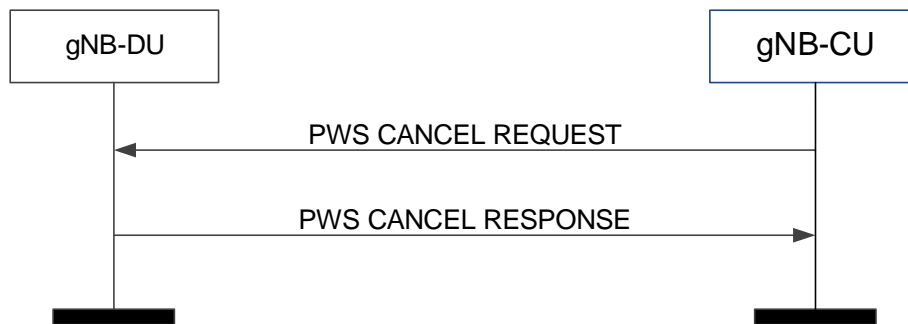

Figure 8.5.2.2-1: PWS Cancel procedure: successful operation

The gNB-CU initiates the procedure by sending a PWS CANCEL REQUEST message to the gNB-DU.

The gNB-DU shall acknowledge the PWS CANCEL REQUEST message by sending the PWS CANCEL RESPONSE message.

If the *Cancel-All Warning Messages Indicator* IE is present in the PWS CANCEL REQUEST message, then the gNB-DU shall stop broadcasting and discard all warning messages for the area as indicated in the *Cell Broadcast To Be Cancelled List* IE or in all the cells of the gNB-DU if the *Cell Broadcast To Be Cancelled List* IE is not included. The gNB-DU shall acknowledge the PWS CANCEL REQUEST message by sending the PWS CANCEL RESPONSE message, and shall, if there is area to report where an ongoing broadcast was stopped successfully, include the *Cell Broadcast Cancelled List* IE with the *Number of Broadcasts* IE set to 0.

If the *Cell Broadcast To Be Cancelled List* IE is not included in the PWS CANCEL REQUEST message, the gNB-DU shall stop broadcasting and discard the warning message identified by the *Message Identifier* IE and the *Serial Number* IE in the *Notification Information* IE in all of the cells in the gNB-DU.

If the *Notification Information* IE is included in the PWS CANCEL REQUEST, the gNB-DU shall cancel broadcast of the public warning message identified by the *Notification Information* IE.

8.5.1.3 Unsuccessful Operation

Not applicable.

8.5.1.4 Abnormal Conditions

Not applicable.

8.5.3 PWS Restart Indication

8.5.3.1 General

The purpose of PWS Restart Indication procedure is to inform the gNB-CU that PWS information for some or all cells of the gNB-DU are available for reloading from the CBC if needed. The procedure uses non UE-associated signalling.

8.5.3.2 Successful Operation

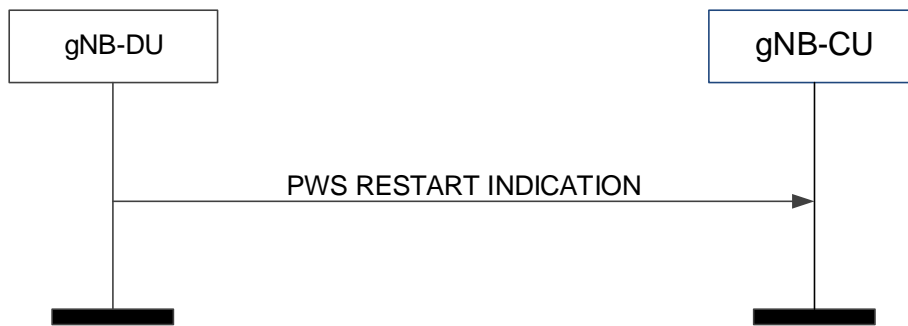

Figure 8.5.3.2-1: PWS restart indication

The gNB-DU initiates the procedure by sending a PWS RESTART INDICATION message to the gNB-CU.

8.5.3.3 Abnormal Conditions

Not applicable.

8.5.4 PWS Failure Indication

8.5.4.1 General

The purpose of the PWS Failure Indication procedure is to inform the gNB-CU that ongoing PWS operation for one or more cells of the gNB-DU has failed. The procedure uses non UE-associated signalling.

8.5.4.2 Successful Operation

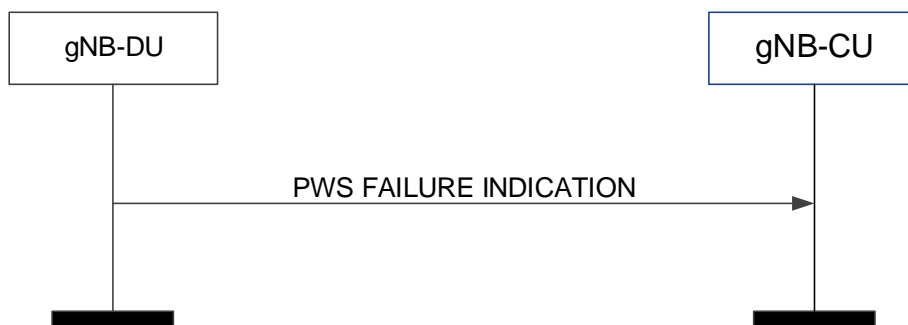

Figure 8.5.4.2-1: PWS failure indication

The gNB-DU initiates the procedure by sending a PWS FAILURE INDICATION message to the gNB-CU.

8.5.4.3 Abnormal Conditions

Not applicable.

8.6 System Information Procedures

8.6.1 System Information Delivery

8.6.1.1 General

The purpose of the System Information Delivery procedure is to command the gNB-DU to broadcast the requested Other SI. The procedure uses non-UE associated signalling.

8.6.1.2 Successful Operation

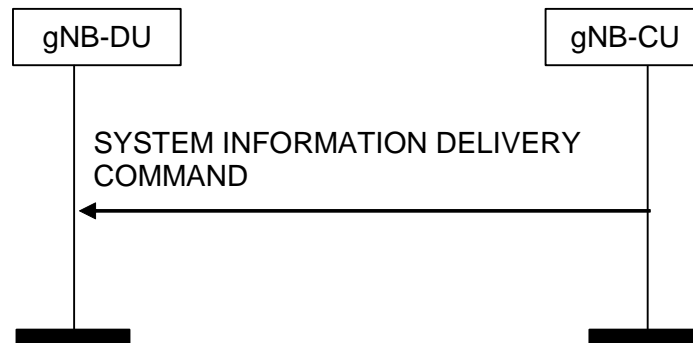

Figure 8.6.1.2-1: System Information Delivery procedure. Successful operation.

The gNB-CU initiates the procedure by sending a SYSTEM INFORMATION DELIVERY COMMAND message to the gNB-DU.

Upon reception of the SYSTEM INFORMATION DELIVERY COMMAND message, the gNB-DU shall broadcast the requested Other SI, and delete the UE context corresponding to the *Confirmed UE ID* IE, if any.

Interactions with gNB-DU Configuration Update procedure:

Upon reception of SYSTEM INFORMATION DELIVERY COMMAND message, the gNB-DU Configuration Update procedure may be performed, and as part of such procedure the gNB-DU shall include the *Dedicated SI Delivery Needed UE List* IE in GNB-DU CONFIGURATION UPDATE message for UEs that are unable to receive system information from broadcast.

8.6.1.3 Abnormal Conditions

Not applicable.

8.7 Paging procedures

8.7.1 Paging

8.7.1.1 General

The purpose of the Paging procedure is used to provide the paging information to enable the gNB-DU to page a UE. The procedure uses non-UE associated signalling.

8.7.1.2 Successful Operation

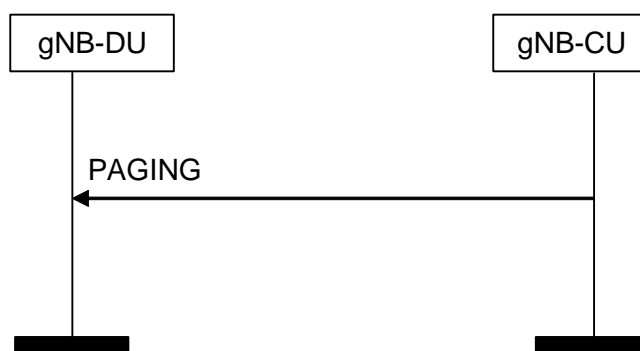

Figure 8.7.1.2-1: Paging procedure. Successful operation.

The gNB-CU initiates the procedure by sending a PAGING message.

The *Paging DRX* IE may be included in the PAGING message, and if present the gNB-DU may use it to determine the final paging cycle for the UE.

The *Paging Priority* IE may be included in the PAGING message, and if present the gNB-DU may use it according to TS 23.501 [21].

At the reception of the PAGING message, the gNB-DU shall perform paging of the UE in cells which belong to cells as indicated in the *Paging Cell List* IE.

The *Paging Origin* IE may be included in the PAGING message, and if present the gNB-DU shall transfer it to the UE.

8.7.1.3 Abnormal Conditions

Not applicable.

9 Elements for F1AP Communication

9.1 General

Subclauses 9.2 and 9.3 present the F1AP message and IE definitions in tabular format. The corresponding ASN.1 definition is presented in subclause 9.4. In case there is contradiction between the tabular format and the ASN.1 definition, the ASN.1 shall take precedence, except for the definition of conditions for the presence of conditional IEs, where the tabular format shall take precedence.

The messages have been defined in accordance to the guidelines specified in TR 25.921 [14].

When specifying IEs which are to be represented by bitstrings, if not otherwise specifically stated in the semantics description of the concerned IE or elsewhere, the following principle applies with regards to the ordering of bits:

- The first bit (leftmost bit) contains the most significant bit (MSB);
- The last bit (rightmost bit) contains the least significant bit (LSB);
- When importing bitstrings from other specifications, the first bit of the bitstring contains the first bit of the concerned information;

The following attributes are used for the tabular description of the messages and information elements: Presence, Range Criticality and Assigned Criticality. Their definition and use can be found in TS 38.413 [3].

9.2 Message Functional Definition and Content

9.2.1 Interface Management messages

9.2.1.1 RESET

This message is sent by both the gNB-CU and the gNB-DU and is used to request that the F1 interface, or parts of the F1 interface, to be reset.

Direction: gNB-CU → gNB-DU and gNB-DU → gNB-CU

| IE/Group Name | Presence | Range | IE type and reference | Semantics description | Criticality | Assigned Criticality |
|---|----------|---|----------------------------|-----------------------|-------------|----------------------|
| Message Type | M | | 9.3.1.1 | | YES | reject |
| Transaction ID | M | | 9.3.1.23 | | YES | reject |
| Cause | M | | 9.3.1.2 | | YES | ignore |
| CHOICE <i>Reset Type</i> | M | | | | YES | reject |
| > <i>F1 interface</i> | | | | | | |
| >>Reset All | M | | ENUMERATED (Reset all,...) | | - | |
| > <i>Part of F1 interface</i> | | | | | | |
| >>UE-associated logical F1-connection list | | 1 | | | - | |
| >>>UE-associated logical F1-connection Item | | 1 .. <maxnoofIndividualF1ConnectionsToReset> | | | EACH | reject |
| >>>> gNB-CU UE F1AP ID | O | | 9.3.1.4 | | - | |
| >>>> gNB-DU UE F1AP ID | O | | 9.3.1.5 | | - | |

| Range bound | Explanation |
|---------------------------------------|--|
| maxnoofIndividualF1ConnectionsToReset | Maximum no. of UE-associated logical F1-connections allowed to reset in one message. Value is 65536. |

9.2.1.2 RESET ACKNOWLEDGE

This message is sent by both the gNB-CU and the gNB-DU as a response to a RESET message.

Direction: gNB-DU → gNB-CU and gNB-CU → gNB-DU.

| IE/Group Name | Presence | Range | IE type and reference | Semantics description | Criticality | Assigned Criticality |
|---|----------|---|-----------------------|-----------------------|-------------|----------------------|
| Message Type | M | | 9.3.1.1 | | YES | reject |
| Transaction ID | M | | 9.3.1.23 | | YES | reject |
| UE-associated logical F1-connection list | | 0..1 | | | YES | ignore |
| >UE-associated logical F1-connection Item | | 1 .. <maxnoofIndividualF1ConnectionsToReset> | | | EACH | ignore |
| >>gNB-CU UE F1AP ID | O | | 9.3.1.4 | | - | |
| >>gNB-DU UE F1AP ID | O | | 9.3.1.5 | | - | |
| Criticality Diagnostics | O | | 9.3.1.3 | | YES | ignore |

| Range bound | Explanation |
|---------------------------------------|--|
| maxnoofIndividualF1ConnectionsToReset | Maximum no. of UE-associated logical F1-connections allowed to reset in one message. Value is 65536. |

9.2.1.3 ERROR INDICATION

This message is sent by both the gNB-CU and the gNB-DU and is used to indicate that some error has been detected in the node.

Direction: gNB-CU → gNB-DU and gNB-DU → gNB-CU

| IE/Group Name | Presence | Range | IE type and reference | Semantics description | Criticality | Assigned Criticality |
|-------------------------|----------|-------|-----------------------|---|-------------|----------------------|
| Message Type | M | | 9.3.1.1 | | YES | ignore |
| Transaction ID | M | | 9.3.1.23 | This IE is ignored if received in UE associated signalling message. | YES | reject |
| gNB-CU UE F1AP ID | O | | 9.3.1.4 | | YES | ignore |
| gNB-DU UE F1AP ID | O | | 9.3.1.5 | | YES | ignore |
| Cause | O | | 9.3.1.2 | | YES | ignore |
| Criticality Diagnostics | O | | 9.3.1.3 | | YES | ignore |

9.2.1.4 F1 SETUP REQUEST

This message is sent by the gNB-DU to transfer information associated to an F1-C interface instance.

NOTE: If a TNL association is shared among several F1-C interface instances, several F1 Setup procedures are issued via the same TNL association after that TNL association has become operational.

Direction: gNB-DU → gNB-CU

| IE/Group Name | Presence | Range | IE type and reference | Semantics description | Criticality | Assigned Criticality |
|-------------------------------------|----------|-----------------------|-----------------------------------|---|-------------|----------------------|
| Message Type | M | | 9.3.1.1 | | YES | reject |
| Transaction ID | M | | 9.3.1.23 | | YES | reject |
| gNB-DU ID | M | | 9.3.1.9 | | YES | reject |
| gNB-DU Name | O | | PrintableString(SIZE(1..150,...)) | | YES | ignore |
| gNB-DU Served Cells List | | 0.. 1 | | List of cells configured in the gNB-DU | YES | reject |
| >gNB-DU Served Cells Item | | 1.. <maxCellingNBD U> | | | EACH | reject |
| >>Served Cell Information | M | | 9.3.1.10 | Information about the cells configured in the gNB-DU | - | |
| >>gNB-DU System Information | O | | 9.3.1.18 | RRC container with system information owned by gNB-DU | - | |
| gNB-DU RRC version | M | | RRC version 9.3.1.70 | | YES | reject |

| Range bound | Explanation |
|----------------|---|
| maxCellingNBDU | Maximum no. cells that can be served by a gNB-DU. Value is 512. |

9.2.1.5 F1 SETUP RESPONSE

This message is sent by the gNB-CU to transfer information associated to an F1-C interface instance.

Direction: gNB-CU → gNB-DU

| IE/Group Name | Presence | Range | IE type and reference | Semantics description | Criticality | Assigned Criticality |
|--|----------|----------------------|-----------------------------------|--|-------------|----------------------|
| Message Type | M | | 9.3.1.1 | | YES | reject |
| Transaction ID | M | | 9.3.1.23 | | YES | reject |
| gNB-CU Name | O | | PrintableString (SIZE(1..150,..)) | Human readable name of the gNB-CU. | YES | ignore |
| Cells to be Activated List | | 0.. 1 | | | YES | reject |
| >Cells to be Activated List Item | | 1.. <maxCellingNBDU> | | List of cells to be activated | EACH | reject |
| >> NR CGI | M | | 9.3.1.12 | | - | |
| >> NR PCI | O | | INTEGER (0..1007) | Physical Cell ID | - | |
| >>gNB-CU System Information | O | | 9.3.1.42 | RRC container with system information owned by gNB-CU | YES | reject |
| >>Available PLMN List | O | | 9.3.1.65 | | YES | ignore |
| >>Extended Available PLMN List | O | | 9.3.1.76 | This is included if <i>Available PLMN List</i> IE is included and if more than 6 Available PLMNs is to be signalled. | YES | ignore |
| gNB-CU RRC version | M | | RRC version 9.3.1.70 | | YES | reject |

| Range bound | Explanation |
|----------------|---|
| maxCellingNBDU | Maximum no. cells that can be served by a gNB-DU. Value is 512. |

9.2.1.6 F1 SETUP FAILURE

This message is sent by the gNB-CU to indicate F1 Setup failure.

Direction: gNB-CU → gNB-DU

| IE/Group Name | Presence | Range | IE type and reference | Semantics description | Criticality | Assigned Criticality |
|-------------------------|----------|-------|-----------------------|-----------------------|-------------|----------------------|
| Message Type | M | | 9.3.1.1 | | YES | reject |
| Transaction ID | M | | 9.3.1.23 | | YES | reject |
| Cause | M | | 9.3.1.2 | | YES | ignore |
| Time to wait | O | | 9.3.1.13 | | YES | ignore |
| Criticality Diagnostics | O | | 9.3.1.3 | | YES | ignore |

9.2.1.7 GNB-DU CONFIGURATION UPDATE

This message is sent by the gNB-DU to transfer updated information associated to an F1-C interface instance.

NOTE: If F1-C signalling transport is shared among several F1-C interface instance, this message may transfer updated information associated to several F1-C interface instances.

Direction: gNB-DU → gNB-CU

| IE/Group Name | Presence | Range | IE type and reference | Semantics description | Criticality | Assigned Criticality |
|--|----------|------------------------------|-----------------------|---|-------------|----------------------|
| Message Type | M | | 9.3.1.1 | | YES | reject |
| Transaction ID | M | | 9.3.1.23 | | YES | reject |
| Served Cells To Add List | | 0..1 | | Complete list of added cells served by the gNB-DU | YES | reject |
| >Served Cells To Add Item | | 1 .. <maxCellingNBD U> | | | EACH | reject |
| >>Served Cell Information | M | | 9.3.1.10 | Information about the cells configured in the gNB-DU | - | |
| >>gNB-DU System Information | O | | 9.3.1.18 | RRC container with system information owned by gNB-DU | - | |
| Served Cells To Modify List | | 0..1 | | Complete list of modified cells served by the gNB-DU | YES | reject |
| >Served Cells To Modify Item | | 1 .. <maxCellingNBD U> | | | EACH | reject |
| >>Old NR CGI | M | | NR CGI 9.3.1.12 | | - | |
| >>Served Cell Information | M | | 9.3.1.10 | Information about the cells configured in the gNB-DU | - | |
| >>gNB-DU System Information | O | | 9.3.1.18 | RRC container with system information owned by gNB-DU | - | |
| Served Cells To Delete List | | 0..1 | | Complete list of deleted cells served by the gNB-DU | YES | reject |
| >Served Cells To Delete Item | | 1.. <maxCellingNBD U> | | | EACH | reject |
| >>Old NR CGI | M | | NR CGI 9.3.1.12 | | - | |
| Cells Status List | | 0..1 | | Complete list of active cells | YES | reject |
| > Cells Status Item | | 0 .. <maxCellingNBD U> | | | EACH | reject |
| >> NR CGI | M | | 9.3.1.12 | | - | |

| | | | | | | |
|--|---|----------------------------|------------------------------------|---|------|--------|
| >>Service Status | M | | 9.3.1.68 | | - | |
| Dedicated SI Delivery Needed UE List | | 0..1 | | List of UEs unable to receive system information from broadcast | YES | ignore |
| > Dedicated SI Delivery Needed UE Item | | 1 .. <maxnoofUEIDs> | | | EACH | ignore |
| >>gNB-CU UE F1AP ID | M | | 9.3.1.4 | | - | |
| >>NR CGI | M | | 9.3.1.12 | | - | |
| gNB-DU ID | O | | 9.3.1.9 | | YES | reject |
| gNB-DU TNL Association To Remove List | | 0..1 | | | YES | reject |
| >gNB-DU TNL Association To Remove Item IEs | | 1..<maxnoofTNLAssociation> | | | EACH | reject |
| >>TNL Association Transport Layer Address | M | | CP Transport Layer Address 9.3.2.4 | Transport Layer Address of the gNB-DU. | - | - |
| >>TNL Association Transport Layer Address gNB-CU | O | | CP Transport Layer Address 9.3.2.4 | Transport Layer Address of the gNB-CU | - | - |

| Range bound | Explanation |
|-------------------------|---|
| maxCellingNBdu | Maximum no. cells that can be served by a gNB-DU. Value is 512. |
| maxnoofUEIDs | Maximum no. of UEs that can be served by a gNB-DU. Value is 65536. |
| maxnoofTNLAassociations | Maximum numbers of TNL Associations between the gNB-CU and the gNB-DU. Value is 32. |

9.2.1.8 GNB-DU CONFIGURATION UPDATE ACKNOWLEDGE

This message is sent by a gNB-CU to a gNB-DU to acknowledge update of information associated to an F1-C interface instance.

NOTE: If F1-C signalling transport is shared among several F1-C interface instances, this message may transfer updated information associated to several F1-C interface instances.

Direction: gNB-CU → gNB-DU

| IE/Group Name | Presence | Range | IE type and reference | Semantics description | Criticality | Assigned Criticality |
|--|----------|-------------------------|-----------------------|-------------------------------|-------------|----------------------|
| Message Type | M | | 9.3.1.1 | | YES | reject |
| Transaction ID | M | | 9.3.1.23 | | YES | reject |
| Cells to be Activated List | | 0.. 1 | | List of cells to be activated | YES | reject |
| >Cells to be Activated List Item | | 1.. <maxCellingNBdu> | | | EACH | reject |
| >> NR CGI | M | | 9.3.1.12 | | - | |

| | | | | | | |
|--|---|-------------------------|-------------------|--|------|--------|
| >> NR PCI | O | | INTEGER (0..1007) | Physical Cell ID | - | |
| >> gNB-CU System Information | O | | 9.3.1.42 | RRC container with system information owned by gNB-CU | YES | reject |
| >>Available PLMN List | O | | 9.3.1.65 | | YES | ignore |
| >>Extended Available PLMN List | O | | 9.3.1.76 | This is included if <i>Available PLMN List</i> IE is included and if more than 6 Available PLMNs is to be signalled. | YES | ignore |
| Criticality Diagnostics | O | | 9.3.1.3 | | YES | ignore |
| Cells to be Deactivated List | | 0.. 1 | | List of cells to be deactivated | YES | reject |
| >Cells to be Deactivated List Item | | 1.. <maxCellingNBDU> | | | EACH | reject |
| >> NR CGI | M | | 9.3.1.12 | | - | - |

| Range bound | Explanation |
|----------------|---|
| maxCellingNBDU | Maximum no. cells that can be served by a gNB-DU. Value is 512. |

9.2.1.9 GNB-DU CONFIGURATION UPDATE FAILURE

This message is sent by the gNB-CU to indicate gNB-DU Configuration Update failure.

Direction: gNB-CU → gNB-DU

| IE/Group Name | Presence | Range | IE type and reference | Semantics description | Criticality | Assigned Criticality |
|-------------------------|----------|-------|-----------------------|-----------------------|-------------|----------------------|
| Message Type | M | | 9.3.1.1 | | YES | reject |
| Transaction ID | M | | 9.3.1.23 | | YES | reject |
| Cause | M | | 9.3.1.2 | | YES | ignore |
| Time to wait | O | | 9.3.1.13 | | YES | ignore |
| Criticality Diagnostics | O | | 9.3.1.3 | | YES | ignore |

9.2.1.10 GNB-CU CONFIGURATION UPDATE

This message is sent by the gNB-CU to transfer updated information associated to an F1-C interface instance.

NOTE: If F1-C signalling transport is shared among several F1-C interface instances, this message may transfer updated information associated to several F1-C interface instances.

Direction: gNB-CU → gNB-DU

| IE/Group Name | Presence | Range | IE type and reference | Semantics description | Criticality | Assigned Criticality |
|---|----------|---------------------------------|--|--|-------------|----------------------|
| Message Type | M | | 9.3.1.1 | | YES | reject |
| Transaction ID | M | | 9.3.1.23 | | YES | reject |
| Cells to be Activated List | | 0..1 | | List of cells to be activated or modified | YES | reject |
| >Cells to be Activated List Item | | 1.. <maxCellingNBD U> | | | EACH | reject |
| >> NR CGI | M | | 9.3.1.12 | | - | |
| >> NR PCI | O | | INTEGER (0..1007) | Physical Cell ID | - | |
| >> gNB-CU System Information | O | | 9.3.1.42 | RRC container with system information owned by gNB-CU | YES | reject |
| >>Available PLMN List | O | | 9.3.1.65 | | YES | ignore |
| >>Extended Available PLMN List | O | | 9.3.1.76 | This is included if <i>Available PLMN List</i> IE is included and if more than 6 Available PLMNs is to be signalled. | YES | ignore |
| Cells to be Deactivated List | | 0..1 | | List of cells to be deactivated | YES | reject |
| >Cells to be Deactivated List Item | | 1.. <maxCellingNBD U> | | | EACH | reject |
| >> NR CGI | M | | 9.3.1.12 | | - | |
| gNB-CU TNL Association To Add List | | 0..1 | | | YES | ignore |
| >gNB-CU TNL Association To Add Item IEs | | 1..<maxnoofTNLA ssociations> | | | EACH | ignore |
| >>TNL Association Transport Layer Information | M | | CP Transport Layer Address 9.3.2.4 | Transport Layer Address of the gNB-CU. | - | |

| | | | | | | |
|--|---|---------------------------------|------------------------------------|---|------|--------|
| >>TNL Association Usage | M | | ENUMERATED (ue, non-ue, both, ...) | Indicates whether the TNL association is only used for UE-associated signalling, or non-UE-associated signalling, or both. For usage of this IE, refer to TS 38.472 [22]. | - | |
| gNB-CU TNL Association To Remove List | | 0..1 | | | YES | ignore |
| >gNB-CU TNL Association To Remove Item IEs | | 1..<maxnoofTNLA ssociation> | | | EACH | ignore |
| >>TNL Association Transport Layer Address | M | | CP Transport Layer Address 9.3.2.4 | Transport Layer Address of the gNB-CU. | - | |
| >>TNL Association Transport Layer Address gNB-DU | O | | CP Transport Layer Address 9.3.2.4 | Transport Layer Address of the gNB-DU. | YES | reject |
| gNB-CU TNL Association To Update List | | 0..1 | | | YES | ignore |
| >gNB-CU TNL Association To Update Item IEs | | 1..<maxnoofTNLA ssociations> | | | EACH | ignore |
| >>TNL Association Transport Layer Address | M | | CP Transport Layer Address 9.3.2.4 | Transport Layer Address of the gNB-CU. | - | |
| >>TNL Association Usage | O | | ENUMERATED (ue, non-ue, both, ...) | Indicates whether the TNL association is only used for UE-associated signalling, or non-UE-associated signalling, or both. For usage of this IE, refer to TS 38.472 [22]. | - | |
| Cells to be barred List | | 0..1 | | List of cells to be barred. | YES | ignore |
| >Cells to be barred List Item | | 1..<maxCellingNBD U> | | | EACH | ignore |
| >>NR CGI | M | | 9.3.1.12 | | - | |

| | | | | | | |
|---|---|-----------------------|--------------------------------------|--|------|--------|
| >> Cell Barred | M | | ENUMERATED (barred, not-barred, ...) | | - | |
| Protected E-UTRA Resources List | | 0..1 | | List of Protected E-UTRA Resources. | YES | reject |
| >Protected E-UTRA Resources List Item | | 1.. <maxCellineNB> | | | EACH | reject |
| >>>Spectrum Sharing Group ID | M | | INTEGER (1..maxCellineNB) | Indicates the E-UTRA cells involved in resource coordination with the NR cells affiliated with the same Spectrum Sharing Group ID. | - | |
| >> E-UTRA Cells List | | 1 | | List of applicable E-UTRA cells. | - | |
| >>> E-UTRA Cells List Item | | 1.. <maxCellineNB> | | | - | |
| >>>>EUTRA Cell ID | M | | BIT STRING (SIZE(28)) | Indicates the E-UTRAN Cell Global Identifier as defined in subclause 9.2.14 in TS 36.423 [9]. | - | |
| >>>>Served E-UTRA Cell Information | M | | 9.3.1.64 | | - | |

| Range bound | Explanation |
|-------------------------|---|
| maxCellingNB | Maximum number of cells that can be served by a gNB-DU. Value is 512. |
| maxNoofTNLAassociations | Maximum numbers of TNL Associations between the gNB-CU and the gNB-DU. Value is 32. |
| maxCellineNB | Maximum no. cells that can be served by an eNB. Value is 256. |

9.2.1.11 GNB-CU CONFIGURATION UPDATE ACKNOWLEDGE

This message is sent by a gNB-DU to a gNB-CU to acknowledge update of information associated to an F1-C interface instance.

NOTE: If F1-C signalling transport is shared among several F1-C interface instance, this message may transfer updated information associated to several F1-C interface instances.

Direction: gNB-DU → gNB-CU

| IE/Group Name | Presence | Range | IE type and reference | Semantics description | Criticality | Assigned Criticality |
|--|----------|-----------------------------|------------------------------------|---|-------------|----------------------|
| Message Type | M | | 9.3.1.1 | | YES | reject |
| Transaction ID | M | | 9.3.1.23 | | YES | reject |
| Cells Failed to be Activated List | | 0..1 | | List of cells which are failed to be activated | YES | reject |
| >Cells Failed to be Activated Item | | 1.. <maxCellingNBDU> | | | EACH | reject |
| >> NR CGI | M | | 9.3.1.12 | | - | |
| >>Cause | M | | 9.3.1.2 | | - | |
| Criticality Diagnostics | O | | 9.3.1.3 | | YES | ignore |
| gNB-CU TNL Association Setup List | | 0..1 | | | YES | ignore |
| >gNB-CU TNL Association Setup Item IEs | | 1..<maxnoofTNLAssociations> | | | EACH | ignore |
| >>TNL Association Transport Layer Address | M | | CP Transport Layer Address 9.3.2.4 | Transport Layer Address of the gNB-CU | - | |
| gNB-CU TNL Association Failed to Setup List | | 0..1 | | | YES | ignore |
| >gNB-CU TNL Association Failed To Setup Item IEs | | 1..<maxnoofTNLAssociations> | | | EACH | ignore |
| >>TNL Association Transport Layer Address | M | | CP Transport Layer Address 9.3.2.4 | Transport Layer Address of the gNB-CU | - | |
| >>Cause | M | | 9.3.1.2 | | - | |
| Dedicated SI Delivery Needed UE List | | 0..1 | | List of UEs unable to receive system information from broadcast | YES | ignore |
| >Dedicated SI Delivery Needed UE List | | 1 .. <maxnoofUEIDs> | | | EACH | ignore |
| >>gNB-CU UE F1AP ID | M | | 9.3.1.4 | | - | - |
| >>NR CGI | M | | 9.3.1.12 | | - | - |

| Range bound | Explanation |
|------------------------|---|
| maxCellingNBDU | Maximum no. cells that can be served by a gNB-DU. Value is 512. |
| maxnoofTNLAssociations | Maximum no. of TNL Associations between the gNB-CU and the gNB-DU. Value is 32. |
| maxnoofUEIDs | Maximum no. of UEs that can be served by a gNB-DU. Value is 65536. |

9.2.1.12 GNB-CU CONFIGURATION UPDATE FAILURE

This message is sent by the gNB-DU to indicate gNB-CU Configuration Update failure.

Direction: gNB-DU → gNB-CU

| IE/Group Name | Presence | Range | IE type and reference | Semantics description | Criticality | Assigned Criticality |
|-------------------------|----------|-------|-----------------------|-----------------------|-------------|----------------------|
| Message Type | M | | 9.3.1.1 | | YES | reject |
| Transaction ID | M | | 9.3.1.23 | | YES | reject |
| Cause | M | | 9.3.1.2 | | YES | ignore |
| Time to wait | O | | 9.3.1.13 | | YES | ignore |
| Criticality Diagnostics | O | | 9.3.1.3 | | YES | ignore |

9.2.1.13 GNB-DU RESOURCE COORDINATION REQUEST

This message is sent by a gNB-CU to a gNB-DU, to express the desired resource allocation for data traffic, for the sake of resource coordination. The message triggers gNB-DU resource coordination (for NR-initiated resource coordination), to indicate an initial resource offer by the E-UTRA node (for E-UTRA-initiated gNB-DU Resource Coordination), or to indicate the agreed resource allocation that is to be executed.

Direction: gNB-CU → gNB-DU

| IE/Group Name | Presence | Range | IE type and reference | Semantics description | Criticality | Assigned Criticality |
|--|----------|-------|------------------------------------|---|-------------|----------------------|
| Message Type | M | | 9.3.1.1 | | YES | reject |
| Transaction ID | M | | 9.3.1.23 | | YES | reject |
| Request type | M | | ENUMERATED (offer, execution, ...) | | YES | reject |
| E-UTRA – NR Cell Resource Coordination Request Container | M | | OCTET STRING | Includes the X2AP E-UTRA – NR CELL RESOURCE COORDINATION REQUEST message as defined in subclause 9.1.4.24 in TS 36.423 [9]. | YES | reject |
| Ignore Coordination Request Container | O | | ENUMERATED (yes, ...) | | YES | reject |

9.2.1.14 GNB-DU RESOURCE COORDINATION RESPONSE

This message is sent by a gNB-DU to a gNB-CU, to express the desired resource allocation for data traffic, as a response to the GNB-DU RESOURCE COORDINATION REQUEST.

Direction: gNB-DU → gNB-CU

| IE/Group Name | Presence | Range | IE type and reference | Semantics description | Criticality | Assigned Criticality |
|---|----------|-------|-----------------------|--|-------------|----------------------|
| Message Type | M | | 9.3.1.1 | | YES | reject |
| Transaction ID | M | | 9.3.1.23 | | YES | reject |
| E-UTRA – NR Cell Resource Coordination Response Container | M | | OCTET STRING | Includes the X2AP E-UTRA – NR CELL RESOURCE COORDINATION RESPONSE message as defined in subclause 9.1.4.25 in TS 36.423 [9]. | YES | reject |

9.2.1.15 GNB-DU STATUS INDICATION

This message is sent by the gNB-DU to indicate to the gNB-CU its status of overload.

Direction: gNB-DU → gNB-CU

| IE/Group Name | Presence | Range | IE type and reference | Semantics description | Criticality | Assigned Criticality |
|-----------------------------|----------|-------|--|-----------------------|-------------|----------------------|
| Message Type | M | | 9.3.1.1 | | YES | ignore |
| Transaction ID | M | | 9.3.1.23 | | YES | reject |
| gNB-DU Overload Information | M | | ENUMERATED (overloaded, not-overloaded) | | YES | reject |

9.2.1.16 F1 REMOVAL REQUEST

This message is sent by either the gNB-DU or the gNB-CU to initiate the removal of the interface instance and the related resources.

Direction: gNB-DU → gNB-CU, gNB-CU → gNB-DU.

| IE/Group Name | Presence | Range | IE type and reference | Semantics description | Criticality | Assigned Criticality |
|----------------|----------|-------|-----------------------|-----------------------|-------------|----------------------|
| Message Type | M | | 9.3.1.1 | | YES | reject |
| Transaction ID | M | | 9.3.1.23 | | YES | reject |

9.2.1.17 F1 REMOVAL RESPONSE

This message is sent by either the gNB-DU or the gNB-CU to acknowledge the initiation of removal of the interface instance and the related resources.

Direction: gNB-CU → gNB-DU, gNB-DU → gNB-CU.

| IE/Group Name | Presence | Range | IE type and reference | Semantics description | Criticality | Assigned Criticality |
|-------------------------|----------|-------|-----------------------|-----------------------|-------------|----------------------|
| Message Type | M | | 9.3.1.1 | | YES | reject |
| Transaction ID | M | | 9.3.1.23 | | YES | reject |
| Criticality Diagnostics | O | | 9.3.1.3 | | YES | ignore |

9.2.1.18 F1 REMOVAL FAILURE

This message is sent by either the gNB-DU or the gNB-CU to indicate that removing the interface instance and the related resources cannot be accepted.

Direction: gNB-CU → gNB-DU, gNB-DU → gNB-CU.

| IE/Group Name | Presence | Range | IE type and reference | Semantics description | Criticality | Assigned Criticality |
|-------------------------|----------|-------|-----------------------|-----------------------|-------------|----------------------|
| Message Type | M | | 9.2.3.1 | | YES | reject |
| Transaction ID | M | | 9.3.1.23 | | YES | reject |
| Cause | M | | 9.3.1.2 | | YES | ignore |
| Criticality Diagnostics | O | | 9.3.1.3 | | YES | ignore |

9.2.1.19 NETWORK ACCESS RATE REDUCTION

This message is sent by the gNB-CU to indicate to the gNB-DU a need to reduce the rate at which UEs access the network.

Direction: gNB-CU → gNB-DU

| IE/Group Name | Presence | Range | IE type and reference | Semantics description | Criticality | Assigned Criticality |
|----------------------------|----------|-------|-----------------------|-----------------------|-------------|----------------------|
| Message Type | M | | 9.3.1.1 | | YES | ignore |
| Transaction ID | M | | 9.3.1.23 | | YES | reject |
| UAC Assistance Information | M | | 9.3.1.83 | | YES | reject |

9.2.2 UE Context Management messages

9.2.2.1 UE CONTEXT SETUP REQUEST

This message is sent by the gNB-CU to request the setup of a UE context.

Direction: gNB-CU → gNB-DU.

| IE/Group Name | Presence | Range | IE type and reference | Semantics description | Criticality | Assigned Criticality |
|--|----------|-----------------------------------|-----------------------------------|--|-------------|----------------------|
| Message Type | M | | 9.3.1.1 | | YES | reject |
| gNB-CU UE F1AP ID | M | | 9.3.1.4 | | YES | reject |
| gNB-DU UE F1AP ID | O | | 9.3.1.5 | | YES | ignore |
| SpCell ID | M | | NR CGI 9.3.1.12 | Special Cell as defined in TS 38.321 [16]. For handover case, this IE is considered as target cell. | YES | reject |
| ServCellIndex | M | | INTEGER (0..31,...) | | YES | reject |
| SpCell UL Configured | O | | Cell UL Configured 9.3.1.33 | | YES | ignore |
| CU to DU RRC Information | M | | 9.3.1.25 | | YES | reject |
| Candidate SpCell List | | 0..1 | | | YES | ignore |
| >Candidate SpCell Item IEs | | 1 .. <maxnoofCandidateSpCells> | | | EACH | ignore |
| >>Candidate SpCell ID | M | | NR CGI 9.3.1.12 | Special Cell as defined in TS 38.321 [16] | - | |
| DRX Cycle | O | | DRX Cycle 9.3.1.24 | | YES | ignore |
| Resource Coordination Transfer Container | O | | OCTET STRING | Includes the <i>MeNB Resource Coordination Information</i> IE as defined in subclause 9.2.116 of TS 36.423 [9] for EN-DC case or <i>MR-DC Resource Coordination Information</i> IE as defined in TS 38.423 [28] for NGEN-DC and NE-DC cases. | YES | ignore |
| SCell To Be Setup List | | 0..1 | | | YES | ignore |
| >SCell to Be Setup Item IEs | | 1.. <maxnoofSCells> | | | EACH | ignore |
| >>SCell ID | M | | NR CGI 9.3.1.12 | SCell Identifier in gNB | - | |
| >>SCellIndex | M | | INTEGER (1..31) | | - | |
| >>SCell UL Configured | O | | Cell UL Configured 9.3.1.33 | | - | |
| >>servingCellMO | O | | INTEGER (1..64) | | YES | ignore |
| SRB to Be Setup List | | 0..1 | | | YES | reject |
| >SRB to Be Setup Item IEs | | 1 .. <maxnoofSRBs> | | | EACH | reject |
| >>SRB ID | M | | 9.3.1.7 | | - | |
| >>Duplication Indication | O | | ENUMERATED (true, ..., false) | If included, it should be set to true. | - | |
| DRB to Be Setup List | | 0..1 | | | YES | reject |

| IE/Group Name | Presence | Range | IE type and reference | Semantics description | Criticality | Assigned Criticality |
|--|----------|-------------------------------------|---|--|-------------|----------------------|
| >DRB to Be Setup Item IEs | | 1 .. <maxnoofDRBs> | | | EACH | reject |
| >>DRB ID | M | | 9.3.1.8 | | - | |
| >>CHOICE QoS Information | M | | | | - | |
| >>>E-UTRAN QoS | M | | 9.3.1.19 | Shall be used for EN-DC case to convey E-RAB Level QoS Parameters | - | |
| >>>DRB Information | | 1 | | Shall be used for NG-RAN cases | YES | ignore |
| >>>>DRB QoS | M | | 9.3.1.45 | | - | |
| >>>>S-NSSAI | M | | 9.3.1.38 | | - | |
| >>>>Notification Control | O | | 9.3.1.56 | | - | |
| >>>>Flows Mapped to DRB Item | | 1 .. <maxnoofQoSFlows> | | | - | |
| >>>>>QoS Flow Identifier | M | | 9.3.1.63 | | - | |
| >>>>>QoS Flow Level QoS Parameters | M | | 9.3.1.45 | | - | |
| >>>>>QoS Flow Mapping Indication | O | | 9.3.1.72 | | YES | ignore |
| >>UL UP TNL Information to be setup List | | 1 | | | - | |
| >>> UL UP TNL Information to Be Setup Item IEs | | 1 .. <maxnoofULUPTNLInformation> | | | - | |
| >>>>UL UP TNL Information | M | | UP Transport Layer Information 9.3.2.1 | gNB-CU endpoint of the F1 transport bearer. For delivery of UL PDUs. | - | |
| >> RLC Mode | M | | 9.3.1.27 | | - | |
| >> UL Configuration | O | | UL Configuration 9.3.1.31 | Information about UL usage in gNB-DU. | - | |
| >>Duplication Activation | O | | 9.3.1.36 | Information on the initial state of CA based UL PDCP duplication | - | |
| >> DC Based Duplication Configured | O | | ENUMERATED (true, ..., false) | Indication on whether DC based PDCP duplication is configured or not. If included, it should be set to true. | YES | reject |
| >>DC Based Duplication Activation | O | | Duplication Activation 9.3.1.36 | Information on the initial state of DC based UL PDCP duplication | YES | reject |
| >>DL PDCP SN length | M | | ENUMERATED (12bits, 18bits, ...) | | YES | ignore |
| >>UL PDCP SN length | O | | ENUMERATED (12bits, 18bits, ...) | | YES | ignore |

| IE/Group Name | Presence | Range | IE type and reference | Semantics description | Criticality | Assigned Criticality |
|---|--------------|-------|------------------------------|--|-------------|----------------------|
| Inactivity Monitoring Request | O | | ENUMERATED (true, ...) | | YES | reject |
| RAT-Frequency Priority Information | O | | 9.3.1.34 | | YES | reject |
| RRC-Container | O | | 9.3.1.6 | Includes the <i>DL-DCCH-Message</i> IE as defined in subclause 6.2 of TS 38.331 [8], encapsulated in a PDCP PDU. | YES | ignore |
| Masked IMEISV | O | | 9.3.1.55 | | YES | ignore |
| Serving PLMN | O | | PLMN ID 9.3.1.14 | Indicates the PLMN serving the UE. | YES | ignore |
| gNB-DU UE Aggregate Maximum Bit Rate Uplink | C-ifDRBSetup | | Bit Rate 9.3.1.22 | The gNB-DU UE Aggregate Maximum Bit Rate Uplink is to be enforced by the gNB-DU. | YES | ignore |
| RRC Delivery Status Request | O | | ENUMERATED (true, ...) | Indicates whether RRC DELIVERY REPORT procedure is requested for the RRC message. | YES | ignore |
| Resource Coordination Transfer Information | O | | 9.3.1.73 | | YES | ignore |
| servingCellMO | O | | INTEGER (1..64, ...) | | YES | ignore |
| New gNB-CU UE F1AP ID | O | | gNB-CU UE F1AP ID 9.3.1.4 | | YES | reject |
| RAN UE ID | O | | OCTET STRING (SIZE (8)) | | YES | ignore |

| Range bound | Explanation |
|---------------------------|--|
| maxnoofSCells | Maximum no. of SCells allowed towards one UE, the maximum value is 32. |
| maxnoofSRBs | Maximum no. of SRB allowed towards one UE, the maximum value is 8. |
| maxnoofDRBs | Maximum no. of DRB allowed towards one UE, the maximum value is 64. |
| maxnoofULUPTNLInformation | Maximum no. of ULUP TNL Information allowed towards one DRB, the maximum value is 2. |
| maxnoofCandidateSpCells | Maximum no. of SpCells allowed towards one UE, the maximum value is 64. |
| maxnoofQoSFlows | Maximum no. of flows allowed to be mapped to one DRB, the maximum value is 64. |

| Condition | Explanation |
|------------|---|
| ifDRBSetup | This IE shall be present only if the <i>DRB to Be Setup List</i> IE is present. |

9.2.2.2 UE CONTEXT SETUP RESPONSE

This message is sent by the gNB-DU to confirm the setup of a UE context.

Direction: gNB-DU → gNB-CU.

| IE/Group Name | Presence | Range | IE type and reference | Semantics description | Criticality | Assigned Criticality |
|--|----------|-------------------------------------|--|--|-------------|----------------------|
| Message Type | M | | 9.3.1.1 | | YES | reject |
| gNB-CU UE F1AP ID | M | | 9.3.1.4 | | YES | reject |
| gNB-DU UE F1AP ID | M | | 9.3.1.5 | | YES | reject |
| DU To CU RRC Information | M | | 9.3.1.26 | | YES | reject |
| C-RNTI | O | | 9.3.1.32 | C-RNTI allocated at the gNB-DU | YES | ignore |
| Resource Coordination Transfer Container | O | | OCTET STRING | Includes the <i>SgNB Resource Coordination Information</i> IE as defined in subclause 9.2.117 of TS 36.423 [9] for EN-DC case or <i>MR-DC Resource Coordination Information</i> IE as defined in TS 38.423 [28] for NGEN-DC and NE-DC cases. | YES | ignore |
| Full Configuration | O | | ENUMERATED (full, ...) | | YES | reject |
| DRB Setup List | | 0..1 | | The List of DRBs which are successfully established. | YES | ignore |
| >DRB Setup Item list | | 1 .. <maxnoofDRBs> | | | EACH | ignore |
| >>DRB ID | M | | 9.3.1.8 | | - | |
| >>LCID | O | | 9.3.1.35 | LCID for the primary path if PDCP duplication is applied | - | |
| >>DL UP TNL Information to be setup List | | 1 | | | - | |
| >>> DL UP TNL Information to Be Setup Item IEs | | 1 .. <maxnoofDLUPTNLInformation> | | | - | |
| >>>>DL UP TNL Information | M | | UP Transport Layer Information 9.3.2.1 | gNB-DU endpoint of the F1 transport bearer. For delivery of DL PDUs. | - | |
| SRB Failed to Setup List | | 0..1 | | | YES | ignore |
| >SRB Failed to Setup Item | | 1 .. <maxnoofSRBs> | | | EACH | ignore |
| >>SRB ID | M | | 9.3.1.7 | | - | |
| >>Cause | O | | 9.3.1.2 | | - | |
| DRB Failed to Setup List | | 0..1 | | | YES | ignore |
| >DRB Failed to Setup Item | | 1 .. <maxnoofDRBs> | | | EACH | ignore |

| IE/Group Name | Presence | Range | IE type and reference | Semantics description | Criticality | Assigned Criticality |
|---------------------------------------|----------|------------------------|---------------------------------|--|-------------|----------------------|
| >>DRB ID | M | | 9.3.1.8 | | - | |
| >>Cause | O | | 9.3.1.2 | | - | |
| SCell Failed To Setup List | | 0..1 | | | YES | ignore |
| >SCell Failed to Setup Item | | 1.. <maxnoofSCells> | | | EACH | ignore |
| >>SCell ID | M | | NR CGI 9.3.1.12 | SCell Identifier in gNB | - | |
| >>Cause | O | | 9.3.1.2 | | - | |
| Inactivity Monitoring Response | O | | ENUMERATED (not-supported, ...) | | YES | reject |
| Criticality Diagnostics | O | | 9.3.1.3 | | YES | ignore |
| SRB Setup List | | 0..1 | | | YES | ignore |
| >SRB Setup Item | | 1.. <maxnoofSRBs> | | | EACH | ignore |
| >>SRB ID | M | | 9.3.1.7 | | - | |
| >>LCID | M | | 9.3.1.35 | LCID for the primary path if PDCP duplication is applied | - | |

| Range bound | Explanation |
|---------------------------|---|
| maxnoofSCells | Maximum no. of SCells allowed towards one UE, the maximum value is 32. |
| maxnoofSRBs | Maximum no. of SRB allowed towards one UE, the maximum value is 8. |
| maxnoofDRBs | Maximum no. of DRB allowed towards one UE, the maximum value is 64. |
| maxnoofDLUPTNLInformation | Maximum no. of DL UP TNL Information allowed towards one DRB, the maximum value is 2. |

9.2.2.3 UE CONTEXT SETUP FAILURE

This message is sent by the gNB-DU to indicate that the setup of the UE context was unsuccessful.

Direction: gNB-DU → gNB-CU

| IE/Group Name | Presence | Range | IE type and reference | Semantics description | Criticality | Assigned Criticality |
|--------------------------------------|----------|----------------------------------|-----------------------|---|-------------|----------------------|
| Message Type | M | | 9.3.1.1 | | YES | reject |
| gNB-CU UE F1AP ID | M | | 9.3.1.4 | | YES | reject |
| gNB-DU UE F1AP ID | O | | 9.3.1.5 | | YES | ignore |
| Cause | M | | 9.3.1.2 | | YES | ignore |
| Criticality Diagnostics | O | | 9.3.1.3 | | YES | ignore |
| Potential SpCell List | | 0..1 | | | YES | ignore |
| >Potential SpCell Item IEs | | 0.. <maxnoofPotentialSpCells> | | | EACH | ignore |
| >>Potential SpCell ID | M | | NR CGI 9.3.1.12 | Special Cell as defined in TS 38.321 [16] | - | |

| Range bound | Explanation |
|-------------------------|---|
| maxnoofPotentialSpCells | Maximum no. of SpCells allowed towards one UE, the maximum value is 64. |

9.2.2.4 UE CONTEXT RELEASE REQUEST

This message is sent by the gNB-DU to request the gNB-CU to release the UE-associated logical F1.

Direction: gNB-DU → gNB-CU

| IE/Group Name | Presence | Range | IE type and reference | Semantics description | Criticality | Assigned Criticality |
|-------------------|----------|-------|-----------------------|-----------------------|-------------|----------------------|
| Message Type | M | | 9.3.1.1 | | YES | ignore |
| gNB-CU UE F1AP ID | M | | 9.3.1.4 | | YES | reject |
| gNB-DU UE F1AP ID | M | | 9.3.1.5 | | YES | reject |
| Cause | M | | 9.3.1.2 | | YES | ignore |

9.2.2.5 UE CONTEXT RELEASE COMMAND

This message is sent by the gNB-CU to request the gNB-DU to release the UE-associated logical F1 connection.

Direction: gNB-CU → gNB-DU

| IE/Group Name | Presence | Range | IE type and reference | Semantics description | Criticality | Assigned Criticality |
|-----------------------------|----------------------|-------|------------------------|--|-------------|----------------------|
| Message Type | M | | 9.3.1.1 | | YES | reject |
| gNB-CU UE F1AP ID | M | | 9.3.1.4 | | YES | reject |
| gNB-DU UE F1AP ID | M | | 9.3.1.5 | | YES | reject |
| Cause | M | | 9.3.1.2 | | YES | ignore |
| RRC-Container | O | | 9.3.1.6 | Includes the <i>DL-DCCH-Message</i> IE as defined in subclause 6.2 of TS 38.331 [8] encapsulated in a PDCP PDU, or the <i>DL-CCCH-Message</i> IE as defined in subclause 6.2 of TS 38.331 [8]. | YES | ignore |
| SRB ID | C- ifRRCContainer | | 9.3.1.7 | The gNB-DU sends the RRC message on the indicated SRB. | YES | ignore |
| old gNB-DU UE F1AP ID | O | | 9.3.1.5 | Include it if RRCReestablishmentRequest is not accepted | YES | ignore |
| Execute Duplication | O | | ENUMERATED (true, ...) | This IE may be sent only if duplication has been configured for the UE. | YES | ignore |
| RRC Delivery Status Request | O | | ENUMERATED (true, ...) | Indicates whether RRC DELIVERY REPORT procedure is requested for the RRC message. | YES | ignore |

| Condition | Explanation |
|----------------|---|
| ifRRCContainer | This IE shall be present if the <i>RRC container</i> IE is present. |

9.2.2.6 UE CONTEXT RELEASE COMPLETE

This message is sent by the gNB-DU to confirm the release of the UE-associated logical F1 connection.

Direction: gNB-DU → gNB-CU

| IE/Group Name | Presence | Range | IE type and reference | Semantics description | Criticality | Assigned Criticality |
|-------------------------|----------|-------|-----------------------|-----------------------|-------------|----------------------|
| Message Type | M | | 9.3.1.1 | | YES | reject |
| gNB-CU UE F1AP ID | M | | 9.3.1.4 | | YES | reject |
| gNB-DU UE F1AP ID | M | | 9.3.1.5 | | YES | reject |
| Criticality Diagnostics | O | | 9.3.1.3 | | YES | ignore |

9.2.2.7 UE CONTEXT MODIFICATION REQUEST

This message is sent by the gNB-CU to provide UE Context information changes to the gNB-DU.

Direction: gNB-CU → gNB-DU

| IE/Group Name | Presence | Range | IE type and reference | Semantics description | Criticality | Assigned Criticality |
|--|----------|--|-----------------------------------|--|-------------|----------------------|
| Message Type | M | | 9.3.1.1 | | YES | reject |
| gNB-CU UE F1AP ID | M | | 9.3.1.4 | | YES | reject |
| gNB-DU UE F1AP ID | M | | 9.3.1.5 | | YES | reject |
| SpCell ID | O | | NR CGI 9.3.1.12 | Special Cell as defined in TS 38.321 [16]. For handover case, this IE is considered as target cell. | YES | ignore |
| ServCellIndex | O | | INTEGER (0..31, ...) | | YES | reject |
| SpCell UL Configured | O | | Cell UL Configured 9.3.1.33 | | YES | ignore |
| DRX Cycle | O | | DRX Cycle 9.3.1.24 | | YES | ignore |
| CU to DU RRC Information | O | | 9.3.1.25 | | YES | reject |
| Transmission Action Indicator | O | | 9.3.1.11 | | YES | ignore |
| Resource Coordination Transfer Container | O | | OCTET STRING | Includes the <i>MeNB Resource Coordination Information</i> IE as defined in subclause 9.2.116 of TS 36.423 [9] for EN-DC case or <i>MR-DC Resource Coordination Information</i> IE as defined in TS 38.423 [28] for NGEN-DC and NE-DC cases. | YES | ignore |
| RRC Reconfiguration Complete Indicator | O | | 9.3.1.30 | | YES | ignore |
| RRC-Container | O | | 9.3.1.6 | Includes the <i>DL-DCCH-Message</i> IE as defined in subclause 6.2 of TS 38.331 [8], encapsulated in a PDCP PDU. | YES | reject |
| SCell To Be Setup List | | <i>0..1</i> | | | YES | ignore |
| >SCell to Be Setup Item IEs | | <i>1.. <maxnoofS Cells></i> | | | EACH | ignore |
| >>SCell ID | M | | NR CGI 9.3.1.12 | SCell Identifier in gNB | - | |
| >>SCellIndex | M | | INTEGER (1..31) | | - | |
| >>SCell UL Configured | O | | Cell UL Configured 9.3.1.33 | | - | |
| >>servicingCellMO | O | | INTEGER (1..64) | | YES | ignore |
| SCell To Be Removed List | | <i>0..1</i> | | | YES | ignore |
| >SCell to Be Removed Item IEs | | <i>1 .. <maxnoofS Cells></i> | | | EACH | ignore |
| >>SCell ID | M | | NR CGI 9.3.1.12 | SCell Identifier in gNB | - | |

| IE/Group Name | Presence | Range | IE type and reference | Semantics description | Criticality | Assigned Criticality |
|---|----------|----------------------------------|--|--|-------------|----------------------|
| SRB to Be Setup List | | 0..1 | | | YES | reject |
| >SRB to Be Setup Item IEs | | 1..<maxnoofSRBs> | | | EACH | reject |
| >>SRB ID | M | | 9.3.1.7 | | - | |
| >>Duplication Indication | O | | ENUMERATED (true, ..., false) | | - | |
| DRB to Be Setup List | | 0..1 | | | YES | reject |
| >DRB to Be Setup Item IEs | | 1 .. <maxnoofDRBs> | | | EACH | reject |
| >>DRB ID | M | | 9.3.1.8 | | - | |
| >>CHOICE QoS Information | M | | | | - | |
| >>>E-UTRAN QoS | M | | 9.3.1.19 | Shall be used for EN-DC case to convey E-RAB Level QoS Parameters | | |
| >>>DRB Information | | 1 | | Shall be used for NG-RAN cases | YES | ignore |
| >>>>DRB QoS | M | | 9.3.1.45 | | - | |
| >>>>S-NSSAI | M | | 9.3.1.38 | | - | |
| >>>>Notification Control | O | | 9.3.1.56 | | - | |
| >>>>Flows Mapped to DRB Item | | 1 .. <maxnoofQoSFlows> | | | - | |
| >>>>>QoS Flow Identifier | M | | 9.3.1.63 | | - | |
| >>>>>QoS Flow Level QoS Parameters | M | | 9.3.1.45 | | - | |
| >>>>>QoS Flow Mapping Indication | O | | 9.3.1.72 | | YES | ignore |
| >>UL UP TNL Information to be setup List | | 1 | | | - | |
| >>>UL UP TNL Information to Be Setup Item IEs | | 1 .. <maxnoofULUPTNLInformation> | | | - | |
| >>>>UL UP TNL Information | M | | UP Transport Layer Information 9.3.2.1 | gNB-CU endpoint of the F1 transport bearer. For delivery of UL PDUs. | - | |
| >> RLC Mode | M | | 9.3.1.27 | | - | |
| >>UL Configuration | O | | UL Configuration 9.3.1.31 | Information about UL usage in gNB-DU. | - | |
| >>Duplication Activation | O | | 9.3.1.36 | Information on the initial state of CA based UL PDCP duplication | - | |
| >> DC Based Duplication Configured | O | | ENUMERATED (true, ..., false) | Indication on whether DC based PDCP duplication is configured or not. If included, it should be set to true. | YES | reject |

| IE/Group Name | Presence | Range | IE type and reference | Semantics description | Criticality | Assigned Criticality |
|--|----------|-------------------------------------|---|--|-------------|----------------------|
| >>DC Based Duplication Activation | O | | Duplication Activation 9.3.1.36 | Information on the initial state of DC based UL PDCP duplication | YES | reject |
| >>DL PDCP SN length | O | | ENUMERATED (12bits, 18bits, ...) | | YES | ignore |
| >>UL PDCP SN length | O | | ENUMERATED (12bits, 18bits, ...) | | YES | ignore |
| DRB to Be Modified List | | 0..1 | | | YES | reject |
| >DRB to Be Modified Item IEs | | 1 .. <maxnoofDRBs> | | | EACH | reject |
| >>DRB ID | M | | 9.3.1.8 | | - | |
| >>CHOICE QoS Information | O | | | | - | |
| >>>E-UTRAN QoS | M | | 9.3.1.19 | Used for EN-DC case to convey E-RAB Level QoS Parameters | - | |
| >>>DRB Information | | 1 | | Used for NG-RAN cases | YES | ignore |
| >>>>DRB QoS | M | | 9.3.1.45 | | - | |
| >>>>S-NSSAI | M | | 9.3.1.38 | | - | |
| >>>>Notification Control | O | | 9.3.1.56 | | - | |
| >>>>Flows Mapped to DRB Item | | 1 .. <maxnoofQoSFlows> | | | - | |
| >>>>>QoS Flow Identifier | M | | 9.3.1.63 | | - | |
| >>>>>QoS Flow Level QoS Parameters | M | | 9.3.1.45 | | - | |
| >>>>>QoS Flow Mapping Indication | O | | 9.3.1.72 | | YES | ignore |
| >> UL UP TNL Information to be setup List | | 0..1 | | | - | |
| >>> UL UP TNL Information to Be Setup Item IEs | | 1 .. <maxnoofULUPTNLInformation> | | | - | |
| >>>>UL UP TNL Information | M | | UP Transport Layer Information 9.3.2.1 | gNB-CU endpoint of the F1 transport bearer. For delivery of UL PDUs. | - | |
| >>UL Configuration | O | | UL Configuration 9.3.1.31 | Information about UL usage in gNB-DU. | - | |
| >>DL PDCP SN length | O | | ENUMERATED(12bits, 18bits, ...) | | YES | ignore |
| >>UL PDCP SN length | O | | ENUMERATED (12bits, 18bits, ...) | | YES | ignore |
| >>Bearer Type Change | O | | ENUMERATED (true, ...) | | YES | ignore |
| >> RLC Mode | O | | 9.3.1.27 | | YES | ignore |

| IE/Group Name | Presence | Range | IE type and reference | Semantics description | Criticality | Assigned Criticality |
|---|----------|-----------------------|-------------------------------|---|-------------|----------------------|
| >>Duplication Activation | O | | 9.3.1.36 | Information on the initial state of CA based UL PDCP duplication | YES | reject |
| >> DC Based Duplication Configured | O | | ENUMERATED (true, ..., false) | Indication on whether DC based PDCP duplication is configured or not. | YES | reject |
| >>DC Based Duplication Activation | O | | 9.3.1.36 | Information on the initial state of DC based UL PDCP duplication | YES | reject |
| SRB To Be Released List | | 0..1 | | | YES | reject |
| >SRB To Be Released Item IEs | | 1.. <maxnoofSRBs> | | | EACH | reject |
| >>SRB ID | M | | 9.3.1.7 | | | |
| DRB to Be Released List | | 0..1 | | | YES | reject |
| >DRB to Be Released Item IEs | | 1 .. <maxnoofDRBs> | | | EACH | reject |
| >>DRB ID | M | | 9.3.1.8 | | - | |
| Inactivity Monitoring Request | O | | ENUMERATED (true, ...) | | YES | reject |
| RAT-Frequency Priority Information | O | | 9.3.1.34 | | YES | reject |
| DRX configuration indicator | O | | ENUMERATED (release, ..) | | YES | ignore |
| RLC Failure Indication | O | | 9.3.1.66 | | YES | ignore |
| Uplink TxDirectCurrentList Information | O | | 9.3.1.67 | | YES | ignore |
| gNB-DU Configuration Query | O | | ENUMERATED (true, ...) | Used to request the gNB-DU to provide its configuration. | YES | reject |
| gNB-DU UE Aggregate Maximum Bit Rate Uplink | O | | Bit Rate 9.3.1.22 | The gNB-DU UE Aggregate Maximum Bit Rate Uplink is to be enforced by the gNB-DU. | YES | ignore |
| Execute Duplication | O | | ENUMERATED (true, ...) | This IE may be sent only if duplication has been configured for the UE. | YES | ignore |
| RRC Delivery Status Request | O | | ENUMERATED (true, ...) | Indicates whether RRC DELIVERY REPORT procedure is requested for the RRC message. | YES | ignore |
| Resource Coordination Transfer Information | O | | 9.3.1.73 | | YES | ignore |
| servingCellMO | O | | INTEGER (1..64, ...) | | YES | ignore |

| IE/Group Name | Presence | Range | IE type and reference | Semantics description | Criticality | Assigned Criticality |
|--------------------|----------|-------|------------------------|---|-------------|----------------------|
| Need for Gap | O | | ENUMERATED (true, ...) | Indicate gap for SeNB configured measurement is requested. It only applied to NE DC scenario. | Yes | ignore |
| Full Configuration | O | | ENUMERATED (full, ...) | | YES | reject |

| Range bound | Explanation |
|---------------------------|---|
| maxnoofSCells | Maximum no. of SCells allowed towards one UE, the maximum value is 32. |
| maxnoofSRBs | Maximum no. of SRB allowed towards one UE, the maximum value is 8. |
| maxnoofDRBs | Maximum no. of DRB allowed towards one UE, the maximum value is 64. |
| maxnoofULUPTNLInformation | Maximum no. of UL UP TNL Information allowed towards one DRB, the maximum value is 2. |
| maxnoofQoSFlows | Maximum no. of flows allowed to be mapped to one DRB, the maximum value is 64. |

9.2.2.8 UE CONTEXT MODIFICATION RESPONSE

This message is sent by the gNB-DU to confirm the modification of a UE context.

Direction: gNB-DU → gNB-CU.

| IE/Group Name | Presence | Range | IE type and reference | Semantics description | Criticality | Assigned Criticality |
|--|----------|-------------------------------------|--|--|-------------|----------------------|
| Message Type | M | | 9.3.1.1 | | YES | reject |
| gNB-CU UE F1AP ID | M | | 9.3.1.4 | | YES | reject |
| gNB-DU UE F1AP ID | M | | 9.3.1.5 | | YES | reject |
| Resource Coordination Transfer Container | O | | OCTET STRING | Includes the <i>SgNB Resource Coordination Information</i> IE as defined in subclause 9.2.117 of TS 36.423 [9] for EN-DC case or <i>MR-DC Resource Coordination Information</i> IE as defined in TS 38.423 [28] for NGEN-DC and NE-DC cases. | YES | ignore |
| DU To CU RRC Information | O | | 9.3.1.26 | | YES | reject |
| DRB Setup List | | 0..1 | | The List of DRBs which are successfully established. | YES | ignore |
| >DRB Setup Item IEs | | 1 .. <maxnoofDRBs> | | | EACH | ignore |
| >>DRB ID | M | | 9.3.1.8 | | - | |
| >>LCID | O | | 9.3.1.35 | LCID for primary path if PDCP duplication is applied | - | |
| >>>DL UP TNL Information to be setup List | | 1 | | | - | |
| >>>>DL UP TNL Information to Be Setup Item IEs | | 1 .. <maxnoofDLUPTNLInformation> | | | - | |
| >>>>>DL UP TNL Information | M | | UP Transport Layer Information 9.3.2.1 | gNB-DU endpoint of the F1 transport bearer. For delivery of DL PDUs. | - | |
| DRB Modified List | | 0..1 | | The List of DRBs which are successfully modified. | YES | ignore |
| >DRB Modified Item IEs | | 1 .. <maxnoofDRBs> | | | EACH | ignore |
| >>DRB ID | M | | 9.3.1.8 | | - | |
| >>LCID | O | | 9.3.1.35 | LCID for primary path if PDCP duplication is applied | - | |

| IE/Group Name | Presence | Range | IE type and reference | Semantics description | Criticality | Assigned Criticality |
|---|----------|---|--|--|-------------|----------------------|
| >>DL UP TNL Information to be setup List | | 1 | | | - | |
| >>>DL UP TNL Information to Be Setup Item IEs | | 1 .. <maxnoofDLU PTNLInformati on> | | | - | |
| >>>>DL UP TNL Information | M | | UP Transport Layer Information 9.3.2.1 | gNB-DU endpoint of the F1 transport bearer. For delivery of DL PDUs. | - | |
| >>RLC Status | O | | 9.3.1.69 | Indicates the RLC has been re-established at the gNB-DU. | YES | ignore |
| SRB Failed to be Setup List | | 0..1 | | The List of SRBs which are failed to be established. | YES | ignore |
| >SRB Failed to be Setup Item IEs | | 1 .. <maxnoofSRB s> | | | EACH | ignore |
| >>SRB ID | M | | 9.3.1.7 | | - | |
| >>Cause | O | | 9.3.1.2 | | - | |
| DRB Failed to be Setup List | | 0..1 | | The List of DRBs which are failed to be setup. | YES | ignore |
| >DRB Failed to be Setup Item IEs | | 1 .. <maxnoofDRB s> | | | EACH | ignore |
| >>DRB ID | M | | 9.3.1.8 | | - | |
| >>Cause | O | | 9.3.1.2 | | - | |
| SCell Failed To Setup List | | 0..1 | | | YES | ignore |
| >SCell Failed to Setup Item | | 1 .. <maxnoofSCel ls> | | | EACH | ignore |
| >>SCell ID | M | | NR CGI 9.3.1.12 | SCell Identifier in gNB | - | |
| >>Cause | O | | 9.3.1.2 | | - | |
| DRB Failed to be Modified List | | 0..1 | | The List of DRBs which are failed to be modified. | YES | ignore |
| >DRB Failed to be Modified Item IEs | | 1 .. <maxnoofDRB s> | | | EACH | ignore |
| >>DRB ID | M | | 9.3.1.8 | | - | |
| >>Cause | O | | 9.3.1.2 | | - | |
| Inactivity Monitoring Response | O | | ENUMERATE D (Not-supported, ...) | | YES | reject |
| Criticality Diagnostics | O | | 9.3.1.3 | | YES | ignore |
| C-RNTI | O | | 9.3.1.32 | C-RNTI allocated at the gNB-DU | YES | ignore |
| Associated SCell List | O | | 9.3.1.77 | | YES | ignore |
| SRB Setup List | | 0..1 | | | YES | ignore |
| >SRB Setup Item | | 1 .. <maxnoofSRB s> | | | EACH | ignore |

| IE/Group Name | Presence | Range | IE type and reference | Semantics description | Criticality | Assigned Criticality |
|------------------------------|----------|-----------------------|------------------------|--|-------------|----------------------|
| >>SRB ID | M | | 9.3.1.7 | | - | |
| >>LCID | M | | 9.3.1.35 | LCID for the primary path if PDCP duplication is applied | - | |
| SRB Modified List | | 0..1 | | | YES | ignore |
| >SRB Modified Item | | 1 .. <maxnoofSRBs> | | | EACH | ignore |
| >>SRB ID | M | | 9.3.1.7 | | - | |
| >>LCID | M | | 9.3.1.35 | LCID for the primary path if PDCP duplication is applied | - | |
| Full Configuration | O | | ENUMERATED (full, ...) | | YES | reject |

| Range bound | Explanation |
|---------------------------|---|
| maxnoofSRBs | Maximum no. of SRB allowed towards one UE, the maximum value is 8. |
| maxnoofDRBs | Maximum no. of DRB allowed towards one UE, the maximum value is 64. |
| maxnoofDLUPTNLInformation | Maximum no. of DL UP TNL Information allowed towards one DRB, the maximum value is 2. |
| maxnoofSCells | Maximum no. of SCells allowed towards one UE, the maximum value is 32. |

9.2.2.9 UE CONTEXT MODIFICATION FAILURE

This message is sent by the gNB-DU to indicate a context modification failure.

Direction: gNB-DU → gNB-CU

| IE/Group Name | Presence | Range | IE type and reference | Semantics description | Criticality | Assigned Criticality |
|-------------------------|----------|-------|-----------------------|-----------------------|-------------|----------------------|
| Message Type | M | | 9.3.1.1 | | YES | reject |
| gNB-CU UE F1AP ID | M | | 9.3.1.4 | | YES | reject |
| gNB-DU UE F1AP ID | M | | 9.3.1.5 | | YES | reject |
| Cause | M | | 9.3.1.2 | | YES | ignore |
| Criticality Diagnostics | O | | 9.3.1.3 | | YES | ignore |

9.2.2.10 UE CONTEXT MODIFICATION REQUIRED

This message is sent by the gNB-DU to request the modification of a UE context.

Direction: gNB-DU → gNB-CU.

| IE/Group Name | Presence | Range | IE type and reference | Semantics description | Criticality | Assigned Criticality |
|---|----------|-----------------------------------|--|--|-------------|----------------------|
| Message Type | M | | 9.3.1.1 | | YES | reject |
| gNB-CU UE F1AP ID | M | | 9.3.1.4 | | YES | reject |
| gNB-DU UE F1AP ID | M | | 9.3.1.5 | | YES | reject |
| Resource Coordination Transfer Container | O | | OCTET STRING | Includes the <i>SgNB Resource Coordination Information</i> IE as defined in subclause 9.2.117 of TS 36.423 [9] for EN-DC case or <i>MR-DC Resource Coordination Information</i> IE as defined in TS 38.423 [28] for NGEN-DC and NE-DC cases. | YES | ignore |
| DU To CU RRC Information | O | | 9.3.1.26 | | YES | reject |
| DRB Required to Be Modified List | | 0..1 | | | YES | reject |
| >DRB Required to Be Modified Item IEs | | 1 .. <maxnoofDRBs> | | | EACH | reject |
| >>DRB ID | M | | 9.3.1.8 | | - | |
| >>DL UP TNL Information to be setup List | | 0..1 | | | - | |
| >>>DL UP TNL Information to Be Setup Item IEs | | 1 .. <maxnoofDL UPTNLInformation> | | | - | |
| >>>>DL UP TNL Information | M | | UP Transport Layer Information 9.3.2.1 | gNB-CU endpoint of the F1 transport bearer. For delivery of DL PDUs. | - | |
| >>RLC Status | O | | 9.3.1.69 | Indicates the RLC has been re-established at the gNB-DU. | YES | ignore |
| SRB Required to be Released List | | 0..1 | | | YES | reject |
| >SRB Required to be Released List Item IEs | | 1 .. <maxnoofSRBs> | | | EACH | reject |
| >>SRB ID | M | | 9.3.1.7 | | - | |
| DRB Required to be Released List | | 0..1 | | | YES | reject |
| >DRB Required to be Released List Item IEs | | 1 .. <maxnoofDRBs> | | | EACH | reject |
| >>DRB ID | M | | 9.3.1.8 | | - | |
| Cause | M | | 9.3.1.2 | | YES | ignore |

| Range bound | Explanation |
|---------------------------|---|
| maxnoofSRBs | Maximum no. of SRB allowed towards one UE, the maximum value is 8. |
| maxnoofDRBs | Maximum no. of DRB allowed towards one UE, the maximum value is 64. |
| maxnoofDLUPTNLInformation | Maximum no. of DL UP TNL Information allowed towards one DRB, the maximum value is 2. |

9.2.2.11 UE CONTEXT MODIFICATION CONFIRM

This message is sent by the gNB-CU to inform the gNB-DU the successful modification.

Direction: gNB-CU → gNB-DU.

| IE/Group Name | Presence | Range | IE type and reference | Semantics description | Criticality | Assigned Criticality |
|---|----------|----------------------------------|--|--|-------------|----------------------|
| Message Type | M | | 9.3.1.1 | | YES | reject |
| gNB-CU UE F1AP ID | M | | 9.3.1.4 | | YES | reject |
| gNB-DU UE F1AP ID | M | | 9.3.1.5 | | YES | reject |
| Resource Coordination Transfer Container | O | | OCTET STRING | Includes the <i>MeNB Resource Coordination Information</i> IE as defined in subclause 9.2.116 of TS 36.423 [9] for EN-DC case or <i>MR-DC Resource Coordination Information</i> IE as defined in TS 38.423 [28] for NGEN-DC and NE-DC cases. | YES | ignore |
| DRB Modified List | | 0..1 | | The List of DRBs which are successfully modified. | YES | ignore |
| >DRB Modified Item IEs | | 1 .. <maxnoofDRBs> | | | EACH | ignore |
| >>DRB ID | M | | 9.3.1.8 | | - | |
| >>UL UP TNL Information to be setup List | | 1 | | | - | |
| >>>UL UP TNL Information to Be Setup Item IEs | | 1 .. <maxnoofULUPTNLInformation> | | | - | |
| >>>>UL UP TNL Information | M | | UP Transport Layer Information 9.3.2.1 | gNB-DU endpoint of the F1 transport bearer. For delivery of UL PDUs. | - | |
| RRC-Container | O | | 9.3.1.6 | Includes the DL-DCCH-Message IE as defined in subclause 6.2 of TS 38.331 [8], encapsulated in a PDCP PDU. | YES | ignore |
| Criticality Diagnostics | O | | 9.3.1.3 | | YES | ignore |
| Execute Duplication | O | | ENUMERATED (true, ...) | This IE may be sent only if duplication has been configured for the UE. | YES | ignore |
| Resource Coordination Transfer Information | O | | 9.3.1.73 | | YES | ignore |

| Range bound | Explanation |
|---------------------------|---|
| maxnoofDRBs | Maximum no. of DRB allowed towards one UE, the maximum value is 64. |
| maxnoofULUPTNLInformation | Maximum no. of UL UP TNL Information allowed towards one DRB, the maximum value is 2. |

9.2.2.11A UE CONTEXT MODIFICATION REFUSE

This message is sent by the gNB-CU to indicate the UE context modification was unsuccessful.

Direction: gNB-CU → gNB-DU.

| IE/Group Name | Presence | Range | IE type and reference | Semantics description | Criticality | Assigned Criticality |
|-------------------------|----------|-------|-----------------------|-----------------------|-------------|----------------------|
| Message Type | M | | 9.3.1.1 | | YES | reject |
| gNB-CU UE F1AP ID | M | | 9.3.1.4 | | YES | reject |
| gNB-DU UE F1AP ID | M | | 9.3.1.5 | | YES | reject |
| Cause | M | | 9.3.1.2 | | YES | ignore |
| Criticality Diagnostics | O | | 9.3.1.3 | | YES | ignore |

9.2.2.12 UE INACTIVITY NOTIFICATION

This message is sent by the gNB-DU to provide information about the UE activity to the gNB-CU.

Direction: gNB-DU → gNB-CU

| IE/Group Name | Presence | Range | IE type and reference | Semantics description | Criticality | Assigned Criticality |
|--------------------------|----------|---------------------------|---------------------------------------|-----------------------|-------------|----------------------|
| Message Type | M | | 9.3.1.1 | | YES | ignore |
| gNB-CU UE F1AP ID | M | | 9.3.1.4 | | YES | reject |
| gNB-DU UE F1AP ID | M | | 9.3.1.5 | | YES | reject |
| DRB Activity List | | 1 | | | YES | reject |
| >DRB Activity Item | | 1 .. <maxnoof DRBs> | | | EACH | reject |
| >>DRB ID | M | | 9.3.1.8 | | - | |
| >>DRB Activity | O | | ENUMERATED (Active, Not active) | | - | |

| Range bound | Explanation |
|-------------|---|
| maxnoofDRBs | Maximum no. of DRB allowed towards one UE, the maximum value is 64. |

9.2.2.13 NOTIFY

This message is sent by the gNB-DU to notify the gNB-CU that the QoS for already established DRBs associated with notification control is not fulfilled any longer or it is fulfilled again.

Direction: gNB-DU → gNB-CU

| IE/Group Name | Presence | Range | IE type and reference | Semantics description | Criticality | Assigned Criticality |
|------------------------|----------|---------------------------|---|-----------------------|-------------|----------------------|
| Message Type | M | | 9.3.1.1 | | YES | ignore |
| gNB-CU UE F1AP ID | M | | 9.3.1.4 | | YES | reject |
| gNB-DU UE F1AP ID | M | | 9.3.1.5 | | YES | reject |
| DRB Notify List | | 1 | | | YES | reject |
| >DRB Notify Item IEs | | <1 .. maxnoofD RBs> | | | EACH | reject |
| >>DRB ID | M | | 9.3.1.8 | | - | |
| >>Notification Cause | M | | ENUMERATED (Fulfilled, Not- Fulfilled, ...) | | - | |

| Range bound | Explanation |
|-------------|---|
| maxnoofDRBs | Maximum no. of DRB allowed towards one UE, the maximum value is 64. |

9.2.3 RRC Message Transfer messages

9.2.3.1 INITIAL UL RRC MESSAGE TRANSFER

This message is sent by the gNB-DU to transfer the initial layer 3 message to the gNB-CU over the F1 interface.

Direction: gNB-DU →gNB-CU

| IE/Group Name | Presence | Range | IE type and reference | Semantics description | Criticality | Assigned Criticality |
|--------------------------------|----------|-------|-------------------------|---|-------------|----------------------|
| Message Type | M | | 9.3.1.1 | | YES | ignore |
| gNB-DU UE F1AP ID | M | | 9.3.1.5 | | YES | reject |
| NR CGI | M | | 9.3.1.12 | NG-RAN Cell Global Identifier (NR CGI) | YES | reject |
| C-RNTI | M | | 9.3.1.32 | C-RNTI allocated at the gNB-DU | YES | reject |
| RRC-Container | M | | 9.3.1.6 | Includes the <i>UL-CCCH-Message</i> IE as defined in subclause 6.2 of TS 38.331 [8]. | YES | reject |
| DU to CU RRC Container | O | | OCTET STRING | <i>CellGroupConfig</i> IE as defined in subclause 6.3.2 in TS 38.331 [8]. Required at least to carry SRB1 configuration. The <i>ReconfigurationWithSync</i> field is not included in the <i>CellGroupConfig</i> IE. | YES | reject |
| SUL Access Indication | O | | ENUMERATED (true, ...) | | YES | ignore |
| Transaction ID | M | | 9.3.1.23 | | YES | ignore |
| RAN UE ID | O | | OCTET STRING (SIZE (8)) | | YES | ignore |
| RRC-Container-RRCSetupComplete | O | | 9.3.1.6 | Includes the <i>UL-DCCH-Message</i> IE including the <i>RRCSetupComplete</i> message, as defined in subclause 6.2 of TS 38.331 [8]. | YES | ignore |

9.2.3.2 DL RRC MESSAGE TRANSFER

This message is sent by the gNB-CU to transfer the layer 3 message to the gNB-DU over the F1 interface.

Direction: gNB-CU →gNB-DU

| IE/Group Name | Presence | Range | IE type and reference | Semantics description | Criticality | Assigned Criticality |
|--|----------|-------|---------------------------|--|-------------|----------------------|
| Message Type | M | | 9.3.1.1 | | YES | ignore |
| gNB-CU UE F1AP ID | M | | 9.3.1.4 | | YES | reject |
| gNB-DU UE F1AP ID | M | | 9.3.1.5 | | YES | reject |
| old gNB-DU UE F1AP ID | O | | 9.3.1.5 | Include it if RRCConnectionReestablishment is included in RRC-Container | YES | reject |
| SRB ID | M | | 9.3.1.7 | | YES | reject |
| Execute Duplication | O | | ENUMERATED (true, ...) | | YES | ignore |
| RRC-Container | M | | 9.3.1.6 | Includes the <i>DL-DCCH-Message</i> IE as defined in subclause 6.2 of TS 38.331 [8] encapsulated in a PDCP PDU, or the <i>DL-CCCH-Message</i> IE as defined in subclause 6.2 of TS 38.331 [8]. | YES | reject |
| RAT-Frequency Priority Information | O | | 9.3.1.34 | | YES | reject |
| RRC Delivery Status Request | O | | ENUMERATED (true, ...) | Indicates whether RRC DELIVERY REPORT procedure is requested for the RRC message. | YES | ignore |
| UE Context not retrievable | O | | ENUMERATED (true, ...) | | YES | reject |
| Redirected RRC message | O | | RRC Container 9.3.1.6 | Includes the <i>UL-DCCH-Message</i> IE as defined in subclause 6.2 of TS 38.331 [8], encapsulated in a PDCP PDU. | YES | reject |
| PLMN Assistance Info for Network Sharing | O | | PLMN Identity 9.3.1.14 | | YES | ignore |
| New gNB-CU UE F1AP ID | O | | gNB-CU UE F1AP ID 9.3.1.4 | | YES | reject |

9.2.3.3 UL RRC MESSAGE TRANSFER

This message is sent by the gNB-DU to transfer the layer 3 message to the gNB-CU over the F1 interface.

Direction: gNB-DU →gNB-CU

| IE/Group Name | Presence | Range | IE type and reference | Semantics description | Criticality | Assigned Criticality |
|-----------------------|----------|-------|---------------------------|--|-------------|----------------------|
| Message Type | M | | 9.3.1.1 | | YES | ignore |
| gNB-CU UE F1AP ID | M | | 9.3.1.4 | | YES | reject |
| gNB-DU UE F1AP ID | M | | 9.3.1.5 | | YES | reject |
| SRB ID | M | | 9.3.1.7 | | YES | reject |
| RRC-Container | M | | 9.3.1.6 | Includes the <i>UL-DCCH-Message</i> IE as defined in subclause 6.2 of TS 38.331 [8], encapsulated in a PDCP PDU. | YES | reject |
| Selected PLMN ID | O | | PLMN Identity 9.3.1.14 | | YES | reject |
| New gNB-DU UE F1AP ID | O | | gNB-DU UE F1AP ID 9.3.1.5 | | YES | reject |

9.2.3.4 RRC DELIVERY REPORT

This message is sent by the gNB-DU to inform the gNB-CU about the delivery status of DL RRC messages.

Direction: gNB-DU → gNB-CU

| IE/Group Name | Presence | Range | IE type and reference | Semantics description | Criticality | Assigned Criticality |
|---------------------|----------|-------|-----------------------|-----------------------|-------------|----------------------|
| Message Type | M | | 9.3.1.1 | | YES | ignore |
| gNB-CU UE F1AP ID | M | | 9.3.1.4 | | YES | reject |
| gNB-DU UE F1AP ID | M | | 9.3.1.5 | | YES | reject |
| RRC Delivery Status | M | | 9.3.1.71 | | YES | ignore |
| SRB ID | M | | 9.3.1.7 | | YES | ignore |

9.2.4 Warning Message Transmission Messages

9.2.4.1 WRITE-REPLACE WARNING REQUEST

This message is sent by the gNB-CU to request the start or overwrite of the broadcast of a warning message.

Direction: gNB-CU → gNB-DU

| IE/Group Name | Presence | Range | IE type and reference | Semantics description | Criticality | Assigned Criticality |
|--|----------|-----------------------------|-----------------------|--|-------------|----------------------|
| Message Type | M | | 9.3.1.1 | | YES | reject |
| Transaction ID | M | | 9.3.1.23 | | YES | reject |
| PWS System Information | M | | 9.3.1.58 | This IE includes the system information for public warning, as defined in TS 38.331 [8]. | YES | reject |
| Repetition Period | M | | 9.3.1.59 | | YES | reject |
| Number of Broadcasts Requested | M | | 9.3.1.60 | | YES | reject |
| Cell To Be Broadcast List | | 0..1 | | | YES | reject |
| >Cell to Be Broadcast Item IEs | | 1.. <maxCelli ngNBDU> | | | EACH | reject |
| >>NR CGI | M | | 9.3.1.12 | | - | |

| Range bound | Explanation |
|----------------|---|
| maxCellingNBdu | Maximum no. cells that can be served by a gNB-DU. Value is 512. |

9.2.4.2 WRITE-REPLACE WARNING RESPONSE

This message is sent by the gNB-DU to acknowledge the gNB-CU on the start or overwrite request of a warning message.

Direction: gNB-DU → gNB-CU

| IE/Group Name | Presence | Range | IE type and reference | Semantics description | Criticality | Assigned Criticality |
|---|----------|-------------------------|-----------------------|---|-------------|----------------------|
| Message Type | M | | 9.3.1.1 | | YES | reject |
| Transaction ID | M | | 9.3.1.23 | | YES | reject |
| Cell Broadcast Completed List | | 0..1 | | | YES | reject |
| >Cell Broadcast Completed Item IEs | | 1.. <maxCellingNBDU> | | | EACH | reject |
| >>NR CGI | M | | 9.3.1.12 | | - | |
| Criticality Diagnostics | O | | 9.3.1.3 | | YES | ignore |
| Dedicated SI Delivery Needed UE List | | 0..1 | | List of UEs unable to receive system information from broadcast | YES | ignore |
| >Dedicated SI Delivery Needed UE Item | | 1.. <maxnoofUEIDs> | | | EACH | ignore |
| >>gNB-CU UE F1AP ID | M | | 9.3.1.4 | | - | |
| >>NR CGI | M | | 9.3.1.12 | | - | |

| Range bound | Explanation |
|----------------|--|
| maxCellingNBDU | Maximum no. cells that can be served by a gNB-DU. Value is 512. |
| maxnoofUEIDs | Maximum no. of UEs that can be served by a gNB-DU. Value is 65536. |

9.2.4.3 PWS CANCEL REQUEST

This message is forwarded by the gNB-CU to gNB-DU to cancel an already ongoing broadcast of a warning message

Direction: gNB-CU → gNB-DU

| IE/Group Name | Presence | Range | IE type and reference | Semantics description | Criticality | Assigned Criticality |
|--|----------|-------------------------|-----------------------|--|-------------|----------------------|
| Message Type | M | | 9.3.1.1 | | YES | reject |
| Transaction ID | M | | 9.3.1.23 | | YES | reject |
| Number of Broadcasts Requested | M | | 9.3.1.60 | This IE is not used in this version of the specification | YES | reject |
| Cell Broadcast To Be Cancelled List | | 0..1 | | | YES | reject |
| >Cell Broadcast to Be Cancelled Item IEs | | 1.. <maxCellingNBDU> | | | EACH | reject |
| >>NR CGI | M | | 9.3.1.12 | | - | |
| Cancel-all Warning Messages Indicator | O | | | ENUMERATED (true, ...) | YES | reject |
| Notification Information | O | | | | YES | reject |
| >Message Identifier | M | | 9.3.1.81 | | | |
| >Serial Number | M | | 9.3.1.82 | | | |

| Range bound | Explanation |
|----------------|---|
| maxCellingNBDU | Maximum no. cells that can be served by a gNB-DU. Value is 512. |

9.2.4.4 PWS CANCEL RESPONSE

This message is sent by the gNB-DU to indicate the list of warning areas where cancellation of the broadcast of the identified message was successful and unsuccessful.

Direction: gNB-DU → gNB-CU

| IE/Group Name | Presence | Range | IE type and reference | Semantics description | Criticality | Assigned Criticality |
|--|----------|-------------------------|-----------------------|---|-------------|----------------------|
| Message Type | M | | 9.3.1.1 | | YES | reject |
| Transaction ID | M | | 9.3.1.23 | | YES | reject |
| Cell Broadcast Cancelled List | | 0..1 | | | YES | reject |
| >Cell Broadcast Cancelled Item IEs | | 1.. <maxCellingNBDU> | | | EACH | reject |
| >>NR CGI | M | | 9.3.1.12 | | - | |
| >>Number of Broadcasts | M | | INTEGER (0..65535) | This IE is set to '0' if valid results are not known or not available. It is set to 65535 if the counter results have overflowed. | - | |
| Criticality Diagnostics | O | | 9.3.1.3 | | YES | ignore |

| Range bound | Explanation |
|----------------|--|
| maxCellingNBDU | Maximum no. of cells that can be served by a gNB-DU. Value is 512. |

9.2.4.5 PWS RESTART INDICATION

This message is sent by the gNB-DU to inform the gNB-CU that PWS information for some or all cells of the gNB-DU are available if needed.

Direction: gNB-DU →gNB-CU

| IE/Group Name | Presence | Range | IE type and reference | Semantics description | Criticality | Assigned Criticality |
|---|----------|---------------------|-----------------------|-----------------------|-------------|----------------------|
| Message Type | M | | 9.3.1.1 | | YES | ignore |
| Transaction ID | M | | 9.3.1.23 | | YES | reject |
| NR CGI List for Restart List | | 1 | | | YES | reject |
| >NR CGI List for Restart Item IEs | | 1..<maxCellingNBDU> | | | EACH | reject |
| >>NR CGI | M | | 9.3.1.12 | | - | |

| Range bound | Explanation |
|----------------|--|
| maxCellingNBDU | Maximum no. of cells that can be served by a gNB-DU. Value is 512. |

9.2.4.6 PWS FAILURE INDICATION

This message is sent by the gNB-DU to inform the gNB-CU that ongoing PWS operation for one or more cells of the gNB-DU has failed.

Direction: gNB-DU → gNB-CU

| IE/Group Name | Presence | Range | IE type and reference | Semantics description | Criticality | Assigned Criticality |
|---------------------------------------|----------|--------------------------|-----------------------|---|-------------|----------------------|
| Message Type | M | | 9.3.1.1 | | YES | ignore |
| Transaction ID | M | | 9.3.1.23 | | YES | reject |
| PWS failed NR CGI List | | 0..1 | | | YES | reject |
| >PWS failed NR CGI Item IEs | | 1..<maxCellingNB BDU> | | | EACH | reject |
| >>NR CGI | M | | 9.3.1.12 | | - | |
| >>Number of Broadcasts | M | | INTEGER (0..65535) | This IE is set to '0' if valid results are not known or not available. It is set to 65535 if the counter results have overflowed. | - | |

| Range bound | Explanation |
|-----------------|--|
| maxCellingNBBDU | Maximum no. of cells that can be served by a gNB-DU. Value is 512. |

9.2.5 System Information messages

9.2.5.1 SYSTEM INFORMATION DELIVERY COMMAND

This message is sent by the gNB-CU and is used to enable the gNB-DU to broadcast the requested other SI.

Direction: gNB-CU → gNB-DU

| IE/Group Name | Presence | Range | IE type and reference | Semantics description | Criticality | Assigned Criticality |
|-----------------|----------|-------|---------------------------------|-----------------------|-------------|----------------------|
| Message Type | M | | 9.3.1.1 | | YES | ignore |
| Transaction ID | M | | 9.3.1.23 | | YES | reject |
| NR CGI | M | | 9.3.1.12 | NR cell identifier | YES | reject |
| SIType List | M | | 9.3.1.62 | | YES | reject |
| Confirmed UE ID | M | | gNB-DU UE F1AP ID 9.3.1.5 | | YES | reject |

9.2.6 Paging messages

9.2.6.1 PAGING

This message is sent by the gNB-CU and is used to request the gNB-DU to page UEs.

Direction: gNB-CU → gNB-DU

| IE/Group Name | Presence | Range | IE type and reference | Semantics description | Criticality | Assigned Criticality |
|-------------------------|----------|----------------------------------|-----------------------|---|-------------|----------------------|
| Message Type | M | | 9.3.1.1 | | YES | ignore |
| UE Identity Index value | M | | 9.3.1.39 | | YES | reject |
| CHOICE Paging Identity | M | | | | YES | reject |
| >RAN UE Paging identity | M | | 9.3.1.43 | | - | |
| >CN UE paging identity | M | | 9.3.1.44 | | - | |
| Paging DRX | O | | 9.3.1.40 | It is defined as the minimum between the RAN UE Paging DRX and CN UE Paging DRX | YES | ignore |
| Paging Priority | O | | 9.3.1.41 | | YES | ignore |
| Paging Cell List | | 1 | | | YES | ignore |
| >Paging Cell Item IEs | | 1 .. <maxnoofPagingCells > | | | EACH | ignore |
| >>NR CGI | M | | 9.3.1.12 | | - | |
| Paging Origin | O | | 9.3.1.79 | | YES | ignore |

| Range bound | Explanation |
|--------------------|--|
| maxnoofPagingCells | Maximum no. of paging cells, the maximum value is 512. |

9.3 Information Element Definitions

9.3.1 Radio Network Layer Related IEs

9.3.1.1 Message Type

The *Message Type* IE uniquely identifies the message being sent. It is mandatory for all messages.

| IE/Group Name | Presence | Range | IE type and reference | Semantics description |
|---------------------|----------|-------|--|-----------------------|
| Message Type | | | | |
| >Procedure Code | M | | INTEGER (0..255) | |
| >Type of Message | M | | CHOICE (Initiating Message, Successful Outcome, Unsuccessful Outcome, ...) | |

9.3.1.2 Cause

The purpose of the *Cause* IE is to indicate the reason for a particular event for the F1AP protocol.

| IE/Group Name | Presence | Range | IE Type and Reference | Semantics Description |
|-----------------------------|----------|-------|--|-----------------------|
| CHOICE Cause Group | M | | | |
| >Radio Network Layer | | | | |
| >>Radio Network Layer Cause | M | | ENUMERATED (Unspecified, RL failure-RLC, Unknown or already allocated gNB-CU UE F1AP ID, Unknown or already allocated gNB-DU UE F1AP ID, Unknown or inconsistent pair of UE F1AP ID, Interaction with other procedure, Not supported QCI Value, Action Desirable for Radio Reasons, No Radio Resources Available, Procedure cancelled, Normal Release, ..., Cell not available, RL failure-others, UE rejection, Resources not available for the slice, AMF initiated abnormal release, Release due to Pre-Emption, PLMN not served by the gNB-CU, Multiple DRB ID Instances, Unknown DRB ID) | |
| >Transport Layer | | | | |
| >>Transport Layer Cause | M | | ENUMERATED (Unspecified, Transport Resource Unavailable, ...) | |
| >Protocol | | | | |
| >>Protocol Cause | M | | ENUMERATED (Transfer Syntax Error, Abstract Syntax Error (Reject), Abstract Syntax Error (Ignore and Notify), Message not Compatible with Receiver State, Semantic Error, Abstract Syntax Error (Falsely Constructed Message), Unspecified, ...) | |
| >Misc | | | | |
| >>Miscellaneous Cause | M | | ENUMERATED (Control Processing Overload, Not enough User Plane Processing Resources, Hardware Failure, O&M Intervention, Unspecified, ...) | |

The meaning of the different cause values is described in the following table. In general, "not supported" cause values indicate that the related capability is missing. On the other hand, "not available" cause values indicate that the related capability is present, but insufficient resources were available to perform the requested action.

| Radio Network Layer cause | Meaning |
|--|---|
| Unspecified | Sent for radio network layer cause when none of the specified cause values applies. |
| RL Failure-RLC | The action is due to an RL failure caused by exceeding the maximum number of ARQ retransmissions. |
| Unknown or already allocated gNB-CU UE F1AP ID | The action failed because the gNB-CU UE F1AP ID is either unknown, or (for a first message received at the gNB-CU) is known and already allocated to an existing context. |
| Unknown or already allocated gNB-DU UE F1AP ID | The action failed because the gNB-DU UE F1AP ID is either unknown, or (for a first message received at the gNB-DU) is known and already allocated to an existing context. |
| Unknown or inconsistent pair of UE F1AP ID | The action failed because both UE F1AP IDs are unknown, or are known but do not define a single UE context. |
| Interaction with other procedure | The action is due to an ongoing interaction with another procedure. |
| Not supported QCI Value | The action failed because the requested QCI is not supported. |
| Action Desirable for Radio Reasons | The reason for requesting the action is radio related. |
| No Radio Resources Available | The cell(s) in the requested node don't have sufficient radio resources available. |
| Procedure cancelled | The sending node cancelled the procedure due to other urgent actions to be performed. |
| Normal Release | The action is due to a normal release of the UE (e.g. because of mobility) and does not indicate an error. |
| Cell Not Available | The action failed due to no cell available in the requested node. |
| RL Failure-others | The action is due to an RL failure caused by other radio link failures than exceeding the maximum number of ARQ retransmissions. |
| UE rejection | The action is due to gNB-CU's rejection of a UE access request. |
| Resources not available for the slice | The requested resources are not available for the slice. |
| AMF initiated abnormal release | The release is triggered by an error in the AMF or in the NAS layer. |
| Release due to Pre-Emption | Release is initiated due to pre-emption. |
| PLMN not served by the gNB-CU | The PLMN indicated by the UE is not served by the gNB-CU. |
| Multiple DRB ID Instances | The action failed because multiple instances of the same DRB had been provided. |
| Unknown DRB ID | The action failed because the DRB ID is unknown. |

| Transport Layer cause | Meaning |
|--------------------------------|--|
| Unspecified | Sent when none of the above cause values applies but still the cause is Transport Network Layer related. |
| Transport Resource Unavailable | The required transport resources are not available. |

| Protocol cause | Meaning |
|---|--|
| Transfer Syntax Error | The received message included a transfer syntax error. |
| Abstract Syntax Error (Reject) | The received message included an abstract syntax error and the concerning criticality indicated "reject". |
| Abstract Syntax Error (Ignore And Notify) | The received message included an abstract syntax error and the concerning criticality indicated "ignore and notify". |
| Message Not Compatible With Receiver State | The received message was not compatible with the receiver state. |
| Semantic Error | The received message included a semantic error. |
| Abstract Syntax Error (Falsely Constructed Message) | The received message contained IEs or IE groups in wrong order or with too many occurrences. |
| Unspecified | Sent when none of the above cause values applies but still the cause is Protocol related. |

| Miscellaneous cause | Meaning |
|--|---|
| Control Processing Overload | Control processing overload. |
| Not Enough User Plane Processing Resources Available | No enough resources are available related to user plane processing. |
| Hardware Failure | Action related to hardware failure. |
| O&M Intervention | The action is due to O&M intervention. |

| Miscellaneous cause | Meaning |
|---------------------|--|
| Unspecified Failure | Sent when none of the above cause values applies and the cause is not related to any of the categories Radio Network Layer, Transport Network Layer or Protocol. |

9.3.1.3 Criticality Diagnostics

The *Criticality Diagnostics* IE is sent by the gNB-DU or the gNB-CU when parts of a received message have not been comprehended or were missing, or if the message contained logical errors. When applicable, it contains information about which IEs were not comprehended or were missing.

For further details on how to use the *Criticality Diagnostics* IE, (see clause 10). The conditions for inclusion of the *Transaction ID* IE are described in clause 10.

| IE/Group Name | Presence | Range | IE type and reference | Semantics description |
|--|----------|------------------------------------|--|---|
| Procedure Code | O | | INTEGER (0..255) | Procedure Code is to be used if Criticality Diagnostics is part of Error Indication procedure, and not within the response message of the same procedure that caused the error. |
| Triggering Message | O | | ENUMERATED(initializing message, successful outcome, unsuccessful outcome) | The Triggering Message is used only if the Criticality Diagnostics is part of Error Indication procedure. |
| Procedure Criticality | O | | ENUMERATED(reject, ignore, notify) | This Procedure Criticality is used for reporting the Criticality of the Triggering message (Procedure). |
| Transaction ID | O | | 9.3.1.23 | |
| Information Element Criticality Diagnostics | | <i>0 .. <maxnoof Errors></i> | | |
| >IE Criticality | M | | ENUMERATED(reject, ignore, notify) | The IE Criticality is used for reporting the criticality of the triggering IE. The value 'ignore' is not applicable. |
| >IE ID | M | | INTEGER (0..65535) | The IE ID of the not understood or missing IE. |
| >Type of Error | M | | ENUMERATED(not understood, missing, ...) | |

| Range bound | Explanation |
|---------------|--|
| maxnoofErrors | Maximum no. of IE errors allowed to be reported with a single message. The value for maxnoofErrors is 256. |

9.3.1.4 gNB-CU UE F1AP ID

The gNB-CU UE F1AP ID uniquely identifies the UE association over the F1 interface within the gNB-CU.

NOTE: If F1-C signalling transport is shared among multiple interface instances, the value of the gNB-CU UE F1AP ID is allocated so that it can be associated with the corresponding F1-C interface instance.

| IE/Group Name | Presence | Range | IE type and reference | Semantics description |
|-------------------|----------|-------|-----------------------------------|-----------------------|
| gNB-CU UE F1AP ID | M | | INTEGER (0 .. 2 ³² -1) | |

9.3.1.5 gNB-DU UE F1AP ID

The gNB-DU UE F1AP ID uniquely identifies the UE association over the F1 interface within the gNB-DU.

NOTE: If F1-C signalling transport is shared among multiple interface instances, the value of the gNB-CU UE F1AP ID is allocated so that it can be associated with the corresponding F1-C interface instance.

| IE/Group Name | Presence | Range | IE type and reference | Semantics description |
|-------------------|----------|-------|----------------------------|-----------------------|
| gNB-DU UE F1AP ID | M | | INTEGER (0 .. $2^{32}-1$) | |

9.3.1.6 RRC-Container

This information element contains a gNB-CU→UE or a UE → gNB-CU message that is transferred without interpretation in the gNB-DU.

| IE/Group Name | Presence | Range | IE type and reference | Semantics description |
|---------------|----------|-------|-----------------------|-----------------------|
| RRC-Container | M | | OCTET STRING | |

9.3.1.7 SRB ID

This IE uniquely identifies a SRB for a UE.

| IE/Group Name | Presence | Range | IE type and reference | Semantics description |
|---------------|----------|-------|-----------------------|--|
| SRB ID | M | | INTEGER (0..3, ...) | Corresponds to the <i>SRB-Identity</i> defined in TS 38.331 [8]. |

9.3.1.8 DRB ID

This IE uniquely identifies a DRB for a UE.

| IE/Group Name | Presence | Range | IE type and reference | Semantics description |
|---------------|----------|-------|-----------------------|--|
| DRB ID | M | | INTEGER (1..32, ...) | Corresponds to the <i>DRB-Identity</i> defined in TS 38.331 [8]. |

9.3.1.9 gNB-DU ID

The gNB-DU ID uniquely identifies the gNB-DU at least within a gNB-CU.

| IE/Group Name | Presence | Range | IE type and reference | Semantics description |
|---------------|----------|-------|----------------------------|---|
| gNB-DU ID | M | | INTEGER (0 .. $2^{36}-1$) | The gNB-DU ID is independently configured from cell identifiers, i.e. no connection between gNB-DU ID and cell identifiers. |

9.3.1.10 Served Cell Information

This IE contains cell configuration information of a cell in the gNB-DU.

| IE/Group Name | Presence | Range | IE type and reference | Semantics description | Criticality | Assigned Criticality |
|-------------------------------------|----------|---|---------------------------------|---|-------------|----------------------|
| NR CGI | M | | 9.3.1.12 | | - | |
| NR PCI | M | | INTEGER (0..1007) | Physical Cell ID | - | |
| 5GS TAC | O | | 9.3.1.29 | 5GS Tracking Area Code | - | |
| Configured EPS TAC | O | | 9.3.1.29a | | - | |
| Served PLMNs | | <i>1..<maxnoofBPLMNs></i> | | Broadcast PLMNs | - | |
| >PLMN Identity | M | | 9.3.1.14 | | - | |
| >TAI Slice Support List | O | | Slice Support List 9.3.1.37 | Supported S-NSSAIs per TA. | YES | ignore |
| CHOICE <i>NR-Mode-Info</i> | M | | | | - | |
| > <i>FDD</i> | | | | | - | |
| >> FDD Info | | <i>1</i> | | | - | |
| >>>UL FreqInfo | M | | NR Frequency Info 9.3.1.17 | | - | |
| >>>DL FreqInfo | M | | NR Frequency Info 9.3.1.17 | | - | |
| >>>UL Transmission Bandwidth | M | | Transmission Bandwidth 9.3.1.15 | | - | |
| >>>DL Transmission Bandwidth | M | | Transmission Bandwidth 9.3.1.15 | | - | |
| > <i>TDD</i> | | | | | - | |
| >> TDD Info | | <i>1</i> | | | - | |
| >>> NR FreqInfo | M | | NR Frequency Info 9.3.1.17 | | - | |
| >>> Transmission Bandwidth | M | | Transmission Bandwidth 9.3.1.15 | | - | |
| Measurement Timing Configuration | M | | OCTET STRING | Contains the <i>MeasurementTimingConfiguration</i> inter-node message defined in TS 38.331 [8]. | - | |
| RANAC | O | | RAN Area Code 9.3.1.57 | | YES | ignore |
| Extended Served PLMNs List | | <i>0..1</i> | | This is included if more than 6 Served PLMNs is to be signalled. | YES | ignore |
| > Extended Served PLMNs Item | | <i>1..<maxnoofExtendedBPLMNs></i> | | | - | |
| >>PLMN Identity | M | | 9.3.1.14 | | - | |
| >>TAI Slice Support List | O | | Slice Support List 9.3.1.37 | Supported S-NSSAIs per TA. | - | |
| Cell Direction | O | | 9.3.1.78 | | YES | ignore |
| Cell Type | O | | 9.3.1.87 | | YES | ignore |

| | | | | | | |
|--|---|-------------------------------------|--|--|-----|--------|
| Broadcast PLMN Identity Info List | | <i>0..<maxnoofBPLMNsNR-1></i> | | This IE corresponds to the <i>PLMN-IdentityInfoList</i> IE in <i>SIB1</i> as specified in TS 38.331 [8]. The PLMN Identities and associated information contained in this IE is provided in the same order as broadcast in <i>SIB1</i> . | YES | ignore |
| >PLMN Identity List | M | | Available PLMN List 9.3.1.65 | | - | |
| >Extended PLMN Identity List | O | | Extended Available PLMN List 9.3.1.76 | | - | |
| >5GS-TAC | O | | OCTET STRING (3) | | - | |
| >NR Cell Identity | M | | BIT STRING (36) | | - | |
| >RANAC | O | | RAN Area Code 9.3.1.57 | | - | |

| Range bound | Explanation |
|-----------------------|---|
| maxnoofBPLMNs | Maximum no. of Broadcast PLMN Ids. Value is 6. |
| maxnoofExtendedBPLMNs | Maximum no. of Extended Broadcast PLMN Ids. Value is 6. |
| maxnoofBPLMNsNR-1 | Maximum no. of PLMN Ids.broadcast in an NR cell minus 1. Value is 11. |

9.3.1.11 Transmission Action Indicator

This IE indicates actions for the gNB-DU for the data transmission to the UE.

| IE/Group Name | Presence | Range | IE type and reference | Semantics description |
|-------------------------------|----------|-------|------------------------------------|-----------------------|
| Transmission Action Indicator | M | | ENUMERATED (stop, ..., restart) | |

9.3.1.12 NR CGI

The NR Cell Global Identifier (NR CGI) is used to globally identify a cell.

| IE/Group Name | Presence | Range | IE type and reference | Semantics description |
|------------------|----------|-------|--------------------------|-----------------------|
| PLMN Identity | M | | 9.3.1.14 | |
| NR Cell Identity | M | | BIT STRING (SIZE(36)) | |

9.3.1.13 Time To wait

This IE defines the minimum allowed waiting times.

| IE/Group Name | Presence | Range | IE type and reference | Semantics description |
|---------------|----------|-------|---------------------------------------|-----------------------|
| Time to wait | M | | ENUMERATED(1s, 2s, 5s, 10s, 20s, 60s) | |

9.3.1.14 PLMN Identity

This information element indicates the PLMN Identity.

| IE/Group Name | Presence | Range | IE type and reference | Semantics description |
|---------------|----------|-------|------------------------|---|
| PLMN Identity | M | | OCTET STRING (SIZE(3)) | <ul style="list-style-type: none"> - digits 0 to 9, encoded 0000 to 1001, - 1111 used as filler digit, two digits per octet, - bits 4 to 1 of octet n encoding digit 2n-1 - bits 8 to 5 of octet n encoding digit 2n <p>-The PLMN identity consists of 3 digits from MCC followed by either</p> <ul style="list-style-type: none"> -a filler digit plus 2 digits from MNC (in case of 2 digit MNC) or -3 digits from MNC (in case of a 3 digit MNC). |

9.3.1.15 Transmission Bandwidth

The *Transmission Bandwidth* IE is used to indicate the UL or DL transmission bandwidth.

| IE/Group Name | Presence | Range | IE Type and Reference | Semantics Description |
|---------------|----------|-------|--|--|
| NR SCS | M | | ENUMERATED (scs15, scs30, scs60, scs120, ...) | The values scs15, scs30, scs60 and scs120 corresponds to the sub carrier spacing in TS 38.104 [17]. |
| NRB | M | | ENUMERATED (nrb11, nrb18, nrb24, nrb25, nrb31, nrb32, nrb38, nrb51, nrb52, nrb65, nrb66, nrb78, nrb79, nrb93, nrb106, nrb107, nrb121, nrb132, nrb133, nrb135, nrb160, nrb162, nrb189, nrb216, nrb217, nrb245, nrb264, nrb270, nrb273, ...) | This IE is used to indicate the UL or DL transmission bandwidth expressed in units of resource blocks "NRB" (TS 38.104 [17]). The values nrb11, nrb18, etc. correspond to the number of resource blocks "NRB" 11, 18, etc. |

9.3.1.16 Void

Reserved for future use.

9.3.1.17 NR Frequency Info

The NR Frequency Info defines the carrier frequency used in a cell for a given direction (UL or DL) in FDD or for both UL and DL directions in TDD or for an SUL carrier.

| IE/Group Name | Presence | Range | IE Type and Reference | Semantics Description |
|--------------------------------|----------|-------------------------|-------------------------|---|
| NR ARFCN | M | | INTEGER (0..maxNRARFCN) | RF Reference Frequency as defined in TS 38.104 [17] section 5.4.2.1. The frequency provided in this IE identifies the absolute frequency position of the reference resource block (Common RB 0) of the carrier. Its lowest subcarrier is also known as Point A. |
| SUL Information | O | | 9.3.1.28 | |
| Frequency Band List | | 1 | | |
| >Frequency Band Item | | 1..<maxnoofNrCellBands> | | |
| >>NR Frequency Band | M | | INTEGER (1..1024, ...) | Operating Band as defined in TS 38.104 [17] section 5.4.2.3. The value 1 corresponds to NR operating band n1, value 2 corresponds to NR operating band n2, etc. |
| >>Supported SUL band List | | 0..<maxnoofNrCellBands> | | |
| >>>Supported SUL band Item | M | | INTEGER (1..1024, ...) | Supplementary NR Operating Band as defined in TS 38.104 [17] section 5.4.2.3 that can be used for SUL duplex mode as per TS 38.101-1 [26] table 5.2.-1. The value 80 corresponds to NR operating band n80, value 81 corresponds to NR operating band n81, etc. |

| Range bound | Explanation |
|--------------------|--|
| maxNRARFCN | Maximum value of NR ARFCNs. Value is 3279165. |
| maxnoofNrCellBands | Maximum no. of frequency bands supported for a NR cell. Value is 32. |

9.3.1.18 gNB-DU System Information

This IE contains the system information generated by the gNB-DU.

| IE/Group Name | Presence | Range | IE type and reference | Semantics description |
|---------------|----------|-------|-----------------------|--|
| MIB message | M | | OCTET STRING | MIB message, as defined in TS 38.331 [8]. |
| SIB1 message | M | | OCTET STRING | SIB1 message, as defined in TS 38.331 [8]. |

9.3.1.19 E-UTRAN QoS

This IE defines the QoS to be applied to a DRB for EN-DC case.

| IE/Group Name | Presence | Range | IE type and reference | Semantics description |
|-----------------------------------|----------|-------|-----------------------|--|
| QCI | M | | INTEGER (0..255) | QoS Class Identifier defined in TS 23.401 [10]. Logical range and coding specified in TS 23.203 [11]. |
| Allocation and Retention Priority | M | | 9.3.1.20 | |
| GBR QoS Information | O | | 9.3.1.21 | This IE shall be present for GBR bearers only and is ignored otherwise. |

9.3.1.20 Allocation and Retention Priority

This IE specifies the relative importance compared to other E-RABs for allocation and retention of the E-UTRAN Radio Access Bearer.

| IE/Group Name | Presence | Range | IE type and reference | Semantics description |
|---------------------------|----------|-------|---|---|
| Priority Level | M | | INTEGER (0..15) | Desc.: This IE should be understood as "priority of allocation and retention" (see TS 23.401 [10]). Usage: Value 15 means "no priority". Values between 1 and 14 are ordered in decreasing order of priority, i.e. 1 is the highest and 14 the lowest. Value 0 shall be treated as a logical error if received. |
| Pre-emption Capability | M | | ENUMERATED(sh all not trigger pre-emption, may trigger pre-emption) | Desc.: This IE indicates the pre-emption capability of the request on other E-RABs (see TS 23.401 [10]). Usage: The E-RAB shall not pre-empt other E-RABs or, the E-RAB may pre-empt other E-RABs The Pre-emption Capability indicator applies to the allocation of resources for an E-RAB and as such it provides the trigger to the pre-emption procedures/processes of the eNB. |
| Pre-emption Vulnerability | M | | ENUMERATED(not pre-emptable, pre-emptable) | Desc.: This IE indicates the vulnerability of the E-RAB to pre-emption of other E-RABs (see TS 23.401 [10]). Usage: The E-RAB shall not be pre-empted by other E-RABs or the E-RAB may be pre-empted by other RABs. Pre-emption Vulnerability indicator applies for the entire duration of the E-RAB, unless modified, and as such indicates whether the E-RAB is a target of the pre-emption procedures/processes of the eNB. |

9.3.1.21 GBR QoS Information

This IE indicates the maximum and guaranteed bit rates of a GBR E-RAB for downlink and uplink.

| IE/Group Name | Presence | Range | IE type and reference | Semantics description |
|------------------------------------|----------|-------|-----------------------|--|
| E-RAB Maximum Bit Rate Downlink | M | | Bit Rate 9.3.1.22 | Maximum Bit Rate in DL (i.e. from EPC to E-UTRAN) for the bearer. Details in TS 23.401 [10]. |
| E-RAB Maximum Bit Rate Uplink | M | | Bit Rate 9.3.1.22 | Maximum Bit Rate in UL (i.e. from E-UTRAN to EPC) for the bearer. Details in TS 23.401 [10]. |
| E-RAB Guaranteed Bit Rate Downlink | M | | Bit Rate 9.3.1.22 | Guaranteed Bit Rate (provided that there is data to deliver) in DL (i.e. from EPC to E-UTRAN) for the bearer. Details in TS 23.401 [10]. |
| E-RAB Guaranteed Bit Rate Uplink | M | | Bit Rate 9.3.1.22 | Guaranteed Bit Rate (provided that there is data to deliver) in UL (i.e. from E-UTRAN to EPC) for the bearer. Details in TS 23.401 [10]. |

9.3.1.22 Bit Rate

This IE indicates the number of bits delivered by NG-RAN in UL or to NG-RAN in DL within a period of time, divided by the duration of the period. It is used, for example, to indicate the maximum or guaranteed bit rate for a GBR QoS flow, or an aggregated maximum bit rate.

| IE/Group Name | Presence | Range | IE type and reference | Semantics description |
|---------------|----------|-------|------------------------------------|-----------------------|
| Bit Rate | M | | INTEGER (0..4,000,000,000,000,...) | The unit is: bit/s |

9.3.1.23 Transaction ID

The *Transaction ID* IE uniquely identifies a procedure among all ongoing parallel procedures of the same type initiated by the same protocol peer. Messages belonging to the same procedure use the same Transaction ID. The Transaction ID is determined by the initiating peer of a procedure.

NOTE: If F1-C signalling transport is shared among multiple interface instances, the Transaction ID is allocated so that it can be associated with an F1-C interface instance. The Transaction ID may identify more than one interface instance.

| IE/Group Name | Presence | Range | IE type and reference | Semantics description |
|----------------|----------|-------|-----------------------|-----------------------|
| Transaction ID | M | | INTEGER (0..255, ...) | |

9.3.1.24 DRX Cycle

The *DRX Cycle* IE is to indicate the desired DRX cycle.

| IE/Group Name | Presence | Range | IE Type and Reference | Semantics Description |
|------------------------|----------|-------|--|-------------------------------------|
| Long DRX Cycle Length | M | | ENUMERATED (ms10, ms20, ms32, ms40, ms60, ms64, ms70, ms80, ms128, ms160, ms256, ms320, ms512, ms640, ms1024, ms1280, ms2048, ms2560, ms5120, ms10240, ...) | This IE is defined in TS 38.331 [8] |
| Short DRX Cycle Length | O | | ENUMERATED (ms2, ms3, ms4, ms5, ms6, ms7, ms8, ms10, ms14, ms16, ms20, ms30, ms32, ms35, ms40, ms64, ms80, ms128, ms160, ms256, ms320, ms512, ms640, ...) | This IE is defined in TS 38.331 [8] |
| Short DRX Cycle Timer | O | | INTEGER (1..16) | This IE is defined in TS 38.331 [8] |

9.3.1.25 CU to DU RRC Information

This IE contains the RRC Information that are sent from gNB-CU to gNB-DU.

| IE/Group Name | Presence | Range | IE type and reference | Semantics description | Criticality | Assigned Criticality |
|----------------------------------|----------|-------|-----------------------|---|-------------|----------------------|
| CG-ConfigInfo | O | | OCTET STRING | CG-ConfigInfo, as defined in TS 38.331 [8]. | - | |
| UE-CapabilityRAT-ContainerList | O | | OCTET STRING | This IE is used in the NG-RAN and it consists of the UE-CapabilityRAT-ContainerList, as defined in TS 38.331 [8]. | - | |
| MeasConfig | O | | OCTET STRING | MeasConfig, as defined in TS 38.331 [8] (without MeasGapConfig). For EN-DC/NGEN-DC operation, includes the list of FR2 frequencies for which the gNB-CU requests the gNB-DU to generate gaps. For NG-RAN, NE-DC and MN for NR-NR DC, includes the list of FR1 and/or FR2 frequencies for which the gNB-CU requests the gNB-DU to generate gaps and the gap type (per-UE or per-FR). | - | |
| Handover Preparation Information | O | | OCTET STRING | HandoverPreparationInformation, as defined in TS 38.331 [8]. | YES | ignore |
| CellGroupConfig | O | | OCTET STRING | CellGroupConfig, as defined in TS 38.331 [8]. | YES | ignore |
| Measurement Timing Configuration | O | | OCTET STRING | Contains the <i>MeasurementTimingConfiguration</i> inter-node message defined in TS 38.331 [8]. In EN-DC/NGEN-DC, it is included when the gaps for FR2 are requested to be configured by the MeNB. For MN in NR-NR DC, it is included when the gaps for FR2 and/or FR1 are requested by the SgNB | YES | ignore |
| UEAssistanceInformation | O | | OCTET STRING | UEAssistanceInformation, as defined in TS 38.331 [8]. | YES | ignore |
| CG-Config | O | | OCTET STRING | CG-Config, as defined in TS 38.331 [8]. | YES | ignore |

9.3.1.26 DU to CU RRC Information

This IE contains the RRC Information that are sent from the gNB-DU to the gNB-CU.

| IE/Group Name | Presence | Range | IE type and reference | Semantics description | Criticality | Assigned Criticality |
|--------------------------------|----------|-------|-----------------------|--|-------------|----------------------|
| CellGroupConfig | M | | OCTET STRING | CellGroupConfig, as defined in TS 38.331 [8]. | | |
| MeasGapConfig | O | | OCTET STRING | MeasGapConfig as defined in TS 38.331 [8]. For EN-DC/NGEN-DC operation, includes the gap for FR2, as requested by the gNB-CU via MeasConfig IE. For NG-RAN,NE-DC and MN for NR-NR DC, includes the gap(s) for FR1 and/or FR2, as requested by the gNB-CU via MeasConfig IE and according to the requested gap type (per-UE or per-FR). | | |
| Requested P-MaxFR1 | O | | OCTET STRING | requestedP-MaxFR1, as defined in TS 38.331 [8]. For EN-DC operation, this IE should be included. | | |
| DRX Long Cycle Start Offset | O | | INTEGER (0..10239) | Identical to the value of the drx-LongCycleStartOffset IE within the DRX-Config as defined in TS 38.331. This field is not used in NR-DC. | | |
| Selected BandCombinationIndex | O | | OCTET STRING | BandCombinationIndex, as defined in TS 38.331 [8]. For (NG)EN-DC and NR DC operation, this IE should be included so that gNB-CU is informed of the selected Band Combination. | YES | ignore |
| Selected FeatureSetEntryIndex | O | | OCTET STRING | FeatureSetEntryIndex, as defined in TS 38.331 [8]. For (NG)EN-DC and NR DC operation, this IE should be included so that gNB-CU is informed of the selected FeatureSet. | YES | ignore |
| Ph-InfoSCG | O | | OCTET STRING | PH-TypeListSCG, as defined in TS 38.331[8].For MR-DC, this IE should be included so that gNB-CU is informed of the Power Headroom type for each serving cell in SN. | Yes | ignore |
| Requested BandCombinationIndex | O | | OCTET STRING | BandCombinationIndex, as defined in TS 38.331 [8]. This IE is used for the gNB-DU to request a new Band Combination. | YES | ignore |
| Requested FeatureSetEntryIndex | O | | OCTET STRING | FeatureSetEntryIndex, as defined in TS 38.331 [8]. This IE is used for the gNB-DU to request a new Feature Set. | YES | ignore |
| Requested P-MaxFR2 | O | | OCTET STRING | This IE is not used in this version of the specification. | YES | ignore |
| DRX Config | O | | OCTET STRING | DRX-Config, as defined in TS 38.331 [8]. This field is only used in NR-DC. | YES | ignore |
| PDCCH BlindDetectionSCG | O | | OCTET STRING | pdcch-BlindDetectionSCG, as defined in TS 38.331[8]. This IE is used between the MgNB-DU and the MgNB-CU. | YES | ignore |

| | | | | | | |
|-----------------------------------|---|--|--------------|---|-----|--------|
| Requested PDCCH BlindDetectionSCG | O | | OCTET STRING | requestedPDCCH-BlindDetectionSCG, as defined in TS 38.331[8]. This IE is used between the SgNB-DU and the SgNB-CU. | YES | ignore |
| Ph-InfoMCG | O | | OCTET STRING | PH-TypeListMCG, as defined in TS 38.331[8]. For MR-DC, this IE should be included so that gNB-CU is informed of the Power Headroom type for each serving cell in MCG. | YES | ignore |
| MeasGapSharingConfig | O | | OCTET STRING | MeasGapSharingConfig as defined in TS 38.331 [8]. | YES | ignore |

9.3.1.27 RLC Mode

The *RLC Mode* IE indicates the RLC Mode used for a DRB.

| IE/Group Name | Presence | Range | IE Type and Reference | Semantics Description |
|---------------|----------|-------|---|-----------------------|
| RLC Mode | | | ENUMERATED (RLC-AM, RLC-UM-Bidirectional, RLC-UM-Unidirectional-UL, RLC-UM-Unidirectional-DL, ...) | |

9.3.1.28 SUL Information

This IE provides information about the SUL carrier.

| IE/Group Name | Presence | Range | IE type and reference | Semantics description |
|----------------------------|----------|-------|---------------------------------|---|
| SUL ARFCN | M | | INTEGER (0.. maxNRARFCN) | RF Reference Frequency as defined in TS 38.104 [17] section 5.4.2.1. The frequency provided in this IE identifies the absolute frequency position of the reference resource block (Common RB 0) of the SUL carrier. Its lowest subcarrier is also known as Point A. |
| SUL Transmission Bandwidth | M | | Transmission Bandwidth 9.3.1.15 | |

| Range bound | Explanation |
|-------------|---|
| maxNRARFCN | Maximum value of NR ARFCNs. Value is 3279165. |

9.3.1.29 5GS TAC

This information element is used to identify Tracking Area Code.

| IE/Group Name | Presence | Range | IE type and reference | Semantics description |
|---------------|----------|-------|-------------------------|-----------------------|
| 5GS TAC | M | | OCTET STRING (SIZE (3)) | |

9.3.1.29a Configured EPS TAC

This information element is used to identify a configured EPS Tracking Area Code in order to enable application of Roaming and Access Restrictions for EN-DC as specified in TS 37.340 [7]. This IE is configured for the cell, but not broadcast.

| IE/Group Name | Presence | Range | IE type and reference | Semantics description |
|--------------------|----------|-------|-------------------------|-----------------------|
| Configured EPS TAC | M | | OCTET STRING (SIZE (2)) | |

9.3.1.30 RRC Reconfiguration Complete Indicator

This IE indicates the result of the reconfiguration performed towards the UE.

| IE/Group Name | Presence | Range | IE type and reference | Semantics description |
|--|----------|-------|----------------------------------|-----------------------|
| RRC Reconfiguration Complete Indicator | M | | ENUMERATED (true, ... , failure) | |

9.3.1.31 UL Configuration

This IE indicates how the UL scheduling is configured at gNB-DU.

| IE/Group Name | Presence | Range | IE type and reference | Semantics description |
|---------------------|----------|-------|---|---|
| UL UE Configuration | M | | ENUMERATED (no-data, shared, only, ...) | Indicates how the UE uses the UL at gNB-DU, for which "no-data" indicates that the UL scheduling is not performed at gNB-DU, "shared" indicates that the UL scheduling is performed at both gNB-DU and another node, and "only" indicates that the UL scheduling is only performed at the gNB-DU. |

9.3.1.32 C-RNTI

This IE contains the C-RNTI information.

| IE/Group Name | Presence | Range | IE type and reference | Semantics description |
|---------------|----------|-------|-------------------------|-------------------------------------|
| C-RNTI | M | | INTEGER (0..65535, ...) | C-RNTI as defined in TS 38.331 [8]. |

9.3.1.33 Cell UL Configured

This IE indicates whether the gNB-CU requests the gNB-DU to configure the uplink as no UL, UL, SUL or UL+SUL for the indicated cell for the UE.

| IE/Group Name | Presence | Range | IE type and reference | Semantics description |
|--------------------|----------|-------|---|--|
| Cell UL Configured | M | | ENUMERATED (none, UL, SUL, UL and SUL, ...) | Further details are defined in TS 38.331 [8] |

9.3.1.34 RAT-Frequency Priority Information

The RAT-Frequency Priority Information contains either the *Subscriber Profile ID for RAT/Frequency priority* IE or the *Index to RAT/Frequency Selection Priority* IE. These parameters are used to define local configuration for RRM strategies.

| IE/Group Name | Presence | Range | IE type and reference | Semantics description |
|---|----------|-------|------------------------|-----------------------|
| CHOICE RAT-Frequency Priority Information | M | | | |
| >EN-DC | | | | |
| >>Subscriber Profile ID for RAT/Frequency priority | M | | INTEGER (1.. 256, ...) | |
| >NG-RAN | | | | |
| >> <i>Index to RAT/Frequency Selection Priority</i> | M | | INTEGER (1.. 256, ...) | |

9.3.1.35 LCID

This IE uniquely identifies a LCID for the associated SRB or DRB.

| IE/Group Name | Presence | Range | IE type and reference | Semantics description |
|---------------|----------|-------|-----------------------|--|
| LCID | M | | INTEGER (1..32, ...) | Corresponds to the <i>LogicalChannelIdentity</i> defined in TS 38.331 [8]. |

9.3.1.36 Duplication activation

The *Duplication Activation* IE indicates whether UL PDCP Duplication is activated or not.

| IE/Group Name | Presence | Range | IE Type and Reference | Semantics Description |
|------------------------|----------|-------|------------------------------------|-----------------------|
| Duplication Activation | M | | ENUMERATED (Active, Inactive, ...) | |

9.3.1.37 Slice Support List

This IE indicates the list of supported slices.

| IE/Group Name | Presence | Range | IE type and reference | Semantics description |
|------------------------|----------|-------------------------|-----------------------|-----------------------|
| Slice Support Item IEs | | 1..<maxno ofSliceltems> | | |
| >S-NSSAI | M | | 9.3.1.38 | |

| Range bound | Explanation |
|-------------------|--|
| maxnoofSliceltems | Maximum no. of signalled slice support items. Value is 1024. |

9.3.1.38 S-NSSAI

This IE indicates the S-NSSAI as defined in TS 23.003 [23].

| IE/Group Name | Presence | Range | IE type and reference | Semantics description |
|---------------|----------|-------|------------------------|-----------------------|
| SST | M | | OCTET STRING (SIZE(1)) | |
| SD | O | | OCTET STRING (SIZE(3)) | |

9.3.1.39 UE Identity Index value

This IE is used by the gNB-DU to calculate the Paging Frame.

| IE/Group Name | Presence | Range | IE type and reference | Semantics description |
|---------------------------------------|----------|-------|-----------------------|---------------------------------------|
| CHOICE <i>UE Identity Index Value</i> | M | | | |
| > <i>Length-10</i> | | | | |
| >>Index Length 10 | M | | BIT STRING (SIZE(10)) | Coded as specified in TS 38.304 [24]. |

9.3.1.40 Paging DRX

This IE indicates the Paging DRX as defined in TS 38.304 [24].

| IE/Group Name | Presence | Range | IE type and reference | Semantics description |
|---------------|----------|-------|-----------------------------------|-----------------------|
| Paging DRX | M | | ENUMERATED(32, 64, 128, 256, ...) | Unit in radio frame. |

9.3.1.41 Paging Priority

This IE indicates the paging priority for paging a UE.

| IE/Group Name | Presence | Range | IE type and reference | Semantics description |
|-----------------|----------|-------|--|--|
| Paging Priority | M | | ENUMERATED (PrioLevel1, PrioLevel2, PrioLevel3, PrioLevel4, PrioLevel5, PrioLevel6, PrioLevel7, PrioLevel8, ...) | Lower value codepoint indicates higher priority. |

9.3.1.42 gNB-CU System Information

This IE contains the system information encoded by the gNB-CU.

| IE/Group Name | Presence | Range | IE type and reference | Semantics description | Criticality | Assigned Criticality |
|----------------------------------|----------|---------------------------|------------------------|--|-------------|----------------------|
| SIB type to Be Updated List | | 1 | | | | |
| >SIB type to Be Updated Item IEs | | 1... <maxnoofSIBTypes> | | | | |
| >>SIB type | M | | INTEGER (2..32, ...) | Indicates a certain SIB block, e.g. 2 means sibType2, 3 for sibType3, etc. Values 6, 7, 8 and values 10 and higher are not applicable in this version of the specifications. | | |
| >>SIB message | M | | OCTET STRING | SIB message containing SIB as defined in TS 38.331 [8]. | | |
| >>Value Tag | M | | INTEGER (0..31, ...) | | | |
| >>areaScope | O | | ENUMERATED (true, ...) | Indicates that a SIB is area specific. If the field is not present, the SIB is cell specific. | YES | ignore |
| SystemInformationAreaID | O | | BIT STRING (SIZE (24)) | Indicates the system information area that the cell belongs to, if any. | YES | ignore |

| Range bound | Explanation |
|-----------------|--|
| maxnoofSIBTypes | Maximum no. of SIB types, the maximum value is 32. |

9.3.1.43 RAN UE Paging identity

This IE indicates the RAN UE Paging identity.

| IE/Group Name | Presence | Range | IE type and reference | Semantics description |
|---------------|----------|-------|--------------------------|-----------------------|
| I-RNTI | M | | BIT STRING (SIZE(40)) | |

9.3.1.44 CN UE Paging Identity

The 5G-S-TMSI is used as UE identifier for CN paging.

| IE/Group Name | Presence | Range | IE type and reference | Semantics description |
|-------------------------------------|----------|-------|--------------------------|----------------------------------|
| CHOICE <i>CN UE paging identity</i> | M | | | |
| >5G-S-TMSI | | | | |
| >>5G-S-TMSI | M | | BIT STRING (SIZE(48)) | Details defined in TS 38.413 [3] |

9.3.1.45 QoS Flow Level QoS Parameters

This IE defines the QoS to be applied to a QoS flow or to a DRB.

| IE/Group Name | Presence | Range | IE type and reference | Semantics description | Criticality | Assigned Criticality |
|---|----------|-------|------------------------------|--|-------------|----------------------|
| CHOICE QoS Characteristics | M | | | | - | |
| >Non-dynamic 5QI | | | | | - | |
| >>Non Dynamic 5QI Descriptor | M | | 9.3.1.49 | | - | |
| >Dynamic 5QI | | | | | - | |
| >>Dynamic 5QI Descriptor | M | | 9.3.1.47 | | - | |
| NG-RAN Allocation and Retention Priority | M | | 9.3.1.48 | | - | |
| GBR QoS Flow Information | O | | 9.3.1.46 | This IE shall be present for GBR QoS Flows only and is ignored otherwise. | - | |
| Reflective QoS Attribute | O | | ENUMERATED (subject to, ...) | Details in TS 23.501 [21]. This IE applies to non-GBR flows only and is ignored otherwise. | - | |
| PDU Session ID | O | | INTEGER (0 ..255) | As specified in TS 23.501 [21]. | YES | ignore |
| UL PDU Session Aggregate Maximum Bit Rate | O | | Bit Rate 9.3.1.22 | The PDU session Aggregate Maximum Bit Rate Uplink which is associated with the involved PDU session. | YES | ignore |

9.3.1.46 GBR QoS Flow Information

This IE indicates QoS parameters for a GBR QoS flow or GBR bearer for downlink and uplink.

| IE/Group Name | Presence | Range | IE type and reference | Semantics description |
|-----------------------------------|----------|-------|--------------------------------------|---|
| Maximum Flow Bit Rate Downlink | M | | Bit Rate 9.3.1.22 | Maximum Bit Rate in DL. Details in TS 23.501 [21]. |
| Maximum Flow Bit Rate Uplink | M | | Bit Rate 9.3.1.22 | Maximum Bit Rate in UL. Details in TS 23.501 [21]. |
| Guaranteed Flow Bit Rate Downlink | M | | Bit Rate 9.3.1.22 | Guaranteed Bit Rate (provided there is data to deliver) in DL. Details in TS 23.501 [21]. |
| Guaranteed Flow Bit Rate Uplink | M | | Bit Rate 9.3.1.22 | Guaranteed Bit Rate (provided there is data to deliver). Details in TS 23.501 [21]. |
| Maximum Packet Loss Rate Downlink | O | | Maximum Packet Loss Rate 9.3.1.50 | Indicates the maximum rate for lost packets that can be tolerated in the downlink direction. Details in TS 23.501 [21]. |
| Maximum Packet Loss Rate Uplink | O | | Maximum Packet Loss Rate 9.3.1.50 | Indicates the maximum rate for lost packets that can be tolerated in the uplink direction. Details in TS 23.501 [21]. |

9.3.1.47 Dynamic 5QI Descriptor

This IE indicates the QoS Characteristics for a Non-standardised or not pre-configured 5QI for downlink and uplink.

| IE/Group Name | Presence | Range | IE type and reference | Semantics description |
|---------------------------|-----------------|-------|---|--|
| QoS Priority Level | M | | INTEGER (1..127) | For details see TS 23.501 [21]. |
| Packet Delay Budget | M | | 9.3.1.51 | For details see TS 23.501 [21]. |
| Packet Error Rate | M | | 9.3.1.52 | For details see TS 23.501 [21]. |
| 5QI | O | | INTEGER (0..255,...) | This IE contains the dynamically assigned 5QI as specified in TS 23.501 [21]. |
| Delay Critical | C- ifGBRflow | | ENUMERATED (delay critical, non-delay critical) | For details see TS 23.501 [21]. |
| Averaging Window | C- ifGBRflow | | 9.3.1.53 | For details see TS 23.501 [21]. |
| Maximum Data Burst Volume | O | | 9.3.1.54 | For details see TS 23.501 [21]. This IE shall be included if the <i>Delay Critical</i> IE is set to "delay critical" and is ignored otherwise. |

| Condition | Explanation |
|-----------|---|
| ifGBRflow | This IE shall be present if the <i>GBR QoS Flow Information</i> IE is present in the <i>QoS Flow Level QoS Parameters</i> IE. |

9.3.1.48 NG-RAN Allocation and Retention Priority

This IE specifies the relative importance of a QoS flow or a DRB compared to other QoS flows or DRBs for allocation and retention of NG-RAN resources.

| IE/Group Name | Presence | Range | IE type and reference | Semantics description |
|---------------------------|----------|-------|---|---|
| Priority Level | M | | INTEGER (0..15) | Desc.: This IE defines the relative importance of a resource request (see TS 23.501 [21]). Usage: Values are ordered in decreasing order of priority, i.e., with 1 as the highest priority and 15 as the lowest priority. Further usage is defined in TS 23.501 [21]. |
| Pre-emption Capability | M | | ENUMERATED (shall not trigger pre-emption, may trigger pre-emption) | Desc.: This IE indicates the pre-emption capability of the request on other QoS flows (see TS 23.501 [21]). Usage: The QoS flow shall not pre-empt other QoS flows or, the QoS flow may pre-empt other QoS flows. Note: The Pre-emption Capability indicator applies to the allocation of resources for a QoS flow and as such it provides the trigger to the pre-emption procedures/processes of the NG-RAN node. |
| Pre-emption Vulnerability | M | | ENUMERATED (not pre-emptable, pre-emptable) | Desc.: This IE indicates the vulnerability of the QoS flow to pre-emption of other QoS flows (see TS 23.501 [21]). Usage: The QoS flow shall not be pre-empted by other QoS flows or the QoS flow may be pre-empted by other QoS flows. Note: The Pre-emption Vulnerability indicator applies for the entire duration of the QoS flow, unless modified and as such indicates whether the QoS flow is a target of the pre-emption procedures/processes of the NG-RAN node. |

9.3.1.49 Non Dynamic 5QI Descriptor

This IE indicates the QoS Characteristics for a standardized or pre-configured 5QI for downlink and uplink.

| IE/Group Name | Presence | Range | IE type and reference | Semantics description |
|---------------------------|----------|-------|-----------------------|---|
| 5QI | M | | INTEGER (0..255,...) | This IE contains the standardized or pre-configured 5QI as specified in TS 23.501 [21] |
| Priority Level | O | | INTEGER (1..127) | For details see TS 23.501 [21]. When included overrides standardized or pre-configured value. |
| Averaging Window | O | | 9.3.1.53 | For details see TS 23.501 [21]. When included overrides standardized or pre-configured value. |
| Maximum Data Burst Volume | O | | 9.3.1.54 | For details see TS 23.501 [21]. When included overrides standardized or pre-configured value. |

9.3.1.50 Maximum Packet Loss Rate

This IE indicates the Maximum Packet Loss Rate.

| IE/Group Name | Presence | Range | IE type and reference | Semantics description |
|--------------------------|----------|-------|-----------------------|--|
| Maximum Packet Loss Rate | M | | INTEGER(0..1000) | Ratio of lost packets per number of packets sent, expressed in tenth of percent. |

9.3.1.51 Packet Delay Budget

This IE indicates the Packet Delay Budget for a QoS flow.

| IE/Group Name | Presence | Range | IE type and reference | Semantics description |
|---------------------|----------|-------|------------------------|--|
| Packet Delay Budget | M | | INTEGER (0..1023, ...) | Upper bound value for the delay that a packet may experience expressed in unit of 0.5ms. |

9.3.1.52 Packet Error Rate

This IE indicates the Packet Error Rate for a QoS flow.

| IE/Group Name | Presence | Range | IE type and reference | Semantics description |
|---------------|----------|-------|-----------------------|--|
| Scalar | M | | INTEGER (0..9, ...) | The packet error rate is expressed as Scalar x 10-k where k is the Exponent. |
| Exponent | M | | INTEGER (0..9, ...) | |

9.3.1.53 Averaging Window

This IE indicates the Averaging Window for a QoS flow, and applies to GBR QoS Flows only.

| IE/Group Name | Presence | Range | IE type and reference | Semantics description |
|------------------|----------|-------|------------------------|--|
| Averaging Window | M | | INTEGER (0..4095, ...) | Unit: ms. The default value is 2000ms. |

9.3.1.54 Maximum Data Burst Volume

This IE indicates the Maximum Data Burst Volume for a QoS flow, and applies to delay critical GBR QoS flows only.

| IE/Group Name | Presence | Range | IE type and reference | Semantics description |
|---------------------------|----------|-------|------------------------|-----------------------|
| Maximum Data Burst Volume | M | | INTEGER (0..4095, ...) | Unit: byte. |

9.3.1.55 Masked IMEISV

This information element contains the IMEISV value with a mask, to identify a terminal model without identifying an individual Mobile Equipment.

| IE/Group Name | Presence | Range | IE type and reference | Semantics description |
|---------------|----------|-------|------------------------|---|
| Masked IMEISV | M | | BIT STRING (SIZE (64)) | Coded as the International Mobile station Equipment Identity and Software Version Number (IMEISV) defined in TS 23.003 [23] with the last 4 digits of the SNR masked by setting the corresponding bits to 1. The first to fourth bits correspond to the first digit of the IMEISV, the fifth to eighth bits correspond to the second digit of the IMEISV, and so on. |

9.3.1.56 Notification Control

The *Notification Control* IE indicates whether the notification control for a given DRB is active or not-active.

| IE/Group Name | Presence | Range | IE Type and Reference | Semantics Description |
|----------------------|----------|-------|-------------------------------------|-----------------------|
| Notification Control | M | | ENUMERATED(Active, Not-Active, ...) | |

9.3.1.57 RAN Area Code

This information element is used to uniquely identify a RAN Area Code.

| IE/Group Name | Presence | Range | IE type and reference | Semantics description |
|---------------|----------|-------|-----------------------|-----------------------|
| RANAC | M | | INTEGER (0..255) | RAN Area Code |

9.3.1.58 PWS System Information

This IE contains the system information used for public warning.

| IE/Group Name | Presence | Range | IE type and reference | Semantics description | Criticality | Assigned Criticality |
|---------------------------------|----------|-------|-----------------------|---|-------------|----------------------|
| SIB type | M | | INTEGER (6..8, ...) | Indicates a certain SIB block for public warning message, e.g. 6 means sibType6, 7 for sibType7, etc. | - | |
| SIB message | M | | OCTET STRING | SIB message for public warning, as defined in TS 38.331 [8]. | - | |
| Notification Information | O | | | | YES | ignore |
| >Message Identifier | M | | 9.3.1.81 | | - | |
| >Serial Number | M | | 9.3.1.82 | | - | |
| Additional SIB Message List | O | | 9.3.1.86 | Additional SIB messages containing different segments of a public warning message if segmentation is applied, as defined in TS38.331 [8]. | Yes | reject |

9.3.1.59 Repetition Period

This IE indicates the periodicity of the warning message to be broadcast.

| IE/Group Name | Presence | Range | IE type and reference | Semantics description |
|-------------------|----------|-------|---------------------------------|--|
| Repetition Period | M | | INTEGER (0..2 ¹⁷ -1) | The unit of value 1 to 2 ¹⁷ -1 is [second]. |

9.3.1.60 Number of Broadcasts Requested

This IE indicates the number of times a message is to be broadcast.

| IE/Group Name | Presence | Range | IE type and reference | Semantics description |
|--------------------------------|----------|-------|-----------------------|-----------------------|
| Number of Broadcasts Requested | M | | INTEGER (0..65535) | |

9.3.1.61 Void

9.3.1.62 SType List

This IE is used by gNB-CU to provide SI list of other SI for gNB-DU.

| IE/Group Name | Presence | Range | IE type and reference | Semantics description |
|-------------------------|----------|-----------------------------|-----------------------|---|
| SI type item IEs | | 1.. <maxnoofSI Types> | | |
| >SI Type | M | | INTEGER (1..32, ...) | Indicates a certain SI type required to be broadcasted by the gNB-DU. |

| Range bound | Explanation |
|----------------|---|
| maxnoofSITypes | Maximum no. of SI types, the maximum value is 32. |

9.3.1.63 QoS Flow Identifier

This IE identifies a QoS Flow within a PDU Session. The definition and use of the QoS Flow Identifier is specified in TS 23.501 [21].

| IE/Group Name | Presence | Range | IE type and reference | Semantics description |
|---------------------|----------|-------|-----------------------|-----------------------|
| QoS Flow Identifier | M | | INTEGER (0 ..63) | |

9.3.1.64 Served E-UTRA Cell Information

This IE contains served cell information of an E-UTRA cell for spectrum sharing between E-UTRA and NR.

| IE/Group Name | Presence | Range | IE type and reference | Semantics description |
|--------------------------------------|----------|-------|-----------------------|--|
| CHOICE <i>EUTRA-Mode-Info</i> | M | | | |
| > <i>FDD</i> | | | | |
| >> FDD Info | | 1 | | |
| >>>UL Offset to Point A | M | | INTEGER (0..2199,...) | Indicates the offset to the center of the NR carrier for UL. |
| >>>DL Offset to Point A | M | | INTEGER (0..2199,...) | Indicates the offset to the center of the NR carrier for DL. |
| > <i>TDD</i> | | | | |
| >> TDD Info | | 1 | | |
| >>>Offset to Point A | M | | INTEGER (0..2199,...) | Indicates the offset to the center of the NR carrier. |
| Protected E-UTRA Resource Indication | O | | OCTET STRING | Indicates the Protected E-UTRA Resource Indication as defined in subclause 9.2.125 of TS 36.423 [9]. |

9.3.1.65 Available PLMN List

This IE indicates the list of available PLMN.

| IE/Group Name | Presence | Range | IE type and reference | Semantics description |
|-------------------------|----------|---------------------|-----------------------|-----------------------|
| Available PLMN Item IEs | | 1..<maxnoofBPLMNs > | | |
| >PLMN Identity | M | | 9.3.1.14 | |

| Range bound | Explanation |
|---------------|--|
| maxnoofBPLMNs | Maximum no. of Broadcast PLMN Ids. Value is 6. |

9.3.1.66 RLC Failure Indication

This IE indicates the LCID associated with the RLC entity needing re-establishment.

| IE/Group Name | Presence | Range | IE type and reference | Semantics description |
|-----------------|----------|-------|-----------------------|-----------------------|
| Associated LCID | M | | LCID 9.3.1.35 | |

9.3.1.67 Uplink TxDirectCurrentList Information

This IE contains the Uplink TxDirectCurrentList information that is configured by the UE.

| IE/Group Name | Presence | Range | IE type and reference | Semantics description |
|--|----------|-------|-----------------------|---|
| Uplink TxDirectCurrentList Information | M | | OCTET STRING | <i>UplinkTxDirectCurrentList</i> as defined in TS 38.331 [8]. |

9.3.1.68 Service Status

This IE is used to indicate the service status of a cell by the gNB-DU.

| IE/Group Name | Presence | Range | IE type and reference | Semantics description |
|-----------------------|----------|-------|--|---|
| Service State | M | | ENUMERATED (In-Service, Out-Of-Service, ...) | Indicates the Service State of the cell. In-Service and Out-of-Service Service States are defined in TS 38.401 [4]. |
| Switching Off Ongoing | O | | ENUMERATED (True, ...) | This IE indicates that the gNB-DU will delete the cell after some time using a new gNB-DU Configuration Update procedure. |

9.3.1.69 RLC Status

This IE indicates about the RLC configuration change included in the container towards the UE.

| IE/Group Name | Presence | Range | IE type and reference | Semantics description |
|----------------------------|----------|-------|---------------------------------|---|
| Reestablishment Indication | O | | ENUMERATED (reestablished, ...) | Indicates that following a change in the radio status, the RLC has been re-established. |

9.3.1.70 RRC Version

This information element is used to identify RRC version corresponding to TS 38.331 [8].

| IE/Group Name | Presence | Range | IE type and reference | Semantics description | Criticality | Assigned Criticality |
|-----------------------------|----------|-------|-------------------------|---|-------------|----------------------|
| Latest RRC Version | M | | BIT STRING (SIZE (3)) | This IE is not used in this release. | - | |
| Latest RRC Version Enhanced | O | | OCTET STRING (SIZE (3)) | Latest supported RRC version in the release corresponding to TS 38.331 [8]. For a 3GPP specification version x.y.z, x is encoded by the leftmost byte, y by the middle byte, and z by the rightmost byte. | YES | ignore |

9.3.1.71 RRC Delivery Status

This IE provides information about the delivery status of RRC messages to the UE.

| IE/Group Name | Presence | Range | IE type and reference | Semantics description |
|--------------------|----------|-------|---------------------------------|--|
| Delivery Status | M | | INTEGER (0..2 ¹² -1) | Highest NR PDCP SN successfully delivered in sequence to the UE. |
| Triggering Message | M | | INTEGER (0..2 ¹² -1) | NR PDCP SN for the RRC message that triggered the report. |

9.3.1.72 QoS Flow Mapping Indication

This IE is used to indicate only the uplink or downlink QoS flow is mapped to the DRB.

| IE/Group Name | Presence | Range | IE type and reference | Semantics description |
|-----------------------------|----------|-------|------------------------|--|
| QoS Flow Mapping Indication | O | | ENUMERATED(ul, dl,...) | Indicates that only the uplink or downlink QoS flow is mapped to the DRB |

9.3.1.73 Resource Coordination Transfer Information

This IE contains information for UE-associated E-UTRA – NR resource coordination.

| IE/Group Name | Presence | Range | IE type and reference | Semantics description |
|---|----------|-------|-----------------------|---|
| MeNB Cell ID | M | | BIT STRING (SIZE(28)) | E-UTRAN Cell Global Identifier defined in TS 36.423 [9] clause 9.2.14 |
| Resource Coordination E-UTRA Cell Information | O | | 9.3.1.75 | |

9.3.1.74 E-UTRA PRACH Configuration

This IE indicates the PRACH resources used in E-UTRA cell.

| IE/Group Name | Presence | Range | IE type and reference | Semantics description |
|----------------------------------|----------|-------|-----------------------|---|
| RootSequenceIndex | M | | INTEGER (0..837) | See section 5.7.2. in TS 36.211 [27] |
| ZeroCorrelationZoneConfiguration | M | | INTEGER (0..15) | See section 5.7.2. in TS 36.211 [27] |
| HighSpeedFlag | M | | BOOLEAN | TRUE corresponds to Restricted set and FALSE to Unrestricted set. See section 5.7.2 in TS 36.211 [27] |
| PRACH-FrequencyOffset | M | | INTEGER (0..94) | See section 5.7.1 of TS 36.211 [27] |
| PRACH-ConfigurationIndex | C-ifTDD | | INTEGER (0..63) | See section 5.7.1. in TS 36.211 [27] |

| Condition | Explanation |
|-----------|---|
| ifTDD | This IE shall be present if the <i>EUTRA-Mode-Info</i> IE in the <i>Resource Coordination E-UTRA Cell Information</i> IE is set to the value "TDD". |

9.3.1.75 Resource Coordination E-UTRA Cell Information

This IE contains E-UTRA cell information for UE-associated E-UTRA – NR resource coordination.

| IE/Group Name | Presence | Range | IE type and reference | Semantics description | Criticality | Assigned Criticality |
|----------------------------------|----------|-------|--|--|-------------|----------------------|
| CHOICE <i>EUTRA-Mode-Info</i> | M | | | | - | |
| > <i>FDD</i> | | | | | - | |
| >> FDD Info | | 1 | | | - | |
| >>>UL EARFCN | O | | INTEGER (0 .. maxExtendedEARFCN, ...) | The relation between EARFCN and carrier frequency (in MHz) is defined in TS 36.104 [25]. | - | |
| >>>DL EARFCN | M | | INTEGER (0 .. maxExtendedEARFCN, ...) | The relation between EARFCN and carrier frequency (in MHz) is defined in TS 36.104 [25]. | - | |
| >>>UL Transmission Bandwidth | O | | E-UTRA Transmission Bandwidth 9.3.1.80 | Present if <i>UL EARFCN</i> IE is present. | - | |
| >>>DL Transmission Bandwidth | M | | E-UTRA Transmission Bandwidth 9.3.1.80 | | - | |
| > <i>TDD</i> | | | | | - | |
| >> TDD Info | | 1 | | | - | |
| >>>EARFCN | M | | INTEGER (0 .. maxExtendedEARFCN, ...) | The relation between EARFCN and carrier frequency (in MHz) is defined in TS 36.104 [25]. | - | |
| >>>Transmission Bandwidth | M | | E-UTRA Transmission Bandwidth 9.3.1.80 | | - | |
| >>>Subframe Assignment | M | | ENUMERATED(sa0, sa1, sa2, sa3, sa4, sa5, sa6,...) | Uplink-downlink subframe configuration information defined in TS 36.211 [27]. In NB-IOT, sa0 and sa6 are not applicable. | - | |
| >>> Special Subframe Info | | 1 | | Special subframe configuration information defined in TS 36.211 [27] | - | |
| >>>>Special Subframe Patterns | M | | ENUMERATED(ssp0, ssp1, ssp2, ssp3, ssp4, ssp5, ssp6, ssp7, ssp8, ssp9, ssp10, ...) | | - | |
| >>>>Cyclic Prefix DL | M | | ENUMERATED(Normal, Extended,...) | | - | |
| >>>>Cyclic Prefix UL | M | | ENUMERATED(Normal, Extended,...) | | - | |
| E-UTRA PRACH Configuration | M | | 9.3.1.74 | | - | |
| Ignore PRACH Configuration | O | | ENUMERATED(true,...) | | YES | reject |

| Range bound | Explanation |
|-------------|-------------|
|-------------|-------------|

| | |
|-------------------|--|
| maxExtendedEARFCN | Maximum value of extended EARFCN. Value is 262143. |
|-------------------|--|

9.3.1.76 Extended Available PLMN List

This IE indicates the list of available PLMN.

| IE/Group Name | Presence | Range | IE type and reference | Semantics description |
|----------------------------------|----------|-----------------------------|-----------------------|-----------------------|
| Extended Available PLMN Item IEs | | 1..<maxnoofExtendedBPLMNs > | | |
| >PLMN Identity | M | | 9.3.1.14 | |

| Range bound | Explanation |
|-----------------------|---|
| maxnoofExtendedBPLMNs | Maximum no. of Extended Broadcast PLMN Ids. Value is 6. |

9.3.1.77 Associated SCell List

This IE indicates the list of SCells associated with the RLC entity indicated by the *RLC Failure Indication* IE.

| IE/Group Name | Presence | Range | IE type and reference | Semantics description | Criticality | Assigned Criticality |
|---------------------------|----------|---------------------|-----------------------|-----------------------|-------------|----------------------|
| Associated SCell Item IEs | | 1..<maxnoofSCells > | | | - | - |
| >SCell ID | M | | NR CGI 9.3.1.12 | | - | |

| Range bound | Explanation |
|---------------|--|
| maxnoofSCells | Maximum no. of SCells allowed towards one UE, the maximum value is 32. |

9.3.1.78 Cell Direction

This IE indicates if the cell is either bidirectional or only DL or only UL.

| IE/Group Name | Presence | Range | IE type and reference | Semantics description |
|----------------|----------|-------|----------------------------------|-----------------------|
| Cell Direction | M | | ENUMERATED (dl-only, ul-only) | |

9.3.1.79 Paging Origin

This IE indicates whether Paging is originated due to the PDU sessions from the non-3GPP access.

| IE/Group Name | Presence | Range | IE type and reference | Semantics description |
|---------------|----------|-------|-------------------------------|-----------------------|
| Paging Origin | M | | ENUMERATED (non-3GPP, ...) | |

9.3.1.80 E-UTRA Transmission Bandwidth

This IE is used to indicate the E-UTRA UL or DL transmission bandwidth expressed in units of resource blocks "N_{RB}" (TS 36.104 [25]). The values bw1, bw6, bw15, bw25, bw50, bw75, bw100 correspond to the number of resource blocks "N_{RB}" 6, 15, 25, 50, 75, 100.

| IE/Group Name | Presence | Range | IE Type and Reference | Semantics Description |
|-------------------------------|----------|-------|--|-----------------------|
| E-UTRA Transmission Bandwidth | M | | ENUMERATED (bw6, bw15, bw25, bw50, bw75, bw100,...) | |

9.3.1.81 Message Identifier

This IE identifies the warning message.

| IE/Group Name | Presence | Range | IE type and reference | Semantics description |
|--------------------|----------|-------|-----------------------|--|
| Message Identifier | M | | BIT STRING (SIZE(16)) | This IE is set by the 5GC, transferred to the UE by the NG-RAN node. |

9.3.1.82 Serial Number

This IE identifies a particular message from the source and type indicated by the Message Identifier and is altered every time the message with a given Message Identifier is changed.

| IE/Group Name | Presence | Range | IE type and reference | Semantics description |
|---------------|----------|-------|-----------------------|-----------------------|
| Serial Number | M | | BIT STRING (SIZE(16)) | |

9.3.1.83 UAC Assistance Information

This information element contains assistance information helping the gNB-DU to set parameters for Unified Access Class barring.

| IE/Group Name | Presence | Range | IE type and reference | Semantics description |
|------------------------------|----------|------------------------|-----------------------|--|
| UAC PLMN List | | 1 | | |
| >UAC PLMN Item | | 1..<maxnoofUAC PLMNs> | | |
| >>PLMN Identity | M | | 9.3.1.14 | |
| >>UAC Type List | | 1 | | |
| >>>UAC Type Item | | 1..<maxnoofUACperPLMN> | | |
| >>>>UAC Reduction Indication | M | | 9.3.1.85 | |
| >>>>CHOICE UAC Category Type | M | | | |
| >>>>>UAC Standardized | | | | |
| >>>>>> UAC Action | M | | 9.3.1.84 | |
| >>>>>>UAC Operator Defined | | | | |
| >>>>>>>Access Category | M | | INTEGER (32..63, ...) | Indicates the operator defined Access Category as defined in subclause 6.3.2 in TS 38.331 [8]. |
| >>>>>>>Access Identity | M | | BIT STRING (SIZE(7)) | Indicates whether access attempt is allowed for each Access Identity as defined in subclause 6.3.2 in TS 38.331 [8]. |

| Range bound | Explanation |
|-------------------|--|
| maxnoofUACPLMNs | Maximum no. of UAC PLMN Ids. Value is 12. |
| maxnoofUACperPLMN | Maximum no. of signalled categories per PLMN. Value is 64. |

9.3.1.84 UAC Action

This IE indicates which signalling traffic is expected to be reduced by the gNB-CU, as defined in clause 8.7.7 of TS 38.413 [3]

| IE/Group Name | Presence | Range | IE type and reference | Semantics description |
|---------------|----------|-------|--|-----------------------|
| UAC Action | M | | ENUMERATED (Reject RRC connection establishments for non-emergency MO DT, Reject RRC connection establishments for Signalling, Permit Emergency Sessions and mobile terminated services only, Permit High Priority Sessions and mobile terminated services only,...) | |

9.3.1.85 UAC reduction Indication

This IE indicates the percentage of signalling traffic expected to be reduced by the gNB-CU, relative to the instantaneous incoming rate from the gNB-DU

| IE/Group Name | Presence | Range | IE type and reference | Semantics description |
|--------------------------|----------|-------|-----------------------|---|
| UAC reduction Indication | M | | INTEGER (0..100) | Value 0 indicates that no access rate reduction is desired. Value 100 indicates that full access rate reduction is desired. |

9.3.1.86 Additional SIB Message List

This IE indicates the list of additional SIB messages containing all the remaining segments of a public warning message if segmentation is applied to such message.

| IE/Group Name | Presence | Range | IE type and reference | Semantics description |
|---|----------|---------------------------------|-----------------------|--|
| Additional SIB Message List Item IEs | | 1.. <maxnoofAdditionalSIBs > | | |
| >Additional SIB | M | | OCTET STRING | SIB message containing one segment of a public warning message, as defined in TS 38.331 [8]. |

| Range bound | Explanation |
|-----------------------|--|
| maxnoofAdditionalSIBs | Maximum no. of additional segments of a public warning message. Value is 63. |

9.3.1.87 Cell Type

This IE provides the cell coverage area.

| IE/Group Name | Presence | Range | IE type and reference | Semantics description |
|---------------|----------|-------|--|-----------------------|
| Cell Size | M | | ENUMERATED (verysmall, small, medium, large, ...) | |

9.3.2 Transport Network Layer Related IEs

9.3.2.1 UP Transport Layer Information

The *UP Transport Layer Information* IE identifies an F1 transport bearer associated to a DRB. It contains a Transport Layer Address and a GTP Tunnel Endpoint Identifier. The Transport Layer Address is an IP address to be used for the F1 user plane transport. The GTP Tunnel Endpoint Identifier is to be used for the user plane transport between gNB-CU and gNB-DU.

| IE/Group Name | Presence | Range | IE type and reference | Semantics description |
|---|----------|-------|-----------------------|-----------------------|
| <i>CHOICE Transport Layer Information</i> | M | | | |
| >GTP Tunnel | | | | |
| >>Transport Layer Address | M | | 9.3.2.3 | |
| >>GTP-TEID | M | | 9.3.2.2 | |

9.3.2.2 GTP-TEID

The *GTP-TEID* IE is the GTP Tunnel Endpoint Identifier to be used for the user plane transport between the gNB-CU and gNB-DU.

| IE/Group Name | Presence | Range | IE type and reference | Semantics description |
|---------------|----------|-------|------------------------|--|
| GTP-TEID | M | | OCTET STRING (SIZE(4)) | For details and range, see TS 29.281 [18]. |

9.3.2.3 Transport Layer Address

This *Transport Layer Address* IE is an IP address.

| IE/Group Name | Presence | Range | IE type and reference | Semantics description |
|-------------------------|----------|-------|--------------------------------|---|
| Transport Layer Address | M | | BIT STRING (SIZE(1..160, ...)) | The Radio Network Layer is not supposed to interpret the address information. It should pass it to the Transport Layer for interpretation. For details, see TS 38.414 [19]. |

9.3.2.4 CP Transport Layer Information

This IE is used to provide the F1 control plane transport layer information associated with a gNB-CU – gNB-DU.

| IE/Group Name | Presence | Range | IE type and reference | Semantics description | Criticality | Assigned Criticality |
|--|----------|-------|---------------------------------|-----------------------|-------------|----------------------|
| CHOICE <i>CP Transport Layer Information</i> | | | | | - | |
| > <i>Endpoint-IP-address</i> | | | | | - | |
| >> Endpoint IP address | M | | Transport Layer Address 9.3.2.3 | | - | |
| > <i>Endpoint-IP-address-and-port</i> | | | | | - | |
| >> Endpoint IP address | M | | Transport Layer Address 9.3.2.3 | | - | |
| >> Port Number | M | | BIT STRING (SIZE(16)) | | Yes | reject |

9.4 Message and Information Element Abstract Syntax (with ASN.1)

9.4.1 General

F1AP ASN.1 definition conforms to ITU-T Recommendation X.691 [5], ITU-T Recommendation X.680 [12] and ITU-T Recommendation X.681 [13].

The ASN.1 definition specifies the structure and content of F1AP messages. F1AP messages can contain any IEs specified in the object set definitions for that message without the order or number of occurrence being restricted by ASN.1. However, for this version of the standard, a sending entity shall construct an F1AP message according to the PDU definitions module and with the following additional rules:

- IEs shall be ordered (in an IE container) in the order they appear in object set definitions.

- Object set definitions specify how many times IEs may appear. An IE shall appear exactly once if the presence field in an object has value "mandatory". An IE may appear at most once if the presence field in an object has value "optional" or "conditional". If in a tabular format there is multiplicity specified for an IE (i.e., an IE list) then in the corresponding ASN.1 definition the list definition is separated into two parts. The first part defines an IE container list where the list elements reside. The second part defines list elements. The IE container list appears as an IE of its own. For this version of the standard an IE container list may contain only one kind of list elements.

NOTE: In the above "IE" means an IE in the object set with an explicit ID. If one IE needs to appear more than once in one object set, then the different occurrences will have different IE IDs.

If an F1AP message that is not constructed as defined above is received, this shall be considered as Abstract Syntax Error, and the message shall be handled as defined for Abstract Syntax Error in clause 10.

9.4.2 Usage of private message mechanism for non-standard use

The private message mechanism for non-standard use may be used:

- for special operator- (and/or vendor) specific features considered not to be part of the basic functionality, i.e., the functionality required for a complete and high-quality specification in order to guarantee multivendor interoperability;
- by vendors for research purposes, e.g., to implement and evaluate new algorithms/features before such features are proposed for standardisation.

The private message mechanism shall not be used for basic functionality. Such functionality shall be standardised.

9.4.3 Elementary Procedure Definitions

```
-- ASN1START
-- *****
--
-- Elementary Procedure definitions
--
-- *****

FlAP-PDU-Descriptions {
itu-t (0) identified-organization (4) etsi (0) mobileDomain (0)
ngran-access (22) modules (3) flap (3) version1 (1) flap-PDU-Descriptions (0)}

DEFINITIONS AUTOMATIC TAGS ::=

BEGIN

-- *****
--
-- IE parameter types from other modules.
--
-- *****

IMPORTS
    Criticality,
    ProcedureCode

FROM FlAP-CommonDataTypes
    Reset,
    ResetAcknowledge,
    FlSetupRequest,
    FlSetupResponse,
    FlSetupFailure,
    GNBDUConfigurationUpdate,
    GNBDUConfigurationUpdateAcknowledge,
    GNBDUConfigurationUpdateFailure,
    GNBCUConfigurationUpdate,
    GNBCUConfigurationUpdateAcknowledge,
    GNBCUConfigurationUpdateFailure,
    UEContextSetupRequest,
    UEContextSetupResponse,
    UEContextSetupFailure,
    UEContextReleaseCommand,
    UEContextReleaseComplete,
    UEContextModificationRequest,
    UEContextModificationResponse,
    UEContextModificationFailure,
    UEContextModificationRequired,
    UEContextModificationConfirm,
    ErrorIndication,
    UEContextReleaseRequest,
    DLRRCCMessageTransfer,
    ULRRCCMessageTransfer,
```

GNBDUResourceCoordinationRequest,
GNBDUResourceCoordinationResponse,
PrivateMessage,
UEInactivityNotification,
InitialULRRCCMessageTransfer,
SystemInformationDeliveryCommand,
Paging,
Notify,
WriteReplaceWarningRequest,
WriteReplaceWarningResponse,
PWSCancelRequest,
PWSCancelResponse,
PWSRestartIndication,
PWSFailureIndication,
GNBDUStatusIndication,
RRCDeliveryReport,
UEContextModificationRefuse,
FlRemovalRequest,
FlRemovalResponse,
FlRemovalFailure,
NetworkAccessRateReduction

FROM FlAP-PDU-Contents

id-Reset,
id-FlSetup,
id-gNBDUConfigurationUpdate,
id-gNBCUConfigurationUpdate,
id-UEContextSetup,
id-UEContextRelease,
id-UEContextModification,
id-UEContextModificationRequired,
id-ErrorIndication,
id-UEContextReleaseRequest,
id-DLRRCCMessageTransfer,
id-ULRRCCMessageTransfer,
id-GNBDUResourceCoordination,
id-privateMessage,
id-UEInactivityNotification,
id-InitialULRRCCMessageTransfer,
id-SystemInformationDeliveryCommand,
id-Paging,
id-Notify,
id-WriteReplaceWarning,
id-PWSCancel,
id-PWSRestartIndication,
id-PWSFailureIndication,
id-GNBDUStatusIndication,
id-RRCDeliveryReport,
id-FlRemoval,
id-NetworkAccessRateReduction

```

FROM FlAP-Constants

    ProtocolIE-SingleContainer{},
    FlAP-PROTOCOL-IES

FROM FlAP-Containers;

-- *****
--
-- Interface Elementary Procedure Class
--
-- *****

FlAP-ELEMENTARY-PROCEDURE ::= CLASS {
    &InitiatingMessage          ,
    &SuccessfulOutcome          OPTIONAL,
    &UnsuccessfulOutcome        OPTIONAL,
    &procedureCode              ProcedureCode UNIQUE,
    &criticality                 Criticality   DEFAULT ignore
}
WITH SYNTAX {
    INITIATING MESSAGE          &InitiatingMessage
    [SUCCESSFUL OUTCOME        &SuccessfulOutcome]
    [UNSUCCESSFUL OUTCOME      &UnsuccessfulOutcome]
    PROCEDURE CODE             &procedureCode
    [CRITICALITY                &criticality]
}

-- *****
--
-- Interface PDU Definition
--
-- *****

FlAP-PDU ::= CHOICE {
    initiatingMessage    InitiatingMessage,
    successfulOutcome    SuccessfulOutcome,
    unsuccessfulOutcome  UnsuccessfulOutcome,
    choice-extension     ProtocolIE-SingleContainer { { FlAP-PDU-ExtIEs } }
}

FlAP-PDU-ExtIEs FlAP-PROTOCOL-IES ::= { -- this extension is not used
    ...
}

InitiatingMessage ::= SEQUENCE {
    procedureCode    FlAP-ELEMENTARY-PROCEDURE.&procedureCode    ( {FlAP-ELEMENTARY-PROCEDURES} ),
    criticality      FlAP-ELEMENTARY-PROCEDURE.&criticality      ( {FlAP-ELEMENTARY-PROCEDURES} ){@procedureCode} ),
    value            FlAP-ELEMENTARY-PROCEDURE.&InitiatingMessage ( {FlAP-ELEMENTARY-PROCEDURES} ){@procedureCode} )
}

SuccessfulOutcome ::= SEQUENCE {
    procedureCode    FlAP-ELEMENTARY-PROCEDURE.&procedureCode    ( {FlAP-ELEMENTARY-PROCEDURES} ),

```

```

    criticality    FLAP-ELEMENTARY-PROCEDURE.&criticality    ( { FLAP-ELEMENTARY-PROCEDURES } { @procedureCode } ),
    value         FLAP-ELEMENTARY-PROCEDURE.&SuccessfulOutcome ( { FLAP-ELEMENTARY-PROCEDURES } { @procedureCode } )
}

UnsuccessfulOutcome ::= SEQUENCE {
    procedureCode  FLAP-ELEMENTARY-PROCEDURE.&procedureCode    ( { FLAP-ELEMENTARY-PROCEDURES } ),
    criticality    FLAP-ELEMENTARY-PROCEDURE.&criticality    ( { FLAP-ELEMENTARY-PROCEDURES } { @procedureCode } ),
    value         FLAP-ELEMENTARY-PROCEDURE.&UnsuccessfulOutcome ( { FLAP-ELEMENTARY-PROCEDURES } { @procedureCode } )
}

-- *****
--
-- Interface Elementary Procedure List
--
-- *****

FLAP-ELEMENTARY-PROCEDURES FLAP-ELEMENTARY-PROCEDURE ::= {
    FLAP-ELEMENTARY-PROCEDURES-CLASS-1 |
    FLAP-ELEMENTARY-PROCEDURES-CLASS-2,
    ...
}

FLAP-ELEMENTARY-PROCEDURES-CLASS-1 FLAP-ELEMENTARY-PROCEDURE ::= {
    reset |
    flSetup |
    gNBDUConfigurationUpdate |
    gNBCUConfigurationUpdate |
    uEContextSetup |
    uEContextRelease |
    uEContextModification |
    uEContextModificationRequired |
    writeReplaceWarning |
    pWSCancel |
    gNBDUResourceCoordination |
    flRemoval |
    ...
}

FLAP-ELEMENTARY-PROCEDURES-CLASS-2 FLAP-ELEMENTARY-PROCEDURE ::= {
    errorIndication |
    uEContextReleaseRequest |
    dLRRCMessagesTransfer |
    uLRRCMessagesTransfer |
    uEInactivityNotification |
    privateMessage |
    initialULRRCMessagesTransfer |
    systemInformationDelivery |
    paging |
    notify |
    pWSRestartIndication |
    pWSFailureIndication |
    gNBDUStatusIndication |
    rRCDeliveryReport
}

```



```

    networkAccessRateReduction      ,
    ...
}
-- *****
--
-- Interface Elementary Procedures
--
-- *****

reset FlAP-ELEMENTARY-PROCEDURE ::= {
    INITIATING MESSAGE      Reset
    SUCCESSFUL OUTCOME      ResetAcknowledge
    PROCEDURE CODE          id-Reset
    CRITICALITY              reject
}

flSetup FlAP-ELEMENTARY-PROCEDURE ::= {
    INITIATING MESSAGE      FlSetupRequest
    SUCCESSFUL OUTCOME      FlSetupResponse
    UNSUCCESSFUL OUTCOME    FlSetupFailure
    PROCEDURE CODE          id-FlSetup
    CRITICALITY              reject
}

gnBDUConfigurationUpdate FlAP-ELEMENTARY-PROCEDURE ::= {
    INITIATING MESSAGE      gNBBDUConfigurationUpdate
    SUCCESSFUL OUTCOME      gNBBDUConfigurationUpdateAcknowledge
    UNSUCCESSFUL OUTCOME    gNBBDUConfigurationUpdateFailure
    PROCEDURE CODE          id-gNBBDUConfigurationUpdate
    CRITICALITY              reject
}

gnBCUConfigurationUpdate FlAP-ELEMENTARY-PROCEDURE ::= {
    INITIATING MESSAGE      gNBCUConfigurationUpdate
    SUCCESSFUL OUTCOME      gNBCUConfigurationUpdateAcknowledge
    UNSUCCESSFUL OUTCOME    gNBCUConfigurationUpdateFailure
    PROCEDURE CODE          id-gNBCUConfigurationUpdate
    CRITICALITY              reject
}

ueContextSetup FlAP-ELEMENTARY-PROCEDURE ::= {
    INITIATING MESSAGE      UEContextSetupRequest
    SUCCESSFUL OUTCOME      UEContextSetupResponse
    UNSUCCESSFUL OUTCOME    UEContextSetupFailure
    PROCEDURE CODE          id-UEContextSetup
    CRITICALITY              reject
}

ueContextRelease FlAP-ELEMENTARY-PROCEDURE ::= {
    INITIATING MESSAGE      UEContextReleaseCommand
    SUCCESSFUL OUTCOME      UEContextReleaseComplete
    PROCEDURE CODE          id-UEContextRelease
    CRITICALITY              reject
}

```

```
UEContextModification FlAP-ELEMENTARY-PROCEDURE ::= {
    INITIATING MESSAGE      UEContextModificationRequest
    SUCCESSFUL OUTCOME      UEContextModificationResponse
    UNSUCCESSFUL OUTCOME    UEContextModificationFailure
    PROCEDURE CODE          id-UEContextModification
    CRITICALITY             reject
}

UEContextModificationRequired FlAP-ELEMENTARY-PROCEDURE ::= {
    INITIATING MESSAGE      UEContextModificationRequired
    SUCCESSFUL OUTCOME      UEContextModificationConfirm
    UNSUCCESSFUL OUTCOME    UEContextModificationRefuse
    PROCEDURE CODE          id-UEContextModificationRequired
    CRITICALITY             reject
}

writeReplaceWarning FlAP-ELEMENTARY-PROCEDURE ::= {
    INITIATING MESSAGE      WriteReplaceWarningRequest
    SUCCESSFUL OUTCOME      WriteReplaceWarningResponse
    PROCEDURE CODE          id-WriteReplaceWarning
    CRITICALITY             reject
}

PWSCancel FlAP-ELEMENTARY-PROCEDURE ::= {
    INITIATING MESSAGE      PWSCancelRequest
    SUCCESSFUL OUTCOME      PWSCancelResponse
    PROCEDURE CODE          id-PWSCancel
    CRITICALITY             reject
}

errorIndication FlAP-ELEMENTARY-PROCEDURE ::= {
    INITIATING MESSAGE      ErrorIndication
    PROCEDURE CODE          id-ErrorIndication
    CRITICALITY             ignore
}

UEContextReleaseRequest FlAP-ELEMENTARY-PROCEDURE ::= {
    INITIATING MESSAGE      UEContextReleaseRequest
    PROCEDURE CODE          id-UEContextReleaseRequest
    CRITICALITY             ignore
}

initialULRRCTestMessageTransfer FlAP-ELEMENTARY-PROCEDURE ::= {
    INITIATING MESSAGE      InitialULRRCTestMessageTransfer
    PROCEDURE CODE          id-InitialULRRCTestMessageTransfer
    CRITICALITY             ignore
}

DLRRCTestMessageTransfer FlAP-ELEMENTARY-PROCEDURE ::= {
    INITIATING MESSAGE      DLRRCTestMessageTransfer
    PROCEDURE CODE          id-DLRRCTestMessageTransfer
    CRITICALITY             ignore
}
```

```
}  
  
uLRRCTestMessageTransfer FlAP-ELEMENTARY-PROCEDURE ::= {  
    INITIATING MESSAGE      ULRRCMessageTransfer  
    PROCEDURE CODE          id-ULRRCTestMessageTransfer  
    CRITICALITY             ignore  
}  
  
uEInactivityNotification FlAP-ELEMENTARY-PROCEDURE ::= {  
    INITIATING MESSAGE      UEInactivityNotification  
    PROCEDURE CODE          id-UEInactivityNotification  
    CRITICALITY             ignore  
}  
  
gNBDRResourceCoordination FlAP-ELEMENTARY-PROCEDURE ::= {  
    INITIATING MESSAGE      GNBDRResourceCoordinationRequest  
    SUCCESSFUL OUTCOME      GNBDRResourceCoordinationResponse  
    PROCEDURE CODE          id-GNBDRResourceCoordination  
    CRITICALITY             reject  
}  
  
privateMessage FlAP-ELEMENTARY-PROCEDURE ::= {  
    INITIATING MESSAGE      PrivateMessage  
    PROCEDURE CODE          id-privateMessage  
    CRITICALITY             ignore  
}  
  
systemInformationDelivery FlAP-ELEMENTARY-PROCEDURE ::= {  
    INITIATING MESSAGE      SystemInformationDeliveryCommand  
    PROCEDURE CODE          id-SystemInformationDeliveryCommand  
    CRITICALITY             ignore  
}  
  
paging FlAP-ELEMENTARY-PROCEDURE ::= {  
    INITIATING MESSAGE      Paging  
    PROCEDURE CODE          id-Paging  
    CRITICALITY             ignore  
}  
  
notify FlAP-ELEMENTARY-PROCEDURE ::= {  
    INITIATING MESSAGE      Notify  
    PROCEDURE CODE          id-Notify  
    CRITICALITY             ignore  
}  
  
networkAccessRateReduction FlAP-ELEMENTARY-PROCEDURE ::= {  
    INITIATING MESSAGE      NetworkAccessRateReduction  
    PROCEDURE CODE          id-NetworkAccessRateReduction  
    CRITICALITY             ignore  
}
```

```

pWSRestartIndication FlAP-ELEMENTARY-PROCEDURE ::= {
    INITIATING MESSAGE      PWSRestartIndication
    PROCEDURE CODE         id-PWSRestartIndication
    CRITICALITY             ignore
}

PWSFailureIndication FlAP-ELEMENTARY-PROCEDURE ::= {
    INITIATING MESSAGE      PWSFailureIndication
    PROCEDURE CODE         id-PWSFailureIndication
    CRITICALITY             ignore
}

gNBDUStatusIndication FlAP-ELEMENTARY-PROCEDURE ::= {
    INITIATING MESSAGE      GNBDUStatusIndication
    PROCEDURE CODE         id-GNBDUStatusIndication
    CRITICALITY             ignore
}

rRCDeliveryReport FlAP-ELEMENTARY-PROCEDURE ::= {
    INITIATING MESSAGE      RRCDeliveryReport
    PROCEDURE CODE         id-RRCDeliveryReport
    CRITICALITY             ignore
}

flRemoval FlAP-ELEMENTARY-PROCEDURE ::= {
    INITIATING MESSAGE      FlRemovalRequest
    SUCCESSFUL OUTCOME      FlRemovalResponse
    UNSUCCESSFUL OUTCOME    FlRemovalFailure
    PROCEDURE CODE         id-FlRemoval
    CRITICALITY             reject
}

END
-- ASN1STOP

```

9.4.4 PDU Definitions

```

-- ASN1START
-- *****
--
-- PDU definitions for FlAP.
--
-- *****

FlAP-PDU-Contents {
    itu-t (0) identified-organization (4) etsi (0) mobileDomain (0)
    ngran-access (22) modules (3) flap (3) version1 (1) flap-PDU-Contents (1) }

DEFINITIONS AUTOMATIC TAGS ::=

BEGIN

```

```
-- *****  
--  
-- IE parameter types from other modules.  
--  
-- *****
```

IMPORTS

```
Candidate-SpCell-Item,  
Cause,  
Cells-Failed-to-be-Activated-List-Item,  
Cells-Status-Item,  
Cells-to-be-Activated-List-Item,  
Cells-to-be-Deactivated-List-Item,  
CellULConfigured,  
CriticalityDiagnostics,  
C-RNTI,  
CUtoDURRCInformation,  
DRB-Activity-Item,  
DRBID,  
DRBs-FailedToBeModified-Item,  
DRBs-FailedToBeSetup-Item,  
DRBs-FailedToBeSetupMod-Item,  
DRB-Notify-Item,  
DRBs-ModifiedConf-Item,  
DRBs-Modified-Item,  
DRBs-Required-ToBeModified-Item,  
DRBs-Required-ToBeReleased-Item,  
DRBs-Setup-Item,  
DRBs-SetupMod-Item,  
DRBs-ToBeModified-Item,  
DRBs-ToBeReleased-Item,  
DRBs-ToBeSetup-Item,  
DRBs-ToBeSetupMod-Item,  
DRXCycle,  
DRXConfigurationIndicator,  
DUtoCURRCInformation,  
EUTRANQoS,  
ExecuteDuplication,  
FullConfiguration,  
GNB-CU-UE-FlAP-ID,  
GNB-DU-UE-FlAP-ID,  
GNB-DU-ID,  
GNB-DU-Served-Cells-Item,  
GNB-DU-System-Information,  
GNB-CU-Name,  
GNB-DU-Name,  
InactivityMonitoringRequest,  
InactivityMonitoringResponse,  
NotificationControl,  
NR CGI,  
NR PCI,  
UEContextNotRetrievable,  
Potential-SpCell-Item,
```

RAT-FrequencyPriorityInformation,
ResourceCoordinationTransferContainer,
RRCContainer,
RRCContainer-RRCSetupComplete,
RRCReconfigurationCompleteIndicator,
SCellIndex,
SCell-ToBeRemoved-Item,
SCell-ToBeSetup-Item,
SCell-ToBeSetupMod-Item,
SCell-FailedtoSetup-Item,
SCell-FailedtoSetupMod-Item,
ServCellIndex,
Served-Cell-Information,
Served-Cells-To-Add-Item,
Served-Cells-To-Delete-Item,
Served-Cells-To-Modify-Item,
ServingCellMO,
SRBID,
SRBs-FailedToBeSetup-Item,
SRBs-FailedToBeSetupMod-Item,
SRBs-Required-ToBeReleased-Item,
SRBs-ToBeReleased-Item,
SRBs-ToBeSetup-Item,
SRBs-ToBeSetupMod-Item,
SRBs-Modified-Item,
SRBs-Setup-Item,
SRBs-SetupMod-Item,
TimeToWait,
TransactionID,
TransmissionActionIndicator,
UE-associatedLogicalFl-ConnectionItem,
DUtoCURRCCContainer,
PagingCell-Item,
SIType-List,
UEIdentityIndexValue,
GNB-CU-TNL-Association-Setup-Item,
GNB-CU-TNL-Association-Failed-To-Setup-Item,
GNB-CU-TNL-Association-To-Add-Item,
GNB-CU-TNL-Association-To-Remove-Item,
GNB-CU-TNL-Association-To-Update-Item,
MaskedIMEISV,
PagingDRX,
PagingPriority,
PagingIdentity,
Cells-to-be-Barred-Item,
PWSSystemInformation,
Broadcast-To-Be-Cancelled-Item,
Cells-Broadcast-Cancelled-Item,
NR-CGI-List-For-Restart-Item,
PWS-Failed-NR-CGI-Item,
RepetitionPeriod,
NumberOfBroadcastRequest,
Cells-To-Be-Broadcast-Item,
Cells-Broadcast-Completed-Item,

Cancel-all-Warning-Messages-Indicator,
EUTRA-NR-CellResourceCoordinationReq-Container,
EUTRA-NR-CellResourceCoordinationReqAck-Container,
RequestType,
PLMN-Identity,
RLCFailureIndication,
UplinkTxDirectCurrentListInformation,
SULAccessIndication,
Protected-EUTRA-Resources-Item,
GNB-DUConfigurationQuery,
BitRate,
RRC-Version,
GNBDUOverloadInformation,
RRCDeliveryStatusRequest,
NeedforGap,
RRCDeliveryStatus,
ResourceCoordinationTransferInformation,
Dedicated-SIDelivery-NeededUE-Item,
Associated-SCell-Item,
IgnoreResourceCoordinationContainer,
PagingOrigin,
UAC-Assistance-Info,
RANUEID,
GNB-DU-TNL-Association-To-Remove-Item,
NotificationInformation

FROM FLAP-IEs

PrivateIE-Container{} ,
ProtocolExtensionContainer{} ,
ProtocolIE-Container{} ,
ProtocolIE-ContainerPair{} ,
ProtocolIE-SingleContainer{} ,
FLAP-PRIVATE-IES ,
FLAP-PROTOCOL-EXTENSION ,
FLAP-PROTOCOL-IES ,
FLAP-PROTOCOL-IES-PAIR

FROM FLAP-Containers

id-Candidate-SpCell-Item ,
id-Candidate-SpCell-List ,
id-Cause ,
id-Cancel-all-Warning-Messages-Indicator ,
id-Cells-Failed-to-be-Activated-List ,
id-Cells-Failed-to-be-Activated-List-Item ,
id-Cells-Status-Item ,
id-Cells-Status-List ,
id-Cells-to-be-Activated-List ,
id-Cells-to-be-Activated-List-Item ,
id-Cells-to-be-Deactivated-List ,
id-Cells-to-be-Deactivated-List-Item ,
id-ConfirmedUEID ,

id-CriticalityDiagnostics,
id-C-RNTI,
id-CUtoDURRCInformation,
id-DRB-Activity-Item,
id-DRB-Activity-List,
id-DRBs-FailedToBeModified-Item,
id-DRBs-FailedToBeModified-List,
id-DRBs-FailedToBeSetup-Item,
id-DRBs-FailedToBeSetup-List,
id-DRBs-FailedToBeSetupMod-Item,
id-DRBs-FailedToBeSetupMod-List,
id-DRBs-ModifiedConf-Item,
id-DRBs-ModifiedConf-List,
id-DRBs-Modified-Item,
id-DRBs-Modified-List,
id-DRB-Notify-Item,
id-DRB-Notify-List,
id-DRBs-Required-ToBeModified-Item,
id-DRBs-Required-ToBeModified-List,
id-DRBs-Required-ToBeReleased-Item,
id-DRBs-Required-ToBeReleased-List,
id-DRBs-Setup-Item,
id-DRBs-Setup-List,
id-DRBs-SetupMod-Item,
id-DRBs-SetupMod-List,
id-DRBs-ToBeModified-Item,
id-DRBs-ToBeModified-List,
id-DRBs-ToBeReleased-Item,
id-DRBs-ToBeReleased-List,
id-DRBs-ToBeSetup-Item,
id-DRBs-ToBeSetup-List,
id-DRBs-ToBeSetupMod-Item,
id-DRBs-ToBeSetupMod-List,
id-DRXCycle,
id-DUtoCURRCInformation,
id-ExecuteDuplication,
id-FullConfiguration,
id-gNB-CU-UE-FlAP-ID,
id-gNB-DU-UE-FlAP-ID,
id-gNB-DU-ID,
id-gNB-DU-Served-Cells-Item,
id-gNB-DU-Served-Cells-List,
id-gNB-CU-Name,
id-gNB-DU-Name,
id-InactivityMonitoringRequest,
id-InactivityMonitoringResponse,
id-new-gNB-CU-UE-FlAP-ID,
id-new-gNB-DU-UE-FlAP-ID,
id-oldgNB-DU-UE-FlAP-ID,
id-PLMNAssistanceInfoForNetShar,
id-Potential-SpCell-Item,
id-Potential-SpCell-List,
id-RAT-FrequencyPriorityInformation,
id-RedirectedRRCmessage,

id-ResetType,
id-ResourceCoordinationTransferContainer,
id-RRCContainer,
id-RRCContainer-RRCSetupComplete,
id-RRCConfigurationCompleteIndicator,
id-SCell-FailedtoSetup-List,
id-SCell-FailedtoSetup-Item,
id-SCell-FailedtoSetupMod-List,
id-SCell-FailedtoSetupMod-Item,
id-SCell-ToBeRemoved-Item,
id-SCell-ToBeRemoved-List,
id-SCell-ToBeSetup-Item,
id-SCell-ToBeSetup-List,
id-SCell-ToBeSetupMod-Item,
id-SCell-ToBeSetupMod-List,
id-SelectedPLMNID,
id-Served-Cells-To-Add-Item,
id-Served-Cells-To-Add-List,
id-Served-Cells-To-Delete-Item,
id-Served-Cells-To-Delete-List,
id-Served-Cells-To-Modify-Item,
id-Served-Cells-To-Modify-List,
id-ServCellIndex,
id-ServingCellMO,
id-SpCell-ID,
id-SpCellULConfigured,
id-SRBID,
id-SRBs-FailedToBeSetup-Item,
id-SRBs-FailedToBeSetup-List,
id-SRBs-FailedToBeSetupMod-Item,
id-SRBs-FailedToBeSetupMod-List,
id-SRBs-Required-ToBeReleased-Item,
id-SRBs-Required-ToBeReleased-List,
id-SRBs-ToBeReleased-Item,
id-SRBs-ToBeReleased-List,
id-SRBs-ToBeSetup-Item,
id-SRBs-ToBeSetup-List,
id-SRBs-ToBeSetupMod-Item,
id-SRBs-ToBeSetupMod-List,
id-SRBs-Modified-Item,
id-SRBs-Modified-List,
id-SRBs-Setup-Item,
id-SRBs-Setup-List,
id-SRBs-SetupMod-Item,
id-SRBs-SetupMod-List,
id-TimeToWait,
id-TransactionID,
id-TransmissionActionIndicator,
id-UEContextNotRetrievable,
id-UE-associatedLogicalFl-ConnectionItem,
id-UE-associatedLogicalFl-ConnectionListResAck,
id-DUtoCURRCCContainer,
id-NRCCI,
id-PagingCell-Item,

id-PagingCell-List,
id-PagingDRX,
id-PagingPriority,
id-SItype-List,
id-UEIdentityIndexValue,
id-GNB-CU-TNL-Association-Setup-List,
id-GNB-CU-TNL-Association-Setup-Item,
id-GNB-CU-TNL-Association-Failed-To-Setup-List,
id-GNB-CU-TNL-Association-Failed-To-Setup-Item,
id-GNB-CU-TNL-Association-To-Add-Item,
id-GNB-CU-TNL-Association-To-Add-List,
id-GNB-CU-TNL-Association-To-Remove-Item,
id-GNB-CU-TNL-Association-To-Remove-List,
id-GNB-CU-TNL-Association-To-Update-Item,
id-GNB-CU-TNL-Association-To-Update-List,
id-MaskedIMEISV,
id-PagingIdentity,
id-Cells-to-be-Barred-List,
id-Cells-to-be-Barred-Item,
id-PWSSystemInformation,
id-RepetitionPeriod,
id-NumberOfBroadcastRequest,
id-Cells-To-Be-Broadcast-List,
id-Cells-To-Be-Broadcast-Item,
id-Cells-Broadcast-Completed-List,
id-Cells-Broadcast-Completed-Item,
id-Broadcast-To-Be-Cancelled-List,
id-Broadcast-To-Be-Cancelled-Item,
id-Cells-Broadcast-Cancelled-List,
id-Cells-Broadcast-Cancelled-Item,
id-NR-CGI-List-For-Restart-List,
id-NR-CGI-List-For-Restart-Item,
id-PWS-Failed-NR-CGI-List,
id-PWS-Failed-NR-CGI-Item,
id-EUTRA-NR-CellResourceCoordinationReq-Container,
id-EUTRA-NR-CellResourceCoordinationReqAck-Container,
id-Protected-EUTRA-Resources-List,
id-RequestType,
id-ServingPLMN,
id-DRXConfigurationIndicator,
id-RLCFailureIndication,
id-UplinkTxDirectCurrentListInformation,
id-SULAccessIndication,
id-Protected-EUTRA-Resources-Item,
id-GNB-DUConfigurationQuery,
id-GNB-DU-UE-AMBR-UL,
id-GNB-CU-RRC-Version,
id-GNB-DU-RRC-Version,
id-GNB-DU-OverloadInformation,
id-NeedforGap,
id-RRCDeliveryStatusRequest,
id-RRCDeliveryStatus,
id-Dedicated-SIDelivery-NeededUE-List,
id-Dedicated-SIDelivery-NeededUE-Item,

```

id-ResourceCoordinationTransferInformation,
id-Associated-SCell-List,
id-Associated-SCell-Item,
id-IgnoreResourceCoordinationContainer,
id-UAC-Assistance-Info,
id-RANUEID,
id-PagingOrigin,
id-GNB-DU-TNL-Association-To-Remove-Item,
id-GNB-DU-TNL-Association-To-Remove-List,
id-NotificationInformation,
maxCellingNBDU,
maxnoofCandidateSpCells,
maxnoofDRBs,
maxnoofErrors,
maxnoofIndividualFlConnectionsToReset,
maxnoofPotentialSpCells,
maxnoofSCells,
maxnoofSRBs,
maxnoofPagingCells,
maxnoofTNLAssociations,
maxCelllineNB,
maxnoofUEIDs

```

FROM FlAP-Constants;

```

-- *****
--
-- RESET ELEMENTARY PROCEDURE
--
-- *****

-- *****
--
-- Reset
--
-- *****

```

```

Reset ::= SEQUENCE {
    protocolIEs          ProtocolIE-Container    { {ResetIEs} },
    ...
}

```

```

ResetIEs FlAP-PROTOCOL-IES ::= {
    { ID id-TransactionID          CRITICALITY reject TYPE TransactionID          PRESENCE mandatory }|
    { ID id-Cause                  CRITICALITY ignore TYPE Cause                PRESENCE mandatory }|
    { ID id-ResetType              CRITICALITY reject TYPE ResetType          PRESENCE mandatory },
    ...
}

```

```

ResetType ::= CHOICE {
    fl-Interface
    ResetAll,

```

```

    partOfF1-Interface          UE-associatedLogicalF1-ConnectionListRes,
    choice-extension            ProtocolIE-SingleContainer { { ResetType-ExtIEs } }
}

ResetType-ExtIEs FlAP-PROTOCOL-IES ::= {
    ...
}

ResetAll ::= ENUMERATED {
    reset-all,
    ...
}

UE-associatedLogicalF1-ConnectionListRes ::= SEQUENCE (SIZE(1.. maxnoofIndividualF1ConnectionsToReset)) OF ProtocolIE-SingleContainer { { UE-
associatedLogicalF1-ConnectionItemRes } }

UE-associatedLogicalF1-ConnectionItemRes FlAP-PROTOCOL-IES ::= {
    { ID id-UE-associatedLogicalF1-ConnectionItem    CRITICALITY reject   TYPE UE-associatedLogicalF1-ConnectionItem  PRESENCE mandatory},
    ...
}

-- *****
--
-- Reset Acknowledge
--
-- *****

ResetAcknowledge ::= SEQUENCE {
    protocolIEs          ProtocolIE-Container          { {ResetAcknowledgeIEs} },
    ...
}

ResetAcknowledgeIEs FlAP-PROTOCOL-IES ::= {
    { ID id-TransactionID                                CRITICALITY reject   TYPE TransactionID                PRESENCE
mandatory }|
    { ID id-UE-associatedLogicalF1-ConnectionListResAck  CRITICALITY ignore   TYPE UE-associatedLogicalF1-ConnectionListResAck  PRESENCE
optional }|
    { ID id-CriticalityDiagnostics          CRITICALITY ignore   TYPE CriticalityDiagnostics          PRESENCE optional },
    ...
}

UE-associatedLogicalF1-ConnectionListResAck ::= SEQUENCE (SIZE(1.. maxnoofIndividualF1ConnectionsToReset)) OF ProtocolIE-SingleContainer { { UE-
associatedLogicalF1-ConnectionItemResAck } }

UE-associatedLogicalF1-ConnectionItemResAck FlAP-PROTOCOL-IES ::= {
    { ID id-UE-associatedLogicalF1-ConnectionItem    CRITICALITY ignore   TYPE UE-associatedLogicalF1-ConnectionItem  PRESENCE mandatory },
    ...
}

-- *****
--
-- ERROR INDICATION ELEMENTARY PROCEDURE

```

```

--
-- *****
-- *****
--
-- Error Indication
--
-- *****

ErrorIndication ::= SEQUENCE {
    protocolIEs          ProtocolIE-Container          {{ErrorIndicationIEs}},
    ...
}

ErrorIndicationIEs FlAP-PROTOCOL-IES ::= {
    { ID id-TransactionID          CRITICALITY reject  TYPE TransactionID          PRESENCE mandatory }|
    { ID id-gNB-CU-UE-FlAP-ID      CRITICALITY ignore TYPE GNB-CU-UE-FlAP-ID      PRESENCE optional }|
    { ID id-gNB-DU-UE-FlAP-ID      CRITICALITY ignore TYPE GNB-DU-UE-FlAP-ID      PRESENCE optional }|
    { ID id-Cause                  CRITICALITY ignore TYPE Cause                  PRESENCE optional }|
    { ID id-CriticalityDiagnostics CRITICALITY ignore TYPE CriticalityDiagnostics PRESENCE optional },
    ...
}

-- *****
--
-- Fl SETUP ELEMENTARY PROCEDURE
--
-- *****

-- *****
--
-- Fl Setup Request
--
-- *****

FlSetupRequest ::= SEQUENCE {
    protocolIEs          ProtocolIE-Container          { {FlSetupRequestIEs} },
    ...
}

FlSetupRequestIEs FlAP-PROTOCOL-IES ::= {
    { ID id-TransactionID          CRITICALITY reject  TYPE TransactionID          PRESENCE mandatory }|
    { ID id-gNB-DU-ID              CRITICALITY reject  TYPE GNB-DU-ID              PRESENCE mandatory }|
    { ID id-gNB-DU-Name            CRITICALITY ignore  TYPE GNB-DU-Name            PRESENCE optional }|
    { ID id-gNB-DU-Served-Cells-List CRITICALITY reject  TYPE GNB-DU-Served-Cells-List PRESENCE optional }|
    { ID id-GNB-DU-RRC-Version     CRITICALITY reject  TYPE RRC-Version           PRESENCE mandatory },
    ...
}

GNB-DU-Served-Cells-List ::= SEQUENCE (SIZE(1.. maxCellingNBdu)) OF ProtocolIE-SingleContainer { { GNB-DU-Served-Cells-ItemIEs } }

GNB-DU-Served-Cells-ItemIEs FlAP-PROTOCOL-IES ::= {
    { ID id-GNB-DU-Served-Cells-Item CRITICALITY reject  TYPE          GNB-DU-Served-Cells-Item PRESENCE mandatory },

```

```

}
...
}

-- *****
--
-- Fl Setup Response
--
-- *****

FlSetupResponse ::= SEQUENCE {
    protocolIEs          ProtocolIE-Container      { {FlSetupResponseIEs} },
    ...
}

FlSetupResponseIEs FlAP-PROTOCOL-IES ::= {
    { ID id-TransactionID          CRITICALITY reject  TYPE TransactionID          PRESENCE mandatory }|
    { ID id-gNB-CU-Name            CRITICALITY ignore  TYPE GNB-CU-Name            PRESENCE optional }|
    { ID id-Cells-to-be-Activated-List CRITICALITY reject  TYPE Cells-to-be-Activated-List PRESENCE optional }|
    { ID id-GNB-CU-RRC-Version      CRITICALITY reject  TYPE RRC-Version            PRESENCE mandatory },
    ...
}

Cells-to-be-Activated-List ::= SEQUENCE (SIZE(1.. maxCellingNBDU)) OF ProtocolIE-SingleContainer { { Cells-to-be-Activated-List-ItemIEs } }

Cells-to-be-Activated-List-ItemIEs FlAP-PROTOCOL-IES ::= {
    { ID id-Cells-to-be-Activated-List-Item          CRITICALITY reject  TYPE Cells-to-be-Activated-List-Item          PRESENCE mandatory},
    ...
}

-- *****
--
-- Fl Setup Failure
--
-- *****

FlSetupFailure ::= SEQUENCE {
    protocolIEs          ProtocolIE-Container      { {FlSetupFailureIEs} },
    ...
}

FlSetupFailureIEs FlAP-PROTOCOL-IES ::= {
    { ID id-TransactionID          CRITICALITY reject  TYPE TransactionID          PRESENCE mandatory }|
    { ID id-Cause                  CRITICALITY ignore  TYPE Cause                  PRESENCE mandatory }|
    { ID id-TimeToWait             CRITICALITY ignore  TYPE TimeToWait             PRESENCE optional }|
    { ID id-CriticalityDiagnostics CRITICALITY ignore  TYPE CriticalityDiagnostics PRESENCE optional },
    ...
}

```

```

-- *****
--
-- GNB-DU CONFIGURATION UPDATE ELEMENTARY PROCEDURE
--
-- *****
--
-- *****
--
-- GNB-DU CONFIGURATION UPDATE
--
-- *****

GNBDUConfigurationUpdate ::= SEQUENCE {
    protocolIEs          ProtocolIE-Container    { {GNBDUConfigurationUpdateIEs} },
    ...
}

GNBDUConfigurationUpdateIEs FLAP-PROTOCOL-IES ::= {
    { ID id-TransactionID          CRITICALITY reject TYPE TransactionID          PRESENCE mandatory } |
    { ID id-Served-Cells-To-Add-List CRITICALITY reject TYPE Served-Cells-To-Add-List PRESENCE optional } |
    { ID id-Served-Cells-To-Modify-List CRITICALITY reject TYPE Served-Cells-To-Modify-List PRESENCE optional } |
    { ID id-Served-Cells-To-Delete-List CRITICALITY reject TYPE Served-Cells-To-Delete-List PRESENCE optional } |
    { ID id-Cells-Status-List       CRITICALITY reject TYPE Cells-Status-List       PRESENCE optional } |
    { ID id-Dedicated-SIDelivery-NeededUE-List CRITICALITY ignore TYPE Dedicated-SIDelivery-NeededUE-List PRESENCE optional } |
    { ID id-gNB-DU-ID               CRITICALITY reject TYPE GNB-DU-ID               PRESENCE optional } |
    { ID id-GNB-DU-TNL-Association-To-Remove-List CRITICALITY reject TYPE GNB-DU-TNL-Association-To-Remove-List PRESENCE optional } |
    ...
}

Served-Cells-To-Add-List ::= SEQUENCE (SIZE(1.. maxCellingNBDU)) OF ProtocolIE-SingleContainer { { Served-Cells-To-Add-ItemIEs } }
Served-Cells-To-Modify-List ::= SEQUENCE (SIZE(1.. maxCellingNBDU)) OF ProtocolIE-SingleContainer { { Served-Cells-To-Modify-ItemIEs } }
Served-Cells-To-Delete-List ::= SEQUENCE (SIZE(1.. maxCellingNBDU)) OF ProtocolIE-SingleContainer { { Served-Cells-To-Delete-ItemIEs } }
Cells-Status-List ::= SEQUENCE (SIZE(0.. maxCellingNBDU)) OF ProtocolIE-SingleContainer { { Cells-Status-ItemIEs } }

Dedicated-SIDelivery-NeededUE-List ::= SEQUENCE (SIZE(1.. maxnoofUEIDs)) OF ProtocolIE-SingleContainer { { Dedicated-SIDelivery-NeededUE-ItemIEs } }

GNB-DU-TNL-Association-To-Remove-List ::= SEQUENCE (SIZE(1.. maxnoofTNLAssociations)) OF ProtocolIE-SingleContainer { { GNB-DU-TNL-Association-To-Remove-ItemIEs } }

Served-Cells-To-Add-ItemIEs FLAP-PROTOCOL-IES ::= {
    { ID id-Served-Cells-To-Add-Item          CRITICALITY reject TYPE Served-Cells-To-Add-Item          PRESENCE mandatory },
    ...
}

Served-Cells-To-Modify-ItemIEs FLAP-PROTOCOL-IES ::= {
    { ID id-Served-Cells-To-Modify-Item          CRITICALITY reject TYPE Served-Cells-To-Modify-Item          PRESENCE mandatory },
    ...
}

Served-Cells-To-Delete-ItemIEs FLAP-PROTOCOL-IES ::= {
    { ID id-Served-Cells-To-Delete-Item          CRITICALITY reject TYPE Served-Cells-To-Delete-Item          PRESENCE mandatory },
    ...
}

```

```

}

Cells-Status-ItemIEs FLAP-PROTOCOL-IES ::= {
  { ID id-Cells-Status-Item          CRITICALITY reject  TYPE          Cells-Status-Item          PRESENCE mandatory  },
  ...
}

Dedicated-SIDelivery-NeededUE-ItemIEs FLAP-PROTOCOL-IES ::= {
  { ID id-Dedicated-SIDelivery-NeededUE-Item          CRITICALITY ignore  TYPE          Dedicated-SIDelivery-NeededUE-Item          PRESENCE mandatory  },
  ...
}

GNB-DU-TNL-Association-To-Remove-ItemIEs FLAP-PROTOCOL-IES ::= {
  { ID id-GNB-DU-TNL-Association-To-Remove-Item          CRITICALITY reject  TYPE          GNB-DU-TNL-Association-To-Remove-Item          PRESENCE
mandatory  },
  ...
}

-- *****
--
-- GNB-DU CONFIGURATION UPDATE ACKNOWLEDGE
--
-- *****

GNBDUConfigurationUpdateAcknowledge ::= SEQUENCE {
  protocolIEs          ProtocolIE-Container          { {GNBDUConfigurationUpdateAcknowledgeIEs} },
  ...
}

GNBDUConfigurationUpdateAcknowledgeIEs FLAP-PROTOCOL-IES ::= {
  { ID id-TransactionID          CRITICALITY reject  TYPE TransactionID          PRESENCE mandatory  }|
  { ID id-Cells-to-be-Activated-List          CRITICALITY reject  TYPE Cells-to-be-Activated-List          PRESENCE optional  }|
  { ID id-CriticalityDiagnostics          CRITICALITY ignore  TYPE CriticalityDiagnostics          PRESENCE optional  }|
  { ID id-Cells-to-be-Deactivated-List          CRITICALITY reject  TYPE Cells-to-be-Deactivated-List          PRESENCE optional  },
  ...
}

-- *****
--
-- GNB-DU CONFIGURATION UPDATE FAILURE
--
-- *****

GNBDUConfigurationUpdateFailure ::= SEQUENCE {
  protocolIEs          ProtocolIE-Container          { {GNBDUConfigurationUpdateFailureIEs} },
  ...
}

GNBDUConfigurationUpdateFailureIEs FLAP-PROTOCOL-IES ::= {
  { ID id-TransactionID          CRITICALITY reject  TYPE TransactionID          PRESENCE mandatory  }|
  { ID id-Cause          CRITICALITY ignore  TYPE Cause          PRESENCE mandatory  }|
  { ID id-TimeToWait          CRITICALITY ignore  TYPE TimeToWait          PRESENCE optional  }|

```



```

    { ID id-CriticalityDiagnostics      CRITICALITY ignore  TYPE CriticalityDiagnostics      PRESENCE optional },
    ...
}

-- *****
-- GNB-CU CONFIGURATION UPDATE ELEMENTARY PROCEDURE
-- *****
-- *****
-- GNB-CU CONFIGURATION UPDATE
-- *****

GNBCUConfigurationUpdate ::= SEQUENCE {
    protocolIEs          ProtocolIE-Container      { { GNBCUConfigurationUpdateIEs } },
    ...
}

GNBCUConfigurationUpdateIEs FLAP-PROTOCOL-IES ::= {
    { ID id-TransactionID              CRITICALITY reject  TYPE TransactionID              PRESENCE mandatory } |
    { ID id-Cells-to-be-Activated-List  CRITICALITY reject  TYPE Cells-to-be-Activated-List  PRESENCE optional } |
    { ID id-Cells-to-be-Deactivated-List CRITICALITY reject  TYPE Cells-to-be-Deactivated-List PRESENCE optional } |
    { ID id-GNB-CU-TNL-Association-To-Add-List CRITICALITY ignore TYPE GNB-CU-TNL-Association-To-Add-List PRESENCE optional } |
    { ID id-GNB-CU-TNL-Association-To-Remove-List CRITICALITY ignore TYPE GNB-CU-TNL-Association-To-Remove-List PRESENCE optional } |
    { ID id-GNB-CU-TNL-Association-To-Update-List CRITICALITY ignore TYPE GNB-CU-TNL-Association-To-Update-List PRESENCE optional } |
    { ID id-Cells-to-be-Barred-List     CRITICALITY ignore  TYPE Cells-to-be-Barred-List     PRESENCE optional } |
    { ID id-Protected-EUTRA-Resources-List CRITICALITY reject  TYPE Protected-EUTRA-Resources-List PRESENCE optional } |
    ...
}

Cells-to-be-Deactivated-List ::= SEQUENCE (SIZE(1.. maxCellingNBDU)) OF ProtocolIE-SingleContainer { { Cells-to-be-Deactivated-List-ItemIEs } }
GNB-CU-TNL-Association-To-Add-List ::= SEQUENCE (SIZE(1.. maxnoofTNLAssociations)) OF ProtocolIE-SingleContainer { { GNB-CU-TNL-Association-To-Add-ItemIEs } }
GNB-CU-TNL-Association-To-Remove-List ::= SEQUENCE (SIZE(1.. maxnoofTNLAssociations)) OF ProtocolIE-SingleContainer { { GNB-CU-TNL-Association-To-Remove-ItemIEs } }
GNB-CU-TNL-Association-To-Update-List ::= SEQUENCE (SIZE(1.. maxnoofTNLAssociations)) OF ProtocolIE-SingleContainer { { GNB-CU-TNL-Association-To-Update-ItemIEs } }
Cells-to-be-Barred-List ::= SEQUENCE(SIZE(1.. maxCellingNBDU)) OF ProtocolIE-SingleContainer { { Cells-to-be-Barred-ItemIEs } }

Cells-to-be-Deactivated-List-ItemIEs FLAP-PROTOCOL-IES ::= {
    { ID id-Cells-to-be-Deactivated-List-Item          CRITICALITY reject  TYPE Cells-to-be-Deactivated-List-Item          PRESENCE mandatory },
    ...
}

GNB-CU-TNL-Association-To-Add-ItemIEs FLAP-PROTOCOL-IES ::= {
    { ID id-GNB-CU-TNL-Association-To-Add-Item          CRITICALITY ignore  TYPE GNB-CU-TNL-Association-To-Add-Item          PRESENCE mandatory },
    ...
}

```

```

GNB-CU-TNL-Association-To-Remove-ItemIES FLAP-PROTOCOL-IES ::= {
  { ID id-GNB-CU-TNL-Association-To-Remove-Item      CRITICALITY ignore  TYPE      GNB-CU-TNL-Association-To-Remove-Item      PRESENCE
mandatory  },
  ...
}

GNB-CU-TNL-Association-To-Update-ItemIES FLAP-PROTOCOL-IES ::= {
  { ID id-GNB-CU-TNL-Association-To-Update-Item      CRITICALITY ignore  TYPE      GNB-CU-TNL-Association-To-Update-Item      PRESENCE
mandatory  },
  ...
}

Cells-to-be-Barred-ItemIES FLAP-PROTOCOL-IES ::= {
  { ID id-Cells-to-be-Barred-Item      CRITICALITY ignore  TYPE      Cells-to-be-Barred-Item      PRESENCE mandatory  },
  ...
}

Protected-EUTRA-Resources-List ::= SEQUENCE (SIZE(1.. maxCellineNB)) OF ProtocolIE-SingleContainer { { Protected-EUTRA-Resources-ItemIES } }
Protected-EUTRA-Resources-ItemIES FLAP-PROTOCOL-IES ::= {
  { ID id-Protected-EUTRA-Resources-Item      CRITICALITY reject  TYPE Protected-EUTRA-Resources-Item      PRESENCE
mandatory},
  ...
}

-- *****
--
-- GNB-CU CONFIGURATION UPDATE ACKNOWLEDGE
--
-- *****

GNBCUConfigurationUpdateAcknowledge ::= SEQUENCE {
  protocolIES      ProtocolIE-Container      { { GNBCUConfigurationUpdateAcknowledgeIES } },
  ...
}

GNBCUConfigurationUpdateAcknowledgeIES FLAP-PROTOCOL-IES ::= {
  { ID id-TransactionID      CRITICALITY reject  TYPE TransactionID      PRESENCE mandatory  }|
  { ID id-Cells-Failed-to-be-Activated-List      CRITICALITY reject  TYPE Cells-Failed-to-be-Activated-List      PRESENCE optional}|
  { ID id-CriticalityDiagnostics      CRITICALITY ignore  TYPE CriticalityDiagnostics      PRESENCE optional }|
  { ID id-GNB-CU-TNL-Association-Setup-List      CRITICALITY ignore  TYPE      GNB-CU-TNL-Association-Setup-List      PRESENCE optional }|
  { ID id-GNB-CU-TNL-Association-Failed-To-Setup-List      CRITICALITY ignore  TYPE      GNB-CU-TNL-Association-Failed-To-Setup-List
PRESENCE optional  }|
  { ID id-Dedicated-SIDelivery-NeededUE-List      CRITICALITY ignore  TYPE Dedicated-SIDelivery-NeededUE-List      PRESENCE optional },
  ...
}

Cells-Failed-to-be-Activated-List ::= SEQUENCE (SIZE(1.. maxCellingNBDU)) OF ProtocolIE-SingleContainer { { Cells-Failed-to-be-Activated-List-
ItemIES } }
GNB-CU-TNL-Association-Setup-List ::= SEQUENCE (SIZE(1.. maxnoofTNLAssociations)) OF ProtocolIE-SingleContainer { { GNB-CU-TNL-Association-Setup-
ItemIES } }
GNB-CU-TNL-Association-Failed-To-Setup-List ::= SEQUENCE (SIZE(1.. maxnoofTNLAssociations)) OF ProtocolIE-SingleContainer { { GNB-CU-TNL-
Association-Failed-To-Setup-ItemIES } }

```

```

Cells-Failed-to-be-Activated-List-ItemIES FLAP-PROTOCOL-IES ::= {
  { ID id-Cells-Failed-to-be-Activated-List-Item      CRITICALITY reject  TYPE Cells-Failed-to-be-Activated-List-Item      PRESENCE mandatory  },
  ...
}

GNB-CU-TNL-Association-Setup-ItemIES FLAP-PROTOCOL-IES ::= {
  { ID id-GNB-CU-TNL-Association-Setup-Item          CRITICALITY ignore  TYPE          GNB-CU-TNL-Association-Setup-Item          PRESENCE mandatory  },
  ...
}

GNB-CU-TNL-Association-Failed-To-Setup-ItemIES FLAP-PROTOCOL-IES ::= {
  { ID id-GNB-CU-TNL-Association-Failed-To-Setup-Item  CRITICALITY ignore  TYPE          GNB-CU-TNL-Association-Failed-To-Setup-Item          PRESENCE
mandatory  },
  ...
}

-- *****
--
-- GNB-CU CONFIGURATION UPDATE FAILURE
--
-- *****

GNBCUConfigurationUpdateFailure ::= SEQUENCE {
  protocolIES          ProtocolIE-Container      { { GNBCUConfigurationUpdateFailureIES } },
  ...
}

GNBCUConfigurationUpdateFailureIES FLAP-PROTOCOL-IES ::= {
  { ID id-TransactionID          CRITICALITY reject  TYPE TransactionID          PRESENCE mandatory  }|
  { ID id-Cause                  CRITICALITY ignore  TYPE Cause                  PRESENCE mandatory  }|
  { ID id-TimeToWait             CRITICALITY ignore  TYPE TimeToWait            PRESENCE optional  }|
  { ID id-CriticalityDiagnostics CRITICALITY ignore  TYPE CriticalityDiagnostics PRESENCE optional  },
  ...
}

-- *****
--
-- GNB-DU RESOURCE COORDINATION REQUEST
--
-- *****

GNBDUResourceCoordinationRequest ::= SEQUENCE {
  protocolIES          ProtocolIE-Container      {{GNBDUResourceCoordinationRequest-IEs}},
  ...
}

GNBDUResourceCoordinationRequest-IEs FLAP-PROTOCOL-IES ::= {
  { ID id-TransactionID          CRITICALITY reject  TYPE TransactionID          PRESENCE mandatory  }|
  { ID id-RequestType            CRITICALITY reject  TYPE RequestType            PRESENCE mandatory  }|

```

```

    { ID id-EUTRA-NR-CellResourceCoordinationReq-Container CRITICALITY reject TYPE EUTRA-NR-CellResourceCoordinationReq-Container PRESENCE
mandatory}|
    { ID id-IgnoreResourceCoordinationContainer CRITICALITY reject TYPE IgnoreResourceCoordinationContainer PRESENCE optional },
    ...
}

```

```

-- *****
--
-- GNB-DU RESOURCE COORDINATION RESPONSE
--
-- *****

```

```

GNBDUResourceCoordinationResponse ::= SEQUENCE {
    protocolIEs ProtocolIE-Container {{GNBDUResourceCoordinationResponse-IEs}},
    ...
}

```

```

GNBDUResourceCoordinationResponse-IEs FLAP-PROTOCOL-IES ::= {
    { ID id-TransactionID CRITICALITY reject TYPE TransactionID PRESENCE mandatory }|
    { ID id-EUTRA-NR-CellResourceCoordinationReqAck-Container CRITICALITY reject TYPE EUTRA-NR-CellResourceCoordinationReqAck-Container
PRESENCE mandatory},
    ...
}

```

```

-- *****
--
-- UE Context Setup ELEMENTARY PROCEDURE
--
-- *****
--
-- *****
--
-- UE CONTEXT SETUP REQUEST
--
-- *****

```

```

UEContextSetupRequest ::= SEQUENCE {
    protocolIEs ProtocolIE-Container { { UEContextSetupRequestIEs} },
    ...
}

```

```

UEContextSetupRequestIEs FLAP-PROTOCOL-IES ::= {
    { ID id-gNB-CU-UE-FlAP-ID CRITICALITY reject TYPE GNB-CU-UE-FlAP-ID PRESENCE mandatory }|
    { ID id-gNB-DU-UE-FlAP-ID CRITICALITY ignore TYPE GNB-DU-UE-FlAP-ID PRESENCE optional }|
    { ID id-SpCell-ID CRITICALITY reject TYPE NRCGI PRESENCE mandatory }|
    { ID id-ServCellIndex CRITICALITY reject TYPE ServCellIndex PRESENCE mandatory }|
    { ID id-SpCellULConfigured CRITICALITY ignore TYPE CellULConfigured PRESENCE optional }|
    { ID id-CUtoDURRCInformation CRITICALITY reject TYPE CUtoDURRCInformation PRESENCE mandatory }|
    { ID id-Candidate-SpCell-List CRITICALITY ignore TYPE Candidate-SpCell-List PRESENCE optional }|
    { ID id-DRXCycle CRITICALITY ignore TYPE DRXCycle PRESENCE optional }|
    { ID id-ResourceCoordinationTransferContainer CRITICALITY ignore TYPE ResourceCoordinationTransferContainer PRESENCE optional }|
    { ID id-SCell-ToBeSetup-List CRITICALITY ignore TYPE SCell-ToBeSetup-List PRESENCE optional }|
    { ID id-SRBs-ToBeSetup-List CRITICALITY reject TYPE SRBs-ToBeSetup-List PRESENCE optional }|
}

```

```

{ ID id-DRBs-ToBeSetup-List          CRITICALITY reject TYPE DRBs-ToBeSetup-List          PRESENCE optional }|
{ ID id-InactivityMonitoringRequest  CRITICALITY reject TYPE InactivityMonitoringRequest  PRESENCE optional }|
{ ID id-RAT-FrequencyPriorityInformation CRITICALITY reject TYPE RAT-FrequencyPriorityInformation PRESENCE optional }|
{ ID id-RRCContainer                 CRITICALITY ignore TYPE RRCContainer                 PRESENCE optional }|
{ ID id-MaskedIMEISV                 CRITICALITY ignore TYPE MaskedIMEISV                 PRESENCE optional }|
{ ID id-ServingPLMN                  CRITICALITY ignore TYPE PLMN-Identity                 PRESENCE optional }|
{ ID id-GNB-DU-UE-AMBR-UL            CRITICALITY ignore TYPE BitRate                       PRESENCE conditional }|
{ ID id-RRCDeliveryStatusRequest      CRITICALITY ignore TYPE RRCDeliveryStatusRequest      PRESENCE optional }|
{ ID id-ResourceCoordinationTransferInformation CRITICALITY ignore TYPE ResourceCoordinationTransferInformation PRESENCE optional }|
{ ID id-ServingCellMO                CRITICALITY ignore TYPE ServingCellMO                PRESENCE optional }|
{ ID id-new-gNB-CU-UE-FlAP-ID        CRITICALITY reject TYPE GNB-DU-UE-FlAP-ID        PRESENCE optional }|
{ ID id-RANUEID                      CRITICALITY ignore TYPE RANUEID                      PRESENCE optional },
...
}

Candidate-SpCell-List ::= SEQUENCE (SIZE(1..maxnoofCandidateSpCells)) OF ProtocolIE-SingleContainer { { Candidate-SpCell-ItemIEs } }
SCell-ToBeSetup-List ::= SEQUENCE (SIZE(1..maxnoofSCells)) OF ProtocolIE-SingleContainer { { SCell-ToBeSetup-ItemIEs } }
SRBs-ToBeSetup-List ::= SEQUENCE (SIZE(1..maxnoofSRBs)) OF ProtocolIE-SingleContainer { { SRBs-ToBeSetup-ItemIEs } }
DRBs-ToBeSetup-List ::= SEQUENCE (SIZE(1..maxnoofDRBs)) OF ProtocolIE-SingleContainer { { DRBs-ToBeSetup-ItemIEs } }

Candidate-SpCell-ItemIEs FlAP-PROTOCOL-IES ::= {
  { ID id-Candidate-SpCell-Item          CRITICALITY ignore TYPE Candidate-SpCell-Item          PRESENCE mandatory },
  ...
}

SCell-ToBeSetup-ItemIEs FlAP-PROTOCOL-IES ::= {
  { ID id-SCell-ToBeSetup-Item          CRITICALITY ignore TYPE SCell-ToBeSetup-Item          PRESENCE mandatory },
  ...
}

SRBs-ToBeSetup-ItemIEs FlAP-PROTOCOL-IES ::= {
  { ID id-SRBs-ToBeSetup-Item          CRITICALITY reject TYPE SRBs-ToBeSetup-Item          PRESENCE mandatory},
  ...
}

DRBs-ToBeSetup-ItemIEs FlAP-PROTOCOL-IES ::= {
  { ID id-DRBs-ToBeSetup-Item          CRITICALITY reject TYPE DRBs-ToBeSetup-Item          PRESENCE mandatory},
  ...
}

-- *****
--
-- UE CONTEXT SETUP RESPONSE
--
-- *****

UEContextSetupResponse ::= SEQUENCE {
  protocolIEs          ProtocolIE-Container          { { UEContextSetupResponseIEs } },
  ...
}

```

```

UEContextSetupResponseIEs FlAP-PROTOCOL-IES ::= {
  { ID id-gNB-CU-UE-FlAP-ID          CRITICALITY reject TYPE GNB-CU-UE-FlAP-ID          PRESENCE mandatory } |
  { ID id-gNB-DU-UE-FlAP-ID          CRITICALITY reject TYPE GNB-DU-UE-FlAP-ID          PRESENCE mandatory } |
  { ID id-DUtoCURRCInformation        CRITICALITY reject TYPE DUtoCURRCInformation        PRESENCE mandatory } |
  { ID id-C-RNTI                      CRITICALITY ignore TYPE C-RNTI                      PRESENCE optional } |
  { ID id-ResourceCoordinationTransferContainer CRITICALITY ignore TYPE ResourceCoordinationTransferContainer PRESENCE optional } |
  { ID id-FullConfiguration            CRITICALITY reject TYPE FullConfiguration            PRESENCE optional } |
  { ID id-DRBs-Setup-List              CRITICALITY ignore TYPE DRBs-Setup-List              PRESENCE optional } |
  { ID id-SRBs-FailedToBeSetup-List    CRITICALITY ignore TYPE SRBs-FailedToBeSetup-List    PRESENCE optional } |
  { ID id-DRBs-FailedToBeSetup-List    CRITICALITY ignore TYPE DRBs-FailedToBeSetup-List    PRESENCE optional } |
  { ID id-SCell-FailedtoSetup-List     CRITICALITY ignore TYPE SCell-FailedtoSetup-List     PRESENCE optional } |
  { ID id-InactivityMonitoringResponse CRITICALITY reject TYPE InactivityMonitoringResponse PRESENCE optional } |
  { ID id-CriticalityDiagnostics        CRITICALITY ignore TYPE CriticalityDiagnostics        PRESENCE optional } |
  { ID id-SRBs-Setup-List              CRITICALITY ignore TYPE SRBs-Setup-List              PRESENCE optional } ,
  ...
}

DRBs-Setup-List ::= SEQUENCE (SIZE(1..maxnoofDRBs)) OF ProtocolIE-SingleContainer { { DRBs-Setup-ItemIEs } }

SRBs-FailedToBeSetup-List ::= SEQUENCE (SIZE(1..maxnoofSRBs)) OF ProtocolIE-SingleContainer { { SRBs-FailedToBeSetup-ItemIEs } }
DRBs-FailedToBeSetup-List ::= SEQUENCE (SIZE(1..maxnoofDRBs)) OF ProtocolIE-SingleContainer { { DRBs-FailedToBeSetup-ItemIEs } }
SCell-FailedtoSetup-List ::= SEQUENCE (SIZE(1..maxnoofSCells)) OF ProtocolIE-SingleContainer { { SCell-FailedtoSetup-ItemIEs } }
SRBs-Setup-List ::= SEQUENCE (SIZE(1..maxnoofSRBs)) OF ProtocolIE-SingleContainer { { SRBs-Setup-ItemIEs } }

DRBs-Setup-ItemIEs FlAP-PROTOCOL-IES ::= {
  { ID id-DRBs-Setup-Item              CRITICALITY ignore TYPE DRBs-Setup-Item              PRESENCE mandatory } ,
  ...
}

SRBs-Setup-ItemIEs FlAP-PROTOCOL-IES ::= {
  { ID id-SRBs-Setup-Item              CRITICALITY ignore TYPE SRBs-Setup-Item              PRESENCE mandatory } ,
  ...
}

SRBs-FailedToBeSetup-ItemIEs FlAP-PROTOCOL-IES ::= {
  { ID id-SRBs-FailedToBeSetup-Item    CRITICALITY ignore TYPE SRBs-FailedToBeSetup-Item    PRESENCE mandatory } ,
  ...
}

DRBs-FailedToBeSetup-ItemIEs FlAP-PROTOCOL-IES ::= {
  { ID id-DRBs-FailedToBeSetup-Item    CRITICALITY ignore TYPE DRBs-FailedToBeSetup-Item    PRESENCE mandatory } ,
  ...
}

SCell-FailedtoSetup-ItemIEs FlAP-PROTOCOL-IES ::= {
  { ID id-SCell-FailedtoSetup-Item     CRITICALITY ignore TYPE SCell-FailedtoSetup-Item     PRESENCE mandatory } ,
  ...
}
-- *****

```

```

--
-- UE CONTEXT SETUP FAILURE
--
-- *****
UEContextSetupFailure ::= SEQUENCE {
    protocolIEs          ProtocolIE-Container      { { UEContextSetupFailureIEs } },
    ...
}

UEContextSetupFailureIEs FlAP-PROTOCOL-IES ::= {
    { ID id-gNB-CU-UE-FlAP-ID          CRITICALITY reject  TYPE GNB-CU-UE-FlAP-ID          PRESENCE mandatory }|
    { ID id-gNB-DU-UE-FlAP-ID          CRITICALITY ignore TYPE GNB-DU-UE-FlAP-ID          PRESENCE optional }|
    { ID id-Cause                      CRITICALITY ignore TYPE Cause                      PRESENCE mandatory }|
    { ID id-CriticalityDiagnostics      CRITICALITY ignore TYPE CriticalityDiagnostics  PRESENCE optional }|
    { ID id-Potential-SpCell-List      CRITICALITY ignore TYPE Potential-SpCell-List    PRESENCE optional },
    ...
}

Potential-SpCell-List ::= SEQUENCE (SIZE(0..maxnoofPotentialSpCells)) OF ProtocolIE-SingleContainer { { Potential-SpCell-ItemIEs } }

Potential-SpCell-ItemIEs FlAP-PROTOCOL-IES ::= {
    { ID id-Potential-SpCell-Item      CRITICALITY ignore  TYPE Potential-SpCell-Item          PRESENCE mandatory },
    ...
}

-- *****
--
-- UE Context Release Request ELEMENTARY PROCEDURE
--
-- *****
--
-- *****
--
-- UE Context Release Request
--
-- *****

UEContextReleaseRequest ::= SEQUENCE {
    protocolIEs          ProtocolIE-Container      {{ UEContextReleaseRequestIEs}},
    ...
}

UEContextReleaseRequestIEs FlAP-PROTOCOL-IES ::= {
    { ID id-gNB-CU-UE-FlAP-ID          CRITICALITY reject  TYPE GNB-CU-UE-FlAP-ID          PRESENCE mandatory }|
    { ID id-gNB-DU-UE-FlAP-ID          CRITICALITY reject  TYPE GNB-DU-UE-FlAP-ID          PRESENCE mandatory }|
    { ID id-Cause                      CRITICALITY ignore  TYPE Cause                      PRESENCE mandatory }|
    ...
}

-- *****
--
-- UE Context Release (gNB-CU initiated) ELEMENTARY PROCEDURE

```

```

--
-- *****
-- *****
--
-- UE CONTEXT RELEASE COMMAND
--
-- *****

UEContextReleaseCommand ::= SEQUENCE {
    protocolIEs          ProtocolIE-Container          { { UEContextReleaseCommandIEs } },
    ...
}

UEContextReleaseCommandIEs FLAP-PROTOCOL-IES ::= {
    { ID id-gNB-CU-UE-FlAP-ID          CRITICALITY reject TYPE GNB-CU-UE-FlAP-ID          PRESENCE mandatory }|
    { ID id-gNB-DU-UE-FlAP-ID          CRITICALITY reject TYPE GNB-DU-UE-FlAP-ID          PRESENCE mandatory }|
    { ID id-Cause                       CRITICALITY ignore TYPE Cause                       PRESENCE mandatory }|
    { ID id-RRCContainer                 CRITICALITY ignore TYPE RRCContainer                 PRESENCE optional }|
    { ID id-SRBID                        CRITICALITY ignore TYPE SRBID                        PRESENCE conditional }|
    { ID id-oldgNB-DU-UE-FlAP-ID        CRITICALITY ignore TYPE GNB-DU-UE-FlAP-ID          PRESENCE optional }|
    { ID id-ExecuteDuplication          CRITICALITY ignore TYPE ExecuteDuplication          PRESENCE optional }|
    { ID id-RRCDeliveryStatusRequest    CRITICALITY ignore TYPE RRCDeliveryStatusRequest    PRESENCE optional },
    ...
}

-- *****
--
-- UE CONTEXT RELEASE COMPLETE
--
-- *****

UEContextReleaseComplete ::= SEQUENCE {
    protocolIEs          ProtocolIE-Container          { { UEContextReleaseCompleteIEs } },
    ...
}

UEContextReleaseCompleteIEs FLAP-PROTOCOL-IES ::= {
    { ID id-gNB-CU-UE-FlAP-ID          CRITICALITY reject TYPE GNB-CU-UE-FlAP-ID          PRESENCE mandatory }|
    { ID id-gNB-DU-UE-FlAP-ID          CRITICALITY reject TYPE GNB-DU-UE-FlAP-ID          PRESENCE mandatory }|
    { ID id-CriticalityDiagnostics      CRITICALITY ignore TYPE CriticalityDiagnostics      PRESENCE optional },
    ...
}

-- *****
--
-- UE Context Modification ELEMENTARY PROCEDURE
--
-- *****
-- *****
--
-- UE CONTEXT MODIFICATION REQUEST

```



```

--
-- *****
UEContextModificationRequest ::= SEQUENCE {
  protocolIEs          ProtocolIE-Container      { { UEContextModificationRequestIEs } },
  ...
}

UEContextModificationRequestIEs FLAP-PROTOCOL-IES ::= {
  { ID id-gNB-CU-UE-FlAP-ID          CRITICALITY reject TYPE GNB-CU-UE-FlAP-ID          PRESENCE mandatory } |
  { ID id-gNB-DU-UE-FlAP-ID          CRITICALITY reject TYPE GNB-DU-UE-FlAP-ID          PRESENCE mandatory } |
  { ID id-SpCell-ID                  CRITICALITY ignore TYPE NRCGI                      PRESENCE optional } |
  { ID id-ServCellIndex              CRITICALITY reject TYPE ServCellIndex          PRESENCE optional } |
  { ID id-SpCellULConfigured         CRITICALITY ignore TYPE CellULConfigured          PRESENCE optional } |
  { ID id-DRXCycle                   CRITICALITY ignore TYPE DRXCycle                      PRESENCE optional } |
  { ID id-CUtoDURRCInformation        CRITICALITY reject TYPE CUtoDURRCInformation          PRESENCE optional } |
  { ID id-TransmissionActionIndicator CRITICALITY ignore TYPE TransmissionActionIndicator    PRESENCE optional } |
  { ID id-ResourceCoordinationTransferContainer CRITICALITY ignore TYPE ResourceCoordinationTransferContainer PRESENCE optional } |
  { ID id-RRCReconfigurationCompleteIndicator CRITICALITY ignore TYPE RRCReconfigurationCompleteIndicator PRESENCE optional } |
  { ID id-RRCContainer               CRITICALITY reject TYPE RRCContainer                      PRESENCE optional } |
  { ID id-SCell-ToBeSetupMod-List     CRITICALITY ignore TYPE SCell-ToBeSetupMod-List          PRESENCE optional } |
  { ID id-SCell-ToBeRemoved-List     CRITICALITY ignore TYPE SCell-ToBeRemoved-List          PRESENCE optional } |
  { ID id-SRBs-ToBeSetupMod-List     CRITICALITY reject TYPE SRBs-ToBeSetupMod-List          PRESENCE optional } |
  { ID id-DRBs-ToBeSetupMod-List     CRITICALITY reject TYPE DRBs-ToBeSetupMod-List          PRESENCE optional } |
  { ID id-DRBs-ToBeModified-List     CRITICALITY reject TYPE DRBs-ToBeModified-List          PRESENCE optional } |
  { ID id-SRBs-ToBeReleased-List     CRITICALITY reject TYPE SRBs-ToBeReleased-List          PRESENCE optional } |
  { ID id-DRBs-ToBeReleased-List     CRITICALITY reject TYPE DRBs-ToBeReleased-List          PRESENCE optional } |
  { ID id-InactivityMonitoringRequest CRITICALITY reject TYPE InactivityMonitoringRequest      PRESENCE optional } |
  { ID id-RAT-FrequencyPriorityInformation CRITICALITY reject TYPE RAT-FrequencyPriorityInformation  PRESENCE optional } |
  { ID id-DRXConfigurationIndicator  CRITICALITY ignore TYPE DRXConfigurationIndicator        PRESENCE optional } |
  { ID id-RLCFailureIndication        CRITICALITY ignore TYPE RLCFailureIndication              PRESENCE optional } |
  { ID id-UplinkTxDirectCurrentListInformation CRITICALITY ignore TYPE UplinkTxDirectCurrentListInformation PRESENCE optional } |
  { ID id-GNB-DUConfigurationQuery    CRITICALITY reject TYPE GNB-DUConfigurationQuery          PRESENCE optional } |
  { ID id-GNB-DU-UE-AMBR-UL          CRITICALITY ignore TYPE BitRate                          PRESENCE optional } |
  { ID id-ExecuteDuplication          CRITICALITY ignore TYPE ExecuteDuplication                PRESENCE optional } |
  { ID id-RRCDeliveryStatusRequest    CRITICALITY ignore TYPE RRCDeliveryStatusRequest          PRESENCE optional } |
  { ID id-ResourceCoordinationTransferInformation CRITICALITY ignore TYPE ResourceCoordinationTransferInformation PRESENCE optional } |
  { ID id-ServingCellMO              CRITICALITY ignore TYPE ServingCellMO                    PRESENCE optional } |
  { ID id-NeedforGap                 CRITICALITY ignore TYPE NeedforGap                        PRESENCE optional } |
  { ID id-FullConfiguration          CRITICALITY reject TYPE FullConfiguration                PRESENCE optional } ,
  ...
}

SCell-ToBeSetupMod-List ::= SEQUENCE (SIZE(1..maxnoofSCells)) OF ProtocolIE-SingleContainer { { SCell-ToBeSetupMod-ItemIEs } }
SCell-ToBeRemoved-List ::= SEQUENCE (SIZE(1..maxnoofSCells)) OF ProtocolIE-SingleContainer { { SCell-ToBeRemoved-ItemIEs } }
SRBs-ToBeSetupMod-List  ::= SEQUENCE (SIZE(1..maxnoofSRBs)) OF ProtocolIE-SingleContainer { { SRBs-ToBeSetupMod-ItemIEs } }
DRBs-ToBeSetupMod-List  ::= SEQUENCE (SIZE(1..maxnoofDRBs)) OF ProtocolIE-SingleContainer { { DRBs-ToBeSetupMod-ItemIEs } }

DRBs-ToBeModified-List ::= SEQUENCE (SIZE(1..maxnoofDRBs)) OF ProtocolIE-SingleContainer { { DRBs-ToBeModified-ItemIEs } }
SRBs-ToBeReleased-List ::= SEQUENCE (SIZE(1..maxnoofSRBs)) OF ProtocolIE-SingleContainer { { SRBs-ToBeReleased-ItemIEs } }
DRBs-ToBeReleased-List ::= SEQUENCE (SIZE(1..maxnoofDRBs)) OF ProtocolIE-SingleContainer { { DRBs-ToBeReleased-ItemIEs } }

SCell-ToBeSetupMod-ItemIEs FLAP-PROTOCOL-IES ::= {
  { ID id-SCell-ToBeSetupMod-Item          CRITICALITY ignore TYPE SCell-ToBeSetupMod-Item          PRESENCE mandatory } ,

```

```

}
...
}
SCell-ToBeRemoved-ItemIEs FlAP-PROTOCOL-IES ::= {
  { ID id-SCell-ToBeRemoved-Item          CRITICALITY ignore  TYPE SCell-ToBeRemoved-Item          PRESENCE mandatory  },
  ...
}

SRBs-ToBeSetupMod-ItemIEs FlAP-PROTOCOL-IES ::= {
  { ID id-SRBs-ToBeSetupMod-Item          CRITICALITY reject  TYPE SRBs-ToBeSetupMod-Item          PRESENCE mandatory},
  ...
}

DRBs-ToBeSetupMod-ItemIEs FlAP-PROTOCOL-IES ::= {
  { ID id-DRBs-ToBeSetupMod-Item          CRITICALITY reject  TYPE DRBs-ToBeSetupMod-Item          PRESENCE mandatory},
  ...
}

DRBs-ToBeModified-ItemIEs FlAP-PROTOCOL-IES ::= {
  { ID id-DRBs-ToBeModified-Item          CRITICALITY reject  TYPE DRBs-ToBeModified-Item          PRESENCE mandatory},
  ...
}

SRBs-ToBeReleased-ItemIEs FlAP-PROTOCOL-IES ::= {
  { ID id-SRBs-ToBeReleased-Item          CRITICALITY reject  TYPE SRBs-ToBeReleased-Item          PRESENCE mandatory},
  ...
}

DRBs-ToBeReleased-ItemIEs FlAP-PROTOCOL-IES ::= {
  { ID id-DRBs-ToBeReleased-Item          CRITICALITY reject  TYPE DRBs-ToBeReleased-Item          PRESENCE mandatory},
  ...
}

-- *****
--
-- UE CONTEXT MODIFICATION RESPONSE
--
-- *****

UEContextModificationResponse ::= SEQUENCE {
  protocolIEs          ProtocolIE-Container    { { UEContextModificationResponseIEs } },
  ...
}

UEContextModificationResponseIEs FlAP-PROTOCOL-IES ::= {
  { ID id-gNB-CU-UE-FlAP-ID                CRITICALITY reject  TYPE GNB-CU-UE-FlAP-ID                PRESENCE mandatory  }|
  { ID id-gNB-DU-UE-FlAP-ID                CRITICALITY reject  TYPE GNB-DU-UE-FlAP-ID                PRESENCE mandatory  }|
  { ID id-ResourceCoordinationTransferContainer CRITICALITY ignore  TYPE ResourceCoordinationTransferContainer PRESENCE optional  }|
  { ID id-DUtoCURRCInformation              CRITICALITY reject  TYPE DUtoCURRCInformation              PRESENCE optional  }|
  { ID id-DRBs-SetupMod-List                CRITICALITY ignore  TYPE DRBs-SetupMod-List                PRESENCE optional  }|

```

```

{ ID id-DRBs-Modified-List          CRITICALITY ignore TYPE DRBs-Modified-List          PRESENCE optional } |
{ ID id-SRBs-FailedToBeSetupMod-List CRITICALITY ignore TYPE SRBs-FailedToBeSetupMod-List PRESENCE optional } |
{ ID id-DRBs-FailedToBeSetupMod-List CRITICALITY ignore TYPE DRBs-FailedToBeSetupMod-List PRESENCE optional } |
{ ID id-SCell-FailedtoSetupMod-List  CRITICALITY ignore TYPE SCell-FailedtoSetupMod-List  PRESENCE optional } |
{ ID id-DRBs-FailedToBeModified-List CRITICALITY ignore TYPE DRBs-FailedToBeModified-List PRESENCE optional } |
{ ID id-InactivityMonitoringResponse CRITICALITY reject  TYPE InactivityMonitoringResponse PRESENCE optional } |
{ ID id-CriticalityDiagnostics        CRITICALITY ignore TYPE CriticalityDiagnostics        PRESENCE optional } |
{ ID id-C-RNTI                       CRITICALITY ignore TYPE C-RNTI                       PRESENCE optional } |
{ ID id-Associated-SCell-List         CRITICALITY ignore TYPE Associated-SCell-List         PRESENCE optional } |
{ ID id-SRBs-SetupMod-List           CRITICALITY ignore TYPE SRBs-SetupMod-List           PRESENCE optional } |
{ ID id-SRBs-Modified-List           CRITICALITY ignore TYPE SRBs-Modified-List           PRESENCE optional } |
{ ID id-FullConfiguration            CRITICALITY reject  TYPE FullConfiguration            PRESENCE optional } |
...
}

```

```

DRBs-SetupMod-List ::= SEQUENCE (SIZE(1..maxnoofDRBs)) OF ProtocolIE-SingleContainer { { DRBs-SetupMod-ItemIEs } }
DRBs-Modified-List ::= SEQUENCE (SIZE(1..maxnoofDRBs)) OF ProtocolIE-SingleContainer { { DRBs-Modified-ItemIEs } }
SRBs-SetupMod-List ::= SEQUENCE (SIZE(1..maxnoofSRBs)) OF ProtocolIE-SingleContainer { { SRBs-SetupMod-ItemIEs } }
SRBs-Modified-List ::= SEQUENCE (SIZE(1..maxnoofSRBs)) OF ProtocolIE-SingleContainer { { SRBs-Modified-ItemIEs } }
DRBs-FailedToBeModified-List ::= SEQUENCE (SIZE(1..maxnoofDRBs)) OF ProtocolIE-SingleContainer { { DRBs-FailedToBeModified-ItemIEs } }
SRBs-FailedToBeSetupMod-List ::= SEQUENCE (SIZE(1..maxnoofSRBs)) OF ProtocolIE-SingleContainer { { SRBs-FailedToBeSetupMod-ItemIEs } }
DRBs-FailedToBeSetupMod-List ::= SEQUENCE (SIZE(1..maxnoofDRBs)) OF ProtocolIE-SingleContainer { { DRBs-FailedToBeSetupMod-ItemIEs } }
SCell-FailedtoSetupMod-List ::= SEQUENCE (SIZE(1..maxnoofSCells)) OF ProtocolIE-SingleContainer { { SCell-FailedtoSetupMod-ItemIEs } }

```

```

Associated-SCell-List ::= SEQUENCE (SIZE(1.. maxnoofSCells)) OF ProtocolIE-SingleContainer { { Associated-SCell-ItemIEs } }

```

```

DRBs-SetupMod-ItemIEs FlAP-PROTOCOL-IES ::= {
  { ID id-DRBs-SetupMod-Item          CRITICALITY ignore          TYPE DRBs-SetupMod-Item          PRESENCE mandatory},
  ...
}

```

```

DRBs-Modified-ItemIEs FlAP-PROTOCOL-IES ::= {
  { ID id-DRBs-Modified-Item          CRITICALITY ignore          TYPE DRBs-Modified-Item          PRESENCE mandatory},
  ...
}

```

```

SRBs-SetupMod-ItemIEs FlAP-PROTOCOL-IES ::= {
  { ID id-SRBs-SetupMod-Item          CRITICALITY ignore          TYPE SRBs-SetupMod-Item          PRESENCE mandatory},
  ...
}

```

```

SRBs-Modified-ItemIEs FlAP-PROTOCOL-IES ::= {
  { ID id-SRBs-Modified-Item          CRITICALITY ignore          TYPE SRBs-Modified-Item          PRESENCE mandatory},
  ...
}

```

```

SRBs-FailedToBeSetupMod-ItemIEs FlAP-PROTOCOL-IES ::= {
  { ID id-SRBs-FailedToBeSetupMod-Item CRITICALITY ignore          TYPE SRBs-FailedToBeSetupMod-Item PRESENCE mandatory},
  ...
}

```

```

DRBs-FailedToBeSetupMod-ItemIEs FlAP-PROTOCOL-IES ::= {
  { ID id-DRBs-FailedToBeSetupMod-Item          CRITICALITY ignore  TYPE DRBs-FailedToBeSetupMod-Item          PRESENCE mandatory },
  ...
}

DRBs-FailedToBeModified-ItemIEs FlAP-PROTOCOL-IES ::= {
  { ID id-DRBs-FailedToBeModified-Item          CRITICALITY ignore  TYPE DRBs-FailedToBeModified-Item          PRESENCE mandatory },
  ...
}

SCell-FailedtoSetupMod-ItemIEs FlAP-PROTOCOL-IES ::= {
  { ID id-SCell-FailedtoSetupMod-Item          CRITICALITY ignore  TYPE SCell-FailedtoSetupMod-Item          PRESENCE mandatory },
  ...
}

Associated-SCell-ItemIEs FlAP-PROTOCOL-IES ::= {
  { ID id-Associated-SCell-Item                CRITICALITY ignore  TYPE Associated-SCell-Item                PRESENCE mandatory },
  ...
}

-- *****
--
-- UE CONTEXT MODIFICATION FAILURE
--
-- *****

UEContextModificationFailure ::= SEQUENCE {
  protocolIEs          ProtocolIE-Container    { { UEContextModificationFailureIEs } },
  ...
}

UEContextModificationFailureIEs FlAP-PROTOCOL-IES ::= {
  { ID id-gNB-CU-UE-FlAP-ID                    CRITICALITY reject  TYPE GNB-CU-UE-FlAP-ID                    PRESENCE mandatory  }|
  { ID id-gNB-DU-UE-FlAP-ID                    CRITICALITY reject  TYPE GNB-DU-UE-FlAP-ID                    PRESENCE mandatory  }|
  { ID id-Cause                                CRITICALITY ignore  TYPE Cause                                PRESENCE mandatory  }|
  { ID id-CriticalityDiagnostics                CRITICALITY ignore  TYPE CriticalityDiagnostics                PRESENCE optional   },
  ...
}

-- *****
--
-- UE Context Modification Required (gNB-DU initiated) ELEMENTARY PROCEDURE
--
-- *****
--
-- *****
--
-- UE CONTEXT MODIFICATION REQUIRED
--
-- *****

```

```

UEContextModificationRequired ::= SEQUENCE {
    protocolIEs          ProtocolIE-Container    { { UEContextModificationRequiredIEs } },
    ...
}

UEContextModificationRequiredIEs FLAP-PROTOCOL-IES ::= {
    { ID id-gNB-CU-UE-FlAP-ID          CRITICALITY reject TYPE GNB-CU-UE-FlAP-ID          PRESENCE mandatory } |
    { ID id-gNB-DU-UE-FlAP-ID          CRITICALITY reject TYPE GNB-DU-UE-FlAP-ID          PRESENCE mandatory } |
    { ID id-ResourceCoordinationTransferContainer CRITICALITY ignore TYPE ResourceCoordinationTransferContainer PRESENCE optional } |
    { ID id-DUtoCURRCInformation        CRITICALITY reject TYPE DUtoCURRCInformation        PRESENCE optional } |
    { ID id-DRBs-Required-ToBeModified-List CRITICALITY reject TYPE DRBs-Required-ToBeModified-List PRESENCE optional } |
    { ID id-SRBs-Required-ToBeReleased-List CRITICALITY reject TYPE SRBs-Required-ToBeReleased-List PRESENCE optional } |
    { ID id-DRBs-Required-ToBeReleased-List CRITICALITY reject TYPE DRBs-Required-ToBeReleased-List PRESENCE optional } |
    { ID id-Cause                       CRITICALITY ignore TYPE Cause                       PRESENCE mandatory } |
    ...
}

DRBs-Required-ToBeModified-List ::= SEQUENCE (SIZE(1..maxnoofDRBs)) OF ProtocolIE-SingleContainer { { DRBs-Required-ToBeModified-ItemIEs } }
DRBs-Required-ToBeReleased-List ::= SEQUENCE (SIZE(1..maxnoofDRBs)) OF ProtocolIE-SingleContainer { { DRBs-Required-ToBeReleased-ItemIEs } }

SRBs-Required-ToBeReleased-List ::= SEQUENCE (SIZE(1..maxnoofSRBs)) OF ProtocolIE-SingleContainer { { SRBs-Required-ToBeReleased-ItemIEs } }

DRBs-Required-ToBeModified-ItemIEs FLAP-PROTOCOL-IES ::= {
    { ID id-DRBs-Required-ToBeModified-Item          CRITICALITY reject TYPE DRBs-Required-ToBeModified-Item          PRESENCE mandatory },
    ...
}

DRBs-Required-ToBeReleased-ItemIEs FLAP-PROTOCOL-IES ::= {
    { ID id-DRBs-Required-ToBeReleased-Item          CRITICALITY reject TYPE DRBs-Required-ToBeReleased-Item          PRESENCE mandatory },
    ...
}

SRBs-Required-ToBeReleased-ItemIEs FLAP-PROTOCOL-IES ::= {
    { ID id-SRBs-Required-ToBeReleased-Item          CRITICALITY reject TYPE SRBs-Required-ToBeReleased-Item          PRESENCE mandatory },
    ...
}

-- *****
--
-- UE CONTEXT MODIFICATION CONFIRM
--
-- *****

UEContextModificationConfirm ::= SEQUENCE {
    protocolIEs          ProtocolIE-Container    { { UEContextModificationConfirmIEs } },
    ...
}

UEContextModificationConfirmIEs FLAP-PROTOCOL-IES ::= {
    { ID id-gNB-CU-UE-FlAP-ID          CRITICALITY reject TYPE GNB-CU-UE-FlAP-ID          PRESENCE mandatory } |
    { ID id-gNB-DU-UE-FlAP-ID          CRITICALITY reject TYPE GNB-DU-UE-FlAP-ID          PRESENCE mandatory } |
    { ID id-ResourceCoordinationTransferContainer CRITICALITY ignore TYPE ResourceCoordinationTransferContainer PRESENCE optional } |

```

```

    { ID id-DRBs-ModifiedConf-List          CRITICALITY ignore TYPE DRBs-ModifiedConf-List          PRESENCE optional } |
    { ID id-RRCContainer                    CRITICALITY ignore TYPE RRCContainer                    PRESENCE optional } |
    { ID id-CriticalityDiagnostics          CRITICALITY ignore TYPE CriticalityDiagnostics          PRESENCE optional } |
    { ID id-ExecuteDuplication              CRITICALITY ignore TYPE ExecuteDuplication              PRESENCE optional } |
    { ID id-ResourceCoordinationTransferInformation CRITICALITY ignore TYPE ResourceCoordinationTransferInformation PRESENCE optional },
    ...
}

DRBs-ModifiedConf-List ::= SEQUENCE (SIZE(1..maxnoofDRBs)) OF ProtocolIE-SingleContainer { { DRBs-ModifiedConf-ItemIEs } }

DRBs-ModifiedConf-ItemIEs FlAP-PROTOCOL-IES ::= {
    { ID id-DRBs-ModifiedConf-Item          CRITICALITY ignore TYPE DRBs-ModifiedConf-Item          PRESENCE mandatory },
    ...
}

-- *****
--
-- UE CONTEXT MODIFICATION REFUSE
--
-- *****

UEContextModificationRefuse ::= SEQUENCE {
    protocolIEs          ProtocolIE-Container          { { UEContextModificationRefuseIEs } },
    ...
}

UEContextModificationRefuseIEs FlAP-PROTOCOL-IES ::= {
    { ID id-gNB-CU-UE-FlAP-ID              CRITICALITY reject TYPE GNB-CU-UE-FlAP-ID              PRESENCE mandatory } |
    { ID id-gNB-DU-UE-FlAP-ID              CRITICALITY reject TYPE GNB-DU-UE-FlAP-ID              PRESENCE mandatory } |
    { ID id-Cause                          CRITICALITY ignore TYPE Cause                          PRESENCE mandatory } |
    { ID id-CriticalityDiagnostics          CRITICALITY ignore TYPE CriticalityDiagnostics          PRESENCE optional },
    ...
}

-- *****
--
-- WRITE-REPLACE WARNING ELEMENTARY PROCEDURE
--
-- *****

-- *****
--
-- Write-Replace Warning Request
--
-- *****

WriteReplaceWarningRequest ::= SEQUENCE {
    protocolIEs          ProtocolIE-Container          { { WriteReplaceWarningRequestIEs } },
    ...
}

WriteReplaceWarningRequestIEs FlAP-PROTOCOL-IES ::= {

```

```

    { ID id-TransactionID                CRITICALITY reject TYPE TransactionID                PRESENCE mandatory }|
    { ID id-PWSSystemInformation          CRITICALITY reject TYPE PWSSystemInformation    PRESENCE mandatory }|
    { ID id-RepetitionPeriod              CRITICALITY reject TYPE RepetitionPeriod        PRESENCE mandatory }|
    { ID id-NumberOfBroadcastRequest      CRITICALITY reject TYPE NumberOfBroadcastRequest  PRESENCE mandatory }|
    { ID id-Cells-To-Be-Broadcast-List    CRITICALITY reject TYPE Cells-To-Be-Broadcast-List    PRESENCE optional },
    ...
}

Cells-To-Be-Broadcast-List ::= SEQUENCE (SIZE(1.. maxCellingNBDU)) OF ProtocolIE-SingleContainer { { Cells-To-Be-Broadcast-List-ItemIEs } }

Cells-To-Be-Broadcast-List-ItemIEs FLAP-PROTOCOL-IES ::= {
    { ID id-Cells-To-Be-Broadcast-Item    CRITICALITY reject TYPE Cells-To-Be-Broadcast-Item    PRESENCE mandatory },
    ...
}

-- *****
--
-- Write-Replace Warning Response
--
-- *****

WriteReplaceWarningResponse ::= SEQUENCE {
    protocolIEs ProtocolIE-Container { {WriteReplaceWarningResponseIEs} },
    ...
}

WriteReplaceWarningResponseIEs FLAP-PROTOCOL-IES ::= {
    { ID id-TransactionID                CRITICALITY reject TYPE TransactionID                PRESENCE mandatory }|
    { ID id-Cells-Broadcast-Completed-List    CRITICALITY reject TYPE Cells-Broadcast-Completed-List    PRESENCE optional }|
    { ID id-CriticalityDiagnostics          CRITICALITY ignore TYPE CriticalityDiagnostics          PRESENCE optional }|
    { ID id-Dedicated-SIDelivery-NeededUE-List CRITICALITY ignore TYPE Dedicated-SIDelivery-NeededUE-List    PRESENCE optional },
    ...
}

Cells-Broadcast-Completed-List ::= SEQUENCE (SIZE(1.. maxCellingNBDU)) OF ProtocolIE-SingleContainer { { Cells-Broadcast-Completed-List-ItemIEs } }

Cells-Broadcast-Completed-List-ItemIEs FLAP-PROTOCOL-IES ::= {
    { ID id-Cells-Broadcast-Completed-Item    CRITICALITY reject TYPE Cells-Broadcast-Completed-Item    PRESENCE mandatory },
    ...
}

-- *****
--
-- PWS CANCEL ELEMENTARY PROCEDURE
--
-- *****

-- *****
--
-- PWS Cancel Request
--
-- *****

```

```

PWSCancelRequest ::= SEQUENCE {
    protocolIEs ProtocolIE-Container { {PWSCancelRequestIEs} },
    ...
}

PWSCancelRequestIEs FLAP-PROTOCOL-IES ::= {
    { ID id-TransactionID                CRITICALITY reject TYPE TransactionID                PRESENCE mandatory }|
    { ID id-NumberOfBroadcastRequest     CRITICALITY reject TYPE NumberOfBroadcastRequest PRESENCE mandatory }|
    { ID id-Broadcast-To-Be-Cancelled-List CRITICALITY reject TYPE Broadcast-To-Be-Cancelled-List PRESENCE optional }|
    { ID id-Cancel-all-Warning-Messages-Indicator CRITICALITY reject TYPE Cancel-all-Warning-Messages-Indicator PRESENCE optional }|
    { ID id-NotificationInformation      CRITICALITY reject TYPE NotificationInformation      PRESENCE optional },
    ...
}

Broadcast-To-Be-Cancelled-List ::= SEQUENCE (SIZE(1.. maxCellingNBDU)) OF ProtocolIE-SingleContainer { { Broadcast-To-Be-Cancelled-List-ItemIEs } }

Broadcast-To-Be-Cancelled-List-ItemIEs FLAP-PROTOCOL-IES ::= {
    { ID id-Broadcast-To-Be-Cancelled-Item CRITICALITY reject TYPE Broadcast-To-Be-Cancelled-Item PRESENCE mandatory },
    ...
}

-- *****
--
-- PWS Cancel Response
--
-- *****

PWSCancelResponse ::= SEQUENCE {
    protocolIEs ProtocolIE-Container { {PWSCancelResponseIEs} },
    ...
}

PWSCancelResponseIEs FLAP-PROTOCOL-IES ::= {
    { ID id-TransactionID                CRITICALITY reject TYPE TransactionID                PRESENCE mandatory }|
    { ID id-Cells-Broadcast-Cancelled-List CRITICALITY reject TYPE Cells-Broadcast-Cancelled-List PRESENCE optional }|
    { ID id-CriticalityDiagnostics        CRITICALITY ignore TYPE CriticalityDiagnostics        PRESENCE optional },
    ...
}

Cells-Broadcast-Cancelled-List ::= SEQUENCE (SIZE(1.. maxCellingNBDU)) OF ProtocolIE-SingleContainer { { Cells-Broadcast-Cancelled-List-ItemIEs } }

Cells-Broadcast-Cancelled-List-ItemIEs FLAP-PROTOCOL-IES ::= {
    { ID id-Cells-Broadcast-Cancelled-Item CRITICALITY reject TYPE Cells-Broadcast-Cancelled-Item PRESENCE mandatory },
    ...
}

-- *****
--
-- UE Inactivity Notification ELEMENTARY PROCEDURE
--
-- *****

```



```

-- *****
--
-- UE Inactivity Notification
--
-- *****

UEInactivityNotification ::= SEQUENCE {
    protocolIEs          ProtocolIE-Container    {{ UEInactivityNotificationIEs}},
    ...
}

UEInactivityNotificationIEs FLAP-PROTOCOL-IES ::= {
    { ID id-gNB-CU-UE-FlAP-ID          CRITICALITY reject  TYPE GNB-CU-UE-FlAP-ID          PRESENCE mandatory }|
    { ID id-gNB-DU-UE-FlAP-ID          CRITICALITY reject  TYPE GNB-DU-UE-FlAP-ID          PRESENCE mandatory }|
    { ID id-DRB-Activity-List          CRITICALITY reject  TYPE DRB-Activity-List          PRESENCE mandatory } ,
    ...
}

DRB-Activity-List ::= SEQUENCE (SIZE(1..maxnoofDRBs)) OF ProtocolIE-SingleContainer { { DRB-Activity-ItemIEs } }

DRB-Activity-ItemIEs FLAP-PROTOCOL-IES ::= {
    { ID id-DRB-Activity-Item          CRITICALITY reject  TYPE DRB-Activity-Item          PRESENCE mandatory},
    ...
}

-- *****
--
-- Initial UL RRC Message Transfer ELEMENTARY PROCEDURE
--
-- *****
--
-- *****
--
-- INITIAL UL RRC Message Transfer
--
-- *****

InitialULRRCTransfer ::= SEQUENCE {
    protocolIEs          ProtocolIE-Container    {{ InitialULRRCTransferIEs}},
    ...
}

InitialULRRCTransferIEs FLAP-PROTOCOL-IES ::= {
    { ID id-gNB-DU-UE-FlAP-ID          CRITICALITY reject  TYPE GNB-DU-UE-FlAP-ID          PRESENCE mandatory }|
    { ID id-NRCGI                      CRITICALITY reject  TYPE NRCGI                      PRESENCE mandatory }|
    { ID id-C-RNTI                      CRITICALITY reject  TYPE C-RNTI                      PRESENCE mandatory }|
    { ID id-RRCContainer                CRITICALITY reject  TYPE RRCContainer                PRESENCE mandatory }|
    { ID id-DUtoCURRCCContainer         CRITICALITY reject  TYPE DUtoCURRCCContainer         PRESENCE optional }|
    { ID id-SULAccessIndication         CRITICALITY ignore  TYPE SULAccessIndication         PRESENCE optional }|
    { ID id-TransactionID              CRITICALITY ignore  TYPE TransactionID              PRESENCE mandatory }|
    { ID id-RANUEID                    CRITICALITY ignore  TYPE RANUEID                    PRESENCE optional }|
    { ID id-RRCContainer-RRCSetupComplete CRITICALITY ignore  TYPE RRCContainer-RRCSetupComplete PRESENCE optional },
    ...
}

```

```

}

-- *****
--
-- DL RRC Message Transfer ELEMENTARY PROCEDURE
--
-- *****

-- *****
--
-- DL RRC Message Transfer
--
-- *****

DLRRCTransfer ::= SEQUENCE {
  protocolIEs          ProtocolIE-Container      {{ DLRRCTransferIEs}},
  ...
}

DLRRCTransferIEs FLAP-PROTOCOL-IES ::= {
  { ID id-gNB-CU-UE-FlAP-ID          CRITICALITY reject TYPE GNB-CU-UE-FlAP-ID          PRESENCE mandatory }|
  { ID id-gNB-DU-UE-FlAP-ID          CRITICALITY reject TYPE GNB-DU-UE-FlAP-ID          PRESENCE mandatory }|
  { ID id-oldgNB-DU-UE-FlAP-ID       CRITICALITY reject TYPE GNB-DU-UE-FlAP-ID          PRESENCE optional }|
  { ID id-SRBID                      CRITICALITY reject TYPE SRBID                      PRESENCE mandatory }|
  { ID id-ExecuteDuplication         CRITICALITY ignore TYPE ExecuteDuplication         PRESENCE optional }|
  { ID id-RRCContainer               CRITICALITY reject TYPE RRCContainer               PRESENCE mandatory }|
  { ID id-RAT-FrequencyPriorityInformation CRITICALITY reject TYPE RAT-FrequencyPriorityInformation PRESENCE optional }|
  { ID id-RRCDeliveryStatusRequest   CRITICALITY ignore TYPE RRCDeliveryStatusRequest   PRESENCE optional }|
  { ID id-UEContextNotRetrievable    CRITICALITY reject TYPE UEContextNotRetrievable    PRESENCE optional }|
  { ID id-RedirectedRRCMessage       CRITICALITY reject TYPE OCTET STRING       PRESENCE optional }|
  { ID id-PLMNAssistanceInfoForNetShar CRITICALITY ignore TYPE PLMN-Identity       PRESENCE optional }|
  { ID id-new-gNB-CU-UE-FlAP-ID      CRITICALITY reject TYPE GNB-CU-UE-FlAP-ID      PRESENCE optional },
  ...
}

-- *****
--
-- UL RRC Message Transfer ELEMENTARY PROCEDURE
--
-- *****

-- *****
--
-- UL RRC Message Transfer
--
-- *****

ULRRCTransfer ::= SEQUENCE {
  protocolIEs          ProtocolIE-Container      {{ ULRRCTransferIEs}},
  ...
}

ULRRCTransferIEs FLAP-PROTOCOL-IES ::= {
  { ID id-gNB-CU-UE-FlAP-ID          CRITICALITY reject TYPE GNB-CU-UE-FlAP-ID          PRESENCE mandatory }|

```

```

    { ID id-gNB-DU-UE-FlAP-ID          CRITICALITY reject TYPE GNB-DU-UE-FlAP-ID          PRESENCE mandatory }|
    { ID id-SRBID                      CRITICALITY reject TYPE SRBID                      PRESENCE mandatory }|
    { ID id-RRCContainer               CRITICALITY reject TYPE RRCContainer                PRESENCE mandatory }|
    { ID id-SelectedPLMNID             CRITICALITY reject TYPE PLMN-Identity                PRESENCE optional  }|
    { ID id-new-gNB-DU-UE-FlAP-ID     CRITICALITY reject TYPE GNB-DU-UE-FlAP-ID          PRESENCE optional  },
    ...
}

-- *****
--
-- PRIVATE MESSAGE
--
-- *****

PrivateMessage ::= SEQUENCE {
    privateIEs      PrivateIE-Container {{PrivateMessage-IEs}},
    ...
}

PrivateMessage-IEs FlAP-PRIVATE-IES ::= {
    ...
}

-- *****
--
-- System Information ELEMENTARY PROCEDURE
--
-- *****

-- *****
--
-- System information Delivery Command
--
-- *****

SystemInformationDeliveryCommand ::= SEQUENCE {
    protocolIEs      ProtocolIE-Container      {{ SystemInformationDeliveryCommandIEs}},
    ...
}

SystemInformationDeliveryCommandIEs FlAP-PROTOCOL-IES ::= {
    { ID id-TransactionID          CRITICALITY reject TYPE TransactionID          PRESENCE mandatory }|
    { ID id-NRCGI                 CRITICALITY reject TYPE NRCGI                 PRESENCE mandatory }|
    { ID id-SItype-List           CRITICALITY reject TYPE SItype-List           PRESENCE mandatory }|
    { ID id-ConfirmedUEID         CRITICALITY reject TYPE GNB-DU-UE-FlAP-ID     PRESENCE mandatory },
    ...
}

-- *****
--
-- Paging PROCEDURE
--

```

```

-- *****
-- *****
--
-- Paging
--
-- *****

Paging ::= SEQUENCE {
    protocolIEs          ProtocolIE-Container    {{ PagingIEs}},
    ...
}

PagingIEs FLAP-PROTOCOL-IES ::= {
    { ID id-UEIdentityIndexValue    CRITICALITY reject  TYPE UEIdentityIndexValue    PRESENCE mandatory }|
    { ID id-PagingIdentity          CRITICALITY reject  TYPE PagingIdentity          PRESENCE mandatory }|
    { ID id-PagingDRX                CRITICALITY ignore  TYPE PagingDRX              PRESENCE optional   }|
    { ID id-PagingPriority           CRITICALITY ignore  TYPE PagingPriority          PRESENCE optional   }|
    { ID id-PagingCell-List         CRITICALITY ignore  TYPE PagingCell-list        PRESENCE mandatory }|
    { ID id-PagingOrigin            CRITICALITY ignore  TYPE PagingOrigin           PRESENCE optional   },
    ...
}

PagingCell-list ::= SEQUENCE (SIZE(1.. maxnoofPagingCells)) OF ProtocolIE-SingleContainer { { PagingCell-ItemIEs } }

PagingCell-ItemIEs FLAP-PROTOCOL-IES ::= {
    { ID id-PagingCell-Item          CRITICALITY ignore  TYPE PagingCell-Item        PRESENCE mandatory },
    ...
}

-- *****
--
-- Notify
--
-- *****

Notify ::= SEQUENCE {
    protocolIEs          ProtocolIE-Container    {{ NotifyIEs}},
    ...
}

NotifyIEs FLAP-PROTOCOL-IES ::= {
    { ID id-gNB-CU-UE-FlAP-ID        CRITICALITY reject  TYPE GNB-CU-UE-FlAP-ID      PRESENCE mandatory }|
    { ID id-gNB-DU-UE-FlAP-ID        CRITICALITY reject  TYPE GNB-DU-UE-FlAP-ID      PRESENCE mandatory }|
    { ID id-DRB-Notify-List          CRITICALITY reject  TYPE DRB-Notify-List        PRESENCE mandatory },
    ...
}

DRB-Notify-List ::= SEQUENCE (SIZE(1.. maxnoofDRBs)) OF ProtocolIE-SingleContainer { { DRB-Notify-ItemIEs } }

DRB-Notify-ItemIEs FLAP-PROTOCOL-IES ::= {
    { ID id-DRB-Notify-Item          CRITICALITY reject  TYPE DRB-Notify-Item        PRESENCE mandatory },

```

```

}
...
}

-- *****
--
-- NETWORK ACCESS RATE REDUCTION ELEMENTARY PROCEDURE
--
-- *****
--
-- *****
--
-- Network Access Rate Reduction
--
-- *****

NetworkAccessRateReduction ::= SEQUENCE {
    protocolIEs          ProtocolIE-Container          {{ NetworkAccessRateReductionIEs }},
    ...
}

NetworkAccessRateReductionIEs FLAP-PROTOCOL-IES ::= {
    { ID id-TransactionID          CRITICALITY reject TYPE TransactionID          PRESENCE mandatory }|
    { ID id-UAC-Assistance-Info    CRITICALITY reject TYPE UAC-Assistance-Info    PRESENCE mandatory }|
    ...
}

-- *****
--
-- PWS RESTART INDICATION ELEMENTARY PROCEDURE
--
-- *****
--
-- *****
--
-- PWS Restart Indication
--
-- *****

PWSRestartIndication ::= SEQUENCE {
    protocolIEs ProtocolIE-Container { { PWSRestartIndicationIEs } },
    ...
}

PWSRestartIndicationIEs FLAP-PROTOCOL-IES ::= {
    { ID id-TransactionID          CRITICALITY reject TYPE TransactionID          PRESENCE mandatory }|
    { ID id-NR-CGI-List-For-Restart-List CRITICALITY reject TYPE NR-CGI-List-For-Restart-List PRESENCE mandatory }|
    ...
}

NR-CGI-List-For-Restart-List ::= SEQUENCE (SIZE(1.. maxCellingNBDU)) OF ProtocolIE-SingleContainer { { NR-CGI-List-For-Restart-List-ItemIEs } }

NR-CGI-List-For-Restart-List-ItemIEs FLAP-PROTOCOL-IES ::= {

```

```

    { ID id-NR-CGI-List-For-Restart-Item          CRITICALITY reject TYPE NR-CGI-List-For-Restart-Item PRESENCE mandatory },
    ...
}

-- *****
--
-- PWS FAILURE INDICATION ELEMENTARY PROCEDURE
--
-- *****
--
-- *****
--
-- PWS Failure Indication
--
-- *****

PWSFailureIndication ::= SEQUENCE {
    protocolIEs ProtocolIE-Container { { PWSFailureIndicationIEs } },
    ...
}

PWSFailureIndicationIEs FLAP-PROTOCOL-IES ::= {
    { ID id-TransactionID          CRITICALITY reject TYPE TransactionID          PRESENCE mandatory }|
    { ID id-PWS-Failed-NR-CGI-List CRITICALITY reject TYPE PWS-Failed-NR-CGI-List PRESENCE optional },
    ...
}

PWS-Failed-NR-CGI-List ::= SEQUENCE (SIZE(1.. maxCellingNBDU)) OF ProtocolIE-SingleContainer { { PWS-Failed-NR-CGI-List-ItemIEs } }

PWS-Failed-NR-CGI-List-ItemIEs FLAP-PROTOCOL-IES ::= {
    { ID id-PWS-Failed-NR-CGI-Item          CRITICALITY reject TYPE PWS-Failed-NR-CGI-Item          PRESENCE mandatory },
    ...
}

-- *****
--
-- gNB-DU STATUS INDICATION ELEMENTARY PROCEDURE
--
-- *****
--
-- *****
--
-- gNB-DU Status Indication
--
-- *****

GNBDUStatusIndication ::= SEQUENCE {
    protocolIEs          ProtocolIE-Container          { {GNBDUStatusIndicationIEs } },
    ...
}

GNBDUStatusIndicationIEs FLAP-PROTOCOL-IES ::= {
    { ID id-TransactionID          CRITICALITY reject TYPE TransactionID          PRESENCE mandatory }|

```

```

    { ID id-GNBDOverloadInformation      CRITICALITY reject  TYPE GNBDOverloadInformation  PRESENCE mandatory  },
    ...
}

-- *****
--
-- RRC Delivery Report ELEMENTARY PROCEDURE
--
-- *****
--
-- *****
--
-- RRC Delivery Report
--
-- *****

RRCDeliveryReport ::= SEQUENCE {
    protocolIEs          ProtocolIE-Container          {{ RRCDeliveryReportIEs}},
    ...
}

RRCDeliveryReportIEs FlAP-PROTOCOL-IES ::= {
    { ID id-gNB-CU-UE-FlAP-ID      CRITICALITY reject  TYPE GNB-CU-UE-FlAP-ID  PRESENCE mandatory  }|
    { ID id-gNB-DU-UE-FlAP-ID      CRITICALITY reject  TYPE GNB-DU-UE-FlAP-ID  PRESENCE mandatory  }|
    { ID id-RRCDeliveryStatus      CRITICALITY ignore  TYPE RRCDeliveryStatus  PRESENCE mandatory  }|
    { ID id-SRBID                  CRITICALITY ignore  TYPE SRBID              PRESENCE mandatory  },
    ...
}

-- *****
--
-- Fl Removal ELEMENTARY PROCEDURE
--
-- *****
--
-- *****
--
-- Fl Removal Request
--
-- *****

FlRemovalRequest ::= SEQUENCE {
    protocolIEs          ProtocolIE-Container          {{ FlRemovalRequestIEs }},
    ...
}

FlRemovalRequestIEs FlAP-PROTOCOL-IES ::= {
    { ID id-TransactionID          CRITICALITY reject  TYPE TransactionID      PRESENCE mandatory  },
    ...
}

-- *****

```

```

--
-- Fl Removal Response
--
-- *****

FlRemovalResponse ::= SEQUENCE {
    protocolIEs          ProtocolIE-Container      {{ FlRemovalResponseIEs }},
    ...
}

FlRemovalResponseIEs FlAP-PROTOCOL-IES ::= {
    { ID id-TransactionID          CRITICALITY reject  TYPE TransactionID          PRESENCE mandatory }|
    { ID id-CriticalityDiagnostics CRITICALITY ignore TYPE CriticalityDiagnostics PRESENCE optional  },
    ...
}

-- *****
--
-- Fl Removal Failure
--
-- *****

FlRemovalFailure ::= SEQUENCE {
    protocolIEs          ProtocolIE-Container      {{ FlRemovalFailureIEs }},
    ...
}

FlRemovalFailureIEs FlAP-PROTOCOL-IES ::= {
    { ID id-TransactionID          CRITICALITY reject  TYPE TransactionID          PRESENCE mandatory }|
    { ID id-Cause                  CRITICALITY ignore TYPE Cause                  PRESENCE mandatory }|
    { ID id-CriticalityDiagnostics CRITICALITY ignore TYPE CriticalityDiagnostics PRESENCE optional  },
    ...
}

END
-- ASN1STOP

```

9.4.5 Information Element Definitions

```

-- ASN1START
-- *****
--
-- Information Element Definitions
--
-- *****

FlAP-IEs {
itu-t (0) identified-organization (4) etsi (0) mobileDomain (0)
ngran-access (22) modules (3) flap (3) version1 (1) flap-IEs (2) }

```

DEFINITIONS AUTOMATIC TAGS ::=

BEGIN

IMPORTS

id-gNB-CUSystemInformation,
id-HandoverPreparationInformation,
id-TAISliceSupportList,
id-RANAC,
id-BearerTypeChange,
id-Cell-Direction,
id-Cell-Type,
id-CellGroupConfig,
id-AvailablePLMNList,
id-PDUSessionID,
id-ULPDUSessionAggregateMaximumBitRate,
id-DC-Based-Duplication-Configured,
id-DC-Based-Duplication-Activation,
id-Duplication-Activation,
id-DLPDCPSNLength,
id-ULPDCPSNLength,
id-RLC-Status,
id-MeasurementTimingConfiguration,
id-DRB-Information,
id-QoSFlowMappingIndication,
id-ServingCellMO,
id-RLCMode,
id-ExtendedServedPLMNs-List,
id-ExtendedAvailablePLMN-List,
id-DRX-LongCycleStartOffset,
id-SelectedBandCombinationIndex,
id-SelectedFeatureSetEntryIndex,
id-Ph-InfoSCG,
id-latest-RRC-Version-Enhanced,
id-RequestedBandCombinationIndex,
id-RequestedFeatureSetEntryIndex,
id-RequestedP-MaxFR2,
id-DRX-Config,
id-UEAssistanceInformation,
id-PDCCH-BlindDetectionSCG,
id-Requested-PDCCH-BlindDetectionSCG,
id-BPLMN-ID-Info-List,
id-NotificationInformation,
id-TNLAssociationTransportLayerAddressgNBDU,
id-portNumber,
id-AdditionalSIBMessageList,
id-IgnorePRACHConfiguration,
id-CG-Config,
id-Ph-InfoMCG,
id-MeasGapSharingConfig,
id-systemInformationAreaID,
id-areaScope,
maxNRARFCN,

```

maxnoofErrors,
maxnoofBPLMNs,
maxnoofBPLMNsNRminus1,
maxnoofDLUPTNLInformation,
maxnoofNrCellBands,
maxnoofULUPTNLInformation,
maxnoofQoSFlows,
maxnoofSliceItems,
maxnoofSIBTypes,
maxnoofSITypes,
maxCelllineNB,
maxnoofExtendedBPLMNs,
maxnoofAdditionalSIBs,
maxnoofUACPLMNs,
maxnoofUACperPLMN

```

FROM FlAP-Constants

```

Criticality,
ProcedureCode,
ProtocolIE-ID,
TriggeringMessage

```

FROM FlAP-CommonDataTypes

```

ProtocolExtensionContainer{},
FlAP-PROTOCOL-EXTENSION,
ProtocolIE-SingleContainer{},
FlAP-PROTOCOL-IES

```

FROM FlAP-Containers;

-- A

AdditionalSIBMessageList ::= SEQUENCE (SIZE(1..maxnoofAdditionalSIBs)) OF AdditionalSIBMessageList-Item

```

AdditionalSIBMessageList-Item ::= SEQUENCE {
  additionalSIB          OCTET STRING,
  iE-Extensions          ProtocolExtensionContainer { { AdditionalSIBMessageList-Item-ExtIEs } } OPTIONAL
}

```

```

AdditionalSIBMessageList-Item-ExtIEs FlAP-PROTOCOL-EXTENSION ::= {
  ...
}

```

```

AllocationAndRetentionPriority ::= SEQUENCE {
  priorityLevel          PriorityLevel,
  pre-emptionCapability  Pre-emptionCapability,
  pre-emptionVulnerability Pre-emptionVulnerability,
  iE-Extensions          ProtocolExtensionContainer { {AllocationAndRetentionPriority-ExtIEs} } OPTIONAL,
  ...
}

```

```

AllocationAndRetentionPriority-ExtIEs FLAP-PROTOCOL-EXTENSION ::= {
    ...
}

Associated-SCell-Item ::= SEQUENCE {
    sCell-ID          NRCGI,
    iE-Extensions    ProtocolExtensionContainer { { Associated-SCell-ItemExtIEs } } OPTIONAL
}

Associated-SCell-ItemExtIEs    FLAP-PROTOCOL-EXTENSION ::= {
    ...
}

AvailablePLMNList ::= SEQUENCE (SIZE(1..maxnoofBPLMNs)) OF AvailablePLMNList-Item

AvailablePLMNList-Item ::= SEQUENCE {
    pLMNIdentity      PLMN-Identity,
    iE-Extensions    ProtocolExtensionContainer { { AvailablePLMNList-Item-ExtIEs } } OPTIONAL
}

AvailablePLMNList-Item-ExtIEs FLAP-PROTOCOL-EXTENSION ::= {
    ...
}

AveragingWindow ::= INTEGER (0..4095, ...)

AreaScope ::= ENUMERATED {true, ...}

-- B

BitRate ::= INTEGER (0..4000000000000, ...)

BearerTypeChange ::= ENUMERATED {true, ...}

BPLMN-ID-Info-List ::= SEQUENCE (SIZE(1..maxnoofBPLMNsNRminus1)) OF BPLMN-ID-Info-Item

BPLMN-ID-Info-Item ::= SEQUENCE {
    pLMN-Identity-List      AvailablePLMNList,
    extended-PLMN-Identity-List ExtendedAvailablePLMN-List OPTIONAL,
    fiveGS-TAC             FiveGS-TAC          OPTIONAL,
    nr-cell-ID             NRCellIdentity,
    ranac                  RANAC                OPTIONAL,
    iE-Extensions          ProtocolExtensionContainer { { BPLMN-ID-Info-ItemExtIEs } } OPTIONAL,
    ...
}

BPLMN-ID-Info-ItemExtIEs FLAP-PROTOCOL-EXTENSION ::= {
    ...
}

ServedPLMNs-List ::= SEQUENCE (SIZE(1..maxnoofBPLMNs)) OF ServedPLMNs-Item

ServedPLMNs-Item ::= SEQUENCE {
    pLMN-Identity          PLMN-Identity,

```

```
    iE-Extensions          ProtocolExtensionContainer { { ServedPLMNs-ItemExtIEs } } OPTIONAL,
    ...
}

ServedPLMNs-ItemExtIEs FLAP-PROTOCOL-EXTENSION ::= {
{ ID id-TAISliceSupportList CRITICALITY ignore EXTENSION SliceSupportList PRESENCE optional },
    ...
}

-- C

Cancel-all-Warning-Messages-Indicator ::= ENUMERATED {true, ...}

Candidate-SpCell-Item ::= SEQUENCE {
    candidate-SpCell-ID      NRCGI ,
    iE-Extensions          ProtocolExtensionContainer { { Candidate-SpCell-ItemExtIEs } } OPTIONAL,
    ...
}

Candidate-SpCell-ItemExtIEs FLAP-PROTOCOL-EXTENSION ::= {
    ...
}

Cause ::= CHOICE {
    radioNetwork          CauseRadioNetwork,
    transport             CauseTransport,
    protocol               CauseProtocol,
    misc                  CauseMisc,
    choice-extension      ProtocolIE-SingleContainer { { Cause-ExtIEs } }
}

Cause-ExtIEs FLAP-PROTOCOL-IES ::= {
    ...
}

CauseMisc ::= ENUMERATED {
    control-processing-overload,
    not-enough-user-plane-processing-resources,
    hardware-failure,
    om-intervention,
    unspecified,
    ...
}

CauseProtocol ::= ENUMERATED {
    transfer-syntax-error,
    abstract-syntax-error-reject,
    abstract-syntax-error-ignore-and-notify,
    message-not-compatible-with-receiver-state,
    semantic-error,
    abstract-syntax-error-falsely-constructed-message,
    unspecified,
    ...
}
```

```

}

CauseRadioNetwork ::= ENUMERATED {
    unspecified,
    rl-failure-rlc,
    unknown-or-already-allocated-gnb-cu-ue-flap-id,
    unknown-or-already-allocated-gnb-du-ue-flap-id,
    unknown-or-inconsistent-pair-of-ue-flap-id,
    interaction-with-other-procedure,
    not-supported-qci-Value,
    action-desirable-for-radio-reasons,
    no-radio-resources-available,
    procedure-cancelled,
    normal-release,
    ...,
    cell-not-available,
    rl-failure-others,
    ue-rejection,
    resources-not-available-for-the-slice,
    amf-initiated-abnormal-release,
    release-due-to-pre-emption,
    plmn-not-served-by-the-gNB-CU,
    multiple-drb-id-instances,
    unknown-drb-id
}

CauseTransport ::= ENUMERATED {
    unspecified,
    transport-resource-unavailable,
    ...
}

CellGroupConfig ::= OCTET STRING

Cell-Direction ::= ENUMERATED {dl-only, ul-only}

Cells-Failed-to-be-Activated-List-Item ::= SEQUENCE {
    nRCGI          NRCGI,
    cause          Cause,
    iE-Extensions ProtocolExtensionContainer { { Cells-Failed-to-be-Activated-List-ItemExtIEs } } OPTIONAL,
    ...
}

Cells-Failed-to-be-Activated-List-ItemExtIEs    FLAP-PROTOCOL-EXTENSION ::= {
    ...
}

Cells-Status-Item ::= SEQUENCE {
    nRCGI          NRCGI,
    service-status Service-Status,
    iE-Extensions ProtocolExtensionContainer { { Cells-Status-ItemExtIEs } } OPTIONAL,
    ...
}

```

```
Cells-Status-ItemExtIEs      FLAP-PROTOCOL-EXTENSION ::= {
  ...
}

Cells-To-Be-Broadcast-Item ::= SEQUENCE {
  nRCGI          NRCGI,
  iE-Extensions  ProtocolExtensionContainer { { Cells-To-Be-Broadcast-ItemExtIEs } } OPTIONAL,
  ...
}

Cells-To-Be-Broadcast-ItemExtIEs      FLAP-PROTOCOL-EXTENSION ::= {
  ...
}

Cells-Broadcast-Completed-Item ::= SEQUENCE {
  nRCGI          NRCGI,
  iE-Extensions  ProtocolExtensionContainer { { Cells-Broadcast-Completed-ItemExtIEs } } OPTIONAL,
  ...
}

Cells-Broadcast-Completed-ItemExtIEs      FLAP-PROTOCOL-EXTENSION ::= {
  ...
}

Broadcast-To-Be-Cancelled-Item ::= SEQUENCE {
  nRCGI          NRCGI,
  iE-Extensions  ProtocolExtensionContainer { { Broadcast-To-Be-Cancelled-ItemExtIEs } } OPTIONAL,
  ...
}

Broadcast-To-Be-Cancelled-ItemExtIEs      FLAP-PROTOCOL-EXTENSION ::= {
  ...
}

Cells-Broadcast-Cancelled-Item ::= SEQUENCE {
  nRCGI          NRCGI,
  numberOfBroadcasts  NumberOfBroadcasts,
  iE-Extensions  ProtocolExtensionContainer { { Cells-Broadcast-Cancelled-ItemExtIEs } } OPTIONAL,
  ...
}

Cells-Broadcast-Cancelled-ItemExtIEs      FLAP-PROTOCOL-EXTENSION ::= {
  ...
}

Cells-to-be-Activated-List-Item ::= SEQUENCE {
  nRCGI          NRCGI,
  nRPCI          NRPCI          OPTIONAL,
  iE-Extensions  ProtocolExtensionContainer { { Cells-to-be-Activated-List-ItemExtIEs } } OPTIONAL,
  ...
}

Cells-to-be-Activated-List-ItemExtIEs      FLAP-PROTOCOL-EXTENSION ::= {
```

```

    { ID id-gNB-CUSystemInformation      CRITICALITY reject EXTENSION GNB-CUSystemInformation PRESENCE optional }|
    { ID id-AvailablePLMNList           CRITICALITY ignore EXTENSION AvailablePLMNList PRESENCE optional }|
    { ID id-ExtendedAvailablePLMN-List  CRITICALITY ignore EXTENSION ExtendedAvailablePLMN-List PRESENCE optional },
    ...
}

Cells-to-be-Deactivated-List-Item ::= SEQUENCE {
    nRCGI          NRCGI      ,
    iE-Extensions  ProtocolExtensionContainer { { Cells-to-be-Deactivated-List-ItemExtIEs } } OPTIONAL,
    ...
}

Cells-to-be-Deactivated-List-ItemExtIEs FLAP-PROTOCOL-EXTENSION ::= {
    ...
}

Cells-to-be-Barred-Item ::= SEQUENCE {
    nRCGI          NRCGI      ,
    cellBarred     CellBarred,
    iE-Extensions  ProtocolExtensionContainer { { Cells-to-be-Barred-Item-ExtIEs } } OPTIONAL
}

Cells-to-be-Barred-Item-ExtIEs FLAP-PROTOCOL-EXTENSION ::= {
    ...
}

CellBarred ::= ENUMERATED {barred, not-barred, ...}

CellSize ::= ENUMERATED {verysmall, small, medium, large, ...}

CellType ::= SEQUENCE {
    cellSize      CellSize,
    iE-Extensions ProtocolExtensionContainer { {CellType-ExtIEs} } OPTIONAL,
    ...
}

CellType-ExtIEs FLAP-PROTOCOL-EXTENSION ::= {
    ...
}

CellULConfigured ::= ENUMERATED {none, ul, sul, ul-and-sul, ...}

CNUEPagingIdentity ::= CHOICE {
    fiveG-S-TMSI      BIT STRING (SIZE(48)),
    choice-extension  ProtocolIE-SingleContainer { { CNUEPagingIdentity-ExtIEs } }
}

CNUEPagingIdentity-ExtIEs FLAP-PROTOCOL-IES ::= {
    ...
}

CP-TransportLayerAddress ::= CHOICE {
    endpoint-IP-address  TransportLayerAddress,

```

```

    endpoint-IP-address-and-port      Endpoint-IP-address-and-port,
    choice-extension                   ProtocolIE-SingleContainer { { CP-TransportLayerAddress-ExtIEs } }
}

CP-TransportLayerAddress-ExtIEs FLAP-PROTOCOL-IES ::= {
    ...
}

CriticalityDiagnostics ::= SEQUENCE {
    procedureCode                    ProcedureCode                        OPTIONAL,
    triggeringMessage                 TriggeringMessage             OPTIONAL,
    procedureCriticality               Criticality                    OPTIONAL,
    transactionID                     TransactionID                  OPTIONAL,
    iEsCriticalityDiagnostics         CriticalityDiagnostics-IE-List OPTIONAL,
    iE-Extensions                     ProtocolExtensionContainer {{CriticalityDiagnostics-ExtIEs}} OPTIONAL,
    ...
}

CriticalityDiagnostics-ExtIEs FLAP-PROTOCOL-EXTENSION ::= {
    ...
}

CriticalityDiagnostics-IE-List ::= SEQUENCE (SIZE (1.. maxnoofErrors)) OF CriticalityDiagnostics-IE-Item

CriticalityDiagnostics-IE-Item ::= SEQUENCE {
    iECriticality                     Criticality,
    iE-ID                             ProtocolIE-ID,
    typeOfError                       TypeOfError,
    iE-Extensions                     ProtocolExtensionContainer {{CriticalityDiagnostics-IE-Item-ExtIEs}} OPTIONAL,
    ...
}

CriticalityDiagnostics-IE-Item-ExtIEs FLAP-PROTOCOL-EXTENSION ::= {
    ...
}

C-RNTI ::= INTEGER (0..65535, ...)

CUtoDURRCInformation ::= SEQUENCE {
    cG-ConfigInfo                    CG-ConfigInfo                OPTIONAL,
    uE-CapabilityRAT-ContainerList    UE-CapabilityRAT-ContainerList OPTIONAL,
    measConfig                        MeasConfig                    OPTIONAL,
    iE-Extensions                     ProtocolExtensionContainer { { CUtoDURRCInformation-ExtIEs } } OPTIONAL,
    ...
}

CUtoDURRCInformation-ExtIEs FLAP-PROTOCOL-EXTENSION ::= {
    { ID id-HandoverPreparationInformation CRITICALITY ignore EXTENSION HandoverPreparationInformation PRESENCE optional }|
    { ID id-CellGroupConfig                CRITICALITY ignore EXTENSION CellGroupConfig          PRESENCE optional }|
    { ID id-MeasurementTimingConfiguration CRITICALITY ignore EXTENSION MeasurementTimingConfiguration PRESENCE optional }|
    { ID id-UEAssistanceInformation        CRITICALITY ignore EXTENSION UEAssistanceInformation      PRESENCE optional }|
    { ID id-CG-Config                       CRITICALITY ignore EXTENSION CG-Config                    PRESENCE optional },
    ...
}

```



```

-- D
DCBasedDuplicationConfigured ::= ENUMERATED {true,..., false}

Dedicated-SIDelivery-NeededUE-Item ::= SEQUENCE {
    gNB-CU-UE-FlAP-ID          GNB-CU-UE-FlAP-ID,
    nRCGI                      NRCGI,
    iE-Extensions              ProtocolExtensionContainer { { DedicatedSIDeliveryNeededUE-Item-ExtIEs } } OPTIONAL,
    ...
}

DedicatedSIDeliveryNeededUE-Item-ExtIEs FlAP-PROTOCOL-EXTENSION ::= {
    ...
}

DLUPTNLInformation-ToBeSetup-List ::= SEQUENCE (SIZE(1..maxnoofDLUPTNLInformation)) OF DLUPTNLInformation-ToBeSetup-Item

DLUPTNLInformation-ToBeSetup-Item ::= SEQUENCE {
    dLUPTNLInformation          UPTransportLayerInformation,
    iE-Extensions              ProtocolExtensionContainer { { DLUPTNLInformation-ToBeSetup-ItemExtIEs } } OPTIONAL,
    ...
}

DLUPTNLInformation-ToBeSetup-ItemExtIEs      FlAP-PROTOCOL-EXTENSION ::= {
    ...
}

DRB-Activity-Item ::= SEQUENCE {
    dRBID                      DRBID,
    dRB-Activity              DRB-Activity OPTIONAL,
    iE-Extensions              ProtocolExtensionContainer { { DRB-Activity-ItemExtIEs } } OPTIONAL,
    ...
}

DRB-Activity-ItemExtIEs      FlAP-PROTOCOL-EXTENSION ::= {
    ...
}

DRB-Activity ::= ENUMERATED {active, not-active}

DRBID ::= INTEGER (1..32, ...)

DRBs-FailedToBeModified-Item ::= SEQUENCE {
    dRBID                      DRBID,
    cause                      Cause OPTIONAL,
    iE-Extensions              ProtocolExtensionContainer { { DRBs-FailedToBeModified-ItemExtIEs } } OPTIONAL,
    ...
}

DRBs-FailedToBeModified-ItemExtIEs FlAP-PROTOCOL-EXTENSION ::= {
    ...
}

```

```

DRBs-FailedToBeSetup-Item ::= SEQUENCE {
    dRBID DRBID,
    cause Cause OPTIONAL,
    iE-Extensions ProtocolExtensionContainer { { DRBs-FailedToBeSetup-ItemExtIEs } } OPTIONAL,
    ...
}

DRBs-FailedToBeSetup-ItemExtIEs FLAP-PROTOCOL-EXTENSION ::= {
    ...
}

DRBs-FailedToBeSetupMod-Item ::= SEQUENCE {
    dRBID DRBID ,
    cause Cause OPTIONAL ,
    iE-Extensions ProtocolExtensionContainer { { DRBs-FailedToBeSetupMod-ItemExtIEs } } OPTIONAL,
    ...
}

DRBs-FailedToBeSetupMod-ItemExtIEs FLAP-PROTOCOL-EXTENSION ::= {
    ...
}

DRB-Information ::= SEQUENCE {
    dRB-QoS QoSFlowLevelQoSParameters,
    sNSSAI SNSSAI,
    notificationControl NotificationControl OPTIONAL,
    flows-Mapped-To-DRB-List Flows-Mapped-To-DRB-List,
    iE-Extensions ProtocolExtensionContainer { { DRB-Information-ItemExtIEs } } OPTIONAL
}

DRB-Information-ItemExtIEs FLAP-PROTOCOL-EXTENSION ::= {
    ...
}

DRBs-Modified-Item ::= SEQUENCE {
    dRBID DRBID,
    lCID LCID OPTIONAL,
    dLUPTNLInformation-ToBeSetup-List dLUPTNLInformation-ToBeSetup-List,
    iE-Extensions ProtocolExtensionContainer { { DRBs-Modified-ItemExtIEs } } OPTIONAL,
    ...
}

DRBs-Modified-ItemExtIEs FLAP-PROTOCOL-EXTENSION ::= {
    { ID id-RLC-Status CRITICALITY ignore EXTENSION RLC-Status PRESENCE optional },
    ...
}

DRBs-ModifiedConf-Item ::= SEQUENCE {
    dRBID DRBID,
    uLUPTNLInformation-ToBeSetup-List uLUPTNLInformation-ToBeSetup-List ,
    iE-Extensions ProtocolExtensionContainer { { DRBs-ModifiedConf-ItemExtIEs } } OPTIONAL,
    ...
}

```

```

DRBs-ModifiedConf-ItemExtIEs    FLAP-PROTOCOL-EXTENSION ::= {
  ...
}

DRB-Notify-Item ::= SEQUENCE {
  dRBID          DRBID,
  notification-Cause  Notification-Cause,
  iE-Extensions  ProtocolExtensionContainer { { DRB-Notify-ItemExtIEs } }    OPTIONAL,
  ...
}

DRB-Notify-ItemExtIEs    FLAP-PROTOCOL-EXTENSION ::= {
  ...
}

DRBs-Required-ToBeModified-Item ::= SEQUENCE {
  dRBID          DRBID,
  dLUPTNLInformation-ToBeSetup-List  DLUPTNLInformation-ToBeSetup-List  ,
  iE-Extensions  ProtocolExtensionContainer { { DRBs-Required-ToBeModified-ItemExtIEs } }    OPTIONAL,
  ...
}

DRBs-Required-ToBeModified-ItemExtIEs    FLAP-PROTOCOL-EXTENSION ::= {
  { ID id-RLC-Status          CRITICALITY ignore          EXTENSION RLC-Status          PRESENCE optional },
  ...
}

DRBs-Required-ToBeReleased-Item ::= SEQUENCE {
  dRBID          DRBID,
  iE-Extensions  ProtocolExtensionContainer { { DRBs-Required-ToBeReleased-ItemExtIEs } }    OPTIONAL,
  ...
}

DRBs-Required-ToBeReleased-ItemExtIEs    FLAP-PROTOCOL-EXTENSION ::= {
  ...
}

DRBs-Setup-Item ::= SEQUENCE {
  dRBID          DRBID,
  lCID          LCID          OPTIONAL,
  dLUPTNLInformation-ToBeSetup-List  DLUPTNLInformation-ToBeSetup-List  ,
  iE-Extensions  ProtocolExtensionContainer { { DRBs-Setup-ItemExtIEs } }    OPTIONAL,
  ...
}

DRBs-Setup-ItemExtIEs    FLAP-PROTOCOL-EXTENSION ::= {
  ...
}

DRBs-SetupMod-Item ::= SEQUENCE {
  dRBID          DRBID,
  lCID          LCID          OPTIONAL,
  dLUPTNLInformation-ToBeSetup-List  DLUPTNLInformation-ToBeSetup-List  ,

```

```

    iE-Extensions    ProtocolExtensionContainer { { DRBs-SetupMod-ItemExtIEs } } OPTIONAL,
    ...
}

DRBs-SetupMod-ItemExtIEs    FLAP-PROTOCOL-EXTENSION ::= {
    ...
}

DRBs-ToBeModified-Item ::= SEQUENCE {
    dRBID                DRBID,
    qosInformation        QoSInformation OPTIONAL,
    uLUPTNLInformation-ToBeSetup-List    ULUPTNLInformation-ToBeSetup-List    ,
    uLConfiguration      ULConfiguration OPTIONAL,
    iE-Extensions        ProtocolExtensionContainer { { DRBs-ToBeModified-ItemExtIEs } } OPTIONAL,
    ...
}

DRBs-ToBeModified-ItemExtIEs    FLAP-PROTOCOL-EXTENSION ::= {
    { ID id-DLPDCPSNLength          CRITICALITY ignore  EXTENSION PDCPSNLength          PRESENCE optional }|
    { ID id-ULPDCPSNLength          CRITICALITY ignore  EXTENSION PDCPSNLength          PRESENCE optional }|
    { ID id-BearerTypeChange        CRITICALITY ignore  EXTENSION BearerTypeChange      PRESENCE optional }|
    { ID id-RLCMode                 CRITICALITY ignore  EXTENSION RLCMode               PRESENCE optional }|
    { ID id-Duplication-Activation   CRITICALITY reject  EXTENSION DuplicationActivation  PRESENCE optional }|
    { ID id-DC-Based-Duplication-Configured CRITICALITY reject  EXTENSION DCBasedDuplicationConfigured PRESENCE optional }|
    { ID id-DC-Based-Duplication-Activation   CRITICALITY reject  EXTENSION DuplicationActivation  PRESENCE optional },
    ...
}

DRBs-ToBeReleased-Item ::= SEQUENCE {
    dRBID    DRBID,
    iE-Extensions    ProtocolExtensionContainer { { DRBs-ToBeReleased-ItemExtIEs } } OPTIONAL,
    ...
}

DRBs-ToBeReleased-ItemExtIEs    FLAP-PROTOCOL-EXTENSION ::= {
    ...
}

DRBs-ToBeSetup-Item ::= SEQUENCE {
    dRBID                DRBID,
    qosInformation        QoSInformation,
    uLUPTNLInformation-ToBeSetup-List    ULUPTNLInformation-ToBeSetup-List    ,
    rLCMode              RLCMode,
    uLConfiguration      ULConfiguration OPTIONAL,
    duplicationActivation DuplicationActivation OPTIONAL,
    iE-Extensions        ProtocolExtensionContainer { { DRBs-ToBeSetup-ItemExtIEs } }    OPTIONAL,
    ...
}

DRBs-ToBeSetup-ItemExtIEs    FLAP-PROTOCOL-EXTENSION ::= {
    { ID id-DC-Based-Duplication-Configured CRITICALITY reject  EXTENSION DCBasedDuplicationConfigured PRESENCE optional }|
    { ID id-DC-Based-Duplication-Activation   CRITICALITY reject  EXTENSION DuplicationActivation       PRESENCE optional }|
    { ID id-DLPDCPSNLength          CRITICALITY ignore  EXTENSION PDCPSNLength          PRESENCE mandatory }|

```

```

    { ID id-ULPDCPSNLength          CRITICALITY ignore EXTENSION PDCPSNLength          PRESENCE optional },
    ...
}

DRBs-ToBeSetupMod-Item ::= SEQUENCE {
    drBID                DRBID,
    qosInformation        QoSInformation,
    uLUPTNLInformation-ToBeSetup-List    ULUPTNLInformation-ToBeSetup-List,
    rLCMode              RLCMode,
    uLConfiguration      ULConfiguration OPTIONAL,
    duplicationActivation DuplicationActivation OPTIONAL,
    iE-Extensions        ProtocolExtensionContainer { { DRBs-ToBeSetupMod-ItemExtIEs } } OPTIONAL,
    ...
}

DRBs-ToBeSetupMod-ItemExtIEs FLAP-PROTOCOL-EXTENSION ::= {
    { ID id-DC-Based-Duplication-Configured    CRITICALITY reject EXTENSION DCBasedDuplicationConfigured    PRESENCE optional }|
    { ID id-DC-Based-Duplication-Activation    CRITICALITY reject EXTENSION DuplicationActivation          PRESENCE optional }|
    { ID id-DLPDCPSNLength                    CRITICALITY ignore EXTENSION PDCPSNLength          PRESENCE optional }|
    { ID id-ULPDCPSNLength                    CRITICALITY ignore EXTENSION PDCPSNLength          PRESENCE optional },
    ...
}

DRXCycle ::= SEQUENCE {
    longDRXCycleLength LongDRXCycleLength,
    shortDRXCycleLength ShortDRXCycleLength OPTIONAL,
    shortDRXCycleTimer ShortDRXCycleTimer OPTIONAL,
    iE-Extensions        ProtocolExtensionContainer { { DRXCycle-ExtIEs } } OPTIONAL,
    ...
}

DRXCycle-ExtIEs FLAP-PROTOCOL-EXTENSION ::= {
    ...
}

DRX-Config ::= OCTET STRING

DRXConfigurationIndicator ::= ENUMERATED{ release, ...}

DRX-LongCycleStartOffset ::= INTEGER (0..10239)

DUtoCURRCContainer ::= OCTET STRING

DUtoCURRCInformation ::= SEQUENCE {
    cellGroupConfig      CellGroupConfig,
    measGapConfig        MeasGapConfig OPTIONAL,
    requestedP-MaxFR1    OCTET STRING          OPTIONAL,
    iE-Extensions        ProtocolExtensionContainer { { DUtoCURRCInformation-ExtIEs } } OPTIONAL,
    ...
}

DUtoCURRCInformation-ExtIEs FLAP-PROTOCOL-EXTENSION ::= {
    { ID id-DRX-LongCycleStartOffset          CRITICALITY ignore EXTENSION DRX-LongCycleStartOffset          PRESENCE optional }|

```

```

    { ID id-SelectedBandCombinationIndex      CRITICALITY ignore EXTENSION SelectedBandCombinationIndex PRESENCE optional } |
    { ID id-SelectedFeatureSetEntryIndex      CRITICALITY ignore EXTENSION SelectedFeatureSetEntryIndex PRESENCE optional } |
    { ID id-Ph-InfoSCG                         CRITICALITY ignore EXTENSION Ph-InfoSCG PRESENCE optional } |
    { ID id-RequestedBandCombinationIndex     CRITICALITY ignore EXTENSION RequestedBandCombinationIndex PRESENCE optional } |
    { ID id-RequestedFeatureSetEntryIndex     CRITICALITY ignore EXTENSION RequestedFeatureSetEntryIndex PRESENCE optional } |
    { ID id-RequestedP-MaxFR2                 CRITICALITY ignore EXTENSION RequestedP-MaxFR2 PRESENCE optional } |
    { ID id-DRX-Config                         CRITICALITY ignore EXTENSION DRX-Config PRESENCE optional } |
    { ID id-PDCCH-BlindDetectionSCG          CRITICALITY ignore EXTENSION PDCCH-BlindDetectionSCG PRESENCE optional } |
    { ID id-Requested-PDCCH-BlindDetectionSCG CRITICALITY ignore EXTENSION Requested-PDCCH-BlindDetectionSCG PRESENCE optional } |
    { ID id-Ph-InfoMCG                         CRITICALITY ignore EXTENSION Ph-InfoMCG PRESENCE optional } |
    { ID id-MeasGapSharingConfig              CRITICALITY ignore EXTENSION MeasGapSharingConfig PRESENCE optional } |
    ...
}

DuplicationActivation ::= ENUMERATED{active,inactive,... }

DuplicationIndication ::= ENUMERATED {true, ... , false }

Dynamic5QIDescriptor ::= SEQUENCE {
    qoSPriorityLevel          INTEGER (1..127),
    packetDelayBudget        PacketDelayBudget,
    packetErrorRate          PacketErrorRate,
    fiveQI                   INTEGER (0..255, ...) OPTIONAL,
    delayCritical            ENUMERATED {delay-critical, non-delay-critical} OPTIONAL,
    -- C-ifGBRflow: This IE shall be present if the GBR QoS Flow Information IE is present in the QoS Flow Level QoS Parameters IE.
    averagingWindow          AveragingWindow OPTIONAL,
    -- C-ifGBRflow: This IE shall be present if the GBR QoS Flow Information IE is present in the QoS Flow Level QoS Parameters IE.
    maxDataBurstVolume       MaxDataBurstVolume OPTIONAL,
    iE-Extensions            ProtocolExtensionContainer { { Dynamic5QIDescriptor-ExtIEs } } OPTIONAL
}

Dynamic5QIDescriptor-ExtIEs FLAP-PROTOCOL-EXTENSION ::= {
    ...
}

-- E

Endpoint-IP-address-and-port ::=SEQUENCE {
    endpointIPAddress TransportLayerAddress,
    iE-Extensions        ProtocolExtensionContainer { { Endpoint-IP-address-and-port-ExtIEs} } OPTIONAL
}

Endpoint-IP-address-and-port-ExtIEs FLAP-PROTOCOL-EXTENSION ::= {
    { ID id-portNumber CRITICALITY reject EXTENSION PortNumber PRESENCE optional},
    ...
}

ExtendedAvailablePLMN-List ::= SEQUENCE (SIZE(1..maxnoofExtendedBPLMNs)) OF ExtendedAvailablePLMN-Item

ExtendedAvailablePLMN-Item ::= SEQUENCE {
    pLMNIdentity          PLMN-Identity,
    iE-Extensions        ProtocolExtensionContainer { { ExtendedAvailablePLMN-Item-ExtIEs} } OPTIONAL
}

```

```

ExtendedAvailablePLMN-Item-ExtIEs FLAP-PROTOCOL-EXTENSION ::= {
    ...
}

ExtendedServedPLMNs-List ::= SEQUENCE (SIZE(1.. maxnoofExtendedBPLMNs)) OF ExtendedServedPLMNs-Item

ExtendedServedPLMNs-Item ::= SEQUENCE {
    pLMN-Identity          PLMN-Identity,
    tAISliceSupportList    SliceSupportList OPTIONAL,
    iE-Extensions          ProtocolExtensionContainer { { ExtendedServedPLMNs-ItemExtIEs } } OPTIONAL,
    ...
}

ExtendedServedPLMNs-ItemExtIEs FLAP-PROTOCOL-EXTENSION ::= {
    ...
}

EUTRACells-List ::= SEQUENCE (SIZE (1.. maxCellineNB)) OF EUTRACells-List-item

EUTRACells-List-item ::= SEQUENCE {
    eUTRA-Cell-ID          EUTRA-Cell-ID,
    served-EUTRA-Cells-Information Served-EUTRA-Cells-Information,
    iE-Extensions          ProtocolExtensionContainer { { EUTRACells-List-itemExtIEs } } OPTIONAL
}

EUTRACells-List-itemExtIEs FLAP-PROTOCOL-EXTENSION ::= {
    ...
}

EUTRA-Cell-ID ::= BIT STRING (SIZE(28))

EUTRA-Coex-FDD-Info ::= SEQUENCE {
    uL-EARFCN              ExtendedEARFCN          OPTIONAL,
    dL-EARFCN              ExtendedEARFCN,
    uL-Transmission-Bandwidth EUTRA-Transmission-Bandwidth OPTIONAL,
    dL-Transmission-Bandwidth EUTRA-Transmission-Bandwidth,
    iE-Extensions          ProtocolExtensionContainer { {EUTRA-Coex-FDD-Info-ExtIEs} } OPTIONAL,
    ...
}

EUTRA-Coex-FDD-Info-ExtIEs FLAP-PROTOCOL-EXTENSION ::= {
    ...
}

EUTRA-Coex-Mode-Info ::= CHOICE {
    fDD      EUTRA-Coex-FDD-Info,
    tDD      EUTRA-Coex-TDD-Info,
    ...
}

EUTRA-Coex-TDD-Info ::= SEQUENCE {
    eARFCN              ExtendedEARFCN,
    transmission-Bandwidth EUTRA-Transmission-Bandwidth,

```

```

    subframeAssignment          EUTRA-SubframeAssignment,
    specialSubframe-Info        EUTRA-SpecialSubframe-Info,
    iE-Extensions                ProtocolExtensionContainer { {EUTRA-Coex-TDD-Info-ExtIEs} } OPTIONAL,
    ...
}
EUTRA-Coex-TDD-Info-ExtIEs FLAP-PROTOCOL-EXTENSION ::= {
    ...
}
EUTRA-CyclicPrefixDL ::= ENUMERATED {
    normal,
    extended,
    ...
}
EUTRA-CyclicPrefixUL ::= ENUMERATED {
    normal,
    extended,
    ...
}
EUTRA-PRACH-Configuration ::= SEQUENCE {
    rootSequenceIndex          INTEGER (0..837),
    zeroCorrelationIndex       INTEGER (0..15),
    highSpeedFlag               BOOLEAN,
    prach-FreqOffset            INTEGER (0..94),
    prach-ConfigIndex          INTEGER (0..63) OPTIONAL,
    -- C-ifTDD: This IE shall be present if the EUTRA-Mode-Info IE in the Resource Coordination E-UTRA Cell Information IE is set to the value
    "TDD"
    iE-Extensions                ProtocolExtensionContainer { {EUTRA-PRACH-Configuration-ExtIEs} } OPTIONAL,
    ...
}
EUTRA-PRACH-Configuration-ExtIEs FLAP-PROTOCOL-EXTENSION ::= {
    ...
}

EUTRA-SpecialSubframe-Info ::= SEQUENCE {
    specialSubframePatterns     EUTRA-SpecialSubframePatterns,
    cyclicPrefixDL              EUTRA-CyclicPrefixDL,
    cyclicPrefixUL              EUTRA-CyclicPrefixUL,
    iE-Extensions                ProtocolExtensionContainer { { EUTRA-SpecialSubframe-Info-ExtIEs} } OPTIONAL,
    ...
}
EUTRA-SpecialSubframe-Info-ExtIEs FLAP-PROTOCOL-EXTENSION ::= {
    ...
}
EUTRA-SpecialSubframePatterns ::= ENUMERATED {
    ssp0,
    ssp1,
    ssp2,
    ssp3,

```



```

    ssp4,
    ssp5,
    ssp6,
    ssp7,
    ssp8,
    ssp9,
    ssp10,
    ...
}

EUTRA-SubframeAssignment ::= ENUMERATED {
    sa0,
    sa1,
    sa2,
    sa3,
    sa4,
    sa5,
    sa6,
    ...
}

EUTRA-Transmission-Bandwidth ::= ENUMERATED {
    bw6,
    bw15,
    bw25,
    bw50,
    bw75,
    bw100,
    ...
}

EUTRANQoS ::= SEQUENCE {
    qCI QCI,
    allocationAndRetentionPriority AllocationAndRetentionPriority,
    gbrQoSInformation GBR-QoSInformation OPTIONAL,
    iE-Extensions ProtocolExtensionContainer { { EUTRANQoS-ExtIEs } } OPTIONAL,
    ...
}

EUTRANQoS-ExtIEs FLAP-PROTOCOL-EXTENSION ::= {
    ...
}

ExecutedDuplication ::= ENUMERATED{true,...}

ExtendedEARFCN ::= INTEGER (0..262143)

EUTRA-Mode-Info ::= CHOICE {
    eUTRAFDD EUTRA-FDD-Info,
    eUTRATDD EUTRA-TDD-Info,
    choice-extension ProtocolIE-SingleContainer { { EUTRA-Mode-Info-ExtIEs } }
}

EUTRA-Mode-Info-ExtIEs FLAP-PROTOCOL-IES ::= {

```

```

}
...
}
EUTRA-NR-CellResourceCoordinationReq-Container ::= OCTET STRING
EUTRA-NR-CellResourceCoordinationReqAck-Container ::= OCTET STRING

EUTRA-FDD-Info ::= SEQUENCE {
    uL-offsetToPointA          OffsetToPointA,
    dL-offsetToPointA          OffsetToPointA,
    iE-Extensions              ProtocolExtensionContainer { {EUTRA-FDD-Info-ExtIEs} } OPTIONAL,
    ...
}

EUTRA-FDD-Info-ExtIEs FLAP-PROTOCOL-EXTENSION ::= {
    ...
}

EUTRA-TDD-Info ::= SEQUENCE {
    offsetToPointA              OffsetToPointA,
    iE-Extensions              ProtocolExtensionContainer { {EUTRA-TDD-Info-ExtIEs} } OPTIONAL,
    ...
}

EUTRA-TDD-Info-ExtIEs FLAP-PROTOCOL-EXTENSION ::= {
    ...
}

-- F

FDD-Info ::= SEQUENCE {
    uL-NRFreqInfo              NRFreqInfo,
    dL-NRFreqInfo              NRFreqInfo,
    uL-Transmission-Bandwidth  Transmission-Bandwidth,
    dL-Transmission-Bandwidth  Transmission-Bandwidth,
    iE-Extensions              ProtocolExtensionContainer { {FDD-Info-ExtIEs} } OPTIONAL,
    ...
}

FDD-Info-ExtIEs FLAP-PROTOCOL-EXTENSION ::= {
    ...
}

Flows-Mapped-To-DRB-List ::= SEQUENCE (SIZE(1.. maxnoofQoSFlows)) OF Flows-Mapped-To-DRB-Item

Flows-Mapped-To-DRB-Item ::= SEQUENCE {
    qoSFlowIdentifier          QoSFlowIdentifier,
    qoSFlowLevelQoSParameters  QoSFlowLevelQoSParameters,
    iE-Extensions              ProtocolExtensionContainer { { Flows-Mapped-To-DRB-ItemExtIEs} } OPTIONAL
}

Flows-Mapped-To-DRB-ItemExtIEs FLAP-PROTOCOL-EXTENSION ::= {
    {ID id-QoSFlowMappingIndication    CRITICALITY ignore EXTENSION QoSFlowMappingIndication    PRESENCE optional},

```

```

}
...
}
FreqBandNrItem ::= SEQUENCE {
    freqBandIndicatorNr          INTEGER (1..1024,...),
    supportedSULBandList        SEQUENCE (SIZE(0..maxnoofNrCellBands)) OF SupportedSULFreqBandItem,
    iE-Extensions                ProtocolExtensionContainer { {FreqBandNrItem-ExtIEs} } OPTIONAL,
    ...
}
FreqBandNrItem-ExtIEs  FLAP-PROTOCOL-EXTENSION ::= {
    ...
}
FullConfiguration ::= ENUMERATED {full, ...}
-- G

GBR-QoSInformation ::= SEQUENCE {
    e-RAB-MaximumBitrateDL      BitRate,
    e-RAB-MaximumBitrateUL      BitRate,
    e-RAB-GuaranteedBitrateDL   BitRate,
    e-RAB-GuaranteedBitrateUL   BitRate,
    iE-Extensions                ProtocolExtensionContainer { { GBR-QoSInformation-ExtIEs} } OPTIONAL,
    ...
}
GBR-QoSInformation-ExtIEs  FLAP-PROTOCOL-EXTENSION ::= {
    ...
}
GBR-QoSFlowInformation ::= SEQUENCE {
    maxFlowBitRateDownlink      BitRate,
    maxFlowBitRateUplink        BitRate,
    guaranteedFlowBitRateDownlink BitRate,
    guaranteedFlowBitRateUplink  BitRate,
    maxPacketLossRateDownlink    MaxPacketLossRate    OPTIONAL,
    maxPacketLossRateUplink      MaxPacketLossRate    OPTIONAL,
    iE-Extensions                ProtocolExtensionContainer { { GBR-QoSFlowInformation-ExtIEs} } OPTIONAL,
    ...
}
GBR-QoSFlowInformation-ExtIEs  FLAP-PROTOCOL-EXTENSION ::= {
    ...
}
CG-Config ::= OCTET STRING

GNB-CUSystemInformation ::= SEQUENCE {
    sibtypetobeupdatedlist      SEQUENCE (SIZE(1.. maxnoofSIBTypes)) OF SibtypetobeupdatedListItem,
    iE-Extensions                ProtocolExtensionContainer { { GNB-CUSystemInformation-ExtIEs} } OPTIONAL,
    ...
}

```

```

GNB-CUSystemInformation-ExtIEs FlAP-PROTOCOL-EXTENSION ::= {
  {ID id-systemInformationAreaID CRITICALITY ignore EXTENSION SystemInformationAreaID PRESENCE optional},
  ...
}

GNB-CU-TNL-Association-Setup-Item ::= SEQUENCE {
  tNLAssociationTransportLayerAddress CP-TransportLayerAddress ,
  iE-Extensions ProtocolExtensionContainer { { GNB-CU-TNL-Association-Setup-Item-ExtIEs} } OPTIONAL
}

GNB-CU-TNL-Association-Setup-Item-ExtIEs FlAP-PROTOCOL-EXTENSION ::= {
  ...
}

GNB-CU-TNL-Association-Failed-To-Setup-Item ::= SEQUENCE {
  tNLAssociationTransportLayerAddress CP-TransportLayerAddress ,
  cause Cause,
  iE-Extensions ProtocolExtensionContainer { { GNB-CU-TNL-Association-Failed-To-Setup-Item-ExtIEs} } OPTIONAL
}

GNB-CU-TNL-Association-Failed-To-Setup-Item-ExtIEs FlAP-PROTOCOL-EXTENSION ::= {
  ...
}

GNB-CU-TNL-Association-To-Add-Item ::= SEQUENCE {
  tNLAssociationTransportLayerAddress CP-TransportLayerAddress ,
  tNLAssociationUsage TNLAssociationUsage,
  iE-Extensions ProtocolExtensionContainer { { GNB-CU-TNL-Association-To-Add-Item-ExtIEs} } OPTIONAL
}

GNB-CU-TNL-Association-To-Add-Item-ExtIEs FlAP-PROTOCOL-EXTENSION ::= {
  ...
}

GNB-CU-TNL-Association-To-Remove-Item ::= SEQUENCE {
  tNLAssociationTransportLayerAddress CP-TransportLayerAddress ,
  iE-Extensions ProtocolExtensionContainer { { GNB-CU-TNL-Association-To-Remove-Item-ExtIEs} } OPTIONAL
}

GNB-CU-TNL-Association-To-Remove-Item-ExtIEs FlAP-PROTOCOL-EXTENSION ::= {
  {ID id-TNLAssociationTransportLayerAddresssgNBDU CRITICALITY reject EXTENSION CP-TransportLayerAddress PRESENCE optional},
  ...
}

GNB-CU-TNL-Association-To-Update-Item ::= SEQUENCE {
  tNLAssociationTransportLayerAddress CP-TransportLayerAddress ,
  tNLAssociationUsage TNLAssociationUsage OPTIONAL,
  iE-Extensions ProtocolExtensionContainer { { GNB-CU-TNL-Association-To-Update-Item-ExtIEs} } OPTIONAL
}

GNB-CU-TNL-Association-To-Update-Item-ExtIEs FlAP-PROTOCOL-EXTENSION ::= {

```

```

}
...
}
GNB-CU-UE-FlAP-ID ::= INTEGER (0..4294967295)
GNB-DU-UE-FlAP-ID ::= INTEGER (0..4294967295)
GNB-DU-ID ::= INTEGER (0..68719476735)
GNB-CU-Name ::= PrintableString(SIZE(1..150,...))
GNB-DU-Name ::= PrintableString(SIZE(1..150,...))

GNB-DU-Served-Cells-Item ::= SEQUENCE {
    served-Cell-Information Served-Cell-Information,
    gNB-DU-System-Information GNB-DU-System-Information OPTIONAL,
    iE-Extensions ProtocolExtensionContainer { { GNB-DU-Served-Cells-ItemExtIEs } } OPTIONAL,
    ...
}

GNB-DU-Served-Cells-ItemExtIEs FlAP-PROTOCOL-EXTENSION ::= {
    ...
}

GNB-DU-System-Information ::= SEQUENCE {
    mIB-message MIB-message,
    sIB1-message SIB1-message,
    iE-Extensions ProtocolExtensionContainer { { GNB-DU-System-Information-ExtIEs } } OPTIONAL,
    ...
}

GNB-DU-System-Information-ExtIEs FlAP-PROTOCOL-EXTENSION ::= {
    ...
}

GNB-DUConfigurationQuery ::= ENUMERATED {true, ...}

GNBDUOverloadInformation ::= ENUMERATED {overloaded, not-overloaded}

GNB-DU-TNL-Association-To-Remove-Item ::= SEQUENCE {
    tNLAssociationTransportLayerAddress CP-TransportLayerAddress ,
    tNLAssociationTransportLayerAddressgNBCU CP-TransportLayerAddress OPTIONAL,
    iE-Extensions ProtocolExtensionContainer { { GNB-DU-TNL-Association-To-Remove-Item-ExtIEs } } OPTIONAL
}

GNB-DU-TNL-Association-To-Remove-Item-ExtIEs FlAP-PROTOCOL-EXTENSION ::= {
    ...
}

GTP-TEID ::= OCTET STRING (SIZE (4))

GTPTunnel ::= SEQUENCE {
    transportLayerAddress TransportLayerAddress,
    gTP-TEID GTP-TEID,

```

```
    iE-Extensions          ProtocolExtensionContainer { { GTPtunnel-ExtIEs } } OPTIONAL,
    ...
}

GTPtunnel-ExtIEs FlAP-PROTOCOL-EXTENSION ::= {
    ...
}

-- H

HandoverPreparationInformation ::= OCTET STRING

-- I

IgnorePRACHConfiguration ::= ENUMERATED { true,...}

IgnoreResourceCoordinationContainer ::= ENUMERATED { yes,...}
InactivityMonitoringRequest ::= ENUMERATED { true,...}
InactivityMonitoringResponse ::= ENUMERATED { not-supported,...}

-- J

-- K

-- L

LCID ::= INTEGER (1..32, ...)

LongDRXCycleLength ::= ENUMERATED
{ms10, ms20, ms32, ms40, ms60, ms64, ms70, ms80, ms128, ms160, ms256, ms320, ms512, ms640, ms1024, ms1280, ms2048, ms2560, ms5120, ms10240, ...}

-- M

MaskedIMEISV ::= BIT STRING (SIZE (64))

MaxDataBurstVolume ::= INTEGER (0..4095, ...)
MaxPacketLossRate ::= INTEGER (0..1000)

MIB-message ::= OCTET STRING

MeasConfig ::= OCTET STRING

MeasGapConfig ::= OCTET STRING

MeasGapSharingConfig ::= OCTET STRING

MeasurementTimingConfiguration ::= OCTET STRING

MessageIdentifier ::= BIT STRING (SIZE (16))

-- N

NeedforGap ::= ENUMERATED {true, ...}
```

```

NGRANAllocationAndRetentionPriority ::= SEQUENCE {
    priorityLevel          PriorityLevel,
    pre-emptionCapability  Pre-emptionCapability,
    pre-emptionVulnerability Pre-emptionVulnerability,
    iE-Extensions          ProtocolExtensionContainer { { NGRANAllocationAndRetentionPriority-ExtIEs } } OPTIONAL
}

NGRANAllocationAndRetentionPriority-ExtIEs FLAP-PROTOCOL-EXTENSION ::= {
    ...
}

NR-CGI-List-For-Restart-Item ::= SEQUENCE {
    nRCGI          NRCGI,
    iE-Extensions  ProtocolExtensionContainer { { NR-CGI-List-For-Restart-ItemExtIEs } } OPTIONAL,
    ...
}

NR-CGI-List-For-Restart-ItemExtIEs FLAP-PROTOCOL-EXTENSION ::= {
    ...
}

NonDynamic5QIDescriptor ::= SEQUENCE {
    fiveQI          INTEGER (0..255, ...),
    qoSPriorityLevel INTEGER (1..127)          OPTIONAL,
    averagingWindow AveragingWindow          OPTIONAL,
    maxDataBurstVolume MaxDataBurstVolume    OPTIONAL,
    iE-Extensions  ProtocolExtensionContainer { { NonDynamic5QIDescriptor-ExtIEs } } OPTIONAL
}

NonDynamic5QIDescriptor-ExtIEs FLAP-PROTOCOL-EXTENSION ::= {
    ...
}

Notification-Cause ::= ENUMERATED {fulfilled, not-fulfilled, ...}

NotificationControl ::= ENUMERATED {active, not-active, ...}

NotificationInformation ::= SEQUENCE {
    message-Identifier MessageIdentifier,
    serialNumber       SerialNumber,
    iE-Extensions     ProtocolExtensionContainer { { NotificationInformationExtIEs } } OPTIONAL,
    ...
}

NotificationInformationExtIEs FLAP-PROTOCOL-EXTENSION ::= {
    ...
}

NRFreqInfo ::= SEQUENCE {
    nRARFCN          INTEGER (0..maxNRARFCN),
    sul-Information  SUL-Information          OPTIONAL,
    freqBandListNr  SEQUENCE (SIZE(1..maxnoofNrCellBands)) OF FreqBandNrItem,
    iE-Extensions  ProtocolExtensionContainer { { NRFreqInfoExtIEs } } OPTIONAL,
}

```

```

}
...
}
NRFreqInfoExtIEs      FLAP-PROTOCOL-EXTENSION ::= {
    ...
}

NR CGI ::= SEQUENCE {
    pLMN-Identity      PLMN-Identity,
    nRCellIdentity     NRCellIdentity,
    iE-Extensions      ProtocolExtensionContainer { {NR CGI-ExtIEs} } OPTIONAL,
    ...
}

NR CGI-ExtIEs FLAP-PROTOCOL-EXTENSION ::= {
    ...
}

NR-Mode-Info ::= CHOICE {
    fDD      FDD-Info,
    tDD      TDD-Info,
    choice-extension      ProtocolIE-SingleContainer { { NR-Mode-Info-ExtIEs} }
}

NR-Mode-Info-ExtIEs FLAP-PROTOCOL-IES ::= {
    ...
}

NRCellIdentity ::= BIT STRING (SIZE(36))

NRNRB ::= ENUMERATED { nrb11, nrb18, nrb24, nrb25, nrb31, nrb32, nrb38, nrb51, nrb52, nrb65, nrb66, nrb78, nrb79, nrb93, nrb106, nrb107, nrb121,
nrb132, nrb133, nrb135, nrb160, nrb162, nrb189, nrb216, nrb217, nrb245, nrb264, nrb270, nrb273, ...}

NRPCI ::= INTEGER(0..1007)

NRSCS ::= ENUMERATED { scs15, scs30, scs60, scs120, ...}

NumberOfBroadcasts ::= INTEGER (0..65535)

NumberOfBroadcastRequest ::= INTEGER (0..65535)

-- O

OffsetToPointA ::= INTEGER (0..2199,...)

-- P

PacketDelayBudget ::= INTEGER (0..1023, ...)

PacketErrorRate ::= SEQUENCE {
    pER-Scalar      PER-Scalar,
    pER-Exponent    PER-Exponent,

```



```
    iE-Extensions      ProtocolExtensionContainer { {PacketErrorRate-ExtIEs} } OPTIONAL,
    ...
}

PacketErrorRate-ExtIEs FLAP-PROTOCOL-EXTENSION ::= {
    ...
}

PER-Scalar ::= INTEGER (0..9, ...)
PER-Exponent ::= INTEGER (0..9, ...)

PagingCell-Item ::= SEQUENCE {
    nRCGI          NRCGI          ,
    iE-Extensions  ProtocolExtensionContainer { { PagingCell-ItemExtIEs } }   OPTIONAL
}

PagingCell-ItemExtIEs FLAP-PROTOCOL-EXTENSION ::= {
    ...
}

PagingDRX ::= ENUMERATED {
    v32,
    v64,
    v128,
    v256,
    ...
}

PagingIdentity ::= CHOICE {
    rANUEPagingIdentity RANUEPagingIdentity,
    cNUEPagingIdentity CNUEPagingIdentity,
    choice-extension    ProtocolIE-SingleContainer { { PagingIdentity-ExtIEs } }
}

PagingIdentity-ExtIEs FLAP-PROTOCOL-IES ::= {
    ...
}

PagingOrigin ::= ENUMERATED { non-3gpp, ...}

PagingPriority ::= ENUMERATED { priolevel1, priolevel2, priolevel3, priolevel4, priolevel5, priolevel6, priolevel7, priolevel8,...}

PDCCH-BlindDetectionSCG ::= OCTET STRING

PDCP-SN ::= INTEGER (0..4095)

PDCPSNLength ::= ENUMERATED { twelve-bits, eighteen-bits, ...}

PDUSessionID ::= INTEGER (0..255)

Ph-InfoMCG ::= OCTET STRING

Ph-InfoSCG ::= OCTET STRING
```

```

PLMN-Identity ::= OCTET STRING (SIZE(3))

PortNumber ::= BIT STRING (SIZE (16))

Pre-emptionCapability ::= ENUMERATED {
    shall-not-trigger-pre-emption,
    may-trigger-pre-emption
}

Pre-emptionVulnerability ::= ENUMERATED {
    not-pre-emptable,
    pre-emptable
}

PriorityLevel ::= INTEGER { spare (0), highest (1), lowest (14), no-priority (15) } (0..15)

ProtectedEUTRAResourceIndication ::= OCTET STRING

Protected-EUTRA-Resources-Item ::= SEQUENCE {
    spectrumSharingGroupID SpectrumSharingGroupID,
    eUTRACells-List EUTRACells-List,
    iE-Extensions ProtocolExtensionContainer { { Protected-EUTRA-Resources-ItemExtIEs } } OPTIONAL
}

Protected-EUTRA-Resources-ItemExtIEs FLAP-PROTOCOL-EXTENSION ::= {
    ...
}

Potential-SpCell-Item ::= SEQUENCE {
    potential-SpCell-ID NRCGI ,
    iE-Extensions ProtocolExtensionContainer { { Potential-SpCell-ItemExtIEs } } OPTIONAL,
    ...
}

Potential-SpCell-ItemExtIEs FLAP-PROTOCOL-EXTENSION ::= {
    ...
}

PWS-Failed-NR-CGI-Item ::= SEQUENCE {
    nRCGI NRCGI,
    numberOfBroadcasts NumberOfBroadcasts,
    iE-Extensions ProtocolExtensionContainer { { PWS-Failed-NR-CGI-ItemExtIEs } } OPTIONAL,
    ...
}

PWS-Failed-NR-CGI-ItemExtIEs FLAP-PROTOCOL-EXTENSION ::= {
    ...
}

PWSSystemInformation ::= SEQUENCE {
    sIBtype SIBType-PWS,
    sIBmessage OCTET STRING,
    iE-Extensions ProtocolExtensionContainer { { PWSSystemInformationExtIEs } } OPTIONAL,
    ...
}

```

```

}

PWSSystemInformationExtIEs FlAP-PROTOCOL-EXTENSION ::= {
  { ID id-NotificationInformation      CRITICALITY ignore  EXTENSION NotificationInformation  PRESENCE optional}|
  { ID id-AdditionalSIBMessageList    CRITICALITY reject  EXTENSION AdditionalSIBMessageList  PRESENCE optional},
  ...
}

-- Q

QCI ::= INTEGER (0..255)

QoS-Characteristics ::= CHOICE {
  non-Dynamic-5QI          NonDynamic5QIDescriptor,
  dynamic-5QI              Dynamic5QIDescriptor,
  choice-extension        ProtocolIE-SingleContainer { { QoS-Characteristics-ExtIEs } }
}

QoS-Characteristics-ExtIEs FlAP-PROTOCOL-IES ::= {
  ...
}

QoSFlowIdentifier ::= INTEGER (0..63)

QoSFlowLevelQoSParameters ::= SEQUENCE {
  qoS-Characteristics          QoS-Characteristics,
  nGRANAllocationRetentionPriority  NGRANAllocationAndRetentionPriority,
  gBR-QoS-Flow-Information    GBR-QoSFlowInformation          OPTIONAL,
  reflective-QoS-Attribute    ENUMERATED {subject-to, ...}          OPTIONAL,
  iE-Extensions              ProtocolExtensionContainer { { QoSFlowLevelQoSParameters-ExtIEs } } OPTIONAL
}

QoSFlowLevelQoSParameters-ExtIEs FlAP-PROTOCOL-EXTENSION ::= {
  { ID id-PDUSessionID          CRITICALITY ignore  EXTENSION PDUSessionID          PRESENCE optional}|
  { ID id-ULPDUSessionAggregateMaximumBitRate  CRITICALITY ignore  EXTENSION BitRate          PRESENCE optional},
  ...
}

QoSFlowMappingIndication ::= ENUMERATED {ul,dl,...}

QoSInformation ::= CHOICE {
  eUTRANQoS                  EUTRANQoS,
  choice-extension          ProtocolIE-SingleContainer { { QoSInformation-ExtIEs } }
}

QoSInformation-ExtIEs FlAP-PROTOCOL-IES ::= {
  { ID id-DRB-Information      CRITICALITY ignore  TYPE DRB-Information      PRESENCE mandatory},
  ...
}

-- R

RANAC ::= INTEGER (0..255)

```

```

RANUEID ::= OCTET STRING (SIZE (8))

RANUEPagingIdentity ::= SEQUENCE {
    iRNTI                BIT STRING (SIZE(40)),
    iE-Extensions        ProtocolExtensionContainer { { RANUEPagingIdentity-ExtIEs } } OPTIONAL}

RANUEPagingIdentity-ExtIEs  FLAP-PROTOCOL-EXTENSION ::= {
    ...
}

RAT-FrequencyPriorityInformation ::= CHOICE {
    eNDC                SubscriberProfileIDforRFP,
    nGRAN                RAT-FrequencySelectionPriority,
    choice-extension    ProtocolIE-SingleContainer { { RAT-FrequencyPriorityInformation-ExtIEs } }
}

RAT-FrequencyPriorityInformation-ExtIEs  FLAP-PROTOCOL-IES ::= {
    ...
}

RAT-FrequencySelectionPriority ::= INTEGER (1.. 256, ...)

Reestablishment-Indication ::= ENUMERATED {
    reestablished,
    ...
}

RequestedBandCombinationIndex ::= OCTET STRING

RequestedFeatureSetEntryIndex ::= OCTET STRING

Requested-PDCCH-BlindDetectionSCG ::= OCTET STRING

RequestedP-MaxFR2 ::= OCTET STRING

RequestType ::= ENUMERATED {offer, execution, ...}

ResourceCoordinationEUTRACellInfo ::= SEQUENCE {
    eUTRA-Mode-Info                EUTRA-Coex-Mode-Info,
    eUTRA-PRACH-Configuration        EUTRA-PRACH-Configuration,
    iE-Extensions    ProtocolExtensionContainer { { ResourceCoordinationEUTRACellInfo-ExtIEs } } OPTIONAL,
    ...
}

ResourceCoordinationEUTRACellInfo-ExtIEs  FLAP-PROTOCOL-EXTENSION ::= {
    {ID id-IgnorePRACHConfiguration    CRITICALITY reject EXTENSION IgnorePRACHConfiguration    PRESENCE optional },
    ...
}

ResourceCoordinationTransferInformation ::= SEQUENCE {
    meNB-Cell-ID                EUTRA-Cell-ID,
    resourceCoordinationEUTRACellInfo    ResourceCoordinationEUTRACellInfo    OPTIONAL,
    iE-Extensions    ProtocolExtensionContainer { { ResourceCoordinationTransferInformation-ExtIEs } }    OPTIONAL,
}

```

```

}
...
ResourceCoordinationTransferInformation-ExtIEs  FLAP-PROTOCOL-EXTENSION ::= {
}
...
ResourceCoordinationTransferContainer ::= OCTET STRING

RepetitionPeriod ::= INTEGER (0..131071, ...)

RLCFailureIndication ::= SEQUENCE {
    associatedLCID          LCID,
    iE-Extensions          ProtocolExtensionContainer { {RLCFailureIndication-ExtIEs} } OPTIONAL
}

RLCFailureIndication-ExtIEs  FLAP-PROTOCOL-EXTENSION ::= {
}
...

RLCMode ::= ENUMERATED {
    rlc-am,
    rlc-um-bidirectional,
    rlc-um-unidirectional-ul,
    rlc-um-unidirectional-dl,
    ...
}

RLC-Status ::= SEQUENCE {
    reestablishment-Indication  Reestablishment-Indication,
    iE-Extensions              ProtocolExtensionContainer { { RLC-Status-ExtIEs } } OPTIONAL,
    ...
}

RLC-Status-ExtIEs  FLAP-PROTOCOL-EXTENSION ::= {
}
...

RRCContainer ::= OCTET STRING

RRCContainer-RRCSetupComplete ::= OCTET STRING

RRCDeliveryStatus ::= SEQUENCE {
    delivery-status          PDCP-SN,
    triggering-message       PDCP-SN,
    iE-Extensions            ProtocolExtensionContainer { { RRCDeliveryStatus-ExtIEs } } OPTIONAL}

RRCDeliveryStatus-ExtIEs  FLAP-PROTOCOL-EXTENSION ::= {
}
...

RRCDeliveryStatusRequest ::= ENUMERATED {true, ...}

```

```

RRCReconfigurationCompleteIndicator ::= ENUMERATED {
    true,
    ...,
    failure
}

RRC-Version ::= SEQUENCE {
    latest-RRC-Version      BIT STRING (SIZE(3)),
    iE-Extensions           ProtocolExtensionContainer { { RRC-Version-ExtIEs } } OPTIONAL}

RRC-Version-ExtIEs  FLAP-PROTOCOL-EXTENSION ::= {
    {ID id-latest-RRC-Version-Enhanced      CRITICALITY ignore EXTENSION OCTET STRING (SIZE(3))  PRESENCE optional },
    ...
}

-- S

SCell-FailedtoSetup-Item ::= SEQUENCE {
    sCell-ID              NRCGI      ,
    cause                 Cause      OPTIONAL ,
    iE-Extensions         ProtocolExtensionContainer { { SCell-FailedtoSetup-ItemExtIEs } } OPTIONAL,
    ...
}

SCell-FailedtoSetup-ItemExtIEs  FLAP-PROTOCOL-EXTENSION ::= {
    ...
}

SCell-FailedtoSetupMod-Item ::= SEQUENCE {
    sCell-ID              NRCGI      ,
    cause                 Cause      OPTIONAL ,
    iE-Extensions         ProtocolExtensionContainer { { SCell-FailedtoSetupMod-ItemExtIEs } } OPTIONAL,
    ...
}

SCell-FailedtoSetupMod-ItemExtIEs  FLAP-PROTOCOL-EXTENSION ::= {
    ...
}

SCell-ToBeRemoved-Item ::= SEQUENCE {
    sCell-ID              NRCGI      ,
    iE-Extensions         ProtocolExtensionContainer { { SCell-ToBeRemoved-ItemExtIEs } } OPTIONAL,
    ...
}

SCell-ToBeRemoved-ItemExtIEs  FLAP-PROTOCOL-EXTENSION ::= {
    ...
}

SCell-ToBeSetup-Item ::= SEQUENCE {
    sCell-ID              NRCGI      ,
    sCellIndex            SCellIndex,
    sCellULConfigured     CellULConfigured  OPTIONAL,
    iE-Extensions         ProtocolExtensionContainer { { SCell-ToBeSetup-ItemExtIEs } } OPTIONAL,
}

```

```

}
...
}
SCell-ToBeSetup-ItemExtIEs  FLAP-PROTOCOL-EXTENSION ::= {
  { ID id-ServingCellMO      CRITICALITY ignore EXTENSION ServingCellMO      PRESENCE optional },
  ...
}

SCell-ToBeSetupMod-Item ::= SEQUENCE {
  sCell-ID          NRCGI      ,
  sCellIndex        SCellIndex,
  sCellULConfigured CellULConfigured  OPTIONAL,
  IE-Extensions     ProtocolExtensionContainer { { SCell-ToBeSetupMod-ItemExtIEs } }  OPTIONAL,
  ...
}

SCell-ToBeSetupMod-ItemExtIEs  FLAP-PROTOCOL-EXTENSION ::= {
  { ID id-ServingCellMO      CRITICALITY ignore EXTENSION ServingCellMO      PRESENCE optional },
  ...
}

SCellIndex ::= INTEGER (1..31, ...)

SerialNumber ::= BIT STRING (SIZE (16))

SIBType-PWS ::= INTEGER (6..8, ...)

SelectedBandCombinationIndex ::= OCTET STRING

SelectedFeatureSetEntryIndex ::= OCTET STRING

CG-ConfigInfo ::= OCTET STRING

ServCellIndex ::= INTEGER (0..31, ...)

ServingCellMO ::= INTEGER (1..64, ...)

Served-Cell-Information ::= SEQUENCE {
  nRCGI          NRCGI,
  nRPCI          NRPCI,
  fiveGS-TAC     FiveGS-TAC      OPTIONAL,
  configured-EPS-TAC  Configured-EPS-TAC  OPTIONAL,
  servedPLMNs    ServedPLMNs-List,
  nR-Mode-Info   NR-Mode-Info,
  measurementTimingConfiguration  OCTET STRING,
  IE-Extensions  ProtocolExtensionContainer { {Served-Cell-Information-ExtIEs} } OPTIONAL,
  ...
}

Served-Cell-Information-ExtIEs  FLAP-PROTOCOL-EXTENSION ::= {
  { ID id-RANAC          CRITICALITY ignore EXTENSION RANAC          PRESENCE optional }|
  { ID id-ExtendedServedPLMNs-List  CRITICALITY ignore EXTENSION ExtendedServedPLMNs-List  PRESENCE optional }|
  { ID id-Cell-Direction  CRITICALITY ignore EXTENSION Cell-Direction  PRESENCE optional }|
  { ID id-BPLMN-ID-Info-List  CRITICALITY ignore EXTENSION BPLMN-ID-Info-List  PRESENCE optional }|
}

```

```

    { ID id-Cell-Type                CRITICALITY ignore EXTENSION CellType          PRESENCE optional},
    ...
}

Served-Cells-To-Add-Item ::= SEQUENCE {
    served-Cell-Information          Served-Cell-Information,
    gNB-DU-System-Information        GNB-DU-System-Information OPTIONAL,
    iE-Extensions                    ProtocolExtensionContainer { { Served-Cells-To-Add-ItemExtIEs } } OPTIONAL,
    ...
}

Served-Cells-To-Add-ItemExtIEs    FlAP-PROTOCOL-EXTENSION ::= {
    ...
}

Served-Cells-To-Delete-Item ::= SEQUENCE {
    oldNR CGI                        NR CGI ,
    iE-Extensions                    ProtocolExtensionContainer { { Served-Cells-To-Delete-ItemExtIEs } } OPTIONAL,
    ...
}

Served-Cells-To-Delete-ItemExtIEs FlAP-PROTOCOL-EXTENSION ::= {
    ...
}

Served-Cells-To-Modify-Item ::= SEQUENCE {
    oldNR CGI                        NR CGI ,
    served-Cell-Information          Served-Cell-Information ,
    gNB-DU-System-Information        GNB-DU-System-Information OPTIONAL ,
    iE-Extensions                    ProtocolExtensionContainer { { Served-Cells-To-Modify-ItemExtIEs } } OPTIONAL,
    ...
}

Served-Cells-To-Modify-ItemExtIEs FlAP-PROTOCOL-EXTENSION ::= {
    ...
}

Served-EUTRA-Cells-Information ::= SEQUENCE {
    eUTRA-Mode-Info                  EUTRA-Mode-Info,
    protectedEUTRAResourceIndication ProtectedEUTRAResourceIndication,
    iE-Extensions                    ProtocolExtensionContainer { {Served-EUTRA-Cell-Information-ExtIEs} } OPTIONAL,
    ...
}

Served-EUTRA-Cell-Information-ExtIEs FlAP-PROTOCOL-EXTENSION ::= {
    ...
}

Service-State ::= ENUMERATED {
    in-service,
    out-of-service,
    ...
}

```



```

Service-Status ::= SEQUENCE {
    service-state          Service-State,
    switchingOffOngoing    ENUMERATED {true, ...} OPTIONAL,
    iE-Extensions          ProtocolExtensionContainer { { Service-Status-ExtIEs } } OPTIONAL,
    ...
}

Service-Status-ExtIEs  FLAP-PROTOCOL-EXTENSION ::= {
    ...
}

ShortDRXCycleLength ::= ENUMERATED {ms2, ms3, ms4, ms5, ms6, ms7, ms8, ms10, ms14, ms16, ms20, ms30, ms32, ms35, ms40, ms64, ms80, ms128, ms160,
ms256, ms320, ms512, ms640, ...}

ShortDRXCycleTimer ::= INTEGER (1..16)

SIB1-message ::= OCTET STRING

SItypes ::= INTEGER (1..32, ...)

SItypes-List ::= SEQUENCE (SIZE(1.. maxnoofSITypes)) OF SItypes-Item

SItypes-Item ::= SEQUENCE {
    sItypes          SItypes ,
    iE-Extensions    ProtocolExtensionContainer { { SItypes-ItemExtIEs } } OPTIONAL
}

SItypes-ItemExtIEs  FLAP-PROTOCOL-EXTENSION ::= {
    ...
}

SibtypesupdateListItems ::= SEQUENCE {
    sIBtypes          INTEGER (2..32,...),
    sIBmessage         OCTET STRING,
    valueTag           INTEGER (0..31,...),
    iE-Extensions      ProtocolExtensionContainer { { SibtypesupdateListItems-ExtIEs } } OPTIONAL,
    ...
}

SibtypesupdateListItems-ExtIEs  FLAP-PROTOCOL-EXTENSION ::= {
    {ID id-areaScope  CRITICALITY ignore EXTENSION AreaScope  PRESENCE optional},
    ...
}

SliceSupportList ::= SEQUENCE (SIZE(1.. maxnoofSliceItems)) OF SliceSupportItem

SliceSupportItem ::= SEQUENCE {
    sNSSAI  SNSSAI,
    iE-Extensions      ProtocolExtensionContainer { { SliceSupportItem-ExtIEs } } OPTIONAL
}

SliceSupportItem-ExtIEs  FLAP-PROTOCOL-EXTENSION ::= {
    ...
}

```

```
SNSSAI ::= SEQUENCE {
    sST          OCTET STRING (SIZE(1)),
    sD          OCTET STRING (SIZE(3)) OPTIONAL ,
    iE-Extensions ProtocolExtensionContainer { { SNSSAI-ExtIEs } } OPTIONAL
}

SNSSAI-ExtIEs  FLAP-PROTOCOL-EXTENSION ::= {
    ...
}

SpectrumSharingGroupID ::= INTEGER (1..maxCelllineNB)

SRBID ::= INTEGER (0..3, ...)

SRBs-FailedToBeSetup-Item ::= SEQUENCE {
    sRBID      SRBID ,
    cause      Cause OPTIONAL,
    iE-Extensions ProtocolExtensionContainer { { SRBs-FailedToBeSetup-ItemExtIEs } } OPTIONAL,
    ...
}

SRBs-FailedToBeSetup-ItemExtIEs  FLAP-PROTOCOL-EXTENSION ::= {
    ...
}

SRBs-FailedToBeSetupMod-Item ::= SEQUENCE {
    sRBID      SRBID ,
    cause      Cause OPTIONAL,
    iE-Extensions ProtocolExtensionContainer { { SRBs-FailedToBeSetupMod-ItemExtIEs } } OPTIONAL,
    ...
}

SRBs-FailedToBeSetupMod-ItemExtIEs  FLAP-PROTOCOL-EXTENSION ::= {
    ...
}

SRBs-Modified-Item ::= SEQUENCE {
    sRBID      SRBID,
    lCID      LCID,
    iE-Extensions ProtocolExtensionContainer { { SRBs-Modified-ItemExtIEs } } OPTIONAL,
    ...
}

SRBs-Modified-ItemExtIEs  FLAP-PROTOCOL-EXTENSION ::= {
    ...
}

SRBs-Required-ToBeReleased-Item ::= SEQUENCE {
    sRBID      SRBID,
    iE-Extensions ProtocolExtensionContainer { { SRBs-Required-ToBeReleased-ItemExtIEs } } OPTIONAL,
    ...
}
```

```

SRBs-Required-ToBeReleased-ItemExtIEs  FLAP-PROTOCOL-EXTENSION ::= {
  ...
}

SRBs-Setup-Item ::= SEQUENCE {
  sRBID                SRBID,
  lCID                LCID,
  iE-Extensions  ProtocolExtensionContainer { { SRBs-Setup-ItemExtIEs } }  OPTIONAL,
  ...
}

SRBs-Setup-ItemExtIEs  FLAP-PROTOCOL-EXTENSION ::= {
  ...
}

SRBs-SetupMod-Item ::= SEQUENCE {
  sRBID                SRBID,
  lCID                LCID,
  iE-Extensions  ProtocolExtensionContainer { { SRBs-SetupMod-ItemExtIEs } }  OPTIONAL,
  ...
}

SRBs-SetupMod-ItemExtIEs  FLAP-PROTOCOL-EXTENSION ::= {
  ...
}

SRBs-ToBeReleased-Item ::= SEQUENCE {
  sRBID                SRBID,
  iE-Extensions  ProtocolExtensionContainer { { SRBs-ToBeReleased-ItemExtIEs } }  OPTIONAL,
  ...
}

SRBs-ToBeReleased-ItemExtIEs  FLAP-PROTOCOL-EXTENSION ::= {
  ...
}

SRBs-ToBeSetup-Item ::= SEQUENCE {
  sRBID  SRBID ,
  duplicationIndication  DuplicationIndication  OPTIONAL,
  iE-Extensions  ProtocolExtensionContainer { { SRBs-ToBeSetup-ItemExtIEs } }  OPTIONAL,
  ...
}

SRBs-ToBeSetup-ItemExtIEs  FLAP-PROTOCOL-EXTENSION ::= {
  ...
}

SRBs-ToBeSetupMod-Item ::= SEQUENCE {
  sRBID  SRBID,
  duplicationIndication  DuplicationIndication  OPTIONAL,
  iE-Extensions  ProtocolExtensionContainer { { SRBs-ToBeSetupMod-ItemExtIEs } }  OPTIONAL,
  ...
}

```

```

SRBs-ToBeSetupMod-ItemExtIEs    FLAP-PROTOCOL-EXTENSION ::= {
    ...
}

SUL-Information ::= SEQUENCE {
    SUL-NRARFCN                INTEGER (0..maxNRARFCN),
    SUL-transmission-Bandwidth  Transmission-Bandwidth,
    iE-Extensions              ProtocolExtensionContainer { { SUL-InformationExtIEs } } OPTIONAL,
    ...
}

SUL-InformationExtIEs    FLAP-PROTOCOL-EXTENSION ::= {
    ...
}

SubscriberProfileIDforRFP ::= INTEGER (1..256, ...)

SULAccessIndication ::= ENUMERATED {true,...}

SupportedSULFreqBandItem ::= SEQUENCE {
    freqBandIndicatorNr        INTEGER (1..1024,...),
    iE-Extensions              ProtocolExtensionContainer { { SupportedSULFreqBandItem-ExtIEs } } OPTIONAL,
    ...
}

SupportedSULFreqBandItem-ExtIEs FLAP-PROTOCOL-EXTENSION ::= {
    ...
}

SystemInformationAreaID ::= BIT STRING (SIZE (24))

-- T

FiveGS-TAC ::= OCTET STRING (SIZE(3))

Configured-EPS-TAC ::= OCTET STRING (SIZE(2))

TDD-Info ::= SEQUENCE {
    nRFreqInfo                NRFreqInfo,
    transmission-Bandwidth    Transmission-Bandwidth,
    iE-Extensions              ProtocolExtensionContainer { { TDD-Info-ExtIEs } } OPTIONAL,
    ...
}

TDD-Info-ExtIEs FLAP-PROTOCOL-EXTENSION ::= {
    ...
}

TimeToWait ::= ENUMERATED {v1s, v2s, v5s, v10s, v20s, v60s, ...}

TNLAassociationUsage ::= ENUMERATED {
    ue,
    non-ue,
}

```

```

    both,
    ...
}

TransportLayerAddress ::= BIT STRING (SIZE(1..160, ...))

TransactionID ::= INTEGER (0..255, ...)

Transmission-Bandwidth ::= SEQUENCE {
    nRSCS NRSCS,
    nRNRB NRNRB,
    iE-Extensions ProtocolExtensionContainer { { Transmission-Bandwidth-ExtIEs } } OPTIONAL,
    ...
}

Transmission-Bandwidth-ExtIEs FLAP-PROTOCOL-EXTENSION ::= {
    ...
}

TransmissionActionIndicator ::= ENUMERATED {stop, ..., restart }

TypeOfError ::= ENUMERATED {
    not-understood,
    missing,
    ...
}

-- U
UAC-Assistance-Info ::= SEQUENCE {
    uACPLMN-List UACPLMN-List,
    iE-Extensions ProtocolExtensionContainer { { UAC-Assistance-InfoExtIEs } } OPTIONAL
}

UAC-Assistance-InfoExtIEs FLAP-PROTOCOL-EXTENSION ::= {
    ...
}

UACPLMN-List ::= SEQUENCE (SIZE(1..maxnoofUACPLMNs)) OF UACPLMN-Item

UACPLMN-Item ::= SEQUENCE {
    pLMNIdentity PLMN-Identity,
    uACType-List UACType-List, iE-Extensions ProtocolExtensionContainer { { UACPLMN-Item-ExtIEs } } OPTIONAL
}

UACPLMN-Item-ExtIEs FLAP-PROTOCOL-EXTENSION ::= {
    ...
}

UACType-List ::= SEQUENCE (SIZE(1..maxnoofUACperPLMN)) OF UACType-Item

UACType-Item ::= SEQUENCE {
    uACReductionIndication UACReductionIndication,
    uACCATEGORYType UACCATEGORYType,
    iE-Extensions ProtocolExtensionContainer { { UACType-Item-ExtIEs } } OPTIONAL
}

```

```

}
UACType-Item-ExtIEs FlAP-PROTOCOL-EXTENSION ::= {
  ...
}
UACCategoryType ::= CHOICE {
  uACstandardized          UACAction,
  uACOperatorDefined       UACOperatorDefined,
  choice-extension         ProtocolIE-SingleContainer { { UACCategoryType-ExtIEs } }
}
UACCategoryType-ExtIEs FlAP-PROTOCOL-IES ::= {
  ...
}
UACOperatorDefined ::= SEQUENCE {
  accessCategory          INTEGER (32..63,...),
  accessIdentity          BIT STRING (SIZE(7)),
  iE-Extensions           ProtocolExtensionContainer { { UACOperatorDefined-ExtIEs } } OPTIONAL
}
UACOperatorDefined-ExtIEs FlAP-PROTOCOL-EXTENSION ::= {
  ...
}
UACAction ::= ENUMERATED {
  reject-non-emergency-mo-dt,
  reject-rrc-cr-signalling,
  permit-emergency-sessions-and-mobile-terminated-services-only,
  permit-high-priority-sessions-and-mobile-terminated-services-only,
  ...
}
UACReductionIndication ::= INTEGER (0..100)
UE-associatedLogicalFl1-ConnectionItem ::= SEQUENCE {
  gNB-CU-UE-FlAP-ID       GNB-CU-UE-FlAP-ID    OPTIONAL,
  gNB-DU-UE-FlAP-ID       GNB-DU-UE-FlAP-ID    OPTIONAL,
  iE-Extensions           ProtocolExtensionContainer { { UE-associatedLogicalFl1-ConnectionItemExtIEs } } OPTIONAL,
  ...
}
UEAssistanceInformation ::= OCTET STRING
UE-associatedLogicalFl1-ConnectionItemExtIEs FlAP-PROTOCOL-EXTENSION ::= {
  ...
}
UE-CapabilityRAT-ContainerList ::= OCTET STRING
UEContextNotRetrievable ::= ENUMERATED {true, ...}

```

```

UEIdentityIndexValue ::= CHOICE {
    indexLength10      BIT STRING (SIZE (10)),
    choice-extension   ProtocolIE-SingleContainer { {UEIdentityIndexValueChoice-ExtIEs} }
}

UEIdentityIndexValueChoice-ExtIEs FLAP-PROTOCOL-IES ::= {
    ...
}

ULConfiguration ::= SEQUENCE {
    uLUEConfiguration    ULUEConfiguration,
    iE-Extensions        ProtocolExtensionContainer { { ULConfigurationExtIEs } }    OPTIONAL,
    ...
}

ULConfigurationExtIEs    FLAP-PROTOCOL-EXTENSION ::= {
    ...
}

ULUEConfiguration ::= ENUMERATED {no-data, shared, only, ...}

ULUPTNLInformation-ToBeSetup-List ::= SEQUENCE (SIZE(1..maxnoofULUPTNLInformation)) OF ULUPTNLInformation-ToBeSetup-Item

ULUPTNLInformation-ToBeSetup-Item ::=SEQUENCE {
    uLUPTNLInformation    UPTransportLayerInformation,
    iE-Extensions        ProtocolExtensionContainer { { ULUPTNLInformation-ToBeSetup-ItemExtIEs } }    OPTIONAL,
    ...
}

ULUPTNLInformation-ToBeSetup-ItemExtIEs    FLAP-PROTOCOL-EXTENSION ::= {
    ...
}

UplinkTxDirectCurrentListInformation ::= OCTET STRING

UPTransportLayerInformation    ::= CHOICE {
    gTPTunnel        GTP Tunnel,
    choice-extension   ProtocolIE-SingleContainer { { UPTransportLayerInformation-ExtIEs} }
}

UPTransportLayerInformation-ExtIEs FLAP-PROTOCOL-IES ::= {
    ...
}
-- V
-- W
-- X
-- Y
-- Z

```

```
END
-- ASN1STOP
```

9.4.6 Common Definitions

```
-- ASN1START
-- *****
--
-- Common definitions
--
-- *****

FlAP-CommonDataTypes {
itu-t (0) identified-organization (4) etsi (0) mobileDomain (0)
ngran-access (22) modules (3) flap (3) version1 (1) flap-CommonDataTypes (3) }

DEFINITIONS AUTOMATIC TAGS ::=

BEGIN

Criticality      ::= ENUMERATED { reject, ignore, notify }

Presence        ::= ENUMERATED { optional, conditional, mandatory }

PrivateIE-ID    ::= CHOICE {
    local          INTEGER (0..65535),
    global         OBJECT IDENTIFIER
}

ProcedureCode   ::= INTEGER (0..255)

ProtocolExtensionID ::= INTEGER (0..65535)

ProtocolIE-ID   ::= INTEGER (0..65535)

TriggeringMessage ::= ENUMERATED { initiating-message, successful-outcome, unsuccessful-outcome }

END
-- ASN1STOP
```

9.4.7 Constant Definitions

```
-- ASN1START
-- *****
--
-- Constant definitions
--
-- *****

FlAP-Constants {
itu-t (0) identified-organization (4) etsi (0) mobileDomain (0)
```



```
ngran-access (22) modules (3) flap (3) version1 (1) flap-Constants (4) }
```

```
DEFINITIONS AUTOMATIC TAGS ::=
```

```
BEGIN
```

```
-- *****  
--  
-- IE parameter types from other modules.  
--  
-- *****
```

```
IMPORTS
```

```
    ProcedureCode,  
    ProtocolIE-ID
```

```
FROM FLAP-CommonDataTypes;
```

```
-- *****  
--  
-- Elementary Procedures  
--  
-- *****
```

```
id-Reset ProcedureCode ::= 0  
id-FlSetup ProcedureCode ::= 1  
id-ErrorIndication ProcedureCode ::= 2  
id-gNBDCUConfigurationUpdate ProcedureCode ::= 3  
id-gNBCUCUConfigurationUpdate ProcedureCode ::= 4  
id-UEContextSetup ProcedureCode ::= 5  
id-UEContextRelease ProcedureCode ::= 6  
id-UEContextModification ProcedureCode ::= 7  
id-UEContextModificationRequired ProcedureCode ::= 8  
id-UEMobilityCommand ProcedureCode ::= 9  
id-UEContextReleaseRequest ProcedureCode ::= 10  
id-InitialULRRCCMessageTransfer ProcedureCode ::= 11  
id-DLRRCCMessageTransfer ProcedureCode ::= 12  
id-ULRRCCMessageTransfer ProcedureCode ::= 13  
id-privateMessage ProcedureCode ::= 14  
id-UEInactivityNotification ProcedureCode ::= 15  
id-GNBDUResourceCoordination ProcedureCode ::= 16  
id-SystemInformationDeliveryCommand ProcedureCode ::= 17  
id-Paging ProcedureCode ::= 18  
id-Notify ProcedureCode ::= 19  
id-WriteReplaceWarning ProcedureCode ::= 20  
id-PWSCancel ProcedureCode ::= 21  
id-PWSRestartIndication ProcedureCode ::= 22  
id-PWSFailureIndication ProcedureCode ::= 23  
id-GNBDUStatusIndication ProcedureCode ::= 24  
id-RRCDeliveryReport ProcedureCode ::= 25  
id-FlRemoval ProcedureCode ::= 26  
id-NetworkAccessRateReduction ProcedureCode ::= 27
```

```

-- *****
--
-- Extension constants
--
-- *****

maxPrivateIEs                INTEGER ::= 65535
maxProtocolExtensions        INTEGER ::= 65535
maxProtocolIEs               INTEGER ::= 65535
-- *****
--
-- Lists
--
-- *****

maxNRARFCN                   INTEGER ::= 3279165
maxnoofErrors                INTEGER ::= 256
maxnoofIndividualFlConnectionsToReset INTEGER ::= 65536
maxCeilingNBDU               INTEGER ::= 512
maxnoofSCells                INTEGER ::= 32
maxnoofSRBs                  INTEGER ::= 8
maxnoofDRBs                  INTEGER ::= 64
maxnoofULUPTNLInformation    INTEGER ::= 2
maxnoofDLUPTNLInformation    INTEGER ::= 2
maxnoofBPLMNs                INTEGER ::= 6
maxnoofCandidateSpCells      INTEGER ::= 64
maxnoofPotentialSpCells      INTEGER ::= 64
maxnoofNrCellBands           INTEGER ::= 32
maxnoofSIBTypes              INTEGER ::= 32
maxnoofSITypes               INTEGER ::= 32
maxnoofPagingCells           INTEGER ::= 512
maxnoofTNLAssociations       INTEGER ::= 32
maxnoofQoSFlows              INTEGER ::= 64
maxnoofSliceItems            INTEGER ::= 1024
maxCelllineNB                INTEGER ::= 256
maxnoofExtendedBPLMNs        INTEGER ::= 6
maxnoofUEIDs                 INTEGER ::= 65536
maxnoofBPLMNsNRminus1       INTEGER ::= 11
maxnoofUACPLMNs              INTEGER ::= 12
maxnoofUACperPLMN            INTEGER ::= 64
maxnoofAdditionalSIBs        INTEGER ::= 63

-- *****
--
-- IEs
--
-- *****

id-Cause                      ProtocolIE-ID ::= 0
id-Cells-Failed-to-be-Activated-List ProtocolIE-ID ::= 1
id-Cells-Failed-to-be-Activated-List-Item ProtocolIE-ID ::= 2
id-Cells-to-be-Activated-List ProtocolIE-ID ::= 3
id-Cells-to-be-Activated-List-Item ProtocolIE-ID ::= 4

```

| | |
|--|----------------------|
| id-Cells-to-be-Deactivated-List | ProtocolIE-ID ::= 5 |
| id-Cells-to-be-Deactivated-List-Item | ProtocolIE-ID ::= 6 |
| id-CriticalityDiagnostics | ProtocolIE-ID ::= 7 |
| id-CUtoDURRCInformation | ProtocolIE-ID ::= 9 |
| id-DRBs-FailedToBeModified-Item | ProtocolIE-ID ::= 12 |
| id-DRBs-FailedToBeModified-List | ProtocolIE-ID ::= 13 |
| id-DRBs-FailedToBeSetup-Item | ProtocolIE-ID ::= 14 |
| id-DRBs-FailedToBeSetup-List | ProtocolIE-ID ::= 15 |
| id-DRBs-FailedToBeSetupMod-Item | ProtocolIE-ID ::= 16 |
| id-DRBs-FailedToBeSetupMod-List | ProtocolIE-ID ::= 17 |
| id-DRBs-ModifiedConf-Item | ProtocolIE-ID ::= 18 |
| id-DRBs-ModifiedConf-List | ProtocolIE-ID ::= 19 |
| id-DRBs-Modified-Item | ProtocolIE-ID ::= 20 |
| id-DRBs-Modified-List | ProtocolIE-ID ::= 21 |
| id-DRBs-Required-ToBeModified-Item | ProtocolIE-ID ::= 22 |
| id-DRBs-Required-ToBeModified-List | ProtocolIE-ID ::= 23 |
| id-DRBs-Required-ToBeReleased-Item | ProtocolIE-ID ::= 24 |
| id-DRBs-Required-ToBeReleased-List | ProtocolIE-ID ::= 25 |
| id-DRBs-Setup-Item | ProtocolIE-ID ::= 26 |
| id-DRBs-Setup-List | ProtocolIE-ID ::= 27 |
| id-DRBs-SetupMod-Item | ProtocolIE-ID ::= 28 |
| id-DRBs-SetupMod-List | ProtocolIE-ID ::= 29 |
| id-DRBs-ToBeModified-Item | ProtocolIE-ID ::= 30 |
| id-DRBs-ToBeModified-List | ProtocolIE-ID ::= 31 |
| id-DRBs-ToBeReleased-Item | ProtocolIE-ID ::= 32 |
| id-DRBs-ToBeReleased-List | ProtocolIE-ID ::= 33 |
| id-DRBs-ToBeSetup-Item | ProtocolIE-ID ::= 34 |
| id-DRBs-ToBeSetup-List | ProtocolIE-ID ::= 35 |
| id-DRBs-ToBeSetupMod-Item | ProtocolIE-ID ::= 36 |
| id-DRBs-ToBeSetupMod-List | ProtocolIE-ID ::= 37 |
| id-DRXCycle | ProtocolIE-ID ::= 38 |
| id-DUtoCURRCInformation | ProtocolIE-ID ::= 39 |
| id-gNB-CU-UE-FLAP-ID | ProtocolIE-ID ::= 40 |
| id-gNB-DU-UE-FLAP-ID | ProtocolIE-ID ::= 41 |
| id-gNB-DU-ID | ProtocolIE-ID ::= 42 |
| id-gNB-DU-Served-Cells-Item | ProtocolIE-ID ::= 43 |
| id-gNB-DU-Served-Cells-List | ProtocolIE-ID ::= 44 |
| id-gNB-DU-Name | ProtocolIE-ID ::= 45 |
| id-NRCellID | ProtocolIE-ID ::= 46 |
| id-oldgNB-DU-UE-FLAP-ID | ProtocolIE-ID ::= 47 |
| id-ResetType | ProtocolIE-ID ::= 48 |
| id-ResourceCoordinationTransferContainer | ProtocolIE-ID ::= 49 |
| id-RRCContainer | ProtocolIE-ID ::= 50 |
| id-SCell-ToBeRemoved-Item | ProtocolIE-ID ::= 51 |
| id-SCell-ToBeRemoved-List | ProtocolIE-ID ::= 52 |
| id-SCell-ToBeSetup-Item | ProtocolIE-ID ::= 53 |
| id-SCell-ToBeSetup-List | ProtocolIE-ID ::= 54 |
| id-SCell-ToBeSetupMod-Item | ProtocolIE-ID ::= 55 |
| id-SCell-ToBeSetupMod-List | ProtocolIE-ID ::= 56 |
| id-Served-Cells-To-Add-Item | ProtocolIE-ID ::= 57 |
| id-Served-Cells-To-Add-List | ProtocolIE-ID ::= 58 |
| id-Served-Cells-To-Delete-Item | ProtocolIE-ID ::= 59 |
| id-Served-Cells-To-Delete-List | ProtocolIE-ID ::= 60 |
| id-Served-Cells-To-Modify-Item | ProtocolIE-ID ::= 61 |

| | |
|--|-----------------------|
| id-Served-Cells-To-Modify-List | ProtocolIE-ID ::= 62 |
| id-SpCell-ID | ProtocolIE-ID ::= 63 |
| id-SRBID | ProtocolIE-ID ::= 64 |
| id-SRBs-FailedToBeSetup-Item | ProtocolIE-ID ::= 65 |
| id-SRBs-FailedToBeSetup-List | ProtocolIE-ID ::= 66 |
| id-SRBs-FailedToBeSetupMod-Item | ProtocolIE-ID ::= 67 |
| id-SRBs-FailedToBeSetupMod-List | ProtocolIE-ID ::= 68 |
| id-SRBs-Required-ToBeReleased-Item | ProtocolIE-ID ::= 69 |
| id-SRBs-Required-ToBeReleased-List | ProtocolIE-ID ::= 70 |
| id-SRBs-ToBeReleased-Item | ProtocolIE-ID ::= 71 |
| id-SRBs-ToBeReleased-List | ProtocolIE-ID ::= 72 |
| id-SRBs-ToBeSetup-Item | ProtocolIE-ID ::= 73 |
| id-SRBs-ToBeSetup-List | ProtocolIE-ID ::= 74 |
| id-SRBs-ToBeSetupMod-Item | ProtocolIE-ID ::= 75 |
| id-SRBs-ToBeSetupMod-List | ProtocolIE-ID ::= 76 |
| id-TimeToWait | ProtocolIE-ID ::= 77 |
| id-TransactionID | ProtocolIE-ID ::= 78 |
| id-TransmissionActionIndicator | ProtocolIE-ID ::= 79 |
| id-UE-associatedLogicalFl-ConnectionItem | ProtocolIE-ID ::= 80 |
| id-UE-associatedLogicalFl-ConnectionListResAck | ProtocolIE-ID ::= 81 |
| id-gNB-CU-Name | ProtocolIE-ID ::= 82 |
| id-SCell-FailedtoSetup-List | ProtocolIE-ID ::= 83 |
| id-SCell-FailedtoSetup-Item | ProtocolIE-ID ::= 84 |
| id-SCell-FailedtoSetupMod-List | ProtocolIE-ID ::= 85 |
| id-SCell-FailedtoSetupMod-Item | ProtocolIE-ID ::= 86 |
| id-RRCReconfigurationCompleteIndicator | ProtocolIE-ID ::= 87 |
| id-Cells-Status-Item | ProtocolIE-ID ::= 88 |
| id-Cells-Status-List | ProtocolIE-ID ::= 89 |
| id-Candidate-SpCell-List | ProtocolIE-ID ::= 90 |
| id-Candidate-SpCell-Item | ProtocolIE-ID ::= 91 |
| id-Potential-SpCell-List | ProtocolIE-ID ::= 92 |
| id-Potential-SpCell-Item | ProtocolIE-ID ::= 93 |
| id-FullConfiguration | ProtocolIE-ID ::= 94 |
| id-C-RNTI | ProtocolIE-ID ::= 95 |
| id-SpCellULConfigured | ProtocolIE-ID ::= 96 |
| id-InactivityMonitoringRequest | ProtocolIE-ID ::= 97 |
| id-InactivityMonitoringResponse | ProtocolIE-ID ::= 98 |
| id-DRB-Activity-Item | ProtocolIE-ID ::= 99 |
| id-DRB-Activity-List | ProtocolIE-ID ::= 100 |
| id-EUTRA-NR-CellResourceCoordinationReq-Container | ProtocolIE-ID ::= 101 |
| id-EUTRA-NR-CellResourceCoordinationReqAck-Container | ProtocolIE-ID ::= 102 |
| id-Protected-EUTRA-Resources-List | ProtocolIE-ID ::= 105 |
| id-RequestType | ProtocolIE-ID ::= 106 |
| id-ServCellIndex | ProtocolIE-ID ::= 107 |
| id-RAT-FrequencyPriorityInformation | ProtocolIE-ID ::= 108 |
| id-ExecuteDuplication | ProtocolIE-ID ::= 109 |
| id-NRCGI | ProtocolIE-ID ::= 111 |
| id-PagingCell-Item | ProtocolIE-ID ::= 112 |
| id-PagingCell-List | ProtocolIE-ID ::= 113 |
| id-PagingDRX | ProtocolIE-ID ::= 114 |
| id-PagingPriority | ProtocolIE-ID ::= 115 |
| id-SItype-List | ProtocolIE-ID ::= 116 |
| id-UEIdentityIndexValue | ProtocolIE-ID ::= 117 |
| id-gNB-CUSystemInformation | ProtocolIE-ID ::= 118 |

| | |
|--|-----------------------|
| id-HandoverPreparationInformation | ProtocolIE-ID ::= 119 |
| id-GNB-CU-TNL-Association-To-Add-Item | ProtocolIE-ID ::= 120 |
| id-GNB-CU-TNL-Association-To-Add-List | ProtocolIE-ID ::= 121 |
| id-GNB-CU-TNL-Association-To-Remove-Item | ProtocolIE-ID ::= 122 |
| id-GNB-CU-TNL-Association-To-Remove-List | ProtocolIE-ID ::= 123 |
| id-GNB-CU-TNL-Association-To-Update-Item | ProtocolIE-ID ::= 124 |
| id-GNB-CU-TNL-Association-To-Update-List | ProtocolIE-ID ::= 125 |
| id-MaskedIMEISV | ProtocolIE-ID ::= 126 |
| id-PagingIdentity | ProtocolIE-ID ::= 127 |
| id-DUtoCURRCContainer | ProtocolIE-ID ::= 128 |
| id-Cells-to-be-Barred-List | ProtocolIE-ID ::= 129 |
| id-Cells-to-be-Barred-Item | ProtocolIE-ID ::= 130 |
| id-TAISliceSupportList | ProtocolIE-ID ::= 131 |
| id-GNB-CU-TNL-Association-Setup-List | ProtocolIE-ID ::= 132 |
| id-GNB-CU-TNL-Association-Setup-Item | ProtocolIE-ID ::= 133 |
| id-GNB-CU-TNL-Association-Failed-To-Setup-List | ProtocolIE-ID ::= 134 |
| id-GNB-CU-TNL-Association-Failed-To-Setup-Item | ProtocolIE-ID ::= 135 |
| id-DRB-Notify-Item | ProtocolIE-ID ::= 136 |
| id-DRB-Notify-List | ProtocolIE-ID ::= 137 |
| id-NotificationControl | ProtocolIE-ID ::= 138 |
| id-RANAC | ProtocolIE-ID ::= 139 |
| id-PWSSystemInformation | ProtocolIE-ID ::= 140 |
| id-RepetitionPeriod | ProtocolIE-ID ::= 141 |
| id-NumberOfBroadcastRequest | ProtocolIE-ID ::= 142 |
| id-Cells-To-Be-Broadcast-List | ProtocolIE-ID ::= 144 |
| id-Cells-To-Be-Broadcast-Item | ProtocolIE-ID ::= 145 |
| id-Cells-Broadcast-Completed-List | ProtocolIE-ID ::= 146 |
| id-Cells-Broadcast-Completed-Item | ProtocolIE-ID ::= 147 |
| id-Broadcast-To-Be-Cancelled-List | ProtocolIE-ID ::= 148 |
| id-Broadcast-To-Be-Cancelled-Item | ProtocolIE-ID ::= 149 |
| id-Cells-Broadcast-Cancelled-List | ProtocolIE-ID ::= 150 |
| id-Cells-Broadcast-Cancelled-Item | ProtocolIE-ID ::= 151 |
| id-NR-CGI-List-For-Restart-List | ProtocolIE-ID ::= 152 |
| id-NR-CGI-List-For-Restart-Item | ProtocolIE-ID ::= 153 |
| id-PWS-Failed-NR-CGI-List | ProtocolIE-ID ::= 154 |
| id-PWS-Failed-NR-CGI-Item | ProtocolIE-ID ::= 155 |
| id-ConfirmedUEID | ProtocolIE-ID ::= 156 |
| id-Cancel-all-Warning-Messages-Indicator | ProtocolIE-ID ::= 157 |
| id-GNB-DU-UE-AMBR-UL | ProtocolIE-ID ::= 158 |
| id-DRXConfigurationIndicator | ProtocolIE-ID ::= 159 |
| id-RLC-Status | ProtocolIE-ID ::= 160 |
| id-DLPDCPSNLength | ProtocolIE-ID ::= 161 |
| id-GNB-DUConfigurationQuery | ProtocolIE-ID ::= 162 |
| id-MeasurementTimingConfiguration | ProtocolIE-ID ::= 163 |
| id-DRB-Information | ProtocolIE-ID ::= 164 |
| id-ServingPLMN | ProtocolIE-ID ::= 165 |
| id-Protected-EUTRA-Resources-Item | ProtocolIE-ID ::= 168 |
| id-GNB-CU-RRC-Version | ProtocolIE-ID ::= 170 |
| id-GNB-DU-RRC-Version | ProtocolIE-ID ::= 171 |
| id-GNBDUOverloadInformation | ProtocolIE-ID ::= 172 |
| id-CellGroupConfig | ProtocolIE-ID ::= 173 |
| id-RLCFailureIndication | ProtocolIE-ID ::= 174 |
| id-UplinkTxDirectCurrentListInformation | ProtocolIE-ID ::= 175 |
| id-DC-Based-Duplication-Configured | ProtocolIE-ID ::= 176 |

| | |
|---|-----------------------|
| id-DC-Based-Duplication-Activation | ProtocolIE-ID ::= 177 |
| id-SULAccessIndication | ProtocolIE-ID ::= 178 |
| id-AvailablePLMNList | ProtocolIE-ID ::= 179 |
| id-PDUSESSIONID | ProtocolIE-ID ::= 180 |
| id-ULPDUSESSIONAggregateMaximumBitRate | ProtocolIE-ID ::= 181 |
| id-ServingCellMO | ProtocolIE-ID ::= 182 |
| id-QoSFlowMappingIndication | ProtocolIE-ID ::= 183 |
| id-RRCDeliveryStatusRequest | ProtocolIE-ID ::= 184 |
| id-RRCDeliveryStatus | ProtocolIE-ID ::= 185 |
| id-BearerTypeChange | ProtocolIE-ID ::= 186 |
| id-RLCMode | ProtocolIE-ID ::= 187 |
| id-Duplication-Activation | ProtocolIE-ID ::= 188 |
| id-Dedicated-SIDelivery-NeededUE-List | ProtocolIE-ID ::= 189 |
| id-Dedicated-SIDelivery-NeededUE-Item | ProtocolIE-ID ::= 190 |
| id-DRX-LongCycleStartOffset | ProtocolIE-ID ::= 191 |
| id-ULPDCPSNLength | ProtocolIE-ID ::= 192 |
| id-SelectedBandCombinationIndex | ProtocolIE-ID ::= 193 |
| id-SelectedFeatureSetEntryIndex | ProtocolIE-ID ::= 194 |
| id-ResourceCoordinationTransferInformation | ProtocolIE-ID ::= 195 |
| id-ExtendedServedPLMNs-List | ProtocolIE-ID ::= 196 |
| id-ExtendedAvailablePLMN-List | ProtocolIE-ID ::= 197 |
| id-Associated-SCell-List | ProtocolIE-ID ::= 198 |
| id-latest-RRC-Version-Enhanced | ProtocolIE-ID ::= 199 |
| id-Associated-SCell-Item | ProtocolIE-ID ::= 200 |
| id-Cell-Direction | ProtocolIE-ID ::= 201 |
| id-SRBs-Setup-List | ProtocolIE-ID ::= 202 |
| id-SRBs-Setup-Item | ProtocolIE-ID ::= 203 |
| id-SRBs-SetupMod-List | ProtocolIE-ID ::= 204 |
| id-SRBs-SetupMod-Item | ProtocolIE-ID ::= 205 |
| id-SRBs-Modified-List | ProtocolIE-ID ::= 206 |
| id-SRBs-Modified-Item | ProtocolIE-ID ::= 207 |
| id-Ph-InfoSCG | ProtocolIE-ID ::= 208 |
| id-RequestedBandCombinationIndex | ProtocolIE-ID ::= 209 |
| id-RequestedFeatureSetEntryIndex | ProtocolIE-ID ::= 210 |
| id-RequestedP-MaxFR2 | ProtocolIE-ID ::= 211 |
| id-DRX-Config | ProtocolIE-ID ::= 212 |
| id-IgnoreResourceCoordinationContainer | ProtocolIE-ID ::= 213 |
| id-UEAssistanceInformation | ProtocolIE-ID ::= 214 |
| id-NeedforGap | ProtocolIE-ID ::= 215 |
| id-PagingOrigin | ProtocolIE-ID ::= 216 |
| id-new-gNB-CU-UE-FlAP-ID | ProtocolIE-ID ::= 217 |
| id-RedirectedRRCmessage | ProtocolIE-ID ::= 218 |
| id-new-gNB-DU-UE-FlAP-ID | ProtocolIE-ID ::= 219 |
| id-NotificationInformation | ProtocolIE-ID ::= 220 |
| id-PLMNAssistanceInfoForNetShar | ProtocolIE-ID ::= 221 |
| id-UEContextNotRetrievable | ProtocolIE-ID ::= 222 |
| id-BPLMN-ID-Info-List | ProtocolIE-ID ::= 223 |
| id-SelectedPLMNID | ProtocolIE-ID ::= 224 |
| id-UAC-Assistance-Info | ProtocolIE-ID ::= 225 |
| id-RANUEID | ProtocolIE-ID ::= 226 |
| id-GNB-DU-TNL-Association-To-Remove-Item | ProtocolIE-ID ::= 227 |
| id-GNB-DU-TNL-Association-To-Remove-List | ProtocolIE-ID ::= 228 |
| id-TNLAssociationTransportLayerAddressgNBDU | ProtocolIE-ID ::= 229 |
| id-portNumber | ProtocolIE-ID ::= 230 |

```

id-AdditionalSIBMessageList      ProtocolIE-ID ::= 231
id-Cell-Type                     ProtocolIE-ID ::= 232
id-IgnorePRACHConfiguration     ProtocolIE-ID ::= 233
id-CG-Config                    ProtocolIE-ID ::= 234
id-PDCCH-BlindDetectionSCG      ProtocolIE-ID ::= 235
id-Requested-PDCCH-BlindDetectionSCG ProtocolIE-ID ::= 236
id-Ph-InfoMCG                   ProtocolIE-ID ::= 237
id-MeasGapSharingConfig         ProtocolIE-ID ::= 238
id-systemInformationAreaID      ProtocolIE-ID ::= 239
id-areaScope                    ProtocolIE-ID ::= 240
id-RRCContainer-RRCSetupComplete ProtocolIE-ID ::= 241

```

```

END
-- ASN1STOP

```

9.4.8 Container Definitions

```

-- ASN1START
-- *****
--
-- Container definitions
--
-- *****

FLAP-Containers {
itu-t (0) identified-organization (4) etsi (0) mobileDomain (0)
ngran-access (22) modules (3) flap (3) version1 (1) flap-Containers (5) }

DEFINITIONS AUTOMATIC TAGS ::=

BEGIN

-- *****
--
-- IE parameter types from other modules.
--
-- *****

IMPORTS
    Criticality,
    Presence,
    PrivateIE-ID,
    ProtocolExtensionID,
    ProtocolIE-ID

FROM FLAP-CommonDataTypes
    maxPrivateIEs,
    maxProtocolExtensions,
    maxProtocolIEs

FROM FLAP-Constants;

```

```

-- *****
--
-- Class Definition for Protocol IEs
--
-- *****

FLAP-PROTOCOL-IES ::= CLASS {
    &id          ProtocolIE-ID          UNIQUE,
    &criticality Criticality,
    &Value,
    &presence    Presence
}
WITH SYNTAX {
    ID          &id
    CRITICALITY &criticality
    TYPE        &Value
    PRESENCE    &presence
}

-- *****
--
-- Class Definition for Protocol IEs
--
-- *****

FLAP-PROTOCOL-IES-PAIR ::= CLASS {
    &id          ProtocolIE-ID          UNIQUE,
    &firstCriticality Criticality,
    &FirstValue,
    &secondCriticality Criticality,
    &SecondValue,
    &presence    Presence
}
WITH SYNTAX {
    ID          &id
    FIRST CRITICALITY &firstCriticality
    FIRST TYPE      &FirstValue
    SECOND CRITICALITY &secondCriticality
    SECOND TYPE     &SecondValue
    PRESENCE        &presence
}

-- *****
--
-- Class Definition for Protocol Extensions
--
-- *****

FLAP-PROTOCOL-EXTENSION ::= CLASS {
    &id          ProtocolExtensionID    UNIQUE,
    &criticality Criticality,
    &Extension,
    &presence    Presence
}

```



```

WITH SYNTAX {
    ID                &id
    CRITICALITY       &criticality
    EXTENSION         &Extension
    PRESENCE          &presence
}

-- *****
--
-- Class Definition for Private IEs
--
-- *****

FlAP-PRIVATE-IES ::= CLASS {
    &id                PrivateIE-ID,
    &criticality       Criticality,
    &Value,
    &presence          Presence
}
WITH SYNTAX {
    ID                &id
    CRITICALITY       &criticality
    TYPE              &Value
    PRESENCE          &presence
}

-- *****
--
-- Container for Protocol IEs
--
-- *****

ProtocolIE-Container {FlAP-PROTOCOL-IES : IEsSetParam} ::=
    SEQUENCE (SIZE (0..maxProtocolIEs)) OF
    ProtocolIE-Field {{IEsSetParam}}

ProtocolIE-SingleContainer {FlAP-PROTOCOL-IES : IEsSetParam} ::=
    ProtocolIE-Field {{IEsSetParam}}

ProtocolIE-Field {FlAP-PROTOCOL-IES : IEsSetParam} ::= SEQUENCE {
    id                FlAP-PROTOCOL-IES.&id                ({IEsSetParam}),
    criticality       FlAP-PROTOCOL-IES.&criticality        ({IEsSetParam}{@id}),
    value            FlAP-PROTOCOL-IES.&Value              ({IEsSetParam}{@id})
}

-- *****
--
-- Container for Protocol IE Pairs
--
-- *****

ProtocolIE-ContainerPair {FlAP-PROTOCOL-IES-PAIR : IEsSetParam} ::=
    SEQUENCE (SIZE (0..maxProtocolIEs)) OF
    ProtocolIE-FieldPair {{IEsSetParam}}

```

```

ProtocolIE-FieldPair {FlAP-PROTOCOL-IES-PAIR : IEsSetParam} ::= SEQUENCE {
    id                FlAP-PROTOCOL-IES-PAIR.&id                ( {IEsSetParam} ),
    firstCriticality  FlAP-PROTOCOL-IES-PAIR.&firstCriticality  ( {IEsSetParam} { @id } ),
    firstValue        FlAP-PROTOCOL-IES-PAIR.&firstValue        ( {IEsSetParam} { @id } ),
    secondCriticality FlAP-PROTOCOL-IES-PAIR.&secondCriticality ( {IEsSetParam} { @id } ),
    secondValue       FlAP-PROTOCOL-IES-PAIR.&secondValue       ( {IEsSetParam} { @id } )
}

-- *****
--
-- Container for Protocol Extensions
--
-- *****

ProtocolExtensionContainer {FlAP-PROTOCOL-EXTENSION : ExtensionSetParam} ::=
    SEQUENCE (SIZE (1..maxProtocolExtensions)) OF
        ProtocolExtensionField { {ExtensionSetParam} }

ProtocolExtensionField {FlAP-PROTOCOL-EXTENSION : ExtensionSetParam} ::= SEQUENCE {
    id                FlAP-PROTOCOL-EXTENSION.&id                ( {ExtensionSetParam} ),
    criticality        FlAP-PROTOCOL-EXTENSION.&criticality        ( {ExtensionSetParam} { @id } ),
    extensionValue     FlAP-PROTOCOL-EXTENSION.&Extension         ( {ExtensionSetParam} { @id } )
}

-- *****
--
-- Container for Private IEs
--
-- *****

PrivateIE-Container {FlAP-PRIVATE-IES : IEsSetParam } ::=
    SEQUENCE (SIZE (1.. maxPrivateIEs)) OF
        PrivateIE-Field { {IEsSetParam} }

PrivateIE-Field {FlAP-PRIVATE-IES : IEsSetParam} ::= SEQUENCE {
    id                FlAP-PRIVATE-IES.&id                ( {IEsSetParam} ),
    criticality        FlAP-PRIVATE-IES.&criticality        ( {IEsSetParam} { @id } ),
    value              FlAP-PRIVATE-IES.&Value              ( {IEsSetParam} { @id } )
}

END
-- ASN1STOP

```

9.5 Message Transfer Syntax

F1AP shall use the ASN.1 Basic Packed Encoding Rules (BASIC-PER) Aligned Variant as transfer syntax, as specified in ITU-T Recommendation X.691 [5].

9.6 Timers

10 Handling of unknown, unforeseen and erroneous protocol data

Clause 10 of TS 38.413 [3] is applicable for the purposes of the present document, with the following additions for non-UE-associated procedures:

- In case of Abstract Syntax Error, when reporting the *Criticality Diagnostics* IE for not comprehended IE/IEgroups or missing IE/IE groups, the *Transaction ID* IE shall also be included;
- In case of Logical Error, when reporting the *Criticality Diagnostics* IE, the *Transaction ID* IE shall also be included;
- In case of Logical Error in a response message of a Class 1 procedure, or failure to comprehend *Transaction ID* IE from a received message, the procedure shall be considered as unsuccessfully terminated or not terminated (e.g., transaction ID unknown in response message), and local error handling shall be initiated.

Annex A (informative): Change History

| Change history | | | | | | | |
|----------------|---------|-----------|------|-----|-----|---|-------------|
| Date | Meeting | TDoc | CR | Rev | Cat | Subject/Comment | New version |
| 2017-06 | R3 NR#2 | R3-172493 | - | - | - | First version | 0.1.0 |
| 2017-07 | R3 NR#2 | R3-172640 | - | - | - | Incorporated agreed TPs from R3 NR#2 Adhoc | 0.2.0 |
| 2017-08 | R3#97 | R3-173451 | - | - | - | Incorporated agreed TPs from R3#97 | 0.3.0 |
| 2017-10 | R3#97b | R3-174247 | - | - | - | Incorporated agreed TPs from R3#97b | 0.4.0 |
| 2017-12 | R3#98 | R3-175062 | - | - | - | Incorporated agreed TPs from R3#98 | 0.5.0 |
| 2017-12 | RAN#78 | RP-172287 | | | | Submitted for approval to RAN | 1.0.0 |
| 2017-12 | RAN#78 | | | | | TR approved by RAN plenary | 15.0.0 |
| 2018-03 | RP-79 | RP-180468 | 0001 | 2 | B | Baseline CR for March version of TS 38.473 covering agreements of RAN3#99 | 15.1.0 |
| 2018-04 | | | | | | Editorial correction to ASN.1 (correction to id-TimeToWait ProtocolIE-ID) | 15.1.1 |
| 2018-06 | RP-80 | RP-181237 | 0011 | 6 | B | Introduction of SA NR (38.473 Baseline CR covering RAN3 agreements) | 15.2.0 |
| 2018-06 | RP-80 | RP-181239 | 0043 | 3 | F | Essential corrections of EN-DC for NSA NR (38.473 Baseline CR covering RAN3 agreements) | 15.2.0 |
| 2018-06 | RP-80 | RP-181237 | 0045 | - | B | F1 support for LTE - NR coexistence | 15.2.0 |
| 2018-06 | RP-80 | | | | | Correction to ASN.1 and to Change History table | 15.2.1 |
| 2018-09 | RP-81 | RP-181920 | 0055 | 2 | F | Introduction of DU Configuration Query | 15.3.0 |
| 2018-09 | RP-81 | RP-181921 | 0056 | 4 | F | CR to 38.473 on further clarifications on System information transfer over F1 | 15.3.0 |
| 2018-09 | RP-81 | RP-181921 | 0058 | 4 | F | CR to 38.473 on corrections to System information delivery | 15.3.0 |
| 2018-09 | RP-81 | RP-181920 | 0059 | 1 | F | CR to 38.473 on corrections to PWS transfer over F1 | 15.3.0 |
| 2018-09 | RP-81 | RP-181921 | 0063 | 3 | F | CR to 38.473 on PDCP SN over F1 interface | 15.3.0 |
| 2018-09 | RP-81 | RP-181922 | 0064 | 3 | F | NR Corrections (38.473 Baseline CR covering RAN3-101 agreements) | 15.3.0 |
| 2018-09 | RP-81 | RP-181997 | 0068 | - | F | Introduction of UL AMBR on F1 | 15.3.0 |
| 2018-09 | RP-81 | RP-181921 | 0072 | 3 | F | Correction on cell management | 15.3.0 |
| 2018-09 | RP-81 | RP-181921 | 0073 | 2 | F | RLC Mode Indication over F1 | 15.3.0 |
| 2018-09 | RP-81 | RP-181921 | 0076 | 3 | F | CR to 38.473 on UE Identity Index value | 15.3.0 |
| 2018-09 | RP-81 | RP-181920 | 0077 | 1 | F | Correction for UE Context Modification on presence of ServCellIndex IE | 15.3.0 |
| 2018-09 | RP-81 | RP-181920 | 0078 | - | F | Executing duplication for RRC-container | 15.3.0 |
| 2018-09 | RP-81 | RP-181921 | 0079 | 1 | F | Indication of RLC re-establishment at the gNB-DU | 15.3.0 |
| 2018-09 | RP-81 | RP-181920 | 0080 | - | F | Exchange of SMTc over F1 | 15.3.0 |
| 2018-09 | RP-81 | RP-181920 | 0081 | - | F | Solving remaining issues with QoS parameters – TS 38.473 | 15.3.0 |
| 2018-09 | RP-81 | RP-181921 | 0090 | | F | Correction of 5GS TAC | 15.3.0 |
| 2018-09 | RP-81 | RP-181921 | 0095 | 1 | F | Extend the RANAC size to 8bits | 15.3.0 |
| 2018-09 | RP-81 | RP-181921 | 0097 | - | F | Corrections of Choice | 15.3.0 |
| 2018-09 | RP-81 | RP-181921 | 0098 | 1 | F | Correction of TNL criticality | 15.3.0 |
| 2018-09 | RP-81 | RP-181921 | 0099 | 1 | F | Corrections of usage of single container | 15.3.0 |
| 2018-09 | RP-81 | RP-181921 | 0105 | 2 | B | RRC version handling | 15.3.0 |
| 2018-09 | RP-81 | RP-181921 | 0106 | 1 | B | Introduction of Overload Handling in F1-C | 15.3.0 |
| 2018-09 | RP-81 | RP-181921 | 0113 | - | F | CR to 38.473 on presence of QoS information | 15.3.0 |
| 2018-09 | RP-81 | RP-181921 | 0114 | 1 | F | Correction C-RNTI format | 15.3.0 |
| 2018-09 | RP-81 | RP-181921 | 0115 | - | F | Correction of QoS Parameters | 15.3.0 |
| 2018-09 | RP-81 | RP-181921 | 0116 | 1 | F | Correction on F1 Setup Request | 15.3.0 |
| 2018-12 | RP-82 | RP-182446 | 0070 | 3 | F | RRC Delivery Indication | 15.4.0 |
| 2018-12 | RP-82 | RP-182446 | 0117 | 1 | F | Correction of AMBR Enforcement | 15.4.0 |
| 2018-12 | RP-82 | RP-182446 | 0138 | - | F | CR for correction on Initial UL RRC message transfer | 15.4.0 |
| 2018-12 | RP-82 | RP-182446 | 0140 | 1 | F | CR to 38.473 on bearer type change indication | 15.4.0 |
| 2018-12 | RP-82 | RP-182446 | 0142 | 1 | F | CR to 38.473 on correction to PWS System Information | 15.4.0 |
| 2018-12 | RP-82 | RP-182446 | 0144 | 2 | F | CR to 38.473 on asymmetric mapping for UL and DL QoS flow | 15.4.0 |
| 2018-12 | RP-82 | RP-182447 | 0145 | 4 | F | Corrections on UE-associated LTE/NR resource coordination | 15.4.0 |
| 2018-12 | RP-82 | RP-182446 | 0147 | 2 | F | CR for F1 Cell Management | 15.4.0 |
| 2018-12 | RP-82 | RP-182447 | 0150 | 1 | F | Missing Transaction ID in non-UE-associated procedures | 15.4.0 |
| 2018-12 | RP-82 | RP-182446 | 0157 | 1 | F | CR to 38.473 on mapping of servingCellMO and Serving Cell | 15.4.0 |
| 2018-12 | RP-82 | RP-182446 | 0160 | 1 | F | CR to 38.473 on UE context modification required procedure | 15.4.0 |
| 2018-12 | RP-82 | RP-182447 | 0165 | 1 | F | Addition of the RLC Mode information for bearer modification | 15.4.0 |
| 2018-12 | RP-82 | RP-182448 | 0167 | 2 | F | Rapporteur CR to align tabular | 15.4.0 |
| 2018-12 | RP-82 | RP-182448 | 0168 | 2 | F | Rapporteur CR to align ASN.1 | 15.4.0 |
| 2018-12 | RP-82 | RP-182447 | 0169 | 2 | F | Correction of MaxnoofBPLMNs | 15.4.0 |
| 2018-12 | RP-82 | RP-182351 | 0174 | 2 | F | Correction on PDCP SN length on F1 | 15.4.0 |
| 2018-12 | RP-82 | RP-182447 | 0178 | 2 | F | CR for TS 38.473 for MR-DC coordination | 15.4.0 |
| 2018-12 | RP-82 | RP-182447 | 0179 | 2 | F | Support of system information update for active UE without CSS | 15.4.0 |
| 2018-12 | RP-82 | RP-182447 | 0187 | 1 | F | CR to 38.473 on clarification to the presence of UE AMBR | 15.4.0 |
| 2018-12 | RP-82 | RP-182506 | 0195 | 2 | F | CR on Scell release for RLC failure | 15.4.0 |
| 2018-12 | RP-82 | RP-182447 | 0205 | 1 | F | About bandcombinationindex and featureSetEntryIndex | 15.4.0 |
| 2018-12 | RP-82 | RP-182447 | 0211 | 1 | F | CR to 38.473 on DRB PDCP duplication | 15.4.0 |

| | | | | | | | |
|---------|-------|-----------|------|---|---|---|--------|
| 2018-12 | RP-82 | RP-182447 | 0216 | 1 | F | CR to 38.473 on clarifications on system information update over F1 | 15.4.0 |
| 2018-12 | RP-82 | RP-182448 | 0219 | - | F | Correction of RRC version handling and UE inactivity notification | 15.4.0 |
| 2019-01 | RP-82 | | | | | - correction to ASN.1: adding a missing change to "WriteReplaceWarningResponseIEs F1AP-PROTOCOL-IES ::= {" | 15.4.1 |
| 2019-03 | RP-83 | RP-190555 | 0202 | 2 | F | Indication that cells are only UL or DL on F1 | 15.5.0 |
| 2019-03 | RP-83 | RP-190554 | 0204 | 1 | F | AMF initiated UE Context Release failure cause | 15.5.0 |
| 2019-03 | RP-83 | RP-190554 | 0220 | 1 | F | Correction to reconfiguration with sync for gNB-DU | 15.5.0 |
| 2019-03 | RP-83 | RP-190554 | 0225 | 1 | F | Introduction of PH-InfoSCG in DU to CU RRC Information | 15.5.0 |
| 2019-03 | RP-83 | RP-190554 | 0226 | 1 | F | CR to 38.473 on Measurement gap coordination | 15.5.0 |
| 2019-03 | RP-83 | RP-190554 | 0228 | 1 | F | CR for TS 38.473 for MR-DC coordination | 15.5.0 |
| 2019-03 | RP-83 | RP-190554 | 0229 | 2 | F | Condition for inclusion of the Dedicated SI Delivery Needed UE List IE | 15.5.0 |
| 2019-03 | RP-83 | RP-190554 | 0230 | 1 | F | Correction of the Transmission stop/restart indication | 15.5.0 |
| 2019-03 | RP-83 | RP-190554 | 0231 | - | F | Corrections on gNB-CU/gNB-DU Configuration Update | 15.5.0 |
| 2019-03 | RP-83 | RP-190556 | 0236 | 2 | F | Correction of QoS Flow Mapping Indication | 15.5.0 |
| 2019-03 | RP-83 | RP-190554 | 0244 | - | F | Release due to pre-emption | 15.5.0 |
| 2019-03 | RP-83 | RP-190554 | 0245 | 2 | F | CR on RRC container in UE context modification request message | 15.5.0 |
| 2019-03 | RP-83 | RP-190554 | 0246 | 2 | F | CR on UE context modification refuse | 15.5.0 |
| 2019-03 | RP-83 | RP-190554 | 0247 | - | F | Transaction ID in Error Indication procedure | 15.5.0 |
| 2019-03 | RP-83 | RP-190554 | 0249 | 2 | F | Cells to be deactivated over F1 | 15.5.0 |
| 2019-03 | RP-83 | RP-190554 | 0251 | 1 | F | CR to 38.473 on SRB duplication and LCID | 15.5.0 |
| 2019-03 | RP-83 | RP-190554 | 0258 | - | F | CR to 38.473 on corrections for removal of PDCP duplication for SRB | 15.5.0 |
| 2019-03 | RP-83 | RP-190554 | 0263 | 1 | F | CR to 38.473 on transferring UEAssistanceInformation over F1 | 15.5.0 |
| 2019-03 | RP-83 | RP-190554 | 0265 | - | F | Rapporteur updates | 15.5.0 |
| 2019-03 | RP-83 | RP-190554 | 0266 | 1 | F | Correction on gNB-DU Resource Coordination | 15.5.0 |
| 2019-03 | RP-83 | RP-190554 | 0267 | 1 | F | Endpoint IP address and port | 15.5.0 |
| 2019-03 | RP-83 | RP-190554 | 0268 | 1 | F | Correction to add paging origin IE | 15.5.0 |
| 2019-03 | RP-83 | RP-190555 | 0269 | 2 | F | Multiple SCTP associations over F1AP | 15.5.0 |
| 2019-03 | RP-83 | RP-190554 | 0272 | 1 | F | About Cells Failed to be Activated IE in gNB-CU Configuration Update Ack | 15.5.0 |
| 2019-03 | RP-83 | RP-190556 | 0273 | 1 | F | gNB-DU UE Aggregate Maximum Bit Rate Uplink correction | 15.5.0 |
| 2019-03 | RP-83 | RP-190554 | 0276 | 1 | F | RRC Reconfiguration failure | 15.5.0 |
| 2019-03 | RP-83 | RP-190554 | 0278 | 1 | F | Node behaviour at reception of DU to CU RRC Information | 15.5.0 |
| 2019-03 | RP-83 | RP-190554 | 0281 | - | F | Addition of Transaction ID to Initial UL RRC Message Transfer | 15.5.0 |
| 2019-07 | RP-84 | RP-191397 | 0200 | 5 | F | RAN sharing with multiple Cell ID broadcast | 15.6.0 |
| 2019-07 | RP-84 | RP-191397 | 0270 | 5 | F | Addition of Network Access Rate Reduction message | 15.6.0 |
| 2019-07 | RP-84 | RP-191397 | 0271 | 3 | F | RAN UE ID for F1 | 15.6.0 |
| 2019-07 | RP-84 | RP-191396 | 0283 | 2 | F | MR-DC resource coordination in F1 | 15.6.0 |
| 2019-07 | RP-84 | RP-191396 | 0316 | 2 | F | Full configuration indication from gNB-CU to gNB-DU. | 15.6.0 |
| 2019-07 | RP-84 | RP-191396 | 0322 | 2 | F | CR to 38.473 on clarification to RRC reconfigure complete indicator | 15.6.0 |
| 2019-07 | RP-84 | RP-191394 | 0326 | 2 | F | CR to 38.473 on deconfiguring CA based PDCP duplication for DRB | 15.6.0 |
| 2019-07 | RP-84 | RP-191395 | 0330 | 3 | F | CR to 38.473 on Removal of Multiple TNLAs | 15.6.0 |
| 2019-07 | RP-84 | RP-191396 | 0348 | - | F | Full configuration in UE Context Setup | 15.6.0 |
| 2019-07 | RP-84 | RP-191396 | 0351 | 2 | F | CR on PWS segmentation over F1 | 15.6.0 |
| 2019-07 | RP-84 | RP-191396 | 0352 | 1 | F | CR on cell type over F1 | 15.6.0 |
| 2019-07 | RP-84 | RP-191396 | 0357 | - | F | Rapporteur updates: Alignment and editorials | 15.5.0 |
| 2019-07 | RP-84 | RP-191396 | 0358 | - | F | Rapporteur update: Correction of Presence for DRB information | 15.6.0 |
| 2019-07 | RP-84 | RP-191396 | 0359 | - | F | Rapporteur updates: Correction of Presence for E-UTRA PRACH Configuration | 15.6.0 |
| 2019-07 | RP-84 | RP-191396 | 0370 | - | F | Full configuration IE included in the UE Context Modification Response. | 15.6.0 |
| 2019-07 | RP-84 | RP-191396 | 0376 | | F | CR to 38.473 on clarification for UP TNL Information IE over F1 | 15.6.0 |
| 2019-07 | RP-84 | RP-191396 | 0377 | 2 | F | Procedure description on optional IEs in CU to DU RRC information IE. | 15.6.0 |
| 2019-09 | RP-85 | RP-192166 | 0343 | 3 | F | CR on MR-DC low layer coordination with an MgNB-DU | 15.7.0 |
| 2019-09 | RP-85 | RP-192166 | 0344 | 2 | F | CR on MCG PHR format in MgNB-DU | 15.7.0 |
| 2019-09 | RP-85 | RP-192166 | 0388 | | F | CR on DC Coordination for PDCCH Blind Detection | 15.7.0 |
| 2019-09 | RP-85 | RP-192167 | 0393 | 1 | F | Rapporteur update - clarification of semantics | 15.7.0 |
| 2019-09 | RP-85 | RP-192166 | 0399 | 1 | F | Clarification for TNLA removal | 15.7.0 |
| 2019-12 | RP-86 | RP-192915 | 0318 | 5 | F | Correction about gNB-CU System Information IE | 15.8.0 |
| 2019-12 | RP-86 | RP-192915 | 0447 | 1 | F | On CellGroupConfig handling | 15.8.0 |
| 2019-12 | RP-86 | RP-192915 | 0458 | 1 | F | Correction of S-NSSAI coding | 15.8.0 |
| 2019-12 | RP-86 | RP-192915 | 0459 | 1 | F | Removal of Requested P-MaxFR2 | 15.8.0 |
| 2019-12 | RP-86 | RP-192915 | 0479 | 2 | F | Addition of Message Identifier and Serial Number to PWS Cancel Request | 15.8.0 |
| 2019-12 | RP-86 | RP-192916 | 0482 | 2 | F | Clarifications on SCell lists | 15.8.0 |
| 2019-12 | RP-86 | RP-192916 | 0494 | - | F | RRC Container in Modification Procedure | 15.8.0 |

| | | | | | | | |
|---------|-------|-----------|------|---|---|---|--------|
| 2019-12 | RP-86 | RP-192916 | 0508 | 0 | F | CR to 38.473 on applicability of the IE Selected BandCombinationIndex and Selected FeatureSetEntryIndex | 15.8.0 |
| 2019-12 | RP-86 | RP-192916 | 0509 | 1 | F | CR to 38.473 on MeasGapSharingConfig and gNB-CU System Information | 15.8.0 |
| 2019-12 | RP-86 | RP-192916 | 0510 | 1 | F | CR to 38.473 on cause values over F1 | 15.8.0 |
| 2019-12 | RP-86 | RP-192916 | 0515 | 2 | F | Clarification on Initial UL RRC Message Transfer procedure | 15.8.0 |

History

| Document history | | |
|-------------------------|--------------|-------------|
| V15.2.1 | July 2018 | Publication |
| V15.3.0 | October 2018 | Publication |
| V15.4.1 | April 2019 | Publication |
| V15.5.0 | May 2019 | Publication |
| V15.6.0 | July 2019 | Publication |
| V15.7.0 | October 2019 | Publication |
| V15.8.0 | January 2020 | Publication |